

EVERYDAY ENGINEERING MAGAZINE

January, 1920
Vol. 8 No. 4

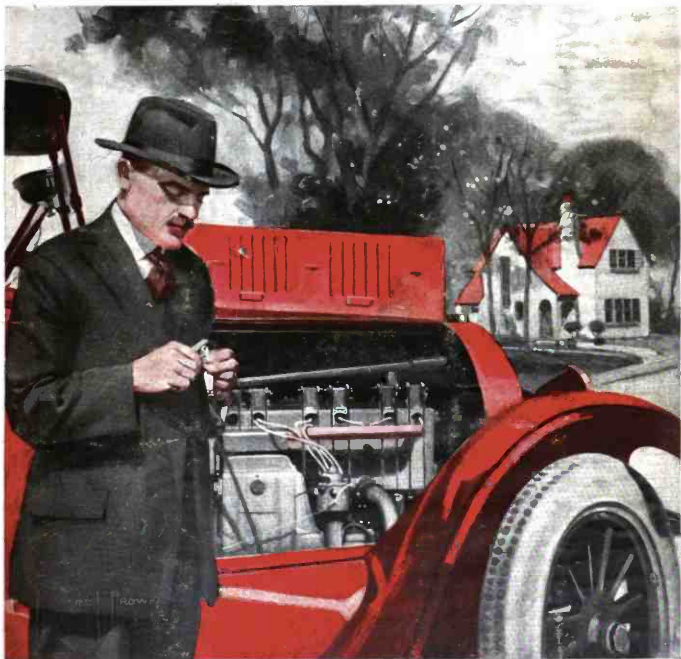

Fifteen Cents
a Copy



WHAT TO DO WHEN THE MOTOR STALLS (See Page 169)

Let me work for you



WORK for Kings and Queens.
I work for the President of the United States.

I work for the architects who build your sky scrapers.

I work for the surveyors and engineers who make your big bridges and subways possible.

I have a mathematical key board with the characters and signs used in higher and lower mathematics, and for engineering, mechanics, etc.

I am invaluable to the student of mathematics, engineering, chemistry and medicine as I carry the signs and symbols used in every profession—every science.

I "speak" every language, from Eskimo Indian to Kata Kana Japanese.

I use "speak" advisedly, because I *literally* make your writing talk—as the following samples of my work show.

I have over 365 different type sets, including all languages, from this note size to the following extended type for

HEAD LINES

I put the same *Power of Emphasis* into the written word that oratory puts into the spoken word. "Just Turn the Knob" and *emphasis*.
Two type sets always on each machine.



Also an Aluminum PORTABLE Model

For traveling — for Home. Weighs about 11 lbs. Full capacity. Ask for *special folder*.

The Hammond Typewriter Co.
585A E. 69th Street New York City

The Heart of the Hammond



I am the

MULTIPLEX HAMMOND

Standard "Writing Machine"
Over 365
Different Type-Sets

Including All Languages to Select From
Any one of which may be substituted in a few seconds — "Just Turn the Knob"

I have shown you a few proofs of my versatility in the various types in the column opposite.

I think you will agree with me, when you see me, that no other typewriter can do what I do.

No other typewriter can make your writing "TALK." No other typewriter can **INSTANTLY** change from one style of type, or from one language to another.

Multiplex Hammond Reasons

1. Variety of writing beyond the ordinary.
 2. All sorts of type and languages on ONE Multiplex.
 3. Automatically uniform type impressions without a cultivated touch.
 4. Permanently perfect alignment.
 5. Any width of paper, and writes cards flat without bending.
 6. Large type, small type, medium type—all on ONE Multiplex.
 7. Aluminum Portable, travellers' and home model.
- There are more than sixteen (16) things I can do that cannot be done on any other writing machine; and it will pay you to

Mail the Coupon for FREE BOOKLET "How President Wilson Frightened the Lords at Midnight!"

We will also send you our pamphlet, "People Who Count." Thousands of prominent men and women in all walks of life, and in all four corners of the globe, prefer and personally use the Multiplex. Note this partial list:
President Wilson
Queen Alexandra of England
King and Crown Prince of Sweden

Caliph of Morocco
King and Queen of Norway
Cardinal Merry del Val
Sir James Matthew Berris
Walt Mason
Wallace Irwin
William Dean Howells
Bertha M. Clay
John Kendrick Bangs
Laird Mitchell Hodges
Prof. L. A. Loiseau
Etc., Etc.

MAIL FOR FREE BOOKLETS

HAMMOND TYPEWRITER COMPANY,

385A East 69th St., New York City.

Please send, entirely free and without obligation, the literature mentioned in your advertisement in Everyday Engineering.

Name

Address

Occupation

Our 21 Jewel SMASHES PRICES



Look!

21 Ruby and Sapphire Jewels—
Adjusted to the second—
Adjusted to temperature—
Adjusted to isochronism—
Adjusted to positions—
25-year gold strata case—
Genuine Montgomery Railroad
Dial—
New Ideas in Thin Cases.

Only
\$3.50
A Month

And all of this for \$3.50—only \$3.50 per month—you pay only rock-bottom price—yes, “bed rock-bottom price”—the lowest price at which the Burlington is sold. Think of the high grade, guaranteed watch we offer here at such a remarkable price. And if you wish, you may pay this price at the rate of \$3.50 a month. Indeed, the days of exorbitant watch prices have passed. Write now.

See It First You don't pay a cent to anybody

until you see the watch. You don't buy a Burlington watch until you see the watch. You don't buy a Burlington watch until you see the watch. This model, handsomely shaped—aristocratic in every line. Then look at the works. There you will see the masterpiece of the watch makers' skill, a perfect timepiece adjusted to positions, temperature and isochronism.

Watch without seeing it. Look at the splendid beauty of the watch itself. This model, handsomely shaped—aristocratic in every line. Then look at the works. There you will see the masterpiece of the watch makers' skill, a perfect timepiece adjusted to positions, temperature and isochronism.

Practically every vessel in the U. S. Navy has many Burlington watches aboard. Some have over 100 Burlingtons. The victory of the Burlington among the men in the U. S. Navy is testimony of Burlington superiority.

Burlington Watch Co.
19th Street and Marshall Boulevard
Dept. 1399 Chicago, Ill.

Please send me (without obligations and prepaid) your free book on watches with full explanation of your cash or \$3.50 a month offer on the Burlington Watch.

Name

Address

**Send Your Name on This
Free Coupon** Get the Burlington Watch Book by sending this coupon now. You will know a lot more about watch buying when you read it. You will be able to “steer clear” of over-priced watches which are no better. Send the coupon today for the watch book and our offer.

Burlington Watch Company

19th Street and Marshall Blvd. Dept. 1399 Chicago, Ill.
Canadian Offices: 338 Portage Ave., Winnipeg, Man.

C O N T E N T S

Vol. 8 JANUARY, 1920 No. 4

WHAT TO DO WHEN THE MOTOR STALLS.....	169
<i>By Victor W. Pagé</i>	
THE R. O. G. BIPLANE FLIER.....	177
<i>By H. C. Ellis</i>	
FITTING AND ADJUSTING CONNECTING ROD BEARINGS.....	179
<i>By Victor W. Pagé</i>	
THE CHEMISTRY AND PHYSICS OF FLAME.....	182
<i>By W. C. Dumas</i>	
THE CONSTRUCTION OF THERMO-ELECTRIC CELLS.....	183
<i>By Roy Franklin Heath</i>	
THE EVERYDAY MOTORIST.....	184
A CARDBOARD MODEL PASSENGER STEAMER...	186
<i>By Edward Beal</i>	
WELL-DESIGNED CRYSTAL DETECTORS.....	187
AVIATION BRIEFS.....	188
THE HYDRODROME, A NEW GLIDING CRAFT CAPABLE OF A SPEED OF 70 MILES PER HOUR.....	189
A FILE REST AND INDEX HEAD FOR A SMALL LATHE.....	190
A WELL-DESIGNED LATHE TOOL HOLDER.....	192
A BORING BAR HOLDER.....	192
<i>By S. C. Swansen</i>	
A NEW SCREW-CUTTING LATHE.....	193
A TWO-PASSENGER SEAPLANE.....	195
<i>By C. E. Muller</i>	
THE AMERICAN SOCIETY OF EXPERIMENTAL ENGINEERS.....	197
A MODEL OF THE NORTH DAKOTA.....	198
<i>By Charles A. Myers</i>	
SOME NEW DEVELOPMENTS IN AVIATION.....	202
ELECTRICAL PROGRESS DIGEST.....	206
EVERYDAY ENGINEERING SHOP CONTEST.....	208
CALIBRATING PRESSURE GAUGES.....	209
<i>By E. Bachman</i>	
A MECHANICAL VACUUM CLEANER.....	210
<i>By E. H. Williams</i>	
MAGIC IN METAL CASTING.....	212
<i>By Raymond Francis Yates</i>	
EVERYDAY SCIENCE.....	215
<i>By Prof. T. O'Connor Sloane</i>	
A MODERN ELECTRICALLY PROPELLED DREADNAUGHT BATTLESHIP.....	217
<i>By Brewster Beach</i>	
A RADIO TELEPHONE TRANSMITTER.....	222
<i>By M. B. Sleeper</i>	
INTERESTING DECISIONS REGARDING TRADE MARKS.....	225
MANUFACTURING DETAILS OF THE B BATTERY..	226
A LIGHT-WEIGHT AIRPLANE TRANSMITTER...	228
NOTES ON RADIO ANTENNAS.....	229
THE RADIO DEPARTMENT.....	230
THE WORK OF THE BUREAU OF STANDARDS...	232
NEW DETECTOR AND AMPLIFIER UNITS.....	235

EVERYDAY ENGINEERING MAGAZINE



2 West 45th Street

New York City

Editor *Managing Editor* *Radio Editor*
 RAYMOND F. YATES VICTOR W. PAGÉ M. B. SLEEPER

Contributing Editor
 PROF. T. O'CONNOR SLOANE

Advertising Manager
 STEPHEN ROBERTS

Branch Advertising Offices
 E. M. CLEMENT, 320 Wayne Avenue, East Oakland, Calif.
 SEARS & IRVING, Peoples Gas Building, Chicago, Ill.

Southern Representative
 H. W. ENGLISH, P. O. Box 339, Birmingham, Ala.

Published Monthly by
 EVERYDAY MECHANICS COMPANY, Inc.
 New York, N. Y.

Entered as second-class matter November 20, 1915, at the post office at New York, N. Y., under the Act of March 3, 1879.
 Subscription price \$1.50 a year in the United States and possessions. Canada, \$1.75; Foreign, \$2.00 a year.

Copyright, 1920, by Everyday Mechanics Co., Inc.

Are You a Good Workman?

MEN who dabble around in home shops like to be called mechanics. Some of them are deserving of the name and some are not. A man may possess a considerable knowledge of mechanics and yet his fingers may be so awkward that he is not able to manipulate tools successfully. The writer knows of a young man who has an extensive knowledge of chemistry, and yet has been accused of being a blacksmith in the manipulation of chemical apparatus. Genius does not always find its way to the finger tips.

MANY men are natural born mechanics; some have to be trained; some simply cannot be trained. Probably one of the greatest essentials of a good workman is accuracy. Without accuracy, nothing of value can be accomplished. The eye, no matter how "mechanical," can never replace measuring instruments. That is one great mistake made by many young men training themselves for a mechanical career; they rely too much upon their eyesight, and are quite forgetful of its natural limitations. Moral: If the eyesight were accurate enough, there would never have been a need for scales and micrometers.

THE second great essential of a good workman is neatness. True, some mechanics can produce wonderful work in an untidy shop, but there are few. Neatness always helps to develop accuracy as well as efficiency. A poorly kept shop is often an indication of the nature of the work that the shop produces. Moral: A neat shop is a great aid to good work.

THE third essential of the good workman is patience. Patience is a virtue of the good mechanic. The man in a hurry cannot hope to be a mechanic worthy of the name. Of all faults of beginners that of impatience is the greatest and the most difficult to overcome. It is the cautious, calculating mechanic who accomplishes noteworthy work. Many men picture what they are working at in their mind's eye, and they are so anxious and impatient to see the finished article that they rush through the job of producing it in the most haphazard way. A set of castings received one day must be machined and assembled the next—or the same day. Moral: A good mechanic is patient.

RAYMOND FRANCIS YATES,
 Editor.

FREDERICK J. DRAKE & CO.
 1014 Michigan Avenue
 Chicago, Ill.

GENTLEMEN:—Please send me free, postage paid, your illustrated catalogue which lists and describes over 100 Practical Mechanical Books for Home Study.

My name is.....
 and my address.....

**MAIL
 COUPON
 For
 FREE
 CATALOG**

**YOUR
 GUIDE
 to
 HOME
 STUDY**



**FOR HOME STUDY
 DRAKE'S BOOKS
 PRACTICAL MECHANICAL**

They Raise Pay Checks ORDER THEM ON OUR MONEY-BACK PLAN

Drake's practical mechanical books for home study are written in non-technical language by acknowledged experts,—for electricians, engineers, telephone men, machinists, automobilists, carpenters, plumbers, sign and card writers, in fact for all mechanics and skilled workers. Drake books are as easy to read as the pay checks which they so often increase. Order direct from this page. Send the price of any book listed below—we'll send the books postpaid—you keep them five days—if not entirely satisfied return the books and your money will be refunded in full.

**Marine and Stationary Engineers
 Complete Examination and Answers**

By Swingle, M. E., 400 pages, 212 Illustrations. Pocket size, leatherette\$2.00
 Concise, thoroughly reliable. Covers every phase of marine and stationary engineering. Gives latest and most improved answers for steam boiler engineer examinations.

Brookes' Automobile Handbook

1918 edition revised by Manly. 700 pages, illustrated, 400 pages on new equipment. Pocket size, leatherette.....\$2.00
 Contains practical information for owners, operators and automobile mechanics. Covers both gasoline and electric automobiles. Gives remedies for road troubles—motor, carburetor, ignition, battery, clutch, and starting troubles, charts, tables and diagrams. Sure to save time and money.

Practical Gas and Oil Engine Handbook

Special references to Diesel and other new oil engines. By Brookes. 270 pages, 81 illustrations. Pocket size, cloth...\$1.00
 Full of practical information on the care, maintenance and repairs of gas and oil engines. An invaluable guide on construction, operation and maintenance of stationary, portable and marine gas and oil engines. Fuel and fuel consumption carefully analyzed in non-technical terms.

Operators' Wireless Telegraph and Telephone Handbook. 1918 Edition

By Laughter. 210 pages, with illustrations of wireless installation on U. S. war ships and ocean liners, cloth.....\$1.00
 A complete treatise of this important subject, from construction and "tuning up" to study of rules of naval stations with all codes, abbreviations, etc. Written so any layman can understand.

Steam Boilers, Their Construction, Care and Operation, With Questions and Answers

By Swingle, M. E. 305 pages, 170 illustrations. Pocket size, leatherette\$2.00
 Goes carefully into boiler construction, setting, and operation. Has valuable tables and rules for calculating boiler strength, heating surface and horsepower. Evaporation tests explained. All modern boiler room equipment given particular attention.

The books listed above are only a few of the many in our catalogue, which you will receive promptly after filling out and mailing us the coupon above. For quick action order direct from this page—cross name of each book wanted and send in with the price quoted. We prepay postage and send books on our money-back plan.

At All Bookstores, or

Wooden Boat and Ship Building

A Practical Course by Richard M. Van Gaasbeek. Bound in cloth, profusely illustrated.....\$1.50
 A complete instruction book for carpenters. Every step of boat and wooden shipbuilding clearly explained. Right up to date. Just off the press.

Electric Motors, Direct and Alternating

By Prof. Moreton, B.S., E.E., written in non-technical language, 250 pages, illustrated, pocket size, limp cloth....\$1.00
 Covers the principles, construction and maintenance of all types of electric motors—treats fully of troubles, their cause, location and how to remedy them.

Automobile Starting and Lighting

By Manly. 302 pages, fully illustrated. Pocket size, cloth...\$1.00
 Changes in starting and lighting brought down to 1918. Every device on the market covered in manner easy to understand. Invaluable for repair man and car owner.

Oxy-Acetylene Welding and Cutting

Electric and Thermit Welding. By Manly. 215 pages, illustrated. Cloth\$1.00
 Fully describes annealing, tempering, hardening, heat treatment, and restoration of steel, and gives much practical information on the uses and characteristics of various metals. Hand forging and welding included.

Twentieth Century Machine Shop Practice

By Brookes. 650 pages, 400 illustrations. Cloth.....\$2.00
 The latest and most practical book for machinists, engineers and others interested in 100% efficient use of machinery and machine tools in a modern machine shop. Covers everything from simple Arithmetic to applied mechanics.

The Ford Motor Car and Truck and Tractor Attachments

By Manly. 256 pages, fully illustrated. Pocket size, limp cloth\$1.00
 Gives complete instructions on every feature of Ford cars, with particular attention to adjustments and repairs, upkeep and care. Truck and tractor attachments fully covered.

FREDERICK J. DRAKE & CO.

PUBLISHERS

1014 Michigan Ave.

CHICAGO

**Order direct from this page —
 ON OUR MONEY-BACK PLAN.**

Get Bigger Pay through ELECTRICITY

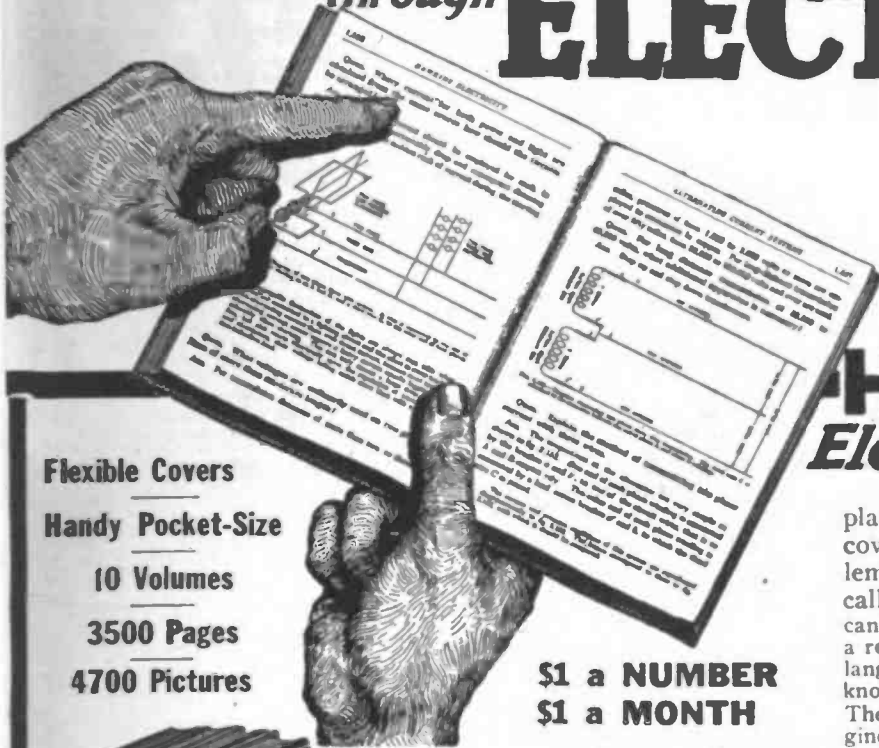

by using your set of **HAWKINS Electrical Guides Every Day.** They tell you just what you need to know.

HAWKINS Electrical Guides

- Flexible Covers
- Handy Pocket-Size
- 10 Volumes
- 3500 Pages
- 4700 Pictures

\$1 a NUMBER
\$1 a MONTH

place electricity at your fingers' ends. They cover every subject, principle, theory, problem, trouble, and way of doing things electrically. Every subject is indexed so that you can turn right to it. They are a study course and a reference guide in one, written in plain every day language—no wasted words—only what you need to know—full of up-to-the-minute electrical knowledge. The guides are a complete course in electrical engineering.

They will help you in every detail of the day's work. You can't ask an electrical question that Hawkins Guides can't give you help on.

The **WHOLE SET** sent **FREE** for your inspection

The books are small enough to slip into your coat pocket—handsomely bound in flexible black covers.

You can carry each volume with you until you have mastered its contents. 3,500 pages of actual information and 4,700 illustrations. Once you see these books and put them into actual use you will never again want to be without them. Try it at our expense.

TO EARN MORE—LEARN MORE

It will cost you nothing to receive these books—to look them over—ask them all the questions you can think of—use them in your work—study them—pick up some information that will increase your earning ability. We will ship you the entire set of 10 volumes entirely FREE.

This is a sign of our confidence in the guides. Pure gold does not object to being tested. Keep them for seven days and if you do not decide that you can't get along without them, return them to us and owe us nothing.

When you decide to keep them you only have to pay \$1.00 down and remit the balance of \$9.00 on the easy payment of \$1.00 a month till paid for.

Use the coupon to get the books. It will pay you many times over.

What Users Say:

Become a Superintendent
Hawkins Guides are worth double their price. I have been able to secure higher pay and a better position with their aid.
K. W. Monard,
Supt. Erskine Light & Power Plant, Erskine, Minn.

\$5,000 Saved
The ten dollars I invested in Hawkins Electrical Guides netted the company by whom I am employed somewhere around \$5,000.

The knowledge gained from your books enabled me to save a transformer house, whereas a year ago I should have thought myself in great danger and have run.

Use this letter as you please as I am truly thankful for having the little wonders.
A. L. Foster, Opber, Colo.

Handy to Carry
The great beauty of them is that you can carry them in your pocket. That suits me for I never want to be without them.
F. S. Collins,
Richardson Engineering Co., Hartford, Conn.

THEO. AUDEL & CO.
72 Fifth Ave., New York, N. Y.

THIS COUPON BRINGS THE GUIDES

SEND NO MONEY

THEO. AUDEL & COMPANY
72 Fifth Avenue, N. Y.

Please submit me for examination Hawkins Electrical Guides (price \$1 each). Ship at once, prepaid, the 10 numbers. If satisfactory I agree to send you \$1 within seven days and to further mail you \$1 each month until paid.

Signature

Occupation

Employed by

Residence

Reference

SEND NO MONEY—USE THE COUPON

Please mention **EVERYDAY ENGINEERING MAGAZINE**

READ THIS PARTIAL LIST OF CONTENTS

No. 1 Contains 348 pages, 398 illustrations. Electrical signs and symbols—static and current electricity—primary cells—conductors and insulators—resistance and conductivity—magnetism—induction coils—dynamo principles—classes of dynamos—armatures—windings—commutation—brushes, etc.

No. 2 Contains 348 pages, 394 illustrations. Motor principles—armature reaction—motor starting—calculations—brake horsepower—selection and installation of dynamos and motors—galvanometers—standard cells—current measurement—resistance measurement—voltmeters—wattmeters—watt-hour meters—operation of dynamos—operation of motors, etc.

No. 3 Contains 300 pages, 423 illustrations. Distribution systems—wires and wire calculations—inside, outside and underground wiring—sign flashers—lightning protection—rectifiers—storage battery systems, etc.

No. 4 Contains 270 pages, 379 illustrations. Alternating current principles—alternating current diagrams—the power factor—alternator principles—alternator construction—windings, etc.

No. 5 Contains 320 pages, 614 illustrations. A. C. Motors—synchronous and induction motor principles—A. C. commutator motors—induction motors—transformers: losses, construction, connections, tests—converters—rectifiers, etc.

No. 6 Contains 298 pages, 472 illustrations. Alternating current systems—switching devices—current breakers—relays—lighting protector apparatus—regulating devices—synchronous condensers—indicating devices—meters—power factor indicators—wave form measurement—switch boards, etc.

No. 7 Contains 315 pages, 379 illustrations. Alternating current, wiring power stations—turbines: management, selection, location, erection, testing, running, care and repair—telephones, etc.

No. 8 Contains 332 pages, 436 illustrations. Telegraph—simultaneous telegraphy and telephony—wireless—electrolysis bells—electric lighting—photometry, etc.

No. 9 Contains 322 pages, 627 illustrations. Electric railways—electric locomotives—car lighting—trolley car operation—miscellaneous applications—motion pictures—gas engine ignition—automobile self-starters and lighting systems, electric vehicles, etc.

No. 10 Contains 513 pages, 599 illustrations. Elevators—cranes—pumps—air compressors—electric heating—electric welding—soldering and brazing—industrial electrolysis—electro-plating—electro-therapeutics—X-rays, etc.

Also a complete 128 page ready reference index of the complete library. This index has been planned to render easily accessible all the vast information contained in the 10 electrical guides. There are over 13,500 cross references. You find what you want to know instantly.

EVERY PRACTICAL MAN'S LIBRARY SHOULD CONTAIN THE FOLLOWING BOOKS

The Modern Gasoline Automobile, Its Design, Construction, Operation.

By VICTOR W. PAGÉ, M.S.A.E. This is the most complete, practical and up-to-date treatise on gasoline automobiles and their component parts ever published. In the new revised and enlarged 1920 edition, all phases of automobile construction, operation and maintenance are fully and completely described and in language anyone can understand. 1,000 pages. 1,000 illustrations. Price, \$4.00

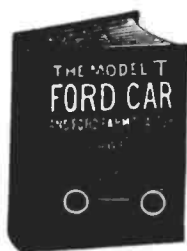

The Model T Ford Car, Its Construction, Operation and Repair, Including the Fordson Farm Tractor. The F. A. Starting and Lighting System and the Worm Drive 1-Ton Truck.

By VICTOR W. PAGÉ. This is the most complete and practical instruction book ever published on the Ford car and the Fordson Tractor. Illustrated by specially made drawings and photographs. All parts of the Ford Model T Car are described and illustrated in a comprehensive manner—nothing is left for the reader to guess at. The construction is fully treated and operating principle made clear to everyone. 425 pages, 150 illustrations. Price, \$1.50

How to Run an Automobile.

By VICTOR W. PAGÉ. This treatise gives concise instructions for starting and running all makes of gasoline automobiles, how to care for them, and give distinctive features of control. Describes every step for shifting gears, controlling engines. 178 pages. 72 illustrations. Price, \$1.25

Automobile Welding with the Oxy-Acetylene Flame.

By M. KEITH DUNHAM. Explains in a simple manner apparatus to be used, its care, and how to construct necessary shop equipment. Proceeds then to the actual welding of all automobile parts, in a manner understandable by everyone. 167 pages, fully illustrated. Price, \$1.50

Abrasives and Abrasive Wheels.

By FRED B. JACOBS. A new book for everyone interested in abrasives or grinding. A careful reading of the book will not only make mechanics better able to use abrasives intelligently, but it will also tell the shop superintendent of many short cuts and efficiency-increasing kinks. The economic advantage in using large grinding wheels are fully explained, together with many other things that will tend to give the superintendent or workman a keen insight into abrasive engineering. 340 pages, 200 illustrations. This is an indispensable book for every machinist. Price, \$3.00

Automobile Repairing Made Easy.

By VICTOR W. PAGÉ. A thoroughly practical book containing complete directions for making repairs to all parts of the motor car mechanism. Written in a thorough but non-technical manner. This book also contains Special Instructions on Electric Starting, Lighting and Ignition Systems. Tire Repairing and Rebuilding. Autogenous Welding, Brazing and Soldering, Heat Treatment of Steel, Latest Timing Practice, Eight and Twelve-Cylinder Motors, etc., etc. You will never "Get Struck" on a job if you own this book. 1,000 specially made engravings on 500 plates. 1,056 pages (5½"x8"). 11 folding plates. Price, \$4.00



Machine Shop Arithmetic.

By COLVIN CHERNEY. Most popular book for shop men. Shows how all shop problems are worked out and "why." Includes change gears for cutting any threads; drills, taps, shrink and force fits; metric system of measurements and threads. Used by all classes of mechanics and for instruction in Y. M. C. A. and other schools. Seventh edition. 131 pages. Price 60c

Steel: Its Selection, Annealing, Hardening and Tempering.

By E. R. MARKHAM. This work was formerly known as "The American Steel Worker," but on the publication of the new, revised edition, the publishers deemed it advisable to change its title to a more suitable one. This is the standard work on hardening, tempering, and annealing steel of all kinds. This book tells how to select, and how to work, temper, harden, and anneal steel for everything on earth. It is the standard book on selecting, hardening, and tempering all grades of steel. 400 pages. Very fully illustrated. Fourth edition. Price, \$3.00

Saw Filing and Management of Saws.

By ROBERT GRIMSHAW. A practical hand book on filing, gumming, swaging, hammering and the brazing of band saws, the speed, work, and power to run circular saws, etc. A handy book for those who have charge of saws, or for those mechanics who do their own filing, as it deals with the proper shape and pitches of saw teeth of all kinds and gives many useful hints and rules for gumming, setting, and filing, and is a practical aid to those who use saws for any purpose. Third edition, revised and enlarged. Illustrated. Price, \$1.25

Brazing and Soldering.

By JAMES F. HOBART. The only book that shows you just how to handle any job of brazing or soldering that comes along; it tells you what mixture to use, how to make a furnace if you need one. Full of valuable kinks. The fifth edition of this book has just been published, and to it much new matter and a large number of tested formulas for all kinds of solders and fluxes have been added. Price, 35c

Drafting of Cams.

By LOUIS ROUILLION. The laying out of cams is a serious problem unless you know how to go at it right. This puts you on the right road for practically any kind of cam you are likely to run up against. Third edition. Price, 35c

House Wiring.

By THOMAS W. POPPE. Describing and illustrating up-to-date methods of installing electric light wiring. Intended for the electrician, helper and apprentice. Contains just the information needed for successful wiring of a building. 125 pages, fully illustrated, flexible cloth. Price, 75c

Electric Wiring, Diagrams and Switchboards.

By NEWTON HARRISON, with additions by THOMAS POPPE. This is the only complete work issued showing and telling you what you should know about direct and alternating current wiring. It is a ready reference. The work is free from advanced technicalities and mathematics, arithmetic being used throughout. It is in every respect a handy, well-written, instructive, comprehensive volume on wiring for the wire-man, foreman, contractor or electrician. Second revised edition. 303 pages, 130 illustrations. Cloth. Price, \$2.00

High Frequency Apparatus, Its Construction and Practical Application.

By THOMAS STANLEY CURTIS. The most comprehensive and thorough work on this interesting subject ever produced. The book is essentially practical in its treatment and it constitutes an accurate record of the researches of its author over a period of several years, during which time dozens of coils were built and experimented with. 248 pages. Fully illustrated. Price, \$2.50

The Lathe—Its Design, Construction and Operation, With Practical Examples of Lathe Work.

By OSCAR E. PERRIGO. A new revised edition, and the only complete American work on the subject, written by a man who knows not only how work ought to be done, but who also knows how to do it, and how to convey this knowledge to others. It is strictly up-to-date in its descriptions and illustrations. A number of difficult machining operations are described at length and illustrated. The new edition has nearly 500 pages and 350 illustrations. Price, \$3.00

Henley's Twentieth Century Book of Recipes, Formulas and Processes.

Edited by GARDNER D. HISCOX. The most valuable techno-chemical formulae book published, including over 10,000 selected scientific, chemical, technological and practical recipes and processes. This book of 800 pages is the most complete book of recipes ever published, giving thousands of recipes for the manufacture of valuable articles for everyday use. Hints, helps, practical ideas and secret processes are revealed within its pages. It covers every branch of the useful arts in every respect. Contains an immense number of formulas that every one ought to have that are not found in any other work. New edition. Cloth. Price, \$4.00

Starting, Lighting, and Ignition Systems.

By VICTOR W. PAGÉ. A practical treatise on modern starting and ignition system practice. This practical volume has been written with special reference to the requirements of the non-technical reader desiring easily understood explanatory matter relating to all types of automobile ignition, starting and lighting systems. It can be understood by anyone even without electrical knowledge. Nearly 500 pages. 297 specially made engravings. New Edition. Price, \$2.50



Any of these books sent prepaid on receipt of price. FREE—Our new 1920 Catalog of Practical Books sent free on request

THE NORMAN HENLEY PUBLISHING COMPANY
Dept. E. E. 2 West 45th Street, New York

Please mention EVERYDAY ENGINEERING MAGAZINE

Everything New About Shop Work!

Examine Them Free

The sixth edition of Modern Shop Practice is now off the press. Let us send you the six volumes for seven days' free examination—not a penny in advance. See how 27 mechanical engineers, designers, and specialists in shop methods have given you the benefit of their vast experience. Read what they say about production, metallurgy, welding, tool making, tool design, die making, metal stamping, foundry work, forging, pattern making, mechanical and machine drawing, speed lathes, planers, metal drillers, grinders, milling machines, stamping machines, die presses, etc. Then after free examination, send the books back unless you are convinced they will raise your pay.

Jump Ahead The more you know about machine shop practice, the more money you will earn. Don't depend on your hands alone to earn your pay.

Make your head work for you. Equip yourself with knowledge that designs machinery, that does the *big* work. These six massive volumes tell everything you want to know about every phase of shop work. Written in clear, non-technical language.

Only 7c a Day

These six magnificent volumes are flexibly bound in American Morocco, gold stamped. Contain 2300 pages, 2500 illustrations, photographs, drawings, explanatory diagrams, tables, etc. Up-to-date labor saving methods that big manufacturers have spent thousands of dollars to learn. Facts that you can use in your everyday work at once. Examine the books free. Then if satisfied, pay for them at rate of 7c a day.

No Money in Advance

Not a cent in advance. See the books in your own home first. Read them for seven whole days before you decide. Make no deposit—assume no obligation. If you are not more than satisfied—send them back and you won't owe a cent. If you are sure they will raise your pay—send only \$2.80 within seven days and then \$2 a month until the special introductory price of \$19.80 has been paid. (Regular price \$30.) With each set we give you Free a year's Consulting Membership in the American Technical Society. (Worth \$12.) Mail coupon for the books now. Send no money.

AMERICAN TECHNICAL SOCIETY
Dept. M-351 CHICAGO, U. S. A.

AMERICAN TECHNICAL SOCIETY
Dept. M-351, CHICAGO, U. S. A.

Please send me the six-volume set of "Modern Shop Practice" for seven days' examination, shipping charges collect. If I decide to buy, I will send \$2.80 within seven days and balance at \$2 a month until \$19.80 has been paid. Then you will send me a receipt showing that the set of books and the Consulting Membership are mine, and fully paid for. If I think I can get along without the books, I will return them at your expense after seven days.

Name.....
Address.....
Reference.....



6 Great Volumes

Flexibly bound in American Morocco, gold stamped, six thick volumes, 2300 pages, 2500 photographs, drawings, tables and other explanatory illustrations.

Double Your Earnings

Mechanists, tool-makers, designers, pattern-makers, foundrymen, production experts are everywhere in demand. There are big positions and steady work for "Top Notchers." Master these practical shop books, written by 27 experts, and double or treble your pay.

Partial List of Contents

Shop Work, Shop Kinks, Gear Cutting, Turret Lathes, Screw Machines, Manufacturing Shop Management, Metallurgy, Welding, Die Making, Metal Stamping, Tool Making, Punch and Die Work, Machine Design, Foundry Work, Pattern Making, Forging Practice, Mechanical Drawing, Machine Drawing and Design, Automobile Shop Work.

Please mention EVERYDAY ENGINEERING MAGAZINE

Learn Mechanical Drafting

Earn \$35 to \$100 A Week

"Get into the profession of big pay and Rapid Advancement with the help of the school that has started hundreds on the Road to Success. I am ready to

help you." Roy C. Claflin, President
Columbia School of Drafting.



Learn at Home in Spare Time

You don't have to stop work or leave home in order to become a trained Draftsman. Through our practical Home Study Training we teach you in your own home, and enable you to qualify as a practical Draftsman.

No Previous Training Required

Owing to the comprehensive nature of our course, you need no previous training in the subject. Though you have never done any kind of drawing before, you can become a thorough Draftsman by following our instructions.

Can Learn in Short Time by Our Methods

The reason for this is that we eliminate unnecessary theoretical work and concentrate upon the PRACTICAL problems such as confront the professional Draftsman. We do not require you to spend months of your time on "preliminary" work, but start you on REAL DRAFTING at once. That is one reason why our students "make good" so readily.

Our Graduates Get to the Top

The universal success of our graduates as Professional Draftsmen, many of whom have advanced rapidly to positions of Chief Draftsmen, is evidence of the REAL VALUE of the training given by the COLUMBIA SCHOOL OF DRAFTING. Large numbers of our students have secured excellent positions even before completing their courses. We gladly cooperate with our students and graduates in securing desirable positions, which has been easy for us owing to the many demands upon us to supply our "product" for these positions.

Draftsmen Get \$35 to \$100 a Week

Our graduates have shown their ability to reach high salaries RAPIDLY, owing to their practical training. They secure excellent salaries AT THE START, as high as \$2,000 a year. The usual pay of Draftsmen is \$35 to \$100 a week.

The Demand is Greater than the Supply

The demand for properly trained Draftsmen has always been greater than the supply, but this is more so today than ever before, owing to greatly increased construction and mechanical development. The Draftsman is an essential connecting link in all engineering work. This great demand is indicated by the long lists of want ads for Draftsmen in the daily papers, especially those of industrial centers.

Specialists in Mechanical Drafting

The COLUMBIA SCHOOL OF DRAFTING not only trains Draftsmen by mail but also maintains a large local institution of the highest standing. For many years it has been the leader in SPECIALIZING on the teaching of DRAFTING. This is an obvious advantage over teaching Drafting only as a side issue.

Drawing Outfit Furnished

We supply all our students with a drafting outfit for use throughout the course. There is no extra charge for this, and it becomes your personal property when the course has been paid for in full.

Book of Particulars Sent Free

If you are interested in becoming a practical Draftsman through the thorough training of the COLUMBIA SCHOOL OF DRAFTING, whereby you can enter a Profession in which your services will always be in demand, you are invited to write us for our free book of particulars, which describes our school and methods.

COLUMBIA SCHOOL OF DRAFTING
Dept. 1076—14th and T Sts.
Washington, D. C.

For your convenience you can fill out and
Mail This Coupon To-day

Columbia School of Drafting,
Dept. 1076, 14th & T Sts. N.W.,
Washington, D. C.

Without obligation to me, please send me full particulars of your practical home study training in Drafting.

Name

Address

City..... State.....

The Burgess BLUE BOOK

For Practical Men and
Electrical Students

I have prepared a pocket-size note book especially for the practical man and those who are taking up the study of electricity. It contains drawings and diagrams of electrical machinery and connections over two hundred formulas for calculations, and problems worked out showing how the formulas are used. This data is taken from my personal note book, which was made while on different kinds of work, and it will be found of value to anyone engaged in the electrical business.

The drawings of connections for electrical apparatus include Motor Starters and Starting Boxes, Overload and Underload Release Boxes, Reversible Types, Elevator Controllers, Tank Controllers, Starters for Printing Press Motors, Automatic Controllers, Variable Field Types, Controllers for Mine Locomotives, Street Car Controllers, Connections for Reversing Switches, Motor and Dynamo Rules and Rules for Speed Regulation. Also, Connections for Induction Motors and Starters, Delta and Star Connections and Connections for Auto Transformers, and Transformers for Lighting and Power Purposes. The drawings also show all kinds of lighting circuits, including special controls where Three and Four Way Switches are used.

The work on Calculations consists of Simple Electrical Mathematics, Electrical Units, Electrical Connections, Calculating Unknown Resistances, Calculation of Current in Branches of Parallel Circuits, How to Figure Weight of Wire, Wire Gauge Rules, Ohm's Law, Watt's Law, Information regarding Wire used for Electrical Purposes, Wire Calculations, Wiring Calculations, Illumination Calculations, Shunt Instruments and How to Calculate Resistance of Shunts, Power Calculations, Efficiency Calculations, Measuring Unknown Resistances, Dynamo and Dynamo Troubles, Motors and Motor Troubles, and Calculating Size of Pulleys.

Also Alternating Current Calculations in finding Impedance, Reactance, Inductance, Frequency, Alternations, Speed of Alternators and Motors, Number of Poles in Alternators or Motors, Conductance, Susceptance, Admittance, Angle of Lag and Power Factor, and formulas for use with Line Transformers.

This book is recommended by practical men. It is being used in technical schools. Electrical establishments furnish them to their employees to save time. Industrial establishments give them to their customers.

The Burgess BLUE BOOK will be Mailed,
Postpaid, on Receipt of \$1.00

Send dollar bill, money order or check. I guarantee satisfaction or will return your money if you decide not to keep the book after using it for five days.

Information and Write-ups on
Electrical Subjects Supplied.
Questions Answered, Problems
Solved, Inventions Perfected.

Burgess Engineering Co.

Consulting Electrical Engineering
YORKE BURGESS, President
753 East 42nd St. Chicago, Ill.

ELECTRICITY

Taught by a Practical Man

If you are interested in a HOME STUDY COURSE, which is really an Engineering Service, and well adapted to men who are engaged in the electrical industry, SEND FOR MY CATALOG. Superintendents, Chief Electricians and Foremen, who are interested in the welfare of their men, ARE INTERESTED in what I have to offer. Students may discontinue at any time, if not satisfied, and their payments stop then. PRACTICAL MEN recommend this course. Seventy-five percent of my students are engaged in practical work and find my instruction well suited to their needs. Over 11 percent of my enrollment has been obtained from students.

Burgess Electrical School
YORKE BURGESS, Superintendent
751 EAST 42nd STREET
Chicago, Illinois

Please mention EVERYDAY ENGINEERING MAGAZINE

FREE TRIAL

**Keep It
For \$3.00
Per Month**



**Or Return
It At Our
Expense**

The Oliver Typewriter—Was \$100—Now \$57

The Guarantee of a \$2,000,000 Company that it Is the Identical Model

Be your own salesman and earn \$43. You get the identical typewriter formerly priced \$100—not a cent's alteration in value. The finest, the most expensive, the latest Oliver Model. Old methods were wasteful. Our new plan is way in advance. It is in keeping with new economic tendencies. It does away with waste. Inflated prices are doomed forever.

During the war we learned that it was unnecessary to have great numbers of traveling salesmen and numerous, expensive branch houses throughout the country. We were also able to discontinue many other superfluous, costly sales methods. You benefit by these savings.

Brand New—Latest Model

Do not confuse this with offers of earlier models, rebuilt or second-hand. Note the signature of this advertisement. This is a \$2,000,000 concern.

We offer new Oliver's at half price because we have put typewriter selling on an efficient, scientific basis.

You can now deal direct—sell to yourself, with no one to influence you. This puts the Oliver on a merit test.

You Save \$43 Now

This is the first time in history that a new standard \$100 typewriter has been offered for \$57. Remember, we do not offer a substitute model, cheaper nor different. But the same splendid Oliver used by the big concerns. Over 700,000 Oliver's have been sold.

We ship direct from the factory to you. No money down—no red-tape. Try the Oliver Nine at our expense. If you decide to keep it, send us \$3 per month. If you return it, we even refund the outgoing transportation charges. You are not placed under the slightest obligation. That's our whole plan.

We rely on your judgment. We know you don't want to pay double. And who wants a lesser typewriter? You may have an Oliver for free trial by checking the coupon below. Or you may ask for further information.

An Amazing Book

All the secrets of the typewriter world are revealed in our startling book entitled "The High Cost of Typewriters—The Reason and the Remedy"—sent free if you mail the coupon now. Also our catalog. Order your free-trial Oliver—or ask for further information at once.

Canadian Price, \$72

THE OLIVER TYPEWRITER CO.
C-40 Oliver Typewriter Bldg., Chicago

NOTE CAREFULLY—This coupon will bring you either the Oliver Nine for free trial or further information. Check carefully which you wish. (24-02)

Mail
This Coupon
Now!

THE OLIVER TYPEWRITER CO.,
C-40 Oliver Typewriter Bldg., Chicago

Ship me a new Oliver Nine for five days' free inspection. If I keep I will pay \$57 at the rate of \$3 per month. The title to remain in until fully paid for.

My shipping point is..... This does not place me under any obligation to buy. If I choose to return Oliver, I will ship it back at your expense at the end of five days.

Do not send a machine until I order it. Mail me your book—"The 1 Cost of Typewriters—The Reason and the Remedy," your de luxe cat and further information.

Name
Street Address
City State
Occupation or Business

Please mention EVERYDAY ENGINEERING MAGAZINE



Comptroller
\$3,000-\$15,000



Credit Man
\$1,500-\$10,000



Auditor
\$1,500-\$8,000



Office Manager
\$1,500-\$5,000



Cost Accountant
\$2,000-\$12,000

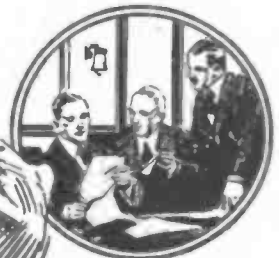

Public Accountant
\$1,500-\$25,000



Face the Facts- Training Brings Real Money

There are too many bookkeepers and clerks—not enough Expert Accountants. Training makes the difference. Only by training can you win the bigger job.

You—yourself—must decide whether tomorrow you will be a plodding bookkeeper or clerk or an independent executive. The worker market has plenty of \$800 employees—but altogether too few qualified to handle the \$3,000, \$5,000 and \$10,000 positions.

Why Accountancy Training Is So Valuable Today

New Income and Excess Profit taxes have brought home to literally thousands of firms the necessity of accurate records. American business is branching out in all directions—foreign and domestic—and with this tremendous expansion has come a keen appreciation of the importance of preventing waste and misdirected energies—of developing better methods of Cost Accounting. Positions are open today in every community for auditors, comptrollers, cost accountants, credit men, and public accountants at salaries ranging from \$2,500 to \$12,000, and even higher. Face the subject squarely. Where men are scarce—there must trained experience demand highest salaries. Fit yourself for this most profitable of professions and tomorrow's success will take care of itself.

Applying the Success Formula

W. A. Thompson was once a bookkeeper—today he is Comptroller of the Allis Chalmers Mfg. Co. In less than 3 years through I. A. S. training he made the jump.

Arnold O. Link rose from Assistant Bookkeeper to Office Manager through the study of our course in Accountancy—increasing his salary 500%.

E. W. Brickell was a clerk when he began his I. A. S. training—today he is General Auditor of the Everwear Hosiery Company.

These stories are not the exceptions—if you will mail the coupon below for our book "Stories of Success," you will find hundreds of similar examples. They prove, without a shadow of a doubt, that you can learn through the home study method—that I. A. S. trained men actually are holding big executive, auditing and cost positions.

Executive Positions Always Open to the Trained Accountant

Big business simply cannot get enough of men with trained accountancy experience. The accountant is executive timber. His work gives him a bird's-eye view of the whole business. The accountancy trained man dominates. No matter what your present position or education—if you have the gritty determination to make good—I. A. S. training will bridge the gap for you between your present position and high-salaried independence—training that may be secured in spare time without giving up your present work.

Study at Home Under the Guidance of Experts

Every member of our faculty is a Certified Public Accountant actively engaged in the practice of his profession with successful experience in the teaching of Accounting. The sixteen-year successful record backs up the course—among our students and graduates are over 100 Certified Public Accountants. Low tuition and easy terms place the benefits of I. A. S. home study training within the reach of every ambitious man.

Elective Features Multiply the Value of the Lessons

In addition to a remarkably thorough practical training in Accountancy you are enabled through our elective feature to specialize in any branch of Accountancy you may prefer. Scientifically planned lessons fitted to the individual needs of each student enable you to save more than six months in the completion of your course—make it possible for you to cash in on the value of your training just that much sooner.

Two Big Books "Stories of Success" and "How to Learn Accounting"—FREE

Get these books—at once. They describe in a simple, straight-forward way the opportunities in higher accountancy today—show how hundreds of others have won better positions—tell how you, too, can fit yourself for a better position—a bigger salary. The evidence will certainly convince you.

Request

International Accountants Society
Dept 44-E Chicago Illinois

Gentlemen:- Please send me without obligation whatever "Stories of Success" post paid

Very truly

Name _____
Address _____
City _____ State _____

INTERNATIONAL ACCOUNTANTS SOCIETY
a department of the Tanner-Gilman Schools Incorporated
DEPARTMENT 44-E, 2626 S. Michigan Ave., CHICAGO, ILL.

Please mention EVERYDAY ENGINEERING MAGAZINE

What To Do When the Motor Stalls

A Helpful Exposition for the Man Who Operates His Own Car, Dealing With Common Automobile Power Plant Troubles and How to Locate Them

By Victor W. Pagé, M. S. A. E.

EVEN though the automobile of to-day has been perfected to a high degree, the mechanism has not been developed to the point that it is entirely free from trouble on the road, though any trouble that cannot be easily located and remedied by the average automobile operator is a rare one that is usually the direct result of neglect or abuse. Obviously, it is not possible to consider all the things that might happen to an automobile motor in a limited discussion of this character, but the common troubles that are apt to occur in everyday operation of an automobile can be touched on to some extent and suggestions given for their systematic location and cure that should be helpful to the automobilist, or to anyone interested in automotive vehicles.

The internal-combustion motor, which is the power plant of nearly all automotive apparatus, such as cars, trucks, tractors, motorcycles, motor boats and airplanes, is composed of a number of distinct groups, which in turn include distinct components. These various appliances of any group are so closely related to each other that defective action of any one may interrupt the operation of the entire power plant. Some of the auxiliary groups are more necessary than others, and the power plant will continue to operate for a time even after the failure of some important parts of some of the auxiliaries. The gasoline engine in itself is a complete mechanism, but it is evident that it cannot deliver power without some means of supplying gas to the cylinders and igniting the compressed gas charge after it has been compressed in the combustion chamber. From this, it is patent that the ignition and carburetion systems are parts of the power plant just as essential as the pistons, connecting rods, or cylinders of the motor. The failure of either the carburetor or igniting means to function properly will be

immediately apparent by faulty action of the entire power plant.

To insure that the motor will continue to operate it is necessary to keep it from overheating by some form of cooling system and to supply oil to the moving parts to reduce friction. The cooling and lubrication groups are not so important as carburetion and ignition, as the engine would run for a limited period of time even should the cooling system fail or the oil supply

but a defect in the cooling or oiling system would not be noticed so readily.

The careful driver will always inspect the motor mechanism before starting on a trip of any consequence, and if inspection is carefully carried out and loose parts tightened it is seldom that irregular operation will be found due to actual breakage of any of the components of the mechanism. Depreciation of mechanism due to natural causes matures slowly, and sufficient warning is

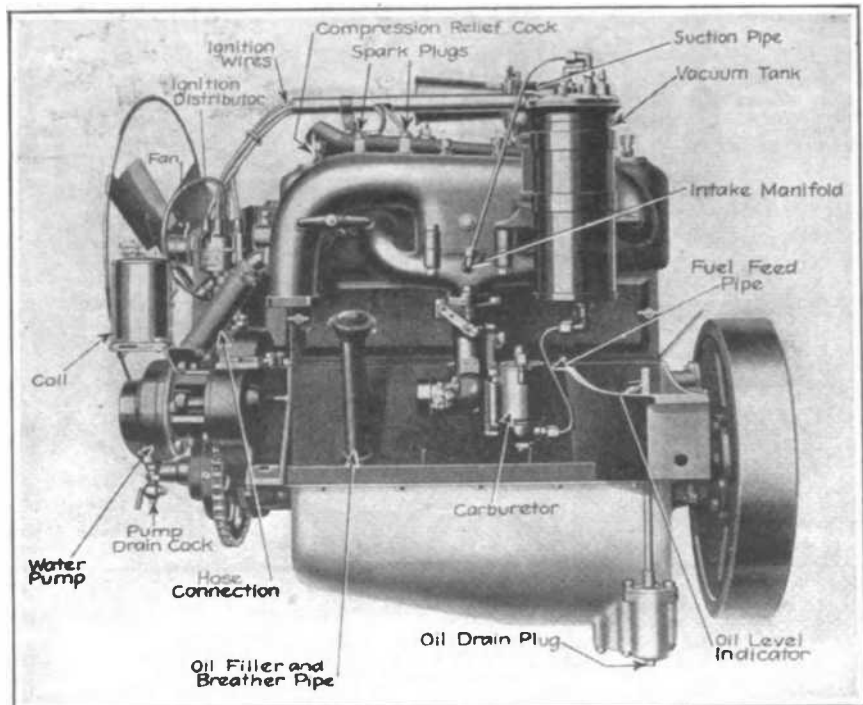

Typical automobile power plant showing location of parts of auxiliary systems

cease. It would only be a few minutes, however, before the engine would overheat if the cooling system was at fault, and the parts seize if the lubricating system should fail. Any derangement in the carburetor or ignition mechanism would manifest itself at once because the engine operation would be affected,

always given when parts begin to wear, so satisfactory repairs may be promptly made before serious derangement or failure is manifested.

A Typical Engine Stoppage Analyzed

Before describing the points that may fail in the various auxiliary systems it

will be well to assume a typical case of engine failure and show the process of locating the trouble in a systematic manner by indicating the various steps which are in logical order and which could reasonably be followed. In any case of engine failure the fuel supply, ignition system and motor compression should be tested in the order given. If the ignition system is working properly and there is a decided resistance in the cylinders when the hand starting handle is turned, proving that there is good compression, one may suspect the carburetor. The usual cause of engine trouble is failure of either the fuel supply or the spark. A sudden motor stop may mean lack of gasoline or the breaking of an important ignition wire, such as the primary wire leading to the timer or the secondary cable from ignition coil to the distributor.

The gasoline feed pipe may be

ber the carburetor is said to be flooded. This condition results from failure of the shut-off needle to seat properly or from a punctured hollow metal float or a gasoline-soaked cork float. It is possible that not enough gasoline is fed to the float chamber. If the passage controlled by the float-needle valve is clogged or if the float is badly out of adjustment, this contingency would be probable. When the carburetor is examined and the float bowl cover removed, if the gasoline level appears to be at the proper height, one may suspect that a particle of lint or dust, or fine scale, or rust from the gasoline tank has clogged the bore of the jet in the mixing chamber.

Conditions That Cause Failure of Ignition System

If the first test of the motor had showed that the compression was as it

ground connection, a loose battery terminal, or a broken connector. If none of these conditions are present, it is safe to say that the battery is no longer capable of delivering current. If there is no spark at the plugs, but the timer functions properly, this shows that the primary winding is as it should be and that the fault must be looked for in either the wires comprising the secondary circuit, or at the plugs.

The spark plugs may be short circuited by cracked insulation or carbon and oil deposits around the electrode. The secondary ignition wires may be broken or have the defective insulation which permits the current to ground to some metal part of the frame or motor. The battery strength should be tested with volt or ampere meter to determine if the voltage and amperage are sufficient. Storage-battery capacity is usually gauged by a hydrometer read-

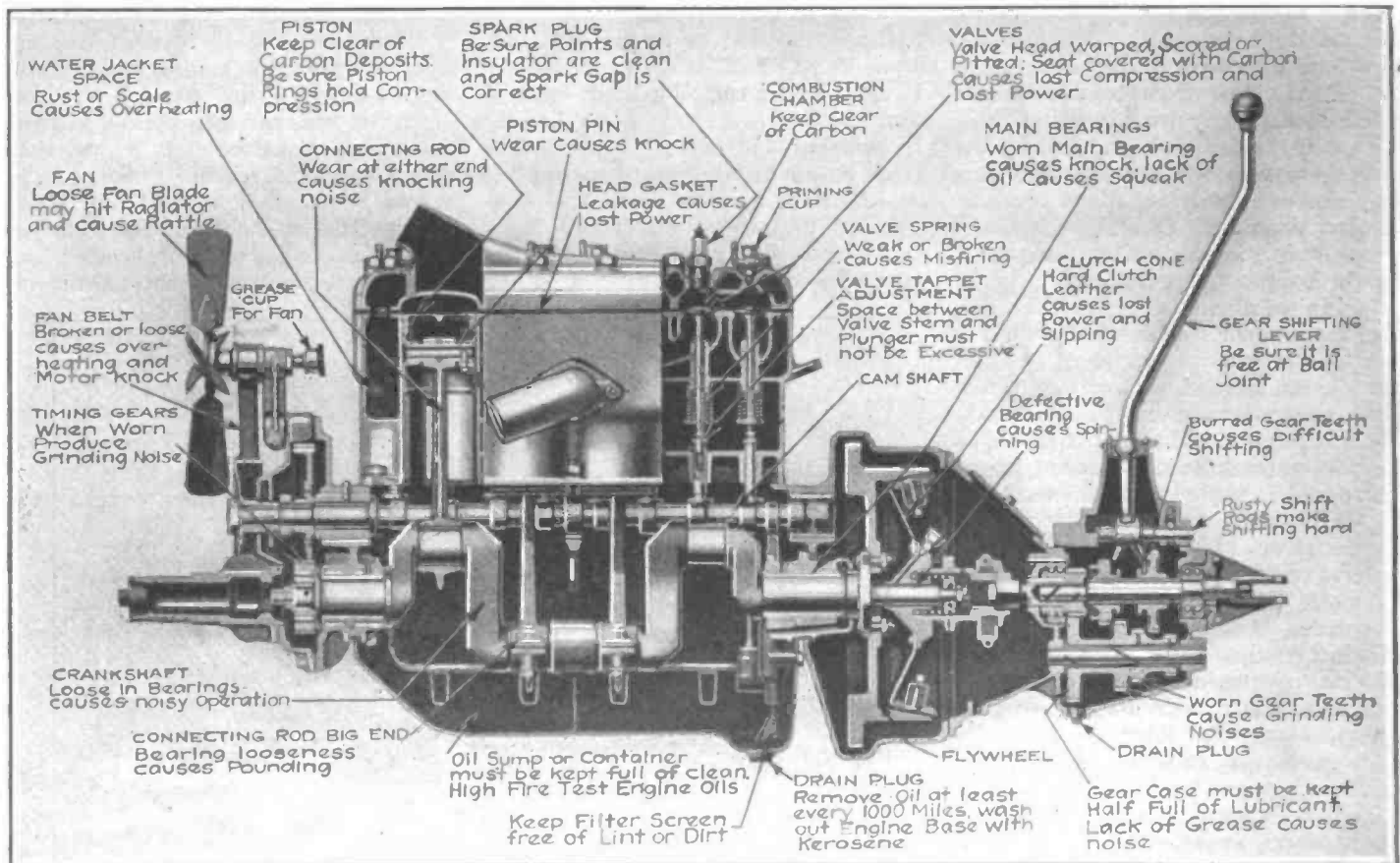

Modern unit power plant showing parts of engine and gearbox liable to give trouble and common difficulties and their indications

clogged or broken, the fuel supply may be depleted, or the shut-off cock in the gasoline line may have jarred closed. The gasoline filter may be filled with dirt or water which prevents passage of the fuel.

The defects outlined above are common, and if the main gasoline tank or vacuum tank is found to contain fuel and the pipe line to be clear to the carburetor, it is safe to assume the vaporizing device is at fault. If fuel continually runs out of the mixing cham-

ber and that there were no serious mechanical defects and there was plenty of gasoline at the carburetor, this would have demonstrated that the ignition system was not functioning properly. If a battery is employed to supply current the first step is to take the spark plugs out of the cylinders and test the system by turning over the engine by hand. If there is no spark in any of the plugs, this may be considered a positive indication that there is a broken main current lead from the battery, a defective

ing, while dry cells are judged by their amperage. A storage battery should show at least a gravity of 1.280°, or if tested with a volt meter, 2 volts per cell which will be 6 volts for the usual car battery. Dry batteries that indicate less than six amperes per cell are not considered reliable or satisfactory for ignition service.

If there is no spark at the plugs the trouble may be due to weak current source, broken timer wires, or defective connections at the commutator or timer

contact points. The electrodes of the spark plug may be too far apart to permit a spark to overcome the resistance of the compressed gas, even if a spark jumps the air space when the plug is laid on the cylinder. If no spark is produced at the plugs the secondary wire may be broken, the primary wire

tions; the distributor contacts may not be making proper connection because of wear, and there may be a more serious derangement, such as a burned out secondary winding, or a punctured condenser in the coil, which are rare.

There are a number of defective conditions which may exist in the ignition

contact at breaker box or at collecting brushes. A dirty or cracked insulator at a spark plug will cause short circuit and can only be detected by careful examination. The following points should also be checked over when the plug is inspected: Excessive space between electrodes, points too close together, loose central electrodes, or loose point on plug body, soot or oil particles between electrodes, or on the surface of the insulator.

When testing a dry battery, the terminals should be gone over carefully to make sure that all terminal nuts are tight and that there are no loose or broken cell connectors. The wiring at the coil, timer and switch should be inspected to see that all connections are tight and that the insulation is not chafed or cracked. Defective insulation will allow leakage of current, while loose connections make for irregular operation. In testing a storage battery care should be taken to remove all the verdigris or sulphate from the terminals before attaching the testing wires. If a magneto is used there may be a short circuit in the ground wire or a poor connection at either switch lever or switch key.

The timer or distributor used with a battery-ignition system may be dirty and if the device wobbles or has loose bearings the primary contact is apt to be very poor. The insulating ring at the timer or distributor, or the fibre or hard-rubber bushings at magneto or timer may allow loss of current if they are cracked.

Ford Has Vibrator Coils

In the Ford cars a vibrator coil is employed and the trembler platinum contact points should be examined for

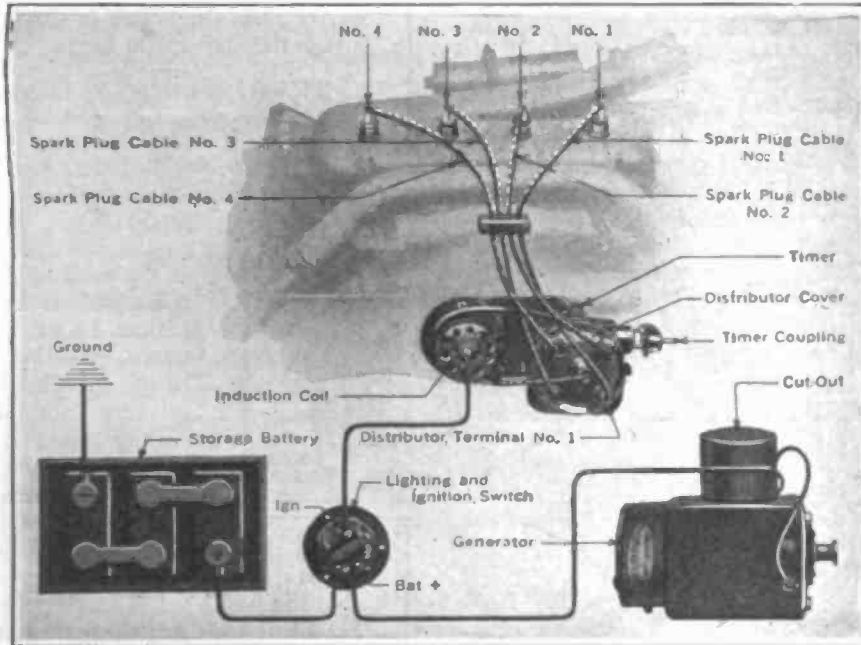

Modern ignition system parts

may make contact with some metallic portion of the chassis before it reaches the switch, the carbon collecting or current distributing brushes may be broken or not making contact; the contact points of the make-and-break device may be out of adjustment; the wiring may be attached to wrong terminals; the distributor filled with metallic particles, carbon, dust or oil accumula-

group that will result in "skipping" or irregular operation, and the following is the logical order in which the various points should be inspected—the parts which demand inspection oftenest are considered first: Weak source of current due to worn out dry cells or discharged storage batteries; weak magnets in magneto, or defective contacts at magneto; dirt in distributor or poor

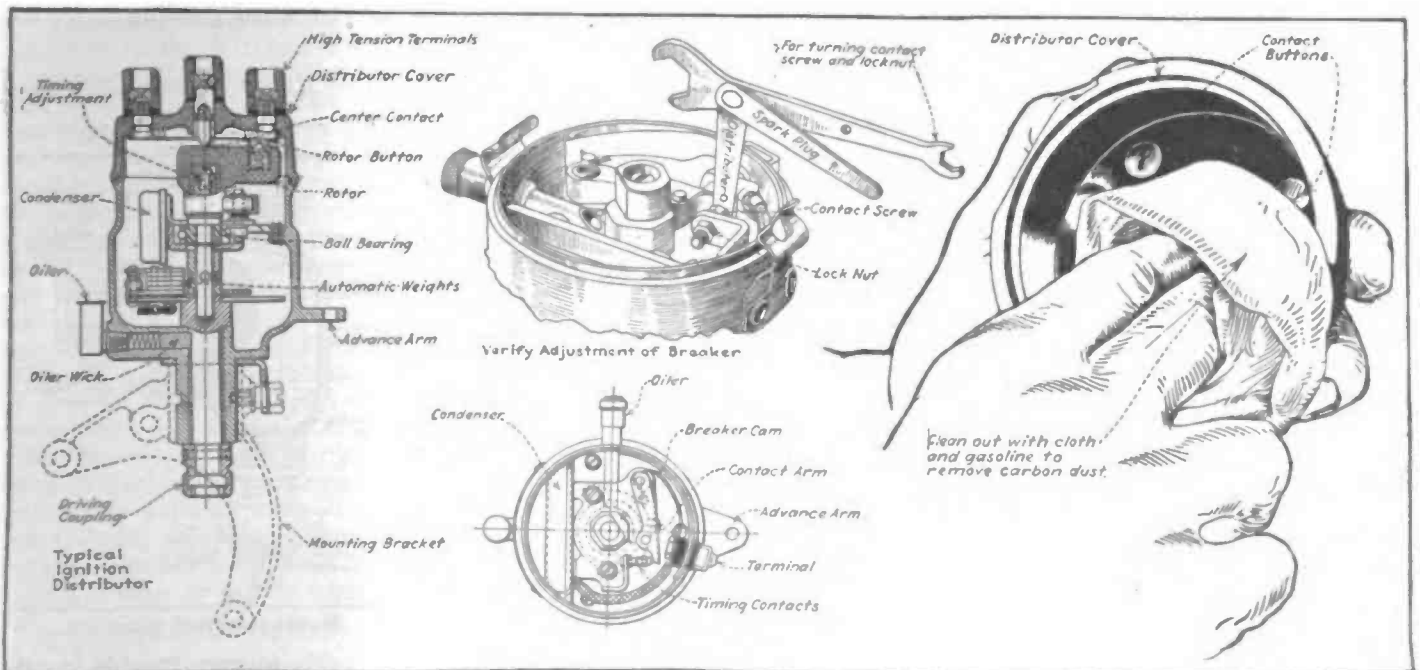

Diagrams showing ignition distributor construction and care

pits or carbonized particles that would interfere with good contact. If defective, they should be thoroughly cleaned and the surfaces of the platinum point on both vibrator spring and adjusting screw should be filed smooth to insure positive contact. The tension of the vibrator spring should not be too light or too heavy and the vibrator should work rapidly enough to make a sharp, buzzing sound when contact is established at the timer. The adjusting screw should be tight in the vibrator bridge and when proper spring tension is obtained the regulating screw should be locked firmly to prevent movement.

If the vibrator operates satisfactorily, but there is a brilliant spark between the vibrator points and a poor spark at the spark plug, one may assume that the coil condenser is punctured. Short circuits in the condenser or internal wiring of induction coils or magnetos, which fortunately are not common, can seldom be remedied except at the factory where these devices were made. If an engine stops suddenly and the defect is in the ignition system, the trouble is usually never more serious than a broken or loose wire. This may be easily located by inspecting the wiring at all the terminals, especially the ground wire at battery or its point of attachment to the frame. Irregular operation or misfiring is harder to locate because the trouble can only be found after the many possible defective conditions have been checked over, one by one.

Common Defects in Fuel Systems

Defective carburetion often causes

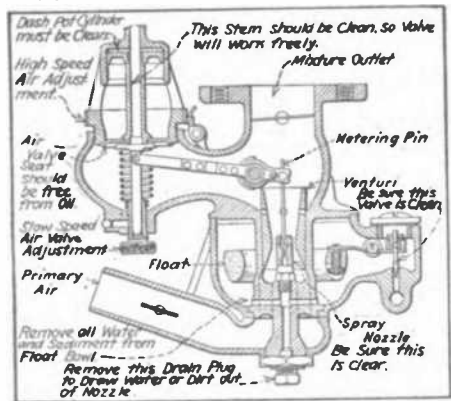

Things to look for in carburetor

misfiring or irregular operation. The common derangement of the components of the fuel system that are common enough to warrant suspicion and the best methods for their location follows:

First, disconnect the feed pipe from the carburetor and see if the gasoline flows freely from the supply source. If the stream coming out of the pipe is not the full size of the orifice it is an indication that the pipe is clogged with

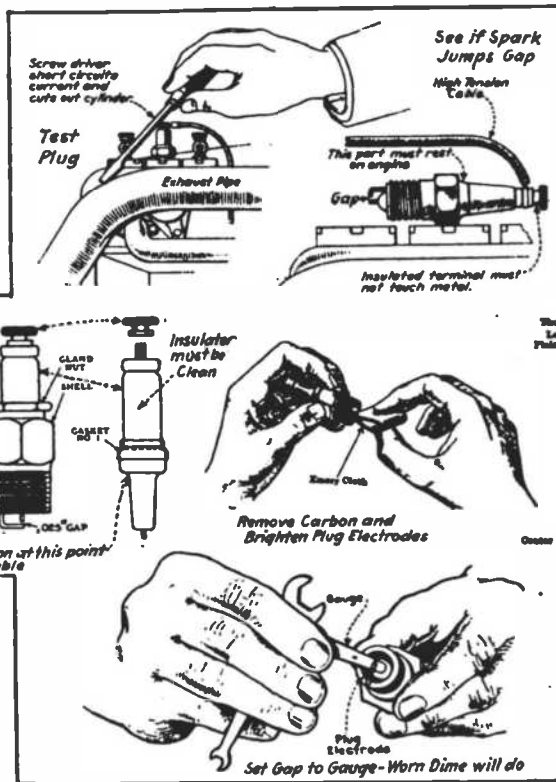

Showing how to locate defective spark plugs and what to do to cure the trouble

dirt or that there is an accumulation of rust, scale or lint in the strainer screens of the filter. It is also possible that the fuel shut-off valve may be wholly or partly closed. If the gasoline flows by gravity, the liquid may be air bound in the tank, while if a pressure-feed system is utilized the tank may leak so that it does not retain pressure; the check valve retaining the pressure may be defective or the pipe conveying the air or gas under pressure to the tank may be clogged.

If the gasoline flows from the pipe in a steady stream the carburetor demands examination. There may be dirt or water in the float chamber, which will constrict the passage between the float chamber and the spray nozzle, or a particle of foreign matter may have entered the nozzle and stopped up the fine hole therein. The float may bind on its guide, the needle valve regulating the gasoline-inlet opening in bowl may stick to its seat. Any of the conditions mentioned would cut down the gasoline supply and the engine would not receive sufficient quantities of gas. The air-valve spring may be weak or the air valve broken. The gasoline-adjusting needle may be loose and jar out of adjustment, or the air-valve spring-adjusting nuts may be such a poor fit on the stem that adjustments will not be re-

tained. Air may leak in through the manifold, due to a porous casting, or leaky joints because of poor gaskets and dilute the mixture. The air-intake dust screen may be so clogged with dirt and lint that not enough air will pass through the mesh. Water or sediment in the gasoline will cause misfiring because the fuel feed varies when the water or dirt constricts the standpipe bore.

When Carburetor Is Out of Adjustment

It is possible that the carburetor may be out of adjustment. If clouds of black smoke are emitted at the exhaust pipe it is positive indication that too much gasoline is being supplied the mixture and the supply should be cut down by screwing in the needle valve on types

where this method of regulation is provided, and by making sure that the fuel level is at the proper height and air adjustment correct in those forms where the spray nozzle has no means of adjustment. If the mixture contains too much air there will be a pronounced popping back in the carburetor. This may be overcome by screwing in the air-valve adjustment so the spring tension is increased or by slightly opening up the gasoline-supply regulation needle. When a carburetor is properly adjusted and the mixture delivered the cylinder burns properly, the exhaust gas will be clean and free from the objectionable odor present when gasoline is burned in excess.

Defects in Cooling System Outlined

Cooling systems are very simple and

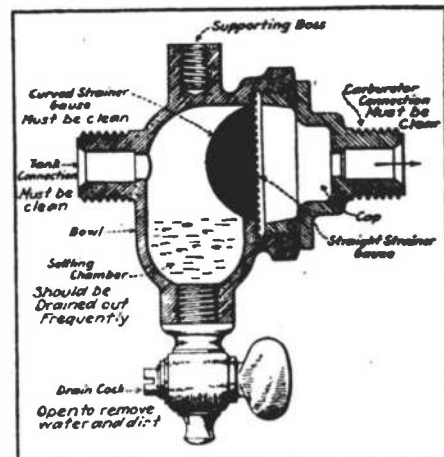

Troubles in fuel filter

are not liable to give trouble on the road as a rule if the radiator is kept full of clean water and the circulation

is not impeded. When overheating is due to defective cooling the most common troubles are those that impede water circulation. If the radiator is clogged or the piping or water jackets filled with rust or sediment the speed of water circulation will be slow, which will also be the case if the water pump or its driving means fail. Most automobile cooling systems are so closely proportioned to the actual requirements

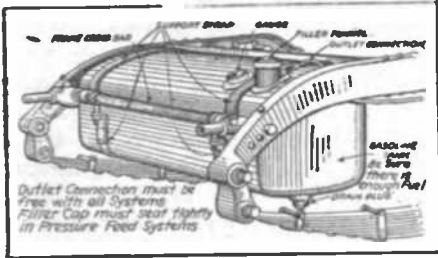

What to look for at the fuel tank

that the stoppage of a cooling fan will be enough to cause the engine to overheat. Any scale or sediment in the water jackets or in the piping or radiator passages will reduce the heat conductivity of the metal exposed to the air, and the water will not be cooled as quickly as though the scale was not present.

The rubber hose often used in making the flexible connections demanded between the radiator and water manifolds of the engine may deteriorate inside and particles of rubber hang down that will reduce the area of the passage. The grease from the grease cups mounted on the pump-shaft bearing to lubricate that member often finds its way into the water system and rots the inner walls of the rubber hose, this resulting in strips of the partly decomposed rubber lining hanging down and restricting the passage. Keep the fan belt tight and be sure fan is properly oiled.

Overheating is often caused by some condition in the fuel system that produces too rich mixture. Excess gasoline may be supplied if any of the following conditions are supplied: Bore of spray nozzle or standpipe too large, auxiliary air-valve spring too tight, gasoline level too high, loose regulating valve, fuel-soaked cork float, punctured sheet-metal float, dirt under float control shut-off valve or insufficient air supply because of a clogged air screen. If pressure feed is utilized there may be too much air pressure in the tank, or in gravity feed, the float controlled mechanism operating the shut-off in either the vacuum tank or the dash or the float bowl of the carburetor may not act quickly enough. Steaming radiators indicate overheating, but do not indicate whether the trouble is in the cooling system or due to other causes.

Defects in Oiling Systems

While troubles existing in the ignition or carburetion groups are usually denoted by imperfect operation of the

motor, such as lost power, and mis-firing, derangements of the lubrication or cooling systems are usually evident by overheating, diminution in engine capacity, or noisy operation. Overheating may be caused by poor carburetion as much as by deficient cooling or insufficient oiling. When the oiling group is not functioning as it should the friction between the motor parts produces heat. If the cooling system is in proper condition, as will be evidenced by inspection of the parts and the water supply in the radiator, and the carburetion group appears to be in good condition, the overheating is probably caused by some defect in the oiling system.

The conditions that most commonly result in poor lubrication are: Insufficient oil in the engine crank case or sump, broken or clogged oil pipes, screen at filter filled with lint or dirt, broken oil pump, or defective oil-pump drive. The supply of oil may be reduced by a defective inlet or discharge-check valve at a plunger pump or worn gear pumps. A clogged oil passage or pipe leading to an important bearing point will cause trouble because the oil

ing. The most common trouble is a clogged filter screen which can be prevented by draining out the old oil from the crank case periodically, cleaning out with kerosene and supplying new oil. In some motors this should be done every 500 miles the car is run, in others a cleaning out every 1,000 miles is sufficient.

Causes of Poor Compression

If the ignition system and carburetor appear to be in good working order, and the hand crank shows that there is no compression in one or more of the cylinders, it usually means some defect in the valve system. If the engine is a multiple-cylinder type and one finds poor compression in all of the cylinders it may be due to the rare defect of improper valve timing. This may be caused by a gear having altered its position on the cam shaft or crank shaft, because of a sheared key or pin having permitted the gear to turn about a half of a revolution and then having caught and held the gear in place by a broken or jagged end so that cam shaft would turn, but the valves open at the wrong

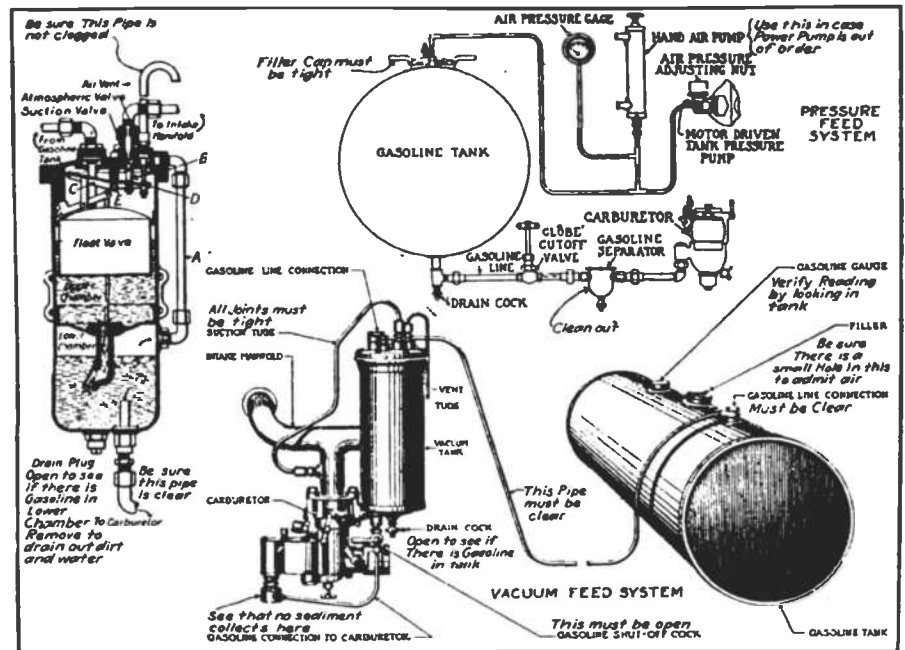

Typical fuel systems. At top, the pressure feed system; below, the popular vacuum feed system

cannot get between the working surfaces. The indicating gauge on the dash may not show oil feed because the pipes leading from them to the engine are full, or because the conductor is clogged with oil wax. This gives sufficient warning, however, and the oil pipe may be easily cleared by removing it and blowing it out with air or steam under pressure. It is well to remember that much of the trouble caused by defective oiling may be prevented by using only the best grade of lubricant, and even if all parts of the oiling system are working properly oil of poor quality will cause friction and overheat-

time. If but one of the cylinders is at fault and the rest appear to have good compression the trouble may be due to a defective condition either inside or outside of that cylinder. The external parts may be inspected easily, so the following should be looked for: A broken valve, a warped valve head, broken valve springs, sticking or bent valve stems, dirt under valve seat, leak at valve-chamber cap or spark-plug gasket. Defective priming cock; cracked cylinder head (rarely occurs); leak through cracked spark-plug insulation; valve plunger stuck in the guide; lack of clearance between valve-stem end

tions are met at equal distances, two to every revolution of the starting crank in a four-cylinder motor, or take out the spark plugs of all cylinders except the one to be tested. If compression is lacking, examine the parts of the cylinder at fault in the following order, trying to start the motor whenever any one fault is found and remedied. See that the valve push rods do not touch valve stems for more than approximately 1/2 revolution in every 2 revolutions, and that there is not more than 1/64 inch clearance between them. Make sure that the inlet and exhaust valves seat. To determine this, examine the spring and see that it is connected to the valve stem properly. Take out valves and see that there is no obstruction, such as carbon, on the seat. See that valve works freely in its guide. Listen for a hissing sound while cranking motor for leaks at other places, such as due to poor fitting piston rings. Remember that a cylinder that has poor compression will not work reliably or give full power because it does not suck in a full charge of gas, and besides the explosive power is less.

ARTIFICIAL WOOD FROM WASTE

WHEN sawdust is mixed with a binding material to which other ingredients, giving weight, color, hardness, moulding property, etc., are added, compositions can be obtained which may be used for parquetry, terra cotta imitation, table tops, floorboard-coating, wood cements, etc. Patented and unprotected recipes of these compositions are very numerous. The employment of sawdust in the manufacture of products that are used for furniture, wall and ceiling decoration has gained an important place among the industries of the world. Many of the beautiful panels and friezes of the Italian Renaissance and French Baroque one admires in modern mercantile and private palatial buildings are made of artificial wood, and without having found so practical and lucrative a utilization of waste wood as these moulded decorations, many architectural designs of inner decorations could not be carried into practice, except by spending prohibitive sums for carvings.

The following mixtures may be taken to represent typical examples of artificial wood preparations:

Messieurs Latri, of Paris, use resinous sawdust mixed with fresh ox blood, the paste being pressed by an hydraulic press into heated steel moulds. The product is capable of filling the finest depressions of the mould; it may be coloured, and can be worked in every respect like wood itself.

Harra's Imitation Wood consists of sawdust cellulose, and an albuminous binding material, the resulting paste be-

ing also capable of being pressed into moulds or applied like wood carvings.

In Hurtig's Wood-composition sawdust is mixed with sodium silicate (ordinary waterglass) and milk of lime; common curd soap and water being added to wet the ingredients. The composition for low relief and high relief is improved by adding casein to the above mixture for producing a low relief, and mashed potato, infusorial earth and pitch for high relief paste.

A Water Distiller

By R. D. Galt

WITH the great use of motor cars and the increasing demand from day to day, there arises several questions for the small town garage to contend with. One of these,

furnish the trade, and in order to do this, a water distiller made on the lines of the accompanying drawing will be found serviceable and economical.

A small one burner gas or oil stove is used for heating the water. Water to be distilled is placed in a common one gallon oil can and the spout allows the steam to escape. For a condenser, a five gallon oil can that the oil companies use for shipping gas and oil may be used by cutting it into two parts at the middle. In the lower half cut two holes on opposite sides, one a little below the other, and place a piece of steam gauge glass through these holes. After the glass has been put in, shellac may be run around it to keep it from leaking. Then a rubber tubing small enough to fit tightly about the spout of the can and into the glass gauge will

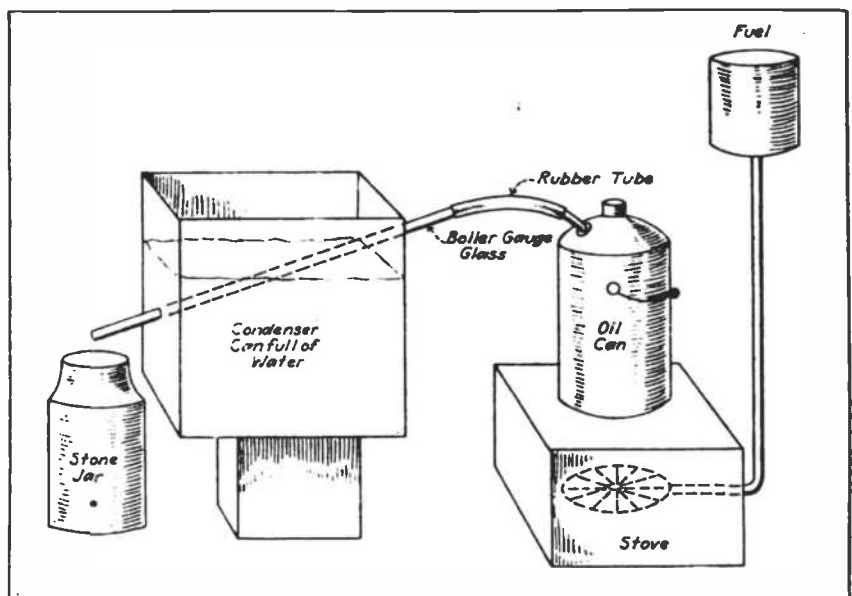

Simple method of distilling water to use in storage battery electrolyte

if not the most important, nevertheless one to be considered, is the battery trade. All the larger cars are equipped with storage batteries for ignition and lighting and now the Ford also will be equipped likewise. One of the necessary articles needed to supply this branch of the garage business is distilled water and for some of the smaller towns, this affords a trying question.

During the past year I have known of several garages who were faced by a situation something like this. Distilled water could be bought in some of the larger cities for as low as five cents a gallon, but the cost of transportation by rail to the retailer was near fifty cents, bringing the cost of the water when delivered to near sixty cents a gallon. Readers can readily see what water would weigh and the expense of shipping if the water was shipped any great distance. But notwithstanding this, water has to be kept on hand to

connect the two, allowing the steam to pass into the condenser where cold water about the glass will cause it to form into drops of water. A stone or glass jar set under the end of the glass gauge will collect the finished product. The water in the condenser, if changed every hour or so will keep the distilled product forming rapidly. The only expense is the gasoline or kerosene, which amounts to about five cents per gallon of water, and in the mean time the small garage is as efficient as the large, and operates as cheaply, keeping home trade at home.

Take care not to adjust the brakes too close when car is without load. If you do the brakes may bind when car is loaded, the springs deflected and the wheel base slightly extended. Rough roads will augment the trouble and intermittent dragging of the brake may result if the bands fit tightly.

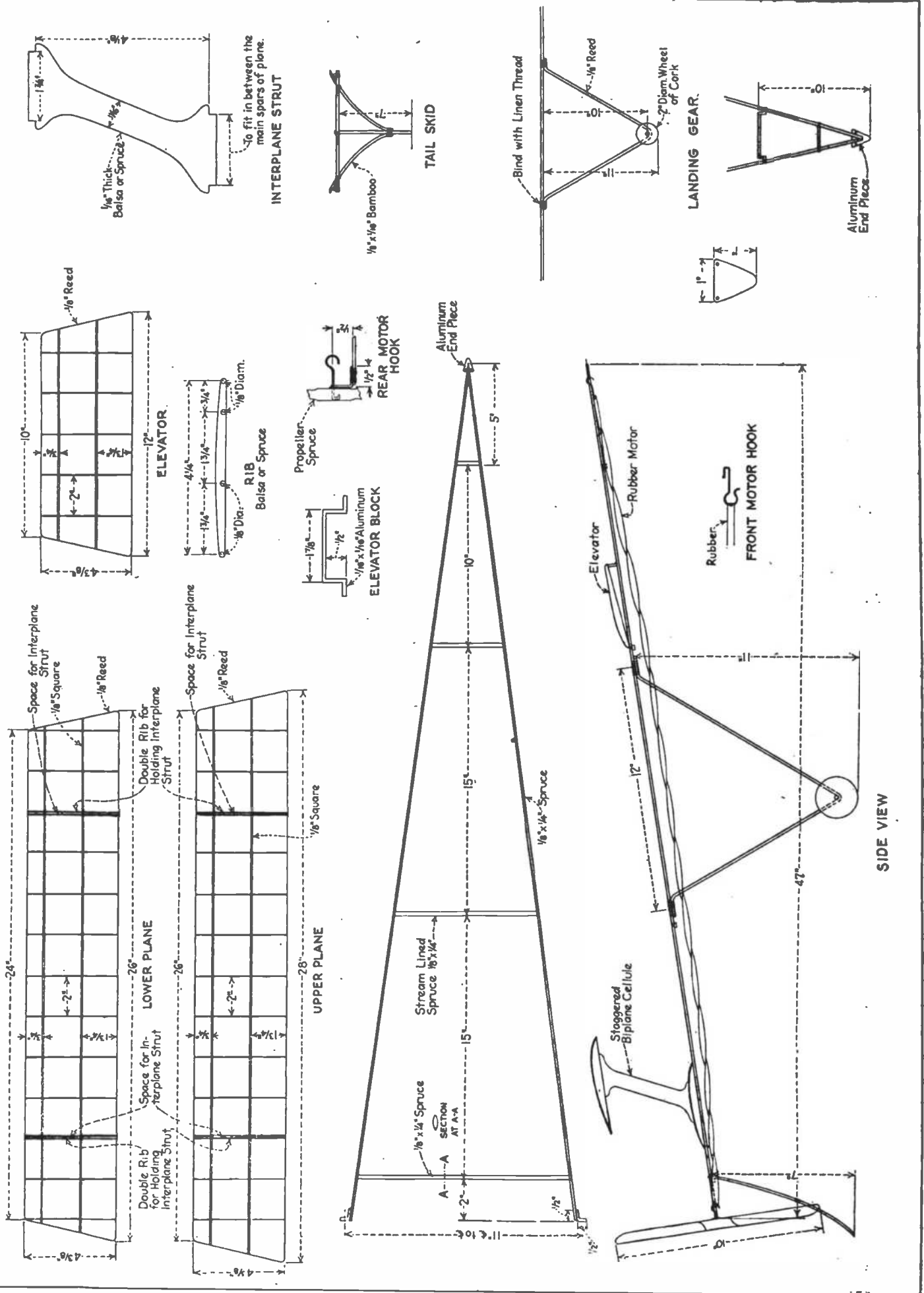

Fig. 1. Constructional details of the R.O.C. biplane model after giving dimensions of important parts.

The R. O. G. Biplane Flier

A Modification of the Simple A Frame Flying Model That is Provided With Double Aerofoils and Wheeled Landing Gear

By H. C. Ellis

BEFORE attempting to construct this Model, study the drawings carefully. This machine, should not weight over seven and one-half ounces when completed if care is taken in the construction. The bracing wires shown in photographs should be used only if the frame shows a tendency to buckle when motors are tightly wound.

Fuselage

The fuselage is the A frame type and consists of two longerons $45 \times 1\frac{1}{8}$ " $\frac{1}{4}$ " spruce. Three crosspieces of the same material $\frac{1}{8} \times \frac{1}{4}$ " are used and placed at distances shown in the drawing, and bound with strong linen thread and glued. The crosspieces are given a stream line section to lighten them and also to reduce their resistance. The elevator block is of aluminum $\frac{1}{16}$ " x $\frac{1}{16}$ " x $3\frac{1}{2}$ inches long or this can be of reed or bamboo or any light stiff wire. It is bound and glued as shown near the apex of the triangular framework.

The rear skid is of bamboo $\frac{1}{16}$ " x $\frac{1}{8}$ ". This is made high enough to keep the propellers from touching the ground. The landing gear is made of $\frac{1}{8}$ " reed, shaped as shown in the drawing by bending it over a gas or candle flame. Bind and glue to the fuselage approximately as indicated. The frame hooks are made of a piece of $\frac{1}{16}$ " drill rod bent and bound to the fuselage or may be attached to an aluminum piece set in the apex of the frame. The axle is a piece of $\frac{1}{16}$ " drill rod nine inches long. On the Model described and illustrated the writer used cork wheels two inches in diameter, these being lighter than other types. Obviously any type of wheel may be used, such as the aluminum disc or wooden type which may be purchased from any model supply house and which are shown at Fig. 5.

Main Planes

The ribs of the main planes and elevator are the same size. They are not, as you will notice, built up but are cut from a piece of balsa or spruce $\frac{1}{16}$ " thick. The rib should be laid

out full size as it is reduced on the drawings. Care must be taken when cutting these ribs out to be sure to

Fig. 2. Rear view of the R.O.G. biplane flier



$\frac{1}{8}$ " dowels must be in line as there are a number of ribs to be made, a metal pattern may be cut and drilled to act as a jig to insure uniformity in ribs. It will be noticed in the drawing that the third ribs from each end of the wing tips are doubled. These ribs are placed $\frac{1}{16}$ " apart to act as a socket for the struts. The struts are cut from spruce $\frac{1}{16}$ " thick to the shape shown. They are then sanded with fine sand paper and after they are finished, they are given one coat of Dope.

After all the ribs are placed on the wing beams and are properly spaced according to the drawing they are glued and allowed to dry. After the glue is dry, the edges, which are $\frac{1}{8}$ " reed are put on. This is done by tying the reed back over the wing beams with strong thread and gluing it to the ribs. The wing tips are bent to the shape shown by passing them over a gas or candle flame. Care should be taken so as to

make all the tips the same shape. After the glue is dry the thread may be cut away. The elevator is built up in the same way except that the double ribs are left out.

Covering and Doping

Bamboo paper is used for covering the wings. Cover the bottom first and allow to dry. After it is dry the extending edges may be trimmed off. Then cover the top side. Care must be taken to have the paper lay even and without any wrinkles. After the wings are covered and the glue is perfectly dry, the Dope is applied. This is best done with a small, soft brush as a stiff brush is liable to puncture the paper covering. This Dope can be purchased from any model supply house. Four ounces is the quantity required to dope the wings properly. Apply the dope evenly, first on the top and then the bottom side. Then place wing away to dry.

Propellers, Shafts and Bearings

The propellers are ten inches in diameter. As these are the most difficult

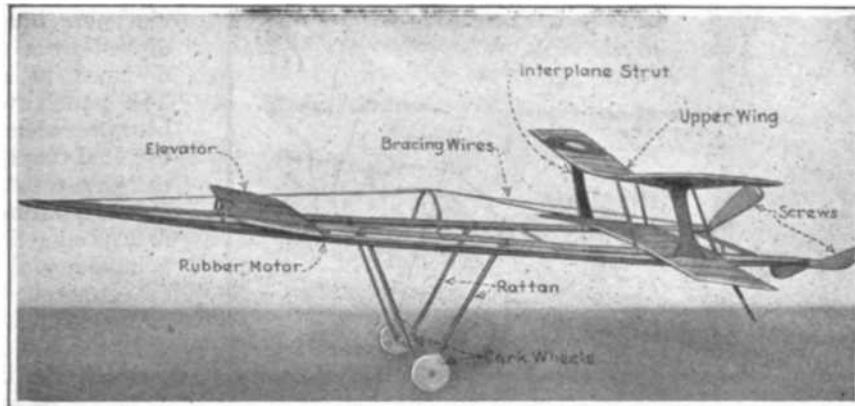

Fig. 3. Side view of model biplane flier showing relative placing of parts

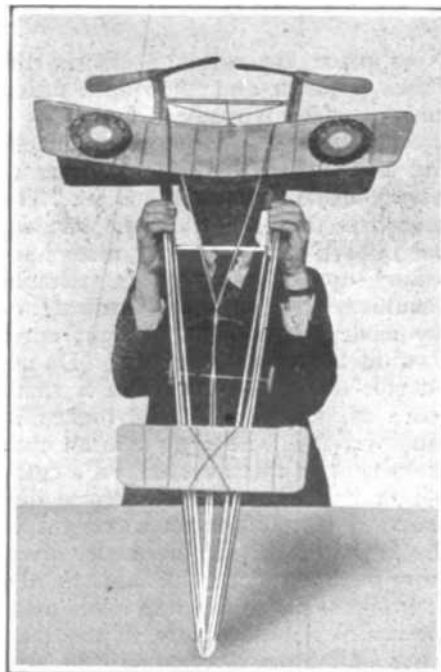

Fig. 4. Plan view of R.O.G. biplane flier

have them all the exact size and all the holes for the wing beams, which are

part of the model to make it is better to buy them from a model supply house. The bearings are made of 1/16" thick brass and are 3/16" wide. They are bent to the shape shown. A 1/16" hole is drilled through them to take the propeller shaft which is a 1/16" piece of drill rod bent to the shape shown in the drawing. The bearings are then securely bound to the fuselage with linen thread and glued. The motor hooks are of 1/16" drill rod.

The motive power consists of 40 feet of 1/8" flat rubber for each motor. This rubber should be looped over the hands into 12 even strands. Place one end in the propeller hook, and the other

where the struts are inserted so as to hold them in position against the frame members. Now place them on the fuselage and pass a strip of rubber around the bottom plane and around each longeron of the fuselage. The elevator is fastened on the fuselage in the same way. Be sure and have the front edge of same resting on the elevator block.

The model should be launched from the hand before flying it from the ground. Have an assistant hold the propellers at the bearings, the model hooks into a double winder and stretch the motors twice their length. Turn the handle of the winder 100 times.

ing the motors 250 times with the winder. Select a hard and level surface to launch it from.

Moisture Absorption Through Varnish Same For Different Species of Wood

IN experiments made by the Forest Products Laboratory, it was found that varnishes do not entirely prevent the transmission of moisture into wood, but merely retard it, and that apparently there is no difference in moisture absorption through the coating due to the species of wood used.

The panels used in the experiments were of yellow birch, basswood, red gum, African mahogany, white ash, white pine, Sitka spruce, southern yellow pine, bald cypress, incense cedar, white oak, western yellow pine, Port Oxford cedar, and sugar pine.

Three coats of high-grade spar varnish were applied to four panels of each species. Two panels of each species were brush-coated and two were dipped by a special dipping machine designed to secure an even coating. The panels were allowed to dry 72 hours between coats and 10 days after the final coat before they were given the moisture-resistance test.

The moisture-resistance test consisted in exposing the panels for 17 days to a humidity of 95/100 per cent, or in an atmosphere practically saturated with moisture.

At the end of this test, it was found that all the brush-coated panels had absorbed between 5 and 6.5 grams of moisture per square foot of surface, and the dipped panels between 4 and 5 grams. Such variations in amount of absorption as appeared could easily have been due to inequalities in the application of the varnish. It was quite noticeable that the dipping process produced a more moisture-resistant coating than brushing.

Copperite Alloy

COPPERITE is a new high-speed alloy. It is said to be an alloy of zirconium and nickel. It has a bright silvery lustre and a specific gravity much lower than other alloys used for high-speed work. Copperite contains no carbon or iron, and consequently is not a steel. Its melting point is only about 1150 deg. C., and owing to the fact that the alloy remains in a liquid state for a considerable period before solidifying, difficult castings can be made with ease. No heat treatment is said to be required, the hardness being varied by changing the proportion of the constituents. Cutting tools have been produced with a hardness of 250 up to 500 Brinell, the latter still retaining sufficient toughness to withstand heavy roughing cuts.

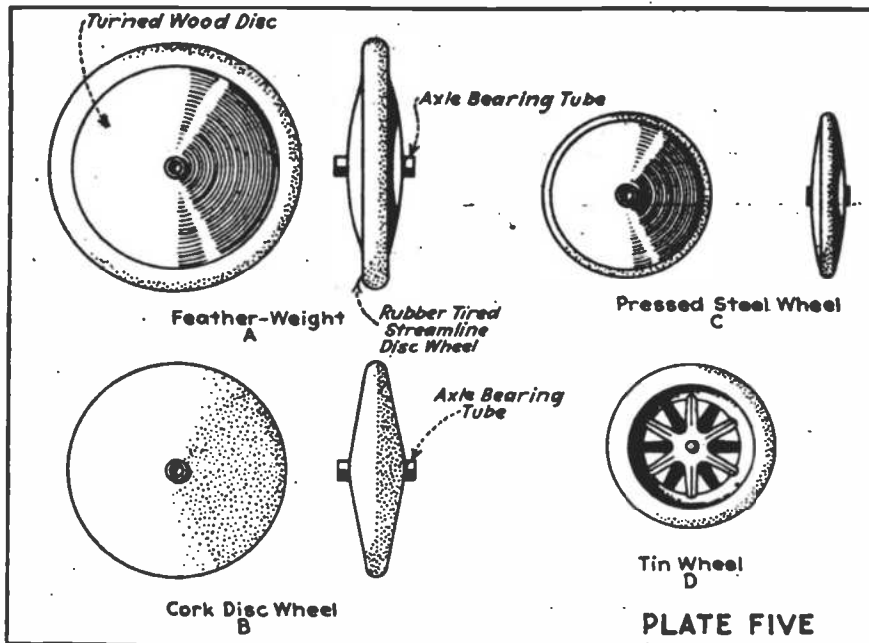

Fig. 5. Types of wheels suitable for model airplanes are made of wood or metal

end into the motor hook. The motor hook is then placed into the frame hook at the front of the fuselage. The motor hooks may be removed from the frame hooks and placed in the winder. The propellers must turn out in opposite directions and rotate so their entering edges cut the air first.

Assembling and Flying

After the main planes and elevator are thoroughly dry, the model is ready to assemble. Place the propellers through their respective bearings and attach the rubber motors as described. Now take the smaller plane, which is the bottom one and cut the paper out between the double ribs with a sharp knife on the top only, for the struts to enter the space provided for them. Do the same with the larger one, but cut out only on the bottom side. Now place the two struts in the sockets of the lower plane, and then into the sockets of the upper plane as shown in the photograph. Place a large rubber band around the main plane at the point

Now place the motor hooks in the frame hooks or aluminum apex fitting and the model is ready to fly.

Some practice is required in launching a model of this type in order to have it make a successful flight. The propellers must be held from turning, one in each hand, after the motors are wound up. They must be released simultaneously with the throwing of the model upwards at a slight angle forward from above the head. Do not attempt to fly this model in a small space as it is liable to be broken in landing. It is best to fly it in an open grass land as the grass acts as a cushion in landing. Do not become discouraged if you are not successful in the first attempt. If the model dives, move the main planes forward slightly. If it climbs at too steep an angle move the main planes slightly to the rear. After a little practice you will find the best position for the main planes to make a successful flight. After the model is properly balanced, it may be launched from the ground after wind-

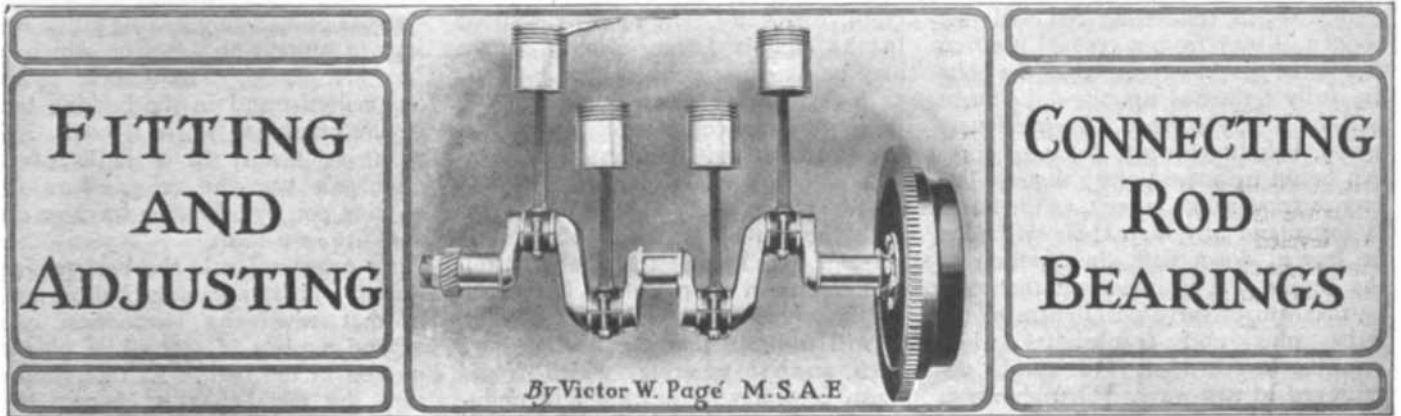

PART II

Remetalling Connecting Rods

In a number of the cheaper cars, the bearing metal is cast in place in the connecting rod lower end and in the main bearings, and is not in the form of removable die cast bushings as are used on the more expensive cars. The repairman who is called upon to replace the bearing metal will perhaps find the following instructions regarding remetalling bearings of valve. The method described was used by the writer while in charge of a large shop where much work of this kind was done, and while the instructions given below and shown at Fig. 1 apply specifically to lining the big ends of connecting rods, the same process may be used successfully on any other bearings where the mandrel and collars can be used, the dimensions being changed to suit the requirements of the worker.

In the case mentioned the journals of the crankshaft were two inches in diameter and the big ends of the connecting rods were worn too much to allow of adjusting. A piece of pipe about 9 inches long was procured and turned down in a lathe until it was .020 inch under two inches in diameter, which made a hollow mandrel of it. A piece of steel tubing could have been used to as good advantage had any been available. As the outside of the bearing caps were machined true a couple of set collars were bored out to be a good fit on the mandrel, and while still in the lathe they were recessed out to just fit over the outside of the big ends, as shown in sketch and each of the collars was provided with a drilled vent. One of these collars (C) was placed on the hollow mandrel (A), after which the mandrel was pushed through the big end, and the other collar was put on the other side, insuring that the mandrel was as near center as possible for it to be.

The assemblage is then supported on a couple of V-blocks, which are supported on a lathe bed as a convenient support, the ends of the mandrel lying within the V-blocks while the connecting rod hangs between the ways. A

piece of solid round iron or steel which will go inside of the hollow mandrel should be made red hot while the anti-friction metal is being melted and is pushed inside the mandrel to heat it. In a minute or two the metal may be poured in through B to fill the space and as the metal and the big end caps are well heated the molten metal will flow to every point. The heating of the mandrel can be just as well accomplished by directing the flame from a

the simple way it can be heated and cooled. Vents may be made for the heated gases by grooving the face of each of the collars nearest the big end and on the same side as the hole through which the metal is poured. If provision is not made for "venting," the molten metal will not run uniformly and will become honeycombed. After cooling, the bearing is either bored out in a lathe to nearly the size of the journal and then reamed to the finished

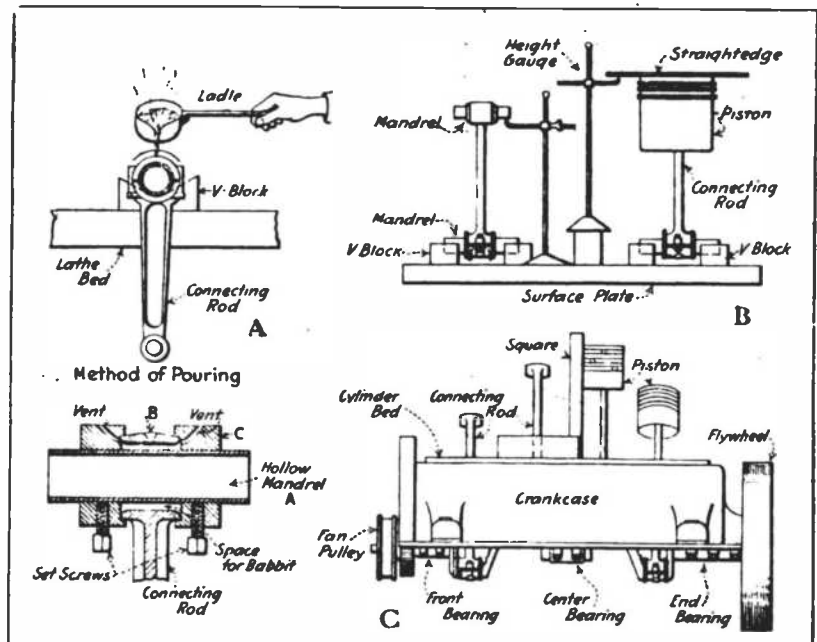

Fig. 1. Suggestions for remetalling connecting rod bearings when bearing metal must be poured in

blow torch or Bunsen burner into the opening. After the metal is poured and has set for a time the whole may be easily cooled by running water through the mandrel or by directing a blast of air against the big end, as desired.

Before the cap is assembled with the connecting rod several shims or liners of sheet brass or copper should be placed between them so that adjustment for wear of the new bearing can be compensated for by the removal of a liner. As is evident, the thinner the liner and the greater the number used, the finer the adjustment possible.

The use of a hollow mandrel is to be preferred to a solid one because of

size or scraped to a fit by hand. The method of pouring the molten metal is clearly shown while the sectional view makes the construction and application of the mandrel clear. The same method may be used to rebabbit main boxes except that a pair of collars will be needed for each bearing and a long mandrel used.

Testing Bearing Parallelism

It is not possible to give other than general directions regarding the proper degree of tightening for a connecting rod bearing, but as a guide to correct adjustment it may be said that if the connecting rod cap is tightened suffi-

ciently so the connecting rod will just about fall over from a vertical position due to the piston weight, when the bolts are fully tightened up, the adjustment will be nearly correct. As previously stated, babbitt or white brass bearings can be set up more tightly than yellow bronze (now seldom used), as the metal is softer and any high spots will soon be leveled down with the running of the engine. It is important that care be taken to preserve parallelism of the wrist pins and crankshafts while scraping in bearings. This can be determined in two ways. That shown at Fig. 1, B, is used when the parts are not in the engine assembly and when the connecting rod bearing is being fitted to a mandrel or arbor the same

crank case, and that member secured in the chassis frame, a steel square may be used as outlined at Fig. 1, C, as it is reasonable to assume that the wrist pin, and consequently the piston it carries, should observe a true relation with the top of the engine base. If the piston side is at right angles with the top of the engine base it is reasonable to assume that the wrist pin and crank pin are parallel. If the piston is canted to one side or the other, it will indicate that the brasses have been scraped tapering, which would mean considerable heating and undue friction if the piston is installed in the cylinder on account of the pressure against one portion of the cylinder wall. The height gauge method shown above

consists of a casting having guide bearings to support an arbor on which collars are placed. These serve to hold the molten metal in the bearing boxes in the crankcase while it cools. The metal is heated in a ladle over a plumber's kerosene or gasoline fired melting pot, by a brazing torch or charcoal fire in a form.

As a general rule the best temperature at which to pour the babbitt metals is that when the commotion ceases around a piece of soft white pine immersed in the bath. At this temperature the metal has a clear, silvery, mirror-like surface, from which oxide dross is easily skimmed and on which it is slow to re-form. At the same temperature the metal takes a neat mold

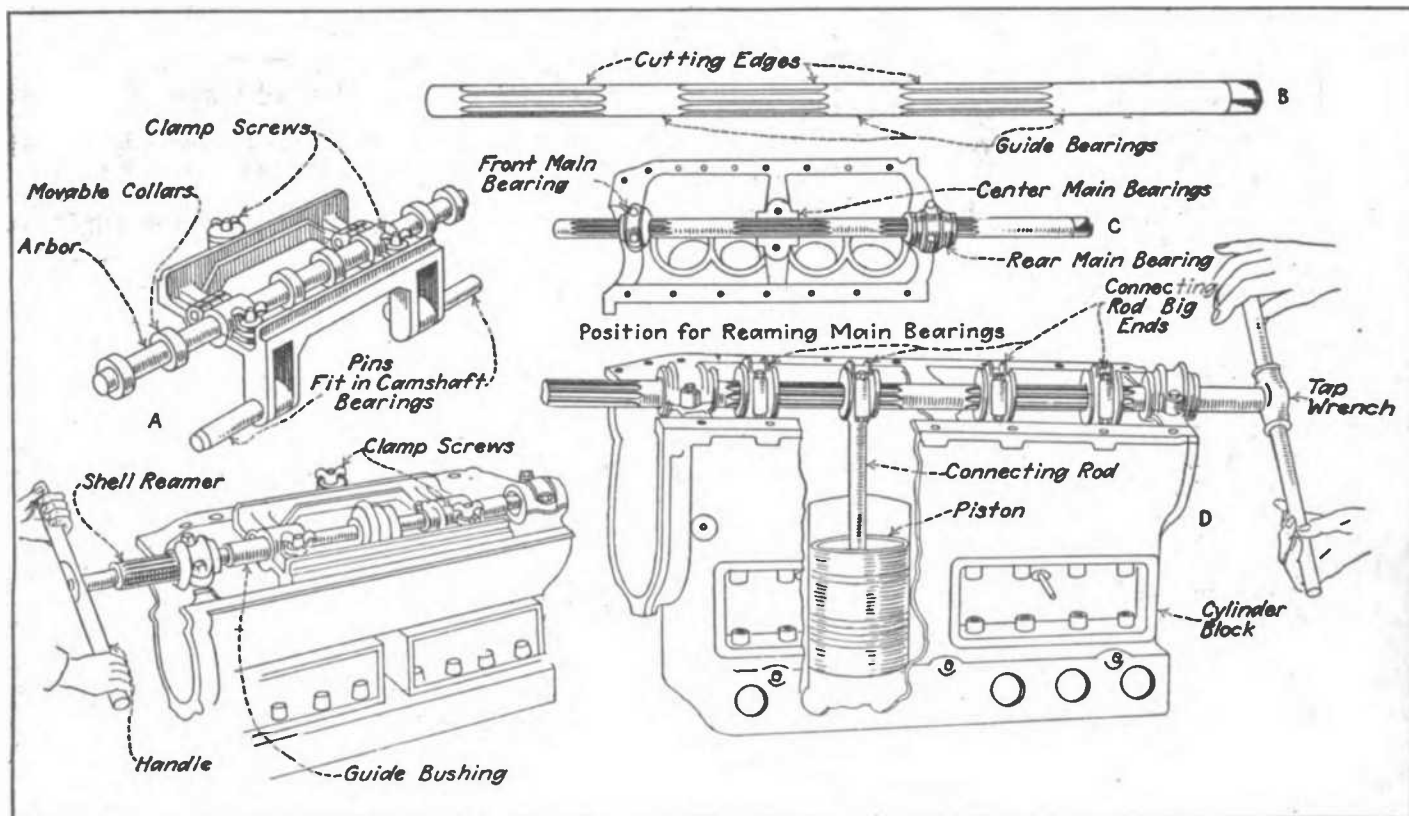

Fig. 2. Diagrams showing special fixtures to assist in remetalting main bearings and how poured bearings may be fitted by a reaming process

size as the crank pin. The arbor, which is finished very smooth and of uniform diameter, is placed in two V-blocks, which in turn are supported by a level surface plate. An adjustable height gauge may be tried, first at one side of the wrist pin which is placed at the upper end of the connecting rod, then at the other, and any variation will be easily determined by the degree of tilting of the rod. This test may be made with the wrist pin alone, or if the piston is in place, a straight edge or spirit level may be employed. The spirit level will readily show any inclination while the straight edge is used in connection with the height gauge as indicated.

When the connecting rods are being fitted with the crankshaft in place in

may be used instead of the steel square, if desired, because the top of the crank case is planed or milled true and should be parallel with the center line of the crankshaft.

Remetalting Main Bearings

What has been said in regard to remetalting and refitting connecting rod bearings applies just as well to the pouring of bearing metal in the cylinder block of such cars as the Ford, which still use poured integral bearings of babbitt rather than removable brasses of white metal. Special aligning and pouring jigs and reamers make the operation of bearing replacement a comparatively simple one. A typical pouring fixture is shown at Fig. 2. This

impression and will usually be found free from those surface discolorations arising from over-heating.

The use of aligning reamers and fixtures insure that the bearings will be reamed out to the proper size, making refitting a very simple task. A typical combination fixture that serves either for holding a babbiting arbor or guiding the bearing finishing reamer is shown at Fig. 2 A. This has locating pins which fit the camshaft bearings and insures that the crankshaft will be parallel to the camshaft when the bearings are finished. A very simple aligning reamer is shown at Fig. 2 B, and its use for reaming main bearings is outlined at C. After the main bearings are properly fitted, they can be used as supports and all the connecting rod big

ends may be reamed as shown at D. The practice of reaming bearings is growing and is not confined to cheap cars, by any means. Expensive hand scraping is largely eliminated and the repairman is sure the bearings will be in line if reamed altogether as the aligning reamer permits.

the coating should be smooth, free from bubbles, shiny, and an eighth of an inch thick over the end.

If the stock is to be subjected to rough handling which might cause the coating to chip when cool, linseed oil may be added, in the proportion of 1 to 15 by weight, but this will have a

part of common salt, which is moistened just enough to make it cohesive. The moist mixture can be left on until the plate is clean, but the action is more rapid if the mixture is scraped off every two or three hours and the iron scrubbed thoroughly with a wire brush and water; the treatment is repeated until the plate is clean. Usually 24 hours is sufficient for a badly corroded plate. When the plate is thoroughly clean it is well washed with an alkaline solution and dried quickly. A coating of paraffin oil (kerosene) is at once applied to protect the surface against oxidation. The metal is then ready for the paint or other protective covering. This method has been found to be more effective than hammering, chiseling, the use of wire brushes, or even a sand-blast.

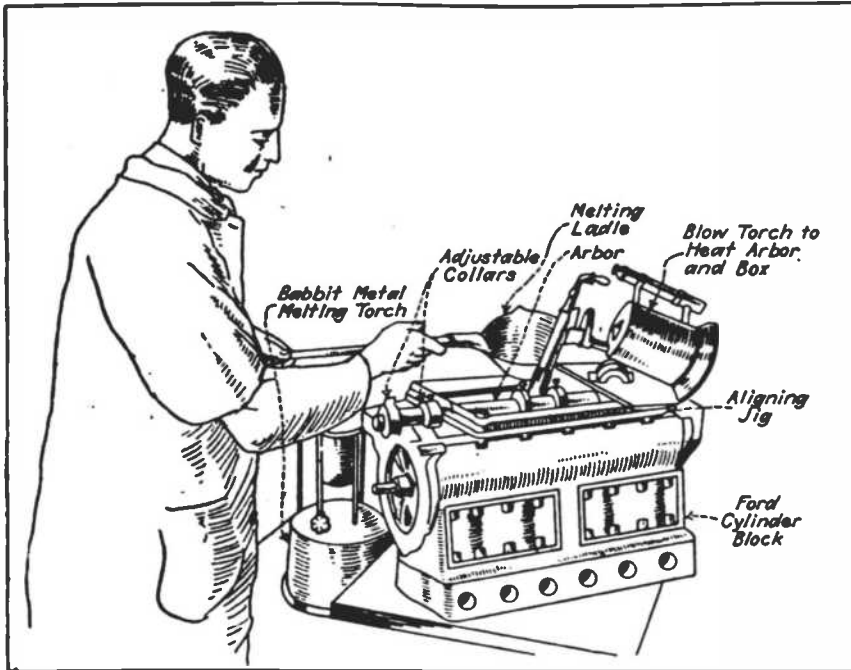

Fig. 3. Showing method of pouring bearing metal in the main bearings in cylinder block of Ford engine showing use of mandrel and aligning fixture

Coatings that Prevent End Checking

WOOD, whether in the form of logs, lumber, timber, shaped blanks or veneer, will split and check at the ends during seasoning if drying is allowed to go on at a natural rate through the end grain. To retard the rate of drying from the ends, it is necessary to cover them with some protective coating.

The law of end coatings, in simple terms, is that the harder and greener the wood, the more effective must be the coating. In its experiments to determine the practicability of various coatings and end dips, the Forest Products Laboratory found the following to be true: *Paint* is convenient to handle, but is of low effectiveness. *White lead* is convenient to handle, and is of medium effectiveness. *Lorac*, a commercial compound, is convenient to handle, and is of considerable effectiveness. *Rosin-lampblack* is inconvenient to handle, but is of high effectiveness.

Rosin-lampblack is made according to the following formula:

Clear grain rosin.60 parts by weight
Lampblack 1 part by weight

The rosin should be melted but not allowed to boil or froth. The lampblack should then be thoroughly stirred in. The ends of the sticks should be dipped in this molten mixture to a distance of about 1/2 inch. When hard

tendency to make the coating excessively soft in the kiln at temperatures above 130° F.

Life of a Locomotive

THE iron horse does not last much longer than the horse of flesh and bones. The ordinary life of a locomotive is said to be thirty years. Some of the smaller parts require renewal every six months; the boiler tubes last five years, and the crank axles, six years; tires, boilers and fire boxes from six to seven years; the side frames, axles and other parts, thirty years. An important advantage is that a broken part can be repaired, and does not condemn the whole locomotive to the junk shop; while, when an animal breaks a leg, the whole is only worth the flesh, fat, and bones, which amount to a very small sum in this country, where horse flesh does not find its way to the butcher shop as it does in France and Germany.

Removing Iron Plate Rust

A CHEAP and effective method of removing rust from corroded and pitted iron plates has recently been evolved as a result of experiments described in *Machinery*. It consists in applying to the surface of the iron a mixture of two parts of finely crushed sodium bisulphate (sodium acid sulphate, Na₂SO₃, H₂SO₄, 3H₂O) and one

Uses of Castor Oil

APART from the needs of the aircraft, for which very large quantities of castor oil are required as lubricant, only 25 per cent. of the oil extracted, if quite that much, is consumed in the various departments of pharmacy. The other fields of employment are much more extensive than is generally realized. For instance, castor oil figures to a large extent in the manufacture of artificial leather, which is used in upholstery. Castor oil is an essential component in some artificial rubbers, and there are various kinds of celluloid which depend upon this product of the castor bean. Castor oil furnishes a very satisfactory coloring for butter; and from castor oil is produced so-called "Turkey-red oil," which is an important factor in the dyeing of textiles and in the treatment of the fabrics.

One of its largest uses is in the making of transparent soaps. Castor oil yields sebacic acid, which is superior to stearic acid in the manufacture of candles, and from it is also obtained caprylic acid, which lends itself to the composition of varnishes peculiarly suited to the polishing of all kinds of high-class furniture, carriage bodies and paintings, and is extensively employed in the preparation of vellum, tracing cloth, etc. Caprylic acid plays a part in the production of ethers which are used by perfumers and confectioners. Castor oil is used in the making of certain waterproof preparations, and a liquid disinfectant is obtained from the "seconds" or lower grade oil. The oil is an admirable preservative for various kinds of leathers, is extensively used in the leather industry, and is particularly serviceable in adding to the service life of leather belting employed in heavy work. Our fly papers would not be so effective if it were not for castor oil, and the oil enters into the composition of a great many adhesive agents.

The Chemistry and Physics of Flame

By W. C. Dumas

SUCH an apparently simple phenomenon as the combustion of a gas with its visible manifestation called flame is very interesting when considered in detail.

Flame is nothing more than a combustible gas heated to incandescence. It is a chemical combination made visible. During this combination light and heat are produced. The words "to burn" usually convey the idea that carbon itself, or one of the many compounds of carbon, unites with oxygen producing the flame, and having as end products carbon dioxide and water.

Simply stated, this is the usual mechanism of flame, but flame and burning may take place when oxygen is not concerned at all. For instance, hydrogen will burn in chlorine producing hydrochloric acid.

In ordinary burning, the actual flame is produced by the combination of

stopper is now replaced in the bottom of the chimney and the gas continues to burn at *g*. Now slowly turn the gas up to full height. The flame leaps from *g* to the end of the tube, *c*, connecting with the air. A large pale flame, *d*, is formed on the end of *c*. At the same time, a second large flickering flame develops at the upper opening of the chimney. This is the flame, *e*, in the diagram.

The flame, *d*, is *air burning in gas*, and at the same time the excess gas escaping at *e* ignites and burns in the outer air. When this takes place there is no longer any flame at all at *g*.

This experiment shows both the direct and reverse flames. The flame at *e*, gas burning in air, is a direct flame, while the flame at *d* is a reverse flame or air burning in gas.

This experiment can even be carried further, as shown in Figure 2. If a

istence of combustible gases in this zone can be demonstrated by inserting the end of the bent tube, *e*, into the inner cone. When a light is applied at the other end of the glass tube, the flame, *d*, will form and burn. This is an actual burning of the combustible gases passing out from the inner cone.

The dark central zone is surrounded by a luminous zone, *b*. In this mid-luminous zone of the candle, the hydrocarbons, mainly ethylene, C_2H_4 , passing from the inner cone, are broken down into methane, CH_4 , and carbon. The methane uniting with oxygen burns completely to carbon dioxide and water while the separated carbon is heated to incandescence. This is the cause of the luminosity of the central zone. There is not enough oxygen present in this zone to unite with all of the carbon.

The presence of free, unburned car-

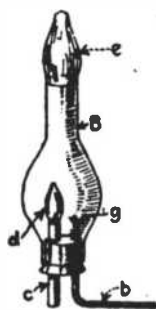

Fig. 1

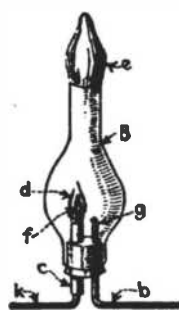

Fig. 2

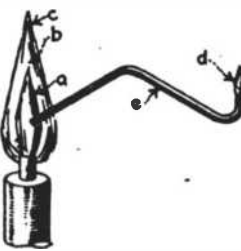
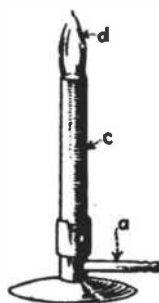

Fig. 3

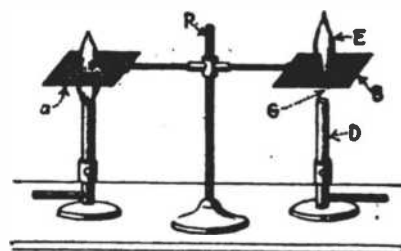

Fig. 4

gaseous decomposition products with oxygen. When flame is observed in the burning of wood, coal, or a candle, it is due to the fact that at high temperatures gaseous decomposition products are formed.

When a gas can be made to burn in air or oxygen, it is spoken of as a combustible gas. However, this term is only relative, as oxygen can be easily made to burn in ordinary illuminating gas. When air burns in gas, the flame is known as the *reverse flame* to distinguish it from the *direct flame* produced by gas burning in air. Both the reverse and direct flames can be produced by the following experiment:

B is a medium sized lamp chimney fitted at the bottom with a large two-holed rubber stopper. The tube, *b*, which is connected with the gas supply, is of rather small bore, while the tube, *c*, opening into the outer air, is of a relatively large bore.

The chimney, *B*, is first removed and the gas lighted at the end of the tube, *b*, at *g*, and regulated so that the flame is only about half an inch long. The

very small glass tube, *k*, is bent and carefully inserted in *c* and then the gas slowly passed through it, a tiny blue flame, *f*, will appear in the larger flame. This is a flame within a flame. To summarize, we can say that the flame, *e*, is gas burning in air; the flame, *d*, is air burning in gas; and the flame, *f*, is again gas burning in air. All of these phenomena are taking place at the same time.

An examination of the actual structure of the flame is interesting and instructive. It can be very clearly illustrated by a diagram of the ordinary candle flame shown in Figure 3.

The candle flame has three primary zones. The central zone, *a*, consists of volatile compounds which do not burn. The zone, *b*, is the luminous zone, while the outer zone, *c*, is non-luminous.

When a candle is lighted, the following changes take place: The stearin is first melted and by capillary action the liquefied stearin is drawn up into the wick. The heat volatilizes the hydrocarbons forming the central zone, *a*, in which there is no combustion. The ex-

bon in the mid-central zone of the candle flame can be shown by inserting a cold glass rod into it. The carbon particles will adhere to the cold surface and be deposited in the form of soot.

The third part of the flame is the non-luminous outer zone, *c*. In this zone combustion is complete. The carbon which is present in the central cone passes outwardly and is burned completely in the zone, *c*, with the formation of carbon dioxide.

Flames may be so nearly non-luminous as to give little or no light. The hydrogen flame produced by the combustion of hydrogen gas in air is almost invisible because water is the end product and there are no solid particles of carbon to be heated to incandescence.

The familiar gas flame, very luminous from its incandescent carbon particles, can be made almost non-luminous by introducing a large amount of air and letting it mix with the gas before it burns.

Every substance which will burn has to be raised to a certain definite temperature before combustion takes place.

This temperature is called the temperature of ignition and is fairly constant for a given substance. Every gas has its kindling temperature. This ignition temperature must be reached before the flame will appear, or, in other words, before the gas will burn. The following experiment illustrated in the diagram in Figure 4 shows this:

A and B are two squares of close mesh wire gauze clamped in the holders of the stand, P, as shown in the diagram. If the gas is turned on the burner, D, and a match applied above the gauze, B, the flame, E, will appear and burn while the space, G, between the bottom of the gauze and the top of the burner will be cool and free from flame.

This is because the wires of the gauze conduct the heat produced away so fast that the gas rising from the burner un-

der the gauze is not heated to its ignition temperature. But if a light is applied below the gauze, the flame will burn both above and below the gauze as shown on the left. In this case, the match raises the temperature of the ascending gas high enough for it to ignite.

This principle was long ago utilized in the miner's safety lamp. The light is enclosed in a screening of fine wire gauze. If such a lamp is carried into the atmosphere of a mine containing an explosive mixture, the dangerous gases are not ignited. Instead, they simply pass through the meshes of the gauze into the lamp and burn quietly there.

The actual temperature of the average flame is much lower than might be supposed from theoretical considerations. For instance, when hydrogen gas burns in oxygen, the calculated temperature is

6600 degrees Centigrade, but if the temperature is actually measured it will not be found in excess of 2500 degrees Centigrade. There must be some basic reason for such a great discrepancy.

The temperature of 6600 degrees Centigrade could be obtained at a given point if oxygen and hydrogen united instantaneously and completely, and if the steam formed were not again dissociated partially into the component gases. At 1300 degrees Centigrade the formation of water is checked by the opposite process of dissociation of steam by heat. This process of dissociation absorbs heat, so the theoretical temperature of burning hydrogen cannot be obtained. The combustion cannot take place at any particular point but must be gradual throughout the whole extent of the flame.

Construction of Thermo-Electric Cells

By Roy Franklin Heath

THE thermo-cell or battery is a device which is capable of converting radiant heat waves into electrical energy. The action of these cells is not clearly understood by scientists.

All of the metals have been classified and their thermo-electrical properties are fairly well understood. If two dissimilar pieces of metal are brought in contact and the junction heated, an electric current will be produced. If just two pieces of metal are employed to form the battery, the current produced will be almost beyond measurement with the crude means generally at the disposal of the experimenter. For this reason, a number of pieces of metal are used, which cause a measureable current to flow in the circuit when the heat is applied.

Figure 1 gives a design for a small thermo-cell made by zinc and metal plates arranged alternately in the same manner as the plates of a Volta pile are grouped. There should be a lead plate at one end of the cell and a zinc plate at the opposite end of the cell. The cell shown was designed to be used with a Bunsen burner or alcohol lamp as the source of heat. The lead plates are three inches in diameter and the zinc plates two and one-half inches in diameter.

Figure 2 illustrates a different type of thermo-battery which receives its heat from the sun. The heat waves are brought

to a focus by means of a parabolic reflector (2). Bismuth plates (5) and antimony plates (4) form the active elements of the battery. These are arranged upon a standard which is mounted in the center of the reflector so that the battery will be in the focus of the heat waves.

A third form of thermo-cell is illustrated in Figure 3. This, too, employs a parabolic reflector and a concentrating lens. The cell makes use of the electro-thermic properties of the metals zinc and lead. An especially long type of cell is employed in this case.

The best time to experiment with thermo-cells is during the summer months. This is especially true in the northern regions of the country.

To carry on experiments with thermo-cells and electro-thermic phenomena, a good sensitive galvanometer or electrometer is needed for current detection and measurement.

In work of this nature, the experimenter has before him a very little explored field. Great possibilities lie with thermo-cells. The problem of converting heat waves directly into electric current will probably be solved through the medium of the electro-thermic cell. The construction of the simple cells outlined in this article will do much to give the experimenter a start in this interesting study. At the present time, the world is just waiting to crown the man with glory who is able to produce a practical cell capable of rendering commercial service.

An experimenter named Seebeck discovered the method of producing electro-thermic currents in the year 1822.

In 1834, Peltier discovered a phenomenon which is the converse of that discovered by Seebeck. Peltier found that if a current of electricity was sent through a junction of dissimilar metals that the junction is either heated or cooled depending upon the direction of the current.

It may be possible to produce an intense cold by the use of this peculiar effect.

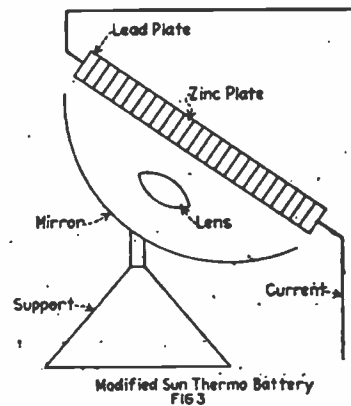
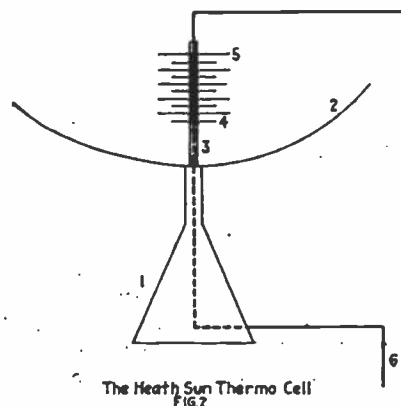
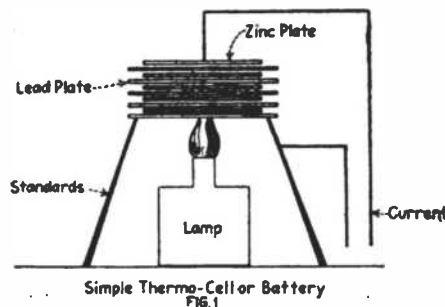

EVERYDAY MOTORIST

Garage Heater

THE outfit illustrated consists of a small box or house close to the rear of a garage in which an oven of fire-brick is placed on the ground to surround a burner supported to clear the ground. The four-inch gas burner is placed in the center of the oven and connected through a shut-off valve to the gas supply of the house-lighting

warm and the car ready for use at a moment's notice. The degree of heating is easily controlled and the only precaution is to see that the heating can and pipes and the tank of the radiator are kept full and that the upper pipe slopes gradually upward and does not sag or kink anywhere, otherwise air or steam locks may stop circulation.

loose. At 2, the right way is shown, as the head is pounded down firmly in the slot of the nut and the ends of the pin are securely held as one end is pounded back over the end of the bolt, the other leg being bent down. The cotter pin is a positive lock when installed in this manner.

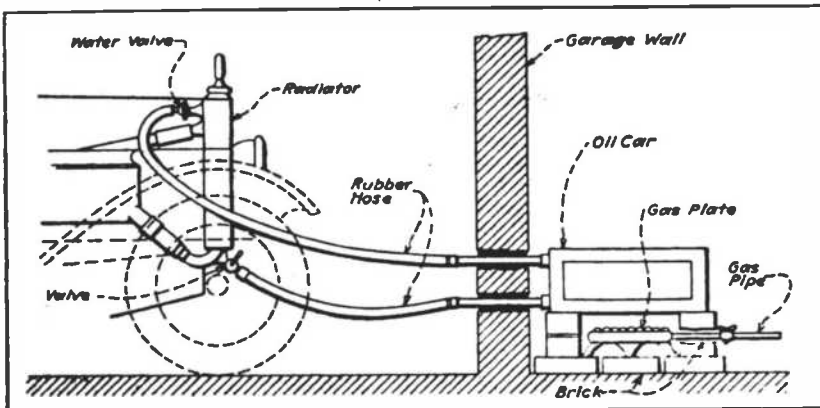

Simple heater for garage

system. A two-gallon gasoline or oil-can is placed over the burner setting on the brick sides of the oven and clearing the burner three or four inches. Two 3/8-inch pipes were run from the side of the can through the wall of the garage, one pipe above the other. The pipes are attached to the can by soldering brass nipples to it. Rubber tubing, 1/2-inch bore, leads from the pipe to the radiator of the car, the lower tube being connected to the drain petcock and the

Proper Use of Split Pins

THE most common form of nut retention is by employing a split pin in connection with a castellated nut. A number of tools have been described for cotter-pin removal, but many owners of cars do not possess anything but the tools furnished with the repair kit. Two methods of doing this work easily which do not require the use of a special tool are shown. One of the best ways for getting an ordinary split pin out of the hole is shown at the top of the illustration. The pin is grasped between the ordinary combination plier jaws and a hammer is used against the plier to draw out the pin. The other method, which is shown below, consists of inserting a steel drift pin or nail-set through the hole in the cotter-pin head and then striking the drift with a hammer. It will be found that the removal of the pin will be expedited considerably by squeezing the ends together, if they are spread, with the pliers before attempting to withdraw the pin from the hole. It is not generally known that there is a wrong and right way to do such a simple thing as securing a split pin. These are shown at 1 and 2 in accompanying cut. In the former, the head of the cotter is not in the slot of the nut because it is turned wrong and the ends are not split right. This combination may work

Simple Priming Devices

SEVERAL simple priming devices may be constructed by anyone of average mechanical ability to facilitate motor starting in cold weather. One such equipment is shown herewith and comprises a dash priming cup, tubing connecting it with the intake manifold and a spraying device, which is shown separately in the drawing. It will be noted that the last named member is perforated. To utilize the primer a little gasoline or ether is poured into the cup on the dash and the lever turned slightly to admit the fluid, also a little air. The fuel flows through the tube to the perforated member and upon cranking the engine the air drawn in through the choked-down air-intake of the carburetor and petcock breaks up the fuel, converting it into a rich mixture.

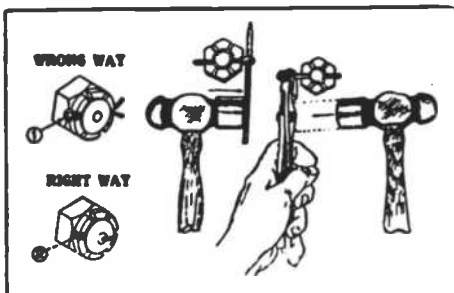

Proper use of split pins

upper tube is carried in an easy curve to a petcock soldered at the top of the radiator inside. When the automobile is run into the garage for the night the hose are connected at the top and bottom of the radiator, the petcocks opened and the gas lighted at the burner. The water will heat in the tank and a circulation will be started through the radiator that will keep the cooling liquid

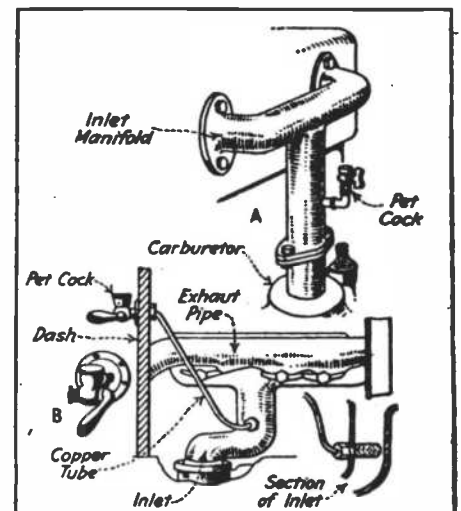

Simple priming devices

It is stated that the motor will start readily even in the coldest weather. The material required to install the primers consists of a petcock, which is secured to a plate on the dash, a connector having a tubing and pipe-thread end, one-quarter-inch annealed copper tubing, and a union. To the last named is soldered a piece of brass tubing which is drilled full of No. 62 drill holes. Its length should be approximately that of the diameter of the intake pipe, into

which it is inserted by drilling and tapping a hole. The manner of installing the parts is clearly depicted in the drawing. It is stated that the equipment described can be made at a slight cost. A simpler installation is also shown, this consisting merely of a petcock threaded into the intake manifold. It has the disadvantage that it is inaccessible as it can be reached to be filled only by raising the hood. The owner of a Ford states that he has obtained increased mileage by the use of the primer, as the petcock on the dash may be opened to admit auxiliary air. In average running in warm weather he has secured 26.5 miles to the gallon and 32 miles on long trips.

Warming Manifold for Easy Starting

ONE finds numerous instructions for easy starting of a gasoline engine under conditions of low temperature when the gasoline does not evaporate readily. Some writers have recommended the use of hot cloths heated by being saturated with boiling water, others have advised to heat the manifold with an ordinary blow torch.

The necessity of keeping the naked flame away from gasoline is apparent to any one familiar with this liquid and it is also evident that water dripping from a saturated cloth in through an auxiliary air valve and freezing would cause considerable trouble on account of being matter out of place. An excellent method of heating a carburetor or manifold without any danger is to use a tube of cloth or long bag which is filled with sand and heated in an oven, after which it may be wrapped around either the carburetor or manifold as

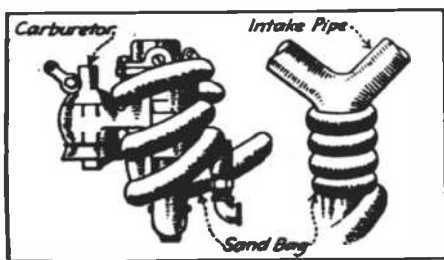

Safe method of warming manifold

shown without any danger of fire as is present when a torch is used or getting ice into the carburetor as is possible when wet cloths are employed as a heating medium. Electrically heated primers are now available that will assist in easy starting; these are not expensive and can be installed without much trouble.

Tighten the front spring clips occasionally. This may prevent a broken spring or the axle shifting out of line and greater safety will be insured together with less tire wear.

Cover for Mudguard

AUTOMOBILE repair men, the opinions of many car owners notwithstanding, do not like to be called upon to make embarrassing apologies for scratching, marring and otherwise damaging the varnish on mudguards, hoods and car bodies while they are undergoing repairs in their shops.

The accompanying illustration shows a new fender protector that can be easily made by the mechanic or that may be purchased on the open market.

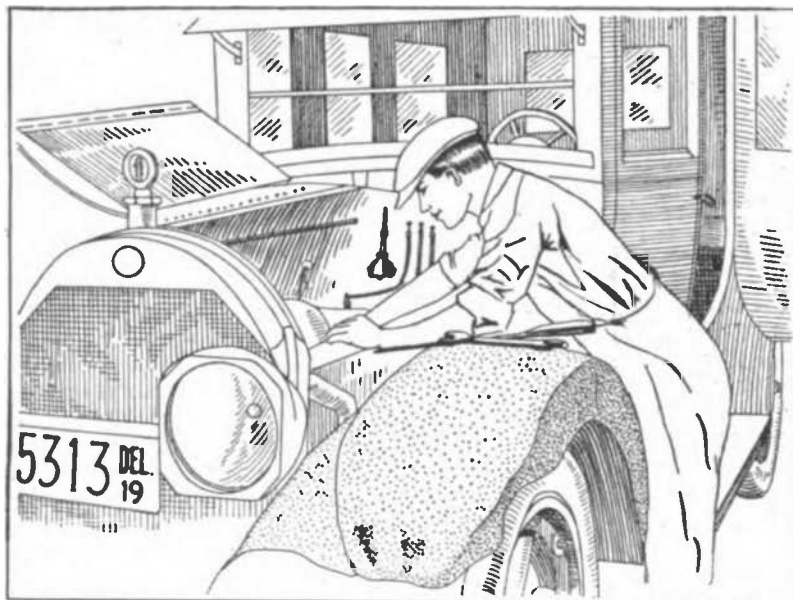

Cover to protect finish of mudguards

It is made of a leather substitute consisting of a strong cotton fabric base coated with pyroxylin "dope." It has a pocket along the outside edge into which the edge of the mudguard is inserted. A flap on the cover runs down the inside in such a way that the finish is entirely covered while the mechanic is leaning over it to work inside the hood. Thus the buttons on the clothing cannot scratch the varnish, nor is any harm done if he drops a tool or lays it down on the mudguard, which is a very handy receptacle or shelf for tools and parts not in use.

Motor Fuel Intensifiers

MANY ideas have been advanced for adding substances to motor gasoline to increase its volatility, fuel value or give it carbon removing properties. There is considerable difference of opinion regarding the value of such agents.

The best one unquestionably is ether. Of course ether cannot be put into a tablet or powder form. As a matter of fact, ether is so powerful that one can use kerosene to run a gasoline engine if he fortifies it with ether sufficiently. Most of the carbon Removers are nothing more than "Flake Tar Camphor" compressed into cake form or dissolved

in gasoline. Manufacturers of these claim that besides removing carbon, it also gives more power and more mileage. It may do all three, but authorities are now almost convinced from actual experience that it does not do any of the three. A mixture that would do for both more power and mileage, and also for removing carbon, would be as follows:

- Ether1 part
- Acetone1 part
- Turpentine1 part

One ounce of this to 5 gallons is said to be enough to show results, and its advocates do not recommend more than 1 oz. to 2 gallons of gasoline.

When lubricating the car, look for oil holes that are stopped up with mud and clean them out with a piece of wire. All holes should be covered with an oil cup, but sometimes manufacturers do not take this precaution, leaving the holes open, especially on brake cross shaft and clutch pedal shaft support bearings. If the impediment is not removed the oil cannot reach the bearing surfaces. Do you fill the universal joints about every 500 or 1,000 miles? Perhaps you are wondering why the car is noisy in action. Don't wait until they squeak or develop back lash but be sure to keep these hard working parts properly oiled.

Watch your steering mechanism closely. Do not allow too much lost motion in the wheel. A careful inspection should be made from the wheels back to determine that all parts of the steering linkage are tight and properly adjusted. Periodical adjustment and lubrication will insure not only easier control of the car, but greater safety as well.



THE JUNIOR EXPERIMENTER

A Cardboard Model Passenger Steamer

By Edward Beal

FOR a model dock, on a railroad system of $\frac{7}{8}$ in. gauge, this water-line steamer was made by the writer some time ago. The model cost absolutely nothing to make, all material being waste or surplus. The vessel is exactly 3 feet in length by about $4\frac{1}{2}$ ins. maximum beam. Since it was modelled merely to occupy a spare corner on the dock itself, there was little need for strength to be considered. Yet the model is strictly designed to a scale of $\frac{3}{16}$ of an inch to the foot. It has been called a passenger steamer, though it can also claim to be equally a freighter, the passenger "accommodation" only occupying a few inches. It was originally built as shown in the first photograph, but was afterwards dismantled as it was not exactly to scale, the finished product being that seen in the other photos.

The hull was made from stout strawboard, cut from empty boxes obtained free from a dry-goods store. The pieces were fitted together with glued inside tabs, being cut to shape before being assembled. A similar base was fixed with strong pins, and the various decks were thus placed in position as the design stipulated. The decks were given the necessary curve to centre, being afterwards covered with gray, or pale brown paper, exactly to the color

forced into holes which are first pierced in the panel centers. The hatchways, which look very realistic, though they cannot be seen on the photographs, are made from the lids of Remington ribbon tin boxes, a piece of thick paper being stuck on the top, lined out as planking with a compass point, and painted. The ventilators, always very expensive items to buy from the various manufacturers, are simply short lengths of $\frac{1}{8}$ in. iron wire, hammered over to shape and painted, afterwards being driven through the decks to the base. Handrails and staunchions are of white thread and headless pins, the latter painted after the model was completed,

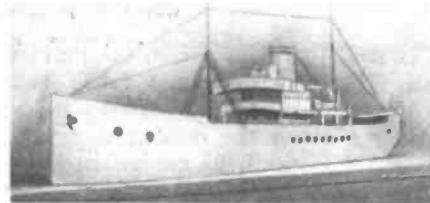

A side view of the finished model steamer
the enamel holding the thread in strict position. Davits and deck staunchions are of $\frac{1}{16}$ in. iron wire, straightened carefully and enamelled white. The ports in the hull consist of the large type of shoemakers' eyelets, being

real. Two small bell terminal bases were put together, the flanged ends outward, and a small watch wheel was then fixed with the terminal screw to the wrong end of each terminal. The result was a long brass bobbin with a wheel at either end. One of the wheels is a block and the other spoked. This portion was then placed on a pair of bearings which were glued down to the deck between the bows. The masts are made from disused paint brush shafts, the hairs being cut off and a piece of wire lashed on for a top-mast. The funnel is a Kodak film can, covered with white paper, a red band being attached to it. Rigging cord is black thread.

The hull was not painted, as paint on such a small model would tend to produce a thick and heavy look, but the whole was covered with white paper, trimmed after attaching. The life boats presented the most difficult task, but when once set about they were made in ten minutes. A small piece of wood was whittled with a pocket knife roughly to shape, after which the model was trimmed thoroughly with coarse and fine sandpaper. The steering wheel is a small watch-gear, painted brown. Aft the boat deckhouse is a ladder and handrails leading to the main deck.

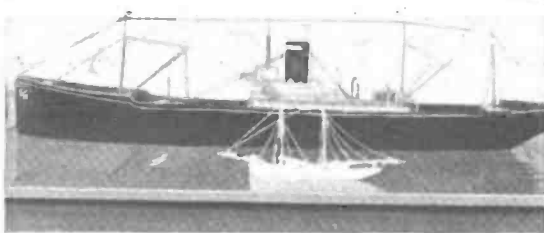

At the left is shown the boat and a small sailing vessel at its side. The right shows another view of the completed boat

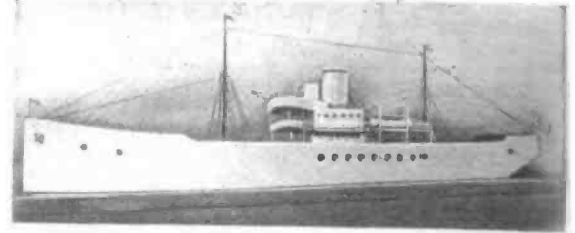

required. These decks, after thorough drying were marked out with a soft black pencil and straight edge, afterwards being placed in position. The deckhouses are of cardboard, glued into position, and marked out with deep black ink. In the center of each panel on the walls a porthole is fitted. The ports on the deck houses consist of very small eyelets used by shoemakers to make laceholes. These are merely

brown. For hawse pipes on the deck and hull four of these eyelets were nipped in the pliers and took the exact shape required. Those on the bows of the hull are black, to contrast with the brown ports. The anchors are of cardboard, cut strictly to scale. A length of cable passes from the concealed ends of the anchor stocks and is wrapped twice over the winch. The winch is made in a very simple manner, but it looks quite

This was the only accessory on the whole model to be purchased.

When completed, the vessel's appearance is very imposing, and it occupies an important place on the model dock already mentioned. Its "waterline" nature is no deprivation, since the dock is lined out with polished glass, laid on dark brown paper. The reflection of the ship in the water is no small factor in its realistic appearance.

Well-Designed Crystal Detectors

Ideas for Making Crystal Detectors Are Suggested by These Types Built by the Wireless Specialty Company

AS is true of any radio instruments, the design of detectors must not be of the stuck together sort if the results are to be satisfactory. The extra work and expense of making good apparatus is always repayed in

small hole in a wooden or metal block, or by putting a brass rod in a length of brass tubing. The alloy may be soft solder and mercury. Setting the crystal is just a matter of putting a little alloy in the mould, and, when it is nearly

moved in and out or to either side. A third handle varies the pressure of the contact.

Three stands of the same type are shown in Fig. 2. A universal adjustment is provided by the ball and socket

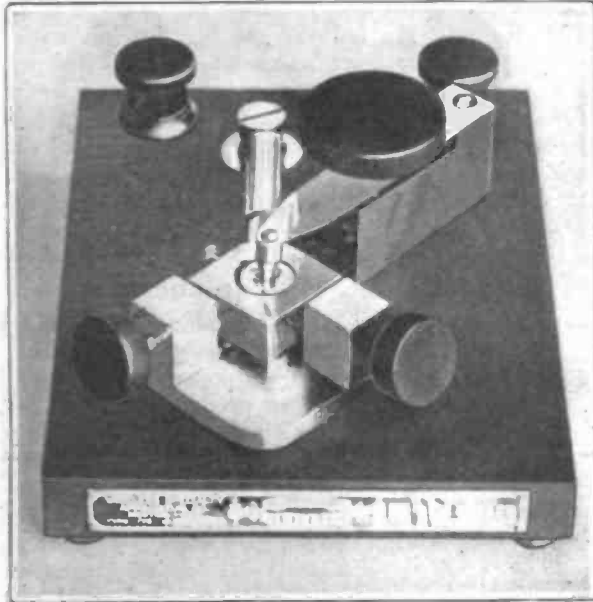

Fig. 1. While a universal adjustment is provided, the construction is so rugged that the detector will not jar out

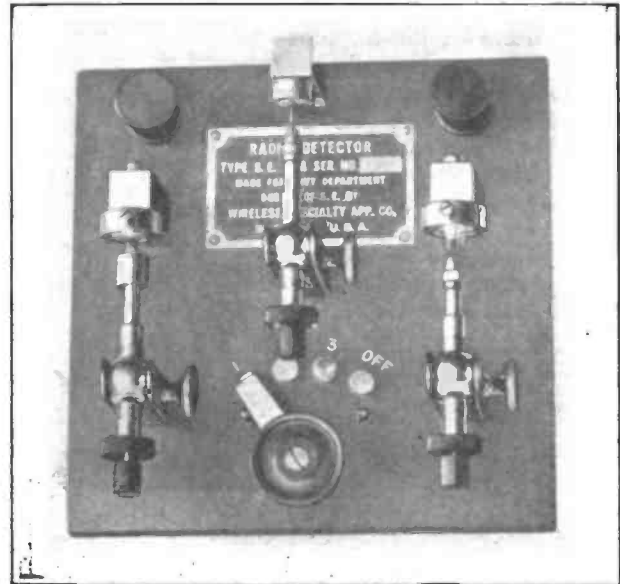

Fig. 2. The excellence of this design lies in the ball mounting and the adjustable spring tension

results and pride which can be taken in creditable work.

One of the first points is the crystal mounting. A detector crystal is not intended to be set in suspender clips, bent safety pins, spring binding posts, but put in a secure mounting which

cool but still liquid, pressing the mineral in it.

Four detectors, manufactured by the Wireless Specialty Apparatus Co., are shown as examples of good construction.

The type in Fig. 1 has three adjustments, two lateral and one vertical.

which can be set by pressing the supporting strips together with a thumb-screw at the side. The contact is carried by a rod in a threaded barrel. This barrel can be screwed in or out of the ball, thus varying the tension of a spring located inside of the barrel

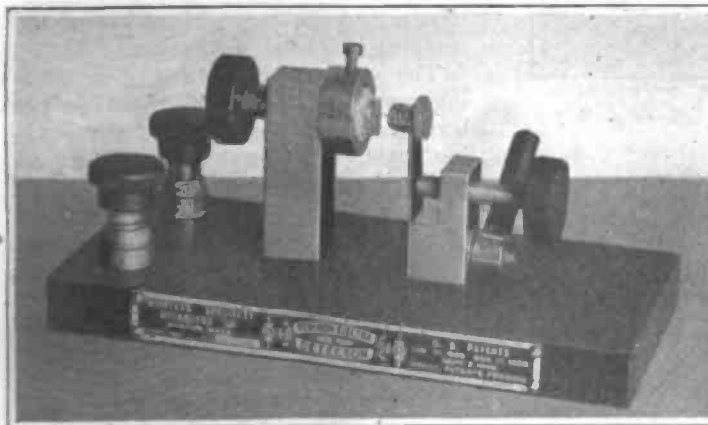

Fig. 3. Once adjusted, this galena detector will hold its setting, for it is both rugged and delicate

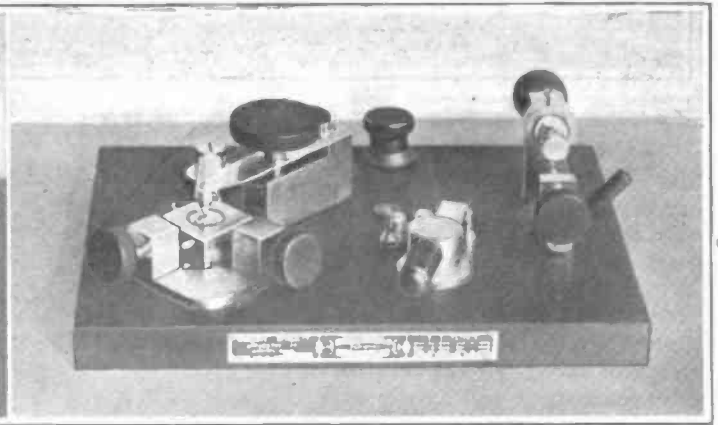

Fig. 4. Galena and silicon make an excellent combination of ruggedness and sensitivity. The switch is unusual in design

furnishes a proper contact with the crystal. It is necessary, of course, to try out the crystal before mounting. This can be done in a simple stand. Then when the sensitive spots have been located it should be set in an alloy.

A mould can be made by turning a

The metal block which holds the crystal carries a rod which is fitted in a tube secured to a pivot screw. Inside the tube is a spring pushing against the rod, so that the crystal block is pressed against the two adjusting screws. By turning these screws the crystal can be

which presses the contact rod forward.

Fig. 3, a galena detector, needs no explanation, as the design is an excellent example of the simplicity which should be characteristic of radio instruments. In Fig. 4 a combination of Figs. 1 and 3 is shown.

AVIATION BRIEFS

Metal in Airplane Construction

IN endeavoring to find a satisfactory substitute for spruce, which was hard to obtain in the required quantities in England during the war, Messrs. Vickers, builders of the machine that made the first non-stop flight from America to Europe, tried a number of experiments with metals of different kinds for the framework of aerofoils. Both high tensile strength alloy steel and duralumin were tried. Steel was not suitable for building pieces of thin section that had to be heat-treated on account of distortion during the heating process. Test spars for various ma-

method of manufacture of rubber coatings, says a writer in "Aviation." The best of the modern airship fabrics seldom have a permeability of less than 8 liters per square meter (.236 cubic feet per square yard) in 24 hours, measured at 25 degrees Centigrade (77 degrees Fahrenheit). Thus it comes about that there is always some diffusion of air into, and of hydrogen out of, a balloon, quite apart from the leakage of hydrogen which takes place through holes in the balloon when the pressure inside is greater than the pressure outside. The relative rates of penetration of rubber by hydrogen and air are not the same but are in the ratio of four to one;

gen in the gas, is very small on account of the small difference in the densities of these gases. The determination of the oxygen content may be useful, however, from another standpoint, that of the determination of the stage at which the balloon gas becomes an explosive mixture. This stage is reached with a greater percentage of pure hydrogen than would be ordinarily the case, since the oxygen content of the "air" diffusing into the balloon is so high.

A British Commercial Airplane

WHAT is claimed to be the first airplane designed entirely for commercial purposes in England has recently been produced by the British Aerial Transport Co., Ltd. Although the span of the machine is only 46 feet, with a length of 33 feet, the cabin accommodation is 8 feet by 3 feet, and is high enough for the passengers to stand upright, while its seating arrangements are in the form of upholstered revolving bucket seats. Heating from the exhaust is provided when necessary and the admission of the heat is controlled by the turning of a button and it is claimed that inside the cabin there is no noise from the engines. Wireless telephones are installed for the purpose of communication with ground stations while in flight.

The engine is Rolls Eagle Series VIII, of 12 cylinders and 375 horsepower, and the range of action of the machine is 6 hours-600 miles.

The very useful feature of a landing speed as low as 40-45 miles per hour has been attained, and the landing chassis incorporates rubber and oil shock absorbers—working on much the same principle as the recoil mechanism of a gun. Another novelty in the construction of the machine is the provision of trimming gear, which enables the incidence of the horizontal stabilizer tail-plane to be varied according to the load carried and thus maintain a constant center of pressure, although the center of gravity may be other than the normal due to disposition of passenger load and its varying weight.

Caleb Bragg, flying a Loening hydro-monoplane fitted with a 300 h.p. Hispano-Suiza engine, established at Port Washington, L. I., a world altitude record for seaplanes by ascending to 18,500 feet with a passenger.

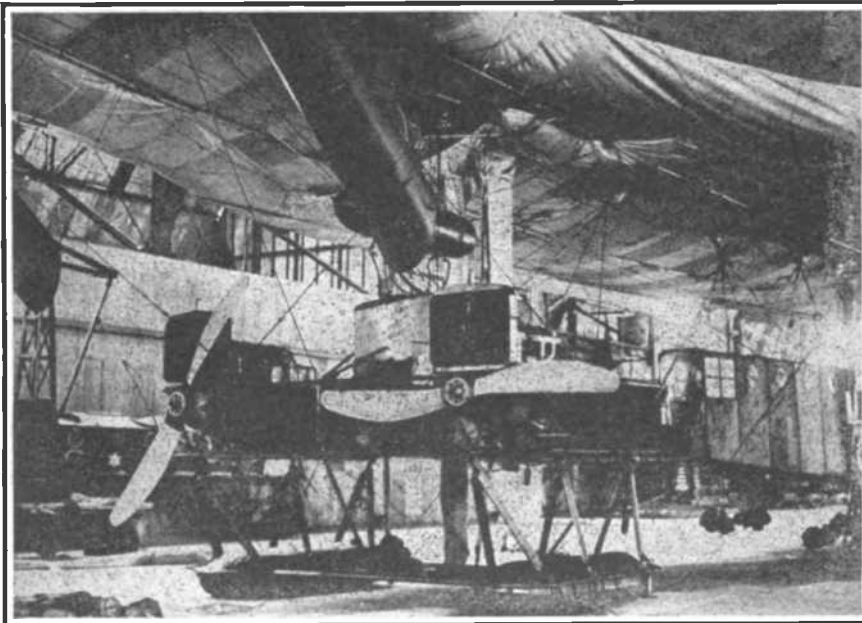

The power plant arrangement of a British non-rigid type dirigible balloon used for coast patrol duty

chines were made of duralumin and these showed a saving of 25 per cent in weight over spruce members of the same strength. Wing frames made entirely of duralumin spars and ribs were made of equal strength to wood construction at only 75 per cent of the weight. A seaplane of very large size is being built by this firm which will have a total lift of fifty tons in which all important structural parts will be built entirely of metal, steel in some parts and duralumin in others.

Gas Leakage in Dirigibles

PERMEABILITY to gases is an inherent property of rubber and it can only be modified, not eliminated, by the

that is, when the envelope contains approximately pure hydrogen, one volume of air passes through the fabric into the balloon for each four volumes of hydrogen leaking out. But the "air" passing into the balloon is richer in oxygen than normal air, owing to the fact that rubber is about twice as permeable to oxygen as to nitrogen. The method of determining the purity of balloon gas by measuring its oxygen content and assuming that nitrogen is present in the proportion in which it occurs in air is therefore obviously in error. A better method is to determine the specific gravity of the gas in the envelope, when the error in estimating the purity from the result, without actually finding the relative amounts of oxygen and nitro-

The Hydrodrome, a New Gliding Craft Capable of a Speed of 70 Miles Per Hour

THE inventor of the telephone, Dr. Alexander Graham Bell has just completed a gliding craft that will skim over the surface of the water at record speed when the two Liberty Navy type or low compression aircraft engines are opened up. The energy available is 350 horsepower for each engine or an aggregate of 700 horsepower, and the thrust that produces the record-breaking speed is obtained from two four-bladed propellers. As will be noted from the accompanying illustration, the craft is of very novel construction and applies

lifting the hull clear of it, is by no means new. Cooper-Hewitt in this country and the engineer Folanini in Italy both have experimented with superposed hydrofoils and even the early types attained considerable speed.

and are large at the top and gradually become smaller as they near the bottom of the shutter-like frame. The rear set is used for steering. As the speed increases, the hull rises up more out of the water because less surface is needed to carry the weight as the velocity augments, just as in an airplane working in the lighter medium.

It is stated that the hydrofoils are supporting a ton load per square foot when the machine is making about 60 miles per hour. At one-third that speed, enough surface is immersed so the load is about 300 pounds per square foot.



The hydrodrome at rest on the water is shown at right

Dr. Alexander G. Bell seated in the cockpit of the hydrodrome

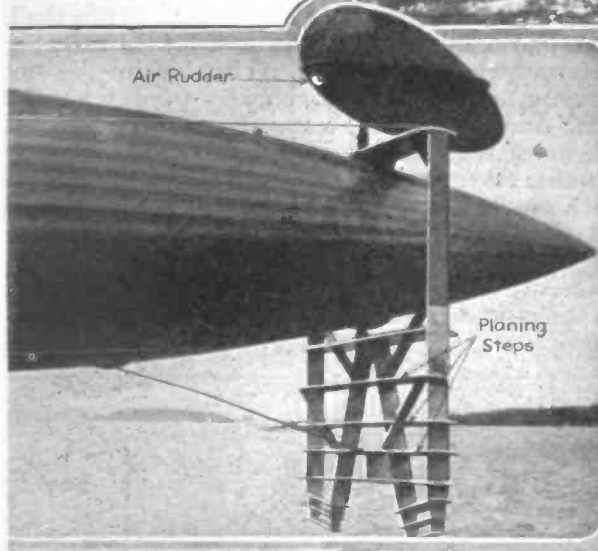

The rear planing steps which also act as a rudder



When the hydrodrome is at speed it rides on planing steps

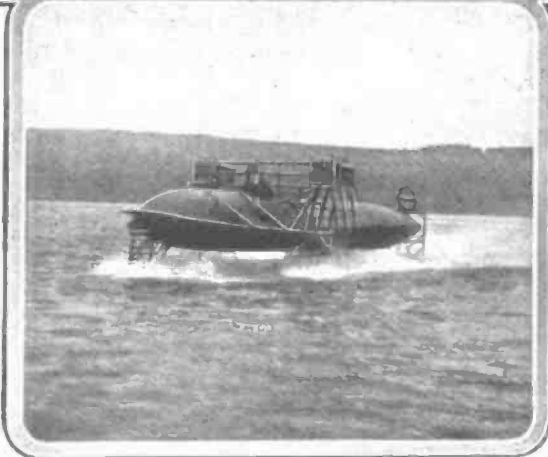

aeronautical engineering principles to a creation designed to operate in a medium having a specific gravity 800 times greater than that of air. Owing to this, the steps or hydrofoils needed to support the craft at full speed need be but 1/800th the area of the aerofoils that would be needed to carry an airplane of the same weight.

The craft is neither seaplane or hydroplane, though it operates on principles common to both of these craft. The main idea, that of reducing the resistance of the supporting medium by

The photograph shows details of the steps, and while only those at the rear end of the hull are shown, it is easy to understand how similar planes are also installed at each side of the hull and at the front end. The planes are of steel

Doubling this speed results in ten square feet carrying the load, which is then sustained at a ratio of 1,000 pounds per square foot. The main portion of the craft is a torpedo-shaped hull of good streamline form, sixty feet long, having two outrigger hulls or pontoons sixteen feet long and connected to the main hull by a deck which assists in supporting the motors. This deck is in the form of a cambered top, flat under surface aerofoil, and when the machine is at rest, it is partly submerged



MECHANICAL NOTES

SHOP PRACTICE

FOR AMATEUR MECHANICS

A File Rest and Index Head for Small Lathes

A VERY handy attachment for the amateur's lathe is a File Rest in combination with an indexed head. In making any small mechanical devices there is generally some part which has to be square or hexagonal. The usual amateur's equipment seldom includes a shaper or milling machine. Thus, it becomes necessary to worry the piece to shape with file and square, and the result—for most of us—is never quite satisfactory.

The little device described here will, to a very large extent, aid in the accurate squaring of small pieces and save a great deal of time and trouble; far more than the time it takes to construct it.

We will first describe the method of constructing the file rest. This particular attachment was designed to fit the amateur's bench lathe No. 125 made by the Goodell-Pratt Co. Leg A, Fig. 1, is cast square, as it is less difficult to make the pattern for a square casting than for a round casting. The

pattern is cut from a solid piece of wood. Soft pine is probably the easiest to work, although mahogany or cherry are undoubtedly the best on account of their freedom from warping. A jig saw is the easiest way to cut the pattern, especially with one on which the table can be tipped. In this case, the table is set at an angle of about 85° which will give the requisite draft. The cuts are taken in opposite directions (see Fig. 1), and followed around the outline of the piece. The metal used is crucible steel, although if the amateur desires to save time in machining, cast iron may be used. Of course, the piece may be forged, but for anyone capable of this method of construction there is no need of instruction. Another method is to saw the whole piece from cold-rolled stock, but unless there is a power saw available this method will be found exceedingly tedious.

On receiving the casting from the foundry it should be treated as follows: First run it over an emery wheel to re-

move the scale. Next centers 1 and 2 (Fig. 1) should be prick-punched. In doing this, be sure that the line between the centers passes down the center of the leg and is as nearly parallel to faces B and C as possible. The casting is next center drilled on these marks, set between centers and machined to the finished size. In machining, it will be found necessary to compensate for the off-center weight of the casting by mounting a weight on the opposite side of the face plate. Unless this is done it will not be possible to machine the stock truly. Scribe the lines E and cut the slot for the rollers with a hack saw. The sides of the slots are next filed up as true as possible with the center line of the leg A. It is better to make the two slots of the same width as in that case the rollers will be interchangeable. Next comes the task of drilling the holes for the roller pins. The centers of these holes are found by scribing lines F which should be as nearly parallel as possible to the bed of

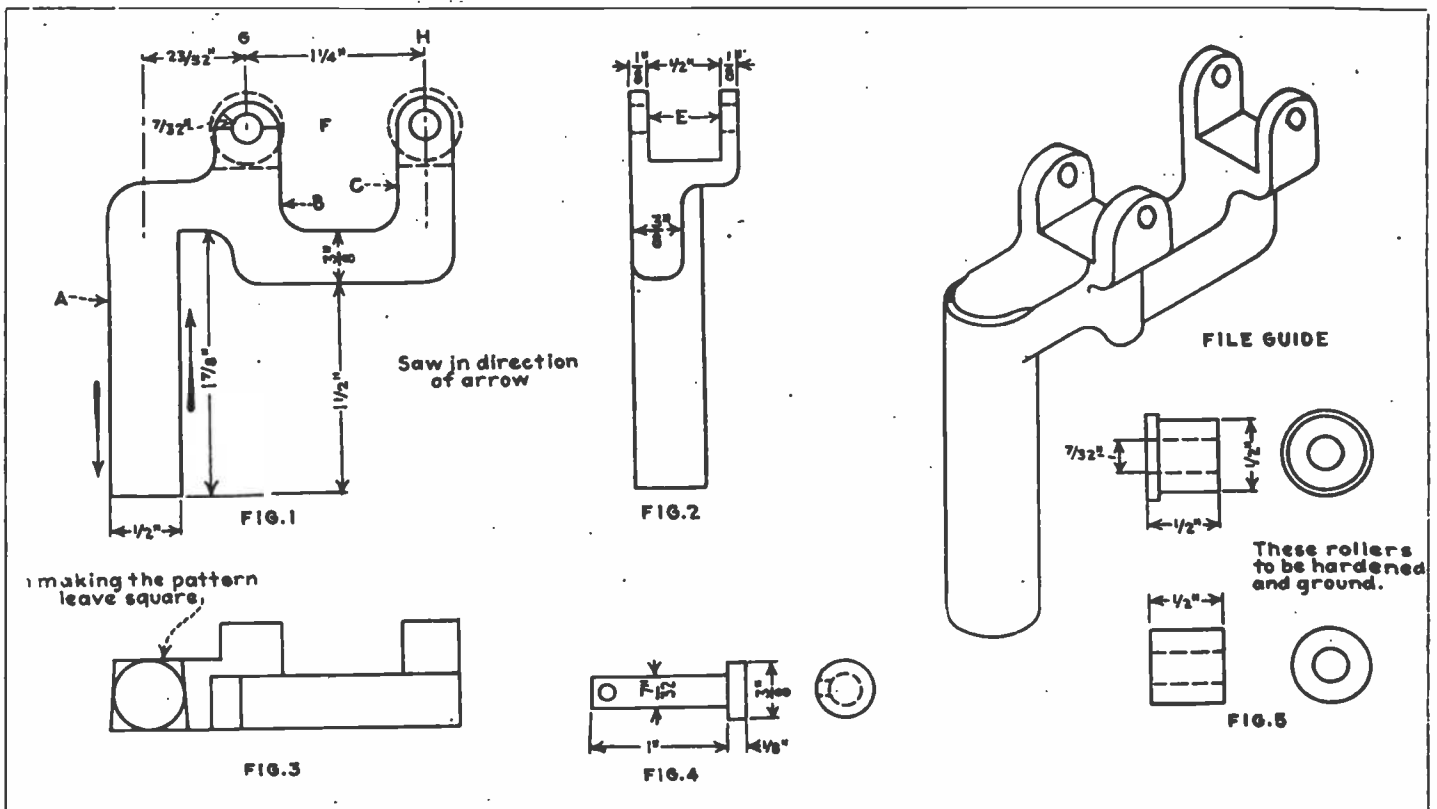

the lathe when the casting is set in the tool rest. One of the easiest ways of doing this is to place the casting in the tool rest and a scribe in the tail stock. Place the tool rest on the ways and set the casting to the desired height. Press it against the scribe and move the tool rest across the ways so that the scriber will mark a line. The intersections of line F with the center lines G and H of the arms are thus marked and may be prick-punched. The holes may now be drilled, but great care must be taken that the center lines of the holes are parallel to the lathe bed as otherwise the work done with the tool will not be accurate. One method by which the

when squaring up to a definite point, while the straight rollers would be used for longer pieces.

The purpose of the index head is to hold the stock fixed in one position while one side of it is being filed and secondly to rotate the stock through any desired angle. A simple and practical method of construction is shown in Figs. 5 and 6. No exact dimensions are given for the reason that in the majority of cases the design will have to be modified to fit the size of the machine and the needs of the operator.

The device is made up as follows: A $\frac{1}{8}$ -in. by $\frac{1}{2}$ -in. cold-rolled steel bar is clamped around the head stock, as

begin with, center a piece of stock and turn it down to $\frac{3}{16}$ -in. diameter. Place the file in the guide in the tool rest so that the arms surround the $\frac{3}{16}$ -in. stock. Place a flat bar of known thickness on the rollers and above the stock. Adjust the height of the rollers until the distance from the top of the flat stock to the bottom of the $\frac{3}{16}$ -in. piece is equal to the thickness of the flat stock plus one-half of the diameter across the flats plus one-half the diameter of the stock on centers. In the illustration given, if the flat stock is $\frac{1}{4}$ in. then the roller should be adjusted so that the distance from the top of the flat bar to the bottom of the turned piece is equal to $\frac{1}{4}$ in. plus $\frac{3}{32}$ in. plus $\frac{1}{8}$ in., or $\frac{15}{32}$ in. The height of the rollers having been properly adjusted the stock which it is required to square is placed in the lathe and filed. One side of the squared surface is thus obtained, and by means of the index head the other three surfaces may be accurately obtained. In squaring holes or cutting key-ways a file of the proper width is obtained, the rollers raised to such a height that the center of the file is on a plane with the center of the stock, and the file forced against the work.

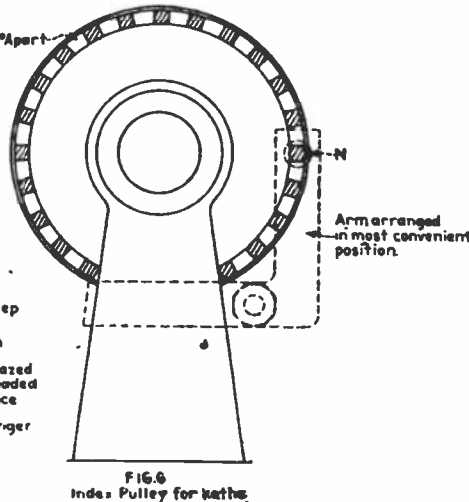
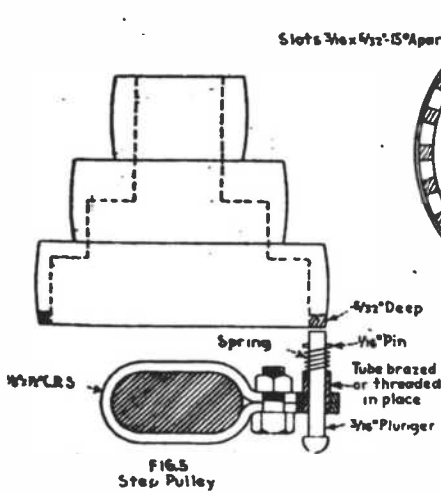

holes may be accurately lined up is described as follows: Place the casting in the tool rest and parallel with its foot or base. Clamp the tool rest at right angles to the ways (a fairly accurate right angle setting may be obtained by use of the try square). Chuck a $\frac{7}{32}$ -in. drill and true it up. Loosen the clamp of the tool rest and move the casting till the drill point touches either arm B or C at one of the points which has already been located. Then reclamp the rest making sure that it is still at right angles to the ways. Bring up the tail stock and mark carefully where it center touches the work. After prick-punching on this mark recenter on the point of the drill and the tail stock center. Unclamp the tool rest and holding it firmly down with the left hand force the work against the drill point by means of the tail stock screw. When one side of the arm has been drilled, reverse the work and drill the other side. In a similar manner drill the other arm. If a reamer is handy, drill the holes slightly undersize and ream to the finished size.

The next pieces to be machined are the pins. These are cut from cold-rolled stock and turned up on the lathe.

The rollers are turned nearly to size from good machine steel, then hardened and ground. As will be noted from the drawings there are two kinds of rollers. Those with a shoulder are of great use

shown in Fig. 5. The bar is bent at right angles as shown by the dotted lines in Fig. 6 and a hole N drilled through it parallel to the center line of the live spindle. This hole must be large enough to take the cold-rolled tube shown in Fig. 5. The inside diameter of the tube is $\frac{3}{16}$ in. The tube is brazed or threaded into place. A plunger, likewise shown in Fig. 5, is turned up on the lathe and a hole for a $\frac{1}{16}$ -in. pin drilled through it close to one end. In assembling, the plunger is slipped into place and a light compression spring is placed around the plunger and between the tube and the pin. In the periphery of the driving pulley nearest the head stock, slots are milled into which one end of the plunger fits. These slots should be $\frac{3}{16}$ in. by $\frac{5}{32}$ in. and their center lines placed 15° apart. The amateur is probably not equipped to mill these slots and it is much better to have this done at some properly equipped shop than to attempt cutting them out with hack-saw and file. In sending out the pulley a properly centered arbor should go with it as this will cut down the cost of the machine work to a considerable extent.

A practical illustration of the way the device works is given below. Suppose it is required to square a piece of round stock of $\frac{3}{8}$ -in. diameter; the diameter across the flats to be $\frac{3}{4}$ in. To

A New Caliper

Probably one of the most ingenious and practical tools that has appeared on the commercial market in some time is shown in the illustration. This is a self-reading caliper. Its construction and operation is very simple. It is a product of accurate workmanship and it will give entirely reliable readings.

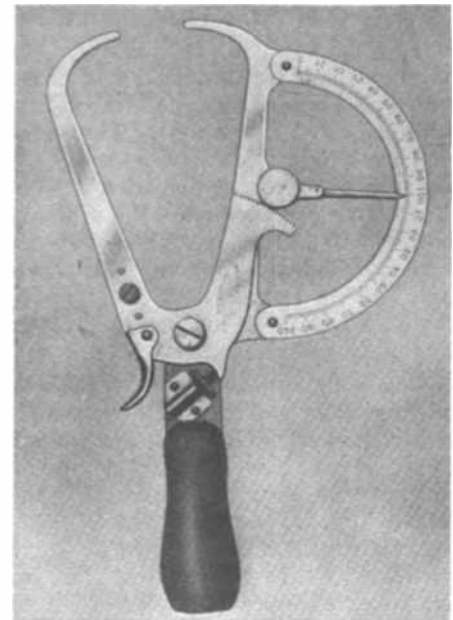

It is made of the best steel beautifully polished. The new caliper is manufactured in different sizes. The one shown in the illustration measures articles up to two inches. The caliper can be set in any position by means of the screw at the side.

A Well-Designed Lathe Tool Holder

THE lathe tool holder shown in the illustration is made from a single piece of steel provided with slots and a small screw clamp. The general idea embodied in this simple, but well-designed tool, will be apparent upon examining the drawing. The tool is provided with slots at each end. One side is provided with a slot $\frac{1}{4}$ in. in diameter for small tools and the opposite side is provided with two slots, one for $\frac{3}{8}$ in. tools and the other for $\frac{5}{16}$ in. tools. The slots to be made properly should be milled out, but this little job need not worry the ingenious mechanic who does not possess a miller. It is not essential that the slots be absolutely true. With a good sharp file, a hacksaw and chisel the slots can be very easily cut in the shop.

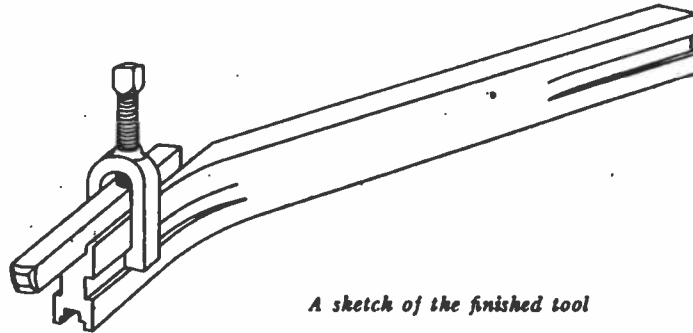

A sketch of the finished tool

It will be seen that one end of the holder is bent a few degrees. This can be done by heating the steel to redness and bending it to the required angle with a vise. Two slots, one on each side, must also be provided for the

drawing is intended for the smaller tools which are used by amateur mechanics on small screw cutting and bench lathes.

A screw clamp can be cut in a solid piece of steel and drilled out in the top to receive at least a $\frac{1}{4}$ in. machine screw with square head, so that a wrench can be used to tighten it.

There are many different types of patented lathe tool holders on the market but none of them seem to be so well adapted to amateur needs as this one which is able to accommodate several different sizes of tool stock.

All other patented tools are only able to use one size of tool stock. This holder can be manufactured very cheaply and sold at a price within the range of all experimental engineers. It contains only four parts.

small screw clamp which holds the cutting tool firmly in position. Tool holders of this type can be made for all ordinary size tools from $\frac{1}{4}$ in. up. The one shown in the

are only able to use one size of tool stock. This holder can be manufactured very cheaply and sold at a price within the range of all experimental engineers. It contains only four parts.

A Boring Bar Holder

By S. C. Swanson

MOST of the boring tools on the market have drawbacks of one kind or another. The ordinary one-piece forged tool is satisfactory in the medium and larger sizes, but has the disadvantage of not being adjustable for rake without grinding. The several patented boring tools are not made for very small work, and the cost of one might, in many cases, be prohibitive.

The toolholder described and illustrated herewith combines cheapness, simplicity and ruggedness. The shape was evolved by force of necessity, as the slide rest screw on the writer's South Bend lathe did not permit the ordinary boring tool to traverse far enough for very small work by reason of its shortness. This accounts for the bore in the holder being so much off the center line of the casting.

The body of the holder should be either cast or malleable cast iron. It should first be faced off on the bottom either by filing or by chucking in the independent chuck and faced off in the lathe. If faced in the lathe, the $\frac{11}{32}$ -in. hole for the holding down bolt may be drilled at the same setting, but for the sake of appearances it is best to drill this from the top so that it may be centered in the boss there provided. This boss should be faced off to provide a suitable bearing for the nut.

The casting is then bolted on the slide rest, so that the center line of the cylindrical part coincides with the lathe centers, and then drilled $\frac{1}{2}$ in. by feed-

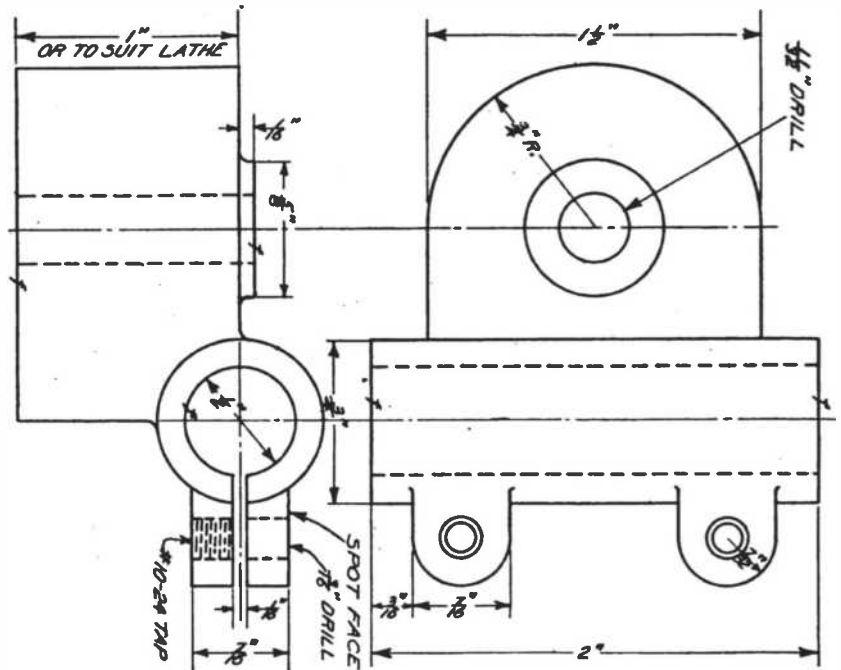

ing up to the drill in the live spindle. The end faces can be filed up sufficiently true for the purpose.

Drill the lugs $\frac{3}{16}$ in. half way through the finish with No. 26 drill, tapping out No. 10-24. A saw cut longitudinally through the center of the lugs into the bore completes the casting. Two $\frac{1}{2}$ -in. No. 10-24 round or fillister head machine screws are used for clamping the tool in place.

Tools for use in this holder can be made of $\frac{1}{2}$ -in. drill rod, drawn out, or filed to shape, hardened, tempered and ground. Smaller sizes of drill rod

may be used by providing split bushings to fit the holder, and bored out to take the various sizes of rod used.

If the tool is properly made slight adjustments can be made in the rake by altering its position in the holder. This holder may also be used for holding drills, etc., by properly locating its center line to coincide with lathe centers.

One dimension which is so marked on the drawing is variable according to the lathe on which the tool is to be used. This should be made equal to the distance vertically from the top of the slide rest to the lathe center.

To Sharpen Files

DULL files may be sharpened without recutting by treating them with acid or with the sand blast.

In treating files with acid they are first freed from adhering grease by scratch-brushing with the use of potash or soda lye. They are then brought into an oblong box of a material not attacked by acids, a few thin glass rods or varnished sticks of wood being first placed upon the bottom. The files being laid alongside each other, sufficient cold water to cover them is poured into the box, the eighth part of concentrated nitric acid is then added, and after mixing water and acid by moving the box, the whole is allowed to stand quietly for 25 minutes. The files are then taken from the bath, thoroughly scratch-brushed with the use of water and replaced in the box for 25 minutes, the bath having previously been strengthened by an additional eighth part of nitric acid. During this operation care must be had to several times turn the files and to see that they are entirely covered with the fluid. The files are then again taken from the bath, thoroughly cleansed with a scratch-brush and replaced in the bath, to which previously the sixteenth part of concentrated sulphuric acid has been added. The bath now becomes heated, and red-brown vapors of hyponitric acid escape. Care must be had to keep the box in a rocking motion so that the acids act as uniformly as possible. After 5 minutes the files are again taken out, cleansed, and then replaced for 5 minutes more in the same bath, previously strengthened by the addition of one-sixteenth part more of concentrated sulphuric acid; care must be had to constantly keep the bath in an undulatory motion. The operation is now finished, the files being finally scratch-brushed, and, for the removal of every trace of acid, placed in a vessel with water compounded with a few handfuls of caustic lime, which gives them a good color. They are then rinsed in clean water, dried over a spirit-flame and rubbed with a little oil.

The treatment with acid may also be effected by means of a galvanic battery, the bath, which is composed of water, 100 parts; nitric acid, 80, and sulphuric, 40, being connected with the positive pole. The negative pole is formed of a copper spiral passing around the files without touching them, and with the end pointing toward the surface of the fluid. By using a galvanic battery of 12 Bunsen elements 10 minutes suffice for the treatment.

If the experimenter follows these directions he will not need to discard his old files when they have become dull.

A New Screw Cutting Bench Lathe

A BENCH lathe has recently been brought out which possesses a number of distinct and original features. The driving motor is built directly in the head stock, which also encloses the driving gears, which are submerged in oil. The bearings are made with radial thrust which totally eliminates end play on the live spindle.

and a swing over the carriage of $5\frac{3}{4}$ inches, with a maximum distance of 12 inches between centers. Although the general features of the bed, tail stock and carriage greatly resemble the English Drummond lathe, there is one feature which has not been added and which is very characteristic of the English type. This is the boring table with

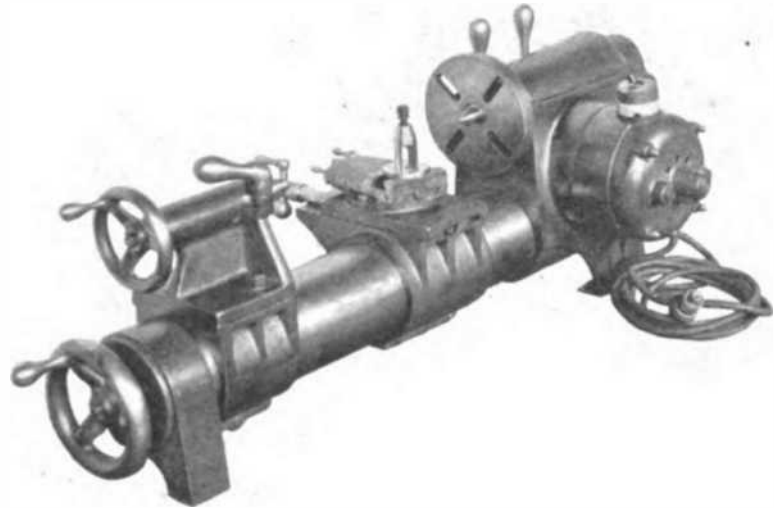

The bed of the lathe greatly resembles the well-known English Drummond lathe. The motion of the lead screw is controlled by the wheel at the end of the lathe. When located concentrically within the lathe bed, the lead screw is well protected from chips and dirt which insures maximum wear. The change gears, which are provided with the machine, will enable the operator to cut threads from 8 to 64.

The weight of this new lathe complete with driving motor is in the neighborhood of 200 lbs. and can receive its power from the ordinary electric light socket.

The lathe is provided with selected forward speeds, 125, 250, 400, 650 and 1,000, with a reverse speed of 3 r.p.m. It has a swing over the bed of 8 inches

inverted T slots. It is regrettable that American manufacturers have not as yet recognized the value and convenience of the boring table. Of course, the boring table makes it difficult to equip the lathe with a compound slide rest such as this machine is provided with.

The most gratifying feature of this machine is the driving motor which forms an integral part of the head stock, thereby eliminating belts, pulleys and countershaft, which greatly adds to the expense of the lathe and to the trouble of setting it up for operation. A machine of the nature described is ready for use the moment it is received. It also requires but little pains and the possibilities of the operator injuring his fingers with uncovered gears or belts is entirely eliminated.

A Handy Scale Clip

A VERY useful article which every machinist should have is shown in the sketch. In fact, every one who uses

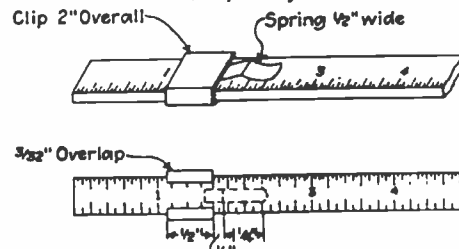

a pocket scale will find this little device very useful.

This clip is made of sheet brass .015 of an inch thick by 2 ins. long, allowing enough so that the clip will lap over $\frac{3}{32}$ in. on the back of the scale, as shown on the sketch. The clip is laid out with a combination square, the surplus stock cut away with a tinner's shears. The clip then resembles the letter T. It is then placed on the scale so that the spring is in the center, put in a vise, hammered one side, taken out, turned around and the same done with the other side. It is then slipped off the scale, bent and shaped as shown in the sketch.

HERMAN KEPPLER.

FUSELAGE DETAILS TWO SEATER SEA-PLANE

Designed By C.E. MULLER M.A.E.

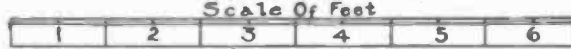

~ PLATE SIX ~

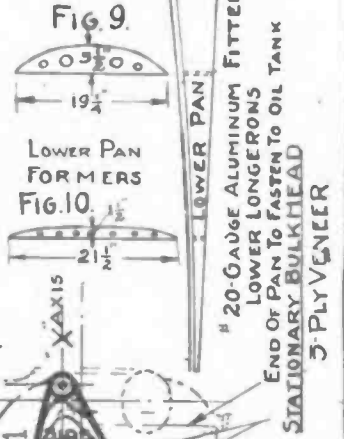
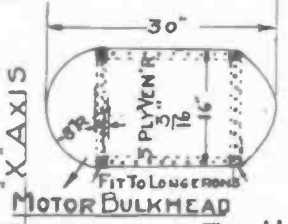
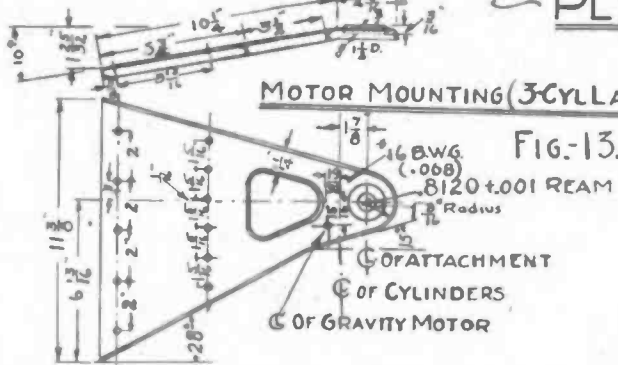

CONVENTIONAL CONTOURS

NOT TO SCALE

AMER. MONOCOQUE

PLAN

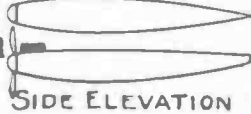

ROTARY MOTOR "SCOUTS"

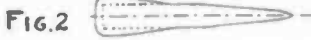

POOR DESIGN



ENGLISH PRACTICE



"SPAD TYPE"

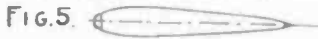

SIDE ELEVATION OF THE ABOVE



CURTISS TRAINING TYPE



LOW CENTER OF GRAVITY



SPINDLED LONGERON SECTIONS
Only Between Stations

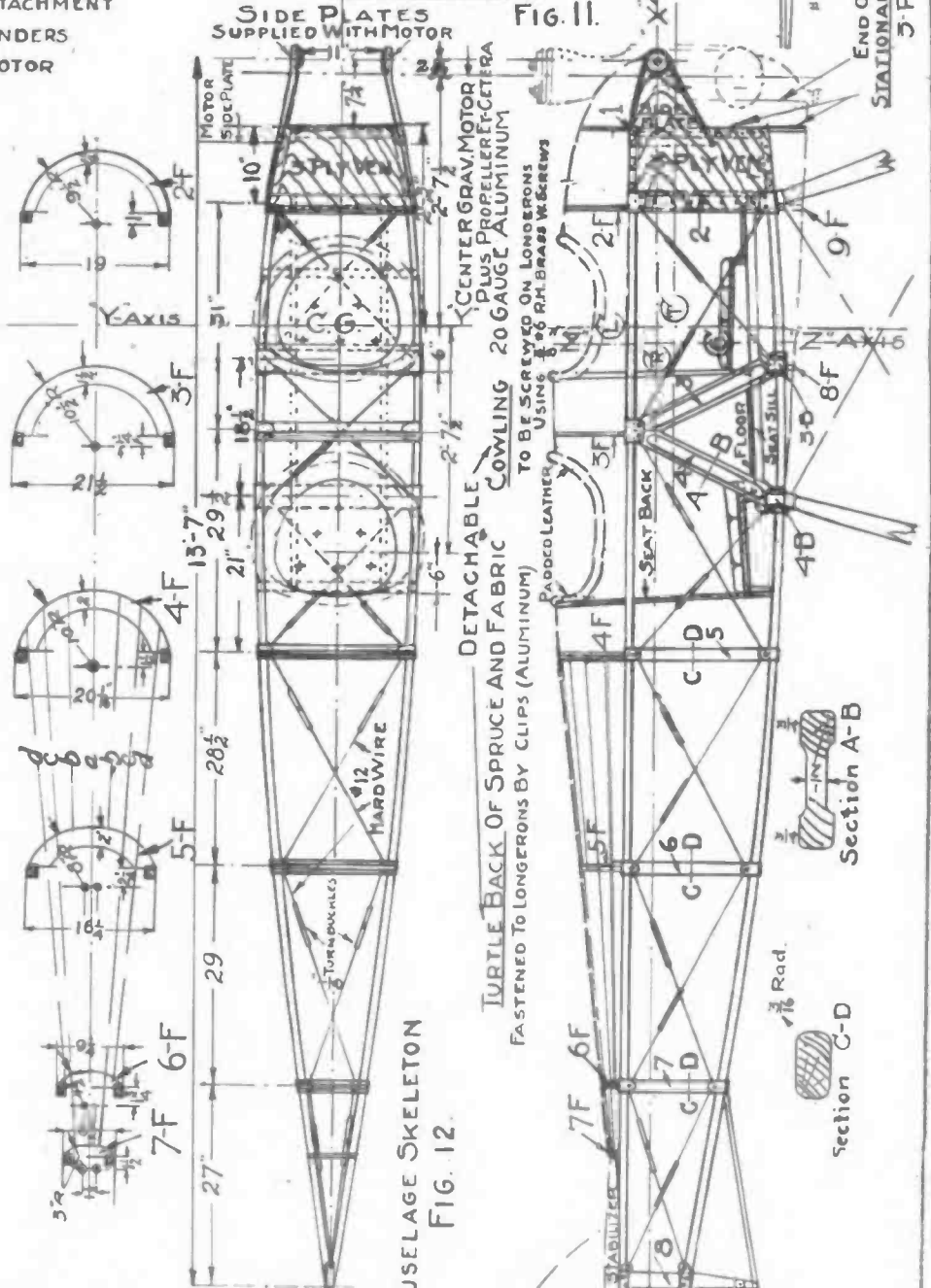

FIG. 14.

Building A Two-Passenger Seaplane

By Charles E. Muller

Consulting Aeronautical Engineer

Fuselage Construction

Part Five

THE fuselage or body constitutes the nucleus of the complete airplane. It may be considered a unit, as it is usually assembled and disassembled as such. It originated with the monoplane in France and by combining it with the biplane cellule or wings produced the present type of "tractor biplane." Sometimes, for transportation purposes under its own power, the wings are folded back or detached, then fastened edgewise to the fuselage. It is often packed in automobiles, freight cars, trucks or baggage cars in this condition or towed behind an auto by hitching the tail end to the tonneau of an automobile or to the rear of a truck.

Methods of Fuselage Construction

There are practically four types or methods of wood fuselage construction which may be classified in the following order:

(1) The box girder method using four longerons or rails with horizontal and vertical struts (sometimes called spreaders) in compression with a wire bracing as tension members and will be adopted with veneer panelling as suitable for the two-seater seaplane.

(2) The second method has the tail section of the first method, but the wires of the front portion (usually designated as the motor section) are replaced by a diagonal wood bracing which is fastened by wood screws or with either three-ply veneer or sheet aluminum.

(3) The third eliminates the wiring. Four and sometimes six longitudinal rails connected by cross struts, formers or bulkheads cut to the required shape from three-ply laminations are entirely covered with three-ply veneer, making an excellent structure.

(4) The laminated and monocoque types are built over a collapsible form, the skin being of two or three layers of wood with fabric between the layers, the whole glued as one solid shell of approximately four millimetres in thickness. The veneer layers composing the skin are sometimes stitched together with copper wire as in racing boat hull construction.

Steel is also being used, the longerons and diagonals made from special angle or steel channels. This method was developed by the T. A. Co., of Boston, but failed to become very popular. The French "Breguet Bomber" and the German Fokker use a similar method, but of round steel tubing longerons and struts with wire bracings. The last two

mentioned machines were masterpieces of welding and steel engineering, but are decidedly handicapped when replacements and repairs are necessary.

The longerons used in the first three methods of the foregoing classification were either all ash, hickory, spruce, or some combination of these woods, with the hard resilient wood constituting the forward section, extending from the nose of the fuselage to beyond the rear cockpit. The ash and hickory longerons permit of sharper bends and are stiffer for their size. They also resist the shocks of landing and the vibration of the engine better. When the longerons are of more than one length a vertical splice of approximately twelve inches is used, glued, bolted and wrapped with twine or tape, well doped. Formerly a butt joint was used with a long steel ferrule six to eight inches long of twenty gauge steel as a reinforcement. Sometimes laminated wood longerons are used, especially where there is excessive bending. The use of spindled longerons is gaining prominence, as this method provides for extra material at points where it may be necessary to compensate for holes drilled; also it is desirable for production reasons to use the same size longeron fittings as much as possible. A practice much in evidence is to maintain the same cross sectional area to near the pilot seat then taper to the stern post.

Two other methods of tapering have come to the writer's notice. One may taper the longerons gradually from any place back of the engine bearers to the tail post, which is usually condemned owing to complications in the size of fittings, but with the particular fitting recommended for the two-seater Seaplane this objection is obviated by decreasing the struts proportionately. Also there is a rather odd arrangement of keeping the rail parallel section for approximately eight feet from the engine bearers and then diminishing in a series of steps to the tail post. This method only requires three to four sizes of fittings.

The diagonal wood bracing is used considerably when sheet aluminum or duralumin is used, but the difficulty of re-truing this construction when distortion occurs, and also as the erection is somewhat involved, decided the writer not to recommend this construction for the Seaplane. It is also heavier than the first types although it affords a more solid engine mounting with a considerable reduction of vibration. Three-ply fuselage construction, introduced by the series of German Albatross machines,

apparently warrants the development that now follows this practice. There is also a saving in weight as a square foot of No. 20 B. W. G. aluminum, the usual thickness used for this purpose weighs eight oz., compared to the five oz. weight of the 3/32 in. birch three-ply. The saving of this weight in the aggregate with the advantage gained through three-ply veneer being a superior stiffening medium, also as it is so readily glued, nailed or screwed to the longerons, surely warrants this construction. The advantages of rapid production, great strength in a vertical and horizontal direction and also the fact that if shot through it would not endanger the structure to the same extent as with a wire braced system, are offset by two important facts. First, it is heavier than the wire bracing. Second, although holes may be cut where permitted, saving weight, it is weak under a torsional stress caused by the difficulty in truing up to allow for distortion.

The monocoque system, Fig. 1, Plate 6, I believe originated in France, originating with the Antoinette monoplane, which was flown at Nassau Boulevard, in 1911. If I remember correctly, the Deperdussin had a similar monocoque body too, consisting of very small stringers and light formers shaped to the fuselage section.

In the designing of the contour of the fuselage the type of motor used is undoubtedly the dominating consideration which surely compromises the ideal stream line. With the vertical four or six-cylinder ("in line") engine it is possible to design a very narrow body, excellent examples being the Italian S. V. A. and S. P. A. biplanes. A rotary or radial engine necessitates an increase in the width, Fig. 2, which also means increased drift. By permitting the tops of the Vee type engine cylinders, Fig. 1, to project through the cowling a gain in the width of the body is accomplished. Fig. 2 illustrates diagrammatically the method used on the Thomas Morse and other rotary engined "Scouts" of carrying the cowling over formers and stringers, gradually merging into the main fuselage. Fig. 3 is similar to Fig. 2, but with the cowling stopping too abruptly, resulting in a dead air region, unquestionably causing excessive drift and inefficiency.

The drawing at Fig. 4 depicts the English standard practice and although theoretically it is not as well streamlined as the German and the French machines typified by Fig. 5, the loss of efficiency is more apparent than real as

is proven by actual tests. The many constructional and other advantages gained surely compensate for any possible additional drift. Figures 6, 7, 8 show the side elevations of the current practice, Fig. 6 predominating. This arrangement of having the top longerons, Fig. 6, parallel to the normal line of flight furnishes a convenient datum line for assembling and aligning the airplane. Also for lining up the engine bearers on machines whose line of thrust, i. e., the axis of the motor, is coincidental with the normal flight. In Fig. 7, the Curtiss type, the top longerons are parallel to flight from the stern post to the engine section then dip

usually spindled out between stations especially in the tail section. They are always left solid at the stations, where struts and fittings join them and in most cases are left solid section from rear of the pilot's seat to the front of the frame. The fuselage struts are sometimes hollowed or spindled in a similar manner, but left solid at the ends for a better bearing on longerons. The longerons and the wing beams are the most important wooden members in the entire machine and should be very carefully selected of two-year weather dried or steam saturated kiln dried by experts. This fuselage was particularly designed for the benefit of the amateur so

even torque and having less vibration.

Assembling the Fuselage

I believe the builder will have no difficulty in assembling this fuselage if a temporary bench made of loose boards twenty-four inches by sixteen feet is placed on low horses and a rough layout be made from the dimensions furnished by a reference to the length of struts at stations designated. It is obviously manifest that this fuselage be assembled inverted. Three methods may be used. One, assemble the top side and bottom side, then connect them, or the two sides may be first assembled, then connected. The third method is recommended of

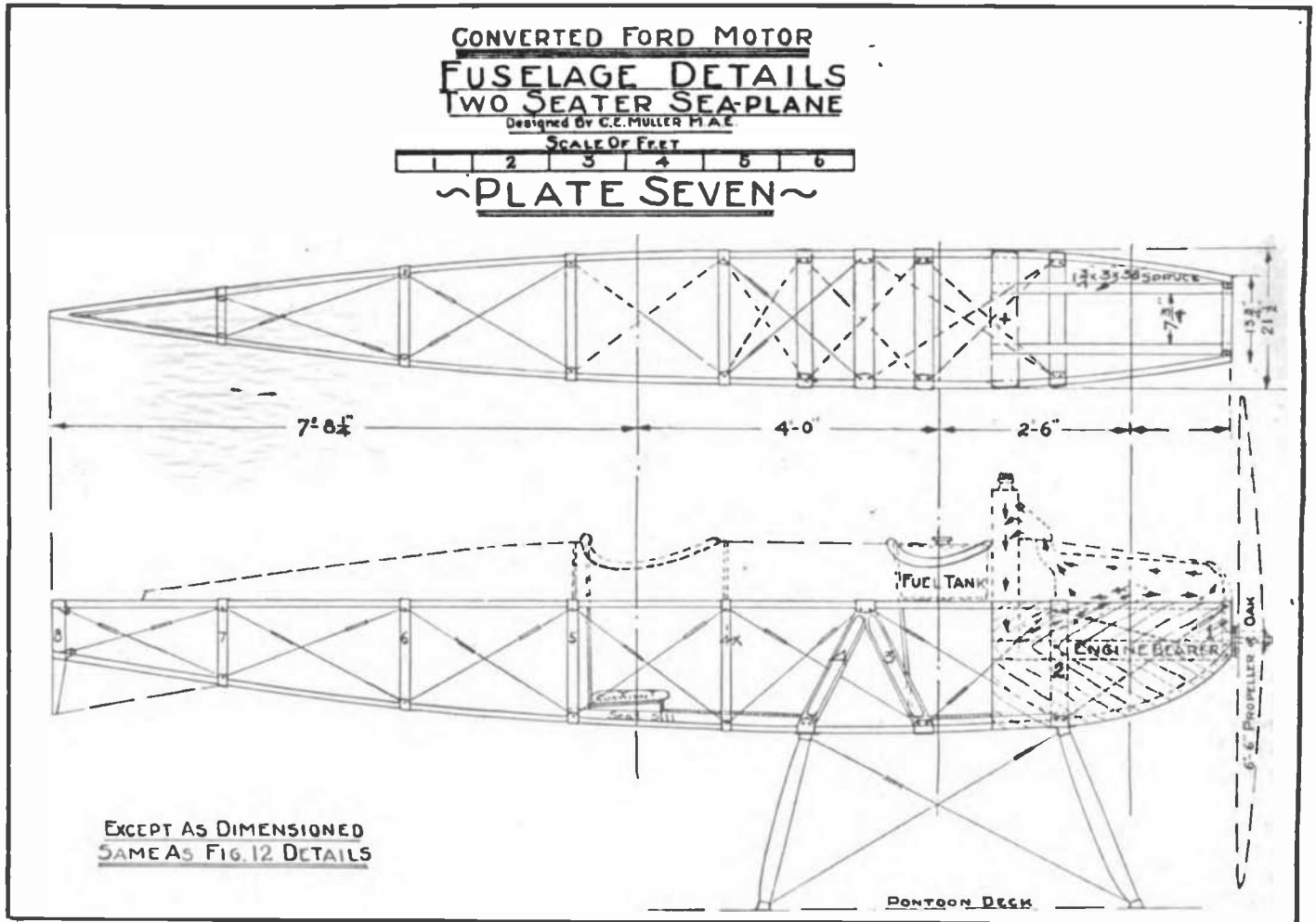

downward to stiffen the engine bearers and front section.

The illustration at Fig. 8 shows a similar arrangement used for obtaining an accessible motor location, also to produce a low center of gravity. Most all fuselages terminate in a vertical edge the width of the rudder post, but the French Morane monoplane, the German Fokker, the Albatross D-1 and the American Loening monoplane terminate in a horizontal edge which usually permits a certain amount of movement owing to the flat angle of the bracing wires, which is apt to result in the loss of empennage alignment.

The diagram at Fig. 14 illustrates three of the ways that longerons are

that no complicated bending of longerons necessitates steaming or special forms. But if this equipment is convenient, shaping the lower longerons slightly in excess of required bends will facilitate the operation of assembling. One may, if he chooses, bend the lower longerons from station near 8-F to a point flush with the reinforcing flanges of the motor side plates. This will unquestionably stiffen that section, but it is not necessary and would hardly compensate for the additional labor and expense. The three-ply stiffeners with the bulkhead, Fig. 11, has been found sufficient for motors weighing more than five times the weight of the three-cylinder Lawrence, but admittedly of more

assembling the top longerons, turning them over, clamp to table and assemble first section with header in place, secure three-ply panels to all four sides, then continue second section, etc. I believe this will save forms and require less equipment. When springing longerons, a twisted tourniquet will be found all that is necessary. The Static Balance of an Airplane (i. e., equilibrium of the machine at rest) is represented by the line marked C-G or center of gravity. This may be checked up by placing a rounded edge of a 2" by 4" under the pontoons where the center of gravity (when machine is completed) is indicated in the skeleton fuselage diagram,

(Continued on page 221)

A Combination Electric Wrench, Drill and Screw Driver

A NEW machine has recently been brought out which possesses many unique features. It can be used either as a drill, wrench or screw driver. It can also be pressed into service in boring holes in wood with the conventional bit, as illustrated.

All the parts of the machine are set on ball bearings together with an especially constructed clutch. A suitable electric motor of the high speed variety controlled with a properly designed rheostat is incased in a metal cylinder which encloses the operating mechanism. The weight of the machine is but 14 lbs. The body is 10 inches long and 14 inches in diameter. Although the

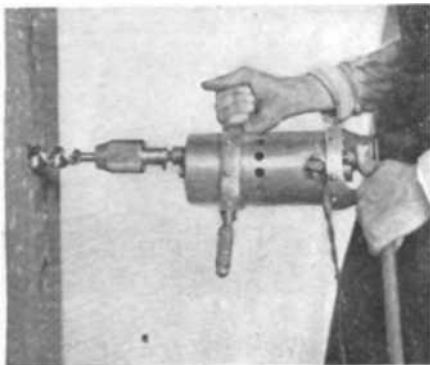

The machine in use boring holes in wood

device is small, it develops from three to five horsepower in torsion.

When the machine is used as a wrench in placing nuts a simple me-



Using the machine to remove a nut

chanical device prevents the threads from stripping when the nut is fully seated. At this point the power is automatically cut off by means of a special patented device enclosed in the case.

This machine, owing to its utility, will be of great service in the machine shop or garage where it can be used in a number of ways.

The American Society of Experimental Engineers

Who's Who in the A. S. E. E.

MR. R. RUSSELL MILLER is an active member of the A. S. E. E., having joined the Society in 1918. He was born in Dayton, Ohio, the city of a thousand factories, and the site of the greatest and most disastrous floods in the history of the United States. Mr. Miller well remembers this unpleasant event.

Mr. Miller graduated from the grade and high schools of Dayton and later attended the Ohio State University at



Mr. R. R. Miller

Columbus. Here he specialized in physical education, recreational leadership and manual training. He was then employed for two seasons by the Department of Recreations, Dayton, leaving this location finally to assume duties as Recreation Superintendent for the City of Raleigh, North Carolina. Mr. Miller also served as Deputy Scout Commissioner for this district. He later accepted a position with the Wright Airplane Co., of Dayton, Ohio. Leaving the Wright Co. he went to Lakewood, N. J., to serve as head of the Boys' Department in the Y. M. C. A. He now holds the position of Assistant Scout Executive, Queens Council, Boy Scouts of America.

Mr. Miller is very much interested in the promotion of experimental work among boys. He seems to inherit the ability and enthusiasm of his father, who was an expert model engineer in the employ of the National Cash Reg-

ister Company. Mr. Miller well recalls the days, when as a lad, he tinkered in his father's shop, building models and experimenting. During an exhibition given in honor of Wright Brothers he won first prize in a contest conducted by the Junior Aero Club of that community. He believes, and rightly so, that model engineering is a more worthy and interesting hobby than is commonly understood.

Mr. Miller is very fond of all forms of athletics, and swimming in particular. In this latter sport he is unusually proficient, being a member and examiner of the Life Saving Corps of the American Red Cross. He is a registered A. A. U. basket ball official and handled some of the large college games in the South. Anything that pertains to camping, woodcraft and nature study deeply interests Mr. Miller. He is very fond of music, loves the movies and roots for the Giants.

Philadelphia Chapter of A. S. E. E.

THE Philadelphia Chapter of the A. S. E. E., of which Harry Levene is secretary, held a large meeting in Friendship Hall on Friday evening, December 12th. Large posters were used in recruiting new members and a drive was started for the establishment of a local experimental laboratory where all Philadelphia members could have access to apparatus and equipment that they could not afford as individuals.

The officers of the Society in New York urge every Philadelphia member to put their shoulders to the wheel in order to help this good movement along. Those who contemplate joining this live branch of the A. S. E. E. should immediately communicate with one of the following men: Harry Levene, 2123 W. Dauphin Street; Thomas W. Benson, 3722 M Street, or Dr. M. Eugene Balfrey, Med. Electrician, 5213 Master Street. The next regular meeting will be held January 16, 1920, at Widener Library, 1200 N. Broad St., Philadelphia. All are urged to attend.

The A. S. E. E. Bulletin.

The second copy of the Bulletin issued bi-monthly by the American Society of Experimental Engineers has appeared. This little sheet is given over to news of the Society and what its members and chapters are doing. In each issue there is also included an article that will be sure to interest all real experimenters. As the Society grows, the Bulletin will grow with it until it reaches a good, healthy size.

A MODEL OF THE NORTH DAKOTA

BY C. A. MYERS Jr. U. S. N. R. F.

Constructed by the Author

PART I.

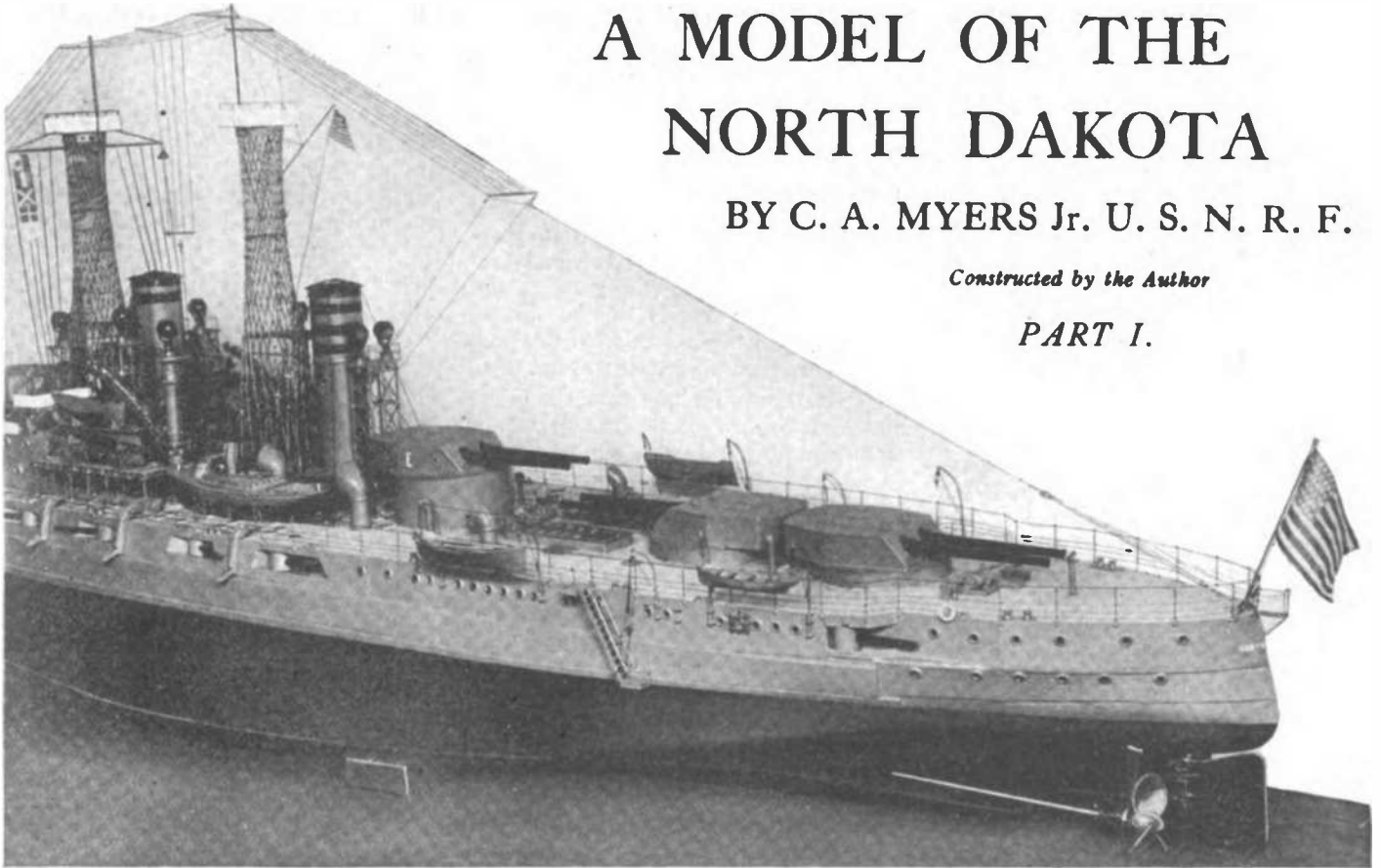

THE writer has been interested in model-making for a good many years, and, as described in the June issue of EVERYDAY ENGINEERING, has taken up the building of working models of warships, showing by stages the development of naval architecture over the past 2000 years.

As the latest example of the writer's work the model of the U. S. dreadnought *North Dakota* lends itself very well to a description. This model is 5 feet 4 inches long, 10½ inches beam and has a draft of 3⅞ inches. She displaces about 55 lbs. of water and makes a speed of about 150 ft. per minute. At first glance this speed may seem low when compared with an out and out speed boat, but it should be borne in mind that it would look incongruous to see a battleship model rushing around at what would be relatively to its large prototype a mile-a-minute clip; and the speed of each of the writer's models therefore has been brought to what would be the correct rate for vessels of their type.

Only spare time has been devoted to the construction of the *North Dakota* as the work is solely a hobby and no attempt was made to "speed up" or to adopt wholesale methods of turning out the various parts, all of which represent nothing but the most painstaking hand work. The model is constructed entirely of metal from the keel to the topmost part of the fire control towers, the only wooden parts being such items for instance as the oars in the life-

The model of the "North Dakota" described in this and a subsequent article is a masterpiece of miniature naval architecture and workmanship. It represents not only a tremendous amount of painstaking labor but a knowledge of naval matters that is in possession of few individuals. Not many models have come to our attention so faithfully reproduced, so carefully executed to the most minute detail and imposing such a tremendous amount of labor upon their builders as this one. We take this occasion to congratulate Mr. Myers and we feel sure that our readers will join us in giving him all the respect and praise due him.—

EDITOR.

boats. She represents approximately 2,000 hours' work, or, expressed in another way, five years of spare time effort.

The model is constructed absolutely to scale from Government plans of the real ship, the scale adopted being ⅛ inch to the foot, which produces a very good sized model and yet one that may be carried from place to place with ease by two persons. Every measurement on the large ship is faithfully reproduced on the model down to the

minutest particulars and it "works" in every detail down to the firing mechanism of the guns and the steam-launches which are actually propelled by steam.

The ordinary exhibition or glass case model is a land-going ship, and while it may be beautiful to look upon, it is devoid of machinery and if placed in the water would be likely to float on its side if indeed it did not completely capsize and sink. To build a model which will not only faithfully reproduce the real ship in every detail but will also have exactly the correct characteristics of trim, stability, speed, flotation, etc., is no mean problem, to say the least. All of these characteristics the *North Dakota* model has, and in addition her hull, like the real vessel's, is built up of steel plates. Only one who has attempted to build metal-hulled vessels can appreciate the difficulties involved in this point alone.

When the average man wants to build a model ship he takes a log of wood and after rough-hewing and sawing it to shape removes the surplus wood with a draw-knife and hollows out the interior. It is because of the ease with which this work may be done that nearly everyone makes model ship hulls of wood, whether the real ship is built of wood or not. But while the metal hull is as difficult to build as the wooden hull is easy, the metal one nevertheless has certain inherent advantages over the wooden hull that makes it preferable if the difficul-

ties of construction are overcome. The writer has succeeded in solving the problem in what he believes to be a very satisfactory way and a later issue of EVERYDAY ENGINEERING will describe the process in detail. In describing the hull of the *North Dakota*, then, suffice it to say for the present that the steel plates are fastened to suitable frames reproduced from the plans to the proper dimensions, and, as may be seen from some of the photographs, particularly the one shown, the hull is as smooth and sweet in its lines as any wooden one the writer has ever seen and in addition is considerably lighter. To illustrate the accuracy of the method used in constructing the hull it might be added that the completed model comes within less than a single pound of displacing the weight calculated when working on the plans months before laying the keel.

The armor-belt which on the real ship is 11 inches thick consists of aluminum a scant $\frac{1}{8}$ inch thick on the model and resting on the armor shelf is bolted to the side plating just as in Uncle Sam's own vessel. Gun positions for the secondary battery, ash chutes, port holes, electric winches and a thou-

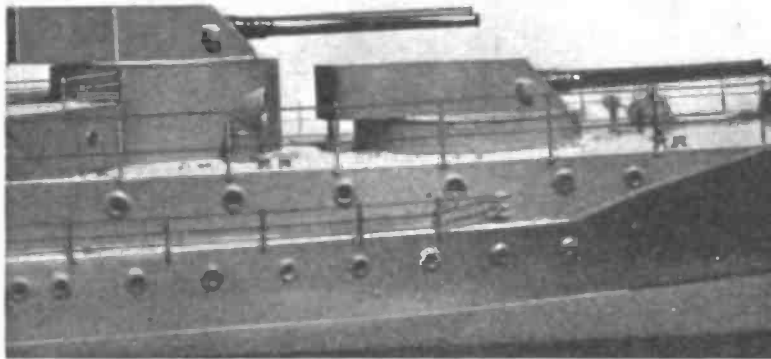

The forward turrets

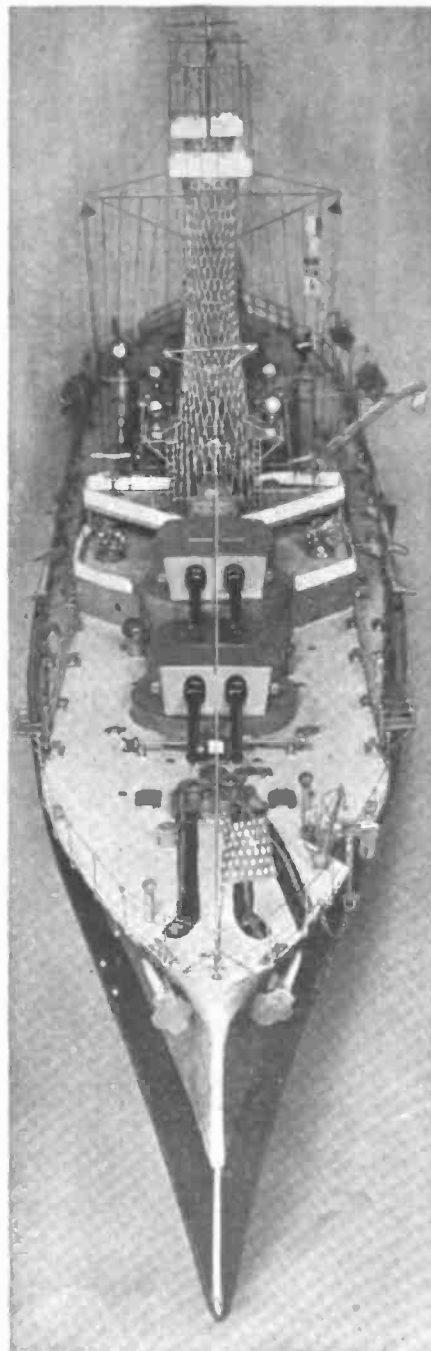

© Edwin Levick, N. Y.
The deck looking aft from above

The construction of these towers was in itself a rather difficult problem, but it was solved by building them over a wooden mould. The masts, as will be noted by a glance at the photographs, are smaller about two-thirds of the way up than they are at either end and it was therefore necessary to have the mould made in two sections with the joint at the point of smallest diameter; otherwise the mould could never have been withdrawn once the wire mast was soldered together around it. The

positions for the vertical wires were marked off and numbered at top and bottom and small copper tacks were driven in the mould at these points. Then a single strand of brass wire was soldered to tack number one on the top and the other end to tack number one on the bottom and so on around. Number one on the bottom of the mould, of course, was not directly beneath number one on the top as there was a difference of about 90° in the positions of the various numbers. This gave the wires a slightly twisted appearance; and after all the wires were run one direction another set was started in the

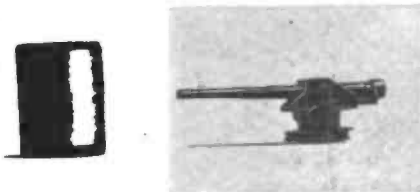

Size of one of the deck guns when compared with a spool of thread

sand other details must be finished and fastened in position before the hull itself is completed, yet the hull is but a small part of the work on the whole model.

A single item, such for instance as the fire control towers or peach-basket masts as they are sometimes called, represents a simply tremendous amount of work. The masts themselves contain over 60 feet of brass wire and each one has more than one thousand separate soldered joints! But this is not all, for not only are there the usual grating platforms inside with tiny ladders running from one level to another and trapdoors less than $\frac{1}{4}$ inch square, but inside the forward tower is the navigating bridge with its steering wheel, binnacle, log-desk, engine-telegraphs, etc., to say nothing of a "1,200-gallon" water tank, an "800-lb." bell and even a chart table with a microscopically small chart of New York Harbor laid out under its glass top.

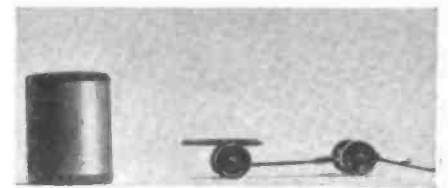

Size of a small land gun when compared with a spool of thread

opposite one so that they intersected the first set at an acute angle. All points of intersection were then securely soldered and rings fastened around the towers at the positions shown in the plans (see photograph); and after the grating platforms and other details were mounted inside the towers they were then ready to be placed in position on the ship. The writer would like to add right here that while he expected considerable strength in these towers (from what has been written about the large ones on our various battleships) he was absolutely astounded at their tremendous rigidity and the resistance they offer to a crushing force, coupled with their remarkable lightness.

The five turrets of the *North Dakota* each mounting two "12-inch" guns ($\frac{1}{8}$ inch on the model) are made of steel like those on the real ship and are revolved by tiny electric motors concealed beneath the deck, one to each turret. The guns are breech loading and are

mounted on trunnions and may be elevated or lowered at will. They are designed, moreover, to fire with gunpowder, minute brass cartridge cases not more than $\frac{1}{2}$ inch long being used to hold the explosive charge. The powder is ignited by electricity just as in the case of our real battleships and the wiring is so arranged that the guns may be fired individually or by throwing a switch all ten may be fired in salvo. One of the accompanying photographs shows the instantaneous discharge of both guns in No. 2 turret, and as can be seen, the flash of flame leaps a foot or more from the mouths of the guns, the explosion making one's ears ring. The effect is certainly realistic in the extreme.

Of searchlights the *North Dakota* has eight and on the model these are illuminated with tiny nitrogen-filled electric lights of great power, the bulbs, although less than $\frac{1}{4}$ inch in diameter, consuming in all more than 30 watts. Highly polished nickelplated parabolic reflectors concentrate all the rays and give the maximum result. In addition to the searchlights there are, of course, the regula-

tion port and starboard (red and green) and masthead running lights which are also lighted by electricity.

Of lifeboats and steam launches the model has the full equipment, carry-

launches slip through the water at a surprisingly good clip.

The *North Dakota* is propelled by twin screws and on the model these are revolved by six powerful electric motors three to each shaft, the current being supplied by a 6-volt storage battery which also furnishes the power for lighting the searchlights, revolving the turrets, firing the guns, blowing the whistle, etc. The motors are wired so as to provide three permanent speeds forward and one on reverse. Thus, at first speed forward only the last motor on each shaft receives power, the other two idling. At second speed the last two receive current and the other revolves idly. At full speed ahead all six motors drive the propellers. On reverse just

as in the case of first speed forward, only the last motor on each shaft does the work. The storage battery has power sufficient to drive the model $1\frac{1}{2}$ hours at full speed, about three hours at second speed and nearly five hours at first speed. With the scale-model idea constantly in mind, two convenient air ventilators have been employed to operate the controller and reverse mech-

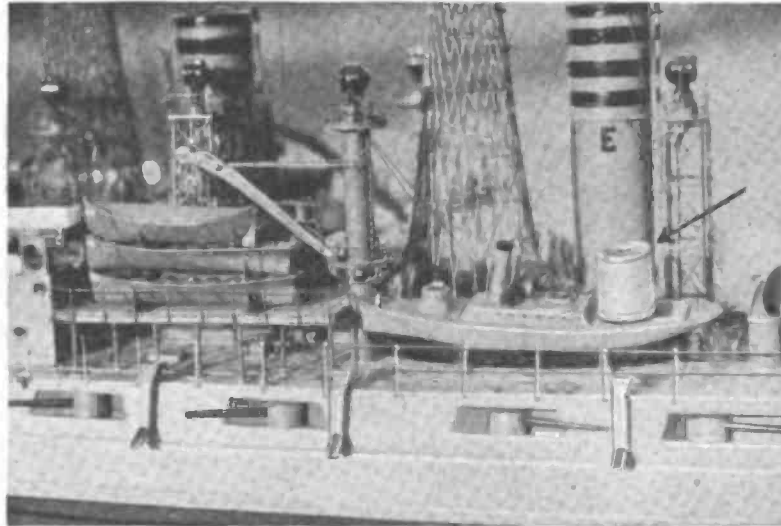

A close-up view amidships. The spool of cotton is placed on the steam cutter to give an idea of its size

ing among others one "56-foot" and one "40-foot" steam cutter. These boats, as faithfully reproduced to scale as any other item on the model, are 7 and 5 inches long, respectively, and surprising as it may seem are both driven by steam generated by a tiny alcohol lamp under a fire-tube boiler holding less than a teaspoonful of water! When a full head of steam is up, these



Few readers would believe that this was the photograph of a model if it did not accompany this article

anism for the main driving motors, thus obviating the necessity of wheels or levers passing through the deck and avoiding in this way the "top-boat" effect which these instantly give to any model on which they are used no matter how well it may in other respects be constructed.

operator she executes circles, figure-eights, and other complicated manoeuvres with a precision that to an on-looker seems almost uncanny.

The writer has devoted a great deal of thought to the problem of radio control for a good many years, having first started it with the idea of steering

can be accomplished with greater speed. The hot iron, which can be an old file or a stove poker, is run along the putty. The heat will cause the putty to crack and drop off. In doing this, the mechanic should not touch the glass, as the sudden change in temperature would be apt to crack it.

Tricks in all Trades

YANKEE ingenuity is one way of describing the resourcefulness of a job superintendent in charge of the erection of a cotton mill for a large concern of Nashua, N. H. It was found frequently necessary to erect derricks to hoist materials to the upper stories of the structure. The new mill stands in the midst of an oak grove and in clearing the site, many of the trees had been left standing close to the building. Using their trunks as part of the derrick saved the time and



We will leave this to the judgment of the reader: Does this look like the "North Dakota" taken from Brooklyn Bridge?

Another unique feature of the *North Dakota* is that it is provided with complete radio control, it being possible to steer the ship when in the water by merely pressing a key on the sending station on shore. The response of the vessel to the wireless waves is well-nigh perfect and at the will of the

torpedoes for the Navy, as long ago as 1904. This antedates the efforts of any one else along this line so far as he knows; but his opinion is that while the idea works out very satisfactorily for steering model ships, the wireless-controlled torpedo as a weapon of warfare is a child of the mind and always will be.

Boiling Water in a Paper Bag

A TRAVELING salesman who had some knowledge of physical laws tells how he boiled water in a paper bag over a gas flame in a small-town hotel. The paper is not prevented from burning merely because it is wet as many may believe, but because the water in the bag conducts the heat away as fast as it is produced, thereby preventing the paper from reaching the kindling temperature. The knowledge of this simple fact helped the salesman to provide himself with the convenience

of hot water for shaving. It is surprising how often experimenters find everyday use for their knowledge of the sciences.

Removing Old Putty from Windows

THE job of removing old putty from window panes is a tedious and troublesome one that often results in a broken glass. If a red hot iron is used for this purpose, much of the trouble experienced in removing the putty will be eliminated and the work



expense ordinarily required to erect a mast, and as the majority of the trees had to come out anyway, for the sake of light, no actual damage was done the grove. A similar "stunt" performed some years ago by an employee of the contractor was the shaking of empty cement bags to recover the dust. This simple trick reduced the cost per barrel of cement by considerably more than enough to pay for the labor of shaking and beating the sacks.

A Good Wood Stain

A very simple wood stain can be made by dissolving bichromate of potassium in warm water to form a saturated solution. The solution is then diluted with more water and in this state the stain is ready for application. When this stain is used the wood needs no rubbing, as it leaves the wood with a beautiful satin finish. This is a little kink worth knowing.

Some New Developments in Aviation

How Governmental Aid Encourages European Aeronautical Progress While American Aviation Improvements Depend Almost Entirely Upon Initiative of Individual Manufacturers

By Victor W. Page, M.S.A.E.

IN no other country of prominence is aviation being neglected as in our own. We are rapidly losing the prestige we gained by our efforts in aviation development during the World War and due to an unexplained and inexcusable lethargy on the part of our lawmakers, we will soon be in a position where many of the small European countries will have air services and equipment much superior to our own. There is every argument for the development of commercial aviation as well as the military air service in this country and there is no sound reason why we should not be leaders in aviation progress instead of trailing behind countries that are not of the first rank.

Even in Germany, there is great progress noted in the post war develop-

ment of aviation and various craft are being developed, ostensibly for passenger and freight transport, that have wicker possibilities as military air craft if it should be desired to use them

ity than any that were used during the war. The leading European countries are not in any sense ideal fields for the development of commercial aviation because they are limited in area compared

to our country and authorities concede that long distances are necessary to bring out the advantages of the new rapid aerial transport over the older methods of fast rail transportation.

To date, there has been no definite plan formulated for aerial development in this country that has met with the approval of the lawmakers. The American aircraft industry, which was in such

a flourishing condition a year ago and which promised so much for the future has dwindled so that even our leading constructors are working with skeleton organizations and many have closed down their plants entirely. The neglect



© International

Improved Spad Biplane capable of a speed of 187 miles per hour, uses 300 horsepower Hispano-Suiza engine

for other than commercial work. In England, France and Italy there has been a constant evolution, with governmental encouragement, of aircraft of both the heavier-than-air and lighter-than-air classes of much greater capac-

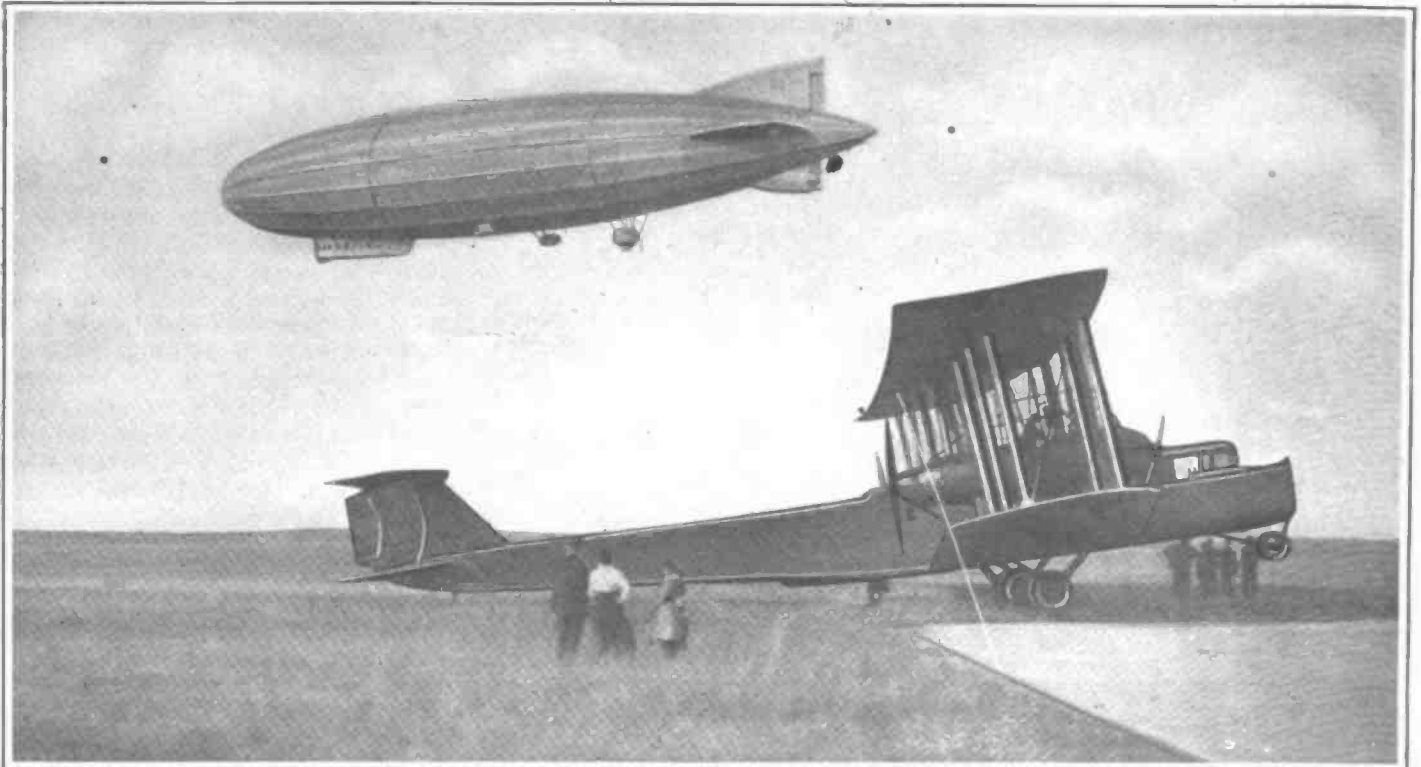

© International

Recent aircraft development in Germany is exemplified by the dirigible balloon, "Bodensee," and a four-engine giant biplane, both used commercially for passenger transport

to provide a practical working plan that would encourage private capital in the development of airplanes or dirigibles suitable for commercial or military purposes, if continued another year will result in having our country without any aircraft protection to speak of. Prompt action is necessary to save the situation and it is hoped by all who have the interests of our country at heart that a definite plan of centralized aviation control under competent technical and business executives will be soon adopted that can co-ordinate the various aviation activities of the Army, Navy, Post Office Department and civilians to secure the good that always comes from intelligently directed co-operative effort.

In European countries, the value of aircraft for offensive and defensive operations in military work is so well rec-

A German all-metal monoplane, said to have accommodations for six passengers

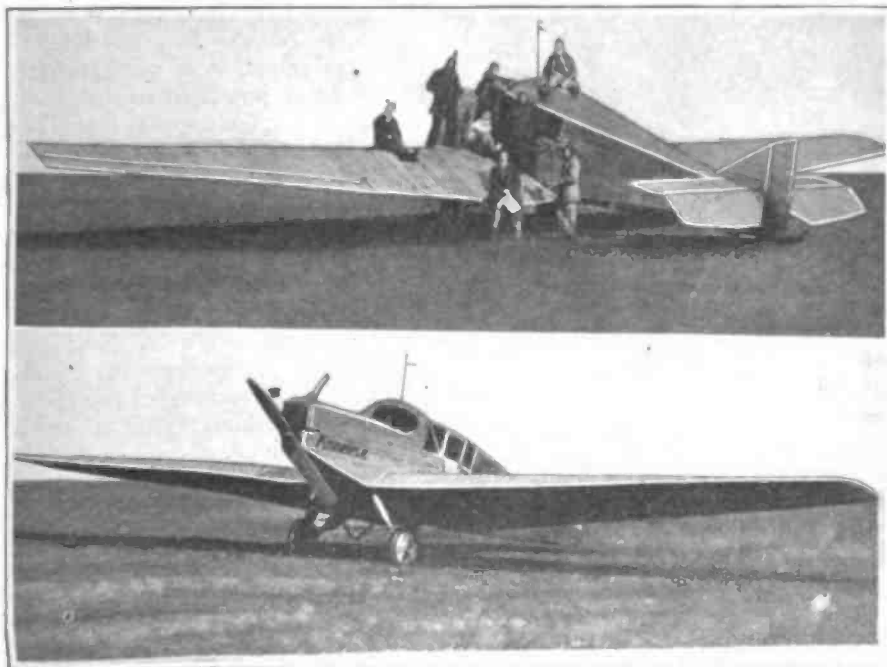

© Underwood and Underwood

ognized that every effort is being made to assist aircraft development not only by keeping active the aerial activities of the army and navy air services but also in the establishment of aerial mail, express and passenger carrying services, and encouraging civilian aviation by allowing fliers not connected with the army and navy to use the facilities of the military airdromes.

Let us review what is being accomplished abroad by this policy of encouraging the aviation industry. The French have developed a modified Spad biplane that has attained a record breaking speed of 187 miles per hour in a straight flight and this was accomplished with only 300 horse power. They have also adapted a well-known pusher type biplane for commercial use by providing a special landing gear that gives maximum

safety in landing. The machine can carry a pilot and three passengers in a special nacelle carried between the wings. They have also developed a giant four-motored Bleriot biplane, that, as accompanying illustrations

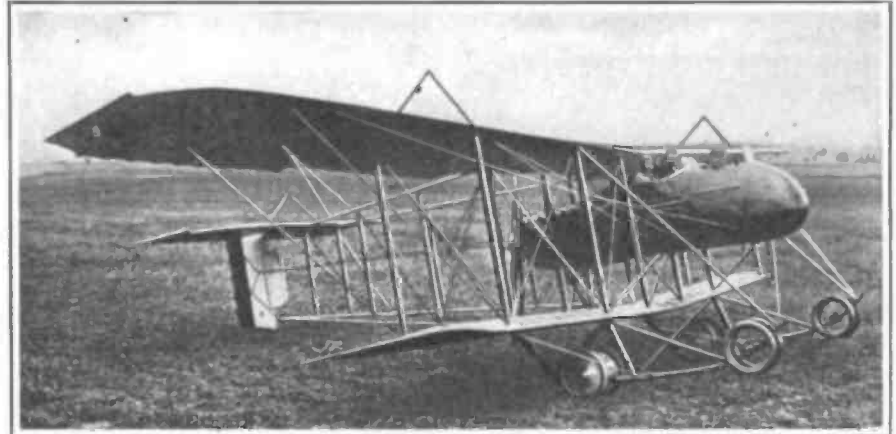

© International

has been recently flown in this country.

The Germans are also developing all metal airplanes, the latest craft of this type is a monoplane capable of carrying six passengers. This is made entirely of metal, even the wing struc-

French pusher biplane with special landing gear to prevent nosing over in landing

ture being composed of duralumin cantilever beams and ribs of the same material surfaced with corrugated sheet aluminum of very light gauge. The fuselage has pressed steel long-erons and stamped metal compression members, and the machine is not only fireproof but is said to be much stronger than those of conventional wood and fabric construction. While no engineering details are given it is probable that this machine is a development of the Fokker-Junkers biplane which the writer examined while in Belgium at a German airdrome that had been captured by the American forces. These machines were slow fliers and were intended for trench "strafing" with machine gun armament and had armored pilots and observers compartments. They were very strongly built and the corrugated metal used in surfacing the wings and fuselage was about .016 inch thick with the corrugations parallel to the line of flight. The armor was of hardened alloy steel 5 millimeters thick. It is evident that eliminating the armor and armament and simplifying the machine by making it a monoplane instead of a double surfaced craft will greatly increase its aerodynamical efficiency and make it possible to carry passengers without increasing the engine power used in the war craft.

A point that is evidently lost sight of by our lawmakers is that it is easier to transform commercial aircraft types to military use than to employ strictly military machines for commerce. The large passenger carrying planes can be easily made into bombers, the passenger weight being replaced by its equivalent in bombs and bomb racks; the fast mail plane can be changed to a reconnaissance machine or two-seat fighter; the sporting single seater can

show, towers above the normal sized airplane as an ocean liner overshadows a tug. This has a capacity for 26 passengers in a specially designed and strongly built fuselage of exceptionally good aerodynamic properties. The four engines aggregate 1,000 horse power and the plane will fly well with any two of them.

The Germans have also been active in developing passenger carrying aircraft of the two main classes. The reproduction of the photograph herewith was taken at an aviation field outside of Berlin and shows the passenger carrying dirigible "Bodensee" manœuvring above a large four-motored biplane also designed for passenger carrying. This machine has many of the characteristics of the Super Handley-Page, which is used in England for passenger carrying purposes and which

be used as a fast scout. The passenger carrying dirigible of peace times becomes a naval scout or bomber of terrible destructive possibilities in times of war. The country that has the best commercial air service in peace times is

and streamline bracing wire has been accepted as a safe proposition. In some airplanes, especially those intended for high speeds, a single strut of the modified "K" form is used for interplane separation and great care is

fications have been changed so built-up-spars may be used as tests have been shown that some of the newer methods of building them up gives strength equal to solid spars with less weight and also enables the builders to use wood that might otherwise be rejected.

Materials have been studied and experience has shown that cotton is good as a wing covering if properly woven and that it is as strong and durable as linen. Veneer has been utilized in the fuselage and as rib webs and has also been used in spars. Abroad, wings of very high speed machines have been covered on the top surface almost to the rear spar with veneer. An increasing use of stamped steel fittings is noticed and most of these are designed to be clamped in place without piercing the important structural parts with bolt holes. Fireproof dope and fabrics have also been developed as a result of the war.

Engines have increased in capacity and have become less in weight per horse power and now we have engines of 750 horse power in one unit with a weight of 2 pounds per horse power. Air-cooled engines are now accepted as practical and efficient. Light weight engine starters of various forms are employed, some working on electrical principles, others on air pressure. Carburetor stacks and safety screens have reduced the fire risk. Mufflers that silence the engine without offering too much back pressure are also obtainable. The successful use of the supercharger for high flying is also a recent development.

The greatest aid to navigation of passenger carrying craft has undoubtedly been the radio-direction finder and places the pilot in a position to defy fog or clouds and makes it possible for him to reach his destination. Then again, we have the turn indicator which is a very simple instrument that will give a positive indica-

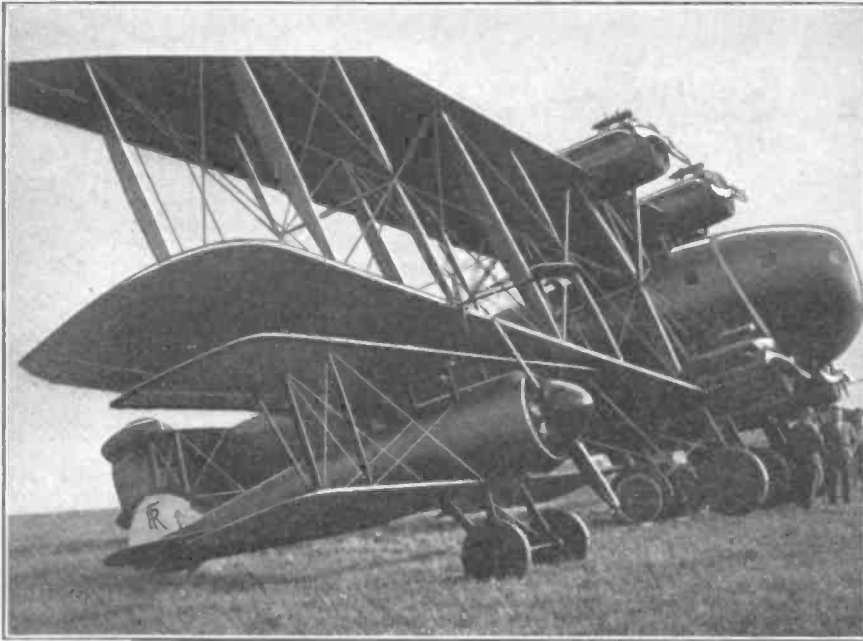

© International
Side view of giant Bleriot biplane, showing its size compared to that of a scout plane.
Note body design, which has excellent streamline form

best prepared for its aerial defense if attacked and has a big advantage if it is the aggressor.

If one compares the modern airplane with the types of five years ago, but little exterior change is noticed. There has been a great improvement in matters of detail refinement, however, and many structural changes have taken place that are not apparent without close study. Considering changes which affect aerodynamical efficiency we find much better body or fuselage forms which greatly reduce resistance. Better wing sections with high lift and reduced drift have been evolved. The framework of wings has been improved

taken, as can be seen by illustration of the modified Spad biplane, to streamline the points of attachment where the strut ends and wing frames join.

Struts are now made of steel or duralumin and we have learned that spruce is not the only material that can be employed for this purpose. Steel struts do not reduce weight appreciably but they can be made of smaller section without sacrificing strength and thus cut down head resistance. Steel spars can be made of drawn tubing or can be built up of two stamped halves welded together if they are to be of varying section at different points as the wood struts are. Speci-

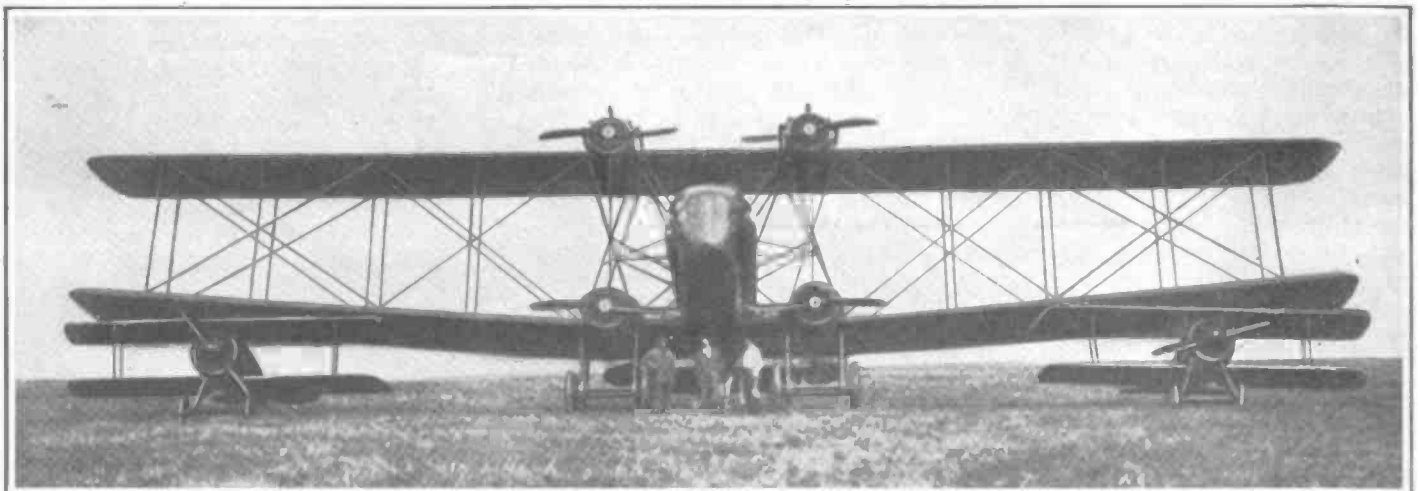

© International
Front view of Bleriot four-motored biplane, showing location of power plants and comparing its great spread with two typical single-seater scout planes

tion of any tendency to turn. It is possible, therefore, to fly a straight course by using the compass and turn indicator together. The radio direction finder will warn the pilot of drift so one can well believe that the problem of navigation regardless of weather conditions, providing it is possible to fly at all, seems to be solved. Then we have the interphone, which permits communication between the pilot and passenger and a dual control release that will be of great value in instruction work because it gives the teacher absolute control in case of the student "running out of knowledge" as the army expression has it, at the wrong moment.

This progress cannot be continued without building airplanes or dirigibles to try out new ideas with and keeping sufficient men trained to fly and take care of them. Laboratory work must be continued and designs must be worked out so new aircraft can be constructed. This work should be carried on under Government supervision and supported by its funds until an industry is created that is self-supporting. It is only by a slow process of evolution that one can improve mechanical things and if done gradually, the expenditures are very much less than is the case when an emergency arises and billions of dollars are wasted because several years of normal development must be crowded in a few months of feverish activity in endeavoring to catch up with the times.

A definite, well planned aviation policy is needed in this country because it is only by this means that the aviation industry can survive and the Government be assured of an adequate supply of up-to-date aircraft when needed. Commercial aviation should be encouraged and every possible Government aid extended to the courageous pioneers of a new era of transportation.

New Bristol Motor

Experts who witnessed a flight by the latest Bristol fighter made recently at Filton, England, were impressed with the performance of both plane and engine. The machine was designed both for fighting and bombing. The engine develops 450 hp. with 9 air-cooled cylinders, and a weight of 636 lbs. The machine is built to fly at a maximum speed of about 150 m.p.h. A patented air cooling system does away with weight and attendant troubles of water. It has been approved by the British Air Control Board and adopted by large airplane firms and is said to cool satisfactorily even on extended flights. The weight-horsepower ratio is 1.41 pounds per brake horsepower, a very good figure and somewhat lower than has been achieved to date in engines of this power.

Shop-Made Oil Filler

By Thos. W. Poppe

IN the modern gasoline motor manufactory each and every minute must be used to speed up and then keep up the speed at which the motors travel from the time the rough cylinder block casting goes to meet the rapidly revolving cutters of the milling machine until they are crated and placed upon the platform ready for shipment.

In a most recent installation of a works of the above nature the motor parts found their way to the assembly line and lost their individuality by becoming a part of what would soon be a power plant for some automobile with

The bottom cap was drilled and tapped for 1¼-inch pipe. The top cap was connected through one-inch pipe to the source from whence the oil came and the bottom cap became the outlet.

To obtain quick action ordinary lever valves or stop-cocks were placed as shown in cut, and the lever handles connected together by a half-inch round iron rod. This permitted a single downward pull to operate the lower valve and close the upper one. A strong spring placed at the top of the rod as shown in diagram automatically reversed the operation and insured the oil receptacle being ready for the next motor.

The oil was pumped through the one-inch supply line into the oil receptacle. This caused a compressing action, the lower valve was opened, this compression forced the necessary amount of oil into the lower case of the motor in a minimum amount of time. A compression chamber placed on the top of the oil receptacle later improved the action of the oil filler, as we termed it, to such a degree that the hold-up of motors at this particular point ceased.

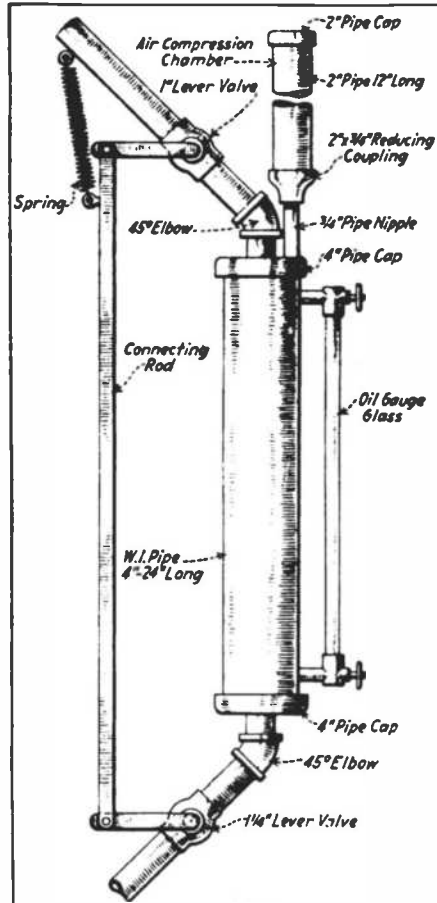

Shop-made oil filler

surprising speed and sureness. But the assembled motors were held up just before going on the gasoline test blocks where they were run under their own power as a final test. Investigation showed that the cause of delay was a very inefficient method of filling the lower crankcase with lubricating oil.

The problem of filling the lower case with oil was put up to the writer for solution, which must be rapid and sure as the delay was proving costly. After some thought the following device was constructed and upon trial proved very satisfactory.

A piece of 4-inch wrought iron pipe 24 inches long was threaded on each end. To each end was screwed a pipe cap. The cap on the top was drilled and tapped centrally for one-inch pipe.

Antidotes for Poisons

SULPHURIC, nitric, hydrochloric, or glacial acetic acids require magnesia, chalk, whiting, lime water or carbonate of soda administered, stirred up with water.

Caustic alkalis require vinegar or the juice of an acid fruit or extremely dilute acetic, citric, or tartaric acids.

Arsenic—Freshly made hydrated ferric oxide with magnesia.

Copper—White of egg mixed with water and plenty of milk.

Cyanides—Freshly precipitated peroxide of iron with potassium carbonate, coldest water poured over head and down spine.

Lead—A very dilute solution of sulphuric acid.

Mercury—White of egg mixed with milk, the white of one egg to each four grains of mercury chloride taken.

Oxalic acid and oxalates—Lime water or chalk may be used, but alkaline carbonates must not be used.

Silver Nitrate—Common salt in solution.

Zinc salts—Warm barley water may be taken.

In all above cases the application of special remedy must be preceded by the use of strong emetics, except in strong acids, when water should be taken to dilute acids before inducing the vomiting.

For burns and scalds, around the plating room and elsewhere, wet the part with cold water, and sprinkle with bicarbonate of soda (baking soda); the relief is instantaneous and permanent.



ELECTRICAL PROGRESS DIGEST

A Powerful Electric Locomotive

ONE of the most powerful electric locomotives in the world has recently been tested at Erie, Pa., where it was made in the shops of the General Electric Company. This giant locomotive takes its current from a 3000-volt source. The current is fed to fourteen direct-current motors which are placed upon as many axles. The motors are directly connected. Tests have shown that a gearless locomotive operates at 10 per cent. higher efficiency, when travelling beyond 50 miles per hour, than those that receive their power through a train of gears from the driving motor. The aggregate horsepower of all the motors carried by the new locomotive is 3240.

This locomotive, which was designed especially for the Chicago, Milwaukee and St. Paul Railroad, is to be used on a new branch of the system to handle a 12-car train of 960 tons against a 2 per cent. grade at a speed of 25 miles per hour. A center cab is provided in which is placed the heating equipment. Oil is used for the heating fuel and a motor driven blower is included in the system for forced draught.

In testing this locomotive on the four-mile stretch of track at the plant of the General Electric Company, two large Atlantic type New York Central engines were used. These engines were coupled together and used to push the big electric locomotive. When the steam engines had started to move the big electric locomotive, current was slowly turned into its fourteen motors. The two great steam engines accepted the challenge and they were soon straining every part and puffing loudly with their throttles wide open to overcome the terrific "push" of their rival. Slowly, but very surely, as the resistance was taken out of the motor circuits, the new giant started to push the steam engines in the opposite direction despite their protests. With the drivers sliding around helplessly on the rails, the steam engines were forced gradually back.

This new electric locomotive is so designed that its motors can be used as dynamos. In this way current can be generated and sent back to the power house as the engine is coasting down grade. On the line that these locomotives are to be used, there are many miles of continuous grade and the use of the motors as dynamos helps to pull locomotives up on the opposite rail.

A New Quadrant Electrometer

A VERY interesting type of quadrant electrometer has recently been brought out for making measurements of very small current or electrostatic potentials. It is becoming a greatly favored instrument in connection with

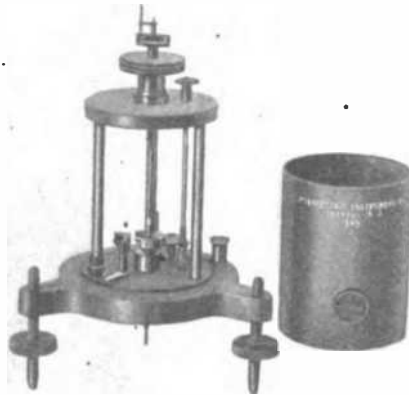

the measurement of electronic and radio activity research. It is also used to measure watts, volts or amperes in direct current and for a wide range of frequency in alternating current.

The instrument can also be used for the comparison of small capacities for the determination of dielectric constants, losses and other characteristics.

This electrometer can be used where

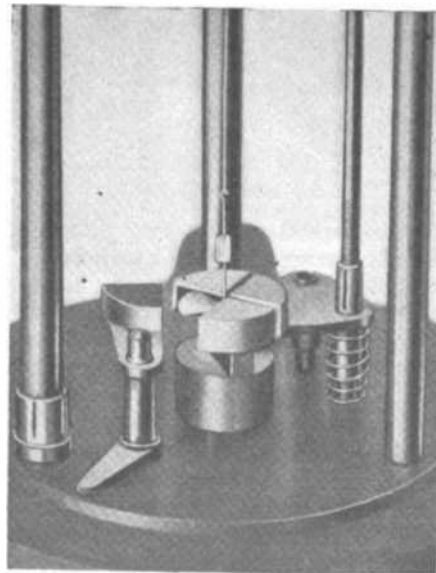

it is desired to make measurements and determinations with almost absolute elimination of electro-magnetic effects in the detector or measuring instrument.

The electrometer was designed by Dr. Karl T. Compton and Dr. Arthur H.

Compton, both of Princeton University. The complete electrical system is made very much smaller than the popular Dolezalek design. The number of parts is materially reduced and one set of insulated leads are used. Very high sensitivity is obtained from the electrostatic control nearly neutralizing the restored torque of the suspension.

The construction of the instrument is very noteworthy. The needle and plane mirror comprise one unit and the quartz fibre suspension the other. The needle is of aluminum leaf and is made slightly unsymmetrical in its relation to the quadrants. The degree of dissymmetry can be changed from the outside of the case to suit various conditions.

Notable Export Shipment of Electric Furnace Equipment

ELECTRICAL equipment for twenty electric furnaces which, when placed in operation will comprise the largest electric furnace installation ever made, is now being shipped from the United States to the Glomfjord Smeltverk Company of Glomfjord, Norway.

The apparatus was made by the Westinghouse Electric & Manufacturing Company, and is divided into units, each unit comprising the equipment for one furnace. Each of the twenty units includes a 1300-k.v.a., single-phase, main-power transformer; a 26.2-k.v.a. series transformer, a 26.2 k.v.a. induction regulator, an automatic selector switch, a transformer switch and a two-panel separately mounted switchboard for the control of the electrical apparatus. Sixteen thousand two hundred gallons of oil for insulating and cooling the transformers and regulators are a part of the shipment.

The general scheme of connections is such that the voltage variation necessary to the heat regulation of the furnace is accomplished by changing taps on the high voltage winding of the main power transformer. A portion of the winding which is proportional to the amount of voltage control desired is provided with taps in a number of equal steps. Switches and induction regulator operate together to automatically change connections on the high tension winding and to provide voltage control on each step. In this scheme the capacity of the regulator need be sufficient to control only the voltage of one step on the tap winding, thus sustaining a high power factor and at the same time providing a voltage control which is equivalent to an infinite number of steps.

Testing Incandescent Lamps

DURING the past year about five million incandescent bulbs were offered to the government purchasing authorities. Out of this number 12 per cent, or 600,000 lamps were rejected in the initial inspection at the factory. This inspection covers all the mechanical qualities of the lamp and their rating in regard to power consumption and efficiency. Samples were also selected for the burning or life tests. Three thousand five hundred lamps were subjected to this test, and with few exceptions both the vacuum and gas-filled lamps showed a life considerably in excess of 1,000 hours.

A New Wire Holder

AN American manufacturing concern which produces electrical equipment has just introduced to the trade a new wire holder, which is nothing more than a metal strip carrying one or more porcelain insulators. The porcelain members have a hole through them for holding the wires. The metal strips are screwed or nailed to the wall and the wires pass through the porcelain insulators. This little device will add greatly in reducing electric insulation to a purely mechanical job. The wire holders are said to be made at less cost than the more inconvenient type, are stronger, save tire wires and turn out to be safer than the usual methods.

A Small D.C. Motor with Splash-Proof Feature

ASMALL direct-current motor incorporating a splash-proof housing of unique design which completely protects the winding and all live parts from splashing water or accidental contact is proving popular for light domestic and industrial purposes.

Made by the Westinghouse Electric & Manufacturing Company, it is known as the CDH type and is built in $\frac{1}{8}$ and $\frac{1}{4}$ horsepower sizes.

The large commutators and box type brush-holders with large brush area make these motors particularly well adapted for operation from the low-voltage storage battery plants now being installed in great numbers on farms and in suburban residences. Motors wound for thirty-two volts are in great demand in rural communities for application to house pumps, washing machines, cream separators and similar machines.

Also, a wide field of application for motors of this type, wound for 115 and 230 volts, comprises light labor-saving machines used in homes, offices, stores, manufacturing plants, etc. They are interchangeable mechanically with

alternating-current motors of similar ratings, and therefore appeal strongly to the manufacturer of motor-driven devices. Their splash-proof feature

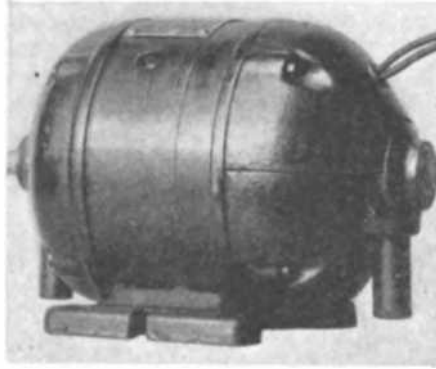

makes them especially adapted to use on washing machines.

The frame consists of a seamless forged steel ring to which the cast-iron foot and end brackets are bolted. The pole pieces are bolted to the steel ring, thereby permitting the use of form-wound field coils, easily replaced in case of injury.

The motors are light in weight, compact, sturdy and uniform in performance.

Extending Railroad Electrification

THE Chicago, Milwaukee & St. Paul Railroad has recently turned on current in another 110-mile section of its main line, reaching from Othello to Cle Elum, Washington. It is stated that by January 1 the remaining 135-mile stretch of the road from Harlotown, Mont., to Seattle, will be completely electrified. This makes the complete electrified lines of the Chicago, Milwaukee & St. Paul Railroad aggregate 885 miles. The last stretch, which covers, 135 miles, will cost about nine million dollars.

A New Safety Push Button Panel

IN order to provide a safety lighting panel of small capacity for apartment houses, residences, etc., a new push button has recently been developed by a large manufacturer.

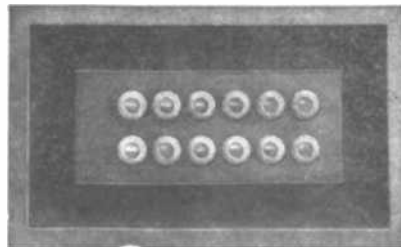

These panels are made up of push buttons and plug fuses, and all parts accessible are electrically dead, so that

the operator is in no danger of getting a shock in turning the lights on or off. Each pair of buttons with their fuses constitutes a unit and should a switch become damaged, all that is necessary is to remove the switch cover section and unscrew the defective part, without disconnecting any wires, exposing other switches or removing the panel from the box.

By reason of its construction, this panel is the narrowest safety panel on the market and the only one of its capacity that can be furnished with a safety-type main switch if desired.

These panels are made for two or three-wire systems, and for from two to thirty-two branch circuits. The capacity of the main ranges from 30 to 200 amperes, 125 volts, and the capacity of each branch circuit is ten amperes.

Petroleum Located Electrically

THE *Electrical Review* recently published an article outlining the work of Eugene Elkins, an inventor, who has produced apparatus with which natural sources of petroleum can be discovered. Mr. Elkins describes his apparatus and its operation in the following manner:

"The system consists in forming an electrical circuit through the earth by dropping an insulated wire to the bottom of a dry water hole, valley or indentation and placing a series of batteries on top of the earth, to the positive pole of which is attached a land wire. This land wire is then taken out over the field in any direction and for any distance, and all of the intermediate territory is combined thoroughly with electric currents flowing from the anode or positive pole to the cathode or negative pole. The earth being simply a huge inverted magnet, the electric currents travel from one to the other of the charged poles by the path of least resistance, much as does the return current of the telegraph system through its ground wires to the point of origin.

"Oil and its constituent components being the only minerals in the earth through which electricity cannot pass, it therefore follows that an oil pool in the path of the electric currents mentioned will offer a great resistance to the said currents; and we register these resistances on an extremely delicate meter in the hands of the operator on the surface of the earth."

Many different plans for locating mineral deposits electrically have been proposed during the past twenty-five years. Some of them have been practical and some have not. A number of different systems working on the same principle as that outlined above have been proposed, but not one of them has been developed to a point where it could be applied in a commercial way.

The Everyday Engineering Workshop Contest

The Winners of the Third Prize

THE photographs of the shops shown on this page belong to H. E. Bitner of Harrisburg, Penn., and S. C. Swanson, Secretary of the Chicago Society of Model Engineers, Chicago, Ill. The judges of the shop contest found it difficult to choose between two shops, and it was therefore

What Is in It and How I Use It." Mr. H. E. Bitner describes his shop as follows:

A part of the equipment consists of a bench lathe with back gears giving four speeds (gears fitted by myself), 6 in. face plate, 3 in. jaw chuck with inside and outside jaw, slide rest, and a

shaft being turned for the refrigerating outfit described in EVERYDAY ENGINEERING MAGAZINE. Cylinder, piston, connecting rod and both halves of the crank case are shown on table. On the table also is shown a $\frac{1}{8}$ h.p. water motor. Back of the bench drill is a casting for an A. C. rectifier just start-

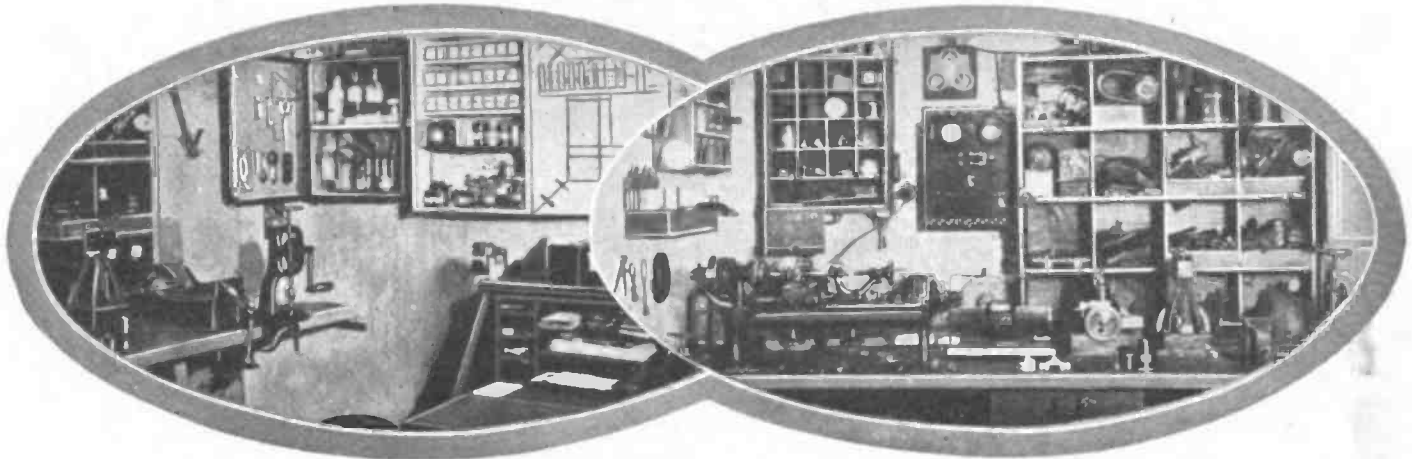

The shop of H. E. Bitner of Philadelphia, Pa.

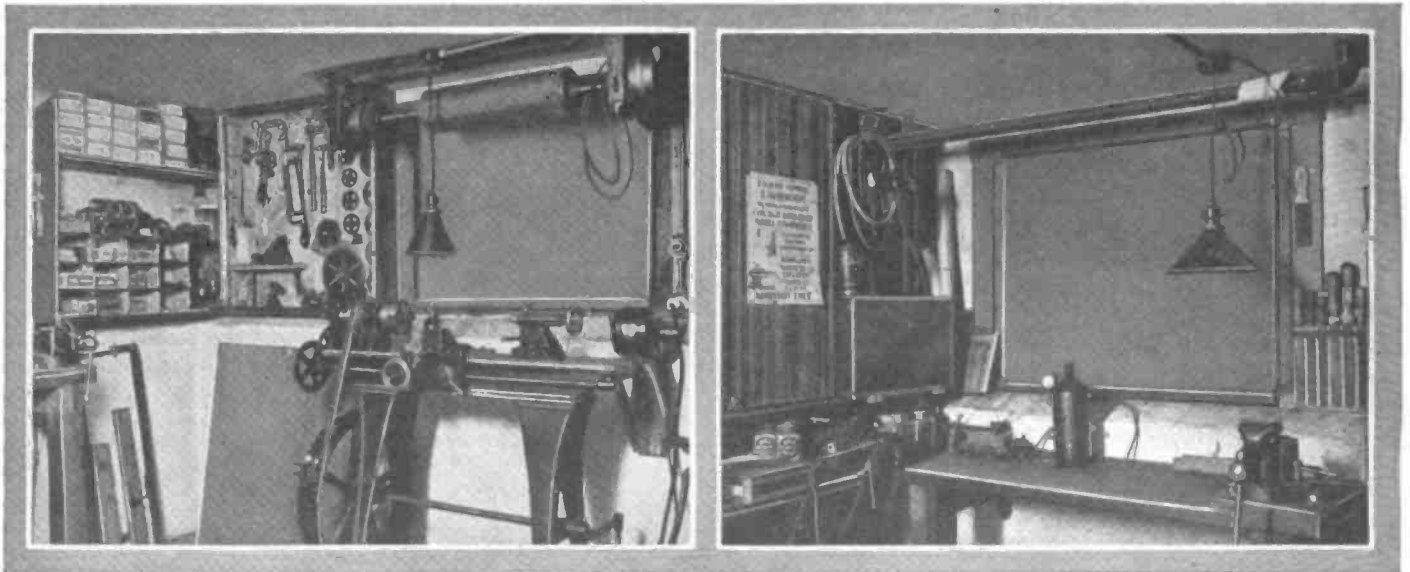

Two views of the shop owned by Mr. S. C. Swanson, who is Secretary of the Chicago Society of Model Engineers

decided to award both contestants the third prize.

The Editor of EVERYDAY ENGINEERING has decided to publish the remainder of the photographs that were received under a new department to be called "Our Readers' Shops." If enough photographs can be obtained this department will be a permanent feature of "EVERYDAY." Readers who care to send in a short description of their shops together with a photograph will be paid for their trouble when the description is published. All matter of this nature will be paid for at space rate. In describing the shop, the general theme to be followed is "My Shop:

$\frac{1}{4}$ h.p. A. C. motor which also drives a 4 in. grinding wheel. A 61 V. 6 Amp. generator is directly connected to the motor used for charging storage battery and supplying D. C. to the switchboard. The bench drill has a round table and vise, a 3 in. vise and hand drill complete the main part. I also have taps and dies from size 4 to $\frac{3}{8}$ in. hacksaw, trimmers, shears and many small tools. Switchboard has 6-V. D. C. $3\frac{1}{2}$ -6-8-10 volts A. C. used in operating small motors, coils and lamps; switchboard has A. C. and D. C. ammeters and double throw switch gives either A. C. or D. C. to one pair of binding posts. In the lathe is a crank-

ing construction. The microscope is 25 dia. The Tesla coil is home made and gives $1\frac{1}{2}$ in. spark. On top of the shelf is a complete enlarging printing and developing outfit. The chemical outfit has 60 chemicals and apparatus. I use a Bunsen burner to melt babbitt for pouring bearings. My shop is used as a hobby to build models that work and make experiments in chemicals to teach myself and pass pleasant evenings."

Mr. S. C. Swanson, who is a well-seasoned model engineer of the A class variety, sent in the following description of his shop:

"I wish our Editor had made the subject, 'What Is My Workshop?' as I

would then have had more latitude in my choice of material, as it is not natural to think of my shop as merely an assemblage of 'such-and-such' tools, for a certain purpose. Furthermore, our Editor has evidently not taken into consideration the fact that some of our shops are mere 'two-by-fours' and consequently require more than one photo to properly illustrate.

My shop is located in a dry basement halfway in the ground with fair light from two windows. Directly in front of the brightest window is the lathe, a 9 in. South Bend, with two pedal foot power. A countershaft is shown directly above the lathe, carrying a drum. This is used to drive the lathe in connection with the 1/6 h.p. motor at the right, for rather long, light jobs. The drum is for driving a tool post drilling spindle. The lathe equipment includes plain and compound slide rests, a 4 in. Cushman independent chuck, and a 1/2 in. Jacobs drill chuck.

The tool board to the left of the lathe contains, besides the tools visible, heavy tools such as chucks, etc. The upper shelf at the left of the photo contains boxes of supplies of all kinds, the second shelf mainly work in progress, and the lower shelf pigeon holes for wrenches, chisels, boring bars, boxes of odd tools, etc.

The second illustration shows the bench, with a 3 in. swivel vise, the tool chest for fine tools, taps, dies, micrometers, etc., and the cupboard for photographic supplies and chemicals.

I use my shop mainly in the practice of my hobby, model engineering. This includes, besides the building of models, such work as special tools from time to time as required. As to how I use it, I will say that everything has its place, and at the end of every 'work' period each tool goes into its place. A rusty tool is an abomination to me, so everything is kept well oiled. Emery is a necessary evil; special precautions are taken to protect the lathe from it. The small motor-driven grinder is kept at its distance from the lathe and other good tools. To fill out my 400, let me add for the benefit of the 'shopless' one: Get a shop, treat it right, and you have the best friend in the world."

Mr. Swanson's philosophy regarding his shop is good advice for all of those who are not fortunate enough to be in possession of such a luxury. It is very true that a little workshop can be a man's best friend. He can go to it and enjoy himself when "everything is wrong" or when there is just nothing else to do. The little workshop contains tools—the very instruments of creation. Every normal man or boy has the creative instinct in some form. When in the possession of tools and a shop to put them in, he can spend many useful and happy hours exercising his genius and skill in "making things."

Calibrating Pressure Gauges

By Edwin J. Bachman

THERE is really nothing difficult about making small pressure gauges, but it seems that the articles published to date come to a close too quickly when calibrating should be considered.

It is all very well to connect the newly made gauge with a standard gauge if you have one, or if you have one and it is accurate; but at that the boys might like to know how the standard gauge was calibrated in the first place. At a gauge factory here in eastern Pennsylvania they make all kinds, from automobile fuel tank and oil pressure gauges that have bent tubes with a wall thickness of only two-thousandths of an inch and indicate 4 to 6 pounds maximum pressure, to hydraulic gauges which indicate upward of 300,000 pounds to the square inch, which have a tube of tool steel, drilled from the solid, bent red hot and finally tempered. When they calibrate these gauges they do not connect them up with a standard gauge.

The worker who calibrates the newly made gauges or who sets the printed dials so that the hand registers correctly has a small device on his bench which consists of a hand-pump opening into an upright column on which is supported a plunger, the bottom of which is flat and rests on a flat seat. There is an opening in the seat whose area is one-fifth of a square inch exactly. The top of the plunger has a circular platform about four inches in diameter on which the weights are placed. Connected to the bottom of this column and open to the pressure from the pump is a stan-

dard pipe connection on which the gauge to be calibrated is fastened. The whole thing is then filled with oil.

Now it is evident that if a weight of one pound is placed on the platform it will require a hydraulic pressure of five pounds to the square inch to raise it, since the area of the opening in the seat under the plunger is one-fifth of a square inch. There are about 75 pounds of brass weights, all machined and fitting into one another. The weights weighing one pound actually are marked five pounds, the two-pound is marked ten, etc. The pointer on the gauge having moved according

to the pressure will indicate where the mark is to be made on the dial. As each weight is added a new mark is placed on the dial. Thus when a gauge registers five pounds you may be sure that the pressure is that.

By changing the size of the aperture under the plunger the values of these same weights may be changed.

An amateur could make a simple apparatus similar to the one described, using a set of avoirdupois weights such as are used in a grocery store, or a beam with a sliding weight could be constructed using only one weight. The

pump may be a bicycle tire pump. In case the beam type is used, an adjustable weight should be provided for balancing the beam. The distance between the notches on the beam is the same as the distance between the two pivots. The column is shown high. This will prevent the oil from overflowing when the pressure has reached the point where it will lift the plunger. This upright is shown in section, the rest being simple enough so that anyone can understand.

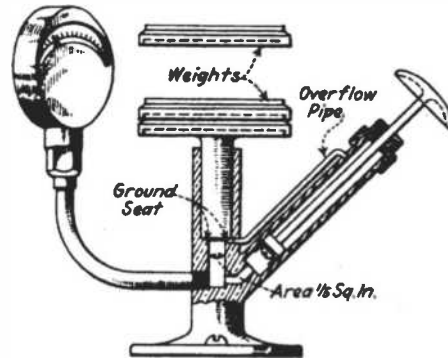

Calibrating gauges with small weights

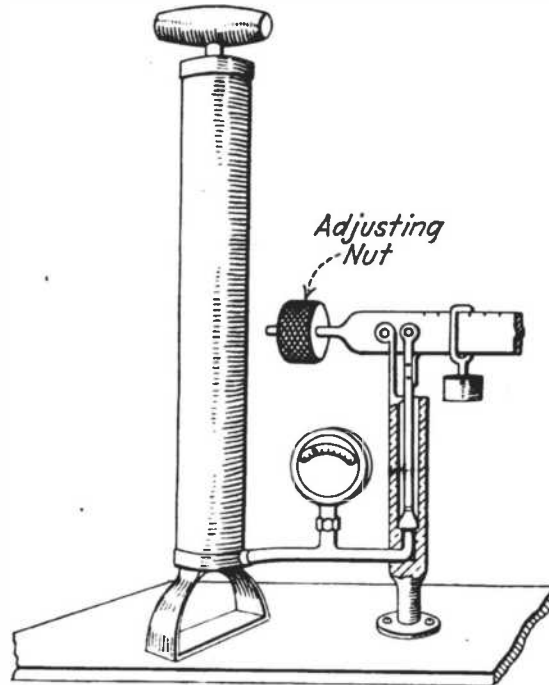

The beam type of gauge calibrating instrument

Construction of a Mechanical Vacuum Cleaner

By E. H. Williamson

PART II

Conclusion

GREAT care should be taken to place the bearings so that the spindles are held in a vertical position as to the cover (C) and also that the teeth mesh freely, but neither too close nor too far apart, as the success of the machine depends upon this. The bearing for the bottom end of the spindle of (G) is a brass plate $\frac{1}{8}$ in. thick and 2 in. long by 1 in. wide, which is screwed to the face of the wooden cover, the wood being bored out to accommodate the end of the lower gudgeon.

To avoid the expense of unnecessary machine work, the spindle of the gear (G) may be made as follows: A piece of $\frac{1}{2}$ in. round iron rod, $1\frac{1}{2}$ in. long, with a smooth surface is prepared and the ends filed square. Take a centre punch and make a dent in the exact centre of each end, and start the hole with a

piece of 1 in. pine, 4 in. long by 2 in. deep, screwed firmly to the right-hand cover below the air duct, as shown in the photo.

To prevent side play, a $1\frac{1}{4}$ in. tube is screwed to the shaft between the other two tubes. As it is necessary that the fan and train of gears should continue to revolve of their own momentum if the motion of the cleaner is temporarily stopped, some form of release is necessary, and this device is shown in

screw. It is held against the teeth of the ratchet by the pressure of the light spiral spring, as shown.

The driving shaft is supported at the left end by a bearing composed of a strip of $\frac{1}{8}$ in. iron, 1 in. wide and 5 in. long, which is screwed to the wooden cover of the gear box. This cover is $\frac{3}{8}$ in. thick, 6 in. long and 4 in. wide. The driving wheels are turned from 1 in. pine and are 6 in. in diameter. There is a semi-circular groove $\frac{1}{4}$ in. deep cut in the rim to receive a tire of $\frac{3}{8}$ in. rubber which is cut from a length of baby carriage wire, and fastened to the wheel with sprigs driven down below the surface of the rubber. The wheels are attached to the shaft by metal hubs of the size shown in Fig. (8). These may be made of brass if desired, but in the writer's case were cast from type metal in a wooden mold and smoothed up and trued on a wood lathe. The photo-

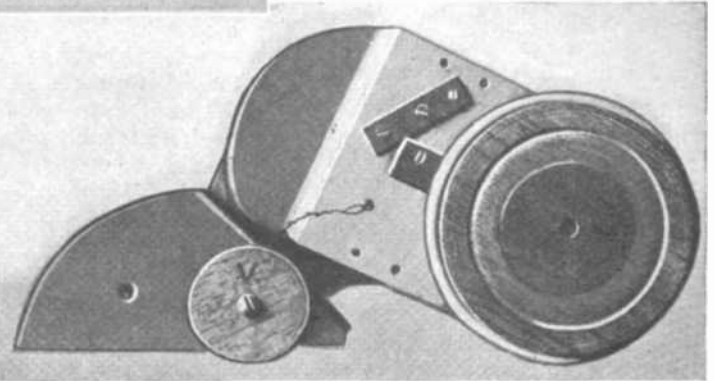
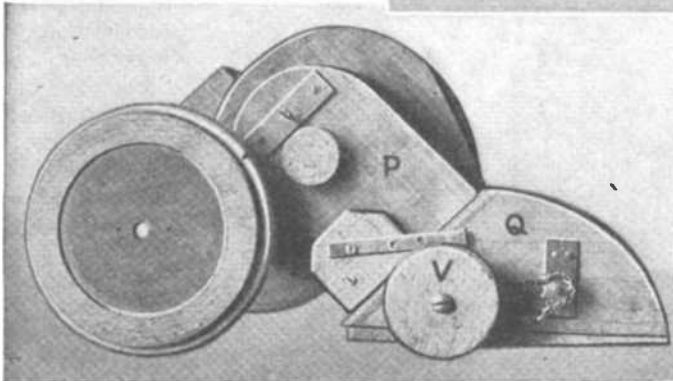
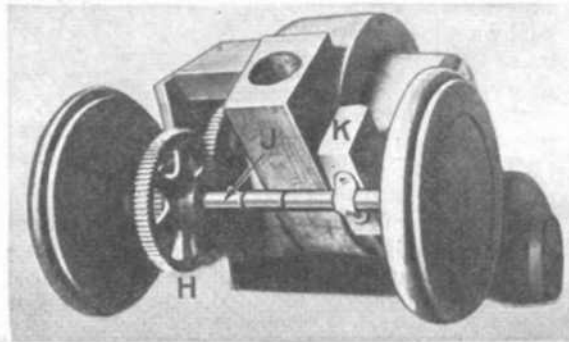

Top, Fig. 6. Left, Fig. 9. Right, Fig. 11

No. 40 drill. Next take a $\frac{1}{8}$ in. drill and bore a hole to a depth of $\frac{3}{4}$ in., keeping the drill square with the end of the iron. This requires considerable care, but it can be done.

Now take two pieces of steel rod a shade over $\frac{1}{8}$ in. thick and 1 in. long and drive them into the holes in the iron, so that they project $\frac{3}{8}$ in. Two pieces of broken drill shanks of the proper size will answer perfectly. The photo., Fig. (6), shows the driving mechanism. A 4 in. gear wheel (H) is set on a piece of brass tube (I), $2\frac{3}{8}$ in. long. This sets on the driving shaft, which is a piece of round iron rod, $\frac{7}{16}$ in. outside diameter and 11 in. long. This shaft is supported at the right side by a bearing sleeve (J) which is a brass tube $2\frac{3}{4}$ in. long and is fastened by a pipe strap to the bearing block (K), which is made from a

the photograph, Fig. 5, at the end of the shaft, and also in the diagram, Fig. 7, which gives the dimensions.

The steel ratchet (M), which is $1\frac{1}{2}$ in. diameter and $\frac{1}{4}$ in. face, has the bore enlarged sufficiently to slip over the end of the brass sleeve (I) and is attached to the side of the 4 in. gear (G) with a couple of 8-32 flat head machine screws, the ratchet being countersunk to receive the heads. The L-shaped block (N), which is of $\frac{5}{16}$ in. brass, $1\frac{1}{2}$ in. by $1\frac{1}{2}$ in., is drilled to $\frac{7}{16}$ in. to fit on the driving shaft, to which it is fastened with a set screw, driven through the shaft. The dog (O) is made from a piece of $\frac{3}{8}$ in. by $\frac{1}{16}$ in. iron, sharpened at one end and hardened. It is screwed to a half inch square block of the same thickness of brass as (N) and is pivoted to the side of the latter with an 8-32 machine

graph, Fig. (9), shows the left side of the cleaner, and the air duct (P) which connects the fan box with the floor box (Q). This duct is $4\frac{1}{2}$ in. wide and 6 in. long to the top of the rounded part, and 2 in. deep, outside dimensions. The rounded part is made by turning a circular shell, $4\frac{1}{2}$ in. outside, $3\frac{1}{2}$ in. inside, and $1\frac{5}{8}$ in. deep. This is cut in half and one of the halves is nailed securely to the cover of the fan box concentric with the $3\frac{1}{2}$ in. inlet hole. The side pieces are of $\frac{3}{8}$ in. pine, $1\frac{5}{8}$ in. wide and 4 in. long, and are nailed to the cover so as to make a tight butt joint with both the ends of the wooden semi-circle and the slanting face of the floor box. The cover is cut from $\frac{3}{8}$ in. pine to conform to the outside dimensions of the duct, and is nailed to the box with small brads. The photograph, Fig. (10), shows a view of the interior

of the floor box. At one end of the slanting side will be noted the opening into the air duct. This is $1\frac{1}{2}$ in. by 3 in. and is arranged to be closed if desired by a sliding cover made of cigar box wood, 4 in. by 5 in., which slides in narrow bevelled strips, and is pulled back and forth by a piece of picture wire, which is run through the sides of the box. If the slide is pulled over the opening, the suction is cut off, and the opening in the side of the air duct can be used to receive an air hose for special work. This opening is normally closed with a stopper, as shown in the photograph, Fig. (9). The dimensions of the floor box are as follows: $8\frac{1}{2}$ in. by 8 in. at the bottom, the sides are 8 in. long at the bottom, 5 in. long on the slanting part, and the curved part has a radius of 4 in. The height is 4 in. from the base to the top of the slant. The slanting side is 5 in. wide by $8\frac{1}{2}$ in. long. The curved part is covered with a sheet of thin tin, fastened with small tacks all around, and all joints are lined inside the box with strips of thin leather, cut from old gloves and glued over the cracks. The revolving brush (S), which stirs up the dust and also collects debris too large to go through the fan, is made from a brush taken from a discarded carpet sweeper. The ends of the wooden centre are cut off to make the brush $6\frac{1}{2}$ in. long, and a $\frac{3}{16}$ in. hole, $1\frac{1}{2}$ in. deep, is drilled in the centre of each end. A bit of $\frac{3}{16}$ in. round iron rod 2 in. long is driven into one end, and a piece 3 in. long is set in the other, so as to project about one inch beyond the side of the box. The brush is supported in bearings formed from plates

is attached to the wheel by small screws driven through the web of the sprocket. The small wheels (V) and (V¹) are turned from $\frac{3}{8}$ in. pine, and are $2\frac{3}{4}$ in. in diameter. A bit of brass tube, $\frac{1}{4}$ in. inside diameter, is driven through a hole bored in the centre and forms a sleeve on which the wheel revolves. The axles on which they turn are stove bolts. As the sides of the box are only $\frac{3}{8}$ in. through, it is best to mount the wheels on reinforcement blocks as shown, the stove bolts passing through both pieces and being locked with a nut

sleeve, and the cloth is bound around in the groove with binding wire to make a tight fit. The interior of the sleeve is $1\frac{1}{2}$ in. in diameter, to receive the metal tube which connects it to the outlet from the fan box. This tube, which is 4 in. long, was made, in the writer's case, from a piece of the barrel of an old bicycle foot pump. The upper end of the bag is reduced in size from seven to five inches, and when in operation the mouth is held together by a clamp, which may be made of two strips of wood bolted together, at the ends, and provided with thumb nuts for easy removal, or an ordinary trouser hanger may be used. Being of white pine, the body of the cleaner may be stained any desired color, but mahogany or rosewood gives a good effect, and the wood after staining should be rubbed down and then varnished with shellac. The operation of the cleaner follows: It is pushed forward by the handle like an ordinary carpet sweeper, and the revolution of the large wheels drives the fan at high speed, producing a strong suction and quickly inflating the bag. Where the space to be cleaned is limited, the cleaner is given a series of short, quick punches and by the action of

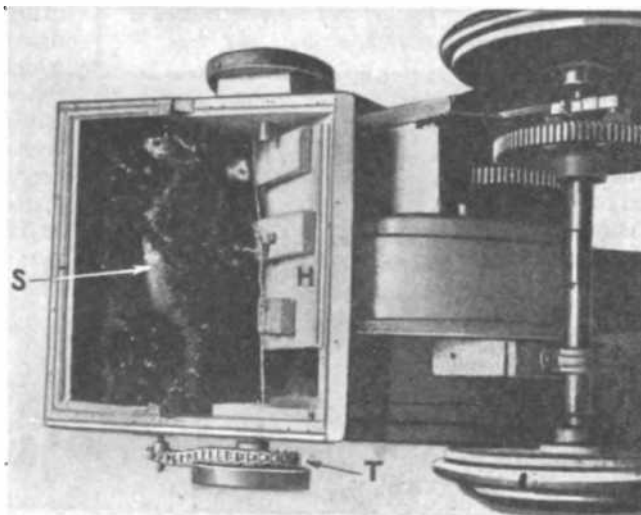

Fig 10

within the box. This makes a rigid job.

A short thick rubber band is sprung over the rim to act as a tire, and secured with a touch of liquid glue. Returning to the revolving brush: A one-inch brass sprocket wheel is set on the gudgeon that projects through the box, and secured by a small machine screw, through both hub and spindle. (See Fig. 11.) The two sprockets are connected by a wire sprocket chain, which should not be drawn tight. The handle (W) by which the cleaner is pushed along is made from a piece of pine, 28 in. long, $1\frac{1}{2}$ in. wide and 1 in. thick. It is provided with an iron fork for attachment to the cleaner made from two strips of 1 in. by $\frac{1}{8}$ in. and 14 in. long. Three inches of this length is secured to the wooden bar by two stove bolts driven through the wood, and the ends are bent symmetrically to embrace the sides of the cleaner, allowing a space of 8 in. between the prongs. These are pivoted at the ends on machine screws, size $\frac{1}{4}$ -20, driven into $\frac{1}{8}$ in. iron plates, 1 in. by 3 in., which are screwed to the covers of the gear box and air duct, as shown in the photograph, Fig. 11. The dust bag is made from khaki cloth which is close grained and light, and is 24 in. long by 7 in. wide, stitched with double seams at the edges. The lower end is cut so as to make a close fit around a wooden sleeve, $2\frac{1}{2}$ in. in diameter by 4 in. long. A groove is cut a half an inch from one end of the

the ratchet the fan will continue to revolve at a practically constant high speed, due to its momentum. The same method is used, where it is desired to use an air hose attached to the opening in the air duct, for cleaning walls, curtains, etc., in which case, of course, the trap must be pulled over the opening from the air duct to the floor. The method by which the trap is pulled is shown in Fig. 9. A small lever of $\frac{1}{16}$ in. strap iron, $\frac{3}{8}$ in. wide and 4

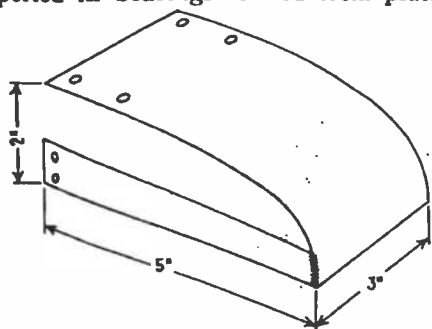
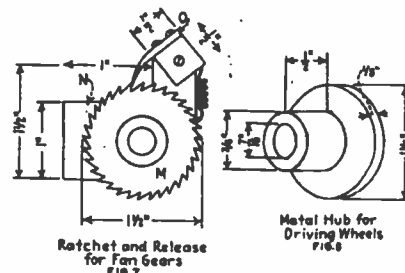

Fig. 12

of $\frac{1}{8}$ in. brass, 1 in. by $1\frac{1}{2}$ in., bored to receive the brush gudgeons, and screwed to the inner sides of the box in such a position that the bristles of the brush press on the floor when the cleaner is in use. The brush is driven from a $2\frac{3}{4}$ in. brass sprocket wheel (T), which is screwed to the side of the small front wheel (V). The sprocket is set out from the side of the wheel by a washer of cigar box wood, so as to give the chain a space to run freely, and



in. long is attached to the side of the air duct, being set on a small block to bring it even with the side of the floor box, and the end of the picture cord is attached to this lever. Where the cord emerges from the other side of the box it is formed into a loop and hung over a small screw driven into the wood, (as in Fig. 11). The driving gear and the part of the gear (G) which projects from the gear box are to be protected with a cover, which is not
(Continued on page 242)

Magic in Metal Casting

The Story of Die-Castings and the Great Industry They Have Created

By Raymond Francis Yates

THE casting of metal in prepared moulds is not a new art. Its beginning is lost in the mists of antiquity. The Egyptians were probably the first peoples to practice this useful art. The Greeks, although they acquired the necessary skill and knowledge at a much later date, were more proficient and succeeded in producing much more creditable work. The great Greek, Chares, who made the Colossus of Rhodes (The Sun God Helios) during the reign of Demetrius in the fourth century before Christ, accomplished one of the greatest feats of metal casting known to mankind. This massive statue took twelve years to make and when completed it stood 105 feet high and weighed in the neighborhood of 360 tons. The relentless shocks of an earthquake destroyed it in the year 224 B.C.

Other famous Greek colossi such as the Apollo of Calamis, the Zeus of Hercules of Lysippus and the Zeus of Olympia, are numbered among the greatest castings of the world.

King Solomon's throne was placed between two massive bronze lions, which showed that the people he ruled had some knowledge of metal casting. Several references appear in the Bible which gives undoubted evidence of ancient knowledge of the casting art.

Die-casting is the magic of the metal industry. So rapid and perfect are metal castings produced by this process that it would seem that the machine operator resorts to the magician's "Presto" and there is created a casting smooth, accurate and clean.

Die-casting now forms an infant industry that bears all of the earmarks of developing into a giant. Ere long, all small castings may be produced by this method, which is far more rapid, convenient, and for large quantities, less expensive than the conventional process of sand moulds.

Archæologists tell us that civilization has passed through three distinct stages in the change from barbarism to civilization. The first, or stone age, is that period in which the people used implements of stone. The second period is called the bronze age, in which mankind discovered the use of the alloy bronze which consisted of the combination of the metals copper and tin. This is disputed in many quarters and some archæologists believe that the metal copper superseded the use of bronze, owing to the fact that copper could be found in its natural metallic state, whereas tin would have to be reduced from its ore. Iron is the chief metal of the next period which is commonly known as the iron age.

The early Egyptians used a smelting furnace which was made by sinking a hole in the ground and setting the crucible into it. The crucible was then surrounded with the fuel. A forced draft was produced by fanning the fire with bamboo matting. In later types of furnaces bellows were used and these were manipulated by foot power. This type of furnace was the forerunner of the modern pit furnace which is used in foundry practice.

The Greeks used furnaces which greatly resembled the cupola furnace of the present era. As early as the fifteenth century the modern reverbera-

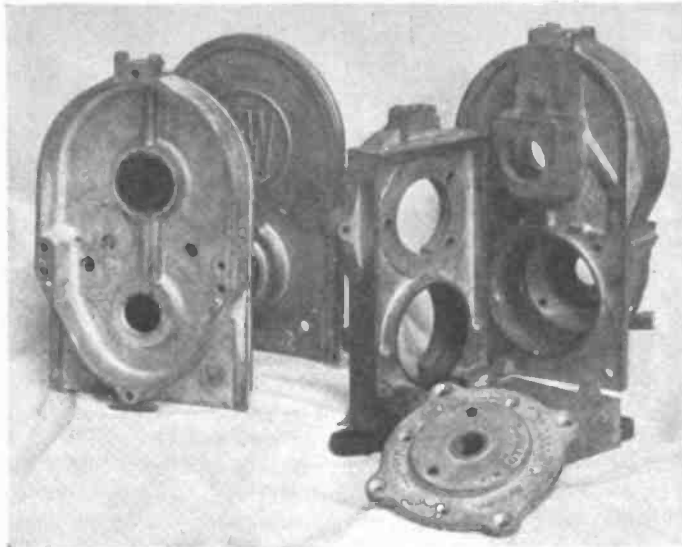

Courtesy of Doehler Die-Casting Co.
A group of castings made by the die-casting process

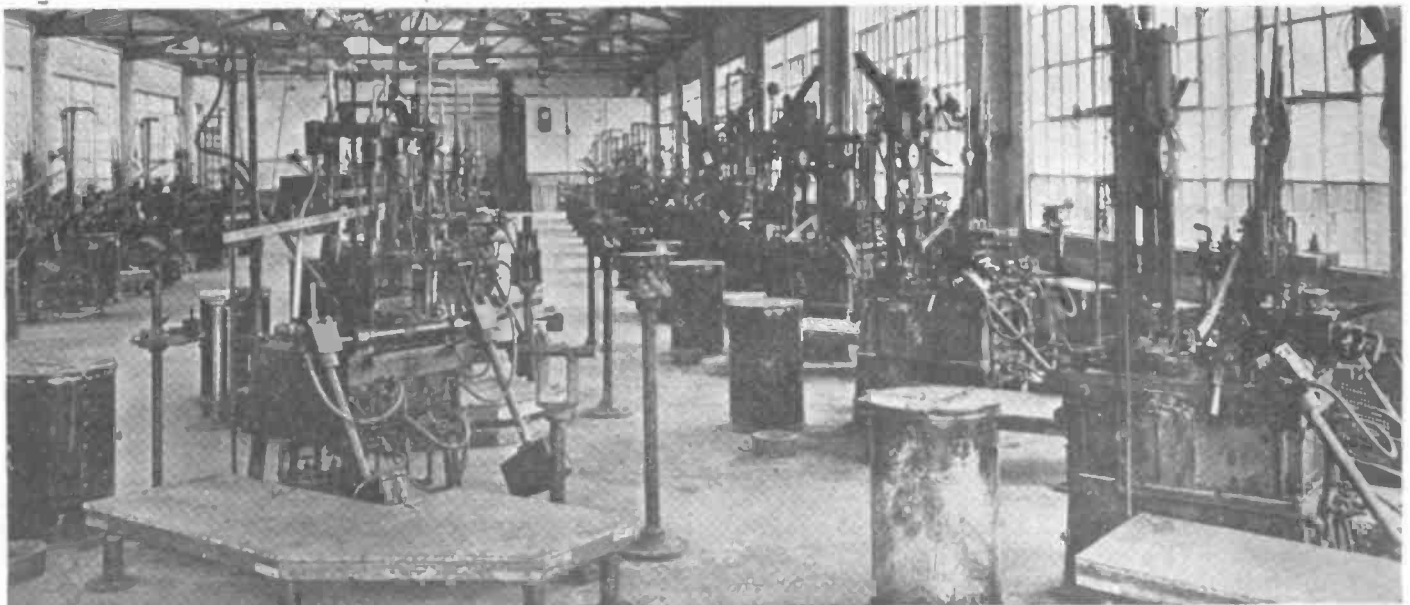

Courtesy of Doehler Die-Casting Co.
A number of automatic die-casting machines. The molten metal in the base of the machine is forced into the die

tory furnace was brought into use.

Archæologists have recently unearthed a series of moulds which they claim to have belonged to the first Dynasty of Egypt. These moulds were carved in thick pieces of clay which were baked into pottery and lined with fine ashly clay. Among the lake dwellings of Switzerland moulds have been unearthed which date back as far as 2000 B.C. Some of these moulds are of rock and others are of clay. These moulds were more or less permanent in nature.

The casting of metal in sand was started commercially in about 1708. A

castings industry is to-day one of the largest and most important branches of the non-ferrous metal trades.

Die-casting can be described as a process in which molten metal is forced under pressure into a metallic mould where it is chilled and extracted. The metal is forced into the mould either by compressed air or steam so that it will reach every nook and corner of the die and form a casting which will be as free from blow-holes and other imperfections as possible.

Die-castings are quite expensive and range in price from one hundred dollars

makers are engaged to construct the dies. The employment of veteran tool makers is absolutely necessary in order to produce accurate dies which will make castings of the required size. In making a die, proper attention must be given to the grating, venting and the general design.

The original die-casting machine developed by Mr. Doehler was operated by hand. The molten metal was forced by a plunger into the die. This type was replaced with a gravity die-casting machine. The very latest development is an automatic die-casting machine which is more rapid and convenient than its forerunners. However, many of the hand-operated and gravity machines are still in use. Several batteries of automatic die-casting machines are shown in one of the illustrations.

Prior to the year 1914 about 90 per cent of all the die-castings manufactured were produced with zinc base alloys. The zinc alloy used can be expressed with the following formula: Zinc, 84.5 per cent; tin, 9.0 per cent; copper, 4.5 per cent; aluminum, 2.0 per cent.

These zinc alloys were found more or less unsatisfactory owing to the fact that they did not possess sufficient mechanical strength to withstand great strains and they could only be used to form parts of machines that did not require a great amount of strength. However, there are certain parts that could be made satisfactorily with zinc alloys, such as magneto housings, switch handles, switch locks, oil pump parts, speed indicators, etc. Zinc alloy castings can be strengthened considerably by the use



Courtesy of Doehler Die-Casting Co.

A cleaning room in a die-casting plant

man by the name of John Thomas, who was an apprentice of Abraham Darby in Wales, conceived the idea of using sand instead of clay. An English patent covering the casting of metal in sand was obtained dated 1758.

The advent of the metallic mould was brought about in the printing industry in the year 1454. This metallic mould was used for the casting of type and it was probably the first step toward the development of the modern linotype machine.

The casting of the metal by forming moulds in sand is a very unsatisfactory method. It is slow, troublesome, costly and produces a very crude and unfinished result that requires a great amount of machining and finishing to bring it to a usable shape. Modern industry has long felt the need of a process whereby castings could be accurately and rapidly made in an almost finished condition. The manufacturers desire to have metal parts cast that would not need to be ground or filed to bring them to shape. In the year 1906 Mr. H. H. Doehler perfected a system of castings in metal dies. In the year 1907 Mr. Doehler was granted a patent upon his process and from that time to this the art of die-casting has grown rapidly. Die-castings are smooth and accurate and require little or no machining. Castings are made accurately to within one-thousandth of an inch. The die-

for simple parts to one thousand or more for the castings of more complicated parts. However, when a great number of castings are to be made, the rapidity of the die-casting process rapidly offsets



Courtesy of Doehler Die-Casting Co.

A metal mixing room in one of the large die-casting plants

any extra expense involved in the making of the ordinary die, which can be used for many thousands of castings before it is necessary to repair it or replace it with a new one. Expert tool

of ribs, webs, fillets, inserts of iron, steel or brass where an increase in strength is required. Zinc alloys are also corroded by water and aqueous solutions of any kind, which is a very bad feature.

Zinc alloys of the type used in die-castings show a tendency to fuse at a temperature of 350° Fahr. At 780° they will be in a purely liquid condition. The highest melting point of the zinc alloys is 750° Fahr. Where abnormal temperatures exist it is not advisable to employ zinc alloys, owing to the fact that their sensitivity to abnormal temperatures will cause a serious reduction in their mechanical strength.

Tin alloy die-castings have come into use in the construction of hygienic and surgical instruments, dairy utensils, food container parts, etc. Such alloys are comparatively soft and are found to have a melting point of 425° Fahr. One of the most important uses of tin alloy castings is in the manufacture of babbitt bearings for gasoline motors.

Lead alloy die-castings are used where inexpensive, non-corrosive alloy is desired, at a sacrifice of mechanical strength. Such die-castings find extensive use in fire extinguishers, shrapnel shells, hand grenades, etc.

Aluminum alloys have recently come into use in the die-casting industry after a great amount of research work which finally overcame the many obstacles that stood in the way of successful castings. The melting point of aluminum alloys is in the neighborhood of 1200° Fahr. Such alloys have a tensile strength of about 25,000 lbs. per square foot. These alloys have come into wide use in automobile construction. The strength of these alloys can be nicely controlled by either increasing or decreasing the copper content. Aluminum alloys take a high polish and are able to retain it for a considerable length of time. The freedom from crystalline structure, a greater strength, a lower specific gravity and a higher melting point, make aluminum die-castings superior to zinc die-castings.

After a great amount of development it was found possible to die-cast aluminum parts that were previously die-cast in zinc, which process is much older and better understood. The cost of aluminum die-castings is much higher than zinc castings, but on the

other hand, aluminum alloys possess a number of advantages over the zinc alloys.

From the beginning of the die-casting industry manufacturers were desirous of producing castings by the use of brass and bronze. Certain properties peculiar to these alloys made this process a difficult one. At times, after much experimental and development work, metal castings were produced which seem to possess more promising features, but when tried on a commercial basis they were invariably found to be failures.

It was during the year 1917 that brass and copper die-castings were produced on a dependable commercial basis. Die-castings of brass are now used extensively in naval torpedoes, starting and lighting systems, turbines, railroad steam couplings, carburetors and roller bearings.

The strength of die-castings produced by forcing molten metal under pressure into a permanent metallic mould is first obtained by the proper designing of the part to be die-cast. This, of course, rests with the engineer that designs the part. Designing engineers of to-day are becoming more and more accustomed to the design and construction of die-castings and it will not be long before our colleges and universities will be including this important branch of the metal industry in their engineering courses. The strength of die-castings also depends largely upon the raw materials of the alloy and the production of castings that are closely grained by the elimination of casting defects. Great trouble is experienced with blow-holes in the production of die-castings, just as in the ordinary process of metal casting. However, by properly designing the die, this source of trouble is greatly eliminated and strong, perfect castings are produced. In the type of die now used, as the metal is forced in, the air is allowed to escape. However, it is impossible to exclude all of the air and a certain amount remains in the die. Attempts have been made at designing machines which will remove all of the

air in the die before the metal is allowed to enter. Actual practice has proven that the vacuum machine which has been perfected, does not possess any advantage over the ordinary machine. This may be surprising to the lay mind, but it is, nevertheless, true.

Casting of practically any shape can be produced by the die-casting process. A number of castings are shown in one of the illustrations which accompany this article. Many of the dies which are used are very costly and from one to six months are spent in their construction. The great advantage, however, of die castings when they are produced cannot be overestimated. When the manufacturer receives them they require little or no machining and the holes are bored, ready for tapping, and in cases where a very accurate bearing surface is required it is only necessary to use a reamer in order to produce it. There is no filing, grinding or scraping, as the castings are smooth and ready to be polished if this is necessary. Even such minor operations as counter-boring, and countersinking are done by the die-casting machine, thereby saving a great amount of handling for these operations.

It has been found possible to produce gears by the die-casting method, but, of course, these parts do not possess the strength that cut gears do made by the more conventional method. In certain cases, however, they possess sufficient strength to be used and they are produced much more cheaply than gears cut on gear-cutting machines.

The die-casting industry is still in its infancy. It is safe to say that in the near future all small castings will be made with die-casting machines. Of course, it will never be practical to produce large castings by this method. Experiments are now being made with iron and ere long a workable iron die-casting outfit may be produced. When this happens the industry will probably be developed to a point where it will be both costly and impractical to resort to the old methods of casting small pieces by the use of sand.

TO PROTECT IRON AND STEEL FROM RUST

THE following method is but little known, although it deserves preference over many others: Add 1¾ pints of cold water to 7 oz. of quicklime. Let the mixture stand until the supernatant fluid is entirely clear. Then pour this off and mix it with enough olive oil to form a thick cream, or rather to the consistency of melted and recongealed butter. Grease the articles of iron or steel with this compound, and then wrap them up in paper, or, if this cannot be done, apply the mixture somewhat more thickly.

SOLDERING OF ALUMINUM BRONZE

TO solder aluminum bronze with ordinary soft (pewter) solder: cleanse well the parts to be joined from dirt and grease. Then place the parts to be soldered in a strong solution of sulphate of copper and place in the bath a rod of soft iron touching the parts to be joined. After a while a copper-like surface will be seen on the metal. Remove from bath, rinse quite clean and brighten the surface. These surfaces can then be tinned by using a fluid consisting of zinc dissolved in hydrochloric acid in the ordinary way with common soft solder.

A RADIOGRAM TO EVERYDAY ENGINEERING.

The Editor of EVERYDAY ENGINEERING recently received a radiogram from Chicago via the American Radio Relay League which told of the opening of the first model engineering workshop in Chicago. The text of the message follows:

"We hereby announce the opening of the first model engineering workshop in Chicago.

Chicago Society of Model Engineers." Via The American Radio Relay League. The editors of EVERYDAY ENGINEERING extend their best wishes for the success of the new shop.

EVERYDAY SCIENCE NOTES

BY PROF. T. O'CONOR SLOANE

Sir Dugald Clerk recently read an elaborate paper before the Royal Society of Arts, his theme being the position gas takes in the scale of efficiency. The modern mantle gas burner compares with the best incandescent electric lamp in light given per power unit. A one watt incandescent electric lamp uses 35 B. T. U.'s at the generating station and a half watt bulb 20.3 B. T. U.'s per candle power-hour. The inverted mantle gas burner uses 38 B. T. U.'s per candle power-hour. High pressure mantle gas burners give much higher results, as little as 19 B. T. U.'s per candle power-hour. The electric flame arc on the other hand surpasses this, using as little as 9 B. T. U.'s per candle power-hour.

Gas thus appears about as economical in the lighting field as the incandescent electric lamp. In the production of mechanical power the modern gas engine develops 13.6 per cent. efficiency referred to brake horsepower, while the electric motor returns only 10.4 per cent of the energy at the factory. The lecturer strongly advocated internal combustion gas engines for power. The last proposal in the way of electric power development in England is the proposed installation of 16 gigantic electric power stations to work at one and a half times the efficiency of the best modern station and at two and three-tenth times the efficiency of the average station.

With modern mantle burners giving 25 candle power per cubic foot, per hour, where in former times 3 candle power was good practise, and high pressure gas burning giving 40 to 60 candles per cubic foot per hour, he considered that gas still held the preeminence over electric power. As Sir Dugald Clerk is a gas engineer of international reputation, it is natural he should advance arguments in favor of gas for both light and power.

An alloy of 15% magnesium and 85% lead oxidizes with great rapidity in moist air, both metals participating in the reaction. Sometimes an hour or two is sufficient, sometimes eight or more may be required to complete the oxidation of the metals. They fall into a black powder. It is suggested that a method of making nitrogen or nitrogen and hydrogen mixtures might be based on the use of this alloy. The oxygen of the air and that of the water present as water vapor would combine with the metals, setting free the hydrogen of the water and leaving the free nitrogen of the air mixed with it.

Austria and Germany were at one time relatively great producers of radium compounds; now the industry is established in its own home and birthplace in France. The Combeville works make radium salts and are the only establishment producing mesothorium bromide.

The aeroplane record, Turin to Rome with a passenger has been broken, the flight having been done in 2 hrs. and 15 min. for the 362 miles, a rate of 161 miles an hour.

Had the war continued Helium would have been produced at comparatively low cost and at the rate of two million feet a month in the United States and British Empire.

Where small objects or fine and inaccessible joints in places hard to reach with the ordinary soldering iron are to be soldered, the arrangement illustrated in the cut, may be employed. The writer has used it with much satisfaction. It consists of a copper wire inserted into a handle. For very small work a wire not over 1/16 inch inserted in a cork will answer. For larger work, a 1/4th or even thicker wire may be used with a bit of broom-stick for its handle. Don't try to hold it with pliers. The wire is kept hot as shown. The outer end may be taken to represent the copper bit of a soldering iron and may be filed to a flat chisel edge or to a point according to the work to be done.

ing—a great contrast to the few years of the tropical plant's life which suffice to give it size enough for the industry in question. Another effort in somewhat the same direction is the invention of a machine to treat cotton seeds after ginning to remove the small amount of cotton fibre which still adheres to them. This fibre can be used in paper making.

A few years ago the cultivation of flax was regarded as a dying industry, but the great demand for linen during the war gave a great stimulus to the cultivation of flax in Ireland, Scotland and Canada. The great continental sources of flax were cut off by

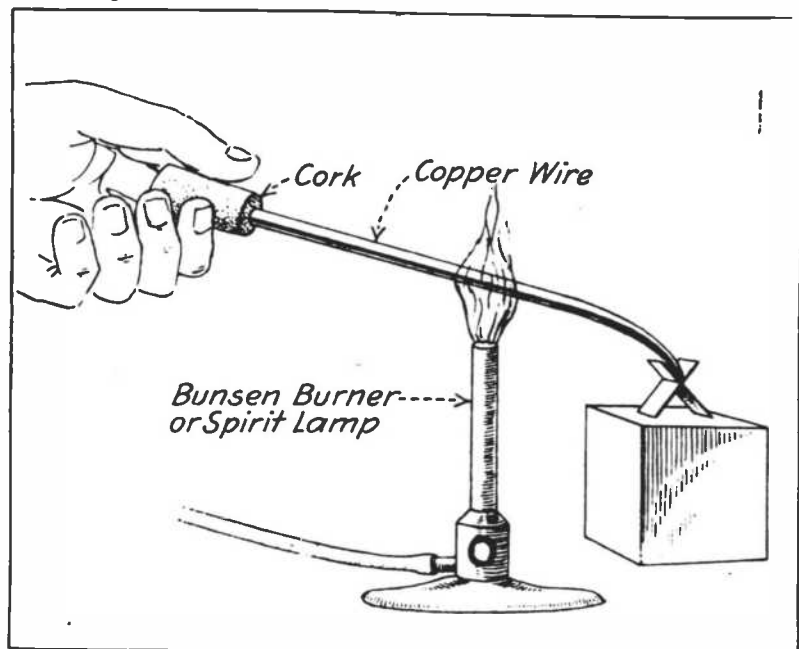

This end is tinned and the arrangement is used as shown in the cut. The wire may be of any desired thickness and while the soldering is in progress is kept hot by Bunsen or common gas burner or other source of heat. The point is kept hot as long as desired—if used as an ordinary iron it would lose its heat in a minute or two. As long as the soldering is being done the wire is kept hot as illustrated, never being taken out of the flame.

China is credited with supplying over 50% of the antimony in the world. The metal is used in alloys, such as type metal, and its compounds are employed in rubber factories and elsewhere.

An Edinburgh firm of publishers are reported to have started the cultivation of bamboo in Trinidad and to have secured the government license to cut the wild bamboo to be used in making paper pulp. Three or four years after the plant is started it is large enough to cut. The knots have given some trouble and the bleaching also has been attended with difficulty, but both troubles are said to have been overcome. It is greatly to be desired that the slow growing trees of the north could be spared. It takes many years for a spruce tree to attain a sufficient growth to answer for paper mak-

the war. In Parliament the question has been brought up of employing discharged soldiers in the raising of flax in India. One great use of linen has been for the wings of aeroplanes, but later developments have permitted the use of a specially devised long fibre cotton fabric with every success, so the linen available can be employed to greater advantage in its household applications.

One of the Swiss carbide of calcium works, it is reported, is about to make alcohol from acetylene in quantity—7,500 to 10,000 tons per annum of 90% alcohol. There is a strong movement in the direction of using alcohol as a gasoline substitute in motors. It is of interest to note that acetylene as such has been successfully employed to drive automobiles. Here we have the same acetylene as the basis for alcohol, perhaps, to be used for the same purpose. It has been mixed with benzol for motive purposes. Pure alcohol seems not to have been so available.

Grain elevator fires have been traced to incandescent lamps. The dust settling on the bulb would catch fire and cause the conflagration. The danger was overcome by the obvious method of using a double bulb, one bulb as a case inside of which the lamp bulb was placed. The air space between the bulb and case insulated the heat.

In a chemical laboratory where round-bottom flasks and retorts are in use, a simple support for them may be constructed with three corks and a bit of wire. The wire is first inserted through the center of the three corks, and is then bent into an equilateral triangle and its ends twisted enough to hold it. This forms an admirable and secure support for a round bottom flask or retort and is a substitute for the old time wicker work or straw ring which was long used for the purpose. An old name for it was a valet—perhaps because it held the flask upright when it was full.

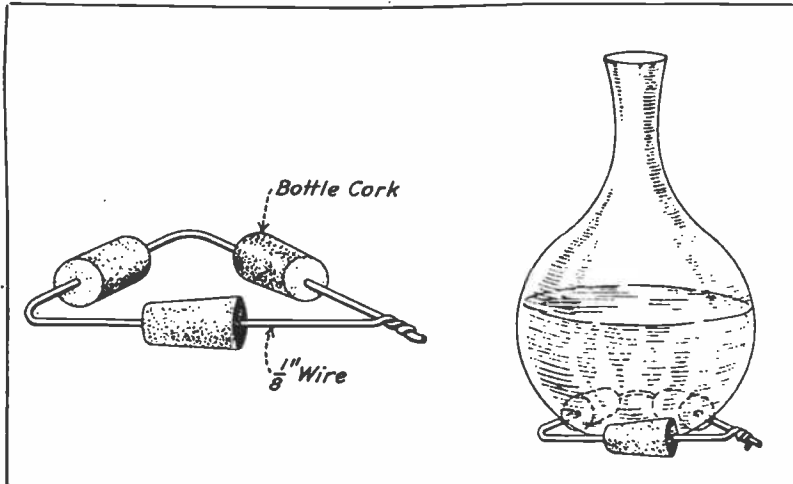

Carbonic acid gas foam has been found effectual in the extinguishing of oil fires. Two solutions, one of the carbonate and the other an acid one are discharged on the fire. A special substance whose composition is not disclosed is added to make the mixture produce a foam. This floats on the top of the oil, discharging the gas and displacing the air, so that there is nothing to support the flame. When all is over, any of the compound left parts with its gas, becomes a liquid again and sinks to the bottom of the tank.

Sound-ranging is the term applied to the determining of the distances of submarine explosions. A recording instrument called a hydrophone is employed which records the period when the sound was received to within the .002 to .003 part of a second. A single station can locate the distance of an explosion under water to within a few hundred yards. With several stations distributed along a base line or lines great accuracy can be obtained. A ship in a fog drops a depth bomb and in a few minutes the shore observers can locate her position with great accuracy, even close enough for artillery practise. The method can be used by aeroplanes; bombs dropped and exploding tell the shore where they are in case their wireless gives out. A ship's position can be given accurately when she is 200 miles distant. Directional wireless can give a ship's position at sea from a single station within about 2°, but with two stations giving cross-bearings the position can be given with great accuracy, both for latitude and longitude. The Leader gear cable on the bottom of the sea excited by alternating current and detected on shipboard can take a ship through intricate channels which are unmarked or in fog.

It is reported that an aeroplane engine is now in use for power in a London factory. It is to be run far below its rated power—75 H. P. instead of 200 H. P. in order to make it last. As it is a comparatively inexpensive relic of the war and occupies a small space, there is no reason why it should not answer as a reserve motor, which about expresses the service expected of it.

By the use of a special form of X-ray tube, the Coolidge, which operates something like the Fleming valve, familiar to radio operators, it has been found possible to detect flaws in the interior of iron castings. In this tube the rays from the cathode are received on a plate of tungsten carried at the end of an arm of molybdenum, the face is set at angle of 45° so as to deflect the stream of rays at right angles and out through the side walls of the tube. The tungsten face is called the target. It is welded to the molybdenum. A steel casting was tried; it was placed 20 inches from the

Georges Claude, the eminent French inventor and engineer, has made the suggestion that ammonium chloride should be used as the regular commercial ammonium salt instead of the sulphate; the latter has always been the compound hitherto made. The idea is that the weight for a given amount of ammonical gas "fixed," as it may be expressed, by chlorine will be much less than when sulphuric acid is used. The Solvay and allied processes, it is said, should be used to yield sodium bicarbonate and ammonium chloride.

The pollution of the air in England by solids, such as soot and the like, has been reported on for the years 1917-1918 by the Atmospheric Pollution Committee. The purest air found was on Malvern Hills. There in the month of May, 1917, 5.15 metric tons were deposited over each square kilometer. In Newcastle-on-Tyne 44 28/100 tons were deposited over the same area in the month of April of the same year. The above quantities for a square mile are about 2.6 times greater.

The chemist and experimenter often is called upon to handle a hot test tube or retort and while tongs are made for this purpose, they are seldom at hand when needed and a makeshift of some kind such as a wad of paper, corner of an apron or other material is interposed between the fingers and hot

tube, and though it was 2½ inches thick defects were revealed by a radiograph taken with two minutes exposure, on a plate backed by a sheet of lead. The voltage corresponded to that required to produce a fifteen inch spark, and the current measured 1.1-4 milli-ampere.

It is stated that there is enough gold in a twenty-dollar gold piece to cover more than sixteen square yards or 144 square feet of surface if it is beaten into gold leaf.

A good hint has been given for the desulphating of a storage battery by charging and gassing. The acid with which the operation is started should be as weak as possible, 2° to 3° Baumé is enough. Then as the plates desulphate the sulphuric acid radical goes to the solution in the battery constantly strengthening it and bringing it up towards the proper specific gravity.

Large potash deposits are reported to have been found in Sicily. The Stassfurt mines in Germany have for many years been the great source of potash supply. In the old times when the demand was insignificant, wood ashes were leached or boiled in water to extract the potassium carbonate. As the ashes were boiled in pots, the name of potash was given to the product. The finding of the potash deposits in another nation's limits has international importance. It is provoking to realize that the common mineral feldspar (orthoclase) contains a considerable per cent of potassium silicate but the valuable potassium has never been successfully extracted on any commercial scale.

The X-ray has been applied in concrete ship-building to detect voids in the cement and displacements of the reinforcement. The apparatus for this purpose weighs 90 pounds. It has been suggested also to use it to examine the joints in electrically welded steel ships.

A French manufacturer has met the demand for an eight-hour day for human labor by the introduction of a sixteen-hour day for machinery; thus there are two shifts of workmen for a full machinery day.

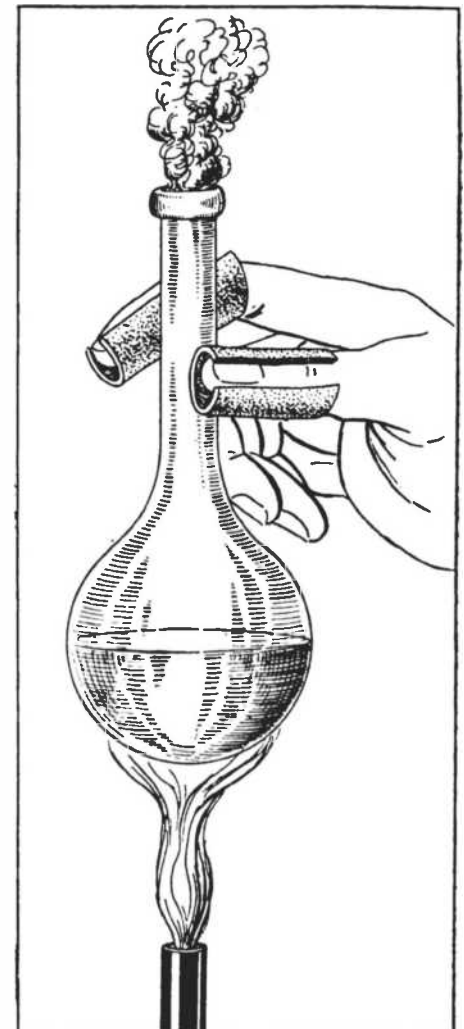

glass. Our French contemporary *La Nature* illustrates a simple expedient that gives better control over the vessel than tongs do. The sketch is self-explanatory, the fingers being protected by simple means. Sheet asbestos may be used and held in place by a rubber band or pieces of rubber hose may be cut to the proper length and slit so they will constrict about the fingers.

A MODERN ELECTRICALLY PROPELLED DREADNAUGHT BATTLESHIP

The U. S. S.

NEW MEXICO

INTERESTING FACTS ABOUT THE NEW FLAGSHIP OF THE PACIFIC FLEET



A RADICAL DEVELOPMENT IN NAVAL ENGINEERING PROVES SUCCESSFUL

By Brewster S. Beach

ELECTRICITY had never been seriously considered as an agency in the propulsion of large marine craft until a few years ago, though the adoption of electrical current in the operation of street cars, automobiles, railroad engines, etc., was an accepted fact. The forward march of electrical propulsion was comparatively slow to reach the ocean. Various applications of electricity as a motive force in driving locomotives and other vehicles of land transportation had reached an advanced stage of development, but the steamboat seemed to have "escaped," due probably to the difficul-

ties surrounding the adoption of satisfactory and efficient electrical means of power generation and transmission. with light weight, engineers were ready to try electricity as a means of transmission between the turbine and propellers. They have been successful and the United States Navy, as indicated by Secretary Daniels, has been won over to the principle of electric drive and has decided to equip all of the new capital ships with electrical propulsive machinery, while the idea is already receiving consideration in the mercantile marine.

One of the oldest examples of electrically propelled vessels in this country are the fire boats of Chicago, Ill., where the first boat was equipped in 1908. Chicago was the first municipality to

propelling the vessel. The current is usually produced by a steam turbine which turns a generator. The apparatus is called a turbo-generator and this unit together with the usual engine room auxiliary, the boilers, constitutes the power plant. The electric current generated by the dynamos is led through copper cables and suitable control apparatus to electric motors, and it is these motors which actually drive the propellers of the ship. Electricity acts as a connecting link between the steam or other motive force and the propellers. The internal combustion engine operating on the Diesel principle is also com-

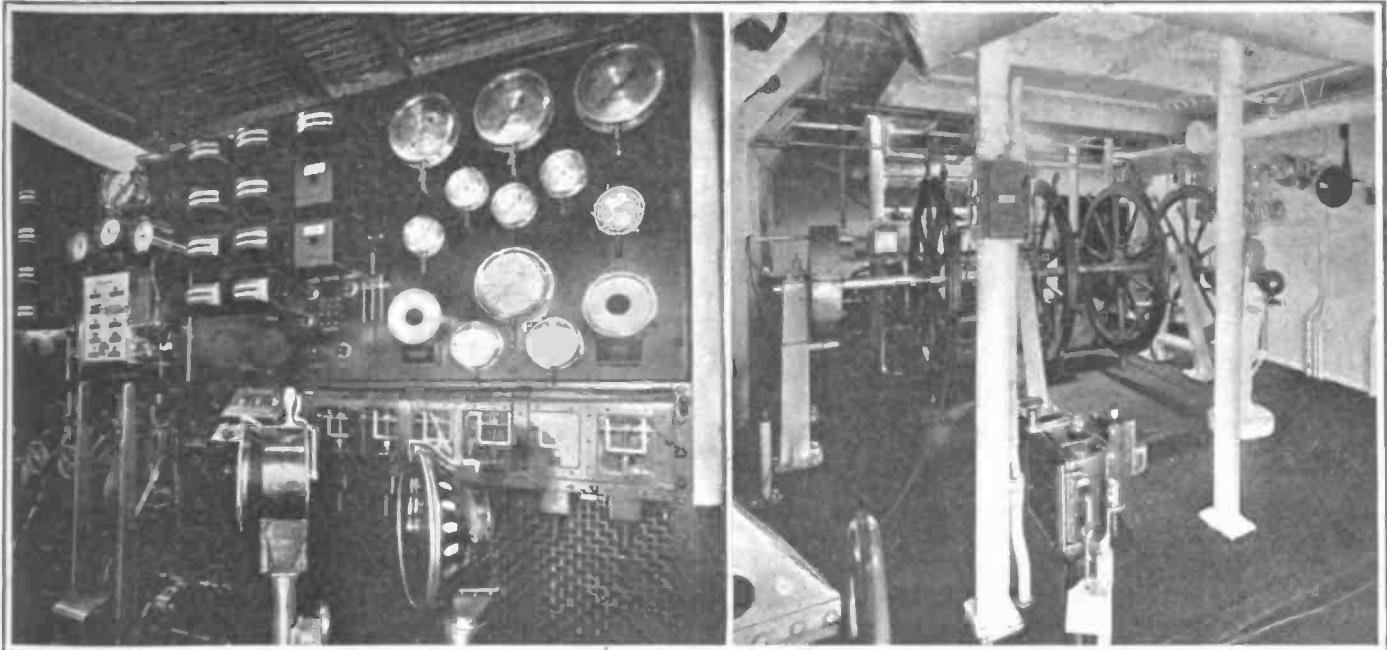

Main control apparatus and switchboard through which the electrical current is distributed from the power source to the propeller motors at the left. Room for emergency steering apparatus at the right

ties surrounding the adoption of satisfactory and efficient electrical means of power generation and transmission.

Turbine Development Helps Electric Propulsion

The possibility of electric propulsion of large craft was talked about as soon as electric motors began to be used, but actual, serious study needed for its application awaited the development of the steam turbine. When the turbine development reached its present advanced stage, combining high speed

accept the theory of electric drive for boats of this class. The popular mind, no doubt, conceives an electric ship to be like a small electric automobile or truck—something that stores the energy necessary to its operation in large batteries, carries it along and draws upon it as occasion may demand.

What an Electric Ship Is

This is not the case, as electric current must be generated continuously within the ship in order that this current may be put to its proper use in

ing into prominence as a power for the generation of electricity. The dynamo driving means whether it is a steam turbine or an oil-engine, is called the prime mover.

No Mechanical Reduction Gears

No gears are needed in the electrically driven ship. The function usually performed by gears (that is, to make a connection between the turbine which is to be efficient must revolve at a relatively high speed, and the propeller, which to be efficient must rotate rela-

tively slow), is accomplished electrically, thus permitting both turbine and propeller to operate at high efficiency. Just as in the automobile, it is sometimes desirable to "shift gears," it may be necessary at times to accomplish the same result on board ship, though not necessarily for the same reason. Electricity lends itself admirably to effecting these speed changes, whereas no practical and reliable means has yet been found to accomplish this mechanically on large ships.

Military Advantages

The primary military advantage of the electric ship, rests on the ability to arrange the propelling machinery in a number of separate watertight compartments throughout the hull placed near the center so that they may be protected

engineers cooperating with the Government to solve the problem presented.

The New Mexico Described

The *New Mexico* displaces 32,000 tons and requires 28,000 H.P.—nearly one H.P. for every ton of displacement. It is of the oil-burning type with a total oil capacity of 3,400 tons which is 6,800,000 pounds, or about one million gallons.

The oil burners heat nine steam boilers, each of which can produce 4,000 H.P., and deliver steam at a pressure of 250 lbs. to the square inch. The steam from these boilers operates two turbo-generators which constitute the power plant, each capable of generating 14,000 H.P. The current from the dynamo operates four motors—one for

It has been estimated that there are 300 motors on the *New Mexico*, and here is a partial list of some of the uses to which they are put: Operating the steering gear and anchor windlass mechanism, for boat cranes and deck winches, for turning turrets and elevating guns; driving smoke ejector air compressors, operating numerous pumps for sanitary purposes, supplying fresh water, pump oil and driving drainage pumps. The refrigerating system utilizes electric power and there are twenty motor-generator sets for interior communication, gun firing, etc. Motors turn the large searchlights and run the ventilating fan. Eight motors are used in the kitchen for such humdrum but no less necessary purposes as peeling vegetables, mixing dough, washing

Views at right show the large thrust bearing and length of propeller shaft used in power transmission

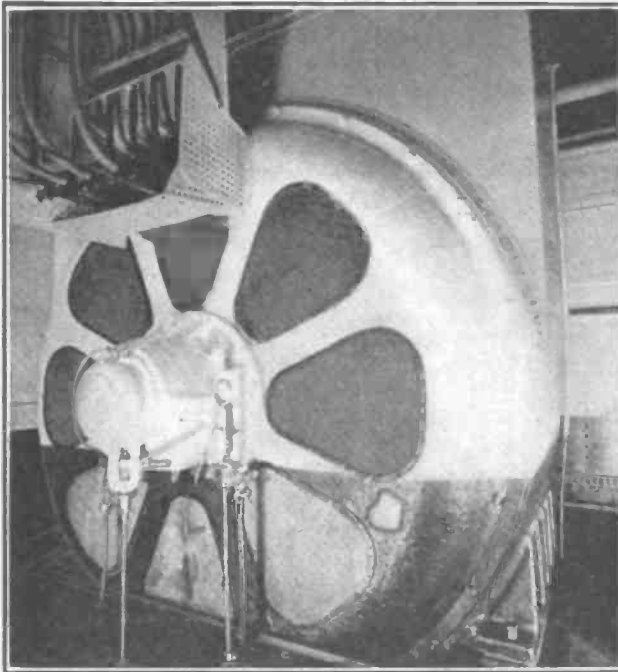

One of the large propeller driving motors used on the U.S.S. *New Mexico* is shown above

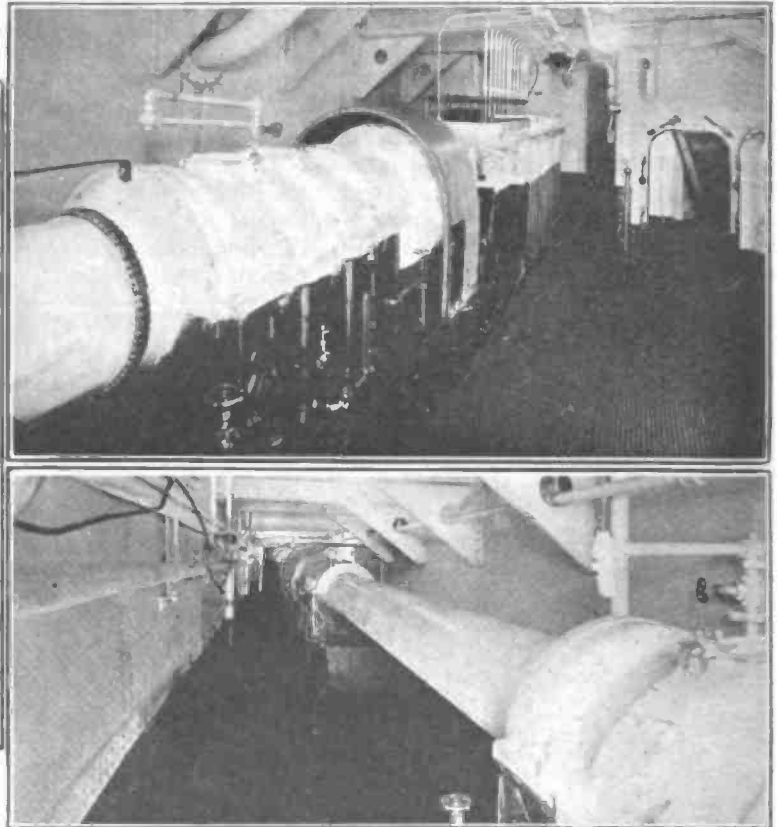

from damage due to torpedo attack, shell fire, grounding, collision, etc.

The ability to form new combinations of control and operation by the convenient isolation of defective apparatus, simply by cutting off the electric connections; an estimated low cost of maintenance; the reliability of the equipment and an economical operation at many different speeds are also valuable considerations.

Let us now examine these principles in actual practice. The best example today is the U. S. battleship *New Mexico*, the first capital ship of any navy to be equipped for electric propulsion. It was built at the Brooklyn Navy Yards and launched in 1917. The electrical propulsion equipment was made and installed by the General Electric Co., its

each propeller. The motors are twelve feet in diameter. They are controlled from a central switchboard or control station where the engineers on receipt of instructions from the ship's bridge can start the ship forward, or backward and run the propellers at different speeds in either direction. They can run all four motors from one turbo-generator or they can run the two port motors from one generator and the two starboard motors from the other generator.

Part of the steam produced in the boilers is diverted to six auxiliary turbo-generator sets located in different parts of the ship and these power plants produce the electricity which operates all of the mechanical devices, outside of the propulsion equipment, including the electric lights.

dishes, and grinding meat. The machinery in the various shops is all operated by individual motor drive.

It is stated that the electric lights of the *New Mexico* can be supplied from two independent sources of supply, first the auxiliary turbo-generators already mentioned, and second, a set of storage batteries which is designed to be brought into service in any emergency where the main source of lighting current should fail.

Another interesting feature is the distilling plant which produces 30,000 gallons of pure water from the sea in every 24 hours. The larger portion of this liquid is used in the boilers which require water of the utmost purity. The refrigerating system sup-

plied is capable of producing six tons of ice each day.

Two electrically driven boat cranes used in hoisting and lowering the boats and loading supplies aboard the ship have a capacity of 4,000 pounds each. The large calibre guns of the *New Mexico* are fired by electricity, ammunition is hoisted from the magazines by electric motors and some of the guns are loaded by electricity.

The ponderous rudder is moved into any desired position by the simple movement of a controller on the navigating bridge, which sets in motion machinery carried in the hold of the vessel for this purpose. There are several steering stations located in various parts of the ship where this operation may be performed in case one station should be disabled. In all, there are five different ways of steering the *New Mexico*, one of which is the hand method, which requires the strength of six men, and which is reserved for emergencies.

The ventilation and heating of the ship is by air—cold air is forced into the vessel in warm weather and hot air during the winter months. The air is forced through pipes by blowers operated by electric motors.

There is a completely equipped electric carpenter shop, machine shop, foundry, laundry, hospital operating room, and a bakery where bread is baked in electrically heated ovens, while the gallery or kitchen is steam operated, the ranges burn oil instead of coal, and there are big steam jacketed pots for heating.

First Experiments with the Jupiter

While the *New Mexico* is the pioneer battleship with electric drive, the Navy began its first experiments on the collier *Jupiter*, built at Mare Island Navy Yard, San Francisco, Calif., and launched August 24, 1912. Among other battleships being equipped with electric drive are the *California*, *Tennessee*, *Maryland*, *West Virginia*, *Colorado* and *Washington*.

The disadvantage of the direct connected turbine led to the advocacy of electricity as a means of propulsion before a successful means of speed reduction was developed. Very soon after, however, active development of mechanical gears for connecting turbines to ships' propellers was begun and successful forms were evolved. This is known as geared turbine drive and may be considered a direct rival of the electrical method which we have already described.

Merchant Vessels to Come Next

Having established the principle of electric propulsion in the Navy of the United States, attention is now centered on the adoption of the same means of propulsion to the cargo and passen-

ger carrying ships which will make up our merchant fleet. Electric propulsion for this class of vessel has been slower in development than the same principle applied to naval vessels. Many noted engineers, however, are now at work on American Turbo-electric and oil engine-electric systems for cargo vessels in this country, so some authorities believe future growth along these lines to be unusually bright.

It cannot be denied that there is still much divergence of professional opinion over the relative merits of one form of ship propulsion over other methods. A discussion of the question at this time would be out of place, even if it were adapted to the needs of a non-technical popular article. No attempt has therefore been made to compare electric ship drive to the older forms of propulsion. It is hoped that this short article will give the reader an idea of what electric ship propulsion is, how it has been utilized, and through what stages of scientific evolution it has grown up.

CAUSES OF BOILER DEFECTS

An abridged summary of Inspector's Reports compiled for 1911 from the records of the Hartford Steam Boiler Inspection and Insurance Co. distinctly shows that over one-half of the defects generally found in steam boilers are to be attributed to the feed water.

Boiler Defects Ascribed to Water

Nature of defects	No. of defects found	Percentage of total
Incrustation & scale.	43,663	25.8%
Deposit of sediment.	19,471	11.5%
Internal corrosion...	13,781	8.15%
External corrosion..	9,668	5.71%
Burned plates.....	5,174	3.06%
Other defects.....	77,445	45.78%

Total number of defects169,202 100.00%

It is well known that a deposit of scale greatly hinders the transmission of heat to the boiling water, which is accounted for by the fact that the heat conductivity of mineral substance is very much less than that of metals. Scale 1/16-inch thick is apt to reduce the efficiency of the heating surface 5 to 10%; 1/8-inch thick causes a loss of 10 to 20% depending upon the density of the incrusting solids.

A contemporary states that a medium-sized steam boiler was kept clear of scale for over twenty years by the simple expedient of boiling a bushel of potatoes in it. After these were boiled for a time, the scale loosened and collected in the boiler base from which it was easily removed. This would not work with all boilers because the chemical substances in solution in water varies with locality. In any event, it

is a remedy that can have no injurious action even if it does no good which is more than can be said for a number of boiler scale remedies that have been proposed.

SPONTANEOUS IGNITION OF ENGINE FUELS

The engines operating on the Diesel and semi-Diesel principles do not use electrical ignition means but depend on the heat developed in compressing air to pressures of over 500 pounds per square inch and then injecting fuel under still higher pressure into the heated air which causes spontaneous combustion of the resulting air and fuel gas mixture. A British firm of engineers have made a series of laboratory tests to determine the ignition temperature of various liquid and semi-liquid engine fuels suitable for this type of engine, and have tabulated the results as follows:

	Spontaneous ignition temperature in oxygen	
	Deg. C.	Deg. F.
Gasoline No. 1.....	272	522
Gasoline No. 2.....	270	518
Kerosene	252	486
Gas Oil.....	254	489
Petroleum Fuel Oil...260	500	
Shale Oil (Broxburn)..253	487	
Tar Oil.....	470	878
Coke Oven Tar.....	494	922
Water Gas Tar.....	464	867
Blast Furnace Tar...498	928	
Whale Oil.....	273	523
Napthalene	402	756
Alcohol	395	743

From these figures it will be noted that the tar oils have much higher spontaneous ignition temperatures than petroleum oils, and that there is very little difference in degrees required between gasoline and petroleum oil under the conditions of the tests. This means that a degree of compression sufficient to raise the compressed air to a temperature that will ignite petroleum may be insufficient for tar oils—hence engines of the spontaneous ignition type working with such heavy oils should have either higher compression or some external means of raising the temperature of the air, before it is compressed in the working cylinder.

TANKS HOLD PLACE IN ARMY

The success of the armored tank in the late war has been so marked that the continuance of the Tank Corps as a peace-time organization has been approved by Congress. A minimum of 1,050 tanks will remain in commission with the army, 330 of the heavy type and 720 of the light type. A third type, the signal tank is provided for each company and battalion commander, 45 being the total for the complete tank organization. The corps will be made up of 377 commissioned officers and 5,862 enlisted men.

A New Lightweight Monoplane

An Interesting English Design of Low Weight and Relatively Low Power That Should be Simple to Fly and Economical to Maintain

AN English aeronautical engineer has devised a very small monoplane which is said to weigh but 220 pounds complete and ready for flight. As will be evident from the illustrations, it is a modern modification of the old Santos-Dumont Demoiselle monoplane which was shown at several aviation meets in this country over a decade ago and which was flown in France by its builder with an engine of the same form but of only 20 h. p. The engine used in the machine illustrated is of the 40 h.p. horizontal, opposed cylinder air cooled type made by the A. B. C. interests and is their type "Gnat." This engine, as will be evident from the illustration, is mounted in front of the airplane and forms, with the gasoline and oil tanks, a complete power plant unit that is easily detached. The torpedo shaped fuel tank holds 5 gallons of gasoline and 2 quarts of oil which is said to be sufficient for a flight of 2 hours, which time permits covering a distance of 125 miles under favorable conditions. The maximum speed is given as 65 miles an hour and an exceptionally slow landing speed of less than 30 miles per hour is made possible by the design.

It is claimed that if sufficient hangar space is not available, the single plane may be removed by taking off a few bolts. The fuselage is very simple in construction, consisting of two outriggers which carry the empennage consisting of vertical and horizontal stabilizing planes, vertical rudder and elevators at the back end. The outriggers or tail booms are joined to the small undercarriage which provides accommodations for the pilot's

seat and the "joy stick" and rudder board, by which the machine is controlled. An aluminum shield very similar to the front end of a motorcycle side car is placed in the front of the pilot to protect his limbs.

The wheels are mounted on a laminated wood axle member to which steel tubes are attached, for the wheel hubs to rotate on, this laminated construc-

shop facilities. It is stated that a company is being formed for their manufacture, and that the machine will be sold at about \$1500 when it is produced on a quantity basis. The general construction is very clearly outlined in the illustration and the principal dimensions are given.

There are several things that can be criticised about this monoplane, however, one being the location of the power plant above the pilot in such a position that in case of a fall it might become detached from its fastenings and injure the operator by falling upon him. Another disadvantage of the design is that the pilot is sitting very close to the ground and any rough landing that would not injure him if he were sitting higher, might be apt to result disastrously on account of the proximity of the pilot to the earth when landing. The conventional forms of aircraft undercarriage give more protection to the aviator and when he is sitting in the usual type of fuselage, even if a landing is made that is sufficiently rough to break the landing gear, the first shock is taken up and the pilot is not so apt to be injured as in the construction shown where he hits the ground first.

A modification of the design in which the pilot was seated higher would make

for greater safety in landing though the craft might not be so easily controlled because of the higher location of the center of gravity. When the pilot's weight is carried below the plane, as in the form shown, it is believed that easier control is obtained when flying as the lateral stability is said to be greater.



A light weight monoplane that the enthusiastic designer calls "the motorcycle of the air"

tion having enough spring to take care of the shock of landing. The wing span is but 15 feet and the length over all is given as 14 feet. The machine is extremely simple in construction and as ample power is provided for such a small craft it should prove to be a good flier. The machine seems to be a type that can be readily made by any amateur equipped with very ordinary

Building A Two-Passenger Seaplane

(Continued from page 196)

Fig. 12. The center of gravity of the three-cylinder Lawrance motor complete with a fifteen-pound propeller of oak or a walnut propeller copper tipped of 6' 6" dia. x 60" pitch is approximately 27 7/32" back of the center line of the motor attaching bolts and 15/16" below that point. The manufacturers locate the center of gravity of their motor minus the propeller, as dimensioned on Fig. 13, 19/32" plus 1 7/8" to the rear of the point of attachment.

The centers of weight computed are given at 2' 7 1/2" forward and 2' 7 1/2" rear of the static center of gravity, allowing 165 lbs. for motor, accessories, propeller, etc., and a 165-lb. pilot. The passengers' weight and gasoline tank are on the C-G. Any deviation from the above calculations must be compensated for by computing the moment of that difference. The dynamic balance (equilibrium in flight) marked C-L, center of any airplane is influenced by the speed of the machine (the lift varies as the square of the velocity) and the efficiency of the motor, as the center of thrust is below the center of resistance. This will give inherent stability within certain limits up to approximately twelve degrees incidence.

As the torque of the motor tends to turn the machine in the opposite direction to the propeller movement, it is offset by one of two methods. First by the "wash in" and "wash out," a slight increase of incidence in the left wing and decrease of incidence in the opposite wing or by additional supporting surface which is the more popular practice. The dynamic balance may be adjusted by increasing the stagger of the top plane if found nose heavy or decreasing the stagger if found tail heavy.

Changes Necessary for Ford Motor

A complete description of a remodelled Ford motor will be given in a coming issue of this magazine. It is claimed by experimenters that by alterations and the addition of an overhead valve cylinder head that this engine weighing 200 lbs. will develop up to 40 horsepower at 1650 R. P. M. with a maximum thrust of 250 lbs. with a 6' dia. and 4 1/2' pitch propeller. Ascertain the center of gravity of the complete motor (approximately 262 lbs.) including the radiator, propeller, water (estimated at three gallons) and the oil in the crank case, place the center at the C-G indicated. This will necessitate locating the pilot seat as indicated. Locate the motor or engine bearers using the fourteen crank case bolt holes as centers, drill through the bearers. The bed bolts will then be also used as the crank case bolts. It is obvious that no flywheel need be used and the propeller

BILLS OF MATERIAL TWO-SEATER—FUSELAGE COMPONENTS

VERTICAL STRUTS					
Station No. of Strut	Quantity Required	Thickness in inches	Width in inches	Length in inches	Material
No. 1	2	13/16	1	16	Spruce
No. 2	2	"	3	17 1/2	Ash
No. 3	2	"	2 3/4	21 3/4	Spruce
No. 4	2	"	3	20 1/2	Ash
No. 5	2	"	1 1/2	17 1/2	Spruce
No. 6	2	"	1 1/2	15 1/4	"
No. 7	2	"	1 1/2	11 1/2	"
Stern Post	1	1 1/8	2	18 1/2	Ash
HORIZONTAL STRUTS					
T-Top					
B-Bottom					
No. 1	1-T, 1-B	13/16	1	13 1/2	Spruce
2-T, 2-B	1-T, 1-B	"	3	16 3/4	"
3-B	1-B	"	2 3/4	19 3/8	Ash
3-T	1-T	"	2 3/4	19 3/8	Spruce
4-B	1-B	"	2 3/4	19 1/2	Ash
5-T, 5-B	1-T, 1-B	"	1 1/2	18	Spruce
6-T, 6-B	1-T, 1-B	"	1 1/2	14	"
7-T, 7-B	1-T, 1-B	"	1 1/2	7	"
LONGERONS					
	2	Top 1"	1"	13'-2"	Ash
	2	Bottom 1"	1"	13'-1"	"
FORMERS OF 1/4" 3-PLY VENEER					
2-F	8 1/2" x 19"	Shaped as shown at Fig. 2-F		
3-F	9 1/4" x 21 1/2"	"	"	3-F
4-F	8 3/4" x 21 1/16"	"	"	4-F
5-F	5 3/4" x 16 1/4"	"	"	5-F
6-F	2 3/4" x 9 1/4"	"	"	6-F
7-F	1 1/2" x 6 1/2"	"	"	7-F
8-F	1 1/2" x 21 1/2"	"	"	8-F
9-F	3 1/2" x 19 1/4"	"	"	9-F
10-F	16" x 30"	"	"	10-F
STRINGERS					
A	1 piece	1/4" x 3/4"	5'-7"	
B	2 pieces	1/4" x 3/4"	2'-5"	
C	2 pieces	1/4" x 3/4"	5'-7"	
D	2 pieces	1/4" x 3/4"	4'-10 1/8"	
FORD MOTOR FUSELAGE					
See plate seven.					
No. 1	2—Vertical	13/16" x 1"	x 9"	Ash
No. 1	2—Horizontal	13/16" x 1"	x 12"	"
No. 2	1—Horizontal	13/16" x 2 1/2"	x 19"	"
No. 2	2—Vertical	13/16" x 2 1/2"	x 17 3/4"	"
No. 4	Extra Vertical	13/16" x 1 1/2"	x 18 3/4"	Spruce
No. 4	Extra Horizontal	13/16" x 1 1/2"	x 19 1/16"	"
No. 4	Bot. 1—Horizontal	13/16" x 2 3/4"	x 19 9/16"	Ash
No. 3	Top 1—Horizontal	13/16" x 2 3/4"	x 19 3/8"	"
No. 4	Bot. 1—Horizontal	13/16" x 2 3/4"	x 19 3/16"	"
	2 Upper Longerons	1"	x 1" x 15'-8"	
	2 Lower Longerons	1"	x 1" x 16'-1"	
	2 Engine Bearers	1 3/4" x 3"	x 38"	Spruce
a	1 Stringer	1/4" x 3/4"	x 5'-9"	
b	2 Stringers	1/4" x 3/4"	x 2'-7"	
c	2 Stringers	1/4" x 3/4"	x 2'-7"	
d	2 Stringers	1/4" x 3/4"	x —	

hub bolts on that flange on the crankshaft to which the flywheel is normally attached. The motor must have a battery or magneto ignition to replace the flywheel generator, high tension magneto being advised. A flat, oil tight plate is welded to the lower crank case, replacing the portion cut off that acted

as the flywheel protector and oil sump. The radiator will require fitting between the longerons and changing the return pipe, which is not a very difficult piece of soldering and riveting for any mechanic capable of building the airplane.

(Part Six in next issue)



RADIO

TELEPHONE AND TELEGRAPH APPARATUS



A Radio Telephone Transmitter

The Divisional Method, Using Standardized Panels, is Employed in Constructing this Short Distance Transmitter

By M. B. Sleeper

SO many requests for a short-distance radio telephone set have come in that this set was constructed to show the reader of *EVERYDAY ENGINEERING* what can be done in working out such an equipment. There are many ways, some complicated and some makeshift, to build a vacuum tube transmitter. Plans

You will recognize the audion mounting and rheostat panels from the December issue. The same system has been used for the new instruments. Each panel is a unit by itself and can be removed or replaced by loosening the brass straps as more panels can be added.

higher voltage on the plate and an amplifier at the receiving end.

ANTENNA TUNING INDUCTANCE

A SUFFICIENT inductance, 58,000 cms., is allowed to give wavelengths up to 260 meters with a stand-

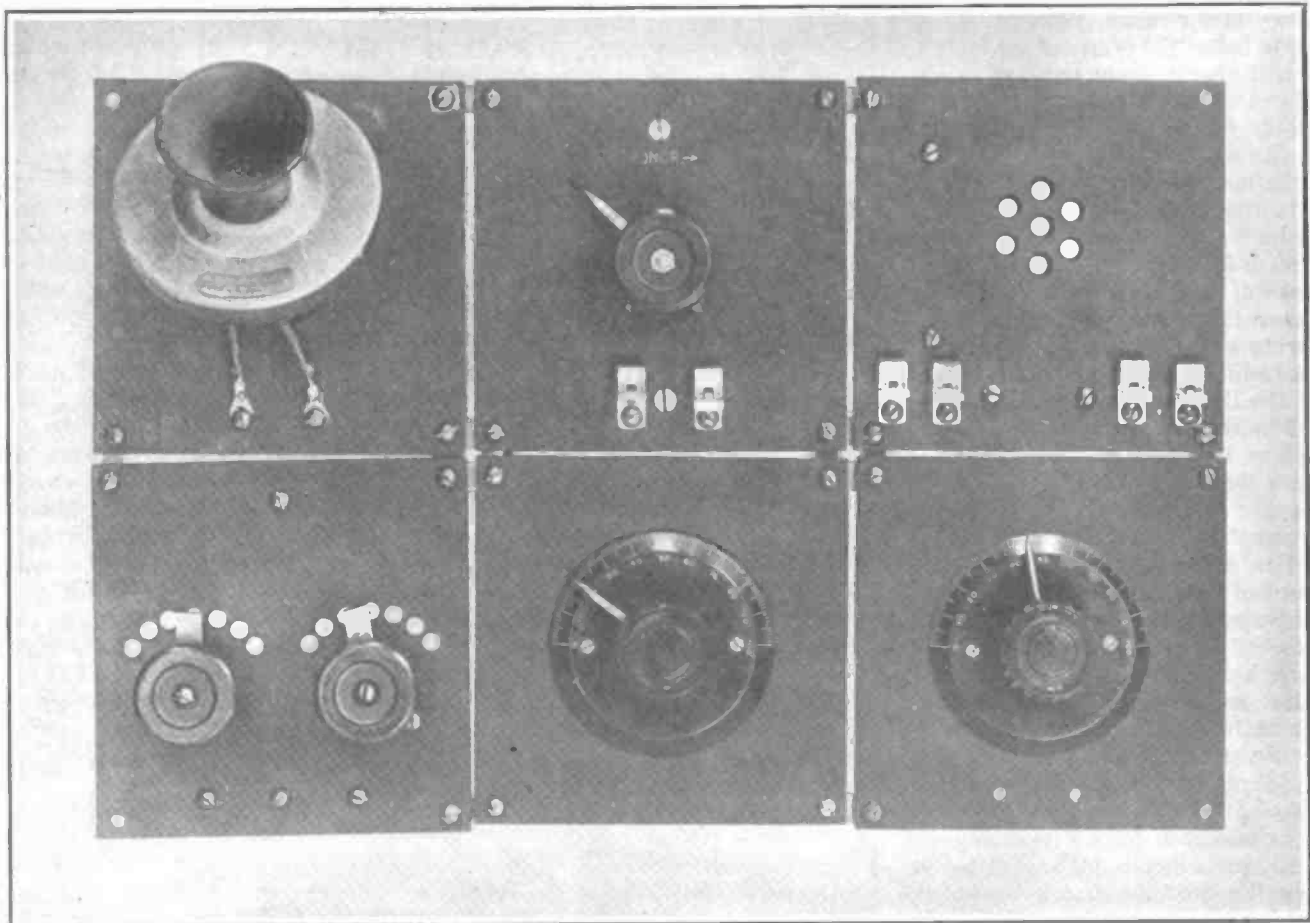

Fig. 1. The true experimenter takes as much pride in the appearance as in the performance of his equipment

for this set were made with the idea of steering an intermediate course, to obtain the maximum results from a simple circuit. The illustrations here show such a set as it was constructed in our own laboratory.

This set, with a De Forest-Marconi VT working on two standard Navy type 22.5-volt batteries, was heard over a distance of four miles at a receiving station using a single audion detector. A great distance can be covered with a

ard transmitting antenna of 0.0005 mfd. and a 0.001 mfd. series tuning condenser.

The tube is $3\frac{1}{2}$ ins. in diameter and, with the mounting legs, 3 ins. long. Three legs, $\frac{3}{4}$ in. long, are cut out of

the tube so that inside contacts can be reached with a soldering iron. They must be laid out carefully before the coil is wound. A knife sharpened on a coarse stone is best for this work.

High frequency cable, 3x16 No. 38, is used for the coil. The winding starts $\frac{1}{8}$ in. from the rear end. Taps are taken at 0, 5, 8, 11, 14, 17, 20 and 23 turns. The ground is connected at the 0 end. Connections should be made so that the inductance is increased by turning the switch clock-wise.

It is important to lay out the panel and drill all holes before assembling any of the parts on it. The switch points were put in and connected across first and the switches fitted in place.

The switches are simple in construction. Three-ply blades were cut from No. 30 spring brass, then a $1\frac{1}{4}$ -inch, 8-32 screw was put through the knob, the switch blade set on the screw and a nut turned down to secure the blades. A spring washer at the back of the panel and a second nut on the end of the screw complete the switch. To prevent the loosening of the nut, it was soldered to the screw. Finally, a strip of No. 34 copper was soldered to the nut and brought out to the connecting screw.

Small legs of $\frac{3}{8}$ by $\frac{1}{16}$ in. brass were cut out and drilled for legs to sup-

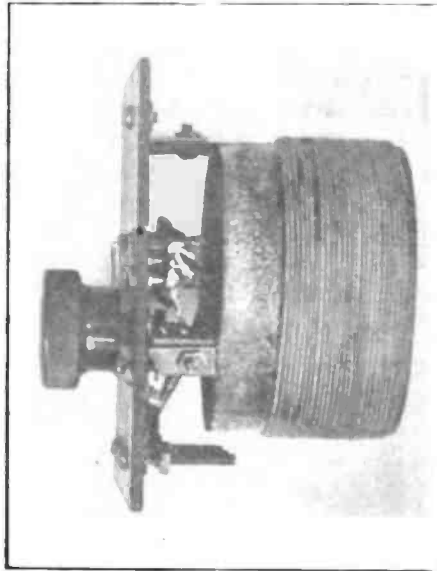

Fig. 3. The inductance control section port the inductance. Figs. 1, 2 and 3 illustrate the construction.

SERIES TUNING CONDENSER

FIG. 4 gives the details of the condenser and mounting. A 0.001 mfd. Clapp-Eastham balanced condenser was changed over with solid bakelite end pieces in place of the aluminum ones. It was mounted, by means of the front plate, to the panel by screws which also held the scale.

The end plates were drilled with the original as template. Then the front plate, panel, and scale were drilled, for the mounting screws, all at once to insure perfect alignment. At first it was planned to have the scale and handle revolve, but the scale did not run perfectly true because it was pushed out by the set screw. Accordingly, a pointer was put into the handle in place of the screw and the scale fastened to the panel. This method had an added advantage in that the capacity was increased when the handle was turned clock-wise, which is the correct way. The handles and dials were obtained from the A. H. Korwin Company.

The collection of dust between the condenser plates causes series losses in a transmitter. For this reason the plan shown in the illustrations was adopted. The corners of the end plates were rounded off and a length of G-A-lite tubing, $3\frac{1}{2}$ ins. outside diameter, slipped over the condenser. Short lengths of strip brass fitted over opposite supporting rods held the tube in place. This can be seen in Fig. 2.

THE GRID CONDENSER

THIS instrument is similar to the series tuning condenser except that a 0.0005 mfd. condenser was used. Connections were made by soldering di-

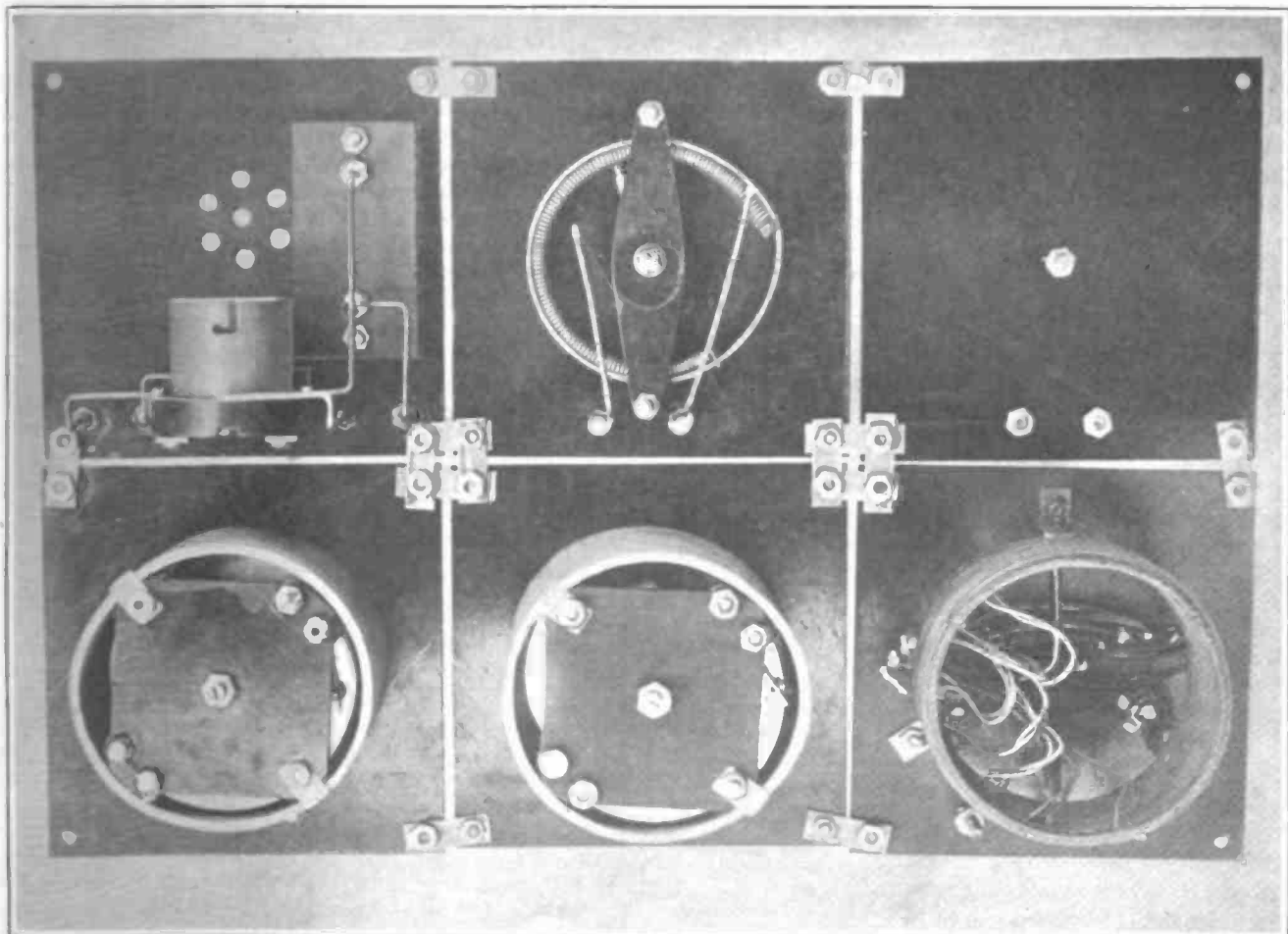

Fig. 2. The rear of the radio telephone set, showing the assembled standardized panels, each carrying a separate section of the apparatus

rectly to the ends of the plate supporting rods.

TELEPHONE TRANSMITTER

BY good luck, a telephone desk was picked up in a second-hand store. The stand was cut off and solder melted into the hollow end around a machine screw. The screw, imbedded in the solder, served as a mounting bolt to hold the transmitter to the panel.

Where such a mounting is not avail-

OPERATING THE TELEPHONE TRANSMITTER

TO put the set in operation, when all the connections have been made, it is only necessary to light the filament of the audion by turning up the rheostat. A hot-wire ammeter is essential to tune the instruments for maximum radiation.

The antenna inductance switch is set at maximum and the plate switch put

length, it is necessary to juggle the inductance switches and condensers until, at the correct wavelength, the hot-wire ammeter shows a maximum radiation.

OUTPUT AND EFFICIENCY

IF the resistance of the antenna has been measured, the output of the set, in watts, is

$$W = I^2 R$$

where W = output, in watts,

I = antenna current, in amps.,

and R = antenna resistance, in ohms.

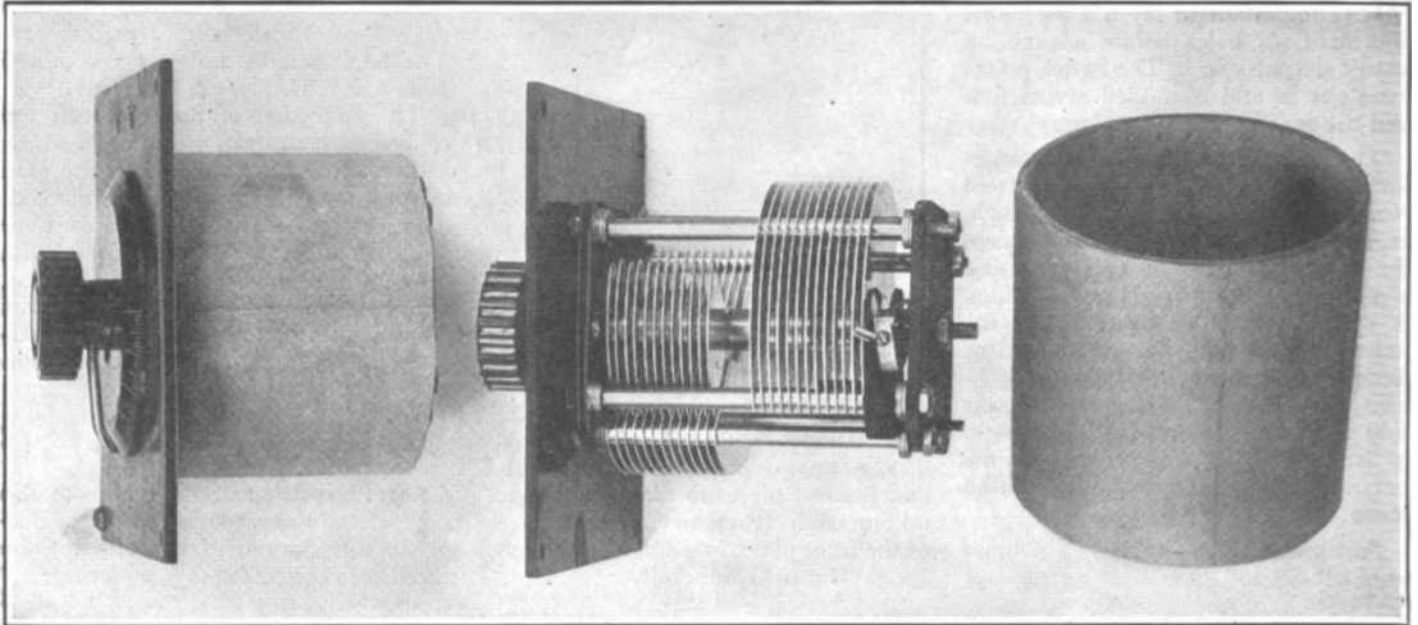

Fig. 4. Details of the tuning condenser

able, a standard Western Electric or Mesco transmitter can be purchased and set up on the panel.

Although modulation in the ground lead is not the most efficient method, it is the simplest and, for short-distance communication, serves the purpose admirably.

CONNECTING THE INSTRUMENTS

FIG. 5 gives a diagram of connections. Binding posts or screws for soldering the wires were put at the rear of the panels, with the exception of the audion mounting and rheostat. Here flexible leads can be run through the spaces separating the panels. All other wiring should be done with No. 16 copper wire, either bare or covered with Empire tubing.

On the audion panel there can be seen two bakelite plates. Between them is a pencil-mark grid leak, made of heavy paper on which marks were made with a soft carbon pencil. The upper plate simply serves as a protection for the leak. The exact adjustment of the pencil lines was made before the top panel was put on and the connections soldered.

By mistake, the B battery is shown in the lead to the switch. This battery must go between the plate and filament.

in a position at which the set oscillates, as shown by an indication on the ammeter. Then the grid condenser is varied and the grid leak rubbed out or put on until, by listening in a coupled wavemeter or receiving circuit, the speech from the transmitter is clear and free from blocking or squealing noises. Once set, the grid leak needs no further attention.

To tune the set for a given wave-

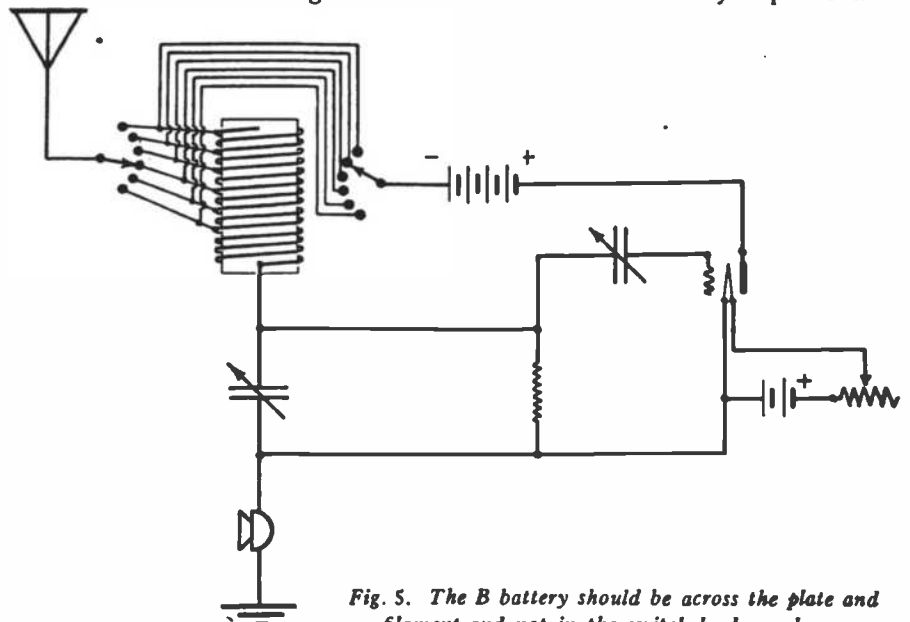

Fig. 5. The B battery should be across the plate and filament and not in the switch lead, as shown

When a milliammeter is available and the plate current can be measured, the input, in watts, is

$$W = EI$$

where E = plate voltage,

and I = plate current in amperes.

The efficiency of the set then is

$$\text{Eff.} = \frac{100 W \text{ output}}{W \text{ input}}$$

where

Eff. = efficiency in per cent.

Interesting Decisions Regarding Trade Marks

That Descriptive Words, or the Names of Widely Advertised Corporations, Cannot be Used as Trade Marks, is Shown in This Article

RADIO companies have played strongly upon the "service" value of their equipment. There have been a number of trade mark suits over the use of the word "service" and similar terms. While there is no objection to the use of such words in advertising matter, there are some important considerations disclosed in this article about descriptive words in trade marks.

A number of companies have incorporated Service in their trade marked labels, bringing the question of its use into the courts.

The Link-Belt Company has been given an interesting decision in the U. S. Court of Appeals at Washington. This company appealed a decision of the Commissioner of Patents, who refused to register the word "service" surmounting a bar with V shaped end as a trade mark for rubber fabric belts. From the outset the censors at the trade mark division of the patent office held that Service as applied to belting or similar products is descriptive and, therefore, not registerable. The use of the word Service was held to indicate that the product is durable and withstands hard wear and long use. The examiners would not concede that there is any difference between the impression given by the single word Service and such an expression as belts built for service. The company contended that Service in spite of its present use in advertisements is only strikingly suggestive and not descriptive. It does not describe, the company declared, any particular attribute or characteristic of the article, but suggests that the articles on which it appears should be put into service. It does not describe them from the point of view of their quality or their use. To these pleas it was replied that any manufacturer has the same right to use such words as Service in describing and advertising his goods, and accordingly a monopoly cannot be given to any one advertiser.

J. W. Milburn, U. S. Examiner of Trade Marks, referred to the approved advertising practice to support his refusal to admit Service to the trade mark fold. He gave an exhibit of advertisements clipped from various leading periodicals, all of which showed the broad significance of the word. There was the advertisement of the A. A. Cutter Co., in which Cutter boots are advertised by the slogan "For all around comfort, service and dryness"; the Jones Hat Co. claimed "A cap that affords real protection and service";

the Krus Engraving Co. plays up "Quality and Service", and the W. C. Russell Moccasin Co. displayed the phrase "Combines lightness with utmost service."

Backed by this evidence the examiner concluded, "The word Service, because of its use in advertising and by dealers and salesmen, has come to have a well known significance in trade, indicating that the goods so described may be expected to give good service to the purchaser. In the case of belts, the goods here specified, good service would indicate good lasting qualities with little trouble or repair. It is believed that the word Service is descriptive and therefore unregistrable as the word Quality, which has repeatedly been refused registration.

When the belt company went over the head of the Trade Mark Examiner, the first assistant Commissioner of Patents, R. F. Whitehead, who was called upon to review the case, confessed that he was impressed by the showing on advertisements illustrative of the wide use of Service in copy. The endorsement in brief follows:

"The word Service is commonly used in advertising to indicate that the goods will give good service to the purchasers. The word is believed to fall within the same class as the word Quality, which has been repeatedly refused registration, and the words High Efficiency, registration of which was refused in the case of the Crosby Steam & Gauge Valve Co."

This conclusive ruling that Service must be left free for the use of all advertisers rather than appropriated to the sole use of anyone, was forthcoming as a result of carrying a case to the Court of Appeals, where the attitude of the Patent Office was upheld. The Court said, "We are of the opinion that the word Service in this instance would be descriptive of the quality of the goods. It has a fixed meaning in trade generally as indicating that goods so described are serviceable and will not only wear well, but are especially adapted to meet the requirements of the user and the goods to which the mark is applied."

Another decision handed down in a trade mark controversy shows that corporate names cannot be used as trade marks. There has been a long dispute over the word Simplex. The case of Burrel against the Simplex Electric Heating Co. was the first one. Later there was a case between the Simplex

Electric Heating Co. and the Ramey Co. Now, as if to make clear the principles already laid down on this important point, the Court of Appeals has upheld the refusal of the patent office to register Simplex as a trade mark for use on brake riggings and similar products of the American Steel Foundries.

The element of prestige attached to well advertised corporate names has entered into this last case to an extent which has arrested the attention of advertisers in general. The rejection of the application of the American Steel Foundries was based on the finding that Simplex was the name of a widely advertised corporation, and the Court of Appeals had already looked with disfavor upon anything that appeared to be an attempt to obtain benefit from wide advertising such as had been done by the Simplex Electric Heating Co. In this case extensive advertising proved to be a protection.

In passing upon this case the Court called attention to the circumstance that several corporations have the word Simplex as the predominating part of their name.

The technical significance of trade names has been taken into account in recent opinions given from the Court of Appeals, in two cases carried up from the Patent Office by the Swan-Finch Co. In the first case, the Court affirmed a decision by the Commissioner of Patents to refuse the registration of SloFlo, a trade mark for lubricating grease for high speed machinery. The trade mark censors considered the fact that a high flash point and the quality of flowing slowly, or great viscosity, are essential in lubricating grease on high speed equipment.

The second case concerned Textul, a trade mark for oil used to clean wool and worsteds. The Court held that Textul is a misspelling of textile, and concluded that because the oil used for cleaning textiles might be properly designated as a textile oil, the corruption must be turned down as objectionably descriptive of the product.

These decisions have been set forth for the benefit of those who are interested in obtaining trade marks for radio or electrical products. It is not possible, of course, to review all the conditions which must be met, but the points made here may guide some applications around difficulties which would lead to refusals at the Patent Office.

Manufacturing Details of the B Battery

The First Disclosure of B Battery Manufacture is Given in This Article on the General Apparatus Standardized Type

GREAT reticence has been shown by battery manufacturers in giving details of the processes they use. However, the makers of the G. A. Standardized B Batteries have furnished the photographs and details which are given here.

The first step in making a battery

It may be said that the depolarizer contains manganese dioxide, a high grade natural graphite, artificial graphite—purer than the natural grade—and an electrolyte. Due to a chemical action within the cell, hydrogen is liberated which, if not counteracted, would collect around the carbon rod and insulate

Again the bobbins are arranged in trays and taken to the soaking room. A rapid and accurate method of determining the length of time the bobbins should be soaked has been developed by this company. Previously the foreman made a guess at the condition of the cartridge, and estimated the soaking

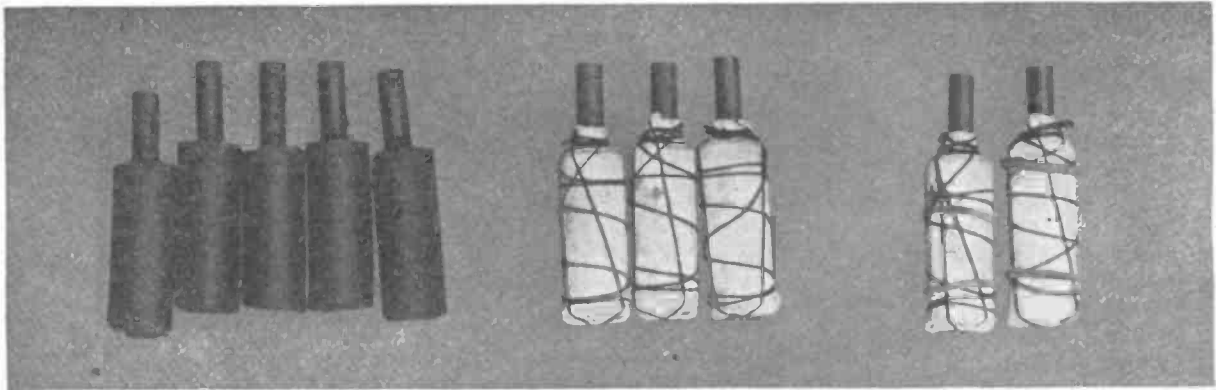

Fig. 1. First three stages of the B battery—the cartridge, bobbin, and bobbin ready for the zinc cup

is the mixing of the chemicals which form the coating of the positive electrode. Here lies the greatest and most important secret. The formula for this mixture is known only to the chemist who worked it out. To prevent the discovery of the formula, the weighing

it. As a result, the resistance of the battery would rise so high that no current would flow.

To prevent such polarization manganese dioxide is used because it liberates oxygen which combines with the hydrogen, making water.

thereby, a time ranging from ten minutes to twenty-four hours. The electrolyte is made up chiefly of a sal-ammoniac and zinc chloride solution.

The mounting room next receives the batteries in process. Here the bobbins are put into zinc cups, which serve as

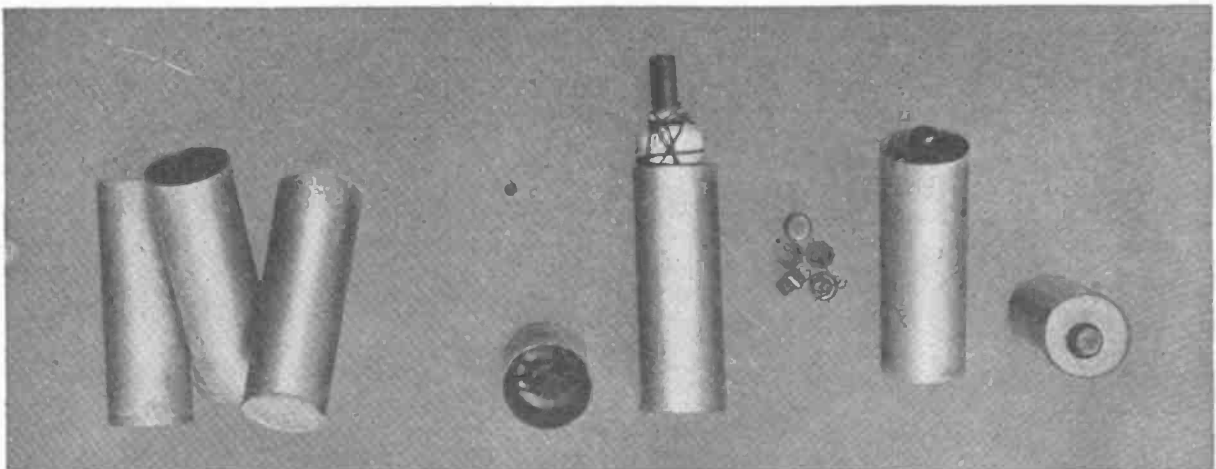

Fig. 2. Zinc cups act as the negative terminals. Mounted bobbins and brass caps. The washer in place, ready for the paraffin

scales are not marked in pounds. The beam simply carries marks at which the weights are set for different chemicals. Mostly unskilled men handle the ingredients because they know nothing of what they are doing.

When the depolarizer, as this mixture is called, is ready for use, it is carried to men who mold the cartridges, shown at the left of Fig. 1. The man fits a piece of low resistance carbon rod into a tamping mold, fills the mold with depolarizer, and tamps it into a solid form.

The cartridges are set in trays and put aside to dry. When ready, they are carried to another room where skilled women workers wrap each cartridge with cloths and bind them with a few turns of thread. The result is called a bobbin, Fig. 1. This wrapping keeps the cartridge intact while it is handled, and prevents it from falling apart when it is soaked in electrolyte later on. Before the bobbins leave this room two rubber bands are put around each one to keep it properly centered in the

the container for the battery as well as the negative pole. A paste to hold the moisture is poured around the bobbin and allowed to solidify.

An interesting automatic machine takes a tray of mounted bobbins and, after pouring a small amount of paraffin in the top of each cell, puts a paper washer around the carbon rod on the paraffin covering. This process prevents the sealing wax from running into the cell.

Another machine picks out the cells

from the tray and sends them in a long file under a hopper containing the brass caps which top the carbon electrodes. A cap is gently pressed on each carbon. Emerging from this part of the machine, they pass to the next section, where sealing wax is poured around the cell, over the cardboard washer previously mentioned. A number of batteries are treated in this way at one time, because some little time is required to pour the wax, while the brass

the carbon and zinc electrodes. If they deliver the rated current they go on to the carrying trays. If not, they drop into a hopper on the floor. This eliminates the possibility of mounting defective cells in the completed battery, where, at the last test, it would be necessary to reject the entire set.

It is necessary to solder the connections between the batteries by hand, although the speed with which the workers perform this operation is almost

is necessary to prevent short circuiting from moisture which would otherwise collect inside the box.

The separators and the sealing wax keep the batteries perfectly rigid, so that there is no trouble from noise due to a change in resistance of the contacts under vibration. Chemical noises have been eliminated by a process which is kept secret with the manufacturers.

During the war the U. S. Govern-

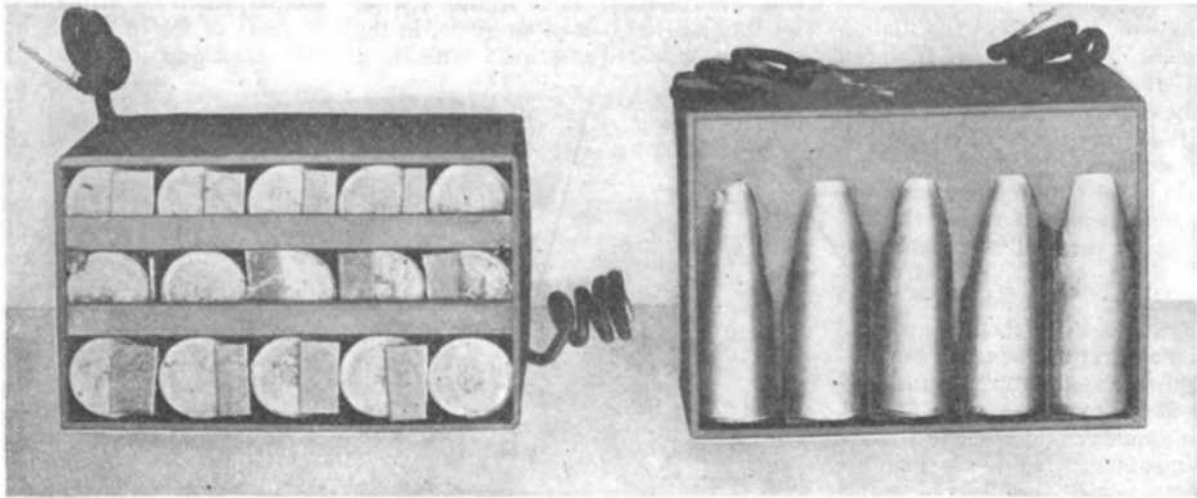

Fig. 3. The side and bottom of a completed battery were removed to show the construction

caps are put on at a much greater rate of speed.

Several grinding wheels are mounted at the end of the machine just described. When the cells reach the end of their journey through this device the grinding wheels touch lightly on the brass caps and the zinc containers, giving clean surfaces for soldering.

Now the cells are ready for a final testing before going into the boxes. They are passed individually through a machine which applies contacts to

mechanical. Paper boxes of great strength, impregnated in paraffin to exclude moisture, are used to hold the cells. Flexible leads are put on the terminals and sealing wax poured slowly over the cells.

Fig. 3 shows the type of container used. Paraffined cardboard separators keep the cells apart. By bending over the strips at the bottom, the cells are prevented from forming short circuit in any possible way. Because the box is of waterproof construction no protection

ment ordered so many of these batteries that they could not be made in one factory. However, the manufacturers were not willing to make public the formulas they had originated. Therefore they mixed the chemicals and sent completed compounds to the other companies.

Although it is not possible to give the experimenters sufficient data that they can make their own batteries, this description will give an idea of the way in which they are made.

Book Reviews

STATION X. By G. McLeod Winsor. 317 pages, 7 $\frac{1}{4}$ ins. Published by J. B. Lippincott, Phila., Pa.

Station X is a book which will appeal strongly to those whose imagination can carry them beyond the limitations of this earthly sphere. A new possibility in interplanetary warfare has been conceived by Mr. Winsor.

His story, while not intended probably to be at all possible, is founded on facts, though not technically accurate. However, some of the considerations which may come to the minds of those more familiar with radio work are forgotten in the fascinating story of the man on the lost island, who operates the power for the Radio Station of the British Navy.

The interest starts on the moment—but it will not do to tell the story in advance. It is enough to say that Sta-

tion X is a refreshing change for anyone, after his day's work, to let his mind wander to the realms and people in whose histories Station X played such an important part.

AIRPLANE ANTENNA CONSTANTS. By J. M. Cork. 14 pages, 10 x 7 ins. Published by the Government Printing Office, Washington, D. C. Price 5c.

Radio men will find in this paper considerable interesting data on the method of measuring airplane antenna resistance and directional effects. A number of characteristics are also given, illustrating the action of the different types of airplane antennas on different machines.

The directional effect is particularly interesting as it shows that the radiation ahead of the machine is several times greater than to the rear.

PRINCIPLES OF RADIO TRANSMISSION AND RECEPTION WITH ANTENNA AND COIL AERIALS. By J. H. Dellinger. 60 pages, 10 x 7 ins. Published by the Government Ptg. Office, Washington, D. C. Price 10c.

In this paper Mr. Dellinger gives quantitatively the functioning of the two principal types of radio aerials, worked out from fundamental electromagnetic theory, corroborated by actual experiments.

Formulas for received current in terms of current in either type of transmitting aerials are given and comparison formulas for the relative performance of the two types under various conditions. Some data is also given on the condenser antenna. In the section devoted to the action and the design of aerials, a number of misunderstandings are cleared up.

There are a number of ideas given for the possibilities for future research on antennas which are of special interest to experimenters.

A Light Weight Airplane Transmitter

The General Design of this $\frac{1}{2}$ K. W. Simon Set Should Give Experimenters a Number of Suggestions for Panel Transmitters

STURDY and simple construction should be the keynote of the new transmitters which are going into commission now that sending sets are operating once more.

The day of the wobbly oscillation transformers, the connections that fall off, and the condenser that sparks around the edges has passed. Of course, there will be beginners always. Experienced workers must take upon themselves the task of pointing out the proper ways and means to those who are just answering the call of experimenting.

The design of the transmitter illustrated in this article, though intended for airplane work, can be easily adapted to the requirements of an experimenter's set. At the front of the panel, a key, radiation ammeter and quenched spark gap are mounted. Inside the case are the antenna reel, oscillation transformer, condenser and transformer. The case measures 11 ins. deep, 11 ins. wide and 12 ins. high.

Such compactness is largely due to the fact that a 1,000-cycle generator is used to supply current to the transformer. Increasing the frequency reduces the size of the transformer and condenser needed. Nine hundred or 1,000-cycle machines are bound to come into extensive use among experimenters as soon as some company realizes

the present unfilled demand for them.

An interesting feature of the oscillation transformer is the winding and supports. Instead of using copper ribbon, the conductor is of stranded wire, set into notches, cut at an angle, in the bakelite supporting strips. This is a

It will be seen that the quenched gap is mounted in an opening in the panel. At the rear of the case, a 3-in. ventilating tube and scoop are attached so that, when the airplane is in motion, a draft is let in which blows out on the spark gap.

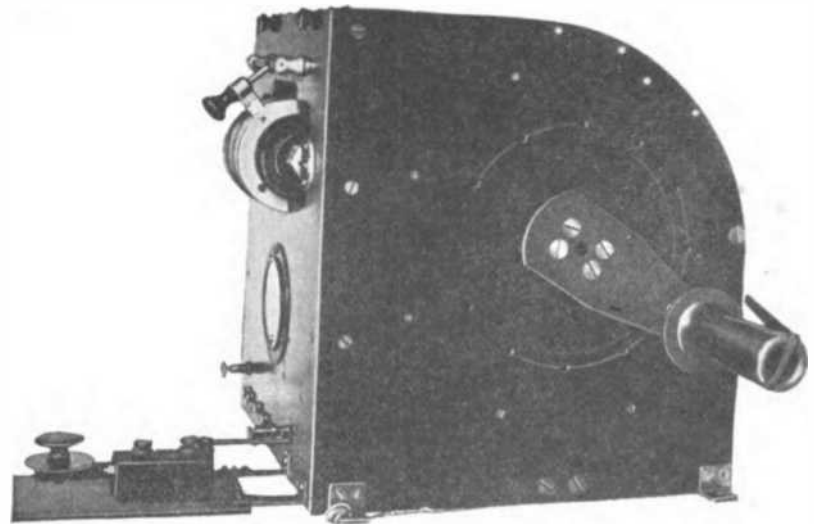

Showing the spark gap mounting, key, and antenna reel handle

simple method construction, and, as in the case of copper ribbon, the wire cannot jar loose from the slots. Coupling adjustment is obtained by moving one of the coils along the bakelite mounting rod.

Although the generator produces a constant frequency of 1,000 cycles, a spark note of 1,000 or 2,000 cycles can be made by adjusting the length of the gap, or the number of sections. With a short gap, spark discharges occur at

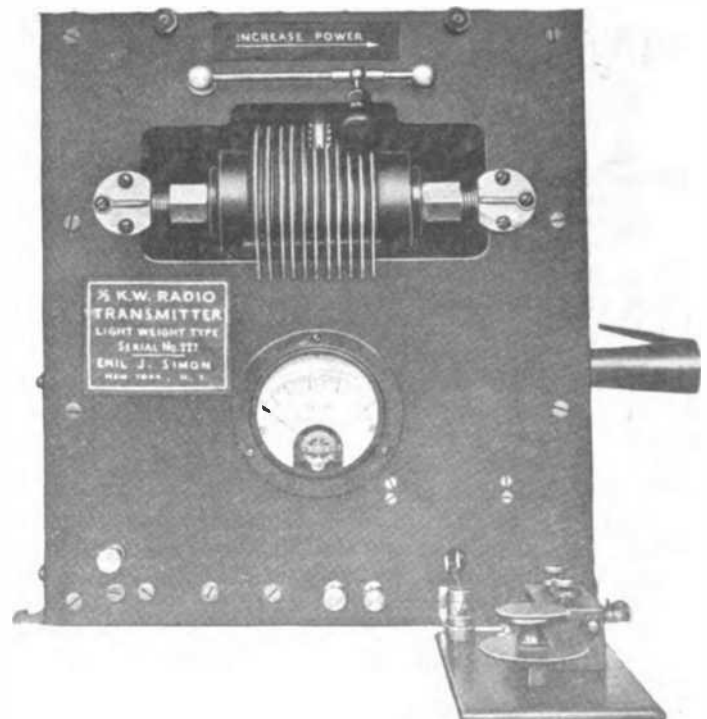
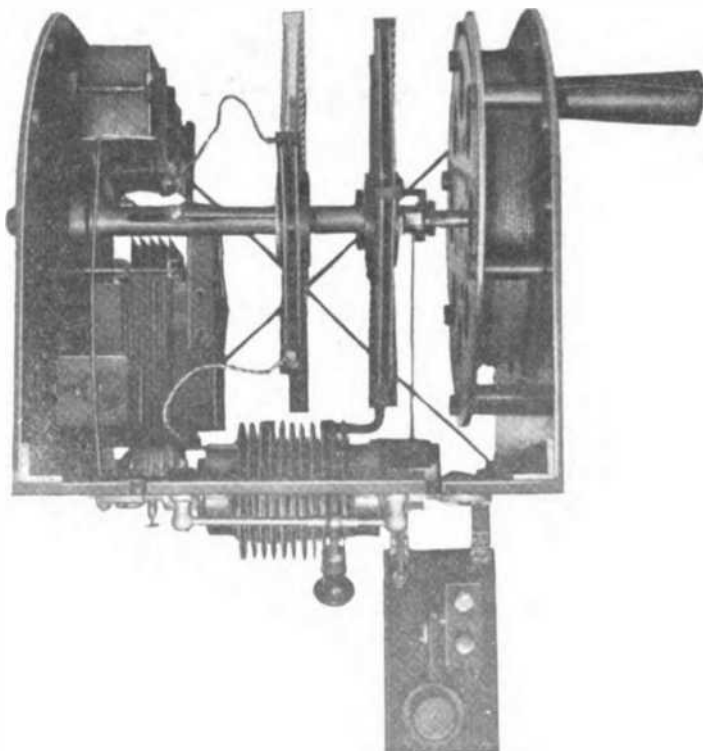

An arrangement of instruments which, with the exception of the antenna reel, might be followed in making a 200-meter set

every alternation of the generator, while with a long gap, a greater charge is required in the condenser with a corresponding longer time between sparks. Thus it is that a full gap gives a 1,000-cycle note, and half the gap, 2,000 cycles.

Moreover, the transformer input and the transmitting range are increased by lengthening the gap. The variation is

from 250 to 500 watts input to the set.

The side view shows that the telegraph key is hinged. In the horizontal position, connections are made for sending. A rod, passing through the panel, actuates a switch, when the key is pushed up, which disconnects the antenna and generator. In this way the necessity for an antenna switch is overcome.

Notes on Radio Antennas

A Few Suggestions are Given for Overcoming Disadvantages of Large Antennas for Transmitting and Receiving

DEVELOPMENTS made during and since the war have solved some of the problems of experimenters who, for lack of space or funds, cannot put up large antennas.

An antenna, according to the accepted conception, is made up of one or more elevated wires, the length and height of which may be from twenty to several hundred feet. In the minds of most experimenters the fact that an antenna possesses comparatively large capacity and small inductance is secondary, though this is a primary consideration to the engineer. For convenience let us apply the name antenna to a radiating system having elevated wires used in conjunction with an earth connection.

The loop is now familiar to all experimenters. It is made up of a large coil of wire, supported in any of a number of ways. While there is some distributed capacity between the turns, it is essentially a concentrated inductance. Therefore, we shall call the radiating system of lumped inductance a loop.

Now comes an old, yet new type—the condenser antenna. It is formed of two large metal plates insulated from each other and from the ground. This is really a first cousin to the antenna, while the loop is of another family. The condenser antenna, then, is a radiating system of lumped capacity.

In other words, the antenna and condenser operate by radiation, while the loop operates by induction.

The problems of small antennas of the three types and their solution are taken up in the succeeding paragraphs.

THE ANTENNA

Transmitting.—Dimensions of sending antennas are necessarily small because of the Government regulations which limit them to operation on 200 meters. Data given on page 274, EVERYDAY ENGINEERING, March, 1919, show that the maximum efficiency is obtained from an antenna when it is operating at its natural wavelength, that is, with as little loading inductance as possible. However, enough inductance must be used in the secondary of the antenna to take the energy from the primary coil.

In short, a 200-meter transmitter should have an antenna whose height plus its length does not exceed 90 to 110 feet, made up of four wires spaced 3 feet apart, with the lead-in taken off at the center or end. It is advisable to connect the wires where the lead is taken, with a single wire running to the operating room.

Receiving.—For all practical purposes, the single wire, of a length great in comparison to the height, is the best antenna for receiving. The General Apparatus Company has standardized on three sizes, called short, long and super range. They are 100, 200 and 300 feet long, respectively, and are intended for an elevation of 30 feet at each end.

The extreme simplicity of the single wire type, coupled with low expense and high efficiency, has brought about its general adoption. Experimenters have reported, during the summer months, that they copied Nauen and Lyons regularly, using a single audion, with a tickler coil to make the circuit oscillate.

When there is not a sufficient stretch for a super range antenna, the wire can often be formed into a V, 150 feet on a side. The angle should be as large as possible. This construction causes only a slight reduction of efficiency and wavelength if the angle is not less than 30°.

As much loading as desired, either with condensers or inductances, can be used in a receiving antenna. Mica condensers, or those using anything but air dielectric, are not suitable for oscillating receiving circuits. A condenser, shunted around the tuning inductance is all right, but it must not have any considerable losses. Never buy a condenser with fibre end plates. Be careful of those using plates of anything other than hard rubber or bakelite. Some black moulded compositions have high losses. A leaky condenser across a coil is as bad as a resistance shunted around it.

The resistance of the primary of a loose coupler is not as important as the resistance of the secondary. Solid wire may be used for the former, but high frequency cable is essential for the secondary inductances.

THE LOOP

Transmitting.—Unlike the antenna, the loop operates by magnetic induction, setting up a current in the receiver in the same manner as a current is induced in the secondary of a transformer by the changing lines of force around the primary. Many experimenters think that the field about one side of the loop will neutralize the field about the other, making transmission impossible. This is not so, for the reason that a time difference exists between the oscillations on the two sides since, fast as it is, electricity requires a certain time to travel through the loop. Hence, the two fields are not exactly opposite.

Here is an important point, however. Greater radiation takes place at short waves than at long waves. A little thought will make this clear. Electricity always travels at the same speed, but short waves oscillate at a faster rate than long ones. Consequently, if the loop is large and the wavelength small, a frequency might be found where the time lag between the two sides would be equal to the time for one-half a cycle, in which case the sides of the loop would aid each other, or would be in phase. Unfortunately, this is not practical, and would require a single turn loop.

Under working conditions, it is feasible to use a loop 4 to 6 feet square for 200-meter work. Only a small capacity is needed across the loop. To obtain the maximum size or number of turns, it may be possible to use no capacity other than the distributed capacity of the loop. Although a spark coil or transformer can be used, the vacuum tube telegraph or telephone transmitter is best adapted for loop work.

A loop can be made to approach the efficiency of an antenna by lowering the resistance. 3-16 No. 38 high frequency cable is better than solid wire for transmitting because its resistance is low at short wavelengths. The wires should be wound on notched bakelite strips, as the insulation between the turns is of the utmost importance.

The loop, then, for short distance work, is well adapted to limited space. As a matter of fact, with a three-stage amplifier and a loop receiver, a single tube loop transmitter will cover 40 or 50 miles. Those who are interested in experimental work rather than in operating, will find that the loop transmitter answers their needs. The directive effect adds interest to the work.

Receiving.—What has been said of the wavelength effect on transmitting loops holds good for receivers. Signals sent out from a loop can be picked up on an antenna, of course, in which case the wavelength does not effect the efficiency of the receiving antenna greatly.

Using the same length of wire on the receiving loop, efficiency is increased by making the size of the loop greater. Increasing the number of turns helps up to a certain point, beyond which the signal strength is decreased. Resistance should be kept low for sharp tuning. When an audion detector is used, a slight negative potential should be maintained on the grid to make the resistance between grid and filament high.

Small loops do not compare with a short range antenna. To cover great distances, two or three stages of amplification are needed. Some experimenters who have space enough in their back yards have made loops 15 feet on a side, arranged to be turned by ropes from their operating rooms. Others, for transoceanic work, have built stationary loops, 15 or 20 feet high and 20 to 30 feet long, with the horizontal sides pointing east and west. Loops of this size give good results on long distance reception.

For radio compass or directive work, the leads must be brought down together from the mounting shaft. Capacity between the loop and leads, or other metal objects, give an antenna effect which causes directive errors.

THE CONDENSER ANTENNA

Transmitting.—The efficiency of an antenna is rather low because of the dielectric losses which effect its action as a condenser. A condenser antenna, with two metal plates serving as the antenna and ground, has a low resistance, compensating for its comparatively small size.

Since solid plates would be heavy and expensive for experimental work, copper netting may be substituted without any appreciable loss. Here is a new idea for those who cannot put up an antenna or a large indoor loop. A condenser antenna can be made of two squares of copper netting 6 feet on a side and 1 foot apart, suspended horizontally so that the upper plate will be 1 foot or more from the ceiling. This will be entirely out of the way, and small enough to fit almost any operating room. Insulators must be provided, of course, so that there will be no breakdown between the plates during transmission. Increasing the area of the plates will, of course, make the transmitting range greater.

Connections are made as with an antenna. The upper plate acts as the aerial, and the lower is the ground. All parts are insulated, however, from the earth. The efficiency of such a radiator is not equal to a 200-meter antenna, yet it will do good work, and serve as an excellent substitute.

Receiving.—So little work has been done with condenser antennas that it is not possible to give accurate data on them. It is certain, however, that they will accomplish as much or more than a loop.

When the plates are square, there is no directional effect, but, if they are rectangular, there should be an effect in line with the greater length. It has not been possible, so far, to try out

the condenser antenna at the EVERYDAY ENGINEERING laboratory. Reports from experimenters who do any work of his kind will be welcome for publication.

The Radio Department

“**W**ONDER who has SOL for call letters,” someone said at a gathering of experimenters in one of the New York radio stores.

Now that the Radio Inspectors are busy with the trials and troubles of regulating the thousands of new transmitting stations that are going up, from Maine to Texas, a different purpose can be seen behind the work of the radio experimenters.

In the old days radio sets were largely used to replace the back yard telegraph line as a means of having some fun. While this may be still true of a few, the real work is for long distance, shore wave work. Long distance transmission and reception calls for high efficiency. It takes five hundred or a thousand miles to elate the man who used to tell with pride that he heard a station in the next town.

This change is due partly to the keener competition among the increased number of experimenters. The older men who have gone at wireless more thoroughly have helped to raise the standards. Popular presentations of engineering principles in the magazines have increased the knowledge of those men interested in wireless. The American Radio Relay League deserves no small amount of credit for its efforts to make over the toy wireless station into a serious hobby.

If experimenters will heed the warning from the Department of Commerce, sounded in the last issue of EVERYDAY ENGINEERING, the future will give them big things.

THE many friends of Louis Pacent will seek him in a new lair shortly. Scenes shift rapidly in wireless. The little groups of inquiring “What do you know about—”, will congregate in new quarters, for Louis Pacent will open a store of his own, about the first of the year, at 150 Nassau Street, New York City.

HAVE you ever stopped to consider that, when you measure distances on the map with a ruler, you do not find the actual number of miles, measured around the surface of the earth? In other words, the shortest distance between two points on a map is a curved line.

Mr. De Loss Martin, well known on the Pacific coast, but now in New York, has worked out a logarithmic scale by means of which the great circle distance between two points can be found, knowing their latitude and longitude. Later this scale will be made available to experimenters.

A NUMBER of letters have come in asking about the possibility of patent suits in case this or that piece of radio apparatus were manufactured and marketed. There are so many companies building infringing instruments now that it appears as if the only way to find the answer to this question is to try it out. Perhaps it depends upon the company whose patents are infringed.

One company which attempted to sell radio telephone transmitters ran into a snag in the form of the modulation patent. The radio patent situation is so involved that even the companies themselves sometimes find that rights which they thought they owned do not belong to them.

Sympathy might well be extended to the judge who will soon be called upon to determine whether a vacuum tube and a gas tube work in the same way. He may have to decide what a pure electron discharge is or is not.

OCCASIONALLY someone says with surprise, “I didn't know that EVERYDAY was a radio magazine.” It depends upon the individual's ideas. In the December, 1918, issue, there were neither radio articles nor radio advertisers. The last issue, a year later, had seventeen pages of articles on wireless and represented thirty-seven companies selling supplies to experimenters.

In a year's time the number of pages in the magazine has doubled, and with the further increase in pages, the Radio Department will be made still larger.

Next month, the first design of a radio frequency transformer ever published will be given to the readers of EVERYDAY. It doesn't call for No. 50 wire either. There will be a complete description with photographs, of a long wave receiver which has been doing some unusually good work. The set is made up by the divisional method, with standard size panels. An audion control set from the Wireless Improvement Company will be illustrated also.

Other things which you will find justify our saying, “Always bigger, always better.”

NOTICE

Send in your name for the Radio Register. We want to have on record the name of every radio experimenter or engineer. Get your name in as soon as possible. Help us to make the Register complete.

The Radio Club of the Elijah D. Clark School

OUR Radio Club endeavors to give a limited number of our boys a thorough theoretical and practical knowledge of the elementary science and art of wireless telegraphy and telephony.

The club meets once a week after school hours. The work ought not to interfere with the school studies; it will supplement the regular work in elementary science.

There is an initiation fee of one dollar and a weekly due of ten cents, all of which is voluntary and is to be spent by the members for their own personal needs in this work.

The greater part of the apparatus will be constructed in the woodwork shop, some of it will be bought. All apparatus used in demonstration is the property of the instructor.

Parents are invited to encourage any such special inclination on the part of their boys. The field of electrical application is enormous, and for future electrical workers this course will prove helpful.

This course will consist of sixty lessons, running through four terms, fifteen lessons of one hour each term. The work will include theoretical and practical work and visits to radio establishments.

The actual classwork is in the hands of Dr. Herman V. Bucher, an amateur radio worker for many years and in charge of the department of Manual Training of this school. Address all letters to Dr. Bucher, Hollis, Long Island, N. Y.

BOOK REVIEW

THE DETERMINATION OF THE OUTPUT CHARACTERISTICS OF ELECTRON TUBE GENERATORS. By Louis M. Hull. 20 pages, 10 x 7 ins. Published by the Government Printing Office, Washington, D. C. Price 5c.

In this Scientific Paper from the Bureau of Standards, the results of a series of experiments on vacuum tube generators are given. It has been found that the current delivered to the output circuit of such a generator is heavily loaded with harmonics, owing to the saturation and rectification effect in the tube. The frequency in the oscillating circuit is the natural frequency of the output circuit, and this circuit acts as a filter in series with the tube and the d. c. power system.

The useful output current is closely sinusoidal, whatever the distortion of the tube currents, depending for the amplitude only upon the characteristics and the tube current. In this paper general expressions are given for the power and output in terms of static characteristics of the generating tube. Experimental results corroborated the formulas given.



“You’ve Gone Way Past Me, Jim!”

“Today good old Wright came to my office. All day the boys had been dropping in to congratulate me on my promotion. But with Wright it was different.

“When I had to give up school to go to work I came to the plant seeking any kind of a job—I was just a young fellow without much thought about responsibility. They put me on the pay-roll and turned me over to Wright, an assistant foreman then as now. He took a kindly interest in me from the first. ‘Do well the job that’s given to you, lad,’ he said, ‘and in time you’ll win out.’

“Well, I did my best at my routine work, but I soon realized that if ever I was going to get ahead I must not only do my work well, but prepare for something better. So I wrote to Scranton and found I could get exactly the course I needed to learn our business. I took it up and began studying an hour or two each evening.

“Why, in just a little while my work took on a whole new meaning. Wright began giving me the most particular jobs—and asking my advice. And there came, also, an increase in pay. Next thing I knew I was made assistant foreman of a new department. I kept right on studying because I could see results and each day I was applying what I learned. Then there was a change and I was promoted to foreman—at good money, too.

“And now the first big goal is reached—I am superintendent, with an income that means independence, comforts and enjoyments at home—all those things that make life worth living.

“Wright is still at the same job, an example of the tragedy of lack of training. What a truth he spoke when he said today, ‘You’ve gone way past me, Jim,—and you deserve to. Heads win—every time!’”

Yes, it’s simply a question of training. Your hands can’t earn the money you need, but your head can if you’ll give it a chance.

The International Correspondence Schools have helped more than two million men and women to win promotion, to earn more money, to know the joy of getting ahead in business and in life.

Isn’t it about time to find out what they can do for you?

You, too, can have the position you want in the work of your choice, with an income that will make possible money in the bank, a home of your own, the comforts and luxuries you would like to provide your family. No matter what your age, your occupation, your education or your means—you can do it!

All we ask is the chance to prove it—without obligation on your part or a penny of cost. That’s fair, isn’t it? Then mark and mail this coupon.

TEAR OUT HERE

INTERNATIONAL CORRESPONDENCE SCHOOL
Box 6065-B, SCRANTON, PA.

Explain, without obligating me, how I can qualify for the position, or in the subject, before which I mark

<input type="checkbox"/> ELECTRICAL ENGINEER	<input type="checkbox"/> CHEMICAL ENGINEER
<input type="checkbox"/> Electrician	<input type="checkbox"/> SALESMANSHIP
<input type="checkbox"/> Electric Wiring	<input type="checkbox"/> ADVERTISING MAN
<input type="checkbox"/> Electric Lighting	<input type="checkbox"/> Show Card Writer
<input type="checkbox"/> Electric Car Running	<input type="checkbox"/> Outdoor Sign Painter
<input type="checkbox"/> Heavy Electric Traction	<input type="checkbox"/> RAILROADER
<input type="checkbox"/> Electrical Draftsman	<input type="checkbox"/> ILLUSTRATOR
<input type="checkbox"/> Electric Machine Designer	<input type="checkbox"/> DESIGNER
<input type="checkbox"/> Telegraph Expert	<input type="checkbox"/> BUSINESS MANAGEMENT
<input type="checkbox"/> Practical Telephony	<input type="checkbox"/> Private Secretary
<input type="checkbox"/> MECHANICAL ENGINEER	<input type="checkbox"/> BOOKKEEPER
<input type="checkbox"/> Mechanical Draftsman	<input type="checkbox"/> Stenographer and Typist
<input type="checkbox"/> Toolmaker	<input type="checkbox"/> Cert. Pub. Accountant
<input type="checkbox"/> Ship Draftsman	<input type="checkbox"/> Traffic Management
<input type="checkbox"/> Machine Shop Practice	<input type="checkbox"/> Commercial Law
<input type="checkbox"/> Gas Engineer	<input type="checkbox"/> GOOD ENGLISH
<input type="checkbox"/> CIVIL ENGINEER	<input type="checkbox"/> Common School Subjects
<input type="checkbox"/> Surveying or Mapping	<input type="checkbox"/> CIVIL SERVICE
<input type="checkbox"/> MINE FOREMAN OR ENG’R	<input type="checkbox"/> Railway Mail Clerk
<input type="checkbox"/> ARCHITECT	<input type="checkbox"/> STATIONARY ENGINEER
<input type="checkbox"/> Architectural Draftsman	<input type="checkbox"/> Textile Dressmaker or Sup.
<input type="checkbox"/> PLUMBING AND HEATING	<input type="checkbox"/> AGRICULTURE
<input type="checkbox"/> Sheet Metal Worker	<input type="checkbox"/> Spooling
<input type="checkbox"/> Navigator	<input type="checkbox"/> Foultry Raising
	<input type="checkbox"/> Automobiles
	<input type="checkbox"/> Italian

Name _____

Present Occupation _____ 7-25

Street and No. _____

City _____ State _____

The Work of the Bureau of Standards

This Article Gives a List of the Radio Tests Made by the Bureau, of Which Experimenters and Manufacturers May Now Take Advantage

EXPERIMENTERS who are carrying on radio research work should take advantage of the services provided by the Bureau of Standards, at Washington, D. C. For the benefit of those not familiar with the tests and measurements made there, a list, with the prices for various kinds of work, is given here.

Application for Test.—All articles submitted for test must be accompanied by a written request for the test. The request should enumerate the articles, giving the serial numbers or other identification marks of each, and should state explicitly the nature of the test desired. It is also desirable that the conditions under which the apparatus is used be stated.

In submitting radio apparatus, the accompanying letter requesting the test should state specifically the nature of the test desired, giving, in the case of wavemeters, condensers, etc., the number of points on the scale and the frequencies of the wavelengths at which the apparatus is to be tested. In the absence of specific instructions, such tests will be performed as are necessary to determine the ordinary constants or operating behavior of the apparatus. Thus, for a wavemeter, variable condenser or inductor, the results obtained would make possible the use of the instrument as a secondary standard.

For special tests involving measurements not specified in the appended schedule, a charge will be made based upon the time required for the test. When the test is one regularly provided for in these instructions, the fee may be computed in advance and should be sent at the time the apparatus is shipped. In making reference to this schedule, mention: Fees for Testing Radio Apparatus, Feb. 6, 1919, Item (D) (a).

Condition of Apparatus.—Before submitting apparatus for test, the applicant should ascertain that it is in good working condition. When defects are found after a test has been begun, which excludes an apparatus from receiving the usual certificate, a report will be rendered giving such information as has been found. All possible care will be taken in handling apparatus, but the risk of injury or breakage in shipment or under test must be borne by the applicant.

Identification Marks.—All packages should be plainly marked with the shipper's name and address, and, when convenient, a list of the contents. Each separate piece of apparatus or sample of material should be provided with

an identification mark or number. The identification mark should be given in the application for the test.

Shipping Directions.—Transportation charges are payable by the person requesting the test. The charge for shipment to the Bureau of Standards must be prepaid, and unless otherwise arranged, articles will be returned or forwarded by express collect. Apparatus submitted for test, as well as all correspondence, should be addressed to the Bureau of Standards, Washington, D. C.

Remittances.—Fees should be sent when the apparatus is shipped, in accordance with this schedule, or promptly upon receipt of bill. Certificates are not given, nor is apparatus returned until the fees due thereon have been received. Remittances may be made by money order or check drawn to the order of the Bureau of Standards.

Nature of Tests.—The general methods used in most of the tests of radio apparatus are described in Circular 74 of the Bureau of Standards, entitled "Radio Instruments and Measurements." A more detailed description of the methods used by the Bureau of Standards in testing radio apparatus will be given in a circular now in preparation.

Reduced Fees for Amateurs.—In the case of wavemeters not suited for precision measurements the Bureau will charge a minimum fee of one dollar per coil. Enough points will be measured to give a calibration curve. The Bureau reserves the right to decide upon the application of this reduction in any specific case.

Condensers

Capacity and phase difference (or high frequency resistance), one point at one frequency.....	\$3.00
Each additional point at same frequency	1.00
Each additional frequency.....	1.00
Capacity of fixed condenser at one radio frequency	2.00
Each additional frequency.....	1.00
Phase difference (or high-frequency resistance) one point at one frequency.	2.00
Each additional point same frequency..	1.00
Each additional frequency.....	1.00
Capacity of variable condenser per point (minimum charge, \$2.50).....	.50

Inductors

Pure inductance of coil.....	\$5.00
Capacity of coil.....	3.00
High-frequency inductance one coil at one frequency	1.00
Each additional coil at same frequency.	.50
Each additional frequency.....	.50
Fundamental wavelength of coil.....	1.00
Resistance (high frequency) one point at one frequency	2.00
Each additional point at same frequency	1.00
Each additional frequency.....	1.00
Calibration of continuously variable inductor, one point at one frequency..	1.00

Each additional point at same frequency	.50
Complete test of a single coil, including unless otherwise specified, high-frequency inductance, pure inductance, capacity, fundamental wavelength...	8.00
For a coil having several sections, the capacity and fundamental will be furnished for the whole coil only, and the other tests as described in the preceding item for the maximum inductance	8.00
Each additional section.....	5.00

Resistors

Resistance (high-frequency) one point at one frequency.....	\$2.00
Each additional point at same frequency	1.00
Each additional frequency.....	1.00

Wavemeters

Wavelength calibration per point (minimum charge, each coil, \$2.50; for reduced fees to amateurs see previous note)	\$0.50
High-frequency inductance (see above, under Inductors).	
Capacity of condenser (see above, under Condensers).	
High-frequency resistance (or decrement) of circuit, one wavelength....	3.00
Each additional wavelength.....	.50
Note:—For high-frequency resistance of coils or condenser alone, see above, under Condensers and Inductors.	

Electron Tubes

Characteristic curve of receiving tube, first curve	\$4.00
Each additional curve on same tube....	2.00
Amplification constant and internal resistance of receiving tube, first determination	2.00
Each additional determination on same tube	1.00
Output of power tube, first determination	2.00
Each additional determination on same tube	1.00
Characteristic curve of power tube, first curve	4.00
Each additional curve on same tube....	2.00
Amplification constant and internal resistance of power tube, first determination	2.00
Vibration test of power tube, first tube	2.00
Each additional tube in same test lot..	1.00
Special fees will be charged for investigations on the detector action of tubes, amplification of amplifiers, tests of power tubes at very high voltages, and other special measurements.	

Current Measuring Instruments

Thermocouple and galvanometer, per point at one frequency	\$2.00
Each additional point at same frequency	1.00
Each additional frequency.....	1.00
High-frequency ammeter, range up to 1 ampere, per point at one frequency	3.00
Each additional point at same frequency	.50
Each additional frequency.....	.50
High-frequency ammeter, range 1 to 20 amperes, per point at one frequency	3.00
Each additional point at same frequency	1.00
Each additional frequency.....	1.00
High-frequency ammeter, range 20-100 amperes, per point at one frequency	5.00
Each additional point at same frequency	2.00
Each additional frequency.....	2.00

Insulating Materials

Dielectric constant at one frequency, per sample	\$3.00
--	--------

Each additional frequency.....\$1.00
Phase difference, or high frequency resistance, same fees as for the determination of the phase difference of condensers.

Effect of high voltages.—Fees for the determination of flashover or breakdown voltage or the effect of high voltage at radio frequencies are computed on a basis of the special modifications of the regular apparatus which are required for test and also the time necessary for its performance.

Note:—Samples of insulating materials should conform to the following sizes where possible. When samples of other sizes are submitted an additional fee may be charged, depending upon the time involved in preparing the sample.

For determination of phase difference and resistance. Laminated materials, 25 cm. x 31 cm. in area, and from 0.3 cm. to 1 cm. in thickness.

Moulded materials, 25 cm. x 31 cm. in area, and from 0.3 cm. to 1 cm. in thickness or discs 25.4 cm. in diameter and from 0.3 cm. to 1 cm. in thickness.

For determination of flashover voltage, samples should be 10 cm. x 10 cm. in area, and 0.63 cm. thick.

Transmitting Sets, Receiving Sets, Buzzers, Detectors, etc.—Certain specific tests are undertaken or a critical study made of the design and behavior of the apparatus as compared with other apparatus used for the same or a similar purpose. Fees for such tests depend upon the special requirements and time necessary in their performance.

A Mounting for Experimental Transformers

A SERIES of experiments on audio frequency transformers required a number of different primary and secondary windings. At first it seemed necessary to make up eight or ten com-

plete transformers, but an idea in the form of a mounting illustrated in this article overcame that difficulty. By its use, only one core was needed.

The illustration shows the bakelite cradle with the transformer assembled. It can be seen that one core, made up of one long and two short legs, is put into the mounting. The ends of the short legs were ground off smooth.

Different primaries and secondaries were assembled on single legs. Then the coils required were put in place and clamped down by the two bakelite strips shown on the side of the instrument.

Experiments were also made with magnetic leakage. Enough room was allowed in the cradle so that the leg carrying the winding could be moved a short distance from the ends of the short legs. When the separation was adjusted, by means of shims, the clamping strips were tightened and the shims removed.

Fahnestock clips were provided at the base so that different taps from the primary and secondary coils could be connected. Since double clips were not available, two single ones were put on each mounting screw.

Although there is nothing remarkable about this device, it saved both time and money on a job which called for speedy completion.

NOTICE!

Mr. R. S. Ould has called attention to the fact that the price of patent specifications, from the Patent Office, Washington, D. C., has been increased from five to ten cents each. Remittances cannot be made by stamps; the Patent Office requires coin or money orders.

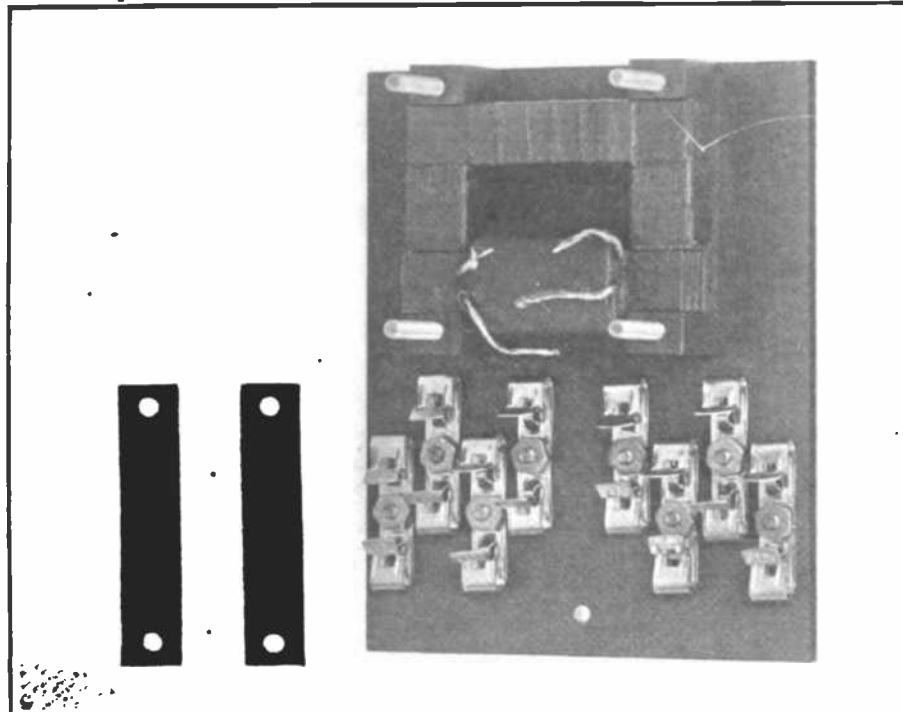

This transformer mounting makes possible experiments in the different kinds of windings

Please mention EVERYDAY ENGINEERING MAGAZINE

Don't Be A Miserable Misfit



STRONGFORT
The Perfect Man

You don't have to go through life fit for nothing, sickly, weak, anemic, with your body wracked and your nerves frayed by constipation, indigestion, catarrh, neuralgia, headaches or any other chronic ailment. Get rid of these handicaps; build yourself up into a real man, so you can get some joy out of life for yourself and your family.

YOU can't get ahead, you can't advance in your work or business—you may even lose your grip on your present job—if you don't make yourself fit. You can do it, whatever your present condition and no matter what brought you to it; you can regain your lost health and strength and feel the fire and pep and enthusiasm of youth coursing through your veins again, if you will only

Stop, Think and ACT

Don't think that your weakness and ailments that are dragging you down are a matter of course—something you can't possibly get rid of. You can overcome them and cast them off, if you go about it the right way, as thousands of other men have done and are doing every day. Drug store dope and patented pills won't cure you; quacks and fake remedies help nobody but the men who make and sell them. Your own abuse of Nature's Laws—perhaps unconsciously—brought your ills upon you, and Mother Nature is the one doctor you want to go to for relief.

SEND FOR MY

FREE BOOK on STRONGFORTISM

Strongfortism is the Science of Living Life as Nature meant it to be lived—the way that gets the greatest enjoyment out of it—and letting Nature work the elimination of any ills in her own way. Every reputable medical man will tell you that Nature is the greatest Doctor in the world. Every surgeon, after an operation, large or small, makes sure that the wound is absolutely free from bacteria and then lets Nature heal it up.

Strongfortism, which is simply a method of utilizing Nature's curative power, will do for YOU what it is doing for my pupils in every part of the world. Strongfortism will show you how to develop every muscle in your body, internal as well as external, and strengthen every vital organ; how to make your blood rich and red; how to clear the clogged out of your brain; how to FIT YOURSELF so you can make a success in life.

I Guarantee Results

There isn't any success to work about Strongfortism: Nature's Laws are as immutable as the operations of the universe. My whole life has been spent in studying them out, experimenting with them, and applying them practically—first to myself and then to my numerous pupils. I GUARANTEE to improve you so that you will become normal in every respect, if you will follow my directions for a few months. "Promotion and Conservation of Health, Strength and Mental Energy," my free book, will tell you all about the Science of Strongfortism and show you the easy, quick, simple way back to REAL MANHOOD. Send for it NOW—DON'T WAIT—you would dig deep down in your pocket and pay good money for it, if you knew what it contains. IT'S FREE. Just fill out the coupon below marking the ailments you wish information on and mail it to me today with three 2c stamps for packing and postage, and I will mail you a copy at once.

LIONEL STRONGFORT

Physical and Health Specialist

1155 Strongfort Institute NEWARK, N. J.

CUT OUT AND MAIL THIS COUPON

Mr. Lionel Strongfort, Newark, N. J.

Dear Strongfort:—Please send me your book "Promotion and Conservation of Health, Strength and Mental Energy," for postage of which I enclose three 2c stamps to cover mailing expenses. I have marked (X) before the subject in which I am interested.

- | | | |
|------------------------|---------------------|------------------------|
| ..Colds | ..Short Wind | ..Poor Circulation |
| ..Catarrh | ..Flat Feet | ..Skin Disorders |
| ..Asthma | ..Stomach Disorders | ..Dependancy |
| ..Obesity | ..Constipation | ..Round Shoulders |
| ..Headache | ..Biliousness | ..Long Troubles |
| ..Thinness | ..Torpid Liver | ..Increased Height |
| ..Rupture | ..Indigestion | ..Nervousness |
| ..Lumbago | ..Nervousness | ..Stoop Shoulders |
| ..Neuralgia | ..Poor Memory | ..Muscular Development |
| ..Flat Chest | ..Rheumatism | |
| ..Deformity (describe) | ..Gastritis | |
| ..Insomnia | ..Heartweakness | |

Name.....
Age..... Occupation.....
Street.....
City..... State.....

CONTRARY to RUMORS

Spread by a Competitor

The Radio Distributing Co. is still manufacturing their unmounted universal wound inductances and will continue to supply their agents these very efficient coils.

That the RADISCO COILS are superior to any similar type of inductances is the opinion of several well known radio men who have received signals from very remote stations.

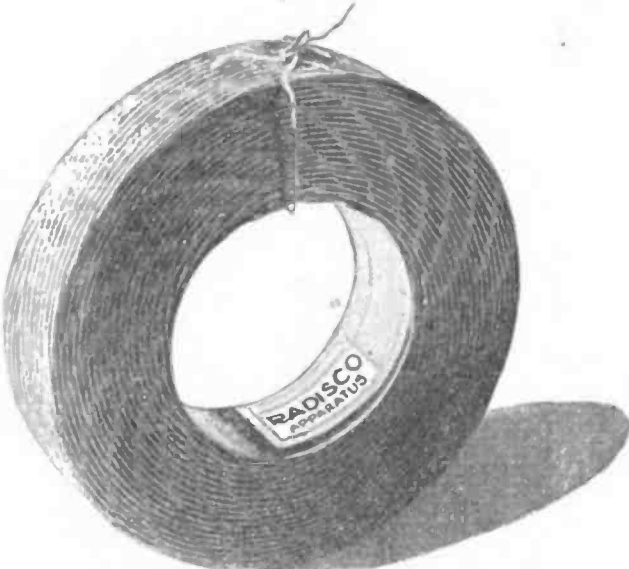

The RADIO DISTRIBUTING COMPANY will assure all purchasers that they will experience no inconvenience by reason of any action now pending or to be started by reason of patent on coils purchased. These coils are in stock at all RADISCO AGENTS.

RADISCO AGENTS carry only apparatus of proven merit. Look for the RADISCO trademark on all coils you buy and be sure of getting efficient apparatus.

Below are listed a few of the reliable firms who carry the Universal wound inductances and are our agents for all standard radio apparatus of merit.

Communicate your wants to them

- | | | | |
|---|--|--|--|
| ALBANY, N. Y.:
E. L. Long,
21 Magnolia Terrace. | BRONX, NEW YORK
CITY:
Amateur Wireless
Equipment Co.
1390 Prospect Ave. | NEWARK, N. J.:
A. H. Corwin & Co.,
4 West Park St. | SCRANTON, PA.:
Shotton Radio Mfg. Co.,
P. O. Box 3,
also at 8 Kingsbury St.,
Jamestown, N. Y. |
| ATLANTIC CITY, N. J.:
Independent Radio Supply Co.
118 So. New Jersey Ave. | CHICAGO, ILL.:
Chicago Radio Laboratories,
1316 Carmon Ave. | NEW ORLEANS, LA.:
L. A. Rose,
4323 Magnolia St. | SPRINGFIELD, MASS.
585 Armory St.,
Electric Service Co. |
| BEINVILLE, QUEBEC,
CANADA:
Canadian Radio Mfg. Co. | McKEESPORT, PA.:
K. & L. Electric Co.,
427 Olive St. | PITTSBURG, PA.:
Radio Electric Co.,
4614 Henry St. | TORONTO, ONTARIO,
CANADA:
585 College St.,
Vimy Supply Co. |
| BOSTON, MASS.:
Atlantic Radio Co.,
34 Batterymarch St. | NEW CASTLE, PA.:
Pennsylvania Wireless
Mfg. Co.,
507 Florence Ave. | PHILADELPHIA, PA.:
Philadelphia School of
Wireless Telegraphy,
Broad and Cherry Sts. | WASHINGTON, D. C.:
National Radio Supply
Company,
1405 U St., N. W. |
| BROOKLYN, N. Y.:
Kelly & Phillips Electric
Co.,
312 Flatbush Ave. | | PROVIDENCE, R. I.:
Rhode Island Electric
Equipment Co. | |

If none of the above agencies are in your vicinity, communicate with

RADIO DISTRIBUTING COMPANY - Newark, New Jersey

NEARLY GONE — DON'T WAIT ANY LONGER

A Standard Wavemeter Condenser, 0.00006 to 0.0015 mfd., \$10.
The cancellation of a GOVERNMENT WAR CONTRACT has made it possible for the G. A. Company to give Experimenters this unusual opportunity—a double variable condenser built for the Signal Corps wavemeters, worth \$50 at a price of \$10. As a WAVEMETER condenser, a finer instrument cannot be purchased at any price. This is your chance to own a real meter. This condenser is of such a high grade type that it is specially adapted for use as a LABORATORY STANDARD for making all kinds of measurements. VACUUM TUBE TRANSMITTERS require air condensers of this type which will not break down between the plates. LONG WAVE RECEIVERS must have condensers of large capacity and very low losses to operate with minimum inductance and to give loudest signals. For all these purposes, the DOUBLE CONDENSER is the best you can buy, regardless of the price you pay.

A limited number of these instruments are available. If your order comes too late, your money will be returned, immediately. The G. A. Company gives no credit slips, makes no substitutions.

0.00006 to 0.0015 mfd. condenser, \$10.00, sent by express. Capacity calibration curve \$1.00. DON'T LET THIS OPPORTUNITY SLIP BY — YOU WILL NOT HAVE THIS CHANCE AGAIN
Orders accepted by mail only.

15-E WEST 45th ST. **The General Apparatus Company** NEW YORK CITY

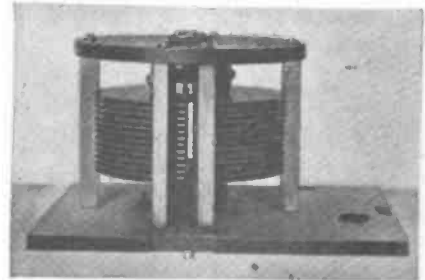

CONDENSER AS SHOWN, NEVER USED. **\$10** ACTUAL VALUE OF THIS INSTRUMENT, \$60

TELEPHONE SUFFERERS!
"THERAPHONE"
High Power Osteopathic Receiver
The earpiece is tuned to the ear. It can't confuse nor fatigue. Absorbs shocks, improves the hearing and conserves time. For Busy, Deaf, Nervous, Privacy and Noise. Guaranteed to suit. (Check or C. O. D. \$2.00 Export \$2.50) No Agents. The Evolution Phone Co., Inc. 48 A Greenwich Ave., New York

\$2

LEARN WIRELESS TELEGRAPHY

Fascinating and Educational Work—Big Salaries—Prepare Now
The United States Shipping Board is making heavy demands upon us for Dodge-trained wireless operators. Travel all over the world, secure, free, unsurpassed living accommodations and earn a big salary.
We Also Teach Morse (Wire) Telegraphy and Railway Accounting
School established 45 years. Endorsed by wireless, railway and telegraph officials. Low rates. Students can earn living expenses while attending school. **Catalog Free. Write Today.**
Dodge's Telegraph and Wireless Institute 33rd St. Valparaiso, Indiana

Please mention EVERYDAY ENGINEERING MAGAZINE

New Detector and Amplifier Units

Particular Attention Has Been Given to the Convenient Location of the Binding Posts and the Elimination of Unnecessary Parts in These International Radio Units

THE tendency towards the simplification of design of radio apparatus for which EVERYDAY ENGINEERING has been working so hard among the amateurs is being brought forcibly to their attention by the new apparatus introduced in the last few months by manufacturers.

Since experimenters so generally take their examples from commercial instruments the detector and amplifier units shown here should impress upon them the fact that the fewer parts and instruments the better the results.

The transformer provided with the amplifier is of a new and interesting type. From its appearance it would seem to be one of the open core type, but as a matter of fact it is a shell type transformer, enclosed in a casing to exclude all moisture, a point often overlooked and one of great importance since the absorption of moisture by the

winding greatly decreases the efficiency of an amplifying transformer.

In the lower illustration a detector

and two-step amplifier can be seen, the binding posts being so arranged that in each case the input circuit is con-

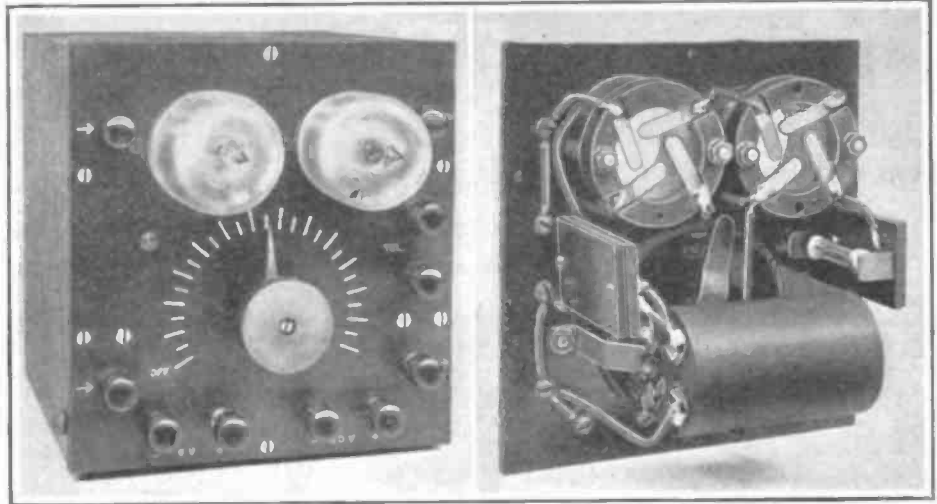

Top, a detector and two-stage amplifier in which efficiency has been increased and the cost lowered by the simple and rugged design. Center left, a detector for this series of units. Input and output posts are indicated by arrows

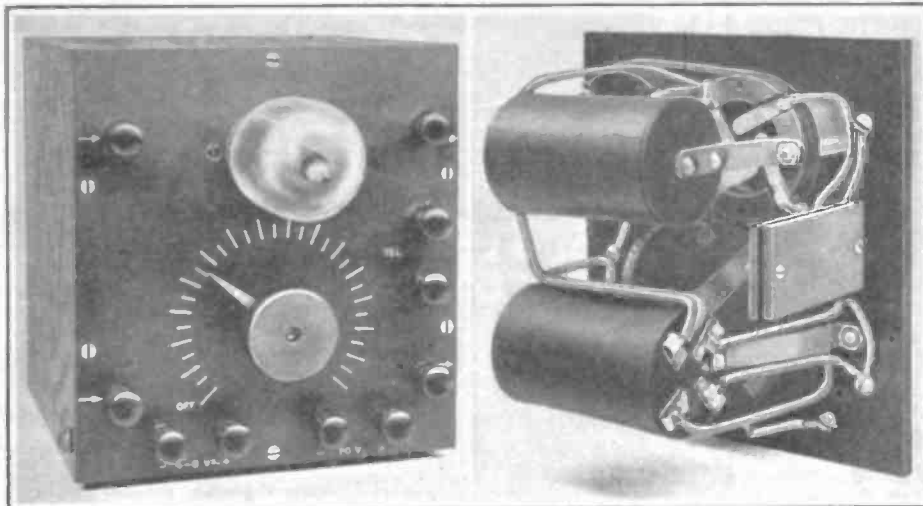

Center right, two stages of amplification are provided in this set. The design of the transformers are such that there is no feed back to cause howling. Below, the detector and two-stage amplifier ready for connection to a receiving set

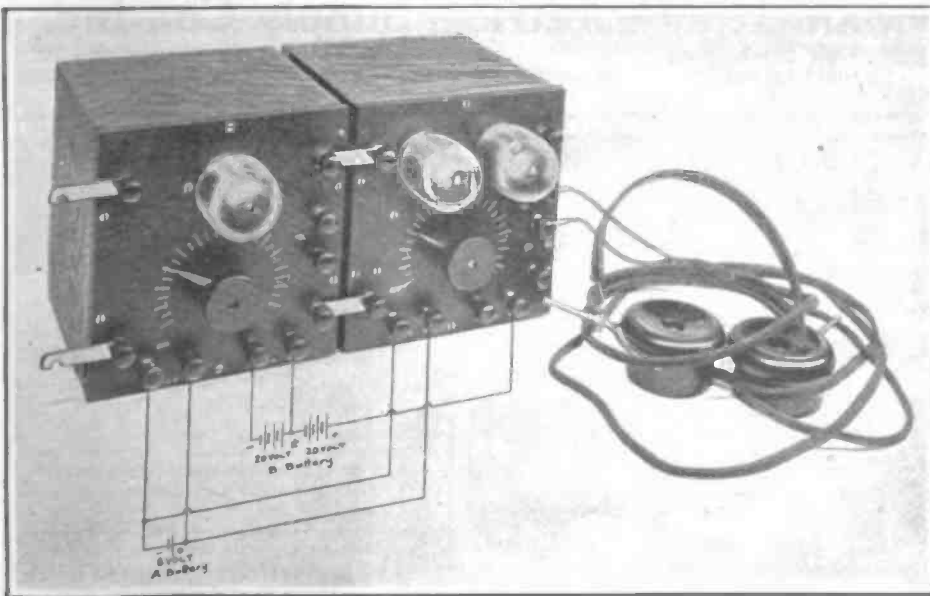

nected on the left and the output on the right. Either an amplifier or a pair of telephones can be joined to the output side of the unit. Where an amplifier is employed connections can be made by straps, as will be seen by the illustrations. The binding posts for the A and B batteries are on the lower part of the panel. No plate battery controls are needed, as these sets operate with standard 22.5-volt batteries.

The idea of divisional construction with a cabinet for each panel is new and particularly good because the boxes can be set on each other without any supporting frame. In this way, the advantages of separate instruments are combined in the panel construction.

A little study of the descriptions of new apparatus which have appeared in EVERYDAY ENGINEERING, shows clearly the revolutionary character of post-war design.

Buy the Best When You Buy

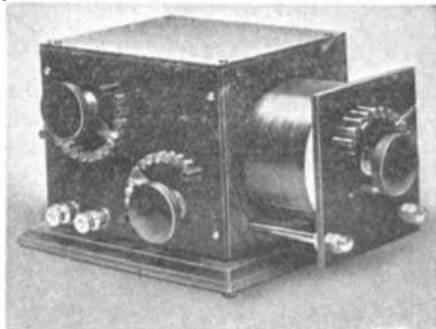

THE BEST COSTS YOU LESS WHEN YOU BUY FROM US.

This 200 to 2500 meter loose coupler costs \$18.00. You cannot buy a better instrument if you pay more.

RADIO EQUIPMENT CO.
630V Washington St. Boston, Mass.

Wireless Receiving Ban Raised

MESCO WIRELESS PRACTICE SET

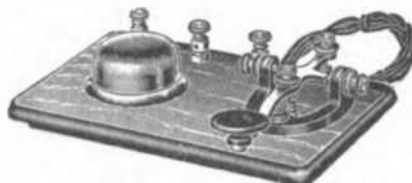

The Practice Set comprises a regular telegraph key, without circuit breaker, a special high pitch buzzer, one cell Red Seal Dry Battery, and four feet of green covered flexible cord.

The key and buzzer are mounted on a highly finished wood base, and three nickel plated binding posts are so connected that the set may be used for five different purposes.

List No. 342 Telegraph Practice Set, with Battery and Cord\$3.24

Weights 4 lbs. packed.
Price does not include postage.

MESCO COMBINATION PRACTICE SET

For Learning the Morse and Continental Visual and Audible Codes

This outfit is the only reliable instrument which will enable students to become proficient operators in the U. S. Naval Service, because it is equipped with a buzzer and miniature lamp enabling the user to master both the visual and audible signals quickly.

List No. 52—Practice Set with Red Seal Battery and Cord\$4.08

Weights 4 lbs. packed.
Price does not include postage.

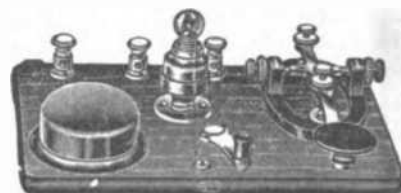

MESCO RADIO BUZZER

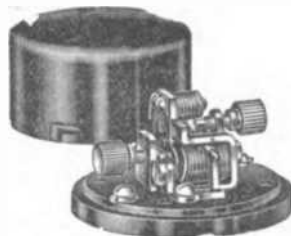

This buzzer maintains a constant note and is recommended as an exciter for checking wavemeters where pure note and ample energy are required.

It consists of practically a closed circuit field of low reluctance, having a steel armature to which is riveted a strap supporting a movable contact. The armature tension is adjustable by means of a screw with a milled head large enough to be easily and permanently adjusted with the fingers. The stationary contact is adjusted by means of a similar screw. The magnet coils are connected in series with a total D. C. resistance of 3.9 ohms. Shunted across these coils is a resistance having a D. C. value of 3 ohms. This shunt eliminates all sparking such as occurs at the break on ordinary radio buzzers and the energy saved thereby is transferred into any oscillating circuit connected to it, the result being that this buzzer as constructed radiates five times more energy than any other existing type. All connecting wires liable to be broken are eliminated. Contacts are of genuine platinum, which is essential in order to maintain a constant note. The parts are mounted on a Condensate base to insure consistency in operation.

Diameter 2 in., height 1 1/4 in. The cap is attached to the base by a bayonet joint

List No. 55 Mesco Radio Buzzer\$2.86

We carry a large and complete line of Standard Wireless Material recognized by experts as such with competent experienced wireless attendants in charge

Send for the New Edition of Our Catalog K28

It is pocket size, contains 264 pages, with over 1,000 illustrations, and describes in plain, clear language all about Bells, Push Buttons, Batteries, Telephone and Wireless Telegraph Material, Electric Toys, Buzzer and Fire Alarms Contrivances, Electric Call Bells, Electric Alarm Clocks, Medical Batteries, Motor Boat Horns, Electrically Heated Apparatus, Battery Connectors, Switches, Battery Gauges, Wireless Telegraph Instruments, Ignition Supplies, etc.

Manhattan Electrical Supply Co., Inc.

NEW YORK: 17 Park Place
CHICAGO: 114 S. Wells St.
BRANCHES: 110 W. 42nd St., 137 W. 156th St.
ST. LOUIS: 1166 Pine St.
San Francisco Office: 604 Mission St.

DUCK'S No. 13
264 Pages
Electrical and Wireless Catalog

JUST OFF THE PRESS

175 Pages of Wireless Instruments

Any radio amateur will tell you there is no catalog to take its place, and that it is a *Beacon Light* to guide you in the selection of your apparatus.

THIS UNRIVALLED CATALOG MAILED TO ANYONE UPON RECEIPT OF 12c IN STAMPS OR COIN, which may be deducted on first dollar purchase.

Great cost of catalog and low prices prohibit distribution otherwise

What This Big Catalog Contains

- 175 pp. Wireless Apparatus for Commercial and Experimental use;
- 10 pp. Raw Material;
- 3 pp. Transformers;
- 9 pp. Auto and Bg. Batteries;
- 8 pp. Telegraph Instruments;
- 42 pp. Motors and Dynamos;
- 8 pp. Flashlights;
- 2 pp. Medical Batteries;
- 3 pp. Ammeters and Voltmeters;
- 20 pp. Electrical and Mechanical Books.

THE WILLIAM B. DUCK CO.
244-246 Superior Street, Toledo, Ohio

THE NEED OF THE HOUR
Wireless Operators for the Merchant Marine.

Start your boy in a profession worth while

Complete Beginners' Wireless Set, \$15.00

Comprising Loose-Coupler, 2,000 Meters; pair 2,000-Ohm Phones, Fixed Condenser, Galena Detector, and instructions book; these are separate instruments and *Guaranteed*; the best value on the market to-day. Note:—We do special Cabinet and Metal Work for Engineering Students; correspondence invited.

Radio Equipment Company
1525 North Fawn Street - Philadelphia

WILCOX PANEL SWITCHES

TYPE 101

A beautiful and efficient standardized switch for general use. Furnished in two sizes.

1" Radius, Brass Finish....40c Nickel Finish....50c
1 1/2" Radius, Brass Finish....50c Nickel Finish....60c

TYPE 102 (Illustrated)

A compound switch especially suitable for the primary of loose couplers. 1 1/2" outside radius.

Brass Finish.....\$1.10 Nickel Finish.....\$1.25
ALL POSTPAID

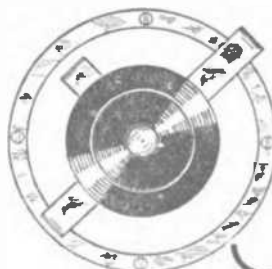
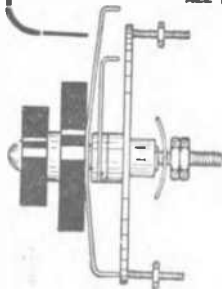

VARIOMETER PARTS

Turned from hardwood. Set as shown consisting of stator (two parts), rotor and form for winding coils. Postpaid \$2.50

Size of stator 5 1/2" sq.
Other sizes made to order

SET NO. TWO contains all parts for the variometer, including the above and knob, scale, pointer, shaft, binding posts, wire and instructions for assembly. Postpaid \$5.00

BUILD YOUR OWN APPARATUS

Our standardized parts and materials make it easy to build efficient apparatus that is beautiful and uniform in appearance.

NEW LOOSE LEAF CATALOG READY Sent for five cents in stamps.
The Wilcox Laboratories
Lansing Dept. D Michigan



The Plate Battery Problem Solved!

The Marcuson "B" Battery

eliminates the use of the inefficient Dry Battery and the old-fashioned expensive Storage Battery

The Marcuson "B" Battery possesses four points of perfection,—it is light, compact, dependable, and inexpensive. The Marcuson "B" Battery can be readily charged from any D. C. lighting circuit.

40 Volts. Over all Dimensions: 6" x 6" x 4". Weight 5 lbs. Price: \$12.00. The Marcuson Batteries have been in use for more than ten years by the largest Electrical Manufacturers, Cable Repair Ships, Technical Institutions, etc.

Can be replaced at lower cost than new Dry Batteries can be bought for

We are sole distributors of the Marcuson "B" Batteries.

It is but one of our many Radio products. Simply drop us a card, and let us send you our catalogue No. Two.

WIRELESS IMPROVEMENT CO.

Radio Engineers
Manufacturers and Distributors
47 West Street New York, U.S.A.

INEXPENSIVE BOOKS FOR THE EVERYDAY PRACTICAL ELECTRICIAN

Wiring a House

By HERBERT PRATT. Shows a house already built; tells just how to start about wiring it; where to begin; what wire to use; how to run it according to insurance rules; in fact, just the information you need. Directions apply equally to a shop. Fourth edition. Price, 35 cents

Electric Bells

By M. B. SLEEPER. A complete treatise for the practical worker in installing, operating and testing bell circuits, burglar alarms, thermostats and other apparatus used with electric bells. Both the electrician and the experimenter will find in this book new material which is essential in their work. 124 pages. Fully illustrated. Price, 60 cents

NORMAN W. HENLEY PUBLISHING CO.
Dept. EE 2 West 45th Street, New York



TRIODE
(Trade Mark)
Vacuum Tube Socket
Type-F

The base of this socket is bakelite dilecto and will not crack and break like the moulded material of the usual socket. Contact springs are stamped with identifying letters. Base is provided with three rubber feet and four countersunk holes for panel mounting.

Eaton Oscillators

Price \$1.25 Postpaid
Engineers, Designers, Manufacturers

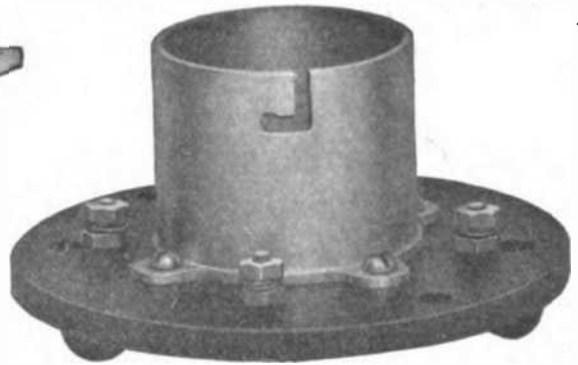

TRIODE
(Trade Mark)
Audio Transformer Type-P

Due to its operation on the principle of voltage amplification thru resonance, this transformer provides a maximum of low frequency amplification and is superior to all others.

Permits reliable daylight reception from European stations.

Establishes new amateur long distance records. Renders remarkable amplification of all signals. May be used with all standard tubes.

Price \$7.00 Postpaid, Immediate Delivery

Immediate Delivery
Two Step Amplifiers

RADIO ELECTRICAL APPARATUS

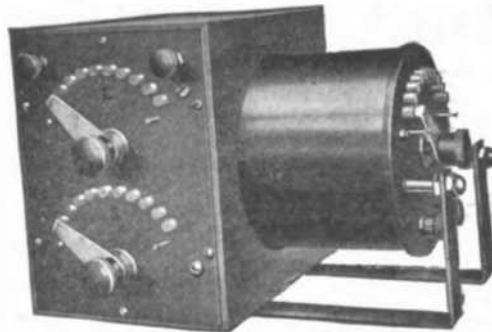

New type radion receiving transformer has bakelite panels, two primary and one secondary 10 point switches. Oak cabinet. Price, \$12.00.

Our new Bulletin Y offers a distinctive line of radio and laboratory apparatus including transformers, spark gaps, oscillation transformers, variometers, variable condensers, etc., in fact the most complete line in America.

Bulletin R describes the Cambridge alternating current rectifier for

STORAGE BATTERY CHARGING

Send 3c. stamp for both bulletins

CLAPP-EASTHAM COMPANY

131 MAIN STREET CAMBRIDGE, MASS.
REMLER RADIO MFG. CO. 62 Post Street SAN FRANCISCO
Pacific Coast Representatives

Catalog of RADIO RECEIVING APPARATUS
MADE BY THE PIONEER COMPANY OF THE PACIFIC COAST. SEND IN A 2-CENT STAMP AT ONCE

AudioTron Sales Company
Lick Building San Francisco

RADIO APPARATUS on the INSTALLMENT PLAN

Full particulars and the RVA BULLETIN each month sent on receipt of two cents—stamps or coin.

J. DONALD VANDERCOOK
LOMBARD Box 442 ILLINOIS

1 K. V. A. 25,000 Volt Wireless Transformer

The Thordarson Wireless Transformer is more than a transformer. It is a machine of efficiency and reliability, a piece of wireless apparatus that every amateur can be justly proud of. A Thordarson Wireless Transformer will make a "Long Distance" amateur of you. Our "20-T" bulletin describes our complete wireless transmitting apparatus.

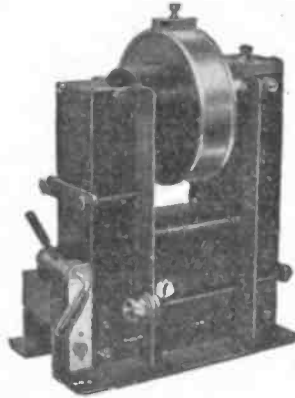

Thordarson Electric Mfg. Co.

501-515 So. Jefferson St.

Chicago, Ill.

Learn By Doing

Every phase of all
branches of

ELECTRICITY

taught by

Actual Practice

In America's foremost and oldest
institution for trade training.

No Books Used

Individual Instruction.
Start Any Day

Write for *FREE 64-page catalog*

The **NEW YORK ELECTRICAL SCHOOL**
36 West 17th Street New York City

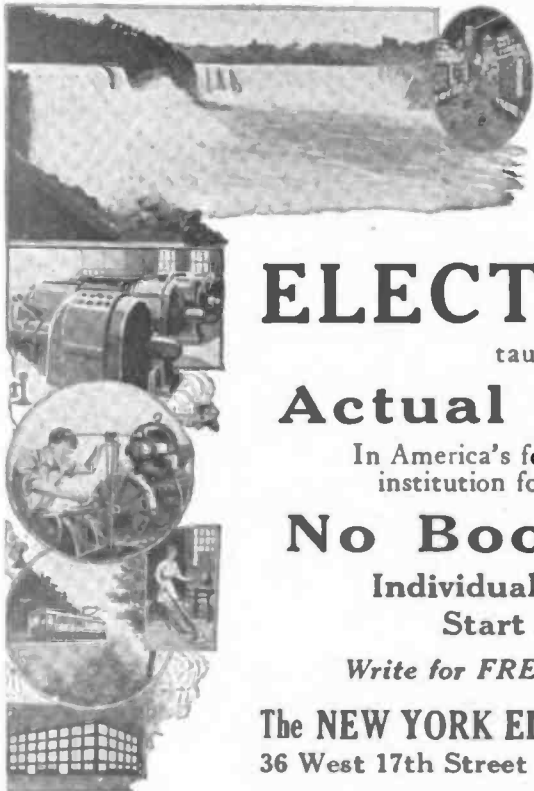

Send for HALCUN Radio Catalogue

Full Line of
Amateur Requirements

Halcun Radio Co.
San Francisco, Calif.

Formerly Haller Cunningham
Elec. Co.

Laboratory Signs

Attractive 8" x 10" signs printed on high quality coated white cardboard in selected wordings for the electrical experimenter.

- 1.—DANGER! HIGH VOLTAGE
2. EXPERIMENTAL RADIO LABORATORY
NO ADMITTANCE
3. GOVERNMENT LICENSED RADIO
4. DO NOT TOUCH THE INSTRUMENTS
STATION
5. PLEASE BE QUIET WHILE THE
OPERATOR IS RECEIVING

15c EACH, ANY TWO FOR 25c
ALL 5 FOR 50c

Immediate Shipments, Postpaid

THE TAYLOR CO. Box 1043-E
LOWELL, MASS.

Cement for Uniting Iron Surfaces and Filling in Joints

MIX 100 parts of iron filings, free from rust and not larger than rape seed, $\frac{3}{4}$ part of coarsely powdered sal-ammoniac, and $\frac{1}{2}$ part of flowers of sulphur; moisten the mixture with urine and beat it, with repeated moistening, until it becomes heated, dry and brittle. In this state it is placed in the joints, and forced in as tightly as possible with chisel and hammer, whereby it again becomes moist and soft. Finally, the joints are filled up evenly, and allowed to dry two days, when, as an indication of good cementing, separate black drops must appear upon the hardened crust. The cement does not adhere to tarred kettles or dirty and greasy joints. To keep it, it is rammed into an iron pot and water poured over it. For use, pour off the water, add to the mass taken out sufficient iron filings to give it the necessary consistency, and pour the water back into the pot. The stronger and quicker the cement rusts in the joints the better it acts. The proportions used vary, however, very much. For instance, (a) iron filings, 30 parts; sal-ammoniac, 1; sulphur, 1. With this composition the danger of progressive rusting is, however, greater on account of the larger quantity of sal-ammoniac in proportion to iron filings; or (b) pulverized cast-iron turnings, 50 parts; sal-ammoniac, 2; flowers of sulphur, 1; or, (c) pulverized iron filings, 100 parts, and pulverized sal-ammoniac, 2 parts. The mixtures are kept in well-closed boxes in a dry place, for use moistened with urine, and applied as mentioned under 11. The cemented places must be heated only when entirely dry.

To Solder Without a Soldering Iron

PIECES of brass can be soldered without it being possible to detect the joint by filing the pieces so as to fit exactly, moistening them with a soldering liquid, then placing a smooth tin-foil between them, tying them together with wire and heating over a lamp or fire until the tin-foil melts. With good soft solder almost all soldering can be done over a lamp without the use of a soldering iron. The different degrees of fusibility of solders can also be advantageously used for several solderings and joints on the same piece. By soldering first with a fine solder composed of lead, 2 parts; tin, 1; and bismuth, 2, there will be no danger of melting when close to the jointed part; another piece is soldered on with solder composed of lead, 4 parts; tin, 4; and bismuth, 1. The best soldering liquid to be used is composed of equal parts of water and hydrochloric acid saturated with zinc.



3 inch Dial only.....75 cents
Postpaid
3 inch Dial with Knob mounted...\$1.30
Postpaid

Bulletin No. 1 describing these parts has been sent to all who sent for our July 1st catalogue. If you have not received our catalogue send 5 cents in stamps and get on our mailing list for future bulletins free.

RADIO MEN

Make your apparatus up to date. Indicating dials now available at a reasonable price.

These dials are fine black polished composition with radial lines and figures accurately engraved and filled with brilliant white. Diameter of dial is 3 inches and they are 3/16 inch thick. The edge is bevelled. The hole in the center will pass 8-32 screw and there are three holes around the center hole to fasten on knob. (These holes are not shown in cut.) We can furnish dial alone or with fine Bakelite Knob mounted. This knob has a set screw to clamp shaft of instrument to which dial is to be applied.

If your dealer cannot supply you send us his name with your order. Immediate deliveries.

For sale at all Radisco Agencies

A. H. Corwin & Co.

4 West Park Street

Newark, N. J.

New Catalog of
Radio Apparatus

RADIO APPARATUS
Our apparatus must please you—
all your money returned if it
does not.

Mailed Postpaid
on Request

Quality
Apparatus
Low Prices



Navy Type Key
Marble Base **\$4.25**
Silver Contacts
Ask for Catalog No. 6046E.

Sears, Roebuck and Co., Chicago

"ASK ANYONE WHO HAS USED IT"

"The Best I Ever Worked"

"The Brandes Headset Is The Best I Ever Worked. Others Look Like a Plaything Beside It." (Testimonial from an expert, Name on Request.) Professionals as well as amateurs, the world over are enthusiastic about the range and absence of blurring in the

BRANDES WIRELESS HEADSET



"Superior", 2000 ohms, \$7

TRIAL OFFER Test out Brandes Wireless Receivers against any other make. Test them for sensitivity, clearness and distance. If within ten days you're not only satisfied but enthusiastic over them—back comes your money without a question. Prove for yourself the fine quality, the "matched tone." The two diaphragms, toned exactly alike, strengthen the signals and prevent blurring. Used by many U. S. Government experts and experts abroad; by colleges and technical schools; and by professionals and amateurs everywhere.

SEND 4c FOR CATALOGUE M

C. BRANDES, INC. 32 Union Square, Room 822 New York
WIRELESS RECEIVER SPECIALISTS

Telegraph Pictures

BY ELECTRICITY
A complete set of two machines of this marvelous equipment for only \$19.50. Instructive, mystifying and useful. This picture of President Wilson was telegraphed by these machines. Picture telegraphing is the coming science. Write today.
L. J. LEISHMAN CO. Dept. L, Ogden, Utah



INSIST

on getting

"PACIFIC RADIO NEWS"

FROM YOUR NEWS DEALER WHEN BUYING A MAGAZINE DEVOTED TO RADIO COMMUNICATION.

GET THE BEST
Don't Fool Yourself

15c. PER COPY - \$1.50 PER YEAR

PACIFIC RADIO PUB. CO.
50 Main St., San Francisco, Cal.

Your Opportunity!

to secure quickly and thoroughly a
Practical Electrical Education is open at the School of Engineering of Milwaukee.
A large faculty of experts, extensive and fully equipped laboratories, drafting rooms and class rooms train you to become a high grade Electrician in One Year.

Institute of Electrotechnics
Junior and Senior Units. 1½-3 Years.
Electrical Engineering
B.S. Degree in three years.
Electrical and Mechanical Drafting—1 year course
Armature Winding and Motor Generator Repair—6 mo. Automotive Electrotechnics. 3 mo. to 2 year courses. Wireless Telegraphy. Extension Department.

New Term January 2d
"Earn While You Learn" system. Athletics, Frat House, Board at cost. B. O. T. C. advantages (optional). Write Today for bulletins and full particulars FREE. Mention course, age and education.

SCHOOL OF ENGINEERING OF MILWAUKEE
140-373 Broadway Milwaukee, Wis.

QST

A MAGAZINE DEVOTED TO AMATEUR WIRELESS

Official Organ: American Radio Relay League

Radio Developments, Vacuum Tubes, Regenerative Rectifying, Loop Aerials, Relaying, Operating Department, Work all A. R. R. L. News, Humorous Stories by The Old Man. All these and many more are included in QST.

SPECIAL TRIAL OFFER

Regular price \$1.50 per year, 15 cents per copy. Introductory rate. 9 months subscription for \$1 and attached coupon.

ON A DOLLAR BILL, TO COUPON AND MAIL IT TODAY!

RETURN COUPON

American Radio Relay League, Hartford, Conn.

Enclosed find \$1; please enter my trial subscription to QST for 9 months.

Name _____

Address _____

EXACTLY! IT'S THE NEW TRACO TYPE 93 LONG WAVE RECEIVER

Will fulfill perfectly your requirements of a long and medium wave set. It's compact, simple to operate, responding to waves from 300 to 18,000 meters, from either Arc or Spark stations.

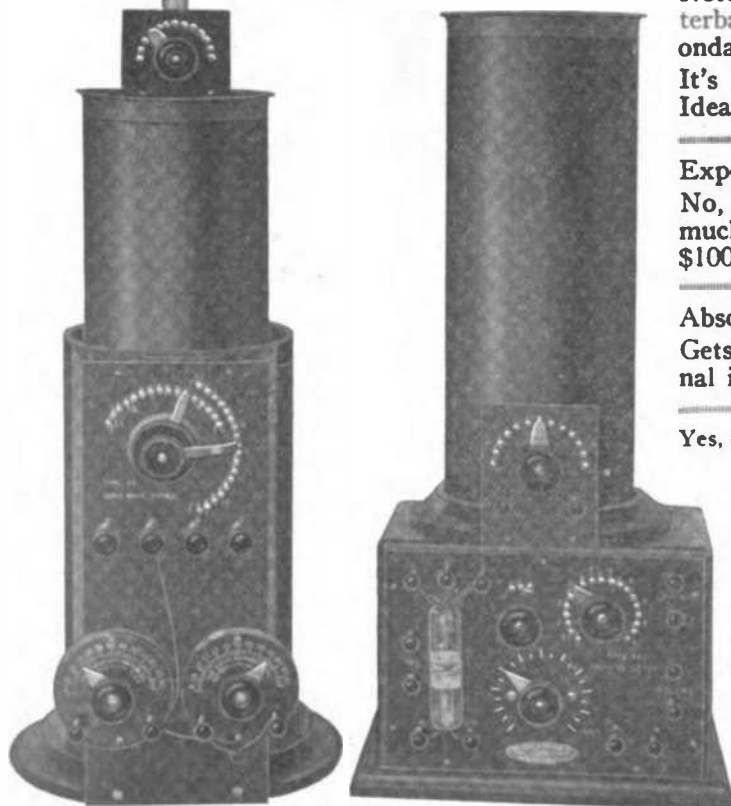

Note the counterbalanced secondary. It's a TRACO Idea.

Expensive? No, it sells for much less than \$100.00.

Absolutely! Gets every signal in the ether.

Yes, our customers are reporting fine results. They are copying undamped stations here and abroad using antennae 300 to 500 feet long and 40 to 60 feet high.

Send us a few stamps and we will tell you all about it.

The Radio Apparatus Co. - Pottstown, Penn., U. S. A.

The "ACE" Vacuum Tube Socket



\$1.50 each
complete
with grid leak

The Ace Vacuum Tube Socket is designed to fit the Standard four prong vacuum tube. The top part consists of a finished aluminum casting, mounted on a formica base $\frac{1}{4}$ inch thick. This base will not break under any condition of service, as moulded composition bases will. Heavy phosphor bronze springs are mounted on the under side of the base for connection to the tube prongs.

This is the only vacuum tube socket on the market which has the grid leak built in as part of the socket. It may be used for back or front of panel mounting. The best socket on the market regardless of price.

We manufacture a complete line of Radio apparatus.

The PRECISION EQUIPMENT CO., Inc.
Manufacturing Engineers Department B.
2437 GILBERT AVE. CINCINNATI, OHIO

Don'ts for Experimenters

By Louis Kasper

DON'T use a file or rasp without a handle; it is dangerous.

Don't try to catch a chisel when you drop it. A nick in the chisel is better than one in the hand.

Don't forget that good tools are cheaper in the long run.

Don't fail to clean up shavings when you stop for the day; it lessens the danger of a fire starting.

Don't let your tools get rusty; keep them oiled.

Don't dabble with chemicals without first reading something on the subject.

Don't fail to keep a record of all experiments.

Don't use glue which is too thin. Fresh glue is best.

Don't expect to do good work with dull tools.

Don't strike wood with a hammer; use a mallet.

Don't set a plane flat on the bench; it is bad for the cutting edge.

Don't buy all your tools; make some of them. It is good experience.

Don't overlook non-essentials (so-called); sometimes they are the most important.

Don't add warm water when making glue; cold water is better.

Don't forget that old files make good chisels, etc.

Don't fail to be systematic; it pays.

Don't overheat your soldering iron.

Don't forget that a grinding wheel will pay for itself in a short time.

Don't fail to make drawings when necessary.

Don't polish a metal surface dry if you expect it to retain its lustre for any length of time; use oil.

Don't forget, when drilling a large hole in metal, that it will be done more accurately if first drilled with a smaller drill.

Don't use nails where strength is desired; screws are better.

Don't fail to carry a notebook—and use it.

Don't forget that glue may be made waterproof by adding an ounce of bichromate of potash per pint.

Dissolve potash and add slowly.

Don't be afraid to swap your knowledge with other workers.

Don't fail to mark all parts of a complicated piece of work; it may be necessary to take it apart some day.

Don't be too quick in throwing away old material; "junk" sometimes comes in handy.

Don't forget that cheap and good tools can sometimes be bought in a pawnshop.

Don't ridicule the other fellow's opinion; he may be right.

Don't forget that a piece of soft brick is good for polishing metal.

Don't fail to keep a scrap book.

Don't always talk about your particular line of work; give the other fellow a chance.

Don't forget that although a piece of work may be theoretically correct; it may not work in actual practice.

Don't cuss if things go wrong; there's a reason.

Don't get discouraged; keep plugging away.

Don't fail to join the A. S. E. E.

Utilization of Red-Brass Turnings

TURNINGS from red-brass works are frequently sold for a low price, even by establishments having facilities for casting in crucibles, because they are apparently not fit for casting. These turnings can, however, be profitably utilized for new castings as well as an addition to other charges. The process is as follows: The turnings are melted by themselves and during the melting process mixed with manganic oxide in the proportion of five parts of weight of manganese to 100 of turnings. In charging for melting it is advisable to cover the bottom of the graphite crucible 0.39-inch deep with manganic oxide; upon this is placed a layer of turnings about 1.18 deep, and so on until the crucible is full. During melting the impurities contained in the turnings settle on the surface and can be readily removed with a graphite ladle. The melt is best cast in buttons (square pieces). When cool each button is cut, in order to determine the qualities of the metal by the fractured surfaces. The metal melted in this manner shows a reddish, nearly coppery fracture, and is very tenacious and dense. An addition of manganic oxide not exceeding, however, 2½ per cent, to new material for melting is also recommended.

Cement for Fastening Brass to Glass

FOR cementing brass on glass the following recipe will be found to answer very well: Take resin soap—made by boiling one part of caustic soda and three parts of resin in five of water—and knead it into half the quantity of plaster of paris. This cement is used largely for fastening the brass tops on glass lamps. It is very strong, is not acted upon by petroleum, bears heat very well and hardens in one-half to three-quarters of an hour. By substituting zinc white, white-lead or slaked lime for plaster of paris it hardens more slowly. Water attacks only the surface of this cement. Of course, as it sets shortly after mixing, only as much as may be needed for immediate use should be made at one time.

Is Your Transmitter Really Tuned?

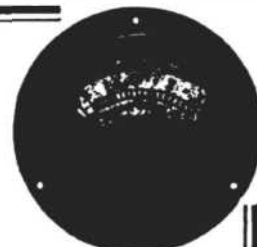

You may think that your transmitter is tuned, but you don't know unless your station is equipped with a reliable Antenna Ammeter.

These Roller-Smith Hot-Wire Ammeters were made for the U. S. Army Air Service for use on fighting planes.

Regularly \$13—Our Special Price \$7

With the Armistice came a cancellation of contracts and these Ammeters, which had successfully passed the exacting Government tests, were returned to the manufacturers. Each is in perfect condition, packed in its original carton and ready for immediate shipment.

The scale reading is: 0-2.5 Amperes. Shunt giving double or triple this range, 75c extra.

By buying the entire surplus we are able to sell these Ammeters at less than the Government paid for them in lots of one thousand. Better order one today as they are going fast. Remit by check or money order.

A. H. GREBE & CO., 71 Van Wyck Blvd., Richmond Hill, N.Y.

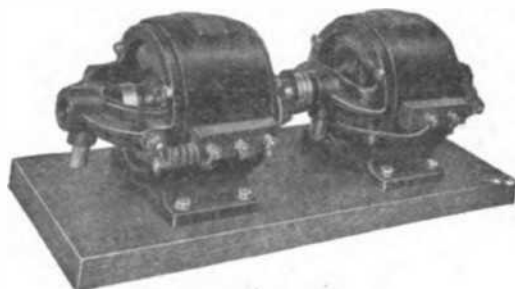

INTERNATIONAL

**HIGH VOLTAGE—
DIRECT CURRENT**

Motor Generators

PRICE \$59.00 F. O. B. FACTORY
SHIPPING WEIGHT 80 LBS.

This unit has a normal output of 100 watts (200 milliamperes at 500 volts) with a voltage range of 200 to 500 volts. The generator is compounded to insure constant voltage under variable load. It is furnished to operate on either D.C. or A.C.; a shunt motor being supplied for D.C. and an induction motor for A.C. The generator is equipped with a commutator of 48 segments reducing the commutator hum to a minimum.

Unit is complete with insulating coupling and mounted as illustrated on a finished base 8" x 20". Shipment can be made immediately.

The motor generator illustrated above is only ONE of the many newly designed radio specialties which we have ready for you. Write us for descriptive bulletins which are being issued covering all International Radio products. Address Dept. No. 21.

INTERNATIONAL RADIO TELEGRAPH CO.

326 Broadway

New York City

A MARK  of QUALITY

96-Page Book Catalogue Sent Free

WE have just issued a 96-page Book Catalogue listing about 2,500 of the most recent Scientific and Technical books. This is all the more welcome by reason of the fact that both the publishing and importing of books have been very much upset by the war, and many books can only be supplied with great difficulty. This catalogue will be sent to any address in the world, free on request.

Manuscripts Considered for Publication

The Book Publishing Department of the **SCIENTIFIC AMERICAN** will be glad to give an examination of any manuscript of Scientific or Technical nature. Submit as much of matter as possible, including illustrative material. There was never a better field for books of this nature than at the present time.

Scientific-American Publishing Company

Woolworth Building

235 Broadway, New York

Mathematics Made Easy

The Arscope—the Combination Triangle with a Bevel—will multiply, divide, square percentage and proportion, solve all problems in trigonometry and geometry, draw geometrical figures, plot arcs, etc. Superior to any slide rule. Simple to operate. Also includes a TRANS-PARENT TRIANGLE, PROTRACTOR and THREE RULERS. Used at Columbia University, West Point, U. S. Aeronautics Schools, Etc. Only \$50 postpaid. Order today before you forget. Dept. U, L. J. LEISHMAN CO., Ogden, Utah



**MODEL AND MACHINE WORK
INVENTIONS DEVELOPED**

SMALL DEVICES MANUFACTURED

Before you make a decision, communicate with

KAUFMAN MACHINE CO.

1357 Odell Street

New York

Please mention **EVERYDAY ENGINEERING MAGAZINE**

Special For This Month

New type Variable Condenser. Low high frequency resistance. Mounted in seamless satin finish nicked case. Bureau Standards scale. Furnished with calibrated curve, thus making excellent wave-meter when used in conjunction with our calibrated inductance units. **\$10.00**
 Same condenser, unmounted, for panel use. **7.00**
 Copper foil, mica dielectric Stopping Condenser **1.50**
 Navy Type copper plated Leyden Jars for your Transmitting Set, .002 mf. **8.00**

Send for descriptive literature on latest type Receiving Cabinets, calibrated inductance units in both Litz and solid wire, parts, etc.

THE COLIN B. KENNEDY COMPANY

Special Radio and Electrical Apparatus

140 SECOND STREET—Phone Kearny 5980 SAN FRANCISCO, CAL.

POROX STORAGE CELLS FOR MODELS, ELECTRICAL, AND RADIO APPARATUS

Porox Storage Batteries are made up of separate 2-volt cells in PY-RA-LIN jars, designed for high efficiency, low weight, and long life. They are lighter, more powerful, last longer, and cost less than dry cells. Can be charged at home. Porox Cells are designed for the requirements of the

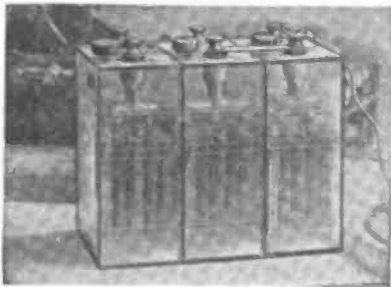

MODEL MAKER AND EXPERIMENTER

2 volts, 10 amp.-hrs., 3 x 1 1/4 x 4 1/2 ins. **3.75**
 2 volts, 15 amp.-hrs., 3 x 2 1/4 x 4 1/2 ins. **4.00**
 2 volts, 16 amp.-hrs., 3 x 1 1/2 x 6 ins. . . **4.00**
 2 volts, 25 amp.-hrs., 3 x 2 1/4 x 6 ins. . . **5.20**

Any number of cells put together for any required voltage. Batteries are also furnished in oak cases for ignition and lighting.

ALBERT MULLER,
 8758 Queens Boulevard,
 JAMAICA, LONG ISLAND, N. Y.

DO YOU LIKE TO SEE WHAT YOU BUY?

Don't buy blindly. Come to the busiest wireless store in New York City and see what you are getting. It is worth while to wait a day if it isn't convenient to stop in just when you want something. You can see the best apparatus from all the manufacturers, de Forest, Grebe, Arnold, Clapp-Eastham, and others. Complete instruments, parts—everything for the radio experimenter. Be sure to see our transmitting equipment before you buy any new apparatus. If you live away from New York, send 10c. for our new catalog. Our service to distant customers makes mail order buying quick and easy.

AMERICAN ELECTRO TECHNICAL APPLIANCE CO.

235a Fulton Street

New York City

THE BARR

Mercury-Cup Wireless Detector



The most efficient Detector on the market. Tested by the United States Government and Marconi Wireless Telegraph Co.

Increases the efficiency of every wireless receiving set by making the signals clear, sharp and distinct.

Instantly adjustable at a constant pressure.

For full information and price—write

The Barr Mercury-Cup Detector, Dept. C, The Wyoming, Washington, D. C.

A Mechanical Vacuum Cleaner

(Continued from page 211)

shown in the photograph, but is to be screwed to the side and top of the gear box. It is made of sheet iron or tin, the shape and dimensions being in Fig. 13. The gearing gives a fan speed of twenty revolutions of the fan to one of the driving wheels, and as the latter will turn about 150 times a minute when the cleaner is in use, we get a fan speed of close to 3000 rev. per minute, showing the necessity for a correctly balanced fan. This speed does not equal that of the electric cleaners, which runs to 5000 r.p.m. and over, and therefore will not produce as strong a vacuum, but will be found very satisfactory if the electric current is unavailable, and will take up a great deal of dirt.

In order to be able to remove the debris taken up by the brush, which does not pass through the fan, the bottom board of the floor box is hinged at the back, and held by a couple of latch hooks, and can be dropped when desired. This board, which does not show in the photograph of the inside of the floor box, is 5 1/2 in. wide and 8 1/2 in. long, and is made of 1/4 in. pine, with two cross braces of 1/4 in. stuff, 1 in. wide and 4 1/2 in. long, nailed to the inner side to prevent warping.

A TEXTBOOK ON HEAT ENGINES, by Prof. Jamison and Ewart S. Andrews. Size 8 x 5 1/2 inches; 500 pages, bound in cloth; price \$3.00. Published by J. B. Lippincott Company, Philadelphia, Pa.

Many of our older readers will not need any introduction to Prof. Jamison's well-known treatment on heat engines. In the revising of Prof. Jamison's standard textbook it was found necessary to include so much new material that the treatment had to be extended to two volumes.

In the 26 chapters, the entire development of the steam engine, from its earliest form, is covered. It includes the laws of heat as applied in the construction of steam engines; a thorough study of all the forms of steam engines now in use and all collateral machinery such as pumps, valves, governors, etc. The book is filled with important diagrams, folding plates and drawings to illustrate the different problems and subjects presented. The appendix of the book contains valuable tables and examination questions used by the Institute of Civil Engineers.

For those who desire one of the most complete books on steam engineering this book will surely meet their needs. It is a thoroughly practical, authoritative and worthy treatment.

Here's a Receiver With Eight Distinct Advantages

DeForest Agencies are located in all Principal Cities. Ask your regular Electrical Dealer to get you DeFOREST Apparatus.

Combination Audio-Ultra Audio and One-step Amplifier; Type P-300. Size 12½"x9½"x7½". Price, \$73.50. Vacuum Tubes, \$7.00 each extra.



A complete, compact and inexpensive Receiving Set having improvements and refinements which increase efficiency and eliminate many objectionable features of receiving apparatus.

No longer is it necessary for you to have two or three expensive, inconvenient and cumbersome tuners spread all over your operating table when working all wave lengths. With this new DeFOREST tuning system you can work any and all wave lengths with the one tuner shown at the right. This Set has distinct advantages of minimum table space and of convenience in coupling not equaled in any other type of apparatus. The entire Set is complete in the two cabinets shown here. The Genuine DeFOREST "Honey Comb" Coil System of Tuning is employed—no superior system has ever been invented.

This is a new DeFOREST production embodying a unique and superior tuning system. Possession of this Set means more efficient and satisfactory operation; more pleasure and practical benefit for every Amateur. Its price is remarkably reasonable for the quality of apparatus and the distinct advantages the Set offers. Find out more about it at once—

Send for a DeFOREST Manual

A 56-page book containing full information about this and many more DeFOREST instruments, as well as giving much useful information for the Amateur. Mailed anywhere upon receipt of 10 cents.

DE FOREST RADIO TELEPHONE AND TELEGRAPH CO.

Inventors and Manufacturers of High Grade Radio Apparatus
1403 Sedgwick Ave.
New York City

These Eight Advantages

are not duplicated in any Receiving Set at double the price:

- 1—Responds to any wave length. 150 to 25,000 meters.
- 2—More flexible in coupling.
- 3—Lower distributed capacity; less high frequency resistance and decrement values.
- 4—Eliminates cumbersome switches, inefficient taps and losses from dead ends.
- 5—Vernier Air Condensers of unusual design.
- 6—Signals come in louder and clearer.
- 7—Superior in efficiency, workmanship, convenience and appearance.
- 8—Requires minimum table space; note sizes of cabinets.

Tuner; Type T-200. Size 13½"x12½"x8". Price, \$77.50 without Coils.

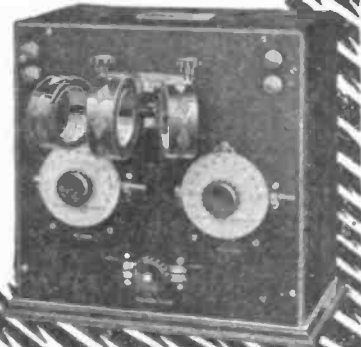

PERFECTION TUNERS
WONDERFUL RESULTS—UNIQUE DESIGN
20,000 Mc—Hook up on bottom. Involute coils —Beat the Honeycomb. XDA—comes in on 1st tap—N.S.S. on 4th.

Any aerial—overhead, underground or loop. Size 4¼ x 4¼ x 2¾. Formica top. Nickel finish. Weight 2 lbs. 100 M. Regenerative tuner same size but with tickler coil and 10 taps P & S. Good for wireless phone and relay work. Every instrument tested by old 9x5. Send for bulletin.

TRESCO DAVENPORT, IOWA
\$15.00 DELIVERED TO YOU

RADIO AMATEURS—HERE IS THE VARIABLE CONDENSER YOU HAVE BEEN LOOKING FOR—AT A PRICE YOU CAN AFFORD TO PAY

The best of materials and workmanship. Bakelite end plates. Heavy aluminum plates and accurately machined spacers. Copper ribbon connection to movable plates. Extremely rigid construction.

PRICES

2 plate Vernier.....\$1.85	23 plate, .0005 m.f. max. capacity.....\$3.25
7 plate, .0001 m.f. max. capacity..... 2.18	31 plate, .0007 m.f. max. capacity..... 3.90
13 plate, .0002 m.f. max. capacity..... 2.50	43 plate, .0010 m.f. max. capacity..... 4.75
17 plate, .0003 m.f. max. capacity..... 2.88	63 plate, .0015 m.f. max. capacity..... 6.75

Include postage for one pound.

THE WIRELESS SHOP
A. J. Edgcomb
511 West Washington St., Los Angeles, Cal.

EVERYDAY ENGINEERING MAGAZINE
2 WEST 45th STREET NEW YORK CITY

You may enter my subscription to EVERYDAY ENGINEERING MAGAZINE for.....years at \$1.50 per year (Canada, \$1.75; foreign, \$2.00). Please let this start with the..... issue. I enclose \$....., and according to your special offer send me copy of book checked off.

Name
Street
City
State

TEAR OFF AND MAIL THIS NOW

EVERYDAY ENGINEERING SERIES OF HANDBOOKS
Check off title desired here

1	HOME MECHANIC'S WORKSHOP COMPANION
2	HINTS AND TIPS FOR AUTOMOBILISTS
3	HOW TO MAKE AND USE A SMALL CHEMICAL LABORATORY
4	SOLDERING AND BRAZING
5	RADIO HOOK-UPS
6	DESIGN DATA FOR RADIO TRANSMITTERS AND RECEIVERS

Please mention EVERYDAY ENGINEERING MAGAZINE

To cut down the cost per cut

Follow the Chart

Make your hack sawing just as efficient as any other machine tool operation. Choose your blade according to your work. You can't cut cold-rolled and heavy angle iron with the same blade without a waste. Whether you are cutting by power or by hand, big quantities of a comparatively few kinds and shapes of metal or smaller quantities of a lot of different things — there's a Starrett Hack Saw that will meet your needs most efficiently.

Get the most out of every box of saws you buy. Use them for the purpose for which they were made.

A copy of the Starrett Hack Saw Chart 'MB' sent free upon request.

THE L. S. STARRETT CO.
The World's Greatest Toolmakers
Manufacturers of Hack Saws Unexcelled
ATHOL, MASS.



the chart

MATERIAL TO BE CUT	No. of Turns per Foot		No. of Turns per Inch	
	Hand	Power	Hand	Power
Light Angle	100	100	100	100
Close Iron	100	100	100	100
Common	100	100	100	100
Heavy Angle	100	100	100	100
Close Iron	100	100	100	100
Light Structural	110-120	100-110	110-120	100-110
Heavy Structural	110-120	100-110	110-120	100-110
Sheet Metal	100	100	100	100
Cast Iron	100	100	100	100
Cast Steel	100	100	100	100
Stainless Steel	100	100	100	100
Soft Brass	100	100	100	100
Hard Brass	100	100	100	100
Aluminum	100	100	100	100
Lead	100	100	100	100
Steel Pipe	100	100	100	100
Iron Pipe	100	100	100	100
Lead Pipe	100	100	100	100
Cast Iron	100	100	100	100
Cast Steel	100	100	100	100
Stainless Steel	100	100	100	100
Soft Brass	100	100	100	100
Hard Brass	100	100	100	100
Aluminum	100	100	100	100
Lead	100	100	100	100
Steel Pipe	100	100	100	100
Iron Pipe	100	100	100	100
Lead Pipe	100	100	100	100
Cast Iron	100	100	100	100
Cast Steel	100	100	100	100
Stainless Steel	100	100	100	100
Soft Brass	100	100	100	100
Hard Brass	100	100	100	100
Aluminum	100	100	100	100
Lead	100	100	100	100
Steel Pipe	100	100	100	100
Iron Pipe	100	100	100	100
Lead Pipe	100	100	100	100
Cast Iron	100	100	100	100
Cast Steel	100	100	100	100
Stainless Steel	100	100	100	100
Soft Brass	100	100	100	100
Hard Brass	100	100	100	100
Aluminum	100	100	100	100
Lead	100	100	100	100
Steel Pipe	100	100	100	100
Iron Pipe	100	100	100	100
Lead Pipe	100	100	100	100
Cast Iron	100	100	100	100
Cast Steel	100	100	100	100
Stainless Steel	100	100	100	100
Soft Brass	100	100	100	100
Hard Brass	100	100	100	100
Aluminum	100	100	100	100
Lead	100	100	100	100
Steel Pipe	100	100	100	100
Iron Pipe	100	100	100	100
Lead Pipe	100	100	100	100
Cast Iron	100	100	100	100
Cast Steel	100	100	100	100
Stainless Steel	100	100	100	100
Soft Brass	100	100	100	100
Hard Brass	100	100	100	100
Aluminum	100	100	100	100
Lead	100	100	100	100
Steel Pipe	100	100	100	100
Iron Pipe	100	100	100	100
Lead Pipe	100	100	100	100
Cast Iron	100	100	100	100
Cast Steel	100	100	100	100
Stainless Steel	100	100	100	100
Soft Brass	100	100	100	100
Hard Brass	100	100	100	100
Aluminum	100	100	100	100
Lead	100	100	100	100
Steel Pipe	100	100	100	100
Iron Pipe	100	100	100	100
Lead Pipe	100	100	100	100
Cast Iron	100	100	100	100
Cast Steel	100	100	100	100
Stainless Steel	100	100	100	100
Soft Brass	100	100	100	100
Hard Brass	100	100	100	100
Aluminum	100	100	100	100
Lead	100	100	100	100
Steel Pipe	100	100	100	100
Iron Pipe	100	100	100	100
Lead Pipe	100	100	100	100
Cast Iron	100	100	100	100
Cast Steel	100	100	100	100
Stainless Steel	100	100	100	100
Soft Brass	100	100	100	100
Hard Brass	100	100	100	100
Aluminum	100	100	100	100
Lead	100	100	100	100
Steel Pipe	100	100	100	100
Iron Pipe	100	100	100	100
Lead Pipe	100	100	100	100
Cast Iron	100	100	100	100
Cast Steel	100	100	100	100
Stainless Steel	100	100	100	100
Soft Brass	100	100	100	100
Hard Brass	100	100	100	100
Aluminum	100	100	100	100
Lead	100	100	100	100
Steel Pipe	100	100	100	100
Iron Pipe	100	100	100	100
Lead Pipe	100	100	100	100
Cast Iron	100	100	100	100
Cast Steel	100	100	100	100
Stainless Steel	100	100	100	100
Soft Brass	100	100	100	100
Hard Brass	100	100	100	100
Aluminum	100	100	100	100
Lead	100	100	100	100
Steel Pipe	100	100	100	100
Iron Pipe	100	100	100	100
Lead Pipe	100	100	100	100
Cast Iron	100	100	100	100
Cast Steel	100	100	100	100
Stainless Steel	100	100	100	100
Soft Brass	100	100	100	100
Hard Brass	100	100	100	100
Aluminum	100	100	100	100
Lead	100	100	100	100
Steel Pipe	100	100	100	100
Iron Pipe	100	100	100	100
Lead Pipe	100	100	100	100
Cast Iron	100	100	100	100
Cast Steel	100	100	100	100
Stainless Steel	100	100	100	100
Soft Brass	100	100	100	100
Hard Brass	100	100	100	100
Aluminum	100	100	100	100
Lead	100	100	100	100
Steel Pipe	100	100	100	100
Iron Pipe	100	100	100	100
Lead Pipe	100	100	100	100
Cast Iron	100	100	100	100
Cast Steel	100	100	100	100
Stainless Steel	100	100	100	100
Soft Brass	100	100	100	100
Hard Brass	100	100	100	100
Aluminum	100	100	100	100
Lead	100	100	100	100
Steel Pipe	100	100	100	100
Iron Pipe	100	100	100	100
Lead Pipe	100	100	100	100
Cast Iron	100	100	100	100
Cast Steel	100	100	100	100
Stainless Steel	100	100	100	100
Soft Brass	100	100	100	100
Hard Brass	100	100	100	100
Aluminum	100	100	100	100
Lead	100	100	100	100
Steel Pipe	100	100	100	100
Iron Pipe	100	100	100	100
Lead Pipe	100	100	100	100
Cast Iron	100	100	100	100
Cast Steel	100	100	100	100
Stainless Steel	100	100	100	100
Soft Brass	100	100	100	100
Hard Brass	100	100	100	100
Aluminum	100	100	100	100
Lead	100	100	100	100
Steel Pipe	100	100	100	100
Iron Pipe	100	100	100	100
Lead Pipe	100	100	100	100
Cast Iron	100	100	100	100
Cast Steel	100	100	100	100
Stainless Steel	100	100	100	100
Soft Brass	100	100	100	100
Hard Brass	100	100	100	100
Aluminum	100	100	100	100
Lead	100	100	100	100
Steel Pipe	100	100	100	100
Iron Pipe	100	100	100	100
Lead Pipe	100	100	100	100
Cast Iron	100	100	100	100
Cast Steel	100	100	100	100
Stainless Steel	100	100	100	100
Soft Brass	100	100	100	100
Hard Brass	100	100	100	100
Aluminum	100	100	100	100
Lead	100	100	100	100
Steel Pipe	100	100	100	100
Iron Pipe	100	100	100	100
Lead Pipe	100	100	100	100
Cast Iron	100	100	100	100
Cast Steel	100	100	100	100
Stainless Steel	100	100	100	100
Soft Brass	100	100	100	100
Hard Brass	100	100	100	100
Aluminum	100	100	100	100
Lead	100	100	100	100
Steel Pipe	100	100	100	100
Iron Pipe	100	100	100	100
Lead Pipe	100	100	100	100
Cast Iron	100	100	100	100
Cast Steel	100	100	100	100
Stainless Steel	100	100	100	100
Soft Brass	100	100	100	100
Hard Brass	100	100	100	100
Aluminum	100	100	100	100
Lead	100	100	100	100
Steel Pipe	100	100	100	100
Iron Pipe	100	100	100	100
Lead Pipe	100	100	100	100
Cast Iron	100	100	100	100
Cast Steel	100	100	100	100
Stainless Steel	100	100	100	100
Soft Brass	100	100	100	100
Hard Brass	100	100	100	100
Aluminum	100	100	100	100
Lead	100	100	100	100
Steel Pipe	100	100	100	100
Iron Pipe	100	100	100	100
Lead Pipe	100	100	100	100
Cast Iron	100	100	100	100
Cast Steel	100	100	100	100
Stainless Steel	100	100	100	100
Soft Brass	100	100	100	100
Hard Brass	100	100	100	100
Aluminum	100	100	100	100
Lead	100	100	100	100
Steel Pipe	100	100	100	100
Iron Pipe	100	100	100	100
Lead Pipe	100	100	100	100

Useful Books

Complete Practical Machinist by Joshua Ross

One of the best-known books on machine shop work, now in its twentieth edition, and written for the practical workman in the language of the workshop. It gives full practical instructions on the use of all kinds of metal-working tools, both hand and machine, and tells how the work should be properly done. It covers lathe work, vise work, drills and drilling, taps and dies, hardening and tempering, the making and use of tools, tool grinding, marking out work, machine tools, etc. Throughout the entire classic the explanations are as clean-cut as the tools they describe, and the earnest mechanic or machinist seeking greater efficiency will be helped toward using both head and hands to better advantage. No machinist's library is complete without this volume.

547 Pages. 432 Illustrations
Price \$3.00

Metal Worker's Handy-Book of Recipes and Processes

By William T. Brannt

This volume is a valuable work of reference and instruction for all engaged in the working of metals. It is a collection of formulas and practical manipulations for the working of all the metals and alloys including the decoration and beautifying of articles manufactured from them. The utmost pains have been taken to insure the accuracy and efficiency of the recipes so that with ordinary care as to quantities and manipulation the results may be implicitly relied upon.

It treats on alloys and amalgams; hardening, tempering, annealing; bronzing and coloring; casting and founding; cements; cleansing, grinding, pickling, polishing; decorating, enameling, engraving, etching; electro-plating, bracing, coppering, galvanizing, gilding, nickelling, silvering, tinning, etc.; fluxes and lutes, lacquers, paints and varnishes; solders and soldering; welding and welding compounds. To the new edition has been added several new chapters on die-casting, thermite and oxyacetylene welding, etc.

562 Pages. 82 Illustrations
Price \$3.00

Techno-Chemical Receipt Book

Edited with Additions by
Wm. T. Brannt and Wm. H. Wahl

This well-known Receipt Book is a mine of accurate information that everyone may work to great advantage. It is encyclopedic in range, yet gives only the best formulas for each preparation or operation, and thorough tests by competent men guarantee their intrinsic merit.

A compact and reliable collection of approved receipts and processes, containing thousands of receipts covering the latest, most important and most useful discoveries in chemical technology and their application in the useful arts and industries. It is indispensable to every practical man and contains 500 pages, closely printed, giving an immense amount of matter on a great variety of subjects. Every care has been taken to select the very best receipts of each kind and there are few persons, no matter in what business or trade they may be engaged, who will not find in this volume something of use and benefit to them. The library of the laboratory, factory or home is not complete without a copy of this handy and useful book of reference.

516 Pages. 78 Illustrations
Price \$2.50

Friction, Lubrication, Fats and Oils

By Emil F. Dieterlehs

When we realize that it is no figure of speech, but a bald statement of fact, to say that lubrication alone keeps the wheels of industry turning, then we must look respectively upon this as a question of vital importance in this mechanical age. The author, himself a chemist and an inventor and manufacturer of lubricants, wrote this manual for the mechanic and manufacturer of ordinary education, that the busiest man might learn the main facts of friction, the origin and characteristics of fats and oils, their uses, their adulterations, their practical testing and the best ways to make them serve his own particular ends.

Price \$1.50

Send for our new 48-page descriptive catalogue mailed free on request.

HENRY CAREY BAIRD & CO., Inc.
Publishers of Mechanical and Industrial Books
110-116 Nassau St., New York, N. Y.

To Cleanse Guns With Petroleum

CLEANSING a weapon with fats and oils does not entirely protect it from rust, the so-called drying oils get gummy and resinous, while the non-drying oils become rancid, and by exposure to the air acids are formed, and these attack the iron. For these reasons petroleum is to be preferred for this purpose. Petroleum is as great an enemy to water as are the fatty oils, and hence it keeps away the water from a gun-barrel covered with it. It is very essential, however, that the petroleum employed be perfectly pure, for impure oil, such as is often met with in commerce, attacks the metal. Care must also be had not to allow it to come in contact with the polished stock. When about to clean a gun, some tow is wrapped around the ramrod and enough petroleum poured upon it to thoroughly moisten it; it is then pushed in a rotary manner through the barrel and back a dozen times, and the tow taken out and unrolled, and the upper and lower ends of the barrel rubbed with the clean part, after which it is thrown away. This removes the coarser portion of the dirt. A round brush of stiff bristles, and fitting the barrel, is now screwed to the ramrod, then moistened thoroughly with petroleum and twisted into the barrel, running it back and forth at least a dozen times, thus loosening the dirt that is more firmly attached. The first operation is now repeated, except that the tow on the ramrod is left dry, and the rubbing with this must be continued in all directions as long as it comes out soiled. The use of wire brushes is objectionable for cleaning guns, as the numerous steel points cut into the tube. Only soft tow, hemp, woolen rags, or the like, should be used, as the petroleum dissolves the dirt sufficiently.

Welding of Platinum

PLATINUM does not oxidize when in a red hot state and may be welded without the use of welding powder by simply placing the red hot pieces upon each other and uniting them by blows of the hammer. Nevertheless the welding together of two pieces of platinum is a difficult operation, since platinum possesses the property of yielding up the absorbed heat with great rapidity and cooling off to such an extent that the two pieces are no longer soft enough to be united. This cooling off takes place with such rapidity that the joining of the hot pieces must be hastened as much as possible, it being advisable to allow the flame of the hydrogen-gas blow-pipe to act upon the pieces of platinum during the entire operation of welding.

BOYS



Learn Drafting

Employers everywhere are looking for skilled draftsmen. They are offering good salaries to start with splendid chances for advancement.

Drafting offers exceptional opportunities to a young man because drafting itself not only commands good pay, but it is the first step toward success in Mechanical or Structural Engineering or Architecture. And drafting is just the kind of work a boy likes to do. There is an easy delightful way in which you can learn right at home in spare time. For 28 years the International Correspondence Schools have been giving boys just the training they need for success in Drafting and more than 200 other subjects. Thousands of boys have stepped into good positions through I. C. S. help, but never were opportunities so great as now.

Let the I. C. S. help you. Choose the work you like best in the coupon, then mark and mail it. This doesn't obligate you in the least and will bring you information that may start you on a successful career. This is your chance. Don't let it slip by. Mark and mail this coupon now.

INTERNATIONAL CORRESPONDENCE SCHOOLS BOX 6087-B, SCRANTON, PA.

Explain, without obligating me, how I can qualify for the position, or in the subject, before which I mark X.

- | | |
|--|--|
| <input type="checkbox"/> ELECTRICAL ENGINEER | <input type="checkbox"/> CHEMICAL ENGINEER |
| <input type="checkbox"/> Electrician | <input type="checkbox"/> SALESMANSHIP |
| <input type="checkbox"/> Electric Wiring | <input type="checkbox"/> ADVERTISING MAN |
| <input type="checkbox"/> Electric Lighting | <input type="checkbox"/> Window Trimmer |
| <input type="checkbox"/> Electric Car Running | <input type="checkbox"/> Show Card Writer |
| <input type="checkbox"/> Heavy Electric Traction | <input type="checkbox"/> Outdoor Sign Painter |
| <input type="checkbox"/> Electrical Draftsman | <input type="checkbox"/> RAILROADER |
| <input type="checkbox"/> Electric Machine Designer | <input type="checkbox"/> ILLUSTRATOR |
| <input type="checkbox"/> Telegraph Expert | <input type="checkbox"/> DESIGNER |
| <input type="checkbox"/> Practical Telephone | <input type="checkbox"/> BUSINESS MANAGEMENT |
| <input type="checkbox"/> MECHANICAL ENGINEER | <input type="checkbox"/> Private Secretary |
| <input type="checkbox"/> Mechanical Draftsman | <input type="checkbox"/> BOOKKEEPER |
| <input type="checkbox"/> Ship Draftsman | <input type="checkbox"/> Stenographer and Typist |
| <input type="checkbox"/> Machine Shop Practice | <input type="checkbox"/> Cert. Pub. Accountant |
| <input type="checkbox"/> Toolmaker | <input type="checkbox"/> Traffic Management |
| <input type="checkbox"/> Gas Engineer | <input type="checkbox"/> Commercial Law |
| <input type="checkbox"/> CIVIL ENGINEER | <input type="checkbox"/> GOOD ENGLISH |
| <input type="checkbox"/> Surveying and Mapping | <input type="checkbox"/> STATIONARY ENGINEER |
| <input type="checkbox"/> NINE FOREIGN LANGUAGES | <input type="checkbox"/> CIVIL SERVICE |
| <input type="checkbox"/> ARCHITECT | <input type="checkbox"/> Railway Mail Clerk |
| <input type="checkbox"/> Architectural Draftsman | <input type="checkbox"/> Textile Overseer or Supt. |
| <input type="checkbox"/> PLUMBING AND HEATING | <input type="checkbox"/> AGRICULTURE <input type="checkbox"/> Spanish |
| <input type="checkbox"/> Sheet Metal Worker | <input type="checkbox"/> Poultry Raising <input type="checkbox"/> French |
| <input type="checkbox"/> Navigator | <input type="checkbox"/> Automobiles <input type="checkbox"/> Italian |

Name 7-25-19
Present Occupation
Street and No.
City State

Battery Charging Your Biggest Money-Maker

\$150 to \$350 Clear Profit a Month with this HB-32 Battery Charger
You can recharge 32 6-volt auto batteries, or equivalent in 12- or 24-volt batteries, at one time, for 10c to 15c each. Customer pays 75c to \$1.50. Figure the profits yourself. Others are making BIG PROFITS with HB Battery Charging.
Why not YOU? Get busy NOW—add those extra profits to your income.
Small investment Pays this Money-Maker in Your Garage. Balance on easy monthly terms. (Outfit easily paid for itself). Absolute Money-Back Guarantee. No burn-outs or renewals. Easy to install and operate. Only attention needed in occasional oiling. Write TODAY for full information.
MOBART BROTHERS COMPANY
Box EE123 Troy Ohio
Successful Since 1914

PATENTS

To the Man with an Idea

I offer a comprehensive, experienced, efficient service for his prompt, legal protection and the development of his proposition.

Send sketch, or model, and description, for advice as to cost, search through prior United States patents, etc. Preliminary advice gladly furnished without charge.

My experience, and familiarity with various arts, frequently enable me to accurately advise clients as to probable patentability before they go to any expense.

Booklet of valuable information and form for properly disclosing your idea, free on request. Write today.

RICHARD B. OWEN
PATENT LAWYER
144 Owen Building, Washington, D. C.

Free Book on PATENTS

Write today for a Free Copy of "How to Obtain a Patent." Contains valuable information and advice to inventors. Tells how to secure Patents. Send model or sketch of your invention for opinion of its patentable nature—Free. (20 years experience.) Talbert & Talbert, 4368 Talbert Bldg., Washington, D. C.



The Book
for
**Inventors and
Manufacturers**

By return mail FREE.
Write **LACEY & LACEY**
Dept. S. Washington, D.C.

Competent Patent Service
By a Former Examining Official of the U. S. Patent Office

NORMAN T. WHITAKER
Lawyer and Engineer
580 Whitaker Bldg. Washington, D. C.
Branch Office, 87 Nassau St., New York City
INQUIRIES INVITED

PATENTS

Record your invention. Upon request, I will forward to you my form "Filing the Essential Dates of Invention" together with full information concerning its use and the best way to secure patent protection. Prompt, personal efficient service, by an attorney-at-law, having over twelve years experience in patent matters. Reasonable pre-war charges.

B. P. FISHER
821 McGill Bldg., Washington, D. C.

Making Your Invention a Financial Success

How best to dispose of your invention
What kind of agreements to make for your protection
What kind of offers and mistakes to avoid
Valuable advice and other data

By **M. G. Delaney**, an experienced inventor, in **The Inventor's Manual of Valuable Information**

\$1.50 per copy, postpaid
Additional information and Table of Contents will be mailed on request.

G. E. Perry Co., Publishers, 1528 Broadway, New York

A Simple Drill Press

The drawing is simple and explains itself. The frame work is made of pipe fittings and designed to any size that suits the builder. I used 1/2 in. The spindle was made of cold rolled steel slightly smaller than the opening in the pipe, turned or bored to fit the chuck. I used a chuck with a tapered hole, and turned the spindle to suit, as it is easier to turn the spindle than to bore it.

The table was a piece of cast iron faced off and bored to fit a cold rolled shank, which is the same size as the spindle. The bearings were made by placing the spindle through the three fittings, parallel with the upright and pouring with hot lead or babbitt.

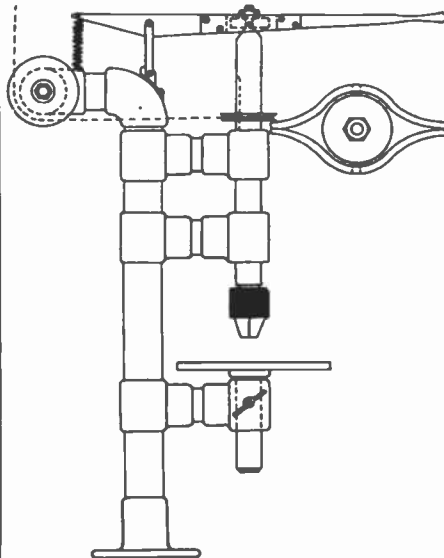

A simple drill press

The feeding mechanism is plainly shown and is very simple to make. The detail explains it more fully. The spindle being keyed to the pulley by means of a long spline in the spindle, thus allowing the pulley to slide as the spindle is raised or lowered.

The drawing shows only one set of pulleys, as I had a motor set directly at the rear of the base, being a direct drive, but it is a simple matter to place two pulleys at the bottom joint, one loose and one for driving.

STUDIES IN THE CONSTRUCTION OF DAMS: EARTHEN AND MASONRY, by Professor E. R. Matthews. Size 6 x 9 inches; bound in paper; pages, 30 diagrams. Published by J. B. Lippincott Company, Philadelphia, Pa.

This book is intended to be of assistance to engineering students who may be preparing for the society membership examination of civil engineering societies or other similar examinations. The text takes the question and answer form, which has been found by experience to be a most useful method of enabling the mind of the student to grasp the essentials of the subjects involved and at the same time to learn how to express his knowledge.

Genuine Armstrong Stocks and Dies



Great care should be exercised in the selection of stocks and dies. Work of quality demands quality tools.

Genuine Armstrong Stocks and Dies are quality tools. Made of the highest quality of material and by expert workmen. They are dependable and accurate tools of constant service.

Send direct to us if your dealer cannot supply you.

Description Catalog on Request

The Armstrong Manufacturing Co
701 Knowlton Street Bridgeport, Conn.



PREVENT
Put the
where it

WASTE
Grease
is Needed

THE BRIDGEPORT Center Thread Grease Cup

This cup will squirt more grease than any cup of the same size made.

Equip your machine, auto or boat with this new type of grease cup, one that does not leak, that cannot be cross-threaded and that forces the grease to the bearing points. The cleanest Grease Cup made.

Send for Circular and Price List

THE GARRISON COMPANY
348 George St. Bridgeport, Conn.

Big Profits Every Month in Battery Charging

MAKE BIG PROFITS IN WINTER BATTERY CHARGING IN LARGE AND SMALL GARAGES

Steffes & Steffes Garage, Chilton, Wis., (pop. 1500), income per month \$125.00, cost \$15.00—Adams Cooper Sales Co., Ft. Smith, Ark. (pop. 37,000), income per month from HB Charger is \$120.00—cost \$15.00—Alamosa Battery & Starter Co., Alamosa, Colo. (pop. 3,000), average income per month \$275.00, average bill per month, \$14.00 for current.

This HB 500 Watt Charger Can Bring You Big Profits This Winter

Small cash payment, balance on easy monthly terms. HB Absolute Money-Back Guarantee recharges 1 to 8 6-volt batteries for 10c to 15c each, customer pays 75c to \$1.50. No burpouts, no expensive renewals; steady, reliable service. Easy to install and operate. No electrical knowledge required. Pin this ad to your letterhead and mail TODAY for information.

NOBART BROTHERS CO
Box RE122, Troy, Ohio.
Successor to Mfrs. since 1885.



Please mention EVERYDAY ENGINEERING MAGAZINE

An Improvised Roller

AN association located in the Adirondacks desired to place a tennis court on the side of a mountain, where it would be very hard to transport a heavy iron roller. The ground could be easily leveled off, but how to get a roller in position to keep the court in shape was the problem. To meet the need an ingenious mind devised an improvised roller that has done service for several years. What is more, this roller was made on the spot, cost almost nothing and takes care of the tennis court as well as an expensive iron roller. Such an improvised roller can be constructed by the amateur builder for grading and rolling the lawn, leveling and packing the dirt in a newly made driveway, smoothing any surface of the ground, and the many general duties demanded of the hand roller.



An improved roller made with ordinary materials

The part that rolls on the ground for this home-made roller was made from a short length of tile two feet long and eighteen inches in diameter. The piece of tile was easily carried to its destination on a pole supported on the shoulders of two men. The center for this tile roller consisted of pieces of stone and rocks picked up on the spot and held in place by cement.

To locate the center of this tile in order to place the shaft in its central position was something of a problem. This was done by laying out with a compass a circle of eighteen inches on a board platform and then placing the tile on the circle marked out. Up through the center a half-inch pipe thirty inches long was placed to act as the shaft. The space between this shaft and the sides of the tile was filled with concrete in which was imbedded coarse gravel and stones. When this was dry the roller was mounted on a frame convenient for use. The only cost of this roller was for the cement, and but little was required, the remainder of the material being picked from the junk pile or found on the spot.

F. E. BRIMMER.

Difference Between Heartwood and Sapwood

IN over 300,000 tests which have been made at the Forest Products Laboratory, Madison, Wisconsin, on the various species of wood grown in the United States, no effect upon the mechanical properties of wood due to its change from sapwood into heartwood has ever been noticed. Any difference in the strength of heartwood and sapwood can usually be explained by the growth and density of the wood.

In other than mechanical properties, there are differences between heartwood and sapwood which have an important bearing on their use for various purposes. The sapwood of most American species is considerably less resistant to decay than the heartwood, and where the wood used without preservative treatment in situations which favor decay, the sapwood is likely to have a much shorter life. In these particular cases, therefore, strength requirements may have an indirect bearing on the choice between heartwood and sapwood, inasmuch as wood infected with decay is likely to have its strength properties, particularly that of shock resistance, greatly reduced.

Electric Steel in Germany

OF the total output of crucible and electric steel in Germany, for 1917, statistics show that 349,480 tons or 62 per cent. was produced in the electric furnace. One-third of this quantity was produced in induction furnaces and two-thirds in arc furnaces, the induction furnace seemingly being preferred by the producers of high-quality steel. The average capacity of the electric furnaces built in Germany during the war was 6.7 tons.



Small Steam Engines & Boilers, Gas & Gasoline Engines 1/2 H.P. and Up, Tanks, Pumps, Model Makers' Supplies. Get our big Catalogue, sent Postpaid for 15c (coin preferred) or Stamps. Refunded first order. 192 Pages, over 200 illustrations.

MODERN ENGINE & SUPPLY CO. 364 Monadnock Bldg., Chicago, Ill.



The Mysterious Ghost

Perfectly visible in the dark. Affords great amusement to the old and young. Never gets out of order. Lasts indefinitely. Postpaid. Lift also 40c; half size 30c.

Canadian Chemical Products Co. Box 133 St. John, N. B.

UmakeM Lathe

You make a High-grade Screw Cutting and Milling Lathe from UmakeM outfit No. 15 which includes all Castings and 12 detail blueprints. Complete outfit \$36. Note following dimensions: Length over all, 3 ft. 11 in.; Breadth, 12 in.; Approximate weight, 106 lbs.; Dimensions of working surface of milling table, 4 in. by 8 in. This lathe has been designed to meet the wants of Model Makers who require a tool capable of very varied and accurate work. It is self-acting and Screw Cutting. With it all plain Milling work can be done, as well as making it easy to do a great many boring jobs otherwise very difficult. Address: W. R. PRICE, Inc., Dept. 17, UmakeM Bldg., 127 9th Ave., N. Y.

You are Judged by Your Appearance

The world sizes you up by your own opinion of yourself—as expressed in your looks, your actions, and the force of your ambition. Look at the photographs of any of the world's business leaders. Note that clean-cut, sharp, alert look in each one's eyes, the firm tilt to the head and chin, the square set of the shoulders. It's the strong, virile man, the man of tireless energy, that gets to the top.

You can't be alert, you can't have full control of your faculties, you can't have that inexhaustible supply of vitality and energy that means success in life unless you have PERFECT HEALTH. Your physical condition is the root of your whole life. Build up your body and muscular strength and you build up your mind and vitality and insure success.

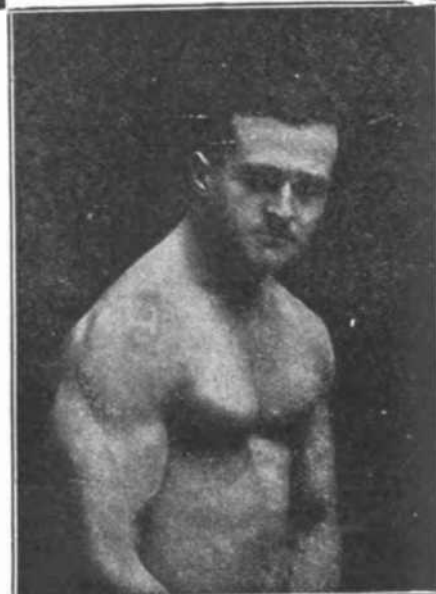

EARLE LIEDERMAN The Acme of Physical Perfection

There is a Short-cut to Health

I have found it and applied it to my own body and proven its results. And I have trained many of the world's strongest men by this same method—taken them when they were mere physical wrecks and made powerful athletes of them. I can do the same for you. No need for you to drift aimlessly along—merely existing. Get a grip on yourself. Resolve right now to start on the road to success—the first step of which is better health.

Send for MY NEW BOOK "Muscular Development"

It tells the secret. Handsomely illustrated with 30 full page photographs of myself and some of the world's best athletes whom I have trained. Also contains full particulars of my splendid offer to you. The valuable book and special offer will be sent on receipt of only 10c, stamps or coin, to cover cost of wrapping and mailing.

Don't miss this opportunity. Sit right down now and fill in the coupon. The sooner you get started on the road to health the easier it will be to reach perfect manhood. Don't drag along one day longer—mail the coupon to-day.

EARLE E. LIEDERMAN

Dept. 706, 203 Broadway, New York

EARLE E. LIEDERMAN, Dept. 706, 203 Broadway, N. Y. City.

Dear Sir:—I enclose herewith 10c for which you are to send me, without any obligation on my part whatever, a copy of your latest book "Muscular Development." (Please write or print plainly.)

Name.....
Address.....
City..... State.....

Please mention EVERYDAY ENGINEERING MAGAZINE

Just Published

The Everyday Engineering Handbooks

The Experience and Knowledge of Experts Condensed and Simplified
for the Handy Man—the Mechanic and the Radio Experimenter

ILLUSTRATED BY SPECIAL DRAWINGS AND PHOTOGRAPHS

HOME MECHANIC'S WORKSHOP COMPANION



TELLS HOW TO DO MANY USEFUL
ELECTRICAL AND MECHANICAL THINGS
INCLUDING NUMEROUS SHOP KINKS

By
ANDREW JACKSON JR.

①

EVERYDAY ENGINEERING SERIES
NORMAN W. HENLEY PUBLISHING CO.
2 WEST 45 TH. STREET, NEW YORK

For the Handy Man in the
Home or Shop

There has always been a demand for a hand book of mechanical instruction that would help the average everyday man to do the many small jobs of repair work that are found around the home and shop.

This treatise includes a compilation of useful suggestions that cannot fail to interest the handy man and while it is not intended for mechanical experts or scientists, it will prove to be a veritable store of information for any one who desires to rig up a small shop where odd jobs can be carried on.

The subject matter is divided in five parts as follows:

Chapter 1—The Home Workshop and Its Equipment. Chapter 2—Special Tools and Shop Expedients. Chapter 3—Useful Home Appliances. Chapter 4—How to Do Things Electrical. Chapter 5—Helpful Recipes and Formulae. The illustrations are especially clear and all suggestions are further amplified or made more easy of comprehension by hundreds of thumb nail sketches made by the author.

HINTS AND TIPS FOR AUTOMOBILISTS

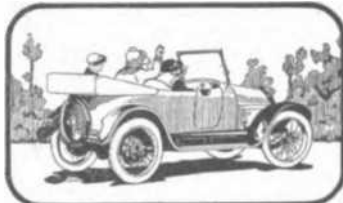

MONEY SAVING HINTS ON CARE AND OPERATION
ALSO LOCATION AND REPAIR OF ROADSIDE TROUBLES

By
VICTOR W PAGE

②

EVERYDAY ENGINEERING SERIES
NORMAN W. HENLEY PUBLISHING CO.
2 WEST 45 TH. STREET, NEW YORK

For the Automobile Owner
or Driver

This volume is replete with interesting facts compiled by an expert from a mass of information furnished by the Service Departments of leading automobile makers on operation, upkeep, lubrication, location of troubles and simple repairs of automobile parts. The instructions given are concise and to the point and no information that will help in the everyday operation of automobiles is omitted.

The book is ideal for the busy man or woman who wants to know about car operation and upkeep because of the economies possible when an automobile is intelligently operated. It contains many money saving hints and a brief simple exposition of location and remedy of roadside troubles apt to occur under ordinary operating conditions.

To permit of logical presentation, the subject matter is divided into four chapters. Chapter 1 deals with the Control and Operation; Chapter 2, Systematic Inspection and Lubrication; Chapter 3, Power Plant and Auxiliary Groups; Chapter 4, Automobile Care and Maintenance Suggestions.

HOW TO MAKE & USE A SMALL CHEMICAL LABORATORY



AN INTRODUCTION TO THE STUDY OF
INORGANIC CHEMISTRY WITH DIRECTIONS
FOR THE CONSTRUCTION OF A SMALL LABORATORY

By
RAYMOND FRANCIS YATES

③

EVERYDAY ENGINEERING SERIES
NORMAN W. HENLEY PUBLISHING CO.
2 WEST 45 TH. STREET, NEW YORK

For the Student Chemist
and Experimenter

The treatise covers all of the essentials of elementary chemistry. The law of definite proportions, solutions, crystalloids, colloids, electrolysis, etc., are explained. The second part of the book is devoted to chemical and electro-chemical experiments. Only those experiments that will tend to broaden the readers' knowledge of chemistry in general have been chosen.

The third part of the book describes the construction and fitting out of the home chemical laboratory. Directions for the construction of the many simple pieces of chemical apparatus are given. A chemical balance, ring stand, electric furnace, etc., are described in detail, with working drawings. The manipulation of chemical glassware is also treated.

This book gives all the necessary information for a well-grounded understanding of chemistry. It will not only be a help, but an inspiration to study further into this fascinating realm of science.

A SPECIAL OFFER TO READERS OF

ANY ONE OF THE ABOVE VALUABLE BOOKS WILL BE

TRY TO SEND US FOUR NEW SUBSCRIBERS—WITH YOUR

Fill Out the Special Blank on Page 243 of this Issue. Check Off the Title Desired and Mail with Your Remittance to

Just Published

Should be in Every Practical Man's Library

All of these Books are written in Simple Non-technical Language and contain Information of Real Value on Subjects of Timely Interest

RADIO BOOKS CONTAIN MANY WIRING DIAGRAMS

SOLDERING & BRAZING



A USEFUL HANDBOOK FOR MECHANICS

By
RAYMOND FRANCIS YATES

④

EVERYDAY ENGINEERING SERIES
NORMAN W. HENLEY PUBLISHING CO
2 WEST 45 TH. STREET, NEW YORK

For the Mechanic and Model Maker

This treatise gives all the necessary "kinks" that will enable one to accomplish successful soldering. If a mechanic has not succeeded in his soldering, this book may tell him just what he needs to produce good work—something that he may heretofore have forgotten.

Hard soldering, for some reason, is not generally known. Hard soldering, however, is very important and must be used in all cases where soft solder does not possess sufficient strength. Hard soldering and solders are thoroughly covered in the book. Nothing has been omitted that will enable the mechanic to apply hard solder successfully.

Brazing and all of its important ramifications are treated in detail. Brazing, like hard soldering, is a process little understood by many mechanics. The book "Soldering and Brazing" is divided in five parts as follows: Part I—Soft Soldering; Part II—Hard Soldering; Part III—Brazing; Part IV—Heating Devices; Part V—Soldering Notes.

RADIO HOOK-UPS



A BOOK OF THE MOST ADVANCED CIRCUITS OF RECEIVERS, AMPLIFIERS AND TRANSMITTERS FOR DAMPED AND UN DAMPED WAVE WORK:

By
M. B. SLEEPER

⑤

EVERYDAY ENGINEERING SERIES
NORMAN W. HENLEY PUBLISHING CO
2 WEST 45 TH. STREET, NEW YORK

For the Radio Experimenter and Amateur

In this book, the best circuits for different instruments and various purposes have been carefully selected and grouped together. The result is a comprehensive summary of radio circuits for tuning coils, loose couplers, capacity coupling, variometers and other equipment for receiving long and short damped and undamped waves; damped, undamped and modulated wave transmitters using buzzers, spark coils, transformers, arcs and vacuum tubes, telephone transmitters, laboratory oscillators, vacuum tube characteristic measuring circuits, wave-meters, and audibility meters—in short, diagrams for every purpose.

A special feature of this book is the explanations which accompany each circuit, giving construction or operating details. Spaces are also provided for notes on the results obtained with each diagram. This arrangement, coupled with the skillful selection of the circuits, makes Radio Hook-ups an essential to every radio experimenter or operator.

DESIGN DATA FOR RADIO TRANSMITTERS & RECEIVERS



SIMPLE METHODS FOR DESIGNING APPARATUS ACCORDING TO ADVANCED AND APPROVED PRACTICE

By
M B SLEEPER

⑥

EVERYDAY ENGINEERING SERIES
NORMAN W. HENLEY PUBLISHING CO
2 WEST 45 TH. STREET, NEW YORK

For the Radio Engineer and Student

Far from being a collection of formulas, Design Data takes up in proper sequence the problems encountered in planning all types of receiving sets for short, medium, and long wave work, and spark coil, transformer, and vacuum tube transmitters operating on 200 meters.

Where formulas are difficult, tables have been worked out so that values can be found without the use of mathematics. The few formulas given are so simple that any school boy can solve them. The subjects are so arranged that, having decided upon the type of receiver or transmitter to be built, the reader can locate immediately the problems and solutions required.

In Design Data, radio experimenters are given such information, readily accessible, as to make it possible for them to have modern and highly efficient equipment and to get the best possible results from the instruments they make or buy.

EVERYDAY ENGINEERING MAGAZINE

SENT FREE FOR EACH NEW OR RENEWAL SUBSCRIPTION

OWN—SO WE CAN SEND YOU THE SET OF SIX BOOKS

EVERYDAY ENGINEERING MAGAZINE, 2 W. 45th ST., NEW YORK CITY

NEW MOTORS

FACTORY GUARANTEED - ALL SIZES - IN ORIGINAL BOXES

Your Opportunity To Buy New Guaranteed Electrical Apparatus of Standard Manufacture.

Single Phase Motors	Charging Generators	Polyphase Motors	Battery Charging Outfits
110-220 volts, A. C., 60 cycle, 1800 R. P. M. with pulley	Suitable for all lighting Battery Charging and Power Requirements.	2 and 3 phase, A.C., 220 v., 60 c. 1750 RPM., complete with base and pulley.	To operate on A. C., 60 cycle, single phase voltage as specified.
1/4 H. P., 110 volts, induction, full load start - -	8 volts, 10 amp. \$16.50	1/2 H. P. - \$42.50	110 volts, A. C., 100 watt, 24 volts, without switchboard \$40.00
1/2 H. P., 110-220 volts, induction, full load start - -	15 volts, 10 amp. \$21.00	1 H. P. - \$59.50	110 volts, A. C., 150 watts, 30 volts, without switchboard \$68.50
1/2 H. P., 110-220 volts, repulsion, for compressor \$46.50	40 volts, 8 amp. \$24.50	2 H. P. - \$72.50	110-220 volts, A. C., 250 watts, 24 volts, without switchboard \$75.00
1 H. P., 110-220 volts, repulsion, with sliding base - - \$67.50	110 v. 2 1/2 amp. \$24.50	3 H. P. - \$84.50	220 volts, A. C., 200 watts, 30 volts, without switchboard \$85.00
2 H. P., 110-220 volts, repulsion, sliding base \$108.50	40 volts, 12 amp. \$38.50	4 H. P. - \$102.50	110 volts, A. C., 275 watts, 30 volts, without switchboard \$85.00
3 H. P., 110-220 volts, repulsion, sliding base \$124.50	170 volts, 5 amp. \$38.50	1 H. P., high speed, 2500 R.P.M., 170 v. \$36.50	220 volts, A. C., 500 watts, 48 volts, with switchboard \$110.00
5 H. P., 110-220 volts, repulsion, sliding base \$164.50	40 volts, 25 amp. \$58.50	2 phase only - \$36.50	110 volts, A. C., 750 watts, 72 volts, without switchboard \$125.00
	110 volts, 10 amp. \$58.50		
	Moving Picture Art Generator \$85.00		

WRITE FOR CATALOG. BARGAINING IN MOTORS AND GENERATORS

1/4 SPECIAL
110 volts
A.C. 60 c.
S.P. 1750 RPM.
Complete, cord, plug & pulley

MONEY BACK

WASHING MACHINE MOTORS
Suitable for operating Small Compressors, Coffee Grinders, Bells, Washers, Etc. Reg. Value \$22.50

\$19.75 EACH

GUARANTEE

SHIPPING TERMS: 25% deposit required on all orders. Balance C. O. D. by Express. Signal draft with Bill of Lading attached by freight.

MANUFACTURERS' DISTRIBUTER
CHAS. H. JOHNSTON, Box 10, West End, Pittsburgh, Pa.

A Lathe Center With Adjustable Point

THE illustration shows the adjustable point lathe center now being marketed by a large manufacturer. The device is very simple consisting of four parts: the body, center point, adjusting screw and locking screw.

The body of the center is made of carbonized steel, but the adjustable center is made of high speed steel containing from eighteen to nineteen point tungsten drawn just enough to relieve the strain of hardening. The diameter of the point is limited to .0005", but the hole in the center has no limit, thus making all points interchangeable.

Not only does the high speed steel point give from seven to nine times more production per grind than does the ordinary carbon steel point now in general use, but when it does become necessary to grind the new point there is a much shorter angle to be ground, and a much heavier feed can be used while grinding, as the high speed steel will stand much more friction heat without its temper being drawn. This makes it possible to reduce the time of the grinding operation from the usual fifteen or twenty minutes to one to two minutes.

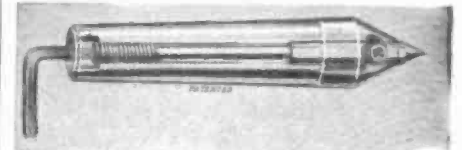

As the point is gradually worn down it is adjusted with the adjusting screw, without the necessity of shifting the tail stock, and when finally worn out, one need only replace the small center point instead of scrapping the entire center as is necessary with the old center.

The new center can be used in either tail stock or spindle of lathe or grinder, and no job is too heavy for it.

D. G. BAIRD.

FROSTING GLASS

A good frosting for glass that imitates ground glass quite well is made up of the following: Sandarac, 18 parts; mastic, 4 parts; benzol, 40 parts, and ether, 200 parts. Clean glass thoroughly before and apply by pouring the mixture on the glass and flowing evenly.

TO PREVENT SCALE IN HARDENING DIES

It is possible to prevent the formation of any scale in the impression of fine jewelers' dies and the like, and retain the finished brilliancy of surface, by applying a mixture of powdered ivory black and sperm oil, mixed to the consistency of paste. It is only necessary to apply a thin coat.

6 INCH BENCH LATHE

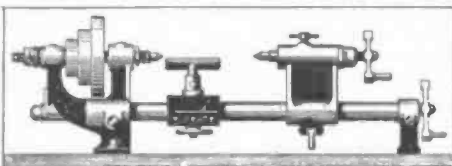

ROUGH CASTINGS OR FINISHED MACHINE
Shop Tools and Equipment
DESIGNS FOR MODEL BOATS—Historic and modern—Drawings of famous 110 ft. U. S. Sub-chaser. Send stamp for catalog.

HUHN MFG. CO., 584 Elm St., Arlington, N. J.

UmakeM Airplanes Curtiss Model J.N.-4 can be made complete ready to fly from UmakeM No. 17 (price \$3.00), which includes blueprints, wood, metals, rubber and special tools necessary. Send for this set quick and Make Money Making UmakeM Flying Airplanes for sale. Enormous demand. Profits big. Completed Plane sells at \$10 and can be made in 6 hours from UmakeM No. 17 Set. Ask about our 40 other UmakeM sets for making Airplanes, Toys, Novelties, Work Benches and practical Screw Cutting and Milling Lathes.

W. R. PRICE, Inc., Dept. 17, UmakeM Bldg., 127 5th Ave., N. Y.

SPEED LATHE \$7.00 Complete Swing 7 inches 24 inch Metal Bed



Head has a three step cone. Spindle is hollow. Centers are No. 1 Morse taper shank. Tail stock has a screw feed spindle and No. 1 Morse taper shank center. Spur center is furnished for wood turning. Bearings are of high grade bearing metal and are adjustable to wear. Rest is adjustable to all positions. Lathe is complete at the above price. Longer bed \$1.00 per additional foot.

M. & J. SPECIALTY CO.
252 S. Parke St., Pontiac, Mich.

MECHANICAL DRAWING

Successfully taught by mail. Learn to make and read drawings and become a Mechanical Draftsman. Fifty cents each lesson, pay as you go. No other expense. Complete drawing outfit valued at \$20.00 free with the Course. One hundred blue-print lessons. Will assist you to secure good paying position when qualified. Send for particulars and sample lessons.

50¢ Per Lesson

ALBANY INSTITUTE MECHANICAL DRAWING
Desk C. Look Box 84, Albany, N. Y.

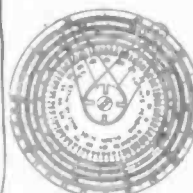

THE MIDGET SLIDE RULE will solve any problem in addition, subtraction, multiplication, division and proportion. A Log-Log Scale gives any root or power of any number. Gives Logarithms, Sines, Tangents, Cosines, Cotangents and the decimal equivalents of fractions to six decimals. It is grease and water proof and will give years of service. This rule is not to be compared with the paper utility rules which sell for \$1.00 and are put together with paper fasteners. It is accurate, simple

to operate and comparison shows that it is undoubtedly the 'best and most complete' rule made. Our refund guarantee protects you from loss or disappointment. An instruction book 16 pages, 12 illustrations, is sent with each rule. Diameter 4 in. Made in two models: Metal (white coated steel), \$1.00; White Celluloid \$1.25. Leather Case 50c extra. Your money back if you are not satisfied. Send for Catalogue of Slide Rules.

Gilson Slide Rule Co., Niles, Mich.

USE HB BALL BEARING ELECTRIC MOTORS

Lower Power Cost—Better Power
HB Ball Bearing Electric Motors save greatly on operating cost. More economical, more dependable, better in every way than gas engine. Trouble proof, built for heavy duty. Ideal power for factory, garage and machine shop.

\$20 brings you any HB Motor. Balance on easy terms.

Sizes 1 to 15 h.p. A size to meet your needs. Service Department gladly advises on your requirements. Get their advice—FREE—simply state what machinery you wish to run and type of current available. Your power system planned for best results at least cost. Pin this ad to your letterhead and mail today for full information. Ask also about HB Battery Chargers, Generators, etc. **HOBBART BROTHERS COMPANY**
508 E. 125 Troy, Ohio
Successful Manufacturers Since 1893



Protect Good Tools

Keep them safe from knocks, bangs, rust—yet handy and all together. The New Utility Chest illustrated is for garage and home use, for machinists, tool makers, masons, carpenters, repairmen, etc.

UNION TOOL CHESTS

19 Styles and Sizes
Write for Catalog. Prices and name of nearest dealer. Ask about "Satisfaction or Money-Back" Guarantee. If no dealer near you, write for special offer.

UNION TOOL CHEST CO., Inc.
34 Mill Street, Rochester, N. Y.



Automatic Lighting Mechanism For Fire-Houses

By John F. Rodgers

AN interesting appliance in use in some of the New York City fire-houses increases the celerity with which the men arise and dress with a night alarm and also eliminates the personal equation in an economy of light.

A clockwork mechanism, acting in conjunction with the alarm circuit and energizing the control wires of a Sundh remote control switch, at the first stroke of the alarm throws on the dormitory and apparatus floor lights. After a lapse of time sufficient to allow the men to dress and the apparatus to leave the floor, the switch, by means of the clockwork control, turns out the lights.

and energizes the central solenoid which trips the switch and throws off the lights.

The switch shown at (M) has two contacts (4 and 5) which, connected, close the battery circuit for operation of the clockwork mechanism. The battery circuit also energizes a magnet (R_1) which, controlled by contacts (R_2), acted upon by an eccentric attached to the spring of the clock, re-winds the mechanism.

The momentary contact switch shown at (O) is used for push-button control of the remote control switch in the event of failure of the clockwork control, by the man on watch at the desk.

The switch shown above the central solenoid of the remote control switch is

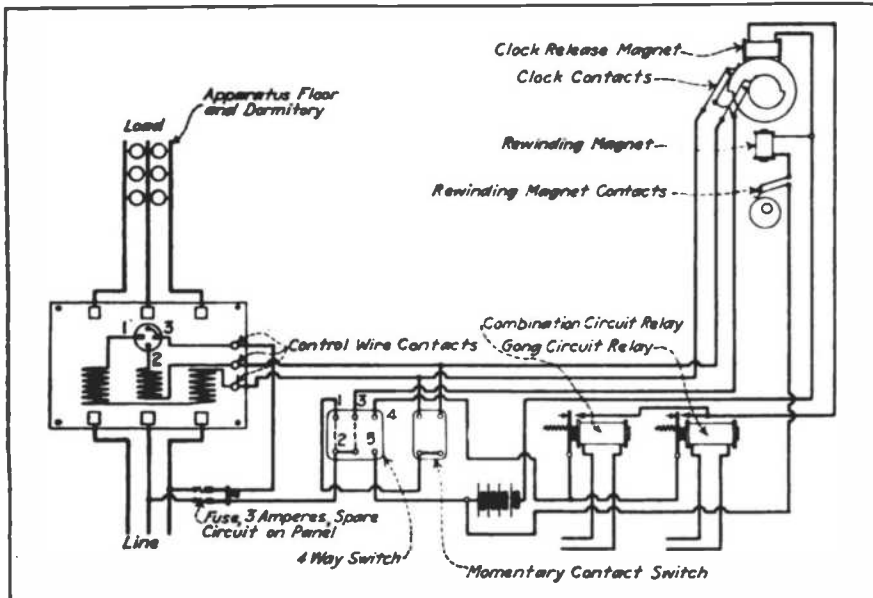

The accompanying diagram shows the action of the mechanism and the switch.

(G) is an electro-magnet in series with the gong circuit. (C) is an electro-magnet in series with what is known as the combination circuit, a secondary alarm which rings at the expiration of the gong alarm as a precaution against non-operation or misinterpretation of the gong alarm. Either of these relays, with the first stroke of the alarm, momentarily closes the battery circuit to the release magnet (R) which releases the cams shown just below this magnet. Revolution of these cams causes the outer of the clockwork contacts (P) to close momentarily, the pilot circuit attached to the line at (F), which enters the outer solenoids of the remote control switch through contacts (Y and Z), and, by action of the switch, to close the load circuit. Further revolution of the cams (after a lapse of time required for the men and apparatus to leave the house) causes the inner clockwork contact at (P) to close again, momentarily, the pilot circuit which this time, however, enters the remote control switch through contacts (Y and X)

used to throw the latter in or out of operation. The connections, while in operation, are from (1 to 3) and from (2 to 3), closing all the solenoids and control circuits to the point of the clockwork contacts.

Momentary contact is all that is necessary for the operation of the remote control switch as its action is caused, in either closing or opening, by tripping, and hence there is no necessity for the solenoid to be energized during the entire period of lighting.

Steady Resting a Splined Shaft

This suggestion will be found of value to those mechanics who are called on to do lathe work. It is simple yet useful to know, for it saves time and makes the task of steadying a shaft provided with a key way easier while working on it. The section of the shaft key way where it revolves in the rest is filled with babbit metal hammered in and scraped to the circumference, and the provision of an unbroken surface permits the shaft to revolve smoothly in the bearings of the steady rest.

Please mention EVERYDAY ENGINEERING MAGAZINE



See! Ain't She A Peach?

—that's what your gang'll say if you win the prize.

We'll tell the names of winners in February. The names and addresses of fellows who won prizes for giving the best uses for the

Auto-Wheel Coaster AND THE Auto-Wheel Roadster

Maybe your name will be there. Better watch. Thousands of fellows entered the contest and the judges had a hard time picking the winners. They promised to let us know in time to tell you in February.

More Prizes Coming

Now, if you or any of your gang did not win you have another chance coming. We're going to have a series of contests this year—just the kind of contests you fellows will like.

And say—the prizes you can win will make the other fellows say—"Ain't She a Peach!" Keep your eyes open for these new contests. Send for our Monthly Magazine. You will like it. It is full of contest news—how to get in on Auto-Wheel contests, with suggestions to help you win. Just give the names of three coaster dealers in your town and state which one handles the Auto-Wheel. Then we'll send the Magazine and a FREE FELT PENNANT. Also the story about organizing an Auto-Wheel Club—with FREE CAPS for all members.

Buffalo Sled Co., 150 Schenck Street.
In Canada: Preston, Ont. N. Tenawanda, N. Y.



Be a Draftsman! Make \$30 to \$75 a Week

Your name and address on the coupon brings this great Cyclopaedia of Drawing without a penny down. Pay only net shipping charges when books arrive. With these books and a low price "school set" of drawing instruments, obtainable at any store, a man can become master of drawing and earn \$30 to \$75 weekly. LEARN AT HOME—Good paying positions open everywhere. Intense activity in manufacturing, railroad, building, etc., calls for more draftsmen.

Shipped on 7 Days' FREE TRIAL CYCLOPEDIA OF DRAWING

4 Volumes. 1650 Pages. Thousands of Illustrations. Bound in genuine American morocco. Pages 8 1/2 x 8 1/2 inches. Covers all branches of Drafting—Architecture, Electrical, Structural Steel, Sheet Metal, etc. Teaches pen-and-ink rendering, lettering, free-hand, perspective, shades and shadows, working shop drawings, machine design, etc., etc. Only \$2 a month if you keep the 50c a Week books. Coupon explains offer, good only within borders of U. S. and Canada. Free Membership in This Society.—A Consulting Membership given free with each set—worth \$12.00.

AMERICAN TECHNICAL SOCIETY
Dept. D-351 Chicago



Please send Cyclopaedia of Drawing for 7 days examination, shipping charges collect. I will send \$1.80 within 7 days and \$2 a month until \$14.80 is paid, or notify you and hold books subject to your order. Title not to pass until fully paid.

Name.....
Address.....
Reference.....

Triplane Breaks Altitude Record

ALL altitude records were shattered when Roland Rohlfs ascended to a height of 34,610 feet in his Curtiss Wasp triplane equipped with a K-12 400 horsepower engine. In an unofficial flight he reached a height of 34,200 feet. The latest flight was officially observed and confirmed throughout, and broke all previous records.

This last flight marks the fourth time that Rohlfs has ascended more than 30,000 feet in the same machine since last July, and in each flight he has beaten all competitors, by returning to the same field from which he started. On July 30th he made an official record of 30,700 feet. The highest credited record until this time has been held by Adjutant Casale, of the French army, who ascended 33,136 feet on June 14th.

The entire flight was made in one hour and 53 minutes. At the height of 34,610 feet the temperature was 43 degrees below zero, one degree warmer than it was at the height of 34,200 feet made on a previous flight.

The same pilot and machine broke all world's records for climbing by rising to an altitude of 19,500 feet in 9 minutes and 42.4 seconds. This feat was accomplished at Roosevelt Field, L. I., in his Curtiss Wasp triplane, and is about 2,000 feet per minute.

Airplane Fuel Pumps

IN the pioneer days of aviation, engines were low-powered and flights short and the gasoline system very simple. In the modern commercial plane, fitted with multiple engines required to run several hours without replenishment and perhaps flying across country with but few landings places between, the problem becomes more complex and the fuel supply system must be completely reliable.

Pumps are of many designs, varying from the simple plunger type to vane pumps and gear pumps. These are sometimes driven by a flexible shaft from the engine. Pressure pumps have been almost totally discarded. Pumps which are geared right on to an engine are not always located in the best possible way for the rest of the system. Flexible shafts are one continuous source of worry.

European designers seem to favor a pump with simple vanes, driven by an air turbine. The air-screw and pump impeller are mounted on the same shaft the pump body is, nicely streamlined, located in the slip-stream of the propeller and well below the level of the tank. The over-all efficiency is undoubtedly low, but there is considerable

This is not a Real Machine but a Wading River 4-Foot Scale Model NC-4

With a Wading River outfit, you, too, can build this perfect exhibition and experimental model. It is equipped with complete controls, dummy Lib-



erty Engines, Paragon Propellers—every detail a perfect reproduction of the original. It is easy to build with Wading River parts.

BUILD AND FLY A MODEL NIEUPOORT SCOUT BIPLANE

You can make it from our complete unassembled outfits. What this builder says stands good with all others who build this perfect model.

Feb. 9, 1919.
Have had fine success with my Nieuport Biplane. It has flown 181 feet. E. Waterhouse, 521 W. Mo. St., El Paso, Texas.

SET OF 11 SCALE DRAWINGS OF BEST KNOWN MACHINES FOR \$1.50

This set includes the Nieuport monoplane, Blériot, Curtiss Hydroplane, Antionette, Langley Tandem, German Taube, Deperdussin, Wright biplane, White Racer, White Flyer, and Champion Racer. Send 5c for our latest catalogue containing illustrations of models of Curtiss J.N.4-B, S.P.A.D. Scout, De Havilland 4, Caproni Biplane, Handley Page, Sopwith Triplane and others.

WADING RIVER MANUFACTURING CO.

672-D Broadway

Brooklyn, N. Y.

choice of position, reliability and simplicity. Owing to the slip-stream of the propeller furnishing the actuating air current, the pump works perfectly well before the plane is started. Several air-driven pumps have already been devised and it would appear that American designers could give pumps of this kind careful consideration in laying out the airplane fuel systems.

Limit of Air Screw Tip Speed

RATHER divergent views regarding the limiting speeds of aerial propeller tips have been advanced recently by British authorities. Lord Weir, of the Air Ministry, has stated that the speed of sound in air (1050 ft. p. s.) should not be exceeded. Dr. Leonard Bairstow claims that experiments at the Royal Aircraft factory have shown that at about 900 ft. per second the nature of a flow from a propeller suffers a marked and striking change. Up to about that speed the usual strong breeze was felt in rear of the propeller, but at higher speeds the slip stream disappeared, leaving a region of comparative calm behind the screw. On investigating the phenomenon it was discovered that the flow above the critical tip speed was largely centrifugal instead of resembling a jet of somewhat less diameter than the screw. As the speed rose through the critical value there was no sudden variation of power required to drive the screw, but it is obvious that at and above the critical speed the propeller must become very inefficient as an organ of propulsion.

AVIATION FREE Information

Send us your name and address for full information regarding the Aviation and Airplane business. Find out about the many great opportunities now open and how we prepare you at home, during spare time, to quality. Our new book "Opportunities in the Airplane Industry" also sent free if you answer at once.
AMERICAN SCHOOL OF AVIATION
Dept. 7451 431 E. Dearborn St. CHICAGO



Glide "O" Plane

Learn the principles of Aviation by flying our famous Glide "O" Plane, shipped complete ready to assemble and fly with illustrated flying instructions. PRICE 55 Cents POSTPAID IN U.S.A.

Illustrated instructions from which you may carve an accurate propeller complete with a sample propeller blank. 30 Cents POSTPAID IN U.S.A.

Both the above postpaid in U. S. A. 75 Cents. Send for our catalogue D4. It is free.

HEC Aeroplane Co.
345 East 49th St., New York City

WHAT IS \$1.50 WORTH ?

In twelve numbers of Everyday Engineering there is the equivalent of:

- 2 BOOKS ON MODEL MAKING, WORTH.....\$ 6.00
- 1 BOOK ON AUTOMOBILES, WORTH..... 3.00
- 1 BOOK ON AIRPLANES, WORTH..... 2.00
- 2 BOOKS ON WIRELESS, WORTH..... 6.00
- 3 BOOKS ON GENERAL EXPERIMENTS, WORTH... 10.00

A \$1.50 subscription to Everyday Engineering is equivalent to \$27.00 worth of books

The Greatest Book Ever Offered to the Public

Henley's Twentieth Century Book of **RECIPES, FORMULAS AND PROCESSES**



10,000 Trade Secrets
Practical Recipes
Chemical Processes
Scientific Formula

HOW TO MAKE EVERYTHING FOR THE HOME, THE FACTORY AND THE WORKSHOP.

Antiseptics, Waterproofing, Lubricants, Rust Preventatives, Dyes, Filters, Cleaning Preparations, Enameling, Beverages, Inks, Adhesives, Polishes, Disinfectants, Flavorings, Cosmetics, Ceramics, etc., etc.; how to make fly paper; to color flowers artificially; to estimate weight of ice by measurement; to make materials fireproof; to work with metals—aluminum, brass, etc.; to make anything and everything, from A to Z.

THIS IS THE BOOK every one who seeks PRACTICAL, ACCURATE KNOWLEDGE and guidance in his everyday work MUST HAVE at his command.

It is a money-maker and a money-saver; it appeals to the young as well as to the old. Great business enterprises owe their success to the manufacture or sale of simple inventions or compounds, usually the result of an experiment at home. One woman writes: "I am supporting myself and two small children from the sale of toilet articles I put up by following directions in your book." Profit by the knowledge that has made others successful. **GET THIS BOOK TODAY.**

Price \$4.00

Delivered to any address

Send for our catalogue of practical books including a description of above book.

THE NORMAN W. HENLEY PUBLISHING COMPANY
2 West 45th St., New York, N. Y.

Airplane Design Based on Models

A COMMITTEE of British aviation experts appointed some time ago to consider the value of model experiments in connection with the design of full-sized machines reached a number of interesting conclusions in its report. It advises as follows:

(1) In testing, biplane design model aerofoils must be mounted as biplanes, and for monoplane determinations as monoplanes. The more closely the model wing conforms to that used on the full scale machine, the more reliable the results. Certain differences remain unexplained, so no high accuracy can be obtained in the prediction or verification of performances at low lift values.

(2) Suitable allowance must be made for scale effect on parts where it is known. In the case of struts, wires, etc., this is known to be large, but these parts can be tested under conditions corresponding with those found on the full scale machine.

(3) The resistance of the various parts taken separately may be added together to give the resistance of the complete airplane with good accuracy, provided that such parts, such as the landing gear, which consists of a number of separate small pieces, are tested as a complete unit.

(4) Model tests form an important and valuable guide in aeroplane design. When used for the determination of resistance, they must be used with discrimination and a full realization of the modifications of co-efficient values which may arise owing to interference and scale effect. In preliminary determinations of the performance of a machine of known type, methods can be employed other than the addition of the resistance of all elementary component parts; every designer has at his disposal the full scale test results of a certain number of types of airplanes, and where a new design conforms to any known type, the most obvious point for starting improvement in design is given by these test results. For suggestion as to how the improvements can be made and their value, the designer is still dependent on model tests. It is of vital importance that the amount of information should be increased, and its use extended by thorough and systematic full scale research.

If you desire to stop by the roadside to change a tire or make other repairs, try to select a place where the car will not obstruct the traffic. Consider two cars passing where you have stopped and place yourself in the position of one of them.

DRAFTING



Learn at Home!

Employers everywhere are looking for skilled draftsmen. They are offering splendid salaries, and good positions are always open.

No line offers greater opportunity for advancement. Drafting itself not only commands good pay, but it is the first step toward success in Mechanical or Structural Engineering or Architecture.

There is an easy delightful way in which you can learn right at home in spare time. For 28 years the International Correspondence Schools have been giving men and women just the training they need for success in Drafting and more than 200 other subjects. Hundreds of thousands have stepped into good positions through I. C. S. help but never were opportunities so great as now.

Let the I. C. S. help you. Choose the work you like best in the coupon below, then mark and mail it today. This doesn't obligate you in the least and it will bring you information that may start you on a successful career. This is your chance. Don't let it slip by. Mark and mail this coupon now.

INTERNATIONAL CORRESPONDENCE SCHOOLS
BOX 6066-SCRANTON, PA.

Explain, without obligating me, how I can qualify for the position, or in the subject, before which I mark X.

- | | |
|---|---|
| <ul style="list-style-type: none"> <input type="checkbox"/> ELECTRICAL ENGINEER <input type="checkbox"/> Electrician <input type="checkbox"/> Electric Wiring <input type="checkbox"/> Electric Lighting <input type="checkbox"/> Electric Car Running <input type="checkbox"/> Heavy Electric Traction <input type="checkbox"/> Electrical Draftsman <input type="checkbox"/> Electric Machine Designer <input type="checkbox"/> Telegraph Expert <input type="checkbox"/> Practical Telephony <input type="checkbox"/> MECHANICAL ENGINEER <input type="checkbox"/> Mechanical Draftsman <input type="checkbox"/> Ship Draftsman <input type="checkbox"/> Machine Shop Practice <input type="checkbox"/> Toolmaker <input type="checkbox"/> Gas Engineer <input type="checkbox"/> CIVIL ENGINEER <input type="checkbox"/> Surveying and Mapping <input type="checkbox"/> FIRE WORKS OR EXPLO <input type="checkbox"/> ARCHITECT <input type="checkbox"/> Architectural Draftsman <input type="checkbox"/> PLUMBING AND HEATING <input type="checkbox"/> Sheet Metal Worker <input type="checkbox"/> Navigator | <ul style="list-style-type: none"> <input type="checkbox"/> CHEMICAL ENGINEER <input type="checkbox"/> SALESMANSHIP <input type="checkbox"/> ADVERTISING MAN <input type="checkbox"/> Window Trimmer <input type="checkbox"/> Show Card Writer <input type="checkbox"/> Outdoor sign Painter <input type="checkbox"/> RAILROADER <input type="checkbox"/> ILLUSTRATOR <input type="checkbox"/> DESIGNER <input type="checkbox"/> BUSINESS MANAGEMENT <input type="checkbox"/> Private Secretary <input type="checkbox"/> BOOKKEEPER <input type="checkbox"/> Stenographer and Typist <input type="checkbox"/> Cert. Pub. Accountant <input type="checkbox"/> Traffic Management <input type="checkbox"/> Commercial Law <input type="checkbox"/> GOOD ENGLISH <input type="checkbox"/> STATIONARY ENGINEER <input type="checkbox"/> CIVIL SERVICE <input type="checkbox"/> Railway Mail Clerk <input type="checkbox"/> Textile Overseer or Supt. <input type="checkbox"/> AGRICULTURE <input type="checkbox"/> Social <input type="checkbox"/> Penitentiary Warden <input type="checkbox"/> Automobile <input type="checkbox"/> Italian |
|---|---|

Name _____ 7-25-19
 Present Occupation _____
 Street and No. _____
 City _____ State _____

Send for This Book of Model Aeroplanes

Tells how you can build and fly accurate, reduced-scale Models of real Aeroplanes; DE HAVILLAND Battle Plane, NC-4 and others. You can build one easily. Send 10c in stamps NOW and get this 48-page book.

Plans for Model Aeroplanes—NC-4, 50c; DE HAVILLAND Battle Plane, Curtiss Military Tractor, Bieriot Monoplane, Nieuport Monoplane, Taube Monoplane, 35c each; Cecil Pool Champion Racer, 25c. Send for Plans or Book Today.

IDEAL AIRPLANE & SUPPLY COMPANY
 Making Model Aeroplanes Since 1911
 Cor. W. Houston & Wooster Sts.
 New York

Speed of Wood Saws

SAWS for cutting wood are generally designed to run at a certain speed which depends upon the size of the saw, the quality and temper of the material of which it is made and the work to be done. For best results operators should try to maintain this speed as closely as possible. The following figures give the revolutions per minute usually recommended for wood saws of the diameters shown. One column applies to high-grade, well-tempered saws and the other to ordinary steel saws used for sawing cordwood:

Diameter in inches	High-grade Cordwood	
	Steel	Grade
16	2500	1970
18	2250	1500
20	1950	1300
22	1750	1200
24	1600	1100
26	1500	1000
28	1400	930
30	1300	870
32	1225	820

If the speed is much lower than that given for the kind and size of saw, the saw will not cut clean and more power will be required, while higher speeds than recommended will tend to cause a large amount of vibration and increase the danger of bursting.

Raising Steam by Electricity

AT first thought, the use of electricity for heating boilers to raise steam would seem to be a very inefficient method of generating power, and it would be if the electricity was generated in the usual way by burning coal under boilers, using a steam engine and turbine to drive a dynamo and then taking the current produced to generate steam again. Greater efficiency would be secured by burning coal under the boiler. Where coal is scarce and electricity developed by water power is cheap, then perhaps the electrical heat would be justified. A German engineering journal describes such a boiler. Narrow tubes of insulating material such as porcelain containing water are arranged vertically so as to communicate with the interior of the boiler at the upper and lower ends of the tubes. Current is passed through the water columns enclosed in the tubes. The resistance is relatively high, and accordingly high voltage alternating current is desirable, three phases being used. The current is regulated by moving electrodes in the tubes, which serves to vary the resistance of the water column. The efficiency of the boilers is said to exceed 95 per cent. One heating unit produces about 5 pounds of steam at 90 to 120 pounds pressure. Steam boilers with a capacity of 1,500 kw., with voltages of supply up to 10,000 volts, have so far been designed and used successfully.

Chemists Develop Tar Remover

ONE of the articles developed by the war chemists while experimenting to produce something else was a tar distillate which will dissolve tar as readily as a fire will melt a tallow candle. But it will also ruin varnish if used by itself. A scientific admixture of the distillate with oil and other ingredients, however, renders it harmless so far as the varnish is concerned, but still leaves it death to tar deposits on the automobile.

When applied, it must not be rubbed hard. The heat engendered by friction causes injury to the varnish. The proper application is as follows: With a soft rag, saturated with the liquid, cover the tarred parts. Allow it to remain on them a minute or two; then with a clean rag wipe it off gently, but at the same time get the surface dry—otherwise, it will accumulate dirt. The material is also a very good engine cleaner. May be used effectually inside or outside the engine. It is safer than gasoline because, while inflammable, its vapor is not explosive under ordinary service conditions.

An Easily Fusible Metal

Wood's Metal is the only known alloy that will fuse at 160 degrees F. and it has the lowest melting point of any of the fusible alloys. It consists of the following:

- Bismuth.....4 parts
- Lead.....2 parts
- Tin.....1 part
- Cadmium.....1 part

This alloy will melt in hot water. Other alloys containing mercury are unsuited for many uses as the mercury is apt to separate under certain conditions. The experimenter can mystify non-scientific friends by casting small objects of this alloy and causing them to disappear by obvious methods.

INDICATING CALIPERS



Here is a finely made tool incorporating features of rule, calipers, indicator and micrometer. Adjustment is provided for wear of parts. Bear movement is effected by ball bearings. A coiled spring draws points together. Tool can be set for desired dimension. It is a one hand tool, leaving other hand free for holding of the work.

Made in two capacities:
 2" capacity, graduated in 100ths in.
 3" capacity, graduated in 64ths in.
 Price \$1.50

Send for folder or inquire of your dealer.

Indicating Calipers Co.
 506 East 19th St., New York

Umakem Outfit No. 8 includes 10 good tools, designs, 3 ply wood, hardware, mechanical parts and everything to make a \$30 Toy Circus set including Animal Wagon and Circus Wagon each drawn by two large jointed animals with Clown Riders, 10 Wild and Domestic Animals, kicking and jumping Donkeys with riders and other Circus Things. This set is a red hot Money Maker and several people can work with Umakem No. 8 at the same time. Fine for families, toy clubs and schools. Send \$10 for this set. Dealers buy Christmas toys now.

W. R. PRICE, Inc., Dept. 17, Umakem Bldg., 127 5th Ave., N.Y.

JUST OUT SELENIUM CELLS

THE Construction, Care and Use of Selenium Cells with Special Reference to the Fritts Cell
 By THOMAS W. BENSON

The lack of definite information relative to the construction of Selenium Cells has led the writer to record the results of some of his experiments and to fully describe the apparatus as developed by him.

- CONTENTS OF CHAPTERS
1. Selenium The Element
 2. Consideration of Cell Types and their Characteristics; The Bildwell Cell; The Rubmer Cell; The Mercadier Cell; The Bell and Taintor Cell; The Gripenberg Cell
 3. Construction of Fritts Selenium Cells
 4. Testing and Maturing Selenium Cells
 5. Applications of Selenium Cells
 6. The Care of Selenium Cells
- 73 pages, 15 diagrams and 3 halftone page plates, 7 1/2 x 5 1/4 inches. Cloth, \$1.50.

SPON & CHAMBERLAIN
 Publishers of Technical Books
 120-122 Liberty Street ; ; New York

MR. INVENTOR! Let us assist you with that idea that you can't just work out, or let us construct a model of your patent. We develop ideas, and are experts in MODEL and EXPERIMENTAL work. We specialize in designing and building special LABOR SAVING MACHINES. Or perhaps your device is ready for manufacturing. If so, get in touch with us. It would be to our mutual advantage.

ELK MFG. CO., INC.
 1926A Broadway, New York

IF YOU USE A. C. MOTORS YOU NEED THE ELECTRICAL WORKER'S FRIEND

A book of 66 diagrams showing the complete details for connecting and rewinding A.C. Motors. It saves more than its cost. Tells you everything you need to know. \$3.50.

H. E. BOSSHART.
 P. O. Box 68, Homewood St., Pittsburgh, Pa.

KLEANE-Z-SUSPENSORY
 FORM FITTING FOR ALL MEN
 LINEN (MESH) \$1.50
 ALL SIZES
 One Extra Sack
 PRICES
 Balbriggan \$1.25
 Linen (Mesh) \$1.50
 Fine Gilt Silk \$2.00
 Heavy Silk (Mesh) \$2.50
 A CLEAN SACK EACH DAY
 At your dealers or sent postpaid on receipt of price.
A. R. CHISHOLM CO., New York, N. Y.
 Suite 597 1328 BROADWAY

Your Prospective Customers
 are listed in our Catalog of 99% guaranteed Mailing Lists. It also contains vital suggestions how to advertise and sell profitably by mail. Counts and prices given on 9000 different national Lists, covering all classes; for instance, Farmers, Noodle Mfrs., Hardware Dirs., Zinc Mines, etc. This valuable reference book free. Write for it.
 Send Them Sales Letters
 You can produce sales or inquiries with personal letters. Many concerns all over U. S. are profitably using Sales Letters we write. Send for free instructive booklet, "Value of Sales Letters."
Ross-Gould
 Mailing Lists St. Louis

Burning Pulverized Coal

THE subject of the burning of pulverized coal and other fuel in boiler fires and the like is exciting great attention in England. The finely powdered fuel is blown into the fire and its combustion is practically instantaneous. Coal with as much as 28% of ash and 6% of sulphur can be used, and has been employed successfully in locomotives. In ordinary hand firing an excess of 100% to 200% of air enters the furnace; with a mechanical stoker it is a little better, only 50% excess entering. With pulverized coal an excess of air of about 20% is standard practice and this can be reduced. Taking the theoretical quantity of carbon dioxide gas, which should be in the chimney gases as 20.77%, this can be reduced to 11% with only 5% loss in efficiency. This reduction, it will be seen, implies an incomplete combustion. 15% of carbon dioxide in the chimney gases is considered good practice. The fuel is so finely pulverized that a single pound is calculated to have a surface area of 26 square feet. The drier the fuel is the better, and it is sometimes artificially dried. It weighs 38 to 45 lbs. to the cubic foot. Of the ash produced 65% is collected as a partly fused slag; the rest goes up the chimney as a fine dust, but seems to do no harm. Excess of air reduces efficiency on account of the fuel wasted in heating the nitrogen of the air.

Welding Torch Cuts Granite

In repairing a drawbridge across the Passaic River, at Newark, N. J., it became necessary to remove a casting and pin from a granite pier. After several unsuccessful attempts to draw the pin, as narrated in Stone, the pin projecting down 3 inches into the masonry, it was found necessary to cut a trench in the hard granite so that the casting might be shifted laterally to one side for removal and replacement by a new and larger center casting. This trench was 4 ft. long, 9 in. wide and 3 in. deep, extending under the old casting. The cutting of the trench would have been an endless task had it not been discovered that an oxyacetylene flame chipped the granite quite readily and could be used under the old casting without damaging the balance of the masonry. The desired channel was thus quickly obtained. The flame was also used for cutting away the abutment back of the fixed span bottom chord to provide expansion clearance. — *Compressed Air Magazine.*

PRINCE ALBERT the national joy smoke
Our exclusive patented process cuts out bite and parch.

Earn '35 to '100 a Week
BECOME A PROFESSIONAL PHOTOGRAPHER
Big opportunities NOW. Qualify for this fascinating profession. Three months' course covers all branches:
MOTION PICTURE—COMMERCIAL—PORTRAITURE
Orders and Materials furnished free
Practical instruction; modern equipment. Day or evening classes; easy terms. The School of Recognized Superiority. Call or write for complete catalog No. 10.
N. Y. INSTITUTE OF PHOTOGRAPHY
141 W. 36th St., N. Y. 505 State St., Bklyn.

PHONOGRAPHS FROM MANUFACTURER
24 different styles, \$4.00 up; \$150 style, \$40; \$100 style, \$35; \$50 style, \$15.
Plays Victor, Columbia and Edison Records.
Mail Orders Filled Promptly. Send for Catalogue.
DEALERS WHOLESALER.
LUCKY 13 PRODUCTS CO.,
5 East 15th St., New York.

DRAFTING
Inventions and Ideas Developed!
Mechanical, Electrical, Patent Office and Engineering Drawings of Every Description.
COMPETENT DRAFTSMEN AT YOUR SERVICE
A. G. HAGSTROM
116 Nassau St. New York City
Telephone Beckman 4888

CELLULOID
SHEETING, PRINTING, MOULDING, TURNING, DIE CUTTING, EXPERIMENTAL WORK, ETC.
NAPIER BROWNING CO.
105 W. 40th ST. NEW YORK CITY

SCHNOTER'S SUSPENSORIES
YOU can enjoy perfect comfort and freedom. Schnoter's Suspensories and Lock Straps have gained their wide-spread popularity by quality, wear, fit, and low price.
At Drug Stores or sent direct \$1.00
Send for booklet of other styles and prices
J. C. SCHNOTER CO.
523 SIXTH AVE. Dept. B N. Y. CITY

Don't Wear a Truss
Brooks' Appliance, the modern scientific invention, the wonderful new discovery that relieves rupture, will be sent on trial. No obnoxious springs or pads.
Mr. G. E. BROOKS
Brooks' Rupture Appliance
Has automatic Air Cushions, binds and draws the broken parts together as you would a broken limb. No valves. No ties. Durable, cheap. Sent on trial to prove it. Protected by U. S. patents. Catalog and measure blanks mailed free. Send name and address today.
Brooks Appliance Co., 264A State St., Marshall, Mich.

You can be quickly cured, if you
STAMMER
Send 10 cents coin or stamps for 70-page book on Stammering and Stuttering, "The Cause and Cure." It tells how I cured myself after stammering for 20 years.
Benjamin N. Boggs, 904 Boggs Bldg., Indianapolis

Stop Forgetting Memory the Basis of All Knowledge
The Key To Success
The secret of business and social success is the ability to remember. I can make your mind an infallible classified index from which you can instantly select thoughts, facts, figures, names, faces. Enables you to concentrate, develop self-control, overcome bashfulness, think on your feet, address an audience. Easy, Simple. The result of 20 years' experience developing memories of thousands.
Write Today for free booklet "How to Remember" and Copy-Righted, also how to speak in Public FREE book, How to Speak in Public.
Dickson School of Memory, 1740 Hearst Bldg., Chicago, Ill.

SPECIAL NON-VER-TER SLIDE RULE
The original KON-VER-TER slide rule has over 8,000 graduations and over 1,500 letters and figures, will handle anything in Arithmetic, Algebra, Geometry or Trigonometry. It is 4 inches in diameter and is used all over the world. It is much simpler to operate than others of similar construction. Eventually you will use the KON-VER-TER. Get it now and save money. Plain Utility rules \$1.00; Special Large white Ivory celluloid \$2.50. Leatherette case for extra.
HAMILTON & CO.
Dept. 17 Wall St., Boston U.S.A.

CHEMIST AMAZING DISCOVERY "MOTOROL"
ONE DOLLAR 25 to 40% more miles per gal.
POSTPAID 25 to 35% more power.
Agents Wanted. Starts your engine on a cold day instantly.
Eliminates Carbon Deposits. Less wear and tear on motor.
AUTO PRODUCTS CO.
Dept. 66 468 West 148th St., N. Y.

Umakem Club You send \$5 for instructions, designs, blueprints then you Make Umakem Money running Umakem Community Shows or form your own Umakem Club with the \$5 outfit. You can make Blarlot, Curline, Sped and other Flying Flashes; also real Work Benches, Sewing Stands, Stationary Baskets, Baskets, Book Trays, Arks, Circus, Wagons, War Tanks, Action Toys, Dogs, Birds, Squirrels, Elephants, Rabbits, Goats, Toads, Giraffes, Ostriches, Numbers, Letters, 10 Jointed Animals, Doll Furniture and Doll Houses. Principal dealers buy all their toys and novelties now for Christmas. Get your Umakem shop started quick and coin Umakem Money.
W. W. PRICE, Inc., Dept. 17 Umakem Bldg., 127 8th Ave., N. Y.

Small Investors Wanted
To co-operate in recovery of \$1,400,000 cargo. Salvage already accomplished by use of LEAVITT DIVING ARMOR proves practicability and big profits in future operations.
For full particulars address
Leavitt Deep Sea Salvage Co. Inc.
Temple Bar Annex, Brooklyn, N. Y.



WANTED-Railway Mail Clerks
\$1300 First Year
Common Education Sufficient
Sure Pay, Life Job. Full unnecessary.
COUPON
FRANKLIN INSTITUTE
Dept. 123 Rochester, N. Y.
Sirs: Send me, without charge (1) sample of Full Railway Mail Clerk Examination questions; (2) schedule showing pieces of all U. S. Government mailing examinations; (3) list of other government jobs open to men and women and (4) free book describing them.
Name.....
Address.....

CLASSIFIED ADVERTISING COLUMNS

Advertisements in these columns 5c per word, average 7 words to the line. To insert advertisement under proper classification copy should reach us not later than the first of the month.

Agents Wanted

AGENTS—Something different! Our Bradium (Laminose) Crucifix actually shines in the Dark. Startling! Mysterious! Wonderful enthusiasm follows every demonstration. 150% profit on every sale. Sole manufacturer. The Pioneer Corporation, 1265 W. 53rd Street, Chicago.

AGENTS. Signs for store and office. Entirely new. \$50-week easily made. Chicago Sign System 1-132-River St., Chicago.

MAKE \$30 NEXT SATURDAY. Sponderator for Fords selling like wildfire. Used by Ford Motor officials. Makes any Ford run like a Packard. Stops stalling and bucking. Put on quick—instant satisfaction. No holes to bore. Sell ten to twelve a day easy. Splendid profits and exclusive territory. Write quick for information. Address **PERBIN COMPANY**, 1043 Hayward Bldg., Detroit, Mich.

WE WANT YOU TO BE OUR LOCAL REPRESENTATIVE. Devote your spare time to taking subscriptions for *Everyday Engineering Magazine*. There is at the present time a great demand for this magazine and among your friends you can get many subscriptions. Good pay. Write for particulars. Address **EVERYDAY ENGINEERING MAGAZINE**, 3 West 45th Street, New York.

Auctioneers

AUCTIONEERS. Make big money. Free Catalogue. Carpenter's Auction School, Kansas City.

Automobile Accessories

MORE Power, less fuel, no carbon. No Mystery, plain facts, results guaranteed. Write for booklet. **No-Leak-O Piston Ring Company**, Baltimore, Maryland.

AUTOMOBILE REPAIRING MADE EASY—The most needed and useful book on Automobiles ever written. Only book of its kind. Covers every phase of Automobile repairing practice. 1000 pages. 1000 engravings. Price \$3.50 prepaid. The Norman W. Henley Publishing Co., 3 West 45th Street, New York.

VULCANIZE RUBBER without heat or tools. Whirlwind seller to every Auto Owner. Further particulars free. Muscatine Agency, B402, Muscatine, Iowa.

Automobile Schools

HAVE YOU A TRADE?—Why not learn the Automobile Business—actual practice under expert instructors qualifies you in a few weeks' time to repair or drive any make of car, truck or tractor. There are always plenty of good positions open for trained men. Write today for particulars to **Buffalo Auto School**, Dept. 84, Buffalo, N. Y.

Aviation

BUILD YOUR OWN AEROPLANE: materials on installment, in the rough or put it fit ready to assemble. Also machines completed. J. Angeles, Centralia, Wash.

WANT TO SELL small, uncompleted airplane, with motor, or will exchange for motorcycle. **BRUBAKER**, 523 East 17th St., New York.

Blueprints

MODEL ELECTRIC MOTOR Blue Prints 25c. Complete working outfit \$1.75. A. F. Cassel, 52 West 130th St., New York City.

Business Opportunities

MONEY SAVED—All kinds used correspondence courses sold. (Also courses bought.) Write **Lee Mountain**, Piagah, Ala.

Chemicals

MICROSCOPES, Balances, Experimental Laboratories. Buy through our easy Payment Plan. No red tape. Write for Booklet **34-E**. Chemical and apparatus supplied for all Chemistry articles appearing in *Everyday Engineering*. Perform their experiments with our equipment. **Lions Scientific Institute**, Bausman Street, Mt. Oliver, Pittsburgh, Penna.

EXPERIMENTERS.—This Ad pays for itself because *Everyday Engineering Readers* are our regular customers. Our chemicals, apparatus, and supplies outfit their laboratories. Why not yours? Ask for free prospectus and free service card. **Lions Scientific Institute**, Mt. Oliver, Pittsburgh, Pa.

Electrical

100 INDUCTION MOTOR winding diagrams 1, 2, 3, 3 phase star delta, 3 to 13 poles inclusive. Postpaid \$5.00. E. Glass, 3108 South Broad Street, Philadelphia, Pennsylvania.

Fish

GOLD FISH. Imported Japanese, Chinese and American fish aquarium plants. We manufacture beautiful home aquariums. Descriptive circular free. **Pioneer Goldfish Hatcheries**, Racine, Wisconsin.

Ford Owners

300-PAGE book on the Ford car for every Ford owner, dealer and repairman. Deals fully with construction, operation and repair. 100 engravings. Best and most complete Ford book published. Price, \$1.00 postpaid. Also Ford Engine Chart. 25x38 in. Location of engine trouble made easy. Price, 25 cents postpaid. The Norman W. Henley Publishing Co., 3 West 45th St., New York.

Formulas

370 FORMULAS, 10c. Fitzgerald, 15 West 65th St., New York.

EXPERT CHEMIST will furnish Formulas, Processes and Trade Secrets. All lines. Lists free. W. L. Cummins, Ph.D., 229-230 Gordon Ave., Syracuse, N. Y.

MANUFACTURING PROCESSES, Formulas, Technical Information. Interesting booklet free. Consulting Chemist, Little Falls, N. J.

For Sale

100 BK ENVELOPES PRINTED in your order (3) colors. 75c prepaid. Write for Samples. **Lincoln Novelty Co.**, Rochester, N. Y.

GENUINE INDIAN BASKETS—50 Styles. Catalogue. **GILHAM**, Highland Springs, California.

SELLING OUT parts for valves, water gauges, steam gauges, taps, dies, reamers and mills. An opportunity for model makers. Write for prices. **AITKEN**, 1714 Brown St., Philadelphia.

Gummed Labels

FREE CATALOGUE containing ideas in package labels suitable for your business. Stock labels a specialty. **Royal Label Co.**, 20 S. Seventh, Philadelphia.

Help Wanted

WRITE for newspapers and magazines. Big Pay. Experience unnecessary, details free. Press Reporting Syndicate, 524 St. Louis.

MODEL MAKERS—Splendid opportunity in marine model shop for several young men who have decided taste and inclination in this line of work in both wood and metal. Write fully stating age, experience, where had, and wages expected. Address **Model Maker**, *Everyday Engineering Magazine*, 3 West 45th Street, New York.

U. S. GOVERNMENT wants hundreds railway mail clerks. Beginners salary \$1200 year. Men-women, 18 up. List positions free. Write today. **Franklin Institute**, Dept. O-99, Rochester, N. Y.

Inventors

INVENTORS. In all matters concerning Patents, The National Institute of Inventors, 118 Fulton St., New York City, a co-operative society of 2500 will help you protect, develop and market your inventions. Annual dues \$10.00. Booklet on request.

INVENTORS—We do experimental, Model, Tool, Die and Jig work. Light manufacturing. **Miller & O'Brien Mfg. Co.**, Saint Paul, Minn.

INVENTOR'S MANUAL, HOW TO MAKE A PATENT PAY is a work of special interest to inventors in perfecting their inventions, taking out their patents, and disposing of them. It is not in any sense a Patent Solicitor's circular nor a Patent Broker's advertisement. No advertisements of any description appear in the work. It is a book containing a quarter of a century's experience of a successful inventor, together with notes based upon the experiences of many other inventors. (20 pages). Price \$1.35 postpaid. The Norman W. Henley Publishing Co., 3 West 45th Street, New York.

TWO VOLUMES ON MECHANICAL MOVEMENTS by G. D. Hinson are works every inventor should have for it is illustrated in these volumes. If it hasn't been referenced, if the thing you want has been invented, invented, then you'll find in it the nearest things to what you want, some movement or device that will apply in your case, perhaps; or which will give you a key from which to work. No books ever published are of more real value to the inventor, draftsman or practical mechanic than this set of books. Price per volume each \$3.00 prepaid. The Norman W. Henley Publishing Co., 3 West 45th Street, New York.

Male Help Wanted

RAILWAY TRAFFIC INSPECTORS; \$110.00 a month to start and expense; travel if desired; unlimited advancement. No age limit. Three months home study situation arranged. Prepare for permanent position. Write for booklet **CM-55 STANDARD BUSINESS TRAINING INSTITUTE**, Buffalo, N. Y.

FIREMEN, BRAKEMEN, BAGGAGEMEN, \$140-\$200. Colored Porters, by railroads everywhere. Experience unnecessary. 898 Railway Bureau, East St. Louis, Ill.

Miscellaneous

TOBACCO OR SNUFF HABIT cured or no pay. \$1.00 if cured. Remedy sent on trial. **Superba Co.**, S. M., Baltimore, Md.

FREED Canaries—Profitable pastime. Particulars free. **Bird Farm**, Lynnhaven, Virginia.

SPORTSMEN.—Trained beagles, rabbit, fox, coon, skunk, squirrel, and opossum dogs, bird dogs, pet and farm dogs, swine, rabbits, pigeons, pheasants, geese.—100 Varieties blooded stock. Circulars 10c. **VIOLETT HILL KENNELS**, YORK, PA.

Model Supplies

SPECIAL MODELS DESIGNED. Also many standard designs. Write, telling us what you want. **F. R. Harris**, Central Y. M. C. A., Columbus, Ohio.

BOYS build your own Electric Motor. Complete outfit \$1.75. Blue Prints 25c. **A. F. Cassel**, 52 West 130th St., New York City.

Motion Picture Plays & Supplies

\$25-\$300 paid anyone for ideas, suggestions suitable for photoplays. Experience unnecessary; complete outline free. **Producers League**, 244 St. Louis, Mo.

Patents

PATENTS. Booklet free. Highest references. Best results. Promptness assured. **WATSON E. COLEMAN**, Patent Lawyer, 824 F St., Washington, D. C.

PATENTS—Herbert Jenner, patent attorney and mechanical expert. 633 F St., Washington, D. C. I report if a patent can be had and its exact cost. Send for circular.

PATENT WHAT YOU INVENT. It may be valuable. Write me. No attorney's fee until patent is allowed. Estab. 1882. "Inventor's Guide" **FRANK**, Franklin H. Hough, 510 Loan & Trust Building, Washington, D. C.

PATENTS. Prompt, personal efficient service by an Attorney-at-law skilled in all branches of Patent practice. Over 13 years actual experience. Full information upon request. **B. P. Flashburne**, 323 McGill Building, Washington, D. C.

PATENTS. Over 70 years' practice; all communications strictly confidential; handbook on patents free on request; special facilities for office consultations. **Mann & Co.**, patent attorneys, 441 Woolworth Building, New York. 625 F Street, Washington, Tower Building, Chicago.

INVENTIONS PATENTED: Trade-Marks Registered; Labels, Prints, Publications Copyrighted; prompt service; reasonable fees; plain advice; request detailed information before placing your business. **Jaynes & Jarvis**, 804 Kelson, Washington, D. C.

PATENTS—Fees in installments. **Frank T. Fuller**, formerly Lieutenant, Engineers, Washington, D. C.

INVENTOR—Write for our free illustrated guide book and Evidence of Conception Blank. Send model or sketch and description of invention for our opinion of its patentable nature free. Highest References. Prompt Service. Reasonable Terms. **VICTOR J. EVANS & CO.**, 748 Ninth, Washington, D. C.

PATENT ATTORNEY, Consulting Engineer. High class patent service in all its branches. Write for particulars. **M. H. Loughridge**, 1457 Broadway, New York.

Photography

DO YOU TAKE PICTURES? Write for free sample of our big magazine showing how to make better pictures and earn money. **American Photography**, 466 Pope Building, Boston, Mass.

Printing

FIRST CLASS JOB PRINTING. Satisfactory work assured at reasonable prices. All orders receive prompt attention. Price list upon request. **Mansler Bros.**, 270 Hanford, Rochester, N. Y.

Purchasing

LET ME DO YOUR BUYING. I will quote you best price and delivery on anything. **Purchasing Agent**, **W. G. B.**, 1337 St. Marks Ave., Brooklyn, N. Y.

Short Stories Wanted

SHORT STORIES, Poems, Plays, Etc., are wanted for publication. **Literary Bureau**, 108 Hannibal, Mo.

Stamps

APPROVALS 50% discount. References, please. Stamps bought. **Lang**, 1433-J 59th, Cicero, Illinois.

STAMPS SENT ON APPROVAL at 70% discount. Reference required. **J. Emory Benoit**, Dept. W, Hanover, Pa.

Tricks

1,000 STAGE TRICKS with 500 illustrations. Catalogue 15c. Small Catalogue Free. **Horsman Magic Co.**, Station 8, 304 West 34th St., New York.

Wireless

WIRELESS PARTS, PROMPT DELIVERY. Standard 1 1/2" switch knob-lever complete 25c. Switch points with screws 25c dozen. State panel thickness. **Norvotry Electric**, Charlotte, N. C.

WELDING APPARATUS for all purposes. All cash number of plants left to fill orders for rental plan. All equipment highest grade. Guaranteed for one year. Write or wire today. **E. E. Bermo Co.**, Omaha, Neb., U. S. A.

WELDING INSTRUCTIONS written in plain language and illustrated. Post paid, fifty cents. **A. J. P. Hertachy**, Cor. 20th and Harney, Omaha, Neb.

Please mention EVERYDAY ENGINEERING MAGAZINE

Short Cuts to Bigger Pay

Your last chance to procure one of these famous McGraw-Hill Home Study Courses at the old prices.



Croft's Library of Practical Electricity

The only electrical library in existence that actually teaches electrical practice as experts know it. 3,000 pages and 2,100 illustrations taken from electrical work itself. 8 flexibly bound volumes, pocket-size. Easy to read and easy to understand, and the principles easily applied to work as it is done. For both the beginner and trained man, for reference or study. Price before Feb. 28th, 1920, \$16. Afterwards \$20, payable \$2 in ten days and \$3 per month.



Power Plant Library

The most used engineers' library ever published. Over 30,000 power plant men are using them as a means of passing examinations and becoming chief engineers. 8 volumes, durably bound in dark blue cloth. About 2,700 pages, 1,800 illustrations. If you are interested in any branch of power plant work you must have these books. They will enable you to pass the examination in any state. Price before Feb. 28th, 1920, \$12. Afterwards \$16, payable \$2 per month.

Not one cent in advance

Merely check the library in which you are interested, fill out the coupon and return to us. We will ship the set of your choice for ten days' absolutely free examination. Return at our expense if you are not thoroughly pleased. Pay only the small monthly payments called for if you are satisfied the books will increase your earning power. But act now. Tomorrow may be too late to get the books at the old price.

McGraw-Hill Book Co., Inc.
239 West 39th Street, New York

Here are three of the McGraw-Hill Home Study Courses that make promotion sure. Each represents practically a life time of study and practice. They are not correspondence courses. They are self-teachers. All the information you need is laid before you in plain language and plain illustrations.



Machine Shop Library

The practical side of machine shop work, written by such well known authorities as Colvin, Stanley, Lake, Goodrich, Haas, &c.. 3,000 pages, 2,000 illustrations. 9 volumes, dark red cloth, morocco grained. Suitable to the needs of every man connected in any way with the machine shop. Records of actual practice that show the way to more pay. Price before Feb. 28th, 1920, \$16. Afterwards \$20, payable \$2 in ten days and \$3 per month.

Save \$4 by ordering NOW

An advance of \$4 in the price of each set must be put into effect after February 28, 1920. Orders received by us after that date will be charged at the increased rate. No exceptions can be made. Even at the new prices these books are the best buy in engineering literature of the time.

FREE EXAMINATION COUPON

Add \$4 to the price of each set after February 28, 1920

McGraw-Hill Book Co., Inc., 239 W. 39th St., N. Y.
Gentlemen: Send for ten days' free inspection the Library I have checked below:

- Croft's Electricity, \$16—payable \$2 per month.
- Machine Shop Library, \$16—payable \$3 per month.
- Power Plant Library, \$12—payable \$1 per month.

If satisfactory I will send first payment in ten days and the same amount each month until paid. If not wanted I will return the books at your expense.

Signature

Residence address.....

City and State.....

Your employer.....

His address.....

Your occupation..... ED-2-2

Let me work for you



WORK for Kings and Queens.
I work for the President of the
United States.

I work for the Architects
who build your sky scrapers.

I work for the Surveyors
and Engineers who make your
big bridges and subways possible.

I have a Mathematical key-
board with the characters and
symbols used in higher and
lower Mathematics, and for
Engineering, Mechanics, etc.

I AM INVALUABLE TO THE
STUDENT OF MATHEMATICS, ENGI-
NEERING, CHEMISTRY, AND MEDIC-
INE, AS I CARRY THE CHAR-
ACTERS AND SYMBOLS IN EVERY
PROFESSION—EVERY SCIENCE.

I "speak" every language,
from Eskimo Indian to Kata
Kana Japanese.

I use "speak" advisedly,
because I literally make your
writing talk—as these sam-
ples of my work show.

The above paragraphs were written on our Multiplex and
give a very limited example of the work that can be done on
this unique "writing machine"—the only "writing machine"
in existence. Just examine the Multiplex and you'll find
that it is as great an improvement over the ordinary typewriter
as the fountain pen is over the old-fashioned quill.



Also an Aluminum PORTABLE Model

For traveling — for
Home. Weighs about
11 lbs. Full capacity.
Ask for special
folder.

The Hammond Typewriter Co.
585A E. 69th Street New York City

The
Heart
of the
Hammond



I am the

MULTIPLY HAMMOND

Standard "Writing Machine"
Over 365
Different Type-Sets

Including All Languages to Select From
Any one of which may be substituted in a few
seconds: "Just Turn the Knob"

I have shown you a few proofs of my versatility in
the various types in the column opposite.
I think you will agree with me, when you see me, that
no other typewriter can do what I do.
No other typewriter can make your writing "TALK."
No other typewriter can INSTANTLY change from
one style of type, or from one language to another.

Multiplex Hammond Reasons

1. Variety of writing beyond the ordinary.
 2. All sorts of type and languages on ONE Multiplex.
 3. Automatically uniform type impressions without a cultivated touch.
 4. Permanently perfect alignment.
 5. Any width of paper, and writes cards flat without bending.
 6. Large type, small type, medium type—all on ONE Multiplex.
 7. Aluminum Portable, travellers' and home model.
- There are more than sixteen (16) things I can do that cannot be done on any other writing machine; and it will pay you to

Mail the Coupon for FREE BOOKLET "How President Wilson Frightened the Lords at Midnight"

We will also send you our
pamphlet, "People Who Count."
Thousands of prominent men
and women in all walks of
life, and in all four corners
of the globe, prefer and personally
use the Multiplex.
Note this partial list:
President Wilson
Queen Alexandra of England
King and Crown Prince of
Sweden

Caliph of Morocco
King and Queen of Norway
Cardinal Merry del Val
Sir James Matthew Barrie
Walt Mason
Wallace Irwin
William Dean Howells
Bertha M. Clay
John Kendrick Bangs
Leigh Mitchell Hodges
Prof. L. A. Loiseau
Etc., Etc.

MAIL FOR FREE BOOKLETS

HAMMOND TYPEWRITER COMPANY,
585A East 69th St., New York City.

Please send, entirely free and without obligation, the literature mentioned in your advertisement in Everyday Engineering.

Name

Address

Occupation



Automobile \$125
Engineer AWeek



Automobile \$50
Repairman AWeek



Expert \$40
Chauffeur AWeek



Garage \$150
Owner AWeek

Take Your Choice of These Big Paying Jobs

THOUSANDS of men like you are wanted to fill these big-paying jobs in the automobile engineering field. Thousands of places are open, too, for chauffeurs and garage managers. It's easy to get one of these good jobs and to prepare yourself to hold it. You don't have to go to school. You don't have to serve an apprenticeship. Spare time only is needed. These great automobile books will teach you everything you need to know. Fifteen of the greatest engineers and experts in the business wrote them in simple language that anybody can understand.

Auto Books 6 Volumes Shipped Free

Just off the press—the 1920 model—an up-to-the-minute six-volume library on Automobile Engineering, covering the construction, care and repair of pleasure cars, motor trucks and motorcycles. Packed full of advance information on Lighting Systems, Garage Design and Equipment, Welding and other repair methods. Contains everything that a mechanic or an engineer or a motorcyclist or the owner or prospective owner of a motor car ought to know. Anybody can understand them. Tastefully bound in American Morocco, flexible covers, gold stamped, 2650 pages and 2300 illustrations, tables, blueprints and explanatory diagrams. A library that cost thousands of dollars to compile but that comes to you free for 7 days' examination. Over 56,000 sets of previous editions have been sold.

Only 7c a Day!

Not a cent to pay in advance. First you see the books in your own home or shop. Just mail coupon and pay express charges when books arrive. You can read them and study them for seven whole days before you decide whether you want to keep them or not. If you like the books, send only \$2.80 in 7 days and \$2 a month until the special introductory price of \$21.80 has been paid. (Regular Price \$30.) Along with the set goes a year's consulting membership in the American Technical Society. (Regular price \$12.) This part of our offer will be withdrawn when the membership is filled. Mail the coupon without delay.

Don't Send Money Now!

Don't take our word for it. See the books without cost. Here is a chance for you to get a real man's job with a man's size pay. Don't waste a minute in sending the coupon. Put the coupon in the mails today. Send no money—just the coupon!

American Technical Society, Dept. A-353 Chicago, Ill.

FREE Examination Coupon

American Technical Society, Dept. A-353 Chicago

Please send me the 6-volume set of Automobile Engineering for 7 days' examination, shipping charges collect. If I decide to buy, I will send \$2.80 within 7 days and the balance at \$2 a month until the \$21.80 has been paid. Then you send me a receipt showing that the \$20 set of books and the \$10 Consulting Membership are mine and fully paid for. If I think I can get along without the books after 7 days' trial, I will notify you to send for them at your expense. (Please fill out all items.)

Name _____
Address _____
City _____ State _____
Reference _____



Partial Contents

Automobile Motors; Welding; Motor Construction and Repair; Carburetors and Settings; Valves; Cooling; Lubrication; Fly-Wheels; Clutch; Transmission; Final Drive; Steering Frames; Tires; Vulcanizing; Ignition; Starting and Lighting Systems; Shop Kinks; Commercial Garage; Design and Equipment; Electric; Storage Batteries; Care and Repair of Motorcycles; Commercial Trucks; Gas Tractors.

128 Blueprints of Electric Wiring Diagrams