

MICROPROCESSOR METHODS—OUR COURSE GETS DOWN TO BASIC NUMBER THEORY

Elementary  
Electronics

# © 02342 elementary Electronics

JULY-  
AUGUST  
1978  
\$1.25

**SIMPLY  
BASIC**

Read your  
computer's mind  
with this easy  
game program

## PICK A WINNER With e/e EQUIPMENT REPORTS

★ New multimeter gives  
you digital  
accuracy at  
analog prices

★ Automatic  
telephone  
dialer's logic  
circuitry saves  
you time  
and money

★ the-art SSB  
mmed CB channels

★ gives your  
r its own  
ne

## IT PROJECTS WORK MILLION

keep that game honest  
e switch  
Mack the Tach—RPM counts  
will never have you reeling  
Signal Chaser—be your receiver's  
Sherlock Holmes

Pennywhistle 103  
Computer-Telephone Modem



Stoner PRO-40 SSB CB  
with Astatic D-104  
Microphone

Sabtronics 2000  
Digital Multimeter

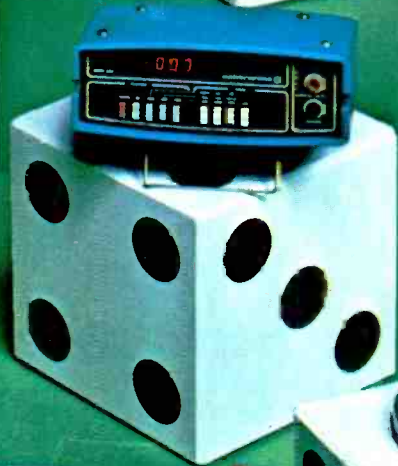

Keymemo KM-816  
Computer  
Telephone  
Dialer



12 62 2885 02V112RDV-1 APR79 P  
JOF 02VOLD  
1112 RODMAN RD  
ENDICOTT NY 13760







## You meet the nicest people on the upper 17.

The most serious CB'ers were the first to move from 23 to 40 channels. And the upper 17 are still their uncrowded province.

President Electronics never made a CB with fewer than 40 channels. We set out fresh to meet the FCC's tough new standards with new electronics and new ideas.

That's why every President has one of the most sophisticated compression circuits in CB—to assure consistent 100% modulation.

And why every President has power output circuits that are vastly improved over many old 23-channel designs.

So when you move up, move up to President.

And if you want to move all the way up, move up to the Madison—the most base station your money can buy.

Madison not only gives you 40 AM channels... it also gives you 40 upper

and 40 lower sideband channels. And it gives you the extra range and performance you get only from superb SSB, with 12 watts of peak envelope power.

And it gives you all the controls you need for complete command of everything that comes out of or goes into the radio... And a digital clock with alarm to remind you of scheduled QSO's...

And a separate speaker for improved sound and improved convenience... And more.

We did, however, leave off the automatic ice maker.

Today, owning a 23-channel CB is like owning a mono record player—great nostalgia, but out of touch.

So get in touch with the upper 17.

There's room.



# PRESIDENT

Engineered to be the very best.

President Electronics, Inc.

16691 Hale Avenue · Irvine, CA 92714 · (714) 556-7355

In Canada: Lectron Radio Sales Ltd., Ontario

CIRCLE 23 ON READER SERVICE COUPON

# 6800/2 IS HERE



The 6800/2 uses our new A2 processor board with socket space for 8K bytes of ROM/PROM. This makes it possible to use the 6800 in applications where ROM programs are useful without purchasing an expensive PROM accessory board. The A2 board has a DIP switch selector that allows you to replace any 8K block of memory above the RAM memory that extends to 32K with memory external to the processor board itself. This lets you develop special programs that will later be put in PROM in a normal RAM memory card where it can be modified and debugged. The A2 board has a crystal controlled baud rate oscillator and a separate clock driver oscillator whose frequency may be changed with a programming resistor. The A2 processor board gives you the maximum possible flexibility in setting up a computer system.

#### SWTBUG® Monitor—

The 6800/2 is supplied with our new SWTBUG® monitor. This new monitor is software compatible with the earlier Mikbug® monitor used in the 6800. All major subroutine entry points are identical. SWTBUG® features a resident MF-68 Minifloppy disk boot, single level breakpoints, vectored software interrupt, generation of punch end of tape formatting and automatic interface configuring for either the MP-C control interface or MP-S serial interface.

#### ACIA Type Interface—

The 6800/2 uses our MP-S serial interface. This RS-232 and

20 Ma. TTY compatible interface may be configured to operate serially at the following baud rates: 110, 150, 300, 600, 1200, 2400, 4800 and 9600. Complete interrupt control is available through the user's software.

#### 4K Static MEMORY—

The 6800/2 comes with 4K of static RAM memory on our MP-8M board. The memory may be expanded to 8K by the addition of eight more memory chips. No additional parts are needed. Full buffering of all data, address and control lines is a standard feature. Memory expansion to 32K of continuous RAM memory and up to a 48K mixture of ROM/RAM is possible with this system.

#### ACCESSORY BOARDS—

Do you have a special job? Our accessory boards make it possible to use the 6800/2 for almost any type of computer application. We have our MP-T interrupt timer with software interrupt selectable output. Our MP-N calculator interface that allows you to do arithmetic functions in hardware. Our MP-R EPROM programmer that programs and verifies EPROMs right in the machine—and more coming.

6800/2 Kit . . . . . \$439.00 ppd Cont. U.S.  
6800/2 Assembled . . . . . \$495.00 ppd Cont. U.S.

SWTBUG® is a registered trademark of Southwest Tech. Prod. Corp.  
Mikbug® is a registered trademark of Motorola, Inc.

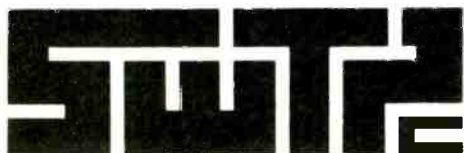

SOUTHWEST TECHNICAL PRODUCTS CORPORATION

219 W. RHAPSODY

SAN ANTONIO, TEXAS 78216

CIRCLE 26 ON READER SERVICE COUPON



## THE STAFF

Editor-in-Chief and  
Electronics Group Coordinator  
**Julian S. Martin**

Managing Editor  
**Alan H. Rose, K2RHK**

Technical Editor  
**Neil Shapiro, WB2KQI, KAFA7222**

Associate Editor  
**Gordon Sell, KBDA1464**

Citizens Band Editor  
**Kathi Martin, KGK3916**

Workbench Editor  
**Hank Scott**

Art Director  
**Ralph Rubino**

Assistant Art Director  
**David Pindar**

Cover Art Director  
**Irving Bernstein**

Art Assistants  
**Joe Groom**  
**Celeste Barbera**  
**Caroline Imparato**  
**Michael Vessio**

Advertising Director  
**David J. Miller, KCX1268**

Advertising/Research Associate  
**Jyll Holzman, KAKZ1490**

Production Director  
**Carl Bartee**

Production Manager  
**Carole Dixon**

Assistant Production Manager  
**Mary Carfagno**

Newsstand Circulation  
Director  
**Don Gabree**

Subscription Circulation &  
Marketing Director  
**Robert V. Enlow**

Subscription Circulation Manager  
**Eugene S. Slawson**

Director of Market  
Development  
**James C. Weakley**

President and Publisher  
**Joel Davis**

Vice President and  
General Manager  
**Leonard F. Pinto**

Vice President and Treasurer  
**Victor C. Stabile, KBP0681**

ELEMENTARY ELECTRONICS is published bi-monthly by Davis Publications, Inc. Editorial and Executive offices: 380 Lexington Ave., New York, NY 10017; all subscription orders and mail regarding subscriptions should be sent to P.O. Box 2630, Greenwich, CT 06835. In U.S.A. and possessions, one-year subscription (six issues) \$6.95; two-year subscription (12 issues) \$12.95; three-years (18 issues) \$18.95; and four years \$23.95. Elsewhere, add \$1.00 postage for each year. For change of address, please advise 6 to 8 weeks before moving. Send us your current mailing label with new address. Advertising offices: New York, 380 Lexington Ave., New York, N.Y. 10017, 212-949-9190; Chicago, 520 N. Michigan Ave., 312-527-0330; Los Angeles, J. E. Publishers' Rep. Co. 8732 Sunset Blvd. 213-659-3810. Second-class postage paid at New York, NY and at additional mailing office. Copyright 1978 by Davis Publications Inc.

# elementary electronics

July/August 1978  
Volume 18, No. 4

### BUILD YOUR WAY TO FUN AND PROFIT

- ☆ 33 Mack the Tach—*track your revs with this amazing phototachometer*
- ☆ 39 Signal Chaser—*troubleshoot your circuits and stay within your budget*
- ☆ 50 Quiz Master—*build this chuckles-galore quizmo*
- 57 Calculator Stand—*turn your calculator into a desktop demon*
- 62 Love That Lettering—*press-on decals make your projects look like a million*

### RADIO—PAST, PRESENT AND FUTURE

- 24 DX Central—*increase your Q.Q.—QSL Quotient*
- 55 Antique Radio Corner—*build an old-fashioned, classic loop antenna*
- 60 Hearing Holland—*listen to a land of beauty and history*
- 64 DXing Out-Of-Bounds—*log the everyday excitement of the point-to-points*
- 71 AM Stereo—*the two-channel wave of the future*

### e/e CHECKS OUT TECHNOLOGICAL DELIGHTS

- 17 Dymek All-Wave Receiving Antenna
- ☆ 37 Sabtronic Digital Multimeter
- ☆ 41 Pennywhistle 103 Modem
- ☆ 67 Keymemo KM-816 Telephone Dialer

### CELEBRATE WITH A COMPUTERFEST

- 43 You and Your Computer—*things your terminal never told you*
- 46 Computer New Products—*a carnival of the latest computer gear*
- ☆ 58 It's Simply Basic—*join in the fun with this computer guessing-game*
- 69 Computer Readout—*liven up your knights with a chess playing computer*
- ☆ 75 Our Basic Course—*more on microprocessor numbering and codes*

### GO CB WITH CLASS AND CLOUT

- 49 CB New Products—*get the lowdown on getting your signal out*
- ☆ 53 Kathi's CB Carousel—*spruce up your shack with a first-class rig*
- 74 e/e Checks Out The EV Game Antenna

### OUR REGULAR DEPARTMENTS

- 8 Hey, Look Me Over—*what's new in the world of electronics*
- 14 Hi-Fi Reports—*catch up on audio with our newest department*
- 16 Bookmark—*by Bookworm*
- 22 Ask Hank, He Knows—*meet our own Mr. Wizard*
- 26 Newscan—*learn all about the new and unique*
- 83 Hobby Mart—*an electronic parts horn-of-plenty*
- 93 Literature Library

☆ Cover Stories



### AUTHORS IN THIS ISSUE

John Boyer, James A. Fred, Larry Friedman, Harry L. Helms, Don Jensen, Randall Kirschman, Kathi Martin, Norm Meyers, Brian A. Rogers, Hank Scott, Gordon Sell, Walter Sikonowiz, Martin Weinstein.



Cover photo by Neal Slavin



The Cobra 50XLR CB has it all. AM/FM Stereo. Cassette. And CB. All in one compact unit. All engineered to bring you the same loud and clear sound Cobra is famous for.

The remote mike houses the channel selector, squelch control, and channel indicator. So all you need for talking CB is right there in your hand. The cassette player features through the dial loading and four-way fader control.

Because they're only five inches deep, there's a Cobra in-dash radio to fit almost any car with little or no modification to the dash. This feature, plus the step-by-step Installation Manual and Universal

Installation Kit makes them the easiest in-dash radios to install. And our Nationwide network of Authorized Service Centers makes them the easiest to service.

There are four Cobra in-dash models to choose from including AM/FM/Stereo/8-track/CB. But no matter which you choose you can be sure of getting the best sounding radio going. The ultimate car radio.

The Cobra.



**Punches through loud and clear.**

Cobra Communications Products  
**DYNASCAN CORPORATION**  
6460 W. Cortland St., Chicago, Illinois 60635

Write for color brochure  
EXPORTERS: Empire • Plainview, NY • CANADA: Atlas Electronics • Ontario  
FCC Approved

**CIRCLE 6 ON READER SERVICE COUPON**

# THE ULTIMATE CAR RADIO.



---

# At CIE, you get electronics career training from specialists.

**If you're interested in learning how to fix air conditioners, service cars or install heating systems – talk to some other school. But if you're serious about electronics, come to CIE – The Electronics Specialists.**

---

*John E. Cunningham*

**Special Projects Director  
Cleveland Institute of Electronics**



OF 18 - ELEMENTARY ELECTRONICS - JULY/AUGUST - 1978 - 4



**M**y father always told me that there were certain advantages to putting all your eggs in one basket. "John," he said, "learn to do one important thing better than anyone else, and you'll always be in demand."

I believe he was right. Today is the age of specialization. And I think that's a very good thing.

Consider doctors. You wouldn't expect your family doctor to perform open heart surgery or your dentist to set a broken bone, either. Would you?

For these things, you'd want a specialist. And you'd trust him. Because you'd know if he weren't any good, he'd be out of business.

**Why trust your education and career future to anything less than a specialist?**

You shouldn't. And you certainly don't have to.

**FACT:** CIE is the largest independent home study school in the world that specializes exclusively in electronics.

We have to be good at it because we put all our eggs in one basket: electronics. If we hadn't done a good job, we'd have closed our doors long ago.

**Specialists aren't for everyone.**

I'll tell it to you straight. If you think electronics would make a nice hobby, check with other schools.

But if you think you have the cool – and want the training it takes – to make sure that a sound blackout during a prime time TV show will be corrected in seconds – then answer this ad. You'll probably find CIE has a course that's just right for you!

**At CIE, we combine theory and practice. You learn the best of both.**

Learning electronics is a lot more than memorizing a laundry list of facts about circuits and transistors. Electronics is interesting because it's based on some fairly recent scientific discoveries. It's built on ideas. So, look for a program that starts with ideas – and builds on them.

That's what happens with CIE's Auto-Programmed® Lessons. Each lesson uses world-famous "programmed learning" methods to teach you important principles. You explore them, master them completely... before you start to apply them!

But beyond theory, some of our courses come fully equipped with the electronics gear to actually let you perform hundreds of checking, testing and analyzing projects.

In fact, depending on the course you take, you'll do most of the basic things professionals do every day – things like servicing a beauty of a Zenith color TV set... or studying a variety of screen display patterns with the help of a color bar generator.

Plus there's a professional quality oscilloscope you build and use to "see" and "read" the characteristic waveform patterns of electronic equipment.

**You work with experienced specialists.**

When you send us a completed lesson, you can be sure it will be reviewed and graded by a trained electronics instructor, backed by a team of technical specialists. If you need specialized help, you get it fast... in writing from the faculty specialists best qualified to handle your question.

**People who have known us a long time, think of us as the "FCC License School."**

We don't mind. We have a fine record of preparing people to take... and pass... the government-administered FCC License exams. In fact, in continuing surveys nearly 4 out of 5 of our graduates who take

the exams get their Licenses. You may already know that an FCC License is needed for some careers in electronics – and it can be a valuable credential anytime.

**Find out more! Mail this card for your FREE CATALOG today!**

If the card is gone, cut out and mail the coupon.

I'll send you a copy of CIE's FREE school catalog, along with a complete package of independent home study information.

For your convenience, I'll try to arrange for a CIE representative to contact you to answer any questions you may have.

Remember, if you are serious about learning electronics... or building upon your present skills, your best bet is to go with the electronics specialists – CIE. Mail the card or coupon today or write CIE (and mention the name and date of this magazine), 1776 East 17th Street, Cleveland, Ohio 44114.



Patterns shown on TV and oscilloscope screens are simulated.

**CIE Cleveland Institute of Electronics, Inc.**

1776 East 17th Street, Cleveland, Ohio 44114  
Accredited Member National Home Study Council

**YES...** John, I want to learn from the specialists in electronics – CIE. Send me my FREE CIE school catalog – including details about troubleshooting courses – plus my FREE package of home study information. EL-96

Print Name \_\_\_\_\_  
 Address \_\_\_\_\_ Apt. \_\_\_\_\_  
 City \_\_\_\_\_  
 State \_\_\_\_\_ Zip \_\_\_\_\_  
 Age \_\_\_\_\_ Phone (area code) \_\_\_\_\_

Check box for G.I. Bill information:  Veteran  Active Duty

**Mail today!**

# AVANTI<sup>®</sup> HIGH PERFORMANCE C.B. ANTENNAS

40 CHANNEL ENGINEERED

## ASTRO PLANE<sup>™</sup> CB Base Antenna Co-inductive

The omni-directional CB antenna that radiates from the top — for greater range and performance. 4.46 db gain over isotropic — stronger signal, clearer reception. No coils to burn or short. Vertical polarity. Patent #3587109 Model AV-101... price \$39.95 2.8x more power E.R.P.

Avanti CB base antennas from \$20.50 to \$404.00



## RACER 27<sup>™</sup> CB Mobile Antenna Magnetic mount

Easy to mount on roof or trunk for car, van or truck — no holes to drill — fast removal for hide away or car washing. Strong magnet assures position. Mylar pad guards vehicle finish.

Hermi-coil (Hermetically sealed coil) — A special molding process provides a weather-proof coil environment. Helps maintain the characteristic antenna impedance, even in damp or salt water atmosphere. Hermi-coil also helps eliminate internal surface leakage.

Ribbed base — Provides a long leakage path used in high voltage insulators, spark plugs, etc.

Specifications: Electrical 1/4 wave length  
● Unity gain ● 27 MHz  
● V.S.W.R. — 1.3:1 or better  
● Coil — shunt fed hermicoil

MODEL AV-727 Mobile Antenna System with 48" whip, 17' coaxial cable with magnetic mount. 40 channel \$32.95

Avanti makes a complete line of high performance mobile CB antenna systems from \$11.95 to \$72.50

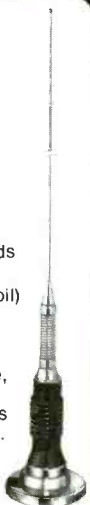

FREE 24 PAGE CATALOG

# avanti

Avanti Research & Development, Inc.

Established 1964

340 Stewart Ave., Addison, IL 60101 USA

creators of the famous

MOONRAKER<sup>®</sup>

© Copyright 1977  
All rights reserved

CIRCLE 25 ON READER SERVICE COUPON

# Hey, look me over

Showcase of New Products

## Watch Biorhythm Cycles

Many researchers have suggested that starting from birth humans have built-in biological clocks that vary their physical emotion and intellectual capacities during regular repeated cycles. By simply looking at this unique clock each day, these cycles are shown in digital form exactly where they are in relationship to the individual for which the unit has

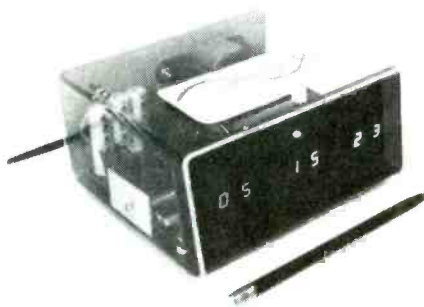

CIRCLE 78 ON READER SERVICE COUPON

been set. This way, you can actually predict your good and bad days well in advance. It lets you put off important decisions during "off" days or to make important decisions on "high" days. The Personal Biorhythm Digital Clock is available factory wired for only \$64.95 each (plus \$2.00 for postage and handling per order). It is fully guaranteed and available from Optoelectronics, Inc., P.O. Box 219, Hollywood, FL 33022.

## Six Mike Mixer

The Numark Microphone Mixer (Model MX3000) is a sound studio control unit capable of handling any high power amplifier without the use of an external pre-amplifier. It has six mike inputs; two line

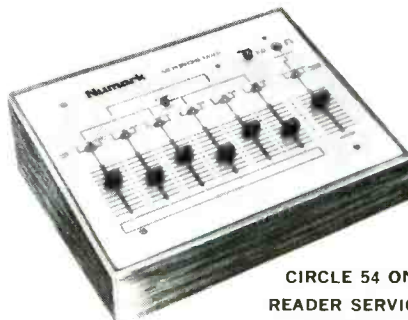

CIRCLE 54 ON  
READER SERVICE  
COUPON

inputs for stereo; individual mike attenuator control switches. Stereo/Mono switches for outputs. Master volume control; Headphone monitor with level control switch. The MX3000 can handle mike inputs from 20 to 18,000 Hz with

distortion levels of 0.1% or less and -52 dB hum and noise level. Headphone jack for monitoring unit's output. Powered by 117 VAC, 50/60 line. Sells for \$149.95. For more details write to Numark Electronics Corp., 503 Raritan Center, Edison, NJ 08817.

## Experimenter's VOM

The 20,000 ohm/volt compact model 110 VOM introduced by B&K-Precision is a 16-range fuse-protected multimeter. For checking the low resistance of coil,



CIRCLE 51 ON  
READER SERVICE  
COUPON

transformer and motor windings, a 10-ohm mid-scale range is featured. This range offers better than one-ohm resolution. Resistance ranges cover 0-1K $\Omega$ , 100K $\Omega$  and 1 meg $\Omega$ . Three DC current ranges (0.05mA, 25mA and 250mA) and five DC voltage ranges (0-2.5V, 10V, 50V, 250V and 1000V) are featured. DC accuracy is  $\pm 3\%$  at full scale. Five AC ranges (0-10V, 50V, 250V, 500V and 1000V) provide "easy-reading" measurements. The 110 is compact enough to fit into most tool kits. Test leads and instructions are included; a carrying case is optional. The ohm meter requires a common "AA" battery. The B&K-Precision Model 110 is user priced at only \$24.50 and is available for immediate delivery at local distributors. Get all the facts direct from B&K-Precision, 6460 W. Cortland Ave., Chicago, IL 60635.

## Budget Digital Alarm Clock

Heath Company has introduced a new low cost digital alarm clock. The GC-1107 offers a number of features not



CIRCLE 31 ON READER SERVICE COUPON

normally found on clocks in its price range. These include a 12 or 24 hour time option, AM/PM indicator, automatic dimming, a 24 hour "smart" alarm, 9 minute snooze button, power failure indication and alarm-on indicator. A 4-digit blue fluorescent display indicates hours and minutes. Fast-set-ahead switches make setting time quick and easy. The colon separating the hours and minutes digits flashes when the alarm has been set. If a power failure should occur, the hours digits flash to indicate that the

(Continued on page 10)



# TRI-COLOR

## WIRE CUTTING AND STRIPPING DISPENSER



- 3 Rolls of wire in one convenient dispenser
- 3 Colors, Blue/White/Red, 50 ft. (15m) of each color
- AWG 30 (0.25mm) KYNAR® insulated wire
- Built-in cutting plunger cuts wire to desired length
- Built-in stripper strips 1" of insulation
- Easily refillable
- For wire-wrapping and other applications.

Model No. **WD-30-TRI**  
Patent Pending

WD-30-TRI	DISPENSER WITH WIRE	\$8.95
R-30-TRI	TRI-COLOR REPLACEMENT SPOOLS	\$3.95

Kynar® Penngalt

MINIMUM BILLING \$25.00 / ADD SHIPPING CHARGE \$1.00 / NEW YORK STATE RESIDENT ADD APPLICABLE TAX



MACHINE & TOOL CORPORATION 3455 CONNER ST. BRONX, N.Y. 10476 (212) 894-8600 Telex 125091

Circle 20 on Reader Service Coupon



Exclusive "Breaker Beam" lights when you key your mike . . . for any good buddy to see. "When antenna is recessed, beam is not visible."



## The Antenna You Can Bank On

Breaker Beam the new fully automatic AM/FM/CB antenna has all the features you never knew existed, and always wanted. Breaker Beam offers more! Compare these outstanding features: 1. Turn your radio on and the antenna goes up, turn your ignition off and it goes down automatically. No antennas to unscrew, nothing to flip or flop. Nothing to "advertise" you have a CB. 2. CB will only operate when antenna is fully extended, eliminating transistor blow-out. 3. Pre-tuned signal splitter to separate frequencies. 4. Center loading coil for maximum performance. 5. Plug-in wiring for easy installation, hardware included. 6. Totally dependable in extreme weather conditions . . . and more.

Breaker Beam<sup>®</sup> . . . the last antenna your car will ever need. You Can Bank On It. Ask for further details; see your local dealer or contact:

**EV·GAME**  
a gulton company

186 Buffalo Avenue, Freeport, N.Y. 11520  
Dept. EE (516) 378-0440

CIRCLE 34 ON READER SERVICE COUPON

## HEY, LOOK ME OVER

(Continued from page 8)

time must be reset. Priced at \$28.95 mail order, the GC-1107 is one of many kit products offered by Heath for the home and shop. For more information about this and other Heathkit products, write for a free catalog to Heath Company, Dept. 350-470, Benton Harbor, MI 48922.

### Electricians Pocket Knives

A new line of electricians pocket knives has been introduced by Vaco. These

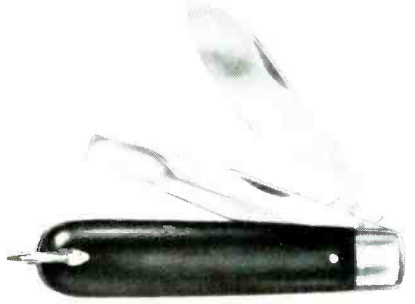

CIRCLE 84 ON READER SERVICE COUPON



handy, heavyduty pocket knives are made of the cutlery steel blades. They are tempered and hold their edge under hard use. Their extra strong construction features riveted shackles with steel and brass bodies. Grip-textured plastic handles resist cracking or chipping. The handy two-bladed model has a standard 2½-in. long spearpoint blade and a 2½-in. screwdriver tip blade with cutting edge. Sells for \$6.25. The versatile three-bladed model has a curved 2¾-in. sheep-foot slitting blade plus a 2½-in. spearpoint blade plus a 2½-in. screwdriver tip blade and both models lock open for safer, more efficient use. Sells for \$7.50. These new Vaco knives, as well as all Vaco tools, are fully warranted. For further information, write to Vaco Products Company, 1510 Skokie Blvd., Northbrook, IL 60062.

### Mini-Shop

A new self-contained mini-shop that affords organization and easy access to tools is now available from Penco Products. Called "Shopcrafter," the mini-shop can be used by home craftsmen, servicemen, and do-it-yourselfers. The mini-shop is composed of two sections, one section includes a work bench with drawer and a peg board back for hanging tools; another section includes standard accessories—rollable machine cabinet, drawer case with 18-drawer insert,

work stool and an extra shelf. The two sections are attached side-by-side so that all tools can be stored easily within arms' reach. Machine cabinet and drawer case allow organization of tools

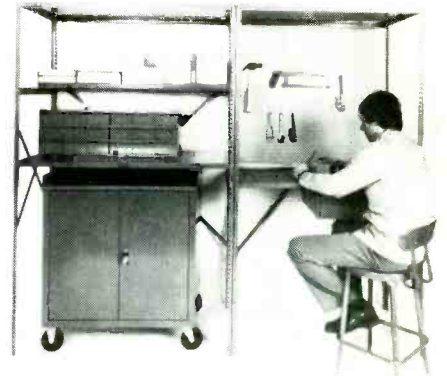

CIRCLE 76 ON READER SERVICE COUPON

and other equipment, to avoid time-consuming searches over the odd-sized tables, drawers and shelves that comprise most homeowners' tool storage facilities. The two work units are each 75-in. high, 48-in. across, and 24-in. deep. The shelves and workbenches can easily be adjusted vertically on 2-in. increments. The mini-shop lists for \$413.00 with individual parts sold separately. Consult factory for price list. For further information, contact Penco Products, Inc., Oaks, PA 19456.

### Wire Dispenser Cuts and Strips

The new WD Series Wire Dispenser by OK features unique cutting and stripping capability. Wire is drawn out of dispenser to required length. Then, built-in plunger cuts length free from roll, while a gentle pull through the stripping blade removes the insulation without nicking the wire. Repeat procedure removes insulation from second end. Although designed particularly for wire-wrapping, the inexpensive dispenser is ideal for many applications. Dispenser includes 50-ft. roll of AWG 30 top industrial quality Kynar insulated OFHC silver plated solid copper wire. Insulation is offered in blue,

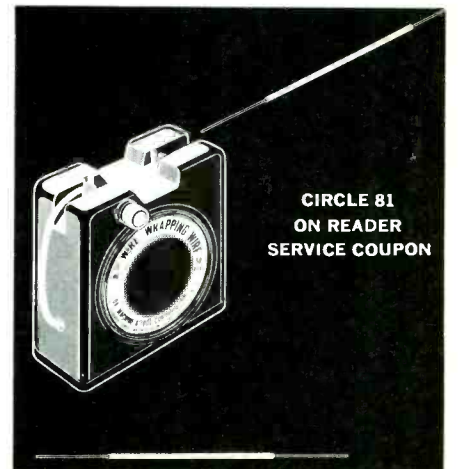

CIRCLE 81 ON READER SERVICE COUPON

white, yellow or red. Sells for \$3.95. Available from your local electronics distributor or directly from O.K. Machine and Tool Corporation, 3455 Conner Street, Bronx, NY 10475.

(Continued on page 12)



# BUILD 20 RADIO and Electronics Circuits

Reg. U. S.  
Pat. Off.



Training Electronics Technicians Since 1946

## PROGRESSIVE HOME RADIO-TV COURSE

### Now Includes

- ★ 12 RECEIVERS
- ★ 3 TRANSMITTERS
- ★ SQ. WAVE GENERATOR
- ★ SIGNAL TRACER
- ★ AMPLIFIER
- ★ SIGNAL INJECTOR
- ★ CODE OSCILLATOR
- ★ No Knowledge of Radio Necessary
- ★ No Additional Parts or Tools Needed
- ★ Solid State Circuits
- ★ Vacuum Tube Circuits

**YOU DON'T HAVE TO SPEND  
HUNDREDS OF DOLLARS FOR A RADIO COURSE**

The "Edu-Kit" offers you an outstanding PRACTICAL HOME RADIO COURSE at a rock-bottom price. Our Kit is designed to train Radio & Electronics Technicians, making use of the most modern methods of home training. You will learn radio theory, construction practice and servicing. THIS IS A COMPLETE RADIO COURSE IN EVERY DETAIL. You will learn how to build radios, using regular schematics; how to wire and solder in a professional manner; how to service radios. You will work with the standard type of punched metal chassis as well as the latest development of Printed Circuit chassis.

You will learn the basic principles of radio. You will construct, study and work with RF and AF amplifiers and oscillators, detectors, rectifiers, test equipment. You will learn and practice code, using the Progressive Code Oscillator. You will learn and practice trouble-shooting, using the Progressive Signal Tracer, Progressive Signal Injector, Progressive Dynamic Radio & Electronics Tester, Square Wave Generator and the accompanying instructional material.

You will receive training for the Novice, Technician and General Classes of F.C.C. Radio Amateur Licenses. You will build Receiver, Transmitter, Square Wave Generator, Code Oscillator, Signal Tracer and Signal Injector Circuits, and learn how to operate them. You will receive an excellent background for television, Hi-Fi and Electronics.

Absolutely no previous knowledge of radio or science is required. The "Edu-Kit" is the product of many years of teaching and engineering experience. The "Edu-Kit" will provide you with a basic education in Electronics and Radio, worth many times the low price you pay. The Signal Tracer alone is worth more than the price of the kit.

### THE KIT FOR EVERYONE

You do not need the slightest background in radio or science. Whether you are interested in Radio & Electronics because you want an interesting hobby, a well paying business or a job with a future, you will find the "Edu-Kit" a worth-while investment. Many thousands of individuals of all

ages and backgrounds have successfully used the "Edu-Kit" in more than 79 countries of the world. The "Edu-Kit" has been carefully designed, step by step, so that you cannot make a mistake. The "Edu-Kit" allows you to teach yourself at your own rate. No instructor is necessary.

### PROGRESSIVE TEACHING METHOD

The Progressive Radio "Edu-Kit" is the foremost educational radio kit in the world, and is universally accepted as the standard in the field of electronics training. The "Edu-Kit" uses the modern educational principle of "Learn by Doing." Therefore you construct, learn schematics, study theory, practice trouble shooting—all in a closely integrated program designed to provide an easily-learned, thorough and interesting background in radio.

You begin by examining the various radio parts of the "Edu-Kit." You then learn the function, theory and wiring of these parts. Then you build a simple radio. In this first set you will enjoy listening to regular broadcast stations, learn theory, practice testing and techniques. Gradually, in a progressive manner, and at your own rate, you will find yourself constructing more advanced multi-tube radio circuits, and doing work like a Professional Radio Technician.

Included in the "Edu-Kit" course are Receiver, Transmitter, Code Oscillator, Signal Tracer, Square Wave Generator and Signal Injector Circuits. These are not unprofessional "breadboard" experiments, but genuine radio circuits, constructed by means of professional wiring and soldering on metal chassis, plus the new method of radio construction known as "Printed Circuitry." These circuits operate on your regular AC or DC house current.

### THE "EDU-KIT" IS COMPLETE

You will receive all parts and instructions necessary to build twenty different radio and electronics circuits, each guaranteed to operate. Our Kits contain tubes, tube sockets, variable electrolytic, mica, ceramic and paper dielectric condensers, resistors, tie strips, hardware, tubing, punched metal chassis, Instruction Manuals, hook-up wire, solder, selenium rectifiers, coils, volume controls, switches, solid state devices, etc.

In addition, you receive Printed Circuit materials, including Printed Circuit chassis, special tube sockets, hardware and instructions. You also receive a useful set of tools, a professional electric soldering iron, and a self-powered Dynamic Radio and Electronics Tester. The "Edu-Kit" also includes Code Instructions and the Progressive Code Oscillator, in addition to F.C.C. Radio Amateur License training. You will also receive lessons for servicing with the Progressive Signal Tracer and the Progressive Signal Injector, a High Fidelity Guide and a Quiz Book. You receive Membership in Radio-TV Club, Free Consultation Service, Certificate of Merit and Discount Privileges. You receive all parts, tools, instructions, etc. Everything is yours to keep.

### PRINTED CIRCUITRY

At no increase in price, the "Edu-Kit" now includes Printed Circuitry. You build a Printed Circuit Signal Injector, a unique servicing instrument that can detect many Radio and TV troubles. This revolutionary new technique of radio construction is now becoming popular in commercial radio and TV sets.

A Printed Circuit is a special insulated chassis on which has been deposited a conducting material which takes the place of wiring. The various parts are merely plugged in and soldered to terminals.

Printed Circuitry is the basis of modern Automation Electronics. A knowledge of this subject is a necessity today for anyone interested in Electronics.

### FREE EXTRAS

#### • SET OF TOOLS

- SOLDERING IRON
- ELECTRONICS TESTER
- PLIERS-CUTTERS
- VALUABLE DISCOUNT CARD
- CERTIFICATE OF MERIT
- TESTER INSTRUCTION MANUAL
- HIGH FIDELITY GUIDE • QUIZZES
- TELEVISION BOOK • RADIO TROUBLE-SHOOTING BOOK
- MEMBERSHIP IN RADIO-TV CLUB: CONSULTATION SERVICE • FCC AMATEUR LICENSE TRAINING
- PRINTED CIRCUITRY

### SERVICING LESSONS

You will learn trouble-shooting and servicing in a progressive manner. You will practice repairs on the sets that you construct. You will learn symptoms and causes of trouble in home, portable and car radios. You will learn how to use the professional Signal Tracer, the unique Signal Injector and the dynamic Radio & Electronics Tester. While you are learning in this practical way, you will be able to do many a repair job for your friends and neighbors, and charge fees which will far exceed the price of the "Edu-Kit." Our Consultation Service will help you with any technical problems you may have.

### FROM OUR MAIL BAG

Ben Valerio, P. O. Box 21, Magna, Utah: "The Edu-Kits are wonderful. Here I am sending you the questions and also the answers for them. I have been in Radio for the last seven years, but like to work with Radio Kits, and like to build Radio Testing Equipment. I enjoyed every minute I worked with the different kits; the Signal Tracer works fine. Also like to let you know that I feel proud of becoming a member of your Radio-TV Club."

Robert L. Shuff, 1534 Monroe Ave., Huntington, W. Va.: "Thought I would drop you a few lines to say that I received my Edu-Kit, and was really amazed that such a bargain can be had at such a low price. I have already started repairing radios and phonographs. My friends were really surprised to see me get into the swing of it so quickly. The Trouble-shooting Tester that comes with the Kit is really swell, and finds the trouble, if there is any to be found."

### SOLID STATE

Today an electronics technician or hobbyist requires a knowledge of solid state, as well as vacuum tube circuitry. The "Edu-Kit" course teaches both. You will build vacuum tube, 100% solid state and combination ("hybrid") circuits.

Progressive "Edu-Kits" Inc., 1189 Broadway, Dept. 591DJ, Hewlett, N.Y. 11557

Please rush me free literature describing the Progressive Radio-TV Course with Edu-Kits. No Salesman will call.

NAME .....

ADDRESS .....

CITY & STATE ..... ZIP .....

### PROGRESSIVE "EDU-KITS" INC.

1189 Broadway, Dept. 591DJ Hewlett, N.Y. 11557



# Measure resistance to .01Ω...



at a price that has no resistance at all.

- 3½ digit bright LED display
- 100μ V, .01Ω resolution
- 0.5% accuracy typical
- Autozeroing
- Completely overload protected on all 29 ranges
- RFI shielded for use in RF fields
- 100% overrange reading
- Selectable high-/low-power ohms
- Full range of optional accessories available

At \$119.95, the 2810 is a "best buy" among DMM's currently available. Its 10 ohms range allows you to check the low contact resistance of switches, relays, breaker points or connectors. Poor solder connections can also be spotted. Place your order now... contact your local distributor for immediate delivery.

**BK PRECISION**  
**DYNASCAN CORPORATION**

6460 West Cortland Avenue  
Chicago, Illinois 60635 • 312/889-9087

In Canada: Atlas Electronics, Ontario  
Int'l. Sis: Empire Exp., 270 Newtown Rd.  
Plainview, LI, NY 11803

CIRCLE 22 ON READER SERVICE COUPON

## HEY, LOOK ME OVER

(Continued from page 10)

### Foolproof Remote Station

An attractive, low-cost coded pushbutton remote control station by Mountain West Alarm Supply Co. eliminates the use of keys and the risk of lock picking. This unit operates momentary contact controls and is usable with many popular control panels without complicated wiring hookups or special power considerations. The new D14 pushbutton alarm



CIRCLE 57 ON  
READER SERVICE  
COUPON

control features a replaceable, pre-programmed code key which is field changeable. Each time the correct code is entered on keyboard, a solid state momentary switch operates. The keyboard has tactile feedback pushbuttons which are reported to be rugged, yet easy to operate. Uses low input power, less than 2 mA standby at 6 to 24 VAC or DC. Has red and green diode status lights. Unit weighs only 7 ounces, is 4⅞-in. x 3½-in. x 1½-in. Case is formed from beige, high impact plastic. Surface mount unit is priced at \$53.00 each. For more information, contact Mountain West Alarm Supply Company, Box 10780, Phoenix, AZ 85064.

### Powered Breadboard

TTL logic system designers are finding an attractive design shortcut available to them, thanks to the Continental Specialties Model PB-203 Proto-Board, a high capacity solderless breadboard that in-

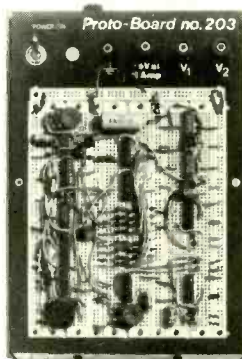

CIRCLE 83 ON  
READER SERVICE  
COUPON

cludes a built-in 1%-regulated 5 VDC power supply. The advantage to a TTL hobby designer is the ability to design directly in hardware, assuring proper circuit operation, before hand wiring. This helps prevent the confusion in translating from gate schematics to actual IC packages, often providing valuable insight into ways of simplifying PC

layouts. The breadboard area on the Proto-Board 203 includes enough tie points to support 24 14-pin DIP ICs. Four binding posts provide power and signal connections on and off the board. The built-in power supply is 1% regulated at 5 ±.25 Volts, rated at 1 A, and boasts a low 10 millivolts combined ripple and noise at 0.5 A out. And it's short-proof. The 5½-pound package measures 9¾-in. long, just over 6½-in. wide and 3¼-in. tall. CSC's low suggested resale price for the PB-203 is just \$80.00 (per unit). Further information is available from CSC dealers and distributors, or direct from Continental Specialties Corporation, 70 Fulton Terrace, New Haven, CT 06509.

### Stereo Headphones

Audio-Technica has a new series of five stereo headphones with moving coil dynamic and electret condenser models. The new stereo headphones, called the ATH series, have a two-part headband for optimum comfort and fit. The outer band is stainless steel for strength and light weight. An inner band of soft synthetic suede conforms to the head, distributing weight evenly and making the physical contact of the headphones slight. The headsets use spring-loaded ball bearings for smooth adjustments. Ear cushions of soft, porous vinyl prevent uncomfortable heat build-up. The lightweight cord is flat to resist tangling.

CIRCLE 46 ON  
READER SERVICE  
COUPON



The new line of headphones offers two electret condenser models, the ATH-6 and ATH-7 (shown). Both use low-mass diaphragms just five microns thick offering top transient characteristics and unusually wide, uniform frequency response. The ATH-6 (\$99.95) offers a frequency response of 20-22,000 Hz, ±3 decibels from 40 to 22,000 Hz. The ATH-7 (\$149.95) has a frequency response of 10-22,000 Hz ±2 decibels from 20 to 22,000 Hz. The ATH-7 has an LED indicator to signal high-level peaks and warn of possible overload. Audio-Technica has nicknamed the ATH-1 (\$29.95) "The Gram Cracker" because of its extremely light weight: just 135 grams (4.75 ounces), less cord, and 190 grams (6.7 ounces) total. The ATH-1 uses an unconventional "planar moving coil" and has a 30-20,000 Hz frequency response. The ATH-3 model (\$59.95) offers a frequency response of 25-20,000 Hz. The electrical system of the ATH-5 (\$79.95) uses a light, compliant dome diaphragm for extended bass and treble response and a smooth, uncolored sound. The frequency response is 20-20,000 Hz.

(Continued on page 91)



# FREE

The world's largest catalog  
of easy-to-build, money-saving  
electronic kits



- Personal Computer Systems now including Floppy Disk Storage
- Power Supplies ● Oscilloscopes ● Frequency Counters ● VTVM's and VOM's
- Ham Radio Gear ● Digital Programmable Color TV ● Hi-Fi Components
- Electronic Clocks and Weather Instruments ● Learn-at-home Electronics Courses
- Auto, Fishing, Marine and Aircraft Accessories — nearly 400 kits in all!

Every Heathkit product comes with a fully-illustrated, step-by-step assembly manual that tells you everything you need to know to make kitbuilding fun and easy. Thousands of people have discovered the satisfaction — and savings — of handcrafting a fine piece of electronic equipment. You can build it better... let us show you how.

Send for your **FREE** Catalog today! ▶

Heath Company, Dept. 139-430, Benton Harbor, Michigan 49022

HEATH Schlumberger	Heath Company, Dept. 139-430 Benton Harbor, Michigan 49022	<b>FREE</b>
Please rush me my FREE Heathkit Catalog. I am not on your mailing list.		
NAME _____		
ADDRESS _____		
CITY _____		STATE _____
CL-657		ZIP _____

CIRCLE 1 ON READER SERVICE COUPON

**74LS22N,  
NSN69,  
LD130,  
8095**

**IT'S YOUR MOVE!**

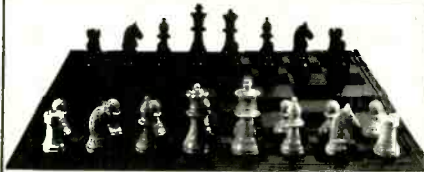

It's no game! When you need ICs for your project, move at once to Hobby Mart, the hobbyist's special advertising section in the back of **ELEMENTARY ELECTRONICS**. Prices are right, selection is large, and you're only a postage stamp away from your fully-stocked supplier.

Need parts? Find them in **HOBBY MART**—page 83.

## Cramped for Antenna space?



### The MCKAY DYMEK DA 100.

The DA 100 is a compact, wide dynamic range, broadband, untuned, omni-directional receiving antenna covering the frequency range of 50 kHz to 30 MHz.

The exterior module, a small weather-proof box with a 56 inch (142 cm) whip delivers the signal to the power supply unit through a supplied 50' coaxial cable.

The power supply locates near your general coverage receiver and attaches with a supplied patch cord.

The DA 100 antenna is small, but will equal or outperform a 100' long wire antenna, and is priced within reach of everyone!

**Output Impedance - Attenuator Switch** provided to match receiver input requirements and prevent overload.

Order factory Direct. Call toll free today! Money Back guarantee. Rent/Own Plan available. Specs and details on request.

Nationwide 800/854-7769  
California 800/472-1783



**MK** McKay Dymek Co.  
111 S. College Ave., PO Box 5000  
Claremont CA 91711

CIRCLE 19 ON READER SERVICE COUPON

## HI-FI REPORTS

**Gordon Sell reports on Pioneer's new low-end tuner and amplifier, and Shure's new super cartridge**

Whether you plan to spend \$200 or \$2000 on a high-fidelity stereo system you are going to have to make some compromises. Of course if you have a \$2000 hi-fi budget I can't really feel very sorry for you. If your budget is closer to \$200, however, the situation is tough but far from hopeless. You can fill your home with quality sound without draining your bank account—all it takes is a bit of careful planning.

Lately budget hi-fi has meant buying one of those jack-of-all-trades, master-of-none machines; you know the kind—an AM/FM radio with a record player on top, a tape player in the side, walnut vinyl on cardboard speakers and a built-in egg timer and coffee grinder. In the trade they call these "compacts." I suspect it's because they usually end up in the compactor. If you can only just afford one of these you haven't saved long enough. Unless you don't intend to play anything other than scratched up old 45s, keep packing away those pennies—good sound is not too far out of reach.



Pioneer TX-5500 II  
CIRCLE 63  
ON READER SERVICE COUPON

Now, thanks to some companies who appreciate that most hi-fi buffs can't afford to drop \$700 for a stereo amplifier, there are alternatives to the jack-of-all-trades ear-iterator. Component stereo systems can be found with prices as pleasing as their sound and with these systems you don't have to buy everything at once. This is the real beauty of component hi-fi—its ability to grow with your budget and your ever expanding appreciation of fine music.

**Tuning in.** Pioneer has just introduced a couple of new products that I thought would be of interest to the hi-fi buff on

a budget. They are the basic foundation of a first class stereo system. You may end up trading them in or giving them to your kid brother in a few years but they will get your hi-fi system off the ground. After all, you have to learn to walk before you can run, and going in to fancy hi-fi too fast is a sure way to stumble.

The Pioneer TX-5500 II AM/FM stereo tuner and SA-5500 II stereo amplifier are two nice-looking units. They make your hi-fi corner look as good as it sounds, when you hook them up to a pair of efficient speakers.

The TX-5500 II tuner has a very simple but attractive front panel with a combined AM signal strength and FM center tuning meter. Tuning is aided by a stereo indicator light and a hefty fly-wheel tuning knob. A single function-switch controls FM muting and AM/FM selection. On the rear apron there are the usual output jacks plus an FM de-emphasis switch, and lugs for either 75- or 300-ohm impedance FM antennas and an AM antenna input. The set has an internal AM loop.

Our test labs checked out this unit (as they do every product e/e reviews) and found its performance was quite good for a unit in this price range. In the FM tuner section the signal-to-noise ratio was an excellent 70 dB and the stereo separation was 40 dB. The THD (total harmonic distortion) measured a respectable 0.5% stereo and 0.22% mono.

At the standard test level the stereo frequency response, with 75-uSec de-emphasis, was measured at +0/-2 dB from 20 to 20,000 Hz. Full limiting was attained with a 4-uV signal. The high fidelity sensitivity was 6-uV for mono with 60 dB quieting and 100-uV for stereo with 55 dB quieting. Full mute release was attained with 2.5 uV.

About the only fly in the ointment was some 19 kHz stereo pilot leakage (only 39 dB down). If you are using a Dolby for tape recordings it should be a model with a built-in or switch-selected mpx (19 kHz) filter. AM performance is about average for this type of tuner although I wonder how much this matters—I've never met anyone who listens seriously to AM on a hi-fi system.

The TX-5500 II carries a suggested retail price of \$150 and is available with a good looking walnut (real wood not vinyl) veneer wooden case for an extra \$30.

**Amplification.** Although Pioneer's TX-5500 II could be mated to any standard amplifier it will be well worth your time to take a hard look at its partner component, the SA-5500 II stereo amplifier. Matching components tend to add a certain amount of class to a hi-fi corner, but this is far from the



only reason.

Pioneer has provided the SA-5500 II with a large, 41-stop click-detent volume knob, ganged bass and treble controls, a three-position function switch, loudness and tape monitor switches and pushbutton controls for two sets of speakers.



Pioneer SA-5500 II

CIRCLE 63 ON  
READER SERVICE COUPON

Using Federal Trade Commission guidelines, Pioneer conservatively reports the SA-5500 II's output at 15 watts RMS per channel with less than 0.5% THD between 20 and 20,000 Hz. On our test bench the unit did better; checking in with 0.2% THD in the same power and frequency range. The frequency response was +0/-0.2 dB from 20 to 20,000 Hz, magnetic input hum and noise measured -67 dB, the stereo separation was 63 dB and the tone control range measured +9/-9.5 dB at 50 Hz and  $\pm 7.5$  dB at 10,000 Hz.

If all of the above means something to you, great—if not, don't get upset. Basically it means that this amplifier, pushing two efficient 8-ohm speakers, will force you to shout to be heard at 10 watts and will probably get you evicted if you leave it on 15 watts continuous output. Don't try to use the argument that the sound was 99 44/100 percent distortion free—landlords are notoriously tone deaf. What is important about SA-5500 II is that it will provide an adequate volume of good quality sound in a normal room-sized environment, and even drive a second set of efficient speakers.

In a few years, when you find that you want more power to drive some larger speakers and you want to brag about your subatomic distortion figures to your friends, you can trade-up to a more powerful amp without having to replace your whole system at once. With a suggested retail price of \$125 you can't go far wrong with this durable Pioneer unit. As with the TX-5500 II a wooden case is available for \$30. For more information on the Pioneer TX-5500 II and SA-5500 II circle No. 63 on the reader's service coupon.

**Upgrading Your System.** If you already have a low to medium priced hi-fi system you have probably been trying to figure out how to upgrade your sound. This is no easy task since it is often very hard to figure out what part of your system is the "weak link" in the chain.

Since I don't know where to start on your system I'll start at the beginning of the audio chain which, in most cases, is where the phono needle, or stylus as it is usually called, is dragged along the groove of an LP. This seemingly simple action is probably the most troublesome area in the whole hi-fi field.

A stylus has to be unbelievably durable and delicate at the same time. It must be tough enough to survive being dragged across a quarter-mile of plastic for each side of a 12-inch LP. If you listen for an hour a day your stylus will chalk up between 350 and 400 miles a year (more than some people walk). This durability has to be combined with the sensitivity needed to reproduce the entire audio spectrum (and more if you go in for four channel) and be gentle enough not to destroy a record after just a few plays. This area is a prime target for improvement on almost any audio system.

The Shure Brothers of Evanston, Illinois, who have been making stereo cartridges and styli for many years have just released the latest product of their extensive R&D department: the V15 IV stereo cartridge with hyperelliptical stylus. The footprint (area of contact with the LP) of this stylus is narrower than the traditional biradial (elliptical) stylus and is also symmetrical to help reduce intermodulation and second harmonic distortion. The stylus is mounted on a very low-mass shank (0.29 milligrams versus 0.33 milligrams on the V15 III which it replaces) and fitted with low-mass magnets. This provides a measurable improvement in tracking performance, particularly in the middle and upper frequencies.

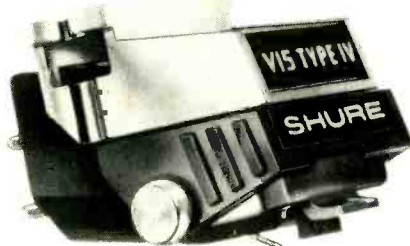

Shure V15 Type IV

CIRCLE 65  
ON READER SERVICE COUPON

**In the Groove.** The Shure V15 IV has one other major improvement that helps its tracking performance and combats wow and flutter (frequency oscillation). Shure calls it a Dynamic Stabilizer—I call it the ultimate dust brush, which is what it looks like. This nifty little gadget is mounted to provide a negative tracking force of 0.5 grams which holds the cartridge at a fixed distance from the record and keeps the stylus shank at a constant angle.

A cartridge/stylus system and the

(Continued on page 91)

## NEW FROM ASIMOV!



Large Size  
8 1/2" x 10 1/2"

—on newsstands nationally, but you can be sure to have this first/collector's issue by ordering now!

Brand new! Exciting! 112 pages, generously illustrated. Chock-full of SF fun and adventure!

☆☆☆

**EXTRA! You'll also get with this issue a full-color 11" x 17" color poster (the cover picture, especially commissioned).**

☆☆☆

Amongst a lot of other exciting stories, you'll enjoy a novelette by Poul Anderson ("Capture of the Centaurianess")... a short novel by Harry Harrison ("The Stainless Steel Rat Wants You")... and a short story by Dr. Asimov himself!

**ASIMOV'S  
SF ADVENTURE MAGAZINE  
380 LEXINGTON AVENUE  
NEW YORK, NY 10017**

Enclosed is \$1.75 plus 25¢ handling/shipping (total of \$2.00), for the first/collector's issue of ASIMOV'S SF ADVENTURE MAGAZINE.

Name \_\_\_\_\_  
(please print)

Address \_\_\_\_\_

City \_\_\_\_\_

State \_\_\_\_\_ Zip \_\_\_\_\_

H8F051



Includes  
Functional  
Tilt Stand!



## NEW EICO 270 3½ DIGIT DMM KIT ONLY \$79.95

### Introductory Offer—FREE AC ADAPTOR

The first and only lab accuracy portable DMM Kit featuring MOS/LSI IC economy and reliability. Measures DC/AC Volts, Kilohms, DC/AC milliamps in 21 ranges. Polarity indicators and overload protection are provided, and 0.5 inch LED displays give easiest-to-read digital readout to 999. The 270 features a basic 0.5% DC accuracy, 10 Megohm input impedance, low voltage drop in all current ranges and automatically-flashing overrange indicator. **Assembled \$109.95**

### FREE '78 EICO CATALOG

Check reader service card or send 50¢ for first class mail. See your local EICO Dealer or call (516) 681-9300, 9:00 a.m.-5:00 p.m. EST. Major credit cards accepted.

EICO—108 New South Rd.  
Hicksville, N.Y. 11801



CIRCLE 2 ON READER SERVICE COUPON

## projection television

Convert  
color  
to  
Giant  
Screen  
with  
the

**f1.85**  
Projection TV Lens

FASTEST LENS SPEED FOR  
BRILLIANCE & BRIGHTNESS  
3 ELEMENTS; 6 OPTIC SURFACES  
FOCAL LENGTH: 12-INCH (305mm)  
MEASURES: 6.5" DIA. x 6.5" LENGTH

**SPECIAL  
PRICE \$135**

Dealer Inquiries Invited  
Send \$1 For Building Projection TV.

THE  
FINEST  
PROJECTION  
LENS THAT IS  
AVAILABLE TODAY

## PROJECTAPIX, LTD.

300 WEST 53 STREET  
NEW YORK, N.Y. 10019  
TELEPHONES: (212) 765-7869



## BOOKMARK BY BOOKWORM

**It Made Radio.** Here's an easy-to-read guide to learning all about microphones—*Microphones—How They Work & How to Use Them* by Martin Clifford. This practical new book takes the mystery out of micro-

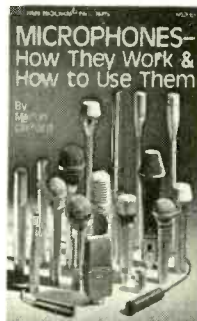

Everything you  
ever wanted to  
know about  
microphones.

**Soft Cover  
224 pages  
\$5.95**

phones and shows how to record almost anything from symphonies to a child's first words, from vocal solos to singing groups. It clearly explains how to get different sound effects and better stereo, and fully describes microphone-positioning techniques. It's a book for anyone who wants good sound. Public speakers, band members, or home recording hobbyists, all will find out how to get truly professional-quality sound on tape or out to an audience in this clear and comprehensive volume. Well-known author Clifford tells all about the many different types of microphones and accessories available, explains how to get the most out of microphone "spec" sheets, and how to interpret polar patterns. Beginning with a brief historical background, the book explains the development of a practical microphone, and details why present-day units have certain electrical characteristics, covering the many factors and design variations that affect the quality and response of various microphones. Published by Tab Books, Blue Ridge Summit, PA 17214.

**Way to Learn.** The most widely used IC is the operational amplifier. If you are not familiar with the op amp, then *The Design of Operational Amplifier Circuits, with Experiments* by Howard M. Berlin is the book for you. This book is about the design and operation of basic operational amplifier circuits coupled with a series of over 35

The Design of  
Operational  
Amplifier

Circuits, with  
Experiments

How to design op  
amp circuitry.

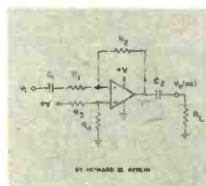

**Soft Cover  
277 pages  
\$9.00**

experiments to illustrate the design and operation of linear amplifiers, differentiators

and integrators, voltage and current converters, comparators, rectifiers, oscillators, active filters, single supply voltage circuits, and the instrumentation amplifier. It is not meant to be a sourcebook of all available op-amp circuits, nor a textbook covering the performance characteristics of the various types that are available. However, this is a text/workbook that explains the design of the fundamental circuits that are the building blocks of the more sophisticated systems using many op-amps. For this reason, this book is useful to the beginning experimenter and hobbyist who wants to learn the basics by self study. Published by E&L Instruments, Inc., Derby, CT 06418.

**Chips to Systems.** *Microprocessors* by Dr. Rodney Zaka is an introduction to microprocessors and microcomputer systems. It presents both the concepts, and the actual techniques and components used to create systems. It introduces the reader to the aspects of system operation, use, and design. Some of the topics covered are: a comparative evaluation of all major micro-

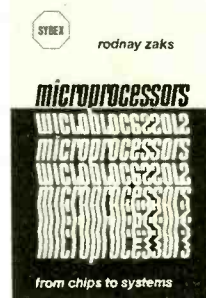

An introduction  
to state-of-the-art  
microprocessors.

**Soft Cover  
416 pages  
\$9.95**

processors, a journey inside a microprocessor chip, how to assemble a system, interfacing the S100 bus and programming. No prior electronic or computer training are necessary. Published by Sybex Inc., 2161 Shattuck Avenue, Berkeley, CA 94704.

**Solid-State Replacement Guide.** The 1978 edition of the *RCA Solid State Replacement Guide* is now available for electronic experimenters. The 240-page book, SPG-202W, can also be used by engineers, servicemen and others who work with solid-state devices. The comprehensive RCA SK line of replacement transistors, rectifiers, thyristors, integrated circuits and high voltage triplers has grown to over 150 devices, including 387 SK which have been added



Need a part? This  
book is the place  
to look.

**Soft Cover  
240 pages  
\$1.50**

to the line since February 1977. The 750 devices replace over 141,000 domestic and foreign industry devices. The 1978 *RCA Solid State Replacement Guide* can be obtained from your local RCA distributor or by sending a check or money order (no cash or stamps) to RCA Distributor and Special Products Division, P.O. Box 85EE, Rutherford, NJ 08078.



e/e checks out the...

# DYMEK DA100 ALL-WAVE RECEIVING ANTENNA

This handy gadget will help you hear more from your receiver and less from your landlord.

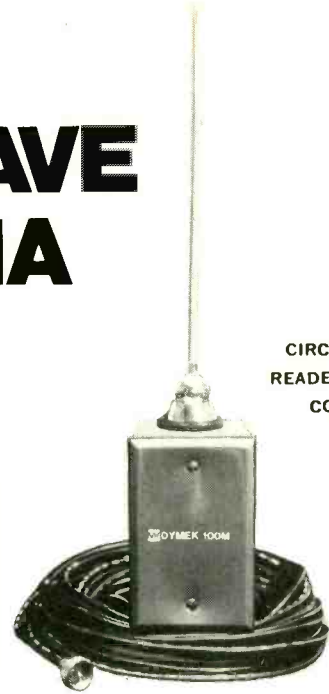

CIRCLE 58 ON  
READER SERVICE  
COUPON

□ MANY SHORT-WAVE LISTENERS and DXers find that the landlord's regulations often preclude the use of a decent receiving antenna. In many buildings, nothing other than the landlord's master TV antennas can be installed on the roof; this often means the SW antenna can be no more than a short whip mounted on a terrace, or window ledge, or a short length of wire hanging down from the window, whose reception sensitivity varies as the wind blows the wire towards and away from the building.

**Features.** One good answer to the problem of no space for an antenna is the Dymek DA-100 All Wave Receiving Antenna, which is basically an automobile type antenna mounted on a weatherproof box with an encapsulated transistorized amplifier inside the box. The complete DA-100 system consists of the weatherproof housing, the auto-type telescopic antenna that mounts on the box, fifty feet of RG-58 coaxia!

cable that brings the signal down from the amplifier and which also carries the DC power, an indoor control box that contains the power supply, an antenna switch that selects either the signal from the preamplifier or an auxiliary wire antenna, and an "output impedance matching" switch that provides output impedances of 50, 100, and 500 ohms. The switch can also be used as a 0, 10 and 20 dB attenuator if needed to compensate for strong stations.

The operating frequency range of the DA-100 is 50 kHz to 30 MHz. The internal amplifier provides approximately 3 dB gain at 100 kHz falling to 0 dB at 1 MHz, again rising to approximately +11.2 dB at 20-25 MHz, and then falling to +8 dB at 30 MHz. Between 100 kHz at 50 kHz the gain falls from +2 dB to -6 dB.

The DA100 system is touted as a replacement for a 1000 foot antenna. As any SWL and DXer should know, length does not necessarily mean "gain,"

or received signal strength, because signal strength does not necessarily depend on the length of the wire used for the receiving antenna. At some frequencies 1000 feet might be ideal, at others it might prove a disaster because of multiple nodes.

Rather than considering the DA100 a substitute for 1000 feet of wire, it is best to consider it as the solution to difficult antenna installations such as mentioned at the beginning of this article. For example, you cannot beat the DA100 with any other "all band" window antenna. Angled outward from the window the DA100 performs as well as a "car radio" whip at the lower frequencies, and as an amplified whip at the higher frequencies. If you have a terrace you can mount the weatherproof box and antenna on the metal railing (the further away from the building the better). If you can get the antenna up on the roof, and find you're short of cable, you can simply add 50 ohm coaxial cable extensions, or use one of the pre-fab coax extensions.

**Fitting it in.** The total antenna height when extended is 4-ft. 8-in. The weatherproof housing is a standard electrical "outdoor/weatherproof" box specially modified with the antenna mounting on top and a weatherproof coax fitting on the bottom. The indoor control box measured 9-in. wide by 5-in. high by 9-in. deep.

The Dymek DA-100 system complete with 50 feet of 50 ohm coaxial cables is priced at \$135.00. For additional information circle No. 58 on the reader's service coupon. ■

AUX. ANTENNA



OUTPUT TO  
RECEIVER

INPUT FROM ANTENNA  
AND AMPLIFIER

A standard UHF connector is used for the coax running to the amplifier and phone type jacks are used for both the output to the receiver and for the auxiliary wire antenna. 115 or 220 VAC

# 25 million reasons into NRI training in CB and

**The CB boom means big opportunities for qualified technicians... learn at home in your spare time.**

There are more than 25 million CB radios out there, millions more two-way radios, walkie-talkies, and other communications apparatus in use by business and industry, government, police and fire departments. And all of this equipment demands qualified technicians to maintain and repair it. In addition to knowing what you're doing, you must have an FCC Radiotelephone License to service most of it. NRI can help you get both... the training and the license.

**Learn on your own 2-meter, digitally synthesized VHF transceiver or 40-channel CB.**

With NRI, you learn by doing. You use the NRI Discovery Lab™ to build and test a whole series of typical communications circuits, even assemble



Some designed-for-learning equipment you get.



your own professional transistorized volt-ohm meter and a CMOS digital frequency counter. You test various types of antennas to gain a firm understanding of broadcasting principles. And finally, you assemble your own 2-meter transceiver for experiments in troubleshooting and servicing. Then, if you want to go on the air, we'll help you get your amateur license. As an alternate choice, you may elect to receive and experiment with a 40-channel CB to get more experience in this booming area.

™Trademark McGraw-Hill

You learn in your own home, in your spare time, at your convenience. NRI's bite-size lessons and carefully matched practical experiments combine theory and bench work to give you the most effective training for your money. No need to quit your job or take night classes, you move ahead at the pace that suits you best.

**NRI guarantees your FCC license.**

The law requires that technicians hold an FCC Radiotelephone License to work on broadcast equipment. NRI training in Complete Communications Electronics or our CB Radio Specialist course is carefully designed to give you the special coaching so helpful in passing FCC license exams. If you fail to pass the FCC examination for radiotelephone license after graduating, *NRI will refund your tuition in full.* The money-back agreement is valid for six months after completion of your course.

**Send for free catalog. No salesman will call.**

Find out all the facts about NRI's Communications or CB course. Or look into other areas of opportunity like TV and audio servicing, digital computer electronics, mobile communications, and more. Mail the postage-paid card today... there are more than 25 million good reasons why.



# why you should look Communications Servicing.

## Or get into TV and audio servicing

NRI can train you at home to service TV equipment and audio systems. Choose from five courses that go up to our 48-lesson Master Color TV/Audio Course. With it you get 14 kits for practical bench training and demonstrations, including NRI's exclusive, designed-for-learning, 25" diagonal solid state color TV, 4-channel audio system complete with speakers, and professional instruments you build and use for learning and earning. It's proven, effective training that's helped thousands of pros already. And it's the best value offered in the field. NRI's bite-size lessons speed learning, exclusive



"Power-On" training makes it real. Send card for free catalog.

## Learn computer electronics

**NRI trains you at home on a real digital computer.**

Qualified technicians are urgently needed for careers in the new field of computer and digital electronics... and NRI trains you at home on the real thing.

As part of your training, you actually assemble a working digital computer with expanded memory, define and flow chart programs, code your program, store it along with data in the memory bank. It's just one of the 10 hands-on training kits you receive. You also build and use your own TVOM; experiment with NRI's exclusive electronics lab. It's the quickest and best way to learn and start a new career in troubleshooting digital computers. Send the card today.

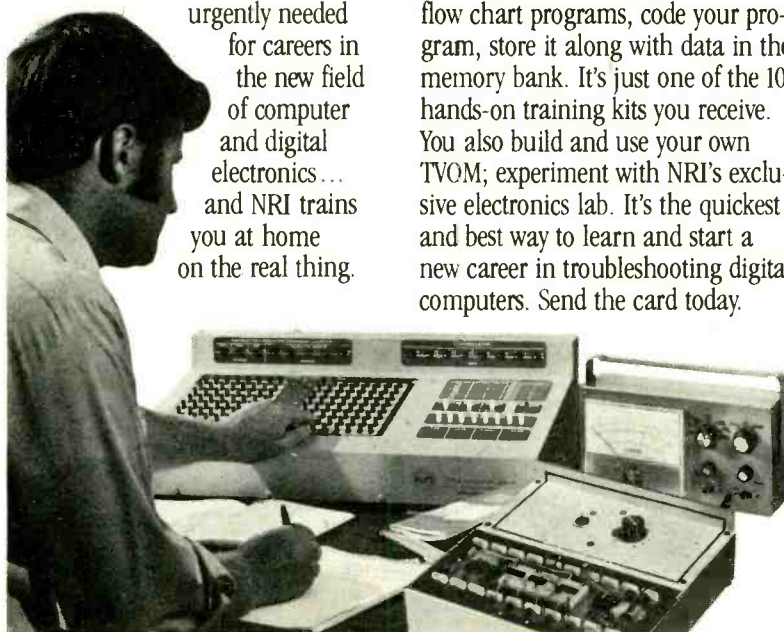

### **NRI instructor/engineers**

Each NRI student is assigned his own course instructor. He's there to help you over any rough spots, explain problems, and give you the advice you need as you progress toward your future. And he knows what he's talking about, because he was more than likely involved in the design of your course or some of the NRI equipment you use. NRI instructors are practical, experienced people who really know their field and do their best to pass their knowledge on to you.

### **You get more for your money from NRI.**

NRI employs no salesmen, pays no commissions. We pass the savings on to you in reduced tuition, top-quality professional equipment, and reliable testing instruments necessary for a successful career. You can pay hundreds of dollars more at other schools, but you can't get better training.

### **Free catalog, no salesman will call.**

Get your free catalog and discover why NRI is the leader in home technical training with over a million students, over 60 years experience in helping people build new careers. Mail the card today and get started on your new future. If card has been removed, write to:



### **NRI SCHOOLS**

McGraw Hill Center  
for Continuing Education  
3939 Wisconsin Avenue  
Washington, D.C. 20016

**WIRE CIRCUITS FASTER**  
WITH SOLDER-THRU PENCIL WIRING  
**VECTOR P178-1**

\$7.95  
NET

**NEW IMPROVED TOOL**

- Makes solder wrapped connections 3 times faster than usual way.
- Quick melt insulation for clean, fast solder joints with 750°F. iron.
- Fast snap-in spools.
- Easy threading & finger controlled tension & advance.
- Slim, light, comfortable tip angle.

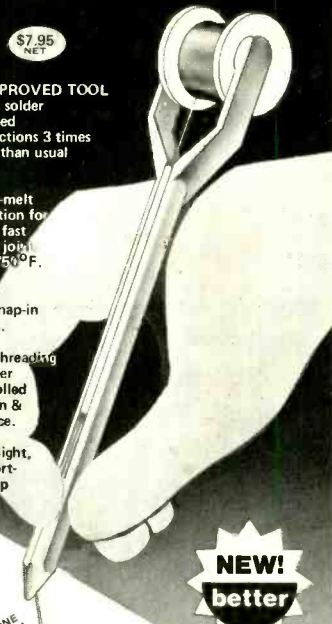

**NEW!**  
**better**

EVERYONE  
NEEDS ONE!



If unavailable locally, factory order. Add \$2.00 shipping and handling charge. California residents add 6% sales tax.

**VECTOR ELECTRONIC COMPANY, Inc.**  
12460 Gladstone Av., Sylmar, CA 91342  
phone (213) 365-9661  
twx 910-496-1539

**CIRCLE 38 ON READER SERVICE COUPON**

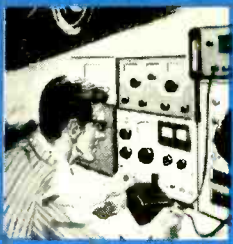

**Ask Hank,  
He Knows!**

Got a question or a problem with a project—ask Hank! Please remember that Hank's column is limited to answering specific electronic project questions that you send to him. Personal replies cannot be made. Sorry, he isn't offering a circuit design service. Write to:

**Hank Scott, Workshop Editor**  
**ELEMENTARY ELECTRONICS**  
380 Lexington Avenue  
New York, NY 10017

**In the Mix**

*When I transmit on CB, my nearby AM radio picks up shortwave stations such as Voice of America, Radio Moscow and Canada International. What causes this?*

—R.C., Martinsburg, WV

Possibly your CB signal and shortwave signal are mixing in the first RF stage of amplification in your receiver. Since the signals are strong, non-linear rectification occurs which is ideal for signal mixing. The difference signal falls into the AM band range and your set responds to it. The discussion is very general because the exact technique for this to happen can be caused many ways. I suggest you look seriously into shortwave listening and buy a good SW receiver.

**Junky Noise**

*Hank, in your Fall-Winter 1977 issue of ELECTRONICS HOBBYIST an item in your column by HW of Jay, New York complained of windshield motor wiper noise on his 1974 Subaru. I have a similar car and the noise problem on CB is very bad. The noise comes from the wiper motor, the radiator fan (electrical), gas pump, and ventilating blower motor. In-line capacitors are needed in all of these to reduce the noise. Also, the alternator in the low speeds (1st, 2nd, 3rd gears) gave quite a bit of noise, 4th speed seems to be too high a frequency for the CB set to pass. Incidentally, all these items caused a considerable amount of noise in the AM radio set also. Installing the aforementioned capacitors has cleaned this up too. (The AM car radio is a piece of junk anyway). The only difficulty I found in clearing the noise on the ventilating blower motor was that there was not a piece of metal to ground the case of the capacitors within a foot or so . . . everything is plastic near the motor. Another item also is to use a piece of coax cable run directly from the battery to the CB set. This shielded power lead helps a great deal.*

—R.S., Pawling, NY

Thanks for the tips. Too many makers of cars are "RF defective." The FCC is looking into this matter to prevent the millions of autos in the U.S. from polluting the radio bands. The coax idea is good, but be sure to fuse the hot line near the battery.

**Ups and Downs, Ins and Outs**

*I have a shortwave receiver that acts a little funny. I don't know if it's normal or not, but the signal keeps fading and building up again. I have to keep turning up the volume when it's weak; and down, when it's strong. What's wrong?*

—D.D., San Francisco, CA

A little reading on basic shortwave propagation will explain that shortwave signals do fade in and out causing the kind of reception you are experiencing. Receivers have an AGC (that's Automatic Gain Control) that works to prevent this from occurring. Some sets can turn the AGC off. See that the AGC (sometimes called AVC) is turned on, if it is switchable in your receiver. Extreme signal fading cannot be remedied by AGC and you will continue to hear fading of signals. That's what SWL is all about.

**8080 Beginner**

*Could you please tell me where I can obtain the schematics and parts lists for the 8080 and 8080A microcomputers? Thank you.*

—D.M., Chandler, AZ

Don't know why you limited your plans to the 8080, for there are other micro-processor chips on the market that are worthy of consideration. Why not contact the Heath Company (see ad in this issue) and ask for info on their computer kits. Also, look to Southwest Technical Products (ad also in this issue) for their literature. Further, read the computer column each issue written by Norm Meyers. If I were you, I'd do a lot of reading and researching before actually investing in a computer system that is home brew.

**Go Another Way**

*Is there any place that will design a P.C. board from a schematic diagram? I am involved with a few projects and would like them mounted on a P.C. board. I've tried to design them myself but run into problems. Does anyone offer this service?*

—S.S., North Platte, NE

What you need is a solderless breadboard. Why not write to Continental Specialties Corp., 44 Kendall Street, New Haven, CT 06509 (West Coast readers write to 351 California St., San Francisco, CA 94104) asking for their catalog. You could also write to AP Products, Box 110, 72 Corwin Drive, Painesville, OH 44077. Solderless breadboards are good because you can build on them, troubleshoot, make design changes and even use the assembly as it is. Another trick is to trace out a printed circuit template, from the layout, that works on the solderless breadboard. You may be able to simplify a bit, then you may not. Try to work out unnecessary jumpers for "art's" sake, but then it's not critical to the operation of the circuit or construction. Try solderless breadboards, they are terrific. As for a

**PAIA 8700 Computer Controller**

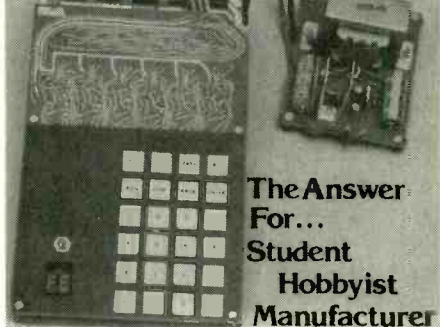

**The Answer For...  
Student  
Hobbyist  
Manufacturer**

**8700 Processor:** 6503 MPU. Wear free "ActiveKeyboard". Micro-Diagnostic. Extensive documentation. Fully Socketed.

**Piebug Monitor:** User Subroutines. Relative address calculator. Pointer High-low. Back-step key.

**Cassette Interface:** Load & Dump by file #. Positive indication of operation. Tape motion control.

Applications systems from \$90 (10 unit quantity)  
Development systems from \$149 (single unit)

**TELL ME MORE** I want to see for myself that the 8700 is The Answer.

- Please send documentation \$10 enclosed.
- send price lists & FREE Catalog of other PAIA kits.

name: \_\_\_\_\_  
Address: \_\_\_\_\_  
City: \_\_\_\_\_ State: \_\_\_\_\_ zip \_\_\_\_\_

**PAIA** DEPT. EE 6 1020 W. Wilshire Blvd.  
**ELECTRONICS** • Oklahoma City, OK 73116 •

22 CIRCLE 15 ON READER SERVICE COUPON



design service, if you don't know a local experimenter, forget the service, the price is too high.

**Tain't So!**

*I have a question about a TV game kit I plan to build. I recently heard from a friend that TV games can eventually damage a TV set. Is this really true? Should I build the kit?*

—P.C., Arlington, VA

You should experience no troubles with your TV set. This problem first occurred and has since been solved. You will not burn any designs into the tube face.

**Funky Counter**

*Would it be possible to connect a VOX system to a digital counting circuit so that one count is advanced for "every sound" picked up by the microphone?*

—E.B., Kearny, NJ

Yes, once you define what "every sound" is so that a sensing circuit could be built!

**Lend a Hand, Boys**

Readers all over the North American Continent need help, and you may be able to send them what they need. If you have a schematic diagram that someone needs, find out what it costs to "copy" and write to the person stating the exact cost. Shop around. Some copy machines are 10 cents a copy and others are 25¢. Never send originals, cause Hank will not be responsible for the mails. Help a buddy (or gal) out and you may start up a penpal friendship.

Maybe I should get in my request first. I'm looking for an old radio, any make, any type, that someone wants to part with. Any reasonable condition is okay, 'cause I want to enjoy restoring it. Just write to me, Hank!

Δ Crosley Trirdyn 3R3, Type 121 regenerative receiver, needs hookup instructions: Tim Brannon, Rt. 6, Box 227, Gilmer, TX 75644. Tim also needs service advice on Firestone Air Chief that is motorboating.

Δ Knightkit R-55A receiver, need operator's manual and schematic diagram: Elmer R. Leonhardt, P.O. Box 655, Jamestown, TN 38556.

**PRO-2001 Update**

Readers should know that, on the PRO-2001 programmable scanner which we reported on last issue, there is a way to resume search after a frequency is entered into a channel without reprogramming LO and UP. Simply: 1) press MONITOR to stop the scanning action, 2) press ENTER, and 3) resume search by pressing FS or SS. Also, you can select the channel in which you wish to make the entry (if you have not beforehand) by switching back to the SCANNER mode and manually advancing to the desired channel position. To return to search: Press PROGRAM, then ENTER, and resume by pressing FS or SS.

**This is easy-  
anyone can solder-  
WITH  
KESTER SOLDER**

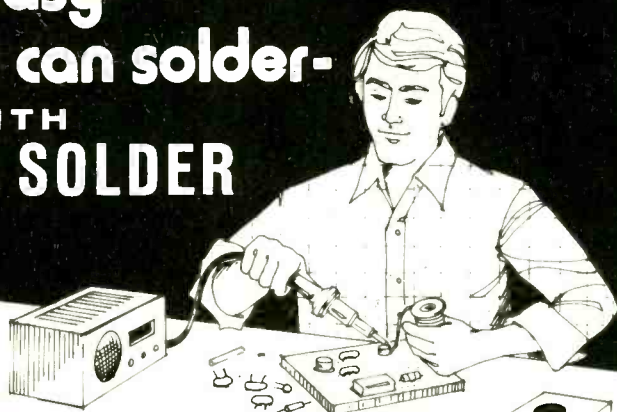

**Handymen! Hobbyists!  
DO-IT-YOURSELFERS!**

Let Kester Solder aid you in your home repairs or hobbies. For that household item that needs repairing — a radio, TV, model train, jewelry, appliances, minor electrical repairs, plumbing, etc. — Save money — repair it yourself. Soldering with Kester is a simple, inexpensive way to permanently join two metals.

When you Solder go "First Class" — use Kester Solder.

For valuable soldering information send self-addressed stamped envelope to Kester for a FREE Copy of "Soldering Simplified".



**KESTER SOLDER**

Litton 4201 WRIGHTWOOD AVENUE/CHICAGO, ILLINOIS 60639

CIRCLE 14 ON READER SERVICE COUPON

**BUILD YOUR OWN  
BIG SCREEN COLOR TV!**

Convert any portable color TV! *TV not included.*  
Can be built in a few spare hours.  
No special tools or electronic skills required.  
SAVE \$15 ON ALL PACKAGE ORDERS!

**NEW!**  
**TRON-EX F/1.9 LENS**  
featured in November  
Popular Science.

The LIFESCREEN III projection system gives you all the enjoyment and excitement of the \$4000 systems. Our new injection molded Tron-Ex lens (F/1.9) produces an amazing image that is over 3 times brighter than most nationally marketed big-screen TVs—including Sony. And the Tron-Ex delivers sharper focus to the screen edge for better overall clarity. Our light-enhancing Extron LS-50 screen is 6 times brighter than most movie screens, because the molded parabolic contour rejects extraneous light, concentrating a directionally selective TV image for clear, colorful viewing. The LIFESCREEN III plans provide exact dimensions to fit the 13" Toshiba (model C389), but they can be modified to fit most 12" to 19" portables. Pre-constructed LIFESCREEN III lens housings available for most TVs. Order the components catalog below. **COMPLETE PACKAGE \$319**

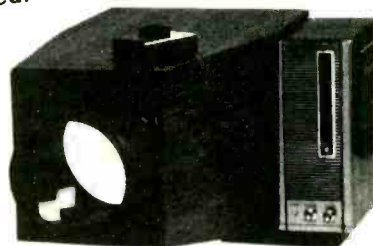

**LIFESCREEN II**

The self-contained projection system that uses any transistor portable TV (12" to 19") requires only 2 x 4 feet of floor space... fits neatly against any wall and lends its beauty to the decor of any room. Includes Tron-Ex F/1.9 lens, Extron LS-50 screen, two front surface mirrors, and building plans for the cabinet. **COMPLETE PACKAGE \$369**



**LIFESCREEN I**

The original independent projection system from Extron. Works with the Sharp 13" model 13A29 color TV or Sony 15" model KV1541R color TV. Can be used with any size screen. The LIFESCREEN I includes our new Tron-Ex F/1.9 lens, one front surface mirror, building plans for cabinet, and the LS-50 screen, 32" x 40"/50" diagonal. **COMPLETE PACKAGE \$339**

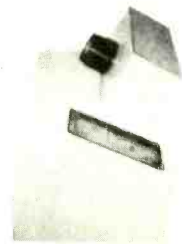

**EXTRON GUARANTEES EVERYTHING:** the professional quality, accuracy of description and availability of components described in this ad. After building your LIFESCREEN PROJECTION SYSTEM, if you are not satisfied for any reason, return all components to EXTRON for instant refund.

LARGER SCREENS FOR THE LIFESCREEN I AND LIFESCREEN III SYSTEMS CAN BE ORDERED FROM OUR CATALOG.

- Please send me the items checked below:
- ONE COMPLETE SET OF LIFESCREEN I PLANS ..... \$9.00
  - ONE COMPLETE SET OF LIFESCREEN II PLANS ..... \$9.00
  - ONE COMPLETE SET OF LIFESCREEN III PLANS ..... \$9.00
  - COMPLETE LIFESCREEN I PACKAGE ..... \$339.00
  - COMPLETE LIFESCREEN II PACKAGE ..... \$369.00
  - COMPLETE LIFESCREEN III PACKAGE ..... \$319.00
  - EXTRON COMPONENTS CATALOG (Applicable toward any purchase) \$1.00



**EXTRON LIFESCREEN PROJECTION SYSTEMS**  
8833 Sunset Boulevard Suite 202  
West Hollywood, CA 90069

Name \_\_\_\_\_  
Address \_\_\_\_\_  
City \_\_\_\_\_ State \_\_\_\_\_ Zip \_\_\_\_\_  
CARD NAME \_\_\_\_\_  
CARD NUMBER \_\_\_\_\_ EXP. DATE \_\_\_\_\_  
SIGNATURE \_\_\_\_\_

All prices F. D. B. factory—Cal. residents add 6% sales tax  
TOTAL \$ \_\_\_\_\_

CIRCLE 9 ON READER SERVICE COUPON





## Help is only a REACT team away

Relax, you've got some friends you haven't even met yet. Probably right in your own home town. They're your neighbors who've joined the local REACT Team, part of an international people-to-people organization dedicated to improving highway safety and serving the community by maintaining an emergency CB radio network.

*Dedicated* is the right word, too.

This year REACT members will volunteer 35 million man and woman hours monitoring CB Emergency Channel 9. They will receive accident reports, help lost or stranded motorists; report unsafe road conditions and accidents; rush medical assistance; help people with car problems; and cooperate with local law enforcement and disaster services.

It's important volunteer work. And today more than 200,000 active REACT participants monitor CB Emergency Channel 9 in all 50 United States, Canada and Mexico. And REACT is growing everywhere CB radios are used.

And that's good news for every motorist. Because with more than 25 million CBers on the road, any CB-equipped car can pass the word about a highway problem to a REACT monitor. Quickly!

If you'd like more information about REACT and highway safety—or how to start or join a volunteer REACT team in your area, write today.

We don't think highway safety is somebody else's concern.



A Non-Profit Public Service Organization

**REACT International, Inc.**

111 E. Wacker Drive, Chicago, IL 60601

# DX central reporting

A world of SWL info!

BY DON JENSEN

□ GETTING THOSE QSLs—or veries, verifications, confirmations; they all mean the same thing—is an art in itself. Many times the DX listener will find that it is tougher to coax a letter or card in reply to their reception report than it was to hear the station in the first place.

A QSL, a verification is just that, a reply from a station confirming that the report of reception you sent to them was correct and, in fact, that you did hear them when and where you stated. Theoretically, at least, a QSL is your proof, to be kept on file or displayed on your walls, that you received the signals of Station X. In practice, the value of a QSL as proof depends on the vagaries of station policy, how carefully your report was checked for accuracy. But regardless, QSL collecting can be fun.

**Getting QSLs.** Many of the large international broadcasters are ready, willing and yes, sometimes even anxious to receive your reception reports and to QSL them in return. These are the stations that deliberately direct their programs, usually in English, to North American SW audiences. They do wish to get feedback from that audience. And so to encourage you to write, they will offer colorful QSL cards, pennants or other little gifts.

But there are many other stations in the world of shortwave. These broadcasters program to home service audiences, local or regional listener. Often their programs are not in English. They are not deliberately seeking North American audiences. So they don't always respond promptly to listener requests for QSLs.

And, of course, no broadcaster is under any obligation to send QSL cards or letters to listeners who report reception of programs. Normally a station's staff replies because they're interested in building goodwill, or because a station engineer is interested in knowing that his signal is doing a good job and is being heard across the world, or simply as a courtesy.

So politeness, when you're writing your reception report to a station, is a must. You may ask for a QSL to confirm your report, but don't demand. It won't get you anything you otherwise

would not have received. And enough nasty letters to stations could adversely affect their QSLing policies.

Perhaps the best way to report your reception is to write a personal letter to the station's manager, engineer or English Language program department.

Your report should include certain basic elements. These are the frequency on which you heard the station, the date and time of reception, the conditions of reception, a detailed listing of the programming you heard and supplemental remarks. The latter could include information about your listening equipment, about yourself and your interests, or your personal comments about the programs you heard.

It is important to state the frequency on which you heard the station. Some stations use a number of different frequencies simultaneously, so if you neglect this aspect, the station will have no idea which particular transmission you heard. Sometimes it is hard to understand a station's announcements and sometimes listeners make mistakes. They think they are hearing one station when it is actually something else.

If the programming is in English, it is usually fairly easy to determine the frequency in kilohertz. Usually it will be mentioned in the announcements. If it is not announced, you must do the best job you can in estimating the correct frequency. Some of the better receivers make it fairly easy to readout the tuned frequency. Others fall down badly on this score. All I can say is to try to be as accurate as you can in determining the frequency of the tuned station.

### DX Glossary

BBC=British Broadcasting Corporation

DX, DXing=Listening to distant or hard-to-hear stations as a hobby

DXer=One who DXes

EDT, CDT, MDT, PDT=Eastern (Central, Mountain, Pacific) Daylight Time

EST, CST, MST, PST=Eastern (Central, Mountain, Pacific) Standard Time

GMT=Greenwich Mean Time

kHz=kilohertz, most commonly used unit of frequency measurement; identical to kilocycles per second, which is abbreviated, kc/s.

log=a list of stations

QSL=verification card or letter from a station, confirming as correct the DXer's report of reception

SW=shortwave



**Timing.** When it comes to a time reference in your reception report, usually the preferred approach is to use the 24-hour clock system and use Greenwich Mean Time references.

The 24-hour time system simply eliminates any a.m. or p.m. designations. The hours from midnight to noon are not much different from the time reference system we're all familiar with. One a.m. becomes 0100, 2 a.m. is 0200 and one minute before noon is designated 1159 hours. After noon, however, the count keeps running. One p.m. is 1300, 2 p.m. is 1400, up until a minute before midnight, which is 2359 hours.

Greenwich Mean Time or GMT is a standard time reference at the zero degree meridian that passes through Greenwich, England. When dealing with stations all over the world, each of which has its own local time, it is much easier and more convenient for everyone concerned to use a standard reference time called GMT.

It is equivalent to EDT + 4 hours, EST or CDT + 5 hours, CST or MDT + 6 hours, MST or PDT + 7 hours, PST + 8 hours. For instance, if it is 12 noon PDT in your California community it is 1900 GMT. And if you live in Miami and the local time is 2:30 p.m. EDT, it is 1830 GMT (1430 + 4 hours).

The important thing to note about the date in your report involves the use of GMT. Be sure to make the date correspond to GMT! Thus, it may be 10 p.m. EDT in Baltimore where you do your DXing, and your calendar may show it to be the evening of August 14, but remember that the GMT time equivalent is 0200 (that's 10 p.m. or 2200, plus 4 hours), some 2 hours into the new date of August 15. Your report should read 0200 GMT, August 15.

**Loud and Clear.** You should report also to the station how well you heard their signal. Admittedly this is something of a formality with the large international broadcasters who get thousands of similar reports. They have a pretty good idea already of how their signals are being heard in North America. Still, even with these outlets, your technical notes on signal strength, interference, static and atmospheric noise and fading could be helpful, especially if you've noted some new condition, some transient problem with their transmitting operation of which they weren't aware.

Without an accurate account of the program you heard, a detailed list of the broadcast items, the station really has no way of determining if it was really the one you heard. Include a summary, but with enough detail so the station's staff can check it against pro-

(Continued on page 92)

# for the Experimenter!

## INTERNATIONAL CRYSTALS and KITS



### OF-1 OSCILLATOR

**\$425** ea.

The OF-1 oscillator is a resistor/capacitor circuit providing oscillation over a range of frequencies by inserting the desired crystal. 2 to 22 MHz, OF-1 LO, Cat. No. 035108. 18 to 60 MHz, OF-1 HI, Cat. No. 035109. Specify when ordering.

.02% Calibration Tolerance

### EXPERIMENTER CRYSTALS

(HC 6/U Holder)

**\$475** ea.



Cat. No.

Specifications

031300

3 to 20 MHz — For use in OF-1L OSC Specify when ordering.

031310

20 to 60 MHz — For use in OF-1H OSC Specify when ordering.

### MX-1 Transistor RF Mixer

3 to 20 MHz, Cat. No. 035105  
20 to 170 MHz, Cat. No. 035106

\$5.50 ea.

### SAX-1 Transistor RF Amp

3 to 20 MHz, Cat. No. 035102  
20 to 170 MHz, Cat. No. 035103

\$5.50 ea.

### BAX-1 Broadband Amp

20 Hz to 150 MHz, Cat. No. 035107

\$5.75 ea.

Enclose payment with order (no C.O.D.). Shipping and postage (inside U.S., Canada and Mexico only) will be prepaid by International. Prices quoted for U.S., Canada and Mexico orders only. Orders for shipment to other countries will be quoted on request. Price subject to change. Address orders to:

M/S Dept. PO Box 32497  
Oklahoma City, Oklahoma 73132

WRITE FOR BROCHURE

International Crystal Mfg. Co., Inc.

10 North Lee Oklahoma City, Oklahoma 73102



CIRCLE 13 ON READER SERVICE COUPON

## The world at your fingertips



Introductory Offer\*

**\$229.50**

+\$5.50 S&H  
(List \$289.95)

### BARLOW WADLEY XCR-30

- 500kHz to 30MHz Continuous Coverage
- Direct Frequency Readout to within 5kHz
- A.M., U.S.B., L.S.B., C.W.
- World Acclaimed Multiple Conversion Circuit



Introductory Offer\*

**\$549.50**

(List \$699.00)

### Satellit 2100

- AM, FM, LW + 18 SW Bands
- 3 Separate Tuning Dials
- Antenna Trim Control
- AC or Battery Operation
- Bandsread on SW

\*FREE! Purchase before 6/30/78 and receive a copy of the 1978 World Radio-TV Handbook.

\*Introductory offers valid thru 6/30/1978

We specialize in catering for your MW and SW listening only. Also in stock Sony, Panasonic and other fine receivers at discount prices. SWL Books, Antennas, Headphones. Send SASE for flyer. We ship world-wide.

## RADIOS INTERNATIONAL

(Div. of S.M. Corporation)

P.O. Box 6053 Richardson, Texas 75080

CIRCLE 29 ON READER SERVICE COUPON

## ELECTRONIC MUSIC-AUDIO

### EXPERIMENTERS

WE OFFER ELECTRONIC COMPONENTS, SYNTHESIZER MODULE KITS, PARTS, PLANS, AND MORE... AT THE LOWEST PRICES ANYWHERE.

741 DIP: 2/25¢, CA 3401 QUAD OP AMP: 49¢ EA, 7815 10-3: \$1.25  
CA-3054 ARRAY: 35¢ EA, LF 351 FET OP AMP: 1099: 95¢ EA, 115-VOLT POWER SUPPLY BASKIT: 1AMP: \$14.95

WRITE FOR FREE FLYER

TAU 123C SYNTHESIZER VCO MODULE, ONLY \$24.50 EACH. HYBRID ACTIVE FILTER, 1AF \$10.95

100 STATE VARIABLE FILTER: ONLY \$7.30

CFR R/O CIRCLE/Box F Newton NH 03858

### FREE KIT MANUALS

1. 40-Watt x 2 complete stereo amp kit with latest BI-FET IC
  2. LEACH 100-Watt x 2 Low TIM power amp kit
  3. LEACH Wide Bandwidth Preamp kit
  4. 30-Watt Class A power amp kit
- All complete with cabinets  
Moonlighter Electronics, 117 Inverness  
San Francisco, CA 94132

WRITE NOW FOR

**McGEE'S**

## BIG SPEAKER CATALOG

1001 BARGAINS IN

SPEAKERS—PARTS—TUBES—HIGH FIDELITY COMPONENTS—RECORD CHANGERS  
Tape Recorders—Kits—Everything in Electronics  
1901 McGee Street, Kansas City, Missouri 64108

# Volksmeters for Sunny Days!

Now with LCD's  
AND longer battery operation  
AND now less than \$100



**LM-300 3 digits \$99.50**

**CIRCLE 39 ON READER SERVICE COUPON**

**LM-350 3½ digits \$125.00**

**CIRCLE 44 ON READER SERVICE COUPON**

**Features Include:**

- Measures VDC, VAC, DCmA, ACmA (four ranges each) and ohms (five ranges).
- Auto zero, auto polarity and overload indication.
- DC accuracy - LM-300: 1%; LM-350: 0.5%.
- Input protection.
- Small size: 1.9" H x 2.7" W x 4.0" D.
- Optional NiCad batteries and charger unit available at extra cost.



**Non-Linear Systems, Inc.**

Originator of the digital voltmeter.

Box N, Del Mar, California 92014

Telephone (714) 755-1134 TWX 910-322-1132

**Be a LOCKSMITH!**  
EARN WHILE YOU LEARN  
Send for FREE BOOK

Locksmithing Institute, Dept. 1472-078  
Div. Technical Home Study Schools, Little Falls, N. J. 07424

Big opportunities. Big profits. Earn quickly. Full or part time. Learn at home, it's easy. Do real jobs: All Tools—Materials Supplied. Accredited member NHSC. Lic. State of NJ—Appd. for Vet. Send name and address for FREE book.

**AMAZING ELECTRONIC PROJECTS and PRODUCTS:**

Phasor Painfield  
Lasers Super Powered, Burning, Cutting, Rifle, Pistol, Pocket. See in Dark—Shotgun Directional Mike—Unscramblers—Giant Tesla—Stunwand—TV Disrupter—Energy Producing, Surveillance, Detection, Electrifying, Ultrasonic, CB, Auto and Mech. Devices, Hundreds More—All New Plus INFO UNLTD PARTS SERVICE. Catalog \$1. Information Unlimited, Box 626E, Lord Jeffery Court, Amherst, N.H. 03031.

**HIGHLY PROFITABLE ONE-MAN ELECTRONIC FACTORY**

Investment unnecessary, knowledge not required, sales handled by professionals. Postcard brings facts about this unusual opportunity. Write today! Barta - E11, Box 248, Walnut Creek, CA 94597.

**BEAT THE HIGH COST OF ELECTRONICS**

We have over 1,000,000 electronic parts at less than 10¢ on the dollar. Circuit boards, transistors, diodes, car stereos, FM tuners. We buy truckloads. You buy what you need.

SEND \$2.00 for complete details & lists!

**ELECTRONIC SURPLUS SUPPLY**  
2950 W. CENTRAL, SUITE 102, SANTA ANA, CA 92705

**Take stock in America.**

With higher paying U.S. Savings Bonds.

# newscan

Electronics in the News!

## Galactic Molecule-Breaks Four-Minute Mile

In the last two years research scientists at the National Research Council's Herzberg Institute of Astrophysics (Canada) have discovered three new "heavy" molecules in deep space. Following the original discovery of the molecule HC<sub>3</sub>N (cyanobutadiyne) with a molecular weight of 75, NRC's radio astronomers continued their investigations leading to the finding of HC<sub>7</sub>N in the Spring of this year. HC<sub>7</sub>N has a weight of 99 on the atomic scale. With today's announcement that HC<sub>9</sub>N (cyanooctatetrayne) has been confirmed as well, the molecular weight of compounds in space has passed the 100 mark, reaching a level of 123 atomic units. That's like breaking the old 4-minute mile barrier.

While the figure of 100 is of passing significance in itself, the finding of this heavy molecule has intensified speculation on how such large compounds originate in space where simplicity is the rule. Most molecules in space are made up of a few small atoms and rarely form any large complex structures. HC<sub>9</sub>N becomes a virtual monster in contrast to previously found species.

More important than weight alone is the now-increased awareness that since molecules of such size exist in space, somewhere in the dark, mysterious dust clouds between the stars may be a real amino acid—the basic building block of life.

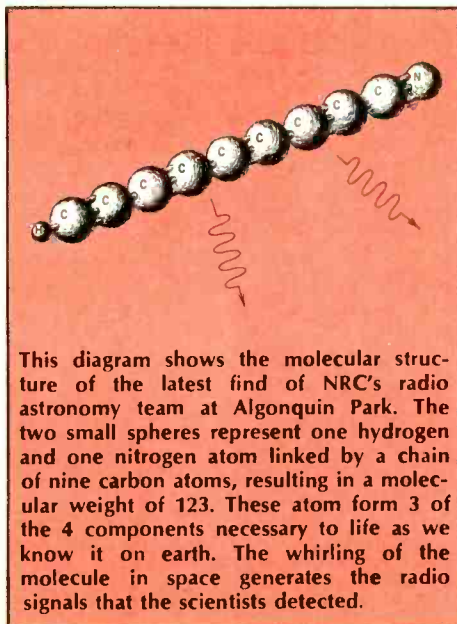

This diagram shows the molecular structure of the latest find of NRC's radio astronomy team at Algonquin Park. The two small spheres represent one hydrogen and one nitrogen atom linked by a chain of nine carbon atoms, resulting in a molecular weight of 123. These atoms form 3 of the 4 components necessary to life as we know it on earth. The whirling of the molecule in space generates the radio signals that the scientists detected.

## Historic Radio Central Dies

A colorful era in communications history ended when RCA Global Communications, Inc., demolished the last of 12 giant transmitter antenna towers at Rocky Point, New York in December of 1977. The 410-foot antenna was all that remained of "Radio Central," the most powerful radio station in the world in its heyday. The Rocky Point facility was built in 1921 and was the principal station that linked the United States with the rest of the world. It was the "hopping off" point for messages transmitted by RCA to Europe, Central and South America. Radio Central covered approximately 10 square miles, an area roughly half as large as Manhattan Island.

The official opening of Radio Central on November 5, 1921, was hailed as a milestone in wireless progress. President Harding, in the White House, threw a switch that put Radio Central into operation. Stations around the globe had been alerted to tune in for a congratulatory statement by the President.

"Long waves" were necessary for long distance communications in those days and the state of the art dictated the use of high steel towers to support massive antenna structures. There were originally 12 towers, each 410-feet high and weighing 150 tons, that stretched over a three-mile area on the eastern end of Long Island. As communications technology developed, the long wave system became obsolete. The vacuum tube, which made possible short wave transmissions, followed by improved cables and eventually satellites, made the two giant Alexanderson alternators and antenna "farms" a thing of the past. One of the 200-kilowatt alternators is now in the Smithsonian.

RCA demolished 11 of the towers in the 1950's and early 1960's. The

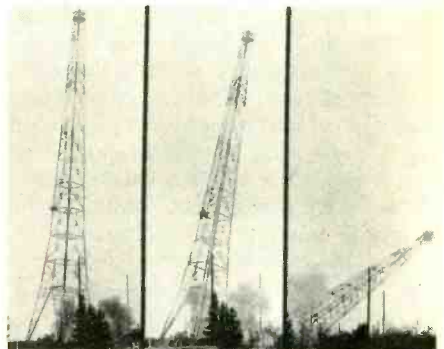

Dynamite charges topple the last of the giant 410-foot radio towers that was once the most powerful station in history, Radio Central. Communications satellites and undersea cables made these towers obsolete remnants of a long-gone era of radio communications and entertainment.

last one has been used most recently as a support for aviation beacon lights and radio antennas for higher frequencies.





Photo shows the Rocky Point transmitting station with its swimming-pool that provided cooling water for the transmitters. Behind are a few of the 12, 410-foot tall long wave antenna towers.

But it's not even needed for that anymore, so RCA decided to demolish it.

It took two months to build the tower; it stood for 56 years, but it was demolished in a few seconds. As it crashed down, the tower gave a booming farewell to a colorful era long past.

## The Chips are Down on Up Elevators

An electronic "sergeant" commanding a whole company of elevators. Bill Hoelscher might not agree with that rather high-blown description of a microprocessor. But he concedes that's what the electronic age has come to: a pygmy computer with a fabulous memory telling up to eight elevators when to go and where to stop.

Hoelscher, if you want to be more formal, is William R. Hoelscher, chief electronics engineer for U.S. Elevator of Spring Valley, California. For more than two years, he and his colleagues have been working to shrink down to suitcase-size the electronic control system required to command and operate a bank of elevators. Now the Hoelscher team has scored with a new generation microprocessor to replace what only a few years ago filled an entire average-sized room with countless yards of wiring, circuitry, vacuum tubes and other electronic paraphernalia.

In layman's terms, the microprocessor memorizes the missions of its elevators and command them to do as they're told. Yet this pygmy microprocessor can command up to eight elevator cars serving up to 48 landings (that's floors to lay people). Since in very tall buildings, not all cars stop at all floors, the little "sergeant" could control and command a fleet of eight cars servicing a 100-story building. This is no Buck Rogers lash-up. The new microprocessor system saves space, parts, electrical power and therefore countless dollars for the customer. Moreover, its reliability is infinitely greater than earlier states-of-the-art made possible.

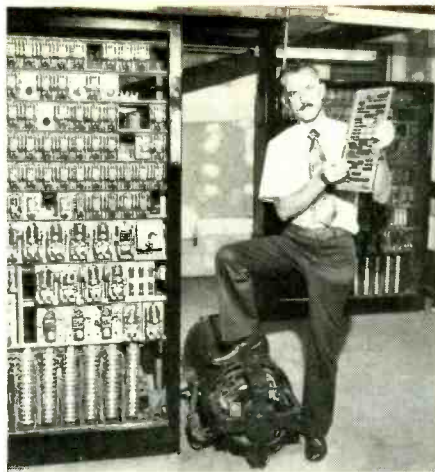

Surrounded by present elevator control equipment, Bill Hoelscher, shows off his new microprocessor commander.

A dramatic savings in costs will come in another new generation development: the replacing of up to 100 individual wires with only two in the call signals for each elevator car. Imagine the savings in costs when you install two wires instead of 100 in each car.

Because Hoelscher is an engineer he is cautious. He concedes "we have to learn to walk before we run" with the microprocessor. Nevertheless, he envisions this combination of electronic "heart" and "brain" as the beginning of a new era in elevator service for either low or high-rise buildings.

## New Light on Power Conservation

A new phosphor is credited with the greatest single boost in fluorescent lamp efficiency since the 1950's. The phosphor, which coats the inside of the new General Electric Watt-Miser II lamp combines a narrower band of blue light from one phosphor with a brighter yellow-emitting phosphor. The resulting 35-watt lamp is capable of producing 97 percent as much light as standard 40-watt fluorescent lamps and thus can reduce lighting system energy costs by as much as 14 percent. That's where the energy saving is, and that's the news story.

Translated into energy costs, this dramatic gain in lighting efficiency means that an estimated \$770 million could be saved in the nation's electric bill each year if the more than 800 million 40-watt fluorescent lamps now installed in commercial and industrial plants throughout the country were replaced by the new GE reduced-wattage fluorescent lamp. This would be a significant contribution to the U.S. energy-conservation program.

Phosphors—the chemical compounds that are coated on the inner surface of a fluorescent tube—emit visible light when exposed to the ultraviolet radiation.

(Continued on page 96)

## 5 GREAT New Books on Microprocessors!

### BEGINNER'S GUIDE TO MICROPROCESSORS

Everything you need to know to get started with microprocessors and personal computers, from the very basics to their internal architecture, from programming to interfacing with the outside world...including how to select your own computer system. Assumes absolutely no prior knowledge of the subject. Includes a point-by-point comparison of the Motorola 6800 and the Intel 8080 chips. 182 p., 106 ill.

Paper \$5.95; Hardbound \$8.95 Order No. 995

### 57 PRACTICAL PROGRAMS AND GAMES IN BASIC

57 of the hardest working, most enjoyable BASIC programs you've ever seen...everything from space war games to blackjack, from craps to I Ching, from arithmetic progression to statistical permutations to one-arm bandits! It's an easy-to-use manual that gives you 57 different Simplified BASIC programs. You can program your minibrain for all kinds of fun and games, or for figuring compound interest, calculating depreciation, etc. 210p., 64ill.

Paper \$7.95; Hardbound \$10.95 Order No. 1000

### MICROPROGRAMMING FOR COMPUTER HOBBYISTS

A unique programming manual that takes you right from the very basics up to state-of-the-art capabilities with enough detail on intermediate and advanced techniques of programming and data structuring to satisfy a working professional programmer. Anyone, no matter how inexperienced, can easily follow it. Covers stacks, queues, deques, strings, trees, graphs, right up through the most supercomplex multiple-linked chains. 378p., 215ill.

Paper \$8.95; Hardbound \$12.95 Order No. 952

### MINIPROCESSORS: FROM CALCULATORS TO COMPUTERS

The computer hobbyist's machine-language hybrid calculator/computer book...shows you how to use, build, design, repair, troubleshoot, program, and customize your own calculators! Bridges the gap between calculator and computer technology, shows you how to start with a few easy-to-obtain calculator chips and gradually construct any kind of superbrained, specialized calculator you want. 192 p., 67 ill.

Paper \$5.95; Hardbound \$9.95 Order No. 971

### THE "COMPUTER" BOOK

An imaginative new project book that shows you how to mate the COMPUTER with the CALCULATOR to build, design, and customize calculators for all kinds of "brainwork"—counting, storing data, measuring times, dialing phones, generating random numbers...even tying one into a Teletype for a tape-controlled calculator with virtually an infinite memory...plus how to build displays several feet high. Includes full-size printed-circuit layouts to make your own PC boards! 322 p., 224 ill.

Paper \$7.95; Hardbound \$10.95 Order No. 975

SEND NO MONEY! We'll invoice you on 10-DAY FREE TRIAL. Clip entire ad to order. 100% guaranteed or your money refunded.

TAB BOOKS DEPT EE-78 BLUE RIDGE SUMMIT, PA. 17214

CIRCLE 21 ON READER SERVICE COUPON

GOING DIGITAL?  
— GO ALL THE WAY!

## KEYBOARD & ENCODER

Assembled & Tested  
Hookup instructions



Only  
**23<sup>98</sup>**  
Complete

- TTL Compatible
- Temporary or Permanent Installation
- Edgeboard for Hookup Convenience
- Compact 3/8 x 3 1/8 x 5 1/8
- Mounting Brackets 1/8 Holes
- Black Keyboard — White Keys/Black Numerals

### TRINETIC ENTERPRISES

P. O. BOX 424, TWO RIVERS, WI. 52421  
Please rush! Enclosed is my check ( ) or M.O. ( ). No C.O.D. please.

Name \_\_\_\_\_  
Street \_\_\_\_\_  
City/State/Zip \_\_\_\_\_

CIRCLE 36 ON READER SERVICE COUPON

# Train with NTS for the MicroComputers, digital the first name



## MicroComputers

The world of electronics is daily becoming more challenging. Technology is growing more specialized, and the importance of digital systems increases every day. Test instruments, home entertainment units and industrial control systems are all going digital. And now, NTS training programs include a wider choice of solid-state and digital equipment than ever before offered in any home study course: Advanced NTS/Heath digital color TV (25" diagonal with optional programming capability), NTS/Heath microcomputer, digital test equipment, digital stereo receiver (70 watts per channel), NTS compu-trainer, plus much more state-of-the-art equipment to make your training exciting and relevant.

The equipment you receive with NTS training programs is selected to provide you with a solid

background in electronic systems. Kits and lessons are designed to work together to demonstrate electronic principles and applications. The kit-building not only shows you how electronic hardware functions, but how various circuit designs accomplish different purposes. Your lessons guide you through any number of experiments associated with many projects. This is the Project-Method, and it works. Step-by-step, you learn how and why digital electronics has become a part of our world, and the even bigger role it is sure to play in the future.

Whether you are looking for training in Consumer, Commercial, or Industrial electronics, NTS offers fourteen courses, some basic, many advanced, in several areas of electronics. An all-new full-color NTS catalog shows you what each course covers,



# electronics of the future.

systems and more...from  
in home study.



**Test Instruments**

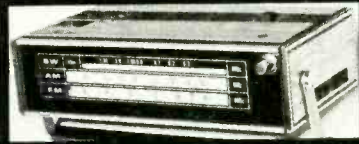

Simulated TV Reception

**Digital  
Color TV**



**Basic  
Electronics**

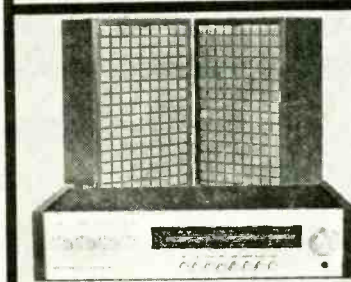

and every piece of equipment included.  
Send for it today, and see for yourself what's really happening in electronics training technology at NTS. Find out how much has changed, and what new directions the field is taking. You'll probably want to be a part of it.  
It's free. Just mail the card or coupon. Today.

**NO OBLIGATION. NO SALESMAN WILL CALL.  
APPROVED FOR VETERAN TRAINING.**

**NATIONAL TECHNICAL SCHOOLS**

TECHNICAL-TRADE TRAINING SINCE 1905  
Resident and Home-Study Schools  
4000 South Figueroa St., Los Angeles, Calif. 90037

**NATIONAL TECHNICAL SCHOOLS** Dept. 222-078  
4000 South Figueroa Street, Los Angeles, California 90037

Please send FREE Color Catalog and Sample Lesson.

- Color TV Servicing
- B & W TV and Radio Servicing
- FCC License Course
- Electronic Communications
- Electronics Technology
- Audio Electronics Servicing
- Digital Electronics
- MicroComputers/MicroProcessors

Name \_\_\_\_\_

Address \_\_\_\_\_

Apartment Number \_\_\_\_\_ Age \_\_\_\_\_

City \_\_\_\_\_

State \_\_\_\_\_ Zip \_\_\_\_\_

- Check if interested in G.I. Bill information.
- Check if interested ONLY in classroom training in Los Angeles.

# YAESU'S NEWEST RECEIVER THE FRG-7000



The FRG-7000—Yaesu's newest receiver features improved selectivity, wider frequency coverage, digital readout, with Yaesu's superb quality of construction.

### — SPECIFICATIONS —

Frequency Range: 0.25-29.9 MHz	Selectivity: SSB/CW $\pm 1.5$ KHz ( $-6$ dB), $\pm 4$ KHz ( $-50$ dB)
Modes of Operation: AM, SSB, CW	AM $\pm 3$ KHz ( $-6$ dB), $\pm 7$ KHz ( $-50$ dB)
Stability: Less than $\pm 500$ Hz drift for any 30 minute period after warmup.	Power Requirements: 100/110/117/200/220/234 VAC, 50/60 Hz
Sensitivity: SSB/CW-Better than $0.7\mu\text{V}$ for S/N 10dB AM-better than $2\mu\text{V}$ for S/N 10dB (400 Hz 30% modulation)	Power Consumption: 25 VA
	Size: 360 mm (W) $\times$ 125 mm (H) $\times$ 295 mm (D)
	Weight: approximately 7 kg.

**GOT YOUR HAM TICKET ALREADY?**  
Then Be Sure To Write Us For Our Complete Catalog  
Of Modern Amateur Equipment.  
Known WORLD WIDE As "THE RADIO"



Price And Specifications Subject To  
Change Without Notice Or Obligation

**YAESU**  
**The radio.**



478

**YAESU ELECTRONICS CORP., 15954 Downey Ave., Paramount, CA 90723 (213) 633-4007**  
**YAESU ELECTRONICS CORP., Eastern Service Ctr., 613 Redna Ter., Cincinnati, OH 45215**

CIRCLE 8 ON READER SERVICE COUPON



# MACK THE TACH

Our phototachometer travels  
in the best of circles!

by Walter Sikonowiz

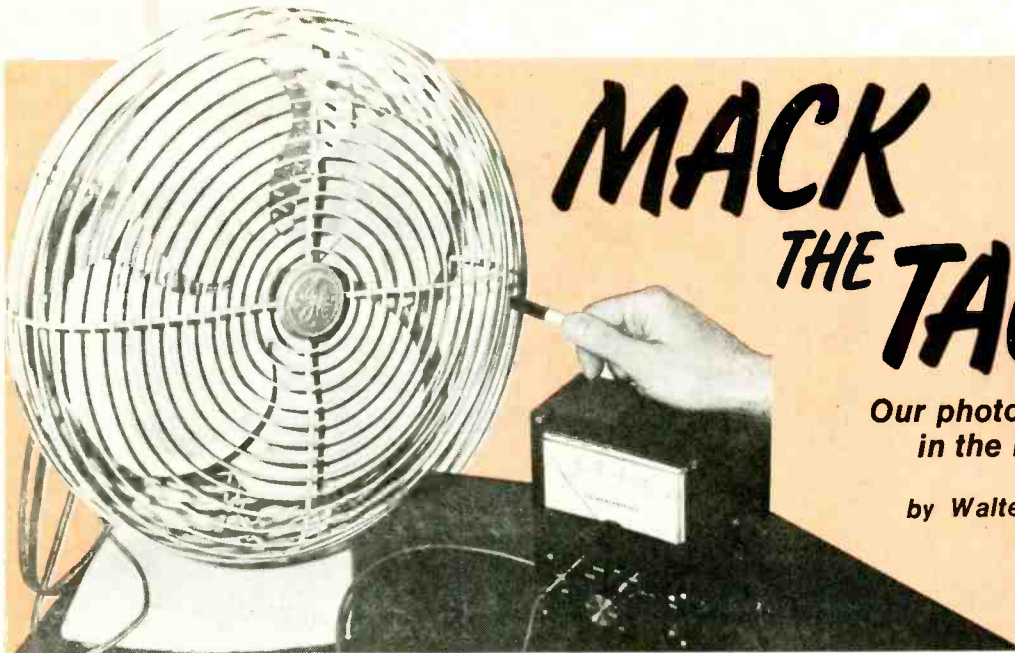

**L**IKE MOST PEOPLE you probably own a variety of motor-driven appliances and devices; autos, boats, washing machines, lawn mowers, power tools, model airplanes, movie projectors, tape recorders, and so forth. Again like most people, you probably never give a thought to the proper maintenance of these items until they break down. One of the surest indications of an upcoming breakdown is improper motor speed, and for about \$35 you can make a tachometer to measure it.

A good tachometer is an absolute necessity for the proper maintenance and tuning of motor-driven devices, and we here present *Mack the Tach*, every bit the equal of commercial units costing around \$200. Motor speed can be measured on four ranges from 1000 RPM full-scale to 30,000 RPM full-scale. Accuracy is an excellent  $\pm 2\frac{1}{2}\%$  of full-scale on the 10,000 RPM range, and  $\pm 3\frac{1}{2}\%$  of full-scale on all other ranges. Furthermore, because this tachometer is optically coupled, no extra load is placed on a rotating device while it is being tested. The result is better accuracy, especially with small, light-duty motors.

**Seeing the Light.** As you probably know, RPM measurements are just frequency measurements. In order to obtain an RPM reading on an analog meter, we need a frequency-to-voltage converter circuit. Such a circuit is detailed in the block diagram. Assume that we have arranged things so that every time the motor rotates, one pulse of light falls on the photo-transistor. This causes the photo-transistor to conduct and trigger the monostable circuit that follows. Each time the monostable is triggered, its output (point A) rises to a high potential for a fixed time interval

T, then drops low again, remaining low until re-triggered. The monostable output next feeds into an averaging circuit, whose output (point B) is ideally a D.C. voltage that drives a meter.

Operation of Mack the Tach is explained more clearly by the voltage diagrams. At low RPM, the monostable's output pulses are spaced fairly well apart. Consequently, the average value of the output is low, as indicated by the D.C. level dashed-in on the diagram. Since the average value is low, the meter will only deflect a little bit. Now, at higher RPM, the monostable gets triggered more frequently. The mono-

stable's output spends proportionately more time at a high potential than at a low potential. The average value of the monostable's output is now higher, and this results in a correspondingly higher reading on the meter. In both the high- and low-RPM cases, the monostable's output rises to the same high potential for the same time interval (T); higher RPM decreases the time between pulses, and this alone results in a higher average voltage at the monostable's output.

Let's next examine Mack's schematic diagram. Diodes D2 and D3 full-wave rectify the A.C. voltage from transformer T1. This rectified current splits

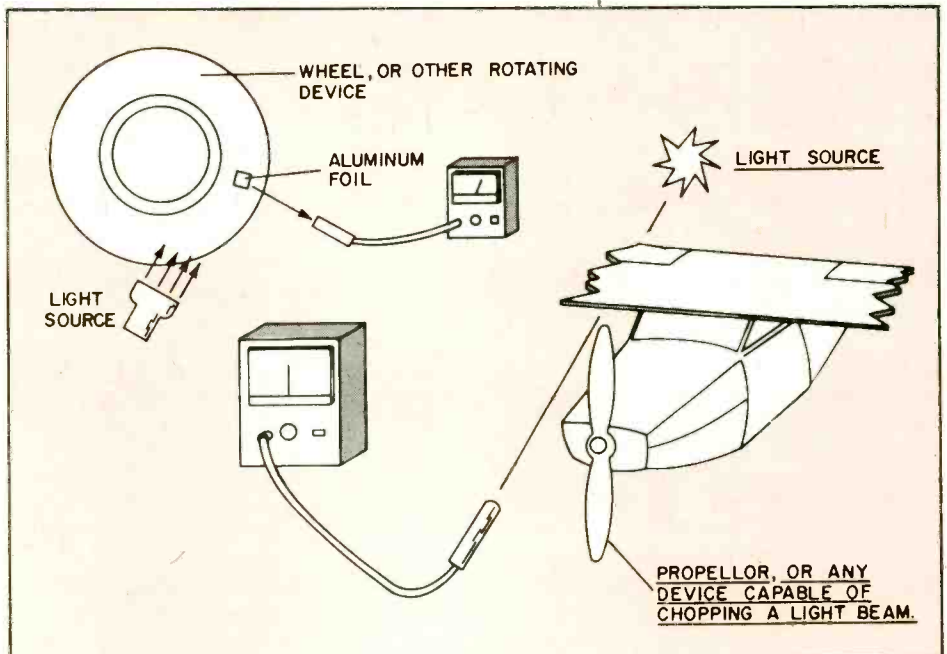

Mack the Tach may be used to measure the rotational speed of just about any object that can "chop" a light beam simply by using it as shown in the lower right. If you wish to measure rotational speed of something such as a wheel then use the aluminum foil as shown, reflecting light off it into Mack's home-built, light-sensitive probe.

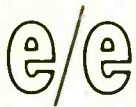

## MACK THE TACH

two ways: to D1 and to R3. Consider first the path through R3, D4, C4, and R2. The purpose of this four-component network is to provide a 120 Hz., clipped, full-wave-rectified sine wave, available whenever S2 is fully clockwise. This signal is used to trigger monostable IC1 during calibration.

Now let's consider the alternative path of the rectified current through D1 to C1 and IC2. C1 smoothes out the rectified A.C., while D1 isolates the R3-C4-D4-R2 network from the smoothing action of C1. Voltage regulator IC2 transforms the unregulated D.C. voltage across C1 into a regulated 5-volt potential at its output (pin 3). Capacitors C2 and C3 bypass the 5-volt supply and stabilize the circuit.

Transistor Q1 is the photo-transistor, and it connects to the rest of the circuit through a piece of coaxial cable terminated in P1. Plug P1 connects to jack J1.

So long as *Range Selector* S2 is not in the *Cal.* position (extreme clockwise), the trigger input (pin 5) of IC1 will be connected to photo-transistor Q1's collector through S2a.

Changes in the intensity of the light incident on Q1 produce changes in Q1's collector potential, thus triggering IC1. The duration of the output pulse available from monostable IC1 is controlled by C6 together with either R4, R5, R6, or R7. Switch S2b selects the resistor appropriate to the RPM range in use.

IC1's output (pin 6) drives transistor Q2, which then drives meter M1 through R8 and R9. Q2 provides some current gain, and it also ensures that all current to the meter gets cut off when pin 6 drops to its low level (a few tenths of a volt). The averaging in this circuit is performed to some extent by meter M1 itself because the inertia of the meter's needle causes the deflection to be proportional to the average current.

At low RPM, however, the meter needle would vibrate perceptibly, so capacitor C5 assists in averaging the pulses. Even so, you may still notice a little vibration when reading very low RPM; this is normal and not a cause for concern.

**Light and Easy.** Construction of the tachometer is particularly simple. Though a printed circuit board is optional, it does make construction even easier—transformer T1 is especially made for PC mounting. Instead of the usual solder lugs, this transformer's lead wires are brought out as pins,

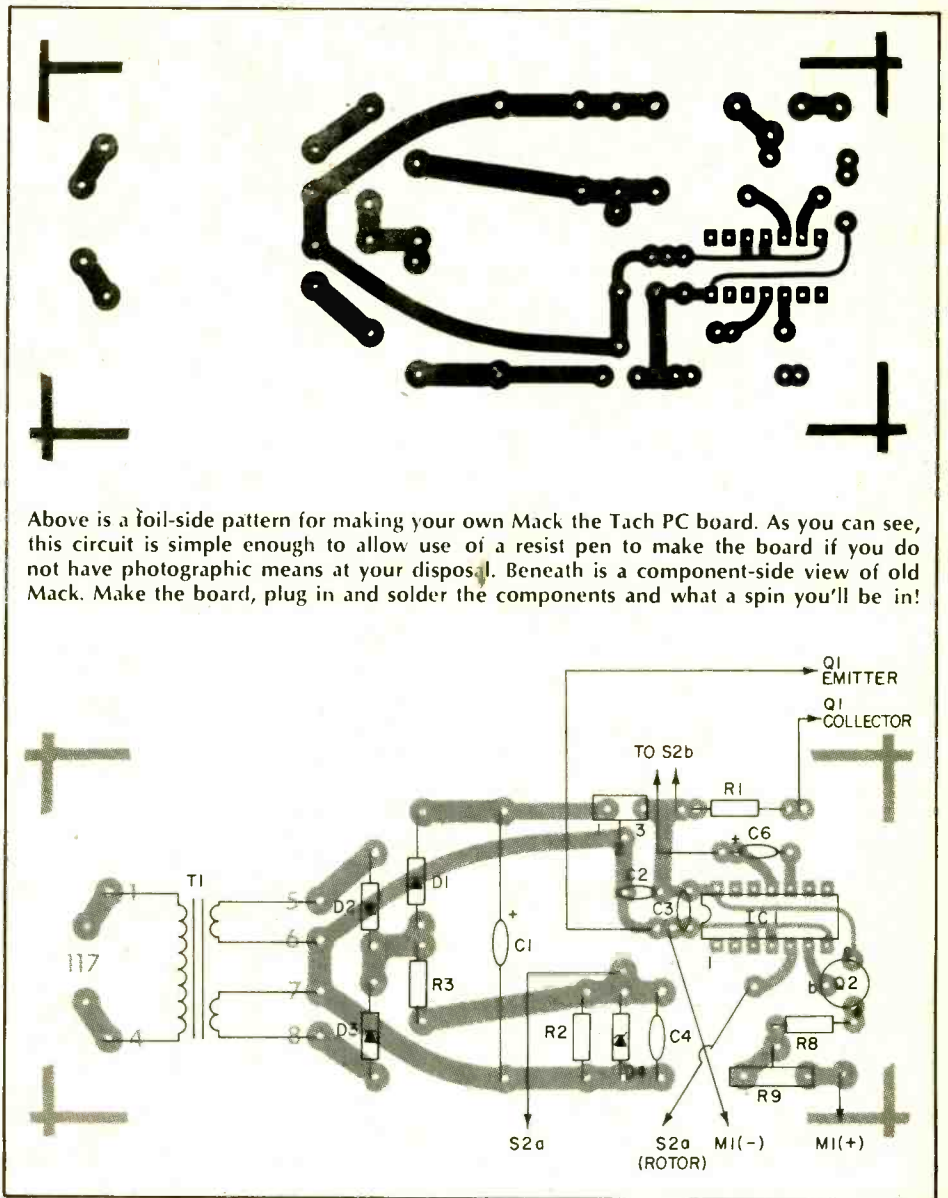

Above is a foil-side pattern for making your own Mack the Tach PC board. As you can see, this circuit is simple enough to allow use of a resist pen to make the board if you do not have photographic means at your disposal. Beneath is a component-side view of old Mack. Make the board, plug in and solder the components and what a spin you'll be in!

which then are soldered directly to the circuit board. The Signal Transformer Co. will supply you with one of these units for just \$4.90 plus postage. See the parts list for their address. Incidentally, while you're ordering the transformer, be sure to request a copy of their catalog. It contains a tremendous variety of reasonably priced and often hard-to-get transformers.

Parts layout within our Mack the Tach is not critical, so you may use any convenient arrangement. The photographs which accompany this article show how the prototype was built into a 6 x 5 x 2½-inch plastic cabinet. As you can see, there was room to spare. When drilling your cabinet, provide an access hole for R9 as this will allow you to calibrate the circuit without removing the front cover every time.

Meter M1 is a 0-100 microamp D.C. unit, and while any similar meter will

do, the Mouser #39LK417 is both accurate and reasonably priced (\$10.95 plus \$3.00 handling). You'll find Mouser's address in the parts list. Incidentally, if you happen to have a 0-100 microamp meter at hand, you can use it, but remember that the accuracy of the meter will determine the overall accuracy of your tachometer.

A few further comments on some of the other components are in order. Note that resistor R3 should be a 150-ohm, 1-watt unit. If you don't have a 1-watt resistor, two 330-ohm, ½-watt resistors in parallel can be used instead. Almost any phototransistor can be used for Q1. Fairchild FPT-110s and FPT-100s (Radio Shack #276-130) were used with success. As noted in the parts list, resistors R4, R5, R6, and R7 were 1% units in the prototype. You can get by with 5% units which will leave the accuracy at about ±2½% of full-scale on





Why spend anywhere from one to two hundred dollars for a tachometer when you can build our Mack the Tach? He's quite functional, and will only set you back about \$35 to get it all together. Optically coupled, his design will assure great accuracy.

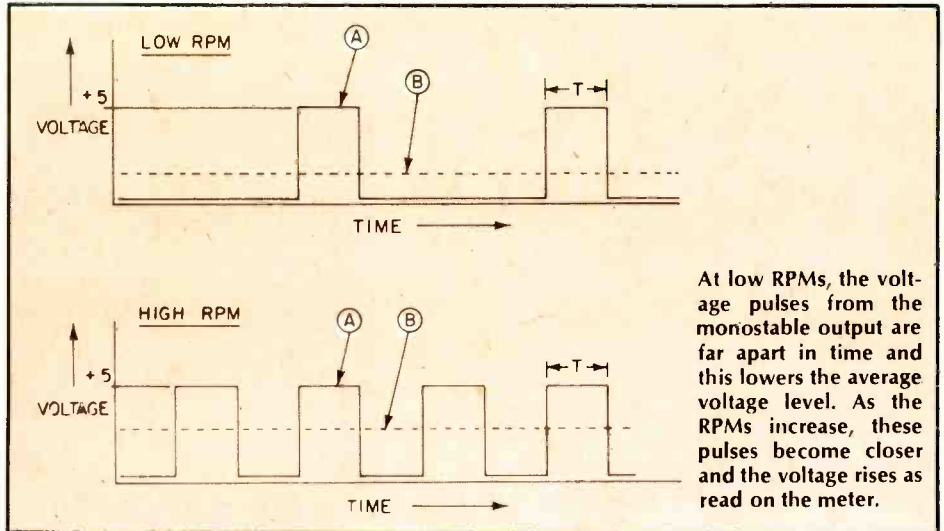

At low RPMs, the voltage pulses from the monostable output are far apart in time and this lowers the average voltage level. As the RPMs increase, these pulses become closer and the voltage rises as read on the meter.

the 10,000 RPM range; however, accuracy on all other ranges will now be less than or equal to  $\pm 7\frac{1}{2}\%$  of full-scale.

Timing capacitor C6 is a 1.0- $\mu$ F electrolytic, but be sure to use a tantalum device, not an aluminum capacitor. With this capacitor you must be sure

to get the proper orientation when installing it into the circuit. The same caution applies to all the semiconductors, meter M1, and capacitors C1, C2, and C5. As an added precaution, use a socket for IC1. In this way the IC can easily be removed if by chance it should

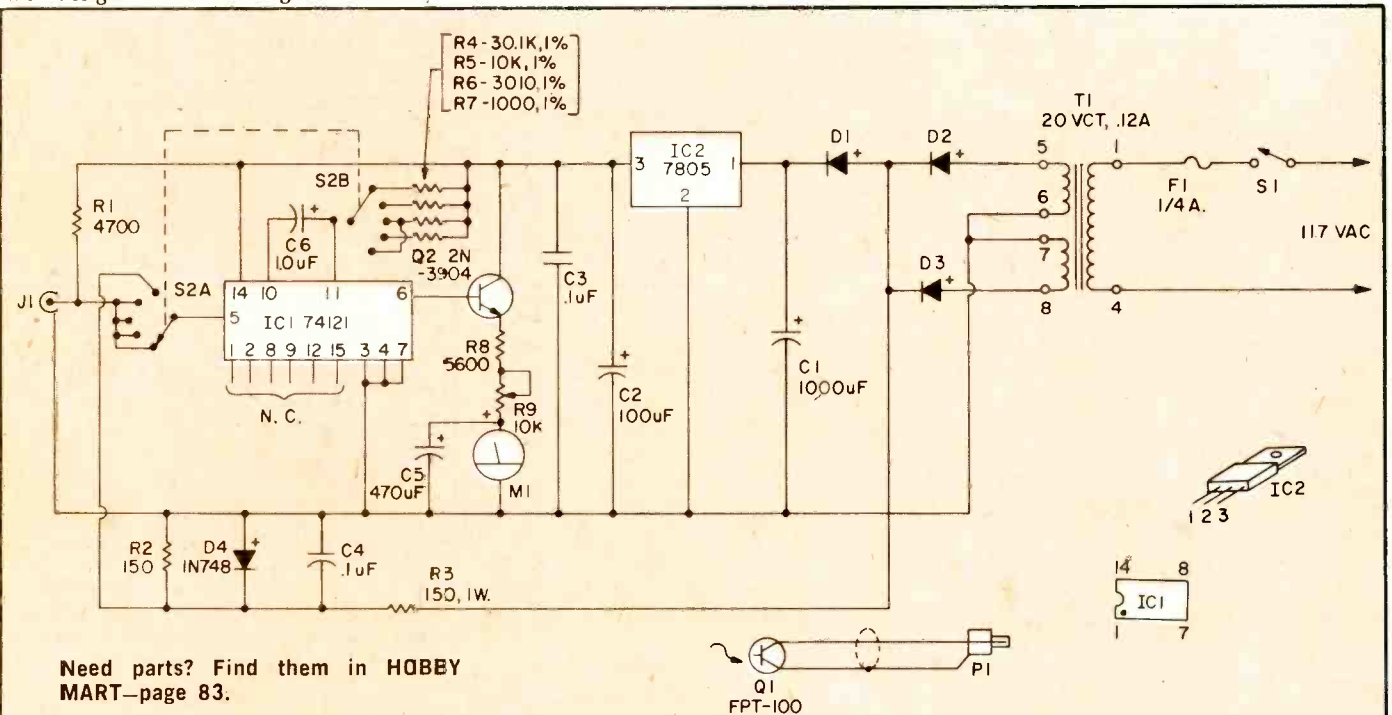

Need parts? Find them in HOBBY MART—page 83.

#### PARTS LIST FOR MACK THE TACH

C1—1000  $\mu$ F, 25V, electrolytic capacitor  
 C2—100  $\mu$ F, 16V, electrolytic capacitor  
 C3, C4—.1  $\mu$ F ceramic capacitor  
 C5—470  $\mu$ F, 35V, electrolytic capacitor  
 C6—1.0  $\mu$ F, 35V, tantalum capacitor  
 D1, D2, D3—1A., 200 PIV rectifiers  
 D4—1N748A, 3.9 volt,  $\frac{1}{2}$  watt zener diode  
 F1— $\frac{1}{4}$  amp. fuse  
 IC1—type 74121 TTL monostable vibrator  
 IC2—type 7805 5V. voltage regulator  
 J1—phono jack  
 P1—phono plug

M1—0-100 microamp. D.C.,  $2\frac{1}{2}\%$  panel meter (Mouser #39LK417)  
 Q1—Fairchild FPT-100 photo transistor  
 Q2—2N3904  
 ALL RESISTORS  $\frac{1}{2}$ -WATT, 10%, UNLESS SPECIFIED OTHERWISE  
 R1—4700-ohm  
 R2—150-ohm  
 R3—150-ohm, 1 Watt  
 R4—30.1K, 1%  
 R5—10,000-ohm, 1%  
 R6—3010-ohm, 1%  
 R7—1000-ohm, 1%

R8—5600-ohm  
 R9—10K trimmer pot  
 S1—SPST slide switch  
 S2—DP5pos. rotary switch  
 T1—20 VCT, 120 mA., PC-mount transformer (Signal #ST-3-20; \$4.90)  
 misc.—fuseholder, pen barrel, plastic case, line cord, knob, coax IC socket.  
 You may obtain the special parts at the following places: Mouser Electronics, 11511 Woodside Ave., Lakeside, Calif. 92040 and Signal Transformer Co., 500 Bayview Ave., Inwood, N.Y. 11696.

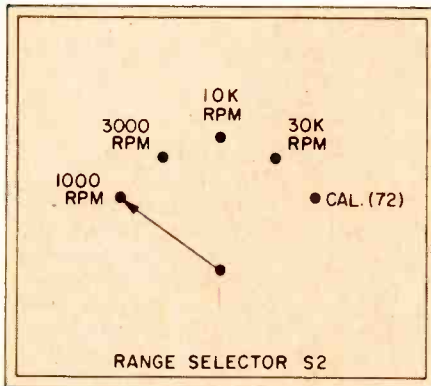

Design your front panel as this diagram shows. The RPM full-scale readings can be calculated using the table of RPM Full Scale vs. Mult. Factor, given in the article.

turn out to be defective. Finally, note that voltage regulator IC2 is simply soldered to the circuit board. No heat-sinking of this IC is required because only a small amount of supply current is consumed by the circuit.

In order to protect Q1, a photo-probe assembly will have to be constructed, which we have illustrated. Start by threading one end of a small-diameter coaxial cable (Belden 8417 or the equivalent) completely through the plastic barrel from an old pen. Now, grasp photo-transistor Q1, and cut its base lead completely off. Solder the central conductor of the coax cable to Q1's collector, and then solder the coax's shield to Q1's emitter. Pull on the coax so as to retract Q1 far enough into the pen barrel so that its light-sensitive face is recessed one-half inch. Carefully secure Q1 and the coax to the pen barrel using epoxy cement. Finish up by attaching plug-P1 to the far end of the coaxial cable.

Once you've completed construction of Mack, only calibration remains. Adjust R9 so that its resistance is maximum. Turn on the power, and put S2 into its *Cal.* position. Now adjust R9 for a reading of exactly 72 on M1. This completes the calibration. In the future you may re-check the calibration simply by repeating the above procedure. For most applications Mack the Tach as originally designed has adequate sensitivity. In fact, it is desirable for a photo-tachometer to have a minimum practical amount of sensitivity; in this way, ambient lighting conditions rarely affect a measurement. If added sensitivity is desired, however, the easiest course (besides going to a more powerful light source) is to replace Q1 with a photo-Darlington transistor, which must be

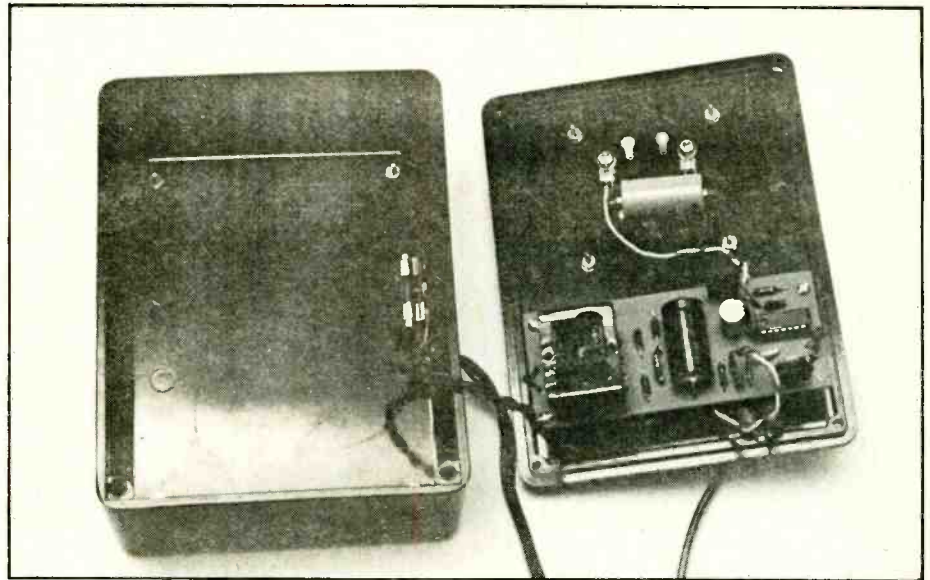

Construction can be made roomy, as it was here in the author's model. One thing the photo does not show is the access hole for R9. It's a good idea to drill one; it can save you all sorts of time whenever you want to recalibrate the circuit. Meter M1 is a 0-100 u-Amp DC unit. We used a Mouser #39LK417 and you will find that company's address and other information in the parts list. Any good phototransistor can be used to give Mack the eye. You'll find that construction will be straightforward and fun too!

When a light pulse falls on the phototransistor, the transistor conducts and triggers the monostable circuit which follows. When triggered, this circuit's output goes high, then returns low. The output is fed into an averaging circuit and the meter.

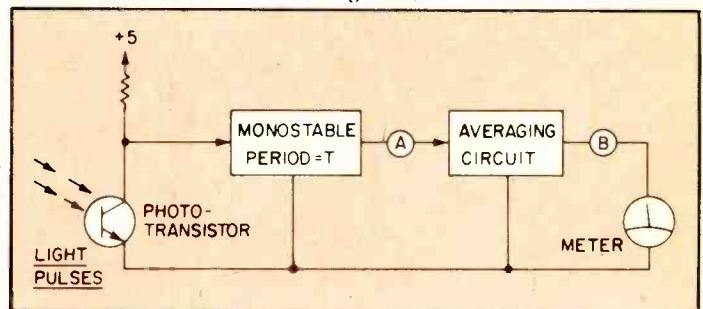

NPN. One good choice is a type 2N5777, available from Poly-Paks as stock number 92CU2649. Other types may be used as well. Hookup is identical to that of a standard photo-transistor.

Let's now discuss the use of the tach. To begin with, you should place range switch S2 so that full-scale deflection is well above the motor's estimated RPM. After the first reading, drop down to a lower range if necessary. You'll notice in the photos of the prototype that meter M1's scale was left with its original markings: 0 to 100. It's then easy to apply a multiplication factor appropriate to the given range, as shown below.

RPM FULL SCALE	MULT. FACTOR
1000	X10
3000	X30
10,000	X100
30,000	X300

When setting up a measurement, it is important that the ratio of maximum to minimum illumination of Q1 be as high

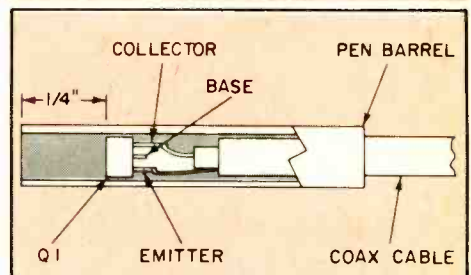

Not only is the pen mightier than the sword but an old pen barrel can show you the light! Build Mack's unique, light-sensitive probe—a pen to house the phototransistor.

as possible. So far as the maximum illumination is concerned, a 100-watt bulb can saturate (fully turn on) Q1 from as far away as 5 feet, approximately. This assumes that the bulb is in a suitable reflector. If not, Q1 will have to be nearer to the lamp (about a foot away). The minimum light intensity on Q1 should be as low as possible. Recessing the photo-transistor helps in this respect, since stray illumination is thus eliminated. Try to avoid fluorescent lights as sources of illumination for your Mack the Tach; incandescent bulbs

(Continued on page 96)



e/e assembles the...

# SABTRONICS 2000 DIGITAL MULTIMETER

CIRCLE 52 ON READER SERVICE COUPON

Easy-to-read digits and professional performance in a low-priced kit.



**T**ECHNOLOGY HAS ADVANCED so quickly you can find an under-\$100 digital multimeter in most electronic parts stores; problem is, however, these are generally "pocket" meters with itty-bitty readouts. When you want a "full size" digital readout and battery power you're generally talking "big bucks," a cost in excess of \$100.

Now for the good news: If you can put in a long evening of assembly, and have had a moderate degree of experience building "solid state" kits, you can have a full size, battery-powered digital multimeter for well under a C-note. The Sabtronics Model 2000 DMM is a digital multimeter kit that will only set you back \$69.95!

The Model 2000 DMM's four digit readout is provided by 0.3" L.E.D.s. Through a rather novel use of the most significant digit (the left one), a "minus" is provided by the center segment of the left digit, thereby providing five symbols though only four L.E.D. devices are used. It is this sort of *maxi-*

*mizing* of functions that allows Sabtronics to deliver so much for so little cost.

Since there are four full L.E.D. devices, rather than three, plus a device with a "carry one" and "+", the DMM provides full 100% overranging. This means that if you have set the meter for, say, 10 volts, it will read to 19.99 volts (a full four digit readout). Similarly, if the meter is set for the 100 VAC range it can indicate as high as 199.9 VAC. When the overrange capacity is exceeded the display blanks out to indicate you have really exceeded the capacity of the meter. Only the decimal point, and negative ("—") indicator—where applicable—stay lit to tell you the meter is really on and that you have exceeded the overrange.

The DMM measures AC and DC volts, ohms, and AC and DC current, with all functions and ranges selected by pushbutton switches. A somewhat unusual arrangement is provided for the range switches. Three switches provide

basic voltage ranges of 100 mV, 10 V, and 1 kV; 10  $\mu$ A, and 100 mA; 100 ohms, 10k ohms, and 1 Megohm. A fourth switch labeled "X10" raises the full scale capacity of each range switch by a factor of 10. As example, if the 10 volts switch is pressed, also pressing the X10 switch provided for a range of 100 volts. Similarly, if the range is set for 10k ohms, pressing the 10 switch provides a range of 100k ohms. The position of the readout's decimal point is always correct for both the direct range and with the X10 selector switch.

Only two inputjacks are provided for all functions, with the meter automatically displaying the correct polarity: it's positive when there is no polarity indication; negative when the "—" is displayed. The "—" is displayed for all ohms ranges, serving as a reminder that the voltage at the positive (red) test lead banana-type jack is *negative*, a fact you must know if you use the resistance ranges for checking solid-state devices.

The meter is protected for an input voltage up to 1 kV, so there is no overranging on the 1 kV voltage range —1 kV is the highest voltage reading. The frequency response of the AC voltage ranges are within 1% from 40 to 20 kHz up to 10 volts (actually 19.99 volts), to 2k Hz on the 100 volt range, and 500 Hz on the 1 kV range; so you can use the meter for accurate audio measurements up to 19.99 volts. Current measurements can be made to 2 amperes, with the meter protected by an internal fast-acting 2 ampere fuse.



Does this readout say MINUS 754-ohms?! Yes, it does and for a very good reason. The negative sign is always indicated in the ohms mode as a reminder that the test voltage used for ohms measurements is negative at the positive test lead jack (red). This is a thing you would wish to remember when testing solid state devices with the ohmmeter!

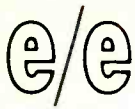

## SABTRONICS MULTIMETER

The worse-case accuracies for the various functions are  $\pm 0.5\% \pm$  digits DC volts;  $1\% \pm 2$  digits AC volts and DC current;  $0.8\% \pm 2$  digits AC current.

The power supply requirements are 4 to 6.5 VDC at 120 mA nominal. As supplied the meter works off four C-cells, with Alkaline cells nominally providing 25 hours operation, while ordinary flashlight-type carbon-zinc batteries provide about 8 hours operation. Optional accessories include Sub-C Nicad and AA Nicad battery packs, a recharger, an AC adaptor, and a "dropping" (regulated) supply for powering the meter off 12 VDC (car battery). The kit is supplied with a special set of calibrating resistors.

The DMM is housed in a plastic cabinet providing complete insulation—no part of the cabinet is connected to the test circuit or the meter itself. Overall dimensions of the cabinet are 8-in. wide x  $2\frac{7}{8}$ -in. high x  $6\frac{1}{2}$ -in. deep. A collapsible tilt bracket raises the front  $1\frac{1}{2}$ -inches.

**Building the kit.** This is not a kit for someone with experience only in Heathkits, or kits similarly supplied with detailed step-by-step instructions. Though all components are designated directly on the printed circuit board(s), and there is an excellent pictorial, the builder has to locate the exact position. The manual says something similar to "Install R1, R2, R3, etc.," it doesn't tell you on what part of the board the resistors are located; you must search out the location yourself. Also, there have been many changes since the assembly manual was printed, not all of which are in the addenda sheets. For example, the switch assemblies originally required extensive preparation by the builder; in our kit the assembly was factory-prepared for direct installation, but there was no mention of this in the addenda sheets, and it took some time to figure it all out.

To the kit's credit they do recommend using sockets for the ICs though they are not provided (Radio Shack has the required sockets). Save yourself heartache if you make a wiring error, use the sockets even though they do add a few extra dollars to the total cost.

One very nice feature, which makes up for the problems with the assembly instructions, is that all test resistors and test points plug into sockets on the PC board. You don't have to open wiring

*(Continued on page 88)*

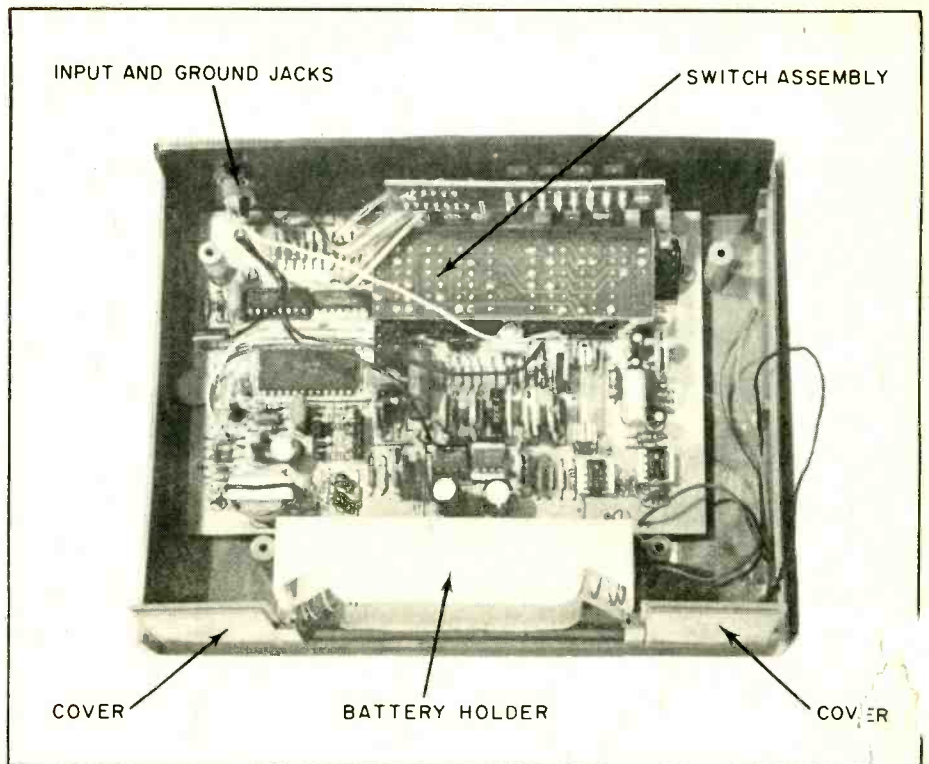

The Sabtronics 2000 Digital Multimeter is housed in an attractive cabinet which is insulated from both the test circuit and the meter's electronic innards. Assembly should take an experienced kit builder an evening or two—but you really should have a few other, complex kits under your belt before tackling this one. For a state-of-the-art instrument, the 2000 goes together very easily if you know the basics. The kit is supplied with pictorials in the manual and both schematic and component views of the PC board. If you want a full-size meter with a digital readout and you'd like to keep the cost down, better check the 2000. Circle No. 52 on the Reader's Service Coupon for information.

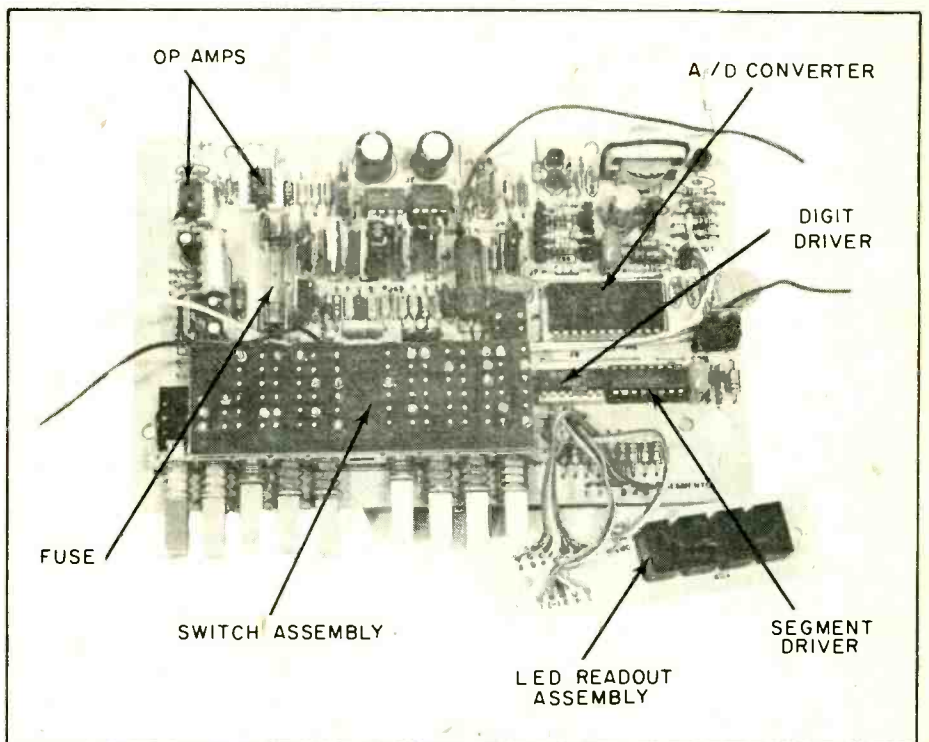

Everything except the LEDs used in the readout is mounted on one printed circuit board. The entire switch assembly is provided as a single unit and there is no interconnecting wiring; instead, a single printed circuit board placed over the switch assembly provides all interconnections and thereby sharply reduces the possibility of a wiring error.



# SIGNAL CHASER

Trap that circuit trouble and chase those blues away!

by Martin Weinstein  
WB8LBV

ONE OF THE SECRETS of troubleshooting is to start at those circuit areas where there is no trouble, then to back your way through the circuit until you've reached the point where it isn't working. The same trick can work frontwards, letting you trace a signal through a circuit until you reach the point where it disappears.

Here's a handy aid for troubleshooting in the frontwards fashion, a signal tracer with a great deal of input sensitivity called Signal Chaser.

**Built-in Demodulator.** An ordinary amplifier could help you find signals in the AF (audio frequency) range, but the Signal Chaser can do more. D1, a 1N914 diode, acts as a demodulator, much like the diode in a simple crystal-set-style radio, to demodulate AM (amplitude modulated), RF and IF signals directly to audio (or whatever the carrier is modulated with). On FM and PM (frequency modulated and phase modulated) signals, the diode acts as a slope detector, giving a suitable, if low-fidelity, audio output.

**High Impedance Input.** The one feature of this circuit that really makes it shine when compared to most signal tracers is its high impedance input. The input impedance of the Signal Chaser is close to 10-Megohms. This is due to the use of a JFET (Junction Field Effect Transistor) for Q1. Q1, a Siliconix 2N5458 or similar P-channel JFET, is configured as a high-to-low impedance converter with an input impedance determined mostly by the value of R2, 10-Megohms. Capacitor C1 blocks DC but passes AF, RF and IF signals. Resistor R1 limits the input current to Q1.

A high input impedance means that for a given signal voltage, very little

current is drawn by the Signal Chaser. This means that under almost all conditions, the Signal Chaser cannot load down the circuit you are troubleshooting.

**Speaker Size Output.** The output of Q1 alone would be enough to drive a high impedance earphone, but keeping one in your ear while busy probing a suspect circuit can be, to say the least, inconvenient.

Instead, the output of Q1 (after demodulation) is coupled to the input of IC1, an LM380N audio amplifier. IC1 provides enough drive to power even

low-impedance speakers, around 8-ohms, to a good, healthy volume.

Capacitor C5 provides DC decoupling between the speaker and the output of IC1.

**Breadboard-Easy Construction.** The entire circuit can be built up on a small solderless breadboard like the one shown (a Continental Specialties Corporation "Experimenter Socket," model EXP350, about \$5.50) almost in less time than it takes to tell about it.

I've used three tricks here I would especially like to share. For one, I used a pair of zig-zag mounting brack-

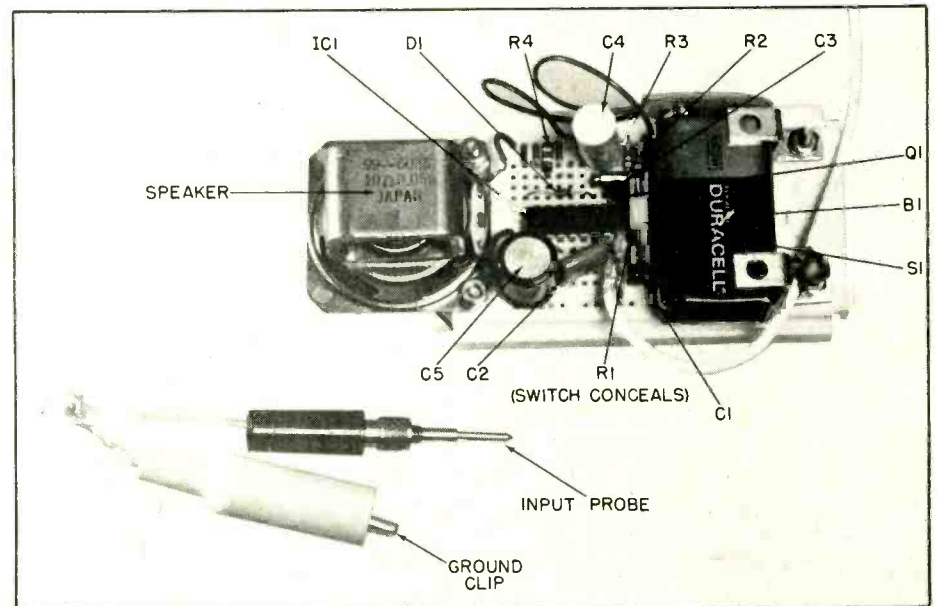

Our Signal Chaser was built using a solderless breadboard and, as you can see, it made for a neat component arrangement. If you follow this photo, be certain you don't forget about R1, which connects to the Gate of Q1 and to C1—it's really there, it's just hard to make out in the picture! Signal Chaser should go together quite quickly, so if you start it after lunch you should be chasing your first signals before the dinner bell.

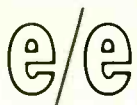

## SIGNAL CHASER

ets (from the local Radio Shack) as battery hold-down clips. The mounting holes in the CSC EXP350 helped make this especially easy. At the far side of the breadboard, the mounting holes there happened to match exactly the holes on a small speaker I had on hand, and I was quick to take advantage of it. My third trick was to solder stiff wire (resistor leads I cut off some of the resistors in the circuit) to the breadboard end of the shielded probe cable. You may also want to use "headers," available from several sources and many parts stores for under a dollar a strip.

The rest of the assembly is fairly straightforward. Follow the lead of my layout, as shown in the photograph, when you lay out your own Signal Chaser—whether on solderless breadboard, a PC board or whatever method you use.

**Understanding Solderless Breadboards.** In case you haven't tried solderless breadboards before, you may not know how easy they are to work with. The holes in the face of the breadboard are arranged on .1" centers (1/10th of an inch apart), which happens to be the lead spacing on standard DIP (dual inline package) integrated circuits and most other modern components.

The center channel (.3" wide) is just right for IC's to straddle. On each side

Signal Chaser has a high impedance input that is close to 10-Megohms. It will draw very little current and so will not usually load down the circuit under test.

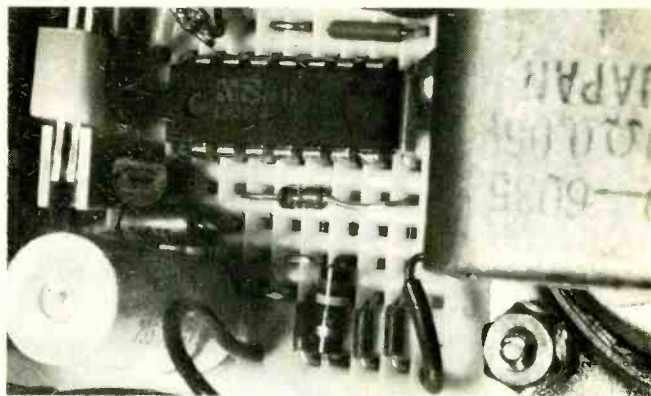

of the center channel are groups of five holes (columns, if you view the breadboard as widest on the horizontal, with the center channel running left to right). Behind each group of five holes is a spring clip with slits between the hole positions to allow a lead inserted into any one hole to be grasped firmly and independently, and interconnected with anything grasped at any other position in the group.

Each five-position terminal can be interconnected with any other by simply using hookup-wire jumpers.

The separate rows (at the top and bottom) are connected across their entire lengths and can be used for power or signal busses. I use them to carry the battery plus and minus lines.

**Using the Signal Chaser.** For most run-of-the-mill signal tracing, clip the probe cable shield to a circuit ground near the area you're testing and touch the probe to each side of the signal

path near each active or passive device in the signal path. Start at the front end and work your way to the output, if you like—but skipping a few stages on the chance they'll work can also help you localize a problem.

The high impedance of the Signal Chaser input means high sensitivity, which lends it to some useful applications.

You can attach a coil of wire or a magnetic tape head to the input to inductively probe circuits and devices. You can "listen" to the magnetic stripe on the back of your credit cards, amplify a telephone conversation or pick off the signal on your transmitter's modulation transformer.

Or attach a photocell to the input and listen to the sounds of light bulbs, LED readouts, the sun, street lights and then some.

Signal Chaser—not only a good introduction to solderless breadboarding, but once it's built you may find it to be one of the handiest gadgets in your electronic bag of tricks-of-the-trade. Have fun and chase those signals—and those problems—down! ■

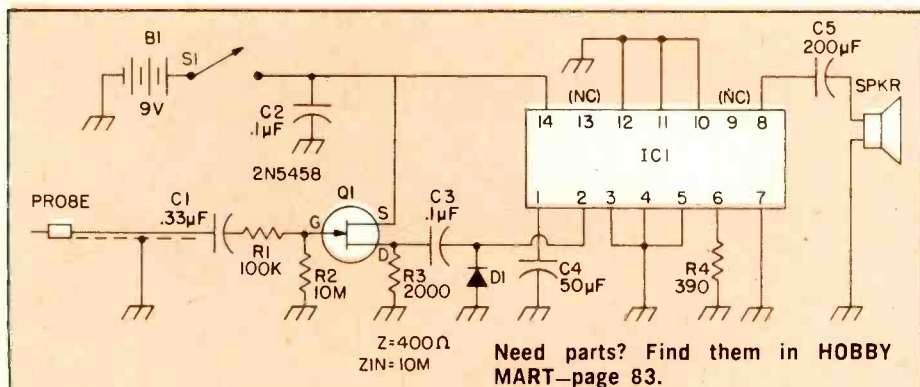

Need parts? Find them in HOBBY MART—page 83.

### PARTS LIST FOR SIGNAL CHASER

- B1—9-VDC battery
- C1—.33-uF capacitor
- C2—.1-uF capacitor
- C3—.1-uF capacitor
- C4—50-uF capacitor
- C5—200-uF capacitor
- D1—1N914 diode
- IC1—LM380N audio amplifier
- Q1—2N5458 JFET (Junction Field Effect Transistor)

- R1—100,000-ohm resistor, 1/4-watt
- R2—10-Megohm resistor, 1/4-watt
- R3—2000-ohm resistor, 1/4-watt
- R4—390-ohm resistor, 1/4-watt
- S1—SPST switch
- SPKR—8-10-ohm speaker
- MISC—Breadboard (Continental Specialties model EXP350 or similar) or other method such as PC board; probe; insulated clip; battery holder/clip; wire; etc.



Solderless breadboard materials is arranged with the holes about 1/10 inch apart. As you can see, this just fits the spacing of the IC's leads and of most modern components.



e/e assembles the...

# Pennywhistle 103 Originate Modem

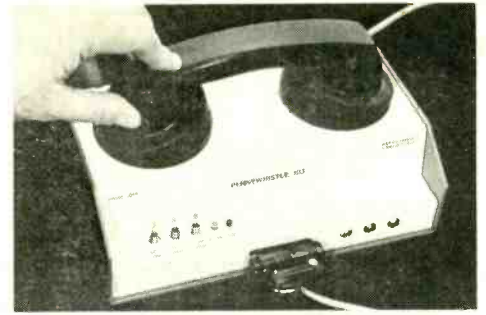

CIRCLE 64 ON READER SERVICE COUPON

Keep in touch with a time-share computer via your home telephone.

**A**S YOU GET MORE INVOLVED in personal computing, meet other computer hobbyists, and join local computer clubs, it's more than likely you'll find there's at least one time-share computer system you can use free, or at a very low cost. It might be the local school's system which is available to students, or perhaps a friend will let you in on his I.D. (identification code), or it might be an older time-share system now underutilized which permits or even encourages outside users for a nominal charge representing the cost of upkeep or repair.

The advantage of a time-share system, in comparison to the average personal computer, is that the time-share generally will have several languages in addition to BASIC: usually Fortran IV and some degree of COBOL. It will also have a file system, and a lot more storage than the average computer hobbyist can afford to build into a home system.

As a general rule, once you locate a time-share you can get on, all you'll need is an acoustic modem and your present terminal. You connect your terminal to the modem, dial the telephone number of the time-share system on your regular phone, place the telephone handset in the modem, and you're on-line to the time-share system.

Though most modems are relatively expensive, you can go the kit route and come up with a full-feature model one half to one quarter the price of a commercial modem.

The way to go is with a Pennywhistle 103 Originate Modem. (*Originate* means it's used at the terminal. An *answer* modem is used at the computer.)

In addition to serving as a standard modem, a means of coupling a terminal to a voice-grade telephone circuit, the Pennywhistle has a few extra features that make it particularly attractive for the hobbyist.

Connection is made through a 25 pin D-connector, the type often listed

by the "surplus" dealers as RS-232 connectors. Depending on the user selected terminals the connections can be arranged for a TTY (teletype) current loop or RS-232 electrical signal. The TTY loop is through a non-polarized optoisolator so even a hobbyist with no knowledge of how a TTY works, or its connections, can connect to the modem with no hassle. Even the TTY current source is provided by the Pennywhistle, so you don't have to dig through the guts of your TTY to find the current source.

If you have a CRT terminal you will use the RS-232 output. Since the Pennywhistle can handle a Baud rate of 300 (30 characters per second) you might as well use this rate in preference to a lower Baud rate. (There are some hobbyists who run a CRT terminal with RS-232 output at a TTY Baud rate of 110—only Heaven knows why.)

A set of LEDs flicker back and forth when data flows through the modem.

Now for the extras. To start with, three jacks are provided which can be used to connect the modem directly to a telephone line coupler, or to record or play signals from the modem. You

can record data produced by the local terminal and data received through the line; you may also play back to the local terminal and to the line.

Another extra is the low/high band switch. Normally, an originate modem transmits on the low band (1070 to 1270 Hz) and receives on the high band (2025 to 2225 Hz). The answer modem at the computer works on the reverse, transmitting on the high band and receiving on the low band. Long distance telephone circuits now have what is known as "echo suppressors" which stop your voice from coming back to you. If you're connected to a time-share through a telephone system with an echo suppressor your terminal's printer is not going to get a signal back from the computer when the terminal is set for *full duplex* (meaning, the printer gets the echo from the computer.)

But with the Pennywhistle 103 you can turn off the echo suppressor by simply flipping the low/high switch to *high* for a few seconds before transmitting data. The modem's output switches to the high band and transmits a signal in the 2025-2225 Hz

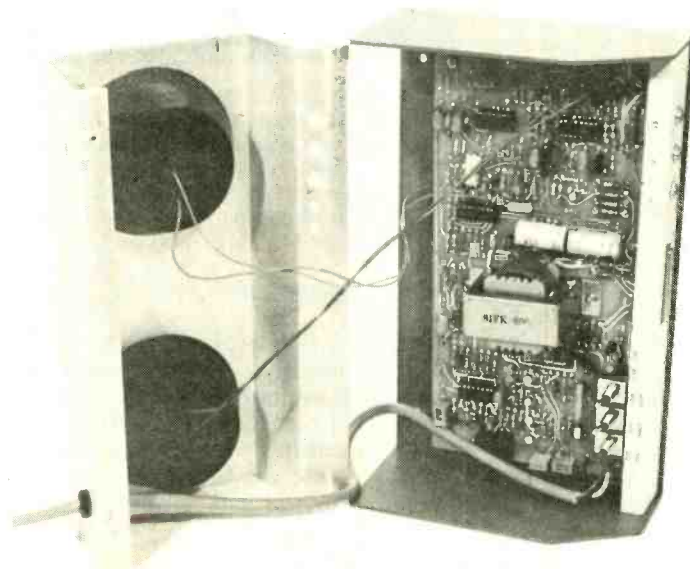

The completed assembly just before closing the cabinet. The PC board mounts in the base. The muffs, acoustically insulated telephone holders, mount on the top section.

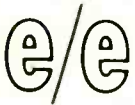

## PENNYWHISTLE MODEM

range. The telephone circuit is fooled into believing it "hears" an answer modem from a computer and turns off the echo suppressor. You then flip the switch back to *low* and use the modem in a normal manner, getting full duplex operation.

The low/high switch can also be used as a *send* switch enabling two terminals to "talk" to each other, though it's to be doubted whether the function would be used by the average computer hobbyist.

**Building The Kit.** This is not a "beginner's" kit, simply because assembly instructions are sparse. You get a parts list, a *stuffing pictorial* (showing where parts are located on the PC board), and a minimal set of assembly instructions. If you need one-step-at-a-time instructions with a pictorial for every unusual step this is not the kit for you.

One outstanding feature of assembly, which would be welcome in all other kits from all manufacturers, is a direct numbering relationship as to component placement on the PC board. Resistor R1 comes first, then R2, then R3, then R4, etc. (If you're looking where to put R23 it will be between R22 and R24. Same bit with the other components such as diodes and capacitors.) In other words, component identification is in the correct order for the PC board, not the schematic. It actually cuts about 75% off PC board assembly time, and makes it a snap to locate a value swap, such as a 10K resistor for a 100K type.

**Aligning Your Pennywhistle.** Alignment requires a frequency counter and a sine wave signal generator capable of performance to at least 300 Hz. There is no way to get around use of these instruments; without them the Pennywhistle 103 cannot work. Most of the alignment consists of a few control adjustments to get the correct counter reading at a few test points. The procedure doesn't take more than five or ten minutes. The only other main adjustment is to set the output level to the telephone line.

**Performance.** The Pennywhistle 103 delivers the same performance as our commercial modems—it works. We did find the sensitivity was somewhat high and tended to respond to noises within the room. An engineering note supplied in the instruction manual shows how to lower sensitivity of the carrier detector by changing the value of two resistors. It was an easy enough modification even after the unit was completed, and we suggest it be made if room

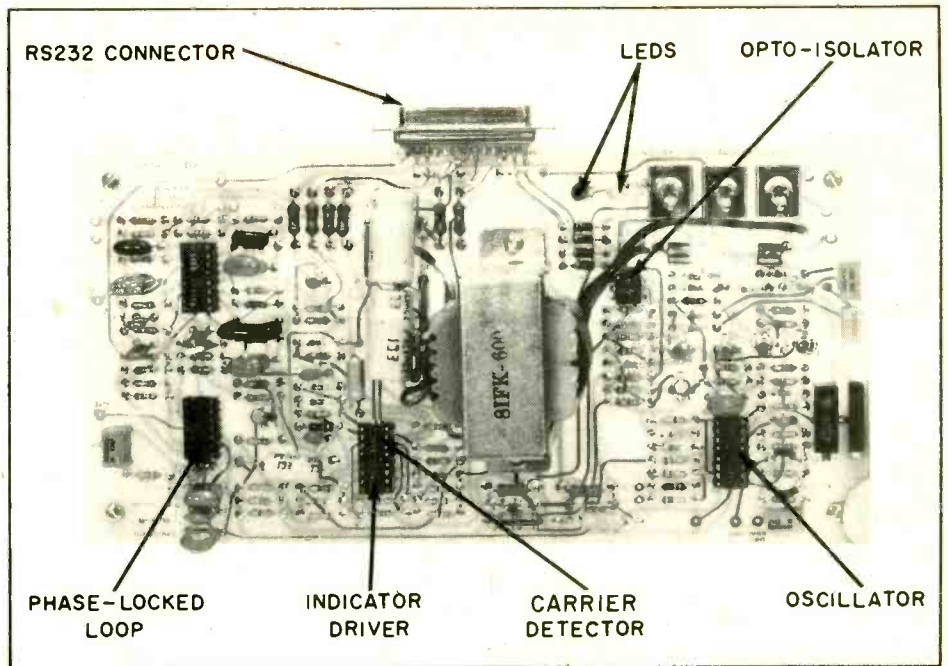

Virtually the entire assembly is on one PC board. Because of a component order that is in sequence for the PC board rather than the schematic this turned out to be the easiest board to assemble we have ever assembled, and the simplest to debug (swapped resistor values were quickly found). Note the input/output D-connector is part of the top edge of the PC board, saving much trouble. Circle number 64 on the Reader Service Coupon.

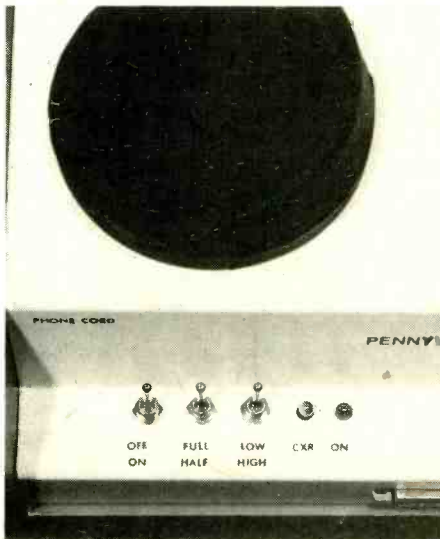

To the right of the three control switches are two LED lamps labeled CXR and ON. These are the data indicators, which flick back and forth when data passes through the modem. If one locks On then there is no data at all passing through the modem.



Using the modem is simple. You simply dial up the computer, wait until you hear a tone in the handset receiver and then force the handset into the muffs. Make certain the handset is firmly seated in the muffs to keep out any extraneous room noises.

noises produce false turn-on of the carrier.

We were able to make recordings of the data signals, and while we have no need for them, nor can see any reason for making recordings of the data signals, nevertheless, the system is there for your use if you have some particular need for the data recordings.

**Summing Up.** The Pennywhistle 103 works as it should, it's a lot of fun to

build (for an experienced builder) and is the least expensive way to modify your personal computer equipment for use on a time-share system. If you have access to a time-share it's time you went for a Pennywhistle.

The Pennywhistle 103 sells for \$129.95 in kit form from M&R Enterprises, Box 61011, Sunnyvale, CA 94088. Circle number 64 on the Reader Service Card for more information. ■



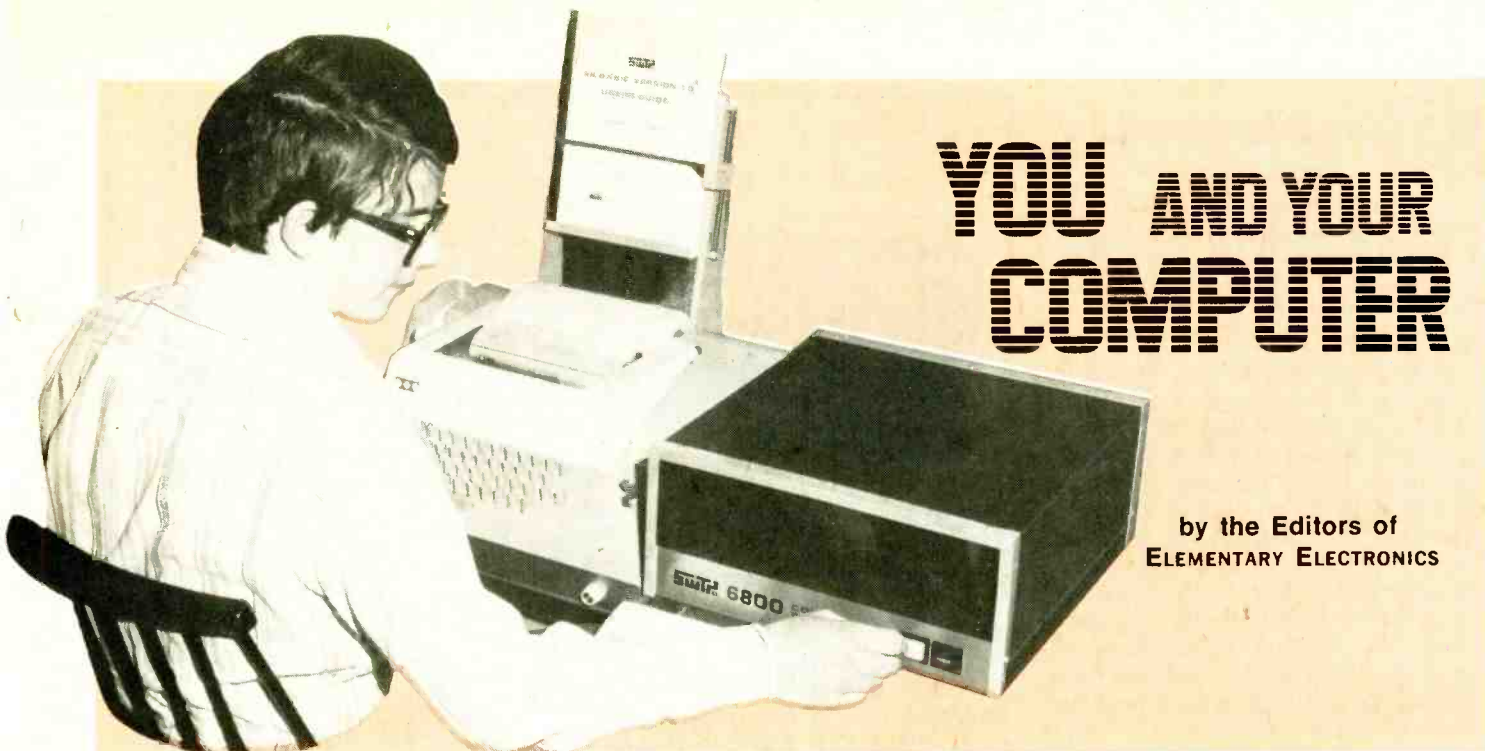

# YOU AND YOUR COMPUTER

by the Editors of  
ELEMENTARY ELECTRONICS

## Answers to some of the most asked questions about personal computers

IT'S BEEN LESS THAN A year since we heard the first rumors that both Heathkit and Radio Shack were working on personal computers for the electronic hobbyist, yet in the few short months since the rumors were proved correct *personal computing* has become the hottest thing going for the electronic hobbyist and experimenter.

It has also become the most confusing, with each manufacturer and distributor inventing new terminology to prove, or imply, his computer, system, or accessory is the best. Even trained computer and data-handling experts with advanced degrees in computer science are often at a loss to explain what in heck many computer dealers are talking about. Personal computing has become a Tower Of Babel; and as yet there is no Rosetta Stone the average hobbyist can use to unscramble *computerese*—a foreign language even more complex than French.

In fact, because ELEMENTARY ELECTRONICS is one of only a few national consumer publications providing extensive coverage of personal computing on the experimenter and hobbyist level we are literally drowning in a sea of reader mail, and can no longer answer each individual letter about personal computing equipment.

Instead, we have compiled the most frequently asked questions and hope the answers meet your particular needs and interests.

For some, the answers will appear simplistic; but keep in mind we are trying to avoid *computerese*. Our primary purpose is to provide you, our reader,

with concrete information you can put to work. We are not going to try to impress you with anyone's expertise. We know computer equipment represents a substantial investment so we aim to present our information in the most useful manner—and that means straight English.

**Question**—*Since some computer kits are priced almost the same as complete computers having built in BASIC and a keyboard, what is the advantage in building a kit?*

**Answer**—The complete computers such as the Apple, OSI, and Radio Shack generally need a TV monitor for output display, or the computer's output

signal is fed through an *RF Modulator* to an ordinary TV set which serves as the display. At present, the complete computers have no peripherals for providing "hard copy" (a printout). The computer kits, on the other hand, permit almost unlimited expansion, though it does get costly when you add in the cost of a complete terminal: either TTY (teletype), CRT, or Selectric typewriter.

**Q**—*I don't care for the print quality of a TTY terminal, nor do my teachers, who don't accept my homework printed all in capital letters. Can I connect a Selectric typewriter terminal to my SWTP 8600 computer?*

**A**—It depends. Most of the rebuilt Selectric terminals you find advertised in computer magazines are for the IBM *correspondence* and EBDC codes, and they won't work with a personal computer. Some surplus outfits, however, build in an ASCII converter with an RS-232 output. If you can find one of these ASCII/RS-232 Selectrics (about \$900) you simply connect it to a personal computer's serial RS-232 I/O. (Just plug it in.)

**Q**—*I would like to get my child started in computing. Which of the beginner's kits in the \$100 range do you suggest?*

Processor Technology manufactures the SOL-20, shown here. The SOL is based on the 8080 chip, has a self-contained keyboard and utilizes the S-100 bus. It has, in the smallest version, 8K of memory and BASIC in ROM. Available kit or wired.



## YOUR COMPUTER

The Challenger IIP, new from Ohio Scientific, is a personal computer with 4K of RAM, BASIC in ROM, and a captive keyboard. The CPU is based on the new 6502 chip. Add a RF modulator or connect directly to a CRT for I/O display.

**A**—There is no such animal. Firstly, if your child is ready to enter High School, or already there, the school probably has an introductory course in either Data Processing or Computer Math. If your child wants to get into the design end, and has shown previous interest and ability in electronics, and really wants to play and experiment with the electrons, the Heathkit 6800 trainer is probably the only kit of practical value. (On a college level it's a whole different game.)

**Q**—Which of the computer kit CPUs do you recommend for a beginner: 8080, 6800, 6502, or whatever?

**A**—Tough question. The 8080 and its relative, the Z-80, often use the S-100 bus, for which there are many accessories. Unfortunately, the I/Os (inputs/outputs) are under software control and it can get somewhat expensive if you need ports for several peripherals. The 6800 I/Os are memory-mapped and it's cheap and easy to add peripherals. For example, the SWTP 6800 computer can handle up to ten peripherals and you simply purchase an inexpensive I/O card whenever you add another printer, terminal, recorder, etc. Also, the 6800 system allows a good intermix of serial and parallel I/O ports. You can do the same with the other CPUs but at much higher cost. Unfortunately, there are more "gadgets" for the S-100 bus than for any other bus or system, so you'll have to plan ahead.

Some personal computers using the 6502 are extremely powerful, but at the time this article was prepared there was little in the way of I/O equipment or even ports for peripherals.

**Q**—What is meant by an integer BASIC?

**A**—It means it cannot handle decimals. For example, the statement "PRINT 2/4" would return an answer of "00" instead of "0.5". Similarly, "PRINT 5/2" would return "2" instead of

Radio Shack's TRS-80 is a self-contained computer, with captive keyboard, based on the Z-80. The smallest version has 4K of RAM and an enhanced Tiny BASIC in ROM, and is complete with video monitor.

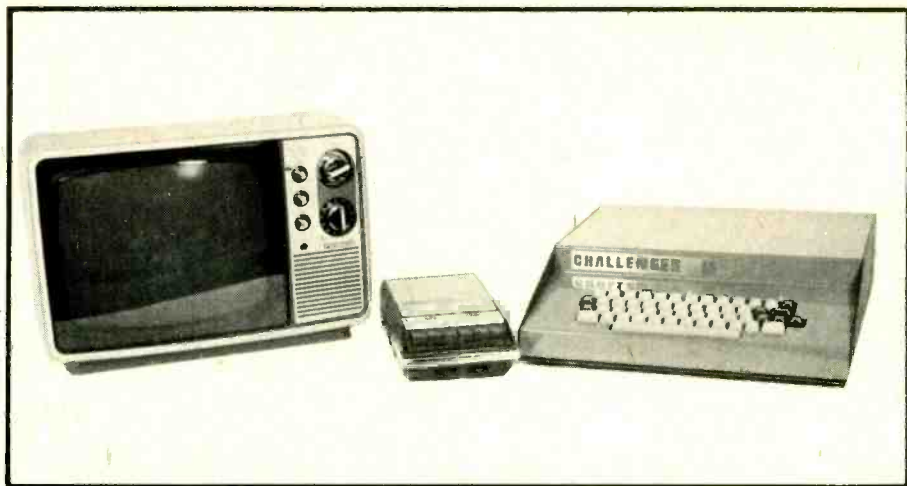

"2.5". Integer BASICS can be powerful in terms of graphics, etc., but they are useless for any school work involving even simple arithmetic. One exception to our rule of "No integer BASICS" is the Apple II computer, whose 4K resident integer BASIC is used to load Apple's notably good 16K BASIC.

**Q**—How much memory would I need for a computer kit?

**A**—12K will handle most BASIC interpreters running on an 8 bit system (8080, 6800, Z-80, etc.), though Apple requires 16K for their BASIC. The Heathkit LSI-11 system is a 16 bit system so you get the same results with half the memory: we would suggest at least 8K on the "Big Heath." Few computer kits come with enough memory to handle BASIC, or even an editor/assembler, so be sure to add in the cost of extra memory to the basic kit price.

**Q**—What is meant by an "ASR Terminal"?

**A**—ASR means **A**utomatic **S**end/**R**eceive and refers to a paper tape reader and punch accessory mounted as part of a teletype terminal. A used ASR TTY—the model 33—sells for about \$900. Without the reader and punch you can get one for about \$500 to \$600; so if you have no need for paper tape you can save a bundle by getting a TTY without ASR. Just the printer part of the TTY, known as an RO33 for **R**ead **O**nly, sells for under \$300, less than the cost of most "computer printer peripherals."

**Q**—What is meant by "Hardware," "Software," and "Firmware"?

**A**—**Hardware** is any equipment: computer, printer, even an individual integrated circuit. **Software** means a program, or instructions for the computer. **Firmware** is some form of program or instruction-set already in the computer, usually called a *resident monitor*, that makes it easy for the user to enter, or write programs. Firmware is ready as soon as power is applied.







The Apple II is a self-contained computer with an integer BASIC in ROM, which can be used to load a 16K BASIC. It includes at least 4K of RAM, and game paddles, and will output full-color to a full-color video monitor or TV set (with RF modulator).

verts the electrical impulses from terminals and computers into audio tones which can be easily handled by voice-grade telephone circuits. Some modems, used on private lines, work at extremely high speeds; the common voice-grade modems operate at TTY speed (110 words per minute) or 300 words per minute. Modems used at terminals are called *originate* modems. Those used at the computer are *answer* modems. Each responds to different audio tones: the originate modem transmits low tones and receives high tones from the computer. The answer modems transmit high tones and receives low tones.

**Q**—What is a “Monitor”?

**A**—See **Firmware** in the previous question.

**Q**—What is meant by “Boot” and “Bootstrap”?

**A**—You have probably heard of the expression “Picking yourself up by your bootstraps.”; meaning, getting yourself started by moving yourself. Same thing with computers. A computer can only sit there and do nothing until programmed; but you can’t just shove a program into the computer; something must tell the computer what’s going on when you start to enter your program. A bootstrap program is a very small program that sets up the computer to load a larger, complex program. To boot a program means to use a program (generally in a resident monitor or operating system) to program a larger program, or to set up something like a disk operating system.

**Q**—An accessory I/O I’m planning on adding to my home computer has a feature called “handshaking.” Exactly what is a computer’s handshake?

**A**—**Handshaking** is electronic confirmation that some piece of computer equipment is ready to execute operations. For example, before a computer transmits to a mass storage device such as a recorder it might send out an electronic signal to find out if the recorder is ready. On receipt of the signal the recorder, if ready, will transmit a signal back to the computer that it is ready. The computer will then transmit the start signal, followed by the data transmission. If the computer does not get its “handshake” from the recorder it doesn’t transmit data. Handshaking can also work the other way: The recorder might send out its handshake signal, and automatically feed data to the computer only if a handshake is received from the computer.

**Modems** also generally use handshaking (see next question).

**Q**—What’s a modem?

**A**—A **modem**—a term derived from **modulator/demodulator**—is a device that connects both computers and terminals through telephone or other remote-wired circuits. A modem con-

**Q**—A group from school would like to set up a computer we could use from each home. Is this possible?

**A**—Yes. You will need an answer modem at the computer, and each of you will need a terminal with an originate modem. Some means must be provided, if there is no one to attend the computer, to automatically answer the phone at the computer, connect the modem, and then “hang up” when the terminal signs off. This is easily accomplished through a modems handshaking signal. (We hope to have a construction project on such a device in an upcoming issue.) Answer modems, and combination originate/answer modems, manufactured by Omnitec—perhaps the most respected name in modems—are available from some surplus dealers from time to time. You have to keep looking because answer modems don’t come cheap—even used.

**Q**—Is there some reason paper tape (teletype) recordings made on my own computer cannot be fed into my school’s computer, or the time-share system available through my school?

**A**—Yes. Even though computers might use the same CPU there are minute variations in the encoded signals. It is more common than not that recordings from one type of computer cannot be fed to another, even when using the same type of recording system. For example, one of the most

(Continued on page 90)



Based on the 8080A, the Heathkit H8 has a 16-key front panel which, in octal numbers, allows you to address registers and memory. I/O interfaces and memory are options, as are peripherals.

# COMPUTER NEW PRODUCTS

Here in one place in each issue of e/e you will find product information on the newest hobby computers and accessories.

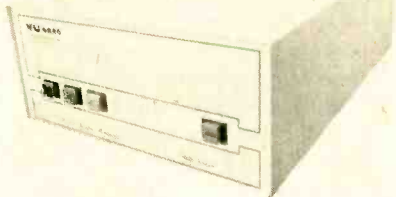

**New 6800 Computer**—Midwest Scientific Instruments has announced the MSI 6800, a microcomputer based on the popular SS-50 bus. The motherboard is a full 16-slot board which offers plenty of room for expansion. As configured from the factory, the MSI 6800 arrives with three boards installed; the CPU board, a fully-populated 8K RAM board, and a serial interface board. This leaves the hobbyist with 13 slots still open for the future. MSI offers additional 8K RAM boards for \$225 kit and \$335 assembled, as well as other accessory boards such as a cassette interface

board for \$75-kit and \$105-wired. All boards are silk-screened and solder-masked. The power supply section is designed to deliver 5 VDC at 20 amperes to allow 56K of RAM and/or PROM to be used. The plus or minus 15 VDC supplies are designed to deliver 3 amps each for adequate capacity in powering PROM boards and other devices. The system has been designed for business, industrial, educational and home environments. With chassis, power supply, motherboard, 8K RAM, interface adapter, and CPU board the price for the MSI 6800 is \$595-kit and \$895-wired. Circle number 53 on Reader's Service Card for more information.

**Home Computer**—The Challenger IIP from Ohio Scientific is a new entry into the hobbyist computer market. It's fully self-contained, complete with a full size keyboard and a 32 x 64 character Video Display Interface along with an Audio Cassette Interface. The computer is equipped with an 8K BASIC in ROM. The BASIC was designed by the Microsoft Corporation and is bug-free. The advanced hobbyist may bypass the BASIC and go directly to machine-language, hexadecimal programming, if he wishes. With 4K of RAM, the computer arrives ready to go, needing only to be hooked up to a CRT or, through a RF Modulator, to the home TV set. All the user need do is attach the IIP to a visual display, hook up a tape recorder for storing programs, and start right in on the most interesting electronic hobby to come along in quite some time. Ohio Scientific uses their own 48-line bus structure and the IIP will accept many of the present OSI boards; other accessories such as a special 16K memory board, a matching floppy disc, along with extended software, are all being planned for the IIP. As supplied, the IIP has a four-slot backplane; two of the slots are filled and two are open for future expansion. Thus, it is a system the hobbyist will be able to grow into. Complete with keyboard, case, backplane, CPU board, video and cassette interfaces, the assembled Challenger IIP sells for \$598. Circle number 61.



**2-for-1 PROM Programmer**—Oliver Audio Engineering (OAE) says this high quality PP2708/16 programmer programs both the 1K 2708 and new 2K 2716 PROMS made by Texas Instruments. A simple parallel interface connects the PP 2708/16 to any micro-computer. An internal address counter makes interfacing a cinch. Only one unregulated 8V supply is required, and

very little software is needed, to support the programmer, according to OAE. Simply dump the data via an output port to program a PROM. The programmer contains address counters, timing and control logic, and a DC to DC regulated power supply. Each unit comes complete with a black anodized aluminum case, a five-foot ribbon cable with pre-wired connectors, and software. Prices: assembled and tested, \$299; kit, \$249; kit without regulators, \$199. Circle 71 on Reader Service Coupon for more information about this product and others from Oliver Audio Engineering.

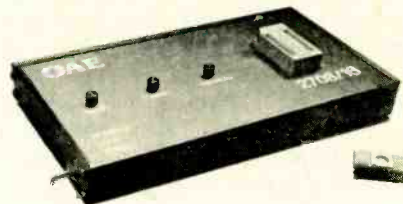

**Data Cassettes for Hobby and Small Business Use**—AVDEX Corp. makes available a full line of data cassettes specifically designed for use in hobby computers and small business computers. The cassettes are loaded in 1-minute, 3-minute and 5-minute lengths for more convenient use than are cassettes that have too much tape for handy hobby/business applications. The cassettes are custom loaded with extra short leaders to prevent the leaders from contacting recording heads, thereby providing instant start operation and eliminating the possibility of lost data. Prices of the short load cassettes are: CDC-1, \$4.95; CDC-3, \$5.65; CDC-5, \$6.35. Also available are three other cassettes in C-20, C-40 and C-60 configurations (\$4.50, \$5 and \$5.50 respectively) which utilize the same computer shell components and are loaded with high quality, high density calendered ferric oxide formulation. Circle No. 67.

**Analog Interface Board**—Vector Graphic says this multi-function Analog Interface Board permits interfacing with potentiometers, joysticks or voltage sources, hence it is ideal for hobby and small business computer applications. An 8-bit digital port with latch strobe can be used as a keyboard input port. Tone pulse gen-

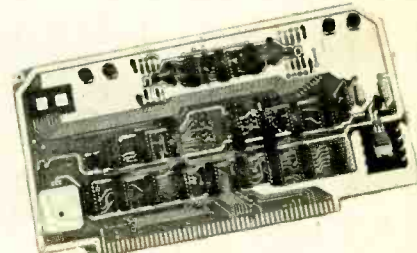

erators also can be used to produce sounds for games or keyboard audio feedback. Additional features include: four A to D inputs; MWRITE logic; power-on jump feature for computers lacking front panels. Prices: kit, \$75; assembled, \$115. Circle no. 68 for information. ■





# CB NEW PRODUCTS



e/e puts together in one neat package some of the newest CB rigs, antennas and accessories for you to use in CB contacts this year!

## CB Pistol Mike

A new concept in two-way mobile radio microphones combines an electret-capacitor element with a compact pistol-grip case that tucks neatly into the palm. The JMR Mobile Ear Microphone, model 40, is specially engineered to be held at the steering wheel while transmitting, allowing you to talk, switch, and use both hands for driving simultaneously. The built-in Velcro pad lets you mount the unit anywhere. Just attach the mating Velcro pad to steering post, dash, or any other handy surface. The tiny electret-



CIRCLE 48 ON READER SERVICE COUPON

capacitor microphone picks up your voice anywhere within arm's reach with exceptional fidelity. There's no need to hold the microphone up to your mouth when transmitting. The specially designed frequency response plus the clear, distortion-free reproduction of the electret-capacitor microphone combine to create an on-the-air sound that punches through noise and interference. Variable microphone gain lets you adjust the level for optimum modulation under varying conditions. Sells for \$44.95. Get all the facts from JMR Systems Corporation, 168 Lawrence Road, Salem, NH 03079.

## CB Variable Audio Filter

Prime Electronics new PR-1000 Variable Audio Filter provides a receive signal improvement by allowing the CB operator to tune out unwanted interference plus sharpen the receiver selectivity to exactly match the desired signal. Operation of the PR-1000 is quite simple with the selectivity control varying the amount of audio selectivity between the receiver and external speaker from a super narrow 40 Hz up to a wide 10,000 Hz. The frequency control varies the



CIRCLE 72 ON READER SERVICE COUPON

center frequency of the VAF, once again from 40 Hz to 10,000 Hz. The Peak mode of the unit allows the selectivity to be varied as wide or as narrow as required and the center frequency to be set to match the

exact characteristics of the receiver and external speaker audio response and tune out off-channel whistles and heterodynes by a minimum of 70 dB. The PR-1000 is powered from 115 VAC or 12 VDC, includes five integrated circuits and has a razor sharp selectivity spec of 80 dB or more. Suggested list price of the AC model is \$59.95; suggested list price of the AC/DC model is \$69.95. For more details, write to Prime Electronics Inc., 221 West Market St., Derby, Kansas 61037.

## Snazzy Base

The Superscope Aircommand CBB-1040 is a base station version of the Aircommand CB-640 which was selected by the California Highway Patrol for exclusive use in its vehicles. The Aircommand BPM-1 Power Microphone is supplied at no extra cost, providing many times more sensitivity than conventional mics. The Aircommand CBB-1040 40-Channel CB Base Station Transceiver offers these features: Emergency channel 9 scanner with flashing light, beeper

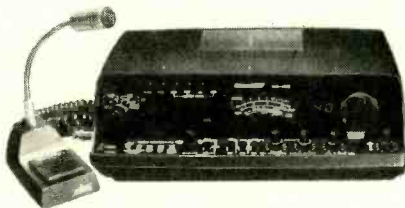

CIRCLE 55 ON READER SERVICE COUPON

and adjustable "threshold," Channel 9 quick access switch, LED digital clock, built-in 40 dB speech compressor, SWR metering, RF power metering, modulation metering, receive signal-strength metering, dual conversion superheterodyne receiver, and many others too numerous to list. Sells for \$389.95. Get all the facts on the entire Aircommand line by writing to Superscope, Inc., 20525 Nordhoff St., Chatsworth, CA 91311.

## Magnetic Edge Mount Antenna

The new Hustler Speedy Seizer, Model SPS, mobile antenna is for the CB'er who wants quick on/off installation of a magnetic mount plus the long-range performance of a permanent antenna installation. The Model SPS is designed for fast mounting and removal on cars, trucks, vans, campers, RV's, farm vehicles, and off-highway equipment without opening doors or trunk. It has a unique edge mount that fits any existing vertical or horizontal 1/8-in. gap with a 3/8-in. minimum return, such as a door or trunk edge. A heavy-gauge rust-proof 18-8 stainless steel clamp holds the Speedy Seizer in place. Just a twist installs or removes the SPS for theft protection or car wash. An adjustable 180° swivel ball keeps

the antenna vertical. The clamping action of the Speedy Seizer mount guarantees the same perfect electrical ground as with a

CIRCLE 66 ON READER SERVICE COUPON

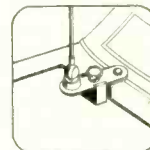
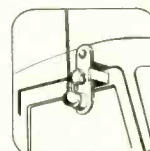

permanent installation. The Hustler Speedy Seizer is 46 inches long, measured from the vehicle surface. The 17-7 PH stainless steel whip and tip rod are very flexible, rust proof, and will not break. The tip rod is screwdriver-adjustable for lowest SWR. A triple-plated chrome swivel ball and high-impact plastic parts assure long life. The Speedy Seizer package includes a 17-foot RG-58 Belden coaxial cable with factory-installed connectors. The suggested list price of the Model SPS is \$19.95, and it is available now. For further information on this or any Hustler product, write to New-Tronics Corporation, 15800 Commerce Park Drive, Brook Park, OH 44142.

## Protect Your CB

Lightning and heavy-duty electrical equipment often create power-line surges and transients. This can cause extensive damage to valuable CB equipment. Electronic Specialists newly introduced line-cord transient suppressors absorb repeated power surges,

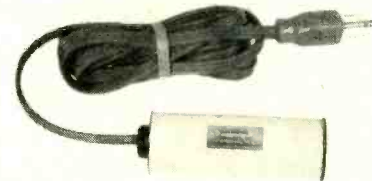

CIRCLE 77 ON READER SERVICE COUPON

protecting delicate base station CB equipment. Sells for \$11.50 (2 prong plug/socket) and \$14.50 (3 prong plug/socket). Units also available which incorporate transient suppressor and power line hash filter. Get all the facts by writing to Electronic Specialists, Box 122, Natick, MA 01760.

# QUIZ MASTER

by Walter Sikonowiz

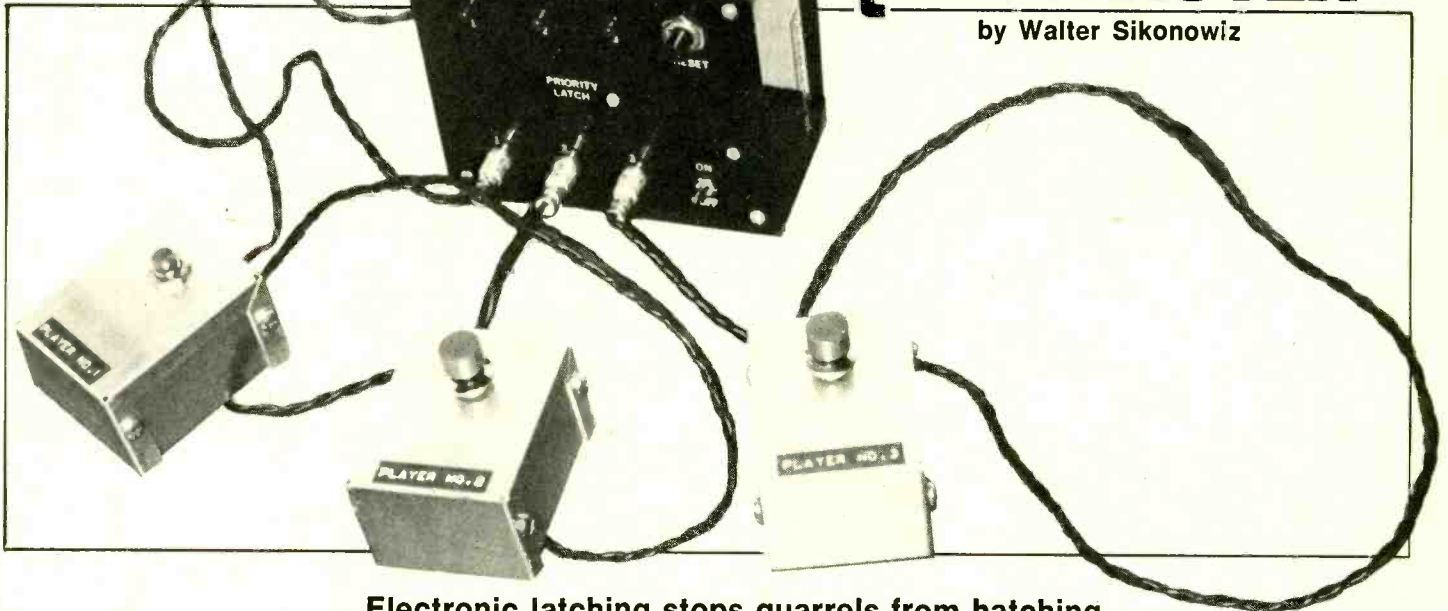

Electronic latching stops quarrels from hatching

**Q**UIZ SHOWS, with their big cash prizes and fast-talking emcees, have been standard television fare for more than two decades. Judging from their vast numbers, it seems that game shows are as popular today as ever, although revelations of rigging did threaten their existence for a time. In spite of such apparent popularity, however, there is one criticism that few game shows can escape: Quiz questions, designed for a mass audience, are usually simple—sometimes ridiculously so. As an example, consider Groucho Marx's sarcastic "Who's buried in Grant's Tomb?" which he reserved for really inept contestants.

You can improve on the quiz concept with questions of your own design, but first you will need a priority latch. This is a device to indicate which one of three contestants makes the first response to a question. Operation of the latch is very simple: Each player is assigned an LED and a pushbutton switch. The first player to press his switch causes his LED to light and prevents any other player's LED from lighting at a later time. Obviously, you can use this device in any game where it is necessary to detect the first response, so it has a very wide range of application.

**SCR Latching.** Let's begin discussion of the circuit by considering the device responsible for the latching action: the SCR. In Figure 1, you can see that the SCR is a three-terminal device. *A* stands for anode, while *G* means gate,

and *C* indicates the cathode. When normally open pushbutton *S2* is pressed, a current  $I_G$  flows into the gate terminal. If  $I_G$  is large enough, it will cause the anode-to-cathode impedance to drop; hence, an anode current  $I_A$  will begin to flow. Now, suppose that *S2* is released. If  $I_A$  is greater than a reference level (known as the latching level) at the instant that *S2* is released,  $I_A$  will continue to flow even though the gate current has stopped. The SCR is now latched in a conducting state, where it will remain indefinitely, unless normally closed pushbutton *S1* is pressed. Pushing *S1* interrupts the anode current, and

when *S1* is finally released, the anode current remains zero until *S2* again supplies a pulse of gate current. As a final observation, it is important to note that the pulse of gate current must last a finite time—usually a few microseconds—in order for latching to occur.

**How It Works.** Now, take a look at the priority latch's schematic diagram. Three LEDs (LED1, LED2 and LED3) are connected in series with the anodes of three SCRs (*Q1*, *Q2* and *Q3*). Latching of any one of these SCRs will cause its corresponding LED to light. Normally, the gate terminals of the three SCRs are grounded through *R4*, *R5* or *R6*. However, if the three switch assemblies are plugged into *J1*, *J2* and *J3*, and if any one of these switches is pressed, then an SCR's gate terminal is connected to the collector of *Q5* via *R1*, *R2* or *R3*. *Q5*'s collector may be either high or low; if it happens to be high when a switch is pressed, an SCR will get latched. If, on the other hand, *Q5*'s collector happens to be at ground potential, no latching can occur. Let's see just what determines the potential at *Q5*'s collector.

Assume that reset switch *S4* has just been pressed. From our previous discussion of SCR characteristics, it is obvious that none of the three SCRs will be able to conduct current when *S4* is finally released to its normal (closed) position. Therefore, the voltage drop across *R7* must be zero since no current is flowing through it. This, in turn, means that no base bias is applied to

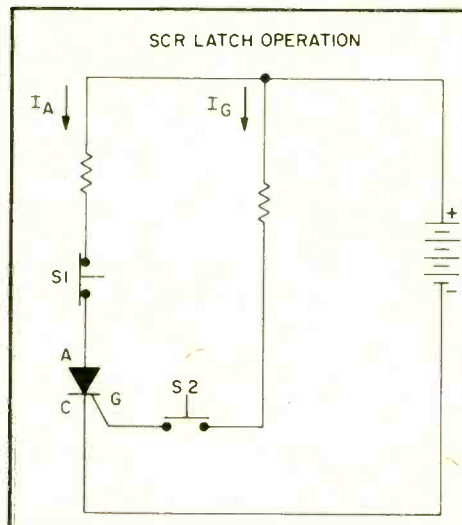

A momentary pulse at the gate causes the SCR to conduct until anode current is cut.



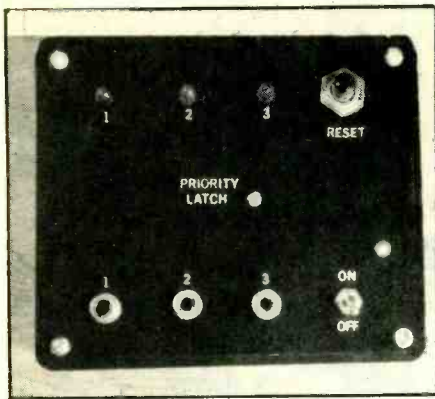

This type of circuit is called a priority latch. Any number could be added.

Q4, with the result that no current can be flowing out of Q4's collector terminal. Consequently, no current can flow into Q5's base terminal, and this means that Q5's collector potential must be high.

Suppose, now, that we press pushbutton S1 and thereby connect Q1's gate to Q5's collector via R1. Gate current will flow, causing Q1 to conduct and LED1 to light. LED1's current causes a potential to appear across R7, and this voltage biases Q4 into conduction. Collector current from Q4 flows through R9 to forward bias Q5, and this causes Q5's collector to drop low, thereby removing Q1's gate bias in the process. Capacitor C3 slows down the response of Q5 by about a microsecond so that Q1's gate drive is not removed before latching can occur.

What happens if pushbutton S2 is now pressed in an attempt to light LED2 by latching Q2? Nothing happens, because Q5's collector is low. As you can see, the latching of an SCR precludes the latching of any other SCR at a later time. While the above argument was illustrated by having Q1 latch first, it is obvious that the same action results no matter which SCR is the first to latch. Pressing reset button S4 returns the circuit to its initial state, with all LEDs extinguished.

Capacitors C1 and C2 bypass the power supply, which, in this case, consists of four AA penlight cells in series, yielding 6 volts. Maximum current drain (in the latched condition) is 25 milliamps, which is well within the capacity of AA cells. Unlatched, the circuit draws practically no current. If you plan to use the priority latch extensively, four C cells could be used instead of AA cells, with a corresponding increase in battery life.

**How It's Made.** Construction of the priority latch is not critical at all; you may use perfboard, a printed circuit or whatever you like. The prototype was constructed in four plastic boxes, with

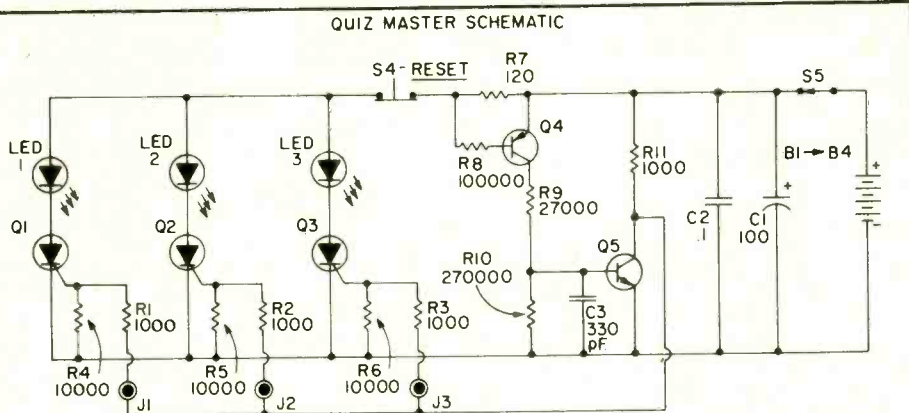

Need parts? Find them in HOBBY MART—page 83.

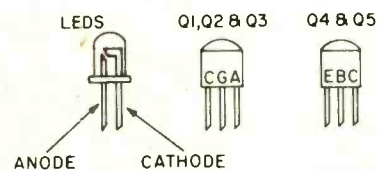

ONE OF THREE SWITCH ASSEMBLIES

#### PARTS LIST FOR QUIZ MASTER

- B1—four 1.5-volt AA cells in series
- C1—100- $\mu$ F, 16 V electrolytic capacitor
- C2—1 $\mu$ F ceramic capacitor
- C3—330-pF polystyrene capacitor (Allied 852-0038)
- J1, J2, J3—phono jacks
- LED1, LED2, LED3—LEDs
- P1, P2, P3—phono plugs
- Q1, Q2, Q3—2N5060 SCRs (\*)
- Q4—2N3906 PNP transistor (\*)
- Q5—2N3904 NPN transistor (\*)
- R1, R2, R3, R11—1000-ohm, 1/2-watt, 10% resistor
- R4, R5, R6—10,000-ohm, 1/2-watt, 10% re-

- istor
- R7—120-ohm, 1/2-watt, 10% resistor
- R8—100,000-ohm, 1/2-watt, 10% resistor
- R9—27,000-ohm, 1/2-watt, 10% resistor
- R10—270,000-ohm, 1/2-watt, 10% resistor
- S1, S2, S3—normally open pushbutton switches
- S4—normally closed pushbutton switch
- S5—SPST toggle switch
- Misc.—battery holders; large plastic cabinet; three small plastic cabinets.

\*All components identified by an asterisk available from: Circuit Specialists, Box 3047, Scottsdale, AZ 85257.

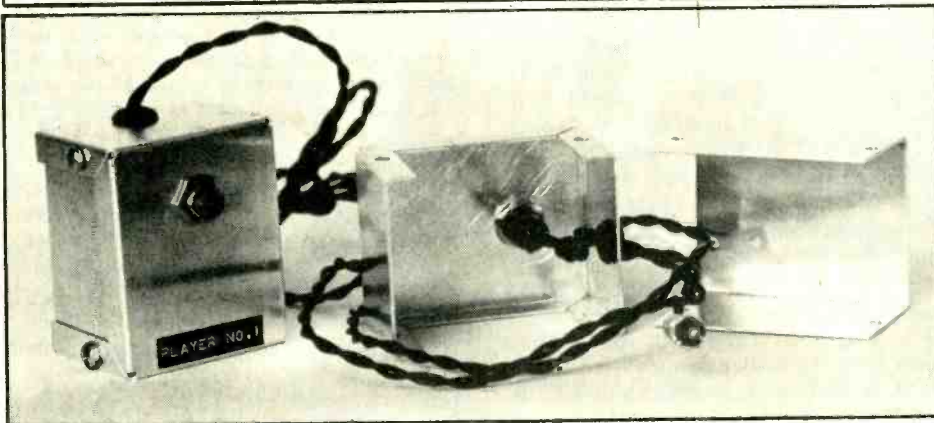

The hand-held contestants' units can consist of almost any type of small box since all they contain are normally open pushbutton switches. They should be durable.

one large box holding the bulk of the circuitry. As the photos show, the large cabinet's front panel contains S4, S5, the three LEDs and the three jacks. Each small box houses one pushbutton switch, which connects to the large main cabinet via a pair of twisted wires terminated in a phono plug. Be sure to use good-quality pushbuttons for S1, S2 and S3; small, cheap pushbuttons are unsuitable because they don't always make contact (especially when pressed rapidly). Use large, reliable

pushbuttons for best results.

Do not substitute other SCRs for Q1 through Q3. These units were chosen because of their sensitivity; if you cannot find them locally, you can mail-order them from the supplier in the Parts List.

A good place to begin construction is with the fabrication of housings for pushbuttons S1, S2 and S3. Bore a hole one-half inch in diameter into the top side of each of three small aluminum or plastic miniboxes. In each hole

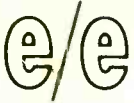

## QUIZ MASTER

mount one pushbutton switch. In a side panel of each minibox, drill a hole large enough to accommodate a small grommet.

Now, take two strands of #22 hook-up wire, and twist them together for a distance of about 12 feet. Cut the twisted pair into three equal-length segments of about four feet each. Solder the wires at one end of each segment to the two lugs of a pushbutton, and thread the other end of the cable segment out through a grommets exit hole. Close up each little cabinet using the screws provided. Then, apply decals to the miniboxes in order to provide identification—for instance, *Contestant #1*, and so on. At the free end of each of the twisted cables, mount a standard RCA-type phono plug. This completes the construction of the switch assemblies, and you can set them aside until later.

The remainder of the circuitry can be most conveniently assembled with the aid of perfboard or a printed circuit. To assist you, a complete PC layout is provided elsewhere in this article. Once you have mounted all the components on the perfboard or printed circuit, go back and double-check your connections. Be on the lookout not only for improper wiring, but for cold solder joints as well. These can cause you a lot of grief later, so take the time to make good solder joints from the start.

**Heat Sinks.** If you happen to be squeamish about the possibility of damaging your semiconductors with the application of too much heat, use heat-sinks on the leads as you solder them. For the uninitiated, a heat-sink looks something like an alligator clip. Attach the heat-sink to the lead you intend to solder at a point fairly close to where the lead enters the transistor package. You can now really heat the joint to make a good solder connection without fear of damaging a semiconductor. Incidentally, be sure that your iron's power is rated at no more than about 25 watts; more power than this is unnecessary. Finally, use only resin-core solder in this project—or in any other electronic project, for that matter.

During the installation of components, be very careful to properly orient those devices which are polarized. This applies to all the semiconductors in this project, and also to electrolytic capacitor C1. Biasing diagrams for the various semiconductors can be found elsewhere in this article.

In the prototype, the printed circuit board was mounted on the inside of the

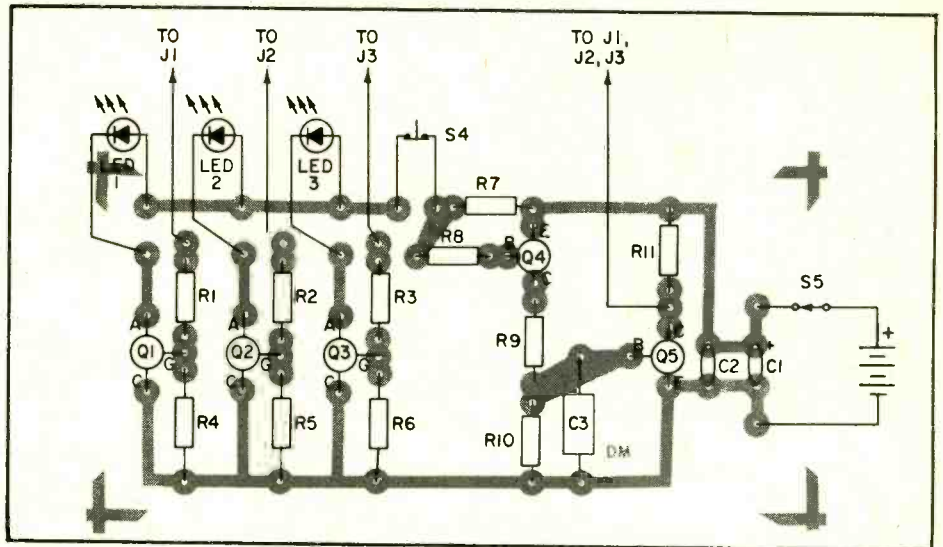

This diagram shows the location of the parts on the Quiz Master's circuit board and where the wires from the circuit board go. Note how neat the layout of this project is—a sure sign of a well designed and carefully planned unit.

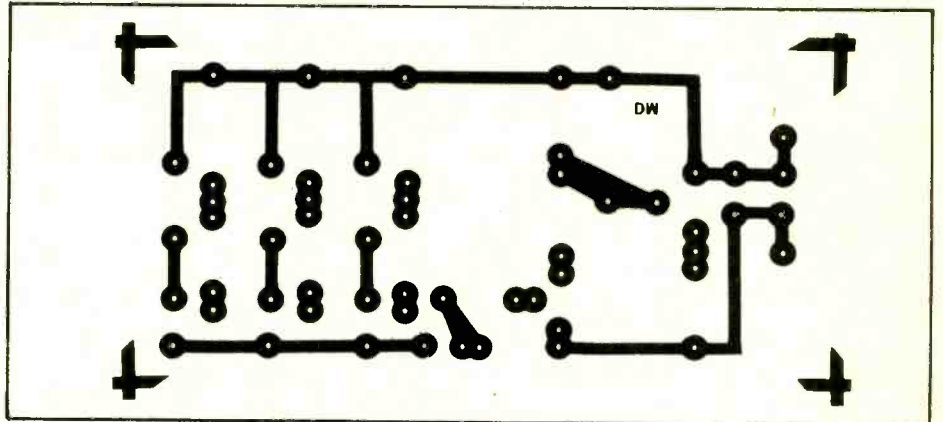

A well constructed printed circuit board can be made by using this template as a pattern for photo etching or resist pen etching. You might even try one of those new kits that allow a template to be lifted right off the page of the magazine.

large plastic box's front panel. There was ample space left on the front panel for the jacks, the LEDs, reset button S4 and power switch S5. In the body of the case, a 4-cell battery holder was installed to accommodate the four AA batteries that power the latch. Construction was completed with the application of press-on, white decals to identify the various controls and LEDs. A coat of clear lacquer sprayed over the decals will bond them to the cabinet.

**Testing.** After you have completed construction, you can test your circuit like this: Plug in all the pushbutton assemblies, and turn on the power. Pressing pushbutton S1 should cause LED1 to light. Afterwards, pressing either S2 or S3 should have no effect. Now, hit reset button S4, and verify that the same priority-latching action is obtained when S2 or S3 is the first button to be pressed.

Response time of this priority latch is something in the vicinity of 5 micro-

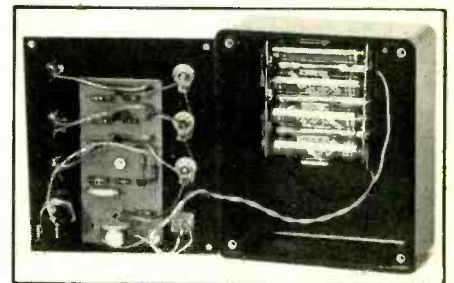

The printed circuit board is mounted on the back of the front cover of the Quiz Master, between the jacks and the LEDs. Any 6 VDC power source can be used.

seconds—considerably less than human reaction time, which is on the order of milliseconds at best. Consequently, this circuit will do an excellent job of determining response priority. On the rare occasion when you end up with two lit LEDs, you will know that the contestants responded either simultaneously or within a few microseconds of each other.





# Kathi's CB Carousel

by Kathi Martin, KGK 3916

Check out the features on Stoner's state-of-the-art rig

□ Nothing Lasts Forever! I don't know if "The One Horse Shay" is still studied in school, but back in my old school-days (well, not so far back!), everyone read the poem about the two wheel, horse-drawn carriage. It was so well made nothing wore out, until the fateful day all the parts fatigued and the entire carriage simply fell apart—every bolt falling out, every seam opening, every rim splitting, etc.

Eventually, everything breaks down, particularly electronic components. They have not yet succeeded in manufacturing a lifetime transistor or integrated circuit; they do eventually go bad. Glass encased diodes are known to shatter; crystals do crack and drift off frequency or simply stop vibrating; and well, you name it and it can happen, as many CBers are just starting to learn.

Each week I get more and more mail inquiring about transceiver repairs, or complaining about defective antenna systems. The plain truth is that transceivers get old, slowly losing receiver sensitivity, power output, and often stability. On the other end of the coax, road salts which are used to melt ice and snow, and even dirty road water, all wear away antenna hardware. Also, water gets under plastic-sleeved antennas, the grounding screws on trunk lip mounts corrode (causing relatively high resistance), and coaxial cable dries out.

In short, CB equipment—from the worst to the best—eventually must be replaced if you want a dependable signal. If you've racked up 10,000 miles or more on a "permanent" antenna installation now's the time to start looking for a replacement. If your transceiver has three or more years on it ask yourself if you're getting the performance needed for today's communications: Do you need more selectivity? Does your rig have the wall-to-wall talk power you now get from even budget priced transceivers? Do you need

the extra TVI suppression now provided by every FCC type-approved rig? Most important, does your old rig cover all 40 channels?

To be perfectly honest, some equipment available in the CB marketplace today will be no better than your old worn out gear; it might even be worse. About the only way to get real inside info on how a transceiver actually performs as tested by an independent lab—and one of the very best ways to be up on what's available in the latest antenna designs—is by latching onto a copy of the 1978 CB BUYER'S GUIDE. Unlike most CB publications that simply reprint the manufacturer's specs in such a way as to make them appear to be the results of some form of lab test, every transceiver listed in the CB BUYER'S GUIDE has actually been tested by an independent lab, and what you see are the results of real lab tests.

Even if you're not interested at the present time in new gear, the '78 CB BUYER'S GUIDE has a well illustrated article showing—through spectrum an-

alyzer photographs—why the new FCC type-accepted transceivers have more talk power and less TVI. Just this article alone is worth the price of the BUYER'S GUIDE.

If you're an active CB'er now's the time to think about upgrading your station, and the '78 CB BUYER'S GUIDE will help you get the best value for your hard-earned dollars.

### The Stoner PRO-40 SSB Transceiver.

Of all the persons hailed as the "Father of CB," none had the impact of Don Stoner. CB was a dead issue, an idea that went no place and had no place to go until a now defunct magazine called "Radio and TV News" published an article on how to build a transceiver for the then new 11-meter Citizen's Band. The author of that article was Don Stoner, and it was his rig, with its simple superregenerative receiver, that really opened up the Citizen's Band. Copies of Stoner's rig were built by the thousands, both by hobbyists and "garage" manufacturers. Even the famous Benton Harbor Lunchbox (Heathkit) was de-

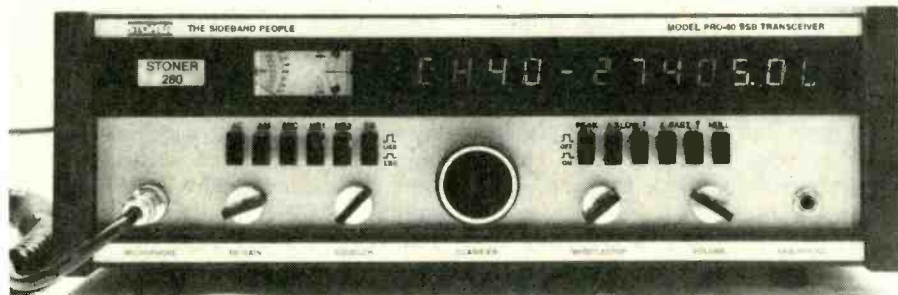

When you sit down in front of a Stoner PRO-40 CB transceiver you'll be looking at true state-of-the-art technology. One of the most useful features in this SSB rig is the "Whistlestop" control. As most SSBers have sorrowfully found out, the predominately AM signals found on the band can wreak havoc with SSB communications. An AM signal can heterodyne with a SSB signal, causing a raucous whistling note. With the PRO-40, this is one annoyance you can tune away. There are all sorts of other features as well, including; true digital readout, null and peak controls, two independent noise blankers, up and down along with fast and slow channel change buttons, and a D-104 microphone is included to give you all around talk-power. Circle number 79 for more information.

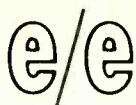

## KATHI'S CB CAROUSEL

signed using Stoner's idea as the foundation. For almost a year, the parts needed to build Don Stoner's CB rig were almost impossible to get because hobbyists snatched them up as fast as the radio parts stores could get them in.

Don Stoner moved on to become one of the big names in commercial sideband equipment. Now he's back again in CB, with a sideband rig that's probably the ultimate in sideband-only equipment.

Known as the PRO-40 Transceiver, Don Stoner's latest contribution to CB has just about everything you can imagine, and then some extras you probably never believed could exist.

First, the PRO-40 is sideband only; it has no AM. If you want to work AM you feed your AM rig through the PRO-40 via a standard coax connector on the rear apron. The AM signal feeds through the PRO-40's TVI filter, and its frequency is displayed by the PRO-40's digital frequency counter display. (More on the counter later.)

Because the PRO-40 is designed exclusively for sidebanders, it has a special feature that gets rid of AM station interference. Called a "Whistlestop," the device is a tuneable filter that tunes out the heterodyne interference (whistle) caused by an AM station operating on a channel being used for sideband.

But, I'm getting ahead of myself. Let's start at the beginning so we can look at all the important features in the PRO-40.

The LED digital display indicates the channel number, the actual transmitter output frequency to 100 Hz, and the letter L or U to indicate the lower or upper sideband. The frequency display is a counter that also indicates the frequency of an AM transmitter fed through to the antenna.

The operating channel is selected by simply depressing *up* and *down* channel-change buttons—both *fast* and *slow* buttons are provided.

A multi-turn clarifier provides up to  $\pm 5$  kHz of fine tuning, the precise amount of tuning off the center channel being indicated by the counter display.

A switch labeled *null* causes the *whistlestop* to function either as a null filter to reject heterodyne whistle interference, or as a *peaker* to enhance a narrow range of received voice frequencies—very useful when the received station has muddy sound. (You can peak the higher frequencies with the

filter).

Other aids to getting the best possible performance include two independent noise blankers with individual selectors, and a microphone equalizer. The PRO-40 is supplied with a D-104 mike, which puts the *talk power* several notches above what you would usually expect from the cheap mikes supplied with many rigs. When the going gets too tough for even the D-104, pressing a switch labeled MIC cuts in a slight additional microphone preamplification and adds a tilt towards the high fre-

As for performance. *Zowie!* You've got to try it to believe it. Receiver sensitivity measured 0.3  $\mu\text{V}$  for a 10 dB S+N/N ratio (signal plus noise to noise). Selectivity was somewhere beyond the 80+ dB of our measurement equipment. Stoner claims 90 dB and it's possible he is correct because we couldn't find the limit at 80+ dB.

The AGC (automatic gain control) action was an unbelievable 0.5 dB between the normal input signal test range of 2 to 10,000  $\mu\text{V}$ . I could hear no change in speaker volume when a

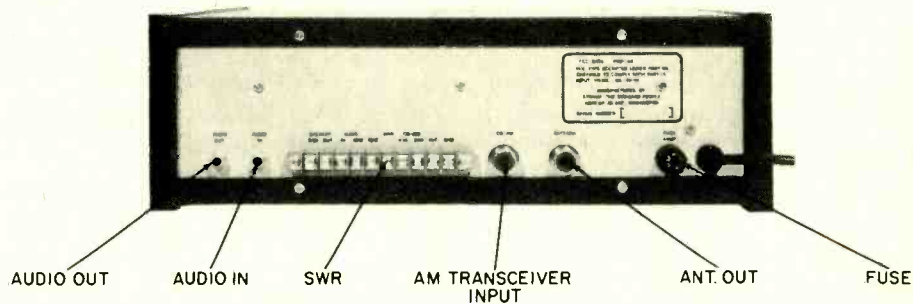

The PRO-40 has a complete set of input/outputs on the back panel. Note the AM transceiver input. This is a SSB-only rig and operation on AM requires an outboard transceiver which is fed into the PRO-40's frequency counter so as to display operating frequency.

quencies to the overall frequency response, thereby providing extra talk power to the intelligence-carrying voice frequencies. (For a local contact it's easier on the receiving operator's ears if you keep the MIC switch in the normal, or *flat* position.)

A dual (two) meter provides some unusual built-in indications. One meter provides the usual S/RF indication, but with a difference. The RF output function indicates the peak envelope power output (P.E.P.) as you modulate. The other meter movement built into the same case provides an unusual antenna condition indication. When the meter shows center scale the antenna is properly tuned. If the antenna system is tuned above or below the operating frequency it will be so indicated by the meter. If the meter indicates below center scale it is tuned below the operating frequency. (This sure beats a standard SWR indication.)

The power supply is 120 VAC. A terminal strip on the rear provides nominally 14 VDC for powering associated equipment such as a mobile transceiver used for AM. The strip also has terminals for a speaker; there is none inside the cabinet. (Pick a really good communications-type speaker for the PRO-40.) If desired, you can monitor received signals through headphones connected to a front panel headphone jack.

strong local signal walked on a very weak signal. Speaking of strong signals, the receiver is immune to overload under worse-case operating conditions; while testing the PRO-40 a local opened up with his mobile right outside my door and did not cause overload or cross modulation—that's performance at its best.

As for the transmitter, it produced exactly 12 watts P.E.P. over all 40 channels. Microphone sensitivity in the normal (*flat*) mode was 45 dB—sensitive, but not so sensitive it picks up every sound in and around the house.

Even though the PRO-40 requires an outboard AM transceiver to operate that mode—you may find yourself enjoying AM more than ever before. The reason? When you feed the AM output of a transceiver into the special jack on the back of the PRO-40, you avail yourself of both the PRO-40's TVI filter and its frequency counter. It's a real kick to operate with a frequency readout in LED digits, something you just can't do with most AM sets.

There's just so much to say about the PRO-40 I could go on and on, but it's time to close. Summing up, the Stoner PRO-40 is the *gold-plated special* of super-performance transceivers. I suggest you get the full story direct from Stoner by circling No. 79 on the reader's service coupon. ■



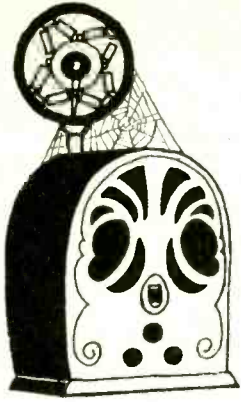

# ANTIQUE RADIO CORNER

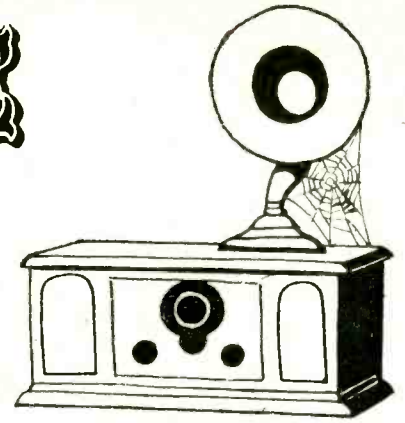

by James A. Fred

## Run rings around long wires with these BCB loops

□ HELLO OUT THERE in Radioland. How is your collecting going this summer? Have you registered for the AWA annual conference? It will be held at Canandaigua, New York again this year and promises to be bigger and better than ever. The dates are September 29 and 30, 1978. I hope to see many of my readers there.

**Looping the Loop.** Several readers have written to me asking about antennas for their radios, and especially about loop antennas since many of the radios built in the 1923-1926 era had these antennas. The outside antenna consisting of 100 feet of wire hung between two glass insulators, as high in the air as possible, was one drawback to radio ownership in the 1920's. Apartment dwellers soon found there wasn't any way they could erect an efficient outdoor antenna. Atwater Kent went to great lengths in his instruction books to show listeners how to put up outdoor antennas.

In large cities where there were many broadcasting stations only 10 to 30 miles from the listeners a loop antenna became a successful substitute for an outdoor antenna. The loop antenna usually consisted of several turns of wire wound on a wooden form varying in

size from a square one-foot on a side to a square four feet on a side. In spite of its small size it would receive almost as many stations as an outdoor antenna. In addition to its compactness another advantage to the loop antenna was that a ground wasn't necessary with the loop. One big advantage to a loop antenna is its directivity. In most cities there is much electrical interference and man made noise. The loop antenna picks up the loudest signal when the loop is turned so its flat side faces in the direction of the station. If the plane of the loop is at right angles to the station very weak signals are heard. Thus by rotating the loop unwanted signals may be attenuated or nulled out leaving the desired station to come in free of interference.

The method for making a loop may vary mechanically, but the following information can be used if you want to build a loop for a radio that never had one or if you want to replace a loop if the original is lost or broken. For most purposes the wire used for a loop can be number 20 or 22 bare copper wire. If you can find some cotton covered stranded wire it will make a loop look very much like an original. The strands of wire can be spaced from  $\frac{1}{4}$  to  $\frac{1}{2}$

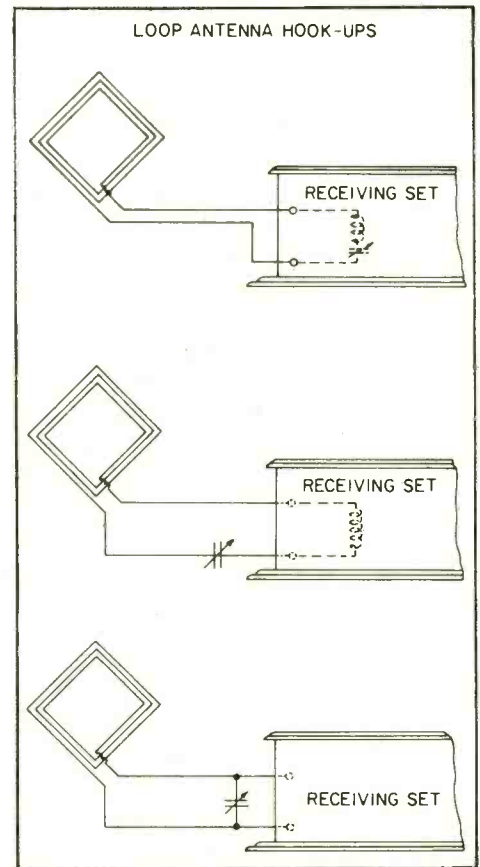

These three diagrams show how the loops are connected to various receivers of differing internal wiring arrangements.

A DESIGN CHART FOR LOOP ANTENNAS

Turns of wire	Spacing "C," inches	Cross-arm length "B," inches	Length of Litz wire, feet
11	1 25/64	66	135
12	1	52	117
13	3/4	43	105
14	9/16	35	92
15	29/64	30	81
16	3/8	26 13/16	77
17	9/32	21 1/2	67

Use this chart to determine the amount of wire needed for a loop antenna with the length of the crossbeam and spacing desired. Use closer spacing on a small loop.

inch apart. A loop made on a four-foot square wound with six to eight turns of wire and tuned with a .001 mfd. capacitor will cover the whole broadcast band. If the size of the loop is smaller, the number of turns of wire must be increased. Thus for a 20-inch square there should be about 16 turns of wire. In general about 100 feet of wire will be needed for a loop. It is evident that as the loop gets smaller in size it begins to resemble the conventional tuning coil.

# ANTIQUE RADIO CORNER

With the chart shown it will be a simple task to make a loop which will work with most of the three-dial tuning battery receivers. The first thing to do when building a loop is to decide how big to build it. Then you can find the number of turns of wire and the spacing from the chart. Let's assume that you want to build a loop 20 inches on a side. On the graph on this page follow the line up through 20 inches to the one inch spacing curve and from that point to the left. This shows about 20 turns are needed; 18 turns are needed for  $\frac{3}{4}$  inch spacing; 15 turns for  $\frac{1}{2}$  inch spacing; and 12 turns for  $\frac{1}{4}$  inch spacing. The table shown will give exact dimensions and length of wire needed for various size loops. The table specifies flexible, stranded wire, but probably it will work OK with plastic covered stranded wire. The inside turn of the loop should be connected to the antenna binding post of the radio.

Now that you have designed and built a loop antenna how do you connect it to your radio. The method of connecting a loop to your radio depends upon the wiring inside your radio. If the set has an antenna coil and tuning capacitor connected in series then the loop is connected in series with them. If the receiving set has a coil only then a tuning capacitor must be placed so that one of its terminals is attached to the loop and the other to the ground connection of the set. Then the inside turn of the loop is connected to the antenna connection of the set. A loop and tuning capacitor may be used to replace the tuning circuit of the RF

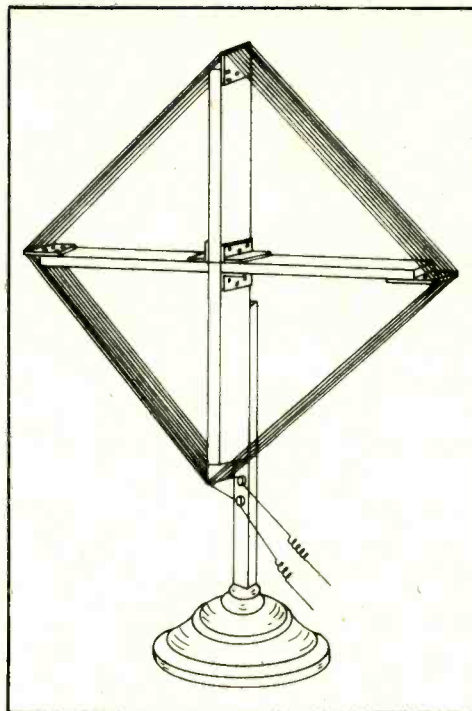

A homemade loop antenna typical of the 1920s. Compactness and directionality made it popular with city dwellers.

amplifier stage in the radio. In this case the tuning capacitor is connected across the grid and filament connection where the original tuning coil was connected. With a loop antenna you needn't worry about a lightning arrestor as you would with an outside antenna.

**Who Was Baby Jacquelin?** Some time ago a collector friend, Frank Heathcote of Logansport, obtained a very unique crystal radio receiver. He purchased it from a collector who lived near Toledo, Ohio. As you can see from the photo it is a plaster statue molded in the shape of a young girl sitting on a box. The girl seems to be dressed in the costume of the French Foreign Legion. Her head covering seems to be a Fez with a tassel. She is holding a staff or a cane, I am not sure which. It has been suggested that the girl is Shirley Temple dressed for a part she may have played in a movie of several years ago. Molded into the front of the box are the words "Baby Jacquelin."

The photo of the back shows a mineral detector, a cat whisker, switch points with a contact arm, and two phone tip jacks mounted on a black phenolic panel. Extending from behind the panel are two wires, possibly the antenna and ground connections. The statue is just as Frank bought it with the exception of the spring clips and insulators on the two wires.

Frank and I are both anxious to know all about this crystal radio statue.

How old is it, who made it, where was it made, and who was the girl? We also wonder if the radio receiver was originally mounted in the box or did someone build it in after the statue was made? If you have any knowledge of this radio or the statue please write to me in care of ELEMENTARY ELECTRONICS magazine. I will publish the best information I receive for the benefit of all radio collectors.

**A Radio Collector Needs Help!** I received a telephone call from Mr. George Ray of Klamath Falls, Oregon in regards to a 1938 German made Phillips radio. It was built after Adolph Hitler rose to power in Germany. He has seen the same model radio in two different WWII movies on TV that showed German Soldiers in their rooms. The radio is a small table model containing two vacuum tubes. The one tube whose number I don't have is no problem since he has two new spares. The other tube is a VCL 11 and has a crack in the glass bulb which has caused it to loose its vacuum. Mr. Ray was overseas several years ago, but was not able to find the VCL 11.

Here is the problem: he hasn't been able to find any information on the tube, he doesn't know of any replacement type for it, he suspects that there were two tubes in one glass envelope because of the way the connections on the tube are arranged. The radio played when he got it and he wants it to play again.

If any reader has a VCL 11 vacuum tube or knows of a replacement for it I would appreciate it if he would write to me in care of ELEMENTARY ELECTRONICS magazine, and I will relay the information on to George Ray.

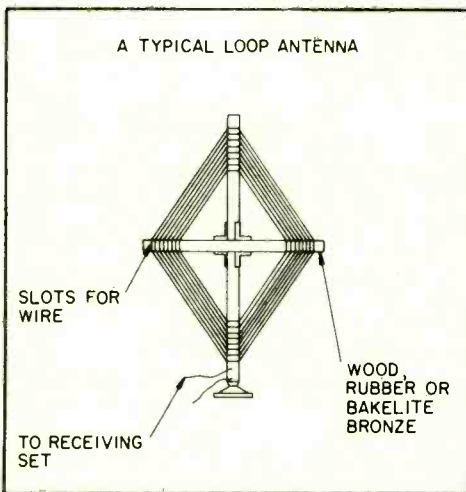

This is a typical, concentrically wired loop antenna. The desired length and spacing can be determined from by using an average of the inner and outer measures of the cross beams or sides of the loop wires.

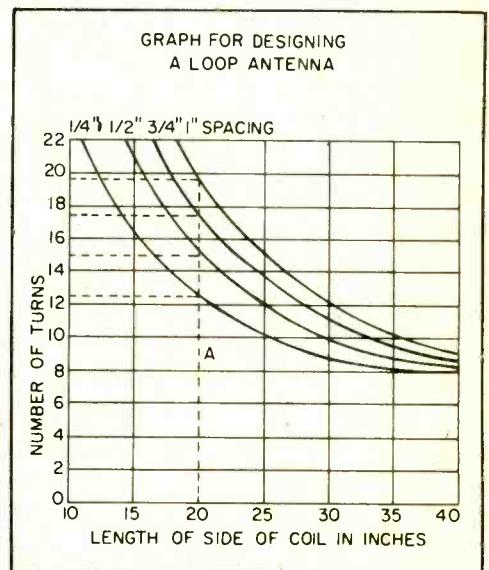

This chart is used to design coils if the length of the side of the coil is known.





The "Baby Jacquelin" crystal radio statue is of unknown origin. The insulated alligator clips are a recent addition.

**Reader Feedback.** Some time ago I mentioned having a Garod radio that looked like it had been rewired from its original manufactured state. Frank Pagano of Meriden, CT sent me the following information. I quote from his letter as follows: "No doubt your Garod radio has been modified because my belief is that it was originally a model EN. The model EN had four AC-100 tubes, one type 10 audio output and an 81 or UX216B for the rectifier tube. I have a Garod like yours, but it is a model EA and has three UX112, one UX99, a type 10 and an 81 rectifier tube. The tube type AC-100 is extremely rare as I only have one."

I am always happy to hear from readers of *ELEMENTARY ELECTRONICS*, especially when they can supply information about radios we have questions about.

We received an entirely different kind of letter from Ray Zorn of Berne, Indiana. Ray wrote a poem back in the early 1930's that was published in *Radio Guide* magazine, volume 1, number 46, for the week of September 4, 1932. If any reader has this magazine as well as an issue a few weeks later in which a reader commented on Mr. Zorn's poem I would appreciate hearing from him. I will put Mr. Zorn in touch with him.

So long for now. We will be back again next issue with news and views on the antique radio collecting hobby. ■

# CALCULATOR CARPENTRY

**Build our calculator stand and don't take weak batteries lying down!**

by John Boyer

□ How would you like to turn your small hand held calculator into a desk model that can operate for a long time for very little cash? You won't need to replace batteries very often nor will you have the nuisance of the AC adapter's line cord running from your calculator to the 117 volt wall socket. You can very easily make this accessory for your calculator, and it's well worth the effort. The cash and trouble it saves is nice, but too, you'll really enjoy the enhanced "feel" of your calculator.

As there are many variables, it is not possible to be specific with instructions as how to build this accessory for your calculator. Use your own imagination and creativity to build the stand to suit your needs. By following the outline and by looking at the photographs there should be no reason why you would have any trouble at all with this project. It's simple—and its simplicity is

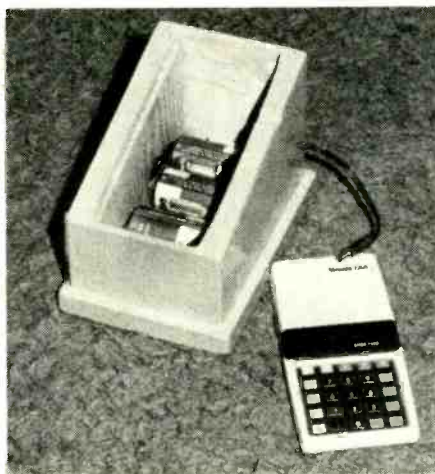

Why spend a fortune on batteries for your calculator? Here's a way to not only save on battery costs, but to enhance performance by turning a hand-held into a desk model! The project is simple and easy to do. The type of cabinet is all up to you. Once built, the stand can be easily disconnected from the calculator. It's a convenience you'll wonder how you did without. Get busy building and save yourself dough.

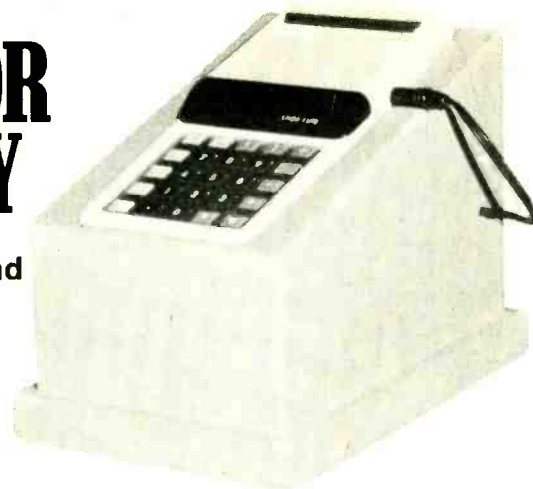

one thing that makes it such a "fun" project! Build a wooden box that is big enough to hold the number of "D" cells it would take to run your calculator. Connect them in series. Each "D" cell is 1½ volts. Build the box, which doubles as a stand, so that the calculator sits on top at an angle that makes viewing the readout comfortable to you. Cut off about 6" of cord from the calculator plug end of the AC adapter. The plug will then go in and out of the calculator as you wish, and the other free end of the cord then has to be hooked to the + and - side of the "D" cells which have been placed in "D" cell holders inside the wooden stand. Be sure you get the polarity correct when you hook up the cord to the "D" cells. (You can hook up your AC adapter to the wall socket and check the polarity of the plug with a DC voltmeter before you cut off the 6" strip of cord at the calculator plug end). Paint the wooden stand as you see fit. I put 4 small felt pads on the bottom of the stand to cushion it from whatever it sits on. The calculator pops in and out of the stand very easily. If you want to take the calculator out of the home or office, simply pull the plug and lift the calculator out of the stand and away you go. Always leave the calculator's internal batteries in if you plan on taking the calculator out of its stand. The internal batteries are not in use as long as the plug from the "D" cells is in the AC adapter socket. Once the plug is pulled the internal batteries of the calculator are again in use.

**A Calculated Savings.** The more you use the calculator in its stand—the greater will be your savings. By using my calculator and stand nearly every day for several hours, it ran for 16 months from one set of Alkaline "D" cells. I don't know how many hours that would be of continuous usage, but I do know that I was replacing the small "AA" batteries in my calculator every month before the stand. ■

# IT'S SIMPLY BASIC

Try to outsmart your computer by guessing its innermost secrets!

by Larry Friedman, WB2AHN

□ In previous columns we've used the computer to solve electronic formulas and do data handling. This month we bring you MIND BENDER, a computer game designed to test your thinking skill. MIND BENDER is similar to some versions of a computer game called MASTERMIND, but it has special features that make it more challenging and enjoyable to play. For example, you can set the amount of guesses allowed to you by the computer. With this feature, you set your own skill level and can advance to higher levels of playing.

**It's Fun Time!** Here's how to play MIND BENDER. The computer picks a random letter sequence using the letters A through J. The sequence, or code, will be four letters, none of which will repeat. You are allowed 10 tries to

guess the code. Since it would be nearly impossible to guess a code of four letters in ten guesses as there are thousands of combinations, the computer will give you hints as to how close you are. If you guess a letter and it is one of the code letters, the computer will print R (for right). However, if the letter is right and is also in the correct position, the computer will print C (for correct). If the code is I A J B and you guess B A C E the computer will print C R because A is a code letter in the correct position, and B is a code letter but in the wrong position. When you guess the correct code, the computer will print C C C C.

MIND BENDER employs several new features not used in our previous programs, such as MID\$ which takes the

middle letters of a stringed variable. MID\$ is used to determine whether or not you have guessed correct code letters. Lines 460 through 620 perform this function.

The computer, through lines 350 to 400, will prevent two code letters from ever repeating.

We also introduce random numbers, which can be found in lines 320-340. These lines utilize the random number function to pick the random letter code using the DATA statement in line 300.

MIND BENDER prevents you from

making an error while entering your guess. If you make a mistake, hit the space bar seven times (or how ever many are required to make the total number of letters + spaces exceed seven). This feature is accomplished through line 440.

If your computer requires a DIM statement (Most computers won't because the largest subscript in the program is 10) simply put in the statement: 10 DIM E\$(10).

Also, to set the amount of guesses allowed by the computer, change the (Continued on page 91)

Just fourteen years old, Larry Friedman, who set up this program, is an old hand with computers. He has built his own computer system using an SWTP 6800 as the base. The computer gets diverse uses as processing complex electronic equipment test reports and keeping the statistics for Larry's baseball and bowling teams. Larry is also a consultant on programs for electronics experimenters, and a real whiz as an amateur radio operator and as a beginning pilot.



## MINDBENDER GAME PROGRAM

LISTING OF "MIND BENDER"

```

0100 L=0:R=0
0105 REM 'L' SETS AMOUNT OF GAMES WON TO 0.
0106 REM 'R' DETERMINES WHETHER OR NOT LETTERS ARE CORRECT.
0110 INPUT "DO YOU WANT INSTRUCTIONS",Y$:IF LEFT$(Y$,1)="" THEN 260
0120 PRINT "*** MIND BENDER INSTRUCTIONS ***"
0130 PRINT "THE COMPUTER WILL PICK A RANDOM LETTER CODE OF"
0140 PRINT "4 LETTERS USING THE LETTERS A THRU J."
0145 PRINT "YOU MUST GUESS THE "
0150 PRINT "CORRECT CODE WITHIN 10 TRIES.":PRINT
0160 PRINT "TO PLAY, ENTER 4 LETTERS AS YOUR GUESS, EACH SEPARATED"
0170 PRINT "BY A SPACE. FOR EVERY LETTER YOU GUESS CORRECTLY"
0180 PRINT "THE COMPUTER WILL PRINT 'R' FOR RIGHT. HOWEVER,"
0190 PRINT "IF THE LETTER IS RIGHT AND IS ALSO IN THE CORRECT"
0200 PRINT "POSITION, THE COMPUTER WILL PRINT 'C' FOR CORRECT."
0210 PRINT "FOR EXAMPLE, IF THE HIDDEN CODE IS 'I A J B' AND YOU "

```

RUN OF "MIND BENDER"

```

DO YOU WANT INSTRUCTIONS? YES
*** MIND BENDER INSTRUCTIONS ***
THE COMPUTER WILL PICK A RANDOM LETTER CODE OF
4 LETTERS USING THE LETTERS A THRU J.
YOU MUST GUESS THE CORRECT CODE WITHIN 10 TRIES.

TO PLAY, ENTER 4 LETTERS AS YOUR GUESS, EACH SEPARATED
BY A SPACE. FOR EVERY LETTER YOU GUESS CORRECTLY
THE COMPUTER WILL PRINT 'R' FOR RIGHT. HOWEVER,
IF THE LETTER IS RIGHT AND IS ALSO IN THE CORRECT
POSITION, THE COMPUTER WILL PRINT 'C' FOR CORRECT
FOR EXAMPLE, IF THE HIDDEN CODE IS 'I A J B' AND
YOU GUESS 'B A C E' THE COMPUTER WILL PRINT 'C R
BECAUSE 'A' IS A CODE LETTER AND IN THE CORRECT
POSITION, AND 'B' IS CODE LETTER, BUT NOT IN THE
CORRECT POSITION.
WHEN YOU GUESS THE CODE,
THE COMPUTER WILL PRINT 'C C C C'

```



HOW MANY GAMES DO YOU WANT TO PLAY? 2

```

0220 PRINT "GUESS 'B A C E' THE COMPUTER WILL PRINT 'C R' BECAUSE ";
0230 PRINT "'A' IS A CODE LETTER AND IN THE CORRECT POSITION, ";
0240 PRINT "AND 'B' IS CODE LETTER, BUT NOT IN THE CORRECT POSITION.";
0250 PRINT "WHEN YOU GUESS THE CODE,"
0255 PRINT "THE COMPUTER WILL PRINT 'C C C'"
0257 REM THE NUMBER OF LETTERS + SPACES EXCEEDS 7.
0260 PRINT :INPUT "HOW MANY GAMES DO YOU WANT TO PLAY",W
0270 FOR J=1 TO W:RESTORE
0280 PRINT TAB(12);"GAME # ";J:PRINT
0290 FOR Q=1 TO 10
0295 REM THE DATA STATEMENT MAY REQUIRE " AROUND EACH LETTER.
0300 DATA A,B,C,D,E,F,G,H,I,J
0310 READ E$(Q):NEXT Q
0315 REM THE COMPUTER NOW PICKS THE CODE.
0320 A$=E$(INT(RND(0)*10)+1):B$=E$(INT(RND(0)*10)+1)
0330 C$=E$(INT(RND(0)*10)+1)
0340 D$=E$(INT(RND(0)*10)+1)
0350 IF A$=B$ THEN 320
0360 IF A$=C$ THEN 320
0370 IF A$=D$ THEN 320
0380 IF B$=C$ THEN 320
0390 IF B$=D$ THEN 320
0400 IF C$=D$ THEN 320
0410 Z$=A$+" "+B$+" "+C$+" "+D$
0420 FOR N=1 TO 10
0430 PRINT "GUESS # ";N;" -> ";INPUT G$
0440 IF LEN(G$)<>7 THEN 430
0450 PRINT "RESULTS: ";
0455 REM THE COMPUTER NOW CHECKS FOR CORRECT CODE LETTERS.
0460 K$=MID$(G$,1,1):L$=MID$(G$,3,1):M$=MID$(G$,5,1)
0470 O$=MID$(G$,7,1):IF K$=A$ PRINT "C ";:R=R+1
0480 IF L$=B$ PRINT "C ";:R=R+1
0490 IF M$=C$ PRINT "C ";:R=R+1
0500 IF O$=D$ PRINT "C ";:R=R+1
0510 IF K$=B$ PRINT "R ";:R=R+1
0520 IF K$=C$ PRINT "R ";:R=R+1
0530 IF K$=D$ PRINT "R ";:R=R+1
0540 IF L$=A$ PRINT "R ";:R=R+1
0550 IF L$=C$ PRINT "R ";:R=R+1
0560 IF L$=D$ PRINT "R ";:R=R+1
0570 IF M$=A$ PRINT "R ";:R=R+1
0580 IF M$=B$ PRINT "R ";:R=R+1
0590 IF M$=D$ PRINT "R ";:R=R+1
0600 IF O$=A$ PRINT "R ";:R=R+1
0610 IF O$=B$ PRINT "R ";:R=R+1
0620 IF O$=C$ PRINT "R ";:R=R+1
0630 IF R=0 PRINT "*** ALL WRONG ***"
0640 IF R<>0 PRINT:R=0
0650 IF G$=Z$ THEN 720
0660 PRINT
0670 NEXT N:PRINT "I'M SORRY, YOU DIDN'T GET THE CODE."
0680 PRINT "THE CODE WAS: ";Z$
0690 PRINT
0700 GOTO 790
0710 PRINT :PRINT TAB(18);"*** YOU WON THE GAME ***"
0720 IF N<6 PRINT "EXCELLENT WORK! YOU SHOULD DO THIS FOR A LIVING!"
0730 IF N=6 PRINT "GOOD WORK!"
0740 IF N=7 PRINT "PRETTY GOOD !!"
0750 IF N=8 PRINT "YOU DID C.K., BUT YOU COULD USE PRACTICE."
0760 IF N>8 PRINT "NOT TOO GOOD. YOU NEED PRACTICE."
0770 L=L+1
0780 PRINT
0790 NEXT J:PRINT "WELL, YOU'VE PLAYED ALL ";W;" GAMES."
0800 PRINT "YOU WON ";L;" GAMES OUT OF THE ";W
0810 PRINT "YOU WON ";INT(L/W*100);"% OF YOUR GAMES."
0999 END

```

READY

HOW MANY GAMES DO YOU WANT TO PLAY? 2

```

GAME # 1
GUESS # 1 -> ? A B C D
RESULTS: R R
GUESS # 2 -> ? E F G H
RESULTS: R
GUESS # 3 -> ? D A F I
RESULTS: C
GUESS # 4 -> ? C B H J
RESULTS: R R
GUESS # 5 -> ? C J D E
RESULTS: C R R R
GUESS # 6 -> ? C E D J
RESULTS: R R R R
GUESS # 7 -> ? J C E D
RESULTS: C R R R
GUESS # 8 -> ? J C D E
RESULTS: C C R R
GUESS # 9 -> ? J D C E
RESULTS: C R R R
GUESS # 10 -> ? J D E C
RESULTS: R R R R
I'M SORRY, YOU DIDN'T GET THE CODE.
THE CODE WAS: D C J E
GAME # 2
GUESS # 1 -> ? A B C D
RESULTS: R
GUESS # 2 -> ? E F G H
RESULTS: C R R
GUESS # 3 -> ? H F E B
RESULTS: R R
GUESS # 4 -> ? H E G A
RESULTS: R R
GUESS # 5 -> ? H D G F
RESULTS: R R R R
GUESS # 6 -> ? F H G D
RESULTS: C R R R
GUESS # 7 -> ? D F H G
RESULTS: R R R R
GUESS # 8 -> ? F G D H
RESULTS: C C C C
YOU DID C.K., BUT YOU COULD USE PRACTICE.
WELL, YOU'VE PLAYED ALL 2 GAMES.
YOU WON 1 GAMES OUT OF THE 2
YOU WON 50 % OF YOUR GAMES.
READY

```

READY

# HEARING HOLLAND

We'd like to DX the Netherlands:  
Wooden Shoe???

by Brian A. Rogers

**I**N 1926, WHEN THE INFANT broadcasting industry was taking its first electronic steps, a group of engineers, employed by the Philips electrical factory in Holland, began experimenting with the mostly unused "short-wave" portion of the radio spectrum. A transmitting station, bearing the call letters PCJ, was established at the company's factory at Eindhoven.

On March 11, 1927, a little more than fifty years ago, the experimenters' efforts brought results. A transmission on a frequency of 10 MHz, powered with a feeble (by today's standards) 10 kW, was received by an amateur radio operator at Bandung, Java, in the Dutch East Indies, a country now known as Indonesia.

The listening ham, excited by hearing something originating so far away, immediately wrote the Philips people and told them of his reception. The engineers were delighted to learn that signals from their station had travelled so far.

Eddy Starz, then a PCJ announcer, and later host of the station's popular "Happy Station" program remarked, "Shortwave has done away with our old enemy—distance," a statement which has been proven accurate countless times since.

PCJ continued its experiments into the 1930's, a decade during which it moved its transmitting site from Eindhoven to Hilversum, Holland. At Hilversum, the Philips scientists discovered that mounting an antenna on a platform, and rotating the platform by means of rails beneath it, enabled energy transmitted by the antenna to be "aimed" at a "target" area. This was a forerunner of the many efficient "beam" antennas which are in almost universal use by present-day international broadcasters.

PCJ was forced to stop transmitting during World War II but, known as



The Netherlands, certainly one of the world's most scenic countries, attracts its due share of Europe-bound tourists. You can stroll down the narrow streets in the city center, streets which have been closed to traffic to make room for people and shops; ride a windowed boat down the Singel canal beside the colorful Amsterdam flower market; or visit historical monuments and sites such as the Montelbaenstone Tower which was built around 1512 as a fortification in the city walls against invading armies.



"Radio Nederland," the station resumed operations on April 15, 1947.

Today, Radio Nederland programs are heard and enjoyed by SWLs around the world. Because of Radio Nederland, Holland has an electronic voice far stronger than countries of similar population and geographical size.

Signals from 100 kW transmitters in Lopik, Holland, and 300 kW transmitters on Bonaire in the Caribbean and on Madagascar in the Indian Ocean, reach most parts of the globe with ease.

A staff of 370 people, produces programs that in 1963, 1968 and 1973, won for Radio Nederland first place in

a popularity poll conducted by SWLs. The station has also received the Merit Award of the National Association of Educational Broadcasters.

Some of the best news-reporting on the high-frequency bands is heard during the twenty-minute-long "Newsblock" programs, one of which opens each transmission. The first seven minutes of each Newsblock is devoted to a review of current world happenings, while the remaining time is taken by in-depth looks at the background and history of present international events.

Variety is the theme of Radio Nederland's musical programs. Besides



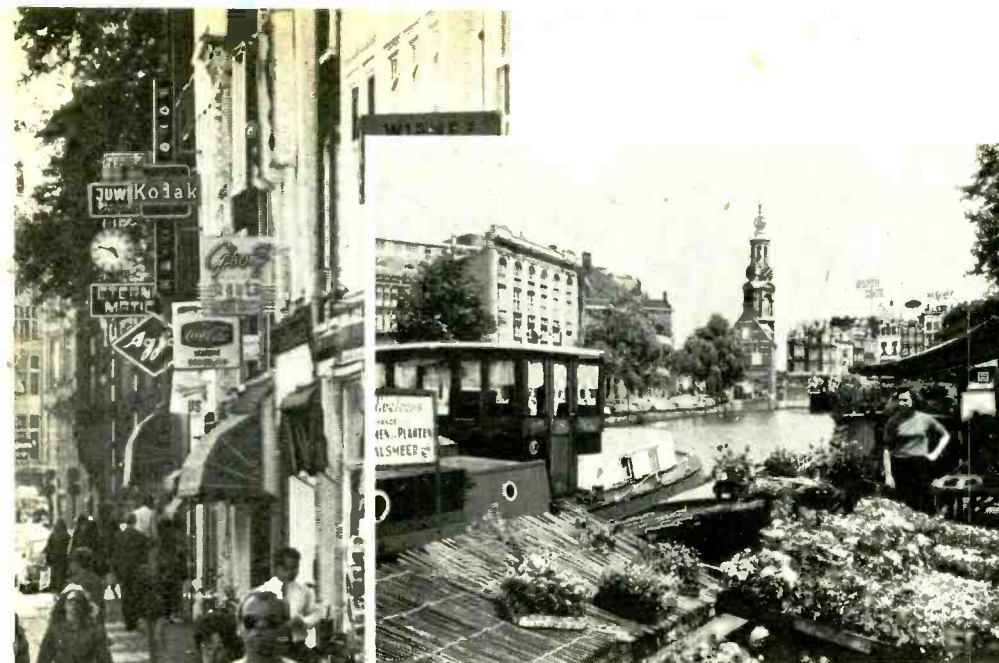

Radio Netherland does its best to bring the spirit of Holland to its listeners. Besides broadcasting in many languages . . . to listeners all over the globe, the station makes . . . unique aids available to its DXing audience. Free to all are data sheets on such topics as crystal calibrators and antenna tuners. There are also technical correspondence courses for which there is no tuition charge. Lively programming too attracts a worldwide audience, along with attractive and colorful QSL card veries.

titles as "Shortwave Propagation," "DX Receivers," and "The All Round DX-er's Course." No tuition charge is made for this instruction.

Receiving Radio Nederland is no problem for North American SWLs, even those who have only inexpensive, transistor portable receivers. Three eighty-minute-long transmissions are broadcast daily to those listeners. The first, broadcast weekdays only, is aimed to Eastern North America. Transmission is from Lopik on 11,730 and 9,715 kHz beginning at 2130 GMT (4:30 P.M. EST.) The second, heard every day at 0200 GMT (9:00 P.M. EST.) comes from Bonaire on 6,165 kHz. The third transmission, meant for West coast listeners, is broadcast by Bonaire every day at 0500 GMT (9:00 P.M. PST.) on 9,715 and 6,165 kHz.

One of Radio Nederland's "don't miss" offerings is "DX Juke Box," heard every Thursday right after News-block. Hosted by Dick Speekman, the program features news of SWL club activities, predictions of future ionospheric conditions, and DX reception reports from such places as the United States, Sweden, the South Pacific and Asia. Harry van Gelder, the program's former emcee, was recently honored on his retirement by having his picture printed on a special Radio Nederland QSL card.

Long noted for its attractive QSL cards, Radio Nederland continues to send these verifications in return for correct, written reception reports. To earn a QSL card the writer's report must contain the date and time (in GMT) of the broadcast heard, the frequency being used and some details of the programming heard during the broadcast. Reception reports should be sent to Radio Nederland, Box 222, Hilversum, Holland. This address can also be used when requesting program schedules, the DX Information Service Catalog and details of the various correspondence courses. ■



broadcasting the latest offerings on the Dutch and international pop hit parades, the station plays symphonic music performed by the world's finest artists.

No description of Radio Nederland's programs would be complete without mentioning the Sunday "Happy Station" music and variety show. Begun more than forty years ago by the late Eddy Starz, Happy Station is now ably hosted by Tom Meyer.

Besides English and, of course, Dutch, Radio Nederland currently offers transmissions conducted in the Afrikaans, Arabic, Indonesian, French

and Spanish languages.

Radio Nederland does not neglect its DXing listeners. In fact, it offers unique benefits to DXers. Free to anyone who writes for it is the "DX Information Service Catalog." Described are data sheets on such topics as crystal calibrators, antenna tuners and interference suppression, as well as booklets about antenna and convertor construction. All are sent at no charge to interested listeners.

Also popular are Radio Nederland's technical correspondence courses. Written by the station's Jim Vastenhoude and other experts, the courses include such



1. Why not build projects you can be proud of, in appearance as well as circuit design? It is neither difficult nor expensive as you'll note when you follow this unit on a step-by-step journey from a blank, machined panel to real artistic beauty.



2. You will need spray and brush-on protective coating, plastic tape, various types of rub-on lettering and designs, and a burnishing tool (the white cylinder) to effect the transfer of the letters from the carrier sheet to a project's front panel.

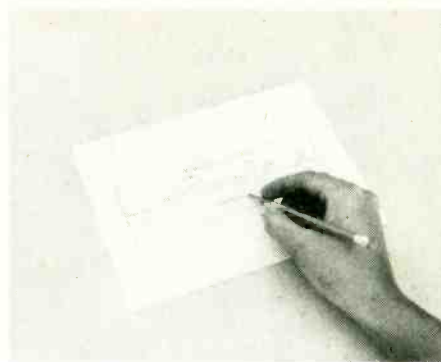

3. You can't fashion it if you have never seen it before—at least seen it on paper. First, make a sketch and work on the arrangement until you are quite satisfied with it. Using the quadrille paper, as pictured here, makes the job easier.

**W**HEN YOU GIVE birth to an electronic project, don't send it into the world illiterate. As shown in this article, it's easy to apply lettering and designs to give your projects a professional appearance, as well as for functional reasons. This is accomplished by using a product called *rub-on lettering* (or *dry-transfer lettering*), which consists of letters, numbers, or designs with an adhesive on their back side so that they can be affixed to a panel or other surface. The letters come attached to the back of a transparent plastic *carrier sheet*, from which they are transferred to the panel by rubbing or *burnishing*. Follow the photos to see how it is done. The process may seem complicated at first, but with a little experience you will find that the steps go quickly.

Rub-on lettering is available in various sizes and colors (black and white are the most common). Sets may contain complete words, individual letters or numbers, or a combination of these. Sets consisting of index marks and other

# LOVE THAT

Press-on decals will turn

by Randall

designs for rotary switches and dials are also available.

A small set, which should see the average hobbyist through half a dozen projects or more, costs only about two dollars. Your local electronics store probably carries rub-on lettering and related supplies, if not, try the suppliers listed at the end of this article. Rub-on lettering is also available from art, graphic arts, and office supply stores. Although the type they carry is intended primarily for other purposes, it can be used for electronic projects.

In addition to the lettering and a few household items (cellophane or plastic

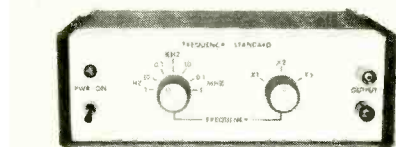

14. And now—the finished project, a delight to the eye! Once you try this method on one of your projects you'll never go back to ugly again. You don't have to be an artist, and it does not add much to the cost. Electronics can be beautiful!

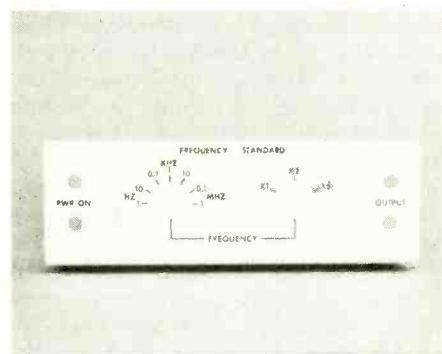

13. Here you see what the panel looks like after the lettering has been completed but before the parts have been mounted. It already has a clean, professional look, more like something out of an assembly-line factory than from your workbench!



12. You can also buy spray overcoating as pictured here. Spray is more even than the brush-on, but the brush-on can be applied thicker. This method too requires that you carefully check for the compatibility of the overcoat with both letters and panel.

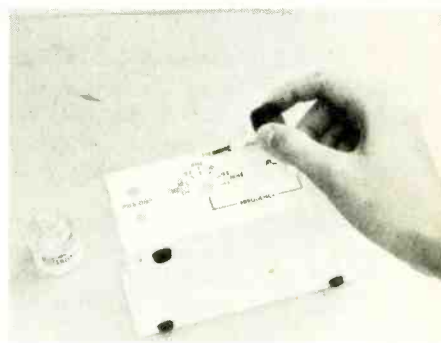

11. You'll want to protect that final panel, and there are two methods you can use. Here we show the brush-on method of overcoating. First, check on a scrap or hidden area for compatibility with both rub-on lettering and the panel finish.



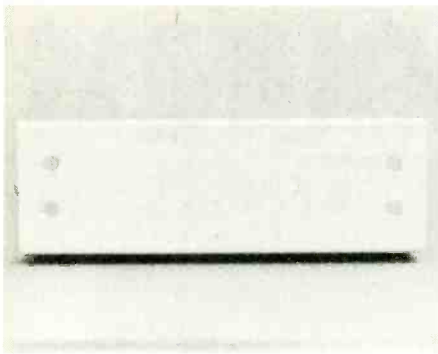

4. Once you know where it is all going to be at, you can begin to machine the panel. Follow your quadrille-paper layout carefully and don't make last minute, poorly planned changes! Then make certain the panel is clean and dry and free of any imperfection.

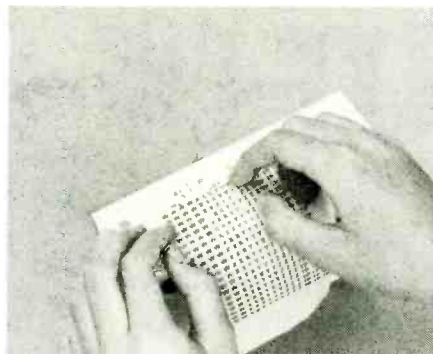

5. Locate the desired letter (or word, or design) on the carrier sheet, place it in position on the panel and press the sheet against the panel. The back of the sheet is tacky so it will not easily slip. Here we have already applied some of the letters.

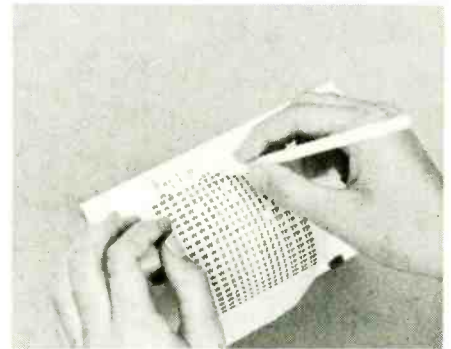

6. Transfer the letter to the panel by use of the burnishing tool. Rub over the letter several times, increasing the pressure each time until the transfer is complete. As you do this a slight change in the letter's appearance verifies transfer is working.

# LETTERING

## projects into works of art

Kirschman

tape, ruler, paper, etc.), you will need a blunt-pointed tool to burnish the letters into place. Tools for this purpose can be obtained where art supplies are sold, or you may be able to find something around the house that will serve the purpose. However, a pencil or ball-point pen tends to be too sharp, and may also obscure the lettering. The burnishing tool shown in the photos was made from 1/4-inch diameter plastic rod sanded round on one end and tapered and rounded to about 1/8-inch diameter on the other end. It could also have been made from a wood dowel.

The panel or other surface to which

you intend to apply the lettering should be clean and dry. Any oil, grease, dirt, or moisture will hinder adhesion of the lettering. Soap and water can be used for cleaning, except on bare aluminum. Rinse and dry the panel thoroughly; after wiping off excess water, use a heater or warm oven to dry. Solvents can also be used for cleaning; test first for compatibility with the finish. *Do not* use a heater or oven with solvents. To clean bare aluminum, solvents can be used, or chemical preparations for this purpose are available from paint and hardware stores. After cleaning do not touch the areas where you will apply the lettering.

If you use solvents or other chemicals be sure to follow the manufacturer's directions and particularly observe the appropriate safety precautions. Spend a little extra time and effort to be safe and minimize the possibility of injury.

After you have applied the lettering, you will probably want to protect it

(Continued on page 96)

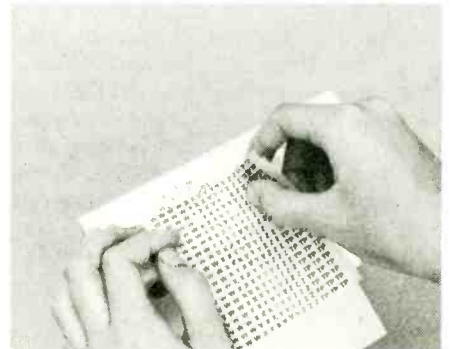

7. Peel the carrier sheet away from the panel, starting from one end and holding the other end in position against the panel. Check that the letter has completely transferred. If it has not, all you have to do is lay the sheet back down and burnish over.

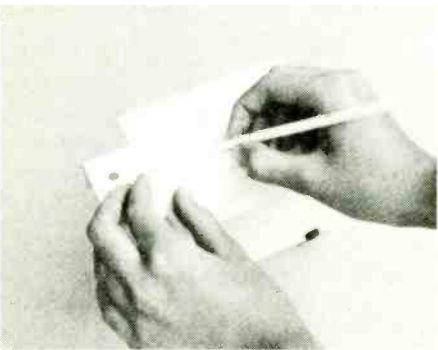

10. Once all lettering is applied, and you are satisfied with it, burnish one more time. Use a backing sheet of slick paper, so the lettering will not stick to the backing sheet, and go over the whole panel. Use the blunt end of the burnishing rod.

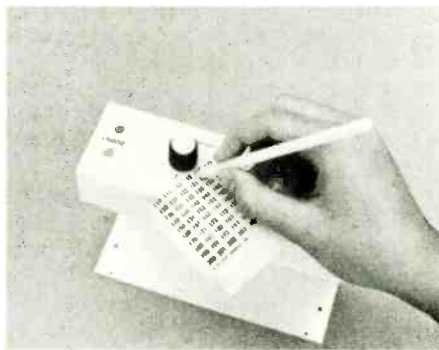

9. Positioning index marks is done by temporarily mounting both a switch and its knob. Turn the knob to each position and align the mark with the pointer. As you see here, the number "1" makes a good index mark, certain other letters may be used.

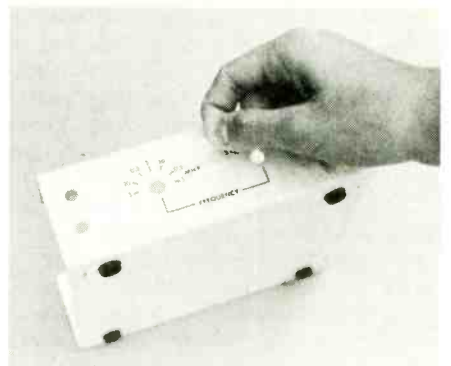

8. Make a mistake? It's no disaster. To remove an error, press ordinary cellophane or plastic tape over the offending letter and then simply lift it off. This may be repeated if needed, until all is clear. An eraser may also be used.

# DXing OUT-OF-BOUNDS

You'll hear a lot more stations when you listen outside the SW Bands

by Harry L. Helms Jr.

□ A LOT OF SWL/DXERS keep strictly in bounds when they're at the dials. No, that doesn't mean they do all their listening on a basketball court or football field. "In bounds" DXing is when one restricts all DXing to the standard, internationally allocated broadcasting bands. Now there's nothing wrong with DXing only shortwave broadcasting stations, but there is something missing. A glance at your logbook and QSL collection will tell you what's missing: places such as American Samoa, Bermuda, Greenland, and Hong Kong! And countries like Iceland, and the former French colony of Afars and Issas operate shortwave broadcast stations but they're really tough to hear in North America.

Simply put, if you want that logbook and QSL collection to grow, you've got to start DXing out of bounds—outside of the standard international shortwave bands!

**Point-to-Point.** It sometimes seems that the international shortwave broadcasting bands are civilization while the rest of the shortwave spectrum is an untamed jungle. But that's misleading. In fact, there is one class of "out of bounds" stations that are probably easier to DX and verify than many outlets in the shortwave broadcasting bands. These stations are the *point-to-point utility stations*.

Utility stations, as their name implies, are stations that do work of some sort instead of broadcasting. Point-to-point utilities relay messages of some sort from one fixed location to another fixed location. Many international-broadcasters, such as the Voice of America and Radio Nederland, use point-to-point stations to relay transmissions from their studios to their overseas relay bases. Perhaps the largest use at present for point-to-point utilities is to relay overseas telephone calls between countries that do not have satellite transmission facilities.

It just so happens that many of the



Point to point DX can take you to exotic Tahiti, bustling Hong Kong or to busy communications terminals such as St. Johns, Newfoundland, shown on the right.

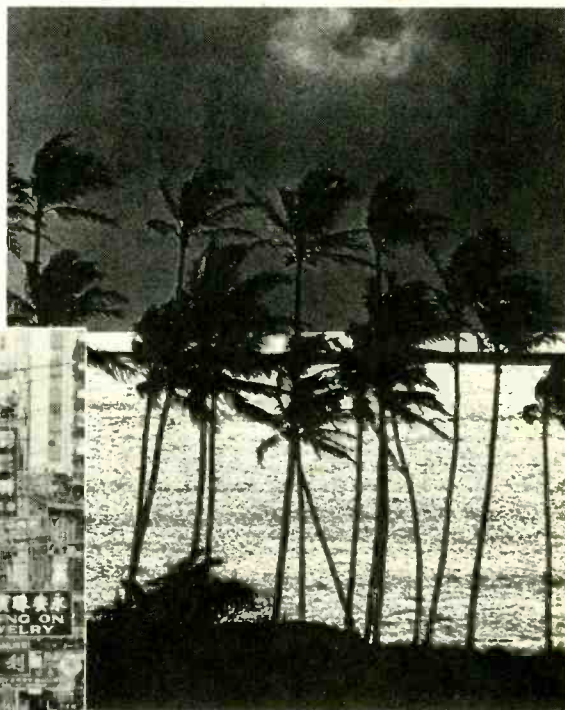

countries lacking adequate satellite communication facilities (and therefore use point-to-point utilities) also happen to be very rare or even impossible to DX on the international shortwave broadcasting bands. To hear them, you'll have to DX the point-to-point utilities—and that makes for DX-citement!

**Marker Magic.** It might seem difficult to identify any point-to-point stations you happen to hear if they are used mainly for handling such things as telephone calls. Fortunately, there's a handy aid for DXers that makes identifying and verifying the point-to-point stations a snap. It's called a *marker transmission*.

A marker transmission is a repeating tape recorded voice message that typically runs something like this: "This is

a test transmission for receiver adjustment purposes from the overseas radiotelephone terminal located at Warsaw, Poland." The vast majority of markers heard are in English, although it is common to hear another language, such as French or Spanish, used in addition to the English. In scattered cases you'll find music used as well, particularly in markers transmitted from the People's Republic of China.

Why do point-to-point utilities use markers? The primary purpose is to allow the sending and receiving stations to test and adjust their equipment prior to actual operation. Markers are used to fill empty air time between messages as well.

Markers make it super-easy to prove your reception of a point-to-point util-





You can DX Greenland (left) out-of-bounds on 11612 kHz or Shanghai China (below) on 13740 kHz. These point to point utility stations identify themselves in English. Don't repeat communications you hear.

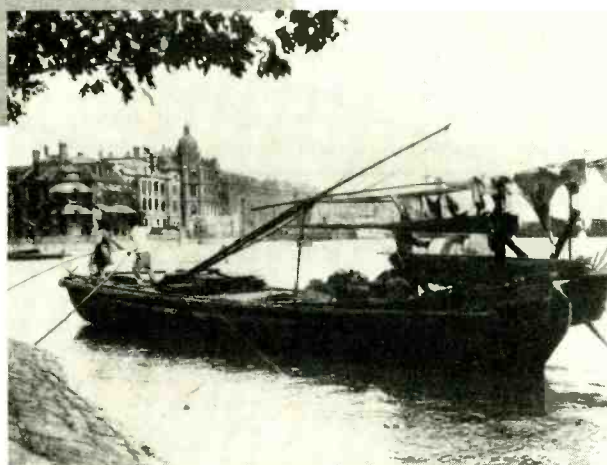

Point to point utilities connect the out-of-the-way places to major communications centers such as London (left) Paris, Rome, New York and Tokyo.

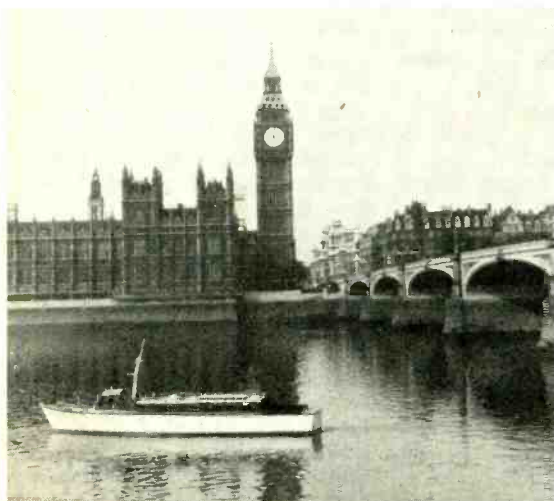

ity stations. All you have to do is to copy the text of the marker word for word! And since markers are repeated over and over for a period of several minutes, it's quite easy to get the entire text.

**Digging Them Out.** If you're accustomed to the orderly schedules of stations in the international shortwave broadcasting bands, you may be in for a shock when you start DXing the point-to-point utilities. Fixed schedules here are virtually unknown. But this is as much of an advantage as it is a disadvantage. While you can't tune in a certain frequency at a fixed time, the opportunity exists for point-to-point DX at virtually any hour of the day or night you choose to listen.

Our table of point-to-point frequency allocations will show you where to tune. Remember, however, that these are rough approximations. Listeners in the East will have more chance to hear Europe and Africa and listeners in the West will have more luck in hearing Asia and the Pacific.

The bulk of marker transmissions will be in single sideband (SSB), although some still use amplitude modulation (AM). To copy SSB you'll need a receiver equipped with a beat-frequency oscillator (BFO). You'll be able to recognize an SSB transmission by its distinctive "quacking duck" audio. Tune in the signal for maximum reading on your S-meter or loudest volume and then switch on your receiver's BFO. Adjust the BFO for the most intelligible audio. Many newer receivers have a fixed BFO indicated by such positions as USB (upper sideband) and LSB (lower sideband) on the receiver's mode selector. To tune in SSB markers on such a set, select which position offers the best copy. Often some slight retuning might be necessary. On older receivers it often helps to turn the volume control all the way up and use the receiver's RF (radio frequency) gain control as a volume control. On some receivers the RF gain control is labeled "sensitivity."

**Business Hours.** Since most point-to-

point marker transmissions are used in connection with overseas telephone services, it pays to DX during what are normal business hours in DX countries. For listeners in North America, this means that it's often productive to tune for European and African stations from the listener's local sunrise to early afternoon, with frequencies above 11 MHz offering best reception. There's another good period from approximately 0500 to 0700 GMT on the lower frequencies, as many European and African stations test and adjust their equipment prior to beginning their daily operations. For Asian and Pacific stations, a good time to tune is from late afternoon to approximately 0700 GMT on the higher frequencies. Activities after 0700 GMT usually shifts to the lower frequencies and continues until sunrise at the DX-ers' location, when it becomes time to DX the Europeans and Africans again.

We have included a list of some point-to-point utility stations. Include the date, frequency, and time in GMT. If you're not one of those lucky SWLs with direct-frequency readout receiver, estimate the frequency to the best of your ability. The only item you need to quote to prove your reception is the text of the marker itself. If some language other than English is used on the marker as well, indicate the language.

# e/e DXING OUT OF BOUNDS

It's not necessary to translate any other language you hear, as the text of the English marker is usually identical to the foreign language marker. Include information on any interference and fading you may encounter. But it's better to describe reception quality in plain English, avoiding various reporting codes like SINPO and SINFO. It's also wise to avoid SWL and ham lingo like "QTH," "73," etc. Don't ask for a QSL—request a card or letter verifying your reception. It helps to enclose return postage in the form of several International Reply Coupons (IRCs), available from your local post office.

You can often mail your reports to

the organization named in the marker transmission. For example, you may hear a marker transmission like this: "This is a test transmission for circuit adjustment purposes from a station of Cable and Wireless, Limited, located at St. Georges, Bermuda." You could then address your report to the station manager, or chief engineer for overseas telephone circuits, Cable and Wireless, Ltd., St. Georges, Bermuda.

But sometimes you'll run into markers that don't contain sufficient information to allow you to address your report properly. A big help here is the *SPEEDX Utility Guide*, which has addresses and QSL information for numerous utility stations.

If you get deeply involved in point-to-point DXing, you may want to join a SWL club that features coverage of such stations. The largest such cover-

age is given by *SPEEDX* (Society to Preserve Engrossing Enjoyment of DXing), P.O. Box E, Elsinore, California 92330. A sample copy of their monthly bulletin is \$1.00. You can also get information on the previously-mentioned *SPEEDX Utility Guide* from that address. Another source of informative books on point-to-point utilities is Gilfer Associates, Box 239, Park Ridge, N.J. 07656.

That's all—now enjoy! But if you should hear something besides a marker transmission over a point-to-point utility, don't include it in your reception report. In fact, don't repeat it to anybody. Under international law, all point-to-point transmissions, except for tests or emergency broadcasts, are supposed to be kept confidential. Fortunately for DXers, markers fall under the category of tests. ■

## POINT-TO-POINT UTILITIES RECENTLY HEARD

Here are some recent point-to-point receptions reported by members of *SPEEDX*. Catches are listed by frequency in kilohertz, followed by country, name of organization transmitting the marker, city where the point-to-point station is located, male or female speaker, languages used, and time of reception in GMT. All transmissions are in SSB unless otherwise indicated.

5307	Guinea. Post, Telegraph, and Telephone, Conakry. Female in English and French, 0800.
5311	Saudi Arabia. Saudi Arabian Post, Telephone, and Telegraph, Jeddah. Male in English and Arabic, 2125.
5388	Belize. Cable and Wireless, Ltd., Belize City. Male in English 0145.
5813	Central African Republic. France Cables et Radio, Bangui. Female in English and French, 0515.
6598	Cuba. All American Cables and Radio, Guantanamo Bay. Male in English, 0025.
6792	Martinique. French Telecommunications Service, Fort de France. Female in French and English, 0225.
6955	Cuba. All American Cables and Radio, Guantanamo Bay. Male in English, 0150.
7350	Mexico. Mexican Post, Telephone, and Telegraph, Mexico City. Female in Spanish, 0440.
7494	Mauritania. Office de Postes et Telecommunications, Nouakchott. Male in French and Arabic, 2330.
7560	Senegal. Telesenegal, Dakar. Female in French and English, 0020.
7665	Costa Rica. Radiografica Costarricense, San Jose. Female in English and Spanish, AM, 0020.
7688	Congo. France Cables et Radio, Brazzaville. Female in French, 0145.
7850	Ivory Coast. Telecommunications Internationale de la Cote d'Ivoire, Female in English and French, 2200.
8105	Bermuda. Cable and Wireless, St. Georges. Male in English, 0330.
8740	England. Post Office Telecommunications, London. Male in English, 1550.
8751	France. St. Lys Radio, St. Lys. Female in French 1745.
9052	Tahiti. French Telecommunications Ser-

	vice, Papeete. Female in English and French, 0900.	14890	France. French Telecommunications Service, Paris. Male in English and French, 1545.
9970	Gambia. Cable and Wireless, Bathurst. Male in English, 0000.	15455	Guyana. Cable and Wireless, Ltd., Georgetown. Male in English, AM, 2115.
10250	Argentina. Empresa Nacional de Telecomunicaciones, Buenos Aires. Female in Spanish, 0000.	15490	Argentina. Centro Internacional, Buenos Aires. Female in Spanish, 1200.
10300	Holland. Posts, Telephone, and Telegraph, Kootwijk. Male in English, 1845.	15575	Venezuela. Compania Anomia Nacional de Telefonos, Caracas. Female in English and Spanish, 1715.
10415	Paraguay. Administracion Nacional de Telecomunicaciones, Asuncion. Female in English and Spanish, 0100.	15675	American Samoa. Government of American Samoa, Pago Pago. Male in English, 1745.
10535	New Caledonia. French Telecommunications Service, Noumea. Female in English and French, 2300	16095	Reunion. French Telecommunications Service, St. Denis. Female in French and English, 1930.
10784	Cuba. International Radiotelephone Service, Havana. Female in Spanish, 1630.	17600	India. International Overseas Telephone Service, New Delhi. Male in English, 0850.
11612	Greenland. Gronlands Tekniske Organisation, Godthaab. Female in English and Danish, 1830.	18090	Upper Volta. France Cables et Radio, Ouagadougou. Female in French and English, 1300/
12025	Afars and Issas. French Telecommunications Service, Djibouti. Female in English and French, 1700.	18862	Hong Kong. Cable and Wireless, Ltd., Cape d'Aguilar. Female in English, 0930.
12175	Iceland. Post and Telegraph Communications Centre, Reykjavik. Male in English, 2230.	19587	Uruguay. Usinas y Telefonos del Estado, Montevideo. Female in English and Spanish, 1820.
13140	Iraq. Posts, Telephone and Telegraph, Bagdad. Female in English and Arabic, 1330.	19837	Ghana. External Telecommunications Service, Accra. Female in English and French, 1310.
13158	Italy. Roma Radio IAR, Rome. Male in Italian, 2000.	20535	India. International Overseas Telecommunication Service, peona. Female in English and Hindi, 1420.
13161	Italy. Genova Radio ICB, Genova. Male in Italian, 1920.	20805	Kuwait. Posts, Telephone, and Telegraph, Kuwait. Female in English and Arabic with Arabic music, 1045.
13505	Bermuda. Cable and Wireless, St. Georges. Male in English, 1605.	20992	Vietnam. Posts, Telephone, and Telegraph, Hanoi. Male in English, 0859.
13740	People's Republic of China. Shanghai International Communications Station, Shanghai. Chinese, English, and French by female speaker with instrumental version of national anthem, "The East is Red," 0955.		
14355	Hong Kong. Cable and Wireless, Ltd., Cape d'Aguilar. Female in English, 0500.		
14520	People's Republic of China. Peking International Communications Station, Peking. Female in English, Chinese, and French, 0950.		
14605	Brazil. Empresa Brasileira de Telecomunicacoes, Rio de Janeiro. Male in English, French, and Portuguese 0125.		

## WHERE TO TUNE FOR POINT-TO-POINT DX

5005-5454 kHz	13360-14000 kHz
5730-5950 kHz	14350-14990 kHz
6765-7000 kHz	15450-16460 kHz
7300-8195 kHz	17360-17700 kHz
9040-9500 kHz	18030-19990 kHz
9775-9995 kHz	20010-21000 kHz
10100-11175 kHz	21750-21850 kHz
11400-11700 kHz	22720-23200 kHz
11975-12330 kHz	



# e/e assembles the...



CIRCLE 62 ON READER SERVICE COUPON

## Keymemo KM-816 Telephone Dialer

Give yourself a photographic  
phone number memory

□ First it was computerized toys and games. Then, computerized auto electrical systems. Now it's a computerized telephone dialer called the Keymemo KM-816, which eliminates all the hassles of dirty heads, tape dropouts and worn gear trains common to telephone dialers which use loops of magnetic tape.

If you need an automatic telephone dialer, now you can get one and be certain it will work every time. True, you lose the excitement of wondering whether a call to your home five blocks away will wind up in some stranger's home on the other side of the country, but you gain the advantage of error-free connections.

The KM-816 features several other important convenience advantages in addition to error-free dialing, and we'll get to them all. First, let's start at the beginning.

The KM-816 computerized telephone dialer measures 6<sup>5</sup>/<sub>8</sub>-in. wide x 8<sup>1</sup>/<sub>8</sub>-in. deep x 2<sup>1</sup>/<sub>4</sub>-in. (nominal) high; it takes up approximately as much desk or table space as a standard telephone. It can store up to fifteen "permanent" telephone numbers in memory and has a temporary memory that permits instant automatic re-dialing when you get a busy signal. It can originate the dialing with a speaker monitoring the line so you know when to pick up your own telephone's handset (or you can originate the call by lifting the handset first). Most important, it permits instant reprogramming of any memory through a touch-tone type keyboard (same arrangement and alpha- numerics as found on standard touch-tone phones (-0 through 9 with \* and #).

The system is line powered through an AC adaptor that plugs into the rear

of the dialer. The adaptor also serves to simultaneously charge a built-in NiCad battery which can hold the memory programming for 24-hours in the event of either a powerline failure or an accidental (or intentional) disconnect from the powerline. Though the NiCad battery preserves the programming, it does not provide automatic dialer operation. If the powerline fails you must dial the phone just as you always did.

**Thanks For The Memory.** The memories can be programmed for any standard number of digits used in the U.S. for local or long distance dialing. You may also program it to automatically provide "dial 9" and the *access pause* required by PABX systems—that's where you dial 9, wait for an "outside dialtone" and then dial the number you want. In short, you can put all dialing information into the KM-816 so it will provide complete dialing at the touch of a button without need to lift the phone's handset even to provide the "dial 9" needed to get an outside line through a PABX system.

The dialer provides a 30-second time-out for ringing. If the telephone automatically dialed through the dialer does not answer within approximately 30-seconds the dialer automatically breaks the connection (disconnects). If you want an extended ring (more than 30- seconds) you simply press a button labeled "ET."

In some areas the phone system might not be able to accept the fast dial pulses from the dialer. If this occurs, the user presses a button marked "AP" to provide a pause for dialtone before the dialer outputs its pulses. The AP button also provides the pause needed

for "dial 9" PABX systems—it is programmed into the memory along with the telephone number.

**Connecting To The Line.** Only three connections are required—two to the telephone line and one to the telephone itself. Actually, one dialer connection is made to *red* along with the *red* lead from the phone; the remaining wires interrupt the normal *green* telephone wire. The KM-16 comes with a special *interrupt* 4-prong male/female adaptor jack that provides the interrupt wiring. You simply plug the KM-16's adaptor into your telephone's jack, and then plug the phone into the adaptor. That's all there is to the installation. If you don't already have a telephone jack installed on your telephone circuit, your local phone company will provide one at nominal cost—or you can substitute a Radio Shack add-on jack for the cover of the terminal block to which your telephone's cable is attached. If your phone uses the new miniature *modular* jack then similar adaptors, and converters, are needed. These are available at local electronic parts and telephone accessory stores.

**Testing 1...2...3.** With modern telephone equipment the most difficult part of the whole operation is insuring an easy and secure, and most important, accurate programming. You don't want your first attempt to be a wrong number 3000 miles away. You know what it's like to get credit when the phone company goofs on a long distance call; imagine what it's like if it's your goof. Fortunately, the KM-816 is almost goof-proof.

Three LED status lights tell you what's going on. The CALL lamp indicates the dialer is pulsing out, but not necessarily to the line. A small safety

## e/e KEYMEMO KM-816 DIALER

switch on the rear allows the owner to disconnect the dialer from the line so unauthorized users cannot dial out—the dialer goes through the motions, even to the extent of flashing the CALL lamp, but no phone is actually dialed.

A DATA lamp indicates if a memory is programmed. It always goes on when dialing if a number is actually in the memory. Similarly, the DATA lamp goes on as you program the memory. When the DATA lamp is out it shows the memory has been erased and is ready to be programmed. A PROG (program) lamp indicates the memory is ready for programming.

In order to prevent accidental erasure of a program, two separate keys must be depressed to erase a memory. Similarly, two keys must be depressed to program a memory. In this manner, accidental erasures and programming caused by someone fooling with the keyboard are made difficult, if not almost impossible. Also, buttons must be keyed in a certain sequence for programming, almost entirely eliminating the possibility of someone programming a number "as a gag, or joke." (Also, the "secret" switch in the back allows busy hands and jokesters to fool with the device while preventing them from actually dialing out.)

Overall, the Keymemo KM-816 proved easy to program, accurate, and secure. In the presence of transient

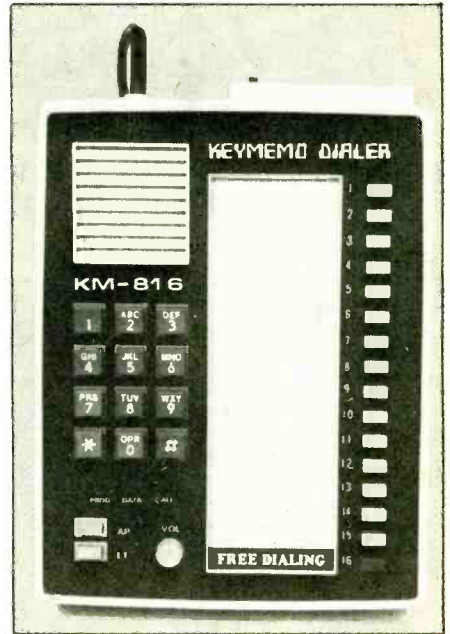

There are 16 memories; 15 are permanent and are provided with a name slot and paper tab. The 16th is labeled Free Dialing and is a temporary memory. It allows a number to be redialed when busy simply by touching this key. A speaker monitors the line so you can hear when the party on the other end answers. You can also use the dialer with the phone off the hook. The speaker is simply a hands-off monitor for calls. The Keymemo KM-816 takes up just about as much space as a normal telephone. Circle No. 62 on the reader service coupon for more information.

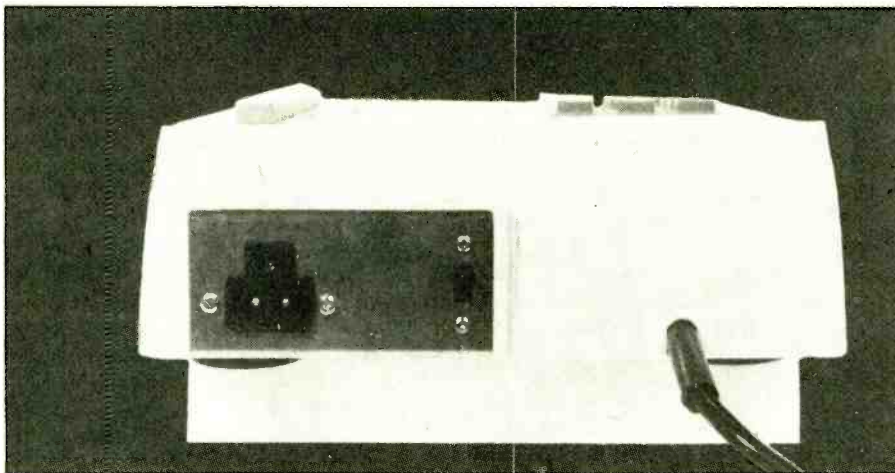

The AC adaptor plugs into a socket on the rear of the dialer. The small miniature switch to the right of the power socket disconnects the dialer from the line while still allowing the dialer to go through all the motions, just as if it's actually dialing a number. This foils would-be pranksters.

powerline pulses, and radio frequency fields (from a nearby transmitter), the KM-816 held its programming, it neither lost all nor part of its programming, or dialed false numbers.

Overall, an excellent dialer.

**Kit?** The model we received was a semi-kit priced at \$129.95. All the difficult assembly was done at the factory, and the kit really consisted of mounting two PC boards, plugging together the interconnecting wires, and installing the monitor speaker and output cables. There are no user adjustments. The whole bit should take less than one hour.

The KM-816 is also available completely assembled for \$220.95. Check with your local telephone equipment store.

The KM-816 complies with Part 68 of the FCC rules and regulations No. AH 297E-62837-DI-R. It has a ringer equivalence of 0.0 B; meaning it takes no ringer power (because it's a dialer, and there is no ringer).

For more information write to Chung Long Electronics Corp., Box 18732, Seattle, WA 98118, or circle No. 62 on the reader's service coupon.

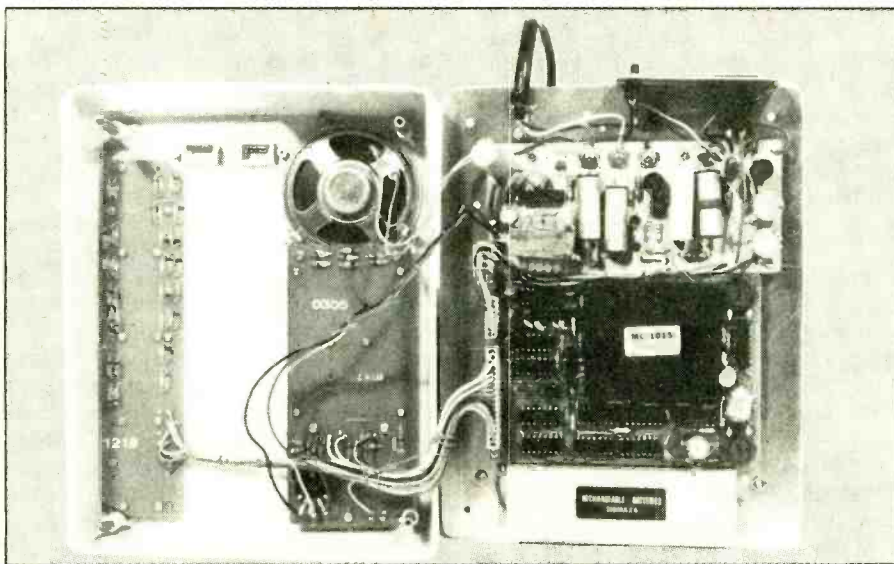

Removing the cover (left) displays the guts of the Keymemo Dialer. On the lower right is the NiCad battery which will keep the memory alive even if the power is off for 24 hours. The battery charges automatically. The computer and memories are above the battery. The speaker and switching matrices are mounted on the inside of the cover.



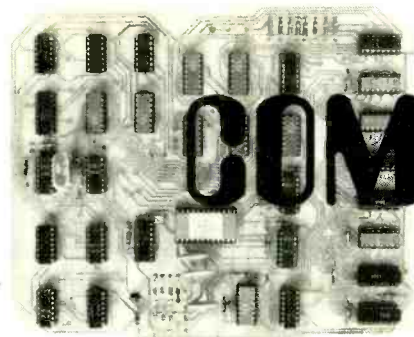

# COMPUTER READOUT

by Norman Myers, Computers Editor

## Choose this tricky computer for challenging chess

□ What you are going to read here could not have been written only five years ago. It would not have been possible. We are going to talk about one of the most challenging applications that a computer—especially a microcomputer—can have. We will talk about computers playing chess. Some feel this is a breakpoint of computer development. After jumping through a little history, we will see what is happening with large computers as they attempt to beat chess masters. Then we will explore a chess-playing computer you can buy (and a checkers computer, in case you prefer that) and we will go into the fascinating micro-computer programming that makes it work. And work it does—it beats good chess players and can be used as an excellent trainer to improve your chess. Only five years ago the thought of such a microcomputer game was but a dream.

**Artificial Intelligence.** Chess on computers dates back almost twenty years. Most universities had someone interested in writing a good program. If a computer could play chess, it was felt, the same programming techniques would allow computers to make fairly rapid and proper decisions in many other areas. The thought that super-human brain power could be programmed for decision making—like what stock to buy and when, or what warehouse items to order, when, and in what volumes—was the driving force. It was a correct line to follow because, while a perfect super-brain program is not yet here, those working in the field of artificial intelligence feel we are presently closer than ever and that progress is being made every month. They claim that someday a person will be able to sit at a console, ask any question and get intelligent answers so realistic that the person will not be able to tell if a human or a computer is giving the answers. This is the ultimate test of artificial intelligence.

An historic test of computer "intelligence" is happening even as you read this article. "Chess 5"—probably the most powerful computer chess-program

in the world is being developed at Northwestern University in Evanston, Illinois. That program will pit wits against one of the best chess players in the world, David Levy of Great Britain. Northwestern University has had the edge in computer chess programs for several years. The last version, called Chess 4.6, has been used in several tournaments against good chess amateurs and has always been victorious. In 1976 it beat over 100 good players in a west coast tournament and in 1977 it entered a tough Minnesota Tournament and emerged not only a total victor but also a winner of the coveted title of chess master. But, there is more. The popular story in chess circles goes that, in the International Computer Chess Tournament held last year in Toronto, the Chess 4.6 program emerged victorious by defeating the Russian computer program four games out of four.

How does a strong chess master fare against the 4.6 program? Well, David Levy beats the 4.6 most of the time. But the brains behind 4.6, a chess-loving computer science whiz at Northwestern, is developing the Chess 5 program that may be able to beat David Levy. It is an historic time. If the computer is able to show the subtle strategy, the adaptability to changes in the opponent's strategy, and the ability to look five and six moves ahead, then a new era in com-

puter development will have been achieved. Further, if the Chess 5 beats David Levy, reports say he will lose a friendly but expensive wager made some years ago with chess-playing colleagues that a computer could not beat him.

The Chess 5 program is run on a large and powerful computer made by Control Data Corporation. There are gobs of memory and lots of processor power in registers, arithmetic units, instruction sets, counters, and complex control units that allow simultaneous events to be performed. This computer with its tape drives, control console, memory units, and processor will not fit in a standard living room. It can perform tens of thousands of operations each second and has enough memory to handle dozens upon dozens of special program routines that can give it that extra quality of making subtle chess moves.

**Chess in a Micro.** Now how does a chess-playing microcomputer stack up against something as powerful as Chess 5? Or, look at it this way; how does a computer that takes up less space than a breadboard measure up to one that cannot fit in the kitchen? Well, I don't know the answer, but I do know this: Fidelity Electronics at 5245 W. Diversity Avenue, Chicago, Ill. 60639 makes a breadboard-sized chess-playing computer that whips the pants off me,

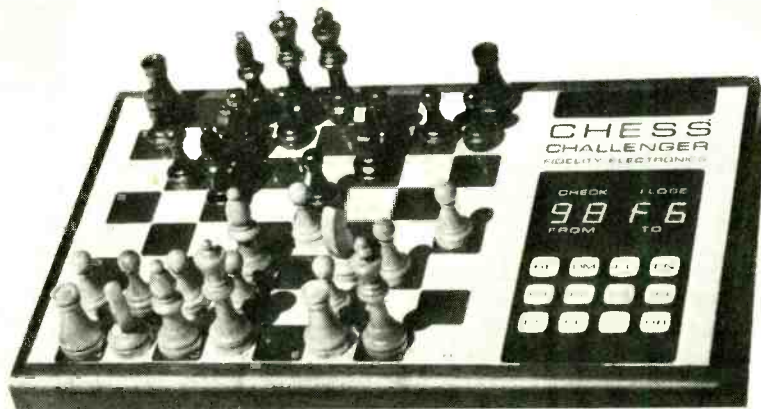

The Chess Challenger from Fidelity Electronics is a chess-playing whiz ready for a game whenever you are. Beginner or pro, it suits its style to you. Circle number 50 for info.



## COMPUTER READOUT

and I was considered to be a good chess player in my college days. Fidelity actually makes two units, one is the Basic Chess Challenger and the other is the Advanced Chess Challenger, which has three levels of play that you can select from. The basic unit sells for around \$150 and the advanced for around \$200. We will get into the differences between the two shortly, but when I say the Challenger beats me, I mean the advanced unit on level three (the top level), and sometimes on level two. And by the way, I have loaned the unit to five good players with the result that four find it hard to beat and one—a chess master who once played Olympic chess—found it beatable because he is able to look ahead more moves than the computer is programmed to do. I understand there is a chess microcomputer made by Applied Concepts in Texas that has different levels of play but I was not able to try it out.

**Hardware First.** Before getting into the software concepts behind this Fidelity masterpiece, let us look at the hardware in the basic and advanced units. First, both units come in a walnut case with a plastic top that has a chess board with numbered rows across and lettered columns. Each square therefore has its own letter/number identifying combination. The keyboard allows you to enter your move by specifying the "from" and "to" positions via a letter and a number. The keys are the soft-touch kind so you just touch the plastic to activate a key. An LED readout shows your entry and shows the computer's choices for moves. The unit is not portable since it requires a house electrical outlet. The basic and advanced Challengers use the popular Intel 8080 microprocessor and 512 bytes (8 bits per byte) of random access memory on four integrated circuits. The random access memory is used by the processor as a kind of scratch pad for trying and evaluating different moves. The program itself is permanently stored in a 2048 byte read only memory for the basic unit, and 4096 byte memory for the advanced unit. This ROM is on a single chip that has been specially masked with the Fidelity chess program. The rest of the Challenger hardware includes a 555 timer integrated circuit for debouncing the keys, power supply circuitry including a voltage regulator, and segment driver integrated circuits for the LEDs.

**Software Smartware.** In most of our past articles on microcomputer applications we discussed hardware and architecture layout with some mention of the program basics. This time we will get into the program basics in much more detail because that is where the heart of this intelligent chess playing box rests. We will not get into actual program code—that would be nothing but a mess of details. We will get into the basic concepts of how the computer plays chess. You do not have to know chess to understand the principles dis-

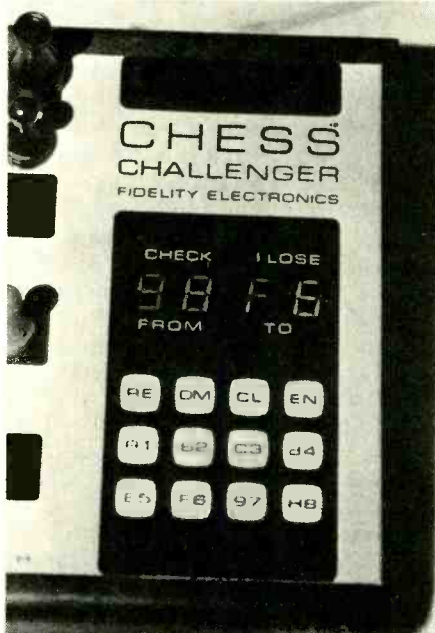

Data on moves is input/output via a keyboard. The computer communicates with human players using the algebraic style of chess notation—a system easily learned.

cussed here. These basics have been used in other computer chess programs but remember that we are dealing here with limited computer memory and a comparatively simple processor—so the programmer has to be especially careful and clever. The Fidelity program was written by Ron Nelson who is now developing other computer games for Fidelity.

In terms of program design, the basic unit can be viewed as the same as the advanced unit operating on level one except that the advanced unit on level one is able to do some extra things, like controlling the center squares of the board. Because of this similarity, we will discuss only the advanced unit here.

We will assume that you are playing white (you move first) and that the computer is playing black, although you can actually choose which color you want. Further, if you want the computer to take white, you can tell it what opening move you want it to make in

order to practice one of your own strategies. So, you have white and you make a move. In order to make this a general discussion, let's assume the game has been going on for some time so this is not just your opening move. You enter the move via the keyboard. The Challenger immediately flips its memory around where it has the location of each piece and pretends it is white. It then attempts to make the same move you have made and checks it against its rules. If it cannot do the move, it knows your entry was illegal and it tells you so via the display. If it can make the move, it knows you made a legal move and flips the memory back to black in order to play its own pieces.

Now comes the fun. The processor goes to the memory location representing the lower corner square on the board. If a black piece is there, it will attempt to move that piece. If the piece is a knight, the knight-moving routine is called in by the processor, etc. If it can be moved, the processor forms a temporary picture in its memory of this new location and the location of all the other pieces on the board. Now the processor flips its memory to play white. The object is to find the move that is best for white given the move that black just temporarily made. This is done by going through all of white's pieces, moving each one in the computer memory and evaluating each new board in memory. Let's be more specific.

Suppose the computer temporarily moved its black knight, then found that white could have two moves, a white pawn or a white bishop. That gives two temporary board layouts that have to be evaluated. The evaluation is done via a control matrix that assigns values to positions of pieces on the board. A value is obtained for each board layout. The 16 bit capacity of the Intel 8080 system is used to assign numbers over a range from zero to 32,000 so very fine resolution is obtained and the chance of a tie between two board layouts is unlikely. The evaluation is done via a control matrix that assigns values to positions of pieces on the board. A value is obtained for each board layout. The 16 bit capacity of the Intel 8080 system is used to assign numbers over a range from zero to 32,000 so very fine resolution is obtained and the chance of a tie between two board layouts is unlikely. The value for one board is compared to the value for the previous board and the board layout with the higher value is saved in memory. In our example, this might be the black knight, white pawn layout.

Having tested and evaluated all the

(Continued on page 88)



# AM STEREO IS IN YOUR FUTURE!

Which of the three competing systems will the FCC finally decide upon?

by Harry L. Helms Jr.

**T**HE AUDIO AND BROADCASTING industries are currently on the brink of a revolution. Within a few months, the Federal Communications Commission (FCC) will almost certainly give the go-ahead for AM broadcast stations to begin operations in full *stereo*, placing them on better competitive footing with FM broadcasters and opening a new spectrum of possibilities for both audiophiles and DXers. The technology for AM stereo already exists—in fact, test broadcasts have already been conducted in the United States!

The concept of AM stereo is not a new idea. In 1958 the FCC was petitioned to allow AM stereo broadcasting, but refused to do so in an order released on October 2, 1961. The FCC

cited technical problems for its refusal to allow AM stereo. Undaunted, several firms continued work on AM stereo systems, and one system was actually used for regular broadcasts by station XETRA, 690 kHz, in Tijuana, Mexico, during 1970! The technical difficulties that caused the 1961 rejection of AM stereo were gradually resolved, leading the FCC to formally propose the establishment of AM stereo on July 6, 1977, in docket 21313. Insiders in the broadcasting industry agree that AM stereo is inevitable—only the decision as to which method will be used to transmit and receive AM stereo is left for the FCC to decide.

**Why AM Stereo?** It's difficult to believe that FM broadcasting was once an

economic disaster area when one observes the huge market for FM receivers and tuners that exists today. But in the 1950's FM was at an extreme competitive disadvantage to AM. Stereo broadcasts for FM were authorized in April, 1961 and one of the reasons given by the FCC for FM stereo was that it could help FM broadcasters compete more effectively with their AM brethren. But, in subsequent years, the entire audio industry has shifted to stereo, and even quadraphonic sound, while AM radio has remained a monophonic medium. Many in the broadcasting industry now feel that FM is a more economically successful medium than AM due to the stereo advantage. It is widely felt that only the introduction of AM stereo can restore competitive balance between the two.

The widespread support for AM stereo is demonstrated by the composition of The National AM Stereophonic Radio Committee, one of the prime movers behind the drive for AM stereo. Included in the Committee's membership are the Institute of Electrical and Electronics Engineers, the Electronics Industries Association, the National Association of Broadcasters, and the National Radio Broadcasters Association. The Committee arranged for on-the-air tests of three stereo AM systems during August, 1977 and submitted the results to the FCC in reply to Docket 21313. Individual broadcasters are also anxious to begin AM stereo service.

"When the FCC approves a system, WBT is planning to broadcast in AM stereo on a full-time basis," says Rich-

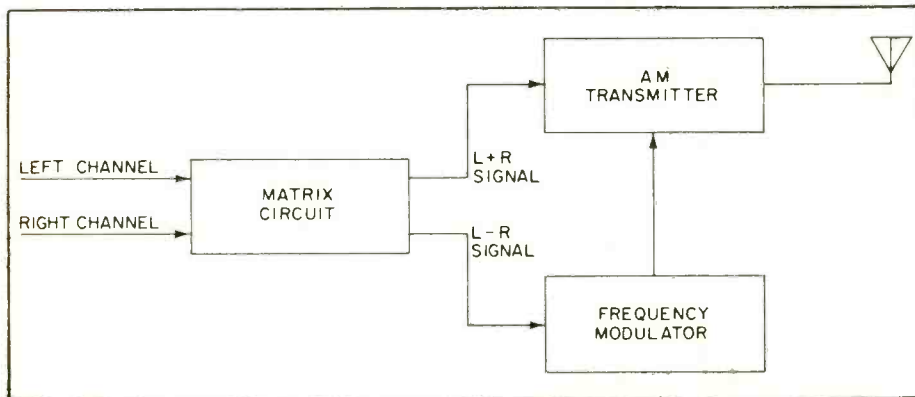

The Belar System begins like the Magnavox in that matrix circuitry produces sum and difference signals from the two channel inputs. The sum signal is conventionally amplitude modulated while the difference frequency is applied to a frequency modulator. Both the outputs from the AM modulator and Frequency modulator are fed, in combination, to an AM transmitter. The combined AM/FM signal is then transmitted as an AM signal, in the usual way. Separate AM and FM detectors and matrix circuit must be used in Belar receiver.

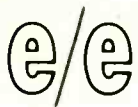

## FUTURE OF AM STEREO

ard Mertz, technical operations manager for station WBT in Charlotte, North Carolina. WBT was one of the stations that conducted AM stereo tests in August, 1977.

**How AM Stereo Works.** There are four basic systems for AM stereo competing for the FCC's approval. All four, like FM stereo, make use of two separate channels commonly referred to as the left and right channels. Beyond that, however, the four systems differ significantly from each other. The various methods are not compatible with the others; only one will be selected by the FCC for use.

The oldest system for AM stereo is known as the *Kahn system*, developed by Kahn Communications, Inc. Kahn was one of those who petitioned the FCC for AM stereo back in 1958. Although the petition was denied, Kahn continued work on their system, eventually leading to full-time use of it over station XETRA in Mexico, as mentioned earlier. While located in and licensed to operate in Mexico, XETRA puts a potent signal into the San Diego, California area and programs almost entirely in English for the San Diego market. Mexican broadcasting regulations are somewhat more flexible than those in the United States, and in 1970 permission was granted for XETRA to use the Kahn system for its regular broadcasts.

A regular AM signal consists of a carrier frequency and two identical sidebands on either side of the carrier frequency. Thus, for XETRA's 690 kHz frequency, its carrier was on 690 with two 3 kHz wide sidebands on 687-690 kHz and from 690-693 kHz. In simplified form, the Kahn system put one stereo channel on the lower frequency sideband and the other stereo channel on the upper frequency sideband. This system made it possible to receive AM stereo broadcasts by using two ordinary AM receivers. One receiver was tuned to XETRA's upper sideband while a second receiver was tuned to the lower sideband. All other stereo AM systems require receivers designed specifically for stereo reception. Proponents of the Kahn system have stressed this availability of AM stereo using conventional equipment in their proposals to the FCC.

The XETRA experiment was eventually discontinued. The FCC allowed Kahn to conduct tests of its system over station WFBR, Baltimore, Maryland

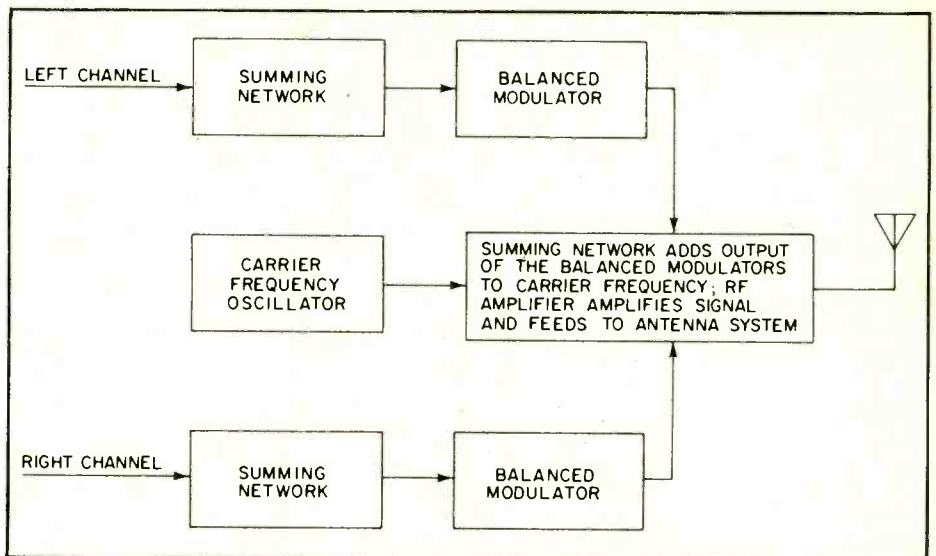

Stereo's two channels, using the Magnavox system, are first converted by matrix circuitry into two new signals; one the sum of the left and right channel frequencies and the other being the difference between those frequencies. The difference (L-R) frequency is AM modulated while the sum frequency (L+R) is phase modulated. A nice touch is a tone generator which adds a subaudible, 5 Hz tone to the phase modulation. A receiver may be designed with a stereo indicator lamp which will light up whenever the tone is received.

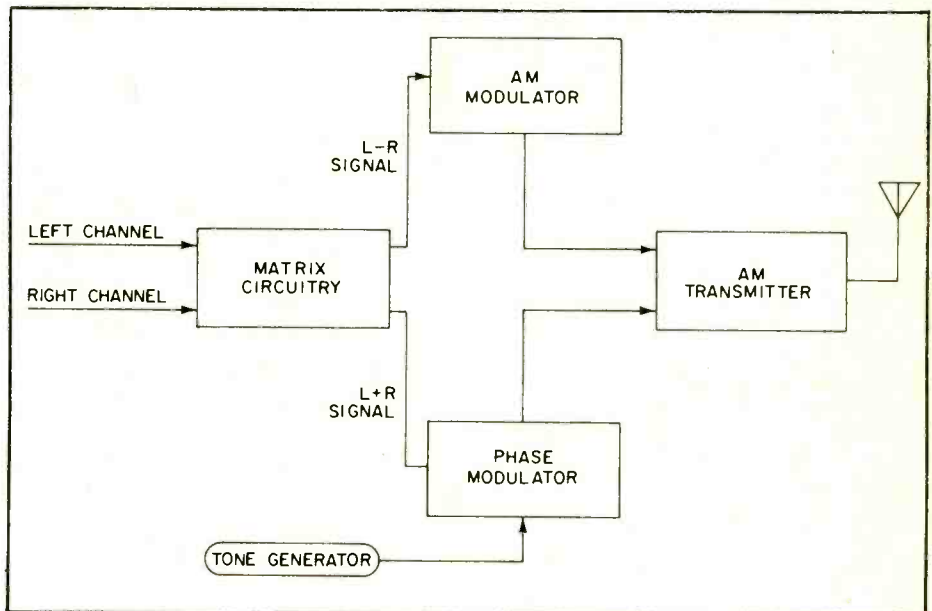

The Motorola idea is to use dual summing networks and balanced modulators in order to separately modulate two carriers at the same frequency but at different phases. The carrier frequency oscillator is used to set the transmitter frequency. Output from the balanced modulators is combined with that of the carrier frequency oscillator's in a summing network and is then fed to a RF power amplifier. A system on the Motorola principle must use phase detection and balanced modulators, but avoids the use of matrices.

during 1975. Yet despite Kahn's head start, most observers feel that it is highly unlikely that the Kahn system will be adopted by the FCC. More recent systems offer the potential for better fidelity and stereo quality than the Kahn system. Perhaps significantly, the National AM Stereophonic Radio Committee omitted the Kahn system from the series of AM stereo tests it conducted in 1977.

The AM stereo system that the FCC eventually selects will almost certainly be either the Magnavox, Motorola, or Belar System. The Magnavox and Belar systems use a combination of amplitude and phase/frequency modulation while the Motorola system uses phase differences between two signals to transmit both stereo channels on the same carrier wave. Stereo signals transmitted by all three methods can be received in mono



on monophonic receivers without modification, while stereo reception will require receivers designed for stereo AM.

The *Magnavox system* uses a matrix circuit to convert the two channels into two new signals, one the sum of the frequencies of the left and right channels with the other the difference in frequency between left and right. The difference (L-R) frequency is AM modulated in the conventional manner while the sum (L+R) frequency is fed to a *phase modulator*. The phase modulator varies the phase, or time interval, between changes in the amplitude of the carrier current wave. The output of the phase modulator is fed to the AM transmitter and transmitted with the output of the AM modulator. An added feature of the Magnavox system is a tone generator which feeds a sub-audible 5 Hz tone into the phase modulator. When received on a receiver designed for the Magnavox system, it lights a stereo indicator lamp similar to those found on FM stereo tuners. This is the only system with such a stereo identification provision and it is a strong point in favor of it. A receiver for the Magnavox system uses both AM and phase modulated detectors to recover the stereo transmissions.

The *Belar system* was originally developed by RCA, although RCA is no longer actively involved in the development of AM stereo systems. Like the

Magnavox system, the Belar method uses a matrix circuit to produce sum and difference signals from the two channel inputs. The sum signal is amplitude modulated in a conventional manner while the difference frequency is applied to a frequency modulator. The output of the frequency modulator is fed to a conventional AM transmitter along with the output of the amplitude modulator. The combined AM/FM signal is then transmitted as an AM signal in the usual manner. A Belar system receiver uses separate AM and FM detectors and a matrix circuit to reproduce the two channels.

The stereo AM system developed by *Motorola* uses summing networks and balanced modulators to separately modulate two carriers at the same frequency but in different phases. The transmitter frequency is determined by a carrier frequency oscillator. The output of the balanced modulators is combined with the carrier frequency oscillator output in a summing network circuit and then fed into a RF power amplifier. A Motorola system receiver uses phase detection and balanced modulators to recover the two stereo channels. An advantage of this system is that it avoids the use of matrix circuits.

**The Tests.** The National AM Stereophonic Radio Committee has established a receiving site and laboratory in

Bethesda, Maryland for the purpose of evaluating tests of the three AM stereo systems. The first tests were conducted over WGMS, 570 kHz, in Bethesda, Md., from August 7 to 10, 1977. The tests were conducted from midnight to 5:00 a.m., local time. The next series ran from August 11 through 15 over WTOP, 1500 kHz, in Washington, D.C. The potentially most significant tests were conducted over WBT, 1110 kHz, in Charlotte, N.C., on August 21. The tests were run from midnight to 5:00 a.m. WBT is a 50-kilowatt clear-channel outlet whose nighttime coverage is from Cuba to the Canadian Maritimes and provided an ideal test for the effects of skywave propagation on AM stereo signals. It is widely believed that the system that performs best as far as skywave propagation is concerned will be the one accepted by the FCC.

In January of 1978, the National AM Stereophonic Radio Committee submitted the results of its August, 1977 tests to the Federal Communications Commission. The Motorola system performed best in the transmission of skywave signals as well as in very noisy environments. The Belar system was found to be the simplest overall, as well as providing the best compatibility with existing monophonic AM receivers. The report did not recommend any of the competing systems, however.

Some manufacturers are already getting into the AM stereo act. National Semiconductor Corporation has begun work on developing integrated circuit chips for demodulating AM stereo signals. Sources in the electronics industry estimate that AM stereo could generate wholesale business of \$250 million per year after its introduction, with about 80% of it in car radio equipment.

If you'd like to delve deeper into the highs and lows of AM stereo you could send for the *AM Stereo Report* from the Electronic Industries Association. The 500-plus page, spiral-bound book is available for \$20.00 from: *AM Stereo Report*, Electronic Industries Association, 2001 Eye St., N.W., Washington, D.C. 20006.

**Effects of AM Stereo.** The introduction of AM stereo will have several effects on broadcasters, equipment manufacturers, and DXers. Broadcasters will likely have to upgrade their studio to transmitter link equipment, as most such links are today handled by telephone lines having virtually no response over 5 kHz. Considering that most AM tuners today cannot reproduce frequencies above 5 kHz, such a limitation poses no problem for monophonic transmission. Yet AM stereo

(Continued on page 90)

**AM STEREO**

The National AM Stereophonic Radio Committee

December 1977

Whose system will the FCC decide upon for AM stereo? Will it be Belar, Motorola, Magnavox—or some other system entirely? It's a close race. The best info to date is contained in the report, "AM Stereo" from the Electronics Industries Association. See the text on how to order.

e/e checks out the...

# EV Game 500

Want to cure those CB rip-off blues?  
Just put one of these disappearing  
CB/AM/FM antennas on the family car

CIRCLE 75 ON READER SERVICE COUPON



The EV Game 500 CB/FM/AM disappearing antenna retracts completely out of sight into its retractor well.

□ One of the most popular and successful defenses against a ripoff of your mobile CB is a disappearing antenna. Without an antenna or its mount to announce the presence of a CB transceiver somewhere in your vehicle it's odds-on no one will know you have one. Unfortunately, many of the so-called disappearing CB antennas which telescope through a motor drive into the trunk or fender well leave some part of the antenna or loading coil sticking out to announce that it is something more than a standard disappearing AM/FM antenna (they telescope completely out of sight). Fact is, those itty-bitty stubs are often a magnet for vandals who try to see if they can pull the antenna to its full height.

But there is one disappearing CB antenna that truly vanishes from sight when not in use—the EV-Game Model 500 Fully Automatic Antenna. Fully collapsed, no part of the antenna itself or its CB loading coil is exposed to busy little hands. The whole thing really looks like an ordinary disappearing AM/FM antenna that's been collapsed into the trunk or fender.

The Model 500 antenna is driven by a vertically oriented motor at the base that permits the antenna to be installed on or in the cowl or fender well of many cars, in addition to the more common trunk installation. Fully extended it's a 40-inch center loaded CB/AM/FM antenna. That's right, a three-way threat. Through the use of a supplied coupler the CB antenna also serves an AM or AM/FM radio without interaction between the radio and the CB.

At the very tip of the antenna is a  
*(Continued on page 89)*

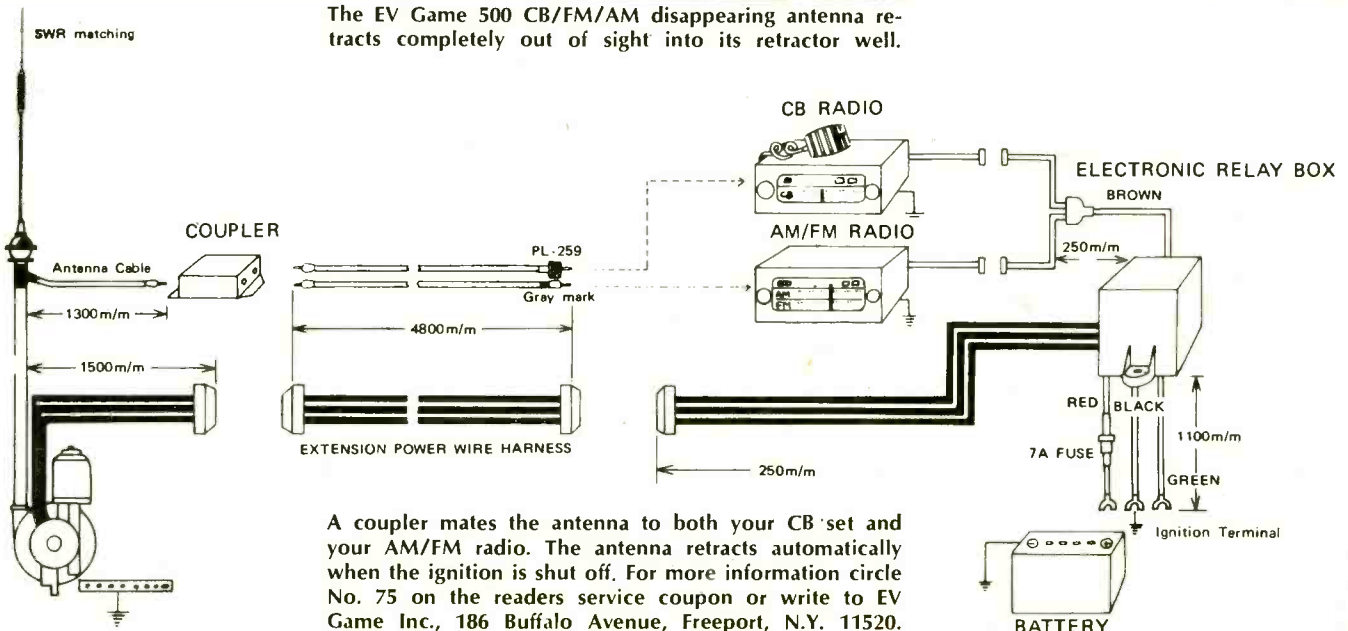

A coupler mates the antenna to both your CB set and your AM/FM radio. The antenna retracts automatically when the ignition is shut off. For more information circle No. 75 on the readers service coupon or write to EV Game Inc., 186 Buffalo Avenue, Freeport, N.Y. 11520.



# E/E

BASIC COURSE

# MICROPROCESSORS THEIR NUMBER SYSTEMS AND CODES

Microprocessors are changing your world, and if you want to keep pace you'll have to know how they work and how to use them. This two part series will have you understanding the basics of using number systems and codes—the essentials of microprocessor programming—and give you the foundation for experimenting on your own. Get ready for the great new microprocessor era with **ELEMENTARY ELECTRONICS**.

Condensed and modified for magazine publication, by permission, from pp. 1-1 to 1-61, in the Heath Microprocessor Course, Heath Catalog number EE-3401. Copyright 1977, all rights reserved. Microprocessor Course is available from Heath Company, Benton Harbor, MI 49022.

**W**HAT YOU WILL LEARN. In this second installment of the Heathkit home-study course on microprocessors you will be introduced to a number of new, useful concepts. You'll be brought one step closer to a full understanding of microprocessors.

You will first learn all about hexadecimal numbers. You will be able to evaluate their decimal equivalents and then convert back from decimal to hexadecimal.

Then, you'll learn to convert back and forth between the binary and hexadecimal systems. You'll comprehend why hexadecimal numbers are so important to understand if you intend to work with binary-based circuitry.

Finally, you'll learn a bit about binary codes. Here you will find the secret of the binary coded decimal and how to convert between that code and the decimal system. You'll discover the Gray code and then you'll meet the modern-day ASCII code, in a few varieties, along with its ancestor the BAUDOT code.

## HEXADECIMAL NUMBER SYSTEM

Hexadecimal is another number system that is often used with microprocessors. It is similar in value structure to the octal number system, and thus allows easy conversion with the binary number system. Because of this feature and the fact that hexadecimal simplifies data entry and display to a greater degree than octal, you will use hexadecimal more often than any other number system in this course. As the name implies, hexadecimal has a base (radix) of  $16_{10}$ . It uses digits 0 through 9 and the letters A through F.

The letters are used because it is necessary to represent  $16_{10}$  different values with a single digit for each value. Therefore, the letters A through F are used to represent the number values  $10_{10}$  through  $15_{10}$ . The following discussion will compare the decimal number system with the hexadecimal number system.

All of the numbers are of equal value between systems ( $0_{10} = 0_{16}$ ,  $3_{10} = 3_{16}$ ,  $9_{10} = 9_{16}$ , etc.). For numbers greater than 9, this relationship exists:  $10_{10} = A_{16}$ ,  $11_{10} = B_{16}$ ,  $12_{10} = C_{16}$ ,  $13_{10} = D_{16}$ ,  $14_{10} = E_{16}$ , and  $15_{10} = F_{16}$ . Using letters in counting may appear awkward until you become familiar with the system. Figure 1 illustrates the relationship between decimal and hexadecimal integers, while Figure 2 illustrates the relationship between decimal and hexadecimal fractions.

DECIMAL	HEXADECIMAL	BINARY
0	0	0
1	1	1
2	2	10
3	3	11
4	4	100
5	5	101
6	6	110
7	7	111
8	8	1000
9	9	1001
10	A	1010
11	B	1011
12	C	1100
13	D	1101
14	E	1110
15	F	1111
16	10	10000
17	11	10001
18	12	10010
19	13	10011
20	14	10100
21	15	10101
22	16	10110
23	17	10111
24	18	11000
25	19	11001
26	1A	11010
27	1B	11011
28	1C	11100
29	1D	11101
30	1E	11110
31	1F	11111
32	20	100000
33	21	100001
34	22	100010
35	23	100011

Figure 1

As with the previous number systems, each digit position of a hexadecimal number carries a positional weight





"overflow" exceeds 9, convert the 2-digit number to its hexadecimal equivalent. Then multiply the product fraction by  $16_{10}$  and again note any overflow. Continue multiplying until an overflow, with 0 for a fraction, results. Remember, you can not always obtain 0 when you multiply by 16. Therefore, you should only continue the conversion to the accuracy or precision you desire. Collect the conversion overflows beginning at the radix point with the MSD and proceed to the LSD. The number  $0.C8_{16} = 0.78125_{10}$ .

Now the decimal fraction 0.136 will be converted into its hexadecimal equivalent with five-place precision.

$0.136 \times 16 = 2.176 = 0.176$	overflow	$2 = 2 \rightarrow$ MSD
$0.176 \times 16 = 2.816 = 0.816$		$2 = 2$
$0.816 \times 16 = 13.056 = 0.056$		$13 = D$
$0.056 \times 16 = 0.896 = 0.896$		$0 = 0$
$0.896 \times 16 = 14.336 = 0.336$		$14 = E \rightarrow$ LSD

The number  $0.22D0E_{16}$  approximately equals  $0.136_{10}$ . If you convert  $0.22D0E_{16}$  back to decimal (using positional notation), you will find  $0.22D0E_{16} = 0.1359996795654296875_{10}$ . This example shows that extending the precision of your conversion is of little value unless extreme accuracy is required.

As shown in this section, conversion of an integer from decimal to hexadecimal requires a different technique than for conversion of a fraction. Therefore, when you convert a hexadecimal number composed of an integer and a fraction, you must separate the integer and fraction, then perform the appropriate operation on each. After you convert them, you must recombine the integer and fraction. For example, the decimal number 124.78125 is converted into its hexadecimal equivalent.

$124.78125_{10} = 124_{10} + 0.78125_{10}$   
 $124 \div 16 = 7$  with remainder  $12 = C \leftarrow$  LSD  
 $7 \div 16 = 0$   $7 = 7 \leftarrow$  MSD

$124_{10} = 7C_{16}$

$0.78125 \times 16 = 12.5 = 0.5$  overflow  $12 = C \leftarrow$  MSD  
 $0.50000 \times 16 = 8.0 = 0$  overflow  $8 = 8 \leftarrow$  LSD

$0.78125_{10} = 0.C8_{16}$

$124.78125_{10} = 124_{10} + 0.78125_{10} =$   
 $7C_{16} + 0.C8_{16} = 7C.C8_{16}$

First separate the decimal integer and fraction. Then convert the integer and fraction to hexadecimal.

Finally, recombine the integer and fraction.

## Converting Between the Hexadecimal and Binary Number Systems

Previously, the octal number system was described as an excellent shorthand form to express large binary quantities. This method is very useful with many microprocessors. The trainer used with this course uses the hexadecimal number system to represent binary quantities. As a result, frequent conversions from binary-to-hexadecimal are necessary. Figures 1 and 2 illustrate the relationship between hexadecimal and binary integers and fractions.

As you know, four bits of a binary number exactly equal  $16_{10}$  value combinations. Therefore, you can represent a 4-bit binary number with a 1-digit hexadecimal number:

$$1101_2 = (1 \times 2^3) + (1 \times 2^2) + (0 \times 2^1) + (1 \times 2^0) = 8 + 4 + 0 + 1 = 13_{10} = D_{16}$$

Because of this relationship, converting binary to hexadecimal is simple and straightforward. For example, binary number 10110110 is converted into its hexadecimal equivalent.

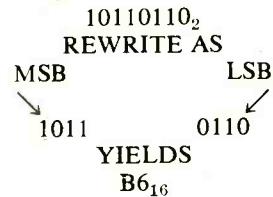

To convert a binary number to hexadecimal, first separate the number into groups containing four bits, beginning with the least significant bit. Then convert each 4-bit group into its hexadecimal equivalent. Don't forget to use letter digits as required. This gives you a hexadecimal number equal in value to the binary number.

Now convert a larger binary number (10101101101) into its hexadecimal equivalent.

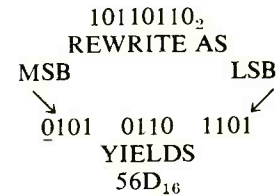

Again, the binary number is separated into 4-bit groups beginning with the LSB. However, the third group contains only three bits. Since each group must contain four bits, a zero must be added after the MSB. The third group will then have four bits with no change in the value of the binary number. Now each 4-bit group can be converted into its hexadecimal equivalent. **Whenever you add zeros to a binary integer, always place them to the left of the most significant bit.**

Binary fractions can also be converted to their hexadecimal equivalents using the same process, with one exception; the binary bits are separated into groups of four, beginning with the most significant bit (at the radix point). For example, the binary fraction 0.01011011 is converted into its hexadecimal equivalent.

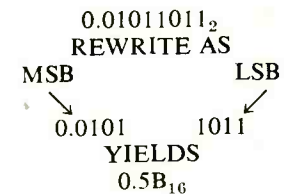

Again, you must separate the binary number into groups of four, beginning with the radix point. Then convert each 4-bit group into its hexadecimal equivalent. This gives you a hexadecimal number equal in value to the binary number.

Now convert a larger binary fraction (0.1101001101) into its hexadecimal equivalent.

0.1101001101<sub>2</sub>  
 REWRITE AS





DECIMAL	8421 BCD	GRAY	BINARY
0	0000	0000	0000
1	0001	0001	0001
2	0010	0011	0010
3	0011	0010	0011
4	0100	0110	0100
5	0101	0111	0101
6	0110	0101	0110
7	0111	0100	0111
8	1000	1100	1000
9	1001	1101	1001
10	0001 0000	1111	1010
11	0001 0001	1110	1011
12	0001 0010	1010	1100
13	0001 0011	1011	1101
14	0001 0100	1001	1110
15	0001 0101	1000	1111

**Figure 4**

code combinations are easy to remember. Once you begin to work with binary numbers regularly, the BCD numbers may come to you as quickly and automatically as decimal numbers. For that reason, by simply glancing at the BCD representation of a decimal number you can make the conversion almost as quickly as if it were already in decimal form. As an example, convert a BCD number into its decimal equivalent.

$$0110\ 0010\ 1000.1001\ 0101\ 0100 = 628.954_{10}$$

The BCD code simplifies the man-machine interface but it is less efficient than the pure binary code. It takes more bits to represent a given decimal number in BCD than it does with pure binary notation. For example, the decimal number 83 in pure binary form is 1010011. In BCD code the decimal number 83 is written as 1000 0011. In the pure binary code, it takes only seven bits to represent the number 83. In BCD form, it takes eight bits. It is inefficient because, for each bit in a data word, there is usually some digital circuitry associated with it. The extra circuitry associated with the BCD code costs more, increases equipment complexity, and consumes more power. Arithmetic operations with BCD numbers are also more time consuming and complex than those with pure binary numbers. With four bits of binary information, you can represent a total of  $2^4 = 16$  different states or the decimal number equivalents 0 through 15. In the BCD system, six of these states (10-15), are wasted. When the BCD number system is used, some efficiency is traded for the improved communications between the digital equipment and the human operator.

Decimal-to-BCD conversion is simple and straightforward. However, binary-to-BCD conversion is not direct. An intermediate conversion to decimal must be performed first. For example, the binary number 1011.01 is converted into its BCD equivalent.

First the binary number is converted to decimal.

$$1011.01_2 = (1 \times 2^3) + (0 \times 2^2) + (1 \times 2^1) + (1 \times 2^0) + (0 \times 2^{-1}) + (1 \times 2^{-2})$$

$$= 8 + 0 + 2 + 1 + 0 + 0.25 \\ = 11.25_{10}$$

Then the decimal result is converted to BCD.

$$11.25_{10} = 0001\ 0001.0010\ 0101$$

To convert from BCD to binary, the previous operation is reversed. For example, the BCD number 1001 0110.0110 0010 0101 is converted into its binary equivalent.

First, the BCD number is converted to decimal.  $1001\ 0110.0110\ 0010\ 0101 = 96.625_{10}$ . Then the decimal result is converted to binary.  $96.625_{10} = 96_{10} + 0.625_{10}$

$96 \div 2 = 48$ with remainder 0	← LSB
$48 \div 2 = 24$	0
$24 \div 2 = 12$	0
$12 \div 2 = 6$	0
$6 \div 2 = 3$	0
$3 \div 2 = 1$	1
$1 \div 2 = 0$	1 ← MSB

$$96_{10} = 1100000_2$$

$0.625 \times 2 = 1.25 = 0.25$ with overflow	1 ← MSB
$0.250 \times 2 = 0.50 = 0.50$	0
$0.500 \times 2 = 1.00 = 0$	1 ← LSB

$$0.625_{10} = 0.101_2$$

$$96.625_{10} = 96_{10} + 0.625_{10} = 1100000_2 + 0.101_2 = 1100000.101_2$$

Therefore:

$$1001\ 0110.0110\ 0010\ 0101 = 96.625_{10} = 1100000.101_2$$

Because the intermediate decimal number contains both an integer and fraction, each number portion is converted as described under "Binary Number System." The binary sum (integer plus fraction) 1100000.101 is equivalent to the BCD number 1001 0110.0110 0010 0101.

## Special Binary Codes

Besides the standard pure binary coded form, the BCD numbering system is by far the most widely-used digital code. You will find one or the other in most of the applications that you encounter. However, there are several other codes that are used for special applications, such as the "Gray Code."

The Gray Code is a widely-used, non-weighted code system. Also known as the cyclic, unit distance or reflective code, the Gray code can exist in either the pure binary or BCD formats. The Gray code is shown in Figure 4. As with the pure binary code, the first ten codes are used in BCD operations. Notice that there is a change in only one bit from one code number to the next in sequence. You can get a better idea about the Gray code sequence by comparing it to the standard 4-bit 8421 BCD code and the pure binary code also shown in Figure 4. For example, consider the change from 7 (0111) to 8 (1000) in the pure binary code. When this change takes place, all bits change. Bits that were 1's are changed to 0's and 0's are changed to 1's. Now notice the code change from 7 to 8 in the Gray code. Here 7 (0100) changes to 8 (1100). Only the first bit changes.

The Gray code is generally known as an error minimizing code because it greatly reduces confusion in the electronic circuitry when changing from one state to the



next. When binary codes are implemented with electronic circuitry, it takes a finite period<sup>1</sup> of time for bits to change from 0 to 1 or 1 to 0. These state changes can create timing and speed problems. This is particularly true in the standard 8421 codes where many bits change from one combination to the next. When the Gray code is used, however, the timing and speed errors are greatly minimized because only one bit changes at a time. This permits code circuitry to operate at higher speeds with fewer errors.

The biggest disadvantage of the Gray code is that it is difficult to use in arithmetic computations. Where numbers must be added, subtracted or used in other computations, the Gray code is not applicable. In order to perform arithmetic operations, the Gray code number must generally be converted into pure binary form.

### Alphanumeric Codes

Several binary codes are called alphanumeric codes because they are used to represent characters as well as numbers. The two most common codes that will be discussed are ASCII and BAUDOT.

**ASCII Code.** The American Standard Code for Information Interchange commonly referred to as ASCII, is a special form of binary code that is widely used in microprocessors and data communications equipment. A new name for this code that is becoming more popular is the American National Standard Code for Information Interchange (ANSII). However, this course will use the most recognized term, ASCII. ASCII is a 6-bit binary code that is used in transferring data between microprocessors and their peripheral devices, and in communicating data by radio and

telephone. With six bits, a total of  $2^6 = 64$  different characters can be represented. These characters comprise decimal numbers 0 through 9, upper-case letters of the alphabet, plus other special characters used for punctuation and data control. A 7-bit code called full ASCII, extended ASCII, or USASCII can be represented by  $2^7 = 128$  different characters. In addition to the characters and numbers generated by 6-bit ASCII, 7-bit ASCII contains lower-case letters of the alphabet, and additional characters for punctuation and control. The 7-bit ASCII code is shown in Figure 5.

	COLUMN	0 <sup>(3)</sup>	1 <sup>(3)</sup>	2 <sup>(3)</sup>	3	4	5	6	7 <sup>(3)</sup>	
ROW	BITS									
	4321									
		765	000	001	010	001	100	101	110	111
0	0000	NUL	DLE	SP	0	@	P	/	p	
1	0001	SOH	DC1	!	1	A	Q	a	q	
2	0010	STX	DC2	"	2	B	R	b	r	
3	0011	ETX	DC3	#	3	C	S	c	s	
4	0100	EOT	DC4	\$	4	D	T	d	t	
5	0101	ENQ	NAK	%	5	E	U	e	u	
6	0110	ACK	SYN	&	6	F	V	f	v	
7	0111	BEL	ETB	'	7	G	W	g	w	
8	1000	BS	CAN	(	8	H	X	h	x	
9	1001	HT	EM	)	9	I	Y	i	y	
10	1010	LF	SUB	*	:	J	Z	j	z	
11	1011	VT	ESC	+	;	K	[	k		
12	1100	FF	FS	,	<	L	/	l		
13	1101	CR	GS	-	=	M	\	m		
14	1110	SO	RS	.	>	N	^ <sup>(1)</sup>	n	-	
15	1111	SI	US	/	?	O	~ <sup>(2)</sup>	o	DEL	

Figure 5

#### NOTES:

- (1) Depending on the machine using this code, the symbol may be a circumflex, an up-arrow, or a horizontal parenthetical mark.
- (2) Depending on the machine using this code, the symbol may be an underline, a back-arrow, or a heart.
- (3) Explanation of special control functions in columns 0, 1, 2, and 7.

NUL	Null	DLE	Data Link Escape
SOH	Start of Heading	DC1	Device Control 1
STX	Start of Text	DC2	Device Control 2
ETX	End of Text	DC3	Device Control 3
EOT	End of Transmission	DC4	Device Control 4
ENQ	Enquiry	NAK	Negative Acknowledge
ACK	Acknowledge	SYN	Synchronous Idle
BEL	Bell (audible signal)	ETB	End of Transmission Block
BS	Backspace	CAN	Cancel
HT	Horizontal Tabulation (punched card skip)	EM	End of Medium
LF	Line Feed	SUB	Substitute
VT	Vertical Tabulation	ESC	Escape
FF	Form Feed	FS	File Separator
CR	Carriage Return	GS	Group Separator
SO	Shift Out	RS	Record Separator
SI	Shift In	US	Unit Separator
SP	Space (blank)	DEL	Delete

The 7-bit ASCII code for each number, letter or control function is made up of a 4-bit group and a 3-bit group. Figure 6 shows the arrangement of these two groups and the numbering sequence. The 4-bit group is on the right and bit 1 is the LSB. Note how these groups are arranged in rows and columns in Figure 5.

To determine the ASCII code for a given number letter or control operation, locate that item in the table. Then use the 3- and 4-bit codes associated with the row and column in which the item is located. For example, the ASCII code for the letter L is 1001100. It is located in column 4, row 12. The most significant 3-bit group is 100, while the least significant 4-bit group is 1100. When 6-bit ASCII is used, the 3-bit group is reduced to a 2-bit group as shown in Figure 7.

In 7-bit ASCII code, an eighth bit is often used as a parity or check bit to determine if the data (character) has been transmitted correctly. The value of this bit is determined by the type of parity desired. **Even parity** means

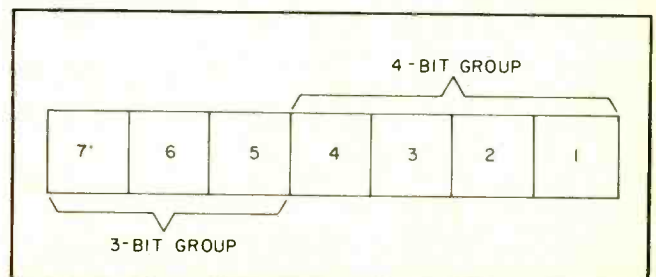



Bit Numbers	Letters Case	Figures Case
5 4 3 2 1		
0 0 0 0 0	Blank	Blank
0 0 0 0 1	E	3
0 0 0 1 0	Line Feed	Line Feed
0 0 0 1 1	A	—
0 0 1 0 0	Space	Space
0 0 1 0 1	S	Bell
0 0 1 1 0	I	8
0 0 1 1 1	U	7
0 1 0 0 0	Car. Ret.	Car. Ret.
0 1 0 0 1	D	\$
0 1 0 1 0	R	4
0 1 0 1 1	J	(Apos)'
0 1 1 0 0	N	(Comma),
0 1 1 0 1	F	!
0 1 1 1 0	C	:
0 1 1 1 1	K	(
1 0 0 0 0	T	5
1 0 0 0 1	Z	"
1 0 0 1 0	L	)
1 0 0 1 1	W	2
1 0 1 0 0	H	Stop
1 0 1 0 1	Y	6
1 0 1 1 0	P	0
1 0 1 1 1	Q	1
1 1 0 0 0	O	9
1 1 0 0 1	B	?
1 1 0 1 0	G	&
1 1 0 1 1	Figures	Figures
1 1 1 0 0	M	.
1 1 1 0 1	X	/
1 1 1 1 0	V	;
1 1 1 1 1	Letters	Letters

**Figure 8**

resent two separate characters. As shown in Figure 1-15, one set of 5-bit codes represents the 26 upper-case alphabet letters. The same 5-bit codes also represent various figures and the decimal number series 0 through 9.

The remaining six 5-bit codes are used for machine control and do not have a secondary function. Two of these 5-bit codes determine which of the 26 double (letter/figure) characters can be transmitted/received. Bit number 11111 forces the printer to recognize all following 5-bit codes as **letters**. Bit number 11011 forces **figure** recognition of all the following 5-bit codes. For example, to type 56 NORTH 10 STREET, the following method is used.

**BAUDOT Code.** While the ASCII code is used almost exclusively with microprocessor peripheral devices (CRT display, keyboard terminal, paper punch/reader, etc.), there are many older printer peripherals that use the 5-bit BAUDOT code. With five data bits, this code can represent only  $2^5 = 32$  different characters. To obtain a greater character capability, 26 of the 5-bit codes are used to represent the sum of all the 1 bits, including the parity bit, is an even number. For example, if G is the character transmitted, the ASCII code is 1000111. Since four 1's are in the code, the parity bit is 0. The 8-bit code would be written 01000111.

**Odd Parity.** This means the sum of all the 1 bits, in-

**NOTES:**

- (1) Depending on the machine using this code, the symbol may be a circumflex, an up-arrow, or a horizontal parenthetical mark.
- (2) Depending on the machine using this code, the symbol may be an underline, a back-arrow, or a heart.
- (3) SP—Space (blank) for machine control.

		COLUMN	0	1	2	3	
ROW	BITS	4321	65	10	11	00	01
0	0000			SP <sup>(3)</sup>	0	@	P
1	0001			!	1	A	Q
2	0010			"	2	B	R
3	0011			#	3	C	S
4	0100			S	4	D	T
5	0101			%	5	E	U
6	0110			&	6	F	V
7	0111			'	7	G	W
8	1000			(	8	H	X
9	1001			)	9	I	Y
10	1010			*	:	J	Z
11	1011			+	;	K	
12	1100			,	<	L	/
13	1101			-	=	M	
14	1110			.	>	N	∪ <sup>(1)</sup>
15	1111			/	?	O	— <sup>(2)</sup>

**Figure 7**

cluding the parity bit, is an odd number. If the ASCII code for G was transmitted with odd parity, the binary representation would be 11000111.

Type—Figures 5 6 Space

Then—Letters N O R T H Space

Then—Figures 1 0 Space

Finally—Letters S T R E E T

**POSITIVE POWERS OF 16**

n	16 <sup>n</sup>				
0	1				
1	16				
2	256				
3	409	6			
4	655	36			
5	104	857	6		
6	167	772	16		
7	268	435	456		
8	429	496	729	6	

**NEGATIVE POWERS OF 16**

n	16 <sup>-n</sup>					
0	1.0					
1	0.062	5				
2	0.003	906	25			
3	0.000	244	140	625		
4	0.000	015	258	789	062	5

### POSITIVE POWERS OF 2

n	2 <sup>n</sup>
0	1
1	2
2	4
3	8
4	16
5	32
6	64
7	128
8	256
9	512
10	1024
11	2048
12	4096
13	8192
14	16384
15	32768
16	65536
17	131072
18	262144
19	524288
20	1048576
21	2097152
22	4194304
23	8388608
24	16777216
25	33554432
26	67108864
27	134217728
28	268435456
29	536870912
30	1073741824
31	2147483648
32	4294967296

### NEGATIVE POWERS OF 2

n	2 <sup>-n</sup>
0	1.0
1	0.5
2	0.25
3	0.125
4	0.0625
5	0.03125
6	0.015625
7	0.0078125
8	0.00390625
9	0.001953125
10	0.0009765625
11	0.00048828125
12	0.000244140625
13	0.0001220703125
14	0.00006103515625
15	0.000030517578125
16	0.0000152587890625
17	0.00000762939453125
18	0.000003814697265625
19	0.0000019073486328125
20	0.00000095367431640625
21	0.000000476837158203125
22	0.0000002384185791015625
23	0.00000011920928955078125
24	0.000000059604644775390625
25	0.0000000298023223876953125
26	0.00000001490116119384765625
27	0.000000007450580596923828125
28	0.0000000037252902984619140625
29	0.00000000186264514923095703125
30	0.000000000931322574615478515625
31	0.0000000004656612873077392578125
32	0.00000000023283064365386962890625

### WHAT YOU HAVE LEARNED

1. The *hexadecimal* numbering system has a *radix* (base) of 16. It uses the digits 0 through 9 and the letters A through F.
2. Hexadecimal *numbers* 0 through 9 are equivalent to the same values in decimal digits. The *letters* A through F represent the decimal digits 10 through 15. Therefore: decimal 9 = hexadecimal 9, but decimal 10 = hexadecimal A.
3. Conversion from *decimal to hexadecimal* is done the same way as decimal to binary or octal. The decimal number is divided by decimal 16, and the remainder noted. The quotient is divided by 16 again, and again the remainder is noted. Division by decimal 16 continues until the quotient is 0. The remainders, from least to most significant digit, are finally collected and written as the hexadecimal number.
4. Conversion from decimal *fractions to hexadecimal* is done in the same manner as decimal fractions to octal or binary. In this case, the fraction is successively multiplied by 16, and the overflow noted.
5. Four *bits* of a binary number exactly equal 16. So, a  
(Continued on page 92)

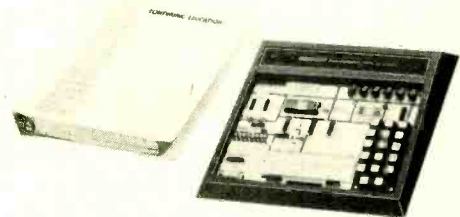

### FORGE FORWARD WITH MICROPROCESSORS

The Heath Microprocessor Course may be purchased with the Heath Digital Microprocessor Trainer kit, Heath Catalog number ET-3400. The Microprocessor Trainer is specifically designed to be used with the Course, and provides an ideal platform upon which you may expand your knowledge of microprocessor programming and interfacing techniques. With the training you receive from the Course, and the flexibility of the miniature Computer, you will be able to begin on a level of technological experimentation you never before dreamed possible! Circle number 31 on Readers Service Coupon.



# VOX

VOICE ACTIVATED CONTROL SWITCH. Self contained, solid state. Has excellent adjustable sensitivity. Recorder activated by voices or other sounds. Uses recorder mike or remote mike. Single AA bat. incl. Great for home, business etc.

2 3/4 x 1 3/4 x 3/8"

## AMAZING ELECTRONIC MICRO MINI MIKE:

World's smallest, solid state, self contained with 1.3V Merc. Bat. turn. Picks up most sounds and transmits without wires up to 300 ft. thru FM Radio. Tuneable. Use as mike, ampl., alarm & alert system, baby sitter, hot line, etc. VOX only \$24.95. Mike only \$18.95. (\*plus \$1.00 ea. pstg. & hand.) B/A, M/C, cod. ok. Cal. res. add tax. Free data. Mail Order. Qty. disc. avail. AMC SALES, Dept. 2, 9335 Lubec St., Box 928, Downey, CA 90241

2 1/4 x 3/4 x 1/2"

# ELEMENTARY ELECTRONICS HOBBY MART

**Computerists,  
Hobbyists,  
Electronic  
Musicians,  
and Mad  
Scientists...**

**SEND FOR OUR FLYER!**

# GODBOUT

BILL GODBOUT ELECTRONICS  
 BOX 2355, OAKLAND AIRPORT, CA 94614

## DIGI-KEY CORPORATION

Quality Electronic Components

# TOLL FREE 1-800-346-5144

MINNESOTA RESIDENTS 218-681-6674

**DON'T FORGET OUR DISCOUNTS WHEN COMPARING PRICES**

I.C.'S • RESISTORS • TRANSISTORS • CAPACITORS • DIODES • I.C. SOCKETS & PINS • SWITCHES  
 CLOCK MODULES • OPTOELECTRONICS • BREADBOARDING & TESTING DEVICES • DRAFTING SUPPLIES  
 DATA BOOKS • HEAT SINKS • WIRE • TOOLS... AND MORE... WRITE FOR FREE CATALOG

### INTEGRATED CIRCUITS

MANUFACTURER	PART NUMBER	PRICE	MANUFACTURER	PART NUMBER	PRICE
7410	7410	1.00	7410	7410	1.00
7411	7411	1.00	7411	7411	1.00
7412	7412	1.00	7412	7412	1.00
7413	7413	1.00	7413	7413	1.00
7414	7414	1.00	7414	7414	1.00
7415	7415	1.00	7415	7415	1.00
7416	7416	1.00	7416	7416	1.00
7417	7417	1.00	7417	7417	1.00
7418	7418	1.00	7418	7418	1.00
7419	7419	1.00	7419	7419	1.00
7420	7420	1.00	7420	7420	1.00
7421	7421	1.00	7421	7421	1.00
7422	7422	1.00	7422	7422	1.00
7423	7423	1.00	7423	7423	1.00
7424	7424	1.00	7424	7424	1.00
7425	7425	1.00	7425	7425	1.00
7426	7426	1.00	7426	7426	1.00
7427	7427	1.00	7427	7427	1.00
7428	7428	1.00	7428	7428	1.00
7429	7429	1.00	7429	7429	1.00
7430	7430	1.00	7430	7430	1.00
7431	7431	1.00	7431	7431	1.00
7432	7432	1.00	7432	7432	1.00
7433	7433	1.00	7433	7433	1.00
7434	7434	1.00	7434	7434	1.00
7435	7435	1.00	7435	7435	1.00
7436	7436	1.00	7436	7436	1.00
7437	7437	1.00	7437	7437	1.00
7438	7438	1.00	7438	7438	1.00
7439	7439	1.00	7439	7439	1.00
7440	7440	1.00	7440	7440	1.00
7441	7441	1.00	7441	7441	1.00
7442	7442	1.00	7442	7442	1.00
7443	7443	1.00	7443	7443	1.00
7444	7444	1.00	7444	7444	1.00
7445	7445	1.00	7445	7445	1.00
7446	7446	1.00	7446	7446	1.00
7447	7447	1.00	7447	7447	1.00
7448	7448	1.00	7448	7448	1.00
7449	7449	1.00	7449	7449	1.00
7450	7450	1.00	7450	7450	1.00
7451	7451	1.00	7451	7451	1.00
7452	7452	1.00	7452	7452	1.00
7453	7453	1.00	7453	7453	1.00
7454	7454	1.00	7454	7454	1.00
7455	7455	1.00	7455	7455	1.00
7456	7456	1.00	7456	7456	1.00
7457	7457	1.00	7457	7457	1.00
7458	7458	1.00	7458	7458	1.00
7459	7459	1.00	7459	7459	1.00
7460	7460	1.00	7460	7460	1.00
7461	7461	1.00	7461	7461	1.00
7462	7462	1.00	7462	7462	1.00
7463	7463	1.00	7463	7463	1.00
7464	7464	1.00	7464	7464	1.00
7465	7465	1.00	7465	7465	1.00
7466	7466	1.00	7466	7466	1.00
7467	7467	1.00	7467	7467	1.00
7468	7468	1.00	7468	7468	1.00
7469	7469	1.00	7469	7469	1.00
7470	7470	1.00	7470	7470	1.00
7471	7471	1.00	7471	7471	1.00
7472	7472	1.00	7472	7472	1.00
7473	7473	1.00	7473	7473	1.00
7474	7474	1.00	7474	7474	1.00
7475	7475	1.00	7475	7475	1.00
7476	7476	1.00	7476	7476	1.00
7477	7477	1.00	7477	7477	1.00
7478	7478	1.00	7478	7478	1.00
7479	7479	1.00	7479	7479	1.00
7480	7480	1.00	7480	7480	1.00
7481	7481	1.00	7481	7481	1.00
7482	7482	1.00	7482	7482	1.00
7483	7483	1.00	7483	7483	1.00
7484	7484	1.00	7484	7484	1.00
7485	7485	1.00	7485	7485	1.00
7486	7486	1.00	7486	7486	1.00
7487	7487	1.00	7487	7487	1.00
7488	7488	1.00	7488	7488	1.00
7489	7489	1.00	7489	7489	1.00
7490	7490	1.00	7490	7490	1.00
7491	7491	1.00	7491	7491	1.00
7492	7492	1.00	7492	7492	1.00
7493	7493	1.00	7493	7493	1.00
7494	7494	1.00	7494	7494	1.00
7495	7495	1.00	7495	7495	1.00
7496	7496	1.00	7496	7496	1.00
7497	7497	1.00	7497	7497	1.00
7498	7498	1.00	7498	7498	1.00
7499	7499	1.00	7499	7499	1.00
7500	7500	1.00	7500	7500	1.00

### NEW! The "NIBBLER"

A MICROCOMPUTER AT A MICROPRICE!

**FEATURES:**

- Assembled and Tested, yet only \$149.95
- Standard 4.5" by 6.5" card with 72 pin edge connector pattern
- All IC's are socketed for easy maintenance
- Memory expandable to 28K
- 110 Baud Serial I/O
- It Speaks Basic Beautifully
- 4K NIBL Basic in ROM and 2K of RAM
- Easily interfaced with CRT or Teletype

CATALOG NUMBER NIBL-ND (not discountible) **\$149.95**

SOFTWARE/HARDWARE MANUAL MANT-ND (not discountible) **\$5.00**

### CLOCK MODULES

MA1002 0.5" High Digit **\$10.50**

MA1010 0.54" High Digit **\$12.95**

MA1003 0.5" High Digit **\$12.95**

MA1004 0.5" High Digit **\$12.95**

MA1005 0.5" High Digit **\$12.95**

MA1006 0.5" High Digit **\$12.95**

MA1007 0.5" High Digit **\$12.95**

MA1008 0.5" High Digit **\$12.95**

MA1009 0.5" High Digit **\$12.95**

MA1011 0.5" High Digit **\$12.95**

MA1012 0.5" High Digit **\$12.95**

MA1013 0.5" High Digit **\$12.95**

MA1014 0.5" High Digit **\$12.95**

MA1015 0.5" High Digit **\$12.95**

MA1016 0.5" High Digit **\$12.95**

MA1017 0.5" High Digit **\$12.95**

MA1018 0.5" High Digit **\$12.95**

MA1019 0.5" High Digit **\$12.95**

MA1020 0.5" High Digit **\$12.95**

MA1021 0.5" High Digit **\$12.95**

MA1022 0.5" High Digit **\$12.95**

MA1023 0.5" High Digit **\$12.95**

MA1024 0.5" High Digit **\$12.95**

MA1025 0.5" High Digit **\$12.95**

MA1026 0.5" High Digit **\$12.95**

MA1027 0.5" High Digit **\$12.95**

MA1028 0.5" High Digit **\$12.95**

MA1029 0.5" High Digit **\$12.95**

MA1030 0.5" High Digit **\$12.95**

MA1031 0.5" High Digit **\$12.95**

MA1032 0.5" High Digit **\$12.95**

MA1033 0.5" High Digit **\$12.95**

MA1034 0.5" High Digit **\$12.95**

MA1035 0.5" High Digit **\$12.95**

MA1036 0.5" High Digit **\$12.95**

MA1037 0.5" High Digit **\$12.95**

MA1038 0.5" High Digit **\$12.95**

MA1039 0.5" High Digit **\$12.95**

MA1040 0.5" High Digit **\$12.95**

MA1041 0.5" High Digit **\$12.95**

MA1042 0.5" High Digit **\$12.95**

MA1043 0.5" High Digit **\$12.95**

MA1044 0.5" High Digit **\$12.95**

MA1045 0.5" High Digit **\$12.95**

MA1046 0.5" High Digit **\$12.95**

MA1047 0.5" High Digit **\$12.95**

MA1048 0.5" High Digit **\$12.95**

MA1049 0.5" High Digit **\$12.95**

MA1050 0.5" High Digit **\$12.95**

### POWERACE

POWERACE 103 **\$23.00**

POWERACE 101 **\$23.00**

POWERACE 102 **\$23.00**

POWERACE 104 **\$23.00**

POWERACE 105 **\$23.00**

POWERACE 106 **\$23.00**

POWERACE 107 **\$23.00**

POWERACE 108 **\$23.00**

POWERACE 109 **\$23.00**

POWERACE 110 **\$23.00**

POWERACE 111 **\$23.00**

POWERACE 112 **\$23.00**

POWERACE 113 **\$23.00**

POWERACE 114 **\$23.00**

POWERACE 115 **\$23.00**

POWERACE 116 **\$23.00**

POWERACE 117 **\$23.00**

POWERACE 118 **\$23.00**

POWERACE 119 **\$23.00**

POWERACE 120 **\$23.00**

POWERACE 121 **\$23.00**

POWERACE 122 **\$23.00**

POWERACE 123 **\$23.00**

POWERACE 124 **\$23.00**

POWERACE 125 **\$23.00**

POWERACE 126 **\$23.00**

POWERACE 127 **\$23.00**

POWERACE 128 **\$23.00**

POWERACE 129 **\$23.00**

POWERACE 130 **\$23.00**

POWERACE 131 **\$23.00**

POWERACE 132 **\$23.00**

POWERACE 133 **\$23.00**

POWERACE 134 **\$23.00**

POWERACE 135 **\$23.00**

POWERACE 136 **\$23.00**

POWERACE 137 **\$23.00**

POWERACE 138 **\$23.00**

POWERACE 139 **\$23.00**

POWERACE 140 **\$23.00**

POWERACE 141 **\$23.00**

POWERACE 142 **\$23.00**

POWERACE 143 **\$23.00**

POWERACE 144 **\$23.00**

POWERACE 145 **\$23.00**

POWERACE 146 **\$23.00**

POWERACE 147 **\$23.00**

POWERACE 148 **\$23.00**

POWERACE 149 **\$23.00**

POWERACE 150 **\$23.00**

### JM1 DIGITAL DISPLAY

JM1001 **\$4.95**

JM1002 **\$4.95**

JM1003 **\$4.95**

JM1004 **\$4.95**

JM1005 **\$4.95**

JM1006 **\$4.95**

JM1007 **\$4.95**

JM1008 **\$4.95**

JM1009 **\$4.95**

JM1010 **\$4.95**

JM1011 **\$4.95**

JM1012 **\$4.95**

JM1013 **\$4.95**

JM1014 **\$4.95**

JM1015 **\$4.95**

JM1016 **\$4.95**

JM1017 **\$4.95**

JM1018 **\$4.95**

JM1019 **\$4.95**

JM1020 **\$4.95**

JM1021 **\$4.95**

JM1022 **\$4.95**

JM1023 **\$4.95**

JM1024 **\$4.95**

JM1025 **\$4.95**

JM1026 **\$4.95**

JM1027 **\$4.95**

JM1028 **\$4.95**

JM1029 **\$4.95**

JM1030 **\$4.95**

JM1031 **\$4.95**

JM1032 **\$4.95**

JM1033 **\$4.95**

JM1034 **\$4.95**

JM1035 **\$4.95**

JM1036 **\$4.95**

JM1037 **\$4.95**

JM1038 **\$4.95**

JM1039 **\$4.95**

JM1040 **\$4.95**

JM1041 **\$4.95**

JM1042 **\$4.95**

JM1043 **\$4.95**

JM1044 **\$4.95**

JM1045 **\$4.95**

JM1046 **\$4.95**

JM1047 **\$4.95**

JM1048 **\$4.95**

JM1049 **\$4.95**

JM1050 **\$4.95**

### LED LIGHTS AND LAMPS

LED1001 **\$1.00**

LED1002 **\$1.00**

LED1003 **\$1.00**

LED1004 **\$1.00**

LED1005 **\$1.00**

LED1006 **\$1.00**

LED1007 **\$1.00**

LED1008 **\$1.00**

LED1009 **\$1.00**

LED1010 **\$1.00**

LED1011 **\$1.00**

LED1012 **\$1.00**

LED1013 **\$1.00**

LED1014 **\$1.00**

LED1015 **\$1.00**

LED1016 **\$1.00**

LED1017 **\$1.00**

LED1018 **\$1.00**

LED1019 **\$1.00**

LED1020 **\$1.00**

LED1021 **\$1.00**

LED1022 **\$1.00**

LED1023 **\$1.00**

LED1024 **\$1.00**

LED1025 **\$1.00**

LED1026 **\$1.00**

LED1027 **\$1.00**

LED1028 **\$1.00**

LED1029 **\$1.00**

LED1030 **\$1.00**

LED1031 **\$1.00**

LED1032 **\$1.00**

LED1033 **\$1.00**

LED1034 **\$1.00**

LED1035 **\$1.00**

LED1036 **\$1.00**

LED1037 **\$1.00**

LED1038 **\$1.00**

LED1039 **\$1.00**

LED1040 **\$1.00**

LED1041 **\$1.00**

LED1042 **\$1.00**

LED1043 **\$1.00**

LED1044 **\$1.00**

LED1045 **\$1.00**

LED1046 **\$1.00**

LED1047 **\$1.00**

LED1048 **\$1.00**

LED1049 **\$1.00**

LED1050 **\$1.00**

### MOLEX I.C. SOCKET PINS

MOX1001 **\$1.00**

MOX1002 **\$1.00**

MOX1003 **\$1.00**

MOX1004 **\$1.00**

MOX1005 **\$1.00**

MOX1006 **\$1.00**

MOX1007 **\$1.00**

MOX1008 **\$1.00**

MOX1009 **\$1.00**

MOX1010 **\$1.00**

MOX1011 **\$1.00**

MOX1012 **\$1.00**

MOX1013 **\$1.00**

MOX1014 **\$1.00**

MOX1015 **\$1.00**

MOX1016 **\$1.00**

MOX1017 **\$1.00**

MOX1018 **\$1.00**

MOX1019 **\$1.00**

MOX1020 **\$1.00**

MOX1021 **\$1.00**

MOX1022 **\$1.00**

MOX1023 **\$1.00**

MOX1024 **\$1.00**

MOX1025 **\$1.00**

MOX1026 **\$1.00**

MOX1027 **\$1.00**

MOX1028 **\$1.00**

MOX1029 **\$1.00**

MOX1030 **\$1.00**

MOX1031 **\$1.00**

MOX1032 **\$1.00**

MOX1033 **\$1.00**

MOX1034 **\$1.00**

MOX1035 **\$1.00**

MOX1036 **\$1.00**

MOX1037 **\$1.00**

MOX1038 **\$1.00**

MOX1039 **\$1.00**

MOX1040 **\$1.00**

MOX1041 **\$1.00**

MOX1042 **\$1.00**

MOX1043 **\$1.00**

MOX1044 **\$1.00**

MOX1045 **\$1.00**

MOX1046 **\$1.00**

MOX1047 **\$1.00**

MOX1048 **\$1.00**

MOX1049 **\$1.00**

MOX1050 **\$1.00**

### BOBOA CHIP SET

BOBOA1001 **\$44.95**

BOBOA1002 **\$44.95**

BOBOA1003 **\$44.95**

BOBOA1004 **\$44.95**

BOBOA1005 **\$44.95**

BOBOA1006



# ELECTRONIC SYSTEMS

P.O. Box 9641 San Jose, CA 95157 (408) 374-5984

FOR CATALOG INCLUDING PARTS LISTS AND SCHEMATICS,  
SEND A SELF ADDRESSED ENVELOPE WITH 24¢ POSTAGE.

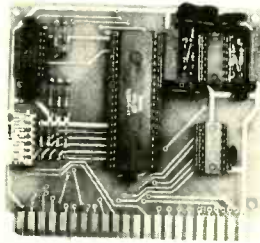

## UART & BAUD RATE GENERATOR\*

- Part no. 101
- Converts serial to parallel and parallel to serial
  - Low cost on board baud rate generator
  - Baud rates: 110, 150, 300, 600, 1200, and 2400
  - Low power drain +5 volts and -12 volts required
  - TTL compatible
  - All characters contain a start bit, 5 to 8 data bits, 1 or 2 stop bits, and either odd or even parity.
  - All connections go to a 44 pin gold plated edge connector
  - Board only \$12.00; with parts \$35.00

## 8K STATIC RAM



- Part no. 300
- 8K Altair bus memory
  - Uses 2102 Static memory chips
  - Memory protect
  - Gold contacts
  - Wait states
  - On board regulator
  - S-100 bus compatible
  - Vector input option
  - TRI state buffered
  - Board only \$22.50; with parts \$160.00

## RS-232/TTL INTERFACE\*



- Part no. 232
- Converts TTL to RS-232, and converts RS-232 to TTL
  - Two separate circuits
  - Requires -12 and +12 volts
  - All connections go to a 10 pin gold plated edge connector
  - Board only \$4.50; with parts \$7.00

## DC POWER SUPPLY\*



- Part no. 6085
- Board supplies a regulated +5 volts at 3 amps., +12, -12, and -5 volts at 1 amp.
  - Power required is 8 volts AC at 3 amps., and 24 volts AC C.T. at 1.5 amps.
  - Board only \$12.50; with parts \$42.50 excluding transformers

## TIDMA\*



- Part no. 112
- Tape Interface Direct Memory Access
  - Record and play programs without bootstrap loader (no prom) has FSK encoder/decoder for direct connections to low cost recorder at 1200 baud rate, and direct connections for inputs and outputs to a digital recorder at any baud rate.
  - S-100 bus compatible
  - Board only \$35.00; with parts \$110.00

Part no. 111

## TAPE INTERFACE\*



- Play and record Kansas City Standard tapes
- Converts a low cost tape recorder to a digital recorder
- Works up to 1200 baud
- Digital in and out are TTL-serial
- Output of board connects to mic. in of recorder
- Earphone of recorder connects to input on board
- Requires +5 volts, low power drain
- Board \$7.60; with parts \$27.50
- No coils

Part no. 107

## RF MODULATOR\*



- Converts video to AM modulated RF, Channels 2 or 3
- Power required is 12 volts AC C.T., or +5 volts DC
- Board \$7.60; with parts \$13.50

## Apple II Serial I/O Interface\*



- Part No. 2
- Baud rates up to 30,000
  - Plugs into Apple Peripheral connector
  - Low-current drain
  - RS-232 Input and Output SOFTWARE
  - Input and Output routine from monitor or BASIC to teletype or other serial printer.
  - Program for using an Apple II for a video or an intelligent terminal. Board only - \$15.00; with parts - \$42.00; assembled and tested - \$62.00.

## RS-232/TTY\* INTERFACE NEW

- Part no. 600
- Converts RS-232 to 20mA current loop, and 20mA current loop to RS-232
  - Two separate circuits
  - Requires +12 and -12 volts
  - Board only \$4.50, with parts \$7.00

## TELEVISION TYPEWRITER

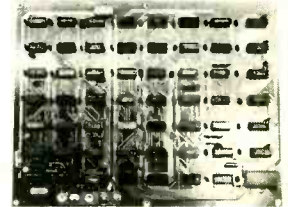

- Part no. 106
- Stand alone TVT
  - 32 char/line, 16 lines, modifications for 64 char/line included
  - Parallel ASCII (TTL) input
  - Video output
  - 1K on board memory
  - Output for computer controlled cursor
  - Auto scroll
  - Non-destructive cursor
  - Cursor inputs: up, down, left, right, home, EOL, EOS
  - Scroll up, down
  - Requires +5 volts at 1.5 amps, and -12 volts at 30 mA
  - All 7400, TTL chips
  - Char. gen. 2513
  - Upper case only
  - Board only \$39.00; with parts \$145.00

## MODEM\*



- Part no. 109
- Type 103
  - Full or half duplex
  - Works up to 300 baud
  - Originate or Answer
  - No coils, only low cost components
  - TTL input and output-serial
  - Connect 8 ohm speaker and crystal mic. directly to board
  - Uses XR FSK demodulator
  - Requires +5 volts
  - Board \$7.60; with parts \$27.50

## To Order:



Mention part number and description. For parts kits add "A" to part number. Shipping paid for orders accompanied by check, money order, or Master Charge, BankAmericard, or VISA number, expiration date and signature. Shipping charges added to C.O.D. orders. California residents add 6.5% for tax. Parts kits include sockets for all ICs, components, and circuit board. Documentation is included with all-products. Dealer inquiries invited. 24 Hour Order Line: (408) 374-5984.\* Designed by John Bell.

CIRCLE 35 ON READER SERVICE COUPON



ONE CENT IC SALE



POLY PAKS 'N PENNY REVOLUTION

THESE ONE-CENTERS ARE THE CENT-CIBLE WAY TO SHOP AND SAVE!

BUY ONE AT SALE PRICE, GET 2ND FOR ONLY 1¢ MORE.

THIS NEW LIST OF "ONE-CENTERS" HELPS FIGHT INFLATION!

Order by Cat. No. 7N1981 & Type No.

Table listing various electronic components like resistors, capacitors, and diodes with their respective prices and quantities.

POP-AMPS AT "CENT-CIBLE" PRICES

Case code: T=TO-220 Power Tab; V=Mini dip; K=TO-3; H=TO-5; N=DIP

Table listing various electronic components like transistors, diodes, and integrated circuits with their respective prices and quantities.

Large table listing a wide variety of electronic components including relays, transformers, and specialized ICs with their prices and quantities.

7-SEGMENT READOUTS

Table listing 7-segment readout components with their prices and quantities.

SPEAKERS!

Table listing various speaker models with their prices and quantities.

MICROPHONES!

Table listing various microphone models with their prices and quantities.

RELAYS!

Table listing various relay models with their prices and quantities.

AMPLIFIERS!

Table listing various amplifier models with their prices and quantities.

TRANSFORMERS!

Table listing various transformer models with their prices and quantities.

DIP SWITCHES!

Table listing various DIP switch models with their prices and quantities.

IC SOCKETS!

Table listing various IC socket models with their prices and quantities.

RIBBON CABLE!

Table listing various ribbon cable models with their prices and quantities.

SPECTROL "SKINNY-TRIMS"

Table listing Spectrol trimmer potentiometers with their prices and quantities.

WRITE FOR POLY PAKS CATALOG

Terms: Add postage. Rated: net 30. Phone: Wakefield, Mass. (617) 245-3829. Retail: 16-18 Del Carmine St., Wakefield, MA. MINIMUM ORDER - \$6.00. P.O. BOX 942-N7 LYNNFIELD, MA. ZIP 01940

YOU GET 120-DAY MONEY BACK GUARANTEE

10 AMP - POWER TABS! SCRS, TRIACS, QUADRACS!

Table listing 10 AMP power components with their prices and quantities.

HI-POWER STUD RECTIFIERS

Table listing HI-POWER stud rectifier components with their prices and quantities.

25 AMP BRIDGE RECTIFIERS

Table listing 25 AMP bridge rectifier components with their prices and quantities.

25 AMP POWER STUD SCRS, TRIACS

Table listing 25 AMP power stud components with their prices and quantities.

Table listing IN4000 Epoxy Rectifiers with their prices and quantities.

BULLET RECTIFIERS!

Table listing bullet rectifier components with their prices and quantities.

MICRO MINI TOGGLE SWITCHES!

Table listing micro mini toggle switch components with their prices and quantities.

LYTIC KLINIC

Table listing Lytic Clinic electrolytic capacitors with their prices and quantities.

6 AMP CARTWHEEL RECTIFIERS

Table listing 6 AMP cartwheel rectifier components with their prices and quantities.

LEDS!

Table listing various LED components with their prices and quantities.

ZENERS!

Table listing various Zener diode components with their prices and quantities.

SALE BUY 1 AT OUR SALE PRICE GET 2 FOR 1¢ MORE



# WIREWRAP

## PRECUT WIRE

Why buy wire on rolls?

PRECUT & STRIPPED WIRE IS:

- Fast - No more cutting & stripping by hand
- Reliable - Good, clean, uniform strip
- Economical - Cheaper than using bulk wire

### Precut Wire

100 pcs of 3' at \$82 = 3¢/ft.  
100 pcs of 6' at 1.06 = 2¢/ft.  
Wire Kit 1 at \$6.95 = 2 1/3¢/ft.

### Bulk Wire

50 ft. roll at \$1.99 = 4¢/ft.  
100 ft. roll at 2.95 = 3¢/ft.

# 30 Kynar stripped 1" on each end. Lengths are overall Colors: Red, Blue, Green, Yellow, Black, Orange, White. Wire packaged in plastic bags. Add 25¢/length for tubes.

	100	500	1000	5000
2 1/2 in.	78	2.40	4.30/K	3.89/K
3 in.	82	2.90	4.71/K	4.22/K
3 1/2 in.	86	2.80	5.12/K	4.55/K
4 in.	90	3.00	5.52/K	4.88/K
4 1/2 in.	94	3.21	5.93/K	5.21/K
5 in.	98	3.42	6.34/K	5.52/K
5 1/2 in.	1.02	3.65	6.75/K	5.86/K
6 in.	1.06	3.85	7.16/K	6.19/K
6 1/2 in.	1.15	4.05	7.57/K	6.52/K
7 in.	1.20	4.25	7.98/K	6.85/K
7 1/2 in.	1.25	4.45	8.39/K	7.18/K
8 in.	1.29	4.65	8.80/K	7.53/K
8 1/2 in.	1.32	4.85	9.21/K	7.84/K
9 in.	1.36	5.05	9.62/K	8.17/K
9 1/2 in.	1.40	5.25	10.03/K	8.50/K
10 in.	1.45	5.51	10.44/K	8.83/K
Add. in.	1.10	.41	.82/K	.66/K

## WIRE KITS

# 1	\$6.95	# 2	\$19.95
250 3' 100 4'		250 2' 250 4'	250 6'
250 3 1/2' 100 5'		500 3' 250 5'	100 6'
100 4' 100 6'		500 3 1/2' 100 5 1/2'	7'
		500 4'	1 250 ft. Roll Bulk

Choose One Color or Assortment

## WIRE WRAP SOCKETS

	1-9	10-24	25-99	100-249	250-999	1K-5K
8 pin	41	38	35	31	29	27
14 pin	42	39	36	32	29	27
16 pin	46	43	39	35	32	30
18 pin	63	58	54	47	44	41
20 pin	84	78	71	63	59	54
22 pin	1.30	1.20	1.10	95	90	84
24 pin	.91	.84	.78	68	64	59
28 pin	1.25	1.15	1.08	95	89	82
40 pin	1.65	1.55	1.42	125	115	109

Gold 3-level Closed Entry Sockets  
End & Side Stackable All prices include gold  
Tin sockets and 2-level sockets available

## WIRE WRAP TOOLS



\$34.95

### HOBBY WRAP

Model BW 630

With Free Wire Kit 1

(\$6.95 Value)

- Batteries & Charger \$11.00
- WSU 30 Hand Wrap-Unwrap Strip Tool 5.95
- WSU 30M, for Modified Wrap 6.95
- BT 30 Extra Bit 2.95

## INTERCONNECT CABLES

Ribbon cable connectors for connecting boards to front panels, or board to board.

SINGLE ENDED			DOUBLE ENDED			
	14 pin	16 pin	24 pin	14 pin	16 pin	24 pin
6"	1.24	1.34	2.05	2.24	2.45	3.37
12"	1.33	1.44	2.24	2.33	2.55	3.92
24"	1.52	1.65	2.63	2.32	2.76	4.31
48"	1.81	2.06	3.40	2.91	3.17	5.08

### Ordering Information:

- Orders under \$25 and COD's, add \$2
- All others, shipped Ppd in U.S. via UPS
- For Blue Label (Air) or 1st Class, add \$1
- We accept Visa & MasterCard
- Most orders shipped same day

Dealer Inquiries Invited

## PAGE DIGITAL ELECTRONICS

135 E. Chestnut Street 4A  
Monrovia, California 91016  
Phone (213) 357-5005

# TV HOCKEY SOCCER GAME PLUS VIDEOCUBE-TV INTERFACE

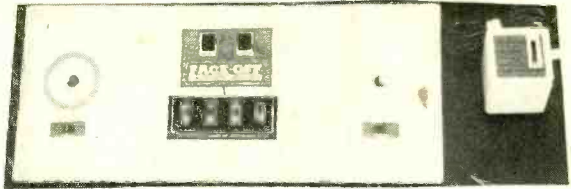

The game we have been selling for \$27.50 in kit form. NOW complete, ready to go including VIDEOCUBE, the TV interface, used for interfacing minicomputers and cameras, as described in August RADIO-ELECTRONICS. Games have 2 levels of skill, LED read-outs for scoring, 2 joysticks which move players in all planes, not just vertical & horizontal. Game sold for \$79.50 in Boston stores. STOCK NO. 5495R Complete TV game & VIDEOCUBE \$18.95

## NEW TRANSFORMERS

115 V primary. Sec. 1—12.6V @ 1.0 A. ct. Sec. 2—33.5V, tapped @ 13.1 V @ 1.0A. Sec. 3—140V @ 100 ma. 2Lbs. 4"x2"x2 3/4".

STOCK NO. 6772R

\$2.95 ea. 2/5.00

Two 115 volt primaries, (can be used on 230V). 4 secondaries. 11.5V @ 4.8 A, 23V @ 9.0 A., 14 V. @ 20 A. and 125 V 1.5 A.

13 lbs. 4 1/2"x4 1/4"x3 3/4"

STOCK NO. 6554R

\$16.95 ea. 2/30.00

TRIAD—N67A ISOLATION transformer. 115 or 230 VAC to 115 AC. 150 VA. Limited quantity. 7 lbs. 4"x4"x3 1/2".

STOCK NO. 6788

\$7.95 ea. 2/15.00

## DELTA ELECTRONICS

P.O. Box 2, 7 Oakland St.  
Amesbury, Mass. 01913  
617-388-4705



### RETAIL OUTLET

ATLANTA, GA. DELTA ELECTRONIC HOBBIES  
5151 Buford Hwy. Doraville, (Atlanta) Ga. 30340

CIRCLE 16 ON READER SERVICE COUPON

CIRCLE 42 ON READER SERVICE COUPON

## Power Supply Kits



- C.B. POWER SUPPLY KIT**  
A complete kit which puts out 10 to 24 VDC at 2 amps, regulated, 115 VAC in. Can be wired for constant 13.8VDC, ideal & compact for C.B. Kit includes PC card, components and instructions... just add your own case. Super as a bench supply! Sh. Wt. 6 Lbs. . . 6C60498. . . \$14.88
- 5A, 10 to 24VDC Reg. P.S. KIT**  
A simple, adjustable regulated power supply. Kit includes all components, vector board and complete schematics. All you add is the case. A powerful supply! Sh. Wt. 15 Lbs. . . 6M160301. . . \$14.88
- 5V, 1A LOGIC POWER SUPPLY KIT**  
Includes all parts needed to build a regulated 5 volt, 1 amp power supply. Case not supplied. A real B&F bargain! 3 Lbs. 7C70267. . . \$6.00 ea. . . 3 for \$16.88

## DC AMP METERS

Four types available, all measure 2-3/8" square. Use these with our P.S. kits.

- 0- 8 Amp Gauge . . . . . #8W20128
- 0-10 Amp Gauge . . . . . #7W0342
- 0-15 Amp Gauge . . . . . #8W20127
- 0-20 Amp Gauge . . . . . #7W0343

Sh. Wt. 12 oz. . . \$2.00 ea. or \$5.00/3

## VIDEO GAME

Unused electronic TV games that are missing the TV interface section. Has some 30 IC's, including 2-555 timers and lots of CMOS stuff. Also has two 7-segment 5" LED displays . . . all on 2 PC boards. Also: 2-joystick controls (each with 2-10K pots); 2" 8 ohm speaker; large sloping-top case & more & more!  
Sh. Wt. 5 Lbs. . . 8GE0028 . . . \$7.88

## Stereo Power Amp



16 Watts RMS Total  
**STEREO POWER AMP KIT**  
A complete kit of parts, including 2 PC boards, already wired, which make up a stereo amplifier. Plus a power transformer, line cord and instructions. You add inputs, controls, case and speakers for a complete working stereo system.  
Sh. Wt. 5 Lbs. . . 7E70464. . . \$12.88 ea

## 12 VOLT AUTO BATTERY CHARGER

We supply diode, line cord, switch, transformer and instructions. Good for 20 amps. You supply case & cosmetics. Super heavy duty!  
Sh. Wt. 16 Lbs.  
#7C7005 . . . \$19.50 ea or \$55.00/3

## Video Monitor

Great for CCTV or Micro-Computer  
Reconditioned  
With New CRT!  
12" Diagonal  
These reconditioned solid state monitors have a new CRT installed & are checked out. They can display up to 80 characters X 16 lines, accepting std. comp. video signal. 75 ohm input via SO-239 connector, 115VAC. 12 page manual incl. Qty. Ltd. 40 Lbs.  
Order No. 8A30200. . . . . \$98.88

## 4-Way Speaker

COMPONENTS SPECIAL  
A SUPERB ENSEMBLE OF Components including: Flaredome 3" tweeter; two (2) 5" Middlers; heavy-duty 12" Woofer: & an L-C-R crossover with two controls. For optimum performance, this system should be mounted in an air tight enclosure of at least 2 cubic feet in volume (available separately, send for catalog). Alnico V type magnets, 5 - 70 Watts, 25 to 20,000 Hz., 6 - 8 ohms. Simply GREAT! 30 Lbs. . . 8EU80063. . . \$119.50/pair (pair=8 speakers, for two 4-way systems)

## NiCad's

RECHARGEABLE, 1.25V per cell. Used, good cond. Sizes are: AA-oversize; & sub-C. (Check dimensions)  
Size (in.) Amp Hr. Wt. Order No.  
.635x1.91 0.60 3 oz #7V0468  
.865x1.63 1.20 5 oz #7V0470  
88¢ each or \$8.00/10

## HI-CURRENT TRANSFORMERS

Heavy duty ferro-resonant transformers for your power supply, all are center tap.  
Wt. Volts Amps Order No. Price  
40 16-CT 35 8G80072 \$19.50  
20 16-CT 25 8G80073 \$15.50  
30 15-CT 25  
& 30-CT 3 8G80074 \$16.50  
30 80-CT 5 8G20197 \$9.88

FREE JUMBO CATALOG: Over 3,000 surplus items - electronics, optics & more! Circle reader service card now!

**10% OFF**  
10% OFF ANY ORDER Over \$10!  
...if you mention this ad: SAY "E-78"!

## Speaker Kits

**SPEAKER SYSTEMS KIT No. 1**  
Super cabinets, size is 21x12x8". Includes 8" woofers w/whizzers; 4" dome tweeters; cross-overs; damping; hardware and instructions. System sells for \$198 if bought ready-to-go, B&F kit price only \$69.95/pair! 45 Lbs.  
Order No. 7ZU70283. . . . \$69.95/pair

## SPEAKER SYSTEMS KIT No. 2

Fantastic cabinets designed for direct dispersion of high freq. and wide dispersion of low freq. Size: 17x10 1/2 x 9 1/2". Sold with 8" woofers, 4" dome tweeters, cross-overs and instructions. 35 Lbs.  
Order No. 7ZU70242. . . . \$49.50/pair

POSTAGE: Please add postage, All material is P.O.B. Peabody, Ma. No C.O.D.'s please. Massachusetts Residents add 5% sales tax.  
**PHONE ORDERS WELCOME!**  
Use your Bank Americard, Master Charge or American Express Credit Card!  
\$10.00 min. on all charge orders.

**B&F ENTERPRISES**  
Dept. "E-78"  
119 FOSTER STREET  
PEABODY, MA. 01960  
Tel. Orders: (617) 531-5774

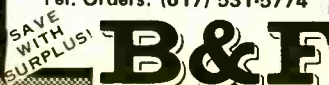



# Scanners will never be the same

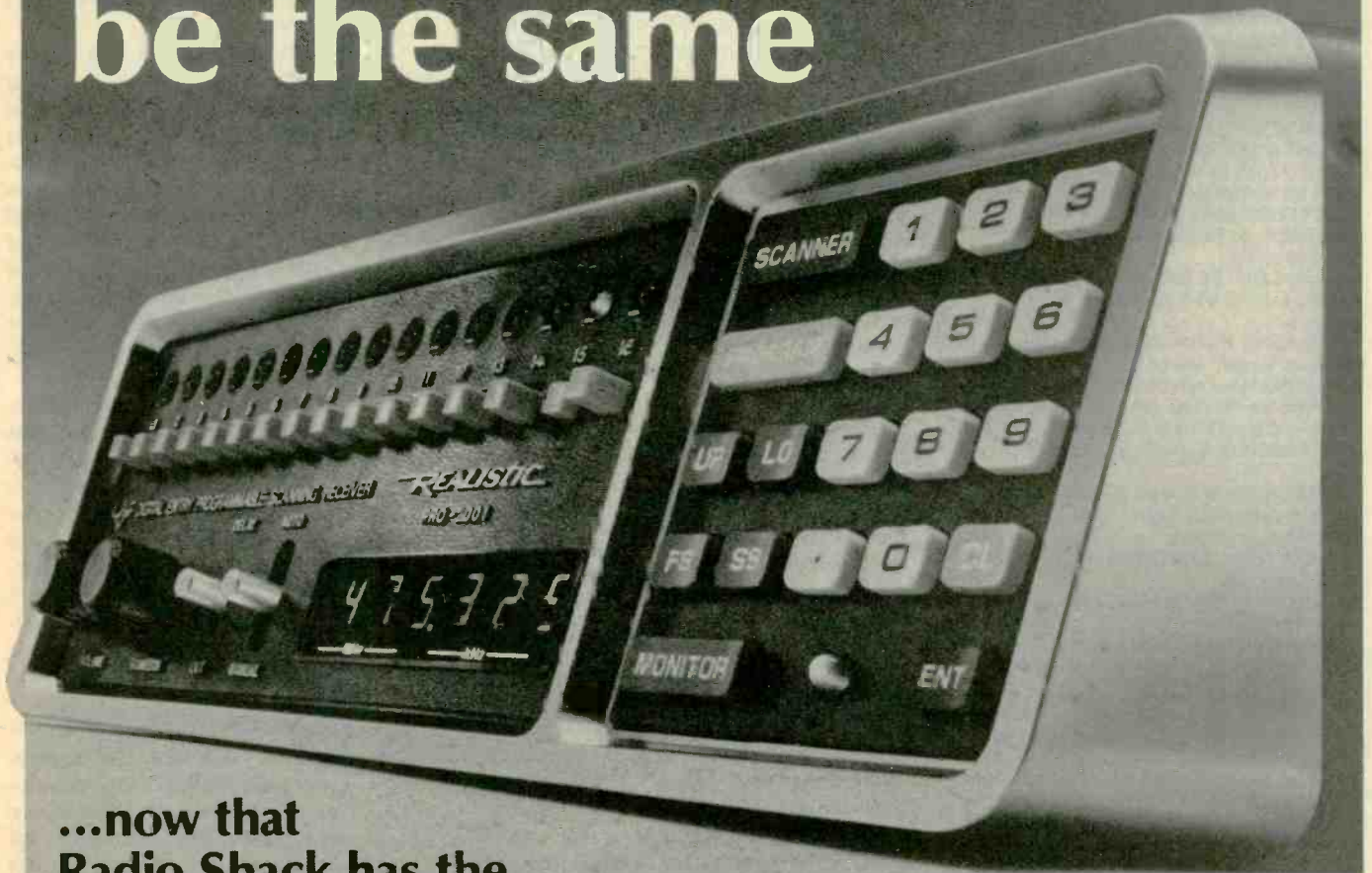

## ...now that Radio Shack has the amazing new Realistic 2001 with built-in microprocessor!

The PRO-2001 makes possible continuous, automatic reception of six UHF and VHF bands for all kinds of action — police, fire, Ham, weather, mobile telephone, railroad communications and more. And with its microprocessor you can program it for any 16 of 16,650 frequencies, without buying crystals!

Enter familiar area frequencies. Use the digital keyboard to punch-in actual frequencies for monitoring, storing or exploring — no codes or switches to slow you down. A special ENTER button reduces accidental entries. Digital readout shows which frequencies are being scanned, monitored or programmed into the memory. And you can monitor any frequency without entering it into the

scanner — it's like having a seventeenth channel for even greater versatility!

Search for "unknown" frequencies. The 2001's powerful search capability lets you find new, often unpublicized channels. Just enter lower and upper limits (they can even be in different bands) and select the search speed. The rest is automatic!

"Traditional" deluxe scanner features. LED channel indicators and individual lockout buttons. Automatic or manual scan. Switchable scan delay. High-speed skipper circuit. Built-in speaker, jacks for recorder, headphone, external speaker. With power cables for home or mobile use. The Realistic® 2001 — a revolution in action radio. About \$400.\*



Mobile use in some states and localities may be unlawful or require a permit — check with local authorities.



These credit cards honored at most Radio Shack stores. \* Prices and products may vary in Canada.

SOLD ONLY WHERE YOU SEE THIS SIGN:

# Radio Shack®

A DIVISION OF TANDY CORPORATION • FORT WORTH, TEXAS 76102  
OVER 7000 LOCATIONS IN NINE COUNTRIES



## JOHN MESHNA JR. Inc.

**PHOTO FLASH complete on PC board w/ flash tube in reflector, 2 ni-cads & camera connecting cable. Cycles in 3 seconds \$7.00**

**8 SWITCHES in MINI DIP 1.80**

**10 SWITCHES in MINI DIP 2.00**

**AA NI-CADS fast charge 1.25**

**5 WAY BINDING POST US made .35**

**U-FIX-EM TV games, w/power pack & video Cube in original boxes (sold for \$50) 11.00**

**JUMBO LED .187 diam. long leads 6/1.00**

**TV CHEATER CORDS 6 ft .75**

**LIQUID CRYSTAL thermometer, reads 86 to 108 degrees F 4/1.00**

**MULTI USE xfmr puts out 140 volts, 12.6, 6, 33.5 volts Many home projects 1.50**

**SEISMIC DETECTOR radio transmitter, used in Viet Nam for troop detection. 4.00**

**COPY LENS FROM ZEROX in mount. 8 1/2 focal length iris f4.5 to f8 10.50**

**U-FIX-EM hand calculator 4 function 3.00**

**LAMBDA solid state regulated slim line power supply 12 volts DC 8 amps 50.00**

**ULTRASONIC transducer 37 or 40 Khz 2.00**

The above includes data on alarm system

**PL 259 coax connector .75**

**SO-239 coax socket .60**

**TOUCH TONE ENCODER KIT, pad, chip & instructions 12.95**

**IR NIGHT VIEWER, new ready to use, see in the dark 199.00**

**All above FOB LYNN MASS (you pay shipping) Amazing 64 page catalog free**

**JOHN MESHNA JR. Inc.**  
PO Box 62, E.Lynn, Mass 01904

CIRCLE 24 ON READER SERVICE COUPON

### ALDELCO ELECTRONICS COMPANY

**NEW IMPROVED DIGITAL ALARM CLOCK KIT**

0.5 LED Display 12 hour format

Snooze Feature

Elapsed Timer

Simulated Wood Grain or Black Leather Cabinet \$24.95

12 or 24 Hour Clock Kit. Similar to Above but without Alarm or Timer features. Only \$23.95

Crystal Time Base Kit for 12 Volt DC use 4.95

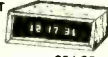

STUD RECTIFIERS		FULL WAVE BRIDGE	
10 Amp 50V .45		2 Amp 50V .35	
10 Amp 200V .65		2 Amp 200V .50	
40 Amp 50V 1.20		3 Amp 50V .50	
40 Amp 200V 1.60		3 Amp 200V .85	
		25 Amp 200V 1.50	
		25 Amp 400V 4.00	
		25 Amp 600V 5.50	
		25 Amp 1000V 8.50	

VOLTAGE REGULATORS		LOGIC PROBE KIT	
TO220 Package		DIGIPEAKE-A \$9.95	
Positive \$1.00	Negative \$1.25	Kit of parts for power supply	
7805 7905	7906 7912	Includes schematic	
7812 7915	7815 7918	5 Volt, 6 Amp \$17.95	
LM309H \$1.10	LM309K 1.10	+15 and -15 2 Amp \$16.95	
LM723 .55			

FETS	40673	1.55	We have transistors.
	MPF102	.55	Send stamp for catalog.

<b>MA 1003 National Car Clock Module</b> With 3 push button switches and filters \$19.95 New aluminum cabinet for MA 1003 6.95	<b>MC1458P SPECIAL</b> Only 49c
--	------------------------------------

<b>JUMBO RED LEDS 6 for \$1.00</b> Monsanto MV5053 Jumbo Red LED and holder 25c each	<b>AMATEUR TV CONVERTER</b> Covers 420 to 450 AM TV BAND. Works on unused Commercial TV Channel. KIT ONLY \$39.95 ASSEMBLED \$49.95
---	---

Green, Yellow or Orange LEDS 5 for \$1.00	<b>BLINKY-FLASHER-TIMER KIT</b> Includes 555, PC Board Parts & Instructions \$25.50
FND 70 CC 0.3 Display LED .49	
FND 500 CC 0.5 Display LED .89	

<b>CLOCK FILTERS 2 1/2 x 5 1/2"</b> Red, Blue, Green or Amber .60 ea.	<b>SPEAKERS 8 OHM</b>
	2 1/2" \$ .75   2 1/2" 100 Ohm \$1.50
	2 1/2" 1.25   2 1/2" 5" 3.00

<b>VARIABLE POWER SUPPLY KITS</b> 5 Amps 5-15 Volt DC \$6.95 add \$1.00 per kit shipping	5 Amps 12-28 Volt DC 6.95
---	---------------------------

Visit Our Store, Hours 9:00 AM to 6:00 PM Mon. to Fri. Sat 9:00 AM to 2:00 PM. Phone Orders accepted. Visa & Master Charge. ADD 5% FOR SHIPPING. ORDERS UNDER \$10.00 add \$1.00. Foreign Orders add 15% shipping (except Canada & Mexico). Send Certified Check or Money Order in USA funds.

# ALDELCO

228E BABYLON TURNPIKE, MERRICK, N.Y. 11566  
(516) 378-4555

CIRCLE 30 ON READER SERVICE COUPON

## Sabtronics Multimeter

(Continued from page 38)

or install jumpers when calibrating the meter. Matter of fact, the calibration is unusually fast and accurate.

Two calibration procedures are suggested in the manual: The first is the user's own calibration; the second is an alignment using equipment normally found in a calibration laboratory. Since the typical builder will not have access to lab calibration standards Sabtronics will do the job for \$15 plus \$3.50 shipping and handling. Since user calibration based on the supplied standards resulted in an overall accuracy better than 3% we really can't see spending the extra money for a lab calibration.

**Accessories Later.** Unlike many kits which have complicated modifications when circuit changes or accessories are added after construction is completed, the Model 2000 DMM provides for its accessories with no hassle. Each accessory, such as a Nicad pack, or charger, is a separate accessory which installs independent of the main circuit board. Two of the rear cover panels are factory embossed to indicate the drill area for mounting jacks, while accessory printed circuit boards install directly over posts already moulded into the cabinet. No modifications are required on the main board for accessories. The accessories connect only to the two power wires that normally connect to the C-cell power pack.

**Final Performance.** We initially calibrated the meter against the built in

standards. Slightly better accuracy was attained by using a high grade multimeter as a reference and adjusting the 2000 DMM so it provided the same readings on voltage, current and resistance as the reference meter. For general use either calibration procedure is satisfactory.

Overall, the 2000 DMM works very well, though it takes somewhat longer than is common for readings to settle down. A reading from the powerline took seven seconds to settle; our regular lab digital meters take between two and four seconds. Considering the 2000 DMM costs a fraction of the price of our lab meters, a few extra seconds of waiting is worth the savings in cost. (A resistance reading took from one to three seconds depending on the range.)

The X10 multiplier seemed somewhat unusual because our other instruments don't have this feature. However, once we got some experience it made no difference; if anything, it provides an advantage in allowing user movement of the decimal point, a particularly attractive feature in light of the 100% overranging. (You can expand some low value readings to two or three decimal places to provide maximum accuracy.)

Overall, the Sabtronics 2000 DMM is an excellent value for the money. Its basic cost of \$69.95 includes no accessories other than the holder for four C-cells. Even the test leads are an optional accessory, though any set of standard leads will fit the banana jacks.

For additional information circle No. 52 on the reader's service coupon. ■

## Computer Readout

(Continued from page 70)

possible white moves for its single temporary black move, and having saved in memory the board layout that gives white the highest value (best position), the processor now goes back to black to find another piece it can move (or the same piece but to a different square). It then flips over to play white and repeats the previous process. It will find the white move that gives white the best situation and it will save that board layout. Now the computer has two board layouts saved; one that gives white the best situation in response to the first black move, and one that gives white the best situation in response to the second black move (which assumes the first test move never happened).

Here comes the key to the whole decision process. The computer must choose between its two pretend black moves based on the two saved board layouts. Which move would you choose?

Easy. The one that gives white the worst board layout situation of the two. Now the computer finds the next black piece it can move, finds the white move that is best for white in response to that black move, compares the board pattern to the one previously saved, and chooses the one (and therefore its black move) that is worst for white (best for the computer) of the two. This process continues until all black pieces have been moved in memory that can be moved. When the processor is finished it knows which of its black moves will be of least benefit to white. It makes that move.

Now all of that logic may sound very defensive, but it really is both offensive and defensive because what can be least good for white may be, for example, that black attacks white's queen or puts the white king in check. This approach of taking the least of the set of best moves is known as a "min/max" (for minimum of the maximum) solution. It is a powerful decision-making tool that humans can use if they can keep enough information in the head at



one time—something the computer is designed to do.

We discussed computerized backgammon in our last article. So far there are no backgammon computers that I am aware of that have different levels of play. It is conceivable that a higher level would mean the computer is doing a look-ahead into the odds of your rolling various dice combinations and consequently moving pieces in certain ways. Fidelity is said to be looking at the backgammon market but, besides that, they have an advanced Checkers Challenger available right now that has four

levels of play and a basic unit that has one level. The advanced unit uses standard checkers openings and looks four moves ahead on level four. Because the game is a thousand times simpler than chess, the computer can do a very thorough job of strategy. It is said to be very hard to beat. For more information on any of the Fidelity units, please write them directly. You should find the chess and checkers units in your local department store.

Next issue will cover more up-to-date micromania. Stay tuned and keep the ideas flowing. ■

## Disappearing Antenna

(Continued from page 74)

small neon lamp encased in a red plastic enclosure (which also telescopes into the fender). Keying the transmitter causes the lamp to light, creating a red glow at the tip. This glowing lamp is called a "Breaker Beam," and while it serves no purpose when transmitting or receiving, it does announce to other CBers in the area that you are on the air.

The antenna requires a one-inch hole (which can be made with a chassis punch or hole saw) in the fender, cowl, or trunk, and at least 17-inches clearance below the mounting surface. If you don't have at least 17-inches you must find another location, so check before you punch the mounting hole. The mounting is essentially the standard "eight-ball," or "universal" mount used by many popular radio antennas; you shove the antenna through the hole from the bottom, hold it vertical, position a plastic ball and metal weather-cap, and run down the mounting nut.

Unlike most telescopic or disappearing antennas which permit water that enters the system to collect and run out the bottom of the motor end into the trunk, the EV-Game antenna provides a plastic drain hose that carries off the water accumulation to the outside.

As normally supplied the Model-500 system is completely automatic without modification by the user. In addition to the CB/AM/FM coupler a special *Electronic Relay Box* is also supplied. It is this device that really makes the Model-500 the most convenient of disappearing CB antennas.

The *Electronic Relay Box* has seven wires. Three connect to a special harness plug that provides power to the antenna's motor. One wire is the ground. One goes to the battery, another to the ignition switch accessory terminal (or the dashboard's accessory circuit), and the final wire—which has a twin socket—connects to the power wire of both the CB transceiver and the radio. Inside the *Electronic Relay*

Box is a sensing circuit that senses when either the radio or CB, or both, is turned on. When it senses power flow to the radio or CB it automatically supplies power to the antenna's motor, causing the antenna to rise to its full length.

If both the radio and CB are turned off the relay box senses zero power and applies reverse current to the antenna motor, causing the antenna to automatically retract. If you should inadvertently park and leave the car without turning off the radio(s), as soon as the relay box senses there is no power through the ignition switch accessory circuit it applies power to the antenna's motor, causing the antenna to retract. Unless you leave your ignition key in the switch in the *on* or *accessory* position the antenna is always retracted when the car is parked. (Yes, the motor automatically turns off when the antenna is fully telescoped.)

The antenna is adjusted for minimum SWR on the Citizen's Band by adjusting the *Breaker Beam* holder at the tip—a wrench is provided so you can loosen the holder's set screw. After extended use the CB/AM coupler might require re-adjustment.

**No Extras.** There are no extras for the EV-Game Model 500 antenna; everything is supplied. First, there's the antenna itself which has a short, attached coax cable and power harness (for the motor) terminating in a connector. Then there's the CB/AM/FM coupler which gets mounted near the antenna. A power wire extension harness, with connectors and two extension coax cables, brings the power and signals from the dash to the trunk. The coax cables connect to the CB and radio, the power cable connects to the *Electronic Relay Box*, which in turn connects to the radios as previously described. Rounding out the kit is a plastic drain hose, antenna mounting strap (for the motor end) and mounting screws. Everything you need for the installation is supplied.

The EV-Game Model 500 Fully Automatic Antenna is priced at \$79.95. For additional information circle No. 75 on the reader's service coupon. ■

# Q Which magazine has the widest scope of equipment test reports?

A. **hi-fi stereo BUYERS' GUIDE**

Read it regularly for the most in consumer audio information and advice.

Allow 6 to 8 weeks for delivery of first copy.

**Hi-Fi/Stereo BUYERS' GUIDE** gives you the absolute tops in number of equipment test reports per issue. We don't just test the top of the line, we report on all levels of more manufacturers' lines than any one else.

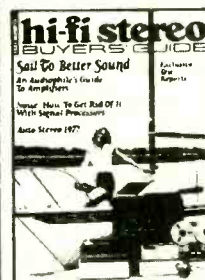

If you're a "best-buy" buyer, don't miss a single issue!

Mail this coupon to  
**Hi-Fi/Stereo BUYERS' GUIDE**  
Box 1855 GPO  
New York, NY 10001

Enclosed is \$2.98 for 6 issues of HFSBG (outside U.S.A., possessions send \$4.00)

Name \_\_\_\_\_  
Address \_\_\_\_\_  
City \_\_\_\_\_  
State \_\_\_\_\_ Zip \_\_\_\_\_

**SAVE** \$2.97 off regular subscription rate.  
\$5.12 off newsstand rate.

H8FO 10

## You and Your Computer

(Continued from page 45)

popular personal computers uses four nulls and a control signal at the end of each line of a BASIC program; this encoding precludes its acceptance by other personal computers. Similarly, it cannot accept recordings from a time-share system. It's a common problem. Some day there might come about a common recording or encoding standard.

**Q—What is an "acoustic coupler"?**

**A—**An acoustic coupler is a modem that is connected to the telephone circuit by placing a telephone's handset in the modem's sound-absorbing cradle—which contains a speaker and microphone to couple sounds from the modem to the phone and vice-versa. This contrasts with a "hard wired" modem that is wired directly to the telephone line(s).

**Q—What would cause intermittent recordings from my computer? I'm using a Kansas City interface and a Panasonic cassette recorder. Sometimes I load a program and find there's errors, even on the safety dump.**

**A—**If you can get good recordings occasionally it's a sure sign both the interface and recorder are okay. Most likely you are using a really cheap tape, and dropouts—which normally go unnoticed with sound recordings—are dropping bits out of your dumps. Even at 300 baud you need decent tape such as TDK-AD, Maxwell UD, and AVDEX, all of which are excellent to at least 4800 baud. When recording baud rates above 4800 a special data cassette is recommended.

**Q—What is the difference between audio and data cassettes, and why are data cassettes at least twice the cost of audio cassettes?**

**A—**The primary difference between an audio and data cassette is the pressure pad. The one on the data cassette is oversize, generally made of a special low-friction material, and often costs more than the tape itself. In addition, the tape (supposedly) has a more uniform coating, is less prone to oxide flaking, and most important, is certified for a specific minimal baud rate. It is claimed the shell and internal construction is better but we haven't noticed construction having any effect when it comes to personal computers.

One advantage of the personal computing data cassettes such as those from AVDEX is they have short tape loads; you don't pay for

30 minutes worth of tape when you need about thirty seconds worth. (Data cassettes often come in several "short" lengths.)

**Q—What is meant by "serial" and "parallel"?**

**A—**In **serial**, each bit of the seven bits (or eight with parity) making up an ASCII character, or binary information, is transmitted to or from a computer in sequence, one bit after the other. Special timing and encoding tells the computer which bits make up a character. In **parallel** form all bits are simultaneously transmitted, so no timing or special encoding is required. TTY uses a serial format. An inexpensive tape reader such as the Oliver uses the parallel format, thereby allowing you to feed the tape as fast as you can pull it through the reader. All you must be certain of is that the computer's I/O matches the terminal or peripheral: serial for serial and parallel for parallel. You cannot mix the two, such as feeding a serial TTY through a parallel I/O port. (Note. Though a TTY feeds and receives in serial unless specially modified, a TTY punched tape is recorded parallel—the TTY makes the "conversion".)

**Q—How much memory can be installed in a personal computer?**

**A—**The maximum amount of memory is determined by the particular CPU and the size of the power supply. Some kits provide for something like 16K, 20K, or 24K in the main cabinet, with an extra cabinet and power supply needed for additional memory. Other kits have a heavy-duty power supply, usually a cooling fan, and can accommodate up to 48K of memory. New memory ICs draw relatively little current and you can now get 8K of memory in less space than you needed for 4K, and the 8K takes less current. As a general rule,

6K to 8K of available memory—in addition to the memory needed for your higher language such as BASIC—is more than enough for 99% of the average personal computer's programs. You need a lot more memory—upwards of 20K—when you start getting into filing systems, or FORTRAN. But if you're into files and/or FORTRAN you really need a disc system.

**Q—What is a "Header"?**

**A—**A **header** can be several things, but it generally refers to a code, often a single letter, placed in front of a program when several programs are recorded on the same tape. The computer can be programmed to search for the header and load only the

program that follows the specified header. Basically, it's a simplified filing system for cassette storage. Some BASICs make provisions for headers, or more commonly, "files"; others don't, and the BASIC loads everything coming off the tape.

• Well, that about wraps up those questions most frequently asked by our readers. We would like to answer your letters individually but it has become physically impossible to do so. But we will keep track of your letters and comments and from time to time cover those questions most frequently asked. Meanwhile, each issue of e/e will keep you up to date on the latest in personal computing hardware, some software, and most especially, those oddball gadgets with particular appeal and value to the hobbyist and experimenter. So keep those letters and cards coming. ■

## Future of AM Stereo

(Continued from page 73)

receivers are envisioned as having response equal to that of stereo FM tuners, on the order of 15 kHz. The introduction of AM stereo will finally force AM broadcasters to pay attention to the range of audio frequencies they transmit. Likewise, equipment manufacturers will devote more attention to the AM section of AM/FM receivers. Current design practice seems to regard the AM section almost as a necessary evil.

DXers will find themselves hunting for distant stations broadcasting in stereo, and the improved AM receivers will be a boon for BCB DXers. Other special equipment, such as directional BCB loop antennas, will likely become available. Yet the improved audio range of AM stereo stations will cause more co-channel interference and may make digging out weak foreign stations on the "split" frequencies between the even 10 kHz frequencies a difficult task.

And even those who only tune the shortwave bands may not be left out—international shortwave broadcasts are AM, after all! Wouldn't you like to spend a cold winter evening listening to South Seas music from Radio Tahiti—in stereo? ■





## Hey, Look Me Over

(Continued from page 12)

Audio-Technica markets these new headphones at audio dealers throughout the U.S.A. Get the complete specs direct from Audio-Technica U.S., Inc., 33 Shiawassee Avenue, Fairlawn, OH 44313.

### Auto Power Amp

The Panasonic Auto Products line of hi-fi car audio products now includes a



CIRCLE 73 ON READER SERVICE COUPON

four-way 50-watt power amplifier. Model CJ255Z is a power amp with dynamically boosted four-way sound. It features four inputs with four output connections to work with a four-speaker system. The CJ255Z offers a full 10-watts per channel without distortion, 50-watt power maximum. The unit is designed to be mounted either under the seat, trunk, or anywhere else where it would be out of the way. Priced to sell at \$79.95. Panasonic Auto Products are available from any Panasonic dealer nationally. For more information, write to Panasonic Auto Products, One Panasonic Way, Secaucus, NJ 07094.

### For Beginning R/C'ers

Heath Company's latest addition to its line is the Delta Products Cessna Skyhawk R/C model airplane. The Skyhawk,

designated RP-1172 by Heath, is offered with complete 3, 5 and 8-channel R/C systems at special discounted prices. It is also available separately. The Skyhawk systems are ideal for beginning R/C pilots because they include everything needed for operation except fuel

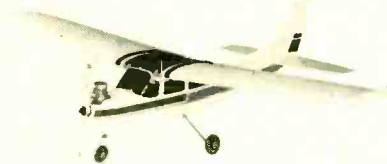

CIRCLE 31 ON READER SERVICE COUPON

and starting battery. The Skyhawk features hot molded wing, tail and fuselage sections and has a 48-inch wingspan. Fuel capacity is from 4 to 6 ounces, and the aircraft is complete with a .25-cubic in. engine. Full R/C systems featuring the Skyhawk and Radio Control gear start as low as \$239.90 mail order. For further information, write for a free catalog to Heath Company, Dept. 350-550, Benton Harbor, MI 49022.

### Magnetic Screwdriver

Vaco's magnetic screwdriver No. 70035 has a powerful magnet built into the shank which holds interchangeable bits and also holds the screw. The unique Vaco comfordome handle allows fatigue-free driving. A removeable smooth dome nylon cap stores the three extra bits

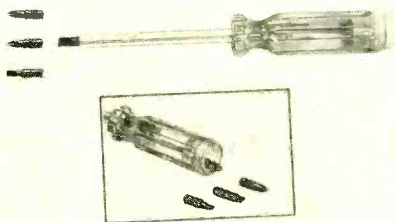

CIRCLE 84 ON READER SERVICE COUPON

inside the handle while the fourth bit is in use. The bits include 3/16-in. and 9/32-in. slotted and #1 and #2 phillips. Sells for \$6.04. Vaco tools are found on dealers counters and peg-board racks

throughout the country. For further information, write to Vaco Products Company, 1510 Skokie Blvd., Northbrook, IL 60062.

### Mobile Hi-Fi Amplifier

Royal Sound's new line of mobile high-fidelity components include the Model IA-400 Mobile high-fidelity integrated amplifier. The IA-400 is a precision pre-amplifier equalizer control console with separate bass and treble controls, automatic power control, LED power indicator, easy input/output connection terminals and high quality heat sinks to easily handle the high power capacity of this 20 watt RMS per channel unit. This model carries a suggested consumer price of \$120.00. Royal Sound Com-

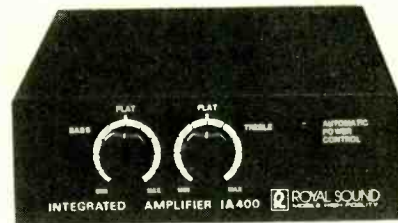

CIRCLE 74 ON READER SERVICE COUPON

pany, Inc. markets a full line of mobile high-fidelity equipment. Get all the facts by writing to them at 248 Buffalo Ave., Freeport, NY 11520.

## Simply Basic

(Continued from page 58)

10 in line 420 to the desired number of guesses.

Your computer system may require you to use quotations around each letter in the DATA statement (Line 300).

Okay. Now load MIND BENDER, and test your brain power.

## Hi-Fi Reports

(Continued from page 15)

way it acts on a record can be more easily understood if you try the following simple experiment: Take a broom and drag it along behind you while walking at a constant speed; now push the end of the handle straight down. Note how the floor end of the broom moves slower across the floor. Now pull the handle back up—the broom moves faster. On a stereo turntable, when the cartridge is pushed down the stylus slows down and when it bounces back up it moves faster across the surface of the album. This causes wow and flutter, an oscillation in the frequency which is quite noticeable in some circumstances.

To eliminate this it is desirable to keep the stylus angle constant which is just what Shure's Dynamic Stabilizer is designed to achieve. The small brush is also made to conduct static electricity off the album and to clear the grooves of dust.

In e/e's test lab the Shure V15 IV easily lived up to expectations. Excellent results were attained throughout the recommended vertical tracking force (VTF) range of 0.75 to 1.25 grams. (Note: since the Dynamic Stabilizer brush exerts a negative tracking force of 0.5 grams it is necessary to set the VTF to 1.75 to get a net VTF of 1.25.) The frequency response measured within +1.5 dB and -1.0 dB from 20 to 20,000 Hz. The channel balance was within 1 dB from 20 to 20,000 Hz and the stereo separation was 23 dB at 1000

Hz and 20 dB at 15,000 Hz. To get more information about Shure's V15 IV cartridge circle No. 65 on the reader's service coupon.

*Hi-fi Report* will be a regular feature in ELEMENTARY ELECTRONICS from now on and I want it to be responsive to your needs. Unfortunately we don't have space to report on every item that you inquire about, but, if there is sufficient interest in a specific piece of equipment, I will get the lab to check it out.

Remember, if you are in the market for your first audio system or want to upgrade your present system, shop around—prices vary from dealer to dealer and you can usually save a bit off the retail price, but you can never save by shortchanging yourself on quality.

## Understanding Microprocessors

(Continued from page 82)

### POSITIVE POWERS OF 8

n	8 <sup>n</sup>
0	1
1	8
2	64
3	512
4	4096
5	32768
6	262144
7	2097152
8	16777216

4-bit binary number can be represented with a 1-digit hexadecimal number. Therefore, to *convert from binary to hexadecimal*: Begin with the *least* significant bit and separate the binary number into 4-bit groups and then convert each 4-bit group directly to its hexadecimal equivalent. This will give you the hexadecimal number equal in value to the binary.

6. Convert binary *fractions* to hexadecimal the same way, but instead of beginning with the least significant bit, the *most* significant bit should be the starting point.
7. When you convert a decimal number to a binary

equivalent, the process is referred to as *coding*. The *pure* binary code is one of many binary codes.

8. Binary coded decimals are easy to use. To represent a decimal number as a binary coded digit (BCD) the appropriate 4-bit code of pure binary numbering is substituted for each of the decimal digits. Advantages to this system is that it is a good *compromise* between men and machines, it is easy to learn and simpler than pure binary. However, it is much *less efficient* than pure binary. Circuits using it must be more complicated, less efficient, and more prone to time delays.
9. The *Gray Code* is a widely-used system. Only one bit changes from one number to the next one in sequence. It minimizes errors in electronic circuitry when it changes from one state to the next. However, it is quite difficult to use in arithmetic computations.
10. ASCII is the microcomputer, data-processing, *alpha-numeric code*. Basically a binary system, it can represent alphanumeric characters through a variety of binary systems using six, seven, or eight bits.
11. *Parity* is the *check bit*, the last bit in a seven or eight-bit ASCII code. It is there to determine if the data has been sent correctly. There is *even* and *odd* parity but both accomplish the same end.
12. BAUDOT code is the ancestor of ASCII. It is hardly in use anymore. It is a 5-bit code and so can only represent 32 characters. Whether a given code represents a letter or a figure must be inputted at the keyboard of the terminal. ■

## DX Central

(Continued from page 25)

gram logs, of what you heard. This would include at least a description of the programs (news, popular music, political commentary, etc.). Better yet, the actual name of the program (BBC Radio Newsreel, DX Merry-go-round, etc.) and pick out specific items or announcements (News Items about Middle East negotiations, a description of Polish country dances, etc.). And indicate, as accurately as you can, the time (in GMT) when each item or program was heard. Your report should cover a 15 to 30 minute period or longer.

You may be wondering where to address your reports to shortwave stations. Two books that will be of help in providing the addresses of SW stations are *World Radio TV Handbook* and the *SWL Address Book*. The former is available from Gilfer Associates Inc., Box 239, Park Ridge, NJ 07656, and Billboard Publications, One Astor Plaza, New York, NY 10036. The latter is available from Gilfer Associates Inc.

**An Alternative to QSL'ing.** Collecting QSLs from stations you hear can be a lot of fun. For many people it is a thrill to find a card or letter from a station half way around the world in their mailbox. There is one drawback to collecting QSLs from stations you hear. It can be rather costly!

Airmail postage to most foreign

countries is 31 cents per half ounce. A reception report could take one or two units of postage to mail, 31 or perhaps 62 cents. Next, there is the cost of incidentals, important incidentals such as stationery and envelopes.

It is generally considered proper to include return postage in your report to a station. Some listeners don't, but your odds of getting a reply from the stations increase if you do. U.S. postage stamps are of no value in mailing a reply from overseas. But mint (unused) stamps from foreign countries can be purchased from stamp dealers or from the DX Stamp Service, 83 Roder Parkway, Ontario, NY 14519. It is also possible to purchase International Reply Coupons at your post office for 42 cents each. These are exchangeable overseas for sufficient postage to send a reply via seemail. Several IRCs are required for an airmail response.

**Tape it.** One way to beat the cost is to forget about collecting QSLs from the stations. Instead, tape record the stations you hear. Not only do your tapes provide the reception proof, they also can be fun to listen to—or play for friends—next week, next month, next year. Tape recordings can let you relive the excitement of hearing a certain station for the first time.

Do some experimenting yourself when it comes to taping your DX catches. But here are a few tips. Rather than using a microphone to pick up the sound from the receiver's speaker, use a "patchcord" from the headphone jack, or external speaker terminal of your re-

ceiver through an attenuating patch cord to the recorder. Don't record long segments of each station, just a minute or so that includes the station's announced identification. Use a reel-to-reel recorder if you can, since it allows you to splice and edit your tapes easier than using a cassette model.

Save some money and have some fun by recording your DX on tape!

**Band Sweep.** Times in GMT, frequencies in kilohertz. 1,295—Trans-Atlantic medium wave DX is possible, particularly for those listeners on the eastern seaboard. The British Broadcasting Corp. outlet at Crowborough was reported as heard with a good signal on this "split" frequency between U.S. stations on 1290 and 1300 kHz, at about 0430. 6,010—Italy's RAI in Rome transmits in English to North America at 0100 on this frequency, 9,022—Iran is a country that quite a few SWLs haven't added to their log book. The Voice of Iran in Teheran can be heard in English at 1930 on this out-of-the-way frequency. 9,650—FEBA, the Far East Broadcasting Association, operates from a rather exotic Indian Ocean spot, the Seychelles islands. You can find it signing on in English at 0315. 15,120—A solid African signal is heard from the Voice of Nigeria at Lagos, Nigeria, at 1800 in English. Credits: Mark Connolly, MA; W. Noel Brown, MI; Bill Sandborn, TN; Kenneth Earhart, PA; Roland Desrosiers, MA; National Radio Club, P.O. Box 3125, Louisville, KY 40232; North American SW Association P.O. Box 13, Liberty, IN 47353 ■



# LITERATURE LIBRARY

301. Get the '78 *Eico* Catalog and see their do-it-yourself kits and factory assembled electronic equipment. Specialties, are test equipment, burglar/fire alarms, hobbyist and auto electronics.
302. *International crystal* has illustrated folders containing product information on radio communications kits for experimenters (PC boards; crystals; transistor RF mixers & amplifiers; etc.).
303. *Regency* has a new low cost/high performance UHF/FM repeater. Also in the low price is their 10-channel monitoradio scanner that offers 5-band performance.
304. *Dynascan's* new *B & K* catalog features test equipment for industrial labs, schools, and TV servicing.
306. Get *Antenna Specialists'* catalog of latest mobile antennas, test equipment, wattmeters, accessories.
308. Compact is the word for *Xcelite's* 9 different sets of midget screwdrivers and nutdrivers with "piggyback" handle to increase length and torque. A handy show case serves as a bench stand also.
310. *Turner* has two catalogs on their CB microphones and antennas. They give individual specifications on both lines. Construction details help in your choice.
311. *Midland Communications'* line of base, mobile and hand-held CB equipment, marine transceivers, scanning monitors, plus a sampling of accessories are covered in a colorful 18-page brochure.
312. *The EDI (Electronic Distributors, Inc.)* catalog is updated 5 times a year. It has an index of manufacturers literally from A to X (ADC to Xcelite). Whether you want to spend 29 cents for a pilot-light socket or \$699.95 for a stereo AM/FM receiver, you'll find it here.
313. Get all the facts on *Progressive Edu-Kits* Home Radio Course. Build 20 radios and electronic circuits; parts, tools, and instructions included.
316. Get the *Hustler* brochure illustrating their complete line of CB and monitor radio antennas.
318. *GC Electronics* offers an "Electronic Chemical Handbook" for engineers and technicians. It is a "problem solver" with detailed descriptions, uses and applications of 160 chemicals compiled for electronic production and packaging. They are used for all types of electronic equipment.
320. *Edmund Scientific's* new catalog contains over 4500 products that embrace many sciences and fields.
321. *Cornell Electronics'* "Imperial Thrift Tag Sale" Catalog features TV and radio tubes. You can also find almost anything in electronics.
322. *Radio Shack's* 1978 catalog colorfully illustrates their complete range of kit and wired products for electronics enthusiasts—CB, ham, SWL, hi-fi, experimenter kits, batteries, tools, tubes, wire, cable, etc.
323. Get *Lafayette Radio's* "new look" 1978 catalog with 260 pages of complete electronics equipment. It has larger pictures and easy-to-read type. Over 18,000 items cover hi-fi, CB, ham rigs, accessories, test equipment and tools.
327. *Avanti's* new brochure compares the quality difference between an Avanti Racer 27 base loaded mobile antenna and a typical imported base loaded antenna.
328. A new free catalog is available from *McGee Radio*. It contains electronic product bargains.
329. Semiconductor Supermart is a new 1978 catalog listing project builders' parts, popular CB gear, and test equipment. It features semiconductors—all from *Circuit Specialists*.
330. There are nearly 400 electronics kits in *Heath's* new catalog. Virtually every do-it-yourself interest is included—TV, radios, stereo and 4-channel, hi-fi, hobby computers, etc.
331. *E. F. Johnson* offers their CB 2-way radio catalog to help you when you make the American vacation scene. A selection guide to the features of the various messenger models will aid you as you go through the book.
332. If you want courses in assembling your own

TV kits, *National Schools* has 10 from which to choose. There is a plan for GLs.

333. Get the new free catalog from *Howard W. Sams*. It describes 100's of books for hobbyists and technicians—books on projects, basic electronics and related subjects.

334. *Sprague Products* has L.E.D. readouts for those who want to build electronic clocks, calculators, etc. Parts lists and helpful schematics are included.

335. The latest edition of the *TAB BOOKS* catalog describes over 450 books on CB, electronics, broadcasting, do-it-yourself, hobby, radio, TV, hi-fi, and CB and TV servicing.

338. "Break Break," a booklet which came into existence at the request of hundreds of CBers, contains real life stories of incidents taking place on America's highways and byways. Compiled by the *Shakespeare Company*, it is available on a first come, first serve basis.

342. *Royce Electronics* has a new 1978 full line product catalog. The 40-page, full-color catalog contains their entire new line of 40-channel AM and SSB CB transceivers, hand-helds, marine communications equipment, and antennas and accessories.

344. For a packetful of material, send for SBE's material on UHF and VHF scanners, CB mobile transceivers, walkie-talkies, slow-scan TV systems, marine-radios, two-way radios, and accessories.

345. For CBers from *Hy-Gain Electronics Corp.* there is a 50-page, 4-color catalog (base, mobile and marine transceivers, antennas, and accessories). Colorful literature illustrating two models of monitor-scanners is also available.

353. *MFJ* offers a free catalog of amateur radio equipment—CW and SSB audio filters, electronic components, etc. Other lit. is free.

354. A government FCC License can help you qualify for a career in electronics. Send for Information from *Cleveland Institute of Electronics*.

355. New for CBers from *Anixter-Mark* is a colorful 4-page brochure detailing their line of base station and mobile antennas, including 6 models of the famous Mark Heliwhip.

356. *Continental Specialties* has a new catalog featuring breadboard and test equipment for the professional and hobbyist. Descriptions, pictures and specifications aid your making a choice.

359. *Electronics Book Club* has literature on how to get up to 3 electronics books (retailing at \$58.70) for only 99 cents each . . . plus a sample Club News package.

361. "Solving CB Noise Problems" is published by *Gold Line* and tells you how to reduce the noise and get a clearer signal. In discussion and diagram you can find out about the kinds of noise, their sources, and the remedies.

362. *B&F Enterprises'* Truckload Sale catalog offers 10% off all merchandise: (military or industrial surplus) speaker kits, TV games, computer terminals, tools, TV components, lenses, and more.

363. Send for *computer enterprises'* catalog of microcomputer systems for personal, business, educational and industrial users. They claim the greatest bargains in microcomputer equipment, systems, parts and supplies.

364. If you're a component buyer or specifier, you'll want this catalog of surplus bargains: industrial, military, and commercial electronic parts, all from *Allied Action*.

365. *Electronic Supermarket* has a new catalog of almost everything in the field—transformers, semiconductors, tv parts, stereos, speakers, P.C. boards, phones, wire and cable, tools, motors.

366. Send for *Poly-Packs'* new catalog featuring hundreds of bargains: new Barrel Pack kits, hobby computer peripheral parts, fiber optics, solar energy chips, digital clocks, and more.

367. *Optoelectronics'* new catalog features their new Frequency Counter, a 6-digit clock calendar kit, mobile LED clock, biorhythm clock, digit conversion kit, and many others.

368. *Cherry Electrical Products* has a handbook describing their new "PRO" keyboard for personal computer, hobbyist and OEM users. Included are instructions on how to customize it on-the-spot, schematics, charts, and diagrams.

369. *Motorola Training Institute* offers a brochure on two new home-study courses: Four lessons cover semiconductors, designed for all technicians servicing electronic equipment; the 34-lesson professional FM two-way radio course is for those planning to service land-mobile equipment.

370. The 1978 catalog from *Computer Warehouse* has data on 10 different microcomputers, with used peripherals, and available for immediate delivery. Over 1,500 products are covered, new and used, from over 170 different vendors.

371. Your computer system needn't cost a fortune. *Southwest Technical Products* offers their 6800 computer complete at \$395 with features that cost you extra with many other systems. Peripheral bargains are included here.

372. See how you can save with *Olson's* "Erector Kit" Computer System; also their factory wired version which includes a 2-volume Bell & Howell instruction course. Send for information.

## ELEMENTARY ELECTRONICS Box 1849, G.P.O. New York, NY 10001

JULY/AUGUST 1978  
Void After December 15, 1978

Please arrange to have the literature whose numbers I have circled below sent to me as soon as possible. I am enclosing 50¢ for each group of 10 to cover handling. (No stamps, please.) Allow 4-6 weeks for delivery.

- |     |     |     |     |     |     |     |     |     |     |     |     |
|-----|-----|-----|-----|-----|-----|-----|-----|-----|-----|-----|-----|
| 301 | 302 | 303 | 304 | 306 | 308 | 310 | 311 | 312 | 313 | 316 | 318 |
| 320 | 321 | 322 | 323 | 327 | 328 | 329 | 330 | 331 | 332 | 333 | 334 |
| 335 | 338 | 342 | 344 | 345 | 353 | 354 | 355 | 356 | 359 | 361 | 362 |
| 363 | 364 | 365 | 366 | 367 | 368 | 369 | 370 | 371 | 372 |     |     |

300  Enter my subscription to Elementary Electronics for 9 issues at \$5.97.

Check enclosed. Add \$1.00 for Canada and all other countries.

H8G018

NAME (print clearly)

ADDRESS

CITY

STATE

ZIP



# Classified

# MARKET

ELEMENTARY ELECTRONICS—is published Bi-monthly. The rate per word for CLASSIFIED ADVERTISEMENTS is \$1.30 payable in advance—minimum ad \$15.00. Capitalized words 40¢ per word additional.

## ADDITIONAL INCOME

**MECHANICALLY INCLINED INDIVIDUALS WANTED ASSEMBLE ELECTRONIC DEVICES IN YOUR HOME.** Get started in spare time. Experience, Knowledge or Investment not Necessary. Expect big profits: \$300-\$600/Wk. Possible. Write for free literature telling how. Electronic Development Lab, Box 1535E, Pinellas Park, FL 33565.

**EXCELLENT** second income working at home. Free details. Rush S.A.S.E. to Pasadena, CA 91104.

## ATHLETIC EQUIPMENT & BODY BUILDING

**NEW!!! POCKET EXERCISER—Easy use.** Anytime, anywhere. Over 100 exercises illustrated. **LIFETIME GUARANTEE!!!** Order NOW—get FREE training instructions for athletes, weightwatchers, bowlers, golf, tennis, joggers . . . \$2.98 + 52¢ handling, Penn, P.O. Box 1354-D1, Clearwater, FL 33517.

## AUTOMOBILES & MIDGET CARS

**TWENTY** car saver formulas helpful hints to save you many dollars in repair bills. \$1.00 Roy Enterprises, 110 New York Ave., Dept. D7, Brooklyn 11216.

## BIG MAIL

**RECEIVE** mail galore! National listing \$1.00. Sullins, Box 1313-EE, Brunswick, GA 31520.

**RECEIVE MONEYMAKING OPPORTUNITIES.** Your name placed with 2,000+ importers, wholesalers, manufacturers, etc. Year listing—\$1.00 (SAVE \$160.00 Postage!) Advertising Agency, Box 123-YNA, Wenonah, NJ 08090.

## BLUEPRINTS, PATTERNS & PLANS

**NEW CRAFT-PRINT CATALOG—Choose from over 100 great easy-to-build plans.** Send \$1.25 (completely refunded with your first order). **BOAT BUILDER**, (CP Div.)—380 Lexington Ave., New York, NY 10017.

**WHAT'S** going on in housing? Get advice on how to economize in modernizing or improving or adding space from idea to completion. Working blueprints available. Send \$1.50 (includes postage) for 110 Better Building Ideas to: Davis Publications, Inc., 380 Lexington Ave., New York, NY 10017.

## BOOKS & PERIODICALS

**CBer's!** Personalized CB decal with a 1-year subscription to Elementary Electronics only \$3.97. E/E, the magazine that covers CB and all areas of radio communication. Send check: Elementary Electronics, Decal Dept., 380 Lexington Ave., New York, NY 10017.

**FREE** Catalogs—Discount Paperbacks—Gambling Systems. Destiny, Box 366-R, Roundlake, IL 60073.

## BUSINESS OPPORTUNITIES

**BECOME** our Mail Order Distributor with \$150 investment. Free brochure. Audit Controls, Box D-35, Emerson, NJ 07630.

**BORROW ANY AMOUNT.** Enjoy A-1 credit. Keep money in bank, get 80% more. Send Stamp. Vernon, Box 75010-HH, Oklahoma City 73107.

**OWN Your Own Business!** Correspondence Club. Magazine, Information, Details 25¢. Destiny, Box 5637-BC, Reno, Nevada 89503.

**MAILORDERS** \$2,000+ Monthly selling information by mail. Free proof! Associates, Box 123-L, Wenonah, NJ 08090.

**BORROW \$25,000 interest free!** indefinitely! Any-Free booklet! Fay's 484E N. Main, Kalispell, MT GA 30518.

**MILLIONS in Mail!** Free Secrets. Transworld-3, Box 6226, Toledo, OH 43614.

**NEW Luxury Car Without Cost!** Free details, CODEX-A, Box 6073, Toledo, OH 43614.

**HOW TO RECRUIT COMMISSION SALES-PEOPLE!** Free Details! Success Publications, P.O. Box 35305, Edina, MN 55435.

**\$300.00 MONTHLY.** Start immediately. Stuff envelopes at home. Information, send self-addressed stamped envelope. Village, Box 2285-DFG, Irwindale, CA 91706.

**OPPORTUNITY!** Earn at home! Good business. Free booklet! Way's 484E N. Main, Kalispell, MT 59901.

**\$180 WEEKLY MAILING** circulars. Start immediately. D'Aluisio, 30 Gladys Ave., #7, Mt. View, CA 94043.

## BUSINESS OPPORTUNITIES—Cont'd

**START** your own Burglar Alarm Business. High profits assembling your own controls. Easy instructions \$2.—Hotman, 427 Pulaski, Greenlawn, NY 11740.

**\$25.00 Daily Possible . . . Home Addressing!** Elite, Box 715-DG, Lynbrook, NY 11563.

**100% PROFIT** Bronzing Baby Shoes. Free Literature. NBC Box 1904-DG, Sebring, FL 33870.

**STAY HOME! EARN BIG MONEY** addressing envelopes. Genuine offer 10¢. Lindco, 3636-DA, Peterson, Chicago 60659.

**BUMPER STICKER PRINTING DEVICE.** Cheap. Simple. Portable. Free Details. Bumper, POB 22791 (J.T.), Tampa, FL 33622.

**How To Write a Classified Ad That Pulls**  
What to Say and How to Say It  
Only \$1.50  
Worth Its Weight In Gold

**MAKE YOUR CLASSIFIED AD PAY.** Get "How to Write a Classified Ad That Pulls." Includes Certificate worth \$2.00 towards a classified ad in this publication. Send \$1.50 (includes postage) to R. S. Wayner, Davis Publications, Inc., Dept. CL, 229 Park Avenue South, New York, NY 10003.

**PLEASE** Be sure to include your zip code when ordering merchandise from classified advertisements. You'll receive faster delivery.

**PHOTO mug-photo button machines.** Brochure. Sample button \$1.00. Write Coffman, 3973M, Glenhaven, Abilene, TX 79603.

**MAIL-ORDER BOOK DEALERS WANTED!** Free Details! Books, P.O. Box 395 B, Excelsior, Minnesota 55331.

**MAKE MONEY.** Unique Mailing Program, No Gimmicks, Free Details. Casler, P.O. Box 111, Wampsville, NY 13163.

**SAVE \$25.00 Or More On Postage.** Eliminate Unnecessary Time Spent Mailing and Addressing! \$2.00 Forwards Your Name and Address to **BUSINESS OPPORTUNITIES, ADDITIONAL INCOME, MONEY-MAKING OPPORTUNITIES, Advertisements,** this Issue. G & G MAILING SERVICE, INC., P.O. Box 4676, MANCHESTER, NH 03105.

**\$3000.00 MONTHLY.** Start immediately. Stuff envelopes at home. Information, send self-addressed stamped envelope Village, Box 2285-DFG, Irwindale, CA 91793.

**BIG Profits** in becoming a supplier to major industry through electroplating small parts and metalizing nonmetals. Write for free particulars: Mason, Room MC-107-HF, 1512 Jarvis, Chicago, IL 60626.

**\$30.00 HUNDRED** stuffing our circulars into stamped addressed envelopes. No limit. Beginners Kit \$2.00. (Refundable). Colossi—Box 333-DC, Brooklyn, NY 11219.

**START** your own business. No investment. Free Details. Bargain House Dept. EE, 1407 South Reservoir, Pomona, CA 91766.

**HOMEWORKERS—\$1000** Weekly mailing circulars! Stamped envelope: KV Advertising, Box 13283, Ft. Carson, CO 80913.

**ENVELOPE** stuffing secrets guaranteed! Free! Wayne, Box 218-LZG, Poteet, TX 78065.

## BUSINESS OPPORTUNITIES—(Cont'd)

**MONEY IN OIL PAINTINGS.** Three highly profitable methods—open an art gallery. Run in home art sale, set up travelling art shows. Details \$2.00. Complimentary Investments, 1723, S. Missouri, Clearwater, FL 33516—(813) 581-8123.

**\$500 Monthly** Clipping Newspaper items. Experience unnecessary. Free Details. American 1108 Colonial, Inkster, MI 48141.

**EARN BIG MONEY** repairing cars. Our book tells how. Send \$3.95 to Minor Car Repairs, P.O. Box 8127, Huntington, WV 25705.

**\$350 WEEKLY** mailing circulars. No gimmicks. Free Proof! REACH 2138 East 75th St., Chicago, IL 60649.

**\$60 hundred** addressing envelopes. Guaranteed earnings. Rasmussen, DP78, 1747 N. 450 E., Ogden, UT 74404.

**COINS** For Profit. Excellent Money Making Hobby. Free Details. Rae's Coins, Box 3591, Stn 'D' Edmonton, Alberta, Canada T5L 4J6.

## BUY IT WHOLESALE

**400,000 BARGAINS** Below Wholesale! Many Free! Liquidations . . . Closeouts . . . Job Lots . . . Single Samples. Free Details. Worldwide Bargain-hunters, Box 730-IO, Holland, MI 49423.

**ELECTRONICS** Surplus plus more. Free Catalogue—Stateside, P.O. Box 805, Oakpark, IL 60303.

## DETECTIVES

**INVESTIGATORS' MANUALS:** Electronic surveillance, lock picking, etc. Write: Mentor, Dept. 5, 135-53 No. Blvd., Flushing, NY 11354.

## DO IT YOURSELF

**ENGRAVING PENCILS** protects against loss, theft, Mark CB's radios, camping and sports equipment. Rush \$2.98 plus 50¢ handling. Phelps, 229 Cedardale, King, NC 27021.

**REPAIR COLOR TV'S.** ANYONE Can. New Easy method. Details Free. Publications, Box 517A, Brea, CA 92621.

**FOR** anyone who wants the satisfaction and economy of repairing, furnishing and maintaining the furniture in his home. Send \$1.50 to FURNITURE, 380 Lexington Ave., New York, NY 10017.

**30-100W Amplifier Kits** under \$53.00. Free catalog: Audiovision, Box 955 Stn B, Willowdale, Ont. M2K 2T6.

## EARTHWORMS

**ATTENTION—EARTHWORM RAISING STARTER KIT.** 1000 select Hybrid Red Wiggler Breeders, 15 lb. SOILESS—ODORLESS bedding, raising instructions, \$29.95 post-paid. Lebers Worm Farm, Stillhouse Road, Freehold, NJ 07728.

## EDUCATION & INSTRUCTION

**USED** Courses! Books! Lists 25¢ SMITH'S, 124 Marlborough, Salem, MA 01970.

**GET INTO BROADCASTING:** Become DJ engineer. Start your own station, get free equipment, records. Free details. "Broadcasting," Box 5516-G7E, Walnut Creek, CA 94596.

**PROFESSIONAL INSTRUCTIONS—Wall Washing, Carpet—Window Cleaning.** \$3.00. Sentry Building Maintenance, 8615 Florence, Downey, CA 90240.

**COLLEGE** degree by mail, via resume. Education, 256D South Robertson, Beverly Hills, CA 90211.

## ELECTRONIC EQUIPMENT & SUPPLIES

**FREE CATALOG:** Electronic supplies—kits for the hobbyist. Low prices. Ankiam Electronics, 4709 nth. 6th St., Wausau, WI 54401.

**BUILD YOUR OWN TV CAMERA.** Great for home and business. Free illustrated catalog. Phone or write: 402-987-3771. ATV Research, 13 E. Broadway Dakota City, ND 58731.

**REPAIR MOTORS! GENERATORS! ALTERNATORS! BUILD TESTERS!** Modectric, Box 7266 Kansas City, MO 64113.

**THERE IS NO CHARGE FOR THE ZIP CODE—PLEASE USE IT IN YOUR CLASSIFIED AD**



# PLACE

To be included in the next issue, please send order and remittance to R. S. Wayner, ELEMENTARY ELECTRONICS, 380 Lexington Ave., New York, N.Y. 10017

**INVENTIONS WANTED**

COMPUTER INTERFACE RF MODULATORS Video monitors, TV cameras. Free catalog. Phone or Write. 402-987-3771. 13-E Broadway, Dakota City, NE 68731.

B&K test equipment. Free catalog. Free shipping. Dinosaur discounts. Spacotron-FG, 948 Prospect, Elmhurst, IL 60126.

WALKIE TALKIE CRYSTALS—We made a great buy and we want to share it with you! Special! While they last. All 40 channels available—in stock—transmit and receive—Fits all walkie talkies \$2.95 PER PAIR, limited time offer! Monitor crystals \$3.95 each. Certified check or money order. C.O.D. ok plus postage and charges—ROLIN DISTRIBUTORS P.O. Box 436, Dunellen, NJ 08812. 201-469-1219.

**EMPLOYMENT INFORMATION**

RADIO-TV Jobs . . . Stations hiring nationwide. Free details: "Job Leads," 1680-HC Vine, Hollywood, CA 90028.

**FOR THE HOME**

PRACTICAL tips for home, garden and workshop can be found in "1001 How-To Ideas." Send \$1.50 for your copy (includes postage) to 1001 How-To Ideas, 380 Lexington Ave., New York, NY 10017.

**GOVERNMENT SURPLUS**

JEEPS—\$59.30—CARS—\$33.50! 200,000 ITEMS—GOVERNMENT SURPLUS—MOST COMPREHENSIVE DIRECTORY AVAILABLE tells how, where to buy—YOUR AREA—\$2.00—MONEYBACK GUARANTEE. Government Information Services, Department E7, Box 99249, San Francisco, CA 94109 (433 California).

**HYPNOTISM**

FREE Fascinating Hypnosis Information! Startling! DLMH, Box 487, Anaheim, California 92805.

**INVENTIONS WANTED**

IDEAS, inventions, new products needed by innovative manufacturers. Marketing assistance available to individuals, tinkers, universities, companies with feasible concepts. Write for Kit-EE, 12th Floor, Arrrott Building, Pittsburgh, PA 15222.

**JEWELRY**

S.S. Turquoise Indian Jewelry at the lowest prices available anywhere. Free brochure. B&W Turquoise Company, P.O. Box 1230-U, Las Vegas, Nevada, 89101. 702-386-5060.

**MAGNETS**

MAGNETS. All types. Specials-20 disc, or 10 bar, or 2 stick, or 8 assorted magnets, \$1.00. Magnets, Box 192-E, Randallstown, MD 21133.

**MAIL-ORDER OPPORTUNITIES**

MAILORDER Secrets to Success. Everything Included, Free. G. J. Ent., 8700 N. Merrill, Niles, IL 60648.

\$1,000 MONTHLY selling information by mail. FREE details. Valentine, Box 6381, Gt. Falls MT 59406.

**MISCELLANEOUS**

PRINTED Circuit Boards from Sketch or Artwork. Free Details DANOCINTHS, Box 261 Westland, MI 48185.

WIN AN ELECTRONIC WORKSHOP! Plus instant prizes! R.T.T.'s New Accelerated Radio & TV course. Radio Television Training, P.O. Box 279-E-56, Syracuse, NY 13206.

WILLS. Outline for preparing your own. Legally binding. \$2. HolRil, P.O. Box 805, Atlanta, GA 30301.

WE may have what you need so send for free catalog. Joan Ellen's Friendly Shoppe, Dept. 25F, Newark-Pompton Tpke., Pequannock, NJ 07440.

**MONEYMAKING OPPORTUNITIES**

\$250.00 profit/thousand possible—stuffing—mailing envelopes. Offer: Rush stamped addressed envelope: Universal-ADVS X16180 Fort Lauderdale, FL 33318.

\$500 thousand stuffing envelopes. Free details. Rush self stamped envelope. R. Mognet Co., Box 449D, Warren, OH 44482.

**MONEYMAKING OPPORTUNITIES—Cont'd**

FANTASTIC Profits: Mailing Circulars Free Samples. Grahamco, DPBX 99371, Tacoma, WA 98499.

WIN \$5,000.00 in monthly free contest. \$5 enrollment enters you full year! Contests, 2830DG-Galley, San Pedro, CA 90731.

MAKE Millions in mail order. Information, tips. \$1.00 to Lamron Ltd., Box 299C, Institute, WV 25112.

\$180.00 WEEKLY Mailing Circulars. Start immediately. Everready, 422A Clermont Ave., Brooklyn, NY 11238.

BECOME Wealthy And Independent in Mail-ordering. A Complete Book that Tells All. John Tabor's GOLDEN MONEY MAKER, 100% Guaranteed, only \$10.95. Box 90370, LA, CA 90009.

MAKE YOUR CLASSIFIED AD PAY. Get "How to Write a Classified Ad That Pulls." Includes certificate worth \$2.00 towards a classified ad in this publication. Send \$1.50 (includes postage) to R. S. Wayner, Davis Publications, Inc., Dept. CL, 380 Lexington Ave., New York, NY 10017.

\$2,000 monthly possible stuffing envelopes! Send stamped self-addressed envelope! Craft, Box 2230 D, Oceanide CA 92054.

EARN \$1000 MONTHLY—Unique Mailing Program! Guaranteed!! FREE DETAILS—L.O.E., Box PD-06180, Portland, OR 97206.

STUFF ENVELOPES, \$250 per thousand. Free Supplies. Rush stamped addressed envelope. L/L Enterprises, Box 226D, Danville, AL 35619.

**OF INTEREST TO ALL**

\$1,000,000. YOU can become millionaire overnight. Eastern States Lotteries. Details free. Send addressed, stamped envelope, Eastern, Box 262-F, Salem, NJ 08079.

**OLD GOLD WANTED**

BUYING GOLD, silver, platinum, any form! Jewelry, sterling, coin, industrial. Prompt appraisal and payment. Your approval guaranteed. American Metallurgy Company, P.O. Box 33009, Charleston, SC 29407.

**PEN PALS**

JOIN North America's leading penpal club. Details from Friends Worldwide CF-95/F Anjou, Montreal, H1K 4G5.

**PERSONAL**

NEW Luxury Car Without Cost! Free Details. Codex-CC, Box 6073, Toledo, OH 43614.

DATES GALORE! Meet singles-anywhere. Call DATELINE, toll-free (800) 451-3245.

ADULT pleasure products—over 600 items! Giant catalog \$1.00. Clifton's, D-1068, Saugus, CA 91351.

DO YOU KNOW "How to Write a Classified Ad That Pulls" includes a certificate worth \$2.00 toward a classified ad in any of our publications? For your copy send \$1.50 (includes postage) to R. S. Wayner, Davis Publications, Inc., Dept. CL, 380 Lexington Ave., New York, NY 10017.

BEAUTIFUL GIRLS from all continents want correspondence, friendship, marriage. Sample photos free. Hermes-Verlag, Box 110660/D, 1000 Berlin 11, Germany.

IMPOTENCE problems? Lack zip? Helpful new report—Free! Reliance-EE2, Box 5157, Santa Monica, CA 90405.

SINGLE? Widowed? Divorced? Nationwide introductions! Identity, Box 315-DC, Royal Oak, MI 48068.

JAPANESE Girls Make Wonderful Wives. We have large number of listings. Many interested in marriage. Only \$1.00 brings application, photos, names, descriptions, questionnaire, Etc. Japan International, Box 156 AA, Carnelian Bay, CA 95711.

BEAUTIFUL Mexican-Oriental girls Needing American Boy-Friends. Free Details "actual" photos. World, Box 3876-DC, San Diego, CA 92103.

"DATE WITH DIGNITY" Professional Matching. Drawer 6765, Fort Worth, 76115 (817) 921-0281.

**PERSONAL—Cont'd**

RECORD telephone conversations privately—automatically. Leave recorder unattended. Robert's, Box 49SM, Parkridge, IL 60068.

FREE: 1,000 LADIES PHOTOS. World's largest Matrimonial Catalog. Postage/Handling \$1.00. Inter-contact, Box 12, Toronto, Canada M4A 2M8.

BEAUTIFUL MEXICAN GIRLS! Friendship, marriage! Photos, information Free. "Latinas," Box 1710-E, Chula Vista, CA 92012.

JAPANESE Introductions! Girls' photographs, descriptions, brochure, details, \$1.00 INTER-PACIFIC, Box 304-SC, Birmingham, MI 48012.

SWEDISH women travelling country! All cities, towns. Details, photos \$1.00. Ingrid, 2520 N. Lincoln, Suite 255-A, Chicago 60614.

**PHOTOGRAPHY-PHOTO FINISHING & SUPPLIES**

SAVE HUNDREDS OF DOLLARS!!! Make your own S & M Densitometer. Send \$3.00 for detailed drawings and instructions. A must for successful photography in your darkroom. Order direct: S & M Instruments, Dept. EE7, 380 Lexington Ave., New York, NY 10017.

**RADIO & TELEVISION**

TV TUBES 36¢ each. Send for Free 48 page color catalog. Cornell, 4217-W University, San Diego, California 92105.

BUILD Distance Crystal Sets. 10 plans—25¢; Handbook "18 Different"—50¢; "20 Different"—50¢. Catalog—25¢, refundable. Laboratories, 1477-G, Garden Grove, CA 92642.

BROADCAST STATION: Operate from home, school, church. Receive free tapes, records. Learn details! Broadcasting, Box 5516-GA, Walnut Creek, CA 94596.

SHORTWAVE DXers! Reception report sheets and postcards now available 4x6 inches. Large space for program details and all information needed for QSL. Pad of 30—1.00. Postcards—10 each. Minimum order: 200. RAB, Box 386, North Myrtle Beach, South Carolina 29582.

"DISTANCE One Tuber" Handbook—50¢. 15 Distance one tube plans—25¢. Catalog 25¢ refundable. Laboratories, 1477-G, Garden Grove, CA 92642.

LINEAR AMPLIFIERS, 25-100 watt solid state. OMNIPOLARIZED BASE ANTENNAS. Portable/mobile/memory/300 MHZ FREQUENCY COUNTER. Construction plans: \$3.00 each, 3/\$7.50. Specify frequency band! Kits available. Free catalog! PANAXIS, Box 5516-G5E, Walnut Creek, CA 94596.

TUBES Oldies, latest. Supplies, components, schematics. Catalog free. (Stamp appreciated). Steinmetz, 7519-EE Maplewood, Hammond, IN 46324.

**RUBBER STAMPS**

RUBBER stamps made. Three lines \$3.75. Rubber Stamps, B1337-E8, Waldo, AR 71770.

**SCIENCE & CHEMISTRY**

FIREWORKS. Spectacular novelties, simplified manufacturers textbook, \$5.00. Guaranteed. Tropic, Box 95M4, Palm Bay, FL 32905.

**SELF-IMPROVEMENT**

YOU ARE WHAT YOU EAT—the key to losing weight. An easy diet plan for you. Suggested Menus for the week, easy lunches to eat out, special recipes for \$1.50. Eleanor Albert, 24641 Parklawn, Oak Park, MI 48237.

**SONGWRITERS**

SONGWRITERS: Exciting offer—poems, songs needed—Free evaluation—Creative Music Productions, Box 1943-A7, Houston, TX 77001.

THERE IS NO CHARGE FOR THE ZIP CODE. PLEASE USE IT IN YOUR CLASSIFIED AD.

**START YOUR OWN BUSINESS**

GET World's Biggest Wholesale Import Merchandise Catalog. Details Free. Worldround-P. Medina, WA 98039.

**WATCHES, WATCHMAKING & REPAIRING**

WATCH and clock repairing books, tools, materials. Free catalog North American, Box 77, EE43, Fox River Grove, IL 60021.

**THERE IS NO CHARGE FOR THE ZIP CODE—PLEASE USE IT IN YOUR CLASSIFIED AD**



## Love That Lettering

(Continued from page 63)

with a brush-on spray coating. It's best to use products made for this specific purpose, which should be available from the same sources as the rub-on lettering. Ordinary lacquers, clear fingernail polish, etc., are likely to damage the lettering. Always make a test beforehand or you may end up with an ugly mess.

Here are some additional suggestions:

- 1) Read the instructions (if any) that accompany the lettering set.
- 2) If this is your first experience with rub-on lettering, practice on scrap material first to get the feel of it.

## NewsScan

(Continued from page 27)

tion generated inside the lamp. The white light of a fluorescent lamp is produced by combining different phosphors into a mixture that emits a spectrum of colors of visible light, such as red, green, or blue. GE's energy-saving Watt-Miser II lamp utilizes a highly efficient combination of phosphors. Es-

## ELEMENTARY ELECTRONICS INDEX TO ADVERTISERS

RS#	ADVERTISER	PAGE
—	AMC	83
30	Aldelco	88
25	Avanti	8
5	B & F Enterprises	86
22	B & K Precision	12
—	Barta	26
—	CFR	25
—	CIE	4-7
6	Cobra	3
28	Continental Specialties	CV3
42	Delta Electronic Co.	86
43	Digi-Key Corp	83
2	Eico	16
—	Electronics Surplus Supply	26
35	Electronic Systems	84
9	Extron Life Screens	23
34	E V Game	10
11	Giffer	14
12	Godbout	83
1	Heath Co.	13
—	Information Unlimited	26
13	International Crystal	25
14	Kester Solder	23
41	Locksmithing	26
—	McGee	25
19	McKay Dymek	14
24	Meshna	88
—	Moonlighter	25
39	Non Linear	26
44	Non Linear	26
—	NRI	18-21
—	NTS	28-31
20	OK Machine & Tool	9
16	Page Digital	86
15	PAIA	22
18	Polypaks	85
23	President	CV2
17	Progressive Edu-Kit	11
45	Projecta-Pix	16
—	Radio Shack	CV4
—	Radio Shack	87
29	Sabtronics	25
26	Southwest Technical	1
21	Tab Books	27
36	Trionetics	27
38	Vector	24
8	Yeasu	32

- 3) When applying the lettering, keep a backing sheet beneath the part of the carrier sheet that you are not using. This prevents unwanted letters from transferring and also keeps the lettering clean. Dirt or skin oils can interfere with adhesion.
- 4) To align rows of letters or words, tape a strip of paper to the panel about 1/16-inch below where the row will go.
- 5) A word made from individual letters can be centered by starting in the middle and working outward to both ends.
- 6) Applying lettering in cramped spaces, such as on assembled equipment, can be made easier by cutting up the carrier sheet.
- 7) Rub-on lettering is also useful on meter scales and printed circuit artwork or boards. ■

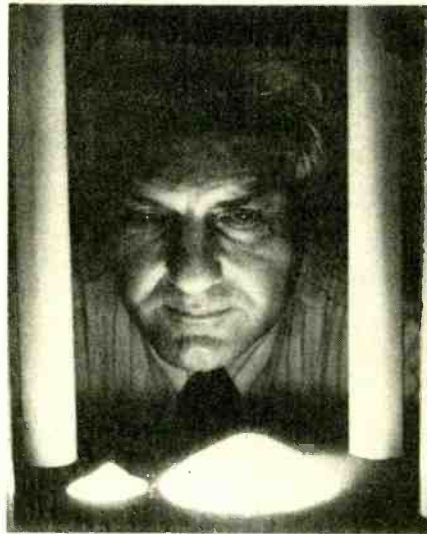

The two ingredients of a new phosphor credited with improved fluorescent lamp efficiency are examined by Dr. William Piper of GE's Research and Development center. The resulting lamps produce more light from less watts to save energy.

entially, GE scientists found a practical way of eliminating the deep blue and red colors that are usually produced by fluorescent lamp phosphors. Human eyes are relatively insensitive to those colors. Energy saved by GE's removal of the deep blue and red colors is then used in more effective parts of the color spectrum, with a resultant increase in lamp efficiency. For example, GE's new Watt-Miser II lamp produces 86 lumens per watt (LPW). By contrast, GE's original Watt-Miser lamp, introduced three years ago, produces 80 LPW, while its 40-watt Mainlighter fluorescent lamp produces 77 LPW.

Next time you shop at a supermarket, add up the running feet of fluorescent lamps and multiply by ten watts. You'll agree that a 14% power savings will save a lot of money and fuel. ■

## Mack the Tach

(Continued from page 36)

and sunlight are best. The trouble with fluorescents is that their light output is intensity-modulated at 120 Hz., which is equivalent to 7200 RPM. Depending upon the exact characteristics of the fluorescent lamp and its distance from the photo-probe, erroneous readings can result from the use of such sources.

There are basically two different ways of using a photo-tachometer; the choice of method depends on whether or not the rotating object can chop a beam of light. Consider first those devices which can chop a light beam, such as fans, propellers, pulley spokes, and even drive chains. With these you simply place the rotating object between the light source and photo-probe, thus allowing the propeller or whatever to chop the light that falls on Q1. Start with a distance of about six feet between your light source (100-watt lamp plus reflector) and the photo-probe. Decrease the spacing until you obtain a steady indication on M1. Further decrease in distance will not affect this reading. Make note of this working distance for future reference. Of course, if you are using sunlight, the above directions don't apply.

Note that if the propellor has two blades, your reading on M1 will be twice the actual speed of rotation. Likewise, four blades yield a reading that is four times too high, and so on. Do not use any backlighting (light coming from probe side of what you're measuring.).

The other mode of operation relies on reflection to supply light pulses to Q1. We have diagrammed a dark-colored wheel, to which a small piece of aluminum foil has been attached. Once every cycle, the foil is in a position that enable it to reflect light from the source onto the photo-probe. Measurements by reflection may tend to be tricky, since you have to set up the angles just right. Nevertheless, a little experimentation is usually all that's necessary to get things working. The total light path—from source to reflector to photo-probe—should be less than or equal to the working distance you determined for the previous case with the propellor. Sometimes stray reflections in this mode can be troublesome, since they may prevent Q1 from cutting off (i.e., ceasing to conduct). A careful elimination of all extraneous sources of reflection will solve this problem.

As a final observation, note that Mack the Tach is a very flexible measuring instrument; its applications are limited only by your own ingenuity. So, when you come upon a measuring task that has not been described here, don't be afraid to experiment! ■



# FREQ. OUT.

CSC's done it again.

Broken the price and performance barriers with new MAX-10C. The multi-mode, professional portable frequency counter that gives you more range, visibility, accuracy and versatility than any comparable unit at anywhere near its low, low price.

## MAXimum performance.

MAX-10C is a cinch to use. It gives you *continuous readings* from 20Hz to a *guaranteed 100MHz*, with 8-digit accuracy. Fast readings with 1/6-sec. update and 1-sec. sampling rate. Precise readings, derived from a crystal-controlled time base with 3ppm accuracy. High-sensitivity readings from signals as low as 50 mV with *diode overload protection* up to 20kV peaks.

Input signals over 100MHz automatically flash the most significant digit. And to indicate low-battery condition and extend remaining battery life, the *entire display* flashes at 1Hz.

**MAXimum versatility.** Wherever and whenever you need accurate frequency readings, MAX can do the job. Use it with clip-lead cable supplied. Mini-whip antenna. Or low-loss in-line tap with UHF connectors. For AM/FM, CB, ham, business radio and R/C transmitter or receiver alignment. Monitoring audio and RF generators. Checking computer clocks

and other digital circuits. Repair of depth solderers and fish spotters. Troubleshooting ultrasonic remote controls. For these, and hundreds of other applications, you'll find it indispensable.

**MAXimum visibility.** MAX-10C features a big, bright 0.6" multiplexed 8-digit LED display, with leading-zero blanking. So you don't have to squint, or work up close. And, MAX's flip-up stand is *built-in*.

**MAXimum flexibility.** MAX-10C operates from *four* power sources, for use in labor field. Internal alkaline or NiCad batteries. 110 or 220V with charger/eliminator. 12V with automobile cigarette-lighter adapter/charger. And external 7.2-10V supply.

**MAXimum value.** With all its impressive specs, you'd expect MAX to cost a lot more than a low \$134.95, complete with clip-lead cable and applications instruction manual. But that's another nice thing about MAX: though it's accurate enough for lab use, it's well within the reach of hobbyists' and CB-ers' budgets.

Order today. Call 203-624-3103 (East Coast) or 415-421-8872 (West Coast): 9 a.m.-5 p.m. local time. Major credit cards accepted. Or see your CSC dealer. Prices slightly higher outside USA.

## Specifications.

Range: 20 Hz to 100 MHz, guaranteed  
 Gate time: 1 sec. Resolution: 1 Hz Accuracy:  $\pm 1$  count - time base error  
 Input Impedance: 1 M $\Omega$ , 36 pF Coupling: AC, Sine  
 Wave Sensitivity: 30 mV RMS @ 50 MHz. Internal Time Base Frequency: 3.579545 MHz crystal osc. Stability:  $\pm 3$  ppm @ 25°C.  
 Temp. Stability: Better than 0.2 ppm/°C, 0-50°C Max. Aging:  $\pm 1$  ppm/year Display: Eight 6" LED digits; anti-glare window. Leading-zero blanking; decimal point appears between 6th and 7th digit when input exceeds 1 MHz.  
 Overflow: with signals over 99,999,999 Hz, most significant (left-hand) digit flashes, allowing readings in excess of 100 MHz. Display update: 1/6-sec. or 1 sec. gate time. Low Battery Indicator: When power supply falls below 6.6 VDC all digits flash @ 1 Hz rate. Flashing display extends battery life. Power: 6 AA Alkaline or NiCad cells (internal); External: 110 or 220 VAC Eliminator/charger; Auto cigarette lighter adapter; 7.2-10 VDC ext. supply; Bat. Charging: 2-4 hr. Size (HWD): 1.75" x 5.63" x 7.75" (1.45 x 1.30 x 19.69 cm.)  
 Weight: Less than 1.5 lb. (0.68 kg.) w/batteries.  
 Accessories included: Clip-lead input cable manual.

CONTINENTAL SPECIALTIES CORPORATION



70 Fulton Terrace, Box #42, New Haven, CT 06509  
 203-624-3103 TWP X 719-462-227  
 WEST COAST: 35 California St., San Francisco, CA 94104,  
 415-421-8872 TWX 910-72-3992  
 GREAT BRITAIN: CSC LTD.,  
 Spur Road, North Feltham Trading Estate,  
 Feltham, Middlesex, England.  
 01-890-8782 Int'l Telex 351-881-3669  
 CANADA: Len Finkler Ltd., Ontario  
 CIRCLE 28 ON READER SERVICE COUPON

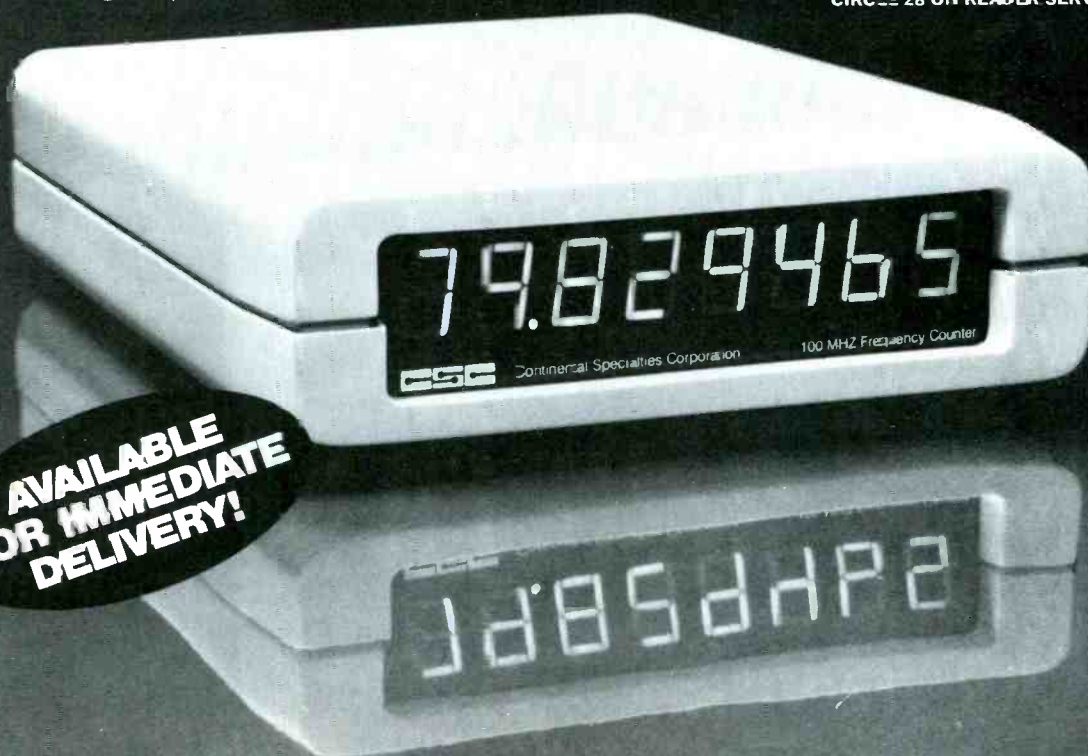

**AVAILABLE FOR IMMEDIATE DELIVERY!**



Maxell? TDK? Scotch? BASF? Memorex? Ampex? Sony?

**Suddenly there's a  
new name that eliminates  
the confusion (and ad-fusion):**



# Supertape Gold.



"I'm Peter Nero. I kid you not. Supertape Gold is everything they say it is even though the guy who wrote the ad is a personal friend."

Could a Radio Shack own-make cassette tape be the greatest new formula in ferric-oxide 5-step-calendering audio tape? And isn't it neat that Supertape Gold requires no special bias settings? Well, we've built the tape, we've compared it in our labs with the summa cum hi-fi brands named above. And now it's your turn to see if your ears and your tape head confirm our findings. Fortunately, the price for your experiment is trifling. If we're right, and Supertape Gold is indeed a breakthrough, then we both win. You get cleaner sound. And Radio Shack gets to be your cassette tape company — all 6,444 of our American and Canadian stores and dealers. 'Tis a consummation devoutly to be wished!

**SUPERTAPE<sup>®</sup> GOLD. Sold Only at:**

**Radio Shack<sup>®</sup>**

A Division of Tandy Corporation, Fort Worth, Texas 76102