

CITIZENS BAND HOBBY RESTRICTION LIFTED BY FCC

Lightning  
Electronics

© 02342

NOVEMBER-DECEMBER

1975

\$1.00

# elementary Electronics

FOR  
BEGINNERS  
**MAGNETISM  
FOR  
ELECTRONICS**  
OUR BASIC COURSE

## GREAT PROJECTS

Simulate space  
flight, make  
superior recordings

## SOUNDING OFF

How Hi Is FM Fi?  
A radio station  
engineer speaks out!

## THEORY

ants on  
shift  
ements

12 62 4295 02V-270R-1 17C11  
JOE 02V0L D  
27 BURNS ST  
JOHNSON CITY  
NY 13790



## PLUS-

Facts for nostalgia buffs and collectors from the days of early wireless • All about an incredible shrinking motorcycle • Our regular SWL, CB, Letters, and Antique Radio Columns • And, we test a continuous-tuning crystal-controlled portable shortwave receiver called Barlow Wadley!

Hunting for  
a better job?

CIE will  
help you get  
the license  
you need

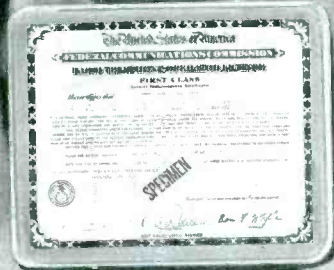

**A Government FCC License can help you qualify for an exciting, rewarding career in ELECTRONICS, the Science of the Seventies. Read how you can prepare at home in your spare time to pass the FCC Licensing examination.**

If you're out to bag a better job in Electronics, a Government FCC License can give you a shot at job opportunities with *real* futures.

According to the U.S. Office of Education Bulletin (4th Edition): "The demand for people with technical skills is growing twice as fast as for any other group, while jobs for the untrained are rapidly disappearing." There are new openings every year in many different industries for electronics specialists. And you don't need a college education to qualify.

But you *do* need knowledge . . . knowledge of electronics fundamentals. And one of the nationally accepted methods of measuring this knowledge . . . is the licensing program of the FCC (Federal Communications Commission).

**Importance of an FCC License and CIE's Warranty of Success**

If you want to work in commercial broadcasting . . . television or AM or FM broadcasting . . . as a broadcast engineer, federal law requires you to have a First Class Radiotelephone License. Or if you plan to operate or to maintain mobile two-way communications systems, microwave relay stations or radar and signaling devices, a Second Class FCC License is required.

But even if you aren't planning a career which involves radio transmission of any kind, an FCC "ticket" is valuable to have as Government certification of certain technical skills. It's a job credential recognized by some employers as evidence that you really know your stuff.

So why doesn't everyone who wants a good job in Electronics get an FCC License?

It's not that simple. To get an FCC License, you must pass a Government licensing exam.

A good way to prepare for your FCC License exam is to take one of the CIE career courses which include FCC License preparation. We are confident you can successfully earn your license, if you're willing to put forth an effort, because the vast majority of CIE students have. In fact, based on continuing surveys, close to 9 out of 10 CIE graduates have passed their FCC exams!

That's why we can offer this time-tested Warranty of Success: when you successfully complete any CIE career course which includes FCC License preparation, you will be able to pass the Government FCC Examination for the License for which the course prepared you or you will be entitled to a full refund of an amount equal to the cash price of tuition for CIE's Course No. 3, "First Class FCC License," in effect at the time you enrolled. This warranty is good from the date you enroll until the last date allowed for completion of your course.

**CIE HAS CAREER COURSES THAT INCLUDE "HANDS ON" TRAINING**

**ELECTRONICS TECHNOLOGY with LABORATORY Courses** . . . takes beginner from fundamentals to skills required of technician or engineering assistant. Includes Experimental Electronics Laboratory for "hands on" training.

**COLOR TV MAINTENANCE and REPAIR** . . . several CIE courses combine electronics theory with the actual construction, testing and troubleshooting a big screen, stolid state color TV.

**With CIE you learn at home**

With CIE, you learn in your spare time at home . . . or wherever else is convenient. No classroom time, ever. No one to make you go too fast . . . or too slow. With CIE's Auto-Programmed® Lessons you'll pick up facts, figures, and electronics theories you may have considered "complicated" . . . even if you've had trouble studying before.

**You can have attractive job opportunities**

There have already been many exciting developments and breakthroughs in Electronics and some people might assume there will be no new frontiers . . . no new worlds to conquer. Not so.

Electronics is still growing. In nearly every one of the new and exciting fields of the Seventies you find electronics skills and knowledge in demand. Computers and data processing. Air traffic control. Medical technology. Pollution control. Broadcasting and communications. Once you have the solid technical background you need, you can practically choose the career field you want . . . work for a big corporation, a small company or even go into business for yourself.

Yes, Electronics can be the door to a whole new world of career opportunities for you. And CIE training can be your key.

**Send for FREE school catalog**

Discover the opportunities open to people with electronics training. *Learn* how CIE career courses can help you build new skills and knowledge and prepare you for a meaningful, rewarding career. We have courses for the beginner, for the hobbyist, for the electronics technician, and for the electronics engineer. Whether you are just starting out in Electronics or are a college-trained engineer in need of updating (or anywhere in between), CIE has a course designed for *you*.

Send today for our FREE school catalog and complete package of career information. For your convenience, we will try to have a representative call to assist in course selection. Mail reply card or coupon to CIE . . . or write: Cleveland Institute of Electronics, Inc., 1776 East 17th Street, Cleveland, Ohio 44114. Do it TODAY.

**APPROVED UNDER G. I. BILL**

All CIE *career* courses are approved for educational benefits under the G.I. Bill. If you are a Veteran or in service now, check box for G.I. Bill information.

**CIE Cleveland Institute of Electronics, Inc.**

1776 East 17th Street, Cleveland, Ohio 44114  
Accredited Member National Home Study Council

**Cleveland Institute of Electronics, Inc.**

1776 East 17th Street, Cleveland, Ohio 44114

Please send me your FREE school catalog and career information package today.

I am especially interested in:

- Electronics Technician
- FCC License Preparation
- Color TV Maintenance
- Mobile Communications
- Industrial Electronics
- Electronics Engineering
- Other \_\_\_\_\_

Print Name \_\_\_\_\_

Address \_\_\_\_\_ Apt. \_\_\_\_\_

City \_\_\_\_\_

State \_\_\_\_\_ Zip \_\_\_\_\_ Age \_\_\_\_\_

Check box for G.I. Bill information.

- Veteran
- On Active Duty

EL-60

# elementary electronics

Dedicated to  
America's  
Electronics  
Hobbyists

Including Electronics Digest®

## TWO BUILD-IT BONANZAS

- 41 Project Spaceflight—*this analog computer project will get you into orbit* ★
- 63 Photo Firefly—*an audio/visual timer for darkroom use*

## BEHIND THE CB HEADLINES

- 72 Kathi's CB Carousel—*communiqués from communicators* ★
- 82 Latest CB Rules & Regs Changes—*the FCC removes CB hobby restrictions!* ★

## RADIO WAVES ALL WAYS

- 26 DX Central Reporting—*three money-saving tools from Don Jensen*
- 60 Ham Radio Special: Vertical All-Band Antenna on a Postage Stamp
- 70 e/e Checks Out the . . . Barlow Wadley Portable SW Receiver ★
- 80 DX in Comfort—*with an easy-to-build headphone adaptor*

## SPEAKING OF AUDIO

- 56 Putting Hi-Fi in the Rear Deck—*the budget way to big highway sound*
- 73 Build a True Peak Reading Meter—*a must for every tape recordist*

## THEORY AND PRACTICE

- 47 What's Wrong with FM Radio?—*compression, noise, and distortion, for starters* ★
- 77 An Old Flash from a New IC—*this "chip off the old block" has many uses*
- 81 Phase and Frequency Measurements—*some oscilloscope tips for you* ★
- 83 Basic Course—*all about magnetism for electronics* ★

## GOLDEN OLDIES

- 53 From the Days of Early Wireless—*circuits and kit construction from yesteryear*
- 58 Antique Radio Corner—*exploring tuning indicators from the '30s*

## OUR REGULARS

- 6 Hey, Look Me Over
- 17 Reader Service Page
- 24 Bookmark
- 34 Newscan
- 38 Ask Hank, He Knows!
- 97 Literature Library
- 100 Classified Ads

★ Cover Features

• **Editor-in-Chief**—Julian S. Martin, WA2CQL • **Technical Editor**—Peter L. Dennis, WA3LOQ  
• **Audio Editor**—Stephen B. Gray • **Associate Editor**—Jeffrey Apter • **News Editor**—  
Rosina F. Sokolnicki • **Citizens Band Editor**—Kathi Martin, KGK3916 • **Workbench Editor**—  
Hank Scott • **Art and Production Managing Director**—Gertrud Borchardt • **Graphic  
Design Director**—Ralph Rubino • **Cover Art Director**—Irving Bernstein • **Art Assistants**—  
John Harper, Kenneth Kummer, Joseph Orlando, David Pindar • **Advertising Director**—  
David J. Miller • **Assistant Production Editor**—Philip Clark • **Newsstand Circulation Director**—  
Don Gabree • **Subscription Circulation & Marketing Director**—Robert V. Enlow • **Instruments  
Division Manager**—Wilfred M. Brown • **Director of Market Development**—James C. Weakley  
• **Electronics Group Coordinator**—Julian S. Martin

• **President, Chairman of the Board (1957-1972)**—B. G. Davis • **President and Publisher**—Joel  
Davis • **Vice President and General Manager**—Leonard F. Pinto • **Vice President and Treasurer**—  
Victor C. Stabile, KBP0681

November-December 1975  
Volume 15, No. 6



Cover photo by Leonard Studios



## AUTHORS IN THIS ISSUE

James A. Fred, Herb Friedman, Charles Green, Don Jensen, Jackson Kaye, Kathi Martin, James Randall, Hank Scott, Thomas R. Sear, Malcolm K. Smith, Harry Stavert, Jan Unser, and the ELEMENTARY ELECTRONICS editorial staff.

ELEMENTARY ELECTRONICS is published bi-monthly by Davis Publications, Inc. Editorial and Executive offices: 229 Park Ave. So., New York, NY 10003; all subscription orders and mail regarding subscriptions should be sent to P.O. Box 2600, Greenwich, CT 06830. One-year subscription (six issues)—\$6.50; two-year subscription (12 issues)—\$13.00; three-year subscription (18 issues)—\$19.00; and four-year subscription (24 issues)—\$25.00. Add 50 cents postage for each year for U.S. possessions and Canada; \$1 each year, all other countries. For change of address, please advise 4 to 6 weeks before moving. Send us your current mailing label with new address. Advertising offices: New York, 229 Park Avenue South, 212-673-1300; Chicago, 520 N. Michigan Ave., 312-527-0330; Los Angeles; J. E. Publishers' Rep. Co., 8732 Sunset Blvd., 213-659-3810. Second-class postage paid at New York, NY and at additional mailing office.

Copyright 1975 by  
Davis Publications, Inc.

# BUILD 20 RADIO

## and Electronics Circuits

### PROGRESSIVE HOME RADIO-T.V. COURSE

Reg. U. S. Pat. Off.



Training Electronics Technicians Since 1946

#### Now Includes

- ★ 12 RECEIVERS
- ★ 3 TRANSMITTERS
- ★ SQ. WAVE GENERATOR
- ★ SIGNAL TRACER
- ★ AMPLIFIER
- ★ SIGNAL INJECTOR
- ★ CODE OSCILLATOR

- ★ No Knowledge of Radio Necessary
- ★ No Additional Parts or Tools Needed
- ★ EXCELLENT BACKGROUND FOR TV
- ★ SCHOOL INQUIRIES INVITED
- ★ Sold In 79 Countries

#### YOU DON'T HAVE TO SPEND HUNDREDS OF DOLLARS FOR A RADIO COURSE

The "Edu-Kit" offers you an outstanding PRACTICAL HOME RADIO COURSE at a rock-bottom price. Our Kit is designed to train Radio & Electronics Technicians, making use of the most modern methods of home training. You will learn radio theory, construction practice and servicing. THIS IS A COMPLETE RADIO COURSE IN EVERY DETAIL.

You will learn how to build radios, using regular schematics; how to wire and solder in a professional manner; how to service radios. You will work with the standard type of punched metal chassis as well as the latest development of Printed Circuit chassis.

You will learn the basic principles of radio. You will construct, study and work with RF and AF amplifiers and oscillators, detectors, rectifiers, test equipment. You will learn and practice code, using the Progressive Code Oscillator. You will learn and practice trouble-shooting, using the Progressive Signal Tracer, Progressive Signal Injector, Progressive Dynamic Radio & Electronics Tester, Square Wave Generator and the accompanying instructional material.

You will receive training for the Novice, Technician and General Classes of F.C.C. Radio Amateur Licenses. You will build Receiver, Transmitter, Square Wave Generator, Code Oscillator, Signal Tracer and Signal Injector circuits, and learn how to operate them. You will receive an excellent background for television, Hi-Fi and Electronics.

Absolutely no previous knowledge of radio or science is required. The "Edu-Kit" is the product of many years of teaching and engineering experience. The "Edu-Kit" will provide you with a basic education in Electronics and Radio, worth many times the low price you pay. The Signal Tracer alone is worth more than the price of the kit.

#### THE KIT FOR EVERYONE

You do not need the slightest background in radio or science. Whether you are interested in Radio & Electronics because you want an interesting hobby, a well paying business or a job with a future, you will find the "Edu-Kit" a worth-while investment. Many thousands of individuals of all

ages and backgrounds have successfully used the "Edu-Kit" in more than 79 countries of the world. The "Edu-Kit" has been carefully designed, step by step, so that you cannot make a mistake. The "Edu-Kit" allows you to teach yourself at your own rate. No instructor is necessary.

#### PROGRESSIVE TEACHING METHOD

The Progressive Radio "Edu-Kit" is the foremost educational radio kit in the world, and is universally accepted as the standard in the field of electronics training. The "Edu-Kit" uses the modern educational principle of "Learn by Doing." Therefore you construct, learn schematics, study theory, practice trouble shooting—all in a closely integrated program designed to provide an easily-learned, thorough and interesting background in radio.

You begin by examining the various radio parts of the "Edu-Kit." You then learn the function, theory and wiring of these parts. Then you build a simple radio. With this first set you will enjoy listening to regular broadcast stations, learn theory, practice testing and trouble-shooting. Then you build a more advanced radio, learn more advanced theory and techniques. Gradually, in a progressive manner, and at your own rate, you will find yourself constructing more advanced multi-tube radio circuits, and doing work like a professional Radio Technician.

Included in the "Edu-Kit" course are Receiver, Transmitter, Code Oscillator, Signal Tracer, Square Wave Generator and Signal Injector Circuits. These are not unprofessional "breadboard" experiments, but genuine radio circuits, constructed by means of professional wiring and soldering on metal chassis, plus the new method of radio construction known as "Printed Circuitry." These circuits operate on your regular AC or DC house current.

#### THE "EDU-KIT" IS COMPLETE

You will receive all parts and instructions necessary to build twenty different radio and electronics circuits, each guaranteed to operate. Our Kits contain tubes, tube sockets, variable, electrolytic, mica, ceramic and paper dielectric condensers, resistors, tie strips, hardware, tubing, punched metal chassis, Instruction Manuals, hook-up wire, solder, selenium rectifiers, coils, volume controls and switches, etc.

In addition, you receive Printed Circuit materials, including Printed Circuit chassis, special tube sockets, hardware and instructions. You also receive a useful set of tools, a professional electric soldering iron, and a self-powered Dynamic Radio and Electronics Tester. The "Edu-Kit" also includes Code Instructions and the Progressive Code Oscillator, in addition to F.C.C. Radio Amateur License training. You will also receive lessons for servicing with the Progressive Signal Tracer and the Progressive Signal Injector, a High Fidelity Guide and a Quiz Book. You receive Membership in Radio-TV Club, Free Consultation Service, Certificate of Merit and Discount Privileges. You receive all parts, tools, instructions, etc. Everything is yours to keep.

#### PRINTED CIRCUITRY

At no increase in price, the "Edu-Kit" now includes Printed Circuitry. You build a Printed Circuit Signal Injector, a unique servicing instrument that can detect many Radio and TV troubles. This revolutionary new technique of radio construction is now becoming popular in commercial radio and TV sets.

A Printed Circuit is a special insulated chassis on which has been deposited a conducting material which takes the place of wiring. The various parts are merely plugged in and soldered to terminals.

Printed Circuitry is the basis of modern Automation Electronics. A knowledge of this subject is a necessity today for anyone interested in Electronics.

#### FREE EXTRAS

##### • SET OF TOOLS

- SOLDERING IRON
- ELECTRONICS TESTER
- PLIERS-CUTTERS
- VALUABLE DISCOUNT CARD
- CERTIFICATE OF MERIT
- TESTER INSTRUCTION MANUAL
- HIGH FIDELITY GUIDE • QUIZZES
- TELEVISION BOOK • RADIO TROUBLE-SHOOTING BOOK
- MEMBERSHIP IN RADIO-TV CLUB: CONSULTATION SERVICE • FCC AMATEUR LICENSE TRAINING
- PRINTED CIRCUITRY

#### SERVICING LESSONS

You will learn trouble-shooting and servicing in a progressive manner. You will practice repairs on the sets that you construct. You will learn symptoms and causes of trouble in home, portable and car radios. You will learn how to use the professional Signal Tracer, the unique signal injector and the dynamic Radio & Electronics Tester. While you are learning in this practical way, you will be able to do many a repair job for your friends and neighbors, and charge fees which will far exceed the price of the "Edu-Kit." Our Consultation Service will help you with any technical problems you may have.

#### FROM OUR MAIL BAG

J. Stataitis, of 25 Poplar Pl., Waterbury, Conn., writes: "I have repaired several sets for my friends, and made money. The "Edu-Kit" paid for itself. I was ready to spend \$240 for a Course, but I found your ad and sent for your Kit."

Ben Valerio, P. O. Box 21, Magna, Utah: "The Edu-Kits are wonderful. Here I am sending you the questions and also the answers for them. I have been in Radio for the last seven years, but like to work with Radio Kits, and like to build Radio Testing Equipment. I enjoyed every minute I worked with the different kits: the Signal Tracer works fine. Also like to let you know that I feel proud of becoming a member of your Radio-TV Club."

Robert L. Shuff, 1544 Monroe Ave., Huntington, W. Va.: "Thought I would drop you a few lines to say that I received my Edu-Kit, and was really amazed that such a bargain can be had at such a low price. I have already started repairing radios and phonographs. My friends were really surprised to see me get into the swing of it so quickly. The Trouble-shooting Tester that comes with the Kit is really swell, and finds the trouble, if there is any to be found."

Progressive "Edu-Kits" Inc., 1189 Broadway, Dept. 575DJ Hewlett, N.Y. 11557

Please rush me free literature describing the Progressive Radio-TV Course with Edu-Kits. No Salesman will call.

NAME .....

ADDRESS .....

CITY & STATE ..... ZIP .....

#### PROGRESSIVE "EDU-KITS" INC.

1189 Broadway, Dept. 575DJ Hewlett, N.Y. 11557

CIRCLE 14 ON READER SERVICE COUPON

# Hey, look me over

Showcase of New Products

## Hand-Held Scanners

Here are two new Bearcat hand-held scanners! Available in two models: a two-band version, covering both the low and high VHF bands; and a single-band



CIRCLE 42 ON READER SERVICE COUPON

model, covering UHF frequencies. Both Bearcat hand-helds feature four channel operation, including light-emitting diode channel indicators plus individual channel lockout switches. Also included is an auto/manual selector switch plus volume and squelch controls. The units come equipped with a telescoping antenna, but provision for an optional rubberized antenna has also been included. Weighing only 11 ounces, they operate on 4 AA batteries. Scan rate is 8 channels per second. Suggested retail price for both models is \$129.95. Crystals are not included. The Electra Company, a division of Masco Corporation of Indiana, is located at 300 South on East County Line Road, Cumberland, IN 46229. Write to them for more information.

## Mobile CB

Introducing the new 23 channel AM citizen 2-way radio, the Pace CB 144! Transmitting at full legal power output, the CB 144 is equipped with: noise



CIRCLE 43 ON READER SERVICE COUPON

blanker switch for suppressing impulse noise interference, automatic noise limiter switch, S/RF-meter for monitoring incoming signal strength and relative power output, RF gain control for receiver sensitivity adjustment, delta tune for compensating off-frequency transmitting

of other party, to name a few. Technical features include a dual conversion receiver for optimum performance. Unit is engineered for positive or negative ground applications. Suggested retail price is \$179.95. Get all the facts from Pace Communications, 24049 So. Frampton Avenue, Harbor City, CA 90710.

## Super Tool Kit

A complete Vaco tool kit in a pouch offers the convenience of twenty of the most often used tools in a versatile roll up pouch. The Super Kit contains a standard and a stubby type heavy duty handle with snap-in interchangeable screw and nut driver blades, reamer and extension plus two pliers and an adjustable wrench. The screwdriver blades are 3/16-in. and 1/4-in. slotted and No. 1 Phillips types. The twelve nut driver blades range in size from 3/16-in. to 1/2-in. including three stubby models. The reamer has a 5-in. body tapered from 1/2-in. in diameter to a point. The extension blade adds an additional 7-in. of

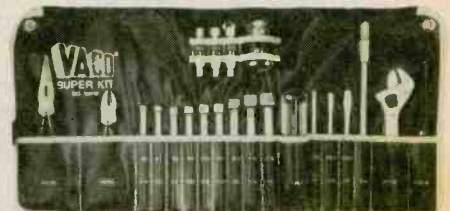

CIRCLE 44 ON READER SERVICE COUPON

working length to all of the nut driver and screwdriver components. All of the blades will fit into either the standard or the stubby handles. The kit also contains a 6-in. long needle nose plier with the wire cutter, a 5-in. diagonal wire cutter and a 6 1/4-in. adjustable wrench. The Vaco Super Kit measures 19 1/8-in. high. The blue pouch with yellow trim is made from top grade, durable vinyl. Pockets and dividers are double stitched. A matching blue dust cover keeps all components clean. The kit can be mounted on a wall or pegboard through brass eyelets, or it can be rolled up for convenient, compact storage in a drawer or a tool kit. Priced to sell at hardware and tool outlets nationwide.

## Range Rider

Here's a new line of center-loaded CB antennas which offer unique performance advantages. Nicknamed "Range Riders", all models in this Antenna Specialists line have special tuning tips which allow adjustment without the need for cut-and-try antenna trimming. The "static ball" tuning tip acts electrically as a capacity hat and can be moved up and down on the active element to achieve resonance and optimum performance. The new Range Rider line also features a com-

(Continued on page 8)

## avanti's Astroplane gives CBers Performance to brag about.

The unique construction features are exceptional.

4.46 db gain over isotropic is, and provides, a stronger transmit and a stronger receive.

To make use of the better signal, the Astroplane radiates the signal from higher up than other CB antennas and at a better angle. According to Dr. Alva Todd of the Midwest College of Engineering, "it possesses an unusually low angle of maximum radiation." This low angle of radiation means that your power is radiated at the horizon and not up into the clouds.

You'll also get long lasting, trouble-free performance because it is compact in design

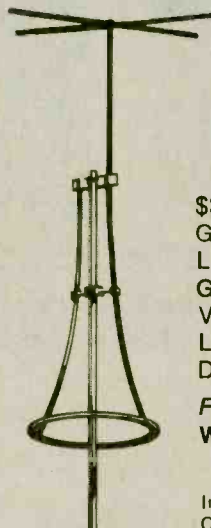

—without long drooping radials, without coils to burn or short out, and with direct ground construction for positive lightning protection and static dissipation.

\$36.95 Sugg. Retail  
Gain 4.46 over isotropic  
Lightning protection D.C. Ground  
V.S.W.R. 1.2:1  
Length 12 Ft.  
Diameter 30 In.

Free 16 page color catalog

Write: Avanti R & D, Inc.

340 Stewart Avenue  
Addison, Illinois 60101

In Canada:  
Cardon Import Co. LTD, Montreal

**avanti**  
RESEARCH AND DEVELOPMENT, INC.

creators of  
the famous



# LIVE IN THE WORLD OF TOMORROW... TODAY!

And our FREE 164 PAGE CATALOG is packed with exciting and unusual values in electronic, hobby and science items — plus 4,500 finds for fun, study or profit... for every member of the family.

## A BETTER LIFE STARTS HERE

### AUTOMATIC REPEATING CASSETTE

Records and plays back on any stereo or mono cassette recorder, w/o splc equip'mt. Automatic repeating of its 20-min. message makes it great for background music, sleep inducing, sales displays, slide & movie shows, learning—anywhere faultless reproduction, repetition and fine fidelity are required. Gives 1000's of hours of use w/o perceptible difference in its amazing sound quality due to exclusive microcon lubricated tape. An endless joy! Instrs.



No. 60.920EK (CASE INCL.) \$10.25 Ppd.

### NEW! KIRLIAN PHOTOGRAPHY KIT!

Experiment in the fascinating new field of "Kirlian" electrophotography — images obtained on film without camera or lens by direct recording of electric charge transmitted by animate & inanimate objects. Each "aura" differs—animate aura said to change corresponding to physical changes. Kit incl portable darkroom, double transformer isolated from power source; instrs.



Stock No. 71.938EK \$49.95 Ppd.  
 "HIGH VOLTAGE PHOTOGRAPHY" by H. S. Dakin \$5.00 Ppd.  
 No. 9129EK (60-PG. PPBK BK.) \$399.00 Ppd.  
 DELUXE KIRLIAN PHOTOGRAPHY SET Stock No. 72.053EK

### WHICH ARE YOUR CRITICAL DAYS?

Can Bio-rhythm tell you? We're not sure, but we're told that vast mood shifts are caused by your body's internal Time Clock whose rhythms can be charted ahead to possibly warn you of "critical" days. Some are great, some blah. Maybe it's your physical, emotional & intellectual rhythms converging at the right or wrong time. Compute your cycles with our Bio-rhythm kit and judge for yourself. Incl Charting kit, metal Dialgraft Calc., instrs.



Stock No. 71.949EK \$14.50 Ppd.  
 1 YR. PERSONALIZED REPORT—BY COMPUTER  
 Stock No. 19.200EK (Send Brthdate) \$15.95

### 3" ASTRONOMICAL REFLECTING TELESCOPE

See stars, moon, planets close-up! 30 to 90X. Famous Mt. Palomar Type. Aluminized & overcoated 3" diameter f/10 primary mirror, ventilated cell. Fork type equatorial mount. Durable PVC tube. Includes 1" F.L. 30X Ramsden, Barlow lens to triple power, 3X finder telescope, hardwood tripod. FREE: "STAR CHART," "HOW TO USE" book.



Stock No. 85.240EK \$59.95 Ppd.  
 DELUXE 3" REFLECTOR TELESCOPE #80.162EK \$89.95 Ppd.  
 4 1/2" REFLECTOR (45X to 135X) #85.105EK \$159.50 FOB  
 4 1/2" REFLECTOR W/CLOCK DRIVE #85.107EK \$219.50 FOB  
 6" REFLECTOR (48X to 360X) #85.187EK \$249.50 FOB  
 6" REFLECTOR W/CLOCK DRIVE #85.086EK \$285.00 FOB

WHEN YOU COME TO PHILADELPHIA BE SURE TO SEE  
**FREE BICENTENNIAL LIGHT SHOW**  
 IN BARRINGTON, N. J. ONLY 10 MINUTES AWAY AT  
**EDMUND FACTORY STORE**



### TWIST ON — TWIST OFF MAGNET

Variable pull—all the way up to 50 lb.! A permanent magnet you turn on & off manually... twist on-twist off. All the control convenience of electromagnet, but not batteries or wires. Compact (size of 2" cube). Easy to use—almost anywhere like an electromagnet. Ideal for: liquid dipping, small parts separation, more. Separated, serves as adjustable breakpoint magnet. Threaded hole for inserting holder rods; eyebolts for suspension.

No. 42.308EK (2" SQ. X 1 1/4") \$17.95 Ppd.



### DAY-AHEAD WEATHER "COMPUTER"

Predict local weather (30-mi. radius) accurately, easily 24 hrs. in advance w/ our professional time-tested instrument. Use w/ barometer & visual observation to forecast wind speed & direction, temp., cloud types, precipitation! Your 28-pg. book incl: circular plastic slide rule "computer" (programmed for over 5000 input variations); 13 pgs. of coded tables to interpret input data; 8 photos; 2 charts; full instrs. Predict anywhere N. of 25° lat.!

Stock No. 61.061EK \$8.25 Ppd.



### BUILD THIS COMPUTER, SAVE \$27

Assembled, our amazing electronic digital computer is \$45. New kit lets you build it for almost 1/3 that! Easy to program, fun to operate; solve problems, play games, try to outwit it. Program it, give it problems, get results from electronic readout. Quickly learn "what makes a computer tick," how to program, soon program w/ your problems, data. 14x15" unit has 3 movable registers, patch cords & plugs; 2 manuals, cards, dice. Req. 3 AA batts., soldering.

No. 72.105EK (HI-IMPACT PLASTIC) \$17.95 Ppd.



### IS SOLAR HEATING FOR YOU?

You'll know if you can take hour to read this vital book by solar home heat experts. It enables you to check out your house point-by-point, room-by-room; insulation, room use, home layout, living habits, more! This timely tome and home survey analysis can help you save \$1,000's by eliminating unnecessary changes, using better design, knowing if you should try to convert to energy-and-money-saving solar heat fully or just make partial changes, if any.

No. 9515EK (SOLAR SURVEY BK.) \$9.95 Ppd.



### SEE MUSIC IN PULSATING COLOR

New 3-Channel Color Organ adds to music listening pleasure, lets you modulate 3 independent strings of colored lamps with intensity of your music to create an audio "light show." They flash, vary in brightness related to music's rhythm, pitch, volume—pulsating lighting performance to music! Fully assembled & priced half that of others, the Edmund Sound To Light Control is a terrific value. Plug in, turn on!

No. 42.309EK (ASSEMBLED) \$17.95 Ppd.  
 No. 42.336EK (UNASSEMBLED) \$13.95 Ppd.



## MAIL COUPON FOR GIANT FREE CATALOG!

164 PAGES • MORE THAN  
**4500 UNUSUAL BARGAINS**

Completely new Catalog. Packed with huge selection of telescopes, microscopes, binoculars, magnets, magnifiers, prisms, photo components, ecology and Unique Lighting items, parts, kits, accessories — many hard-to-get surplus bargains. 100's of charts, illustrations. For hobbyists, experimenters, schools, industry.

**EDMUND SCIENTIFIC CO.**  
 300 Edscorp Building, Barrington, N. J. 08007  
 Please rush Free Giant Catalog EK

Name \_\_\_\_\_  
 Address \_\_\_\_\_  
 City \_\_\_\_\_ State \_\_\_\_\_ Zip \_\_\_\_\_



## COMPLETE AND MAIL WITH CHECK, M. O. OR CHARGE NO. EDMUND SCIENTIFIC CO. 300 Edscorp Building, Barrington, N.J. 08007

How Many	Stock No.	Description	Price Each	Total
<input type="checkbox"/>		PLEASE SEND GIANT FREE CATALOG "EK"		
<input type="checkbox"/>		Charge my BankAmericard *		
<input type="checkbox"/>		Charge my Master Charge *		

Add Handling Chg.: \$1.00, Orders Under \$5.00, 50¢, Orders Over \$5.00

Interbank No.

My Card No. is

Card Expiration Date \_\_\_\_\_ Signature \_\_\_\_\_

**30-DAY MONEY-BACK GUARANTEE.** You must be satisfied or return any purchase in 30 days for full refund. \*\$15.00 minimum

Name \_\_\_\_\_ Address \_\_\_\_\_ City \_\_\_\_\_ State \_\_\_\_\_ Zip \_\_\_\_\_

CIRCLE 39 ON READER SERVICE COUPON

# "Little Giant" RV-Camper antenna

...takes on  
antennas  
twice its size!

Exclusive Shakespeare half wave design makes the *Little Giant* put out like antennas twice its size. The ultimate low profile antenna for CB operation on RVs — campers, snowmobiles, motorcycles—fiberglass or metal.

*No ground strips or ground plane required.*

*Automatic fold down feature* if hit by tree limbs or other low hanging obstacles. Coil and cable permanently sealed. Only 36" tall. Complete with 7' matching cable and connector, with zinc plated heavy gauge steel mount.

Shakespeare Industrial  
Fiberglass Division,  
P.O. Drawer 246,  
Columbia, S.C. 29202

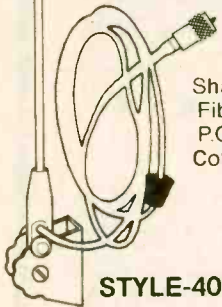

STYLE-4050



## Shakespeare

THE ROYAL LINE OF FIBERGLASS ANTENNA

IN CANADA:

Len Finkler, Ltd., 25 Toro Road, Downsview, Ontario

CIRCLE 16 ON READER SERVICE COUPON

WRITE NOW FOR **McGEE'S**  
**BIG SPEAKER CATALOG**

1001 BARGAINS IN

SPEAKERS — PARTS — TUBES — HIGH FIDELITY  
COMPONENTS — RECORD CHANGERS  
Tape Recorders — Kits — Everything in Electronics  
1901 McGee Street, Kansas City, Missouri 64108

HEY, LOOK ME OVER

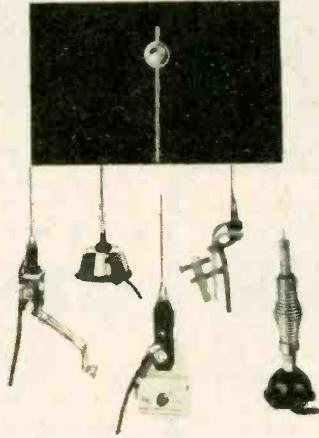

CIRCLE 45 ON READER SERVICE COUPON

pletely waterproof center-loaded coil assembly. Included in the new Range Rider line are models for a wide variety of applications, including dual mirror mount types for heavy duty trucks and the A/S Quick Grip mount for permanent no-holes installations on passenger car trunk lids. All models are supplied complete with coaxial line and connectors plus phasing harnesses when required. Details on the new Range Rider line are available by contacting The Antenna Specialists Company, 12435 Euclid Avenue, Cleveland, Ohio 44106.

### Baby-Sitter

Busy young mothers can call on a new Fanon electronic device to "baby-sit" for them as they go about their daily routine in the house or yard. Called the Echo Baby-Com, the transistorized unit is actually a little radio transmitter that "hears" baby's sounds and broadcasts them through any AM radio, portable or console, within range. The Baby-Com



CIRCLE 46 ON READER SERVICE COUPON

operates on any unused spot on the radio dial between 1250 and 1600 kHz you select. Baby-Com can also help shut-ins confined to their bed or sickroom to communicate with family or neighbors, and can be used to monitor remote areas for safety and protection. Echo Baby-Com comes with AC power supply, tuning wand for frequency adjustment and a built-in 3-meter long antenna. Controls include on/off, sensitivity and frequency adjustment. For complete details, write to Fanon/Courier, 990 South Fair Oaks Avenue, Pasadena, CA 91105.

### Carry the Torch

A UL listed propane Blow Torch Kit (UL 125P) in a newly-designed red polypropylene storage and carrying case has been offered by Bernzomatic. The compact kit contains a standard 14.1 ounce propane fuel cylinder, blow torch burner unit, soldering tip, utility burner, flame spreader, and spark lighter, plus case.



CIRCLE 47 ON READER SERVICE COUPON

The solid brass burner unit is equipped with a gas filter to assure clog-free operation. A must tool for heavy soldering. Bernzomatic is sold nationally at hardware and tool outlets and department stores.

### Battery/AC FET Multimeter

A battery operated full-sized FET multimeter, Leader Model LEM-75, is both portable and AC operable. The LEM-75 offers a wide range of use for most every electronic application, employs a large 4½-in. mirror scale and has an input



CIRCLE 48 ON READER SERVICE COUPON

(Continued on page 14)





Model 2-080 Power Base  
Station Mike Optional

All Royce transceivers  
are FCC type approved

# Largest digital readout in the industry!

## NEW! ROYCE MODEL 1-624 DIGITAL READOUT Professional 23-Channel AM Base Station CB Transceiver

This is Royce's best AM base station. And the new Digi-Tron Dial System—with a digital readout  $\frac{3}{4}$ " high—is just one reason. The new Model 1-624 has full metering—three large meters. Handsome styling. Plus/Matrix switching system for more reliable control. Plus—continuous receiver fine tuning control. And, many, more features. See it, hear it, at your Royce Dealer's soon. Or write for new, full-line catalog!

Just a few reasons why  
the Model 1-624 is our  
best AM base station:

- NEW DIGI-TRON DIAL SYSTEM—for largest digital readout in industry.
- MATRIX SWITCHING SYSTEM.
- THREE LARGE METERS. Monitor receive strength; transmit power, and SWR.
- CONTINUOUS RECEIVER FINE TUNING CONTROL.
- VARIABLE RF GAIN CONTROL.
- PUSHBUTTON ANL CIRCUIT, HIGH-LOW TONE CONTROL, AND CB-PA SWITCH.
- SEPARATE TRANSMIT INDICATOR LIGHT.

And that's only the beginning!  
See and hear this unit soon—  
at your Royce Dealer's.  
Send for our new full-line brochure!



**Royce**  
electronics  
corporation

1746 Levee Road  
North Kansas City, Mo. 64116  
Call: (816) 842-7505 • TELEX: 426-145

# Ever wonder why no other TV/Audio home study school puts its prices in its ads?

**Maybe it's because they can't match this value!**

No other school gives you a choice of five ways to learn TV/Audio servicing, with complete courses starting as low as \$370... with convenient, inexpensive time payment plans. The Master Color TV/Audio training course gives you a unique, engineered-for-training 25" diagonal color set with all the electronic instruments you need for as much as \$600 under the next leading home study school's comparable course. NRI quotes its prices because we believe you get the top educational value from NRI.

## **You pay less because NRI passes its savings on to its students.**

NRI pays no salesmen. We buy no outside "hobby kits" for our experiments or training kits. NRI designs its own instruments and TV sets... to give you great performance plus real training that you can put to practical use. The result is low tuition rates without the penalty of exorbitant interest charges for time payments. We pass the savings on to you.

## **More than 1 million students have come to NRI for home training.**

Home study isn't a sideline with NRI. We've been its innovating leader for 60 years. More than one million students have enrolled in our many career courses. NRI is one of the few home study schools with a full-time staff of engineers, authors and editors to help you with any problem. NRI graduates will tell you: you can pay more, but you can't buy better training.

## **15 Electronic courses available... including digital computer training and complete communications.**

Send for the free NRI electronics catalog and check out the full spectrum of courses available, including Color TV, FCC Licensing, Complete Communications Electronics, Computer Electronics, Marine and Aircraft Electronics, Mobile Communications, etc.



**Mail the card for your Free NRI catalog. No salesman will call.**

**AVAILABLE FOR CAREER STUDY UNDER GI BILL**  
Check the GI Bill Box on the card for information.



**NRI SCHOOLS**  
McGraw-Hill Continuing Education Center  
3939 Wisconsin Avenue,  
Washington, D.C. 20016

## good with 7 kits ... \$370

Or low monthly terms

A basic TV/Audio Servicing Course including 7 training kits for your experiments. You build your own solid-state radio, solid-state volt-ohmmeter, and experimental electronics lab. Includes 65 bite-size lessons (16 on color TV), 15 special reference texts with hundreds of servicing short cuts, tips on setting up your own business, etc. This completely up-to-date course covers black & white and color TV, FM multiplex receivers, public address systems, antennas, radios, tube, transistor and solid-state circuits.

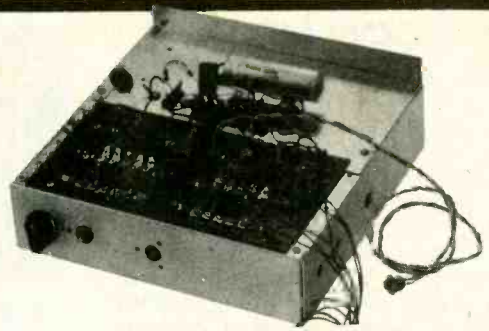

## better ... with 11 kits and B/W TV... \$465

Or low monthly terms

A complete course in B&W and Color TV Servicing, including 65 lessons (16 on color TV), 15 special reference texts and 11 training kits. Kits you build include your own solid-state radio, solid-state volt-ohmmeter, experimental electronics lab, plus a 12" diagonal solid-state black & white portable TV ... to build and use. At each assembly stage, you learn the theory and the application of that theory in the trouble-shooting of typical solid-state TV sets.



## better yet with 11 kits and 19" diag. Color TV... \$795

Or low monthly terms

The course includes 53 lessons and reference texts plus kits and experiments to build a superb solid-state 19" diagonal color TV receiver ... complete with rich woodgrain cabinet, and engineered specifically for training by NRI's own engineers and instructors. This handsome set was designed from the chassis up to give you a thorough understanding of circuitry and professional trouble-shooting techniques. You build your own solid-state volt-ohmmeter, and experimental electronics lab.



## best ... with 14 kits and 25" diagonal Color TV... \$1,095

Or low monthly terms

The ultimate home training in Color TV/Audio servicing with 65 bite-sized lessons, 15 reference texts, and 14 training kits ... including kits to build a 25" diagonal Color TV, complete with handsome woodgrain console cabinet; a wide band, solid-state, triggered sweep, service type 5" oscilloscope; TV pattern generator; digital multimeter, solid-state radio, and experimental electronics lab.

This Master course combines theory with practice in fascinating laboratory units. Unlike "hobby kits", the NRI color TV was designed with exclusive "discovery" stages for experimentation and learning. Building the set will give you the confidence and ability to service any color TV set on the market. And you'll have a magnificent set for years of trouble free performance.



## Plus Advanced Pro Color... \$645 Or low monthly terms

An advanced Color TV Servicing Course for experienced technicians, 18 color lessons, 5 new "Shop Manuals", and NRI 18" diagonal Color TV training kit are included.

## HEY, LOOK ME OVER

(Continued from page 8)

impedance of ten megohms. There are full scales of 0.3 V and 30 uA, AC and DC. Minimum sensitivities are 10 mV and 1 uV on both AC and DC for checking and servicing extremely sensitive low voltage and low current parameters of the most advanced solid-state devices in use today. The LEM-75 is supplied with an AC adapter for field or workbench use. The unit, which sells for \$149.95, comes complete with a heavy duty test probe as well as an AC adapter. Get more information direct from Leader Instruments Corp., 151 Dupont Street, Plainview, NY 11803.

### Bookshelf Bargain

The Advent Model 400 loudspeaker is a miniaturized acoustic suspension speaker system housed in a reinforced polystyrene cabinet measuring just 6½ by 11 by 6-in. deep. The cabinet is a warm white color with a silver gray metal grille. Impedance is 8 ohms, and the Model 400 loudspeaker requires only 4 to 6 watts of power for ample levels in most small to medium size rooms. The suggested retail price is \$32.00. The single acoustic-suspension driver used in the Model 400 loudspeaker has a cone area, excursion capability, and magnetic structure sufficient to provide solid bass

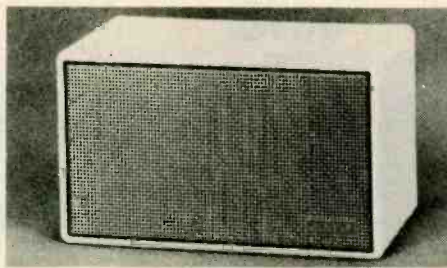

CIRCLE 49 ON READER SERVICE COUPON

at surprisingly high levels. At the same time, the driver's cone is small enough to provide extended and well-dispersed treble response. For more information, write to Advent Corporation, 195 Albany Street, Cambridge, MA 02139.

### Weather Alarm Radio

How would you like to have a receiver that warns the user of impending severe weather conditions automatically? Regency has one, designated model ACT-A 4W. The new 4-channel radio will carry a suggested retail price of \$125.00. The weather alarm monitor radio/scanner provides the listener with automatic weather information plus an additional three channels can be of particular value to emergency crews on VHF high band in the event of disaster. The extra three channels can be of particular value to such organizations as civil defense, police and fire departments, hospitals and

others by permitting them to monitor each other's activities in an emergency situation. The alarm function is activated by the National Weather Service. A flip of a switch takes the radio off alarm



CIRCLE 50 ON READER SERVICE COUPON

status, putting it on programmable scan. The radios come complete with built-in speaker and detachable telescope antenna. Get the facts direct from Regency Electronics, Inc., 7707 Records Street, Indianapolis, IN 46226.

### Memory and Percent

Rockwell's new 18R Memory-Percent calculator, priced at under \$20, has a

(Continued on page 16)

## Why you need a Hustler CB base station antenna.

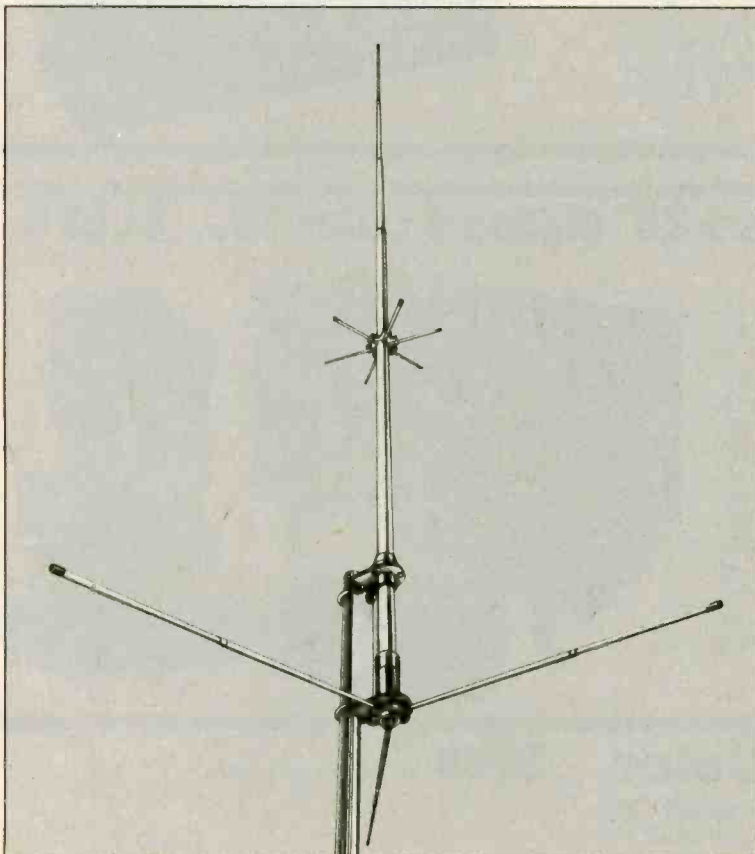

Your antenna is your link with other CB'ers. The more effective that link, the better you hear, and the better you're heard. Hustler CB base station antennas are electrically longer for greater range — up to 20% — to extend your signal over the miles. And they're easy to install, stay tuned for peak performance no matter what Mother Nature does. Each Hustler is manufactured to the highest standards of the industry with the very best materials. Get outstanding all directional coverage with a Hustler "Trumpet" — Model 27T or "Jam Ram" Model 27JR.

AVAILABLE FROM ALL DISTRIBUTORS WHO RECOGNIZE THE BEST!

**HUSTLER**

new-tronics  
corporation

15800 Commerce Park Drive  
Brookpark, Ohio 44142  
(216) 267-3150

"the home of originals"

CIRCLE 12 ON READER SERVICE COUPON

**NEW!**

**THE  
DESIGN  
MATE  
SERIES**

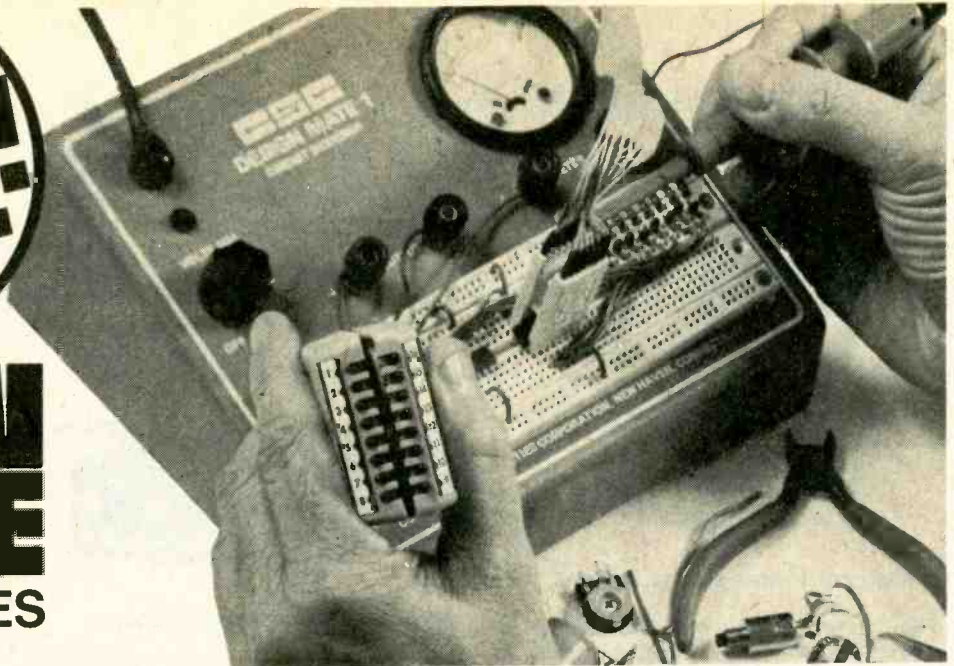

**At last! High quality, laboratory-grade test instruments . . . for the professional and hobbyist . . . at prices everyone can afford!**

**DESIGN MATE 1**  
**CIRCUIT DESIGNER**

Now you can build/test electronic circuits WITHOUT SOLDER . . . using solid #22 AWG wire to interconnect discrete components . . . resistors, transistors, linear/digital ICs in TO5 or DIP packages (8-40 pins), and more. Plus, you get 5-15VDC up to 600ma (9 watts) of variable regulated power, with a built-in 0-15V voltmeter to monitor internal power and/or external circuits. Now, that's design flexibility! And look at the low, low price!

**49<sup>95</sup>**

Add \$2.50 shipping/handling



**SPECIFICATIONS**

**Power Supply:** Output: 5-15V @ 600ma. Ripple and Noise: less than 20mv @ full load. Load/Line regulation: <1%. Meter: 0-15V DC. **Connectors:** 1 QT-59S, 2 QT-59B, 2 power supply 5-way binding posts, 2 meter 5-way binding posts. **Wght:** 3 lbs. **Power Needed:** 117V, AC @ 60 Hz 12W.\* **Patent #**235,554.

Each measures 6.75" L x 7.5" W x 3.25" H.; completely assembled, ready to start testing at once. Order your DESIGN MATES today!  
\*220V @ 50Hz available at slightly higher cost.

All DESIGN MATES are made in USA; available off-the-shelf from your local distributor. Direct purchases from CSC can be charged on Bank Americard, Master Charge, American Express. Plus, you get a FREE English/Metric Conversion Slide Rule with each order. Foreign orders please add 10% for shipping/handling. Prices are subject to change.

**64<sup>95</sup>**

Add \$2.50 shipping/handling



**DESIGN MATE 2**  
**FUNCTION GENERATOR**

Troubleshooting? Design Testing? DM-2 gives you all the signal source capacity you need . . . at a very modest price. This 3-wave form Function Generator has: short-proof output, variable signal amplitude and constant output impedance. Completely wired, tested, calibrated, ready to test audio amplifiers, op-amp and educational lab designs . . . as well as complex industrial lab projects. Complete with easy-to-read instructions/operations manual, application notes, operation theory and more, DM-2 works hand-in-hand with DM-1 for total versatility.

**SPECIFICATIONS**

**Frequency Range:** 1Hz-100KHz (5 ranges: 1-10Hz, 10-100Hz, 100-1000Hz, 1-10KHz, 10-100KHz). **Dial Accuracy:** Calibrated @ 10Hz, 100Hz, 1KHz, 10KHz, freq. accurate to 5% of dial setting. **Wave Forms:** Sine <2% THD over freq. range. Triangle wave linearity, <1% over range. Square wave rise/fall <0.5 microseconds — 600Ω-20pF termination. **Output Amplitude:** (all wave forms) variable-0.1V-10V peak to peak into open circuit. **Output Impedance:** 600Ω-constant over ampl./freq. ranges. **Wght.:** 2 lbs. **Power Needed:** 117V, AC @ 60Hz 5W.\*

**DESIGN MATE 3**  
**R/C BRIDGE**

Have you been bugged by color codes or unreadable component markings? Forget it! DM-3, the low cost R/C Bridge, measures true component values . . . in seconds . . . to better than 5%. And, it's all done with only 2 operating controls and a unique solid-state null detector, to zero-in on exact component selection . . . instantly! Completely wired, calibrated and tested. DM-3 includes an extensive instruction/applications manual, and operational theory too.

**SPECIFICATIONS**

**Resistance Range:** 10Ω-100 megΩ. (6 Ranges: 10-100Ω, 100-1000Ω, 1K-10KΩ, 100K-1 megΩ, 1 megΩ-10 megΩ) **Capacitance Range:** 10pFd-1mFd (5 Ranges: 10-100 pFd, 100-1000pFd, .001-.01 mFd, .01mFd-.1mFd, .1-1 mFd.) **Null Detector:** 2 hi-intensity LEDs-hi/lo markings. **Accuracy:** <5% of null dial, range switch setting. **Wght.** 2 lbs. **Power Needed:** 117V, AC @ 60Hz 3W.\*

**54<sup>95</sup>**

Add \$2.50 shipping/handling



**CSC**  
**CONTINENTAL SPECIALTIES CORPORATION**

44 Kendall Street, Box 1942, New Haven, CT 06509 • 203/624-3103  
West Coast Office: Box 7809, San Francisco, CA 94119 • 415/421-8872  
Canada: Len Finkler Ltd., Ontario

© Copyright Continental Specialties Corporation 1975

CIRCLE 36 ON READER SERVICE COUPON

## HEY, LOOK ME OVER



CIRCLE 51 ON READER SERVICE COUPON

two-key store/recall memory and percent key for automatic add-on and discount. Additional features of the calculator include: automatic repeat, automatic constant, chain calculations, floating decimal, 8-digit display, floating negative indicator, dual clear entry/clear key, automatic underflow, automatic leading and trailing zero suppression, and algebraic logic. The compact, hand-held unit has a manufacturer's suggested retail price of only \$19.88. Available at retail and department stores in North America. For more info, write to Rockwell International, Microelectronic Product Division, 3310 Miraloma Avenue, Anaheim, CA 92803.

### Mobile PA Amplifier

Get ready for electioneering this fall with the new Realistic MPA-10 solid-state 10-watt mobile public address amplifier designed for 12-volt operation in cars, or

anywhere that an AC power source is not available. The MPA-10 is only 1½ x 4¼ x 6½-in. for easy mounting in or under dash, in a glove compartment, under a seat or in any convenient location. Comes with a ruggedly designed dynamic mike and hanger for clipping it to the side of the unit. Separate microphone and auxiliary input jacks allow you to connect a tuner, ceramic phono or tape player to the amplifier with push-button selection of either or both for paging over music.

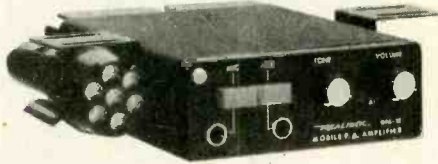

CIRCLE 32 ON READER SERVICE COUPON

A tone control allows adjustment for best tonal quality of sound. Response is given as 200 to 10,000 Hz at full power. Rated 10 watts rms at 8 ohms. The Realistic MPA-10 mobile PA amplifier is priced at \$39.95 complete with microphone and mounting hardware. Realistic products are available exclusively from more than 3,000 Radio Shack stores and authorized sales centers in all 50 states and Canada.

### RF Signal Generator

The Leader LSG-16 wide band signal generator is ideal for service, hobby, education, or industrial use. It features FET oscillator circuitry for high stability performance plus an accurately calibrated frequency dial. Frequency range is 100 kHz to 100 MHz, and up to 300



CIRCLE 48 ON READER SERVICE COUPON

MHz on harmonics. Internal modulation is 1 kHz at 30% or higher while external modulation is 50 Hz–20 kHz at less than 1 Vrms. The LSG-16 is capable of functioning as a marker-generator when used in conjunction with a sweep generator and will check and align RF and IF circuits in TV, FM, and communication-type receivers and transmitters. Use of the product is further extended by provisions to accommodate a 1-15 MHz crystal. The LSG-16 offers a 115/230 V, 50/60 Hz, 3 VA approx. power supply. It sells for \$109.95. Write to Leader at 151 Dupont Street, Plainview, NY 11803 and ask for their catalog.

### CB Headset with Mike

An improvement in CB communications is possible with the Model CB 1200 boom-mike/headset made by Telex. The CB 1200 headset is specifically designed to meet the safety, comfort, and performance requirements of the mobile or base station operator. It is a single side headset so the mobile operator never loses contact with his environment in traffic. The dynamic, foam-cushioned receiver is adjustable for maximum comfort

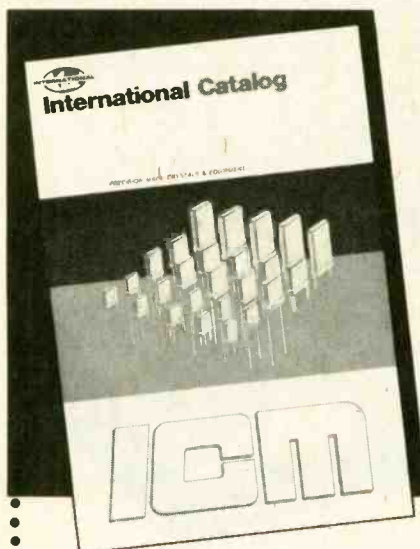

# FREE INTERNATIONAL CATALOG

Your electronics buying guide for precision made radio crystals and electronic equipment.

ICM

International Crystal mfg. co., inc.  
10 N. Lee, Oklahoma City, Okla. 73102

NAME \_\_\_\_\_  
ADDRESS \_\_\_\_\_  
CITY \_\_\_\_\_ STATE \_\_\_\_\_ ZIP \_\_\_\_\_

CIRCLE 24 ON READER SERVICE COUPON



CIRCLE 52 ON READER SERVICE COUPON

and provides a much clearer intelligibility than is possible through conventional CB speakers. The fully adjustable boom microphone can be placed directly in front of the mouth for crisp transmis-

(Continued on page 18)

# ELECTRONICS INFORMATION CENTER

## FREE

### TO ALL READERS OF ELEMENTARY ELECTRONICS

At no cost to you the Editor will have information and literature about products and services advertised in this issue sent to you at no cost!

## YOU SIMPLY

- Tear out the coupon.
- Circle the number under the ad that interests you.
- Circle the number identifying products mentioned in columns and articles.
- If you wish, answer the simple questionnaire on the coupon.
- Print or type your name and address on the coupon.
- Mail to ELEMENTARY ELECTRONICS before the expiration date.
- Please allow 4-6 weeks for delivery.

## AND IF YOU WISH

to subscribe to

## ELEMENTARY ELECTRONICS

please check subscription box 83 on the coupon: \$4.97 brings you 9 issues.

FILL  
OUT  
AND  
MAIL  
TODAY!

FILL  
OUT  
AND  
MAIL  
TODAY!

FILL  
OUT  
AND  
MAIL  
TODAY!

### ELEMENTARY ELECTRONICS Box 886, Ansonia Station, New York, NY 10023

November/December 1975

Void after April 16, 1976

1	2	3	4	5	6	7	8	9	10	11	12	13	14	15
16	17	18	19	20	21	22	23	24	25	26	27	28	29	30
31	32	33	34	35	36	37	38	39	40	41	42	43	44	45
46	47	48	49	50	51	52	53	54	55	56	57	58	59	60
61	62	63	64	65	66	67	68	69	70	71	72	73	74	75

We would like to know about you. Please help us by placing an "X" in the appropriate boxes. • Do you own a CB transceiver? 76  Yes 77  No • If your answer is Yes, please check appropriate boxes below if you have one or more of the types indicated. 78  Base Station 79  Mobile Unit 80  Portable • Do you use CB in your work? 81  Yes 82  No • 83  Please enter my subscription for 9 issues at \$4.97 and bill me. 84  \$4.97 subscription payment enclosed

Name (print clearly)

Address

City

State

Zip Code

### ELEMENTARY ELECTRONICS Box 886, Ansonia Station, New York, NY 10023

November/December 1975

Void after April 16, 1976

1	2	3	4	5	6	7	8	9	10	11	12	13	14	15
16	17	18	19	20	21	22	23	24	25	26	27	28	29	30
31	32	33	34	35	36	37	38	39	40	41	42	43	44	45
46	47	48	49	50	51	52	53	54	55	56	57	58	59	60
61	62	63	64	65	66	67	68	69	70	71	72	73	74	75

We would like to know about you. Please help us by placing an "X" in the appropriate boxes. • Do you own a CB transceiver? 76  Yes 77  No • If your answer is Yes, please check appropriate boxes below if you have one or more of the types indicated, 78  Base Station 79  Mobile Unit 80  Portable • Do you use CB in your work? 81  Yes 82  No • 83  Please enter my subscription for 9 issues at \$4.97 and bill me. 84  \$4.97 subscription payment enclosed

Name (print clearly)

Address

City

State

Zip Code

### ELEMENTARY ELECTRONICS Box 886, Ansonia Station, New York, NY 10023

November/December 1975

Void after April 16, 1976

1	2	3	4	5	6	7	8	9	10	11	12	13	14	15
16	17	18	19	20	21	22	23	24	25	26	27	28	29	30
31	32	33	34	35	36	37	38	39	40	41	42	43	44	45
46	47	48	49	50	51	52	53	54	55	56	57	58	59	60
61	62	63	64	65	66	67	68	69	70	71	72	73	74	75

We would like to know about you. Please help us by placing an "X" in the appropriate boxes. • Do you own a CB transceiver? 76  Yes 77  No • If your answer is Yes, please check appropriate boxes below if you have one or more of the types indicated. 78  Base Station 79  Mobile Unit 80  Portable • Do you use CB in your work? 81  Yes 82  No • 83  Please enter my subscription for 9 issues at \$4.97 and bill me. 84  \$4.97 subscription payment enclosed

Name (print clearly)

Address

City

State

Zip Code

## HEY, LOOK ME OVER

sions or can be pushed up and out of the way when not in use. The built-in battery powered FET amplifier matches the mike to any CB unit. The long-life 1.4-volt mercury battery is inexpensive, readily available, and easy to replace. An in-line push-to-talk switch is supplied with clothing clip. It readily attaches to a shirt pocket or jacket lapel. The switch can be depressed momentarily for short transmissions or locks in for longer transmissions. The operator can then talk and yet keep both hands on the wheel.

or take notes. The ruggedly constructed CB 1200 headset can be worn over left or right ear. It's priced at \$59.95. For more information, contact Telex, 9600 Aldrich Avenue South, Minneapolis, MN 55420.

### Linear Motion Sound

Sansui's new Model LM-110 LM (Linear Motion) loudspeaker system has a number of features that help improve transient response and increase efficiency at the high-frequency end of the audio spectrum. The LM tweeter of the LM-110 uses a copper-clad aluminum wire voice coil to reduce moving mass. The dia-



CIRCLE 53 ON  
READER SERVICE COUPON

phragm features a steeply convex phase equalizer to eliminate phase interference inside the cone. Since the LM tweeter is mounted on a separate baffle, it requires no back cap or cavity to block the strong and potentially damaging high pressure waves created by the woofer. The die-cast aluminum frame of the tweeter of the LM-110 is ported to correspond to the three openings in the multi-radiation baffle and so the tweeter diaphragm is free to move back and forth. It does so in linear response to the input signals with fast rise time. The LM-110 has a peak power rating of 35 watts and an impedance of 8 ohms. Frequency range is 38 Hz to 20,000 Hz. The woofer is a 6½-in. cone type. Priced at \$249.95 the pair. For further information, contact Sansui Electronics Corp., 55-11 Queens Blvd., Woodside, NY 11377.

### Micro-Synthesizer Kit

If you think you could really get into synthesizers but are having trouble justifying the heavy cash outlay on pure speculation, the PAIA Gnome Micro-Synthesizer is designed just for you. The 10-by-6-by-2½-inch case houses an 8-octave voltage-controlled oscillator, linear controller, noise source, 6-octave voltage-controlled filter, voltage-controlled amplifier, and two separate envelope generators. "Normalized" controls completely



CIRCLE 54  
ON READER SERVICE COUPON

eliminate patch-cords and permit a wide variety of sounds and effects. Tunes are played by moving a wiper probe over the surface of a resistance-element controller strip; it's said that even non-musicians can pick out tunes in the first few minutes. Battery-operated, the PAIA Gnome Micro-Synthesizer can be taken anywhere. And if you decide to take the next step up, PAIA also has modular synthesizer kits that let you expand your system just as you choose. The Gnome kit is \$48.95 from PAIA Electronics, Inc., Box 14359-EE, Oklahoma City, OK 73114.

# Listens quiet, talks big.



The Model 13-882B is just about the quietest 23-channel mobile Midland's ever built. There's a switchable automatic noise limiter and a noise blanker. There's full range variable squelch and delta tuning. There's automatic gain control and mechanical filters, so what you hear comes in clear... quiet.

Then, like every Midland mobile, you're sending with the legal maximum 4.0 watts output power plus high level modulation... for maximum talk power. Of course there's a large lighted S/RFO meter, a handy antenna warning indicator that lights at mismatch or failure, and a separate PA switch. Operation's on 12-volt DC, positive or negative ground. Less than \$180 at your dealer.

Write for free, colorful  
Midland CB Brochure:  
Dept. EE, P.O. Box 19032  
Kansas City, MO 64141

**MIDLAND**  
INTERNATIONAL®  
Communications Division



# Now-have fun with electronics- **BUILD YOUR OWN TRANSISTOR RADIO...** **burglar alarm...** **metal locator...** **listening device...** **mini-computer...** **oscillator...** **amplifier...** **and more!**



Try this library of tested, easy-to-follow guides that tell you the parts you need... where to get them... then lead you step-by-step through building and operating useful electronic devices! Your satisfaction is guaranteed.



**ELECTRONICS FOR THE BEGINNER.** This unique volume starts you off. Chapters 1, 6, and 7 show how to use tools and solder, how to read electronic symbols and circuits. Soon you'll find yourself building devices ranging from a "one-hour" radio to a simple stereo amp. **\$4.50**

Build a library of these fascinating, fun-to-use books. They're less than \$5.00 each!



**HOW TO BUILD PROXIMITY DETECTORS & METAL LOCATORS.** Hunt treasure, find jewelry and coins in the sand. Locate pipes and studs in walls and floors. This is just a sample of what you can do with devices this book helps you build. There are projects for novices and technicians alike. **\$4.50**

Build a library of these fascinating, fun-to-use books. They're less than \$5.00 each!



**ELECTRONIC GAMES & TOYS YOU CAN BUILD.** Start each project with a piece of board, some simple tools, and a couple of radio parts. With this "just-for-fun" guide, you can build and enjoy *Test Your Nerve*, *Reaction Timer*, *The Maze*, *Space Shot*, *Party Pooper*, *The Flipper*, and nine more. **\$3.50**



**101 EASY AUDIO PROJECTS.** Almost every project saves you more money than the cost of the book. Create valuable accessories and equipment. Build a filter for annoying record scratches. Build audio testers and tracers, intercoms, hi-fi's, tuners, even a telephone amplifier. **\$3.95**



**99 ELECTRONIC PROJECTS.** You'll want this volume on hand, because it helps you build nearly every category of electronic device imaginable: automotive, burglar alarms, ham and swl, photographic, and more. Most cost less than \$10 to build. Save money-have fun, too! **\$3.50**



**INTEGRATED CIRCUIT PROJECTS.** Expand your electronics know-how—delve into IC technology. This clearly written, challenging volume helps you sharpen your skills by building a stereo headphone amplifier, tone encoder and decoder, waveform generator, voice scrambler, and more. **\$4.95**



**SOLID-STATE ELECTRONIC PROJECTS.** Three chapters help you understand burglar alarms inside-out. Parts lists help you protect your home by building them. This book also helps you construct metal locators, music circuits, a long-range listening device, and more. **\$3.95**



**HI-FI PROJECTS FOR THE HOBBYIST.** This book takes nothing for granted—not even your budget. Shows you tools, techniques, terms, where to buy, what and how to build. Install a small speaker enclosure with big sound, loudness or balance controls, a four-channel adapter, and more. **\$3.95**



**5-MINUTE ELECTRONIC PROJECTS.** Learn basics about electronics the easy way—by setting up projects and demonstrations yourself. This picture-packed book features devices that take minutes of building, but hours of using and enjoying. Included are oscillators, generators, transmitters, a crystal radio, and more. **\$3.95**



**PROJECTS IN SIGHT, SOUND, AND SENSATION.** Build a digital ESP testing machine yourself? This book makes it possible—along with six other unique projects. Advance from simple novelty devices to a sophisticated bio-feedback machine for muscle relaxation. Theory, diagrams, and parts lists are featured with plenty of illustrations. **\$4.95**

Build a library of these fascinating, fun-to-use books. They're less than \$5.00 each!

129

Clip out... mail today

## 10% DISCOUNT COUPON

**YES**—please send me the books checked below for my library of build-it-yourself electronic projects. Enclosed are the modest prices shown, plus 75¢ shipping and handling. I understand that my satisfaction is guaranteed, in that I may return any book within 15 days for full refund.

- CHECK HERE AND SAVE 10%! I have checked at least 3 of the books offered. So 10% of the cost is deducted.**
- |  |   |
|--|---|
| <input type="checkbox"/> <b>ELECTRONICS FOR THE BEGINNER</b> 20677 \$4.50                          | <input type="checkbox"/> <b>INTEGRATED CIRCUIT PROJECTS</b> 21113 \$4.95              |
| <input type="checkbox"/> <b>ELECTRONIC GAMES &amp; TOYS YOU CAN BUILD</b> 20183 \$3.50             | <input type="checkbox"/> <b>SOLID-STATE ELECTRONIC PROJECTS</b> 20921 \$3.95          |
| <input type="checkbox"/> <b>101 EASY AUDIO PROJECTS</b> 20608 \$3.95                               | <input type="checkbox"/> <b>HI-FI PROJECTS FOR THE HOBBYIST</b> 20925 \$3.95          |
| <input type="checkbox"/> <b>99 ELECTRONIC PROJECTS</b> 20818 \$3.50                                | <input type="checkbox"/> <b>5-MINUTE ELECTRONIC PROJECTS</b> 20968 \$3.95             |
| <input type="checkbox"/> <b>HOW TO BUILD PROXIMITY DETECTORS &amp; METAL LOCATORS</b> 20881 \$4.50 | <input type="checkbox"/> <b>PROJECTS IN SIGHT, SOUND &amp; SENSATION</b> 21125 \$4.95 |

NAME \_\_\_\_\_ (please print)

ADDRESS \_\_\_\_\_

CITY \_\_\_\_\_ STATE \_\_\_\_\_ ZIP \_\_\_\_\_

Add sales tax where applicable.

ENCLOSE CHECK OR MONEY ORDER... MAIL TO:

Howard W. Sams & Co., Inc. / 4300 W. 62nd Street / Indianapolis, Indiana 46206

EE11

# The better the training the better you'll

Send for  
**FREE**  
illustrated  
career  
guide

NTS guide  
to careers in  
Electronics

IN-CIRCUIT TRANSISTOR TESTER

COMPU-TRAINER

TROUBLESHOOTER  
VOM

SOLID-STATE  
OSCILLOSCOPE

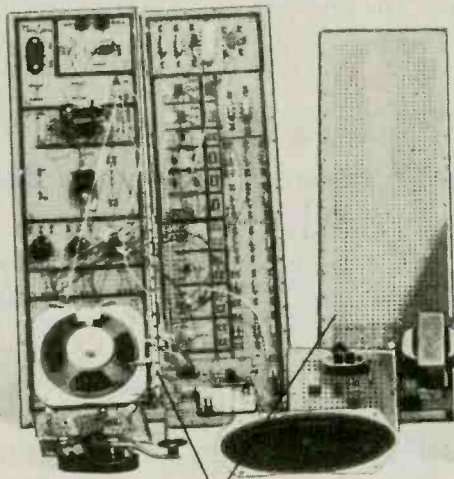

ELECTRO-LAB

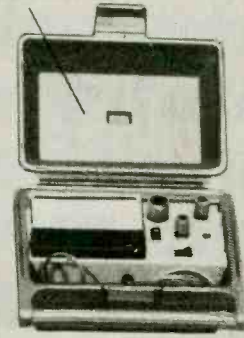
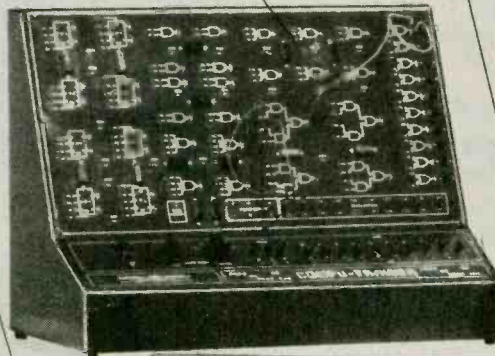

(Simulated TV Reception)

As an NTS student you'll acquire the know-how that comes with first-hand training on NTS professional equipment. **Equipment you'll build and keep.** Our courses include equipment like the **NTS/Heath Digital GR-2000 Solid State color TV** with first-ever features like silent varactor diode tuning; digital channel selection, (with optional digital clock), and big 315 sq. in. ultra-rectangular screen.

Also pictured above are other units — 5" solid state oscilloscope, vector monitor scope, solid-state stereo AM-FM receiver with twin speakers, digital multi-meter, and more. It's the kind of better equipment that gets you better equipped for the electronics industry.

This electronic gear is not only designed for training; it's field-type — like you'll meet on the job, or when you're making service calls. And with NTS easy-to-read, profusely illustrated lessons you learn the theory behind these tools of the trade.

**Choose from 12 NTS courses** covering a wide range of fields in electronics, each complete with equipment, lessons, and manuals to make your training more practical and interesting.

**Compare our training; compare our lower tuition.** We employ no salesmen, pay no commissions. You receive all home-study information by mail only. All Kits, lessons, and experiments are described in full color. Most liberal refund policy and cancella-

# and the equipment be equipped.

**COMPARE OUR  
KITS AND LESSONS.  
COMPARE OUR  
TUITION.**

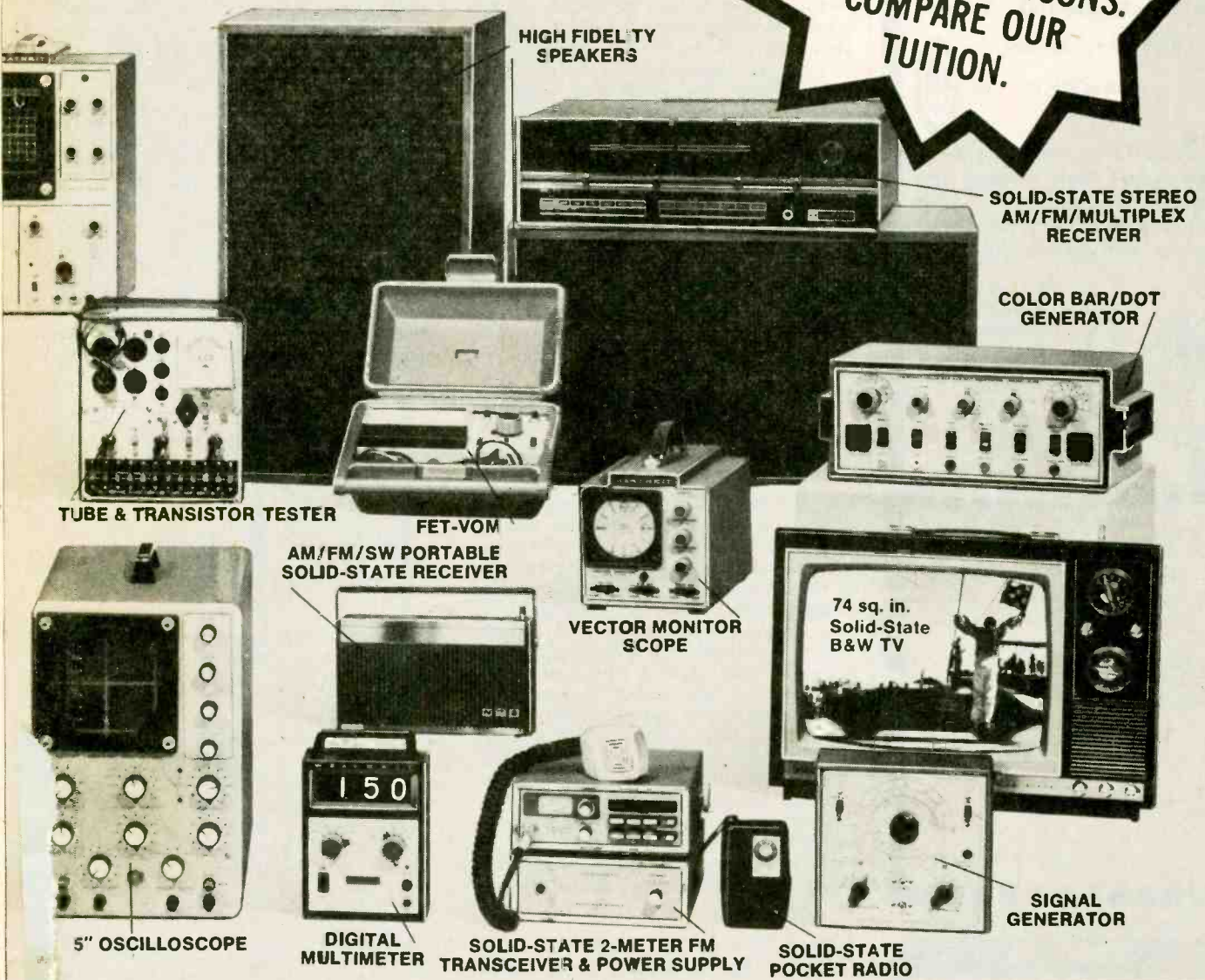

tion privileges spelled out. Make your own comparisons, your own decision. Mail card today, or clip coupon if card is missing.

**NO OBLIGATION. NO SALESMAN WILL CALL**

APPROVED FOR VETERAN TRAINING  
Get facts on new 2-year extension

**NATIONAL TECHNICAL SCHOOLS**

TECHNICAL-TRADE TRAINING SINCE 1905  
Resident and Home-Study Schools  
4000 So. Figueroa St., Los Angeles, Calif. 90037

**NATIONAL TECHNICAL SCHOOLS** Dept. 222-115  
4000 South Figueroa St., Los Angeles, Calif. 90037  
Please send FREE Color Catalog and Sample Lesson.  
NO OBLIGATION. NO SALESMAN WILL CALL.

<input type="checkbox"/> Color TV Servicing	<input type="checkbox"/> Electronics Technology
<input type="checkbox"/> B & W TV and Radio Servicing	<input type="checkbox"/> Computer Electronics
<input type="checkbox"/> Electronic Communications	<input type="checkbox"/> Basic Electronics
<input type="checkbox"/> FCC License Course	<input type="checkbox"/> Audio Electronics Servicing

NAME \_\_\_\_\_ AGE \_\_\_\_\_  
ADDRESS \_\_\_\_\_ APT # \_\_\_\_\_  
CITY \_\_\_\_\_ STATE \_\_\_\_\_  
Please fill in Zip Code for fast service \_\_\_\_\_  
 Check if interested in G.I. Bill information.  
 Check if interested ONLY in classroom training in Los Angeles.



## THE SHOPPING CENTER FOR ELECTRONICS

(our catalog index of Mfrs.)  
extends from ADC to XCELITE

• HOBBYISTS . . . EXPERIMENTERS . . .  
SERVICE TECHNICIANS . . . ENGINEERS

Your Satisfaction is Our Target!

Top Name Brands . . .

Low Prices



AMPLE STOCKS—Including those hard-to-find Parts whether you want a 15c capacitor, a \$50. FET-VOM, or a \$450. stereo system—you can get it at EDI.

Transistors, ICs,  
Modules,  
Speakers,  
Stereo, HI-FI,  
Photo Cells and  
thousands of  
other  
Electronic  
Parts . . .



Send for your  
**FREE Catalog Today!**  
(updated 5 times a year)

RUSH FREE CATALOG

ELECTRONIC DISTRIBUTORS INC.  
Dept. TA-2, 4900 Elston  
Chicago, IL 60630

name

street

city

state

zip

CIRCLE 8 ON READER SERVICE COUPON

# BEA LOCKSMITH

"I have already  
master keyed my  
Elks Lodge and  
38 apartments . . .  
so you see my  
locksmith course  
is practically  
paid for."  
Adelindo Orsi, Jr.  
Azusa, Calif.

You'll enjoy your work as a Locksmith  
because it is more fascinating than a  
hobby—and highly paid besides! You'll  
go on enjoying the fascinating work,  
year after year, in good times or bad  
because you'll be the man in demand  
in an evergrowing field offering big pay  
jobs, big profits as your own boss.  
What more could you ask!

Train at Home — Earn Extra \$\$\$\$ Right Away!

**LOCKSMITHING INSTITUTE**

Div. Technical Home Study Schools  
Dept. 1472-115 Little Falls, N. J. 07424

Name \_\_\_\_\_  
(Please Print)

Address \_\_\_\_\_

City/State/Zip \_\_\_\_\_

Check here if Eligible for Veteran Training

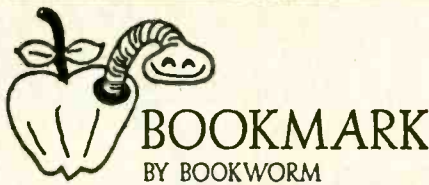

## BOOKMARK BY BOOKWORM

**Listen to the Stars.** This new one-of-a-kind text, *Radio Astronomy for the Amateur* by David Heiserman, combines fascinating, down-to-earth instruction in the science of astronomy with build-it-yourself electronic projects that are designed to catapult electronic experimenters full-force into a whole new universe of hobbying. Anyone with a comfortable background in electronics (ham radio, kit building, or just tinkering) and a curiosity about the universe around him will find the projects in this book the most imagination-triggering and satisfying he's ever undertaken. And

Radio  
Astronomy  
for the  
Amateur  
by Dave Heiserman

Soft cover  
252 pages  
88 illustrations  
\$5.95

once the reader has built his system, no matter how simple it is, he'll be able to start collecting data from space—even to "observe" stars so faint they can't be seen by the 200-in. giant on Mt. Palomar! Although written to the level of the seasoned electronics experimenter, no fore-knowledge of astronomy is assumed. The book begins with the rawest fundamentals of stellar science and moves forward with projects intended to incrementally enhance the reader's interest and add to his growing knowledge of astronomy. Projects include a variety of optical devices, radio-telescope antennas, sensitive receivers, radiometers, interferometers, signal-enhancing devices, converters for use with ham radio equipment, and many more. Published by Tab Books, Blue Ridge Summit, PA 17214.

**Where TV's At.** The Worldwide TV-FM DX Association has published a new book entitled, the *WTFDA TV Station Guide*. The Guide is a comprehensive reference of North and Central American television station data. This big 8½ x 11-in. comb-bound publication, features maps (by chan-

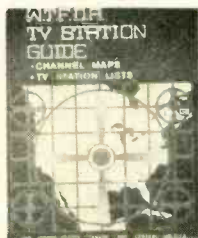

Soft cover  
64 pages  
28 maps  
\$5.00

nel) showing the location, call letters, network, and offset frequency for almost every TV station in North and Central America. The respective station lists provide additional information including, city of license, state of transmitter location (if other than state of license), whether or not the station is a satellite of (rebroadcasts) another station, originating station for the satellite, effective radiated power, antenna height, and what edition of *TV Guide* magazine carries the station's program schedule. The *WTFDA TV Station Guide* includes detailed channel maps which allow rapid access to a great amount of information. To get your copy, write directly to Worldwide TV-FM DX Association, P.O. Box 163, Deerfield, IL 60015.

**FCC Crib.** *2nd Class FCC Encyclopedia* by Kendall Webster Sessions is as sweeping and all-encompassing as the FCC exam itself, and is perhaps the most thoroughly detailed, elaborately illustrated, and easiest-to-read handbook on the 2nd and 3rd Class Federal Communications Commission license. In fact, it's virtually a one-volume electronics library all by itself! It's not a "cram course" but, instead, is an intensive, no-nonsense course in radio theory specifically designed to help the

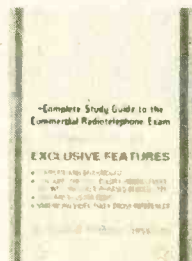

Soft cover  
602 pages  
445 illustrations  
\$7.95

reader obtain his license—and to provide him with the knowledge he needs for success in his career. The result is a study guide that is not just a course, but a whole series of courses that can help the reader master any field related to radio communication. A special feature of this unique new guide is the short-form/long-form answer format to hundreds of FCC-posed questions. Whenever possible, the answer to a question is divided into the shortest answer needed to satisfy the FCC requirements: a longer answer then shows how any similar question may be answered, and is included for reference or more complete understanding. A complete 5000-word index, fully cross-referenced, provides instant access to any rule, formula, circuit diagram, or technical explanation. Published by Tab Books, Blue Ridge Summit, PA 17214.

**VHF-UHF Monitors.** If you desire to understand the police and fire frequencies in your location, not to mention other emergency services, you need to look at Communications Research Bureau's latest free catalog. Most lists are only \$3 each. Write to the Bureau at P.O. Box 56, Commack, NY 11725, enclose a stamped-addressed business envelope for a free catalog. Tell 'em the Ol' Bookworm sent you.

# Cobra 85: Performance plus Simplicity

If you want the most performance with the easiest operation, you want Cobra 85.

Select any of 23 channels; adjust squelch and volume—the rest is automatic.

Like talk-range extending Dynabooast modulation circuitry that automatically gives you the most modulation the law allows and built-in automatic noise limiting that extends your listening range. The large illuminated meter tells you the strength of incoming signals and your relative power output. (You know that your radio and antenna

are good if the meter reads normally.)

Cobra 85 operates from either 117VAC or 12VDC with detachable power cords, so you can use it as a mobile too.

You get big sound from the up front, carefully baffled speaker. You'll hear clearly in your living room or car.

Like every Cobra radio, Cobra 85 is backed by warranty service stations in all 50 states. See the advanced Cobra 85 styling at your dealer.

You'll like its small size and price as well as its superior performance.



 **Cobra 85**

PRODUCT OF DYNASCAN CORPORATION • 1801 W. Belle Plaine • Chicago, Ill. 60613

CIRCLE 7 ON READER SERVICE COUPON

# DX central reporting

A world of SWL info!

BY DON JENSEN

□ It's save-a-buck-time at DX Central! Here are three useful DXing tools you can make yourself for just pennies. The total cost should be no more than about a half dollar—the price of a small pad of graph paper. If you're a student, maybe you already have several sheets around so you'll have a freebie!

One major problem for SWLs is frequency readout. With many receivers it is difficult to tell, even approximately, the frequency to which the SWL is tuned. Can you distinguish between 6,150 and 6,200 kHz, or between 15,110 and 15,120 kHz on your dial? If not, this graph trick is for you.

The technique works best with receivers having a separate bandspread or fine tuning dial. Theoretically it will work also with a simple multi-band portable, with a single sliderule type dial. But with these receivers the shortwave broadcasting segments of the band are tiny, perhaps no more than a half inch of dial length. And it is extremely tough to get much greater frequency accuracy than to the nearest 100 kilohertz.

If your rig has a bandspread dial, look for a "logging scale" on the bottom of the dial face. These are evenly marked graduations, sometimes numbered by tens from 0 to 100. They are, simply, tuning

reference points. If your receiver has no logging scale, make your own, by simply numbering a strip of graph paper and taping it to the bottom of your dial face.

On a separate sheet, mark the graph coordinates. On the vertical scale, the frequencies of a favorite SW band in kHz (the figure shows a graph of the 31 meter band). Duplicate your receiver's logging scale on the horizontal axis.

As you listen to that band, begin to mark the points of stations whose frequencies you know against their logging scale "readings." For example, in the 31 meter band, the time station WWV, easily heard and a key reference point, will be found at a certain logging scale point. Plot it on the graph. (Important: Each time you use the chart in the future, make sure this key station comes in at the same logging scale reading, thus insuring the rest of your tuned stations also show up where they should!)

Plot other stations whose frequencies you know against their logging scale num-

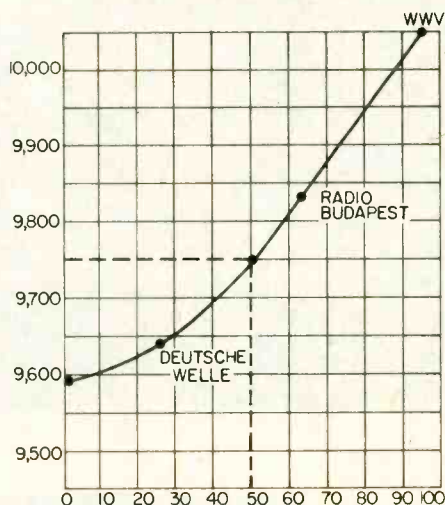

ber. Try Radio Budapest on 9,833 kHz, and Germany's Deutsche Welle (Voice of Germany) on 9,640 kHz, and perhaps a half dozen others. Then connect the plotted points with a line. Since many receivers are not linear across an entire SW band, the line may resemble a shallow curve rather than a straight line.

To use the graph in practice, let's assume you want to tune for a station on 9,750 kHz. Checking the graph in our example, you'll see you should set the dial indicator at logging scale number 50. Depending on the care with which you've plotted your graph, you should be reasonably close to that frequency. Accuracy to within five or 10 kHz is possible with the graphing technique.

Often newcomers to SWLing find themselves all tangled up with time conversion. DXers usually use the 24-hour notation system, in which times from 1 p.m. to 11:59 p.m. are stated as 1300 to 2359 hours. A second related problem is that for listeners, the time standard used is Greenwich Mean Time (GMT) or universal time, not their local clock time.

It is simple to plot a graph that will make both conversions for you at a glance. On the vertical axis, mark GMT hours, 0000, 0100, 0200, etc., up through 2300 hours. On the horizontal axis, mark your local time in a.m. and p.m. hours. If your local time is Eastern Daylight Time, begin with 8 p.m. and continue across the sheet, marking the hours through 7 p.m. If your local time is EST or CDT, begin with 7 p.m. and continue across through 6 p.m. For CST or MDT, begin with 6 p.m.; for MST or PDT, with 5 p.m.; for PST, start with 4 p.m. and mark across through 3 p.m. Then draw a line from the lower left of your graph to the upper right corner. *Voila!* A time conversion chart.

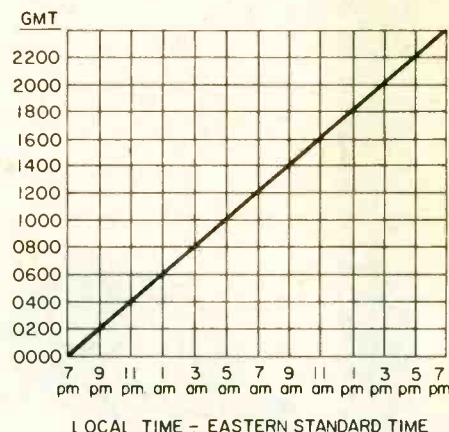

To use, find your local clock time and read up until you cross the graph line. Read the corresponding GMT time from the lefthand scale.

Our third graph is merely a simple way of keeping track of the broadcasting schedules of your favorite SW stations. Along the graph's bottom, mark the hours from 0000 to 2300 GMT. On the other axis, write in the names and frequencies of some of your favorite stations. From their

(Continued on page 28)

## GOLDFINGER ENTERPRISES

ATTENTION MONITOR SCANNER OWNERS

ORDER BY MAIL!

Goldfinger has in stock and available for immediate delivery, crystals for both Regency and Bearcat Scanners. **HIGHEST QUALITY PRECISION CRYSTALS**—Order from Goldfinger, one of the nation's largest specialists in scanner crystals. Send us the frequencies you want, the make and model of your scanner, and only \$4.95 per crystal. That's all there is to it! For immediate delivery send postal money order or certified check, **NO COD'S**. Order now and receive **FREE** our special Goldfinger crystal package.

**GOLDFINGER ENTERPRISES**

**9406 N.W. 74th St.**

**Ft. Lauderdale, Fla. 33319**

CIRCLE 25 ON READER SERVICE COUPON

# NICE TO HAVE AROUND THE HOUSE.

CUDDLE UP WITH A PEARCE-SIMPSON



**PUSSYCAT 23™**  
**\$179<sup>95</sup>**



**LYNX™ \$224<sup>95</sup>**



**SUPER LYNX™ \$284<sup>95</sup>**



**BEARCAT 23C \$339<sup>95</sup>**



**GUARDIAN 23™ \$379<sup>95</sup>**

**PEARCE-SIMPSON**  
DIVISION OF **GLADDING** CORP.

P.O. BOX 520800 BISCAYNE ANNEX MIAMI, FLORIDA 33152

CANADIAN DISTRIBUTOR

SCOTCOMM RADIO, INC., 4643 LEVESQUE BLVD., CHOMEDAY, LAVAL, QUEBEC, CANADA  
CIRCLE 34 ON READER SERVICE COUPON

# DX CENTRAL

(Continued from page 26)

printed schedules, or from the broadcast hours announced over the air, fill in a line graph showing the hours broadcast. As you fill in the graph you'll soon have an "at-a-glance" picture of which of your favorite broadcasters are on the air at any given hour.

And so, for a few cents, you've got three useful SWLing tools to work with.

**Radioactivity.** One of the most massive shuffles of shortwave stations and frequencies in recent years took place in Brazil in May. So extensive was the frequency shift-

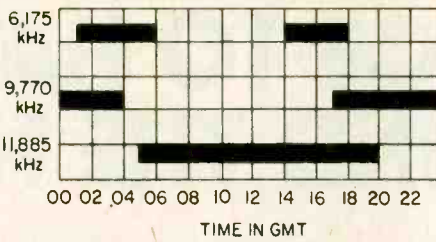

ing, involving over half of the Brazilian shortwave outlets on the lower frequencies, that most published lists of stations in that country are now hopelessly out of date.

Here, thanks to DX Central monitors

Tony Jones in Paraguay and Jack Perolo in Brazil, are some of the 60 meter Brazilians and their new frequencies:

kHz	Station, City
4,775	A Voz do Oeste, Cuiaba
4,785	Radio Brasil, Campinas
4,790	Radio Difusora de Aquidauana, Aquidauana
4,805	Radio Itatiaia, Belo Horizonte
4,815	Radio Difusora do Parana, Londrina
4,835	Radio Difusora Teresina, Teresina
4,865	Radio Sociedade Feira de Santana, Feira de Santana
4,915	Radio Anhanguera, Goiania
4,925	Radio Difusora Taubate, Taubate
4,937	Radio Poti, Natal
4,945	Difusora de Pocos de Caldas, Pocos de Caldas
4,965	Radio Sociedade Triangulo Mineiro, Uberaba
4,985	Radio Brasil Central, Goiania
5,015	Radio Cultura, Cuiaba
5,025	Radio Borborema, Campina Grande
5,035	Radio Aparacida, Aparacida
5,045	Radio Presidente Prudente, Presidente Prudente

And, reportedly there are medium wave broadcasting changes in store for Brazil as well, according to Glenn Hauser, reporting in the bulletin of the North American SW Association. The Brazilian Ministry of Communications is quoted as saying that there will be MW frequency changes, a more rational distribution of channels and the addition of 379 new stations, which will bring the total of medium wave outlets in Brazil to 1,170 in 861 different cities!

**Bandsweep.** Times in GMT, frequencies in kHz—Frequently we get requests for a list of English language broadcasts, their times and frequencies. Unfortunately, a list of this sort is more extensive than we have space for here in DX Central Reporting. But, good news! A list of shortwave stations in over 100 countries which broadcast in the English language, their frequencies and the times of the broadcasts, is available from the North American SW Association, Box 13, Liberty, IN 47353. It is free but you must enclose a long self-addressed, stamped envelope. From that list, here are a few stations and frequencies to start you off.

**3,300:** TGNA, a missionary station in Guatemala City has English programming nightly, Monday through Saturday, at 0300. Later you may find another English speaker, Radio Belize in Central America on the same channel in English. **4,820:** A nice African DX catch is West Africa's Radio Gambia, which airs an English program at 0630, except Sundays. **4,980:** Another African station, sometimes well heard in North America is Swazi Music Radio, in the tiny nation of Swaziland. Listen in after 0400 for the pop music programs directed to listeners in South Africa. **5,020:** This is a fairly new frequency for

(Continued on page 94)

## Checklist of Books for the Libraries of Technicians, Hobbyists & Students

- GRAND-NEW BOOKS...JUST PUBLISHED**
- Handbook of Multichannel Recording. 322 p. \$7.95
  - 14 Simple Radios You Can Build. 140 p. 122 il. \$3.95
  - Most Circuits Guidebook. 196 p. 111 il. \$4.95
  - Central Heating/Air Conditioning Repair Gde. 320 p. \$6.95
  - Electronic Music Cir. Guidebook. 224 p. 180 il. \$6.95
  - Microprocessor: Principles & Practice. 252 p. \$5.95
  - Aviation Electronics Handbook. 406 p. 249 il. \$8.95
  - Master Hdbk. of 1001 Practical Electronic Circuits. \$9.95
  - How to Repair Diesel Engines. 308 p. 236 il. \$5.95
  - Digital/Logic Electronics Handbook. 294 p. 226 il. \$6.95
  - Model Railroad Handbook. 336 p. 238 il. \$7.95
  - Customizing Your Van. 160 p. 150 il. \$3.95
  - Electronic Conversions/Symbols & Formulas. 224 p. \$4.95
  - Practical CB Radio Troubleshooting & Repair 210 p. \$5.95
  - 111 Digital & Linear IC Projects. 210 p. 275 il. \$5.95
  - Computer Programming Handbook 518 p. \$8.95
  - Step-By-Step Guide: Carburetor Tuneup & Overhaul \$4.95
  - Handbook of Practical Boat Repairs. 224 p. 144 il. \$6.95
  - Small-Screen TV Servicing Manual. 240 p. 367 il. \$6.95
  - Hang Gliding Handbook/Fly Like a Bird. 208 p. \$5.95
  - 2nd Genl. FCC Encyclopedia. 602 p. 600 il. \$7.95
  - International Transistor Selector. 140 p. \$4.95
  - Radio Astronomy. 252 p. 88 il. \$5.95
  - Radio Control for Models. 350 p. 417 il. \$6.95
  - Integrated Circuits Guidebook. 196 p. 124 il. \$5.95
  - Advanced Applications/Pocket Calculators. 308 p. \$5.95
  - Transistor Theory for Tech/Engineers. 224 p. 116 il. \$5.95
  - How to Trap a Wad. 124 p. 45 il. \$3.95
  - Complete FM 2-Way Radio Handbook. 230 p. 111 il. \$6.95
  - Basic Digital Electronics. 210 p. 117 il. \$4.95
- AUDIO, HI-FI & TAPE RECORDERS**
- 4-Channel Stereo/Source to Sound—2nd Ed. 252 p. \$4.95
  - Electronic Music Production. 156 p. 84 il. \$3.95
  - Servicing Cassette & Cartridge Tape Players. 294 p. \$6.95
  - Cassette Tape Recorder Repair. 204 p. \$4.95
  - Questions & Answers About Tape Recording. 264 p. \$5.95
  - FM Stereo/Quad Receiver Servicing Manual. 192 p. \$4.95
  - Stereo/Quad HI-FI Principles & Projects. 192 p. \$4.95
  - Acoustic Techniques for Home & Studio. 224 p. \$4.95
  - Selecting & Improving Your HI-FI System. 224 p. \$4.95
  - Basic Audio Systems. 240 p. 203 il. \$4.95
  - Pictorial Guide to Tape Recorder Repairs. 256 p. \$4.95
  - How to Repair Musical Instrument Amplifiers. 280 p. \$5.95
  - How to Build Solid-State Audio Circuits. 320 p. \$5.95
  - HI-FI for the Enthusiast. 176 p. 51 il. \$3.95
  - Electronic Music Design. 192 p. 124 il. \$4.95
  - Servicing Modern HI-FI Stereo Systems. 248 p. \$4.95
  - Handbook of Magnetic Recording. 224 p. over 90 il. \$4.95
  - Installing & Servicing Home Audio Systems. \$5.95
  - Tape Recording for Fun & Profit. 224 p. over 200 il. \$5.95
  - Audio Systems Handbook. 192 p. 124 il. \$4.95
  - Servicing Electronic Organs. 196 p. 81 x 11" \$7.95
  - Japanese Radio, Record & Tape Player Serv. Manual. \$6.95
- AUTO, ENGINE & APPLIANCE REPAIR**
- Auto Electronics Simplified. 256 p. 202 il. \$5.95
  - Gde. to Outboard Motor Service/Repair. 294 p. 226 il. \$8.95
  - Complete Hdbk. of Lawnmower Repair. 434 p. 392 il. \$7.95
  - The Complete & Electric Motor Repair. 240 p. 139 il. \$4.95
  - The Home Appliance Clinic. 196 p. 81 il. \$4.95
  - Complete Hdbk. Auto Engines/Sys. 252 p. 239 il. \$5.95
  - Small Appliance Repair Guide—Vol. 2. 210 p. 113 il. \$4.95
  - Rapid Auto Tuneup & Troubleshooting. 192 p. 97 il. \$3.95
  - The Complete Snowmobile Repair Handbook. 350 p. \$5.95
  - Auto Stereo Servicing Installation. 252 p. 258 il. \$5.95
  - Auto Tuneup/Emission-Control Svcs. 240 p. \$4.95
  - The Complete Mini-Bike Handbook. 309 p. 145 il. \$5.95
  - Everyman's Guide to Auto Maintenance. 192 p. 38 il. \$4.95
  - How to Repair Small Gasoline Engines. 288 p. 124 il. \$5.95
  - Using Electronic Tester for Auto Tune-Up. \$4.95
  - Major Appliance Repair Guide. 288 p. Illustrated \$5.95
  - How to Repair Home/Auto Air Conditioners. 208 p. \$4.95
  - Small Appliance Repair Guide. 224 p. over 100 il. \$4.95
  - Refrigeration. 131 p. 53 il. \$3.95
- RADIO & TV SERVICING**
- Color TV Case Histories. 118 p. 117 il. \$5.95
  - Jack Darr's Service Clinic No. 3. 252 p. \$4.95
  - Pinpoint Transistor Troubles in 12 Minutes. 492 p. \$6.95
  - Poular Tube & Transistor Substitution Guide. 256 p. \$3.95
  - CET License Handbook. 276 p. 289 il. \$5.95
  - TV Tuner Schematic/Servicing Manual. 81 x 11". \$5.95
  - How to Shoot/Repair Electronic Test Equipment. \$6.95
  - TV Troubleshooter's Handbook—3rd Ed. 488 p. \$4.95
  - Effective Troubleshooting with EVM & Scope. 238 p. \$5.95
  - Logical Color TV Troubleshooting. 240 p. 151 il. \$5.95
  - Color TV Trouble Factbook—2nd Ed. 308 p. \$5.95
  - 10-Minute Test Techniques for PC Servicing. 216 p. \$4.95
  - TV Bench Servicing Techniques. 228 p. 177 il. \$4.95
  - TV Shooting Solid-State Wave Gen. & Shaping Cir. \$4.95
  - Pict. Guide to Color TV Circuit Troubles. 256 p. \$4.95
  - Installing TV & FM Antennas. 168 p. 158 il. \$3.95
  - Simplified TV Troubleshooting. 320 p. 192 il. \$5.95
  - How to Interpret TV Waveforms. 256 p. 270 il. \$4.95
  - Kwik-Fix TV Service Manual. 384 p. \$5.95
  - Basic Color Television Course. 420 p. over 300 il. \$7.95
  - All-In-One TV Alignment Handbook. 304 p. 145 il. \$5.95
  - 199 Color TV Troubleshooting Manual. 224 p. \$4.95
  - Modern Radio Repair Techniques. 260 p. \$5.95
  - TV Trouble Diagnosis Made Easy. 256 p. \$5.95
  - Home-Call TV Repair Guide. 144 p. \$3.95
  - 101 TV Troubles—From Symptom to Repair. 224 p. \$4.95
  - Pinpoint TV Troubles in 12 Minutes. 384 il. \$5.95
- COMPUTER TECHNOLOGY**
- Getting the Most Out of Your Electronic Calculator. \$4.95
  - Simplified Computer Programming—The RPG Way. \$5.95

- Beginner's Guide to Computer Programming. 480 p. \$6.95
  - Computer Technician's Handbook. 480 p. over 400 il. \$6.95
  - Beginner's Guide to Computer Logic. 192 p. \$4.95
  - Computer Circuits & How They Work. 192 p. il. \$4.95
  - CATV Circuit Engineering. 294 p. 158 il. \$14.95
  - How To Be A Ham—Incl. Latest FCC Rules. 150 il. \$5.95
  - Amateur FM Conversion/Construction Proj. 258 p. \$5.95
  - Pictorial Guide to CB Radio Installation & Repair. \$5.95
  - Modern Communications Switching Systems. 274 p. \$17.95
- COMMUNICATIONS, CB & HAM RADIO**
- Directional Broadcast Antennas. 210 p. 50 il. \$12.95
  - Bdct Announcer 3rd Class FCC Study Gde. 168 p. \$3.95
  - How To Be A Ham—Incl. Latest FCC Rules. 152 p. \$5.95
  - Complete Shortwave License Handbook. 288 p. \$8.95
  - Mobile Radio Handbook. 192 p. 175 il. \$4.95
  - Modern Radar/Theory/Operation/Maintenance. 480 p. \$7.95
  - CB Radio Operator's Guide. 224 p. scores of il. \$5.95
  - Marine Electronics Handbook. 192 p. 106 il. \$4.95
  - 2-Meter FM Repeater Circuits Handbook. 312 p. \$6.95
  - RTTY Handbook. 320 p. 230 il. \$6.95
  - Citizens Band Radio Service Manual. 228 p. \$5.95
- AMATEUR RADIO STUDY GUIDES—**
- Novice \$5.95  General \$7.95  Advanced \$5.95
  - Extra \$4.95  Incentive \$3.95 il.
- LEARN IT YOURSELF—BEGINNER'S BOOKS**
- Dictionary of Electronics. 420 p. 467 il. \$4.95
  - Working With The Oscilloscope 104 p. 183 il. \$4.95
  - 99 Ways to Use Your Oscilloscope. 192 p. 327 il. \$4.95
  - Working With Semiconductors. 254 p. 185 il. \$4.95
  - How to Become a Radio Disc Jockey. 256 p. il. \$5.95
  - Introduction to Medical Electronics. 272 p. 126 il. \$4.95
  - Understanding & Using the VOM & EVM. 192 p. \$4.95
  - How to Read Electronic Circuit Diagrams. 192 p. \$4.95
  - Elect. Unraveled/A New Commonsense Approach. \$4.95
  - Electrical Wiring/Lighting For Home/Ofces. \$4.95
  - Basic Electricity & Beginning Electronics. 180 p. \$4.95
  - Basic Electronic Test Procedures. 418 p. 178 il. \$6.95
  - Basic Electronics Course. 384 p. 275 il. \$6.95
  - Beginner's Guide to TV Repair. 176 p. \$4.95
  - Electronics Self-Taught With Experiments/Projects. \$5.95
  - Basic Electronics Problems Solved. 192 p. \$4.95
  - How to Test Almost Every Thing Electronic. 160 p. \$2.95
  - Basic TV Course. 224 p. 128 il. \$5.95
  - Basic Transistor Course. 224 p. packed with il. \$4.95
  - Basic Radio Course. 224 Illustrated pages. \$4.95
  - Basic Math Course for Electronics. 168 p. \$4.95
  - Electric Motor Test & Repair. 160 p. \$6.95
- HOBBY PROJECTS & PLANS**
- Amat. Filmmaker's Hdbk. of Sound Sync. Scoring. \$7.95
  - Electronic Experimenter's Gdbk. 192 p. 88 il. \$5.95
  - Electronics For Shutterbugs. 204 p. 109 il. \$5.95
  - Handbook of Semiconductor Circuits. 444 p. \$5.95
  - Digital Electronics: Principles & Practice. 288 p. \$5.95
  - Practical Circuit Design for the Experimenter. 196 p. \$4.95
  - Practical Triax/SCR Projects For the Experimenter. \$4.95
  - Model Sail & Power Boating—by Remote Control. \$4.95
  - Practical Test Instruments You Can Build. 204 p. \$4.95
  - Miniature Projects For Electronic Hobbyists. 168 p. \$3.95
  - Experimenting With Electronic Music. 180 p. 103 il. \$4.95
  - Landmark From RC Models to the Big Ones. 192 p. \$4.95
  - Handbook of IC Circuit Projects. 224 p. 136 il. \$4.95
  - New IC Fet Principles & Projects. 154 p. over 80 il. \$3.95
  - VHF Projects for Amateur & Experimenter. 224 p. \$4.95
  - Model Car Racing... by Radio Control. 224 p. \$3.95
  - Practical Triax/SCR Projects For the Experimenter. 224 p. \$4.95
  - Practical Solid-State Principles & Projects. 176 p. \$3.95
  - Radio-Electronics Hobby Projects. 192 p. 214 il. \$4.95
  - IC Projects for Amateur & Experimenter. 192 p. \$4.95
  - Transistor Projects for Hobbyists & Students. 192 p. \$4.95
  - 125 One-Triax Projects. 192 p. 125 il. \$4.95
  - 104 Easy Proj. for Electronics Gadgets. 160 p. \$3.95
  - 64 Hobby Projects for Home & Car. 192 p. 159 il. \$4.95
  - 104 Simple One-Tube Projects. 192 p. 104 il. \$3.95
  - Electronic Hobbyist's IC Project Handbook. 154 p. \$4.95
  - 104 Easy Transistor Projects You Can Build. 224 p. \$4.95
  - Radio Control Manual—2nd Ed. 192 p. 158 il. \$4.95
- ALL-IN-ONE COLOR & B&W TV SCHEMATIC/SERVICING MANUALS**
- Each vol. has complete service data, parts lists, full-size schematics, and all other info needed. Each 8 1/2 x 11", 196-212 pps. Each only \$4.95 unless marked \$5.95. **COLOR TV:** Adm. Vol. 1 \$5.95  Vol. 2 G-E Vol. 1 \$5.95  Vol. 2 \$5.95  Vol. 3 \$5.95  Vol. 4 \$5.95  Airline \$5.95  Motorola Vol. 1 \$5.95  Vol. 2 \$5.95  Philco \$5.95  RCA Vol. 1 \$5.95  Vol. 2 \$5.95  Vol. 3 \$5.95  Vol. 4 \$5.95  Vol. 5 \$5.95  Sears \$5.95  Serv. Modular Rev. Vol. 1 \$5.95  Vol. 2 \$5.95  Vol. 3 \$5.95  Toshiba \$5.95  Zenith Vol. 1 \$5.95  Vol. 2 \$5.95  Vol. 3 \$5.95  B&W TV: Adm. \$5.95  Jap. \$5.95  Mag. \$5.95  Philco \$5.95  RCA \$5.95  Zenith \$5.95
- NO-RISK COUPON—MAIL ENTIRE AD**
- TAB BOOKS, Blue Ridge Summit, Pa. 17214**  
Please send me books checked above.
- I enclose \$\_\_\_\_\_; send postpaid  
 Please invoice on 10-day FREE trial.  
 Send FREE 44 page catalog.
- Name \_\_\_\_\_ Phone \_\_\_\_\_  
Company \_\_\_\_\_  
Address \_\_\_\_\_  
City \_\_\_\_\_ State \_\_\_\_\_ Zip \_\_\_\_\_
- SAVE POSTAGE by remitting with order. Foreign add 10%; Pa. residents add 6%. EE-118



# For people who count on CB.



## New SSB-23A single sideband mobile transceiver.

You're on a rescue mission and you're relying on your two-way radio to get through. Otherwise it might be curtains for some guy at the bottom of a canyon.

That's the kind of action and you're the kind of guy we designed our new SSB-23A single sideband mobile rig for — the CBer who needs the band for effective, dependable communications in emergencies, in heavy traffic, under all kinds of conditions.

The guy who counts on CB.

The SSB-23A gives you upper and lower sideband selection plus AM on all 23 channels and all the features you'll find in the finest CB equipment.

Yet it costs less than single sideband sets that aren't really in the same league with it.

The new mobile unit features public address capability too, and a sharp high-frequency crystal filter for pinpoint selectivity that helps

the receiver cut through all kinds of interference.

The FCC type-accepted SSB-23A is a precision piece of equipment that looks like it means business under anybody's dash.

And it gives you the performance a serious CBer should demand from single sideband equipment.

If you're one of those people who count on CB communications — sometimes in life-or-death situations — see the new Siltronix SSB-23A at your dealer's today. It's built for you.

**SSB-23A Recommended Retail Price \$359.95**



A Cubic Corporation Company

269 Airport Road • Oceanside, CA 92054  
Telephone: (714) 757-8860

CIRCLE 22 ON READER SERVICE COUPON

# When you're exploring technology... books



# a fascinating new alone are not enough.

If you're like most men, deep down inside there's still a bit of the boy who loved to go exploring... and who'd love to go again. Well, now you can.

Only this time you'll explore the expanding world of electronics... a world more fascinating than any you ever dreamed of as a boy.

**Learn by exploring... Bell & Howell Schools offers an exciting way for you to gain new occupational skills in electronics.**

Everybody enjoys learning something new, but why learn it the old way? Classes to go to. Lectures to sit through. And only a bunch of books to keep you interested.

Bell & Howell Schools' adventure in learning is a far cry from all that.

You can probe into electronics and learn exciting new occupational skills right in your own home, in your spare time. On whatever days and whatever hours you choose. So there's no need to give up your present job and paycheck just because you want to learn something new.

What's more, when you're exploring a field as fascinating as electronics, reading about it is just not enough. That's why throughout this program you'll get lots of "hands on" experience with some of today's latest electronic training tools.

**You'll be stimulated for hours on end as you build, experiment and learn while using the latest ideas and techniques in this fascinating field.**

As part of the program you'll actually learn to build and work with your own electronics laboratory. Using it to put many of today's most dynamic electronic discoveries to the test... including electronic miniaturization.

Among the things you'll discover is how the development of tiny integrated circuits has made possible an electronic calculator small enough to fit into a shirt pocket! And a wristwatch that flashes the time with the push of a button.

You'll investigate the concept of "logic circuits." An idea that has been with us for centuries but only in recent years put to use as the "brain" behind all the new digital consumer appliances we see today.

But more important than anything else is the new occupational skills you'll develop in electronics troubleshooting. While no assurance of income opportunities can be offered, you'll develop skills that could lead you in exciting new directions. Use your training:

1. To seek out a job in the electronics industry.
2. To upgrade your current job.
3. As a foundation for advanced programs in electronics.

**You build and perform many exciting experiments with Bell & Howell's Electro-Lab® an exclusive electronics training system.**

Using our successful step-by-step method,

you'll build:

1. A design console, for setting up and examining circuits.
2. A digital multimeter for measuring voltage, resistance and current (it displays its findings in big, clear numbers like a digital clock).
3. A solid-state "triggered sweep" oscilloscope—similar in principle to the kind used in hospital operating rooms to monitor heartbeats. You'll use it to monitor the "heartbeats" of tiny integrated circuits. The "triggered sweep" feature locks in signals for easier observation.

**Step-by-step you'll build and experiment with Bell & Howell's new generation color TV—investigating digital features you've probably never seen before!**

This 25" diagonal color TV has digital features that are likely to appear on all TV's of the future. As you build it you'll probe into the technology behind all-electronic tuning. And into the digital circuitry of channel numbers that appear right on the screen! You'll also build in a remarkable on-the-screen digital clock, that flashes the time in hours, minutes and seconds. Your new skills will enable you to program a special automatic channel selector to skip over "dead" channels and go directly to the channels of your choice.

You'll also gain a better understanding of the exceptional color clarity of the Black Matrix picture tube, as well as a working knowledge of "state of the art" integrated circuitry and the 100% solid-state chassis.

After building and experimenting with this TV, you'll be equipped with the skills that could put you ahead of the field in electronics know-how.

**We try to give more personal attention than other learn-at-home programs.**

1. Toll-free phone-in assistance. Should you ever run into a rough spot during the program, we'll be there to help. While many schools make you mail in your questions, we have a toll-free line for questions that can't wait.
2. In-person "help sessions." These are held in 50 major cities at various times throughout the year where you can talk shop with your instructors and fellow students.

**No electronics background needed.**

What you really need is the thing you've never lost. A boy's love for exploring. Now you can go again, only this time learning new occupational skills all along the way.

**Mail the postage-paid card today for more details**

Taken for vocational purposes, this program is approved by the state approval agency for Veterans' Benefits.

If card has been removed, write:

An Electronics Home Study School  
DEVRY INSTITUTE OF TECHNOLOGY  
ONE OF THE

**BELL & HOWELL SCHOOLS**  
4141 Belmont, Chicago, Illinois 60641



Simulated TV test pattern.

"Electro Lab" is a registered trademark of the Bell & Howell Company.

# newscan

Electronics in the News!

## Electric Power From Sunlight

West coast scientists have developed a new type of solar cell only  $\frac{1}{8}$ -in. in diameter that produces 10 watts of electricity directly from sunlight. Other solar energy materials require 1,000 times the surface area to produce the same amount of energy. In addition, the solar cell is 20 percent efficient. This is a significant improvement over previous materials used to convert sunlight to electric power.

The solar cells can be connected in series so that 100 cells will produce one kilowatt. Larger series can be constructed to obtain megawatt-rated systems. Because of the high efficiency and reduced space requirement, such large generating arrays of the new solar cells could be installed compatibly in agricultural or desert lands with negligible environmental side effects. The solar cell is made from gallium arsenide, a semiconductor material widely used in electronics, according to Lawrence James and Ronald Moon, members of the Varian Associates solar cell development team. Varian Associates are located at Palo Alto, California.

In Varian's experimental solar generator, a concave reflector collects sunlight and focuses it on the solar cell, thus concentrating the light by a factor of 1,000. The key to the cell's high power output for its small size and low cost is the ability of gallium arsenide to operate efficiently with highly concentrated sunlight. Silicon, the material used in conventional conversion devices, cannot function as effectively at high

temperatures or with high electric current densities.

An economically practical generating system would use large numbers of Varian solar cells, each with its own reflector, arrayed on a frame that would turn slowly to follow the sun. By being able to follow the sun from sunrise to sunset, the rotating array could utilize 40 percent more sunlight per day than immovable flat panel arrays. The Varian solar cell system will function efficiently on any day when the sky is clear enough to see a well-defined shadow.

## Save Cooling Costs

A new power saving wiring panel enables home owners to use outside air to save energy and money in cooling houses. The Honeywell W959A panel is for an economizer system that brings cooler outside air into a house while exhausting inside air. In many sections of the nation the air after sundown is cooler than the air inside the house. Rather than run the air conditioner, the system automatically brings in the outside air. The principle is the same as opening a couple of windows and creating a draft through the house. There are two differences, however. First, if you have your house closed up for air conditioning during the day, it is hard to know just when the outside air is at the temperature you can use. Second, the economizer system runs dirty outside air through the electronic air cleaner or filter on your furnace before supplying it to cool the house. The concept is similar to systems used commercially for stores, offices, manufacturing plants and other buildings operated after sunset.

The new wiring panel includes points for thermostat, damper and outdoor air temperature and humidity sensor control for integrating with the air conditioning condenser and control. Basically, the economizer system allows the ther-

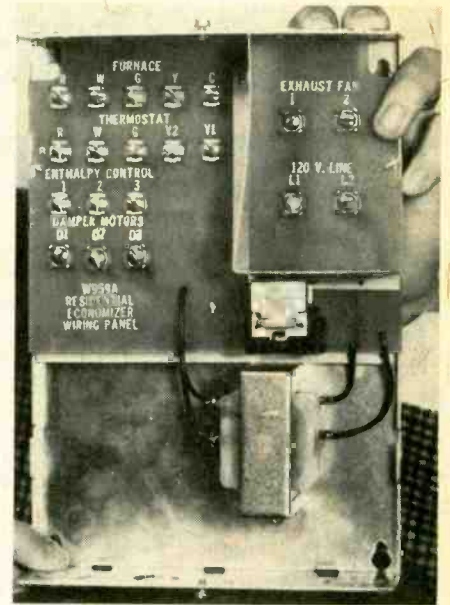

New wiring panel from Honeywell is designed to allow easy integration of the space thermostat, enthalpy changeover control and a damper motor in an "Economizer System." The system is designed to use cool outside air when possible instead of turning on air conditioning equipment.

mostat to bypass starting the air conditioner if outside air humidity and temperature levels are suitable. When the cooling load is too great for outside air alone to handle, then both the economizer and air conditioning systems may operate at the same time.

The upshot is less air conditioning compressor running time, which provides it with a longer lifetime and immediate energy savings for lower utility bills during summer. In most cases the cost of installing an economizer is recovered in the first few years of operation and after that the money saved goes into the home owner's pocket. While the Honeywell residential economizer system can be applied to existing housing, it is much easier to install in new homes and is becoming a regular option offered by builders to persons who want the most energy-saving house they can get.

## New Electronic Kit Company

A new electronic-kit company, Amtroncraft Kits Ltd., has been formed as exclusive U.S. and western-hemisphere distributor of kits manufactured by Amtroncraft of Milan, Italy. The Amtroncraft line consists of a series of 200 kits, most of which will be available in

Varian researcher Ronald Moon observes the experimental solar generator which concentrates sunlight to the solid-state solar cell. Large arrays of these concentrator units could be a low-cost, practical source of electricity.

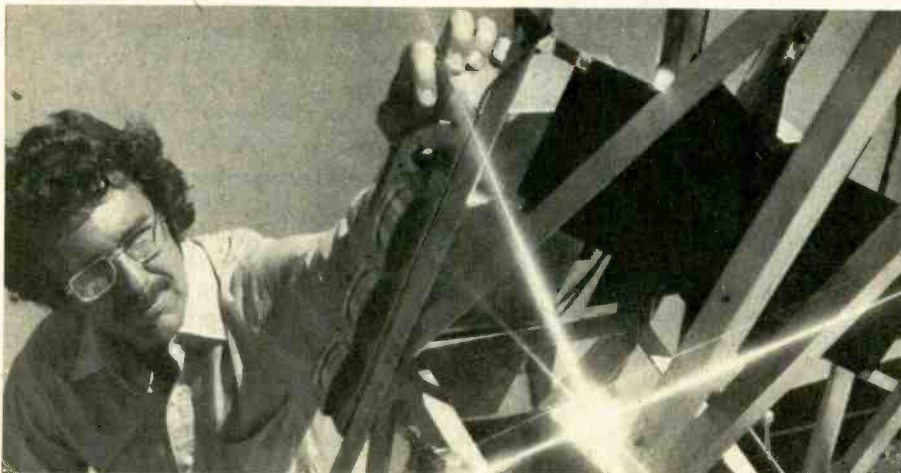

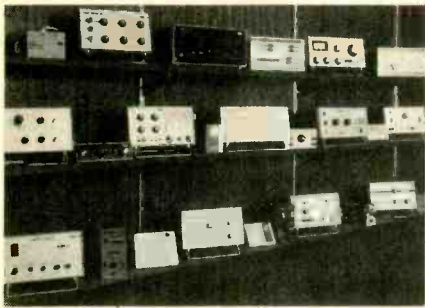

Display of some of the electronic kits in the new Amtroncraft line.

the U.S. through electronic parts distributors. Amtroncraft has been making kits in Italy for over 20 years.

Kits available will include: audio/hi-fi amplifiers and preamplifiers; FM receivers, tuners and transmitters; audio mixers and noise suppressors; automotive products; Citizens Band and amateur radio converters, amplifiers and test equipment; logic devices; accessories for electronic musical instruments and psychedelic lights; photographic products; home, hobbyist and office products; power supplies; television products; battery chargers; security systems; a wide range of test instruments, and equipment cabinets. Interested: Then write to Amtroncraft Kits, Ltd., One West 13th Street, New York, NY 10011.

### Alcohol Odyssey

"If you drink, don't drive" are sobering words at any time, especially on holiday weekends. The potential drunk driver hazard was demonstrated over New Year's Eve in Indiana in a rather unusual way. Don Chebillet, host of the WPTA-TV "Cross Talk" TV program in Fort Wayne, Indiana, progressively

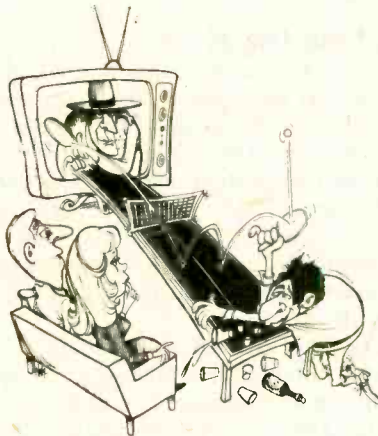

To demonstrate the potential drunk driver hazard, an Indiana TV talk show host drank 100-proof Vodka during his show as he played TV table tennis with an Indiana State Trooper.

drank eight ounces of 100-proof vodka during his show and played a simulated game of table tennis.

The table tennis game was set up on a television set in the studio, by means of "Odyssey," the Magnavox game played on a television screen. The table tennis game is an accurate test of coordination and reflexes.

Guests and observers on the December 31 show were Indiana State Trooper Tom Garrison, a public information officer, and Dr. Elmer Sweig, M.D., administrator for a Ft. Wayne alcoholic rehabilitation center.

Using the Odyssey control units, Chebillet and Trooper Garrison served and played table tennis—with moving lights simulating the tennis balls on the TV screen. During the 40 minutes Chebillet drank vodka and played the game his reactions grew slower, and he developed difficulty in hitting the electronic "ball." His coordination disintegrated as the alcoholic in-take increased. Yet Chebillet didn't notice the insidious effects of the alcohol. After the show, he remarked that he felt he was playing as well at the end as at the beginning. But it was obvious to his audience that his game proficiency gradually deteriorated and contradicted this impression.

(Continued on page 36)

# NEW, FULL-FEATURE PERSONAL 2-WAY RADIO

**STYLED FOR THE CB'ER WHO IS BUDGET MINDED, YET WANTS A COMBINATION OF PERFORMANCE, STYLE AND RUGGEDNESS FOR HIS CB RADIO.**



PACE CB 144 is a fully synthesized 23 channel AM transceiver offering full legal transmit power. Maximum control at your fingertips: Noise blanker switch • Automatic noise limiter switch • RF gain control • PA control • Delta tune • Illuminated S/R/F meter • transmit indicator light • Plug-in microphone. Operates on 12V DC (+) or (-) ground.

**Suggested retail price \$189.95**

**See your PACE dealer today.**



**PACE TWO-WAY RADIO PRODUCTS.**

Div. of Pathcom Inc., 24049 S. Frampton Ave., Harbor City, Ca. 90710. Available in Canada from Superior Electronics, Inc. Export (all other parts of the world): 2200 Shames Dr., Westbury, N.Y. 11590

61

CIRCLE 21 ON READER SERVICE COUPON

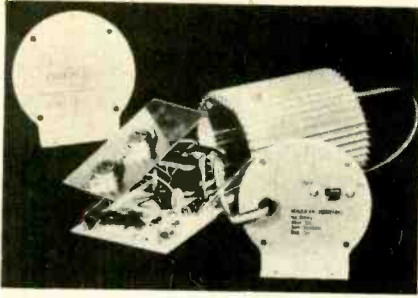

**FROM KIT TO CAR  
IN 80 MINUTES!**

Electronic Ignition is "In". Update your car with the TOPS in power, efficiency and reliability — the TIGER SST capacitive discharge ignition (CD).

The TIGER delivers everything other CD's promise — and more: quicker starting, more power, more gas mileage, tune-ups eliminated, lifetime plugs and points, reduced repairs and pollution.

The TIGER can be built and installed in your car in 80 minutes. The TIGER is unique!

The TIGER comes with a switch for TIGER or standard ignition for 12V negative ground only.

**SATISFACTION GUARANTEED  
or Money Back.**

**Simpli-Kit \$31.95  
POST PAID U.S.A.**

**WE ACCEPT:**  
Mastercharge or BankAmericard.  
Send check or money order with order to:

**Tri-Star Corporation**

DEPT. AA, P.O. Box 1727  
Grand Junction, Colorado 81501  
CIRCLE 23 ON READER SERVICE COUPON



the original  
"wedge-type" screwdriver

**QUICK-  
WEDGE®**

**SCREW-HOLDING  
SCREWDRIVER**

Does all the job!

**HOLDS,  
STARTS,  
DRIVES,  
AND SETS**

the screw  
normal tightness!

**GET A SET TODAY!**

At your dealer's  
or write

**KEDMAN  
COMPANY**

Box 267  
Salt Lake City,  
Utah 84110

**17  
SIZES**

© 1975 by  
Kedman Company

CIRCLE 29 ON READER SERVICE COUPON

**NEWSCAN**

(Continued from page 35)

Trooper Garrison plans to use the "Odyssey" test in other graphic demonstrations for lecture groups. He has already shared the TV show findings, and his ideas about the game center as a method of safe driving education, with other members of the Indiana State Police.

**Electronic License Plate**

The lowly license plate—the last item considered when buying a car—someday may be the most important when it comes to highway safety, traffic control, anti-theft protection, vehicle inspection and automatic toll billing. It also may prove to be a very effective way of transmitting emergency radio messages between motorists and law enforcement officials.

The key to such an automatic and almost instantaneous multi-purpose system is an electronic license plate, which would cost only a few dollars when manufactured in quantity, would perform three basic functions: respond with a vehicle's identifying code number when electronically interrogated; receive and transmit radio messages to and from a vehicle, and; serve as a transponder for use in a cooperative collision avoidance radar.



An electronic license plate system that someday could improve highway safety and automate traffic services is demonstrated by Lyn Roberts at the RCA Laboratories, Princeton, N.J. The license plate contains a sophisticated antenna system for receiving and broadcasting signals.

The heart of the electronic license plate (developed by RCA) is a sophisticated antenna system capable of receiving radio signals at one frequency and re-broadcasting the signals at double that frequency. The addition of an integrated circuit coder would enable the license plate to transmit an electronic signal that distinctly identifies the vehicle carrying it. This feature

could be used in a number of ways. Electronic interrogators (microwave transmitters/receivers) placed along streets and highways as part of a data processing network could provide automatic vehicle monitoring (AVM) of buses, police cars, ambulances, trucks and cabs. This information could be used to provide improved scheduling of buses and speedier and more efficient dispatching of ambulances, police cars, cabs and trucks. It also would enable trucking firms to monitor vehicles carrying valuable cargoes, thus reducing the risk of highjacking.

In addition, the RCA system could alert police as soon as the identifying number and location of a vehicle known to be stolen appears. Likewise, authorities could be alerted to vehicles whose owners had ignored summonses for traffic violations.

The electronic interrogators, equipped with doppler radar speed sensors, could automatically record the identifying number of any vehicle exceeding the post speed limit by a significant amount. A "you are speeding" signal could also be transmitted to the driver via the electronic license plate.

The system could be expanded to limit access of vehicles to certain areas by adding special codes to the basic identification numbers. For example, entry to restricted parking lots could be limited to designated vehicles. Vehicles with special codes could bypass coin toll collectors at bridges and turnpike entrances. The vehicle's identifying number would be automatically recorded from the electronic license plate, and its owner would be periodically billed for accumulated toll charges.

Inspection stations could be automated to test vehicles to manufacturers' specifications. An electronic interrogator would read the car's identifying number and automatically program the inspection equipment to check for compliance with the manufacturers' specifications for that particular car or truck. The license plate could also be used to receive safety messages from fixed roadside transmitters or police cars. Examples of such messages are ice, snow, fog, or accident ahead, vehicle going the wrong way into a one-way street, or car going too fast for conditions.

The driver of a disabled car could use his electronic license plate to transmit a coded call for assistance to either fixed roadside receivers or possibly to passing police cars or other public vehicles.

The main components of the electronic license plate is a "printed-circuit an-

(Continued on page 94)

# RADIO SHACK'S NEW LOOK IN CB MAKES OPERATION EASY AS A MOBILE PHONE!



Universal  
Mounting Bracket



On Dash

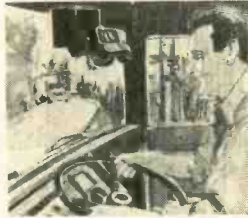

Cab Roof



Floor

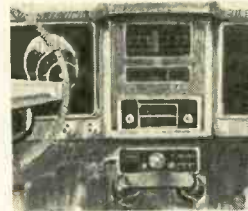

Under Dash

FCC Type Accepted **179<sup>95</sup>**

The Realistic TRC-56 sets a new standard in CB. Loaded with features other brands leave out, we believe it's the most "you designed" mobile transceiver ever. The telephone-type mike and handset virtually eliminate background noise as you talk, and you receive messages clearly and privately — even in high noise locations.

A switch lets you listen with handset, built-in speaker, or both. It has crystals for transmitting and receiving on 23 AM channels, a noise blanker and Automatic Noise Limiter, delta fine-tuning, automatic modulation gain circuit and dual conversion receiver with ceramic filtering. The TRC-56 can be mounted 'most anywhere and still have all controls easily accessible for safe and convenient mobile operation. 12 VDC positive or negative ground. #21-153. There's only one place you can find it

... Radio Shack.



**FREE!** NEW 1976  
RADIO SHACK  
CATALOG

164 PAGES • OVER 2000 ITEMS  
AT OUR OVER 3500 STORES OR  
MAIL THIS COUPON TO:

Radio Shack 604  
P.O. Box 1052  
Fort Worth, Texas 76101

(Please Print)

Name \_\_\_\_\_ Apt. # \_\_\_\_\_

Street \_\_\_\_\_

City \_\_\_\_\_

State \_\_\_\_\_ Zip

**REALISTIC**<sup>®</sup>  
at  
**Radio Shack**<sup>®</sup>

A TANDY CORPORATION COMPANY  
OVER 3500 STORES • 50 STATES • 7 COUNTRIES



Just Say "Charge It"  
At Participating Stores

Retail prices may vary at individual stores. Prices and products may vary in Canada.

CIRCLE 32 ON READER SERVICE COUPON

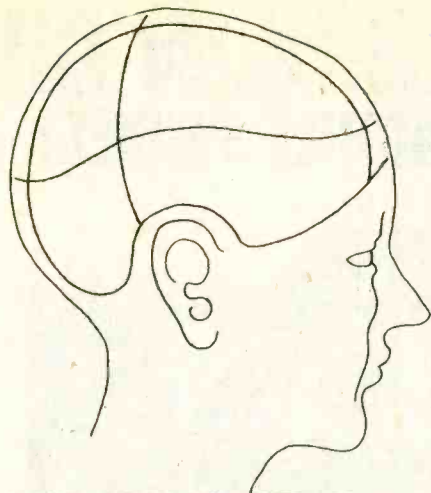

## 'GET INTO YOURSELF'

### Discover your Alpha Brainwaves with this professional Biofeedback System.

#### Lowest Cost Brainwave Monitor

EICO introduces a price breakthrough in the fantastic new field of brainwave biofeedback... a completely safe, battery operated, biofeedback system that offers features and sensitivity comparable to professional models costing much more.

#### You Will Be Amazed At What You Hear

The BW-300 will detect your alpha brainwaves (which occur when you are totally relaxed) and produce a tone varying in frequency according to your mental state.

#### 100% Solid State Circuitry

Reliable All Solid State IC Circuit Design features an active filter that isolates alpha brainwaves and a high-gain low-noise amplifier providing 5-microvolt sensitivity for easy alpha recognition. The BW-300 is supplied with stethoscopic earphones, electrodes headband, contact cream and instructions.

**KIT 3495**  
WIRED 59.95

### FREE EICO CATALOG

For latest EICO Catalog on Test Instruments, Automotive and Hobby Electronics, Eicocraft Project kits, Burglar-Fire Alarm Systems and name of nearest EICO Distributor, check reader service card or send 50¢ for fast first class mail service.

EICO-283 Malta Street, Brooklyn, N.Y. 11207

Leadership in creative electronics



CIRCLE 2 ON READER SERVICE COUPON



**ASK HANK,  
HE KNOWS!**

Got a question or a problem with a project—ask Hank! Please remember that Hank's column is limited to answering specific electronic project questions that you send to him. Personal replies cannot be made. Sorry, he isn't offering a circuit design service. Write to:

**Hank Scott, Workshop Editor  
ELEMENTARY ELECTRONICS  
229 Park Avenue South  
New York, NY 10003**

#### Oops, We Left It Out!

Thanks for the many letters on the "Foil Your Local Burglar" story we published in the Sept./Oct. 1975 issue of ELEMENTARY ELECTRONICS. One question most readers asked was, "Where do I get the parts?" Well, the table below failed to make the issue through a goof in the last minute rush of getting the magazine out. So here it is. Start foiling your local burglar now!

#### FOIL YOUR LOCAL BURGLAR SUGGESTED PARTS LIST

Item	Radio Shack No.
Window foil, self-stick .....	275-502
Magnetic contact switch .....	275-495
Foil block connectors .....	275-504
Master control security center .....	275-485

#### Can You Help Out?

Frank C. Smith, disabled and a pensioner, would like to get into CB. Can anyone near Frank's home help out? He lives at 1624 Jefferson Street, Cinnaminson, NJ 08077.

△ Rats are his problem and he would like to chase them away. E. E. McNeeley, 26734 West Edison Rd., South Bend, IN 46628 would like to pipe the rodents away with an electronic piper, if someone would be good enough to send him a diagram.

△ Bob Miller of Rt. #1, Box 35A, Howard Lake, MN 55347 can use a serviceable OA1 vacuum tube for an A.C. Dayton TRF receiver he is restoring.

#### Just the Facts, Please

I have recently acquired a Stewart Warner Model 9004-G combination phonograph-radio. Can you tell me what year or years it was made, the price at that time, and where I can get a schematic for it?

—D. E., Levelland, TX

If you write to the Antique Radio Editor of this magazine, he would be happy to send you a fact sheet which will help you with your problem. I didn't pass your letter to him because you did not include your full address.

#### Big Ding Dong

I can't seem to find a bell that'll work off the 110-volt AC line. Where can I get one?

—K. M., Kansas City, KS

First, high voltage bell circuits rate house wiring line and careful installation just as if they were regular power circuits. Keep this in mind if you must use 110-volts. Still want one—look in Lafayette's 1975 catalog on page 156.

#### Oldie

I have a Knight Model KG-221 FM monitor receiver (152 MHz-174 MHz) which I built from a kit. It has no RF amplifier stage. Is there anything I can do to it to improve its sensitivity?

—N.K., Highland, IN

Nope! When I first saw that front end, I swore it could not work, but I used the rig for an evening. It was very good for its day, but now's the time to swing over to a modern monitor. The newest top-of-the-line '76 models can be programmed for any channel without the use of a crystal.

#### Never Too Old

I'm 60 come June and have done considerable work in Industrial Electronics. What I'm saying is I think I know my way around an electrical circuit. What about Amateur radio? Can you give me the name of a book that will give me the inside information? Maybe this is what I need to retire and keep me active.

—H.H., Detroit, MI

I suggest you write to the ARRL today. They have several books at good buys. Write to them at 225 Main Street, Newington, CT 06111.

#### CB Newcomer

I'm new to CBing. I would like to buy a 23-channel mobile unit. I can't afford a real expensive one, but I don't want a cheapie either. What do you suggest?

—D. G., Tyler, TX

Wait for the 1976 CB YEARBOOK. The Editor tells me it'll be on sale at your newsstand by mid November, 1975.

#### Lay It On Me

Where can I get some of that nice lettering I see on the projects in ELEMENTARY ELECTRONICS?

—D. N., Harbor City, CA

An outfit under the name of Datak has press-on lettering sets for meter, dial and panel marking like the "pros" do. Several different kits are offered. If you can't find one locally, look in the Radio Shack and Lafayette Electronics catalogs. Datak is not alone, there are other suppliers. Commercial art supply stores carry different type styles but only the alphabet and numerals.

#### Not Going to Quit

Hank, I read one of the letters in your column on "Needs Lots of Work" in the March/April, 1975 issue of ELEMENTARY ELECTRONICS. I believe a lot of youngsters

(Continued on page 94)



# Science Fair P-BOX<sup>®</sup> Kits have helped launch 1000's of careers in electronics!

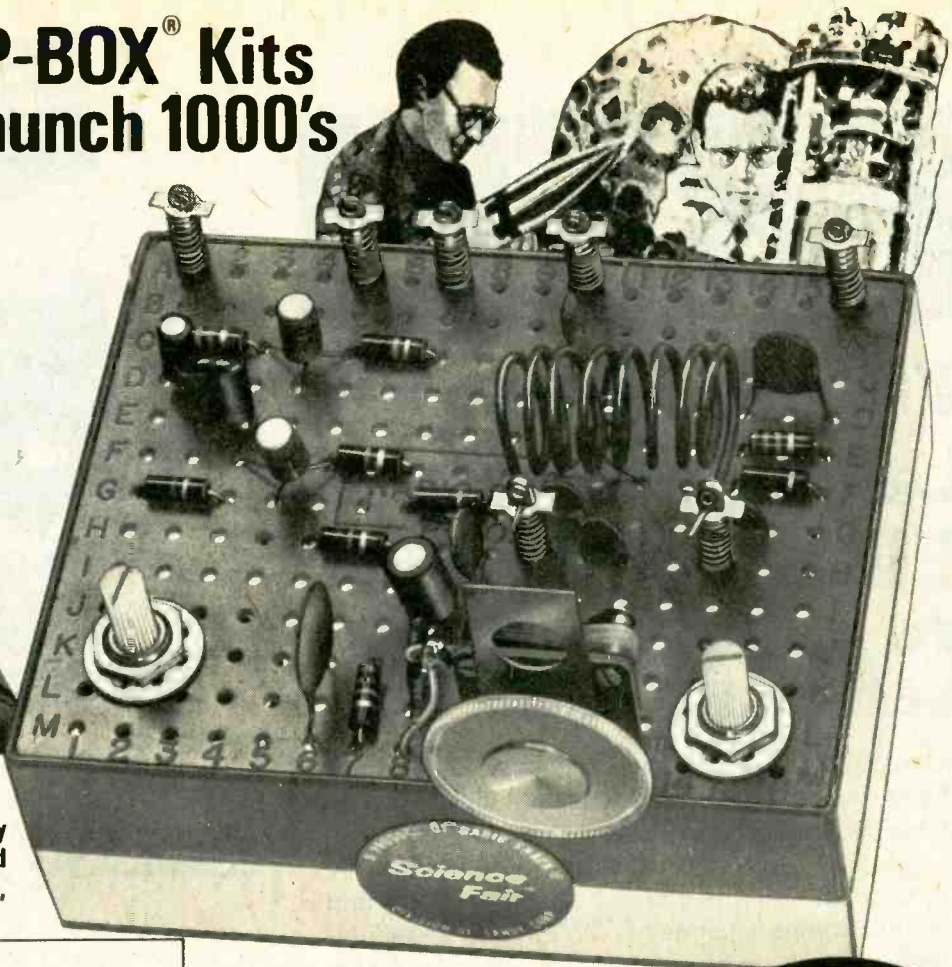

**Great for youngsters . . .**

Build and learn like an engineer by "breadboarding" on a unique molded and coded Perfboard chassis. Fun, safe, educational!

## **FREE** New 1976 Radio Shack Catalog

OVER 2000 PRODUCTS  
EXCLUSIVES ON EVERY PAGE  
BEAUTIFUL FULL COLOR

**Stereo • Quadraphonic • Phonographs  
TV Antennas • Radios • Citizens Band  
Kits • Recorders • Tape • Tools  
Auto Tune-Up • Electronic Parts  
Test Instruments • More!**



164 pages of the finest in home and hobby electronics. Respected brand names like Realistic, Micronta, Archer, Science Fair — and they're available only at Radio Shack stores and dealers nationwide! See what's *really* new in electronics by getting this catalog now.

**SEND FOR YOURS TODAY!  
FILL OUT COUPON BELOW**

1976 Mail to Radio Shack, P. O. Box 1052, 602  
Catalog Ft. Worth, Texas 76101. (Please print.)

Name \_\_\_\_\_ Apt. No. \_\_\_\_\_

Street \_\_\_\_\_

City \_\_\_\_\_

State \_\_\_\_\_ ZIP

## Shortwave Radio Kit— a world of excitement

**ONLY  
795**

Build your own worldwide radio! Tune in foreign stations, Voice of America, WWV, Amateurs, CB'ers and more on the 4.5-50 MHz band. Regenerative high-gain detector and two audio amplifier stages make it sensitive enough to pick up Moscow, London, Tokyo — almost any spot on the globe! And you can listen privately with the earphone that's included. Like every P-BOX kit, it has all parts, wire and step-by-step instructions for easy assembly. Requires one 9-volt battery. #28-110. There's only one place you can find it . . . Radio Shack!

**There's a P-BOX for every interest!**

**Electronic Organ  
Electronic Metronome  
Telephone Amplifier  
IC AM Radio  
Voice Controlled Relay  
Electronic Thermometer  
Metal Locator  
"Rise-Fall" Siren  
Photo Night Light  
Wireless AM Mike**

**Shortwave Radio  
Transistor AM Radio  
One-Tube AM Radio  
2-Transistor FM Radio  
Solar-Powered AM Radio  
3-Way Code Oscillator  
OTL Audio Amplifier  
"Goofy-Lite" Flasher  
Light Operated Alarm  
3" Extension Speaker**

# Radio Shack<sup>®</sup>

A TANDY CORPORATION COMPANY

OVER 3800 STORES • 50 STATES • 7 COUNTRIES

Retail prices may vary at individual stores. Prices and products may vary in Canada.

CIRCLE 32 ON READER SERVICE COUPON

# FREE!

## The all-new 1976 Lafayette Radio Electronics CATALOG

The most comprehensive consumer electronics catalog available. Fully illustrated, the Lafayette catalog features: high fidelity components and accessories of every description; tape equipment, police/public service radios; car stereo; CB and communications equipment; TV/FM and communication antennas; public address; telephones accessories; test equipment; tools; musical instruments and amplifiers; electronic calculators and watches; books; security systems; and an exciting new line of parts, tubes; solid-state devices and hardware *plus* exclusive Lafayette and Criterion brand products backed by our 55 years of experience. Our modern, complete facilities assure you of continual satisfactory service.

Also see the finest in brand name products which offer outstanding features, performance and reliability at Lafayette's competitive prices.

- Stores Coast to Coast
- Personalized Service and Demonstrations
- Check Your White Pages or Shop by Mail
- Use Your BankAmericard or Master Charge on Mail Orders, Too!



We've got an exciting selection of stereo, quad components and compacts.



We've got everything in car stereo, plus auto test equipment and driving aids.



We're communication specialists, with a wide selection of CB and Ham gear, police and fire receivers, weather radios.



We've got the parts, tubes, hardware you need for hobby and experimenter projects of every type.

### Lafayette

the electronics shopping center

Mail Coupon Today!

# FREE!

### Lafayette

Dept, 25115

Radio Electronics, 111 Jericho Turnpike, Syosset, L.I., N.Y. 11791

Send me your FREE 1976 Catalog.

Name ..... Apt. ....  
 Street .....  
 City ..... State .....  
 Zip | | | | |

Send a 1976 Catalog to my friend.

Name ..... Apt. ....  
 Street .....  
 City ..... State .....  
 Zip | | | | |

# Project SPACEFLIGHT

elementary NOV/DEC  
Electronics 1977



by Malcolm K. Smith

**A real analog computer tests your skill at piloting LEM-type Spacecraft . . .  
Do it right and you're docked in orbit . . . Do it wrong and you're lost in space!**

**T**he old Apollo spacecraft, workhorse of the U.S. manned space effort for eight years, will never fly again. Scheduled for use in the early 1980s is a reusable "shuttle" spacecraft. Unlike the expendable Saturn rocket, the space shuttle returns to earth once its fuel is spent—much like a winged aircraft gliding to a landing without power.

What goes on in these interim years between Saturn-Apollo and the space shuttle? Well, for a "space" fan there are always *Star Trek* reruns. Perhaps the TV networks will even get off their duffs and program a year or two of *Planet Earth* (but I wouldn't chug-a-lug Sarian Brady or hold my breath while waiting).

So space fans to keep from going space happy until something a bit more current comes along, e/e thinks this project just the ticket. It's a genuine special-purpose analog computer, dedicated to solving basic distance, time and fuel consumption problems involved in launch-

ing a spacecraft and docking it in space. And of course, it has been designed to e/e's no frills, simplified style. Plus if you're really interested, you can use this construction article as a no-nonsense way to introduce yourself to simple calculus, that division of mathematics that makes some very hard problems seem easy.

So, instead of flying a spacecraft or piloting a lunar lander down onto the moon, would you settle for an exciting scientific game that puts you in the pilot's seat? If so, we have just the project—a true simulation system that lets you pilot a LEM-type spacecraft electronically. The secret is a small, but powerful analog computer using 741 op amps.

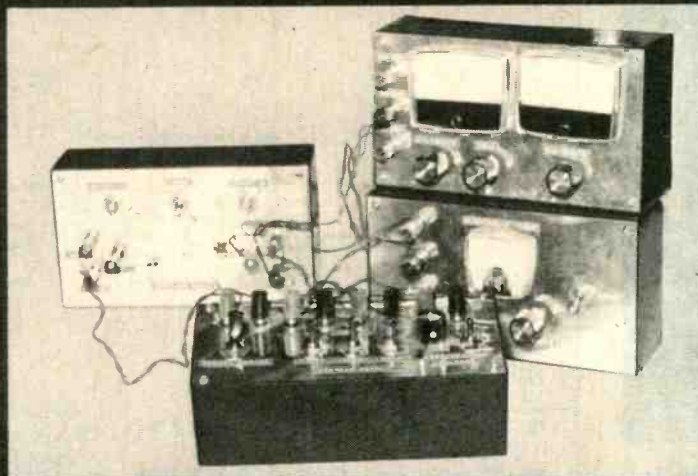

**The System** Building our system gives you a unique and exciting game. To see how it works, look at the block diagram. The would-be "pilot" sits at the control module and actuates the rocket engine switch. Switch on, the rocket is firing, you get an upward thrust. Switch off, the

# e/e PROJECT SPACEFLIGHT

vehicle falls under the action of gravity. By operating the controls you switch voltages to the computer which it uses to compute acceleration of the spacecraft (acceleration means the rate at which speed is changing). Upward rocket thrust produces an upward increase in speed (an upward acceleration); gravity produces a downward acceleration—commonly called “g.”

These voltages are fed to the input of the analog computer. The computer carries out a mathematical operation called integration. If the term integration bothers you, don't worry. You can build and enjoy this project without losing sleep over the meaning of mathematical integration (if you want to know more about it, however, there is a special section about integration in this article). The computer consists of two integrators: the first takes a DC voltage, set by pot R1, the acceleration input voltage, and from it continuously calculates the speed of the spacecraft, either upward or downward. The speed is represented by a voltage output. This speed voltage is fed to both the speed meter and to the second integrator which continuously calculates the altitude (height above earth) of the spacecraft.

The speed and height output voltages are fed to the display unit where two voltmeters act as the speed indicator and altimeter. One object of the game is to fly the vehicle up and come to a stop (reach zero speed) at just the right height.

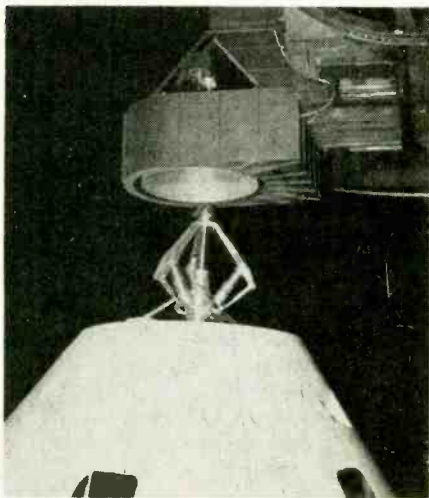

Close up of docking simulator in action. A duplicate cone-like device at right was mounted on a Command and Service Module for actual flights. Here it is shown receiving probe of mock-up Apollo during a practice docking maneuver. Both units were operated by servo systems controlled by EAI large scale 8800 type analog computers.

The timer module scores the skill of your pilots. It measures the amount of fuel burned by recording the time when the rocket engine switch is on. Fuel is always limited, there is about 50 seconds worth; the better the pilot, the less fuel he (or she) burns, which is the second challenge.

**Build The Computer First.** Pin numbers on the schematic are for the type 741 op amp, a “mini dip” integrated circuit package. The 741 op amp comes in several different shapes, but we have found the mini dip to be most satisfactory.

Potentiometers R5 and R6 should be of the screwdriver-adjust type, if avail-

able, since they normally require very little attention. Do not connect resistor R7 (shown dotted) at this time.

Five-way binding posts work well for input and output connections. The easiest units to work with are the all-nylon, fully insulated type (Radio Shack 274-662 or equiv.). If these are not available, or if lowest cost is essential, use the ones with metal stems (Radio Shack 274-661 or equiv.). These must be mounted very carefully, however, to prevent short circuits. The insulating washers provided with the binding posts must be exactly centered in the mounting holes; best practice is to glue the washers in place with epoxy.

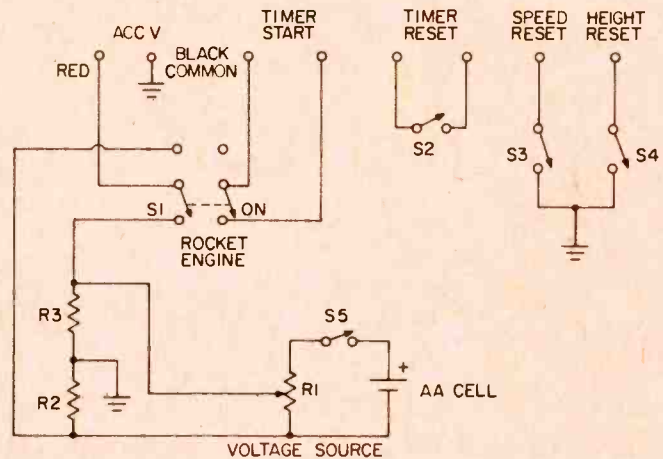

### PARTS LIST FOR THE CONTROL BOX

- R1—5000-ohm potentiometer (Radio Shack 271-1714 or equiv.)
- R2, R3—10,000-ohm, ½-watt resistor (Radio Shack 271-000 or equiv.)
- S1—dpdt switch (Radio Shack 275-652 or equiv.)

S2 to S5—spst switch (Radio Shack 275-602 or equiv.)

Misc.—8-binding posts (see text) (Radio Shack 274-661 or equiv.), “mini” utility box (Radio Shack 270-232 or equiv.), 1.5-volt AA cell, battery holder (Radio Shack 270-1432 or equiv.) wire, solder, etc.

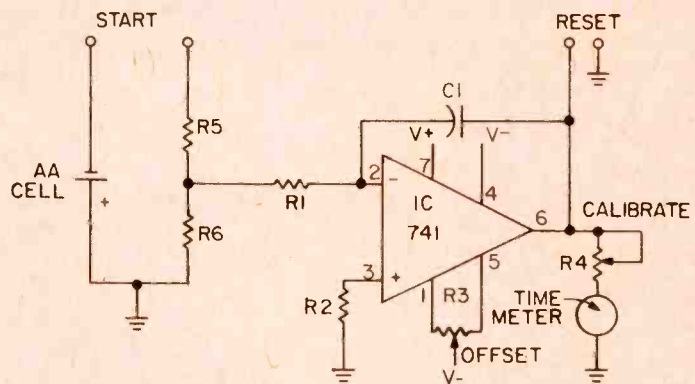

### PARTS LIST FOR THE COMPUTER

- C1—1.0 uF capacitor (see text)
- IC—741 “mini-dip” op amp (Radio Shack 276-007 or equiv.)
- M1—0-1 mA DC meter (Radio Shack 22-018 or equiv.)
- R1, R2—1-megohm, ½-watt resistor (Radio Shack 271-000 or equiv.)
- R3—10,000-ohm potentiometer, screwdriver adjust panel mount, if available
- R4—20,000 or 50,000-ohm potentiometer

(Radio Shack 271-1716 or equiv.)

R5—100,000-ohm, ½-watt resistor (Radio Shack 271-000 or equiv.)

R6—10,000-ohm, ½-watt resistor (Radio Shack 271-000 or equiv.)

Misc.—IC/PC board socket kit (Radio Shack 277-101 or equiv.), “mini” utility box (Radio Shack 270-232 or equiv.), 4-binding posts (see text), (Radio Shack 274-661 or equiv.), 1.5-volt AA cell, battery holder

If you make the connections between your computer perf board and front panel with fairly stiff wire (such as #22 solid hook up wire), the perf board can hang from the panel without putting a strain on the components. Don't try to make these wires too short, four to six inches is fine. Watch out for short circuits; small pieces of insulating tape can be applied to critical spots.

The exact placement of the binding posts and controls is not critical, but you should leave a clear area on the panel to allow for the perf board. We placed the parts around the outside of the panel, about 1-in. in from the edge.

**Important!** The capacitors connected

from the outputs to the minus inputs are essential for the integrators to do their job properly. These capacitors are probably the most critical components in the circuit; get the best you can afford. *Electrolytics are absolutely out!* The most common types of computing capacitors use mylar, polystyrene, or teflon dielectrics. These are, of course, available from industrial suppliers. Stores such as Radio Shack sell assortments of these types; with luck, you'll find at least one 1.0  $\mu\text{F}$  in each package. If not, you can come close by connecting a couple of 0.47s in parallel.

**Computer Checkout.** When wiring is completed, the integrators must be ad-

justed for proper operation using pots R5 and R6, known as the *offset null* controls. The controls are adjusted to make the output voltage stable; that is, the voltage should stay fixed and not drift with time when the input is zero. There is always some drift in a simple integrator, but with proper adjustment the output should be stable for several minutes of computing.

First, determine that the integrator is working. Apply 1.5 volts negative to the computer input; the "speed" voltage should climb fairly rapidly to its maximum value of about +8.5 volts (you must, of course, use a voltmeter for these checks). Reversing the input polarity should reverse the output polarity. Grounding the SPEED terminal to COMMON makes the output go to zero; when the ground is removed, the voltage should climb back to 8.5 volts. If there is no output voltage, or if it goes immediately to 8.5 volts positive (or negative) after the input ground has been removed, something is wrong; check the wiring carefully.

One can next adjust IC1 for zero drift using the most sensitive voltmeter you can get; the drifts are very small, so if you prefer, wait until you complete the display module; the display meters can be adjusted to measure the small drift voltages.

If you do elect to "zero" the integrators, ground the INPUT terminal with a jumper directly to COMMON. Ground the output for ten seconds or so, then release it. If the "speed" voltage is not zero, ground the SPEED terminal to COMMON again, sometimes the capacitor is not fully discharged. If now the output drifts away from zero, adjust *offset null* control, R5, until the drift stops. Ground the output again momen-

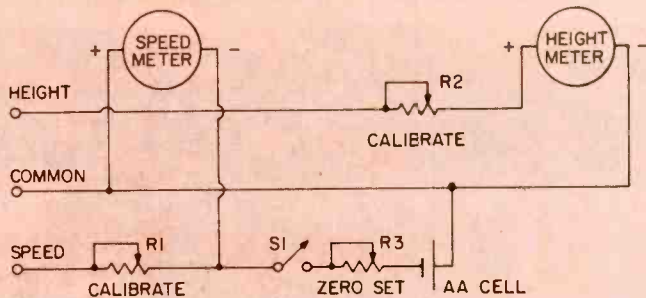

#### PARTS LIST FOR THE DISPLAY UNIT

- M1, M2—0.1 mA DC meter (Radio Shack 22-052 or equiv.)  
 R1, R2—20,000 or 50,000-ohm potentiometer (Radio Shack 271-1716 or equiv.)  
 R3—5000 or 10,000-ohm potentiometer with switch (Radio Shack 271-1443 or equiv.)

- Misc. 3-binding posts (see text) (Radio Shack 274-661 or equiv.), "mini" utility box (Radio Shack 270-232 or equiv.), 1.5-volt AA cell, battery holder (Radio Shack 270-1432 or equiv.) wire, solder, etc.

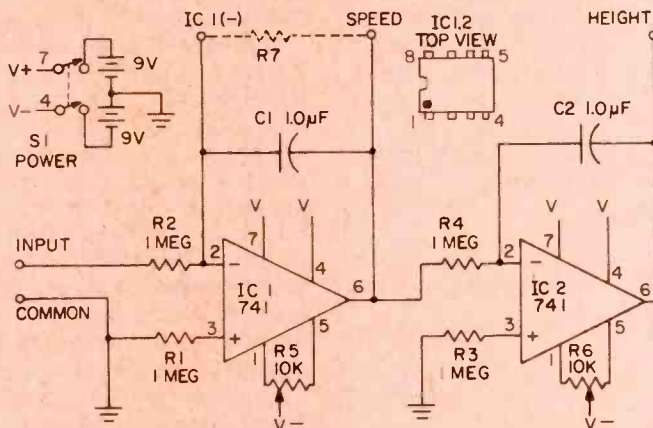

#### PARTS LIST FOR THE TIMER MODULE

- IC1, IC2—741 "mini dip" op amp (Radio Shack 276-007 or equiv.)  
 R1 to R4—1-megohm, 1/2-watt resistor (Radio Shack 271-000 or equiv.)  
 R5, R6—10,000-ohm potentiometer, screw-driver adjust panel mount, if available  
 R7—10-megohm resistor (see text) (Radio Shack 271-000 or equiv.)  
 C1, C2—1.0- $\mu\text{F}$  capacitor (see text)

- S1—dpst switch (Radio Shack 275-666 or equiv.)  
 Misc. IC/PC board socket kit (Radio Shack 277-101 or equiv.), "mini" utility box (Radio Shack 270-232 or equiv.), 6-binding posts (see text) (Radio Shack 274-661 or equiv.), 2-nine-volt batteries, battery connectors, wire solder, etc.



Okay Trekkies, here's a toughie. Workbench Editor Hank Scott wants to know just what episode of Star Trek we've pictured, showing Mr. Spock in what appears to be a snow job.

# e/e PROJECT SPACEFLIGHT

tarily and check to see that it remains at zero after the ground is removed. If not, adjust R5 once more.

Check to make sure IC2 is working by observing the voltage at the HEIGHT output. Adjust for zero drift as you did for IC1; to ground the IC2 input, connect the SPEED terminal to COMMON. This procedure insures that the integrators "compute" the changing velocity and total distance traveled accurately by minimizing error voltages introduced by the computer itself.

**Building The Control Box.** The eight binding posts are mounted evenly spaced, 1-in. from the top edge of the panel. The other components are located 2½-in. down from the top edge, all spaced 1-in. apart—except the rocket engine switch which is placed 2-in. from the next switch.

The pot R1 selects the desired "acceleration" voltage, and the rocket engine switch enables you to select either a positive or a negative voltage with respect to common (the COMMON binding post). Positive voltage represents the rocket thrust; the negative represents "g" downward.

**Building The Display Unit.** The basic requirement is two voltmeters, one with center zero, reading 0 to 1 volt for speed, another reading 0 to 10 volts for

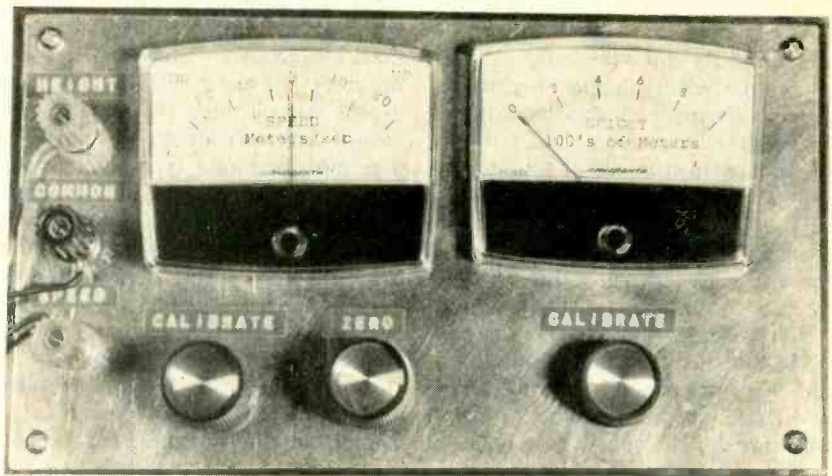

Front panel markings of control and display modules.

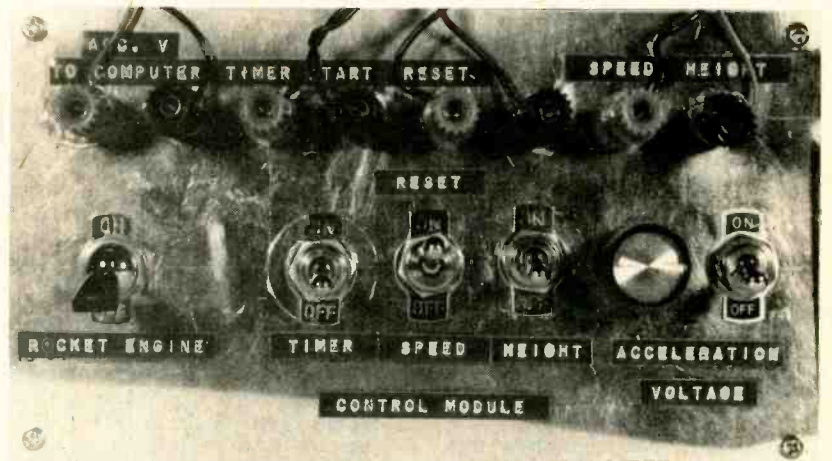

## More About Integration

□ Integration is a kind of addition in which a large number of very small quantities are added; it would be a laborious process on a calculator because you'd have to punch in thousands of individual small entries. But integration allows you to obtain such a sum without all the labor.

As an example of the need for integration, let's examine the charging of a capacitor. In the diagram, capacitor C is connected to a battery of voltage E through resistor R. How does the voltage V across the capacitor change with time? Initially, a current, I, will flow and build up a charge on the capacitor plates and the voltage across the capacitor will increase. But when voltage  $V = E$ , the current will stop, because the two voltages are equal and oppose each other (+ to + and - to -). Now suppose we want to know how long it takes to complete this charging process, and what the value of V is at some intermediate time. How is it done?

To answer these questions, let's

begin by reviewing two basic facts about capacitors. The voltage V across the capacitor terminals depends on the charge stored in the capacitor. It is

$$V = Q/C$$

where Q is the charge in coulombs and C is the capacitance in farads (not microfarads).

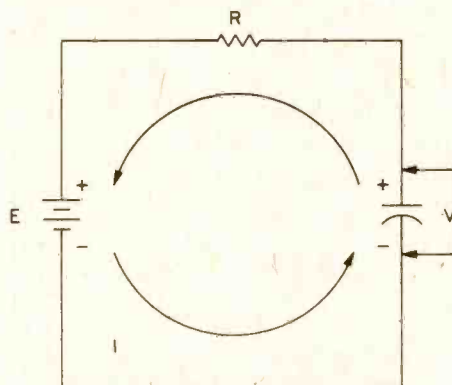

Now, fact number two: current I means the rate at which the charge is moving; not its speed, but rather, the number of coulombs per second that flows past any point in a circuit. In this case the flow causes the

build-up of charge and voltage on the capacitor.

Unfortunately the current I is not constant; charge does not flow onto the capacitor at a steady rate. As charge moves onto the capacitor plates, the capacitor charge (Q) increases, and, by nature, so does the voltage across it. This voltage opposes the current driven by the battery. Therefore, each time a small element of charge moves onto the capacitor, the current I decreases, as shown in the graph of I against time. (By the way, it's *not* correct to say that the total charge transferred onto capacitor plates in time t is  $Q = It$ , because I does not stand for a single number—I refers to a whole series of values.)

A useful way to think of the charging process is to consider it broken up into a large number of very short time intervals; by general agreement such very short intervals are called "dt". Actually, the "d" notation is used to mean a very small element of anything; for example dQ means a very small element of electric charge.

height. Our design uses 0 to 1 mA meters with series resistors (R1 and R2) to do the job.

These meters are supplied with mounting templates that should be taped to the panel, near the right end, to mark points for drilling. If you locate the tops of the meters  $\frac{3}{8}$ -in. from the panel edge, there is enough room for the controls below.

Each meter has a calibrate control; the height meter calibrate control is set to read 8.5 volts when the IC has reached its maximum output voltage. An output of 8.5 volts is the usual value with a nine-volt supply; for greater accuracy, check this with a voltmeter. The calibration of the SPEED meter is discussed later.

The zeroing circuit of the SPEED meter allows you to set it to indicate zero in the center of the scale. Therefore, it responds to positive and negative voltages, indicating speeds both up and down. The *zero* control uses a potentiometer with an on/off switch. This is used to disconnect the AA cell used in the zero circuit when not in use.

The meter dial faces can be relabelled using self-adhesive labels. Plain paper attached with rubber cement also works well. Unwanted decimal points and minor goofs can be removed with typewriter white correction fluid.

**Building The Timer Module.** The timer circuit is also an op amp integrator using a 741. It works on a very



When on a Florida publicity tour in 1968, Star Trek's Captain Kirk (actor William Shatner) was invited to try his hand in the Apollo docking simulator. In preparation for his visit, Cape engineers surprised Shatner and rigged the simulator with a mini "Starship Enterprise" that slowly cruised past his spacecraft observation window. The third season's "Day of the Dove" is shown in the photo at left.

simple principle: when you put a steady DC voltage into an integrator, you get a *steadily increasing* voltage out. The output voltage is directly proportional to the elapsed time.

The battery voltage and component values have been chosen so the integrator reaches its maximum voltage in about 50 seconds—a convenient interval for timing these flights. We used a small 0-1 mA meter and relabelled its dial (as described before) for 0 to 50 seconds. The *calibrate* control for the timer module, R4, is adjusted to read 50 when the integrator output has reached its maximum voltage. If you want more accuracy, use a watch to measure exactly how long the integrator takes to reach maximum; ours took 52 seconds. Set your calibration to read the measured value. Since the timer is an integrator like those in the computer, it

must be adjusted for drift in the way described earlier (ground the input at the junction of R1, R5, R6; ground the output at the RESET terminal).

**Setting Up For Flight.** To set up the simulator for use, place the boxes in convenient locations and connect them together. Make the connections with soft, flexible wire such as #22 (or smaller) *stranded* hook-up wire. For neatness, two or three wires going to the same location should be twisted in a loose braid. Make the following connections, starting at the Control Box.

1. Pair from ACC v to Computer INPUT.
2. Pair from TIMER START to START on Timer.
3. Pair from RESET to RESET on Timer.
4. One from SPEED to SPEED on Computer.

Take a look at the graph. The basic idea is that in the first  $dt$  we "assume" that the current is constant at  $I_1$ ; in the second  $dt$  we assume it is constant at  $I_2$ , and so on. The charge moved onto the capacitor plates in the first  $dt$  is  $I_1 dt$ ; second it is  $I_2 dt$ ; in the third  $I_3 dt$ , and so on. Now, what is the *total* charge transferred from the beginning to some later time  $t$ ?

To find out, we must add up all the small elements of charge that moved onto the plates in the time intervals  $dt$ . These small elements of charge are mathematically defined as the products of current times the time interval.

$$dQ = I dt.$$

To get the total charge, the obvious method is to add up all these small elements. In the language of integration, this is written

$$Q = \int dQ = \int I dt.$$

The symbol  $\int$  is an elongated "S," where S means "sum" which tells us to take the sum of the many elements indicated by either  $I dt$  or whatever else may follow the  $\int$  sign.

Integration is essential for describing, in mathematical terms, any kind of motion—a car speeding up and slowing down, an airplane in flight, a capacitor charging, a spacecraft lifting off then settling into orbit, or a man walking across a field. In describing motion, we begin with the distance traveled, usually symbolized  $x$ .

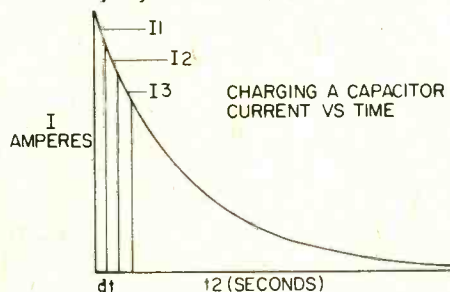

Another essential quantity in describing motion is speed, often called  $v$  (for velocity). Speed means the rate of travel (the distance covered per unit time) written as

$$v = x/t.$$

If the speed is constant over an interval of time,  $t$ , the distance traveled in that time, by simple al-

gebra

$$x = vt$$

But in real motion the speed is never constant; it is continually changing. For this reason, you have to consider the speed at some instant—during a short time interval  $dt$ . Then, the distance traveled is a short distance  $dx$ , and the speed is  $v = dx/dt$ . With a *changing* speed, the distance traveled is calculated by an integration

$$x = \int dx = \int v dt.$$

In discussing motion you also need the concept of acceleration. This is the rate at which speed is changing. Acceleration is change in speed per unit time, written as

$$a = dv/dt.$$

Suppose a vehicle is accelerating, what is its speed after a time  $t$  has passed? Again, use integration.

$$v = \int dv = \int a dt.$$

Now, what's the point of all this? The big point for the electronics experimenter is that one can easily build a simple but effective analog circuit that does the integration process for you and is capable of solving motion problems.

# e/e PROJECT SPACEFLIGHT

The following leads should be run from the Computer to the Display unit.

1. HEIGHT TO HEIGHT
2. SPEED TO SPEED
3. COMMON TO COMMON

Next, to check the control box, turn on the *acceleration voltage* switch and measure its value at the ACC V output terminals. Now we come to a tricky point. Because this computer works on a "scale factor" of 100, every input or output voltage represents a quantity 100 times greater. That is, 1 volt at the HEIGHT output means a height of 100 meters; 0.4 volt at the SPEED output represents a speed of 40 meters/sec (we are using metric units because the Astronauts do and because the voltages available from the integrators give more practical and realistic heights, times, and speeds if we think of them as metric).

We must, therefore, use an acceleration voltage that represents a reasonable acceleration with the scale factor of 100. We will use the acceleration due to earth's gravity at the surface. This is 9.8 meters per sec per sec, written 9.8 meters/sec<sup>2</sup>; let's round it off to 10 meters/sec<sup>2</sup>. We want 1/100 of 10, or 0.1 volt. Using a voltmeter, adjust the voltage at the ACC v terminals to be 0.1 volt. Note that the voltage should be

plus (with respect to the COMMON terminal) when the rocket engine switch is on. The polarity should reverse when the switch is turned off.

**Simulate Atmosphere.** On the computer use the outside terminals SPEED and IC1 (-) to connect a ten megohm resistor from the output of IC1 to its (-) input. If a ten megohm resistor is hard to find, connect two or three resistors in series to get the required value.

## CONTROL BOX CHECKLIST

### Pre-Fight Prep

- Acc V On
- Acc V Output 0.1 volt
- Timer Reset On
- Speed Reset On
- Height Reset On
- Rocket Engine Off
- Timer Calibrated
- Speed Calibrated (With reset off, does meter deflect to 100m/sec?)
- Height Calibrated (With height reset off, does meter stop at about 850 meters?)

### Pre-Lift Off Prep

- Height Reset Off
- Timer Reset Off
- Rocket Engine Off
- Speed Reset On

### Blast Off

- Rocket Engine On
- Speed Reset Off (These switches should be thrown simultaneously)

### Inflight Procedure

- Operate Rocket Engine Switch
- Terminate Powered Flight**
- Rocket Engine Off
- Speed Reset On (At instant speed meter crosses zero)

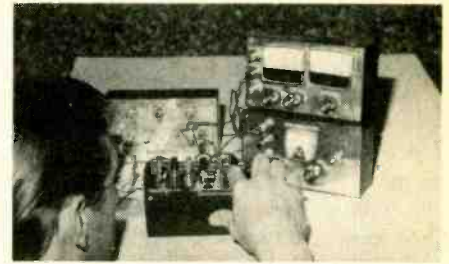

This picture, reported to include an editor sporting a pair of "Spock" ears, shows the altimeter reading below zero, indicating he crashed after expending all fifty seconds worth of allotted rocket fuel by joyriding.

The purpose of this resistor is to simulate an atmosphere with friction drag on the vehicle. The computer then calculates that this air resistance not only slows down the vehicle, but also gives it a "terminal" velocity (a maximum speed limit). In this case the top speed is 100 meters/sec. With R7 in place and the scale factor of 100, the "speed" voltage (at the SPEED terminal) will increase up to one volt, but no further. You can, therefore, calibrate the SPEED meter to read 100 meters/sec when it reaches maximum value.

**A Flight Plan.** Here is a basic flight plan to try. Follow the check lists, then take off from earth's surface at height zero and time zero.

Take your craft up to 800 meters to rendezvous with another vehicle. You must reach speed zero at height 800 meters. If you wish to hold at this

(Continued on page 95)

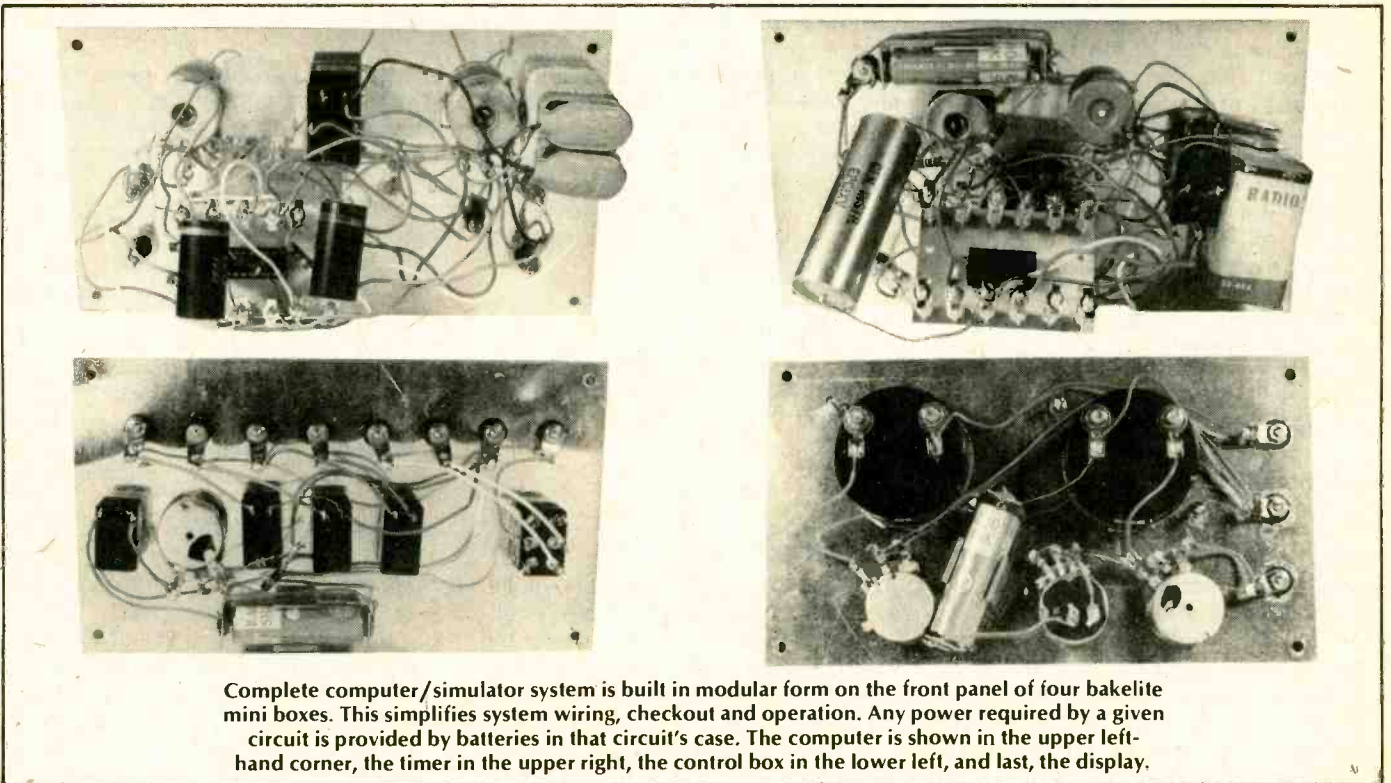

Complete computer/simulator system is built in modular form on the front panel of four bakelite mini boxes. This simplifies system wiring, checkout and operation. Any power required by a given circuit is provided by batteries in that circuit's case. The computer is shown in the upper left-hand corner, the timer in the upper right, the control box in the lower left, and last, the display.



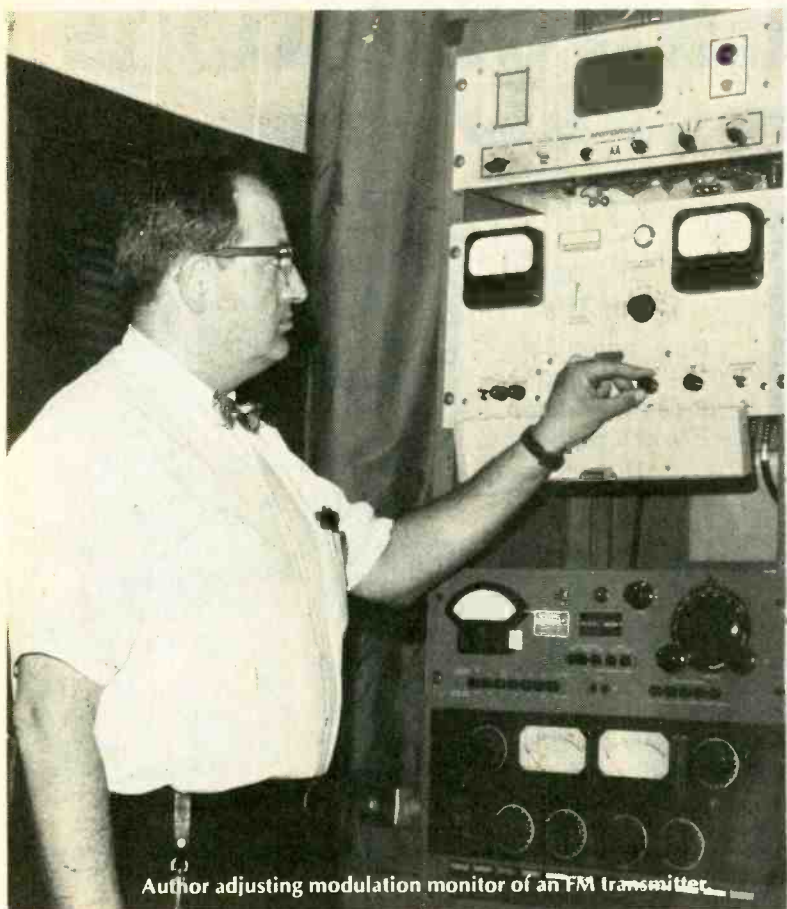

Compression, distortion,  
noise, limited frequency  
response...

# WHAT'S WRONG WITH FM RADIO?

by Herb Friedman

Unfortunately, when some editors run out of ideas they tend to fall back on the "What's wrong with . . ." syndrome, because the easiest article to assign is the one that proves it won't work. Somehow, many editors believe that titles such as "Why Penicillin Won't Cure Your Foot Problems," will sell magazines.

This past year FM broadcasters have been the whipping boys. You'd be hard-pressed to find any good words about FM broadcasting (sometimes with good reason). Do these writers of doom and gloom blame the alleged poor state of FM on the programming, the program source quality, or the avant-garde station manager who insists on drilling the high frequencies into every listener's ears with Dolby? No, that might infuriate some advertisers. It's easier to play it safe by knocking the station's technicians and/or the FCC's FM technical standards—with the FCC the prime source of evil because there's no chance they're going to advertise.

Now how do they prove FM just ain't hi-fi? Simple. Just ignore all technical advancements over the past 30 years and concentrate on the original proposal for FM broadcasting dated August 24, 1945, and then show that the most recent standards aren't much of an improvement.

**The Chain.** To fully comprehend the snow job attempted with the "What's Wrong With FM" articles, you must accept one fact: The FCC *proof of performance* for a station is the overall performance from the main studio console microphone input, through the main line amplifiers (without compression or any other form of signal processing), out the transmitter, back into the frequency and modulation monitor, through the monitor's amplifiers and into the measurement equipment. The required technical performance represents every piece of equipment in this chain including the test oscillator's distortion. That is a lot of equipment, and when all of it is considered, the required performance levels aren't all that bad.

(Once a station meets the minimum technical standards, the program sound quality is not the FCC's concern. If the station chooses to use a tape made on a \$30 battery-powered portable cassette recorder, that's the program manager's problem.)

Let's look at some of the standards. A great fuss has been made over the fact that 3.5% distortion is permitted from 50 to 100 Hz; 2.5% from 100 to 7500 Hz; and 3% from 7500 to 15,000 Hz. Unfortunately, modern station equipment (10 years old, or less) gen-

erally runs about 0.5% THD (total harmonic distortion) midband, 1% THD worse-case from 50 to 10,000 Hz, and possibly 2% THD at 15,000 Hz. (That's quite good considering all the equipment involved; your hi-fi system from pickup to speaker should be that good.) A good 50 percent of the distortion reading comes from the typical test oscillator used by broadcast stations, so the picture isn't all that black.

The next most common complaint is the FM frequency response of "only 50 to 15,000 Hz." Firstly, some of the most famous studio condenser microphones cut off below 50 Hz to reduce room rumble; secondly, very few records or tapes have any significant program information below 50 Hz; thirdly, even if there were significant program information below 50 Hz, your speaker could not reproduce it with any degree of efficiency; finally, if your speaker could go down below 50 Hz with any reasonable degree of efficiency, you'd probably use the amplifier's rumble filter to kill the ultra-low garbage coming out of the turntable as rumble.

As for the high end, we've made a great fuss over the 20-20,000 Hz response. When was the last time you heard anything higher than 15,000 Hz from a commercial record or tape? And

(Continued on page 52)

# 400 Heathkit gift ideas

## efficient, creative values for everyone

①

### Digital-Design Color TVs

Now, enjoy the super performance of Digital-Design TV in 5 picture sizes — 25, 21, 19, 17, 15.



#### The design the experts say leads the way in advanced technology.

Whatever picture size you choose as best for you, the technical advances of the design that startled the industry are yours in Heathkit Color TV.

#### On-Screen Channel Numbers

Big, bright, white numbers you can see from any angle, even across the room. Adjustable in brightness.

Positionable anywhere on the screen. Adjustable for time duration of up to 1½ minutes or they can remain on all the time, at your option. The numbers change as you change channels. No other channel readout is as convenient.



#### On-Screen Clock Time

Here's a \$29.95 option that's a marvel of convenience, too. Big ¾" numbers appearing just below the channel numbers tell you the exact time every time you change channels. Right down to the second, if you wish. And it displays in 12 or 24-hour format.

#### Fixed-Filter for Best Pictures Longer

Unique. Exclusive. Heath-designed circuitry incorporates a fixed L-C type filter with an integrated-circuit IF amplifier to

produce an ideally shaped bandpass. That means you not only get less adjacent channel interference, but also consistently excellent color pictures year after year because it never needs periodic instrument alignment. These Heathkit Color TVs always look better.

#### 100% Solid-State

And more integrated circuits than any. The only tube in these sets is the picture tube. This sophisticated circuitry gives you less interference, truer colors, more precise, reliable tints, improved sensitivity, greater noise immunity, and better picture definition. Solid long-life performance.

#### The Differences

**Tuning.** In the 25v and 21v sizes, you get Total Electronic Touch Tuning. Silent varactor tuners, no moving parts. A programmable digital counter controls the tuning—sweeping up or down the 16 pre-selected channels. And remote control of all functions is just \$89.95. In the small screen sizes, the tuning is all-channel detent type.

**One-Button Picture Control** in the three

smaller sets restores brightness, contrast, color and tint to pre-set levels at the touch of a button. Child-proof performance.

**Latest-design Picture Tubes.** In the two larger sets you enjoy brighter pictures with greater contrast thanks to the deluxe Black (negative) Matrix tubes. The three table models use picture tubes with the new precision in-line gun and slotted shadow mask for greater light output and picture realism.

#### Easier to build and service.

Plug-in circuit modules and wiring harnesses make these sets the easiest to build of all. And the new digital-design Dot Generator, slide-out Service Drawer and Test Meter make self-service easier.

#### Compare the value.

Send for your free Heathkit catalog, choose the model you prefer. Then compare it with any brand — we think you'll agree you get more for your money with Heathkit Digital-Design Color TV.

**For as low as \$399.95, you can enjoy Heathkit Digital Design Color TV.**



② **NEW High Fidelity AM/FM Table Radio**

At last, a table radio worth listening to... one that performs like hi-fi components. 5  $\mu$ V sensitivity; ceramic filters for 60 dB selectivity; and an output power of 5 watts, minimum rms, at less than 1% total harmonic distortion, from 60 to 15,000 Hz into its 8 ohm full range high compliance speaker. The closed cabinet features a teak wood grain vinyl covering and black, molded double-knit jersey front panel. Kit GR-1085, \$99.95



③ **NEW Programmable Electronic "Doorbell"**

Put a song at your doorstep with this unique kit. Program it to play your favorite song. C through C' "keyboard" with plug-in leads for up to 16 notes. Change your tune when you wish to celebrate a season, anniversary, birthday, or special party. One watt sound power; controls for tuning, volume, speed, and decay characteristics. Kit TD-1089, \$44.95



④ **NEW versatile, low cost 5-digit counter**

Measures frequency from 5 Hz to 30 MHz, period to 99.999 seconds, counts events to 99,999, and it will operate on 120 VAC or 12 VDC. As a freq. counter it will resolve to 1 Hz; sensitivity is 15 mV above 50 Hz, 50 mV below 50 Hz. In the period mode, it will resolve to 1 msec. Has Over-range indicator; gate lamp; 3-position input attenuator; 10 MHz time base. Kit IM-4100, \$129.95

## 5 MODULUS™

The new total-flexibility music system. For your changing needs.

Heath proudly introduces MODULUS. The totally modular music system that enables you to make of it what you will, change it when you like. With complete freedom. Without obsolescence.

### As you like it.

Performance and versatility as in the finest of separate components, yet with the convenience of an integrated receiver.

Your MODULUS custom music system begins with Module I, the AN-2016 Digital AM/FM Tuner/Preamplifier. A superb FM tuner with sophisticated circuitry and exceptional specifications (four 1/2" LEDs display frequencies; dual JFET, 4-gang tuner with 7.7  $\mu$ V sensitivity; digital discriminator; LC IF filter with over 100 dB selectivity; phase-locked loop multiplex with over 40 dB separation). AM you'll really enjoy hearing (dual-gate MOSFET tuner and mixer stages; computer-designed 9-pole LC IF filter for no alignment; shielded loop antenna). A superlative preamplifier that functions in stereo or 4-channel modes with specifications unlike any component we've ever offered. Distortion below 0.05% even at full out-

put. Hum and noise are 80 dB below a 0.25 v. input even in the high-level section. A phono preamp with over 94 dB dynamic range — better than most records! Versatile control center. Special speaker protecting circuitry. Four lighted output meters with 40 dB dynamic range. Separate bass, treble, and level controls for front and back channels. Master volume control. 21 pushbutton switches that light when activated. They include: output; inputs (stereo phono, CD-4, aux., tape, tape monitor, dubbing AM and FM); mode (mono, stereo front channels, stereo 4 channels, SQ, and discrete 4-channel); high filter; low filter; loudness; tone flat; squelch defeat; FM Dolby; and power. Use it as a tuner only, as a driver for your present power amps, as a control center for taping, so good you can even use it as a broadcast station monitor. Kit AN-2016, \$599.95

Expand your MODULUS system with your choice of stereo power amplifiers. Module II is the medium power AA-1505. Module III is the high power AA-1506.

35 or 60 watts, min. RMS, per channel into 8 ohms at less than 0.1% distortion from 20-20,000 Hz. Styled to match the Module I tuner/preamp. Add one of either power level for a stereo receiver; add two for a 4-channel receiver. Kit AA-1505, \$159.95; AA-1506, \$179.95

Choose your mode and input. Module IV is the FM Dolby module AD-1504 for reduced noise and greater dynamic broadcast range (\$39.95). Module V is the CD-4 Demodulator for the spacious sound of CD-4 discrete 4-channel records (\$79.95). Module VI is the SQ Decoder for quadraphonic separation of matrixed material; full logic and variable blend (\$49.95). All are housed inside the tuner/preamp module.

### A "Living" music system.

MODULUS is designed for you — the way you live — today and tomorrow. It can grow with you, adapt to your changing life style, flex with changing technology. Whatever your desires in music systems, now and later, MODULUS.



## 6 NEW 3-Way Speaker

Looks and sounds like it should cost \$100 more! High performance 3-way system has a 10" woofer, 4 1/2" mid-range, 1" dome tweeter. Drives with 10 watts, yet a super-power amp reveals its unusual dynamic range and high power handling capabilities. Enclosure has walnut veneer on all sides and front for use without the black foam grille. Tweeter and front-mounted switch plate are interchangeable for optimum imaging in horizontal or vertical position. Kit AS-1373, \$149.95

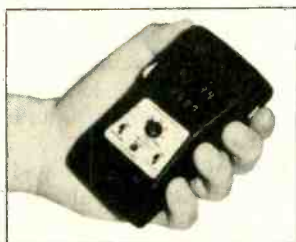

## 7 NEW Digital Stopwatch

Programmable — for the time of your sporting life. You program in a time (up to 9 hours, 59 min., 59 secs.) and it will count up to that time or down from it to zero. Or it will count 99 hours, 59 mins., 59:99 secs. in the five other functions which include: Start/Stop Elapsed; Sequential; Total Activity; Split; & Start/Stop Activity. 8 digits & 2 IC counters with accuracy to  $\pm 0.003\%$  & resolution to 1/100th second. Jacks for external trigger and alarm. Includes nickel-cad. batteries & charger. Kit GB-1201, \$99.95

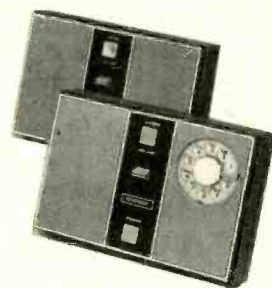

## 8 NEW 2-Way Telephone Amps

Amplified "talk" and amplified "listen", with or without dialer. Real hands-free convenience — use from 10' away. VOX control silently switches from built-in microphone to speaker without clipped words or feedback squeals. GD-1112 works with regular phone. GD-1162 with built-in dial and electronic ringer works like an extension phone. Easy to build, convenient for use at home or office. Kit GD-1112, \$49.95; Kit GD-1162, \$69.95.

**392** other gift ideas in the free Heathkit catalog. Send today.

HEATHKIT ELECTRONIC CENTERS —  
Divs of Schlumberger Products Corporation  
All prices slightly higher.

Z.: Phoenix; CALIF.: Anaheim, El Cerrito, Los Angeles, Pomona, Redwood City, Diego (La Mesa), Woodland Hills; COLO.: Denver; CONN.: Hartford (Avon); FLA.: Miami (Hialeah), Tampa; GA.: Atlanta; ILL.: Chicago, Downers Grove; IND.: Indianapolis; KANSAS: Kansas City (Mission); KY.: Louisville; LA.: New Orleans (Kenner); Baltimore, Rockville; MASS.: Boston (Wellesley), Boston (Peabody); MICH.: Detroit; MINN.: Minneapolis (Hopkins); MO.: St. Louis (Bridgeton); NEB.: Omaha; N.Y.: Buffalo (Amherst), New York City, Jericho (L.I.), Rochester, Fair Lawn; OHIO: Cincinnati (Woodlawn), Cleveland, Columbus, Toledo; PA.: Philadelphia, Pittsburgh; R.I.: Providence (Warwick); TEXAS: Dallas, Houston; VA.: Norfolk (Va. Beach); WASH.: Seattle; WIS.: Milwaukee.

HEATH Schlumberger	Heath Company, Dept. 139-11 Benton Harbor, MI 49022
<input type="checkbox"/> Please send my free new Heathkit Catalog. <input type="checkbox"/> Enclosed is \$_____ plus shipping. Please send model(s)_____	
NAME _____	
ADDRESS _____	
CITY _____	STATE _____ ZIP _____
<small>PRICES ARE FACTORY MAIL ORDER, FOB BENTON HARBOR, MI 49022.          PRICES &amp; SPECIFICATIONS SUBJECT TO CHANGE WITHOUT NOTICE.</small>	
CL-575	

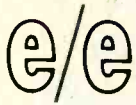

## WHAT'S WRONG WITH FM RADIO

(Continued from page 47)

anyway, how would you know it? (At the 1974 New York hi-fi show, one manufacturer was mobbed by enthusiasts who simply would not believe a brilliant-highs record had nothing on it over 12,000 Hz; yet there was the graphic display going dead on the baseline at 12,000 Hz.) The fact is, 15,000 Hz is the upper limit for a CD-4 record, and no one's yet complained of loss of highs when the record is played in stereo. In all truth, the latest FM transmitters generally do go down to 20 Hz within 3 dB worse-case limits; now all we have to do is find the program source that goes to 20 Hz and the speaker to reproduce it and there'll be no complaints about lack of bass; we'll only have to worry about the non-existent highs.

**Update Noise.** The station's pre-emphasis equalization is another "What's wrong" villain. You see, back in the early days of FM there was something called *noise*, so the highs were boosted at the transmitter and attenuated (de-emphasis) at the receiver. The resultant overall frequency response comes out flat, but the noise is attenuated with the boosted highs. Now according to some recent articles this is all wrong. Modern music has a different spectrum-energy distribution than it did 20 or 30 years ago. It is claimed that modern music, thanks to electronic instruments, has so much high-frequency energy that the pre-emphasis results in overmodulation unless the average program level of the transmitter is reduced. So? Reduce the program level. The fact that the station is trying to stretch its signal to expand the coverage area—thereby securing more listeners for the sponsors—is not a fault of the system, it's a fault of the station managers.

If the FCC wanted the station's coverage expanded—possibly creating intercity interference—it could very easily allow the station to increase its power output, or raise the antenna. But each FM station is part of an overall protected-area distribution, so there is a limit to output power. The station chooses to increase its listening audience by improving the signal-to-noise ratio in the fringe-reception area by increasing the average modulation through audio processing, and this runs them into trouble with the pre-emphasis curve. (If the listeners are willing to put up with a limited dynamic range, they have no right to complain—they can always tune to another station;

there is still some quality broadcasting on FM). For example, several *good music* stations now use Dolby processing. The average listener has no de-processor; he hears the somewhat peaked highs screaming in one ear and out the other. Does he complain? Not on your life. The station can produce at least one survey and a bag full of letters complimenting the station on the improved sound. FM is what the listeners will settle for.

**Fed's Specs.** According to some articles, the FCC specification of 29.7 dB separation for stereo transmitters is an evil ranking second only to a crime against nature. True, this is not an outstanding technical standard, but the average modern stereo exciter manages to produce between 30 dB and 60 dB of separation, more than adequate when you consider that the same writers who whiplash the 29.7-dB FCC spec have turned handsprings over the "spacious, discrete effect of 20 dB separation" from a matrix decoder, or "the point-source directivity from 25-dB CD-4 separation." How come 20 dB or 25 dB separation from a 4-channel system is "spacious," "ethereal," and "spectacular," while 29.7 dB from a transmitter is an "outdated technical standard." At what point does the same technical value switch from "a modern breakthrough in technology" to an "outdated technology"?

No, neither the FM technical standards nor the equipment used is the problem. If a problem does exist it is the user. Can we berate a station for not using the full potential of its dynamic range if the records and tapes used for programs are already compressed to insure a high signal-to-noise ratio in the home? If you're willing to buy the record or tape for your own use, why is it wrong for the station to play it? You're listening to it at home. Is it wrong for a station to apply limiting and compression to raise the average program level of popular music? Popular music already is excessively compressed to maintain maximum output level from juke boxes—does more compression at the station make it worse? What is the point at which excess frequency equalization and compression on the record itself becomes "the natural sound"? The last *natural sound* recording was a flop. (Yes, it was classical.)

The FM broadcaster delivers the sound his listeners want to hear:

- Top 40—plenty of compression and maybe even *sound brightening* frequency equalization.

- MOR (middle of the road)—modest compression, perhaps some bright-

ening (most likely not).

- Classical—maybe just a limiter to protect against overmodulation; a very few go Dolby "for quality" and really sock the highs to you.

When a problem does exist with the standards, the FCC makes changes when there will be an actual technical improvement. For example, several years ago the standard for the station's modulation monitor was changed so peaks would not ride through the meter without positive identification. These over-100% modulation peaks caused the sibilant splatter often blamed on the FM receiver's detector. The new monitors now give a positive, unmistakable indication when the modulation limit is exceeded; that's why many of the same transmitters that had "hot" sibilants now sound better. How much of a change was there? Well, where an older modulation monitor indicated 60% modulation, a new-standards monitor indicates 100%. Imagine what happened when the station cranked the level up for 100% modulation on the old monitor. When there is a need for a change in the FM standards, the FCC will make it.

The point to all this is that there is nothing wrong with the latest technical standards or the equipment. Any FM station could most likely broadcast super-fi at the flick of a switch, but with rare exception, listener attrition to the next guy down the dial wouldn't leave enough listeners to keep the station going for a week. The next time you read or hear of someone complaining about the "poor FM quality," ask yourself; "If he doesn't like it why is he listening?" He is listening because he really likes it, because nothing stops him from buying the record or tape and playing it on his own super-fi equipment. ■



# From the days of Early Wireless



**A look in the circuits and kit construction of yesteryear.**

by Harry Stavert

**BUILD YOUR OWN**  
**ERLA DUO REFLEX**  
 Three-Tube Receiver  
 HERE ARE THE COMPLETE PARTS  
 In a Factory Sealed Carton  
**\$44.75**

**LIST OF COMPLETE PARTS IN THE ERLA SEALED CARTON:**

**A Few Hours Time and You Are "On the Air" With This Wonderful Set**

**THE CORRECT CONSTRUCTION IS SIMPLE**

**NO WELDING IS NECESSARY**

**YOU CAN MAKE THIS SET**

**THIS IS YOUR OWN 125 WATT SET**

**COMMAND**  
 the ENTIRE WORLD  
 with Pilot's Double Duty  
**SUPER-WASP**

**CUSTOM KIT-BUILDER'S PRICE**  
**\$29.50**

**PILOT Now Makes RADIO TUBES!**

**PILOT RADIO & TUBE CORP.**  
 WORLD'S LARGEST RADIO PARTS PLANT  
 323 BERRY STREET  
 BROOKLYN, NEW YORK

**T**HE ACRID SMOKE from melting rosin solder floated upward in lazy patterns from the hot iron resting in its protective cradle on the kitchen table. Empty boxes, packing material, wiring plans and electronic parts were scattered about. This typical scene identifies the presence of a kit builder.

An electronic kit was indeed under construction and in this case Jim and Suzanne were spending the evening in their modest apartment, puzzling through the step-by-step plans in the kit instruction booklet. Might it be an AR 1500A or possibly a color TV set? It is neither for the year is 1924 and the kit is a Fada Neutrodyne Radio.

Our kit-building couple were pioneers and forerunners of the group that would later number in the millions. That particular pastime was pretty new then, for just five years earlier there were hardly any radio sets at all. A few radio amateurs were actively tapping out code signals to one another and tinkering with this new wireless thing. In 1920, when the Westinghouse Company put the Pittsburgh Radio Station KDKA on the air, it proved there was really something to this radio business. Other stations followed in rapid succession until it heightened into a crescendo of broadcasting wavelengths. Instead of code signals, music and voices now electrified the air.

The newspapers and magazines of this period explained this new phenomenon and told of unimaginable feats performed by these strange black boxes with many dials. The layman wondered if such incredible gadgets would really work. Many found the answer to this

question by building a radio themselves! **Galena Grabber.** Jim and Suzanne might have received their introduction to radio by putting together the little electronic wonder—the crystal set. Most of the early radio enthusiasts found this to be a stepping stone into the fascinating world of electronics. It didn't come in a kit but for a few dollars one could get everything needed: a pair of ear-phones, a piece of galena and a coil wound on an oatmeal box. Much to everyone's surprise it did work! The listener was so captivated that he didn't notice it would only pick up locals and wouldn't drive a loudspeaker. But as the novelty wore off they began to contemplate the extent of this veil of radio waves that must be all around. They wondered if waves from distant stations were floating by and whether or not they could tune them with a more powerful set.

After KDKA went on the air, the radio industry found itself unprepared to satisfy the public clamor for ready-made, reasonably priced sets. The wire-



Fig. 1. Before kits really became popular, radio buffs built their own from scratch. This 2-tube regen is typical of the period.

less age had jumped into popularity too quickly. A visit to the local radio store didn't show very many completed radios but parts for them seemed to be available. The strange appearance of the ones in the display cabinets seemed to match those shown in the radio magazines so that was enough to encourage interested persons to undertake building their own

**The Big Pull.** The one thing that made it all worthwhile was the possibility of receiving DX reception. It would take a tube-type radio to perform this feat and the one that first met with popular appeal used the regenerative circuit. Most of these were built from plans that seemed to appear everywhere, even in the daily newspaper. This usually produced a homemade two-tuber that was powerful enough to drive a horn speaker on locals and, with a big long-wire antenna, might even get coast-to-coast on phones. It consisted of a detector tube and one stage of audio amplification. A fine example of such a set where the homebuilder took extreme care in parts layout is shown in Fig. 1.

This was a phenomenal circuit invented years before in 1914 by Major Armstrong. It rivals in sensitivity the performance of some modern sets.

The key to its success was its use of positive feedback from the plate circuit to the grid; a practice which reinforced the incoming signals many times. The circuit not only made it big with the home-brew sets, but the big radio manufacturers also used it to get on the bandwagon. In May 1924, RCA used the full back cover of the popular radio magazines to announce, in full-color,

their ready-made Radiola III—a two tube regenerator. The ad acknowledged the prevalence of set building by stating that it was “priced at less than you could build it for at home.” Just inside the back cover was another full-color announcement of the Crosley Model 51—another regenerative two tuber.

**Browning and Drake?** The first persons to bring a little order to the home radio building business were two scholarly gentlemen—Glenn H. Browning and Fred H. Drake. In 1923, when they were engineering students at Harvard University, they became intrigued with the art of radio frequency amplification. It was reasoned that there must be a more scientific approach to radio than to make the coils from oatmeal boxes. The problem was attacked from a mathematical standpoint, and they soon were able to develop and predict the gain, selectivity and stability of a typical RF amplifier. They found that one big weak point was the inefficiency of the available RF coils. These were nothing more than air core transformers. The construction details caused them to have too much capacitive coupling between the primary and secondary windings. This effect produced out-of-phase components that nullified some of the normal transformer action. Browning and Drake came up with a new design where the primary was wound with very fine wire and cramped into a small space. This reduced the capacitive coupling and virtually eliminated its signal robbing effects.

This was quite a breakthrough, so they went on to design a circuit that would make use of this new technology. The first try was a regenerative detector preceded by an RF amplifier and laid out on a breadboard. The National

Company sponsored the circuit and marketed a “kit” which consisted mainly of the Browning-Drake coils which were assembled to a good quality tuning condenser. A typical magazine ad for these items is shown in Fig. 2. All the other parts necessary to complete the set were the kit builder's selection. This particular configuration didn't go over too well because housewives like Suzanne didn't like breadboard radios because they couldn't be dusted easily. Besides that, it would only drive headphones.

**RF Amp Up.** The circuit for a later and more popular version is shown in Fig. 3. It used a triode regenerative detector, V2, but was preceded by triode RF amplifier V1 in order to sharpen the selectivity. It was followed by a two stage audio amplifier, V3 and V4, which provided healthy loudspeaker volume. Here again, the most important parts were the Browning-Drake coils made by National. The first transformer was part of the tuned RF amplifier and designated as T1. The other transformer, T2, made up the regenerative detector tuned circuit and was designated L1—L2—L3. Both were assembled to a good quality tuning condenser as before. Even with this version the kit provided only the coil-condenser combinations.

Taking a look at Fig. 3 again shows that regeneration was made possible by feeding some plate energy from V2 back to its grid through the mutual coupling of L2 and L3. The amount of feedback was controlled from the front panel by mechanically rotating L3 relative to L2.

The condenser, Cn, had a very important role in the RF amplifier stage because the circuit was not that straight-forward. The triode tubes used in RF amplifiers in those days had a lot of inter-electrode capacitance. This would

—here it is!

*“A wonderful set”* Radio editors of five Boston papers  
(Patents Pending)

**THE NATIONAL REGENAFORMER KIT for the Browning-Drake Receiver**

consisting of

1 NATIONAL REGENAFORMER CONDENSER WITH 4" DIAL	1 NATIONAL ANTENNA INDUCTANCE	1 NATIONAL .0005 Voltless Vernier
1 SET OF HARDWARE	1 NATIONAL .0005 Voltless Vernier CONDENSER WITH 4" DIAL	1 SET OF INSTRUCTIONS FOR WIRING

Regenaformer and Antenna Coil only—Price \$7.50

**PRICE \$22.00**

Couls completely mounted on back of Condensers ready for wiring

Sets made with this Regenaformer Kit have spanned the continent. Send for Bulletin 165RB

Manufactured by NATIONAL CO., Inc., 110 Brookline St., Cambridge, Mass.

Fig. 2. The title “Regenaformer” was attached to the special coils designed by Mr. Browning and Drake. The gain of the RF section of the radio receiver was thus greatly improved upon.

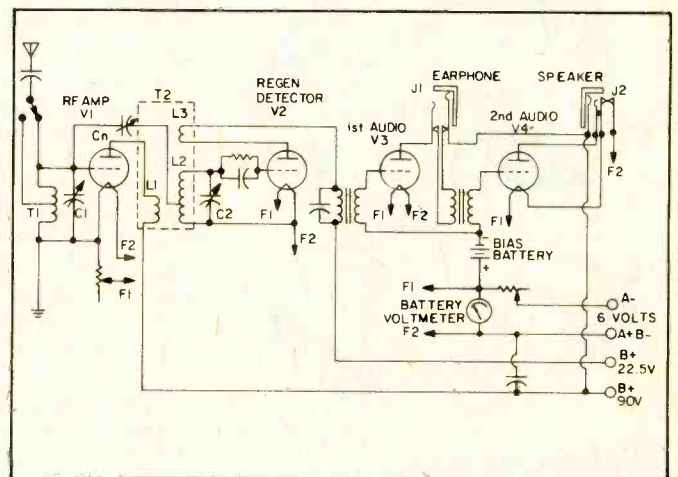

Fig. 3. Official Browning and Drake circuit. Scientifically, it was an improvement in the design of coils T1 and T2. Tuning was accomplished by operating capacitors C1 and C2 together.

let them oscillate even without designing them to do so. This was caused by the plate energy crossing over to the grid through tube capacitance, so an oscillating RF amplifier would result. Browning and Drake had designed their detector to operate on the fringes of oscillation in order to keep the sensitivity high. This gave the listener enough problems trying to control the oscillating detector without the RF amplifier trying to do it too.

**Neutralization.** The solution to this predicament was already available through the efforts of another man who was developing ways of operating RF amplifiers in cascade. His name was Professor L. A. Hazeltine of Stevens Institute of Technology. He worked out a neutralizing technique that utilizes the condenser Cn in Fig. 3. A small amount of RF voltage is picked off at the tap on L2. This voltage is impressed on the grid of V1 through the neutralizing condenser. By adjusting Cn, an equal and opposite voltage is available to offset the undesirable feedback caused by the inter-electrode capacitance. Browning and Drake adopted this scheme to control their RF amplifier and keep it from oscillating.

It must be apparent by now that when the early kit builders received a big box in the mail it didn't usually have all the parts needed to build the set—as in the case of the Browning-Drake. This resulted in all kinds of different configurations of parts layout but it was an exceedingly popular circuit with the do-it-yourselfers. A typical completed Browning-Drake where the set builder used his own judgment in parts layout is shown in Fig. 4.

The regenerative set was very sensitive, but it lacked selectivity. Besides that, its audio quality left a lot to be

desired since the detector was working near its oscillation point at all times. Worst of all, it would pump energy back into the antenna and radiate the squeals and whistles into every set in the neighborhood!

**Multi RFs.** When Professor Hazeltine perfected his method of neutralizing RF amplifiers, it made it possible to use several RF amplifiers without annoying oscillations and still provide fairly good overall gain. It featured good sensitivity and improved selectivity which caused the Tuned Radio Frequency radio (TRF) to spring into popularity and the regenerator dropped into the background. Hazeltine went on to develop the neutrodyne radio and a typical circuit is shown in Fig. 5. It incorporates two RF amplifiers, a grid leak detector and two triode audio amplifiers. The two neutralizing condensers, Cn, helped stabilize the RF amplifiers and keep them free of oscillations. It was a fairly simple straightforward circuit and millions were manufactured as ready-made receivers.

The TRF also appeared in kit form. A very successful one was marketed in 1924 by F.A.D. Andrea, Inc., of New York and became known as the Fada Neutrodyne. It was then that kits were sold in a more complete form with just about everything you needed included. This particular one came with a well-organized 30 page instruction book, but for reasons unexplained, it didn't include the big bakelite front panel! The kit builder could acquire one from the local supply house and face the task of drilling 34 accurately placed holes. Or he could follow the instrument book which recommends that he go to an instrument shop and have one drilled and engraved.

The Fada Neutrodyne was a very

selective, sensitive receiver with reasonable loudspeaker clarity and ease in tuning. Our theoretical Jim and Suzanne could have followed the instruction book carefully with no trouble making it work. Many of them adorned the living rooms of America.

**Supply And Demand.** As the price of ready-made sets began to drop, manufacturers were pressed into providing totally complete kits. Gone were the days when you had to do your own panel drilling. The Erla Duo Reflex kit was a good example. Not only did it come complete, it boasted that it eliminated soldering. More than that, it was designed as a reflex circuit; three tubes produced the performance of five! How could anyone pass it up?

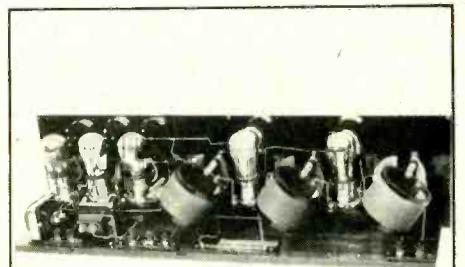

This is what the proud kit builder had created when he did complete his FADA Neutrodyne kit. In those days 200 watt soldering irons were not too uncommon!

We can see that kit building is as old as the science of radio. The scene portrayed in the early days by Jim and Suzanne is repeated many times today. The IC has brought a little more sophistication into the art. But the reason for kit building remains the same—we like to say that we built it and point with pride to our accomplishments. ■

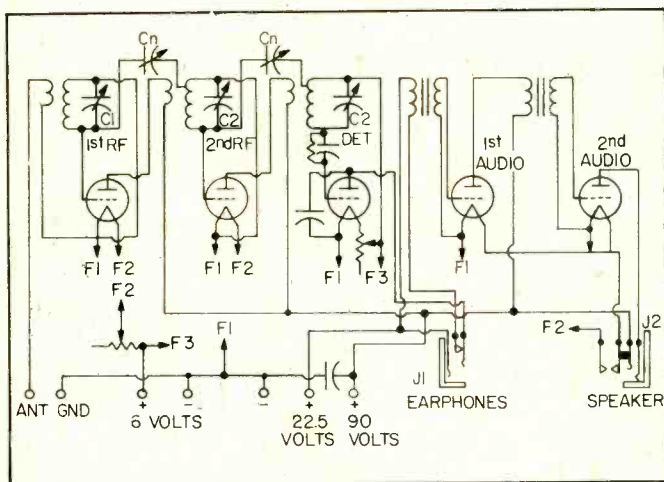

Fig. 4. A home brew Browning Drake using the B-D kit. Those special coils are on the left and right sides of the mounting board. The voltmeter monitors the filament battery voltage.

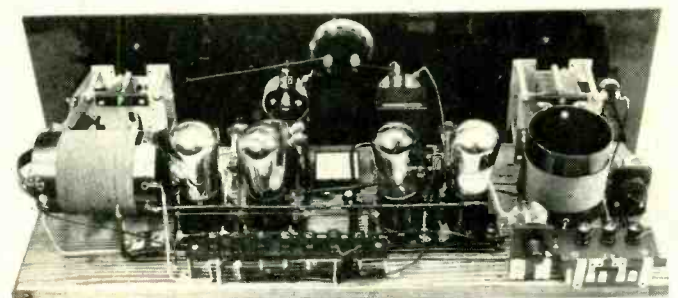

Fig. 5. A five tube FADA Neutrodyne receiver from radio's early days. In this set, tuning was accomplished by tuning capacitors C1, C2 and C3 all in step (as well as one could!).

# PUTTING HI-FI IN

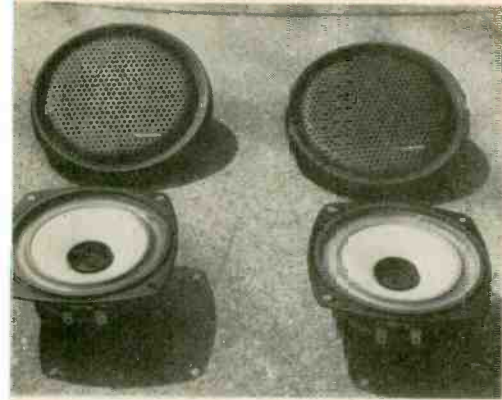

Fig. 1. The basic rear speaker package has the speakers and matching protective grill assemblies. Note the large outer surround on the speaker cones; a pretty reliable guide that these relatively small Radio Shack speakers pack a lot of solid bass.



Fig. 2. You might have to jackknife yourself into the trunk to make a few connections so make certain the trunk is completely empty before you start. Yes, get rid of the spare tire too.

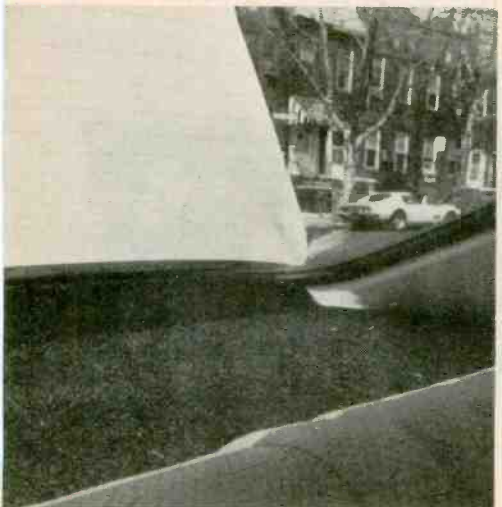

Fig. 3. The rear deck. Concealed beneath that layer of carpeting is a steel deck with the speaker cutouts already prepared at the factory. Even the speaker mounting studs might already be installed.

**B**ESIDES THE OBVIOUS luxury of carpeted floors, leather seats, and leg room for a giant, big fat luxury cars generally have much better sounding radios and tape players. Quite often the luxury car's sound quality begins to approach or equal what we'd accept as hi-fi in our home.

But the secret to a luxury car's better sound is not necessarily that the radio or tape player is any better than what's put into a budget car; rather, the gold-plated Detroit Iron probably has rear deck speakers, and that's what gives it that big sound.

When speakers are mounted on the rear deck the entire trunk becomes a speaker enclosure, and it is a fundamental rule of automobile sound that the larger the enclosure the better the bass. Also, with the speakers facing upwards the highs bounce off the slanting rear windows towards the passengers; the reflection also disperses the highs, creating a "surround-sound" that envelops the passengers in a total experience—as if they were one of the musicians.

Yes, rear deck speakers make any auto radio or tape player sound better, but there's no reason you have to wait for a luxury car in order to enjoy a big, rich sound. We don't know about those cheap foreign imports where everything but the four wheels and a body is left off to keep the price down, but American-made cars are factory-equipped for rear speakers. In most cases a piece of cardboard is all that separates you from rear speakers. You see, here in the U.S. the manufacturer can't be bothered



with making one model for the guy who wants rear speakers and a different model for the buyer who doesn't even want a radio. So he makes one basic metal rear deck pre-cut for speakers. If you order the car without speakers the assembly plant covers the metal rear deck with cardboard, hardboard, or fabric, concealing the speaker cutouts. If you order speakers factory installed, the assembly plant simply substitutes a cover that also has speaker cutouts, and installs the speakers. If you get the car without speakers and then decide you want rear speakers the dealer hands a knife to the least skilled man in the shop and tells him to cut out the cover and install the speakers.

To make life just a little bit easier for everyone, many cars are already pre-wired for rear deck speakers even if they haven't been installed at the assembly plant. Again, it's often easier for Detroit car makers to stock one general



Fig. 4. Just one speck of dust in the cone from installation will rattle for ever and ever. But if you wrap the speaker in an old pantyhose (or even new pantyhose of the 2-for-a-\$1 variety) you'll be able to keep chips out during installation, and the heavier dust—which also rattles—that settles in after the speakers are installed. Leave enough slack in the material so it can be completely wrapped around the speaker when you're finished.



Fig. 5. If you cut and wrap the pantyhose carefully it should look like a factory installation.



# THE REAR DECK



purpose wiring harness than several different models. Often, the rear speaker wiring is tucked into a rear quarter panel along with some extra wires for a rear window defogger, trunk lamp, etc. If you have been wise enough to get your car's service manual you'll be able to locate concealed wires by using the schematic and wiring pictorials supplied in the manual's electrical and accessory sections. Even if your car isn't prewired, the manual will tell you where the front-to-rear wiring channel is located. If you know where the channel is located you can run a wire from the trunk to the dashboard in less than 15 minutes. If you don't know where the channel is located, or even if there is one (and there is), you can spend an hour or more trying to get a pair of speaker wires from trunk to dash.

As for the speakers themselves, get the best; the difference in price between good-quality speakers and poor

ones is only a few dollars. It won't be worth your time and effort if you save a couple of bucks only to wind up with fourth-rate sound quality.

The best place to find high-quality auto speakers is a local general parts distributor (not an auto-sound specialty shop), or one of the national chains; for it is in these places that you'll get a chance to listen to the actual speaker you'll buy, or at least have easy return privileges if you decide you want a better-quality speaker.

The rear deck speaker kits shown in this article came from Radio Shack. You'll note that although the speakers are small they have a relatively large magnet and an obvious large and soft cone surround. This is the stuff of big bass, even in small speakers, and is the payoff when you've completed the installation. Your only problem is to check the size of the cutouts in the rear deck first, and then get the speakers that match. For example, you might have 5-inch round cut outs, or 4 x 5-inch or 5 x 7-inch oval. Get the right size. Don't try to use a 4 x 5 in a 5 x 7 cutout. Part of the sound quality is determined by the fit of the speaker against the rear deck, so match the speaker to the cutout. Finally, get a complete mounting kit: It will save problems later when you try to match a protective grille to a speaker bought earlier; somehow, it usually doesn't come out right because the holes don't match when you buy one piece here, another piece there.

Okay. Ready? Just follow the photographic illustrations to terrific sound. ■

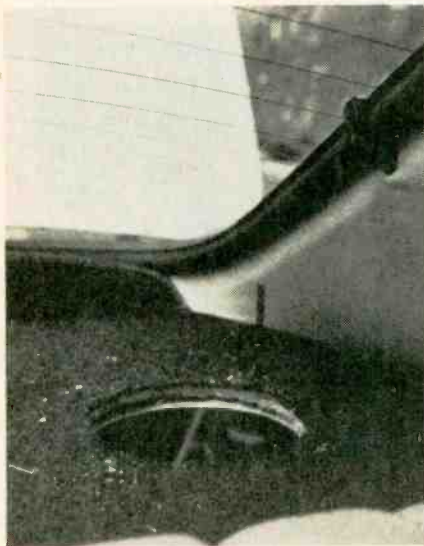

Fig. 6. Cut a hole in the rear deck cover corresponding to the cutout in the steel deck underneath.



Fig. 7. Here's how it looks from inside the trunk. Note that in this car even the speaker mounting holes are pre-punched. Just drill through the rear deck cover from the trunk side. The metal tabs at the rear hold the speaker wires when they are bent upwards.

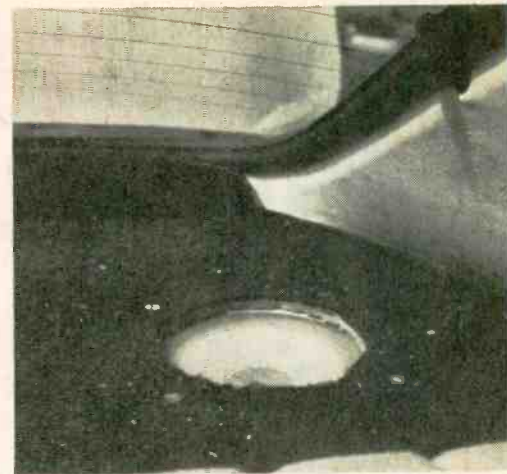

Fig. 10. View from the top. Brush all debris and chips off the pantyhose shield.

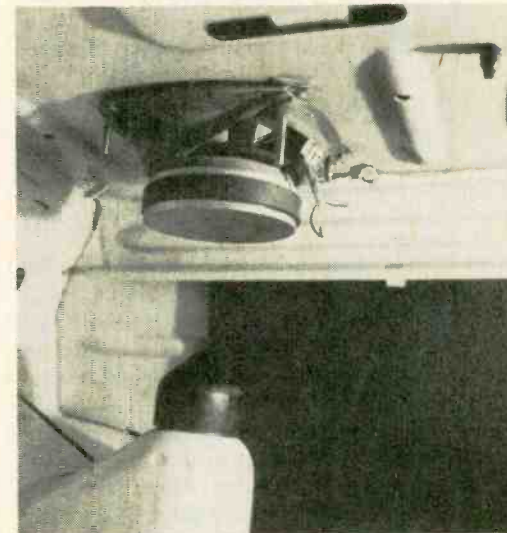

Fig. 9. Connect the speaker wires and route the wires so they are off the floor where they cannot be damaged.

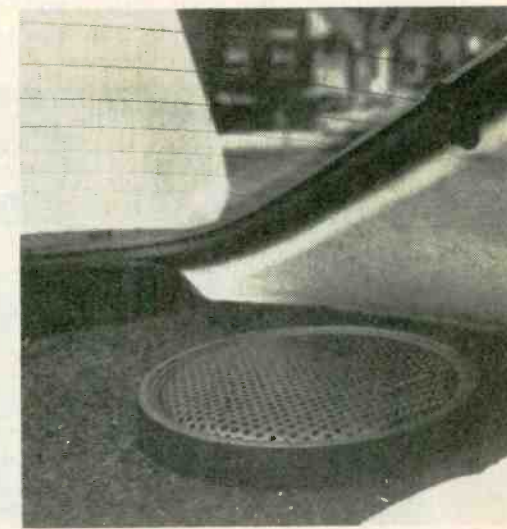
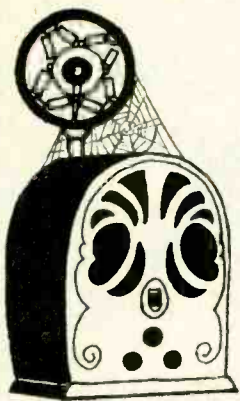
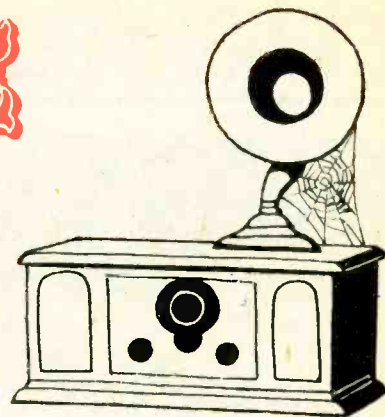

Fig. 8. Install the mounting screws—held in place with Tinnerman nuts, or tape—and then carefully fit the speaker over the screws. Snap down the grill and the installation is complete. A neat, professional job that looks like it came straight off the assembly line.



# ANTIQUE RADIO CORNER



by James A. Fred

□ Hello out there in Radioland! Time surely flies in this fast paced world we live in. The Antique Wireless Association annual conference will have come and gone while you are reading this column. The AWA was founded in 1952 by a group of amateur radio historians. There are now over 1300 members in the AWA. They come from all walks of life—from beginning teenage collectors to the old time telegraphers who still remember the spark equipment.

The association is transferring its thousands of pieces of wireless and radio equipment collected over the last 22 years to a new museum housed in the newly restored, 136-year-old academy building which is owned and shared by the Town of East Bloofield.

The new museum in the East Bloomfield Academy building features a large exhibition hall plus a replica of an early wireless station, an early radio store, a vacuum tube collection, library, and Edison cylinder phonographs.

The AWA Electronic Communication Museum will be open from May through October. The hours are: Sun-

days—2 to 5 p.m., Wednesdays—7 to 9 p.m. There is no admission charge since the museum is maintained by a membership fund.

The association is chartered by the State of New York as a non-profit corporation and enjoys full membership in the American Association of Museums.

**Basic Info.** Starting with this column, and continuing for the next three or four, we are going to explore tuning indicators as they were used in the 1930s radios. Tuning indicators to be discussed are the neon type, shadowgraph, magic eye, and tuning meters.

We shall start with the Tune-A-Lite, also referred to as a Flashograph, when used in a Fada radio. The Tune-A-Lite seems to have been produced in three configurations. One type mounted in an ordinary single contact automobile type base. It was 3½-in. high and ½-in. in diameter. Internally it had two elements, a long cathode, 3 3/16-in. long, and an anode only ½-in. long. The glass tube was filled with neon gas. There was another version the same physical size and shape, but with a miniature 4 pin

base. The third type, as I recall, had wire leads coming out of a glass tube.

The Tune-A-Lite was usually used in receivers employing automatic volume control (AVC). A signal applied to the grid of an amplifying tube, as it increases the grid bias, will decrease the average plate current. The actual plate voltage, therefore, rises due to the decreased voltage drop in the plate circuit of the tube. So the Tune-A-Lite must be connected into the circuit so that the voltage on the cathode will increase and decrease with the strength of the received signal. Suppose that the RF amplifier tubes, whose gain is controlled by the AVC voltage, all have their B+ leads connected together at a common point; suppose also that a high resistance is placed between this common point and the power supply as shown in Fig. 1. The Tune-A-Lite is connected with the anode to the common point, and the cathode to the variable arm on the bleeder resistor in the power supply. The variable arm is for the purpose of adjusting the no-signal voltage applied to the Tune-A-Lite until it is just



One end of the AWA museum where a 1925 radio-wireless store is on display is shown on the left. Two AWA members look over some of the merchandise displayed there. Many items are in their original boxes. Shown, right, is part of the second floor of the AWA museum. This partial view of the general exhibition hall shows radio and telegraph equipment.



Auctions are a lot of fun, especially when antique radios are up for grabs. Two IHRS members, Joe Duray and Warren Johnson (left photo), examine some of the golden oldies before the auction starts. The auction-antique mystique takes hold as a prospective buyer (right photo) ponders product and price. But, it's the final rap that counts. Auctioneer Paul Burns (center photo) works hard at getting top dollar for the gear sold at auction.

equal to its ignition voltage. Now when the action of the AVC voltage causes a decrease in the plate current of the controlled tubes their plate voltage will increase. The voltage across the Tune-A-Lite will then increase, the amount, depending on the strength of the signal. The height of the neon glow will be at a maximum when the station is tuned to exact resonance.

**Men Of Radio.** Dr. Ernest F. W. Alexanderson, the inventor of the high-frequency alternator, died in Schenectady, New York at the age of 97. Alexanderson was born in Sweden in 1878 and after studying engineering in Germany and Sweden he came to the United States in 1901. He spent his working lifetime, 46 years, except for a few years as chief engineer at RCA, with the General Electric Company. He was issued 322 patents during this time. The invention of the high-frequency alternator made the voice transmission possible on radio.

Among his patents were the magnetic amplifier, electronic amplifier, the multiple-tuned antenna, the radio altimeter, as well as many antenna designs. He also pioneered in transmitting pictures by radio. The first home television re-

ception took place in his home in 1927.

Charles Leutz Sr. was born in Boston, Mass. in December 1898. When he was eleven years old he was fascinated by a wireless station near Lexington, Mass. He started to build wireless receivers that fall from plans appearing in the newspapers.

He became a radio amateur and received his licenses in 1913 and 1914. Later while still in high school he and two friends formed the Eastern Scientific Apparatus Company. This company soon attracted the unfavorable attention of the Marconi Wireless Telegraph Company and so went out of business.

Charles Leutz then went to work for the Clapp-Eastman Company, a pioneer radio receiver manufacturer. Short periods of work followed at Bethlehem Steel Company and the Marconi Wireless Telegraph Company of America. Then in 1921 he founded the Experimenters Information Service to produce and sell information and instructions that would enable amateurs to build their own receiving and transmitting equipment. He designed a ten tube model "L" superhetrodyne receiver and at first he supplied blue prints only, but later began to supply parts to build it.

By 1925 his sales had risen to \$3,000.00 per year! This success wasn't to last, however, as RCA and Westinghouse soon obtained an injunction to prevent him from selling blueprints and "kits of parts" for superhetrodyne receivers. They also refused to grant him a license to manufacture superhetrodyne receivers.

**Bounces Back.** Leutz then turned his attention to Tuned Radio Frequency (TRF) receivers, and, with the advent of screen grid tubes in 1927, he was able to build special TRF receivers that were superior to the superhetrodynes of that day.

As reported in the September-October 1975 issue of *ELEMENTARY ELECTRONICS* Leutz wrote three books and many practical radio articles up until 1940, at which time he retired permanently from his radio activity.

The above information is reprinted by permission of the Antique Wireless Association.

Add, to your list of public radio museums listed in the antique radio collectors fact sheet, the following: Communications Hall of Fame, 72 Mountain Street, Sutton, Quebec, Can-

*(Continued on page 95)*

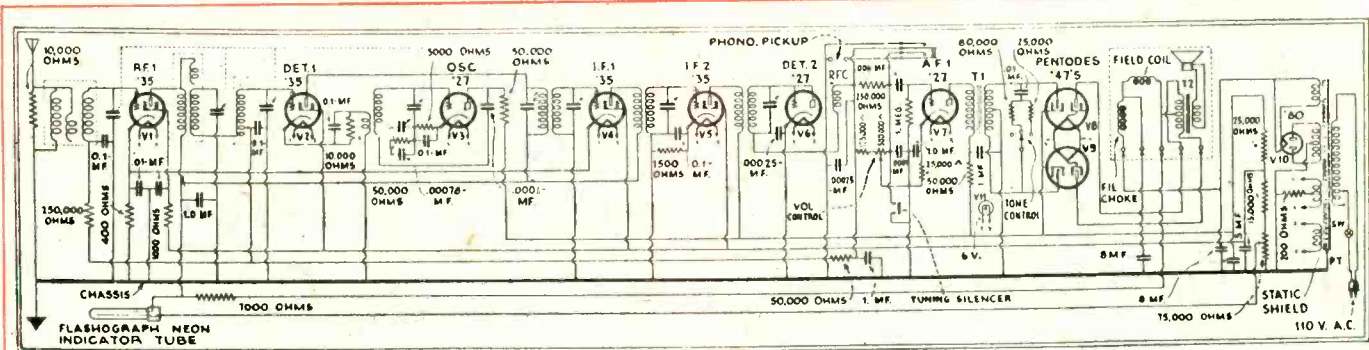

Diagram of the Fada models "48" and "49" receivers. This chassis is superheterodyne employing a diode detector and a Tune-A-Lite for indicating maximum response. This set is equipped with automatic volume control and push-pull pentodes in the output.

# ham radio special!

## Vertical All-Band on a Postage Stamp

by Herb Friedman

The New-Tronics Hustler 4-BTV is from New-Tronics Corporation, 15800 Commerce Park Drive, Brook Park, OH 44142. Retail price is \$79.95. Circle No. 74 on the Reader Service page 17 for more information.

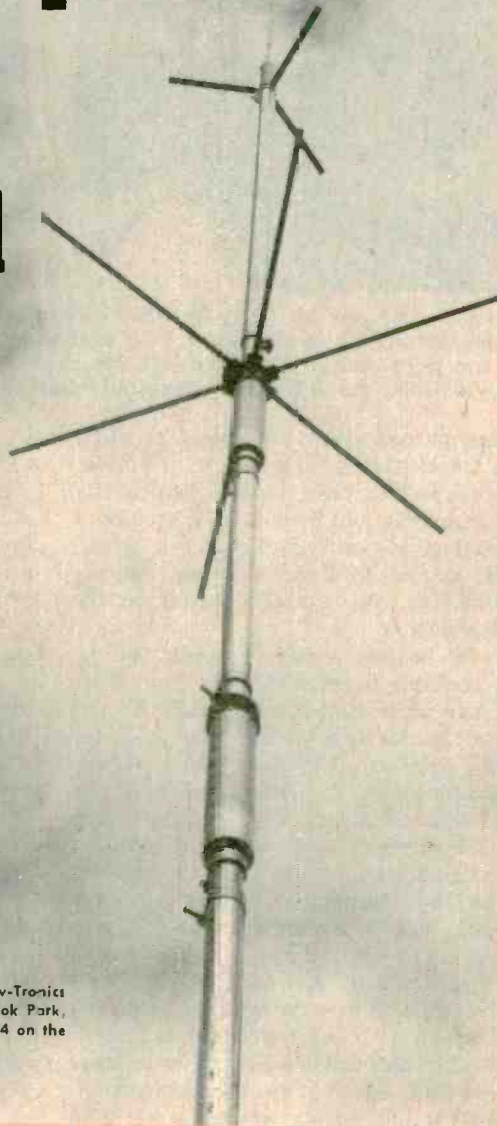

**T**HOUGH NOT NECESSARILY the most ideal transmitting antenna, a trap vertical has become just about the only decent antenna system available to the urban amateur. With property lots shrinking to 20 x 100 feet, community lawsuits over towers, and buried utility cables eliminating the "telephone" pole, there's very little the average urban amateur can do to get a decent signal out on the lower high frequency (hf) bands—particularly 160, 80 and 40 meters. Those using 10, 15 and 20 meters can get by with dipoles, but this often requires permission from a next-door neighbor to cross his postage stamp lot, and not all neighbors are that friendly.

The hams hit hardest by the space problem are the *novices*, for their most effective bands are 80 and 40 meters; yet, an 80-meter antenna can take up to six city lots worth of space. When the *novice* advances to *general*, his chances of putting up an antenna farm to cover all bands is probably less than that for just a single 80-meter dipole.

But if you have as little as two square feet on the ground and can look straight up without interference, you've got enough room for a really effective "all band" hf antenna—either 160, 80, 40 meters, 80 through 10 meters, or 40 through 10 meters. Or take full *novice* coverage starting at 80 meters so you can work all bands when you get your *general*.

**A Close Look.** Now before we get into the "how" of a postage stamp antenna installation let's settle the high/low complaint. Yes, it is quite true the higher the antenna the better. Any antenna above the roof of the house will unquestionably work better than an antenna near the ground. If you can get a vertical antenna on the roof and have room for the required ground radial

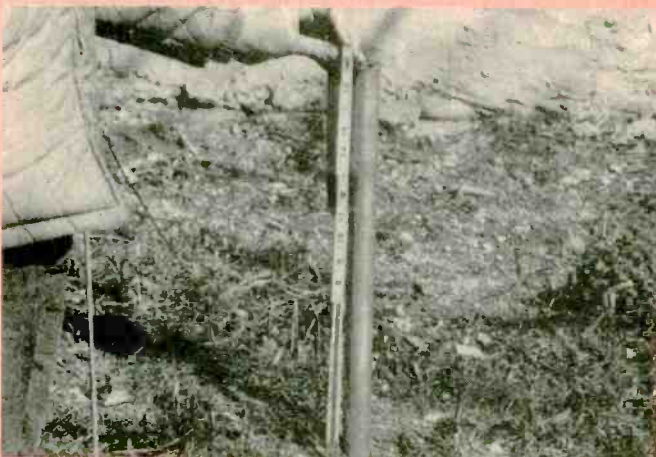

First step is to determine the location of the antenna system and drive in the 4-foot ground stake, leaving 18-inches sticking out above ground. A two pound sledge can be used to drive the stake.

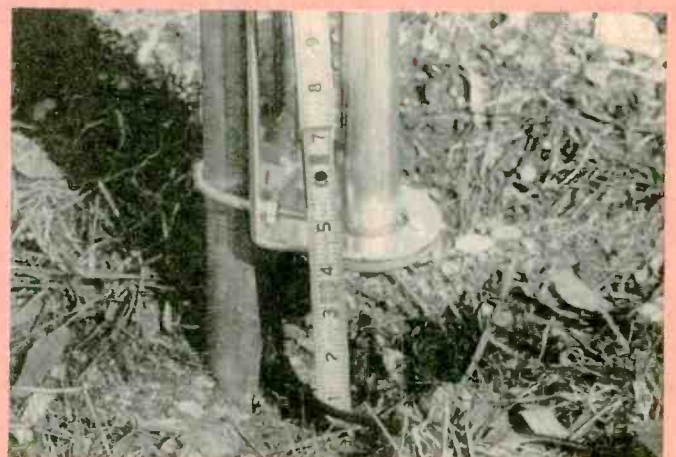

Install the base support bracket on the ground stake so the bottom of the bracket is precisely 4-inches above ground. This dimension is important—don't fudge it.



The three trap sections are supplied pre-tuned and sealed with relatively long shafts on both sides. You've got plenty of shaft length for adjustment without fear of damaging the traps. The black caps on one end of each trap indicates the top of the trap, a better idea than paint that can rub off.



It's all up, and you can see the three traps, the 20 meter capacity hat above the top coil and the top 40-meter section.



If you want 75/80 meter operation you simply run down to your local Ham equipment store and purchase a 75 meter mobile antenna assembly. (The RM-75 for 400 watts SSB/100 watts CW or the RM-75-S for full legal power.) You don't have to pay for 75/80 meter operation if you don't need it; yet it can be added.

system, by all means put it up there. But if you worry about a heavy wind blowing it down (with part of the roof), if the XYL or head of the house objects to something like 25 feet of pipe sticking up from the roof, or you're just too chicken about working on a roof's ridge, it's back to the ground—the easiest way of all.

Just about the easiest all-band vertical for ground level installation we've run across is the New-Tronics Hustler 4-BTV. The 4-BTV is basically a 40 through 10-meter antenna; an optional screw-on assembly that we'll discuss later converts it to 80 through 10 coverage.

The figure shows how a basic trap vertical works. Each trap provides an

isolation unit so the pole section below the trap and everything within the pole including other traps (made of coils and capacitors) are an electrical  $\frac{1}{4}$ -wavelength at the operating frequency. (There are many other vertical trap antenna designs but this one is easy to follow.) Note in Fig. 1 that the first trap—closest to ground—is the 10-meter trap; the section below this trap is the 10-meter antenna. Further up there is a 15-meter trap, then a 20-meter trap and finally just a rod which, together with everything below, forms a 40-meter vertical. The top of the 40-meter rod section has a screw that accepts a common 75-meter mobile antenna, which then provides 75/80 meter operation. With the Hustler 4-BTV antenna, the 75/80-

meter antenna section is optional; it can be added any time after the antenna is up if not originally installed.

**Tune Out SWR.** The trap vertical antenna is tuned by adjusting the length of the telescopic sections between the traps. A low SWR across the entire band (either 75 or 80) can be attained if the antenna is roof mounted with radials. Essentially equal SWR can be attained with a ground mounted antenna using a fairly complex radial system for which instructions are provided. Or, you can avoid digging up the backyard for radials and settle for a low SWR across 10, 15 and 20 meters, either CW or phone coverage on 40 (unless you're willing to work with a 3:1 SWR on the band edges which is



The 75/80 resonator screws on directly to the stud. To avoid damage don't use any tools. Hand-tight will hold forever.



If needed when the 75/80 resonator is used, a capacity hat for the top of the 40-meter section is available upon request from New-Tronics. You simply unscrew the 75/80 resonator and slip the capacity hat on top of the 40-meter section; then you re-install it.



Final check-out must be made on each band with an SWR meter. Lowest SWR should be at the center of each band or particular operating frequency range. You usually will be under 2:1 SWR from end to end except on 80 meters, where on a non-radial installation with an RM-75 will give better than 2:1 for about 150k Hz; sufficient for the Novice frequencies. The RM-75-S gives somewhat broader coverage and is suggested for 75.

e/e

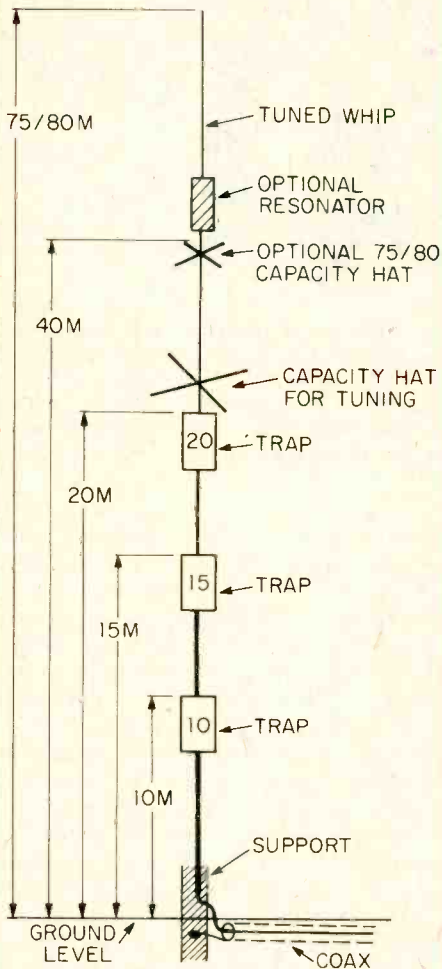

The trap vertical antenna functions as a  $\frac{1}{4}$  wavelength radiator on each band. For 75/80 meter coverage an optional mobile type antenna consisting of resonator (inductor) and tuneable short whip can be mounted on top of the basic 40 to 10-meter antenna, thereby providing an electrical  $\frac{1}{4}$  wavelength antenna for 75/80. Quite often, a buried coaxial transmission line provides all the ground radial necessary. Trap vertical antennas are also available for 160 meters, 160/80 and 160/80/40, though the 40 to 10 and 80 to 10 are the most popular among novices and new generals.

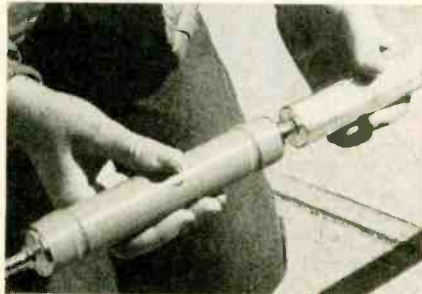

Eighty meter resonator screws on.

usually no big problem) and about 150 kHz coverage on 75/80 (the *novice* 80 meter or 75 meter phone band). Since most e/e readers who wrote in asking for an article on trap verticals specifically requested a no-radial system, we installed and tested the Hustler 4-BTV without the extensive radial system generally suggested.

The photographs show the highlights of a 4-BTV installation, but we also have a few tips that will help you in your own installation. The ground post, the thing that supports the antenna in the ground, is ordinary galvanized  $\frac{1}{4}$ -in. O.D. fence pipe—the stuff used to support cyclone fencing. You'll need exactly 4 feet, which costs about \$5. Do not use "salvaged" galvanized plumbing pipe. If you live in an area of high wind or very soft ground, use  $\frac{1}{2}$ -in. O.D. fence pipe.

Drive the pipe into the ground so 18-in. sticks above ground. (Hustler refers to this pipe as a *ground stake*.)

The antenna support bracket to which the coaxial transmission cable is attached will be positioned on the ground stake so the bottom of the bracket is precisely 4-in. above ground—making it almost impossible to work on the connections. So connect the coax to the antenna bracket terminals before the bracket is installed (with U-bolts) on the ground stake.

**More Hints.** If you install the basic 40 through 10-meter antenna, you will probably get by without radials if the coaxial transmission line is buried an inch or so below ground. You can bring the line out of the ground near where it enters the house. We got excellent results this way, with an SWR of 2:1 or better across all bands. Generally, the antenna is tuned to the center of each band by adjusting the length of the aluminum tubing rods between the traps. But when the 75/80-meter antenna section is installed, the 40-meter tuning is thrown off about 300 kHz, and one of two techniques is required to bring down the 40 meter SWR. Either a small capacity hat—available free on request from Newtronics—must be installed directly below the 75/80 antenna section (the top of the original 40-10 antenna), or at least one ground radial must be tuned for a low 40 meter SWR. For our test installation, in sandy soil, we had to bury about 40 feet of ground wire, which we then trimmed a few inches at a time until we had a 2:1 SWR across all of 40 meters. Whether or not you need the radial after the capacity hat is installed will depend upon your particular installation. But even one radial is a lot better than installing the usual spider-web

radial system.

Though we speak in terms of a *radial*, thereby implying a straight run of wire similar to the spoke of a wheel, with the 4-BTV antenna any radial(s) which might be needed because of 75/80 coverage can be zig-zagged just under the ground, and any configuration can be used that will fit the back or side yard. Remember, the radial can be tuned with wire cutters, so there's no need for precision.

As for tuning the antenna itself, that's a breeze. A supplied chart details the rod dimensions between the traps, and you preset everything on the ground. The base of the antenna, to which the transmission line connections are made, is a separate section installed on the ground stake. After the antenna is assembled, it is simply lifted, placed over the base support rod, and lowered to the base itself (the antenna itself is light enough to be handled by one person even in a moderate wind). The transmitter is fired up and the SWR checked on each band. If an adjustment is needed, the entire antenna is simply lifted from the base and again the necessary adjustments are made on the ground.

**What Power?** The basic 4-BTV antenna with 40 through 10 meter coverage is rated for the full legal SSB and CW power limit. Two antenna sections for 75/80—termed *resonators* by Newtronics—are available. The type RM-75 is rated for 400 watts SSB and 100 watts CW, so it's a perfect choice for the *novice*. For full legal limit operation on 75/80, the RM-75-S is required; the RM-75-S is larger and therefore heavier than the RM-75, and the total antenna system with an RM-75-S might require rope guy lines near the top if there's a possibility of heavy winds. We suggest the RM-75 if you can work within its power handling capacity, but even without guying, our test installation took an extremely bad winter storm with no evidence of damage, while the very same storm blew down towers, beams and even wire dipoles.

**No Party.** Installing a trap vertical antenna system doesn't take an antenna raising party. If you have a two-pound sledge for driving the ground stake, figure about two hours to get everything up and the transmission line to the point where it enters the house. From there on in you're on your own. If you have someone to help, even a child just to pass you screws, or to flip the ground with a shovel for a 1-inch deep slot for burying the transmission line and/or radial, you should be done in about an hour—and that's the fastest all-band antenna you'll ever put up. ■

**I**N THE OLD DAYS, sorcerers and alchemists used incantations to time their experiments while the chemicals interacted in the bubbling cauldrons. In more modern times, photographers use mechanical timers to monitor the developing photos in their darkrooms. These timers had to be constantly reset with hands that may be dripping with photo chemicals. Now, the digital IC has changed things for photographers (and any sorcerers that may be still around). Our photo firefly construction project provides precision timing pulses that do not have to be constantly reset. It's a modern day equivalent of the

**Precision timing pulses tickle the senses of your eyes and ears leaving your hands free to process your negs and photos on time!**

by Charles Green

# PHOTO FIREFLY



olden day incantation. The photo firefly has both audio and visual 1-second and 10-second output pulses from a built in speaker and LEDs.

This project is designed for easy construction. Precise timing circuits are triggered from the 60-Hz AC line in a manner similar to a digital clock, and are contained in three ICs. A single transistor supplies the audio timing pulses for the miniature speaker and a voltage regulator module keeps the built-in AC power supply at a constant output voltage for precise timing pulse operation. The project is built in a handy 6 x 3 x 2-in. plastic box.

**The Circuit.** Even though each of the ICs used in the photo firefly project contains many transistors and diodes, it is not necessary to discuss the individual internal IC circuits to understand how the overall project circuit operates. Just visualize each IC as a "black box" with the inputs and outputs shown in the block diagram. The ICs are essentially binary digital counters that divide the input signals by predetermined factors as indicated in the diagram. IC1 divides by 6, IC2 and IC3 both divide by 10.

Now look at the schematic diagram. A 60-Hz signal from the secondary of T1 is rectified by D1 and the resulting pulsating DC signal is fed into the pin-1 input of IC 1. The internal binary counters divide the 60-Hz signal by a factor of six, with the resulting output (at Pin 8) of 10 Hz. This 10-Hz signal is divided by IC2 by a factor of 10; the resultant 1-Hz output (1-second pulse) is at pin-11 and is fed through the current limiting resistor R3 to operate LED1. The 1-second pulse is connected to the input of IC3 and is divided by ten to provide a 10-second output pulse at pin 11. This 10-second pulse operates LED2 through the current limiting resistor R4.

Switch S3 connects the normally-inoperative circuit of Q1 to the 1-second pulse output of IC2, and the positive portion of the output pulse provides operating bias for Q1. This causes it to momentarily oscillate at an audio rate, with a resulting sound in the 8-ohm speaker. When S2 is closed, Q1 will oscillate at 10-second intervals.

The required 5-volt DC power for the photo firefly circuits is supplied by the diode rectifier (from T1-secondary), filtered by C4, and regulated by the voltage regulator module IC4.

**Construction.** The Photo Firefly is built into a 2-in. high by 3-in. wide by 6-in. long plastic cabinet and plastic panel. The dimensions of the cabinet are not critical and any convenient size cabinet can be used. Inasmuch as the photo firefly project will be used in photo darkrooms (which usually are damp), for electrical safety, only a plastic cabinet and panel should be used—unless you provide a three wire grounding type AC cord with a metal cabinet.

Most of the components are installed on 2½-in. x 4½-in. section of perf board. Look at the perf board parts layout drawing for the approximate locations

of the components for easier wiring. We used a perf board with 0.042-dia. holes and 0.100-in. spacing of the holes for easier mounting of the IC sockets. But other types of perf boards can be used if you drill holes to fit the IC socket lugs. As shown in the photos, the IC sockets are pressed flat against the perf board surface and connections are made from the reverse side of the perf board. This method will hold the sockets in place. After cutting the perf board to size, drill corner holes for the 1¼-in. long 6-32 mounting screws.

Locate and mount the components with push-in clips at the approximate locations shown in the drawing. Keep the leads to the components short and space them to avoid any possible electrical contacts between them. Integrated circuit IC4 is mounted flush against the perf board surface with two machine screws. Drill holes (if necessary) for its lugs to project through the perf board. Mount T2 in the same way, with its connecting lugs through the board holes, and fastened to the board with machine screws and nuts.

Wire the perf board components with small diameter solid wire (#24 or smaller) and lengths of insulated sleeving to prevent any possible electrical shorts. Connections to the case (ground) of IC4 are made with a solder lug installed on one of the mounting screws. Look at the schematic diagram for information on connection to the IC terminals. The IC4 connections are shown as a bottom view, and the ICs are shown top view.

Temporarily position the miniature 8-ohm speaker, T1, S2, S3, and R9 on the top panel in the approximate positions shown in the photo. Mark and drill the required mounting holes for these components. If your particular speaker does not have any mounting ears (as the one used in our unit), cut the speaker hole in the panel a bit smaller than the speaker diameter and install four solder lugs on machine screws and nuts. Position the solder lugs to hold the speaker frame in place. Use stiff plastic grille cloth or screen wire to protect the speaker cone from accidental damage.

Temporarily position the perf board and locate the holes for the corner mounting screws. The LEDs are mounted in rubber grommets installed in front panel holes. If necessary, put a drop of cement on each LED to keep it from

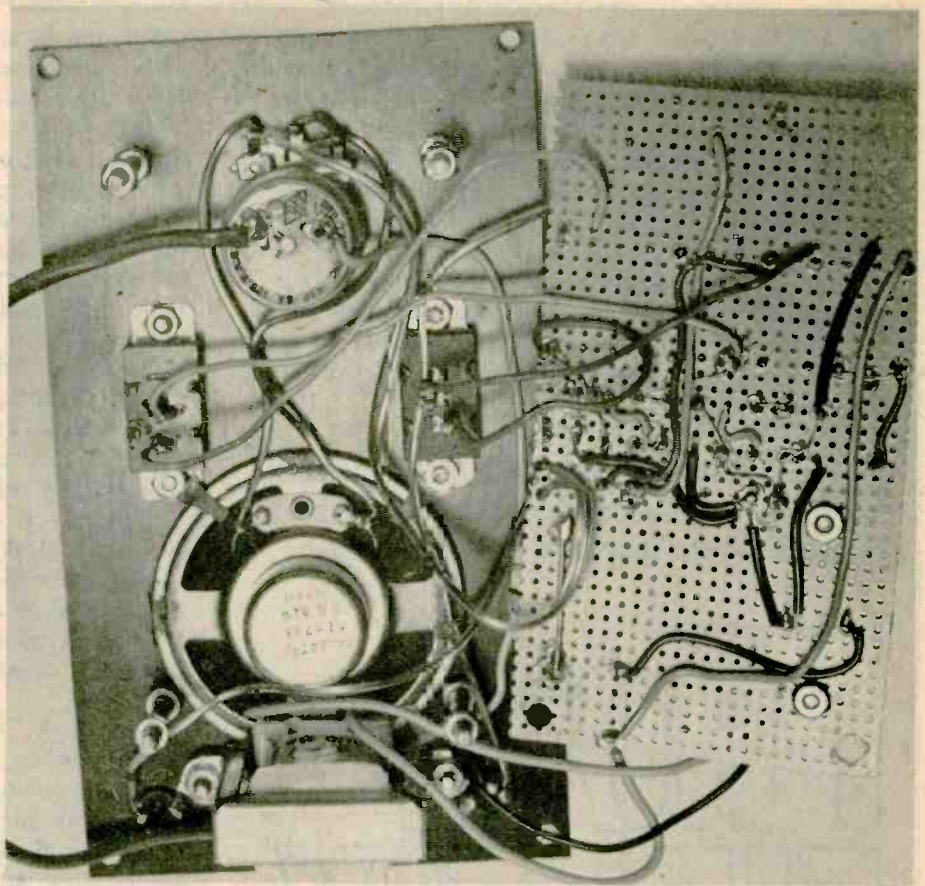

Perf board with major circuit components is mounted over speaker on long screws anchored to the front panel with nuts and lockwashers.

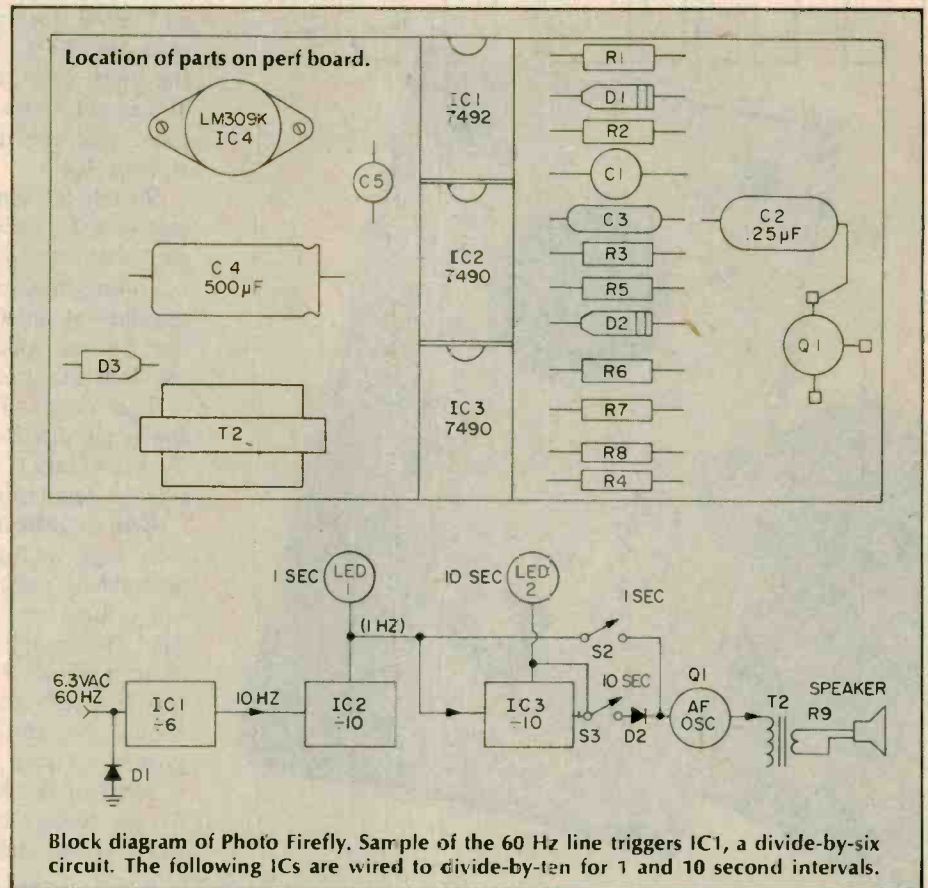



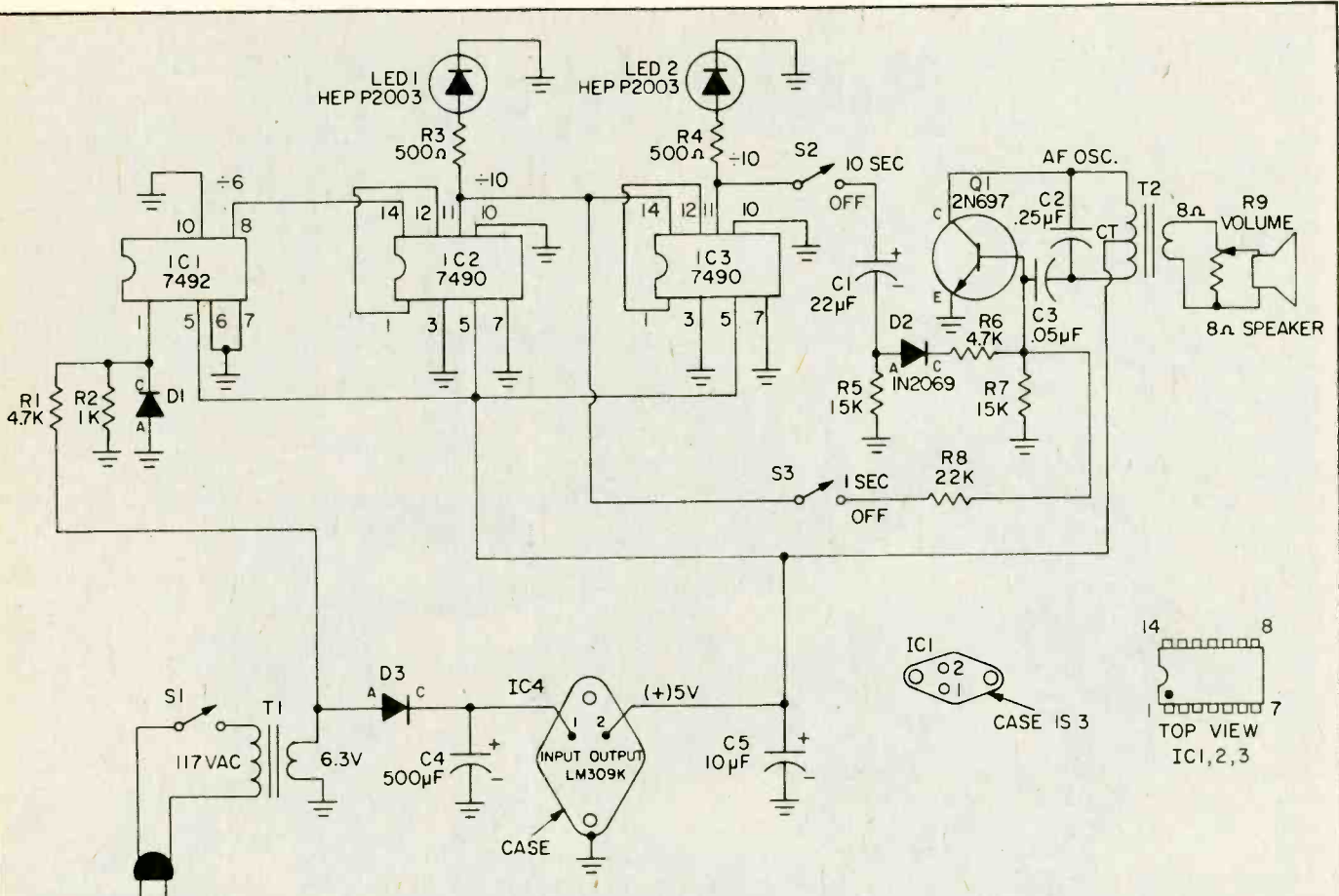

#### PARTS LIST FOR PHOTO FIREFLY

- C1—22-µF, electrolytic capacitor, 16 VDC (Radio Shack 272-953 or equiv.)
- C2—0.25-µF capacitor (Radio Shack 272-1070 or equiv.)
- C3—0.01-µF capacitor (Radio Shack 272-1065 or equiv.)
- C4—500-µF electrolytic capacitor, 16 VDC (Radio Shack 272-1007 or equiv.)
- C5—10-µF electrolytic capacitor, 16 VDC (Radio Shack 272-952 or equiv.)
- D1, D3—1-amp, 50 PIV silicon diode (Radio Shack 276-1135 or equiv.)
- D2—general purpose silicon diode
- IC1—7492 TTL-type integrated circuit
- IC2, IC3—7490 TTL-type integrated circuit (Radio Shack 276-1808 or equiv.)

- IC4—LM-309K IC voltage regulator (National Semiconductor Corp.), (Radio Shack 276-1830 or equiv.)
- LED1, LED2—light emitting diode, red (Radio Shack 276-042 or equiv.)
- Q1—2N697 npn transistor (Radio Shack 276-2009 or equiv.)
- R1, R6—4700-ohm, ½-watt resistor (Radio Shack 271-000 or equiv.)
- R2—1000-ohm, ½-watt resistor (Radio Shack 271-000 or equiv.)
- R3, R4—500-ohm, ½-watt resistor (Radio Shack 271-000 or equiv.)
- R5, R7—15,000-ohm, ½-watt resistor (Radio Shack 271-000 or equiv.)
- R8—22,000-ohm, ½-watt resistor (Radio Shack 271-000 or equiv.)

- R9—500-ohm potentiometer, linear tape with spst switch (Radio Shack 271-066 or equiv.)
- S1—spst switch (part of R9)
- S2, S3—spst slide switch (Radio Shack 275-401 or equiv.)
- T1—117 VAC to 6.3 VAC @ 300 mA power transformer (Radio Shack 273-1384 or equiv.)
- T2—500-ohm to 8-ohm audio output transformer (Radio Shack 273-1381 or equiv.)
- Misc.—8-ohm miniature speaker, approx. 2-in. dia. (Radio Shack 40-245), 6 x 3 x 2-in. plastic cabinet and panel (Radio Shack 270-627), perf board and push-in clips to fit, IC sockets, AC line cord, wire, hardware, knob for R9, rubber grommets, wire solder, etc.

falling out of the grommet. Mark the panel with rub-on decals or pasted on labels.

Connect the perf board circuits to the panel controls before mounting the board. Use spacing nuts or bushings to keep the bottom of the perf board up and away from contact with the panel components. Check your wiring and then cut a slot or hole in the cabinet side for the AC line cord. Tie a small knot in the cord, or use a strain relief bushing to prevent the AC cord from being pulled out of the cabinet. Install the ICs in their sockets, making sure that they are oriented (keyed) in the

right direction.

**Operation.** Place the photo firefly unit in a dry area of your photo darkroom, and connect the AC cord to the outlet. No calibration or adjustments are required, and the unit can be placed into operation immediately.

Set the 1 SEC switch (S3) to the on position and adjust volume control (R9) for a convenient audio level output from the speaker. You can use the one second timing pulses for working with an enlarger. Just listen and time your exposures by counting the audio pulses—no need to continually reset a timer. Begin anytime with the continu-

ous train of pulses. This is especially convenient if you do any "photo-dodging" on your enlarger.

The ten second pulses can be used by setting S2 to the on position (S3 off). These pulses are to be used for the longer time exposures on your enlarger and also for developing your picture. The ten second pulse is longer than the one second pulse, so it can be readily identified when the two pulses are used together (both S2 and S3 set to on position). This is useful for timing operations other than multiples of 10. The LEDs can also be used for "eyeball" timing. ■

# Build this set...



# And build your career in electronics at the same time.

You build and keep a *future* when you learn electronics the ETI way.

“Building” is a key word through all the 16 ETI electronics courses and programs. Whether your goal is to get into TV repair and service, get your FCC license, move into computers,



advance in your present job through learning solid-state

technology, or become an electronics draftsman... you build your tomorrow. You build a lot more than TV sets. You build a solid future in the field where—despite all recent changes in the economy—the action has to come.

You build that future on a foundation of learning that is useful... practical... step-by-step... hands-on.

You build it from the beginning by a special, simplified, building-block teaching system called *Autotext*, exclusive with Electronics Technical Institute, that makes learning fun. You keep building, combining hands-mind-equipment in the most practical way, so you can “talk shop” or present an idea *effectively*, but you can also *do the job*. You’ve learned by doing, and you gain all the confidence that comes with it.

You build with the concerned personal help of a licensed instructor who knows the subject and wants to know *you*. You build with the reputation of the school that began as the Marconi Institute back in 1909.

In many phases of building your technical know-how, you use specially developed Project Kits that move in a logical sequence, hands-on, from the first step through completion of basic units. There is no surer way to build solid electronics knowledge *and* your own confidence in what you can do.

And it’s simple to check it all out right now, with no obligation—and no salesman will call. All it takes to get the colorful new 44-page ETI Career Book is a card or coupon. If you like electronics, you’ll enjoy reading about it. You owe it to yourself to get the facts.

The Career Book itself may be worth real money to you, as you make plans for your future and consider the many opportunities open to you through 16 different courses and programs in electronics.

To build a future in electronics, the first step is to send for your free ETI Career Book today!



## Electronics Technical Institute

Division of Technical Home Study Schools

Electronics Technical Institute, Dept. 2-472-115  
Little Falls, New Jersey 07424

Send me the Electronics Technical Institute Career Book.

Tell me how I can get ahead in Electronics through ETI. I've checked the fields of special interest to me.

- |   |   |                                    |   |
|---|---|------------------------------------|---|
| <input type="checkbox"/> TV/Audio Servicing | <input type="checkbox"/> Communications | <input type="checkbox"/> Computers | <input type="checkbox"/> Business and Engineering |
| Black and White                             | FCC License                             | Digital Electronics                | Electronics Fundamentals                          |
| Color                                       | Aircraft                                | Computer Technology                | Electronics Drafting                              |
| Solid-State                                 | Marine                                  | Computer Programming               | Industrial Electronics                            |
| CATV  | Mobile Two-Way                          |                                    | Advanced Electronics                              |
| Closed Circuit                              | Microwave                               |                                    | Industrial Instrumentation                        |
| Video Recorders                             |   |                                    | Electronics Technology                            |
| Radio                                       |   |                                    | Medical Electronics                               |
| Hi-Fi Stereo                                |   |                                    |   |

Check here for Veterans information.

Name \_\_\_\_\_ (please print)

Address \_\_\_\_\_

City \_\_\_\_\_ State \_\_\_\_\_ Zip \_\_\_\_\_

e/e checks out a...

# BARLOW WADLEY PORTABLE SHORTWAVE RECEIVER



Crystal-controlled continuous tuning from 1/2 to 31 MHz makes this a most unusual and novel short wave portable.

□ We'll say flat out that the Barlow Wadley XCR-30 500 kHz to 31 MHz receiver is the finest portable receiver we have ever seen or used, and we'll include those famous trans-oceanics of years past. The XCR-30 is also a lot better SW receiver than a lot of high priced equipment sold to amateurs and general short wave listeners.

To start with, the XCR-30 is a battery powered portable; the power source is six internal D-cells or any 6 to 12 VDC external source via a power plug. The entire receiver including handle measures 11½-in. wide x 9½-in. high x 3¾-in. deep. Weight, including the batteries, is a shade over 9 lbs.

The most obvious feature is the lack of a band switch. How does the darn thing tune a station? Well, it's really a complex tuning system worthy of a story in itself, but we must break it down to basics in order to fit this report. The XCR-30 has two tuning dials. One is calibrated in kHz from 000 to 1000 in 10 kHz divisions. The other dial is calibrated in MHz from 0 to 30 in 1 MHz divisions.

**The System.** Harmonic frequencies from an internal crystal-controlled oscillator are beat with the output of a "tuning" oscillator in the 45.5 to 75.5 MHz range to produce a signal of approximately 42.5 MHz. The "tuning" oscillator is also used to beat the received signal to approximately 44.8 MHz. The 42.5 MHz crystal-controlled oscillator signal is beat with the 44.8 "received" signal to produce a signal of approximately 2.3 MHz. The 2.3 MHz output is passed through a tunable amplifier-calibrated 0000 to 1000 kHz—and on to the usual receiver circuits such as

fine tuning (SSB clarifier), detector-BFO, etc.

Because the basic tuning is locked to a crystal reference, the main tuning dial tunes in 1 MHz increments; moving the tuning dial from, say, 21 MHz to 22 MHz moves the tuning precisely 1 MHz. There is no in-between tuning; you must use the bandspread for the exact frequency. For example, assume you wanted to tune in a station at 21.450 MHz. You would simply set the MHz dial to 21 and the kHz dial to 450. *Voila!* The receiver is instantly tuned to 21.450 MHz. Rocking the main tuning only serves to peak up the sensitivity; it has no effect on the tuned frequency until deliberately moved to a new calibration, say, for example, 24. If the main tuning were moved to 24 while the kHz dial remained at 450, the new tuned frequency would instantly be 24.450 MHz.

**Features, Features, Features.** Front panel controls include a calibrated antenna trimmer which is used to peak up the received signal, a power/volume control, the SSB clarifier (it also serves as the fine tune) and a mode switch for AM, USB (upper sideband and code), and LSB (lower sideband). Two vertical-spin finger controls are used for the MHz and kHz tuning. There is a small signal strength tuning meter with a tiny knob directly below. The knob serves as a calibration control for the kHz dial (we'll explain this later). A telescopic antenna approximately 36-in. long when extended is built into the top of the case. There are input jacks for an external antenna and ground connection on the top of the cabinet. A headphone jack and remote power socket are located on the side of the case. A complete set of matching plugs and connectors is supplied.

Now all this does not sound like

much in the way of controls and circuits, particularly when the average receiver looks more like the flight control panel of a 747. The answer to the slim, trim appearance of the Barlow Wadley lies in some trick circuit design that works well to cut out operating headaches. For example, while we can obviously tune a 30 MHz range without bandswitches by heterodyning down from a relatively high frequency, it's not so easy to do the same with the RF preamplifier tuning. So Barlow Wadley has combined the RF amplifier range switch (actually microswitches are used) with the antenna trimmer control. As the user peaks reception with the antenna trimmer, the proper tuning coil is automatically switched in and tuned. It works just beautifully. Only by careful touch and concentration do you realize something is being switched (you hear and feel a slight click).

As for precise calibration of the kHz dial, that's more or less automatic because a 1 MHz crystal oscillator is already built in, and is always on because

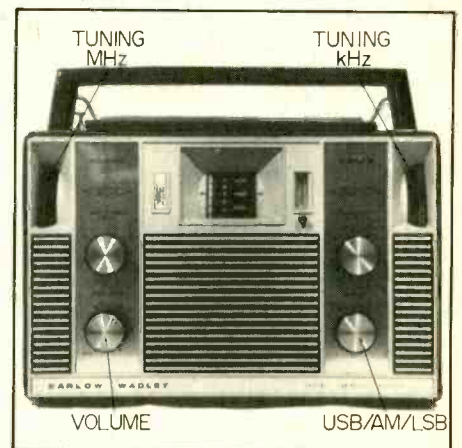

This is what the Barlow Wadley crystal controlled receiver looks like at first glance—a sleek portable transistor radio.

The Barlow Wadley XCR-30 is available by mail order from Gilfer Associates, Inc., Box 239, Park Ridge, NJ 07656. Price is \$290.00. Circle No. 71 on the Reader Service page for more information direct from Gilfer.

it controls the main tuning dial. To calibrate, the kHz dial is simply set to 000 or 1000 and the small knob under the tuning meter is adjusted for maximum meter reading. Or, you can turn on the BFO and adjust the trimmer control for a zero beat—a slightly more accurate dial calibration.

**A Hitch.** Because the 1 MHz oscillator is on at all times, generating a continuous 1 MHz output, the receiver is effectively blocked precisely at 1 MHz spacings, and for this reason you cannot hear, or will have difficulty hearing, the WWV signals on 5, 10 MHz, etc. This is the shortcoming of this type of design, but it does provide rock-steady stability because the tuning, being locked to a crystal oscillator through a servo-control, provides essentially drift-free reception at all frequencies from the moment the receiver is turned on (this unit tunes and holds an SSB signal with the same stability as the \$700 amateur transceiver to which it was compared).

The IF bandpass (selectivity) is automatically determined by the mode selector. When the receiver is set for AM, the selectivity is 6 kHz wide 6 dB down, 14 kHz 40 dB down. When the receiver is set for SSB the selectivity is 3 kHz 6 dB down, 10 kHz 40 dB down.

Because of the high frequency first IF amplifier (about 42 MHz) the image frequency rejection runs better than 50 dB.

Sensitivity on the hf (high frequency) bands of 3 to 30 MHz was 1 $\mu$ V or better for usable reception, the exact value depended on the mode of operation—AM, SSB or CW. Surprisingly, the reception using the telescopic whip compared very favorably with that of a rather expensive receiver connected to an outside antenna. The telescopic whip, however, did not give as good results on the standard broadcast band as is usually attained with radios using ferrite or loopstick antennas—but this is a

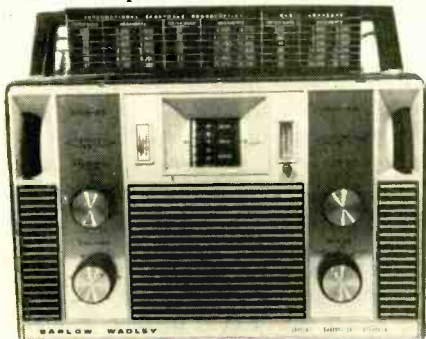

A metal chart holder concealed under the handle flips up to indicate the various shortwave and amateur bands. Four blank frequency/station cards which can be completed by the user and slipped into the chart are supplied with the XCR-30 receiver.

typical characteristic of whips on the BC band. If you want to do BC DX'ing, you'll need an outdoor antenna.

Interestingly, the calibration is precise within 2.5 kHz accuracy anywhere from the broadcast band clear through 31 MHz. If you know the operating frequency of any SW, or even amateur, station, you can tune the XCR-30 di-

rectly to the station—giving a final trimming with the "clarifier" control.

**Easy Service.** The entire receiver circuit is on a single printed circuit board positioned so all adjustments are accessible when the rear cover is dropped—as when loading in batteries. Should there be need for an adjustment,

(Continued on page 103)

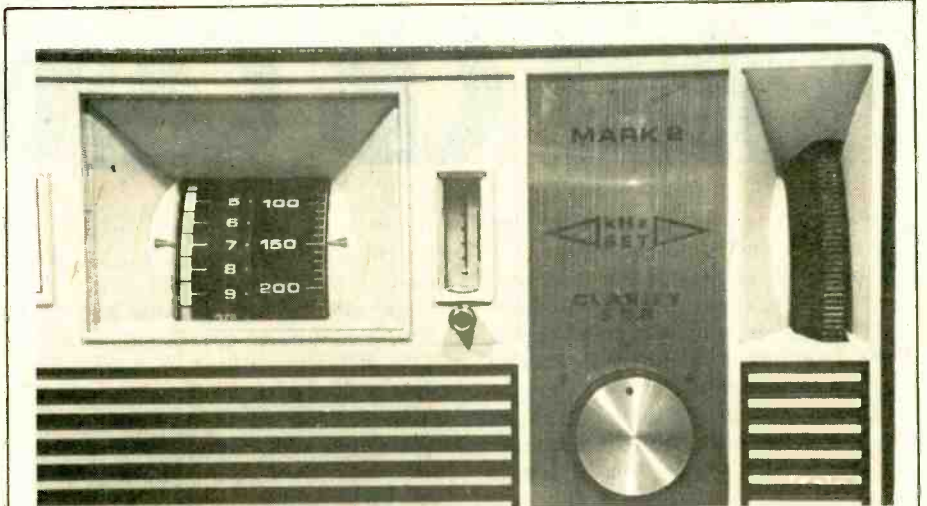

Here's how to tune 7.150 MHz. You set the left MHz dial to 7 and the left kHz dial to 150 and you're tuned right in. Note the broad tuning dial calibration for 7 MHz. There is no in-between tuning on the MHz dial. It would be either 7 MHz or the next higher (8 MHz) or lower (6 MHz) frequency. What you do is "peak" the signal within the indicated MHz dial calibration. The precise frequency readout is set with the kHz dial. The small knob directly under the tuning meter sets the kHz tuning dial calibration to zero beat with the oscillator.

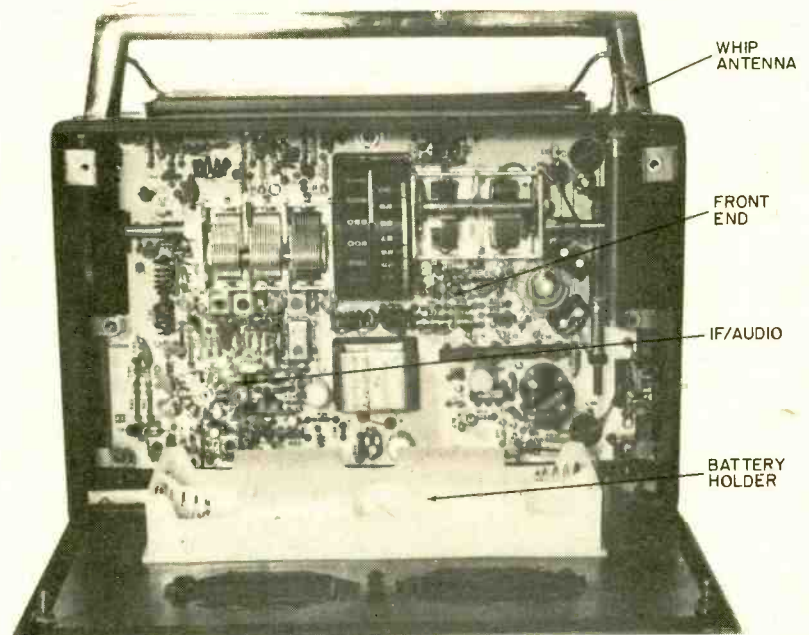

It takes skill to pack this much circuitry on a single PC board easily accessible to the user. This is the whole bit. Everything is on one board. There are no sub-assemblies tucked away in hidden corners or interconnecting wires. The skill necessary to pack everything on this one PC board is evident in the performance.



by Kathi Martin, KGK3916

# Kathi's CB Carousel

**N**OW I KNOW what is meant by hate mail. A few issues back I gave my personal comments on the proposed restructuring of the CB and amateur frequencies with particular regard to the proposed communicator license. Other than a few intelligent and thought out letters, most of the mail and phone calls I received came straight from the same types who would stone a school bus.

Much of the mail was from amateurs indicting every CBER as an illegal, undisciplined lout; and most letters went on for several pages extolling the virtues of radio amateurs. How they do their own policing, how they elevate their technical competence, how they always assist a newcomer, etc., etc., ad nauseam.

Since I always suspect a *goodie two-shoes*, I turned over the mail to Big Herb of the test lab and asked for his reaction to the letters, other than a blanket rejection.

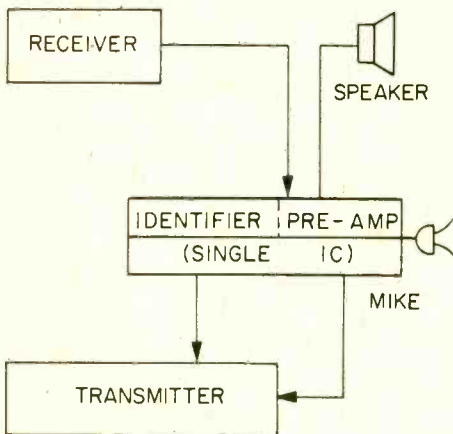

The easiest identifier control would provide an audio preamplifier on the same IC chip, so that disabling the identifier would automatically destroy the receiver/transmitter audio system. But this would still allow a "dead carrier" to be broadcast. The other scheme would permanently silence the transmitter and is the idea getting the most interest at the present time.

But first, here's a little background on Herb. He has more than a quarter-century of active amateur radio operations. He believes no one should be permitted phone operations until they have at least one year on CW and can pass a 20 word per minute code test. Also under no condition should they be considered radio amateurs unless they have built their own equipment or can service what they are using without outside assistance.

After studying my hate mail, Herb's first reaction was, "Most of this stuff is from Technicians who took their license exam by mail with some friend as proctor. As far as I'm concerned, if you don't take the exam under the watchful eyes of an FCC examiner you haven't got a legitimate license. I'd rather work a Novice 12 years old doing 5 wpm on paper or 40 wpm in his head than one of those mail-order techs." Then, Herb promised me a tape of the worst in CB.

A couple of days later Herb showed up with the tape: about thirty minutes of sample comments and discussion of nothing of importance, the type of garbage that clutters the citizen band. When I told Herb that's exactly what we must eliminate from CB he delivered the blow. The tape was of radio amateur 2-meter base stations monopolizing repeaters meant for mobilers. "Is there any difference between the Big Smokey CBER and this group of licensed clowns?", Herb asked me. Personally, I couldn't find any difference. We suffer the same "jerks" on the CB and amateur frequencies.

I know it's difficult for many radio amateurs and others in the communications field to understand that not every CBER is a "Big Smokey." True, if you "read the mail" in the big cities it seems every channel—and a few in between—are populated exclusively by "Big Smokies." But it's just not true. Out my way the CAP (civil air patrol) is using CB, many mobile parks and trailers use CB exclusively for reservations and

emergency messages, and our local rescue squad is using CB until they can afford VHF gear. The list of honest, law abiding users of CB is almost endless. The problem is, the troublemakers make the most noise—as is true anywhere—and good folks looking for someone to blame hear only the troublemakers. And if you need a scapegoat, the best bet is

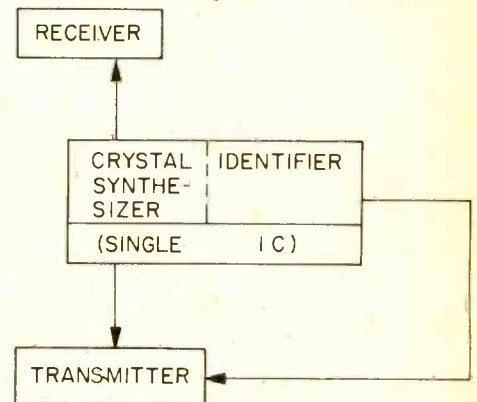

In one proposal the automatic identifier would be part of an integrated circuit that also provided part of the crystal synthesizer function used for receiving and transmitting. Disabling, or attempting to disable the identifier would automatically disable the transmitter, and possibly the receiver. In a similar proposal one of the low level transmitter RF amplifiers is part of the identifier IC, and again, disabling the identifier would disable the transmitter.

CB. The radio amateur ranks have been steadily declining, in particular since the absolute stupidity of the so-called *incentive licensing*. Rather than admit the blunder, the FCC, and the ARRL in particular, have spent years blaming the problem on CB. Who will they blame when there is no more CB?

**Automatic ZAP.** Meanwhile, back at the ranch the FCC is working overtime testing ways to eliminate the Big Smokies and unlicensed CBERs, and it looks like an automatic identifier is the way it will be done. Already, several manufacturers are testing and evaluating inte-

(Continued on page 96)

Make better recordings...

# Build a true peak reading meter



by Herb Friedman

**M**OVIE sound studios, recording studios, dubbing centers and even some of the highest quality "home" tape recorders monitor instantaneous signal peaks to insure optimum high fidelity tape recordings, yet the average tape recorder sold to the stereophile makes no provisions for signal peaks; it lets them drive right into tape saturation with its attendant, distorted "fuzzy" sound quality.

Unless your recorder is a Tandberg, Harman/Kardon, some JVC models, or one with plenty of meter "headroom" such as some models of TEAC, Dokorder and the Revox, you just can't record true hi-fi if you "follow the book." Worse yet, if your recorder has a recording level meter with true VU characteristics (ballistics) you're worse off than if you had a cheap semi-peak meter such as used on the cheapest, low quality cassette recorders.

The problem goes back to the 1930s when broadcast and recording studio meters were semi-peak or almost full-peak indicating. The studio engineers knew exactly what level was feeding the transmitter or disc recorder, but they were also going blind following a meter pointer shaking like a belly dancer at the North Pole. After considerable research, an industry group came up with specifications for the modern VU meter. Basically, the group said that a meter could indicate *average* program level if allowance was made for an actual peak program level some 10 dB higher than that indicated by the meter. In actual fact, such as when recording piano, program peaks can be 20 dB above the VU meter reading, but the average ear hears no distortion if about 10 dB of peak signal is literally chopped off, the average listener will hear no distortion with the signal. So the VU meter became the standard studio console meter as its "sluggish" meter pointer was much easier to follow; since the

engineer knew he had 10 dB headroom in his equipment (a console with a VU meter indicating 0-VU as the normal output level was designed to pass at least +10 dB program peaks) he could "crowd" the program up near 0-VU, or 100 percent modulation—he was still getting maximum transmitter modulation or recording level.

**Background.** But then came tape recording. In order to suppress background hiss, the program level had to be made as high as possible. Depending on the manufacturer, early recorders cut headroom down to 8 dB or even 6 dB, compromising the convenience of tape for a slightly higher peak signal distortion; the signal peaks were in fact set to deliberately drive into tape saturation. As the electronics and tape were improved, the headroom was designed back in; for example, Revox machines provide 8 dB to 12 dB headroom depending on the type of recording tape used. On the other hand, professional studios now use peak indicating meters that "hold" the reading so the engineer can set the maximum level precisely at the point where tape saturation or equipment

overload commences. On the highest quality piano recordings you are likely to find the VU program level is a full 20 dB below peak level (for the studio does not use limiting at all).

Most consumer tape recorders, particularly cassette, use 0-VC record level at tape saturation with all the program peaks driving into distortion. The rationale is that listeners would rather hear less hiss than less distortion. The few superb cassette decks all use peak metering—Tandberg, some JVC, Harman/Kardon, Nakamichie, etc. (Tandberg even uses peak metering on their reel-to-reel recorders, though proper allowance for headroom, as used by Revox for many years, can handle reel-to-reel recorders.) These machines produce outstanding recordings because the signal peaks to which the ear is still sensitive are not driven into tape distortion.

Truth of the matter is that peak metering has become so important in this era of high fidelity sound reproduction that the new Heathkit power amplifier kit has an optional peak power meter. Many users have been surprised

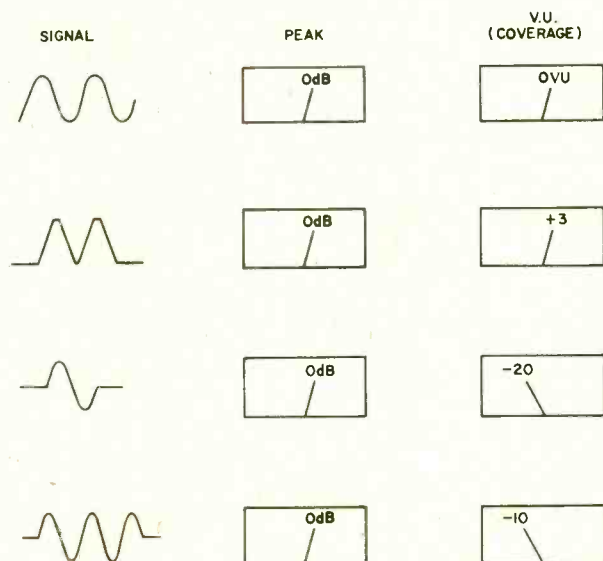
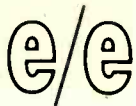

Fig. 1. While a peak meter always indicates the actual peak signal level, an average power meter, such as the VU meter, gives a false indication depending on the waveform. A true VU meter will "read" 10 dB less than true peak when the signal is program material (speech, music).



## PEAK AUDIO METERS

to discover that the measured 10 watts average signal being fed to their speakers actually had program peaks in excess of 100 watts (10+ dB, that old magical "headroom").

Any "hi-fi" recorder without peak record level metering or known headroom can turn out a superior recording by simply adding your own peak meters; the problem is, you will have to build it yourself. But since the basic electronics and meter is available in a single package that looks like an ordinary meter, the complete project is a snap—one or two evenings. And, it will plug into most recorders.

**Inside Story.** The heart of our stereo peak reading meter is a Toyo Model 67 Peak Level Meter, which also provides a logarithmic scale from -40 dB to +5 dB in a single range (without switching). All the necessary electronics including a log converter is inside the meter case, and the calibration is factory set so a 1 volt input produces a 0 dB reading. In addition to the input terminals there are connections for the 24 volt power supply (must be regulated at 24 volts) and 6 volt pilot lamps. Each Toyo meter has current requirements of 20 mA at 24 VDC and about 250 mA at 6.3V.

Since the meter has an input impedance of about 100,000 ohms, it *could* be connected directly to tape recorders or preamplifiers; unfortunately, little hi-fi equipment has as high as 1 volt normal program level. Alternately, if the meter were connected across a speaker circuit, the applied voltage would be higher than the specified maximum of 3 volts. What is needed is both an amplifier and an attenuator. Both can be easily accomplished with an ordinary potentiometer (volume control) and an FET (field effect transistor) amplifier. In the project shown, a stereo peak meter is easily assembled using one printed circuit board containing two amplifiers (one for each channel) and a regulated power supply.

**Keep It Hi-Fi.** The complete project shown has a frequency response almost ruler-flat from 20 to 20,000 Hz. The input impedance is well above 100,000 ohms (determined by the potentiometers used) so it can connect to standard hi-fi equipment. It will provide a 0 dB reading from signal voltage at least as low as 0.1 volt—a typical preamplifier or tape recorder output level. (Note, the FET preamplifier is specifically designed for this project to safely drive the meters. It should not be "lifted" for use in

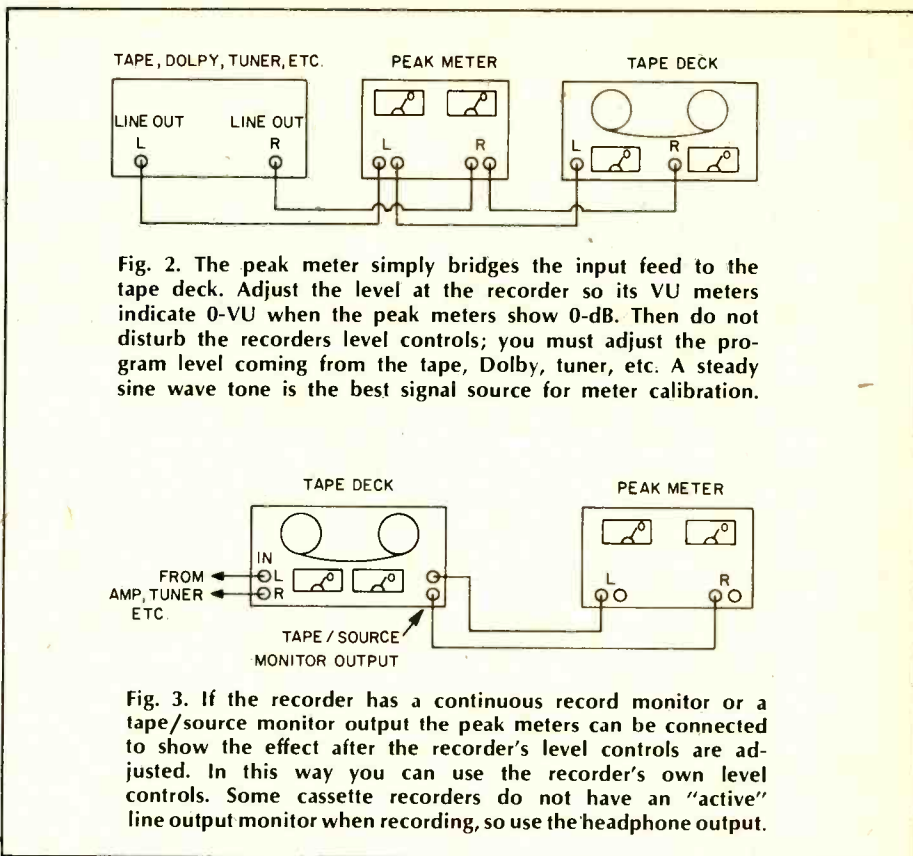

Fig. 2. The peak meter simply bridges the input feed to the tape deck. Adjust the level at the recorder so its VU meters indicate 0-VU when the peak meters show 0-dB. Then do not disturb the recorder's level controls; you must adjust the program level coming from the tape, Dolby, tuner, etc. A steady sine wave tone is the best signal source for meter calibration.

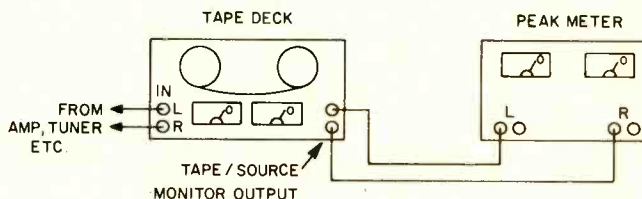

Fig. 3. If the recorder has a continuous record monitor or a tape/source monitor output the peak meters can be connected to show the effect after the recorder's level controls are adjusted. In this way you can use the recorder's own level controls. Some cassette recorders do not have an "active" line output monitor when recording, so use the headphone output.

another project as the distortion might prove excessive.)

Figure 1 shows what you can expect. The meter on the left is always peak reading; the meter on the right indicates average program level and is the type of meter generally supplied on consumer equipment. Note that with sine waveform, as in Fig. 1A, both meters show the same reading. In 1B the signal is a square wave—perhaps from a music synthesizer; note how the VU meter gives a false, high reading. In Fig. 1C the waveform represents a "transient;" note how the VU meter gives a false low reading with an error greater than 20 dB. In Fig. 1D we have a tone burst; here the VU meter shows a false indication of -10 dB. If these signals were fed into a tape recorder with a VU meter calibrated so 0-VU represented tape saturation (the most common calibration), and if the recorder's level controls were adjusted for a 0-VU record level, the 1A signal would be recorded correctly, 1B would be under-recorded by about 3 dB (decreasing the signal-to-noise ratio by 3 dB), 1C would be over-recorded 20+ dB, producing horrendous distortion, and 1D would similarly be over-recorded by 10 dB—slightly less horrendous.

One thing you should also realize from the Fig. 1 illustration is that a peak meter reading does not necessarily follow the reading of an *average* pro-

gram level. When you are using the peak reading meter you must totally ignore any other meter reading; if you try to get some relationship between the two readings the recordings will be awful. Your best results will be attained using peak meter readings; second best using VU meter readings; and nothing of value if you "ride gain" to bring up the VU reading to *match* peak readings. You can use one or the other—not both. This point must be stressed and fully understood.

**Construction.** While any type of cabinet can be used, the Radio Shack 270-261 Woodgrain Experimenter's Cabinet not only fits perfectly but also look right. Once matched to your own recorder, there is no need to re-calibrate, so the calibration controls (R1 and R2) can be installed on the rear apron, as shown, where they cannot be disturbed.

The Toyo meters are supplied with perfect cut-out templates; just lay them on the front panel to mark the meter-mounting holes. To locate the center of the meter body for the main cutout, draw a line from each corner mounting hole to the one diagonally opposite. The intersection of the lines is the precise center of the meter body cutout. Use a 2¼-in. meter punch or circle-saw to cut the hole for the meter body.

Power switch S1 can be anything—whatever is least expensive. If you posi-



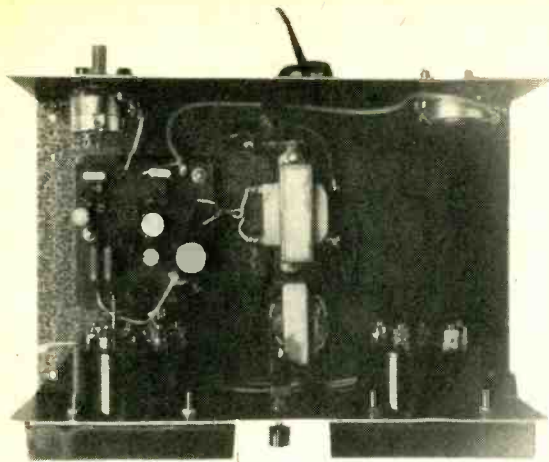

There's plenty of room in the cabinet so don't jam things together. Note that the power transformers are positioned between the meters and away from the input jacks and the calibrate controls which are located on the rear apron.

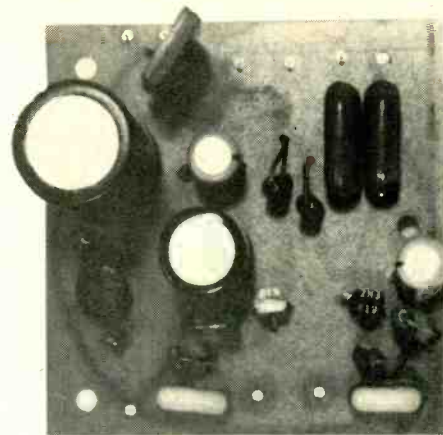

Except for the power transformers the entire preamplifier and regulated power supply is on a 2½ in. x 2½ in PC board.

tion S1 between the meters as was done in the unit shown, make certain transformers T1 and T2 will clear the switch when they are installed. To avoid assembly problems, it is best to install all the chassis components on a temporary basis. It will then be easy to position the PC board and power transformers without the possibility of them interfering with the panel components.

The printed circuit board contains the meter preamplifiers and the 24-volt regulated power supply. Cut a section of ordinary copper clad board to 2½ x 2½-in. Scrub the copper clean with steel wool or a strong household cleanser such as Comet, dry the board and position it under the supplied PC template with the copper side facing up. Tape the board in position under the template.

**Continue On.** Using a center punch, ice pick or other pointed tool, indent the copper at each component and lead hole by forcing the tool through the template and into the copper. Don't hit the tool with a hammer as that will fracture the board; hand pressure is enough. (Just indent the copper foil.) Remove the board from the template.

Using resist dots or a resist pen, place a dot around each indent. Then, using 1/16-in. resist tape or a resist pen, freehand connect the dots following the template. Nothing other than the dot positions is critical so freehand "art-work" is satisfactory. Just make certain none of the "connections" touch where they shouldn't.

Fill a tray with at least ¼-in. of etchant and float the PC board *copper side down* on top of the etchant. Agitate the tray for a few seconds to make certain the etchant flows across the copper without air pockets forming and then just walk away for about 45 minutes. When you return all the undesired copper will have been etched away. Remove the resist dots and tape, or scrub away the resist with steel wool and rinse the board thoroughly under running water.

Drill out all detents with a #55 to #60 bit. Then drill out the three mounting holes for a #4 or #6 screw—which-

ever you want to use. To make final assembly easier, we suggest you install "flea clips" or miniature terminals in all holes that will go to an external connection, such as the input and output wires. The external connections on the board are: inputs (2), outputs (2), +24 VDC for meter (2 though only one need be used), input ground (1), meter/output ground (2 though only one need be used), and 24 VAC input to the rectifier.

**Exact Placement.** The PC copper foil connections for diode bridge rectifier BR1 are for the diagonal diamond terminal arrangement where the + DC output is diagonally opposite the - DC output. Do not substitute one of the newer style DIP bridge rectifiers where the DC output terminals are adjacent on the same side. The bridge used in the model shown came from Radio Shack, where as far as we presently know only

the diamond connection bridges are sold. Make certain you install BR1 correctly as only the "+" terminal is marked. Then doublecheck that filter capacitors C7 and C8 are installed with the correct polarity.

The 24 volt IC regulator is installed diagonally—the center terminal is *ground*. The flat side with the hole for the heat sink mounting screw faces the nearest adjacent corner of the PC board. The flat side with the recessed screw hole faces the center of the PC board. The IC leads are supplied in-line. Use long nose pliers to carefully form the IC leads into a triangle pattern so the IC can drop right into its mounting holes. It's not necessarily needed, but

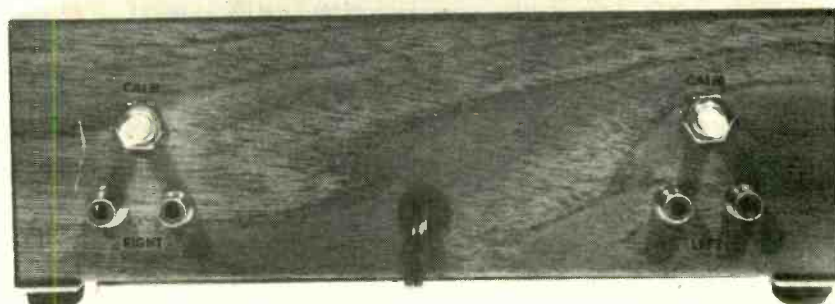
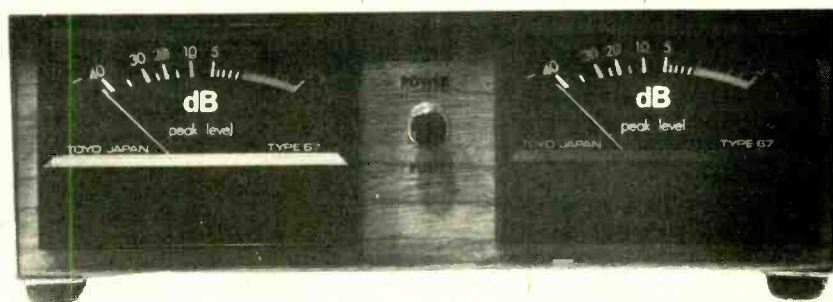

Since the calibrate controls should not normally be disturbed once the peaker meter has been adjusted to your particular recorder, they are best mounted on the rear where their settings cannot be accidentally disturbed. Parallel jacks for the left and right channels allow the peak meter to be bridged across any high level line—the jacks provide a through-connection.

# e/e PEAK AUDIO METERS

we suggest a small heat sink be secured to IC1, or else drill a few ventilation holes in the cabinet directly above the IC.

Take extra care when installing Q1 and Q2. Position the PC board so you are looking at the top with IC1 in the lower right corner (BR1 and C7 are on the right). Note there are three holes in a triangular pattern for Q1 and Q2. If Q1 and Q2 are marked 2N3819 and have a flat side, install the left hand transistor so the flat side faces the bottom edge of the board, the one nearest you. Install the right hand transistor so the flat side faces the top edge of the board, the one farthest from you. Use long nose pliers to form the transistor leads into the correct triangular pattern. If the transistors you get are a general replacement type, or do not have the flat-side case, double and then triple check the lead connections before installing the transistors. The 2N3819s used in this project came from Radio Shack, but there's no guaranty they will have exactly the same shape and lead configuration when you get them. Check the lead arrangement very carefully.

**Use Audio Taper.** Any type of control can be used for the calibration potentiometers as long as it has an audio taper. Use whatever is least expensive. In the model shown, one potentiometer has an unused switch because it cost less than one without the switch. The power transformer T1 secondary is 24 volts and rated at least 300 mA. Do not substitute a 25.5 volt transformer. Power transformer T2 is 6.3 volts rated at least 500 mA (0.5A). Install the transformers away from the meters and the input jacks as shown.

The PC board is installed on ¼-in. spacers (or a stack of washers) to insure the foils do not short circuit to the chassis.

The connection from the right input jacks and calibrate control to the PC board passes under the power cord so it must be shielded cable. Connect the shield to the grounded potentiometer terminal and the opposite end to the input ground of the PC board. The connection from the left calibrate control is a short length of bare or insulated wire.

Connect all the meter "-" terminals together and run one wire from a "-" terminal to the PC board output ground (near IC1). Connect one +24 V meter terminal to the other meter terminal and run one wire to the PC board's +24 V connection—or you can make separate  
(Continued on page 98)

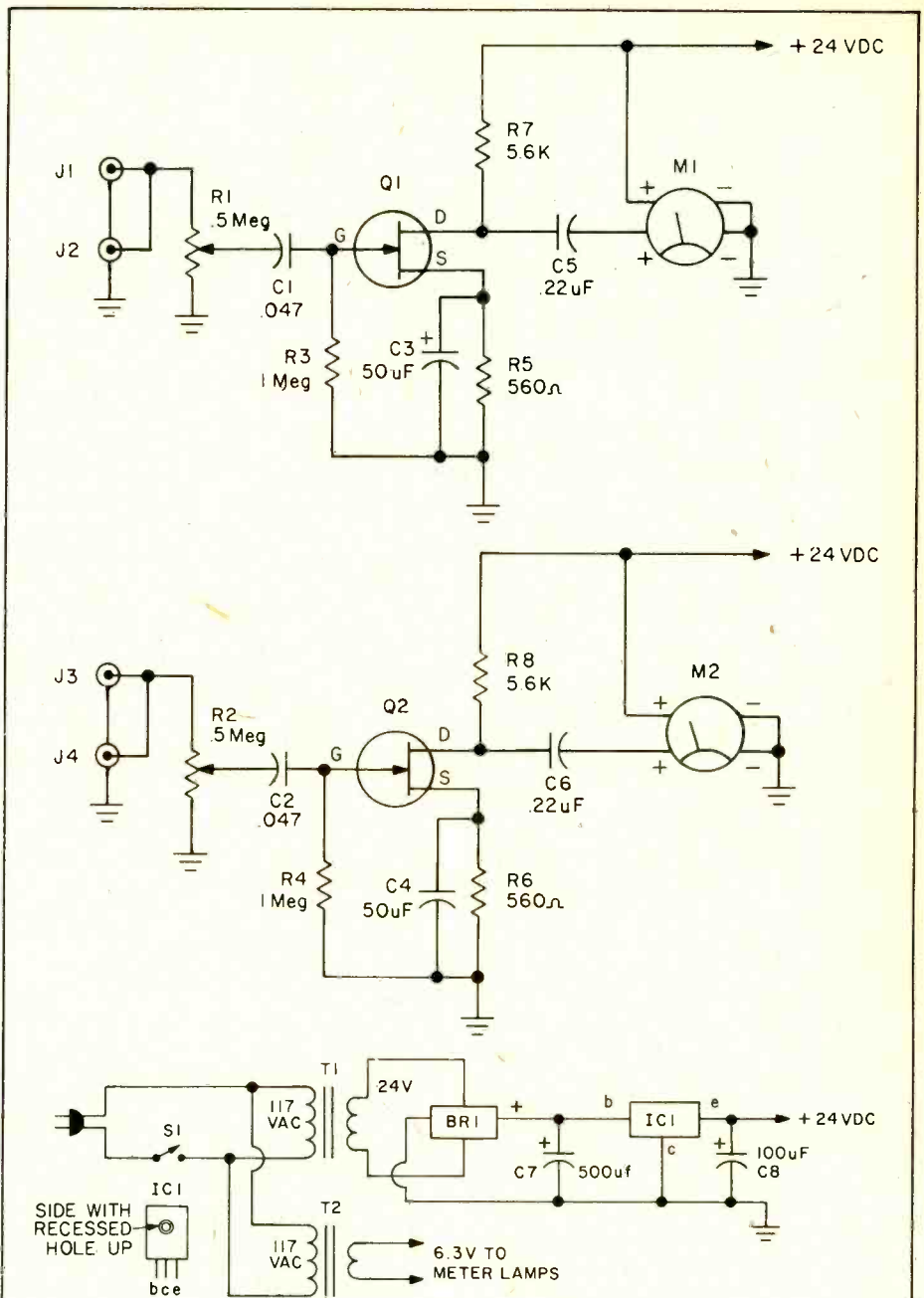

## PARTS LIST FOR PEAK AUDIO METER

- |  |  |
|--|--|
| BR1—2-amp, 100 PIV bridge rectifier (Radio Shack 276-1152 or equiv.)         | R3, R4—1-megohm, ½-watt, (Radio Shack 271-000 or equiv.)   |
| C1, C2—0.047 uF capacitor, 100 VDC (Radio Shack 272-1068 or equiv.)          | R5, R6—560-ohm, ½-watt, (Radio Shack 271-000 or equiv.)  |
| C3, C4—47 uF electrolytic capacitor, 6 VDC (Radio Shack 272-954 or equiv.)   | R7, R8—560-ohm, ½-watt, (Radio Shack 271-000 or equiv.)  |
| C5, C6—0.2 uF capacitor, 50 VDC or higher (Radio Shack 272-1070 or equiv.)   | S1—spst pushbutton (push on, push off) (Radio Shack 275-609 or equiv.)   |
| C7—500 uF electrolytic capacitor, 35 VDC (Radio Shack 272-1030 or equiv.)    | T1—24 volt, 300-mA transformer (Radio Shack 273-1386 or equiv.)  |
| C8—100 uF electrolytic capacitor, 35 VDC (Radio Shack 272-1028 or equiv.)    | T2—6.3 volt transformer, ½-amp or better (Radio Shack 273-050 or equiv.)   |
| IC1—24-volt regulator, Motorola MC7824 or equiv.                             |  |
| M1, M2—Peak meters, Toyo type 67.  |  |
| Q1, Q2—2N3819 (Radio Shack 276-2035 or equiv.)                               | Misc.—Cabinet approx. 9 x 5½ x 3-in., RCA-type phono plugs for J1 to J4, perf board or printed circuit board etching materials, power cord with plug, wire, hardware, solder, etc. |
| R1, R2—500,000-ohm audio tape potentiometer (Radio Shack 271-1723 or equiv.) |  |

# AN OLD FLASH FROM A NEW IC

by Jackson Kaye

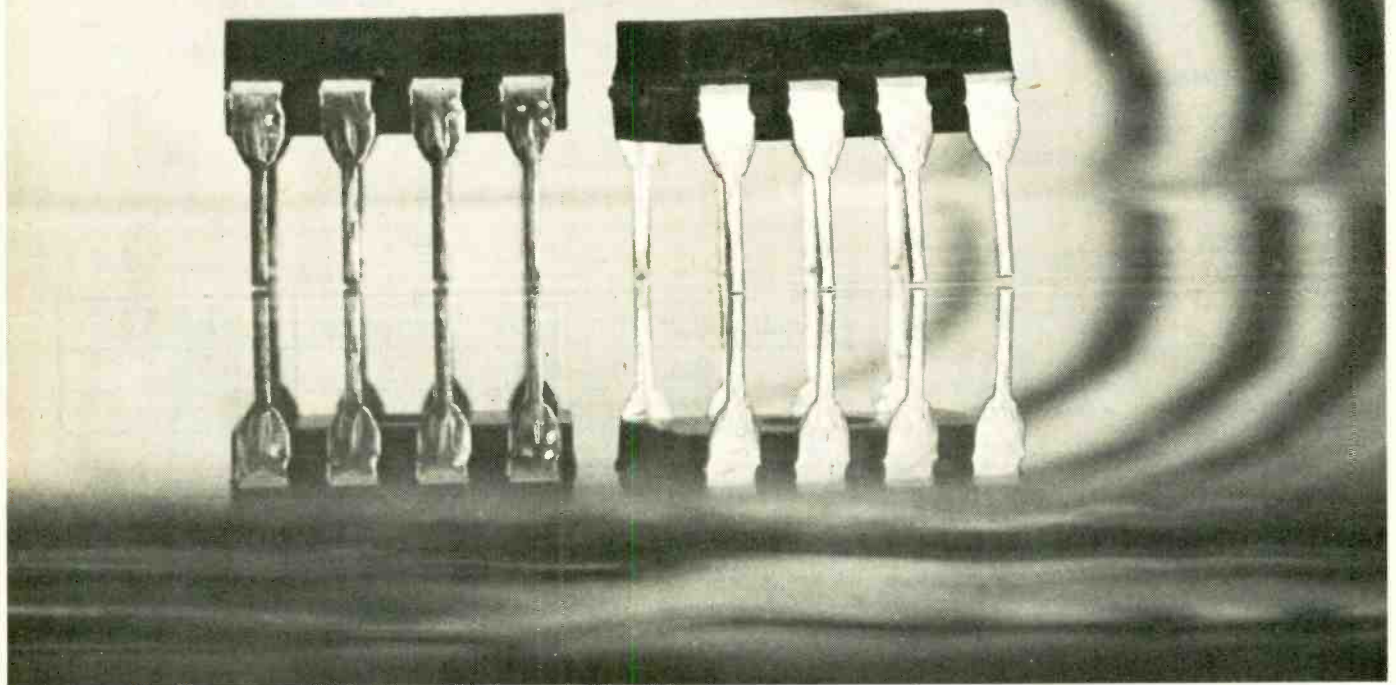

**H**OW WOULD YOU LIKE a circuit that flashes a light-emitting diode (LED) for over a year on one single "C" size flashlight?

Your answer may be, "Wonderful, but what can I use it for?" That answer is found in the IC which happens to be a National Semiconductor LM3909. This unique pulse-generating integrated circuit can actually be used to drive

LEDs from a 1-volt source, even though 1.6 volts is normally needed to turn the LED on. This chip should find wide usage in indicators, test gear, alarms, and timing applications.

The high performance IC (LM3909) can deliver 200 milliamp pulses, or oscillate at over 200 kHz. Thus, applications as an SCR trigger, square-wave generator, and milliwatt DC-to-DC converter are practical. For instance, the ability to drive an 8-ohm speaker directly allows design of extremely simple and low cost audible alarms and audio continuity testers, also operating on 1.5 volts DC.

The IC can operate over a temperature range of  $-25^{\circ}\text{C}$  to  $70^{\circ}\text{C}$  and is supplied in an 8-lead plastic Mini-DIP package experimenters will have no trouble working with. But before we get involved with industrial circuits, let's have fun with an ultra-simple LED flasher.

**Build It.** In LED flasher applications the average power drain from the battery is only 700 microwatts—practically no battery drain at all. Such long-lived flashers can aid in finding flashlights, emergency equipment, mooring floats, power switches, valves and locks in total darkness. Construction of an LED flasher is simple. It is not necessary to mount parts on a printed circuit board as the author did; perf board and flea

clips will do fine. Use an IC socket for the LM3909 to avoid accidental damage and make the same IC available for other projects and experiments. Follow the schematic diagram (Fig. 1) then solder in the 1.5-volt dry cell last after carefully inspecting all connections. Hook-up time should be under one-half hour for a circuit consisting of only four parts. The LED will flash once each second. The table in Fig. 1 gives life expectancy for carbon-zinc (standard) and alkaline dry cells.

The dry cell connected in the circuit of Fig. 1 will deliver approximately

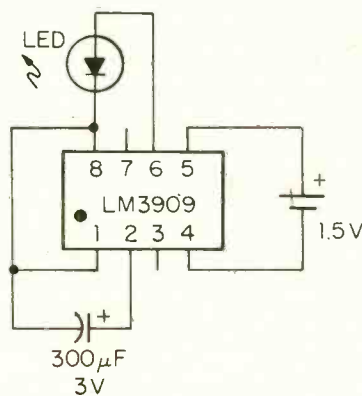

CELL SIZE	STANDARD CELL	ALKALINE CELL
AA	3 MONTHS	6 MONTHS
C	7 MONTHS	15 MONTHS
D	1.3 YEARS	2.6 YEARS

Fig. 1. Simple LED flasher that produces about a one flash per second repetition rate.

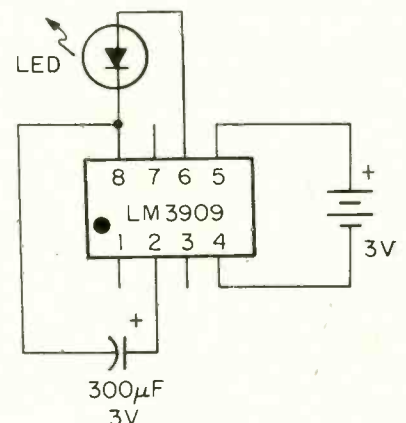

Fig. 2. A 3-volt flasher with a nominal flash rate of one flash per second. Battery drain is about 0.77 milliamperes.

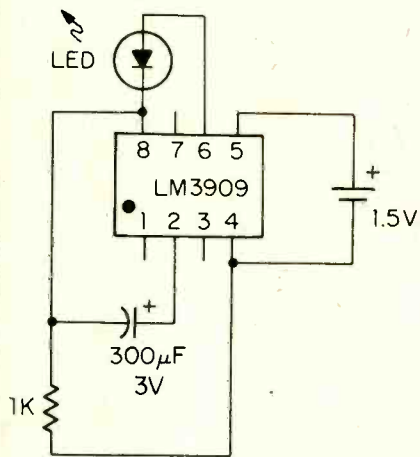

Fig. 3. This fast blinker produces 2.5 flashes per second with an average dry cell drain of 1.2 milliamperes.

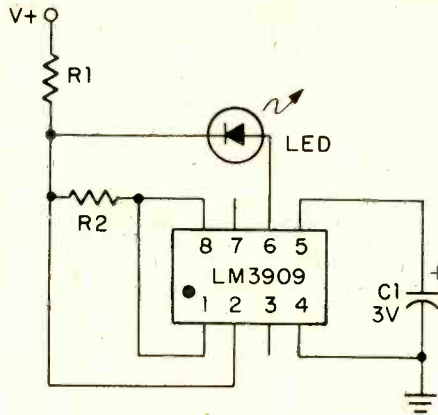

Fig. 4. Power-on flasher indicates that power is available on a DC bus. Resistor R1 is the series voltage dropping resistor for the circuit and must be one watt.

V+ (VDC)	C1 (µF)	R1 (OHMS)	R2 (OHMS)	V+ RANGE (VDC)
6	400	1000	1500	5-25
15	180	3900	1000	13-50
100	180	43000	1000	85-200

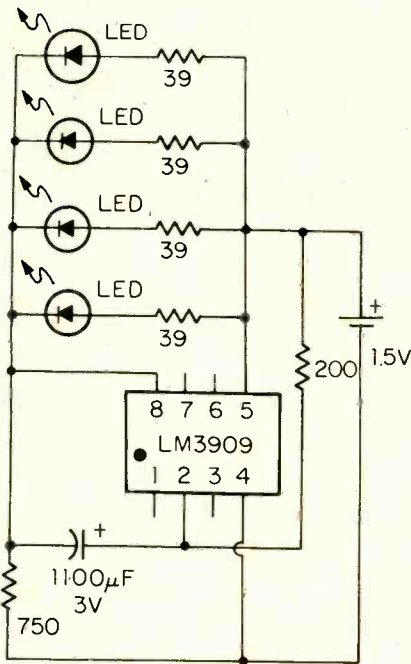

Fig. 5. Four parallel LEDs driven by one IC. Nominal flash rate is 1.3 flashes per second average, with a dry cell drain of only 2 mA.

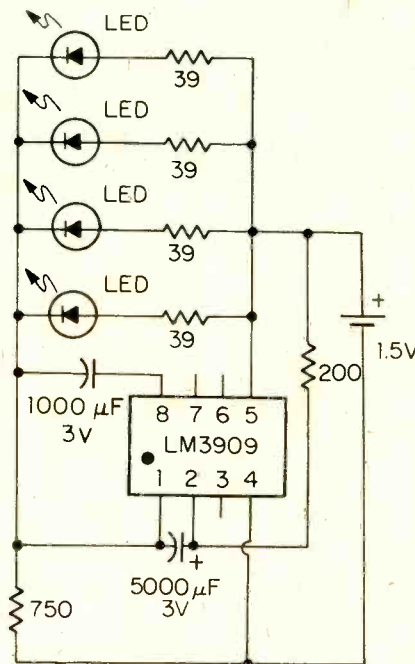

Fig. 6. This circuit is almost identical to Fig. 5. Slight circuit change produces 1.5 flashes per second with a lower dry cell current drain of 1.5 milliamperes.

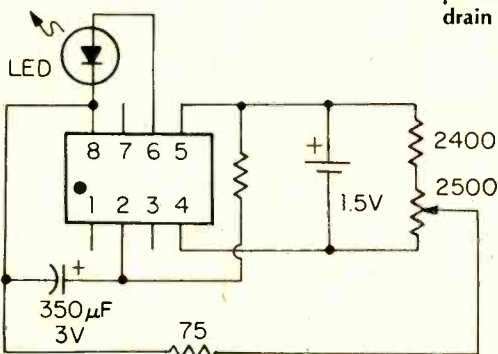

Fig. 7. This variable flasher adjusts the flashing rate from zero to 20 flashes per second. Dry cell drain increases with flashing rate.

0.65 milliamperes at 1.5 volts when new and eventually drop to 0.3 milliamperes at 1.15 volts which is about when the circuit will fail to operate. Since a long in-circuit life of the battery is expected in this and other circuits presented in this article, clad or "leakproof" batteries are recommended for any application where the circuit is left unattended for several months or more. Nickel cadmium cells are not recommended.

**Other Ideas.** The LED flasher just detailed in this article is only one of several gadgets you can make using the LM3909 integrated circuit. For example, 3 volts DC is commonly found in flashlights, so it follows that a 3-volt flasher circuit (Fig. 2) can be packed in a flashlight container. The blinking LED indicates where the flashlight is and that the batteries are putting out at least 2.2 volts (minimum flash level). The flash rate of this circuit is 1.1 flashes per second.

A faster blink rate is possible from a 1.5 VDC source, about 2.5 flashes per second, with the addition of a resistor and some slight circuit modification (Fig. 3).

You can use the basic LED flasher circuit idea to hook up a high-voltage indicator as shown in Fig. 4. The circuit is connected across the line to ground and blinks when the voltage is present. The table given with Fig. 4 indicates three DC line voltages that can be monitored: 6, 12, and 100 VDC. The voltage range column in the table lists the minimum voltage for firing the circuit and the maximum safe voltage

permissible. Install the parts values indicated and the circuit will flash the LED approximately twice each second.

The LM3909 IC can flash more than one LED. Fig. 5 shows four LEDs in parallel driven by one IC and 1.5 VDC. To increase shelf life of this flasher use a "D" size dry cell. The blink rate of this circuit is approximately 1.3 flashes per second with an average battery drain of 2 milliamperes. If battery life is important, then use the alternate circuit shown in Fig. 6. The battery current drain is reduced 25 percent from 2 to 1.5 milliamperes. No matter how you cut it, the current drain of either circuit is very low.

Maybe what you want is a variable flasher. Here, in Fig. 7, the flash frequency per second of the LED is variable from zero to 20. Increasing the number of flashes per second increases battery drain because the LED is the major user of the circuit's power. An increase of 1 to 20 flashes per second increases the battery drain 20 times.

The LM3909 can be used for more than flashing a LED. A typical application is for generating 1-kHz square waves. The diagram in Fig. 8 is simple to hook up. The 18,000-ohm potentiometer is not a frequency control; it adjusts the symmetry of each half of the square wave. The 1-kHz output passed through a suitable blocking capacitor may be used to troubleshoot troublesome audio and RF circuitry.

The circuit in Fig. 9 shows a simple "buzz box" continuity and coil checker. The loudspeaker can be one of those salvaged from an old transistor radio. Low impedance loudspeakers are not efficient in this circuit.

The last circuit offered is an incandescent bulb flasher. The LM3909 in Fig. 10 flashes a #47 lamp at the rate of 1.5 flashes per second. Placing the #47 lamp in a suitable flashlight reflector will beam the bulk of the flash energy down a road to alert pedestrians and oncoming cars of a potential hazard.

All the capacitors shown in the schematic diagrams are electrolytic types. The flash rates and frequencies assume that the capacitors are within  $\pm 5\%$  tolerance. However, most electrolytic capacitors are rated  $-20\%$ ,  $+100\%$  of their stated values and flash rates will vary somewhat. If the circuit you wired up does not flash the LED, suspect the LED. LEDs that cause such problems exhibit a large increase in conduction between 0.9 and 1.2 VDC. This LED is not defective because it will work in other circuits, but not with the LM3909. The LED used by the author is a National NSL5027. ■

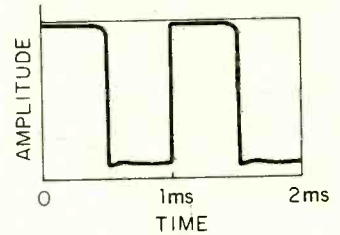
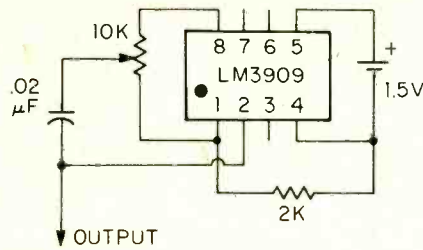

Fig. 8. The LM3909 can be used in a 1-kHz oscillator circuit. The 10K potentiometer is for adjusting symmetry in the output signal.

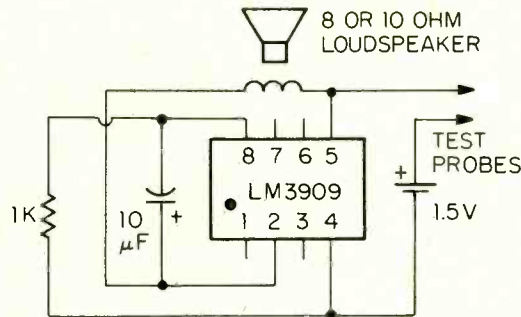

Fig. 9. The LM3909 can be used to generate a buzzing signal when the dry cell circuit is closed. The difference between shorts, coil windings, and a few ohms of resistance can be heard. You could train your ears to measure low resistance by sound output.

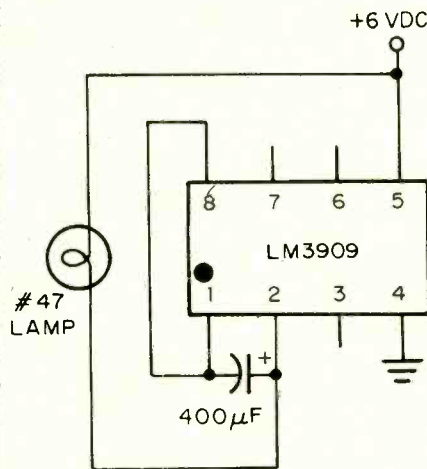

Fig. 10. The flash-rate is about 1 1/2 Hz. Plenty of light will be concentrated in a beam if you build this one in an old flashlight case with a shiny reflector.

#### PARTIAL PARTS LISTING FOR NEW FLASH

Note—See individual schematics for parts values. This is an experimenter's project. If you don't have the ideal values listed in these working circuits, experiment! Innovate, substitute, have fun! Here are Radio Shack numbers for some basic items used in "New Flash."

- 1/2-watt resistors (Radio Shack series 271-000)
- 8-ohm speaker (Radio Shack 40-262)
- 10,000-ohm potentiometer (Radio Shack 271-1721)
- 0.02-uF capacitor (Radio Shack 272-1066)
- 10-uF electrolytic capacitor (Radio Shack 272-1002)
- #47 lamp (Radio Shack 272-1110)



The author assembled the LED flasher diagrammed in Fig. 1. Circuitry is so simple there is no need for you to fashion a printed circuit board. Point-to-point wiring on a perf board with flea clips is good enough for this simple circuit.

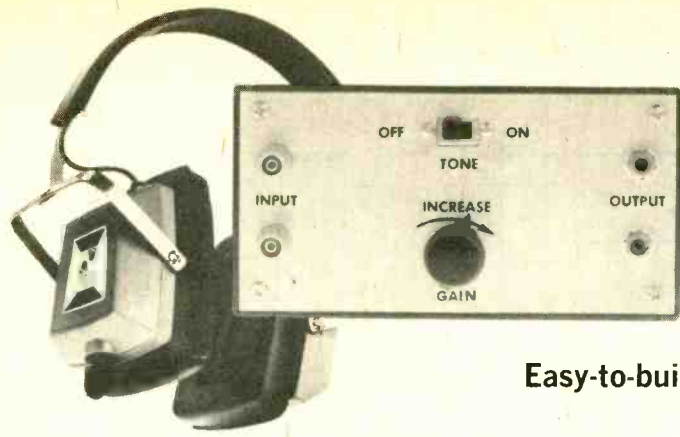

# DX IN COMFORT

by James Randall

Easy-to-build headphone adaptor lets you use comfortable cans instead of an ear plug.

**W**HETHER YOU ARE an SWL, a DXer, or just a guy who wants to listen to his radio, tape recorder, or portable TV in peace and quiet, you'll find this simple headphone adaptor a big help in improving modest-cost ear-phone performance.

Most transistorized radios, TVs, and tape recorders come equipped with an 8- to 10-ohm earphone output, but the single earphone they provide is usually of such poor quality that the sound is distorted, and you have to crank the audio level way up just to hear it. Actually you don't need an expensive pair of headphones to enjoy good listening, a pair of phones costing between \$3.00 and \$10.00 will do the job. One good choice would be the Superex Sensiphones.

Principally, the headphone adaptor performs the function of converting 8- to 10-ohm output to an impedance suitable for conventional higher-impedance headphones, but the adaptor has other features as well; it can serve as a remote audio control. If, for example, you want to listen to your TV while lying in bed with the adaptor on your bedside table you can do so with complete level control. In addition, a tone switch is provided to eliminate some of the high frequency noises.

**Circuit Design Notes.** The simplicity of the design is shown in the circuit diagram. Input transformer T1 is selected to provide a good impedance match for whatever earphones the builder either has on hand or intends to buy. The table is a guide showing various combinations

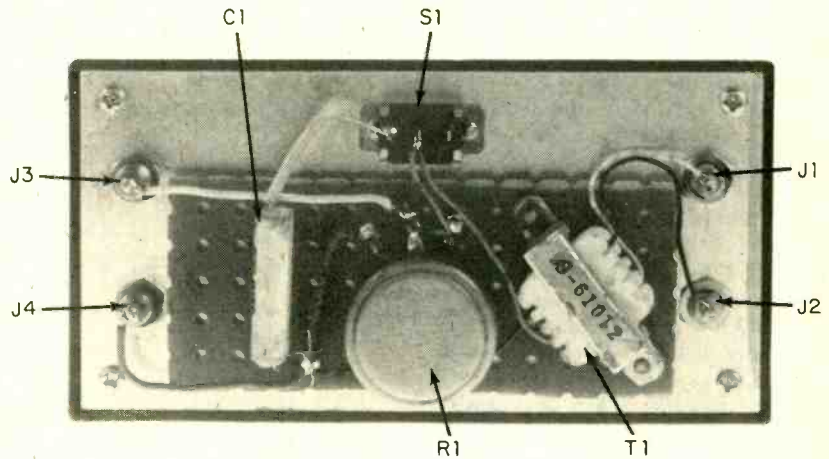

Where everything goes. Follow this interior parts placement photo.

of headphones and transformers. The use of the 2000-ohm input transformer provides a voltage gain.

From the secondary of the input transformer the signal goes to switch S1 which puts a .25- $\mu$ F capacitor across the transformer to cut the highs. The signal is then fed to gain control R1 which can be a linear type if an audio taper is not available.

The headphone adaptor can fit in a small minibox. Construction of the unit is very simple and can probably be accomplished in one evening. The type of connectors which the builder uses for J1, J2, J3, and J4 is a matter of convenience. The writer used 5-way binding posts for the input connectors and pin

jacks for the output, but the builder may want to use a phone plug for the output if the Superex sensiphones, for example, are used.

**To Use the Adaptor.** The first thing to be done when putting the adaptor to work is to make an input lead which plugs into your radio, TV, or tape recorder. Select a plug that fits the unit you are going to use with the adaptor and cut a lead long enough to satisfy your particular requirement. After you plug the adaptor into your radio, for example, connect the headphones to the output terminals J3 and J4 and you are all set. Flip the tone switch to on and you can cut the highs appreciably. ■

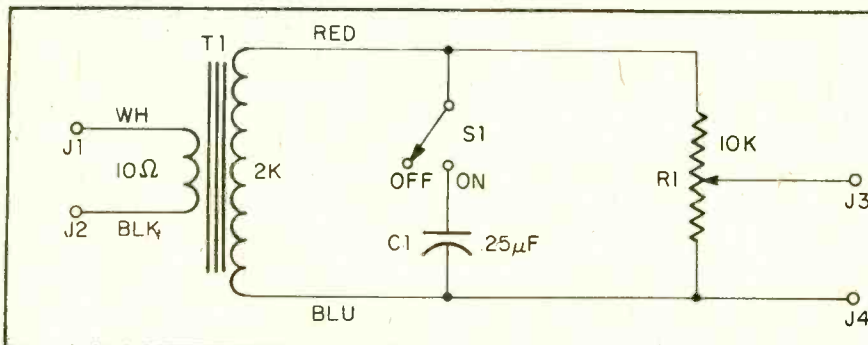

- PARTS LIST FOR HEADPHONE ADAPTOR**
- C1—0.25- $\mu$ F capacitor, 10 VDC or better (Radio Shack 272-1058 or equiv.)
  - J1, J2—5-way binding post (Radio Shack 274-662 or equiv.)
  - J3, J4—Pin jacks or phone plugs, your choice
  - R1—10,000-ohm potentiometer, audio taper (Radio Shack 271-1721 or equiv.)
  - S1—Miniature spst slide switch (Radio Shack 275-401 or equiv.)
  - T1—Transformer, 2000-ohms to 10-ohms (Lafayette 99-61012 or equiv.)
  - Misc.—Case 5-in. x 3-in. x 2 in. (Radio Shack 270-333 or equiv.), wire, solder, etc.

# Phase and Frequency Measurements

**T**HE INCREASING SOPHISTICATION of the home experimenter has resulted in his being required to make ever more demanding measurements. High on the list is the need to measure frequencies and phase shifts generated by experimental circuits. Short of buying one of the many frequency counters available, such measurements can be a problem. But they need not be a problem, because even the most modest experimenter probably has all of the equipment on his bench that is required to measure frequency quickly and accurately. All you need is an inexpensive oscilloscope and a frequency source such as an audio oscillator or a signal generator.

The simple equipment interconnec-

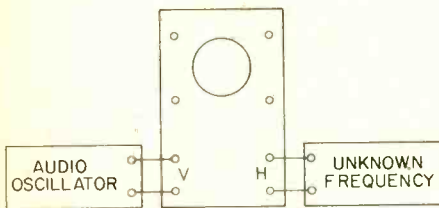

The frequency or phase measurement set up. Frequency less than 1 Hz is usually described in terms of phase angle. When the phase has shifted 360 degrees, it has changed in frequency by one Hertz.

tions required are shown in the figure. Notice that all you have to do is connect the output of your frequency source to the vertical input of your oscilloscope, and the frequency that you wish to measure to the horizontal input. Then by making a few quick control adjustments you can determine the unknown frequency.

Frequency measurement with an oscilloscope is accomplished using Lissajous figures or patterns. Lissajous patterns are the displays that appear on an oscilloscope when, voltages of different frequency, amplitude, and phase relationships are applied to its deflection plates. You have probably seen them in science fiction movies when "weird" patterns are used to indicate abnormal conditions aboard a spaceship.

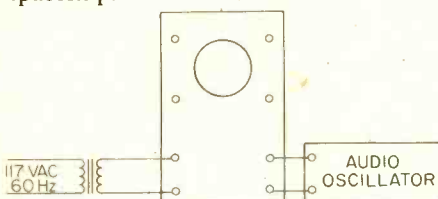

Audio oscillator calibration set up.

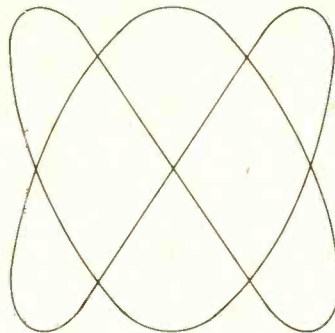

Typical stabilized lissajous pattern.

Getting back to the test set-up, it is obvious that the signal applied to the vertical input will cause the CRT beam to move up and down at a rate determined by the frequency of the signal. The same action can be obtained in the horizontal direction by switching your oscilloscope sweep controls to the positions that bypass the normal sweep circuits and apply signals connected to the horizontal input directly to the horizontal channel amplifier. The result is that the CRT beam will be pulled up, down, right, and left all at the same time. The resulting display will literally resemble a tangled up ball of string unless the two signals are harmonically related to one another. When this condition exists, the display will become steady as a rock, and the unknown frequency can be determined by making a quick mental calculation.

The basis of using your oscilloscope to measure frequency is that you adjust the frequency controls of your frequency source to induce the steady display. Then by reading the frequency dial of your source one of the two frequencies is known and the other can quickly be determined. Simple?

**Here's How.** Returning to the figure, you should now have your equipment connected as shown. Next, adjust the oscilloscope vertical and horizontal sensitivity controls to obtain a suitable deflection both vertically and horizontally. About 1-in. wide and 2-in. high is more than adequate. As mentioned before, at this point the display probably looks

like a real mess. But that is normal.

Now adjust the frequency controls of your frequency source until the display stabilizes and resembles a pattern in the next figure. The accuracy of the final measurement will be a function of how stable you can make the display, so make certain that the display is as steady as you can get it. It might help to let your equipment warm-up for a while if drift is a problem, but don't forget that many frequencies are not too stable. We will tell you how to check the stability of your frequency source later. Also, though it is possible to obtain stable displays that have many loops in them, it is usually best to keep the number of loops in either direction below five if possible. This is simply because they are easier to count.

Finally, referring to the examples shown in the last figure, count the number of times that the trace "touches" the left side of the display, and the number of times that the trace "touches" the top of the screen. Divide the number of "left-touches" by the number of "top-touches" and multiply the indication of your frequency dial by the result. This gives you the unknown frequency.

(“left-touches” / “top-touches”) (frequency) = Unknown Frequency

Couldn't be easier, and you save the cost of a frequency counter.

To firm it all up let's assume that your display looks like that shown in the last figure, and that the frequency dial of your frequency source indicates 3.345 Hz. First divide the number of

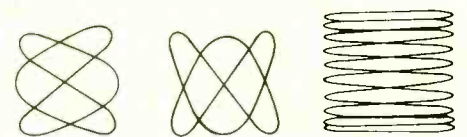

Various vertical to horizontal frequency ratios.

“left-touches” (3) by the number of “top-touches” (4). The result is 0.750 if you hold the answer to a manageable and satisfactory three places. Next mul-

(Continued on page 95)



Major phase angle lissajous patterns.

# Latest CB Rules & Reg. Changes

□ The exact text of the changes of the FCC Rules and Regulations: Part 95—Citizens Radio Service (commonly called Citizens Band) is given below. It will be sometime before the Government Printing Office can issue a revised and up-to-date issue of the Rules and Regulations. So keep this copy of e/e next to your copy of the FCC R&R for reference. The Editor suggest you read this issue's Kathi's CB Carousel for comments on other pending CB Part 95 changes and additions.

## § 95.37 Limitations on antenna structures.

\* \* \*

(Old)

(c) A Class C or Class D station operated at a fixed location shall employ a transmitting antenna which complies with at least one of the following:

(New)

(c) All antennas (both receiving and transmitting) and supporting structures associated or used in conjunction with a Class C or D Citizens Radio Station operated from a fixed location must comply with at least one of the following:

\* \* \*

(Old)

(3) The antenna is mounted on the transmitting antenna structure of another authorized radio station and does not exceed the height of the antenna supporting structure of the other station; or

\* \* \*

(New)

(3) The antenna is mounted on the transmitting antenna structure of another authorized radio station and exceeds neither 60 feet above ground level nor the height of the antenna supporting structure of the other station; or

\* \* \*

## § 95.41 Frequencies available.

\* \* \*

(Old)

(d) The frequencies listed in the following tables are available for use by Class D mobile stations employing radiotelephony only, on a shared basis with other stations in the Citizens Radio Service, and subject to no protection from interference due to the operation of industrial, scientific, or medical devices within the 26.96-27.28 MHz band.

(1) The following frequencies, commonly known as Channels 1 through 8 and 10 through 23, may be used for communications between units of the same station:

(Old)		(New)	
MHz	Channel	MHz	Channel
26.965	1	27.115	13
26.975	2	27.125	14
26.985	3	27.135	15
27.005	4	27.155	16
27.015	5	27.165	17
27.025	6	27.175	18
27.035	7	27.185	19
27.055	8	27.205	20
27.075	10	27.215	21
27.085	11	27.225	22
27.105	12	27.255	23

(New)

MHz	Channel	MHz	Channel
26.965	1	27.125	14
26.975	2	27.135	15
26.985	3	27.155	16
27.005	4	27.165	17
27.015	5	27.175	18
27.025	6	27.185	19
27.035	7	27.205	20
27.055	8	27.215	21
27.075	10	27.225	22
27.105	12	27.255	23
27.115	13		

(Old-deleted)

(2) Only the following frequencies may be used for communications between units of different stations:

MHz	Channel	MHz	Channel
27.075	10	27.125	14
27.085	11	27.135	15
27.105	12	27.255	23
27.115	13		

(Old to New)

Editor's Note: Old paragraph (3) is now numbered (2).

(2) The frequency 27.065 MHz (Channel 9) shall be used solely for:

(i) Emergency communications involving the immediate safety of life of individuals or the immediate protection of property or

(ii) Communications necessary to render assistance to a motorist.

(New)

(3) The frequency 27.085 MHz (Channel 11) shall be used only as a calling frequency for the sole purpose of establishing communications and moving to another frequency (channel) to conduct communications.

\* \* \*

(New Section Added)

## § 95.81 Permissible communications

Stations licensed in the Citizens Radio Service are authorized to transmit the following types of communications:

(a) Communications to facilitate the personal or business activities of the licensee.

(b) Communication relating to:

(1) the immediate safety of life or the immediate protection of property in accordance with §95.85.

(2) the rendering of assistance to a motorist, mariner or other traveler.

(3) civil defense activities in accordance with §95.121.

(4) other activities only as specifically authorized pursuant to §95.87.

(c) Communications with stations authorized in other radio services except as prohibited in §95.83 (a) (3).

\* \* \*

(Old)

## § 95.83 Prohibited uses.

(Editor's Note: This entire section has been rewritten and given below. Since the old version is so very long, its text has been omitted from this report.)

(New)

## § 95.83 Prohibited communications.

(a) A citizens radio station shall not be used:

(1) For any purpose, or in connection with any activity, which is contrary to Federal, State, or local law.

(2) For the transmission of communications containing obscene, indecent, profane words, language, or meaning.

(3) To communicate with an Amateur Radio Service station, an unlicensed station, or foreign stations (other than as provided in Subpart E of this part) except for communications pursuant to §§95.85 (b) and 95.121.

(4) To convey program material for retransmission, live or delayed, on a broadcast facility.

NOTE: A Class A or Class D station may be used in connection with administrative, engineering, or maintenance activities of a broadcasting station; a Class A or Class C station may be used for control functions by radio which do not involve the transmission of program material; and a Class A or Class D station may be used in the gathering of news items or preparation of programs: Provided, that the actual or recorded transmissions of the Citizens radio station are not broadcast at any time in whole or in part.

(5) To intentionally interfere with the communications of another station.

(6) For the direct transmission of any material to the public through a public address system or similar means.

(7) For the transmission of music, whistling, sound effects, or any material for amusement or entertainment purposes, or solely to attract attention.

(8) To transmit the word "MAYDAY" or other international distress signals, except when the station is located in a ship, aircraft, or other vehicle which is threatened by grave and imminent danger and requests immediate assistance.

(9) For advertising or soliciting the sale of any goods or services.

(10) For transmitting messages in other than plain language. Abbreviations including nationally or internationally recognized operating signals, may be used only if a list of all such abbreviations and their meaning is kept in the station records and made available to any Commission representative on demand.

(11) To carry on communications for hire, whether the remuneration or benefit received is direct or indirect.

\* \* \*

## § 95.85 Emergency and assistance to motorist use.

\* \* \*

(Old)

(b) Any station in this service may be utilized during an emergency involving the immediate safety of life of individuals or the immediate protection of property for the transmission of emergency communications. It may also be used to transmit communications necessary to render assistance to a motorist.

(1) When used for transmission of emergency communications certain provisions in this part concerning use of frequencies (§95.41 (d)); prohibited uses

(Continued on page 103)





# BASIC COURSE IN ELECTRICITY & ELECTRONICS

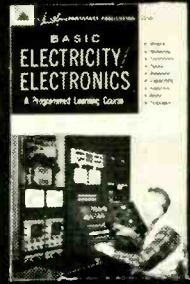

This series is based on BASIC ELECTRICITY/ELECTRONICS, Vol. 1, published by HOWARD W. SAMS & CO., INC.

## MAGNETISM FOR ELECTRONICS

### PART ONE

**W**hat You Will Learn. This section explains the principles of magnetism for DC applications. It includes a description of magnetism, natural magnets, electromagnets, magnetic properties and relationships, magnetic measurements and associated terms, and DC applications of electromagnetic principles. The DC applications include the effects of magnetic fields on current flow and electrical reactions associated with relays, motors, etc.

The fundamental characteristics and typical applications of DC electromagnetism are employed in electrical machinery, radio equipment, laboratory and test equipment, automotive devices, television, radar equipment, computer systems, and many others.

### HISTORY OF MAGNETISM

During the ancient period in the world's history, in a district in Asia Minor known as Magnesia, the Greeks noticed that a lead-colored stone had an attraction for small particles of iron ore.

In later years the Chinese made use of this stone in their desert travels. They suspended the stone or floated it on water and called it loadstone, meaning "leading stone." Loadstone (also spelled lodestone) is a natural magnet, because it possesses magnetic properties when found in its natural state. At the present time the most common method of producing electricity is through the use of the magnetic properties of certain materials.

### A Natural Magnet-Loadstone

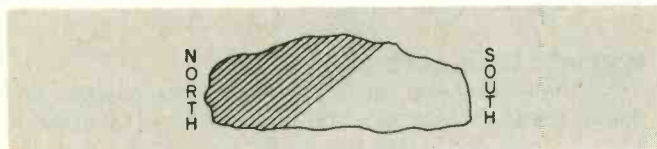

### WHAT IS MAGNETISM?

The dictionary defines magnetism as "a peculiar property possessed by certain materials by which they can naturally repel or attract one another according to determined laws."

Magnetism is actually a force which cannot be seen, although you can witness the effects of magnetism on other materials.

In August, 1975, a group of American scientists described evidence that may confirm the existence of "monopoles"—long thought to be the basic particle of magnetism.

### THE MAGNET

We have already discussed one magnet, the loadstone, as being a natural magnet found in the earth. Magnets manufactured today are much stronger than the loadstone.

Iron, cobalt, and nickel are used in the manufacture of magnets. Iron is easy to magnetize, but loses its magnetic properties almost immediately after the magnetizing force is removed. Steel is harder to magnetize, but it holds its magnetism over a greater period of time after the magnetizing force is removed.

The Chinese learned that when the loadstone was suspended or it was floated on a liquid, one end of the stone always pointed in a given direction. Today we know that any magnetic or magnetized material, when suspended or floated, aligns itself with the earth's magnetic field. The end of the magnet or magnetized material that points toward the north pole of the earth is called the north-seeking pole or north pole; the opposite end is called the south-seeking pole or south pole.

### A Gude Compass

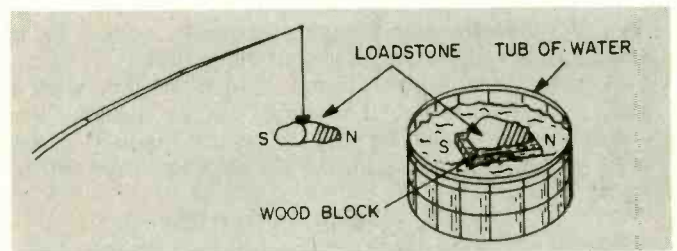

Since magnetism is more pronounced in iron and its alloys than in most other materials, we will take a close look at an atom of iron.

### An Atom Of Iron

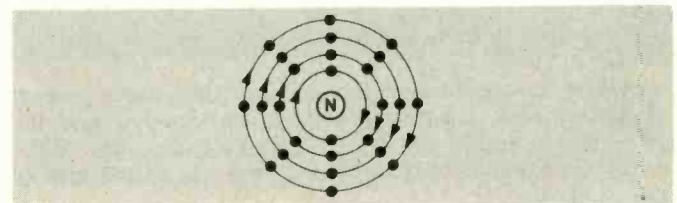

Notice that the majority of electrons in orbit around the nucleus appear to be traveling in the same direction. This is the first clue as to why certain materials are easy to magnetize while other materials are almost impossible to magnetize. If you could take a close look at the atoms in a material that cannot be magnetized, you would see that the electrons in orbit appear to be traveling in different directions; they will cancel out each other's magnetic effects, thus preventing any external magnetic field.

You have learned that any magnet or magnetized material has a north-seeking and a south-seeking pole. One important characteristic possessed by magnets is that if the north poles of two magnets are brought near each other, they repel one another. This also occurs if two south poles are brought near each other.

### QUESTIONS

- Q1.** Write the definition of a molecule.  
**Q2.** How do like charges affect each other?

### ANSWERS

- A1.** A molecule is the **smallest particle of any substance that still retains the physical characteristics of that substance.**  
**A2.** Like charges are **repelled** by each other.

### Magnetic Molecular Alignment

If you were able to view the molecules inside a block of unmagnetized iron, you would see the total disarrangement of the molecules.

#### Molecular Theory Of Magnetism

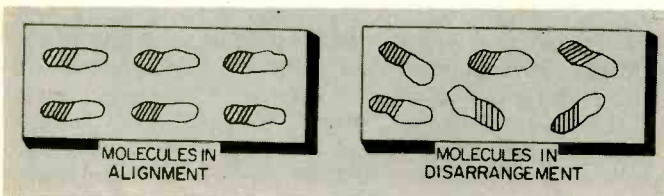

Each molecule within a bar of iron has its own north-seeking and south-seeking poles. Although the magnetic strength of a single molecule is very weak, there are many millions of molecules in a very small piece of metal. When magnetically aligned in the same direction, they can develop a strong magnetic field. This is known as the molecular theory of magnetism.

To magnetize a bar of iron, stroke the bar with a material known to be a magnet. Let us assume you choose to apply the north pole of the magnet to the iron. In the illustration, stroke the iron bar from left to right.

#### Magnetizing An Iron Bar

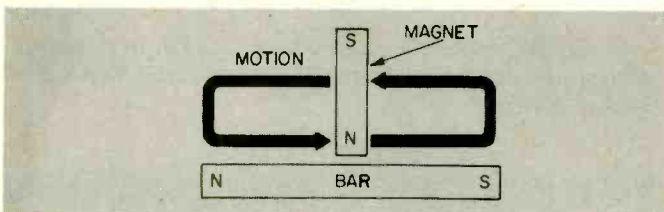

Note that in stroking the iron bar, the same pole of the magnet is always applied to the iron bar and the stroking action is always in the same direction. Make sure the magnet is lifted free of the bar at the end of each stroke.

An alternate method of magnetizing an iron bar is to apply the magnet at the center of the bar and stroke in one direction. After half of the bar is magnetized, reverse the magnet and, again starting at the center, stroke the iron bar in the opposite direction.

#### Alternate Magnetizing Methods

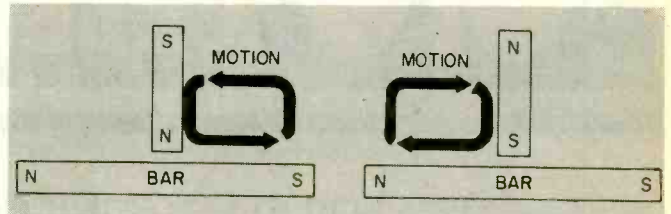

A steel bar can be magnetized in exactly the same way. Steel requires a greater force to align its molecules and therefore takes longer to magnetize. However, steel retains its magnetic properties for a much longer time than iron.

Because steel retains its magnetic properties, it is considered to have a high retentivity (the property of any material to remain magnetized).

#### Other Methods of Magnetizing Metal

Whenever a piece of iron or steel is placed in a magnetic field, it assumes the properties of the magnetic field.

#### How To Make Repair Bills

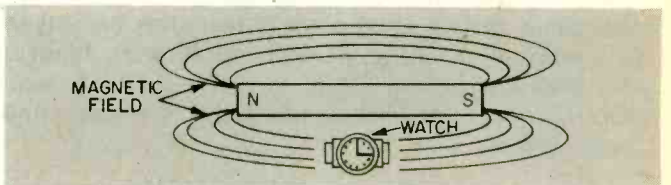

You probably know the danger to your watch if you wear it when working near magnets. Many watches made today are said to be nonmagnetic. This doesn't mean that you can lay your watch on a strong magnet with safety, but it does mean that the watch is shielded from ordinary magnetic fields (lines of force surrounding a magnet).

### QUESTIONS

- Q3.** What is the retentivity of iron as compared with steel?  
**Q4.** What is meant by a magnetic field?

### ANSWERS

- A3.** The retentivity of iron is **very low.**  
**A4.** A magnetic field is the **pattern of lines of force** that surround a magnet.

#### Magnetic Lines of Force

All magnets have invisible force lines surrounding them. These lines leave the north pole of a magnet, form a loop, and enter the south pole of the magnet, completing the loop inside. These loops run parallel to each other inside the magnet and never cross or unite.

The lines formed by the magnetic loops are called magnetic lines of force. The area occupied by these lines is called the magnetic field. The magnetic field is the induced energy surrounding the magnet or the space through which the influence of these magnetic

*(Continued on page 89)*

# 3 important reports on the CB state-of-the-art...

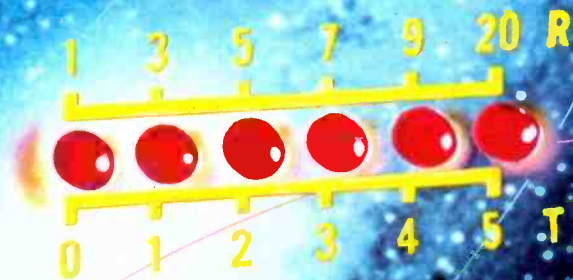

**JOHNSON**





*state-of-the-art in sideband...*

# Johnson sideband. again!

Nearly 10 years ago we introduced the world's first CB single sideband radio — a radio still sought after and prized today. In that tradition of state-of-the-art performance, Johnson offers you the Viking 352. With the most advanced SSB performance on-the-air... including crystal lattice filtering, an efficient RF noise blanker, individual professional controls for every function, and color-keyed lights for instant indication of USB, LSB, or AM mode. Viking 352 brings famous Johnson quality, performance, warranty and service to CB sideband! \$359.95.



state-of-the-art in receiver design ...

**engineer's  
triumph...  
operator's  
dream.**

Improving what is already the best is the ultimate challenge for the engineer. And the ultimate reward for the discerning CB operator. In the new Messenger 323A you can experience the incredible interference rejection of the only *dual cascaded crystal filtering system* available in any CB radio. Plus the exceptional noise rejection of both an efficient RF-type noise blanker and a new fully-automatic noise limiter system that adjusts itself for the cleanest, clearest reception possible. Equally important are the features we *didn't* change — the large, easy-to-read meter, easy-to-handle control knobs, built-in electronic speech compression, P.A. function, and rugged steel cabinetry. It's the dream rig you can own for \$249.95.



**JOHNSON**

E. F. Johnson Company, Waseca, Minn. 56093

In Canada: A. C. Simmonds & Sons, Ltd.

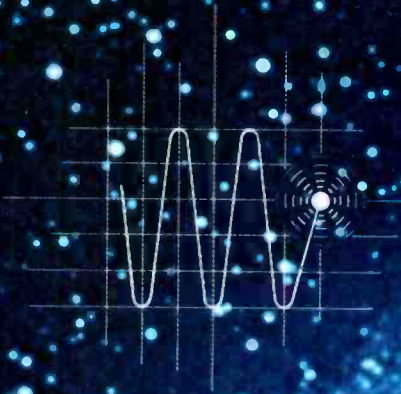

state-of-the-art in metering ...



the Johnson  
solid-state  
meter.  
clearly an  
improvement.



Meet the Messenger 1235J – the first CB radio with LED meter readout! Bright, ruby-red LEDs let you read signal strength, transmit power and modulation precisely and at a glance, or use your meter as a "visual call alert" while keeping your eyes on the road. The Johnson LED meter is all solid-state so it's completely reliable, regardless of temperature, dust and humidity. Add the proven performance of built-in electronic speech compression, mechanical "steep skirt" filtering, voice-tailored audio and plus/minus ground ... and you'll know why it is *clearly* the most advanced CB radio in its class. \$169.95.



**JOHNSON**

E. F. Johnson Company, Waseca, Minn. 56093

In Canada: A. C. Simmonds & Son, Ltd.

### Paths Of Magnetic Lines Of Force

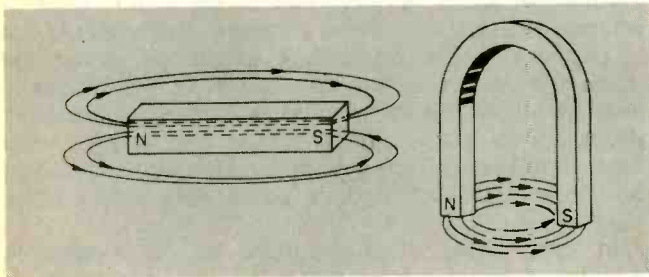

lines of force can be measured. The strength of the magnetic field is measured by determining the number of magnetic lines of force per unit area surrounding the magnet.

These lines are invisible; therefore, you may wonder how their total number can be determined or what pattern they form. A simple experiment that you may wish to perform will answer these questions and enable you to see these lines for yourself.

#### Magnetic Field Pattern Demonstration

You will need a bar or horseshoe magnet, a piece of glass or clear plastic about 12 inches square, and a small can of iron filings.

Place the glass or plastic sheet over the magnet and sprinkle a small amount of iron filings (about a thimble full) over the magnet area on the surface of the sheet.

#### Standard Science Class Demo

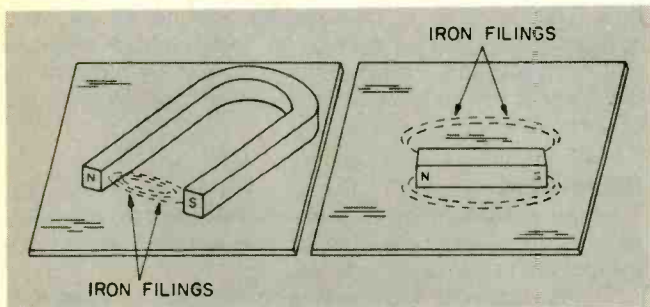

Tap the sheet and notice how the iron filings form a definite pattern similar to that shown.

It was stated previously the lines of force were invisible but that you could see their effects. Notice the heavy concentration of iron filings near the poles of the magnet.

It is possible to magnetize an iron or steel bar by stroking it with a magnet. A steel bar or rod can also be magnetized by placing it parallel to the earth's magnetic field and striking it several sharp blows with a hammer. The force from these blows causes the molecules in the bar or rod to change positions and to align themselves with the earth's magnetic field. If a screwdriver becomes magnetized, strike it on a hard surface a few times. Providing its original magnetic properties were rather weak, this striking will rearrange the molecules and demagnetize the screwdriver. Be sure the screwdriver isn't held parallel to the earth's magnetic field as it strikes the hard surface.

Heating, as well as jarring, reduces the magnetism of any material. When iron is heated above 770°C, it can no longer be magnetized or hold any magnetism. Heating a material accelerates the movement of the mole-

cules, and this action causes the molecules to rearrange their alignment.

#### QUESTIONS

- Q5. How is the strength of the magnetic field around a magnet determined?  
 Q6. What part of a magnet has the greatest magnetic attraction for a steel bar?

#### ANSWERS

- A5. The number of lines of force per unit area around a magnet indicates its magnetic field strength.  
 A6. The area around either pole has the greatest influence on a steel bar.

#### Magnetic Poles

The path of magnetic lines of force can be controlled. The lines of force concentrated at the poles of the magnet are much closer together than those surrounding the magnet. This is true because magnetic lines of force always take the path of least opposition. Iron or steel offers less opposition to these lines of force than air or other nonmagnetic material. This principle can be used to advantage. If an iron or steel ring is placed around a watch, the magnetic lines will follow a path through the ring and will not pass through the watch. This method of diverting magnetic lines of force is called magnetic shielding.

#### Provides Magnetic Shielding

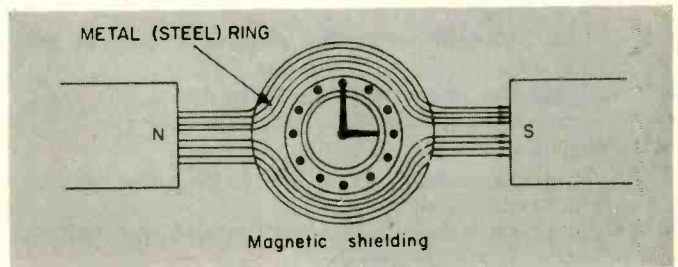

The minimum number of poles a magnet can have is two—a north-seeking pole and a south-seeking pole. It is possible, however, for a magnet to possess more than two poles.

#### Magnet With Multiple Poles

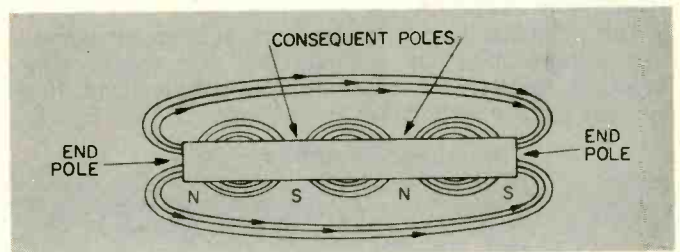

The poles between the ends of a magnet are called consequent poles. Notice there are magnetic fields existing between the consequent poles and the end poles. These fields are the same as the field that exists between the end poles. The magnetic lines of force leave a north-seeking pole and enter a south-seeking pole.

#### TYPES OF MAGNETS

Basically, there are two types of magnets—perma-



nent and temporary. As their names imply, one magnet retains its magnetism for a long period of time (years in some cases), and the other loses its magnetism almost as soon as the magnetizing force is removed. Manufactured magnets are called artificial magnets since the only natural magnet is the loadstone. Incidentally, a loadstone is very weak compared to a manufactured magnet; therefore, a loadstone has very few applications.

### Applications

The types of magnets which have been discussed are widely used in speaker, meter movements, and magnetic compasses. You may wonder about the third use since a magnet deflects the needle of a compass. A compass installed on most boats, cars, or airplanes is usually surrounded by metal. This metal is affected by the earth's magnetic field. Small bar magnets, called compensating magnets, are placed around the compass to counteract the effects of the earth's magnetic field on the surrounding metal. This makes it possible to use the compass in such places.

### QUESTIONS

- Q7. Magnetic lines of force always take the path of .....
- Q8. Diverting magnetic lines of force is one method of magnetic .....
- Q9. What is the minimum number of poles a magnet can have?
- Q10. The poles between the ends of a magnet are called .....
- Q11. Magnetic lines of force leave the .....

### ANSWERS

- A7. Magnetic lines of force always take the path of least opposition.
- A8. Diverting magnetic lines of force is one method of magnetic shielding.
- A9. Two.
- A10. The poles between the ends of a magnet are called consequent poles.
- A11. Magnetic lines of force leave the north pole and enter the south pole.

### Horseshoe Magnets

The magnets used in meters are shaped somewhat like a horseshoe. By bringing the two poles close together, the lines of force are concentrated and thus provide a much stronger magnetic field.

#### Increases Magnetic Field

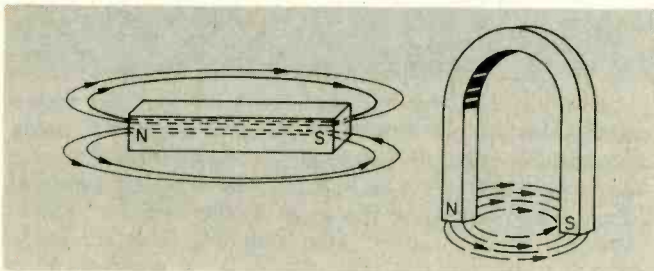

### Care of Magnets

Magnets that are not properly cared for lose their magnetic properties over a period of time. How much

magnetism is lost depends on many variables—how the magnet was originally magnetized, how it is used, where it is used, etc. When a horseshoe magnet is not in use, a soft iron bar should be placed across the poles. This bar will provide a path for the magnetic lines of force, and the magnet will retain its magnetic properties for a much longer period. The iron bar used for this purpose is called a keeper. Bar magnets should be stored parallel to each other with unlike poles together.

In some cases, it is important for the magnet to maintain a specific magnetic force over a long period of time. When this function is necessary, magnets are

### Retaining Magnetism in Storage

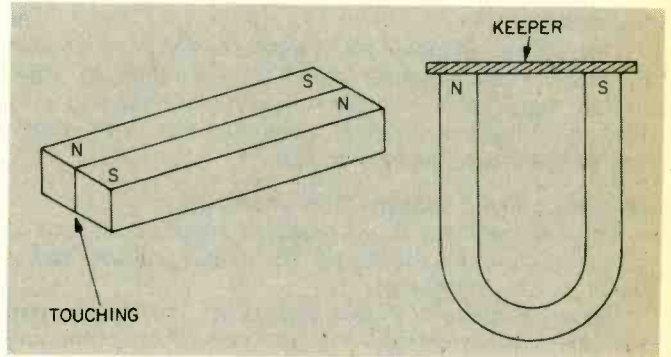

put through a process of aging during their manufacture. This is done by placing the magnet in an oven and subjecting it to controlled temperature changes and to vibrations. This process causes the strength of the magnet to remain nearly constant for a long period of time.

### Reluctance

Some materials offer more opposition to magnetic lines of force than do others. In magnetic circuits this opposition is called reluctance.

In the study of electrical circuits, you learned that electromotive force causes current to flow in a circuit and the flow of that current is limited by resistance. There is also a magnetic circuit in which the magnetic lines of force form closed loops, called flux loops. The force that produces these flux loops is called the magnetomotive force (mmf). The opposition to the flux loops is called reluctance. Notice the similarity to the electrical circuit. In a magnetic circuit the magnetic lines of force always take the path of least reluctance. This is why the magnetic lines followed the steel ring around the watch discussed previously. The steel ring offered less reluctance than the air and the non-magnetic metal of the watch in the center of the ring.

### QUESTION

- Q12. The opposition that some materials offer to magnetic lines of force is called .....

### ANSWER

- A12. The opposition that some materials offer to magnetic lines of force is called reluctance.

### Magnetic Flux

An expression for determining the amount of flux present in a magnetic circuit is:



$$\text{flux} = \frac{\text{magnetomotive force}}{\text{reluctance}}$$

Flux varies directly with the magnetomotive force and inversely with the reluctance. This is the Ohm's law expression for magnetic circuits. Compare the two formulas.

$$\text{Current} = \frac{\text{electromotive force}}{\text{resistance}}$$

Magnetic flux is the total number of magnetic lines existing in a magnetic circuit or extending through a specific region. The symbol for magnetic flux is the Greek letter  $\phi$  (phi). One magnetic line of force is equal to 1 maxwell.

The concentration of these magnetic lines determines the flux density. The symbol for flux density is "B," and the unit of measurement is the gauss. One gauss is a flux density of one line of force per square centimeter.

The degree of flux density between the poles of a horseshoe magnet is directly proportional to the area of the air gap between the poles. The force of attraction or repulsion between the poles varies directly with the strength of the poles and inversely with the square of the distance separating them. This force can be determined as follows.

$$F = \frac{P_1 \times P_2}{\mu d^2}$$

F is the force between poles in dynes (unit of force),  $P_1$  and  $P_2$  are the strengths of the two poles, d is the distance in centimeters between the poles,  $\mu$  is a constant that depends on the medium between the poles. It is 1 for air and greater than 1 for other mediums. To find the total number of flux lines, multiply the flux density (in gauss) by the area (in square centimeters).

Certain materials have more opposition (reluctance) to magnetic lines of force than others. It is therefore true that some materials allow magnetic lines of force to pass more easily than others. The ease with which magnetic lines of force pass through a material is known as permeance, the reciprocal of reluctance (permeance = 1/reluctance). Any substance that allows the magnetic flux to pass with little or no opposition is said to have a high permeability. Iron, for example, has a high permeability. High-permeability materials can be easily magnetized, but they will not retain their magnetism. Permeability varies with the intensity of the magnetic field in which the material is located.

It is also possible to determine the flux in any material by multiplying the magnetomotive force by the permeance:

$$\text{flux} = \text{mmf} \times \text{permeance}$$

Not all materials can be magnetized. Actually, materials can be broken down into three classifications—diamagnetic, paramagnetic, and ferromagnetic. Diamagnetic materials are those that normally cannot be magnetized. Paramagnetic materials are those that are difficult to magnetize. Ferromagnetic materials are those that are relatively easy to magnetize. Some

ferromagnetic materials are iron, cobalt, nickel, silicon steel, and cast steel.

A diamagnetic material is extremely difficult to magnetize and has a permeability of less than 1. A paramagnetic material is also difficult to magnetize, but has a permeability of slightly greater than 1. A ferromagnetic material is easily magnetized, and its permeability is quite high.

## QUESTIONS

- Q13.** If there are 3,000 magnetic lines of force passing through a magnet, what is the magnetic flux?
- Q14.** If there are 2,700 maxwells in a cross-sectional area of 9 square centimeters and the lines are evenly spaced, how many maxwells are there in 1 square centimeter?
- Q15.** In an area of 5 square centimeters the flux density is 6,000 gauss. How many flux lines pass through the area?

## ANSWERS

- A13.** The magnetic flux is 3,000 maxwells.
- A14.** There are 300 maxwells in 1 sq. cm.
- A15.** 30,000 flux lines pass through the area.

## ELECTROMAGNETS

There is another type of magnet that has a wide range of applications in electricity. This is the electromagnet. The dictionary defines an electromagnet as "a bar of soft iron that will become a temporary magnet if an electrical current is caused to pass through a wire coiled around it."

Electromagnetism was first discovered by Hans C. Oersted, a Danish scientist, in 1820. Oersted found that a needle placed near a wire would deflect when current passed through the wire. Further experiments led to the discovery that current flowing through a conductor creates a magnetic field about the conductor. This magnetic field is composed of lines of flux (magnetic lines) that encircle the conductor at right angles to the flow of current. The flux lines are uniformly spaced along the length of the conductor.

### Magnetic Field Around Wire

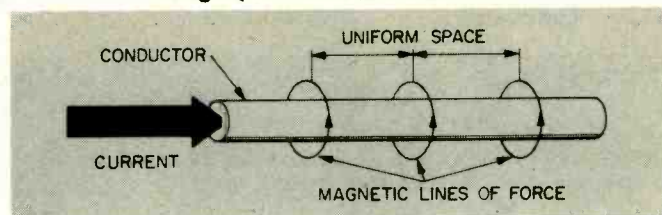

This is another method of creating a magnet. The magnetic field around a straight conductor is not very strong, but it exhibits the same properties as the bar or horseshoe magnet discussed previously. If a compass is placed near the conductor, the compass needle is deflected at right angles to the current-carrying conductor. The compass also indicates that the magnetic field around the current-carrying conductor is polarized. If the current is reversed through the coil, the position of the compass needle also reverses.

The magnetic field around a conductor diminishes with an increase in distance from the conductor.

### Left-Hand Rule

To determine the direction of the magnetic field

### Field Strength vs Distance

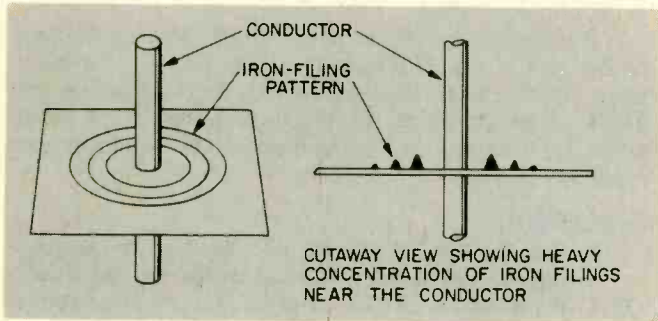

around a current-carrying conductor, grasp the conductor in your left hand, with your thumb pointing in the direction of current flow. The direction that your fingers curl around the wire indicates the direction of the magnetic field.

Do not attempt such an experiment on a bare wire. Instead, place your left hand in a position away from the wire with your thumb pointing in the direction of current flow. Your curled fingers will indicate the direction of the magnetic field. It isn't necessary to grasp the conductor.

### The Left Hand Rule

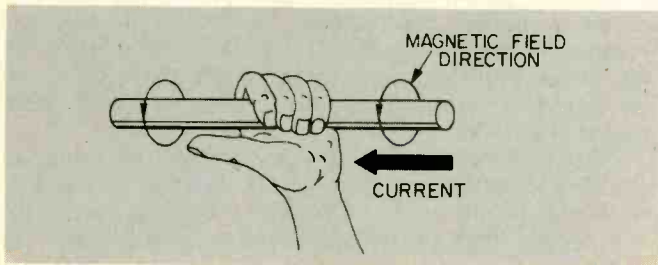

### QUESTION

**Q16.** In what plane do the magnetic lines around a current-carrying conductor lie?

### ANSWER

**A16.** The magnetic lines around a current-carrying conductor lie in a plane at **right angles** to the conductor.

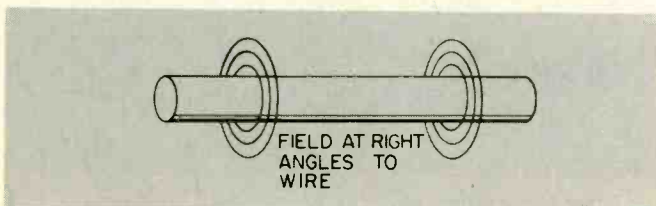

### Do It This Way In Practice

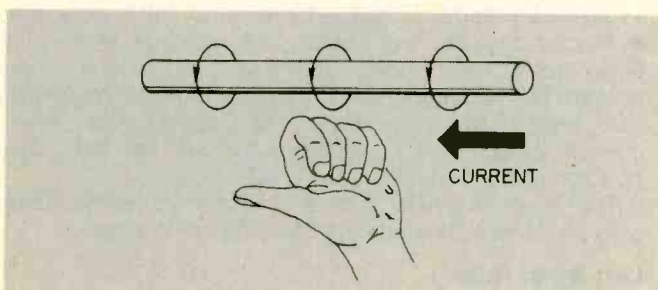

### Magnetic Field Strength

Magnetomotive force is the force that tends to drive the flux through a magnetic circuit. The unit of magnetomotive force is the gilbert.

The unit of measurement used to express field intensity is the oersted. The strength of the magnetic field can be found by using the following expression:  
 $H = I/5d$

H is the field intensity at a point nearest the wire in oersteds, I is the current through the wire in amperes, d is the distance of this point from the axis of the wire in centimeters (1 inch = 2.54 centimeters).

### WHAT YOU HAVE LEARNED

1. Magnetism is a property of certain materials to attract and repel each other.
2. Magnetized materials have north (north-seeking) and south (south-seeking) poles. Magnetic force lines flow from south to north inside the material and north to south outside.
3. Some materials may be magnetized by stroking them with a magnet or by passing direct current through a coil wrapped around them.
4. A permanent magnet has a high retentivity (retains its magnetism). A temporary magnet has low retentivity.
5. Permanent magnets should be stored in a manner which permits the external field to be concentrated in a path of low flux opposition. Bar magnets are stored with N and S poles adjacent. A keeper is placed across the poles of a horseshoe magnet.
6. Reluctance is the opposition offered to the flow of magnetic flux lines. Air has a higher reluctance than iron.
7. Number of flux lines (maxwells) is directly proportional to the magnetomotive force exerted and indirectly proportional to the reluctance of the material through which the flux lines pass.
8. Permeability of a material is a measure of its ability to be magnetized. Low reluctance indicates high permeability.
9. An electromagnet is a device that has been or is being magnetized electrically.
10. Current through a conductor generates a magnetic field. If the thumb of the left hand points in the direction of electron flow, the fingers curl in the direction taken by the flux lines.

*Elementary Electronics will continue its "Magnetism for Electronics" basic course in the next issue. You will supplement this initial exposure with a fresh understanding of magnetic terms and with your further introduction to the famous right-hand and left-hand rules. Magnetism, a "dry" subject to many technicians and experimenters, is nonetheless an important basic in your understanding and enjoyment of electronics. We think you will find our final installment both important and interesting.*

This series is based on material appearing in Vol. 1 of the 5-volume set, BASIC ELECTRICITY/ELECTRONICS, published by Howard W. Sams & Co., Inc. @ \$22.50. For information on the complete set, write the publisher at 4300 West 62nd St., Indianapolis, Ind. 46268.



## Ask Hank, He Knows!

(Continued from page 38)

quit their homestudy courses after a few lessons. But I must say this, Hank, I am one that is going strong and don't ever plan on quitting. I am 14 years old and am working on a course in Basic Electronics.

—J. R., Eagle Pass, TX

Hang in there, pal, I'm rooting for you. It's determination that's a large part of the battle of life.

### No Coverage

I'd like to see some radio/control projects in e/e. Why have you guys avoided this hobby interest area?

—R. G., Medley, Alberta

Like R/C projects? Then save a bundle of cash and buy ready made units from model airplane stores and modify them for specific purposes. The R/C fans have come a long way to where they now have the

best in functional and reliable radio control devices.

### Do, Re, Me Too!

I happened to look into your July/August issue and found the fine article on the mathematics of music. Since I have a slide rule calculator, it gave me an excellent opportunity to use it, and to learn a great deal about my music lessons. I enjoyed it.

—P.C., Lafayette, GA

Gee, it's nice to get letters like yours.

### Lights Out

I'd like to eliminate the idiot lights in my car for gauges. I lost one car from overheating and had dead batteries twice in my present bucket-of-bolts because the idiot lights came on after the damage was done. Where can I get reliable gauges?

—D.M., New City, NY

I know what'cha mean. If your local electronics store does not carry what you want, check out a wholesale automotive supply store—they sell to almost anyone. Also, write to J. C. Whitney & Co., 1917-19 Archer Avenue, Chicago, IL 60680 and ask for

their automotive parts and accessories catalog.

### Hank Eats Crow

I noticed with interest your reply to the person who wanted to know why broadcast stations reduce their power at night. It had to be the most cockamamie piece of misinformation I have ever seen. The truth of the matter is that AM broadcast-band signals are propagated by "skip" at night, mainly by the E-layer, and there is some D-layer "skip" around noon, local time. Where the ground-wave portion of the radiated signal is somewhat limited in its range as it obeys the inverse-square law, with the reduction in ionospheric absorption at night, sky-wave signals in the medium-wave band can be propagated strongly for hundreds or thousands of miles. For this reason, many AM broadcast stations are not permitted to operate after local sunset, and others must reduce their power. Needless to say, I am very disappointed with your column.

—G.K., San Clemente, CA

When I try to oversimplify, I run into trouble. Thanks for writing. ■

## NewsScan

(Continued from page 36)

tenna covered by a visual display of the license number of the vehicle, a frequency doubler, a modulator, and an RF detector." It would be 12-inches long, 6-inches high, and about a half

inch thick.

The electronic license plate meets all of the requirements for a second harmonic reflector to be used in a highway collision avoidance system radar. Thus, once an electronic license plate is in nationwide use, it would become practical to equip highway vehicles with harmonic collision avoidance radars.

Such radars, first demonstrated by RCA in 1972, show great promise of

being capable of sharply reducing highway accidents, particularly rear-end collisions. They eliminate the clutter and blinding problem faced by conventional automotive radars because they see only objects equipped with the electronic license plate. Radar returns from roadways, highway signs, overpasses, trees, and other objects, as well as signals emitted from oncoming cars in separate lanes, are rejected. ■

## DX Central Reporting

(Continued from page 28)

the Solomon Islands Broadcasting Service in the Pacific. It is best heard on the west coast, but is audible at times throughout the country before your local dawn and before 1115. **6,085:** Radio Canada International is an old favorite of many DXers. This frequency is in use, with English programming, around 0100. **9,690:** Argentina's foreign shortwave service, RAE can be logged in English, Tuesday through Saturday on this frequency between 0300 and 0400. **11,830:** Another English speaking voice from Africa is ETLF, Radio Voice of the Gospel in Addis, Ababa, Ethiopia. Tune for this one at 1945 hours. **15,185:** There are a number of times to try for Radio Finland on this SW channel; like at 1400, 1600, 1800, 2030, or 2300. (Credits: "English Broadcasts on Shortwave", North American SW Association).

**Backtalk.** Here at DX Central mailcall is one of the most interesting times of the day. Besides hoping for the mailman to bring in some QSLs, I also look forward to receiving letters from readers. I enjoy hearing what you have to say, your comments, suggestions, reports of what you've heard and would like to hear but haven't thus far. I welcome the pictures you send of

yourselves and your shacks. While it usually isn't possible to reply by mail to individual questions, the most interesting and universal queries usually wind up here in the "Backtalk" section of the column. So keep writing those cards and letters, gang!

On the top of the pile this month is a letter from Robert Fraser, Cohasset, MA. Robert recalls an article in another magazine years ago about a strange TV-DXing experience reported. "It seems a number of people in England were receiving a TV station in Texas. One man took a photo of the ID slide but the story added that this station had closed down three years before. I've never heard any more of this phenomenon. I wonder if you know anything about this story. Frankly, I think a couple of guys in England put one over on the public."

Yes, I recall the story too, Bob. The station was one in Houston on channel 2, now KPRC-TV, though the ID slide the fellow photographed was for a call the station had been assigned some years earlier.

The big question was, how could the guy receive a picture of an ID slide showing call letters which hadn't been used in years. The rest of the report including transatlantic TV reception is possible.

There were some wild theories kicked around. One was that somehow the signal from Houston traveled far out into space

for at least several light years and somehow bounced back to be received long, long after the fact in England. Others believe as you do, that it was a hoax. As far as I know it never has been satisfactorily explained, but I lean toward the hoax theory. Especially since, till just recently, England used a 405 line TV system while the U.S. standard is 525.

Kansas City, MO, DXer, Richard Dale writes about a station he's heard on 800 kHz, medium wave. "The call letters of this high powered station are unknown but it identifies as 'X-Rock 80'. It seems to be located near El Paso TX and it is well heard at night."

Your station is XROK, which explains the "X-Rock-80," no? The outlet is a high powered one, running 150 kilowatts, three times the maximum power allowed U.S. stations. It is located in Ciudad Juarez, Mexico, just over the border and programs in English for U.S. audiences at night.

And last but not least, a quicky from Randy Herring, University, MS. "Is there a religious station broadcasting from Pennsylvania on about 11,750 kHz? I heard the broadcast at 2100 GMT."

Yes, Randy. The station is WINB, operated by the World International Broadcasters, Box 88, Red Lion, PA. It is one of three non-governmental shortwave outlets authorized in the United States. The frequency probably was 11,775 kHz. ■

## Antique Radio Corner

(Continued from page 59)

ada. Edmund J. O. Eberdt, the Curator tells me that you may visit it any time by appointment. The telephone number is 514-538-2649.

Alan Douglass of Pocasset, Mass. has sent some additional information on the Wunderlich tube referred to in my column printed in the July-August, 1975 issue of *e/e*. Alan said there are a number of Wunderlich tubes floating around with numbers like any ordinary vacuum tube. The number 29, 90, and KR20 are all 2.5 volt filament types, while the number 69, 70, 92, and KR22 are 6.3 volt filament types. All have a six pin base. He has all these types, but no Arcturus blue original tube.

**Film Facts.** Some of the photos shown with this column were taken at the meeting of the Indiana Historical Radio Society meeting at Fort Wayne, Indiana. The old speaker contest has become a very popular event. This year there were nineteen different horn and cone type speakers entered. The speakers were made between 1922 and 1928.

Another event that commands every member's attention is the auction of radios, parts, speakers, literature, etc. It is amazing to see the wide variety of old radio equipment that is offered for sale. In the next issue I will have photos from the joint Antique Wireless As-

## Project Spaceflight

(Continued from page 46)

height, turn the *speed-reset* switch on, and the rocket engine off.

Then, return to earth; you have done so if you reach zero height at zero speed. Keep a record of the elapsed time for each pilot and each flight. The best possible time is just under 20 seconds.

Since the system is fairly complicated, and a number of controls must be set correctly before a flight, you might use the brief summary, or check list, at the Control box.

**Flights On The Moon.** Once you are familiar with flight in the earth's atmosphere, try landing on the moon. Remove the 10 meg external resistor—there is no air resistance on the moon. Change the voltage at the ACC v terminal to 0.17 volts—g on the moon is only 1/6 that of earth. Other flight conditions can be simulated using different values of g and air resistance.

Well, there you have it, our version

sociation and Indiana Historical Radio Society meeting held at Purdue University, West Lafayette, Ind. It featured one of the largest displays of regenerative radios ever assembled. The meeting honored Major Howard Armstrong, inventor of the regenerative receiver and the Frequency Modulation method of radio transmission and reception. Also, two historical slide shows were shown, plus a movie of the Freed Radio manufacturing facility as it was in 1929.

After attending these two meetings, I would like to point out the value of meetings to radio collectors. At the West Lafayette meeting there were 85 collectors. One came from Greeley, Colorado, two from Minneapolis, Minn., two from Baltimore, MD, and many from several hundred miles away. I believe that many states have enough collectors to form their own collector club. I hear frequently from collectors who do not know any other collectors, even though they may be living only a few miles from each other.

**So long for now.** We didn't get the capacitor color code chart ready yet nor have we completed the design of the universal power supply we promised you. With winter setting in we will present more technical information in this column. We will also answer one or two questions that will be of interest to many readers. Keep your cards and letters coming because we enjoy reading them.

of the big NASA spacecraft simulators. To keep a relatively complicated computing system simple and low cost, we have specified inexpensive and readily available electronic parts. While our resistors are the 10 percent accuracy variety, those used in actual commercial analog computers are a thousand times more accurate. This computer is designed for fun and experience, not high accuracy.

The clock is running!

## Phase and Frequency

(Continued from page 81)

tively the known frequency by 0.750 ( $0.750 \times 3,345 = 2,509$  Hz) to determine the unknown frequency. It's fast, easy, and as accurate as the degree to which you know the known frequency.

Since your frequency source probably makes you blush when anyone mentions calibration or accuracy, and who doesn't, let's cover how Lissajous patterns can be used to calibrate your frequency source. It is merely an extension of what you do to determine an un-

## FIRST PRIZE \$80,000 I PLAY AND WIN! LEGAL LOTTERY

SPONSORED BY GUATEMALAN GOVERNMENT

OTHER TYPICAL PRIZES

\$20,000 \$9,000 \$7,000

\$ 5,000 \$2,000 \$1,000

AND \$340,786 GIVEN AWAY EACH MONTH IN MANY ATTRACTIVE PRIZES!

★ LOW TICKET COST ★ NO TAXES

★ NO REPORTS TO ANY GOVERNMENT  
FREE INFORMATION AND ORDER FORMS!  
Write Airmail Today

**KURT M. MEYER, E.E.**

38 Av. "A" 0-11 Zo. 7, P.O. Box 165 "A"

GUATEMALA, CENTRAL AMERICA

CIRCLE 11 ON READER SERVICE COUPON

## ELEMENTARY ELECTRONICS INDEX TO ADVERTISERS

READER SERVICE NO.	ADVERTISER	PAGE NUMBER
6	Avanti Research	6
	Bell & Howell Schools	30-33
	Circuit Specialists	98
30	Cleveland Institute of Electronics	2nd Cover, p. 3
7	Cobra Div., Dynascan, Corp.	25
	Cornell Electronics	98
36	Continental Specialties Corp.	15
	Defender Co.	103
18	Electronics Distributors Inc.	24
20,39	Edmund Scientific Corp.	7, 93
2	Eico Electronics	38
	Technical Home Studies Schools	66-69
	Fair Radio Sales	98
25	Goldfinger Enterprises (Bomar Crystal)	26
1	Heath Co.	48-51
	International Corres. Schools	3rd Cover, 104
24	International Crystal Mfrs.	16
33	E. F. Johnson Co.	85-88
29	Kedman Tools	36
38	Lafayette	40
35	Locksmithing Institute	24
	Macrocoma Co.	98
28	Midland Electronics	18
11	Kurt M. Meyer	95
	McGee Radio	8
	National Radio Institute	10-13
	National Technical Schools	20-23
12	Newtronics	14
21	Pace Div., Pathcom Co.	35
34	Pearce-Simpson	27
41	Perma-Power Div., Chamberlain Mfg.	96
14	Progressive Edu-Kits	5
4,32	Radio Shack	4th Cover, 37, 39, 99
	Relco	98
15	Royce Electronics	9
26	Howard W. Sams	19
16	Shakespeare Antennas	8
22	Siltronix	29
	Star-Tronics	98
17	Tab Books	28
23	Tri-Star Corp.	36
	Vintage Radio	102
	Western Radio	98

**YOU'RE THE SOLUTION  
TO WATER POLLUTION**

Are you,  
of all people,  
still opening  
your garage

the  
hard  
way?



## Anybody who's into electronics

certainly should be getting the everyday convenience and family security of automatic garage door operation... especially now, with Perma Power's great Electro Lift opener... made to fit in the trunk of your car, designed for easy handling and simple do-it-yourself installation. Available now at a surprisingly low price from your distributor.



**P.S.** Show off your opener to your friends and neighbors. You'll probably be able to pay for yours with what you make installing openers for them.

**Perma Power**

Chamberlain Manufacturing Corporation  
Perma Power Division  
5740 North Tripp Avenue, Chicago, Illinois 60646  
Telephone (312) 539-7171

CIRCLE 41 ON READER SERVICE COUPON

known frequency, except now you "borrow" the known accuracy of your public utility line frequency. The 60-Hz power that you take from your wall socket is generally frequency controlled to within 0.1%. By using this known frequency, safely stepped down through a filament transformer, you can calibrate your signal generator frequency dial at any frequency that is a multiple of 60.

Connect the circuit shown. Then, beginning at 20 Hz, increase the frequency of your audio oscillator and observe how closely to the correct dial indication the scope display "locks in." After a while, say about 1800 Hz, you won't really be able to count the number of loops. But if you are careful you will be able to see the display stabilize, which indicates that you have reached the next multiple of 60.

### Kathi's CB Carousel (Continued from page 72)

grated circuits that provide a special automatic identification code for each and every CB transceiver to be sold in the future.

Here's how it will be done. The identifier IC will be built into the transceiver and will transmit a rapid identifier signal when the PTT is pressed or when it is released (most likely at the instant each transmission is started). Each identifier will have its own code, reflected on both the warranty card and in FCC records. Therefore, to catch a bootleg operator, or any other violator, the FCC need only tape the transmission, and there will be the identifying signal. A quick check of the records will show who owns the rig.

Now you might think it will be possible to disable the identifier. Not so. The ones being tested right now include the audio or RF preamplifier. Disabling the identifier IC will instantly destroy the preamp, and the rig will be inoperative. While the IC will be warranted against a manufacturing defect, talk is that a deliberately zapped IC will have a service and replacement charge up to 50 percent of the cost of the transceiver. That is, if you spend \$250 for the transceiver and blow the IC trying to eliminate the identifier it might cost you up to \$125 (plus shipping charges) to get the rig working again. As further protection against illegal users, the distribution of "general replacement" or direct replacement identifier ICs through distributors will probably be prescribed by law. You will have to get the part from the manufacturer, and he will provide the new code and the owner's name

Checking the stability of your frequency source is even easier. Simply adjust the frequency dial to obtain a stable display, and watch the display. After a reasonable warm-up time for the equipment, you should be able to obtain a display that seems to rotate very slowly, if at all. Of course, this will be a function of unit quality. But it will give you a feeling for how much drift can be expected from your frequency source. Additional amounts can be attributed to the source of the unknown frequency.

The oscilloscope has always been the most useful tool available to the experimenter. Now you can use it to measure unknown frequencies, phase shifts, calibrate oscillators, check signal stability, and many other uses that will come to mind as you become familiar with Lissajous patterns. ■

and address to the FCC.

The question has been raised as to who will file the original identifier registration code with the FCC. Obviously, if the buyer can avoid filing the code he can beat the system. The original idea was for the manufacturer or importer to file the information from the warranty cards, but it's obvious the system could be beat by simply not filing the cards. Latest thought is the dealer will file the registration card with the manufacturer or importer, or directly with the FCC. It is a simple matter to get a law making it illegal for anyone to sell a transmitter without filing a registration.

**No 220 MHz.** It's amazing what a mere two megahertz can mean. When the proposed Class E CB band was scheduled for the middle of the amateur 220 MHz band, local ham radio clubs shot off protest letters to every politician they believed had some muscle. Now it looks like Class E CB—if it ever comes to pass—will be in the 218 to 220 MHz range, outside the Ham band. That's it! The last scream has been heard and the amateurs couldn't care less. Why couldn't someone have used his head for a change and scheduled Class E CB at 218 MHz to start with. Think of all the wasted paper, postage and effort we could have saved.

**No SSB.** The proposal to restructure Class D CB into SSB only (excepting channel 9) has met stiff opposition from the industry in general. As we predicted, the industry feels SSB-only would be the death-knell for Class D, resulting in a substantial loss of business, and right now the consumer electronics industry needs every sale it can get. Best guestimates of what will finally happen all focus on a slight expansion of the Class D band in the immediate

# LITERATURE LIBRARY

101. Kit builder? Like weird products? *EICO's* 1976 catalog takes care of both breeds of buyers at prices you will like.

102. *International Crystal* has a free catalog for experimenters (crystals, PC boards, transistor RF mixers & amps, and other comm. products).

103. See brochures on *Regency's* 1976 line-up of CB transceivers & scanner receivers (for police, fire, weather, & other public service emergency broadcasts).

104. *Dynascan's* new *B & K* catalog features test equipment for industrial labs, schools, and TV servicing.

105. Before you build from scratch, check the *Fair Radio Sales* latest catalog for surplus gear.

106. Get *Antenna Specialists'* catalog of latest mobile antennas, test equipment, wattmeters, accessories.

107. Want a deluxe CB base station? Then get the specs on *Tram's* super CB rigs.

108. Compact is the word for *Xcelite's* 9 different sets of midget screwdrivers and nutdrivers with "piggyback" handle to increase length and torque. A handy show case serves as a bench stand also.

110. *Turner* has two booklets on their Signal Kicker antennas. They give specifications and prices on their variety of CB base and mobile line. Construction details help in your choice.

111. *Midland Communications'* line of base, mobile and hand-held CB equipment, marine transceivers, scanning monitors, plus a sampling of accessories are covered in a colorful 18-page brochure.

112. The *EDI (Electronic Distributors, Inc.)* catalog is updated 5 times a year. It has an index of manufacturers literally from A to X (ADC to Xcelite). Whether you want to spend 29 cents for a pilot-light socket or \$699.95 for a stereo AM/FM receiver, you'll find it here.

113. Get all the facts on *Progressive Edu-Kits* Home Radio Course. Build 20 radios and electronic circuits; parts, tools, and instruction included.

115. *Trigger Electronics* has a complete catalog of equipment for those in electronics. Included are kits, parts, ham gear, CB, hi fi and recording equipment.

116. Get the *Hustler* brochure illustrating their complete line of CB and monitor radio antennas.

117. *Teaberry's* new 6-page folder presents their 6 models of CB transceivers (base and mobile): 1 transceiver for marine-use, and 2 scanner models (the innovative "Crime Fighter" receiver and a pocket-size scanner).

118. CBers, GC *Electronic's* 8-page catalog offers the latest in CB accessories. There are base and mobile mikes; phone plugs; adaptors and connectors; antenna switchers and matchers; TV1 filters; automotive noise suppressor kits; SWR Power and FS meters, etc.

119. *Browning's* mobiles and its famous Golden Eagle base station, are illustrated in detail in the new 1976 catalog. It has full-color photos and specification data on Golden Eagle, LTD and SST models, and on "Brownie," a dramatic new mini-mobile.

120. *Edmund Scientific's* new catalog contains over 4500 products that embrace many sciences and fields.

121. *Cornell Electronics'* "Imperial Thrift Tag Sale" Catalog features TV and radio tubes. You can also find almost anything in electronics.

122. *Radio Shack's* 1976 catalog colorfully illustrates their complete range of kit and wired products for electronics enthusiasts—CB, ham, SWL, hi-fi, experimenter kits, batteries, tools, tubes, wire, cable, etc.

123. Get *Lafayette Radio's* "new look" 1976 catalog with 260 pages of complete electronics equipment. It has larger pictures and easy-to-read type. Over 18,000 items cover hi-fi, CB, ham rigs, accessories, test equipment and tools.

127. There are *Avanti* antennas (mobile & base) for CB and scanner receivers, fully described and illustrated in a new 16-page full-color catalog.

128. A new free catalog is available from *McGee Radio*. It contains electronic product bargains.

129. Semiconductor Supermart is a new 1975 catalog listing project builders' parts, popular CB gear, and test equipment. It features semiconductors—all from *Circuit Specialists*.

130. There are over 350 kits described in *Heath's* new catalog. Virtually every do-it-yourself interest is included—TV, radios, stereo & 4-channel, hi-fi, etc.

131. *E. F. Johnson* offers their CB 2-way radio catalog to help you when you make the American vacation scene. A selection guide to the features of the various messenger models will aid you as you go through the book.

132. If you want courses in assembling your own TV kits. *National Schools* has 10 from which to choose. There is a plan for GIs.

133. Get the new free catalog from *Howard W. Sams*. It describes 100's of books for hobbyists and technicians—books on projects, basic electronics and related subjects.

134. *Sprague Products* has L.E.D. readouts for those who want to build electronic clocks, calculators, etc. Parts lists and helpful schematics are included.

135. The latest edition of *Tab Books'* catalog has an extensive listing of TV, radio and general servicing manuals.

137. *Pace* communications equipment covers 2-way radios for business, industrial and CB operations. Marine radiotelephones and scanning receivers are also in this 18-p. book.

138. *Shakespeare's* new pocket-size catalog lists and describes their full line of fiberglass CB antennas, mounts and accessories offered in 1976.

142. *Royce Electronics'* new full-color catalog updates information on their CB transceivers (base, mobile, handheld). It also describes new product lines—CB antennas and a VHF marine radiotelephone.

144. For a packetful of material, send for *SBE's* material on UHF and VHF scanners, CB mobile transceivers, walkie-talkies, slow-scan TV systems, marine-radios, two-way radios, and accessories.

145. For CBers from *Hy-Gain Electronics Corp.* there is a 50-page, 4-color catalog (base, mobile and marine transceivers, antennas, and accessories). Colorful literature illustrating two models of monitor-scanners is also available.

150. Send for the free *NRI/McGraw Hill* 100-page color catalog detailing over 15 electronics courses. Courses cover TV-audio servicing, industrial and digital computer electronics, CB communications servicing, among others. G.I. Bill approved, courses are sold by mail.

152. Send for the new, free descriptive bulletin from *Finney Co.* It features the Finco line of VOM multi-testers (and accessories) for electronics hobbyists and service technicians.

153. *MFJ* offers a free catalog of amateur radio equipment—CW and SSB audio filters, electronic components, etc. Other lit. is free.

154. A government FCC License can help you qualify for a career in electronics. Send for Information from *Cleveland Institute of Electronics*.

155. New for CBers from *Anixter-Mark* is a colorful 4-page brochure detailing their line of base station and mobile antennas, including 6 models of the famous Mark Heliwhip.

156. Send for *Continental Specialties* new bread-boarding prototest devices. They vary in prices from a mini-budget kit at \$19.95. Featured is the new logic monitor, giving information on what it does, how it works, and how to use it.

## Elementary Electronics Box 886, Ansonia Station New York, N.Y. 10003

Nov./Dec. 1975  
Not valid after April 16, 1976

Please arrange to have the literature whose numbers I have circled below sent to me as soon as possible. I am enclosing 50¢ for each group of 5 to cover handling. (No stamps, please.) Allow 4-6 weeks for delivery.

Indicate total number of booklets requested.

200  Enter my subscription for 9 issues at \$4.97. Bill me.  
201  Enter my subscription for 9 issues at \$4.97. Check enclosed.

Add \$ .78 in U.S. possessions and Canada; \$1.53 other countries.

101	102	103	104	105	106	107	108	110	111	112	113
115	116	117	118	119	120	121	122	123	127	128	129
130	131	132	133	134	135	137	138	142	144	145	150
152	153	154	155	156							

NAME (print clearly)

ADDRESS

CITY

STATE

ZIP

## SEMICONDUCTOR SUPERMART

FREE CATALOG

NAME BRAND—PRIME QUALITY SEMICONDUCTORS

- MOTOROLA
- NATIONAL
- HEP
- FAIRCHILD
- RCA
- SIGNETICS

Other Parts For Elementary Electronics Projects

CIRCUIT SPECIALISTS CO.

Box 3047, Scottsdale, AZ 85257

**FREE** Send For **FREE**

**CORNELL'S** New Color Catalog

48 Pgs. New Items

**CORNELL TUBES!**

**33¢** per tube

**36¢** per tube

ORDER FREE IF NOT SHIPPED IN 24 HOURS!

4219 E UNIVERSITY AVE. SAN DIEGO, CALIF. 92105

### "LISTEN IN" TO POLICE-FIRE RADIO CALLS IN YOUR CAR!

Works with Any Car—Portable or Home Radio! Just Plugs in - No wiring - 3 minute hookup! Switches instantly from regular radio to All Police - Fire - Emergency - Taxi - State - Gov't 2 way radio calls! Works Everywhere - Anytime! Dual Band 36-49 & 160-175 MHz.



**SEND ONLY \$2.00** (cash Ck. M.O.) and pay postman \$12.99 COD postage or send \$14.95 for PPd Del in USA. Complete with Special Antenna and Plug in for use with Any Home or Portable Radio! Full Instructions - 1 year Service Warranty - 10 Day Money Back Trial - Sold Only Direct from Factory.

WESTERN RADIO, Dept. BE-11 KEARNEY, NEB. 68847

### FIND BURIED TREASURE

Powerful electronic detector finds buried gold, silver coins, etc. Write or call for free catalog. Dealer inquiries invited.



Financing Available  
Phone day - night (713) 682-2728  
RELCO, Dept. DO-28

BOX 10839, HOUSTON, TEX. 77018

## STAR-TRONICS

INDUSTRIAL AND GOVERNMENT ELECTRONIC SURPLUS

PARTS & PIECES FOR SCHOOLS, SHOPS, HAMS & HOBBYISTS  
SEND FOR OUR LATEST ALL DIFFERENT MONTHLY PICTURE CATALOG. NOW!

Box 17127, Portland, Ore. 97217

### NEW! CONVERT TV TO 6 FT. WIDE SCREEN!

Easy Do-it-Yourself Kit

Project a giant 5'x6' picture onto wall or screen. B&W/Color. Kit contains detailed plans, Inst. and Precision Lens System. Only \$15.95 ppd., or write for free illustrated details.

The Macrocoma Co., Dept. 1X  
Washington Crossing, PA 18977

## CODE PRACTICE SET & TAPES



**TG-34 KEYS:** Code practice set used to reproduce signals previously recorded on inked paper tape. Variable speed motor, keying oscillator with speaker & phone jack. Power required: 115 V.

50/60 cyc. Comes in portable carrying case: 15 x 10 x 10". Wt.: 40 lbs. Used, serviceable: \$24.95. Checked: \$29.50.

### 15 TAPES TO A COMPLETE PRACTICE SET:

- |   |                        |
|---|------------------------|
| #1 thru #4 cover different groups of wide space letters | #9 12 WPM Coded/Gr.    |
| #5 Wide space numbers and letters                       | #10 12 WPM Tact./Mess. |
| #6 5 WPM Numbers & letters                              | #11 12 WPM Tact./Mess. |
| #7 7WPM Numbers & letters                               | #12 15WPM Tact./Mess.  |
| #8 10WPM Coded Groups of 5                              | #13 15WPM Tact./Mess.  |
|   | #14 20WPM Tact./Mess.  |
|   | #15 20WPM Tact./Mess.  |

TAPE PRICE: \$2.00 Each • All prices F.O.B., Lima, OH  
SEND TODAY FOR BIG FREE CATALOG! Dept. EE

## FAIR RADIO SALES

1016 E. EUREKA • Box 1105 • LIMA, OH • 45802  
CIRCLE 9 ON READER SERVICE COUPON

future . . . perhaps 10 new channels, and continued AM operation on at least the interstation channels, quite possibly all channels. There's very little information coming out of the FCC as this column is being prepared, but most folks with their fingers on the pulse of the CB business believe there's at least five years life left in the AM/SSB mix we now have; and five years is a long, long time where the government is concerned. Lots of changes can take place in five years. I wouldn't recommend you run and sell your AM gear yet. Fact is, the CB manufacturers have so much faith in CB as it exists that just about every outfit showed a whole new line at the recent Consumer Electronics Show (CES). The CB business is so good deliveries are running up to six months, and no one can get all the transceivers they can sell right now.

Why the sudden shortage of gear? Because unlike other electronic hobbies and interests with shrinking interest, CB grows every single month. The latest figures showed an average of 100,000 new CB license applications monthly.

CB has become so big you can now find CB transceivers sold in discount department stores. One manufacturer is even offering a combination radio/tape player/CB transceiver for cars and trucks.

Anyway, that's all from the rumors and guestimates this month. Next month we hope to have a review of one of the hot new transceivers shown at CES.

Be sure to look over the new rules which became effective September 15, 1975. They include the use of CB channel eleven for calling only, the deletion of the hobby restriction section, new simplified call sign procedures and more. ■

## Peak Reading Meter

(Continued from page 76)

+24 volt connections to each meter.

Finally, connect each output from the PC board to the associated meter input terminal. Take extra care you get it right. Both the audio and DC connections to the meter are marked + and "-" that's all. Use the supplied meter instructions to locate the audio and DC terminals (the audio input terminals are located at the top of the meter). If you want pilot lamp operation connect the lamp terminals to power transformer T2. (The pilot lamp terminals are the set on the bottom of the meter.)

**Avoid Damage.** To avoid possible damage to the meter, which will be expensive, we suggest that the following checks be made as you make each connection. After BR1 and C are installed, temporarily connect T1 and see if you get about 34 DC volts across C7. Install IC1 and C8 and check for +24 volts at the output terminals; then complete the PC board wiring. After the PC board is installed, but before connecting the meters, make certain you can measure +24 volts from the PC terminals to the chassis (cabinet). If not, you have an open ground on the input wire shield. If everything checks out, then connect the meters.

**Checkout.** Turn power switch S1 off. Set the calibration potentiometers (R1 and R2) to full counterclockwise (off). Connect one left and right input jack to any high level signal source such as a signal generator, FM tuner, or tape recorder output. The signal can be mono or stereo; it doesn't matter.

Plug in the power cord and turn power on by closing S1. If all is okay, the meters will pin; pinning the meters when power is first applied is normal operation. The meter pointers might settle back to zero or about -20 dB. Either is normal. If the pointers settle to -20 dB they should settle to zero after the first input signal is applied. Slowly advance the right and left calibrate controls; the meter pointers should start to rise and follow the peaks of the signal. Note that the pointers rise quickly and settle slowly. If you apply a tone burst the meters will still be settling relatively long after the tone is removed. This is normal, otherwise you'd go blind trying to follow the pointer when reading program material.

If you get any variation in the above, or the meters fail to give any indication, check for a wiring error. In particular, check Q1 and Q2.

**A Typical Use.** How you use the peak meter will be determined by your particular installation, but Fig. 2 shows how it usually can be done. Just bear in mind that once you set the peak meter calibration controls you must forget about any VU meter(s) built into the recorder. If you are using a Dolby processor, it goes *before* the peak meter.

If you know for certain your recorder's meter is calibrated so 0-VU is at tape saturation—and you can make this assumption if the recorder's manual does not say otherwise, or it doesn't specify a certain amount of headroom—feed a steady tone onto the recorder and adjust the recorder's level controls for a 0-VU meter reading. The tone can come from a Dolby calibration tape, from another recorder, or from one of the many stereo test records. If

(Continued on page 102)



# NEW FREEDOM OF SPEECH on your phone with Radio Shack's DUOFONE electronic telephone amplifier

Amplifies calls to  
room filling volume!



only  
**29<sup>95</sup>**  
per set



Executives — everyone can  
join in conference calls

Mom — calls are no  
longer an interruption

Dad — talk while you  
enjoy your hobby



## Hands-free use — talk to callers like they're in the room with you

DUOFONE is the first low-cost telephone amplifier system to let you write, work, even walk around as you talk on the phone. An ultra-sensitive microphone picks up your normal conversational voice from anywhere in an average room. And a direct-coupled amplifier lets you hear the caller's voice as clearly as listening to a radio. It's great when someone special calls. Your whole family or group can take part in the conversation without waiting

turns to get at the phone. So easy to use you can answer incoming calls without even taking your telephone off the hook. Volume control, solid-state circuitry, reliable battery power, stylish molded cabinets for mike and amplifier/speaker. System includes cables and special Jack-In-A-Plug connector for instant installation in most homes or offices. #43-270. There's only one place you can find it . . . Radio Shack!

## FREE New 1976 Radio Shack Catalog

OVER 2000 PRODUCTS  
EXCLUSIVES ON EVERY PAGE  
There's a Copy Waiting For You  
At Your Nearby Radio Shack —  
Come In Today!

164 pages of the finest in home and hobby electronics. Respected names like Realistic, Micronta, Archer, Science Fair — and they're available only at Radio Shack stores and dealers nationwide! See what's really new!



Stereo • Quadraphonic • Phonographs  
TV Antennas • Radios • Citizens Band  
Educational Kits • Amateur Radio  
Auto Tune-Up • Batteries • Wire  
• And Much More!

603

## Freedom of travel, too! DUOFONE automatic telephone answerer

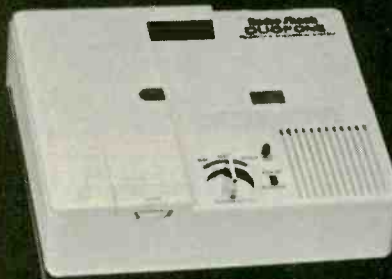

Never miss another call while you're away. DUOFONE answers up to 20 calls with a 15-second message recorded in your own voice. And it records each caller's reply. Change your message anytime using the built-in recorder. With batteries, adapter for hookup to most standard private line phones with-  
out rewiring. #43-250 **79<sup>95</sup>**

Customer-owned equipment directly connected to telephone, company equipment is subject to extra charges.



Master Charge or  
BankAmericard at  
participating stores

# Radio Shack®

A TANDY CORPORATION COMPANY

OVER 3500 STORES • 50 STATES • 7 COUNTRIES  
Retail prices may vary at individual stores.

CIRCLE 32 ON READER SERVICE COUPON

# Classified

# MARKET

ELEMENTARY ELECTRONICS—is published Bi-monthly. The rate per word for CLASSIFIED ADVERTISEMENTS is \$1.15 payable in advance—minimum ad \$15.00. Capitalized words 40¢ per word additional.

## ADDITIONAL INCOME

**AEROSOL FIRE EXTINGUISHERS** \$2.98 and \$3.98. Distributors quantity price 87½¢ and 99½¢. Sample of each \$4.50. Trial Case of each \$34.50 Postpaid. **AUTOMOBILE SIXTY SECOND TIRE FIXER**. No Tools, No Jack—Dealers Invited. Sample and Details, \$4.95. Trial Case \$35.00 Postpaid. Warren, 6922 Congress, Detroit 48207.

## AGENTS WANTED

**ATTENTION!** Salesmen—Distributors \$500.00 Weekly Possible. Selling fine handcrafted jewelry by mail or direct. For information Send \$1.00 handling charges. Spurling Enterprises, P.O. Box 2297 Terminal Annex, Los Angeles, CA 90051.

## AUTHOR'S SERVICE

**PUBLISH** your own book! Join our successful authors: publicity advertising, promotion, beautiful books. All subjects invited. Send for free manuscript report and detailed booklet. Carlton Press, SMW, 84 Fifth Avenue, NY 10011.

## BIG MAIL

**RECEIVE** mail galore! National listing \$1.00. Sullins, Box 1313-EE, Brunswick, GA 31520.

## BLUEPRINTS, PATTERNS & PLANS

**NEW CRAFT PRINT CATALOG**—Choose from over 100 great easy-to-build plans. Send \$1.25 (completely refunded with your first order). **BOAT BUILDER**, (CP Div.)—229 Park Avenue South, New York, NY 10003.

## BOOKS & PERIODICALS

**LIVE LONGER!** Booklet reveals secrets of a long and healthy life. Just \$1.50. Homan, Bivalve, MD 21814.

**FREE** Illustrated Gift Catalog. Save Many Dollars. Write: Skelton Enterprises, 4438 Garden Homes, Los Angeles, CA 90032.

**INFORMATIVE HANDBOOK**—For people with an interest in electronics and desire to know more. Covers basic electricity, resistors, capacitors, micro-waves, facts on frequency, about fuses, circuit breakers, crystals and much more. Send \$1.50 for your copy (includes postage) to: Electronics Theory Handbook, 229 Park Avenue South, N.Y., N.Y. 10003.

## BUSINESS OPPORTUNITIES

**MAKE** Magnetic Signs. Big Profits. Details. Universal, Lenora, KS 67645.

**1000% PROFIT** Bronzing Baby Shoes. Free Literature. NBC-DG, Gower, MO 64454.

**HOW** To Make Money Addressing, Mailing Envelopes. Offer Details 15¢. Lindbloom Services, 3636 Peterson, Chicago 60659.

**FREE** Secret Book "2042 Unique, Proven Enterprises." Fabulous "Little Knowns" Work Home! HAYLINGS-E14, Carlsbad, CA 92008.

**ADDRESSERS**, Malters, Homeworkers needed! 50 Firms listed. Information: Rush 25¢ stamped addressed envelope. LBBS, P.O. Box 39087, Wanamaker, IN 46239.

**MAKE YOUR CLASSIFIED AD PAY**. Get "How to Write A Classified Ad That Pulls." Includes certificate worth \$2.00 towards a classified ad in this publication. Send \$1.25 (includes postage) to R. S. Wayne, Davis Publications, Inc., Dept. CL, 229 Park Avenue South, New York, NY 10003.

**BECOME** our Mail Order Distributor with \$150 investment. Free brochure. Audit Controls, 35 Brookside Av., Fair Lawn, NJ 07410.

**MAILORDER** Millionaire helps beginners make \$500 weekly. Free Report reveals secret plan! Executive IG11, 333 North Michigan, Chicago 60601.

**OWN** Your Own Business! Correspondence Club Magazine, Information. Details 25¢. Destiny, Box 5637-BC Reno, Nevada 98503.

**LAZY?** Produce oil portraits in seconds! Details 25¢. JiffyPortrait, 2830BY-Gaffey, San Pedro, CA 90731.

**ESTABLISH** successful mailorder business. Immediate, continuous income! Mears, G5363 Essex, Alexandria, VA 22311.

**ASK** For Money (never repay) International, 2148 Lawrence Drive, Benton Harbor, MI 49022.

## BUSINESS OPPORTUNITIES—Cont'd

**WE NEED GINSENG GROWERS!** \$3,000-\$30,000 annually! We Buy Your Crop. Send \$2. For seed sample and information. Glass's Ginseng Exchange, Box 336, Rochdale Station, Jamaica, NY 11434.

**BORROW ANY AMOUNT**. Enjoy A-1 credit. Keep money in bank, get 80% more. Send Stamp. Vernon, Box 75010-HH, Oklahoma City 73107.

**\$30.00 HUNDRED** Stuffing Our Circulars Into Stamped Addressed Envelopes. Immediate Earnings. Beginners Kit \$2.00 COLOSSI, 1433-61 Street, DC-10, Brooklyn, NY 11219.

**\$150 WEEKLY** stuffing our sales letter into stamped addressed envelopes. Immediate income! Details 25¢. Lily, Box 4967-FSN, NYC 10017.

**\$500 WEEKLY**—Guaranteed Easy, Immediate Spare-time earnings at home—Free Proof. Research, Box 90133IO, Atlanta, GA 30344.

How to Write a Classified Ad That Pulls  
What to Say and How to Say It  
Only \$1.25  
Worth Its Weight In Gold

**MAKE YOUR CLASSIFIED AD PAY**. Get "How to Write A Classified Ad That Pulls." Includes certificate worth \$2.00 towards a classified ad in this publication. Send \$1.25 (includes postage) to R. S. Wayne, Davis Publications, Inc., Dept. CL, 229 Park Avenue South, New York, NY 10003.

**NEW** Copyrighted home Business Addressing Envelopes. Fantastic Profits. Send Self Addressed Stamped Envelope. Mantor House, Dept. 8SM, Minna, N.Y. 13116.

**GET RICH** with Secret Law that smashes debts and brings you \$500 to \$2 million cash. Free report! Credit 4G11, 333 North Michigan, Chicago 60601.

**SWISS WATCHES**: Prices (CIF) from \$5.42. Credit accounts welcome. Catalogue Air-Mailed \$2.00. Albis Watches, P.O. Box 2924, 8023-Zurich, SWITZERLAND.

**BIG PROFITS** in becoming a supplier to major industry through electroplating small parts and metalizing non-metals. Write for free particulars: Mason, Room MC-107-EM, 1512 Jarvis, Chicago, IL 60626.

**COLLECT** Names. Earn \$300 Per Thousand possible. Also 50 free dealerships available. Send 25¢ and stamped addressed envelope. Baker, 6550 Bellaire #201, Houston, TX 77036.

**SAVE MONEY!** (4) Wholesale Catalogs, Christmas Items. \$2.00 REFUNDABLE first order. Winchester Enterprises, 2807SS Hargrave Street, Phila, PA 19136.

**ADDRESSERS-MAILERS** Homeworkers Needed! 50 Firms Listed. Information: Rush 25¢, Stamped, Addressed Envelope. CE Webb, 501 East 15th, Ada, OK 74820.

**SELL** BOOKS by Mail 400% Profit. Free Details. Write: Tate's Enterprises, 9333 S. Merrill, Chicago, IL 60617.

**FREE** Moneybook! "Millionaires Success Secrets." Get your copy today! J. Radford, Box 387, Lincolnton, NC 28092.

**EASY** Money! Collect names earn \$300 per thousand. Send 25¢ stamped addressed envelope. Business Opportunities, 7250 Chef Menteur Hwy., B6, New Orleans, LA 70126.

**STUFF** Envelopes, \$300 Weekly possible. Send stamped envelope. R. Gantt Enterprises, 1122-B S. Sycamore, L.A., CA 90019.

## BUSINESS OPPORTUNITIES—Cont'd

**\$800 MONTHLY** Possible—stuffing envelopes. Start immediately!! Details \$1.00 (Refundable). Elamco, B1137-C2, Waldo, AR 71770.

**\$100.00 DAILY!** NO DIRECT SELLING. BURNS, 156H SO. ARLINGTON, EAST ORANGE, N.J. 07018.

**ELECTRONIC** Assembly Business. Big Profits. Start home, spare time. Investment, knowledge, experience unnecessary. Free illustrated literature. Barta, Box 248AZW, Walnut Creek, CA 94597.

**\$30.00 PER** hundred addressing envelopes. Immediate earnings. Beginners instructions \$1.00 (Refundable). Neal Gold, Room 406, 205 East 85th St., New York, N.Y. 10028.

**YEAR AROUND INCOME!** Operate Bookkeeping & Tax Service. Business Complete Manual of Instructions \$4.95 Guaranteed. LONDON DP, Box 323, Redondo Beach, CA 90277.

**BIG** Profits from small investment. Details \$10.00. Ducky Enterprises, Box 285, Brewer, ME 04412.

## BUY IT WHOLESALE

**SAVE MONEY!** Bargain hunters, jobbers, wholesalers, Opportunity seekers. Lists, Catalogs, unusual items. \$2.00 refundable first order. Winchester Enterprises, 2807SS Hargrave Street, Philadelphia, PA 19136.

**WHY PAY RETAIL?** Save \$300.00-\$500.00 yearly on over 1,000 household and personal items. Wholesale-to-you! Free details!! Marketing, 1338 Bennett, Dept. 4112-D, North Madison, OH 44057.

## CATALOGS

**FREE** Bargain Book Catalogs: Self-Improvement, How-To, Mailorder, Fiction. National, Box 402, Flushing, N.Y. 11352.

## DETECTIVES

**CRIMEFIGHTERS!** Investigators-Detectives-Police. Catalog \$1.00. Refundable. Don-Q, Box 548, Seattle, Washington 98111.

## DO IT YOURSELF

**SOLAR HOT WATER** can slice your fuel bill a bunch. Make me prove it. Free professional details. Englund, P.O. Box 5074, Orlando, FL 32805.

**MAKE** Delicious Wines and Champagnes at home. Use standard household utensils only. Booklet contains easy directions and recipes. Satisfaction guaranteed. Delicious German Beer-making Booklet FREE with order. Send \$2.00. Rotay, 9504D Buck Lodge Court, Adelphi, MD 20783.

**FOR** the Garden enthusiast. Having problems? Here's a guide to help you select the right plants or vegetables and how to care for them. Send \$1.25 for 101 Great Garden Ideas. To: Davis Publications, Inc., 229 Park Avenue So., New York, NY 10003.

## EDUCATION & INSTRUCTION

**USED** Courses! Books! List 10¢. Smith's 124 Marlborough, Salem, MA 01970.

**COLLEGE** Degrees by Mail. Free Details Box 3195D, Pasadena, CA 91103.

**FREE** Details about highly effective and thorough course in Digital Electronics. Cost of course—\$10.00. Your success guaranteed or \$11.00 refunded! Dynasign. POB 60EE, Wayland, MA 01778.

**UNIVERSITY DEGREES BY MAIL!** Bachelors. Masters. Ph.D.s. Free revealing details Counseling. Box 1425-EE-11, Tustin, CA 92680.

**METRICS—MADE EASY!** Government approved illustrated booklet. Rush \$1.19. Raco Mallorder Mart, Dept. DP-11 437 Strathmore Rd., Havertown, PA 19083.

**LEARN BROADCASTING!** Become a disc jockey, get free tapes, records. Start own station today. Complete details free. Ernie, Box 5516GM, Walnut Creek, CA 94596.

**UNLOCK** Your Future. Become professional Locksmith by spare time homestudy. \$13 in an hour possible. All tools, equipment included. Facts free. Send name. Locksmithing Institute (homestudy). Dept. 1372-115, Little Falls, N.J. 07424.

THERE IS NO CHARGE FOR THE ZIP CODE—PLEASE USE IT IN YOUR CLASSIFIED AD

# PLACE

To be included in the next issue, please send order and remittance to R. S. Wayner,  
ELEMENTARY ELECTRONICS, 229 Park Avenue South, New York, N.Y. 10003

**ELECTRONIC EQUIPMENT & SUPPLIES**

FREE 36-page catalog, updated 5 times a year. Everything for the electronics hobbyist—from TV antenna wire to the latest stereo music equipment. ELECTRONIC DISTRIBUTORS, INC. 4900 N. Elston Ave., Chicago, IL 60630 EE-6.

POLICE CODES EXPLAINED! New report reveals all "10-Codes" and meanings. Also includes special Trucker's CB Codes. Essential with Scanners, CB receivers. Order Report R101-L1, \$2.00 Postpaid. Radio Research, Box 50406 Nashville, TN 37205.

**EMPLOYMENT INFORMATION**

AUSTRALIA—WANTS YOU!! 50,000 Jobs!! Paid transportation—Latest Information and Forms \$1.00. H & M, Box 780-F, Ft. Huachuca, AZ 85613.

WANT a new job? Tri-Job Opportunities 100 jobs in each category. Only 5¢ for each job listing. Check your category and send \$5.00 check or money order to: Tri-Job Opportunities, Box 686 D, Stafford, TX 77477—Engineering, —Edp., —Chemical, —Sales, —Financial, —Management, —Skilled Trades.

**FARMS, ACREAGE & REAL ESTATE**

GOVERNMENT LANDS DIGEST. A Monthly review of government Real Estate offerings throughout the U.S.A. Free subscription information!... DIGEST. Box 25561-DP, Seattle, WA 98125.

**FOR SALE—MISCELLANEOUS**

ELECTRONIC TV MIRACLE! ELIMINATES AN TENNAS, \$2.95. Stevenson, 805 W. 69th Street, Los Angeles, CA 90044.

**FOR THE HOME**

FOR anyone who wants the satisfaction and economy of repairing, furnishing and maintaining the furniture in his home. Send \$1.25 to FURNITURE, 229 Park Avenue South, New York, NY 10003.

**GIFTS THAT PLEASE**

GIFT CATALOG, Send 50¢ handling and postage. \$1.00 discount on first order. Interhol Enterprise Limited, 4601 Edouard Montpetit, Montreal, Canada H3W 1P5.

NOW! Prestige gift. Name engraved, woodtone background, white letters, gold base. Small — 1" high, maximum 18 letters and spaces, \$3.50. Large—2" high maximum 22 letters and spaces, \$7.25. Satisfaction Guaranteed. R & J Sign Co., Dept. 11, P.O. Box 741, Tenafly, N.J. 07670.

FREE Distinctive gifts catalog. Great selections, order your copy today! Delta Gift Shop, 521 Cross Street, Cairo, IL 62914.

UNIQUE Gifts. Money-making Booklets Information. Catalog \$1.00. Mae Distinctive Gifts, 1101 East 4 Avenue, Hialeah, Florida 33011.

**HI-FI EQUIPMENT**

CANADIANS—Free HI-FI discount catalog. Name brands, immediate delivery from our huge stock. Etc. Dept. AA, Box 741, Montreal "A".

**HOBBIES & COLLECTIONS**

FREE CATALOG: Electronic supplies—kits for the hobbyist. Low prices. Anklam Electronics, 4709 nth. 6th St., Wausau, WI 54401.

COLLECTORS! Original WWII German Helmets, \$21.95. Other Military collectibles. FREE CATALOG. Unique Imports, Dept. EE, 610 Franklin St., Alexandria, VA 22314.

**HOME WORKSHOP SUPPLIES**

25 WEEKEND BUILD-IT PROJECTS—Practical designs for home/shop buffs who enjoy working with wood, tools, materials and techniques. Send \$1.50 for your copy (includes postage) to Davis Publications, Inc., 229 Park Avenue South, New York, NY 10003.

**HOME WORKSHOP SUPPLIES—Cont'd**

NUTS, Bolts, Screws, Assortment, Washers, Catalog 75¢. Nutty Co., 1576SMS, Fairfield, CT 06430.

**HYPNOTISM**

AMAZING self hypnosis record releases fantastic mental power. Instant results! Free trial! Write: Forum (AF11), 333 No. Michigan, Chicago 60601.

FREE Fascinating Hypnosis Information! Startling! DLMH, Box 487, Anaheim, California 92805.

**IMPORT-EXPORT**

IMPORT-EXPORT Booklet tells how. Directory of Foreign Suppliers. \$1.50. Cornell Gifts, 9906 E. Flower #1, Bellflower, CA 90706.

**MAGNETS**

FREE flexible magnetic strip with, 20 disc, or 10 bar, or 2 stick, or 8 assorted magnets, \$1.00. Any 5 sets \$4.50. Magnets, Box 192-PE, Randallstown, MD 21133.

**MISCELLANEOUS**

UNIQUE COLLECTION TECHNIQUE for Business with pastdue accounts. Rush \$1.00 for Free Guide. Write: Raymond Fry, 1702 S. Palm, Ontario, CA 91761.

POSTAGE brings Profitable Fifty Stars. Johnnie's, 2619 Hearststone, Parma, OH 44134.

THE MAGIC OF THINKING BIG! Skyrocket your income! Don't gamble success—riches. Achieve financial security, prestige and greater enjoyment. Book \$2.00. Claymont House, (M51), 112 Wilmington Pike, Glen Mills, PA 19342.

**MONEYMAKING OPPORTUNITIES**

STUFF MAIL ENVELOPES!! \$250.00 profit per thousand possible. Offer details: Stamped self-addressed envelope. Kings, B-21487K-115, Ft. Lauderdale, FL 33316.

HOW to Make Money Writing Short Paragraphs. Information Free. Barrett, Dept. C-21-D, 6216 N. Clark, Chicago 60660.

\$1,000 MONTHLY!! Stuffing Envelopes And Clipping Newspaper: Send Stamped Addressed Envelope. JOY, Box 936-A, Hyattsville, MD 20783.

NEW Copyrighted home Business Addressing Envelopes. Fantastic Profits. Send Self Addressed Stamped Envelope. Mantor House, Dept. 8SM, Minoa, N.Y. 13116.

MAKE YOUR CLASSIFIED AD PAY. Get "How to Write A Classified Ad That Pays." Includes certificate worth \$2.00 towards a classified ad. Send \$1.25 (includes postage) to R. S. Wayner, Davis Publications, Inc., 229 Park Avenue South, New York, NY 10003.

NEW Spare Time Fantastic Import Export Without investing. \$1.00. MA Distinctive Gifts, 1101 East 4 Avenue, Box 1561, Hialeah, FL 33011.

\$300 DAILY In Your Mailbox—Free Report reveals wealth-building secrets. Saffar, Box 901331O, Atlanta, GA 30344.

37 WAYS to make money when you are out of work. Details Free. R&R Investment Co., 729 Treat Blvd., Tallmadge, OH 44278.

STUFF Envelopes, \$25.00 Hundred, Start immediately! Rush Stamped Envelope. United, 3838 1/2 Van Dyke, San Diego, CA 92105.

MAILORDER! \$2,000 MONTHLY POSSIBLE WORK HOME... EVENINGS ONLY! Free proof. Associates, Route 3-D8, New Sharon, IA 50207.

\$\$\$\$\$ EXTRA! List of Self Improvement books, send 50¢ (refundable) to: J. P. Hall, 7305 Bay Street, Dept. A, St. Petersburg Beach, FL 33706.

STUFF Envelopes, \$25.00 Hundred, Free Supplies. Send Stamped envelope. Isco, 3835A 42nd, San Diego, CA 92105.

**MONEYMAKING OPPORTUNITIES—Cont'd**

\$1,000 MONTH Mailing Letters. Guaranteed. Details. 25¢ Sandco-IO, Ceres, CA 95307.

PROFITS from Penny Stocks. Free Information. Analyst-DPB, Box 534, Camino, CA 95709.

UNUSUAL hobby could bring you a FREE trip around the world, or \$50,000.00. Get the facts. \$1.50. Bobbie's Boutique, Dept. 11HA, 102 Shore Drive, Branford, CT 06405.

YOUR name sent to 250 firms seeking homeworkers. Be flooded with money-making offers. Save \$25, postage. Rush \$2.00 (refundable). Snyders, Box 2113Z Greenville, N.C. 27834.

STUFF Envelopes, \$25.00 Hundred, Free Supplies. Send stamped envelope. Isco, 3835A 42nd, San Diego, CA 92105.

\$\$\$\$\$ For your know-how! Sell it by mail. Get details. Data Search, 5 Kelly Pky., Bayonne, N.J. 07002.

FREE, The Way to Success. SPECIAL BULLETIN, Order now! Don't delay. Golden, Drawer C 6147, Texarkana, TX 75501.

EXTRA Income! Compile Information in your area. No experience necessary. Details 25¢. Oyewole, Box 4577, New York, N.Y. 10017.

LEARN secrets for Financial Success! "Library of Wealth-Building Information." \$1.00 postage/handling. T. R. Enterprises Dept. 5603, 4115 Kirkham, San Francisco, 94122.

MAIL Commission Circulars—keep 50%. details 25¢. Floyd's, Box 98, Venice, IL 62090.

EXCEPTIONAL PROFITS installing professional grade, silent, police-calling holdup & burglary alarms. We show you how—fast. Write: Garrison Protective, B-350, 42-55 Couden, Flushing, NY 11351.

**MUSIC & MUSICAL INSTRUMENTS**

FREE RECORD COLLECTION—Reviewers wanted. Each month we ship you new record releases to rate. Anyone can qualify. All you pay is postage. You pay nothing for the records. Applicants accepted on first come basis. Write: Music Research, 6162 Washington Circle, Milwaukee, WI 53213.

**PERSONAL**

JAPANESE introductions! Girls' photographs, descriptions brochure, details, \$1.00. INTER-PACIFIC Box 304-SC, Birmingham, MI 48012.

HANDWRITING ANALYSIS \$10.00. Be A Winner. Write: Scriptara, Box 179, Milwaukee, WI 53201.

SINGLE? Widowed? Divorced? Nationwide Introductions! Identity, Box 315-DC, Royal Oak, MI 48068.

JAPANESE Girls Make Wonderful Wives. We have large number of listings. Many interested in marriage. Only \$1.00 brings application, photos, names, descriptions, questionnaire. Etc. Japan International, Box 1181-AA, Newport Beach, CA 92663.

"DATE WITH DIGNITY" Professional Matching. Drawer 6765, Fort Worth, 76115 (817) 921-0281 Anytime.

BEAUTIFUL MEXICAN GIRLS Wanting American Boy-Friends. Details. Photos "Free." World, Box 3876-DC, San Diego, CA 92103.

A serious, informative, entertaining magazine covering just about every topic of interest to hikers. Includes a "Buyers' Guide to Equipment" and a "Beginners Section" for those who want to learn about hiking and backpacking. Send \$1.60 (includes 25¢ for postage/handling) to: Backpacking Journal, 229 Park Avenue South, New York, NY 10003.

PLEASE Be sure to include your zip code when ordering merchandise from classified advertisements. You'll receive faster delivery.

**MORE**

## For Greater Classified Savings... Results... and Profits...

Place your ad in one of our SPECIAL COMBINATIONS: Combo #1, Combo #2 or Combo #3. Each Combination is designed to give your ad the largest audience available. For further information write to R. S. Wayner, Classified Advertising Manager, Davis Publications, Inc., 229 Park Avenue South, New York, N.Y. 10003.

# Classified Continued

## PERSONAL - Cont'd

1001 LONELY LADIES PHOTOS in world's largest marriage partner catalog-\$5. Intercontact: Box 737, Lauderdale 33302 or Box 12, Toronto M4A 2M8.

FEEL BETTER! Easy common sense diet program. \$1.00. Jon Dee Associates, 7610 Penn Avenue South #218H, Richfield, MN 55423.

'X-RATED' Films, Magazines, Cards, Specialties! Fabulous Catalog! Explicit Photos! Rush 50¢ Hand-dling. M. B. Imports, Box 237L, Bronx, NY 10463.

CUBAN Cigars. Hand-Rolled Tampa. Brochure. Guaranteed. Boutique, 8501-I Woodburn, Tampa, FL 33615.

X-FILMS-Lovelace, Others. Sample \$1.00 (Refundable). Action, 217DP, Port Richey, FL 33568.

## PHOTOGRAPHY-PHOTO FINISHING & SUPPLIES

SAVE HUNDREDS OF DOLLARS!!! Make your own S & M Densitometer. Send \$3.00 for detailed drawings and instructions. A must for successful photography in your darkroom. Order direct: S & M Instruments, Dept. EE11, 229 Park Avenue South, N.Y., NY 10003.

## PLASTIC & PLASTIC PRODUCTS

CASTOLITE pours like water, hardens like glass without heat. Crystal clear, colors. Embed flowers, seashells, mementos, anything. Make fine gifts. Reproduce your designs with flexible molds any shape, size. Profitable. Illustrated Manual and Mold Catalog \$1.00. CASTOLITE, Dept. 75L/EE, Woodstock, IL 60098.

## PRINTING, MIMEOGRAPHING & MULTIGRAPHING

SAVE 50% on printing. Directory of wholesale printing and office supplies sources \$3.00 for information. Hutchinson 10818-DBO Brentway, Houston, TX 77070.

CLUB Names, Designs, etc. Custom Printed On License Plates. Alco, P.O. Box 374, Sumter, S.C. 29150.

## RADIO & TELEVISION

TV TUBES 36¢ each. Send for Free 48 page color catalog. Cornell, 4217-W University, San Diego, California 92105.

A NEW CANADIAN MAGAZINE. "Electronics Workshop." \$5.00 yearly, sample \$1.00. ETWCO, Box 741 "A" Montreal, Canada.

ELECTRONIC TV MIRACLE! ELIMINATES ANTENNAS, \$2.95. Stevenson, 805 W. 69th Street, Los Angeles, CA 90044.

"DISTANCE Crystal Set Construction" Handbook-50¢. "Coil Winding"-50¢. Catalog 25¢, refundable. Laboratories, 1477-G Garden Grove, CA 92642.

FREE 1975 TECO Electronics consumer catalog. Hundreds of quality items. Amateur Radios, CB Radios, Antennas, Calculators, Audio, Etc. TECO Electronics, Dept. E, P.O. Box 1050, Garland, TX 75040.

DISCOVER how to avoid calling the serviceman. Save by servicing home equipment yourself. Send \$1.50 (includes postage) for magazine. RADIO-TV REPAIR-229 Park Avenue South, New York, NY 10003.

## SALESMEN-DISTRIBUTORS

AUTOMATIC Fishhooks, Profitable samples, \$2.00 (refundable), Arons, 61 Mastic Beach, New York 11951.

## SCIENCE & CHEMISTRY

FIREWORKS. Spectacular novelties. Simplified manufacturers textbook. \$5.00. Guaranteed. Tropic, Box 95M4, Palm Bay, FL 32905.

KITS. Beginner digital electronics. Electronic games. From \$7.75. Send Stamp. NBL-A, Box 1115, Richardson, TX 75080.

## SONGWRITERS

EXCITING offer! Send poems, songs. Crown Music, 49-RX West 32, New York 10001.

## STAMP COLLECTING

105 FLAG Stamps Free to Approval Applicants. W-B Stamps, Wilkes-Barre, PA 18703.

## START YOUR OWN BUSINESS

TAKES Little to start with. Make Over \$500.00 a Week. Free Brochure. Guaranteed. Brochure, Box 4321, Davenport, IA 52808.

## SURPLUS EQUIPMENT

GIANT Bargain Packed Canadian Surplus Catalogs \$1.00 Etc Electronics-DG, Box 741, Montreal "A".

## TIPS FOR THE HOME, ETC.

PRACTICAL tips for home, garden and workshop are in "1001 How-To Ideas." Send \$1.50 for your copy (includes postage) to 1001 How-To Ideas, 229 Park Avenue South, New York, NY 10003.

## WATCHES, WATCHMAKING & REPAIRING

WATCH and clock repairing books, tools, materials. Free catalog. North American, Box 77, IO-11, Fox River Grove, IL 60021.

# YOU'LL MAKE MONEY

# SAVE MONEY TOO— BY READING and ANSWERING THESE CLASSIFIED ADS



## RELAXING! REFRESHING!

TAKE A BREAK FROM TODAY'S PRESSURES -

Browse with us through the old days of wireless, radio and early TV.

Young or old, you'll be fascinated by our two great books VINTAGE RADIO (1887-1929) and A FLICK OF THE SWITCH (1930-1950). Just relax and wander through

thousands of pictures, many old ads and interesting stories of early radio. You don't have to be an expert to revel in these fine books.

Next, browse through our authentic reproduction of Gernsback's 1927 RADIO ENCYCLOPEDIA to meet the heroes (Who's Marconi?) and see the hardware (what's a coherer?) of early days.

Our RADIO COLLECTOR'S GUIDE will make you an "instant expert" as you go prospecting for those fine old collectible radios. Then you'll need Morris Beitman's 1926-1938 RADIO DIAGRAMS book to restore them. Also, we'll send you the diagram for any pre-1951 set for \$3.50.

NEW GIFT IDEA! BEAUTIFUL COLOR PRINTS from original artwork of the famous Progress in Electronics stamp set. Four different 8" x 10" prints with colorful matte backgrounds.

SEND TODAY to Vintage Radio, Dep't E, Box 2045, Palos Verdes, CA. 90274. Postage Paid. California residents add 6% tax.

- VINTAGE RADIO; \$7.95 hard-cover, \$5.95 handbook
- A FLICK OF THE SWITCH; \$9.95 hard-cover, \$6.95 handbook
- 1927 RADIO ENCYCLOPEDIA; \$12.95 hard, \$9.95 hndbk
- RADIO COLLECTOR'S GUIDE; \$4.45 handbook
- 1926-1938 RADIO DIAGRAMS; \$7.00 handbook
- COLOR PRINTS, Set of four; \$7.50 prints, \$18.50 Plaques
- Diagram for \_\_\_\_\_ radio @ \$3.50.

TOTAL \_\_\_\_\_

Name \_\_\_\_\_  
Address \_\_\_\_\_  
City \_\_\_\_\_ St. \_\_\_\_\_ Zip \_\_\_\_\_

TREAT YOURSELF TO A HOLIDAY GIFT -  
**1254 PAGES OF PLEASURE!**



## Peak Reading Meter

(Continued from page 98)

you have a signal generator, use it. Advance the peak meter's calibration control(s) so the peak meter shows 0 dB. Your system is now calibrated, and you should not disturb the setting of the recorder level controls. You will have to adjust the input signal before the recorder so the peak meter indicates 0 dB on signal peaks.

But suppose you can't, or have no way to control the input level to the

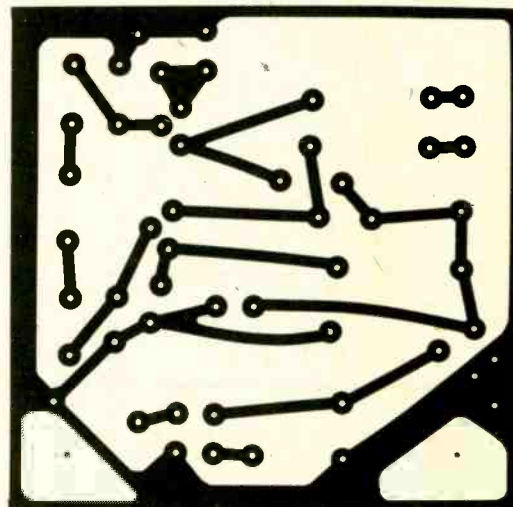

This is an actual size reproduction of the PC board.

recorder other than with the level controls? Then you use the Fig. 3 connections. The peak meter should connect either to the recorder's line output (if it has simultaneous monitoring of the record signal) or the headphone output if the line output is normally muted when recording. Most often, the line and/or headphone output is determined by the record level. Again, set the recorder's level control so a steady tone input signal indicates 0-VU record level and adjust the peak meter's calibration control for 0 dB. Since monitor line outputs of some recorders also have the record equalization, use a tone in the range of 400 to 1000 Hz for this adjustment. Once the peak meter is calibrated, you adjust the recorder's level controls for a 0 dB maximum reading—ignore the VU meter reading.

**Another Way.** If the recorder has headroom built into the meter calibration, you calibrate this way. Say the manual specifies there is 8 dB headroom. Set the recorder's level control for a 0-VU meter reading. Then advance the peak meter calibration control so -8 dB is indicated. You are now calibrated. When feeding program material (not a tone), you adjust the record level for a 0 dB (not -8 dB) peak reading. When the recorder is calibrated in this manner there might be some correlation between the VU and peak meter readings; but you always go by the peak reading.

If the peak meter is connected to the output terminals of a simultaneous playback recorder, such as a three head reel-to-reel deck, it will indicate both the source (input) and tape (output

levels), and there will be considerable confusion if you don't know whether you're set for source or tape monitoring. If the recorder has output level controls, it is best to equalize the meter readings in the following manner. Set the selector to *source* and calibrate the peak meter. Do not disturb the recording level control but set the selector to *tape monitor*. Then adjust the *playback* or *output* control so the peak meter shows the same reading as for source. (Tape down the output level control if necessary.) Now the peak meter readings will be correct whether you are monitoring the source or the tape.

Finally, we once again stress the most important point of peak metering. Pay no attention to any other meter. Adjust the recording level only for the peak meter. ■

## FCC Rules & Regs

(Continued from page 82)

(§95.83 (a) (5), (6), and (14)); operation by or on behalf of persons other than the licensee (§95.87); and duration of transmissions (§95.91 (a) and (b)) shall not apply.

(2) When used for transmission of communications necessary to render assistance to a motorist, the provisions of this part concerning directing communications to specific persons or stations (§95.83 (a) (6)); transmitting messages for other persons (§95.83 (a) (14)); and duration of transmissions (§95.91 (b)) shall not apply.

(New)

(1) When used for transmission of emergency communications certain provisions in this part concerning use of frequencies (§95.41 (d)); prohibited uses (§95.83 (a) (3)); operation by or on behalf of persons other than the licensee (§95.87); and duration of transmissions (§95.91 (a) and (b)) shall not apply.

(2) When used for transmission of communications necessary to render assistance to a traveler, the provisions of this Part concerning duration of transmission (§95.91 (b)) shall not apply.

### § 95.91 Duration of transmissions.

\* \* \*

(New)

(b) All communications between Class D stations (interstation) shall be restricted to not longer than five (5) continuous minutes. At the conclusion of this 5 minute period, or the exchange of less than 5 minutes, the participating stations shall remain silent for at least one minute.

(c) All communication between units of the same Class D station (intrastation) shall be restricted to the minimum practicable transmission.

(Note)

Old paragraphs (c) and (d) in Section 95.91 are redesignated as (e) and (f). Old paragraph (b) is to be deleted.

\* \* \*

### § 95.95 Station identification.

\* \* \*

(Old)

(Editor's Note: Old paragraph (c) which was very wordy and long has been amended. To save space, the old paragraph is not given here.)

\* \* \*

(New)

(c) Except as provided in paragraph (d) of this section, all transmission from each unit of a citizens radio station shall be identified by the transmission of its assigned call sign at the beginning and end of each transmission or series of transmis-

sions, but at least at intervals not to exceed ten (10) minutes.

\* \* \*

(New)

### § 95.119 Control points, dispatch points, and remote control.

(d) Operation of any Class C or Class D station by remote control is prohibited except remote control by wire upon specific authorization by the Commission when satisfactory need is shown. ■

## Barlow-Wadley

(Continued from page 71)

say to change the BFO pitch (frequency), it can be easily done by simply reaching it with an alignment screwdriver. The dial can be recalibrated, if necessary, with similar ease. We suggest the service manual (\$1.00) be ordered at the same time as the receiver.

**Summing Up.** The Barlow-Wadley XCR-30 crystal-controlled receiver delivered everything claimed and then some. It is an excellent main receiver for the SWL, an excellent "spare" or emergency receiver for hf amateurs, and an excellent choice for someone looking for quality performance at a modest price. (Its price tag of \$290 certainly isn't in the budget class, but it's worth every cent.)

The receiver is presently available only by mail order from Gilfer Associates, Inc., Box 239, Park Ridge, N.J. 07656. There is no indication if a matching AC power source is available from Gilfer. We would therefore suggest you ask what they recommend as an AC/DC converter if you plan to save on battery costs.

For further information circle No. 71 on the reader service coupon on page 17. ■

## ISN'T IT TIME WE DEFENDED OURSELVES AGAINST MUGGERS, RAPISTS AND ATTACKERS?

Will you be a victim of a criminal attack? Don't be afraid of going out anytime, anyplace. Defend yourself, your loved ones and your home against attackers with this high quality, dependable 8-shot non-lethal .22 caliber tear gas revolver. Fires 8 shots, in seconds, to stop one or even a gang of attackers instantly. Solid metal construction by skilled European craftsmen. Don't buy a cheap metal or plastic imitation that might misfire or jam when needed.



**ONLY \$24.98** ADD \$5.00 FOR 25 ROUNDS AND PREPAID, INSURED DELIVERY. NO C.O.D.'S PLEASE.

DEFENDER DEPT. A.258

• NEW CASTLE, DEL. 19720

FITS EASILY  
IN PURSE  
OR POCKET

CIRCLE 19 ON READER SERVICE COUPON



Wm.

Elect

NORRISTOV

Electric HEATING CONTRACTOR  
FLAMELESS  
ELECTRIC HEAT  
FOR COMPLETE COMFORT AND CONVENIENCE

CALL US FOR  
AND AN

7

# "Learn an honest trade," my old man used to say, "and you'll never have to knuckle under to any man."

(A TRUE STORY)

Bill De Medio of Conshohocken, Pa., has it made.

At 26, he's a licensed master electrician. The top of a trade where there aren't enough good men to go around.

But more important, Bill's his own boss and calls his own shots.

"I just went into my own business. And even before the sign on my truck was dry, I got my first big job.

"The contractor for a new group of houses asked me to do all the wiring. And there's bound to be a lot more work from him and other builders.

"If it wasn't for my ICS training as an electrician, I'd still be in some dead-end job—hating what I was doing, taking orders from everyone, and never getting any thanks for it.

"As a master electrician, you're the boss on the job—even when you're working for someone. You get respect, good money, and like my old man said, you don't have to take baloney from anyone."

## The right combination for success

Bill De Medio is one of our outstanding graduates. He's hard working. He's in a growing field. And he has good training.

Of course, we can't promise you'll be as successful as Bill—no school can guarantee jobs for its graduates. ICS can't make you smarter than you already are, and we can't make you ambitious if you're lazy.

But ICS can give you the first-rate training you need—especially if you're interested in one of the growing careers where ICS concentrates its training. Like Electrician. Engineer. Auto Mechanic. TV Repairman. Draftsman. Air Conditioning Serviceman. (Check your choice on the attached card.)

## An ideal way to learn

As an ICS student, you study at home, on your own schedule. You waste no time traveling to and from class. And you never have to miss a paycheck.

But you're never alone. Skilled instructors are always ready to help you.

If you ever have doubts or problems or just want to talk to an instructor, you can call ICS from anywhere in the continental United States, day or night, using our special toll-free Dial-a-Question® service.

## ICS training works

Since 1890, millions of men and women around the world have turned to ICS for career training.

More than 70 of America's largest 100 corporations (including Ford, U.S. Steel, Mobil Oil, GE and RCA) use ICS training for their own employees.

And the ICS Center for Degree Studies is authorized by the Pennsylvania Department of Education to award the Associate in Specialized Business Degree in Accounting and Business Management. These are 2-year college degree programs available entirely through home study.

## Free Demonstration Lesson

If you want more—more money, more security, more day-to-day satisfaction and more future—our free Career Guidance Booklet and free Demonstration Lesson can help you get started in the right direction. Just check the box next to the field that interests you most and mail the postpaid card today. There's no obligation.

Remember, it's your life. You might as well make the most of it.

©1975 Intext, Inc.

E

**ICS** International Correspondence Schools  
Scranton, Pa. 18515 XA801K

Please mail me the Free Career Guidance Booklet and Free Demonstration Lesson for the field I have checked below. I understand I am under no obligation.

- |   |  |
|---|--|
| <input type="checkbox"/> Electrician                      | <input type="checkbox"/> Automotive Mechanics    |
| <input type="checkbox"/> Engineering                      | <input type="checkbox"/> Business Management     |
| <input type="checkbox"/> Accounting                       | <input type="checkbox"/> Civil Engineering       |
| <input type="checkbox"/> Drafting                         | <input type="checkbox"/> Interior Decorating     |
| <input type="checkbox"/> Electronics Technician           | <input type="checkbox"/> Restaurant/ Club Mgt.   |
| <input type="checkbox"/> TV Service & Repair              | <input type="checkbox"/> Income Tax              |
| <input type="checkbox"/> Airline/Travel                   | <input type="checkbox"/> Motel/Hotel Mgt.        |
| <input type="checkbox"/> Surveying & Mapping              | <input type="checkbox"/> Mechanical Engineering  |
| <input type="checkbox"/> Construction Electrician         | <input type="checkbox"/> ICS High School Diploma |
| <input type="checkbox"/> Diesel Mechanic                  | <input type="checkbox"/> High School Equivalency |
| <input type="checkbox"/> Air Conditioning & Refrigeration |  |

Name \_\_\_\_\_ Age \_\_\_\_\_

Address \_\_\_\_\_

City \_\_\_\_\_ State \_\_\_\_\_ Zip \_\_\_\_\_

Telephone \_\_\_\_\_

## Earn a college degree

The ICS Center for Degree Studies is authorized by the Pennsylvania Department of Education to offer college programs at home leading to Associate in Specialized Business Degrees. For more information at no cost or obligation, check the degree of your choice.

- Accounting Degree  
 Business Management Degree

Canadian residents use Scranton, Pa. address for service from ICS Canadian, Ltd. In Hawaii: 931 University Ave., Honolulu, Hawaii 96814.

APPROVED FOR VETERANS' TRAINING.  
APPROVED FOR FEDERALLY INSURED STUDENT LOANS.  
ACCREDITED MEMBER NATIONAL HOME STUDY COUNCIL.

At 26, Bill De Medio has more freedom, more security, and gets more respect than guys twice his age. (Photograph by Frank Cowan.)

**Radio Shack**<sup>®</sup>  
A TANDY CORPORATION COMPANY

# 50%-OFF TAPE SALE\*

## TO GET YOU INTO REALISTIC SUPERTAPE<sup>®</sup> (even if you're there already)

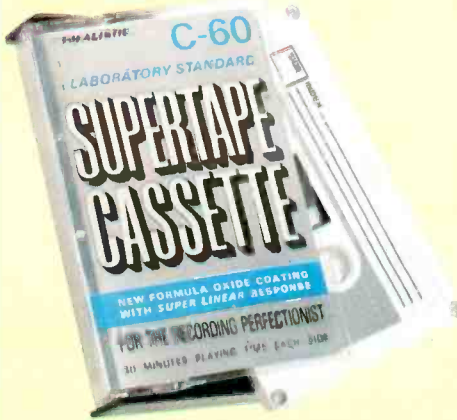

CASSETTE



OPEN REEL



8-TRACK

Join the big switch to Supertape and save a neat 50% on your trial order at any participating Radio Shack store or Dealer. It's made in our factory on the newest equipment and to the highest standard we could set. It's internationally sold and acclaimed. Let your recorder and your ears be the judge. Not our advertising. Not theirs. Try Supertape today. There's only one place you can find it . . . Radio Shack!

\*At Participating Radio Shack Stores and Dealers Now Through Nov. 30, 1975

Radio Shack's  
Own tape factory  
in Fort Worth, Texas



The nation's newest  
tape manufacturing operation  
devoted exclusively to audio tape

## CLIP COUPONS. BRING TO RADIO SHACK

605  
**GET ONE  
SUPERTAPE  
CASSETTE**

**AT NO EXTRA COST**

when you buy the same cassette at the regular price at any participating Radio Shack store or Dealer. Limit one. This coupon must accompany your in-person purchase. None sent by mail.

STORE # \_\_\_\_\_

Sale Ends Nov. 30, 1975.

605  
**GET ONE  
SUPERTAPE  
OPEN REEL**

**AT NO EXTRA COST**

when you buy the same reel at the regular price at any participating Radio Shack store or Dealer. Limit one. This coupon must accompany your in-person purchase. None sent by mail.

STORE # \_\_\_\_\_

Sale Ends Nov. 30, 1975.

605  
**GET ONE  
SUPERTAPE  
CARTRIDGE**

**AT NO EXTRA COST**

when you buy the same 8-track cartridge at the regular price at any participating Radio Shack store or Dealer. Limit one. This coupon must accompany your in-person purchase. None sent by mail.

STORE # \_\_\_\_\_

Sale Ends Nov. 30, 1975.

CIRCLE 4 ON READER SERVICE COUPON