

HOW TO INSTALL GAS SAVING CD IGNITION SYSTEMS

ELECTRONICS

©

02342

JULY-AUGUST
1975

\$1.00

elementary Electronics

FOR
BEGINNERS

HOW YOU MEASURE
ELECTRICITY

OUR BASIC COURSE

Your First RADIO Project!

Learn the fundamentals of AM Radio while building this sure-fire receiver. Up-to-date design uses inexpensive integrated circuit (IC) and field effect transistor to drive a 4-in. loudspeaker.

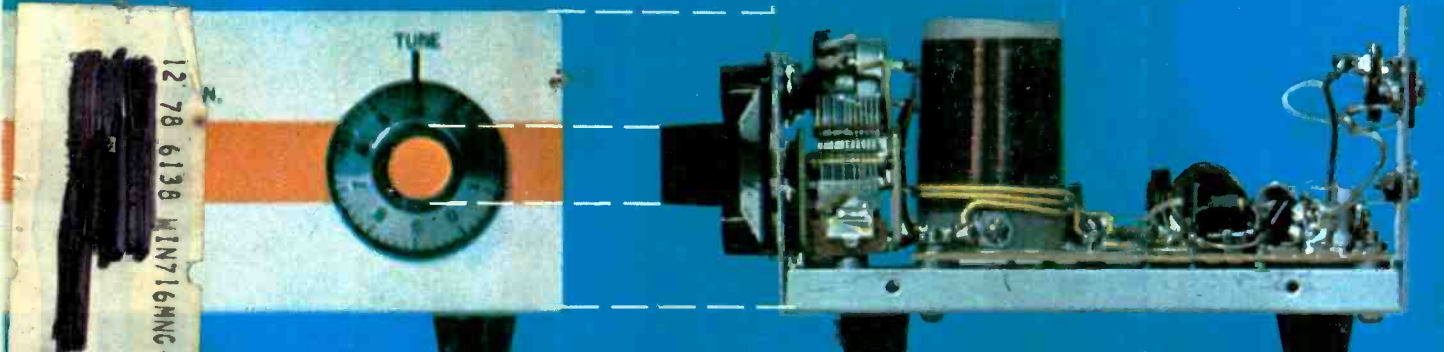
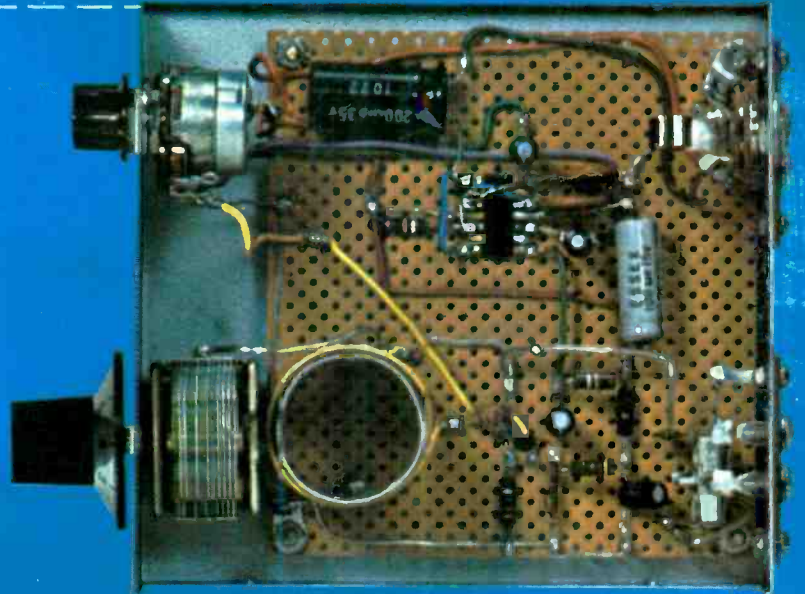

Test—

basic hi-fi system for kit builders on a budget
Radio Shack hands-off 2-way telephone amplifier
Egbert Electronics add-on Select Call for CB sets

**Hunting for
a better job?**

**CIE will
help you get
the license
you need**

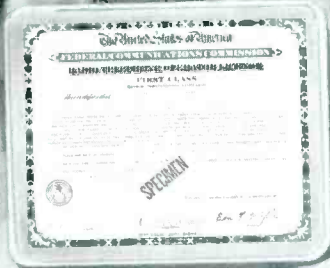

A Government FCC License can help you qualify for an exciting, rewarding career in ELECTRONICS, the Science of the Seventies. Read how you can prepare at home in your spare time to pass the FCC Licensing examination.

If you're out to bag a better job in Electronics, a Government FCC License can give you a shot at job opportunities with *real* futures.

According to the U.S. Office of Education Bulletin (4th Edition): "The demand for people with technical skills is growing twice as fast as for any other group, while jobs for the untrained are rapidly disappearing." There are new openings every year in many different industries for electronics specialists. And you don't need a college education to qualify.

But you *do* need knowledge . . . knowledge of electronics fundamentals. And one of the nationally accepted methods of measuring this knowledge . . . is the licensing program of the FCC (Federal Communications Commission).

Importance of an FCC License and CIE's Warranty of Success

If you want to work in commercial broadcasting . . . television or AM or FM broadcasting . . . as a broadcast engineer, federal law requires you to have a First Class Radiotelephone License. Or if you plan to operate or to maintain mobile two-way communications systems, microwave relay stations or radar and signaling devices, a Second Class FCC License is required.

But even if you aren't planning a career which involves radio transmission of any kind, an FCC "ticket" is valuable to have as Government certification of certain technical skills. It's a job credential recognized by some employers as evidence that you really know your stuff.

So why doesn't everyone who wants a good job in Electronics get an FCC License?

It's not that simple. To get an FCC License, you must pass a Government licensing exam.

A good way to prepare for your FCC License exam is to take one of the CIE career courses which include FCC License preparation. We are confident you can successfully earn your license, if you're willing to put forth an effort, because the vast majority of CIE students have. In fact, based on continuing surveys, close to 9 out of 10 CIE graduates have passed their FCC exams!

That's why we can offer this time-tested Warranty of Success: when you successfully complete any CIE career course which includes FCC License preparation, you will be able to pass the Government FCC Examination for the License for which the course prepared you or you will be entitled to a full refund of an amount equal to the cash price of tuition for CIE's Course No. 3, "First Class FCC License," in effect at the time you enrolled. This warranty is good from the date you enroll until the last date allowed for completion of your course.

CIE HAS CAREER COURSES THAT INCLUDE "HANDS ON" TRAINING

ELECTRONICS TECHNOLOGY with LABORATORY Courses . . . takes beginner from fundamentals to skills required of technician or engineering assistant. Includes Experimental Electronics Laboratory for "hands on" training.

COLOR TV MAINTENANCE and REPAIR . . . several CIE courses combine electronics theory with the actual construction, testing and troubleshooting a big screen, stolid state color TV.

With CIE you learn at home

With CIE, you learn in your spare time at home . . . or wherever else is convenient. No classroom time, ever. No one will make you go too fast . . . or too slow. With CIE's Auto-Programmed® Lessons you'll pick up facts, figures, and electronics theories you may have considered "complicated" . . . even if you've had trouble studying before.

You can have attractive job opportunities

There have already been many exciting developments and breakthroughs in Electronics and some people might assume there will be no new frontiers . . . no new worlds to conquer. Not so.

Electronics is still growing. In nearly every one of the new and exciting fields of the Seventies you find electronics skills and knowledge in demand. Computers and data processing. Air traffic control. Medical technology. Pollution control. Broadcasting and communications. Once you have the solid technical background you need, you can practically choose the career field you want . . . work for a big corporation, a small company or even go into business for yourself.

Yes, Electronics can be the door to a whole new world of career opportunities for you. And CIE training can be your key.

Send for FREE school catalog

Discover the opportunities open to people with electronics training. Learn how CIE career courses can help you build new skills and knowledge and prepare you for a meaningful, rewarding career. We have courses for the beginner, for the hobbyist, for the electronics technician, and for the electronics engineer. Whether you are just starting out in Electronics or are a college-trained engineer in need of updating (or anywhere in between), CIE has a course designed for you.

Send today for our FREE school catalog and complete package of career information. For your convenience, we will try to have a representative call to assist in course selection. Mail reply card or coupon to CIE . . . or write: Cleveland Institute of Electronics, Inc., 1776 East 17th Street, Cleveland, Ohio 44114. Do it TODAY.

APPROVED UNDER G. I. BILL

All CIE career courses are approved for educational benefits under the G.I. Bill. If you are a Veteran or in service now, check box for G.I. Bill information.

CIE Cleveland Institute of Electronics, Inc.

1776 East 17th Street, Cleveland, Ohio 44114
Accredited Member National Home Study Council

Cleveland Institute of Electronics, Inc.
1776 East 17th Street, Cleveland, Ohio 44114

Please send me your FREE school catalog and career information package today.

I am especially interested in:

- Electronics Technician
- FCC License Preparation
- Color TV Maintenance
- Mobile Communications
- Industrial Electronics
- Electronics Engineering
- Other _____

Print Name _____

Address _____ Apt. _____

City _____

State _____ Zip _____ Age _____

Check box for G.I. Bill information.

- Veteran
- On Active Duty

EL-58

elementary electronics

Dedicated to
America's
Electronics
Hobbyists

Including Electronics Digest®

SO YOU WANT TO KNOW MORE

- 48 How to Install a . . . Gas-Saving CD Ignition System ★
- 56 Antique Batteries Light Up this Museum—*here's a place that displays all kinds*
- 63 Fill 'er Up!—*electric cycles recharge during working hours*
- 77 When You Fill in this Gap—*build TV, learn electronics*
- 79 Basic Course—*how to measure electricity* ★

BUILDERS' ELECTRONIC BONANZA

- 41 Professional Power Supply—*match features and specs with lab-grade supplies*
- 57 B&W Printing Meter—*no-hue version of our popular color computer*
- 71 BGNRS FET IC BCB AM RCVR—*start with this one* ★

OUR COMMUNICATION SPECIALTIES

- 50 Action Band Receivers—*a compact and colorful display*
- 60 When CB Goes FM—*plain talk about this may-be mode*
- 62 Kathi's CB Carousel—*about a low-cost ear-pollution plug* ★
- 64 Antique Radio Corner—*readers request more McMurdo & Scott pictures*
- 69 e/e checks out a . . . Radio Shack Telephone Amp—*surprisingly inexpensive and effective* ★

MUSIC-SCIENCE SPECIAL

- 51 There's Math Behind that Sour Note—*of interest to all who play or listen*

SELECTED SOUND IDEAS

- 44 If You Think Turntables Haven't Changed . . . LOOK HERE
- 46 Upgrade That Cheapie Stereo for Higher Fi—*concentrates on compact speaker systems*
- 75 e/e checks out a . . . Budget Stereo System You Can Build Yourself ★

SHORTWAVE LISTENERS' SECTION

- 26 DX Central Reporting—*Don Jensen relays the world of shortwave listening*
- 66 It's Tough DXing the Second Circuit—*between the giants you'll find a homeland's radio heart*

MAILPOUCH ROUTE

- 17 Reader Service Page
- 92 Classified Ads—*bargain-hunting readers' flea market*
- 95 Literature Library—*here's where four bits fills your info file*

PLUS THESE REGULARS

- 7 Hey, Look Me Over
- 16 Ask Hank, He Knows!
- 18 Bookmark
- 35 Newscan
- 74 Oldies but Goodies—*our cartoon page*

★ Cover Features

• **Editor-in-Chief**—Julian S. Martin, WA2CQL • **Technical Editor**—Peter L. DEXNIS, WA3LOQ
• **Audio Editor**—Stephen B. Gray • **Associate Editor**—Jeffrey Apter • **News Editor**—
Rosina F. Sokolnicki • **Citizens Band Editor**—Kathi Martin, KGK3916 • **Workbench Editor**—
Hank Scott • **Art and Production Managing Director**—Gertrud Borchardt • **Graphic**
Design Director—Ralph Rubino • **Cover Art Director**—Irving Bernstein • **Art Assistants**—
John Harper, Kenneth Kummer, Joseph Orlando • **Advertising Director**—David J. Miller •
Assistant Production Editor—Philip Clark • **Newsstand Circulation Director**—Don Gabree
• **Subscription Circulation & Marketing Director**—Robert V. Enlow • **Instruments Division**
Manager—Wilfred M. Brown • **Director of Market Development**—James C. Weakley •
Electronics Group Coordinator—Julian S. Martin

• **President, Chairman of the Board (1957-1972)**—B. G. Davis • **President and Publisher**—Joel
Davis • **Vice President and General Manager**—Leonard F. Pinto • **Vice President and Treasurer**—
Victor C. Stabile, KBP0681

July-August 1975
Volume 15, No. 4

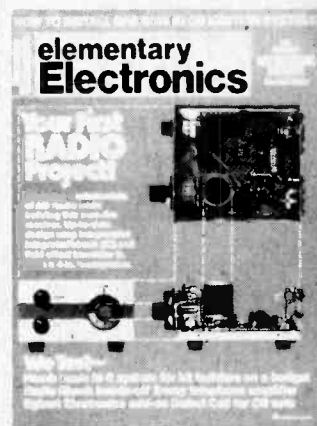

Cover Photo by Leonard Heicklen



AUTHORS IN THIS ISSUE

Peter DEXNIS, James A. Fred,
Herb Friedman, Stephen B. Gray,
Charles Green, Joe Gronk,
Jorma Hyypia, Don Jensen,
Kathi Martin, William Mont-
gomery, Ralph W. Perry, Jack
Schmidt, Hank Scott, David B.
Weems, and the ELEMENTARY
ELECTRONICS editorial staff.

ELEMENTARY ELECTRONICS is pub-
lished bi-monthly by Davis Publi-
cations, Inc. Editorial and Executive
offices: 229 Park Ave. So., New York,
NY 10003; all subscription orders and
mail regarding subscriptions should be
sent to P.O. Box 2600, Greenwich, CT
06830. One-year subscription (six is-
sues)—\$6.50; two-year subscription (12
issues)—\$13.00; three-year subscrip-
tion (18 issues)—\$19.00; and four-year
subscription (24 issues)—\$25.00. Add
\$1.00 per year for postage outside the
U.S.A., its possessions and Canada.
For change of address, please advise
4 to 6 weeks before moving. Send us
your current mailing label with new
address. Advertising offices: New
York, 229 Park Avenue South, 212-673-
1300; Chicago, 520 N. Michigan Ave.,
312-527-0330; Los Angeles, J. E. Pub-
lishers' Rep. Co., 8732 Sunset Blvd.,
213-659-3810. Second-class postage
paid at New York, NY and at additional
mailing office.

Copyright 1975 by
Davis Publications, Inc.

BUILD 20 RADIO

and Electronics Circuits

Reg. U. S.
Pat. Off.



Training Electronics Technicians Since 1946

PROGRESSIVE HOME RADIO-T.V. COURSE

Now Includes

- ★ 12 RECEIVERS
- ★ 3 TRANSMITTERS
- ★ SQ. WAVE GENERATOR
- ★ SIGNAL TRACER
- ★ AMPLIFIER
- ★ SIGNAL INJECTOR
- ★ CODE OSCILLATOR

- ★ No Knowledge of Radio Necessary
- ★ No Additional Parts or Tools Needed
- ★ EXCELLENT BACKGROUND FOR TV
- ★ SCHOOL INQUIRIES INVITED
- ★ Sold In 79 Countries

YOU DON'T HAVE TO SPEND HUNDREDS OF DOLLARS FOR A RADIO COURSE

The "Edu-Kit" offers you an outstanding PRACTICAL HOME RADIO COURSE at a rock-bottom price. Our Kit is designed to train Radio & Electronics Technicians, making use of the most modern methods of home training. You will learn radio theory, construction practice and servicing. THIS IS A COMPLETE RADIO COURSE IN EVERY DETAIL. You will learn how to build radios, using regular schematics, how to solder and solder in a professional manner; how to service radios. You will work with the standard type of punched metal chassis as well as the latest development of Printed Circuit chassis.

You will learn the basic principles of radio. You will construct, study and work with RF and AF amplifiers and oscillators, detectors, rectifiers, test equipment. You will learn and practice code, using the Progressive Code Oscillator. You will learn and practice trouble-shooting, using the Progressive Signal Tracer, Progressive Signal Injector, Progressive Dynamic Radio & Electronics Tester, Square Wave Generator and the accompanying instructional material.

You will receive training for the Novice, Technician and General Classes of F.C.C. Radio Amateur Licenses. You will build Receiver, Transmitter, Square Wave Generator, Code Oscillator, Signal Tracer and Signal Injector circuits, and learn how to operate them. You will receive an excellent background for television, Hi-Fi and Electronics.

Absolutely no previous knowledge of radio or science is required. The "Edu-Kit" is the product of many years of teaching and engineering experience. The "Edu-Kit" will provide you with a basic education in Electronics and Radio, worth many times the low price you pay. The Signal Tracer alone is worth more than the price of the kit.

THE KIT FOR EVERYONE

You do not need the slightest background in radio or science. Whether you are interested in Radio & Electronics because you want an interesting hobby, a well paying business or a job with a future, you will find the "Edu-Kit" a worth-while investment. Many thousands of individuals of all

ages and backgrounds have successfully used the "Edu-Kit" in more than 79 countries of the world. The "Edu-Kit" has been carefully designed, step by step, so that you cannot make a mistake. The "Edu-Kit" allows you to teach yourself at your own rate. No instructor is necessary.

PROGRESSIVE TEACHING METHOD

The Progressive Radio "Edu-Kit" is the foremost educational radio kit in the world, and is universally accepted as the standard in the field of electronics training. The "Edu-Kit" uses the modern educational principle of "Learn by Doing." Therefore you construct, learn schematics, study theory, practice trouble shooting—all in a closely integrated program designed to provide an easily-learned, thorough and interesting background in radio.

You begin by examining the various radio parts of the "Edu-Kit." You then learn the function, theory and wiring of these parts. Then you build a simple radio. With this first set you will enjoy listening to regular broadcast stations, learn theory, practice testing and trouble-shooting. Then you build a more advanced radio, learn more advanced theory and techniques. Gradually, in a progressive manner, and at your own rate, you will find yourself constructing more advanced multi-tube radio circuits, and doing work like a Professional Radio Technician.

Included in the "Edu-Kit" course are Receiver, Transmitter, Code Oscillator, Signal Tracer, Square Wave Generator and Signal Injector Circuits. These are not unprofessional "breadboard" experiments, but genuine radio circuits, constructed by means of professional wiring and soldering on metal chassis, plus the new method of radio construction known as "Printed Circuitry." These circuits operate on your regular AC or DC house current.

THE "EDU-KIT" IS COMPLETE

You will receive all parts and instructions necessary to build twenty different radio and electronics circuits, each guaranteed to operate. Our Kits contain tubes, tube sockets, variable, electrolytic, mica, ceramic and paper dielectric condensers, resistors, tie strips, hardware, tubing, punched metal chassis, Instruction Manuals, hook-up wire, solder, selenium rectifiers, coils, volume controls and switches, etc.

In addition, you receive Printed Circuit materials, including Printed Circuit chassis, special tube sockets, hardware and instructions. You also receive a useful set of tools, a professional electric soldering iron, and a self-powered Dynamic Radio and Electronics Tester. The "Edu-Kit" also includes Code Instructions and the Progressive Code Oscillator, in addition to F.C.C. Radio Amateur License training. You will also receive lessons for servicing with the Progressive Signal Tracer and the Progressive Signal Injector, a High Fidelity Guide and a Quiz Book. You receive Membership in Radio-TV Club, Free Consultation Service, Certificate of Merit and Discount Privileges. You receive all parts, tools, instructions, etc. Everything is yours to keep.

FREE EXTRAS

• SET OF TOOLS

- SOLDERING IRON
- ELECTRONICS TESTER
- PLIERS-CUTTERS
- VALUABLE DISCOUNT CARD
- CERTIFICATE OF MERIT
- TESTER INSTRUCTION MANUAL
- HIGH FIDELITY GUIDE • QUIZZES
- TELEVISION BOOK • RADIO TROUBLE-SHOOTING BOOK
- MEMBERSHIP IN RADIO-TV CLUB: CONSULTATION SERVICE • FCC AMATEUR LICENSE TRAINING
- PRINTED CIRCUITRY

SERVICING LESSONS

You will learn trouble-shooting and servicing in a progressive manner. You will practice repairs on the sets that you construct. You will learn symptoms and causes of trouble in home, portable and car radios. You will learn how to use the professional Signal Tracer, the unique Signal Injector and the dynamic Radio & Electronics Tester. While you are learning in this practical way, you will be able to do many a repair job for your friends and neighbors, and charge fees which will far exceed the price of the "Edu-Kit." Our Consultation Service will help you with any technical problems you may have.

FROM OUR MAIL BAG

J. Stataitis, of 25 Poplar Pl., Waterbury, Conn., writes: "I have repaired several sets for my friends, and made money. The "Edu-Kit" paid for itself. I was ready to spend \$240 for a Course, but I found your ad and sent for your Kit."

Ben Valerio, P. O. Box 21, Magna, Utah: "The Edu-Kits are wonderful. Here I am sending you the questions and also the answers for them. I have been in Radio for the last seven years, but like to work with Radio Kits, and like to build Radio Testing Equipment. I enjoyed every minute I worked with the different kits; the Signal Tracer works fine. Also like to let you know that I feel proud of becoming a member of your Radio-TV Club."

Robert L. Shuff, 1534 Monroe Ave., Huntington, W. Va.: "Thought I would drop you a few lines to say that I received my Edu-Kit, and was really amazed that such a bargain can be had at such a low price. I have already started repairing radios and phonographs. My friends were really surprised to see me get into the swing of it so quickly. The Trouble-shooting Tester that comes with the Kit is really swell, and finds the trouble, if there is any to be found."

Progressive "Edu-Kits" Inc., 1189 Broadway, Dept. 572DJ Hewlett, N.Y. 11557

PRINTED CIRCUITRY

At no increase in price, the "Edu-Kit" now includes Printed Circuitry. You build a Printed Circuit Signal Injector, a unique servicing instrument that can detect many Radio and TV troubles. This revolutionary new technique of radio construction is now becoming popular in commercial radio and TV sets.

A Printed Circuit is a special insulated chassis on which has been deposited a conducting material which takes the place of wiring. The various parts are merely plugged in and soldered to terminals.

Printed Circuitry is the basis of modern Automation Electronics. A knowledge of this subject is a necessity today for anyone interested in Electronics.

Please rush me free literature describing the Progressive Radio-TV Course with Edu-Kits. No Salesman will call.

NAME

ADDRESS

CITY & STATE ZIP

PROGRESSIVE "EDU-KITS" INC.

1189 Broadway, Dept. 572DJ, Hewlett, N.Y. 11557

CIRCLE 21 ON READER SERVICE COUPON

LIVE IN THE WORLD OF TOMORROW... TODAY!

And our FREE 180 PAGE CATALOG is packed with exciting and unusual values in electronic, hobby and science items — plus 4,500 finds for fun, study or profit... for every member of the family.



A BETTER LIFE STARTS HERE

SOLAR ENERGY CUBE!

Unique demonstrator dramatically shows how sunlight converts to kinetic energy. Clear plastic Solar Energy Cube placed in the sun with its 3 highly efficient silicon solar cells powers the motor to whirl the propeller! Unit actually produces 1.5v DC, 825ma. Same cells found in our mighty panels. Speed directly related to sunlight available. Nothing to wear out! Great for executives, hobbyists, teachers.
 No. 42,287EK (4 X 4 X 4") \$19.95 Ppd.



QUALITY DETECTOR UNDER \$40

New Edmund developed, fully transistorized BFO unit capable of locating quarter at 18"—powerful 6 trans. oscillator-amplifier circuit. Easily compares to others priced 50% higher! Aluminum pole and housing—not plastic! 6" waterproof search coil (Faraday shielded to eliminate outside interference); long 50 hr battery (9V) life; powerful 2" speaker; 1-knob on-off tune control. Perfect balance; lightweight (2 lb.) Great buy!
 Stock No. 80,222EK \$39.95 Ppd.



BUILD A SOLAR HOME AND SAVE!

Beat the energy crisis—build a modern 10 room solar heated & air conditioned home designed by famous ecological architect Malcolm B. Wells! Its 10-yr.-proven Thomason "Solaris System" can cut conventional heating costs as much as 2/3! Your builder can modify or use as-is the complete blueprints included with "Solar House Plans III" (by Edmund, Homan, Thomason & Wells). Estimated \$40,000 building cost. 48-pg book shows all pro's and cons. Illustrated.
 No. 9469EK (8 1/2 X 11" PPRBK) \$24.95 Ppd.



ELECTRONIC DIGITAL STOPWATCH: \$69.95

A price breakthrough! New pocket size 4 oz. timer acc. to ±2% of last digit (1/100 sec. increments). Compares with others twice the price! Instant error-free readouts to 9999.99 sec. (over 2 3/4 hr). Starts, stops, re-starts (accumulates). Mechanical pushbutton & electrical remote on/off w/ any 3.5-150v AC/DC source. Plug-in jack. Incls. 9v batt. Solid state.
 No. 1943EK (2 1/4 X 4 1/2 X 7/8") \$69.95 Ppd.
 DELUXE 2 EVENT STOPWATCH (±0.01% OF LAST DIGIT)
 No. 1653EK (PRICE UP IN SEPT.) \$120.00 Ppd.



SUPER POWER FOR ANY AM RADIO



New antenna assist turns a tiny transistor into a tiger, has pulled in stations 1000 miles away! Just set it beside your radio (no wires, clips, grounding) and fine-tune Select-A-Tenna's dial to same frequency—"Gangbusters"! Terrific for sportsmen, vacationers. Great for clearing weak signals in radio depressed areas, off-coast islands, stations in crowded frequencies. Solid state—uses no electricity, batts., tubes. Works almost forever.
 Stock No. 72,095EK \$15.95 Ppd.

AM RADIO FITS IN/ON YOUR EAR!



Wear it inconspicuously everywhere, listen as you work (lawn, yard, office), watch (game, beach) or wait. Instant music, news, sports. No gimmick-6/10 oz. technological wonder w/ integrated circuit, 11 transistors, patented ferrite antenna/tuner/volume dial. Works best outdoors. Uses hearing aid batt. (incl.)-up to 100 hrs. playing. New batt. to slip in avail. at drug stores (about 50¢). No lengthy wires, bulky cases, or power-packed!
 Stock No. 42,275EK \$14.95 Ppd.

The MOST POWERFUL SOLAR CELL!

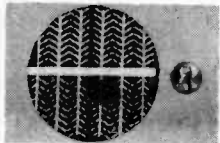

World's biggest (3" dia.), strongest silicon cell delivers over 1 amp. @ .5v D.C. or 1/2W. 5 times more efficient per cost than ever before! Only 1 mil thick. Tab leads for any circuit, 100's of applications. Hook in series for more voltage; parallel—more current. Real breakthrough!
 No. 42,270EK \$19.95 Ppd.
 2" DIA. 500 mA. @.5v No. 145EK \$ 9.95 Ppd.
 PIE-SHAPED 1/4 2" DIA. 100 mA. @ .5v No. 42,146EK \$ 5.50 Ppd.

PRO ELECTRONIC SOUND CATCHER



Parabolic mike w/ 18 3/4" reflecting shield & 2 I.C.'s in amplifier magnifies signals 100X that of omnidirectional mikes. Catch a songbird 1/2 mile off; QB's huddle strategy; sounds never before heard. Super directivity gives highest signal to noise ratio poss. Safe; auto. cuts off ear damaging noises. Earphones, tape recorder output, tripod socket. Req. two 9v trans. batt. (not incl.)
 No. 1649EK (5 1/2 LB.) \$299.00 Ppd.
 BIG EAR "TOY" MODEL #80,176EK \$ 32.25 Ppd.

KNOW YOUR ALPHA FROM THETA!



For greater relaxation, concentration, listen to your Alpha-Theta brainwaves. Ultra-sensitive electrode head-band slips on/off in seconds—eliminates need for messy creams, etc. Atch'd to amplifier, filters brainwaves, signals beep for ea. Alpha or Theta wave passed. Monitoring button simulates Alpha sound; audio & visual (L.E.D.) feedback. Reliable, easy-to-use unit comparable to costlier models. Completely safe. Comprehensive instruction booklet.
 No. 1635 (8x3x4"; 24 oz.) \$134.00 Ppd.
 LOW COST "Starter" UNIT, \$ 55.00 Ppd.
 No. 71,809
 No. 1652EK DELUXE "ON" TIME MONITOR— \$349.50 Ppd.
 Measures & Records %

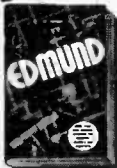

MAIL COUPON FOR GIANT FREE CATALOG!

180 PAGES • MORE THAN **4500** UNUSUAL BARGAINS

Completely new Catalog. Packed with huge selection of telescopes, microscopes, binoculars, magnets, magnifiers, prisms, photo components, ecology and Unique Lighting items, parts, kits, accessories — many hard-to-get surplus bargains. 100's of charts, illustrations. For hobbyists, experimenters, schools, industry.

EDMUND SCIENTIFIC CO.
 300 Edscorp Building, Barrington, N. J. 08007
 Please rush Free Giant Catalog "EK"

Name _____
 Address _____
 City _____ State _____ Zip _____



COMPLETE AND MAIL WITH CHECK, M. O. OR CHARGE NO.

EDMUND SCIENTIFIC CO. 300 Edscorp Building, Barrington, N.J. 08007

How Many Stock No. Description Price Each Total

PLEASE SEND GIANT FREE CATALOG "EK"
 Charge my BankAmericard *
 Charge my Master Charge * Add Handling Chg.: \$1.00, Orders Under \$5.00, 50¢, Orders Over \$5.00

Interbank No. BANKAMERICARD MASTERCARD I enclose check money order for TOTAL \$ _____
 My Card No. Is _____

Card Expiration Date _____ Signature _____

30-DAY MONEY-BACK GUARANTEE. Name _____
 You must be satisfied or return Address _____
 any purchase in 30 days for full refund. City _____ State _____ Zip _____
 *\$15.00 minimum

Hey, look me over

Showcase of New Products

12 Volt DC Power

Here's a solid state power supply ready for use which enables you to enjoy your automotive stereo tape player, CB rig, etc. at home. With the EICO Model 1040, your 12 VDC electronic equipment can be used from 120 VAC lines. The 1080 makes it possible to check out equipment on the test bench before actually installing it in your car



CIRCLE 70 ON READER SERVICE COUPON

or on your boat. It can also be used as a battery charger for 12-volt batteries. In put: 120 VAC, 50-60 Hz; Output: 12 VDC at 4 amps continuous. Sells for \$19.95. Get all the facts by writing to EICO Electronic Instrument Co., Inc., 283 Malta Street, Brooklyn, NY 11207.

Electronic Thermometer

Edmund's electronic thermometer offers many uses to industry, schools and to homeowners. It's easy to use. Just push a button and read one of three separate temperatures located at different distances—from inches to 1,000 feet

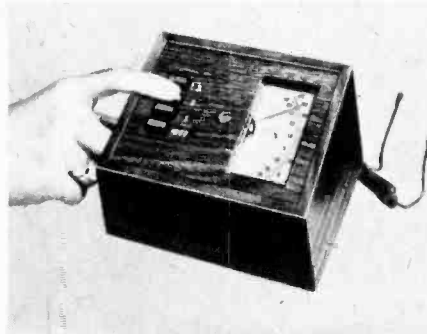

CIRCLE 69 ON READER SERVICE COUPON
away. Gardeners can monitor hot house temperatures. It's ideal for photographers when processing solutions. Also, it is recommended for use in incubators, swimming pools, aquariums, and freezers. Thermometer can connect to three

plug-in type temperature probes with flexible conductor cords. Instant readings are available from -22 to +122 degrees F and -30 to +50 degrees C. Accuracy is indicated at $\pm 1\%$. Comes in a walnut finish cabinet measuring $3\frac{1}{2} \times 4\frac{1}{2} \times 6\frac{3}{4}$ inches. Contains two solid-state waterproof probes—one 18-inch cable and one 15-foot. Instructions are included. Requires a "D" battery which is not included. Listed as stock number 71,741, it is priced at \$49.00 postage paid. Also available are extra 15-foot probes at \$8.00 each postage paid (No. 41,839) and 50-foot extension cord at \$6.00 (No. 41,838). Edmund Scientific Co. is located at 380 Edscorp Bldg., Barrington, NJ 08007.

Weightless AM Radio

Have you heard about the AM radio that is almost weightless? It only weighs



CIRCLE 68 ON READER SERVICE COUPON

(Continued on page 8)

BE FOREMOST with the **HUSTLER** "DOUBLE-TALK" antenna system

Join the thousands of CB'ers who communicate longer, louder, while traveling over the miles with the Hustler "Double-Talk" mobile antenna system. Guaranteed superior performance over a single antenna installation — more uniform signal pattern because of uniquely detailed phasing design, more consistent communications with virtually no fading or blind spots when changing direction in travel.

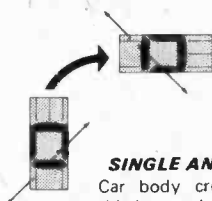

SINGLE ANTENNA
Car body creates lopsided ground plane with directional signal pattern

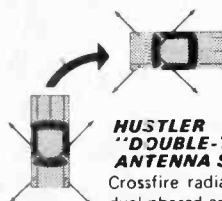

HUSTLER "DOUBLE-TALK" ANTENNA SYSTEM
Crossfire radiation with dual phased antennas results in greater coverage, reinforced signal pattern

CHOOSE FROM FOUR POPULAR VERSIONS

All are supplied ready for easy installation and operation

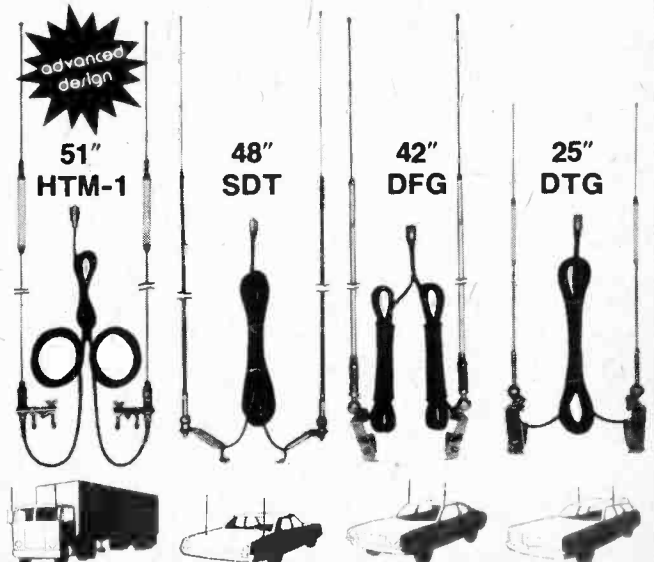

**new-
tronics
corporation**

15800 commerce park drive,
brook park, ohio 44142

HUSTLER

Available from all distributors
who recognize the best!

The great new
Super Scanner

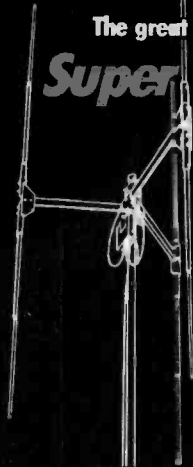

The only "two-antennas" antenna. It scans 360 in milliseconds with 5.75 dB gain. Or beams an 8.75 dB gain signal where and when you want it—instantaneously. (And you'll wish you had a radio as handsome as the control box!)

- New contemporary control console with blackout panel, simulated leather end panels.
- Compact size—radius just 3 feet. Wind rated in excess of 100 mph.
- Ideal for emergency teams—zero in on trouble spots instantly.

MODEL MS 119 Super Scanner electronic beam antenna with control console.

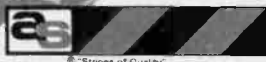

the antenna specialists co.

Division of ORION INDUSTRIES, INC.
12435 Euclid Ave., Cleveland, Ohio 44106
Export: 2200 Shames Dr.,
Westbury, L. I., New York 11590
Canada: A. C. Simmonds & Sons, Ltd.

CIRCLE 5 ON READER SERVICE COUPON

MAXICLOCK COMPONENTS

Prime Factory Fresh Parts. Not Surplus! We stock the parts and printed circuit board for the "Maxiclock" and other E. E. projects. Send addressed envelope with your list for prices.

PHOTOLUME CORPORATION
118 EAST 28TH STREET
NEW YORK, N.Y. 10016

SEMICONDUCTOR SUPERMART
FREE CATALOG

NAME BRAND—PRIME QUALITY SEMICONDUCTORS

- MOTOROLA
- NATIONAL
- HEP
- FAIRCHILD
- RCA
- SIGNETICS

Other Parts For Elementary Electronics Projects

CIRCUIT SPECIALISTS CO.
Box 3047, Scottsdale, AZ 85257

HEY, LOOK ME OVER

(Continued from page 7)

6/10 of an ounce and is available from Edmund Scientific Co. It's not a gimmick and might well be the smallest radio in the world. Can you imagine an integrated circuit with 11 transistors and a patented ferrite antenna tuning and volume dial. No long wires, bulky cases or extra power packs attached to this new mini radio. Just plunk it on your ear and wear it anywhere. Most people won't know you're wearing it. Great for sports fans, golfers, hikers, boaters, cyclists, salesmen—or for mom when she is washing the dishes. It's strong enough to pick up the average-powered station within a 20 to 30 mile radius of transmitter. It comes with a regular silver oxide hearing aid battery good for 100 hours of entertainment. New batteries which can be slipped in easily are available at drug stores for about 50 cents. The new mini AM Radio is available by mail from Edmund Scientific Co., 380 Edscorp Bldg., Barrington, NJ 08007 for only \$14.95 postpaid.

Portable Cassette Recorder

Panasonic has added a portable cassette recorder with an FM/AM/Weather band radio to its line. Model RQ-454S also offers such features as a detachable microphone with remote control, record/playback microphone mixing with volume control, optional rechargeable battery, super alloy head, 3-way power (AC/DC/Car), film dial radio scale, level/battery/tuning meter, 3-digit tape counter, radio dial light, 4-stage IF amplifier and IC, auto-stop mechanism, electronic controlled DC motor, variable sound monitoring, one-touch record button, plus a 4-in. silver cape cone speaker and tone control.



CIRCLE 66 ON READER SERVICE COUPON

Complete with shoulder belt and batteries, the RQ-454S has a manufacturer's suggested price of \$179.95. For further information on Panasonic's new portable cassette recorder, contact Matsushita Electric Corp. of America, Pam Am Bldg., 200 Park Avenue, New York, NY 10017.

Electronics Lab Kit

Edmund Scientific's electronics lab kit is best described as an elementary course in electronics. Offers an opportunity to become an expert in kit projects



CIRCLE 65 ON READER SERVICE COUPON

while having days of fun while learning. Kit contains over 40 experiments including construction of a pollution tester, rain tester, lie and spy detectors, police flasher, metronome, Morse code sending device, and a lemon-powered battery, plus police and fire signal and a two-transistor radio. No soldering is necessary. It's a complete snap-fit assembly. A fully-illustrated, easy-to-understand manual (8½-in. x 11-in., 80 pages) is included. Manual explains step-by-step usage of over 100 precision components in the kit. Three "AA" batteries are required (not in kit). Listed as stock number 71,861, it is priced at \$12.75 post-age paid. Edmund Scientific Co. is located at 380 Edscorp Bldg., Barrington, NJ 08007.

New Turntable

Kenwood introduces the KP-1022, a new manual, belt-drive turntable which features a low-mass, low-friction tone arm with adjustable anti-skating to maintain precise center-of-groove tracing for excellent stereo separation and optimum



CIRCLE 67 ON READER SERVICE COUPON

tracking. A synchronous motor drives a 12-in. aluminum alloy die-cast platter by means of a polyester belt. The belt-drive, which isolates vibration, and the synchronous motor, which accurately controls rotation, combine to insure precision speed and reduced rumble and noise. Wow and flutter are reduced to less than 0.07% (WRMS), while signal-to-noise ratio is better than 47 dB. The KP-1022 has a suggested price of \$119.95. Available at Kenwood dealers throughout the country. For complete information, write Kenwood, Dept. P., 15777 South Broadway, Gardena, CA 90248.

(Continued on page 14)

Royce

Listen to the Royce difference!



Royce
Model 1-603
Digital Readout
Mobile CB Transceiver!



Bright, bold, full 1/4-inch
high digital readout.

New Digital Readout makes channel selection a snap!

- Royce's new Digi-Tron Dial System is completely electronic.
- Channel selection is a snap—with the full 1/4-inch high digital readout.
- Bright-Dim Switch—easy on the eyes for night-time viewing.
- Large S-RF meter.
- Separate transmit indicator light.
- Pushbutton PA-CB switch converts unit into powerful, 4-watt P.A. system.
- Automatic noise eliminator circuit—with pushbutton control.
- Positive and negative 12 volt DC operation.
- Tuned RF stage for greater sensitivity.
- PLUS... Dual conversion receiver with three ceramic filters...new output RF stage...reliable relay switching system...AGC circuit...AMC circuit...full-size, plug-in mike.

LISTEN TO THE ROYCE DIFFERENCE before you buy any mobile transceiver. See the Model 1-603 at your Royce Dealer's today! Suggested Retail Price \$199.95. Get our new literature... write to address below!

Royce electronics corporation

1142 Clay St., North Kansas City, Mo. 64116
CALL: (816) 842-0252 • TELEX: 426-145

You can tear out all the cards in this magazine...

But this is the one you should mail!

**If you're thinking of investing your money
in a learn-at-home program in electronics, there are
a few things you should know first.**

Selecting a home electronics program isn't easy. It could be one of the most important decisions you'll ever make for your future. So you want to decide carefully and get the best education you can.

After all, you're investing your time and money, and you want a full return on that investment.

What should you look for before you select a school?

You probably want a school with a proven track record of quality and performance. You want personal attention plus, the convenience of learning at home. You want the most up-to-date technical texts... teaching aids and learning methods.

But most of all you want to actually learn what electronics is all about. Not just theory, but actual hands-on experience with the latest and best technical equipment available today!

At Bell & Howell Schools, you get all that...and so much more!

Bell & Howell Schools has been in the home-study electronics business a long time. Almost half a century. In that time, we have developed teaching techniques that provide our students with the most vital and comprehensive learning system available for at-home study.

Techniques like our "step-by-step" concept of learning.

At Bell & Howell Schools, we start you off with the basics. Then take you step by step through the learning process. You work at a comfortable pace—not too fast...not too slow. If you already have some learning or experience, we'll arrange advanced standing in the program so you can skip the beginning lessons. And don't worry if you don't have any electronics background. 25% of our graduates never

even had any electronics training before enrolling with Bell & Howell Schools. (Based on a recent survey of our graduates conducted by an independent research firm. Survey results available on request.)

Or our system of personal contact.

No course is without its problems. And when you get hung up on a problem, you want answers and you want them fast. Here at Bell & Howell Schools, we combine the convenience and pleasure of learning at home with a system of personal contact with faculty and other students that rivals—if not beats—any other program available.

For problems that "just can't wait" we have a toll-free "hot-line" that you can call and discuss your questions with an experienced instructor. You get real attention—someone whose only job is to see to it that your individual questions are answered. And answered quickly and clearly!

To help you develop your thoughts and understand electronics principles more thoroughly, Bell & Howell Schools has developed a unique feature that no other learn-at-home program has—In-Person Help Sessions in 50 major cities throughout the United States. These let you get together with instructors and other fellow students. There you can talk shop with other people who share your interests... explore your problems further... and get additional assistance.

But that's not all that Bell & Howell Schools will do for you! In addition to our vast experience and expertise, is a philosophy that the best learning comes from working with the best equipment available. And that's exactly what our students do!

What better way to learn electronics than to actually work with electronics equipment?

And what better way to find out how things fit together... how they work and why they work than to actually build the equipment? And we don't mean gadgets that will be worthless to you later.

We mean equipment like the Bell & Howell Schools exclusive "Electro-Lab[®]" electronic training system including design console, digital multimeter and oscilloscope, that you can use professionally after you've graduated.

The design console will allow you to set up and examine circuits without having to solder them in place.

The digital multimeter measures voltage, current and resistance and displays its findings in big clear numbers for easier reading.

And the solid-state "triggered sweep" oscilloscope is similar in principle to the kind used in hospital operating rooms to monitor heartbeats. But you'll use it to monitor and analyze tiny integrated circuits. And you'll find the "triggered sweep" feature locks in signals for easier observation.

That's not all you build when you choose a course from Bell & Howell Schools!

To learn the most advanced electronics technology, you have to work with the most advanced training tools.

So in addition to the exclusive "Electro Lab[®]" system that you will build as part of Bell & Howell's Home Entertainment Electronics program, you'll also build a 25" diagonal color TV with digital features.

Sounds exciting, doesn't it? Well, digital electronics is exciting! Its growth and application are giving us new and better products and a whole new realm of split-second accuracy that was just a dream a few years ago. And this new technology is being applied more and more to TV's, clocks, radios and other home entertainment equipment.

By studying with Bell & Howell Schools—one of the first schools to introduce digital electronics as part of its training program—you can actually get in on the ground floor of this new technology while learning all the basic electronics principles and skills you'll need to detect and troubleshoot problems professionally on digital and other electronic equipment.

Make no mistake about it! As you build your digital color TV, you'll get a thorough grounding in electronics principles. You'll develop a working knowledge of "state of the art" integrated circuitry and the 100% solid-state chassis. Plus you'll actually know how to program a special automatic channel selector to skip over "dead" channels and how to build a remarkable on-the-screen digital clock that flashes the time in hours, minutes and seconds.

But most importantly, you'll have the skills that could lead you to a brighter future...

And isn't that what education is supposed to be all about? At Bell & Howell Schools we've always thought so although no school can guarantee you a job or income opportunity. Get full details about us, our courses, our philosophy of education by mailing the postage-paid card today. If you take one of our courses for vocational purposes, this program is approved by the state approval agency for Veterans' Benefits.

Mail card today for full details!



"Electro-Lab[®]" is a registered trademark of the Bell & Howell Company. Simulated TV test pattern.

If card has been removed, write:
An Electronics Home Study School
DeVRY INSTITUTE OF TECHNOLOGY

763R1



ONE OF THE
BELL & HOWELL SCHOOLS

4141 Belmont, Chicago, Illinois 60641

Are you,
of all people,
still opening
your garage

the
hard
way?

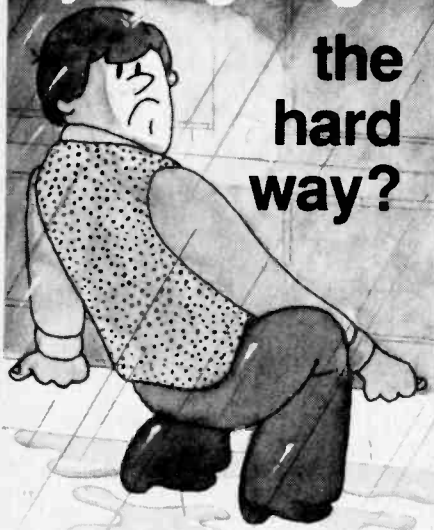

Anybody who's into electronics

certainly should be getting the everyday convenience and family security of automatic garage door operation... especially now, with Perma Power's great Electro Lift opener...

made to fit in the trunk of your car, designed for easy handling and simple do-it-yourself installation.

Available now at a surprisingly low price from your distributor.



P.S. Show off your opener to your friends and neighbors. You'll probably be able to pay for yours with what you make installing openers for them.

Perma Power

Chamberlain Manufacturing Corporation
Perma Power Division
845 Larch Avenue, Elmhurst, Illinois 60126
Telephone (312) 279-3600

CIRCLE 26 ON READER SERVICE COUPON

HEY, LOOK ME OVER

(Continued from page 8)

Cassette Fix-It

Salvage your broken pre-recorded audio tape cassette containing valuable information, educational material, business data, music recording, for less than half the original cost. The Sav-A-Tape Cassette Repair Kit contains all necessary components, splicing equipment,



CIRCLE 64 ON READER SERVICE COUPON

new labels, and clear instructions for making the repair or complete replacement. Send \$6.00 for a set of two kits, Stock #801, to Audio Accessories Company, Route 1, Box 628, Batavia, IL 60510.

Battery Tester

A new RCA Battery Tester, Model WT-537A, provides an accurate test, under typical load conditions, and is well suited for use in service shops, laboratories, schools, industrial maintenance shops, and many stores that sell batteries. It is priced at \$18.75 and is available now from RCA Electronic Instrument Distributors. A single knob function switch provides the following test ranges for standard carbon-zinc and alkaline type batteries: 1.5, 3, 6, 9, 15 and 22.5 volts. Ranges for mercury batteries are 1.4, 5.6 and 8.4 volts. These battery tester ranges



CIRCLE 63 ON READER SERVICE COUPON

can also be used to check most types of nickel-cadmium (nicad) rechargeable batteries. In addition to testing 3-volt batteries, the 3-volt range also provides a handy way to check two 1.5-volt flashlight batteries at the same time without re-

moving them from the flashlight. This test also checks the battery terminals and switch contacts of the flashlight. A special feature of the RCA WT-537A is the convenient "Bulb Test." With this function, since it is actually a "continuity" tester, not only flashlight, pilot light, automobile and standard AC electric bulbs can be tested, but it can also be used to test fuses, switches, and circuit wiring. Test leads are included with the WT-537A, along with a panel-mounted negative contact so that the operator does not need a "third hand" to test a battery or bulb. The rugged, texture-finish high-impact "bright orange" plastic case is 5 1/8-in. x 3 3/8-in. x 2-in. and weighs 10.5 ounces (300 g). The "Bulb Test" function is powered by an internal 1.5-volt penlite battery cell (not supplied). A protective carrying case (WG-447A) is available for \$5.75 each. Additional information on this new RCA WT-537A Battery Tester is available from RCA Electronic Instrument Distributors or from RCA Electronic Instruments, 415 South Fifth St., Harrison, NJ 07029.

FET Multimeter

A new pocket FET Multimeter offers full VTVM ranges and a 10-megohm input, completely protected against overload. Packaged in a rugged, pocket-size, polypropylene case with attached cover the Hickok Model 350 provides features which include: a meter with 1 millivolt resolution on 3 easy-read mirrored scales plus dB and battery condition, hi/low ohms ranges, and true autpolarity with a polarity indicator. High impedance FET



CIRCLE 62 ON READER SERVICE COUPON

circuitry permits VTVM type ranges in this compact unit. Nine voltage ranges of 0.1 to 1000 and seven hi/lo ohms ranges from 100 to 100M center scale make the Model 350 a truly versatile service tool. One year service can be expected from the two 9-volt transistor radio batteries. The Hickok Model 350 Pocket FET Multimeter comes complete with two test leads and instruction manual. Priced at \$119.00. For more information, write to Instrumentation & Controls Division, Hickok Electrical Instrument Co., 10514 Dupont Avenue, Cleveland, OH 44108.

"CLEAR" "Solid"...
"POWERFUL"...
"Crisp" "PENETRATING"...

Speech Compression is built-in every Johnson CB radio. State-of-the-art circuitry electronically selects voice frequencies that penetrate noise and interference... then boosts the level of modulation to give your signal that powerful "Johnson sound." It's one of many engineering advances — like receiver "steep skirt" filtering to cut interference and automatic threshold limiting to slice out noise — that gives U.S.-made Johnson CB that extra edge of performance. Performance that's backed by a full 1-year parts and labor warranty with over 700 authorized service centers nationwide.

Messenger 250
 100% solid-state base station



Messenger 123B 23-channel mobile with +/- ground switch

Messenger 130 and 132
 "The radiotelephone CB System"
 with private listening option



write for free catalog

E.F. Johnson Co.

Waseca, Minnesota 56093 • In Canada: A. C. Simmonds & Sons, Ltd.

CIRCLE 33 ON READER SERVICE COUPON

SAVE THOUSANDS OF DOLLARS

with the Super-sensitive
S & M A-4, The One Photo-Meter
That Does It All!!

TRY ONE—FREE FOR 10 DAYS.

Use your A-4 Meter with dial lights as darkroom PROS now do. It's easy to use at the enlarger with the 5/8 in. high EASEL probe to determine accurate exposures for B & W and COLOR photos, correct paper for prints, and even ft. candle measurements.



A-4 In Darkroom Action

Use your versatile battery-operated A-4 with double sensitivity to do the work of several instruments costing Thousands of Dollars.

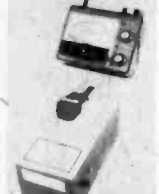

Make this densitometer with the A-4 meter and easy-to-build Light Source.

Use your A-4 to eliminate waste of films and prints, chemicals and time, and to increase production and earnings.

Use your A-4 with the 5/8 in. dia. STANDARD probe as a LIGHT METER. Features? Four sensitivity ranges: EV-EVS-LV settings; ASA settings from 3 to 25,000; f/stops from 0.7 to 90; exposure times from 1/15,000 sec. to 8 hours.

Special Graphic Arts Applications? Ground-glass, contact printing, color separation, screening, copying, standardizing exposures from camera to camera, evenness of lighting, film density readings, etc.



A-4 In Ground-glass action

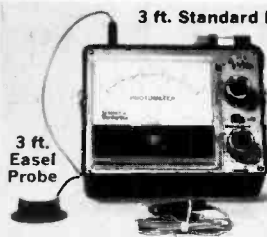

3 ft. Standard Probe

Exposure Calculator

3 ft. Easel Probe

Uses Plug-In Probes 3 ft. Mini Probe

Attn: Wilfred M. Brown
SCIENCE & MECHANICS
INSTRUMENTS DIVISION,
229 Park Ave. South, N.Y., N.Y. 10003

EEJA75

Send the meter and probe(s) with cable length (3-12 ft.) as indicated below. I understand that if I am not satisfied, I may return the meter within 10 days for a complete refund.

S & M A-4 Graphic Arts Photo Meter.
 \$99.95 with _____ ft. long Standard probe, exposure calculator and carrying case and manual.

EXTRA PROBES

- \$9.95 5/8 inch high Easel probe with _____ ft. long cable
- \$9.95 5/8 inch diameter Mini-probe with _____ ft. long cable
- Check or money order enclosed, ship ppd,
- Company Purchase Order attached.

NAME _____
ADDRESS _____
CITY _____
STATE _____ ZIP _____

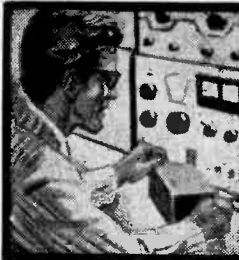

ASK HANK,
HE KNOWS!

Got a question or a problem with a project—ask Hank! Please remember that Hank's column is limited to answering specific electronic project questions that you send to him. Personal replies cannot be made. Sorry, he isn't offering a circuit design service. Write to:

Hank Scott, Workshop Editor
ELEMENTARY ELECTRONICS
229 Park Avenue South
New York, NY 10003

Loud Sound

A friend tells me that it takes more power to reproduce a cymbal than a trumpet. Is this true?

—D. R., Des Plaines, IL

What he may be saying is that it takes about 15 times more peak-power over the audio spectrum to reproduce the clash of a 15-inch cymbal than a blast from a trumpet.

Electrostatic

Where can I get information on electrostatic projects my students can build for science fair projects?

—B. M., Cressona, PA 17929

I have a great project book on the subject. It is Electrostatics Handbook by Charles Green. I suggest you write to Howard W. Sams & Co., Inc., 4300 W. 62nd St., Indianapolis, IN 46206, and ask for their book catalog. Many of the projects in the book originally appeared in ELEMENTARY ELECTRONICS.

Pi in the Eye

How long is the number for pi?

—J. E., Washington, D.C.

The number has no limit and goes on indefinitely. In school you used 3.14 which is good enough for simple problems. The longest value I can find in my library is 3.14159265. I do know that someone programmed a computer to read out the value of pi and a book was made out of the number—the book has no ending because it runs out of pages before pi runs out of numbers.

An Old Word

Hank, what's a binode?

—G. W. Kingsport, TN

Binodes go back to vacuum tube receivers when a thermionic double diode in one glass shell had two plates and one common cathode. Many old rectifier tubes were actually binodes. But, would you believe I never heard the word until you wrote to me about it. See, we both learned on this one.

Hard to Believe

My grandfather tells me that he used a safety razor blade as the crystal detector in a radio in 1925. Is he kidding me?

—R. T., Wichita, KS

No, he is not. The coating, or blueing on the blade, even a fine layer of rust acted as an NP barrier of a diode and made AM detecting possible. What granddad didn't tell you was that it took patience and a strong signal to turn the trick. Why don't you try it today?

Headed for the Slammer

I realize that you do not publish schematic diagrams in your column, but perhaps you can tell me where I can obtain one in order to build a linear amp for my CB base station.

—G. L., Dallas, TX

Linears are out for CB. In fact, the FCC sends kilocycle cops out to track down linear users on CB. Stick to the tried and true 5-watters.

God Help Him

Is it possible to change a public address system from tubes to transistors? The one in our church takes a long time to warm up.

—Lincoln Penner
Box 91, R.R.#1
Ste Anne, Man.
Canada

Nothing is really impossible, but I believe the purpose of conversion from tubes to transistors is to save money, otherwise a new system would have been purchased. Possibly one of our readers has a PA transistorized system that can be spared. If so, please write to our Canadian friend.

Need CB Info

Where can I obtain schematics and parts lists on various CB transceivers?

—D. K., Salt Lake City, Utah

Tab Books, Blue Ridge Summit, PA 17214 can help you in this matter. Write to them telling 'em what rig you're interested in.

Can You Help Out?

Δ F. H. Heberling has an old, like-new Remler Infradyne Amplifier, Type 700, made by Gray & Danielson Mfg. Co. It takes three tubes which have "Remler Type 50" near the sockets. He needs to know tube types, and what A and B batteries to use. Write to him at Bakers-town, PA 15007.

Δ DXers Radio Club would like to communicate with other clubs as reported by Scott Freiman (11 years old). If interested, write to Scott at 1-26A Pinehurst Dr., Lakewood, NJ 08701.

Δ Fred Caughlin picked up a Skyline Radiophone, Model IA30 and would like information and schematic diagrams of the unit. Write to Fred at 11094 71st Ave. N.E., Brooks, Oregon 97305.

Δ If anyone has the schematic diagrams for a Decca DR343 or International Transistor Corp. Model FAP314 (both portable radios), please send them to Emanuel Cattolica, 7861 Barbi Lane, La Palma, CA 90623. ■

ELECTRONICS INFORMATION CENTER

FREE

TO ALL READERS OF
ELEMENTARY
ELECTRONICS

At no cost to you the Editor will have information and literature about products and services advertised in this issue sent to you at no cost!

FILL OUT AND MAIL TODAY!

YOU SIMPLY

- Tear out the coupon.
- Circle the number under the ad that interests you.
- Circle the number identifying products mentioned in columns and articles.
- If you wish, answer the simple questionnaire on the coupon.
- Print or type your name and address on the coupon.
- Mail to ELEMENTARY ELECTRONICS before the expiration date.

FILL OUT AND MAIL TODAY!

AND IF YOU WISH

to subscribe to

ELEMENTARY ELECTRONICS

please check subscription box 83 on the coupon: \$3.98 brings you 8 issues.

FILL OUT AND MAIL TODAY!

ELEMENTARY ELECTRONICS

Box 886, Ansonia Station, New York, NY 10023

July/August 1975

Void after December 19, 1975

1	2	3	4	5	6	7	8	9	10	11	12	13	14	15
16	17	18	19	20	21	22	23	24	25	26	27	28	29	30
31	32	33	34	35	36	37	38	39	40	41	42	43	44	45
46	47	48	49	50	51	52	53	54	55	56	57	58	59	60
61	62	63	64	65	66	67	68	69	70	71	72	73	74	75

We would like to know about you. Please help us by placing an "X" in the appropriate boxes. ● Do you own a CB transceiver? ⁷⁶ Yes ⁷⁷ No ● If your answer is Yes, please check appropriate boxes below if you have one or more of the types indicated. ⁷⁸ Base Station ⁷⁹ Mobile Unit ⁸⁰ Portable ● Do you use CB in your work? ⁸¹ Yes ⁸² No ● ⁸³ Please enter my subscription for 8 issues at \$3.98 and bill me.

Name (print clearly) _____

Address _____

City _____

State _____

Zip Code _____

ELEMENTARY ELECTRONICS

Box 886, Ansonia Station, New York, NY 10023

July/August 1975

Void after December 19, 1975

1	2	3	4	5	6	7	8	9	10	11	12	13	14	15
16	17	18	19	20	21	22	23	24	25	26	27	28	29	30
31	32	33	34	35	36	37	38	39	40	41	42	43	44	45
46	47	48	49	50	51	52	53	54	55	56	57	58	59	60
61	62	63	64	65	66	67	68	69	70	71	72	73	74	75

We would like to know about you. Please help us by placing an "X" in the appropriate boxes. ● Do you own a CB transceiver? ⁷⁶ Yes ⁷⁷ No ● If your answer is Yes, please check appropriate boxes below if you have one or more of the types indicated. ⁷⁸ Base Station ⁷⁹ Mobile Unit ⁸⁰ Portable ● Do you use CB in your work? ⁸¹ Yes ⁸² No ● ⁸³ Please enter my subscription for 8 issues at \$3.98 and bill me.

Name (print clearly) _____

Address _____

City _____

State _____

Zip Code _____

ELEMENTARY ELECTRONICS

Box 886, Ansonia Station, New York, NY 10023

July/August 1975

Void after December 19, 1975

1	2	3	4	5	6	7	8	9	10	11	12	13	14	15
16	17	18	19	20	21	22	23	24	25	26	27	28	29	30
31	32	33	34	35	36	37	38	39	40	41	42	43	44	45
46	47	48	49	50	51	52	53	54	55	56	57	58	59	60
61	62	63	64	65	66	67	68	69	70	71	72	73	74	75

We would like to know about you. Please help us by placing an "X" in the appropriate boxes. ● Do you own a CB transceiver? ⁷⁶ Yes ⁷⁷ No ● If your answer is Yes, please check appropriate boxes below if you have one or more of the types indicated. ⁷⁸ Base Station ⁷⁹ Mobile Unit ⁸⁰ Portable ● Do you use CB in your work? ⁸¹ Yes ⁸² No ● ⁸³ Please enter my subscription for 8 issues at \$3.98 and bill me.

Name (print clearly) _____

Address _____

City _____

State _____

Zip Code _____



BOOKMARK
BY BOOKWORM

IC Wrap-Up. *Linear IC Principles, Experiments, and Projects*, by Edward M. Noll was written to introduce the principles of operation of the integrated circuit. The opening text covers basic semiconductor principles—basic IC structures, the PN

junction, the bipolar transistor, transistor fabrication, the field-effect transistor (FET), and more are discussed. Succeeding chapters explain integrated-circuit structures, basic circuits, operational amplifiers, multipurpose and special ICs, and special IC systems. There is broad coverage of how linear ICs are used in commercial, industrial, and test equipment. Home-entertainment audio, AM, FM, and television applications are also stressed. Ham-radio and shortwave enthusiasts will find projects they may want to tinker with. These final chapters also will be appreciated by those who like the learn-by-doing approach; they'll find an intriguing collection of school, lab and home construction

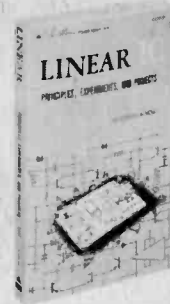

Soft Cover
384 pages
\$8.95

projects. Published by Howard W. Sams & Co., Inc., 4300 W. 62nd Street, Indianapolis, IN 46206.

Quad. One of the most confusing subjects to many people has been that of four-channel sound. New terms, such as CD-4, matrix, quadraphonic, etc. are heard—but what do they mean? Why are four channels needed when we have only two ears? In *Easy-Guide to Four Channel Sound* by Forest H. Belt, the author discusses how and where to shop for quadraphonic am-



Soft Cover
144 pages
\$3.50

plifiers, receivers, eight-track recorder/players, automatic turntables, open-reel tape machines, and automobile four-channel sound. Readers will learn how to connect and adjust a quadraphonic music system, build their own quad/stereo outfits, make four-channel recordings, and add quad music to their cars. Published by Howard W. Sams & Co., Inc., 4300 West 62nd Street, Indianapolis, IN 46206.

Solid Databooks. The new SSD-200C seven-volume, 4482-page set of 1975 Databooks is on RCA's complete standard line of linear integrated circuits, discrete MOS devices, COS/MOS digital integrated circuits, power transistors, thyristors, rectifiers, diacs, RF and microwave devices, and high-reliability ICs and discrete devices. The SSD-200C series contains com-



Soft Cover
2,574 pages
\$19.00

plete technical data sheets and application notes on all standard types in the RCA inventory as of January 1, 1975. The seven

(Continued on page 24)



Three for the ACTION

Now there are three popular priced, high performance Midland Pocket Scanners. Two are brand new, and DUAL BAND! One covers both VHF bands, high and low. The other covers VHF-high and UHF.

If you don't need two bands, Midland's third Pocket Scanner is VHF-high band only and costs a little less.

All are small enough to carry in a shirt pocket, but come with a handy holster carrying case, too, from your Midland dealer.

Write for free, full-color CB and Scanner Brochure,
P.O. Box 19032, Kansas City, Missouri 64141

MIDLAND
INTERNATIONAL®
Communications Division



Science Fair P-BOX® Kits have helped launch 1000's of careers in electronics!



Great for youngsters . . .
Build and learn like an engineer by
"breadboarding" on a unique molded
and coded Perfboard chassis. Fun,
safe, educational!

FREE New 1976 Radio Shack Catalog

OVER 2000 PRODUCTS
EXCLUSIVES ON EVERY PAGE
BEAUTIFUL FULL COLOR

**Stereo • Quadraphonic • Phonographs
TV Antennas • Radios • Citizens Band
Kits • Recorders • Tape • Tools
Auto Tune-Up • Electronic Parts
Test Instruments • More!**



164 pages of the finest in
home and hobby electronics
Respected brand names like
Realistic, Micronta, Archer,
Science Fair — and they're
available only at Radio
Shack stores and dealers
nationwide! See what's really
new in electronics by getting
this catalog now

**SEND FOR YOURS TODAY!
FILL OUT COUPON BELOW**

1976 Mail to Radio Shack, P. O. Box 1052, \$37
Catalog Ft. Worth, Texas 76101. (Please print.)

Name _____ Apt. No. _____

Street _____

City _____

State _____ ZIP _____

Shortwave Radio Kit— a world of excitement

**ONLY
795**

Build your own worldwide radio! Tune in foreign stations, Voice of America, WWV, Amateurs, CB'ers and more on the 4.5-50 MHz band. Regenerative high-gain detector and two audio amplifier stages make it sensitive enough to pick up Moscow, London, Tokyo — almost any spot on the globe! And you can listen privately with the earphone that's included. Like every P-BOX kit, it has all parts, wire and step-by-step instructions for easy assembly. Requires one 9-volt battery. #28-110. There's only one place you can find it . . . Radio Shack!

There's a P-BOX for every interest!

Electronic Organ
Electronic Metronome
Telephone Amplifier
IC AM Radio
Voice Controlled Relay
Electronic Thermometer
Metal Locator
"Rise-Fall" Siren
Photo Night Light
Wireless AM Mike

Transistor AM Radio
One-Tube AM Radio
2-Transistor FM Radio
Solar-Powered AM Radio
3-Way Code Oscillator
OTL Audio Amplifier
"Goofy-Lite" Flasher
Light Operated Alarm
3" Extension Speaker

Radio Shack®

OVER 3000 STORES • 50 STATES • 7 COUNTRIES

Retail prices may vary at individual stores. Prices and products may vary in Canada.

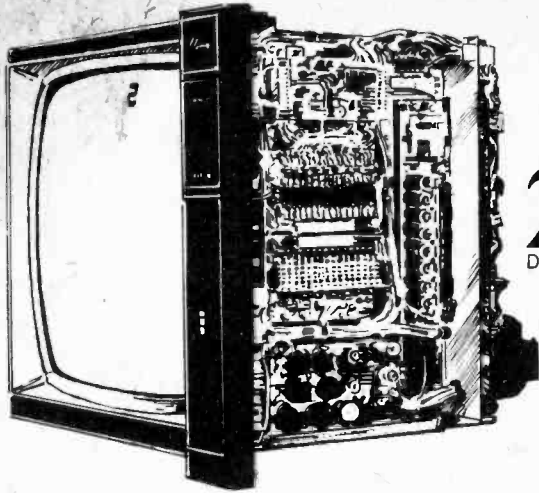

**You get the same
25" hobby-kit color
TV from three
different schools.**



**You get
this designed-
for-learning
25" color TV only
with NRI training.**

No other home-study school gives you a TV like the one you build with NRI's Master Course in Color TV/Audio servicing. Some schools give you three or four plug-in sub-assemblies off the production line to put together a commercial set. Others give you a hobby-kit bought from outside sources. And because neither type was originally designed to train people for TV servicing, lessons and experiments must be "retro-fitted" to the set as it comes.

That's why we went to the trouble to engineer our own, exclusive solid-state TV. It's the only way a student can (1) get the feel of typical commercial circuitry, (2) learn bench techniques while building a complete set from the "ground" up, (3) perform over 25 "in-set" experiments during construction, and (4) end up with a 25" diagonal solid-state color TV with console cabinet and all the modern features you'll find on sets you'll service. Nobody else can give you this combination of advantages because nobody else invested the time and money to design a set with learning in mind.



More know-how per dollar

That's what it all boils down to, the quality of training you get for the money you spend. In our 60-year history, more than a million students have come to NRI and we're fully approved for career study under the G.I. Bill. We must be teaching something right.

Some of those "right" things are bite-size lessons to ease understanding and speed learning . . . personal grading of all tests, with comments or explanations where needed . . . a full-time staff of engineer/instructors to help if you need it . . . plenty of "real-life" kits and experiments to give you hands-on training . . . and fully professional programs oriented to full- or part-time career needs.

Widest choice of career opportunities

NRI offers not one, but five excellent TV/Audio servicing courses so you can tailor your training to your budget. Or, you can study other opportunity fields like Computer Electronics, Communications, Aircraft or Marine Electronics, Mobile Radio, and more. Free catalog describes them all, showing lesson plans, equipment and kits, and career opportunities. There's no obligation and no salesman will ever call, so send for your copy today. See for yourself why NRI experience, selection, and exclusives give you something no other school can.

If card is missing, write to:



NRI SCHOOLS

McGraw-Hill Continuing Education Center
3939 Wisconsin Avenue,
Washington, D.C. 20016

NRI passes the savings on to you

You don't pay a big premium to get this unique TV as part of your training, because NRI engineering eliminates the cost of buying from an outside source. And we pay no salesman's commission. We enroll students by mail only. We pass the savings along to you in the form of low tuition fees, extras like a cabinet for the TV, a solid-state radio you learn on as you build, and actual instrument kits for servicing TVs . . . triggered sweep oscilloscope, integrated circuit TV pattern generator, and 3½ digit digital multimeter. You can pay hundreds of dollars more for a similar course and not get a nickel's worth more in training and equipment.

BOOKMARK

(Continued from page 18)

volumes contain data on 2,574 basic device types, including 1,763 standard packaged types, 811 high-reliability types, and 304 chips. The seven volumes are separated according to product lines. The first volume, SSD-201C, contains data on linear ICs and discrete MOS devices. SSD-202C is a companion to SSD-201C and includes application notes on linear ICs and discrete MOS devices. SSD-203C describes RCA's full line of commercially available COS/MOS (complementary symmetry MOS) digital ICs. SSD-204C encompasses power transistors and power hybrid circuits, and SSD-205C covers RF and microwave devices. The sixth volume, SSD-206C, describes triacs, silicon-controlled rectifiers (SCRs), diacs, and rectifiers. The seventh volume is the aforementioned high-reliability product volume. Volumes SSD-203C through SSD-207C contain both data sheets and application notes. Each volume includes a comprehensive subject index and a type-number index for all devices described in the volume. Databooks may be ordered by individual volumes at \$3.00 each. The seven-volume set is available for \$19.00. Databooks may be ordered from RCA Solid State distributors or by sending checks or purchase orders to RCA Solid State Division, Box 3200, Somerville, NJ 08876.

FM 2-Way. At last, in one book, *The Complete FM 2-Way Radio Handbook* by

Clayton L. Hallmark! This all-in-one guidebook covers both servicing and operation of transmitters and receivers for police and firemen's radio, taxicab and business radio, boaters' radio, amateur radio, and Citizens Band. Starting with explanations of types of systems (simplex, duplex, repeater, remote-controlled), types of stations (fixed, land, base, mobile, land mobile, etc.), FCC technical terms, types



Soft Cover
294 pages
111 illustrations
\$6.95

of emissions, and technical standards, author Hallmark covers every facet of the field before introducing the technical aspects of radio theory and two-way servicing. This serves as a broad-spectrum refresher course in radio fundamentals with emphasis, of course, on FM and PM. A representative sampling of FM 2-way radio equipment is explained and illustrated to give the reader a feel for the systems he'll be servicing. With the information in this book and the appropriate manufacturer's service manual, the reader should be able to service any FM transceiver—tube-type or solid-state—with confidence. The author goes into elaborate detail in the actual setup and checkout of repeaters, remotes,

base stations, mobile units, hand-held portables, as well as station accessory items such as wireline control terminals and repeater logic elements. This up-to-date volume concentrates on solid-state gear throughout—the types of equipment found in actual service applications. Published by Tab Books, Blue Ridge Summit, PA 17214.

For Computerniks. An unusual bi-monthly, *Creative Computing* is aimed at students, educators, and non-technical people. With an off-beat but relevant approach, it looks at the effects of the computer on privacy, automation and jobs,



Soft Cover
48 pages
\$8.00 a year
(\$6.00 for students)

medical care, pollution control, space exploration, and on people in general. In education, it treats computers as tools for teaching math, science, English, and social studies as well as computer science; the emphasis is on classroom activities. There are book reviews, games, puzzles, a fold-out poster, fiction, poetry, and cartoons in this magazine of educational and recreational computing. Published six times a year by Creative Computing, Box 789-M, Morristown, NJ 07960.

SIGMA ⁵/₈ C.B. ANTENNA

- Quality Built
- Heavy Duty Aircraft Aluminum
- Strong, noise-free, long-distance performance
- Omni-Directional
- Matching loop prevents burnouts and detuning. No troublesome coils.
- Factory Pre-Tuned

avanti

RESEARCH AND DEVELOPMENT, INC.
340 Stewart Avenue, Addison, Illinois 60101

Write for
FREE 16-page
color catalog

CIRCLE 6 ON READER SERVICE COUPON

ENJOY OLD RADIO-TV

A FLICK OF THE SWITCH your new 1930-1950 book



A FLICK OF THE SWITCH is your time trip through the golden days of radio broadcasting and into the dawn of television. Revisit "cathedral" radios, old Ham days and many more. Discover the rewards of collecting. Over 1,000 pictures make this book the 1930-1950 collector's reference. Order your copy of this 260-page book now! \$9.95 hard-cover, \$6.95 handbook.

Other valuable books are *Vintage Radio (1887-1929)* \$7.95 hard-cover, \$5.95 handbook; *Radio Collector's Guide (1921-1932)* \$4.95; *1927 Radio Encyclopedia* \$12.95 hard-cover, \$9.95 soft-cover; *1926-1938 Radio Diagrams* \$7.00. Also, we'll furnish any pre-1951 diagram for \$3.50.

Send today to *Vintage Radio*, Dep't E, Box 2045, Palos Verdes Peninsula, CA., 90274. Postage paid. Cal. residents add 6% tax.

_____ \$ _____
 _____ \$ _____
 _____ \$ _____
 TOTAL _____

Name _____
 Address _____
 City _____ St. _____ Zip _____

FREE Radio Age Guide with each order FREE

VINTAGE RADIO SERIES

NICE TO HAVE AROUND THE HOUSE.

CUDDLE UP WITH A PEARCE-SIMPSON



PUSSYCAT 23™
\$179⁹⁵

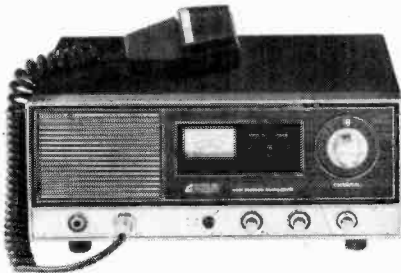

LYNX™ \$209⁹⁵



SUPER LYNX™ \$269⁹⁵



BEARCAT 23C \$319⁹⁵



GUARDIAN 23™ \$349⁹⁵

PEARCE-SIMPSON
DIVISION OF **GLADDING CORP.**

P.O. BOX 520800 BISCAYNE ANNEX MIAMI, FLORIDA 33152

CANADIAN DISTRIBUTOR

SCOTCOMM RADIO, INC., 4643 LEVESQUE BLVD., CHOMEDAY, LAVAL, QUEBEC, CANADA

DX central reporting

A world of SWL info!

BY DON JENSEN

□ For SWLs, perhaps the most interesting space event since the Apollo 11 lunar flight took "one giant step" back in 1969 will be this summer's planned U.S.-U.S.S.R. joint manned space flight.

The test project is a venture which will involve both American astronauts and Soviet cosmonauts "flying" Apollo and Soyuz spacecraft.

The Soyuz launch, with crew members Aleksey Leonov and Valeriy Kubasov, is scheduled for 1230 GMT on July 15. Astronauts Tom Stafford, Vance Brand and Donald "Deke" Slayton will blast off from Florida about 2000 GMT the same day.

The purpose of the joint American-Russian space effort includes the testing of rendezvous and docking techniques and equipment. Just over two days after the Soyuz craft is launched from the Russian space base in central Asia, it will join and dock with the American capsule in earth orbit. Several redocking and crew trans-

fer maneuvers are planned during the following two days.

Soyuz is scheduled to return to earth on July 21; the Apollo "ship" three days later.

Using the ATS-6 relay satellite, the world will be able to see much of this cooperative space venture on television. But again this time, DXers should be able to get much closer to the mission's behind-the-scenes activities.

As with previous U.S. space shots, there will be no shortwave frequencies used for direct communications between the satellites and ground stations. Communications between Apollo and Soyuz and between the two craft and U.S. and Soviet ground stations will be on VHF channels using wideband FM. It is unlikely that very many DXers will have the necessary gear to monitor these direct communications.

The prime VHF frequency to be used by both the U.S. and U.S.S.R. direct communications is 121.75 MHz. Also planned for use is 296.8 MHz, at the high end of the very high frequency range.

However, the NASCOM Communications Network, the radio links between the various overseas satellite tracking stations and the NASA Space Flight Center in Houston, should be heard by shortwave listeners.

In the past some DXers have heard astronaut conversations with ground control on various shortwave frequencies. Some have mistakenly assumed that they were receiving direct communications from space.

Actually what they were hearing—and what you can hear during the July, mission—were NASCOM shortwave relays. The signals from space are picked up on VHF at the worldwide tracking posts and are relayed, via shortwave, back to State-side NASA stations.

In the NASCOM network are transmitters serving the overseas stations at Balboa, Canal Zone; Ascension Island; Canary Islands; Bermuda; London; Kano, Nigeria; Tananarive, Malagasy Republic; Perth, Australia; Canton Island and Honolulu. Some of these use the transmitting facilities of such commercial point-to-point utility outfits as Cable and Wireless, Ltd., Tropical Radio Telegraph and RCA Global Communications.

There is a long list of frequencies worth tuning for these NASCOM signals, depending on propagational conditions and time of day. They include: 7,480; 7,690; 7,919; 8,120; 9,133; 9,212; 9,865; 10,410; 10,950; 11,430; 11,634; 12,107; 12,112; 12,212; 12,275; 13,423; 13,580; 13,905; 15,870; 16,440; 17,683; 18,335; 20,450; 20,990; 21,845 and 22,805 kHz.

The U.S. military, especially the Navy and Air Force, play a major part in our space flights, and in particular, the landing and recovery segments of the mission. And these forces, recovery ships in the Pacific, search and recovery aircraft and military shore installations at Pearl Harbor and elsewhere will be making use of shortwave communications.

(Continued on page 28)

NEW! PACE SIDETALK TWINS

For greater communications range and control

- 23 channels AM with full 4 watts of maximum legal output power.
- 46 channels SSB with full 12 watts PEP maximum legal output power.
- Switchable noise blanker circuit for suppressing unwanted SSB and AM impulse noise.
- Built-in PA circuit with front panel control.
- Full range RF gain control for receiver sensitivity adjustment.
- Clarifier for compensating the transmitter frequency drift and error of received signals.
- AM, LSB and USB mode status indicator lights.
- Receive and transmit indicator lights.

- Mobile unit CB 1000M also features:
- Full-size "S" meter for monitoring incoming signal strength and relative output power strength.
- Base unit CB 1000B also features:
- Clock with alarm and automatic turn-on timer.
 - Multiple functioning full size meter for monitoring:
 - incoming signal strength.
 - relative power output.
 - antenna performance.
 - Engineering for 110V AC and 12V DC applications.

(-) and (+) ground applications.

CB 1000M \$349.95

CB 1000B \$449.95

Pick up the "SIDETALK TWINS" to enjoy super communications power.

((p))

Pace Communications, Div. of Pathcom Inc., 24049 S. Frampton Ave., Harbor City, Ca. 90710. Available in Canada from Superior Electronics Ind.



Radio Shack Price Breakthrough!

Realistic 4-Channel/StereomaxTM Receiver



**STEREOMAXTM—Instantly
Converts Your QTA-720 Into a
Stereo Receiver with More Than
Twice the Power Per Channel**

**Sensational Low
Realistic Price**

only 229⁹⁵

FREE New 1976 Radio Shack Catalog

OVER 2000 PRODUCTS
EXCLUSIVES ON EVERY PAGE
BEAUTIFUL FULL COLOR

**Stereo • Quadraphonic • Phonographs
TV Antennas • Radios • Citizens Band
Kits • Recorders • Tape • Tools
Auto Tune-Up • Electronic Parts
Test Instruments • More!**



164 pages of the finest in home and hobby electronics. Respected brand names like Realistic, Micronta, Archer, Science Fair — and they're available only at Radio Shack stores and dealers nationwide! See what's really new in electronics by getting this catalog now.

**SEND FOR YOURS TODAY!
FILL OUT COUPON BELOW**

1976 Mail to Radio Shack, P. O. Box 1052, Ft. Worth, Texas 76101 (Please print.)

536

Name _____ Apt. No. _____

Street _____

City _____

State _____ ZIP _____

The Realistic® QTA-720 is a great value. Its versatile control center has an SQ decoder, outputs for 4-channel tape recording, CD-4 demodulator jacks and Aux-4 inputs. This receiver won't obsolete your collection of stereo recordings either—Quatravox® synthesizes the depth and realism of 4-channel from stereo sources. The sound is superb—FET/IC FM, superior AM and an amplifier that delivers low-distortion power at any audible frequency. With Stereomax, you can even use it as a full-power stereo receiver if you're not ready to add a second speaker pair right now. And what features! Glide-Path® sliding volume controls, stereo/4-channel headphone jacks, speaker selector, FM detector output, beautiful black-out dial and a walnut-grain vinyl veneer case. Power output into 8 ohms, from 20-20,000 Hz, at not more than 1% total harmonic distortion: 4 channel mode, 5 watts minimum RMS per channel with all channels driven; Stereomax mode, 11 watts minimum RMS per channel with both channels driven. U.L. listed. Ask for #31-4011. There's only one place you can find it... Radio Shack!

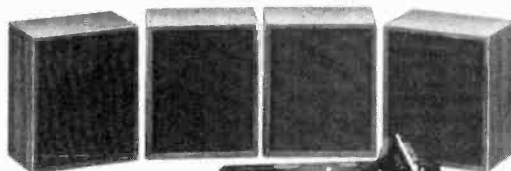

- Four Sclo-5 Vinyl Veneer Speakers
- QTA-720 20-Watt RMS AM/FM 4-Channel/Stereomax Receiver



- Realistic LAB-12C Changer with Base And \$12.95-Value Magnetic Cartridge



**Complete
QTA-720
System**

**SAVE 28⁷⁵
Regular 328.70
299⁹⁵**



**Master Charge or
Bank Americard at
participating stores**

Radio Shack®
A TANDY CORPORATION COMPANY

OVER 3000 STORES • 50 STATES • 7 COUNTRIES
Retail prices may vary at individual stores
Prices and products may vary in Canada

CIRCLE 32 ON READER SERVICE COUPON

DX CENTRAL

(Continued from page 26)

For these military communications, especially on the mission's ninth day, the day the Apollo astronauts will splash down off Hawaii, some frequency ranges to tune would include, give or take 50 kHz each way, 5,700; 6,750; 11,200; 13,200; 15,050; and 18,000 kHz.

And finally the press will again be out in full force with on-the-scene coverage of the recovery mission. Reporters accounts of the space venture directed to their editors back home might be heard on such frequencies as 6,845; 10,390;

13,915 and 18,150 kHz.

With the way our space program seems to be winding down, the joint Apollo-Soyuz flight in July may be one of the last times you'll have the opportunity to get this sort of first-hand info on what goes on behind the scenes during a space mission.

The European Scene. Many readers of DX Central Reporting write to ask for current information about a number of the major shortwave broadcasters in Europe. All right, then, here is a quick roundup of news about some of these SWBC operations on the other side of the Atlantic.

• Great Britain—Most SWLs know of-

Britain's BBC and readily find its broadcasts on a number of shortwave frequencies. But did you know that the BBC also has, like a number of other stations, a program especially directed at SWLs?

The BBC World Radio Club can be heard on Sundays at 0815 GMT, on Wednesdays at 1330 and 2315, and on Fridays at 2030 GMT.

• France—At the end of last year, France's government-operated ORTF broadcasting organization was dissolved. It was replaced by a shortwave operation known as Radio France International. As this is written, its English language programs can be heard at 1700 GMT on 15,140, 15,300, 15,360, 15,425, 17,720 and 17,850 kHz.

• Vatican State—Look for improved reception of Vatican Radio before too long. Word is that new shortwave transmitters, 250 to 500 kilowatts of power, are to be installed beginning this summer.

• Denmark—Once a major European broadcaster whose English language programs were very popular in the States, Denmark's shortwave operations continue downhill. Some years back, Radio Denmark discontinued English programs. Now comes word that three of its antenna towers at Herstedvester had become so unsafe that they were dismantled. Reportedly there are no plans to replace them, leaving the station with only two beam antennas.

Radio Denmark continues to use 15,165 kHz, but plans have been announced to add a transmission to North America at 0200 GMT on 9,520 kHz, about the time you read this. Though programs are in Danish, you may hear an occasional English announcement.

• Belgium—Radio TV Belge continues to air two short—twenty minutes each—English language broadcasts to North America each day. Listen on 9,730 kHz from 2255 to 2315 GMT, or on 6,055 kHz from 0040 to 0100 GMT.

• Finland—According to David Mawby, DX editor of Radio Finland, the station recently purchased new equipment from Sweden which enables it to broadcast with its 100-kw transmitter in the 49 meter band. Formerly the Radio Finland transmitter could only be used in the 19 and 31 meter bands. At press time, the 49 meter outlet was 6,120 kHz.

The Noise That Annoys. One of the first things a person discovers when he or she first tunes the shortwave frequencies is that, compared to the medium wave (540-1600 kHz) band, SW is full of noise.

Much of this SW noise is caused by non-voice radio communications. Those stations that buzz, squawk, howl and chatter may be commercial or military radioteletype (RTTY), or a multiplexed version (MUX) of RTTY combining a number of teletype signals on the same frequency. Some may be the sounds made by radio facsimile transmitters, which send photos and other graphic communications via electromagnetic waves.

There also are jamming transmitters, (Continued on page 34)

Checklist of Books for the Libraries of Technicians, Hobbyists & Students

BRAND-NEW BOOKS...JUST PUBLISHED

- 2nd Class FCC Encyclopedia, 602 p; 600 ill. \$7.95
- International Transistor Selector, 140 p. \$4.95
- Radio Astronomy for the Amateur, 252 p; 88 ill. \$5.95
- Radio Control for Models, 350 p; 417 ill. \$6.95
- Electronic Experimenter's Gdbk, 182 p; 86 ill. \$7.95
- Gde. to Outboard Motor Service/Repair, 294 p. \$6.95
- Complete Hdbk. of Lawnmower Repair, 434 p. \$7.95
- Color TV Case Histories Illus. 238 p; 117 ill. \$5.95
- Adv. Applications for Pocket Calculators, 308 p. \$5.95
- Jack Darr's Service Clinic No. 3, 252 p; \$4.95
- Complete Hdbk. of Home Painting, 210 p; 96 ill. \$4.95
- Broadcasting Production Hdbk., 210 p; 44 ill. \$12.95
- Crafts for Kids, 182 p; 199 ill. \$3.95
- Transistor Theory for Tech/Engineers, 224 p. \$5.95
- Color TV Studio Design/Operation, 168 p; 69 ill. \$9.95
- How to Train a Watch Dog, 224 p; 45 ill. \$5.95
- Encyclopedia of Broadcast Management, 462 p. \$5.95
- 4-Channel Stereo/Source to Sound—2nd Ed., 252 p. \$4.95
- Auto Electronics Simplified, 256 p., 202 ill. \$5.95
- The Complete Auto Electric Handbook, 210 p., 139 ill. \$5.95
- The Home Appliance Clinic, 96 p., 61 ill. \$4.95
- Amat. Filmmaker's Hdbk. of Sound Sync/Scoring. \$5.95
- Complete FM 2-Way Radio Handbook, 294 p. \$6.95
- Complete Hdbk. Auto Engines/Systems, 252 p., 239 ill. \$5.95
- Directional Broadcast Antennas, 210 p., 50 ill. \$12.95
- Practical M.A.T. TV System Design & Serv., 252 p. \$5.95
- Basic Digital Electronics, 210 p., 117 ill. \$4.95
- Electronic Music Production, 156 p., 84 ill. \$3.95
- Servicing Cassette & Cartridge Tape Players, 294 p. \$6.95
- Small Appliance Repair Guide—Vol. 2, 210 p., 113 ill. \$4.95
- Gde. Announcement Class & CC Study Gde., 168 p. \$3.95
- CET License Handbook, 276 p., 239 ill. \$5.95
- TV Tuner Schematic/Servicing Manual, 8 1/2 x 11", \$6.95
- Complete Shortwave Listener's Handbook, 288 p. \$6.95
- How to T/shoot/Repair Electronic Test Equipment. \$6.95
- Electronics For Shutterbugs, 204 p., 109 ill. \$5.95

AUDIO TAPE RECORDERS & RECORDS

- Cassette Tape Recorder for Professionals \$14.95
- Questions & Answers About Tape Recording, 264 p. \$5.95
- FM Stereo/Quad Receiver Servicing Manual, 192 p. \$4.95
- Stereo/Quad Hi-Fi Principles & Projects, 192 p. \$4.95
- Acoustic Techniques for Home & Studio, 224 p. \$4.95
- Selecting & Improving Your Hi-Fi System, 224 p. \$4.95
- Basic Audio Systems, 240 p., 203 ill. \$4.95
- Pictorial Guide to Tape Recorder Repairs, 256 p. \$4.95
- How to Repair Musical Instrument Amplifiers, 288 p. \$5.95
- How to Build Solid-State Audio Circuits, 320 p. \$5.95
- Hi-Fi for the Enthusiast, 224 p., 117 ill. \$3.95
- Electronic Musical Instruments, 192 p., 121 ill. \$4.95
- Servicing Modern Hi-Fi Stereo Systems, 248 p. \$4.95
- Handbook of Magnetic Recording, 224 p., over 90 ill. \$4.95
- Installing & Servicing Home Audio Systems, \$5.95
- Tape Recording for Fun & Profit, 224 p., over 200 ill. \$5.95
- Audio Systems Handbook, 192 p. \$4.95
- Servicing Electronic Organs, 196 p., 8 1/2 x 11" \$7.95
- Japanese Radio, Record & Tape Player Serv. Manual. \$6.95

AUTO ENGINE & APPLIANCE REPAIR

- Rapid Auto Tuneup & Troubleshooting, 192 p. 97 ill. \$3.95
- The Complete Snowmobile Repair Handbook, 350 p. \$9.95
- Auto Tuneup, 288 p., 258 ill. \$4.95
- Auto Tuneup/Emission-Control Svc., 240 p. \$4.95
- The Complete Mini-Bike Handbook, 309 p., 145 ill. \$5.95
- Everyman's Guide to Auto Maintenance, 192 p., 38 ill. \$4.95
- How to Repair Small Gasoline Engines, 288 p., 124 ill. \$5.95
- Using Electronic Testers for Auto Tune-Up, \$4.95
- Major Appliance Repair Guide, 288 p., Illustrated \$5.95
- How to Repair Home/Auto Air Conditioners, 208 p. \$4.95
- Small Appliance Repair Guide, 224 p., over 100 ill. \$4.95
- Refrigeration, 131 p., 53 ill. \$3.95

RADIO-TV SERVICING

- TV Troubleshooter's Handbook—3rd Ed., 488 p. \$4.95
- Effective Troubleshooting with EVM & Scope, 238 p. \$5.95
- Logical Color TV Troubleshooting, 240 p., 151 ill. \$5.95
- Color TV Trouble Fact Book—2nd Ed., 348 p. \$4.95
- 10-Minute Test Techniques For PC Servicing, 216 p. \$4.95
- TV Bench Servicing Techniques, 228 p., 177 ill. \$4.95
- T/shooting Solid-State Wave Gen. & Shaping Cir. \$4.95
- Pict. Guide to Color TV Circuit Troubles, 256 p. \$4.95
- Installing TV & FM Antennas, 168 p., 158 ill. \$3.95
- Simplified TV Trouble Diagnosis, 320 p., 292 ill. \$5.95
- How to Interpret TV Waveforms, 256 p., 270 ill. \$4.95
- Kwik-Fix TV Servicing Manual, 384 p. \$5.95
- Basic Color Television Course, 420 p., over 300 ill. \$7.95
- All-In-One TV Alignment Handbook, 304 p., 145 ill. \$5.95
- 199 Color TV Troubles & Solutions, 224 p. \$4.95
- Modern Radio Repair Techniques, 260 p. \$4.95
- TV Trouble Diagnosis Made Easy, 256 p. \$5.95
- Home-Call TV Repair Guide, 144 p. \$3.95
- 101 TV Troubles—From Symptom to Repair, 224 p. \$4.95
- Pinpoint TV Troubles In 10 Minutes, 372 p., 394 ill. \$5.95

A UNIQUE CONCERN IN KITS—TAB ELECTRONIC BOOK KITS

- For the price of a kit alone, you get a book—PLUS a complete kit Audio Mixer, \$8.95 5-Watt Hi-Fi Amplifier, \$10.95 Electronic Artwork Filter, \$8.95 AM Wireles Light, \$6.95 Electronic Touch Switch, \$9.95 Garage Light Control, \$8.95 Audio Signal Generator/Injector, \$6.95 Low-Voltage DC Power Supply, \$4.95 Diode Tester, \$6.95 High Power Lamp Dimmer, \$5.95 20W 4-Channel "Quad" Amp, \$19.95 Electric Organ, \$5.95 Intrusion Alarm, \$8.95 Tunable Organ, \$9.95

COMPUTER TECHNOLOGY

- Getting the Most Out of Your Electronic Calculator, \$4.95
- Simplified Computer Programming—The Easy RPG Way, \$5.95
- Beginner's Guide to Computer Programming, 480 p. \$6.95
- Computer Technician's Handbook, 480 p., over 400 ill. \$8.95
- Beginner's Guide to Computer Logic, 192 p., over 100 ill. \$4.95
- Computer Circuits & How They Work, 192 p., ill. \$4.95
- CATV Circuit Engineering, 294 p., 138 ill. \$14.95
- Commercial FCC License Handbook, 444 p., 150 ill. \$5.95
- Amateur FM Conversion/Construction Proj., 256 p. \$5.95
- Pictorial Guide to CB Radio Installation & Repair, \$4.95
- Modern Communications Switching Systems, 276 p., \$17.95

COMMUNICATIONS, CB, & HAM RADIO

- How To Be A Ham—Incl. Latest FCC Rules, 192 p. \$3.95
- Mobile Radio Handbook, 192 p., 175 ill. \$4.95
- CB Radio Operator's Guide, 224 p., scores of ill. \$5.95
- Marine Electronics Handbook, 192 p., 106 ill. \$4.95
- 2-Meter FM Repeater Circuits Handbook, 312 p. \$6.95
- RTTY Handbook, 320 p., 230 ill. \$6.95
- Citizens Band Radio Service Manual, 228 p. \$4.95

—AMATEUR RADIO STUDY GUIDES—

- Novice \$5.95 General \$7.95 Advanced \$5.95
- Extra \$4.95 Incentive \$3.95

"LEARN IT YOURSELF" BEGINNER'S BOOKS

- How to Read Electronic Circuit Diagrams, 192 p. \$4.95
- Elect. Unraveled/A New Commonsense Approach, \$4.95
- Electrical Wiring/Lighting For Home/Office, \$4.95
- Basic Electricity & Beginning Electronics, 252 p. \$5.95
- Basic Electronic Test Procedures, 416 p., 178 ill. \$6.95
- Basic Electronic Circuits Simplified, 352 p., 170 ill. \$5.95
- Basic Electronics Course, 384 p., 275 ill. \$6.95
- Beginner's Guide to TV Repair, 176 p. \$4.95
- Electronics Self-Taught With Experiments/Projects, \$5.95
- Basic Electronics Problems Solved, 192 p. \$4.95
- How to Test Almost Everything Electronic, 160 p. \$2.95
- Basic TV Course, 224 p., 128 ill. \$5.95
- Basic TV Course, 224 p., packed with ill. \$4.95
- Basic Radio Course, 224 illustrated pages, \$4.95
- Basic Math Course for Electronics, 168 p. \$4.95
- Electric Motor Test & Repair, 160 p. \$6.95

HOBBY PROJECTS & PLANS

- Practical Circuit Design for the Experimenter, 198 p. \$4.95
- Practical Triac/SCR Projects For The Experimenter, \$4.95
- Model Sail & Power Boating—By Remote Control, \$4.95
- Practical Test Instruments You Can Build, 204 p. \$4.95
- Miniature Projects For Electronic Hobbyists, 168 p. \$3.95
- Experimenting With Electronic Music, 180 p., 103 ill. \$4.95
- Landcalling/From RC Models to the Big Ones, 192 p. \$4.95
- Handbook of IC Circuit Projects, 224 p., 136 ill. \$4.95
- New IC FET Principles & Projects, 154 p., over 80 ill. \$3.95
- VCR Projects for Amateur & Experimenter, 224 p. \$3.95
- Model Car Racing—By Radio Control, 224 p. \$3.95
- Solid-State Projects for the Experimenter, 224 p. \$4.95
- Practical Solid-State Principles & Projects, 176 p. \$3.95
- Radio-Electronics Hobby Projects, 192 p., 214 ill. \$4.95
- IC Projects for Amateur & Experimenter, 192 p. \$4.95
- Transistor Projects for Hobbyists & Students, 192 p. \$4.95
- 125 One-Transistor Projects, 192 p., 125 ill. \$4.95
- 104 Easy Projects for The Electronics Gadgeteer, 160 p. \$3.95
- 64 Hobby Projects for Home & Car, 192 p., 159 ill. \$4.95
- 104 Simple One-Tube Projects, 192 p., 104 ill. \$3.95
- Electronic Hobbyist's IC Project Handbook, 154 p. \$4.95
- 104 Easy Transistor Projects You Can Build, 224 p. \$4.95
- Radio Control Manual—2nd Ed., 192 p., 158 ill. \$4.95

ALL-IN-ONE COLOR & B&W TV SCHEMATIC/SERVICING MANUALS

Each vol. has complete service data, parts lists, full-size schematics, and all other info needed. Each 8 1/2 x 11", 196-212 pps. Each only \$4.95 unless marked \$5.95. COLOR TV:

- Adm. Vol. 1 \$5.95 Vol. 2 G-E Vol. 1 \$5.95 Jap. Vol. 1 Vol. 2 Vol. 3 Vol. 4 \$5.95 Vol. 5 \$5.95 Vol. 6 \$5.95 RCA Vol. 1 \$5.95 Vol. 2 \$5.95 Vol. 3 \$5.95 Vol. 4 \$5.95 Sears \$5.95 Serv. Modular \$5.95 Zenith Vol. 1 \$5.95 Vol. 2 Vol. 3 B & W TV: Adm. G-E Jap. Magnavox Motorola Philco RCA Syl. Zenith

NO-RISK COUPON—MAIL ENTIRE AD

TAB BOOKS, Blue Ridge Summit, Pa. 17214
Please send me books checked above.

- I enclose \$_____ send postpaid
- Please invoice on 10-day FREE trial.
- Send FREE 44 page catalog.

Name _____ Phone _____
Company _____
Address _____
City _____ State _____ Zip _____

SAVE POSTAGE by remitting with order.
Foreign add 10%; Pa. residents add 6%. EE-75

Why settle for a piece of the CB action...

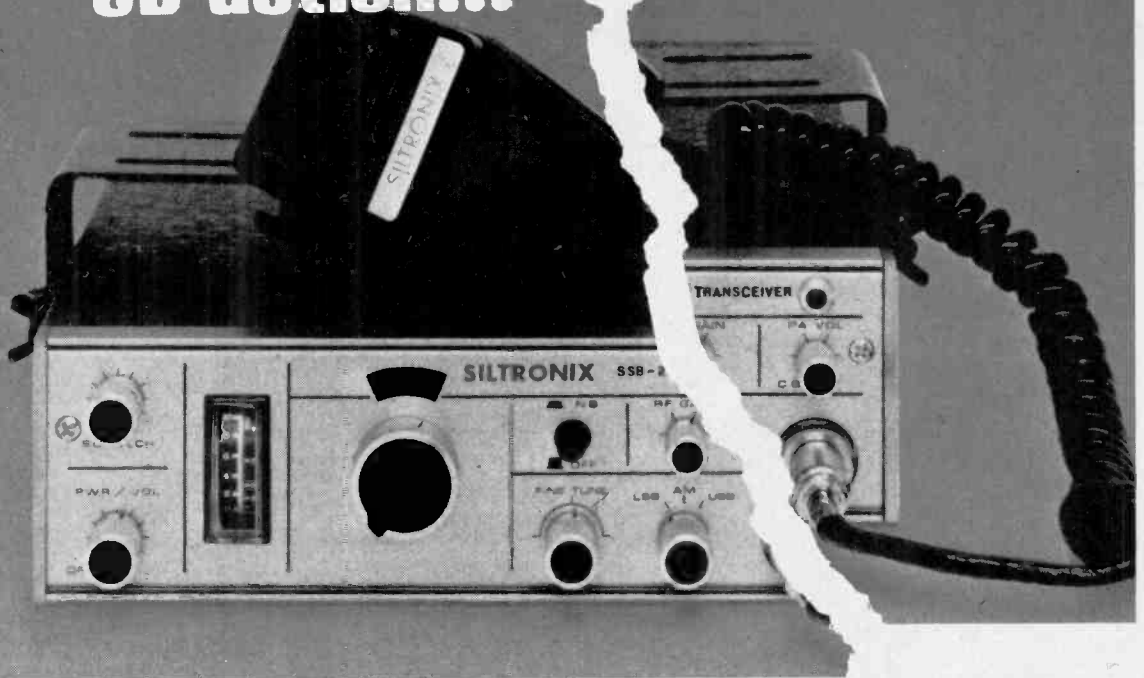

when Siltronix SSB/AM gives you all of it?

Citizens Band radio has a lot more to offer than 23 channels and a weak signal.

Siltronix single sideband CB sets can double or triple your range by giving you more efficient use of your communications power. And they give you twice as many modes to get through on.

And Siltronix CB sets wrap up those 46 modes of single sideband talk power together with full AM capability to give you everything CB radio has to offer in one compact rig.

Sure Siltronix SSB/AM costs more. About a third more than a good AM rig. For that you get over 12 watts of input power punch and twice the number of modes plus AM to boot.

Like three for the price of one.

Believe us, SSB works better. A whole lot better. But you don't have to take our word for it. Check the amateur bands and you'll find that the hams are all talking on SSB—almost to a man.

Why buy just a piece of CB? Go single sideband with the leader and get in on all the action the band has to offer. See your Siltronix dealer today.



A Cubic Corporation Company

269 Airport Road • Oceanside, CA 92054
Telephone: (714) 757-8860

Join the SILTRONIX SIDEBANDERS—See your SILTRONIX dealer.

CIRCLE 18 ON READER SERVICE COUPON

The better the training the better you'll

Send for
FREE
illustrated
career
guide

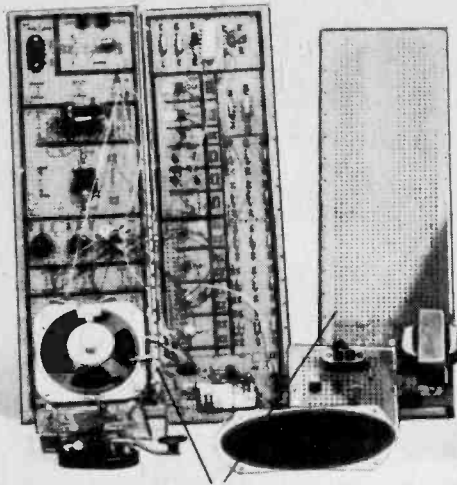
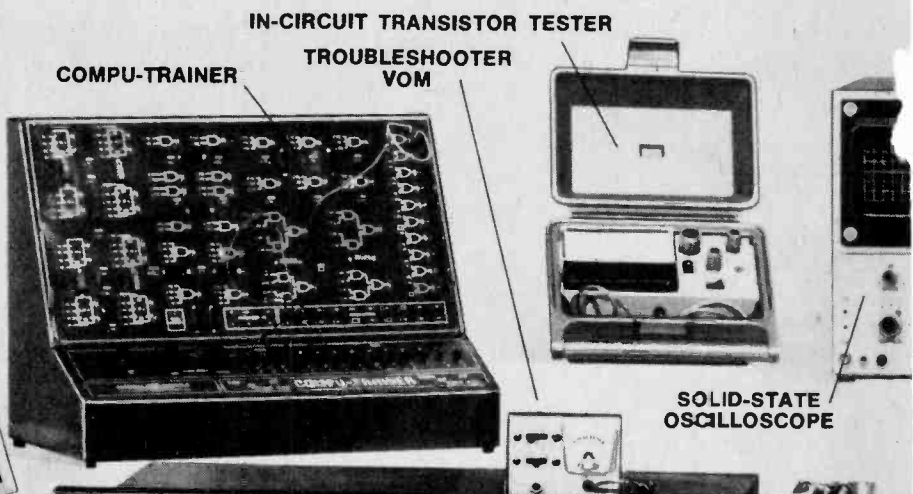
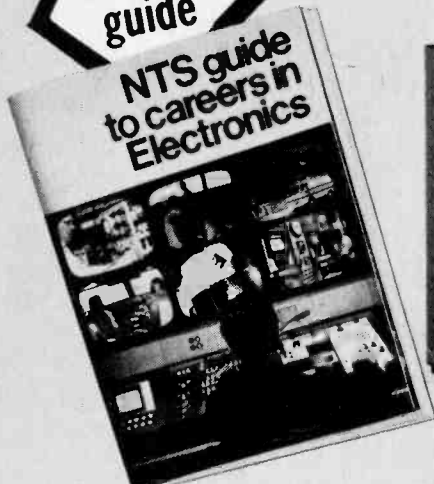

As an NTS student you'll acquire the know-how that comes with first-hand training on NTS professional equipment. **Equipment you'll build and keep.** Our courses include equipment like the **NTS/Heath Digital GR-2000 Solid State color TV** with first-ever features like silent varactor diode tuning; digital channel selection, (with optional digital clock), and big 315 sq. in. ultra-rectangular screen.

Also pictured above are other units — 5" solid state oscilloscope, vector monitor scope, solid-state stereo AM-FM receiver with twin speakers, digital multi-meter, and more. It's the kind of better equipment that gets you better equipped for the electronics industry.

This electronic gear is not only designed for training; it's field-type — like you'll meet on the job, or when you're making service calls. And with NTS easy-to-read, profusely illustrated lessons you learn the theory behind these tools of the trade.

Choose from 12 NTS courses covering a wide range of fields in electronics, each complete with equipment, lessons, and manuals to make your training more practical and interesting.

Compare our training; compare our lower tuition. We employ no salesmen, pay no commissions. You receive all home-study information by mail only. All Kits, lessons, and experiments are described in full color. Most liberal refund policy and cancella-

and the equipment be equipped.

**COMPARE OUR
KITS AND LESSONS.
COMPARE OUR
TUITION.**

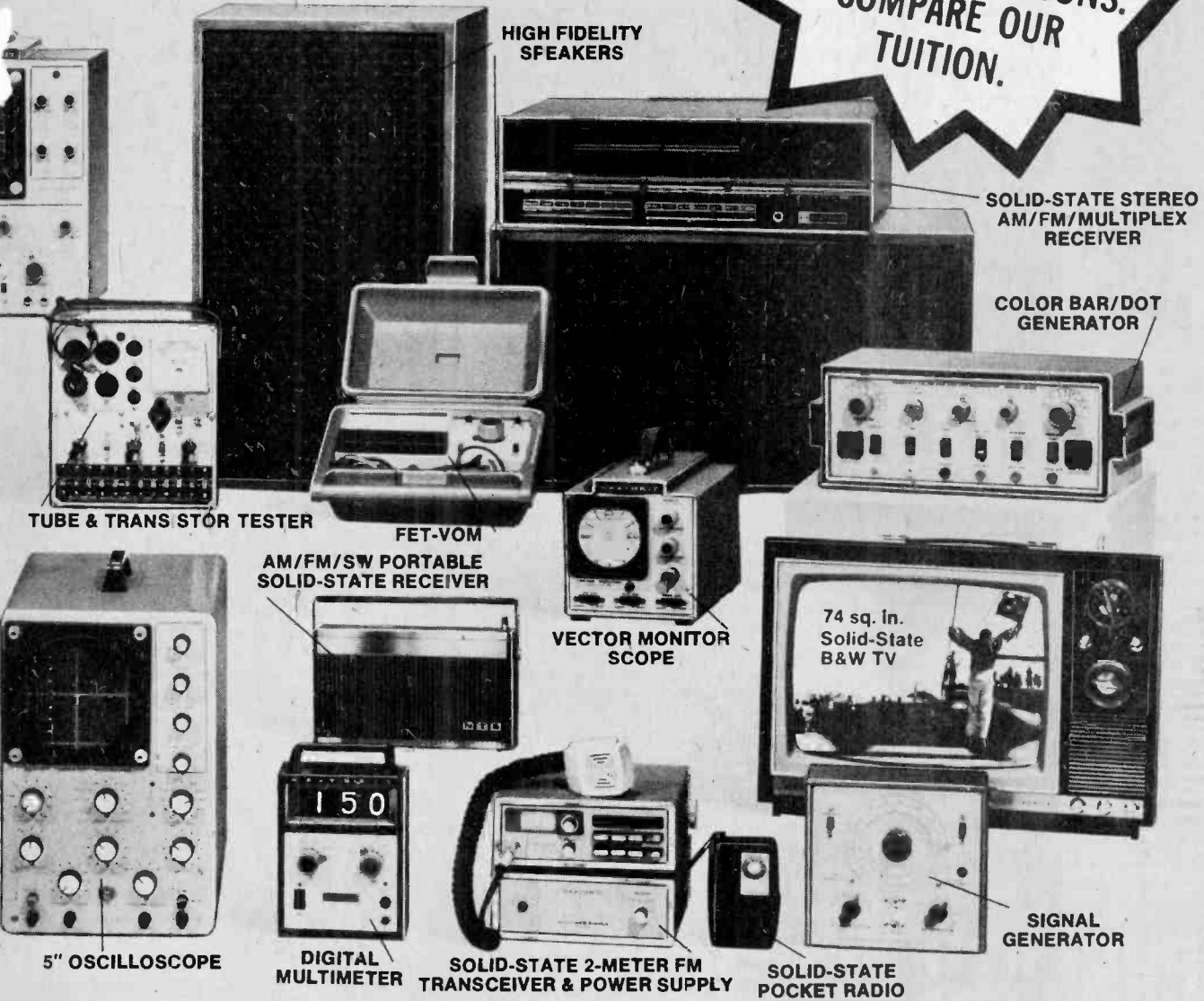

**HIGH FIDELITY
SPEAKERS**

**SOLID-STATE STEREO
AM/FM/MULTIPLEX
RECEIVER**

**COLOR BAR/DOT
GENERATOR**

TUBE & TRANS STOR TESTER

FET-VOM

**AM/FM/SW PORTABLE
SOLID-STATE RECEIVER**

**VECTOR MONITOR
SCOPE**

5" OSCILLOSCOPE

**DIGITAL
MULTIMETER**

**SOLID-STATE 2-METER FM
TRANSCEIVER & POWER SUPPLY**

**SOLID-STATE
POCKET RADIO**

**SIGNAL
GENERATOR**



**74 sq. in.
Solid-State
B&W TV**

tion privileges spelled out. Make your own comparisons, your own decision. Mail card today, or clip coupon if card is missing.

NO OBLIGATION. NO SALESMAN WILL CALL

APPROVED FOR VETERAN TRAINING
Get facts on new 2-year extension

NATIONAL TECHNICAL SCHOOLS

TECHNICAL-TRADE TRAINING SINCE 1905
Resident and Home-Study Schools
4000 So. Figueroa St., Los Angeles, Calif. 90037

ELEMENTARY ELECTRONICS/July-August 1975

NATIONAL TECHNICAL SCHOOLS Dept. 222-075
4000 South Figueroa St., Los Angeles, Calif. 90037
Please send FREE Color Catalog and Sample Lesson.
NO OBLIGATION. NO SALESMAN WILL CALL.

<input type="checkbox"/> Color TV Servicing	<input type="checkbox"/> Electronics Technology
<input type="checkbox"/> B & W TV and Radio Servicing	<input type="checkbox"/> Computer Electronics
<input type="checkbox"/> Electronic Communications	<input type="checkbox"/> Basic Electronics
<input type="checkbox"/> FCC License Course	<input type="checkbox"/> Audio Electronics Servicing

NAME _____ AGE _____
ADDRESS _____ APT # _____
CITY _____ STATE _____

Please fill in Zip Code for fast service _____
 Check if interested in G.I. Bill Information.
 Check if interested ONLY in classroom training in Los Angeles.

now available for the telephone experimenter

COMPLETE CONSTRUCTION PLANS

TELEPHONE PLANS: \$1.00 each.
 Answering Device, Automatic Dialer, "Black Box", Call Diverter, Call Limiter, Conference Bridge, Central Dial Exchange, Melodic Ringing Generator, Recorder-Actuator, Remote Control, Schematics, Speakerphone, Teletalk, Burglar Alarm, Voice Scrambler, Dial/Tone Converter, Tone/Dial Converter.

MISC. PLANS: \$6.00 each
 Biofeedback Conditioner, Multifrequency Encoder Network, Horticulture Stimulator, Dodecahedron Speaker Enclosure, Photographic Pinhole Camera.

ALL OF THE CONSTRUCTION PLANS ABOVE: \$24.95 AIRMAILED.

LEARN THE SECRETS OF YOUR TELEPHONE

Telephone Electronics Line

Have you ever wondered what lies behind that telephone dial? Now you can learn the tricks of the telephone trade. Get the inside story of telephone systems—their quirks and flaws, and remain up to date on vital occurrences within the telephone industry. TELEPHONE ELECTRONICS LINE is a publication designed for the telephone enthusiast, phone phreak, and experimenter, containing interesting articles which offer a wealth of hard to find information. Technical theory is also discussed, among the following items: **Current News Items • Code Numbers Illustrations • Games • Facts • Plans Projects • History • Comics • Stories Facts** previously Tel. Co. confidential is now published in TEL!

One year subscription rate: United States \$6.00, Canadian & foreign \$8.00.

ALL OF THE CONSTRUCTION PLANS ABOVE PLUS A ONE YEAR SUBSCRIPTION TO TELEPHONE ELECTRONICS LINE: \$29.95 AIRMAILED.

THE LEGAL ASPECTS OF INTERCONNECTION

\$29.95 AIRMAILED

The complete reference book to your LEGAL RIGHTS as a telephone subscriber. Study toll evasion, tariffs, wiretapping, customer provided equipment, and many more!

ALL OF THE CONSTRUCTION PLANS ABOVE AND A ONE YEAR SUBSCRIPTION TO TEL PLUS "THE LEGAL ASPECTS OF INTERCONNECTION": \$49.00 AIRMAILED.

TELETRONICS COMPANY OF AMERICA
 22035 BURBANK BLVD., WOODLAND HILLS CA 91364 USA

CIRCLE 16 ON READER SERVICE COUPON.

Our objective is to serve as best we can the ever broadening interest in the electronics and communications field. *Elementary Electronics* is made available nationally on all leading newsstands and in Radio Shack stores. Should, for some reason, copies of E/E not be available, or are sold out at your favorite location, we shall appreciate your letting us know by dropping a card in the mail to the Publisher, *Elementary Electronics*, 229 Park Avenue S., NY, NY 10003.

BEA LOCKSMITH



You'll enjoy your work as a Locksmith because it is more fascinating than a hobby—and highly paid besides! You'll go on enjoying the fascinating work, year after year, in good times or bad because you'll be the man in demand in an evergrowing field offering big pay jobs, big profits as your own boss. What more could you ask!

Train at Home — Earn Extra \$555 Right Away!

LOCKSMITHING INSTITUTE
 Div. Technical Home Study Schools
 Dept. 1472-075 Little Falls, N. J. 07424

"Have seen other Locksmith courses but none compared to yours. Have a successful mobile service of my own... earn \$2000-\$3000 per month."
 Keith Hamill, Toronto

Name _____
 (Please Print)

Address _____

City/State/Zip _____

Check here if Eligible for Veteran Training

DX CENTRAL

(Continued from page 28)

radio signals aired on the same or nearby frequencies used by "opposition" broadcasters as part of the broadcasting "Cold War." Jamming has its ups and downs, depending on the political climate that exists between various countries. Over the years, the Soviet Union and China, plus other Communist Bloc countries have jammed broadcasts from the West. And non-Communist nations have attempted, with varying success, to jam broadcasts from "the other side."

Jamming comes in a number of forms: rapid code-like pulsing of multi-beepers, the whine of electronic "buzzsaws," "growlers" and white noise, a mixture of all audio frequencies.

Other odd noises you may hear include what some DXers have described as bagpipes. And strange collections of a half dozen or so electronic notes, repeated over and over. These, in most cases, are channel markers used by radiotelephone and other utility-type stations during periods when they are not handling voice traffic.

Usually it is useless to try to identify the specific source of these "noises" you hear on shortwave. With time and experience you may be able to determine the basic type of service that causes the clamor, but beyond that there usually isn't much use in trying to identify its exact source. Most often these non-broadcast transmissions, with the exception of the deliberate jamming, are found outside the normal SWBC bands, where they shouldn't hamper your SWLing too much. On those occasions when they do interfere with your favorite station or some DX signal you're trying to log, about all you can do is grin and bear it, hoping they'll leave the air before ID time comes.

Bandsweep. (Frequencies in kHz, times in GMT) **1020**—One medium wave outlet that has attracted some DX attention lately is the Venezuelan, YVRS, *Radio Margarita*. Its location is not in mainland Venezuela, but on the off-shore Isla Margarita, in the state known as Nuevo Esparta. It has been reported logged in British Columbia at 1000 sign on . . . **4,810**—Ecuador, like Venezuela, has its island territory too. For Ecuador it's the Galapagos Islands, some 600 miles out in the Pacific, an area known for its unusual fauna that have intrigued scientists since Darwin. The only broadcasting station in the islands is *La Voz de Galapagos*, owned and operated by a Roman Catholic mission. A nice bit of DX, you can tune for it about 1200 . . . **4,850**—Just up the dial a bit in the 60 meter band, one of the more potent Latin American signals these days comes from *Radio Clarin*, HILR, in the Dominican Republic. Even in Spanish the ID is easy to catch; phonetically, "clah-REEN." And some English has been

reported at 0030 . . . **6,090**—The first commercial, pop music station in Europe and still a great favorite with listeners across the pond is *Radio Luxembourg*. DXers have been reporting it broadcasting in English around 0000 to 0200 . . . **7,105**—Monaco is another little European country with a shortwave radio voice. *Trans World Radio*, which also operates SW stations in Swaziland and on the island of Bonaire, can be heard with an English language religious program at 0745 . . . **9,575**—DX Central received a request from a reader not long ago for information about an Italian shortwave broadcaster. OK, try *RAI*, Rome, on this frequency, in English, at 0100 . . . **11,920**—Here's an interesting one! *Radio TV Ivorienne* at Abidjan, Ivory Coast in West Africa can be heard, often with strong signals, during its English language foreign service. Tune in about 1930 . . . **15,060**—For beginning DXers there's always a fascination in hearing China's *Radio Peking*. Because it is in a rather empty part of the 19 meter band, this is a good frequency to try. Peking broadcasts in English at 0000.

(Credits: Brian Vernon, Br. Columbia; Mark Scannell, MA; Jim Vecchiola, PA; Jerry Lineback, IL; Hadley Cress, VA; Kevin Atkins, AL; Adam Gaffin, NY; National Radio Club, Box 127, Boonton, NJ 07005; SPEEDX, Box E, Elsinore, CA 92330; North American SW Association, Box 8452, S. Charleston, WV 25303.)

Backtalk. Now for a dip into the mailbag for a few of the many letters you've sent to DX Central.

A. Bohdanowicz of Toronto writes to tell about the recently installed longwave transmitting antenna in Poland, at 646 meters in height said to be the tallest in the world. He also wonders why, in the past, we've talked about SW stations in Rumania, Bulgaria, Czechoslovakia and Hungary, but have neglected Polish shortwave.

No slight intended, A.B. It is just that most DXers find the shortwave outlets in the other countries mentioned somewhat easier to hear. Warsaw's *Polish Radio* can be heard on SW without a doubt. You might try 11,810 kHz at 0200 GMT or 9,675 kHz at 0300. Or, at various times, 6,135 and 7,285 kHz.

"Hey, Don," writes Nick Jones, a faithful reader of e/e and DX Central Reporting, "how come you don't talk about *Radio Nederland* in Holland?"

"I heard them on 6,165 kHz at 0319 GMT, relayed by the station on the island of Bonaire in the Netherlands Antilles."

Hey, Nick, check some of your back issues. I have mentioned *Radio Nederland* on a number of occasions. You're right on target with the Bonaire relay. It is scheduled from 0200 to 0320 on 6,165 kHz, and again at 0500 GMT on the same frequency, plus 9,715 kHz. *Radio Nederland* programs transmitted direct from the station at Lopik, Holland, can be heard from 2130 to 2250 GMT on 9,715 and 11,730 kHz, at this writing.

newscan

Electronics in the News!

Cranking Out the Old-Timers

No such thing as a brand-new antique? A contradiction in terms? The people in Western Electric's miscellaneous electron tube organization will fight Webster's down the line on that one. It's their job to make the antiques—vacuum tubes—while their colleagues in the same city turn out modern products like microwave transmission systems, diodes and transistors.

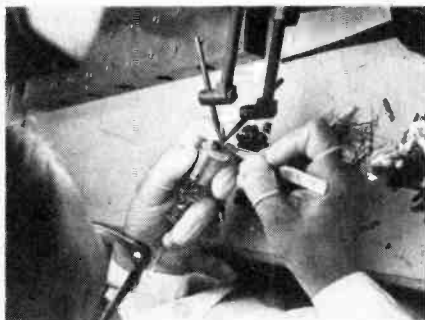

Sharon Randall has to rely on a pair of tweezers to make a spotweld on a mount assembly for one of the nearly 100 different "old-fashioned" electron tubes still turned out for Western Electric's old customers.

In fact, it was the advent of that last product, the transistor, that was responsible for the vacuum tube's "promotion" to antique status. There are six families of vacuum tubes: general purpose, repeaters, ballast lamps, small runners, carrier tubes and mercury rectifiers. In 1947, the year in which the transistor was invented by Bell Labs scientists, each family merited its own production line. As transistors replaced vacuum

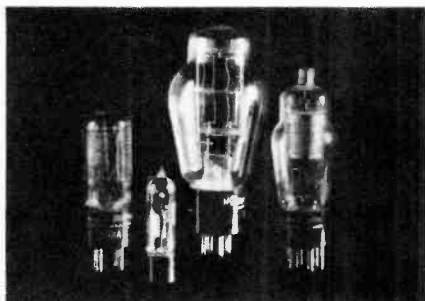

People in the miscellaneous electron tube organization at Western Electric's Kansas City, Missouri, Works are still cranking out these old-timers—vacuum tubes. The 31 Kansas City people can turn out nearly 100 different kinds of tubes, some dating back to the World War I era.

tubes, the six production lines were consolidated into one.

Today, about 30 miscellaneous tube people at the WE Kansas City Works are generalists who can turn out nearly 100 different kinds of vacuum tubes. Assembler Linda Campbell, 10-year veteran of the line, noted that it's not uncommon to get a call for quantities of tubes that haven't been built for as many as 10 years.

Cool Flame

A low-pollution engine, with fuel that "burns cool," may result from de-

signs now under development. Such an engine could be built around the concept of burning fuel in a device called a "transpiration burner," developed originally as a tool for research in combustion processes. The transpiration burner developed at the General Electric Company reduces pollutants by cooling the flame of the burning fuel below its normal temperature. In tests of early developmental models, pollution by nitrogen oxides was reduced to one-fortieth of the usual levels. The device could be used with either a steam

(Continued on page 36)

9-FUNCTION, 8-DIGIT MEMORY CALCULATOR KIT

\$19.95



It's the easiest multi-function kit today
LOWEST PRICE IN THE U.S.A.!

EASY TO PUT TOGETHER! You bet it is... imagine no resistors, capacitors, but it **ONLY REQUIRES 2 CHIPS** and a **READOUT!** How's that for simplicity? The 2 Memory keys are MS Memory Storage and MR Memory Recall (requires very little soldering). The display restore key is to conserve battery life. Your display on panel shuts off 25 seconds after the last operation. By depressing "D" key, the display is restored! Uses 6 N cell batteries. Red decimal appears on left to show when batteries need replacement or charging. Has Decimal, Clear, Constant, Percent, and arithmetic key red, white and blue colors. Lightweight, pocket size 5 1/2" x 3" x 3" (2" x 1 1/4" front side of angular display panel black case. Nifty unit for business, school, home, and for the youngsters. Slips into any pocket, briefcase with ease. Easy-to-understand pictorial instruction booklet and how-to-use-book.

AC/DC too!
KIT INCLUDES: case, 22-key keyboard kit, ON-OFF switch (part of keyboard) PC board, driver and memory calculator chips, 9-digit bubble magnifier LED array, array cable, 6 jumper wires, battery case, 6 battery card display, instruction and pictorial step-by-step construction booklet.

8-DIGIT THE SIMPLEST! FINEST! SMALLEST! 6-FUNCTION AC-DC CALCULATOR KIT! \$17.95



Designed specifically for Poly Paks under the Daltone NO brand. **IMAGINE!** only 2 1/2" x 1 x 4 1/2". Slides easily into your vest pocket, brief case, or handbag. We hunted everywhere to find a calculator kit that can be small, do the many functions, with fine engineering design and **SIMPLE TO BUILD!** WHY? Because it has the fewest parts in a kit. Imagine the pc board only has the chip, 4 resistors, two transistors, two driver ic's with the 9 digit readout. **SIMPLE!** You bet it is. The entire kit is even packed in a multicolor attractively designed box that in itself tells the mini calculator story. Kit includes attractive black case with red array cable. **Key** (type 20SR-66) 18 key keyboard that measures only 2 1/2" x 2" with 2 switches, one for ON-OFF, one for K constant; **MAIN** pc board; readout board; famous Cal Tech 5030 26-pin calculator chip; two 75491 ic drivers; Hewlett Packard 9 digit array; ac jack; 9 Volt battery connector resistors; two transistors; back protective plate; necessary wire plugs; easy instructions. (Less 9 volt standard battery and AC adapter) **EASIEST KIT TO BUILD**

GET KEY THE PARTS! Calculator Basics

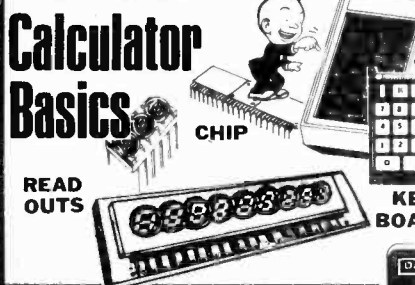

BASIC KIT #1 — includes case, all-function Flex Key Keyboard, Cal Tech CT5002 calculator chip, 9-digit LED display with built-on individual magnifiers, plus sheets. \$16.95
BASIC KIT #2 — same as Basic #1 except calculator chip is National 8-digit MM5724. \$16.95
BASIC KIT #3 — same as Basic #1 except calculator chip is National 6-digit MM5736 and 75492. \$16.95

12 DIGIT BASIC #4 — Key parts include: CT5004 chip, 4-3 digit readouts, factory etched PC board, case, carrying case, 2-resistor, factory decimal switch, Wild Rover Keyboard with ON-OFF switch diagrams. **Sale \$19.95**

8-DIGIT "TEXAS INSTRUMENT" BASIC KIT #7 — includes Texas keyboard, 1KS149, standard 4-function. With T-I calculator chip TMS-0128, p.c. board, case, lens. Microswitch (on-off). 9-digit array; includes diagram. **\$16.95.**

6 & 8 DIGIT MINI CALCULATOR BASICS "The key parts"
*So small fits in 'ur palm!
*Easiest to assemble!
*Requires approx. 6 more parts.

KIT NO. 5030 — 6 functions. Includes mini case, with lens, HP nine digit readouts, with multiplex pc board, main pc board, mini keyboard (with two switches, percent and constant), ac adapter jack, 2- SN75491 drivers, CT5030 calculator chip with diagram. \$16.95
KIT NO. 5031 — 4 function, same as 5030 except CT5031 chip. \$16.95
KIT NO. 5736 — 4 function, like 5031. Uses National MM5736 \$12.95

Terms: add postage. **Rated: net 30**
Phone Orders: Wakefield, Mass. (617) 245-3829
Retail: 16-18 Del Carmine St., Wakefield, Mass. (off Water Street) C.O.D.'S MAY BE PHONED
 20¢ CATALOG on Fiber Optics, IC's, Semis, Parts
MINIMUM ORDER — \$4.00
POLY PAKS
P.O. BOX 842D, LYNNFIELD, MASS. 01940

Sets up in Minutes. Puts out for Years.

Big Stick II base antenna

Here's a 16' half wave fiberglass base station antenna with matching cable that can be assembled and erected in minutes. No ground radials to mess with. No heavy supports required.

Big Stick II can take all the abuse of wind and weather—and keeps putting out where metal antennas would fail. Perfect for campers and for emergency react operations that call for fast set up and complete dependability. Shakespeare Industrial Fiberglass Division, P.O. Drawer 246, Columbia, South Carolina 29202.



Shakespeare

THE ROYAL LINE OF FIBERGLASS ANTENNA

IN CANADA Len Finkler, Ltd., 25 Toro Road, Downsview, Ontario

CIRCLE 14 ON READER SERVICE COUPON

PARTS! CORNELL TUBES!

Send For CORNELL'S New Color Catalog FREE

33¢ per tube

36¢ per tube

ORDER FREE IF NOT SHIPPED IN 24 HOURS!

48 Pgs. New Items IN LOTS OF 100

4219 E UNIVERSITY AVE. SAN DIEGO, CALIF. 92105

NEWSCAN

(Continued from page 35)

engine or a gas turbine engine. The power source considered by General Electric was in the 100 to 150 horsepower range.

The basic principle of the burner is to feed a pre-mixed flow of fuel and air through a flat, porous metal plate, in which one or more cooling coils have been embedded. After the fuel-air mixture is ignited, a flat sheet of flame burns steadily just a fraction of an inch away from the surface of the burner. The flame's temperature is reduced below what it would normally be as heat is absorbed by water in the cooling coils.

When the transpiration burner is used, for instance, as part of a steam engine, steam is generated by heat absorbed by the water as it passes first through the coils inside the burner, then through a boiler surrounded by the hot combustion gases.



A flat sheet of flame hovers a fraction of an inch above the surface of a device that may make possible a virtually pollution-free engine. This version of the device, called a "transpiration burner," was developed by the General Electric Research and Development Center, Schenectady, NY, as a tool for use in research on combustion problems.

The reduction in the flame temperature is vital to reducing pollutants, particularly the oxides of nitrogen. Burning gasoline at about 3500°F (2000°C), a temperature typical of automobile and coal- or oil-fired burners, produces about 600 parts per million of nitric oxides. In contrast, when the transpiration burner is operated with a flame temperature of about 3100°F (1700°C), there are only about 15 parts per million of nitrogen oxides in the burnt gases. Hydrocarbon emissions are likewise

drastically reduced by the new burner. No measurable amounts have ever been observed during controlled laboratory testing at design flow rates, implying less than one part per million. Carbon monoxide emissions from a device employing this concept also would be kept within acceptable limits.

Audio Doctors

"Earmanship"—creating better understanding of the most important component of any hi-fi system, the ears—is the thrust of a novel program unveiled late last year by JVC America, Inc. Called "Audio Doctor" clinics, the program uses more than \$100,000 in special testing equipment to test various hearing characteristics of stereo and music aficionados at participating dealerships. The first clinics were held at nine separate dealerships in Southern California.



At the Sound Preference Clinic, shown above, Shane Ohsaka is seen manipulating graphic equalizers to help a patient select his favorite combination of frequency bands. The doctor gives instruction on how best to reproduce that sound through hi-fi equipment.

Audio Doctor clinics consist of five separate hearing tests, plus two separate seminars, each designed to help the public appreciate how important it is to choose equipment that is suited to individual hearing characteristics and preferences. The five tests of the Audio Doctor clinic are as follows:

1. *Hearing Characteristics*—tests the frequency response of an individual's audible range. The test uses an audio meter to indicate any dips or peaks in one's hearing at certain frequencies.
2. *Sound pressure level and power output test*—measures individual loudness preferences. The Audio Doctor measures an individual's favorite sound pressure level through a sound pressure meter and suggests a compatible speaker system and power amplifier to fit his needs.
3. *Sound preference test*—employs graphic equalizers to help an individual determine his favorite sound, from Bach

(Continued on page 38)

Step up to super "side" power

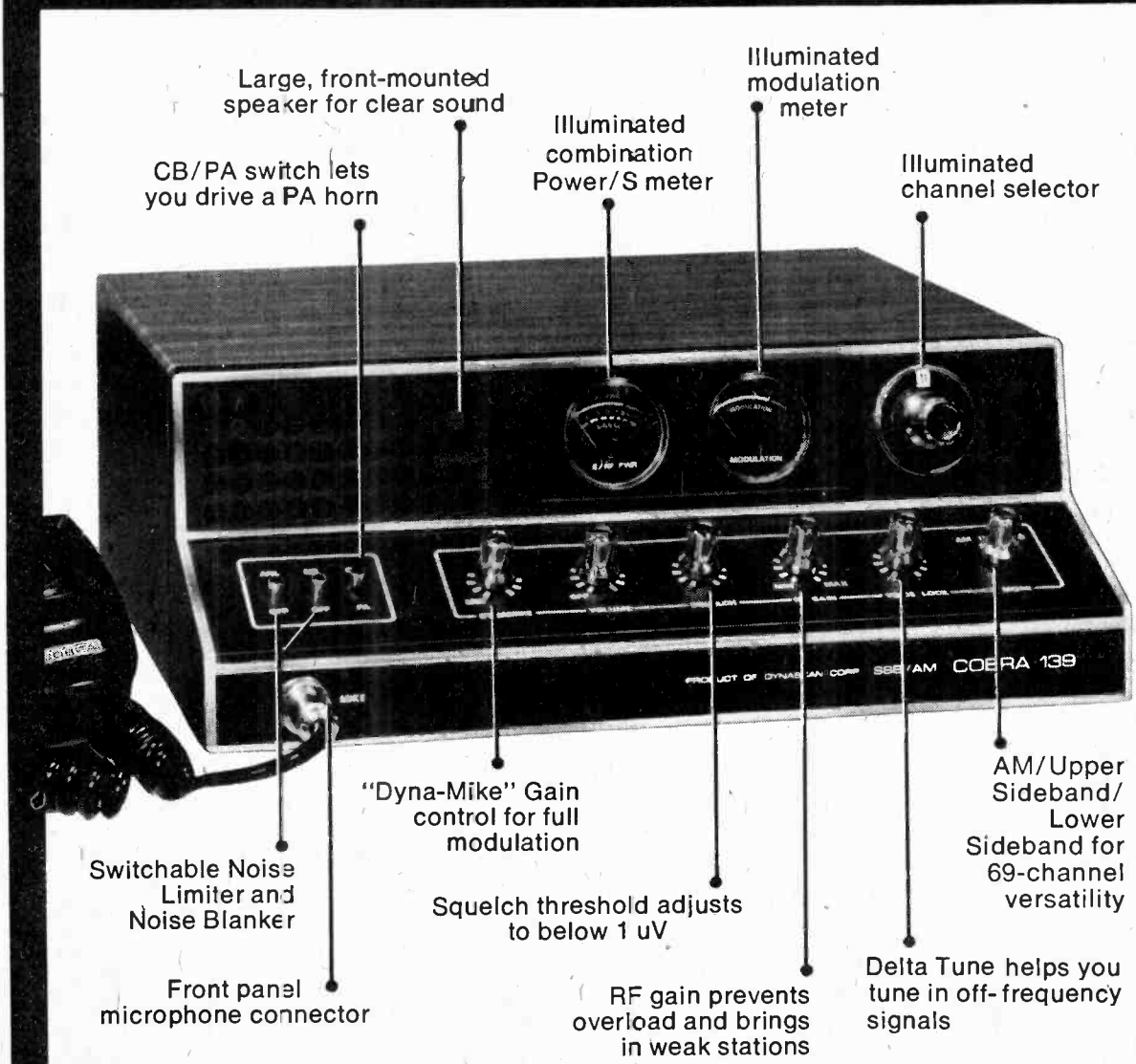

Large, front-mounted speaker for clear sound

CB/PA switch lets you drive a PA horn

Illuminated combination Power/S meter

Illuminated modulation meter

Illuminated channel selector

"Dyna-Mike" Gain control for full modulation

Switchable Noise Limiter and Noise Blanker

Squelch threshold adjusts to below 1 uV

AM/Upper Sideband/Lower Sideband for 69-channel versatility

Delta Tune helps you tune in off-frequency signals

RF gain prevents overload and brings in weak stations

Front panel microphone connector

MAXIMUM LEGAL POWER PLUS...

Emergency DC power operation, extension speaker jack, automatic gain control and slope-front panel for easy operation. Send for more details or see your dealer.



PRODUCT OF DYNASCAN CORPORATION • 1801 W. Belle Plaine • Chicago, Ill. 60613

NEWSCAN

(Continued from page 36)

to rock. The Doctor provides ten examples of different frequency characteristics from which individuals compare and select their favorite sound. When a favorite sound is determined, the Audio Doctor gives instruction on how to best reproduce the sound through the individual's present audio equipment.

4. *Wow and flutter awareness test*—demonstrates the audible and visual characteristics of wow and flutter. Using a wow and flutter test meter and an oscilloscope, the Audio Doctor demonstrates excellent reproduction quality, followed by increasingly more noticeable wow and flutter levels.

5. *Equalization of room acoustics test*—designed to demonstrate how to properly balance the tone controls on a stereo in any given room. Participants briefly describe their room on paper so the Audio Doctor will be aware of specific audible problems that exist in that room. He employs special equipment designed by JVC to demonstrate how to analyze and equalize room acoustics.



Dr. Yoshio Takahara, who holds a Ph.D. in engineering, is shown administering the Sound Pressure Level Preference Test at an Audio Doctor clinic. The doctors measure the patient's favorite sound pressure level in conjunction with amplifier power and speaker efficiency.

The clinics also include a quad seminar, designed to demonstrate completely the various types of quad, as well as the concept of quad itself; and a noise reduction seminar, which explains the principle of noise reduction systems.

Audio Doctor clinics are run by six specially trained engineers from JVC's headquarters in Tokyo. The technicians, one of whom is a Ph.D., are garbed in the traditional doctors' tunics. Additional help is supplied by the JVC sales representative and the dealer's sales people.

Persons attending the clinics must first go to a sign-up table where they receive a questionnaire and test sheet. They

proceed through seven different stations set up at various points throughout the dealership.

During the clinics, no sales effort is made by a program technician, although exclusive JVC features—such as the sound effects amplifier (SEA)—are pointed out. In addition, JVC is preparing an Audio Buyers Guide, an explanation of what to look for in audio components, to mail to Audio Doctor "patients."

Hot News

Found at last! a simple and inexpensive technique for fabricating ceramic parts from silicon carbide, one of the most heat-resistant materials known to man. The unique process, developed by GE, may boost the efficiency of gas turbines used for electrical power generation, improve the performance of high temperature components in airplane engines, and remove a major roadblock to the eventual development of an economical gas turbine engine for automobiles.

In power generation, the inlet gas temperature of a gas turbine fitted with silicon carbide blades and nozzles could be raised to well in excess of 2500°F, increasing its efficiency by several percent. An increase of only two percentage points would be equivalent to a six percent reduction in fuel consumption.

Successful incorporation of silicon carbide in aircraft engines would take



The first simple and inexpensive technique for fabricating ceramic parts from silicon carbide, one of the most heat-resistant materials known to man, has been developed at the General Electric Research and Development Center, Schenectady, NY. A turbine vane made from the high-temperature ceramic is subjected to a flame test by Dr. Svante Prochazka, inventor of the process. The new fabrication technique may boost the efficiency of gas turbines used for electrical power generation.



EDI

THE SHOPPING CENTER FOR ELECTRONICS

(our catalog index of Mfrs.)
extends from ADC to XCELITE

• HOBBYISTS . . . EXPERIMENTERS . . .
SERVICE TECHNICIANS . . . ENGINEERS

Your Satisfaction is Our Target!

Top Name Brands . . . 

Low Prices 

AMPLE STOCKS—Including those hard-to-find Parts whether you want a 15c capacitor, a \$50. FET-VOM, or a \$450. stereo system—you can get it at EDI.



Transistors, ICs,
Modules,
Speakers,
Stereo, HI-FI,
Photo Cells and
thousands of
other
Electronic
Parts . . .

**Send for your
FREE Catalog Today!**
(updated 5 times a year)

RUSH FREE CATALOG

ELECTRONIC DISTRIBUTORS INC.
Dept. TA-2, 4900 Elston
Chicago, IL 60630

name _____

street _____

city _____ state _____ zip _____

CIRCLE 8 ON READER SERVICE COUPON

WRITE
NOW FOR **McGEE'S**
BIG SPEAKER CATALOG

1001 BARGAINS IN

SPEAKERS—PARTS—TUBES—HIGH FIDELITY
COMPONENTS—RECORD CHANGERS
Tape Recorders—Kits—Everything in Electronics
1901 McGee Street, Kansas City, Missouri 64108

advantage of both the high temperature capability of this ceramic and its light weight. By operating engines at higher temperatures with decreased cooling requirements and with significant weight reductions, overall propulsion efficiencies could be markedly improved. In the automobile propulsion area, GE's new process could lead to the development of an inexpensive gas turbine engine, since silicon carbide parts could potentially be fabricated at costs lower than those of the metal alloys presently required for gas turbines.

After the high-temperature properties of silicon carbide were discovered several decades ago, scientists sought in vain for a low-cost way to put this ceramic to use. Until now, the material could be fabricated only by subjecting its starting material—a powder—simultaneously to high pressures and temperatures in large pressure chambers. This technique is too slow and costly for the mass production of inexpensive parts.

In the GE fabrication technique, by contrast, conventional ceramic-forming technology is used to produce silicon carbide parts with properties equal or superior to any previously reported. The GE process uses die pressing, slip casting, injection molding, or extrusion to form relatively porous silicon carbide shapes. The ceramic is then densified by sintering it at high temperature at atmospheric pressure.

Key to the success of the process is the use of additives that allow the ceramic to be sintered to high density without the simultaneous application of pressure. Additives also may be used to make a part either electrically insulating or conductive, properties that may be important in its final application.

A special advantage of producing a conductive silicon carbide part is that it could then be machined by electrical discharge or electrochemical methods, which are more economical than normal grinding techniques.

In laboratory tests, silicon carbide parts fabricated by GE's new technique have demonstrated superior creep resistance at high temperatures. Creep (the slow change in a part's dimensions at elevated temperatures) has been undetectable at 2700°F at a stress of 50,000 pounds per square inch (psi). In addition, the strength properties of GE's silicon carbide have been shown to be fully equivalent to those achieved with silicon carbide prepared by older methods. In tests of GE's material, fracture strengths in excess of 65,000 psi at 2900°F have been observed.

The high-temperature, high-strength properties of silicon carbide should permit the operation of industrial gas tur-

bines at temperatures in excess of 2500°F, increasing their efficiency and specific power output (the horsepower delivered per pound of air passing through the engine). Because turbine blades and nozzles are now fabricated from metal alloys, the operating temperature of turbine materials is presently limited to about 1900°F.

In the past, the operating temperature of a turbine could be increased only by developing improved metal alloys and by cooling the hottest parts of the turbine. However, alloys are now reaching their performance limits, and the complexities of cooling systems are beginning to limit further increases in turbine performance. The time is ripe for silicon carbide and energy conservation.

No Sonic Boom

After several months of preparation in a government-sponsored project, United Airlines recently conducted a computerized demonstration showing that jets could fly at slightly above mach 1, the speed of sound, and avoid the annoying and oftentimes damaging shock waves called a sonic boom.

The demonstration included two simulated, simultaneous flights, one eastbound and one westbound between San Francisco and Dulles International Airport at Washington, DC, by Air Force FB-11 jets. The demonstration was given for scientists and observers of Ka-

(Continued on page 87)



Scientists of Kaman Aerospace Corporation, FAA, Air Transport Association and United Airlines observed a demonstration by United in which simulated supersonic flights are made by two jets without causing a sonic boom heard on the ground. W. Boynton Beckwith, United's chief meteorologist (seated) put winds aloft forecasts into a computer on a CRT (cathode ray tube) console. This information updated the computerized flight plans for the two simulated aircraft.

New INTERNATIONAL broadband amplifier MODEL 150-299



14 db gain — 10 to 1,000 MHz

International's inline amplifier provides 14 db gain flat within 1 db over a range of 10 to 1,000 MHz. Impedance 50 ohms. Requires 20 VDC @ 50 ma. For increased gain additional amplifier may be added. Uses BNC type terminals.

SPECIFICATIONS

Range: 10 to 1,000 MHz
Impedance: 50 ohms
DC Input*: 20 VDC 50 ma
Gain:** 14 db
Flatness: ± 1 db (Ref. 500 MHz)
Operating Temperature: -25 to +70°C
Noise Figure: 9 db
VSWR Output: 2.0
Output capability for -60 db near intermodulation distortion: 100 MV

*Will operate 12 to 24 VDC with some loss in characteristics.
 **May cascade for additional gain with consideration of noise and flatness.

Price \$40.00 plus postage

Write for complete catalog.



10 North Lee
 Oklahoma City, Oklahoma 73102
 405 236-3741

CIRCLE 28 ON READER SERVICE COUPON

"LISTEN IN" TO POLICE-FIRE RADIO CALLS IN YOUR CAR!

Works with Any Car—Portable or Home Radios Just Plug In - No wiring - 3 minute hookup! Switches instantly from regular Radio to All Police - Fire - Emergency - Taxi - State - Gov't 2 way radio calls! Works Everywhere - Anytime! Dual Band 35-45 & 150-175 MHz. (cash Ck. M.O.)
SEND ONLY \$2.00 and pay postman \$12.99 COD postage or send \$14.99 for FPD Del in USA. Complete with Special Antenna and Plug in for use with Any Home or Portable Radios! Full instructions - 1 year Service Warranty - 30 Day Money Back Trial - Sold Only Direct from Factory.
WESTERN RADIO, Dept. BE-7 KEARNEY, NEB. 68847



**YOU'RE THE SOLUTION
TO WATER POLLUTION**

Get the news before it's news ... with a "behind-the-scenes" Scanner Radio from Radio Shack!

Realistic® scanners seek and lock-in on exciting police, fire and emergency calls, even continuous weathercasts* There's one to cover the "action" in your area — 10 models in all.

Radio Shack!

PRO-6 — VHF-Hi and VHF-Low

Continuously, automatically scans up to 4 crystal-controlled channels on 148-174 or 30-50 MHz. It stops on each active channel until the conversation ends, then resumes scanning. You don't miss a thing — it's like 4 radios in one! Lighted channel indicators, switches for bypassing any channels, scan/manual switch, variable volume and squelch, built-in speaker and antenna, earphone jack. With 4 "AA" cells. Requires up to 4 crystals. #20-171.

PRO-5 — UHF "Metro" Band

Same as the PRO-6, but covers 450-470 MHz now used in many larger cities. Requires up to 4 crystals. #20-169.

Accessories Available. Plug-in antenna, 12VDC adapter or AC adapter/battery charger, nickel cadmium batteries.

Pocket Size,
Both Models **119⁹⁵**,
each

FREE New 1976 Radio Shack Catalog

OVER 2000 PRODUCTS
EXCLUSIVES ON EVERY PAGE
BEAUTIFUL FULL COLOR

Stereo • Quadraphonic • Phonographs
TV Antennas • Radios • Citizens Band
Kits • Recorders • Tape • Tools
Auto Tune-Up • Electronic Parts
Test Instruments • More!



164 pages of the finest in home and hobby electronics. Respected brand names like Realistic, Micronta, Archer, Science Fair — and they're available only at Radio Shack stores and dealers nationwide! See what's really new in electronics by getting this catalog now.

SEND FOR YOURS TODAY!
FILL OUT COUPON BELOW

1976 Mail to Radio Shack, P. O. Box 1052,
Catalog Ft. Worth, Texas 76101. (Please print.)

Name _____ Apt. No. _____

Street _____

City _____

State _____ ZIP _____



*On VHF Hi-Band Stations not in all localities

The PRO-16 — a Super Scanner
for the ultimate at-home
or mobile listening post

229⁹⁵



Scans up to 16 crystal-controlled channels, in any combination, on 30-50 and 148-174 MHz VHF and 450-470 MHz UHF. Like 16 radios in one! Lockout buttons and indicator lights for each channel, manual selector, squelch, variable scan rate, scan-delay in/out button, 12 VDC/120 VAC operation, mobile mounting bracket. Requires up to 16 crystals. U.L. listed. #20-165



Master Charge or
Bank Americard at
participating stores

REALISTIC®
at
Radio Shack®

A TANDY CORPORATION COMPANY

OVER 3000 STORES • 50 STATES • 7 COUNTRIES

Retail prices may vary at individual stores

Prices and products may vary in Canada.

CIRCLE 31 ON READER SERVICE COUPON

a professional power supply for hobbyists ... compared to the job it does the cost is peanuts!

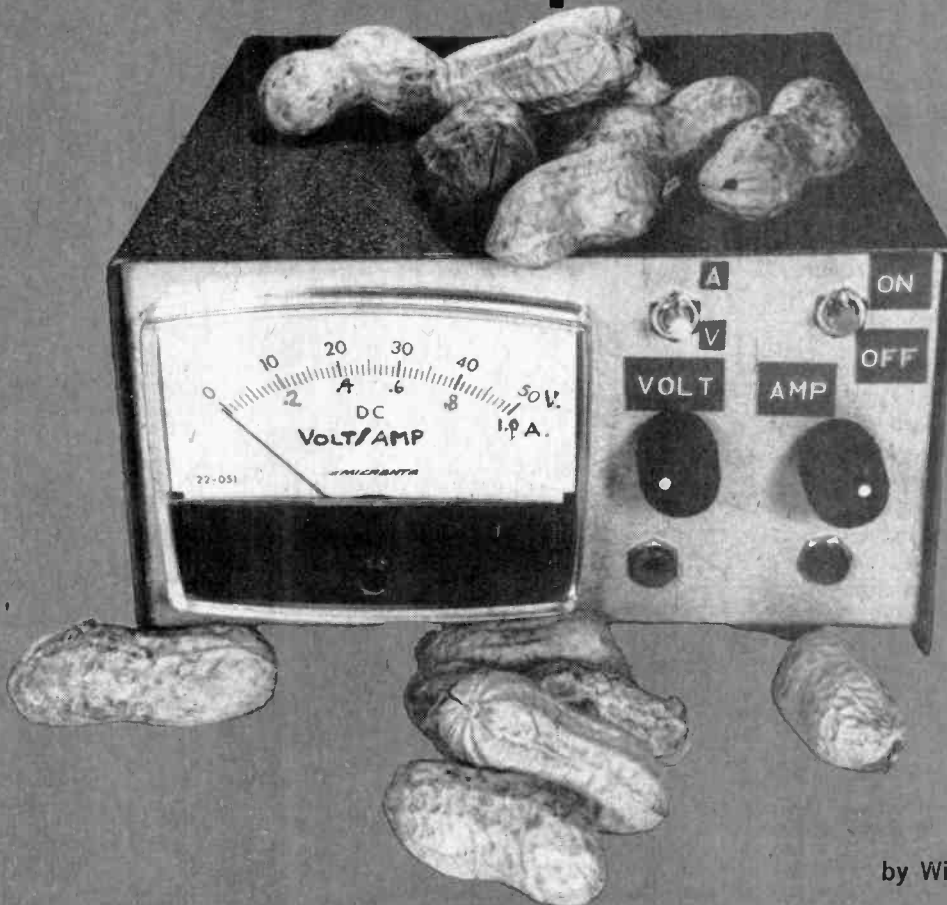

by William Montgomery

Sure, I'm a dyed-in-the-wool experimenter/hobbyist, and I've had the fever for some time. And if you're like me, there's a good chance your budget is just as tight.

That fiscal fact plus an appreciation for a good, efficient design is the "need" that helped provide the "shove" that got the ball rolling to crank out this handy power supply for my own use. Looking over the line-up of commercial units and talking to people in the field gives a pretty good picture of just what features are important and which are popular. You'll find them all here with an experimenter/hobbyist's parts budget to boot! Not a bad deal, actually.

You get the benefits of a commercial lab supply for as little as twenty-five dollars—all new parts, complete with case—by building it yourself. A full-blown version complete with switchable front-panel voltmeter/ammeter will peak out at about thirty-five dollars; but if you can scrounge up a 25-volt, 2 or 3-amp power transformer, don't need the meter, and you have a case, all new parts go for about \$17. Any way you build it, performance is never sacrificed.

Background: Having the right level of DC power available to test a transistor circuit, a motor, or the like is all too often a problem. It is the old story of not having the right tool at the right time. Batteries don't offer variable voltage or much power. Purchasing an inexpensive, unregulated supply may be satisfactory in some cases, but when transistors in the test circuit begin switching on and off, you may find the supply voltage going up and down. Ideally, one would like to have a selectable voltage level that will not change as the load changes, a fair amount of available power, and an adjustable current limit in order to protect both the supply and the item being tested.

Although ICs are available that deliver regulated voltage selectable over a range of around 0 to 20

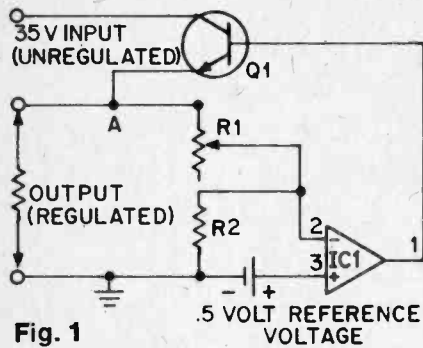

Fig. 1
Author's simplified schematic to show the principle of operation. Reference voltage is not necessarily a battery. It could be, but it's not very practical. In this supply it consists of pre-regulator zener D2 and the one-amp silicon power diode called D1.

volts, the power delivered by these ICs is only a few watts. Finally, to purchase a supply that has the desired features would cost a fair amount mainly because one would have to buy a professional-type supply. The answer to all this, however, is really very simple. The power supply described here can be built in only a few hours at low cost, and the features are outstanding.

While the basic principle of operation of this regulated supply is well known—mainly an operational amplifier controlling a power transistor—we have designed this particular unit using components that offer the most for the money and simple circuit “tricks” that provide the best return for your efforts. The result is a supply that uses a handful of electronic parts costing about \$20 with the following features:

- Twenty watts of available output power (above 20 watts, for safety, the voltage begins to decrease automatically).
- Adjustable current limiting (maximum current fed to the load can be pre-set to any value between 0.1 amp and 1.0 amp).
- One-half percent regulation (at 10 volts output, for example, the voltage will drop only 0.05 volt between no load and full load).
- Adjustable output voltage of 0.6 volt to 30 volts.
- Short circuit protection (the output of the supply can be accidentally short circuited without harming the supply or even blowing a fuse; try it!).

How It Works. This regulated power supply has a “heart” and a “brain.” The brain is a 741 operational amplifier IC which detects error signals. The

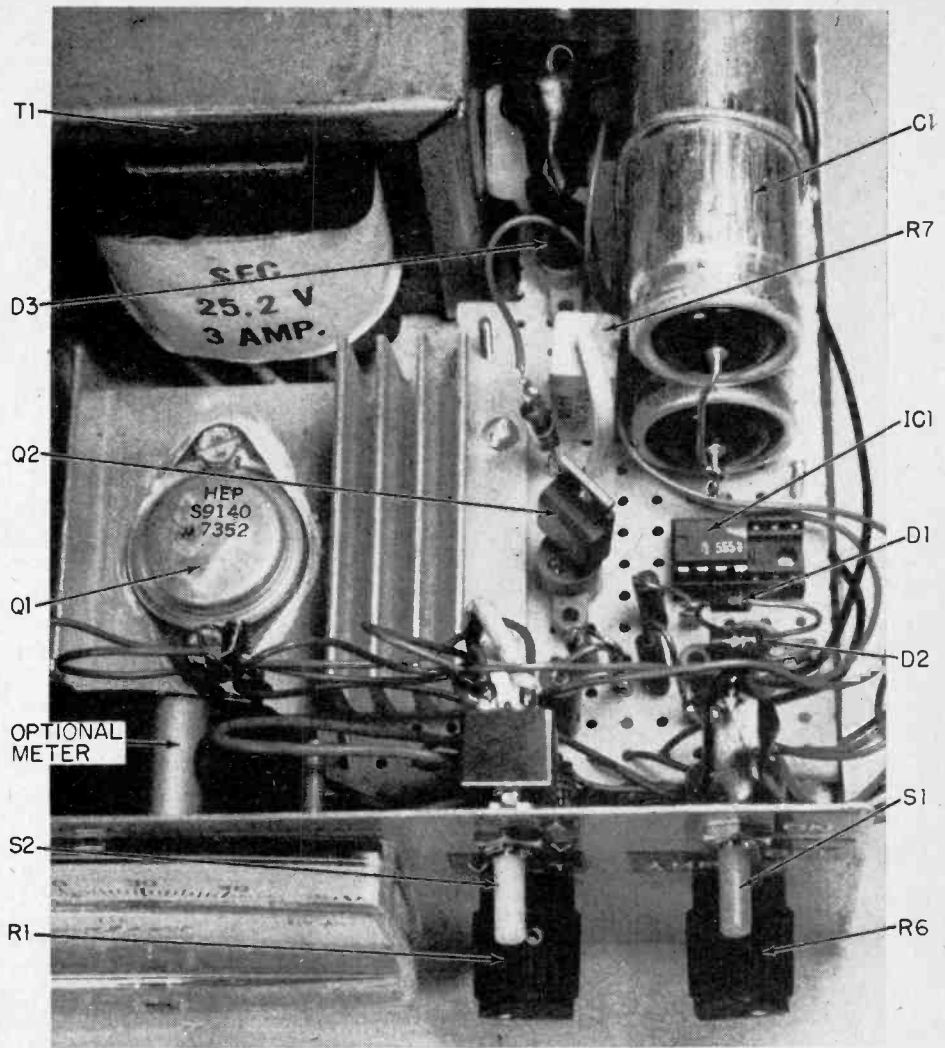

Close-up of construction area showing author's use of transistor sockets for D3, D1 and D2, and Q2. Main point-to-point wiring is done under perf board where hodge-podge wiring techniques can't be seen.

heart is a power transistor which regulates power to the load. Fig. 1 is a simplified schematic showing how it works. The unregulated voltage comes from a transformer and full wave rectifier. Placing a load across this voltage directly would cause it to drop sharply—which is what we want to avoid.

Resistors R1 and R2 determine a voltage gain for the 741 op amp by $(1 + R1/R2)$. The output of the op amp, and therefore the regulated output V_{OUT} is given by $V_{OUT} = 0.6 \times (1 + R1/R2)$, where 0.6 is the reference voltage built into the circuit. This equation holds only when the voltage drop across R2 equals the 0.6 reference voltage, so it is the job of the op amp to force this to happen. The process is basically simple. V_{OUT} is selected by adjusting R1 with, for example, no load on the output. As a load is applied, it momentarily causes V_{OUT} to drop since

point A in Fig. 1 is “pulled” closer to ground than before. The voltage across R2 is then less than the reference voltage, so the op amp sees an imbalance, or error voltage, at its input which is amplified and sent to Q1 to turn it on (make it conduct) more. Q1 then “pumps” more current into the load, thereby maintaining the output voltage at its desired level.

In addition to regulating voltage, this unit limits current. In the complete schematic we see that the desired current limit is selected by adjusting R6. When current through R7 causes the voltage at the base of Q2 to be about 0.7 volt, Q2 begins conducting from collector to emitter thereby grounding the output of the op amp and lowering the output voltage, which in turn has the desired effect of limiting the current to the pre-selected level.

The 741 op amp is an ideal device to

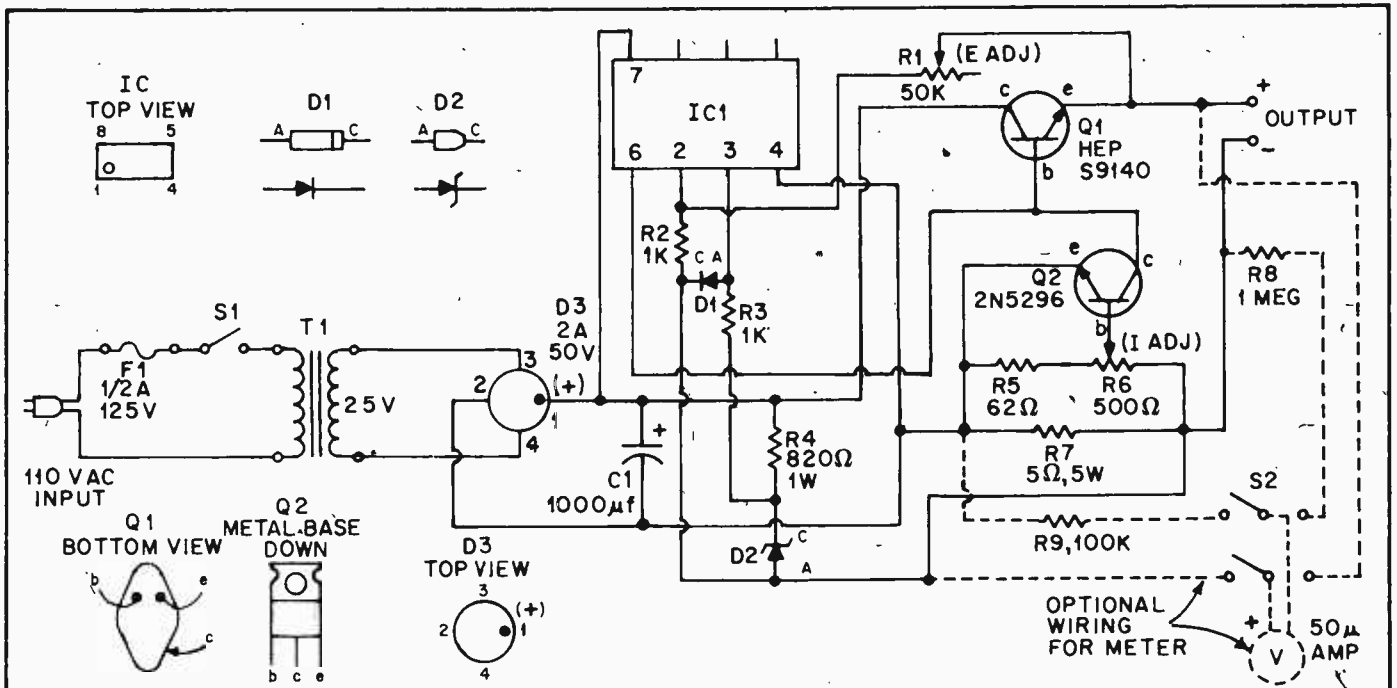

PARTS LIST FOR PROFESSIONAL POWER SUPPLY

- C1—1000-µF, 50-VDC electrolytic capacitor (Radio Shack 272-2047 or equiv.)
 - D1—1-amp, 50-VDC silicon diode (Radio Shack 276-1101 or equiv.)
 - D2—12-volt, 1-watt zener diode (Radio Shack 276-563 or equiv.)
 - D3—2-amp, 50-volt diode bridge (Radio Shack 276-1151 or equiv.)
 - IC1—741-type op amp (Radio Shack 276-038 or equiv.)
 - M1—50-µA panel meter; optional, see text (Radio Shack 22-051 or equiv.)
 - Q1—npn darlington power transistor (Motorola HEP S9140 or equiv.)
- Note: Must be used with a 22 sq. in. heat-sink such as Radio Shack 276-1358. HEP S9102 may be used for Q1 if a 30 sq. in. heatsink is used. The HEP S9140 is avail-

- able for \$2.00 postpaid from Circuit Specialists, P.O. Box 3047, Scottsdale, AZ 85257.
- Q2—2N5296 npn power transistor (Radio Shack 276-2018 or equiv.)
- R1—50,000-ohm linear-taper potentiometer (Radio Shack 271-1716 or equiv.)
- R2, R3—1000-ohm, ½-watt resistor (Radio Shack 271-000 or equiv.)
- R4—820-ohm, ½-watt resistor (Radio Shack 271-000 or equiv.)
- R5—62-ohm, ½-watt resistor (Radio Shack 271-000 or equiv.)
- R6—500-ohm linear-taper potentiometer (Radio Shack 271-066 or equiv.)
- R7—5-ohm, 5-watt resistor
- Note: You can use two 10-ohm, 10-watt power resistors (such as Radio Shack 271-132) in parallel.
- R8—1-megohm, ½-watt resistor (required only

- if meter M1 is used) (Radio Shack 271-000 or equiv.)
- R9—100,000-ohm, ½-watt resistor (required only if meter M1 is used) (Radio Shack 271-000 or equiv.)
- S1—spst switch (Radio Shack 275-612 or equiv.)
- S2—dpdt switch (required only if meter M1 is used) (Radio Shack 275-614 or equiv.)
- T1—power transformer: 120 VAC primary, 24 VAC at 2 amps secondary (Radio Shack 273-1512 or equiv.)
- Misc.—perf board, hardware, case approx. 3 x 5 x 6-in. (Radio Shack 270-253 or equiv.), ½-amp fast-acting fuse, fuse holder (Radio Shack 270-364), kit of mounting hardware for Q1 (HEP A0450 or Radio Shack 276-1370), silicon heat sink compound (Radio Shack 276-1372), wire, solder, etc.

use here because it is inexpensive and has built-in short circuit protection for its output which allows Q2 to ground the output to limit current. When selecting among the various 741 op amps on the market, choose one that, according to its specification sheet, has an offset voltage of less than 10 millivolts; otherwise the lowest output voltage from the power supply will be proportionately greater than the 0.6 volt specified here.

Power transistor Q1 is a darlington type, which means it has a current gain of about 1000. Inside, it is basically one transistor driving another. This results in the high current gain. This high gain is needed to prevent the op amp output from being overloaded, which would reduce regulation quality.

Our Overdesign. Transistor Q1 is rated at 90 watts, but remember that such ratings are at room temperature (25°C). If you set the output voltage to

0.6 volt and draw 1 amp through a load, Q1 will "drop" about 35 volts across it; at 1 amp, that's 35 watts. Without an ice cube on it, Q1 on the heat-sink we have suggested will heat to about 80°C. At this temperature it is capable of dissipating 50 watts, which is well enough above the actual 35 watt requirement for safe operation.

To obtain the low reference voltage for pin 3 of the 741, a regular diode (D1) is used since voltage in the forward direction causes a sharp knee (the voltage at which conduction begins) at about 0.6 volt. It is serving, therefore, as a low voltage zener diode at a fraction of the cost. To greatly improve regulation, D1 is fed by a 12-volt zener, D2, so we have a reference within a reference and a very inexpensive way to obtain a stable low voltage.

Nuts, Bolts 'n Solder. Construction is straightforward. All components will

fit on a 4 x 5-in. perf board and within a 3 x 5 x 6-in. cabinet. The transformer may have a center tap (yellow on the Radio Shack version) which can be cut and taped since it is not needed. All 120 VAC leads that go to S1, the fuse holder, and T1, must be covered with insulating tape to avoid the shock hazard associated with these points. In

(Continued on page 85)

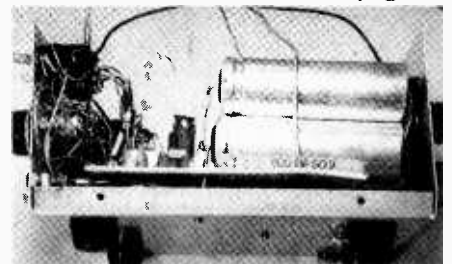

Notice tape wrapped around the on-off switch. Safety first is best. The author used 500-µF capacitors in parallel for C1.



The Thorens TD-125AB Mark II is a three-speed turntable featuring the Thorens TP-16 tonearm with frictionless magnetic anti-skating control. Instead of a push/pull cueing level, the Mark II has a front-panel control that raises and lowers the tonearm at the touch of a finger; \$410.00.

if you think turntables haven't changed...

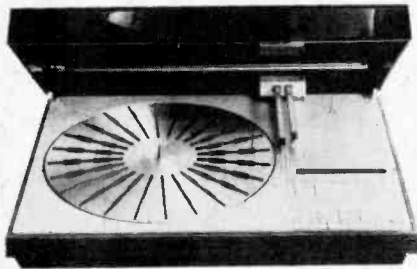

Bang & Olufsen's Beogram 4002 features tangential tracking, which eliminates tracking error and skating force. The pickup is the B&O MMC 6000. What looks like a second arm is a detector that uses a photocell to sense the record edge, at which point the pickup arm lowers itself; \$650.00.



The BSR McDonald 8100X uses viscous damping in cue and pause functions as well as in automatic play modes, and has a dual-range anti-skate control, and variable pitch control. The pickup is the Shure M91ED. Pushbuttons are for manual play, semi-automatic play, infinite repeat, or fully automatic; \$299.80.



Dual's 701 has a direct-drive motor, which is an all-electronic low-speed brushless DC type with Hall-effect feedback control. There is separate anti-skating for conical and elliptical styli, an 8% pitch-control for each speed, and a built-in illuminated strobe; \$350.00.



Toshiba's SR-50 uses a photoelectric pickup whose stylus modulates a beam of light, resulting in a moving mass of only 0.3 milligrams. The preamp in the base contains an electronic optimum stylus-force and anti-skating gauge. End-of-record sensing is also photoelectric; \$449.95.



The PL-71 by Pioneer has a servo-controlled direct-drive system, with strobe pattern cast into the turntable rim. The S-shaped tonearm has a main counterweight that compensates for pickups ranging from 4 to 32 grams, a lateral balancer, and a direct-reading stylus-pressure scale; \$299.95.



By TEAC, the TN400 is a direct-drive turntable with a 20-pole, 60-slot magnetic sensor. Adjustment controls for each speed provide a 4% variation up or down in speed. The die-cast platter weighs 5 1/2 pounds; about \$400.

LOOK HERE!

By Stephen B. Gray

□ As you might expect, the cost for the best is rather high; but then, you're not getting bargain basement specials that rumble like a New York City subway with bad bearings. Today's highest quality turntables include all-mechanical units with massive flywheel/platter systems and the electronic type with servo-mechanism-regulated speed.

Hysteresis synchronous, brushless DC, magnetic sensor, Hall-effect, sixteen-pole, and direct drive is today's turntable lingo. And getting interested e/e readers a little more familiar with it is just what we have in mind . . .

The following companies are represented here. **Bang and Olufsen** of America, Inc., 2271 Devon Ave., Elk Grove Village, IL 60007; **BSR McDonald**, Rt.

303, Blauvelt, NY 10913; **Dual**, 120 S. Columbus Ave., Mt. Vernon, NY 10553; **Empire Scientific, Corp.**, 1055 Stewart Ave., Garden City, NY 11530; **Garrard**, 767 5th Ave., New York, NY 10022; **Kenwood Electronics, Inc.**, 15777 S. Broadway, Gardena, CA 90248; **Lenco Div. of Benjamin**, 40 Smith Street, Farmingdale, NY 11735; **Philips**, 100 E. 42nd Street, New York, NY 10017; **Pioneer**, 178 Commerce Road, Carlstadt, NJ 07072; **Teac Corp. of America**, 7733 Telegraph Road, Montebello, CA 90640; **Technics** by Panasonic, 200 Park Ave., New York, NY 10017; **Thorens**, Thorens Building, New Hyde Park, NY 11040; **Toshiba of America, Inc.**, 280 Park Ave., New York, NY 10017. ■



The SL-1200 is one of four Technics (by Panasonic) direct-drive turntables, has a specially designed S-shaped tubular arm that avoids side-slippage even on warped records. The low-capacitance phono cables make it adaptable for discrete 4-channel by adding a suitable pickup; \$279.95.

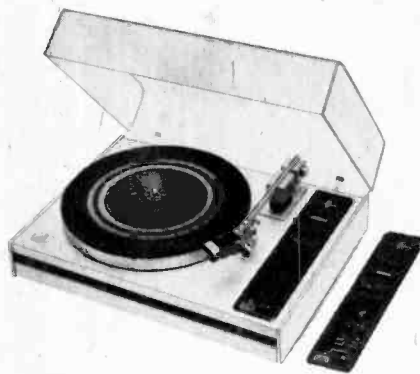

The Philips GA-209 has three motors, for turntable drive, pick-arm movement, and cueing. The turntable "recognizes" the record diameter and starts rotating at the correct speed. For manual operation, the manual controls are grouped in a countersunk "cockpit" under a sliding cover; \$349.50.



The Empire Troubador 598 II has a 12-inch platter and 3-inch-thick balanced-drive flywheel, holding down wow and flutter to only 0.01%. The playback arm can track pickups as low as 0.1 gram; the Empire 1000ZE/X pickup is supplied. A cueing light permits exact track selection; \$399.95.



Garrard's Zero 100SB is an automatic single-play, belt-driven model equipped with Garrard's Zero Tracking Error tonearm, which eliminates horizontal tracking error. With Scandinavian teak-wood base and hinged dust cover; \$209.95.



From the Lenco division of Benjamin, the L-85 has an electronic fine-speed adjustment that allows a 3% change up or down, permitting the tuning of the turntable to a musical instrument for "playing along" with recordings that are off pitch. A 16-pole, slow-speed motor cuts rumble to extremely low levels; \$249.50.



From Kenwood, the direct-drive KP-5022 features an 8-pole, brushless DC servomotor directly coupled to the center of a massive, 12-inch solid die-cast aluminum alloy turntable that has an engraved stroboscope pattern around its rim. A pilot lamp is provided for overhang adjustment; \$299.95.

INEXPENSIVE départment store stereo radios, phonographs, and 8-track tape sets are often given to children on the theory that kids won't know or care about sound quality. Children usually have excellent hearing, and they aren't necessarily dumb either. When they accept poor sound, it is because they are interested in the program material and, unlike most adults, they have great tolerance.

If you have an inexpensive stereo set in your family, you already know about its shortcomings; perhaps you have overlooked its one great merit. The sound is probably so bad that improve-

ment comes easy.

A quick check of several inexpensive stereo sets showed that the weakest link in the audio chain of each was the speaker enclosure. Wood and wood by-product enclosures, which require more labor to produce, were usually worse than plastic boxes. This makes the easy-to-fix wood speaker cabinet stereos prime candidates for reworking, but plastic models can be improved too.

The first test of a speaker enclosure is its rigidity of construction. When rapped with your knuckles, the sound should be similar to that of a piece of good furniture. To train your ear, try

comparing the sound produced by a table top to that of an empty paper-board shipping carton. Then test your speaker enclosures. When I applied the knuckle test to some cheap wood speaker boxes, the sounds varied from a drum-like resonance to a loose rattle. The cheap enclosures I examined fit three different functional types. They were either partially open back, ported front, or closed boxes. Some of them appeared to have visible horns or tweeter openings which, after inspection, were found to be camouflaged ports. This counterfeit horn appearance proved to be those ports' chief virtue.



Pull off the lightweight $\frac{1}{2}$ -in flakeboard rear panel of a cheapie loudspeaker system and surprises await you! This unit had glue along less than 40% of the possible binding area for the back panel. No tweeter exists at all—the fancy duct is just a cosmetic plastic price raiser. Also, the front panel was salvaged from scrap as the printing on the surface indicates. However, since the front panel was $\frac{3}{4}$ -in. flakeboard it is usable, as are the side panels.

UPGRADE THAT CHEAPIE STEREO FOR HIGHER FI!

by David B. Weems



Only two glued wood blocks hold the front panel in place. Here the author adds $\frac{3}{4}$ -in. square blocks to securely hold the front to the sides and bottom. The block being added in the center of the front panel is used to isolate the grille from the remainder of the cabinet. A $\frac{3}{4}$ -in. plywood board will be placed on these blocks to effectively seal off the top half of the cabinet from the fancy but useless grille.

In a listening session some of these ported designs stood out in their ability to sound loud at even moderate volume. The music they reproduced seemed, without exception, to have been recorded in a small echo chamber, or perhaps with the musicians grouped in an empty gasoline refinery tank.

I chose two cheap stereo sets to examine in more detail. One was a small AM/FM stereo radio. It had two out-board 5-inch speakers in ultra compact 100-cubic-inch plastic boxes with slotted backs. The other was a stereo phonograph with similar speakers installed in 500-cubic-inch ported "wood" cabinets.

Both sets of speakers produced rough mid-range even when connected to a high-fidelity source. They were stingy

with upper high frequencies, and the bass roll-off started around 200 Hz with the larger ported boxes and at about 400 Hz with the smaller ones. This gave the ported enclosures an advantage in bass response, but the output from the ports was something else. In addition to port bass, which covered the 200 to 600-Hz range, there were some violent peaks much farther up the scale at 1500, 1800, 2200, and even at 2900 Hz. The peak at 2200 Hz was especially prominent. These peaks were evidently the ported enclosures' secret weapon which had demolished the sound of every recording played through them.

When rapped on their backs, the wood boxes boomed like a drum; their

front panels rattled. After breaking into the glued-on backs, I discovered why. The backs were made of unbraced 1/8-inch pressed wood, and the speaker boards were held in place by a small glue block at the top edge and another at the bottom. In one box the speaker board was warped enough to make a 1/8-inch space between it and the sides at its middle. The sides were good, about 3/8-inch thick and adequately glued at the corners, the only joints which showed. These cabinets, like the plastic boxes, contained no acoustic damping material.

I then began a series of modifications with tests to monitor each change. Those tests showed that there are three ways to improve the sound of almost any cheap stereo speaker. The first two cost little or nothing except your time.

Reinforce the Box. Small boxes don't need the same thick walls and screwed together joints as large ones, but they must be well glued. You can cut glue blocks which fit snugly, and then press them into position in each corner with plenty of glue. This alone stops the rattles.

If the back is less than 1/4-inch thick, you should add another layer of material to it. Even thick paperboard will add rigidity. Use braces, if necessary, on the front panel. Check the results by the rapping test. Vibrating panels absorb energy and degrade bass performance.

It makes sense to have a removable back, so you may have to add cleats inside the enclosure to receive screws from the back. If possible, set the cleats in far enough to permit the thicker back to fit flush with the rear edge of the sides.

You should probably close any ports by gluing a panel over each one. Ports in small enclosures, those of less than about 1/2 cubic foot, for example, are usually worse than worthless. But if you are planning to apply only the first two modification steps, you may want to defer a decision on the port until after you have added damping material. At that point you can temporarily close the port on one box and compare its performance with the remaining ported enclosure. To permanently close the ports you should paint the face of the panel that goes over the port with a flat black paint so it won't show.

Add Damping Material. Bare interior enclosure walls act as sound mirrors which reflect sound waves with various degrees of phase shift, depending on the wave-length of the sound and dimensions of the box, onto the speaker cone. These reflected waves cause dips and,

(Continued on page 90)

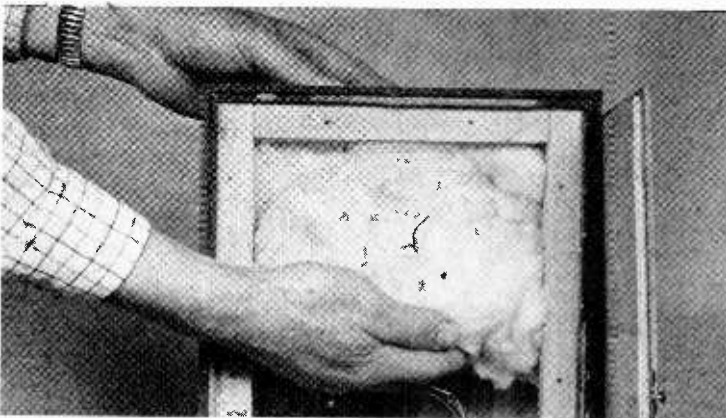

After the grille opening is closed off, damping material is added. "Glass wool" picked up at a lumber yard or from the basement ceiling is slightly compressed into place. A one or two-inch layer can be added to the inside surface of the rear panel if you wish. Sometimes the system will sound better if the entire interior is filled with glass wool. Try it and give the results a listening test. The results vary with different speaker systems. Note that the rear panel was stiffened with the addition of a 3/8-in. plywood board.

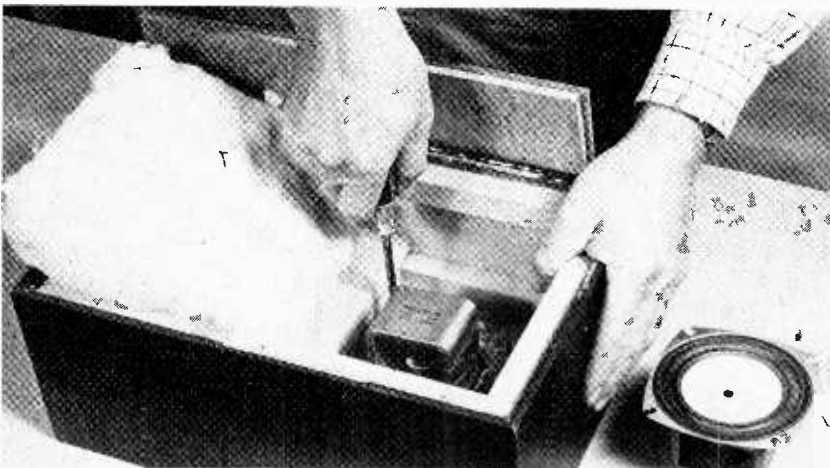

The final touch could be the addition of a new high compliance speaker. You should be able to pick up a reasonable replacement for about five dollars. The new unit should have a voice coil diameter of about 3/4-in. or more. The new speaker should be heavier than the old one, as determined by a heft test at the time of purchase. The material supporting the cone must be softer and spongier than on the old job. Pick a unit of the same total size so installation will be simple.

how to install a... Gas-Saving CD Ignition System

Just 30 minutes of installation time gives you dollar-saving gas economy with a plus for ecology.



Fig. 1



Fig. 2. First installation step is to position the CD and mark the mounting holes. Make certain the hood will close with the CD installed.



Fig. 3. If the CD's mounting surface isn't metal (if it's plastic) install a ground wire from under one of the mounting screws to the nearest ground point—usually the metal part of the body.



Fig. 4. Remove the existing wires to the car's ignition coil and install the supplied spade terminals. A socket or ratchet wrench makes the job a snap, though an open end wrench can be used. Avoid pliers as they might damage the threads on the coil terminal studs.

"Ashes to ashes, dust to dust; if the oil-barons don't get you, then the government must."

Between the oil companies trying to accumulate all the wealth in the world, and the government (city, state, and federal) believing that the best way to fight inflation is to raise the price of gasoline, many a smart motorist is fighting back by getting maximum fuel economy through a capacitive-discharge (CD, as it's called) ignition system. We all know that CD gives you better winter starts (less raw gas going out the tailpipe as the engine starts with coughs and gasps), better high-speed performance, and perhaps (if the engine is properly tuned), better low speed gas economy. A few side benefits are sharply reduced points and plug wear. You might get 50,000 miles or more from the plugs and considerably more from the points—and that's a *real* savings in hard cash.

But how do you get these benefits from a CD system. Simple. You take

The Tiger 500 CD Ignition system is from Tri-Star Corporation, P.O. Box 1727, Grand Junction, CO 81501. Price is \$53.95. Circle No. 73 on the reader service page for more information.

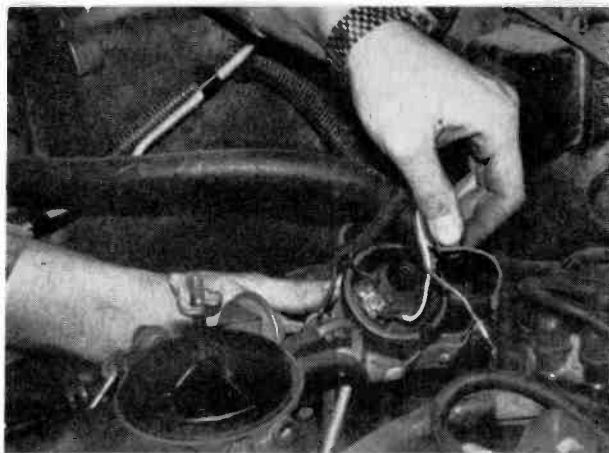

Fig. 5. Simply clip the four CD terminals to the appropriate spade lugs and the installation is complete. Tape the wires down to some support so they cannot fall on the engine.



Fig. 6. Flip the switch on the Tiger 500 to CD and you can select either CD operation or normal Detroit ignition operation.



Fig. 7. CD ignition might raise the motor idle speed so use a tach to check it out. If the idle rpm is high just pull it down to specs with the carburetor's idle speed adjustment screw.



Fig. 8. If you've adjusted the points dwell, or plug gap, you'll have to readjust the timing using a strobe timing light. You also need the strobe if you want to advance the ignition timing. These additional adjustments get every drop of extra performance from CD ignition.



Fig. 9. Finally, you can hang out the CD Ignition decal on a side window for the world to see. Kathi Martin, our CB editor, read the Tiger 500 CD installation instructions to Bill Hillford who did the actual installation. The installation took only 30 minutes and then our installation team took another 30 minutes to drive down to the local "golden arch" for burgers. You can be sure they drove all the way with gas-saving Tiger 500 CD on. Why don't you turn on with CD today?

out about 30 minutes of your time, tighten a few screws under the hood of your car, re-time the engine, and that's it. You don't have to be an auto mechanic or electrical expert to install a CD system. The photographs show how really easy the job can be.

The Tiger CDI (Capacitive-Discharge Ignition) 500 (Fig. 1) is typical of most CD kits. The basic CD unit is supplied with attached connecting wires and a switch that selects standard or CD ignition. A small assortment of screws and possibly terminals and insulation round out the kit.

First step is to mount the CD unit under the hood, preferably on a flat metal surface. Often, the fender skirt is perfectly suitable (Fig. 2) though the firewall can be used. If the skirt is metal, the chassis ground is automatically made through the mounting screws. If the skirt is plastic, you must install a ground wire from the CD unit to the engine block or car-body ground. To ground the CD, install a solder lug under one mounting screw with a lock-washer between the lug and the CD's mounting foot. The ground wire (Fig. 3) is soldered to this lug.

Next, you locate the ignition coil,

which has two terminals. One terminal connects to the distributor. This terminal is the (-) negative terminal. The remaining coil terminal connects (eventually) to the battery through a ballast resistor and the ignition switch. This is the (+) terminal. There might be two wires connected to the (+) terminal, with the extra wire connecting to a radio noise suppression capacitor. If your car has two positive (+) wires, you can consider them one. Trim the insulation and wrap them together into a single wire.

Install a male spade terminal on each coil terminal (Figs. 4 and 5) and on the original coil wires. Then, simply clip the Tiger CD unit's wire to the match-

ing spade terminals as per the color-code specified in the instruction manual. That's the whole bit: The CD system is installed. It's that simple, and the Tiger instruction manual is very clear and easy to follow.

If you want to have the option of using either the CD or conventional ignition system make no adjustments to either the points or plug gaps. The switch on the Tiger 500 (Fig. 6) lets you instantly select either system.

Just the addition of the CD system might, or might not change the engine's idle speed (Fig. 7), so check it with a tach.

If you want the optimum perform-

(Continued on page 88)

ACTION BAND RECEIVERS

They come in all sizes and styles—here are just a few . . .

4, 3, 2, OR 1



4 bands, 8 channels: Electra Bearcat IV. \$179.95 for 30 to 50, 150 to 174, 450 to 470, and 470 to 512 MHz.

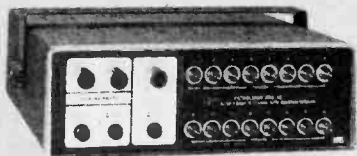

3 bands, 16 channels: Radio Shack PRO-16. \$229.95 for VHF Lo, VHF Hi, and UHF.



2 bands, 8 channels: Midland 13-940. \$209.95 for VHF Hi and VHF Lo.



1 band, 8 channels: Heath GR-110. \$99.95 for VHF Hi in a kit.

COMBO-BAND

Midland's 13-908, AM BCB plus crystal controlled VHF Hi, \$47.95.



Electra's Jolly Roger JR-1 H, AM BCB plus 2-channel scanner, \$79.95.

ACTION BANDS are now. Transmissions are real and up to date. It's a fact. Many news gathering organizations provide their employees with monitors covering local police, fire, aero and/or public safety channels because they know that action band channels carry firsthand information of law enforcement, government, medical, business and other organizations.

Some of you may have read about the "remote control" bank bomber who detonated a charge in the lobby of a New York City bank after being refused, so the story goes, a ransom. At the scene, as people stood and watched from across an intersection a plainclothes detective went bounding across Park Avenue South to an unmarked police car where this editor was standing. He grabbed the 2-way radio mike through the front window and barked (just like TV), "There's another bomb in an identical bag that hasn't gone off yet."

Well, being around a real-life bank bombing was one thing, but standing

there when another bomb might go off was enough to start my feet moving the three blocks to our 10th floor editorial office. As it turned out, that extra bag was for loot he never got.

No one was seriously hurt, and the alleged bomber was picked up a few months later. But that didn't last long; apparently this guy had talent (such as it is), for he soon escaped—James Bond style—by crawling through an air duct and lowering himself to the street. I'm sure local residents could have heard about that first hand too—by monitoring the right police channel.

There are probably many interesting happenings on the radio where you live. Some representative receivers are shown. And e/e presents articles on a wide range of action band subjects. Keep in touch with e/e if you tune the action bands. Incidentally, it's quite legal to listen in on the action bands if you keep what you hear to yourself. Using such info for fun or profit is strictly illegal, so enjoy the action, but keep yer trap shut!

FOUR IN HAND



E. F. Johnson Mini-Scan, VHF Hi, \$119.95.



Regency Monitoradio, VHF Hi, \$119.95.



Midland Model 13-904, VHF Hi, \$129.95.



Teaberry "T" Scan, UHF, \$139.95.



Fanon Scanfare, VHF Hi, \$206.95.

FOUR ON VHF

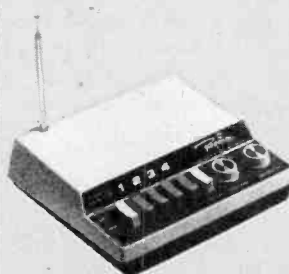

Regency ACT-C4H, \$89.95, AC powered for base use w/whip.



Pace Scan 10-4H, \$99.95, DC powered for portable, mobile.

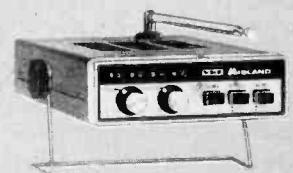

Midland 13-916, \$102.95, DC powered, AC adaptor available.



beside the fingering, position and bowing...

THERE'S MATH BEHIND THAT SOUR NOTE!

by Jorma Hyypia

IF YOU'VE EVER tickled the ivories, listened seriously to Rock, Rachmaninoff or McCartney, tapped your foot to a trombone or tambourine, then you're in tune for a fascinating look at what it is that makes music and your ear *click*. Actually, the logic of music was structured over thousands of years into a highly organized system of carefully conceived ratio and proportion; to this day it is not fully understood by many musicians and/or would-be composers.

The fact is that almost all of the music we hear today, whether Wagnerian opera or high-decibel quad-sound Progressive Rock, is less than perfect. This has nothing to do with room acoustics, poor hi-fi equipment, or mediocre musicianship. For even under the best of conditions, most music is, of necessity, somewhat less than ideal.

It may come as a minor shock to many a music lover to learn that his favorite concert pianist, who appears to be making sublime music with his Steinway, is actually playing his thirds and sixths somewhat sharp, and his fifths slightly flat! He can't avoid it. That's the way his piano is tuned. Then why not call in the piano tuner and have things set right? Because this would force the pianist to use an instrument having over 500 keys instead of the usual 88!

To appreciate the scientific basis and the unavoidable *arbitrariness* of music, let's delve a bit into the underlying mathematics. No, that's not a dirty word. Though musical mathematics can become extremely complex, the basics can easily be grasped by anyone having only rudimentary knowledge of plain old arithmetic.

Even the briefest excursion into musical mathematics can be fascinating. On the one hand, it's most satisfying to discover that there's a certain mathematical neatness about harmonic chords. On the other hand, you may be surprised to learn that dissonance, properly utilized in the playing of even *The Star-Spangled Banner*, can make music more enjoyable than it would be if the music were virginally "pure." And it may be more than a little disconcerting to discover that the "Concert A" note (A above middle C), the traditional tuning note, has not always been the 440 Hz it is today!

Diatonic Scale. Though there is a distinct mathematical basis to all music, we must realize that there is no such thing as a single "natural" scale system. The scale system used in the Western world seems natural enough to us; the scales used by other cultures to produce music strange to our ears seem equally natural to those alien cultures. All have sound mathematical bases.

Our *diatonic* scale is the result of considerable experimentation throughout the musical ages. The term diatonic pertains to, or designates, a standard major or minor scale of eight notes to the octave. For example, a major diatonic scale would be represented by eight consecutive white keys on a piano. Add to these eight notes the five intermediate (black keys) semitones, and you have a *chromatic* scale.

Are these 13 notes per octave sufficient to produce top-quality music? The answer depends on how you define top quality. If you mean adequately pleasing harmony that can be created by physically manageable instruments, then

the answer is yes. If you are thinking about complete tonal purity, the answer is no. You can't have both at the same time *if* you include the use of percussion and valve instruments. The reason will become clear later.

True Scale. In order to understand why we are forced to use a somewhat inexact compromise scale, it's necessary to begin with consideration of a *true* scale. As a convenient example, let's take the key of C major scale beginning with middle C on the piano:

C, D, E, F, G, A, B, C¹

As it happens, A above middle C was long ago selected as the basic pitch for instrumental tuning. In terms of the vibrational frequency of the fundamental tone of A, this note has been many things throughout musical history. The pitch of a musical note was first determined by Pèrre Mersenne (1648), a French ecclesiast and mathematician. During his time, the lowest church pitch of A was 373.7 Hz while the chamber pitch was 402.9 Hz. In 1751 Handel used an A of 422.5 Hz.

In 1834, a group of physicists meeting at Stuttgart, Germany, settled on a standard of 440 Hz, but 25 years later an orchestral A of 435 was legalized in France. This lack of uniformity created problems. For example, instruments made in one country wouldn't be in tune with those manufactured in some other country. A singer trained in one country might be forced to sing at an unaccustomed pitch when performing with a foreign orchestra.

In 1939 the problem was at long last resolved. An international conference held in London set the standard pitch of A above middle C at 440 Hz.

The term *pitch* can be misunderstood. The pitch of a played or sung note is related to, but not synonymous with, the vibrational frequency of the fundamental tone. Pitch is a subjective characteristic of sound that depends not only on the vibrational frequency of the note, but also on the loudness of the sound. Moreover, the pitch of a musical sound pertains to a complex sound consisting of the fundamental frequency (e.g., 440 Hz for A) plus many related frequencies called *overtones*. To avoid confusion, we'll henceforth talk only in terms of fundamental frequencies and avoid the use of the term *pitch*.

To grasp the difficulties that a true scale would impose on musicians, consider what happens when a musician decides to switch from one key to another—for example, from the key of C to the key of D. In terms of vibrational frequencies, the following changes would have to be made:

Note	Key of C (Hz)	Key of D (Hz)
C	264	—
D	297	297
E	330	334*
F	352	371*
G	396	396
A	440	445*
B	495	495
C ¹	528	557*
D ¹	—	594

Note that the four asterisked notes in the key-of-D scale have frequencies that differ from the frequencies of the corresponding notes in the key-of-C scale. In order to switch from the key of C to the key of D, a musician would have to use an instrument which had several new notes added. But that isn't all. Still more new notes would be required when switching to each of the other keys. To complicate matters more, additional notes would be required for the various minor scales. Consequently, at least 72 notes would be needed for each octave of an instrument's total range. Since the piano has seven octaves, more than 500 keys would be needed. This would clearly be impractical.

Percussion instruments such as the piano, and valve instruments such as woodwinds, would be most seriously affected. Stringed instruments such as the violin, and the human voice, could theoretically at least provide all of the tonal nuances demanded by the true scale.

Frequency Calculations. It's a sim-

MUSICAL INTERVALS OF THE DIATONIC SCALE		C	D	E	F	G	A	B	C ¹	
Interval	Freq. ratio	264	297	330	352	396	440	495	528	
Octave	2:1	[Diagram: A single bar spanning from C to C ¹]								
Sixth (Major)	5:3	[Diagram: A bar from C to E]		[Diagram: A bar from D to B]						
Sixth (Minor)	8:5	[Diagram: A bar from C to F]				[Diagram: A bar from G to C ¹]				
Fifth	3:2	[Diagram: A bar from C to E]			[Diagram: A bar from F to C ¹]					
Fourth	4:3	[Diagram: A bar from C to F]		[Diagram: A bar from D to G]			[Diagram: A bar from A to C ¹]			
Third (Major)	5:4	[Diagram: A bar from C to F]		[Diagram: A bar from D to G]			[Diagram: A bar from A to C ¹]			
Third (Minor)	6:5	[Diagram: A bar from C to F]			[Diagram: A bar from D to G]		[Diagram: A bar from A to C ¹]			

Fig. 1. Musical intervals and their frequency ratios for diatonic scale. Since interval ratios are constant, they can be used to find frequencies for scale in another key.

ple matter to calculate the tonal frequencies for any diatonic scale. For example, the key of D scale, above, was developed from the tonic D (a tonic is the first or lowest note in any scale) by multiplying this basic frequency (D=297 Hz) by the appropriate ratios for musical thirds, fourths, fifths, etc. These values are given in Fig. 1.

For example, the frequency ratio of a musical fifth (the interval between the first and fifth notes of the scale) is 3 to 2. In the key of D scale, note A represents a fifth. Thus, by setting up the proportion $3:2=X:297$, and solving for X, we obtain 445 Hz as the frequency of A in the key of D scale. Other values are determined in exactly the same way. The octave D¹ of course has just twice the frequency of the tonic D.

Musical Intervals. There are two kinds of musical intervals. First, those between various notes of a scale and the tonic note (the low "do"). These intervals are identified as thirds, fourths, fifths, etc. Secondly, there are tone intervals represented by adjacent notes in a scale.

In Fig. 1, note that there is one octave interval with a 2 to 1 frequency ratio, two major sixths (5:3), one minor sixth (8:5), three fifths (3:2), four fourths (4:3), three major thirds (5:4), and two minor thirds (6:5). The differences between the major and minor categories are somewhat arbitrary, but important to understanding music's math. For example, if the frequency of E is divided by the frequency of C, (a

"third") the simplest ratio that results is 5:4. The same applies to the F-A third and the G-B third.

On the other hand, the G-E and C¹-A thirds yield a numerically smaller—hence "minor"—ratio of 6:5. The size relationship is clearer if the fractions are changed to decimal forms: $5/4=1.25$ while $6/5=1.20$. The same explanation holds for the difference between the major and minor sixths.

But haven't we overlooked something? What of the seeming D-F third? Is it major or minor? Neither, because the frequency ratio of 352 to 297 cannot be further simplified. Further, this tone interval isn't musically significant according to the law of Pythagoras, which demands that the tonal relations must be reducible to simple whole-number ratios.

Figure 2 shows how these various intervals are calculated. In line three, the frequency of each note is divided by the frequency of the tonic (264). The next line shows the simplified ratios, just as they appeared in Fig. 1.

Some music mathematicians, disliking fractions, eliminate the fractions by multiplying with a common factor, in this case 24. This yields the relative frequencies shown in line four. What do they mean? Simply this: in the time that the tonic C vibrates 24 times, D vibrates 27 times, E vibrates 30 times, etc.

By dividing the relative frequencies of adjacent notes, the adjacent tone interval ratios shown in the last three lines are obtained. Note that there are three

FREQUENCY RATIOS OF THE TRUE SCALE (KEY OF C MAJOR)									
Note	C	D	E	F	G	A	B	C ¹	D ¹
Frequency (Hz)	264	297	330	352	396	440	495	528	594
Ratio to tonic note C	$\frac{264}{264}$	$\frac{297}{264}$	$\frac{330}{264}$	$\frac{352}{264}$	$\frac{396}{264}$	$\frac{440}{264}$	$\frac{495}{264}$	$\frac{528}{264}$	$\frac{594}{264}$
Simplified ratio	$\frac{1}{1}$	$\frac{9}{8}$	$\frac{5}{4}$	$\frac{4}{3}$	$\frac{3}{2}$	$\frac{5}{3}$	$\frac{15}{8}$	$\frac{2}{1}$	$\frac{9}{4}$
Relative frequency (Ratio x 24 to clear fractions)	24	27	30	32	36	40	45	48	54
Major tone intervals	$\frac{9}{8}$		$\frac{9}{8}$		$\frac{9}{8}$		$\frac{9}{8}$		
Major tone intervals	$\frac{10}{9}$		$\frac{10}{9}$		$\frac{10}{9}$		$\frac{10}{9}$		
Semitone intervals	$\frac{16}{15}$		$\frac{16}{15}$		$\frac{16}{15}$		$\frac{16}{15}$		

Fig. 2. Frequency ratios between notes in diatonic scale. In line five, simplified ratios in line four have been cleared of fractions in order to show relative frequencies.

9:8 major intervals (four if the scale is extended by one note), two 10:9 minor intervals, and two 16:15 semitone intervals. In this case the terms major and minor are used simply to indicate the relative numerical sizes of the ratios—i.e., 9:8 represents a bigger number than 10:9.

Figure 3 illustrates the tone intervals in major and minor scales. The minor scale has three flatted notes with frequencies somewhat lower than those of the corresponding notes in the major scale. The last two lines reveal that the same intervals occur in both major and minor scales but in different order. Both scales fully satisfy the law of Pythagoras by adhering to simple numerical ratios between adjacent notes.

Mathematical hint: when handling numbers having decimal fractions, first multiply both denominator and numerator by a common factor (usually 10) to clear the decimal, then reduce to

the simplest fraction. For example, to calculate the G-A flat interval:

$$\frac{442.4}{396} = \frac{4224}{3960} = \frac{16}{15}$$

Tempered Scales. In order to avoid using an inordinately large number of notes per octave, thus necessitating very complicated musical instruments, musicians throughout the centuries have attempted to devise compromise scales called tempered scales. The most important of these have been the Pythagorean, the mean tone temperament, and the now generally accepted equal temperament scale established about 250 years ago.

In the equal temperament scale, each octave is divided into twelve equal divisions called tempered semitones. Two semitones are equivalent to one full tone.

One important consequence of this

MAJOR AND MINOR TRUE SCALES (KEY OF C)								
Notes (major)	C	D	E	F	G	A	B	C ¹
Notes (minor)	C	D	E _b	F	G	A _b	B _b	C ¹
Frequency (major)	264	297	330	352	396	440	495	528
Frequency (minor)	264	297	316.8	352	396	422.4	475.4	528
Intervals (major)	$\frac{9}{8}$	$\frac{10}{9}$	$\frac{16}{15}$	$\frac{9}{8}$	$\frac{10}{9}$	$\frac{9}{8}$	$\frac{16}{15}$	
Intervals (minor)	$\frac{9}{8}$	$\frac{16}{15}$	$\frac{10}{9}$	$\frac{9}{8}$	$\frac{16}{15}$	$\frac{9}{8}$	$\frac{10}{9}$	

Fig. 3. Frequencies and tone intervals for major and minor scales in key of C. Interesting here is that very same intervals occur in both scales, though in different order.

type of tempering is that flats and sharps lose their original significance as different tones. For example G[#] and A_b are now identical. In effect, five new notes (the black keys on a piano) were added to the original diatonic scale (white keys). This arrangement is diagrammed in Fig. 4.

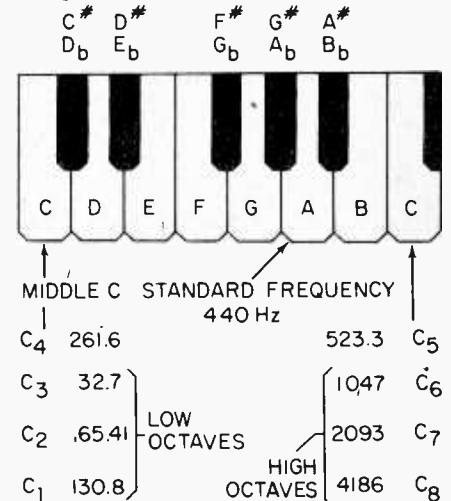

Fig. 4. Equal temperament scale now in common use allows no difference between sharps and flats (D[#] and E_b are thus identical).

It's obvious that when these thirteen notes of an octave are asked to do the job of 72 notes in a true scale system, there must be some sacrifice of tonal quality. An instrument tuned to the equal temperament scale has only one correct interval—the octave. All other intervals are, to some degree, in error; thirds and sixths are a little sharp, while fifths are flat.

Note that middle C now has a frequency of 261.7 Hz instead of the 264 we have so far talked about in relation to the true scale. This adjustment is necessary in order to make the frequency of the standard A work out to 440 Hz.

Figure 5 compares the frequencies of the true scale with those of the equal temperament scale. Note that A is the only note having the same frequency in both scales. The frequency of C¹ is of course, just twice that of its lower octave, C. When the five half tones are added to this diatonic scale, the frequency range between C and C¹ must be divided into twelve equal parts. Mathematically, each twelfth part is the 12th root of 2 because the frequency of C must be multiplied by 2 to obtain C¹.

$$\text{Thus: } n = \sqrt[12]{2} = 1.05946$$

Figure 6 shows how the frequency ratios work out for each note. These ratios are obtained by multiplying each successive ratio by the common factor of 1.05946 to obtain the next ratio. For

e/e SOUR NOTE

example, to derive the ratio for F, multiply the previously calculated ratio for E (1.2598) by 1.05946. The derived ratios can then be used to calculate actual note frequencies. For example, by multiplying 261.7 (tonic C) by 1.6818 (ratio for A), the frequency of 439.985 is obtained for A—very close to the standard 440 Hz.

SCALE FREQUENCIES		
Note	True scale (Hz)	Equal temperament scale (Hz)
C	264	261.7
D	297	293.7
E	330	329.7
F	352	349.2
G	396	392
A	440	440
B	495	493.9
C ¹	528	523.3

Fig. 5. Frequencies of true scale compared with those of equal temperament scale. Only note having same frequency in both is A.

It's important to remember that when intervals are to be added, their ratios must be multiplied. For example, to add the C-F fourth to the C-G fifth, one would multiply 1.3347 x 1.4982 to obtain 1.9996 which is almost 2, the expected octave ratio. To avoid such complicated mathematics, other more empirical systems of indicating frequency intervals are sometimes used. The cent system (Fig. 6) is a numerical

FREQUENCY RATIOS OF THE EQUAL TEMPERAMENT SCALE		
Note	Frequency ratio	Cents from tonic
C	1.0000	0
C# (D _b)	1.05946	100
D	1.1224	200
D# (E _b)	1.1891	300
E	1.2598	400
F	1.3347	500
F# (G _b)	1.4141	600
G	1.4982	700
G# (A _b)	1.5873	800
A	1.6817	900
A# (B _b)	1.7817	1000
B	1.8876	1100
C ¹	2.0000	1200

Fig. 6. Frequency ratios of equal temperament scale. Since scale comprises twelve equal parts, common factor is 1.05946.

scale in which the tonic is 0, the tonic octave is 1200, and each semitone interval is equivalent to 100 cents.

Unlike the decimal frequency ratios, these values can be added. For example, the C-F fourth is represented by 500 cents and the C-G fifth by 700 cents. The sum of these two numbers is 1200 indicating that a fourth plus a fifth is equal to an octave. Another somewhat similar numerical system makes use of units called *savarts*.

Incidentally, you now have enough information to easily calculate the frequency of any note, in any octave of the equal temperament scale. The frequencies of all the Cs on a piano are given in Fig. 4. To obtain the frequency of any other note, use the frequency ratios in Fig. 6.

Let's assume you want to know the frequency of E³ which is the E in the octave below middle C. First find the frequency of E¹ (E above middle C) by multiplying 261.6 by the E-ratio 1.2598. The answer is 329.56. To drop down one octave, simply divide by 2 to get 164.78 Hz as the frequency of C³. Halving this number would give the frequency of E² in the next lower octave. Obviously, to find the value of E in a higher octave, you simply multiply instead of divide by two.

Harmonic Triads. There are certain naturally agreeable ("harmonious") note combinations which chords can be derived from by the addition of a fourth note. (This note, incidentally, must be an octave of one of the three notes comprising the triad.) To show how triads can be discovered by mathematical analysis, it's preferable to work with the *true* scale because the mathematical relationships are simpler and more exact.

Derivation of the harmonic triads in the key of C major is shown in Fig. 7. First set up the diatonic scale and extend it by one note (D¹) and set down the vibrational frequency for each note. Now simplify these frequency relation-

ships by dividing all frequencies by eleven to obtain the relative frequencies shown in line three (C=24, D=27, etc.). It will now be discovered that certain numbers can be divided by 6 to yield still smaller whole numbers; these are C, E, and G which have frequency ratios of 4:5:6. Dividing by 8 and then by 9 will yield two more 4:5:6 triads—FAC¹ and GBD¹.

Incidentally, note what happens if the same calculations are made using the corresponding frequencies in the equal temperament scale (C=261.7, E=329.7, G=392). In this case the CEG ratio would work out to approximately 4.1:5.1:6.1, which is close to what is obtained with the true scale. Even so, it doesn't provide the small whole number relationships that are characteristic of highest consonance or harmony.

Figure 8 shows a similar derivation of the three triads in the scale key of C minor. The mathematical procedure has been modified slightly in order to handle the decimal values more easily. The frequencies are first all multiplied by ten to eliminate the decimal fractions, after which basic simplification is achieved by dividing by 22. When the simplified relative frequencies are then divided by 12, 16, and 18, three sets of minor triads having frequency ratios of 10:12:15 are discovered. Note that though the frequency ratios are different from those obtained with major triads, the same notes still make up the triads.

Incidentally, there's nothing mysterious about the primary divisors used in each case (11 for major triads, 22 for minor triads). Perusal of the frequencies indicated that these divisors were merely convenient for reducing the sizes of the numbers. You could in fact skip this step and divide the major frequencies directly by 66, 88, and 99 and arrive at the same conclusions.

Figure 9 helps show just what the triad ratios mean. Consider the CEG major triad. In the time period that the note C vibrates through four cycles, E

MAJOR HARMONIC TRIADS (KEY OF C)									
Note	C	D	E	F	G	A	B	C ¹	D ¹
Frequency (Hz)	264	297	330	352	396	440	495	528	594
Freq. ÷ 11	24	27	30	32	36	40	45	48	54
÷ 6	4 5 6								
				4 5 6					
÷ 8				4 5 6					
÷ 9				4 5 6					

Fig. 7. Derivation of major harmonic triads for C major diatonic scale. Dividing frequencies by 6, 8, and 9 reveals three triads having frequency ratios of 4:5:6.

MINOR HARMONIC TRIADS (KEY OF C)											
Note	C	D	E _b	F	G	A _b	B _b	C ¹	D ¹		
Frequency (Hz)	264	297	316.8	352	396	422.4	475.4	528	594		
X 10	2640	2970	3168	3520	3960	4224	4754	5280	5940		
÷ 22	120	135	144	160	180	192	216	240	270		
÷ 12	10			12		15			(CEG)		
÷ 16					10			12		15	(FAC ¹)
÷ 18					10		12		15		(GBD ¹)

Fig. 8. Derivation of minor harmonic triads for diatonic scale in key of C minor. Even though frequency ratios differ from those in Fig. 7, triads are comprised of same notes.

will go through 5 cycles, and G will vibrate six times. In the case of the CEG triad, this happens in one 66th of a second. The same vibrational relationships hold for the FAC¹ and GBD¹ triads except that the time periods are shorter.

For the record, the CEG triad is known as the *tonic triad*, GBD¹ is the *dominant triad*, and FAC¹ is the *sub-dominant triad*.

A number of different chords can be developed from the major and minor triads by a procedure called inversion. For example, the chord CEG is called the common chord. A first inversion is obtained by using the octave of C to form the chord EGC¹. A second inversion is obtained by using E that is an octave higher to obtain the chord GC¹E¹. Similar inversions can be made with the minor triads.

Beats. The throbbing or pulsating effects produced when two or more vibrational frequencies interfere with each other are called beats. Figure 10 diagrams how a beat is formed. The two dotted lines represent pure primary sound tones of slightly different frequencies.

Initially, the compressions and rarefactions of air, represented by the "waves," reinforce each other to produce a composite sound (solid line) of greater amplitude than either primary sound. But as the two primary tones drift out of phase, they oppose each

other so as to create a short period of minimal amplitude, or even total silence. This is the beat. The phase shift then continues to again produce a period of reinforcement, followed by another beat, and so on.

The number of beats per second is equivalent to the difference in the frequencies of the two primary sounds. For example, frequencies of 256 and 254 Hz sounding together produce two beats per second.

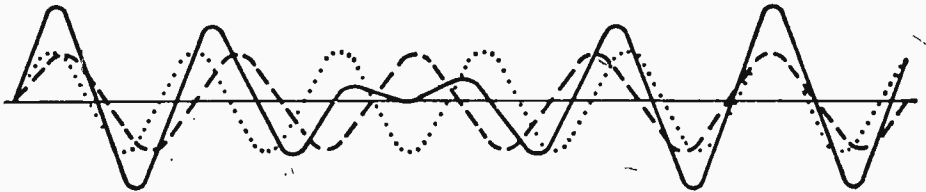

Fig. 10. Artist's representation of how beat is formed. Phase of two tones is basic here, since notes will tend to either reinforce or cancel one another.

In 1873 Professor H. von Helmholtz published his classic mathematical study of the nature of sound and music. Helmholtz had observed that a beat frequency of up to five or six per second produces a pleasing sound, but as the beat frequency increases above this level, the effect becomes increasingly unpleasant. When the beat frequency becomes so rapid that the individual beats cannot be distinguished (above 20 per second), the music still exhibits a dissonance generally termed "roughness."

As the beat frequency is increased even more, the roughness fades away until it disappears when a beat frequency equivalent to a minor third is obtained. The roughness reappears again only when the beat frequency is close to the octave, and once more disappears when the octave interval is made exact. As any musician knows, octave notes must be played correctly or pronounced dissonance is immediately evident.

The beat effect is the basic cause of musical dissonance. But it should be noted that beats are often used to good effect as well. For example, beats are used to provide the so-called *voix celeste* of an organ; this is a soft tremulous tone produced by a labial stop of 8-ft. pitch. Before the advent of electronic instruments, piano tuners were dependent on beat phenomena when tuning pianos.

Much of the musical "quality" obtained when a number of musical instruments play together can also be attributed to beats. For example, it would be very easy to amplify the sound of one violin to make it as loud as ten violins. And yet it isn't done. Why? Ten violins can't be tuned to absolute perfection with each other, so the slight-

ly "incorrect" tunings lead to the production of beats which create a tonal quality we expect from ten individual violins—a single violin is incapable of beating against itself without special electronic processing.

Overtones. Throughout the preceding discussions we have been concerned wholly with pure tones and combinations of pure tones. But musical notes as created by instruments or the human voice are not pure in a vibrational sense; they are in fact complex mixtures of related vibrational frequencies. For example, an instrumental A is not just a frequency of 261.7 Hz; it is that plus many other frequencies called *overtones*. As will be apparent from Fig. 11, the various overtones of a fundamental can be calculated by multiplying the fundamental frequency by 2, 3, 4, etc.

The components that make up a complex sound structure are called *partial tones*, or simply *partials*. The *fundamental* is the partial having the lowest

(Continued on page 90)

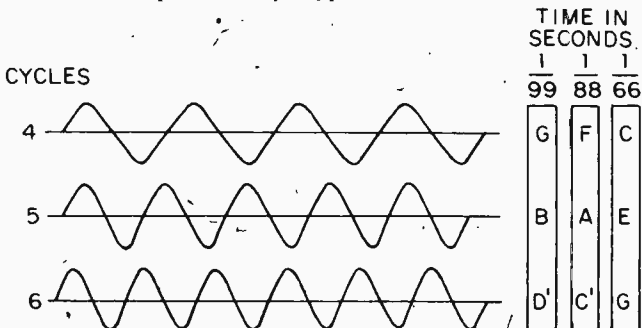

Fig. 9. Best way to understand triad ratios is to view them in terms of what's actually going on during a given time period. Here, while note C goes through four cycles, E will go through five cycles, and G through six.

ANTIQUE BATTERIES LIGHT UP THIS MUSEUM

by Joe Gronk

□ Antique radios . . . rare old vacuum tubes . . . these are some of the relics of yesteryear that hobbyist/collectors are familiar with. There are public and even private museums for ancient radio and wireless equipment all over the U.S., but if you think an Atwater Kent or a classic McMurdo Silver is rare and hard to find, how about the very first battery, a Ritter "accumulator," built in 1802!

The Ritter battery is only one of many housed in the Battery Museum in Hagen, Germany. The museum was opened in 1898, six years after the idea for a battery museum was first proposed. When the museum opened it created a great deal of excitement, and it attracted visitors from all over the world. Why all the fuss? Well, let's not forget that at the turn of the century the battery was as much of a phenomenon as the computer is today. No generator plant, no telegraph office could work without batteries of some kind or another. They were used for stabilizing electrical voltage, as well as for bridging over the periods of electrical failure that were a frequent occurrence in those days. So scientists, technicians, and inventors were soon coming from the U.S., Canada, Australia, and even China to see the rare batteries on view in Hagen.

We don't have anything like the Battery Museum in this country, but here's a sampling of these rare old treasures of the early days of electricity for you to see. ■



1. This is a battery made in Switzerland in 1904. The pans are treated on one side with a negative substance and on the other with a positive substance. The balls between the pans are insulators. Only a few of these batteries were ever produced, since the company that made them went out of business in 1905. This particular battery is believed to be the only one of its type still in existence.



4. This substantial-looking job was made in 1891. It was built for the Danish Railways for the lights on a train. The past versus the present: the battery on the left was made in 1888; the one on the right was made in 1972.



2. This is an "accumulator" made by Carassino of Turin, Italy, in 1900.

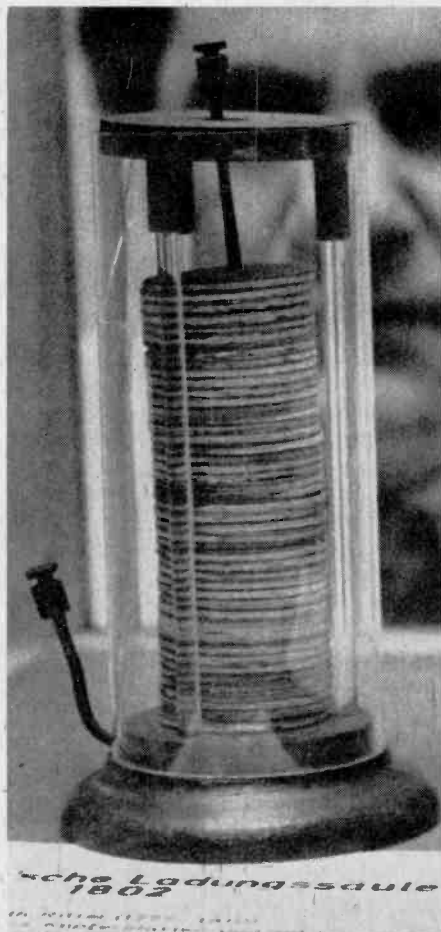

3. This is how it all began: the archetype battery—or "accumulator," as they were then called—the voltage pile constructed by Ritter in 1802.

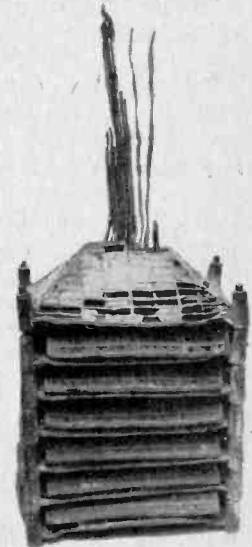

5. This is not a bird-feeding station! We don't know the origin of this battery, but it was probably made between 1880 and 1895, and it was constructed in this odd way in order to save on space.

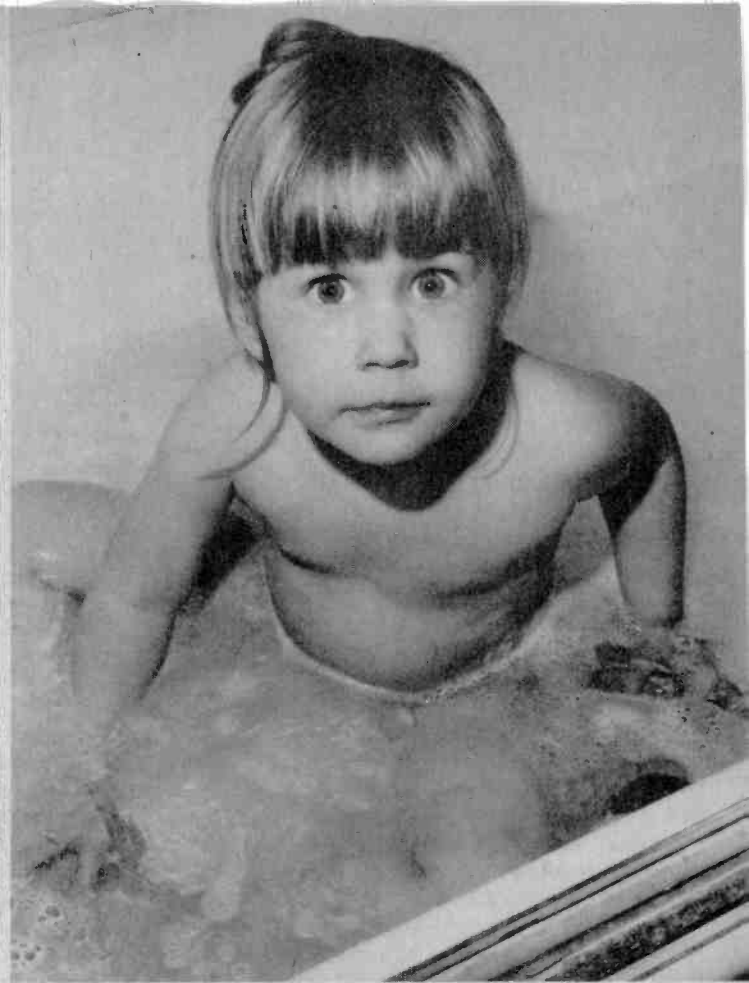

DARKROOM PRINTING METER.

Print-paper saver gives you fine B&W prints sooner!

by Herb Friedman

TRY TO grind out wallet-size prints or enlargements from a full 36-exposure roll in only one evening and you'll know just how frustrating life can be. Every change in magnification and negative density means a different exposure. And if you use test strips or exposure guides to hit the correct exposure you're making at least two prints for every one you need.

The way to take all this drudgery out of your darkroom work is to use an electronic printing meter, a device that takes only seconds to indicate the correct exposure, regardless of whether the enlarger is at the top or bottom of the rack, or whether the exposure and negative development is over or under.

A quick example will illustrate how easy it is to make prints with a printing meter. Let's assume you have just chocked the negative in the enlarger and have cropped the picture exactly the way you want it. Now you take the probe from a printing meter—which you have previously calibrated for a 10 or

20-second exposure—place it on the easel at the point of maximum light transmission through the negative (the black reference in the print—deepest shadow) and adjust the lens diaphragm until the printing meter's pointer indicates some reference value you have previously selected.

That's the whole bit. Expose the paper for your normal 10 or 20-second exposure and the first print will be a good print. Maybe even a great print. If you're grinding out wallet-size jobs for the whole family, each print from each frame will have the same excellent quality.

A Hint. The key to successful use of a printing meter lies in the fact that, except for some particularly artistic work, any print will look decent to excellent if there is some deep black, even if it's just a spot of black; for the black to highlight or border-white contrast gives the visual appearance of a full contrast range, even if the greys are merged. For those who do portraiture, a printing meter can be user-calibrated for "flesh tones."

The printing meter shown in the photographs has been especially de-

signed for construction and use by the typical e/e photographer/electronics hobbyist. It features a calibration—called "speed"—adjustment to accommodate slow to fast enlarging papers (such as Polycontrast and Kodabromide) and readily available parts, many of which will be found in the typical experimenter's junk box. The layout is non-critical—any cabinet can be substituted; there are no critical shielded

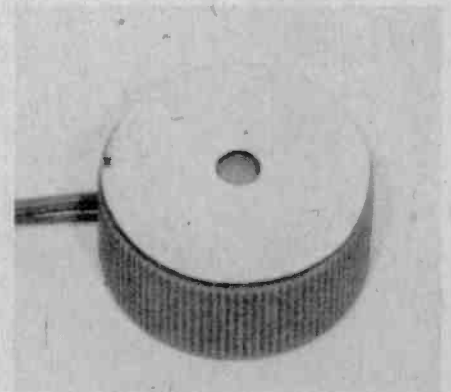

The sensor is really a large tuning knob with photoresistor PR1 embedded in epoxy, plastic or RTV rubber adhesive.

e/e DARKROOM PRINTING

circuits (not even shielded wire is used); and except for the photoresistor sensor, just about any component quality will do. There is absolutely no sense in building the project with the best components money can buy because the best components won't affect the final performance one iota.

Construction. The unit shown is assembled in a 5¼ x 3 x 5⅞-in. metal utility cabinet. Connecting jack J1 is optional as the photoresistor sensor, PR1, can be hard-wired into the circuit. If you use a jack, note that it must be the three-terminal type such as is used for stereo connections; the ground connection is not used since neither PR1 lead is grounded. Do not use an ordinary phone or phono jack as they will ground one of the PR1 leads. Plug P1 must similarly be a matching three-terminal stereo type. Either miniature or full-size jacks and plugs can be used.

Power switch S1 can be anything you care to use—lever, slide, or toggle. Use the least expensive slide switch if you're trying to keep the cost down.

The meter, M1, is a Lafayette Radio 99-26262 illuminated 0-1 mA S-meter. This meter was selected because it has built in pilot lamps with 6 and 12-volt connections. When 12-volt-connected to T1, which is 6 volts, the pilot lamps are dim enough not to affect the sensor and bright enough so that you can see the pointer in the darkroom. Meter M1 mounts in a 1½-in. hole, which can be cut with a standard chassis punch (if you have the punch).

Sort Them. The meter scales are jammed with numerals that can be confusing in the darkroom so the best bet

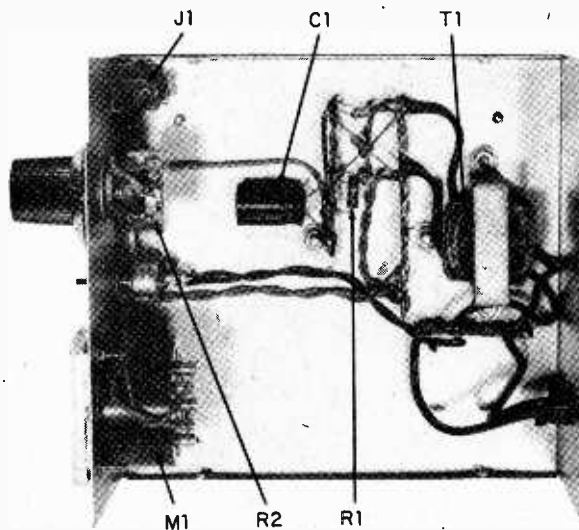

Nothing is critical so don't crowd the layout. Two parallel terminal strips provide the tie points for the rectifier diodes and power supply

is to paint out the unwanted "calibrations" using Liquid Paper or Liquid KO-REC-TYPE, products used to correct typewriter errors (available in stationery stores). First, snap the plastic cover off the meter. It might feel secure but it's not. Grasp the top of the cover and force the cover outward and down, taking care that when it snaps free the pointer isn't damaged. Next, remove the scale by taking out the two small screws and sliding the scale out from under the pointer. Do not attempt to paint the scale while it is mounted in the meter as a single drop of the fast-setting correction fluid can ruin the meter if it gets into the pivot bearing. When re-installing the scale, hold the screws with a tweezer or long-nose pliers until you "catch" the first few threads. When the scale is secure, snap the meter's cover into position. (On the unit shown all scales and markings other than 0-to-1 have been painted out, as the 0-to-1 scale is the most convenient to see

under dim lighting.)

Note that meter M1, power switch S1, and jack J1 have been positioned on the front panel so as to provide the maximum room for the speed control's calibrated knob. Use the largest possible knob as the greater the calibrations the easier it is to reset the control to a desired paper speed.

Power transformer T1 can be any 6.3-volt filament transformer rated 50 mA or higher. (A 6-volt transformer scrounged from a portable cassette recorder will work just fine.)

Power Filter. If the line voltage in your home is known to be reasonably constant, assemble the unit as shown in the schematic. If your local utility likes to bounce the line voltage, or if appliances cause your line voltage to vary (indicated by dimming lights), install zener diode D5 across points A and B. The zener will provide a regulated 6 volts, with the slightly lower circuit voltage (6 VDC rather than 9 VDC)

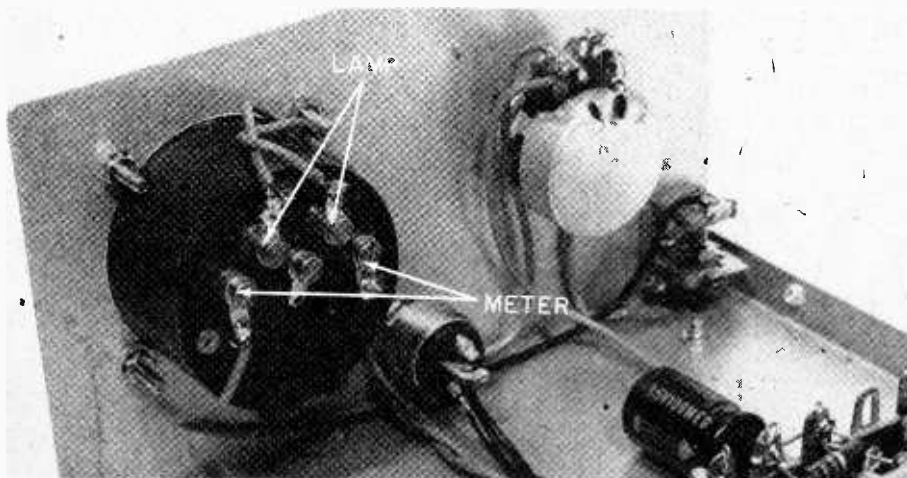

The specified meter has five terminals. The two on the bottom row are for the meter movement. The top row terminals are for the 12-volt lamp connection. The remaining terminal is for a 6-volt lamp connection and is not used.

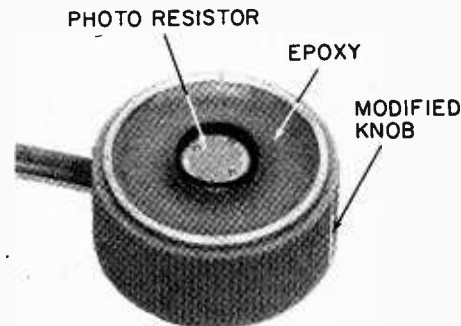

After the sensor is completed, punch a hole in a matching cardboard disc and cement the disc over the sensor. The hole provides a smaller sensitive area required for prints 4 x 5 or smaller. Better results with larger prints are also obtained with the mask.

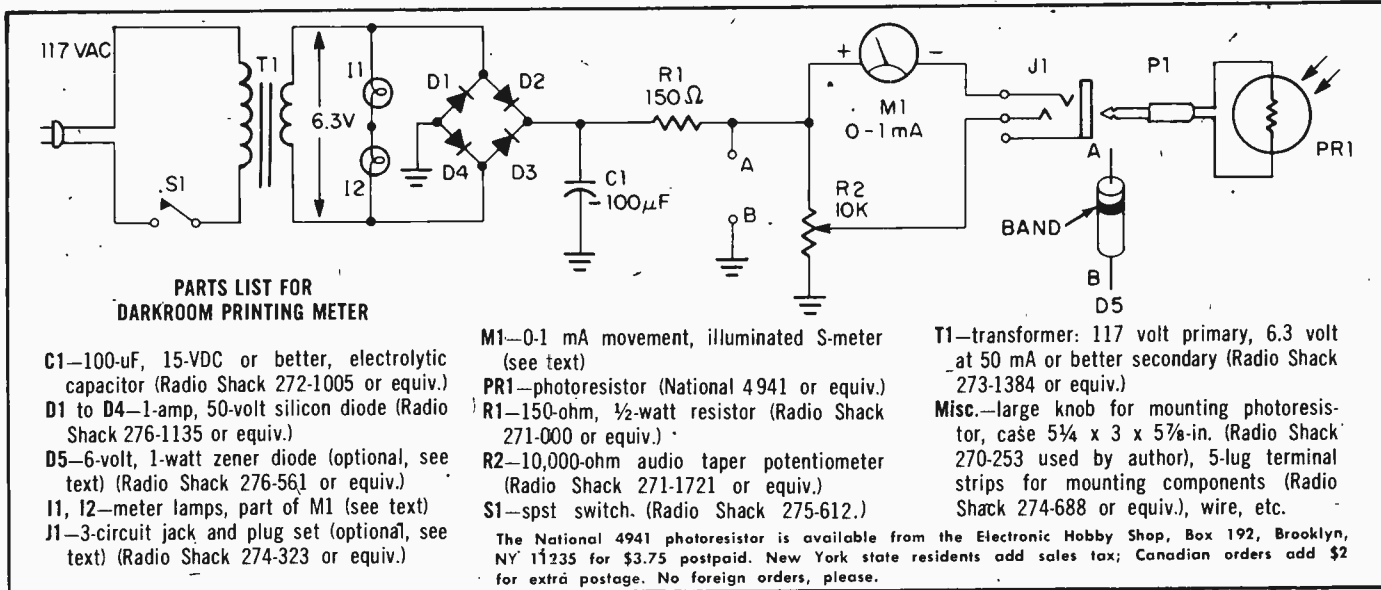

providing slightly reduced sensitivity. Normally, you will not need D5, so there's no need to get it unless you're certain you need it.

In order to get speed control R2 to increase sensitivity in the expected clockwise direction, its ground terminal is opposite to the usual volume control. Facing R1's shaft with its terminals sticking up, the ground terminal is the one on the left.

Meter M1 has five terminals. The one designated "+" and the one adjacent to it are the meter terminals. The three terminals above the meter terminals are the pilot lamps. The extreme end pilot lamp terminals are the 12-volt connections. The center terminal is not used for the 12-volt connection.

The Eye. The only assembly that requires some care is the sensor. The sensor itself is a photoresistor; however, the photoresistor doesn't have enough heft to maintain its position on the easel, so it must be mounted in a support that can maintain its position without falling over. The sensor assembly shown consists of PR1 epoxy-cemented into a relatively large knob. The knob must be plastic—not metal, though it can have a metal decorative rim—and it's best if there is a recess on the top even if the recess is produced by a rim. Remove the set screw and drill out the set screw hole with a bit approximately 3/16-in. (not critical). Then, using a 3/8-in. bit, drill through the shaft hole clear through the top of the knob. If the shaft hole has a brass (or other metal) bushing make certain the drill bit removes all the metal.

Pass the PR1 leads through the hole in the knob from the top. Tape it in position. Feed a section of linecord or speaker wire through the setscrew hole and solder the wires to PR1 as close as

possible to the knob. Trim away the excess PR1 leads; they should not protrude below the knob. Remove the tape holding PR1, get PR1 as close to the center of the knob as possible, and then pour in a quantity of fast-setting epoxy or liquid plastic from a knob repair kit or plastic modeling kit, and let it set a few minutes until the plastic hardens. Keep the level of the epoxy or plastic below the top of PR1—use less rather than more. If you can't get epoxy or plastic you can use G.E.'s silicon RTV rubber (adhesive, caulk, window sealer, etc.); but the RTV rubber must cure for at least 24 hours. Similarly, pack the bottom of the knob with epoxy, plastic or rubber.

Mask Down. Now, the surface area of the photoresistor is too large for small prints—4 x 5 or smaller—and even some 8 x 10s. So cut a disc the diameter

of the knob from shirt cardboard or a manila file folder (but not oak-tag) and using a standard hand punch (such as used in schools) punch a hole in the center of the disc. Apply rubber cement to the rim of the knob and the inside rim of the disc. When the cement is dry drop the disc on the knob so the hole exposes a small part of the photoresistor's surface. It's not all that critical; the hole doesn't have to be precisely over the center of the photoresistor. However, the unit is calibrated for a punch-size hole and might not work properly if the disc is not used, or if the hole is a hand made "pinhole." Use the punch.

Using the Meter. The first step is to select a decent reference negative and make a good print using a 10, 15, or 20-second exposure. We

(Continued on page 89)

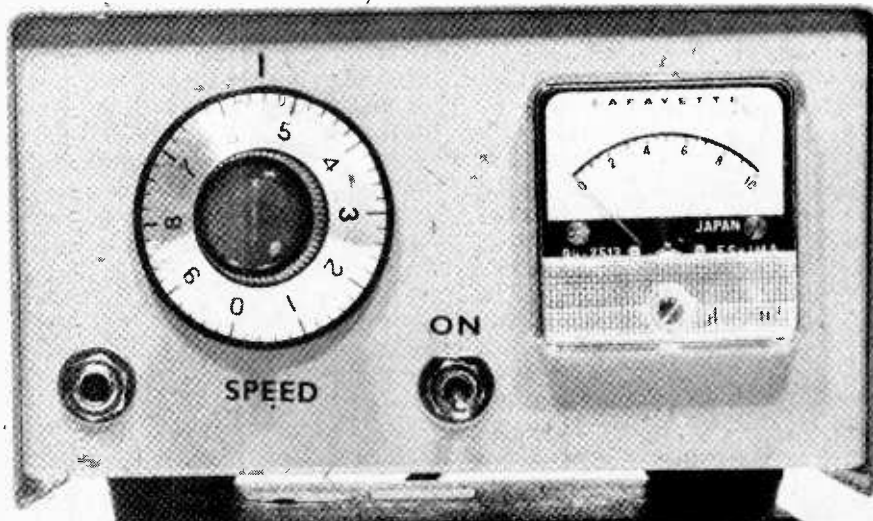

Use the largest calibrated knob you can install without interference by other panel components. The greater the calibration area on the knob the easier it is to preset the paper speed with accuracy.

When CB Goes FM

What's in store for new communicators and former class D CBers if FM is the modulation mode? Technically, there are a lot of pluses!

by The Elementary Electronics Editorial Staff

WHETHER THE FCC decides to provide a CB hobby service by creation of a Class E Citizens Radio Service in the 220 MHz region, or by integrating hobby CBers into the amateur radio ranks under a so-called Communicator's License, the mode of modulation will be narrow-band FM.

Narrow-band FM, or NBFM as it is more commonly termed, is a whole new ball game for the average CBer, and very little of what you know about AM and SSB will serve you when you get your first FM rig.

You'll need to know about such things as deviation, squelch-out, and center deviation. If you get them right, you'll have what is perhaps the finest communications system around. Get them wrong and it's likely no one will hear your transmission.

In both the AM and SSB transceivers there is a carrier, plus two sidebands that represent the signal fed into the microphone—the modulation. The sideband energy is in addition to the carrier power. In AM we broadcast the carrier along with the two sidebands. If there are 4 watts of carrier power, at 100 percent modulation there are also 2 watts of sideband power—1 watt in each sideband. As we have shown previously in the "Inside CB" series, the carrier and one sideband aren't needed to convey a message, so we can remove the carrier and one sideband and put all the available power output into one sideband containing the information to be transmitted; this system we call SSB (single sideband).

In both AM and SSB the received volume level depends on the amount of modulation originally impressed on the carrier—the percent modulation—and the received signal level. If the received signal is strong the signal will be loud; if the received signal is weak the signal will be low.

Basic FM. With FM, modulation sidebands are also created, but the sideband energy is taken directly from the carrier. It is possible that at a given instant of modulation all the energy is in the sidebands with none left in the carrier. Like AM and SSB, FM sidebands depend on both the modulation frequency and the amplitude of the modulating signal. For example, assuming that the modulation signal is a 10-kHz sine wave, if just a slight amount of modulation is applied to the carrier, a 10-kHz sideband would appear on either side of the carrier frequency. As the amplitude of the modulation signal

is increased, additional sidebands spaced 10 kHz apart will appear (the sidebands are always a multiple of the modulating frequency). And as each "set" of new sidebands appears, the carrier power is proportionally *reduced* so that the total power in the carrier and sidebands always equals the original carrier power.

The effect of the sidebands on carrier power is shown in Fig. 1. Note that as we increase the number of sidebands, the carrier power is *reduced*.

In FM, the received volume level is determined by the deviation—the total number of sidebands greater than 1% of the carrier power. These are called *significant sidebands*. How far the significant sidebands extend to one side of the carrier is termed deviation. If they extend, say, 75 kHz, as in standard FM broadcasting, the deviation is said to be

Fig. 1

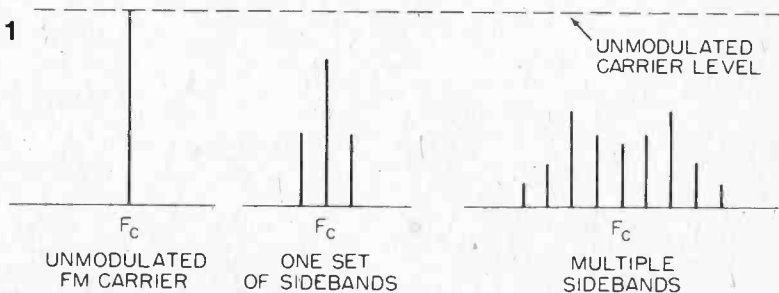

FM sidebands are derived from the carrier power, and under certain conditions of modulation the carrier may disappear for an instant. The power of whatever carrier may remain plus the sideband power equals the unmodulated carrier power.

± 75 kHz, for the sidebands extend equally on both sides of the carrier. If the deviation is ± 75 kHz, the total bandwidth required is at least 150 kHz; we say "at least" because there are sidebands smaller than 1% of the carrier power, and we allow a guard-band for these sidebands. (The broadcast FM channel is 200 kHz wide.)

The volume level is directly proportional to the deviation in terms of percent modulation. If the modulation level that provides ± 75 kHz deviation is arbitrarily called 100% modulation, the modulation level that produces ± 37.5 kHz deviation is 50% modulation, while the modulation level that produces ± 7.5 kHz deviation is 10% modulation.

In FM there is no fixed value to 100% modulation as there is for AM and SSB. The desired deviation is assigned the value of 100% modulation. For example, if an FM system is designed to work with deviation of ± 10 kHz the modulation level that produces 10 kHz deviation is termed 100%. Because FM percent modulation is an arbitrary figure, more or less selected by the user (as with 146 MHz repeaters), or by the FCC, it is more common to see FM transmitters specified in terms of deviation rather than percent modulation. For example, a typical Class E or Communicator's transceiver might be spec'd as "5 kHz deviation," or "7.5 kHz deviation," rather than the more common AM/SSB "100% modulation capability."

For a given degree of deviation, the received volume level remains fixed, not affected by the received signal strength. Assuming the same type of modulation, either tone or speech, for a specified deviation, a very weak FM signal will sound as loud as a strong FM signal. This contrasts with AM and SSB, whose received volume level depends on the strength of the received signal.

Because FM signal strength has no bearing on the received volume level it is very easy to insure noise-free reception. Any amplitude modulation of the carrier would appear as "shot" or impulse noise, the same as it does with AM and SSB. For AM and SSB we use noise limiters to reduce the effect of noise, or noise blankers to punch holes in the signal corresponding to the noise pulses. But in no way can we completely eliminate AM/SSB noise; yet FM can be made noise free, as shown in Fig. 2.

Figure 2A is the transmitted FM signal. Figure 2B shows the impulse noise added as the signal radiates to your antenna. If we demodulate this signal it

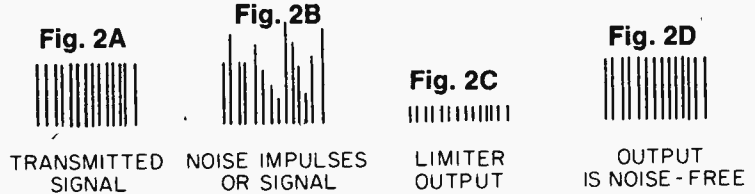

Deviation determines the received volume level of an FM signal. The signal strength has no effect on the received volume level. Because of this, it is possible to literally "slice off" the top of an FM signal to remove man-made and atmospheric noise added as the signal travels to the receiving station. We can pass the sliced signal right into the detector for noise free demodulation.

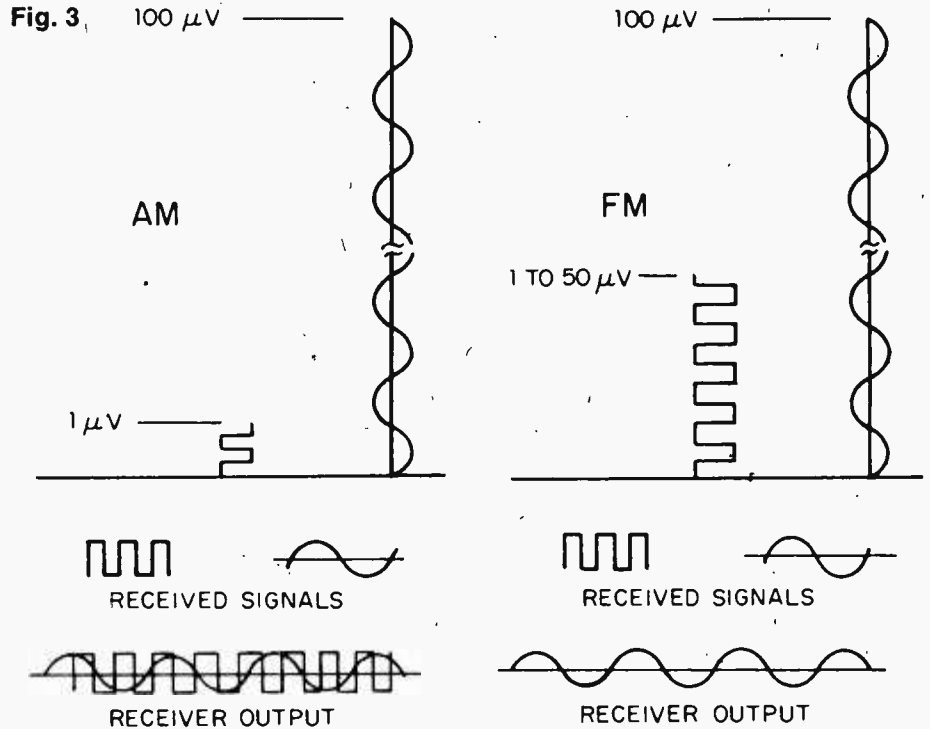

In the above drawing, the "square" wave is an unwanted AM signal while the "sine" wave represents the desired signal. Even though the interfering signal is a hundred times weaker, it causes howls, squeals.

will have all the noise impulses, and a noise limiter would be needed, as for AM/SSB. Rather than go the noise limiter route we pass the received signal through an IF limiting amplifier that shaves off the top of the signal, restoring the original noise-free condition shown in Fig. 2C. This "clean signal" can now be demodulated noise-free, or it can be amplified, as in Fig. 2D, and then demodulated. Either way, we have a noise-free/distortion-free received signal. Modern solid-state limiters are so effective that an inexpensive FM transceiver often has a sensitivity of 0.5 μ V for a very low noise level, 1 μ V for total noise-free reception.

Narrow Band FM. While broadcast FM stations use ± 75 kHz deviation, there wouldn't be much room for two-way radio if every station used almost 200 kHz bandwidth for their signal since that's almost the entire band-

width of Class D CB. For most two-way radio the maximum bandwidth is limited to what it would be using AM, and that's about ± 5 kHz. Now the FM station takes up only as much room as a conventional AM signal, so we call it NBFM (narrow band FM). And we can get the same number of *usable* channels per bandwidth as we do with AM.

One problem with NBFM is that the transmitted deviation cannot exceed the bandwidth of the receiver's detector. If it does, the receiver's squelch is activated and the receiver squelches out on voice peaks, literally chopping the signal into bits. If the receiver squelch isn't activated, the signal deviation extends beyond the range of the detector and simply vanishes—a hole is punched in the signal just as if the squelch was turned on, and again we say the re-

(Continued on page 88)



by Kathi Martin, KGK3916

Kathi's CB Carousel

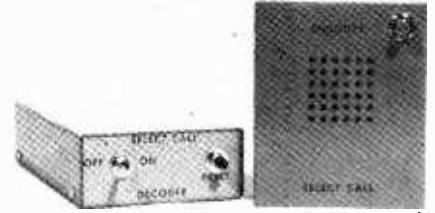

MUCH as I like to monitor the CB channels, there are times when I like some peace and quiet, yet still must listen for an incoming call. A few years ago there'd be no hassle, for many rigs were available with a selective-call optional accessory, a device that would activate the receiver only when a specially coded tone was transmitted by the sending station. But not many are left today. Also, selective-calls were not inexpensive and generally required some modification to the rig if the transceiver did not have a pre-wired selective-call socket.

But necessity is the mother of invention; add that to some up-to-the-minute solid-state devices and you get the Egbert Electronics Select Call, a real low cost selective-call system you just plug into almost any CB transceiver. Actually only part of the Egbert Electronics selective-call plugs in; the other part you carry in your pocket or the glove compartment of your car.

As shown in the photographs, the Egbert Select Call consists of two units: a *decoder* that plugs into your transceiver's remote speaker output jack, and the *encoder*, a package about the size of a cigarette pack that emits a coded tone when the panel button is depressed. The only other items you'll need are some connecting wires and a small remote speaker, for you cannot use the speaker in the transceiver without a small modification to the transceiver. The easiest way to go is with a small remote speaker which requires no modification whatsoever.

As shown, the rear panel of the decoder has three jacks: one is the speaker *out* (from transceiver), one is the speaker *in* (to external speaker) and the remaining jack is for 12 VDC.

That's right, the decoder does not have its own internal power supply. If the device is used in a mobile setup you simply bring out the battery wires to the decoder. If you are using a mobile type transceiver and an AC power pedestal at a base station, you simply splice into the 12 VDC wires connecting the power pedestal to the transceiver. Just be certain you get the polarity correct (check it with a voltmeter).

Powering Up. If your transceiver operates only from 120 VAC (power-line) you must supply 12 VDC to the decoder. A large 12-volt lantern battery will give many months of service; but connect an on-off switch between the battery and decoder, for the decoder's own on-off switch does not turn off the power.

The front of the decoder has an *on-off* switch and a *reset* pushbutton. When the switch is set to *off* the receiver works normally, with the signal fed to the remote speaker. When the switch is set to *on* the speaker is muted and turns on only when the proper tone burst frequency is received. Once the speaker turns on, it remains on until

the system is reactivated with the reset pushbutton.

The tone burst at the sending station is supplied by the encoder. First the rig is switched to transmit the microphone's push-to-talk (PTT) switch. Then the encoder is simply pressed against the microphone. The pushbutton switch on the front of the encoder is pushed, switching the encoder on, and you will hear the tone burst being fed into the microphone. About two seconds is all that's needed to key the decoder. When you remove the encoder from the mike the tone turns off and you simply transmit your message.

The encoder is powered by a standard transistor radio type 9-volt battery, and will last many months. The encoder and decoder are supplied tuned to one frequency, but since the frequency can be changed by simply adjusting a potentiometer in both the encoder and decoder you can readjust the system to any frequency you choose (but a frequency counter is needed, or the tuning gets a bit sticky). Actually, there's really no need to readjust the system to a new frequency unless someone in your

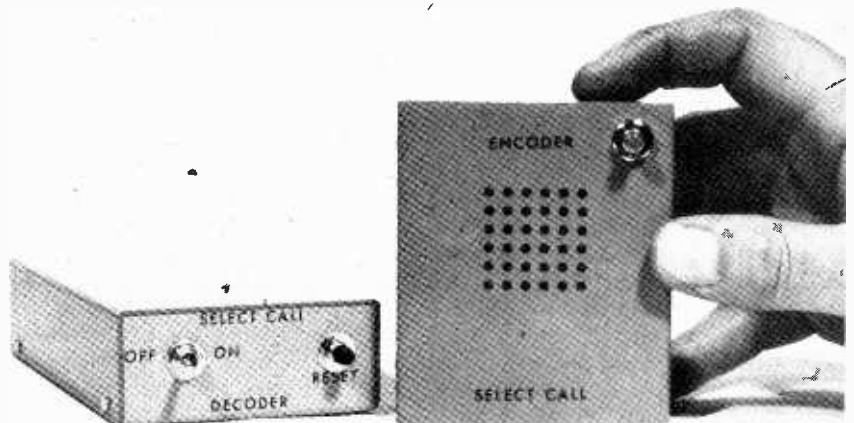

The complete Select Call system consists of an encoder (in hand) that feeds a tone burst into the microphone and a decoder that controls the transceiver-to-speaker connection. The system is noise-immune even if the receiver squelch is inactive. Proper operation only requires the receiver volume control be set to its normal listening position.

The Select Call system is from Egbert Electronics, 17333 Tramonto Drive, Pacific Palisades, CA 90272. Price is \$29.95 for the decoder, \$8.95 for the encoder, both in kit form; also available wired. Circle No. 75 on the reader service page for more information.

neighborhood gets a system with the same operating tone frequency.

The units are supplied with two strips of Velcro, the "hooked" nylon material that is used for zippers or applications where you need a temporary, firm, but easily removed mounting. You stick a strip on the transceiver and a strip on the decoder (or encoder) and the two will stay together as if glued until you want to separate them—then they just slide apart.

Checkout. I installed the decoder on the base rig I keep here in the office. The encoder I gave to big Herb to try out in his mobile small walkie-talkie.

First things first. As soon as I flipped the switch to *on* the base rig went silent and stayed silent. After about a half hour of total silence the receiver sud-



For base station use the decoder can be placed directly on top of the transceiver. Velcro strips supplied with the unit secure the encoder to the transceiver and allow easy removal.

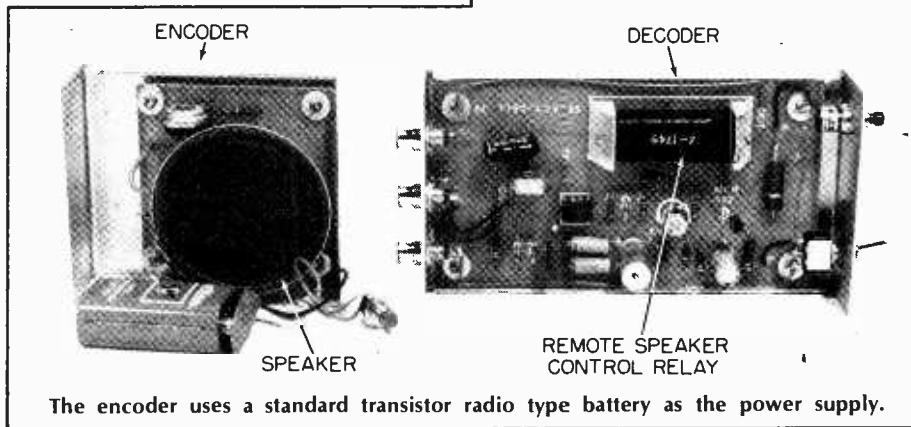

denly switched on and there was Herb in the mobile. Contact finished, I pressed the *reset* pushbutton and the receiver went silent again until the next call from Herb, this time from a small 100-mW walkie-talkie several blocks from the office.

Though the Select Call uses a single tone burst frequency, in several weeks of use I experienced only one instance of false-tripping; that was when two locals used the same channel at the same time, and the heterodyne interference was the same frequency as that to which the Select Call was tuned.

Just to be sure my almost perfect performance wasn't a fluke, I tried the system with several different rigs and walkie-talkies to be certain there'd be no problem transmitting the tone burst. Since my system was tuned to about 1200 Hz, an important voice frequency, I figured there'd be no problems, as any rig should be capable of transmitting the middle of the speech frequencies. I was right. No rig caused difficulty.

One note of caution, however. A year or so ago several mobile rigs were sold which had power supply voltage on the speaker leads, so the remote speaker

jack was insulated from the chassis. These rigs cannot be used directly with the decoder. You must install a small isolation transformer (transistor type is okay) between the remote speaker jack and the decoder input jack. That will take care of the problem.

Summing Up. The Egbert Select Call delivered everything claimed. It's an excellent selective call system, notably easy to install, and low in price. In kit form, and about one evening's work for the average builder, the decoder is priced at \$29.50; the encoder is priced at \$8.95. Wired, the decoder goes for \$39.50 and the encoder for \$11.95. You can specify any frequency from 750 Hz to 2500 Hz. If you don't specify a frequency, it will come adjusted for 1209 Hz (a touchtone frequency). Since the CBer down the block might also wind up with the same frequency as you, I suggest you specify a particular frequency. For CB applications I would suggest any frequency up to 1500 Hz; since some CB transceiver modulators aren't too effective above 1500 Hz.

For additional information circle No. 75 on the reader's service coupon on page 17.

FILL 'ER UP!

by Joe Gronk

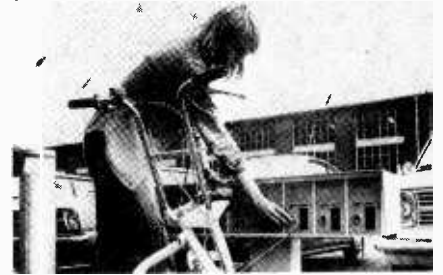

□ No, it's not a female gas-jockey story. In fact, this young Danish secretary just rode to work on her electric cycle (is that how secretaries dress in Denmark?). Actually, since electric motorcycles are limited in range by the capacity of their batteries, there's just not enough power for a round trip. Considering their enormous bulk and weight, batteries deliver too little power compared to gasoline powered motorcycles to be practical without frequent charging. That's where the secretary's employer takes over. His parking lot has a motorbike area complete with a 24-volt hitching post. The rider plugs in his (or her!) bike and goes to work. He doesn't worry about over-charging because the unit is equipped with an automatic cut-off switch. When quitting time rolls around, the battery is charged up and ready for the trip home. This recharging unit, called a "Parkelmeter," is presently being evaluated in the parking lots of several Danish companies. The manufacturers point out that further development could make the unit available to the general public at any location where a powerline exists.



Each T-shaped "Parkelmeter" can recharge as many as six motorbikes at a time. A 6 1/2-ft. recharging cable pulls out of the unit and is connected to the cycle being charged. Furthermore, the unit can be used to recharge any 24-volt battery, which makes for interesting possibilities with other limited-range vehicles, such as electric cars.

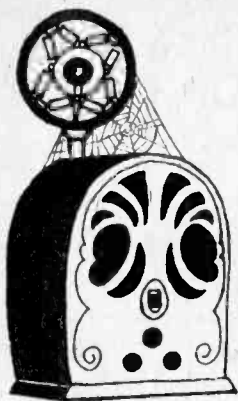

ANTIQUE RADIO CORNER

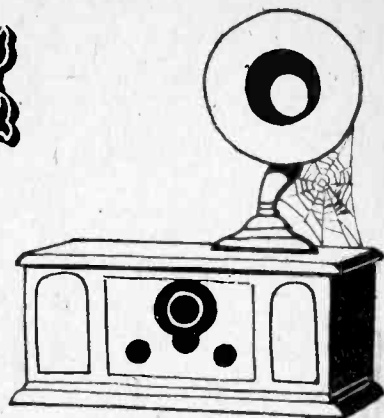

by James A. Fred

□ Hello out there in Radioland! The new look ELEMENTARY ELECTRONICS has is great because it gives us more room for photographs and useful information for antique radio collectors.

Continuing our historical reports on early radio broadcast characters we will tell you something about Dr. John Brinkley, the "goat gland" specialist. It seems as though Dr. Brinkley claimed he could restore the virility of aging males by transplanting certain organs from a male goat into a man. His radio station was KFKB in Milford, Kansas. It broadcast on 1130 kilocycles (now kilohertz), 265.3 meters, and had 5000 watts input power to the final amplifier. He had a hospital about six miles outside of Milford and filled the mails with literature about the wondrous cures he effected. Patients came by the hundreds to be operated on, but many went home to die. At first he had no license as a doctor or surgeon, a fact the state of Kansas had overlooked, so they put him out of business. The Federal Radio Commission finally took his radio sta-

tion license, which forced the station to close. One night, with a few close employees, he fled from Kansas. The next time he was heard from he was broadcasting from Nogales, Mexico. He broadcast from station XERA for a year or so and then the Mexican government closed him up for good. I am indebted to Frank A. Watson of Elsie, Michigan for most of the above info.

Summer Radio Meet. The AWA-IHRS joint summer meet will be held at Purdue University, West Lafayette, Indiana on Saturday, June 21, 1975. There will be displays of old radio equipment, contests, slide shows on antique radio subjects, and good fellowship with fellow collectors. Information on reservations, registrations, and program may be obtained from E. E. Taylor, 245 N. Oakland Avenue, Indianapolis, IN 46201. AWA President Charles Brelsford and Corresponding Secretary-Editor Bruce Kelly will attend the meeting.

A regional branch of the Antique Wireless Association has been organized

in Winston-Salem, North Carolina. All collectors living in the area are urged to contact L. W. Elias, 3919 Poindexter Drive, Winston-Salem, North Carolina for details on how to join the club.

In Dallas, Texas the collectors are becoming more active. The club named the Southwest Vintage Radio and Phonograph Society recently displayed their equipment at the Eastfield College in Mesquite, Texas.

The Mid-America Antique Radio Club has recently been formed in Kansas City, Missouri. Area collectors may write to Bob Lane, 2301 Independence Avenue, Kansas City, MO 64124 for information on how to join the club.

According to the Old Timers Bulletin a book on the history of the vacuum tubes written by Jerry Tyne has gone to the printers.

A "B-C" Power Supply. Since we gave you the necessary information on how to build an "A" power supply in the May-June issue of ELEMENTARY ELECTRONICS magazine, we will now
(Continued on page 86)

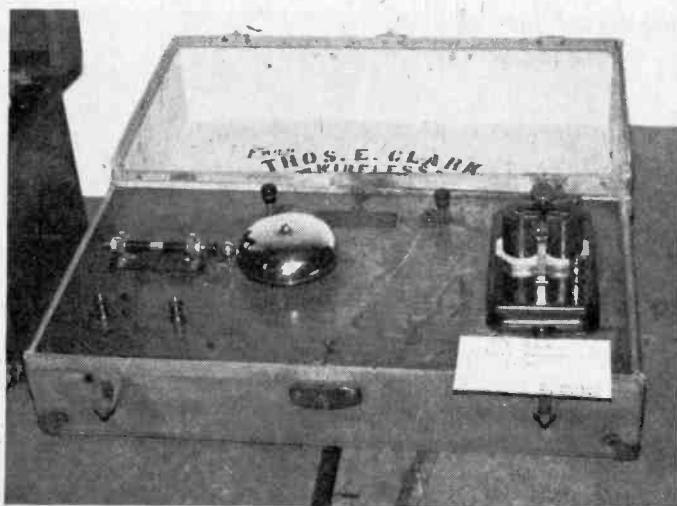

This Thomas E. Clark Coherer Receiver (above left), built in 1902, won third place in the pre-1920 receiver contest at the 1974 AWA

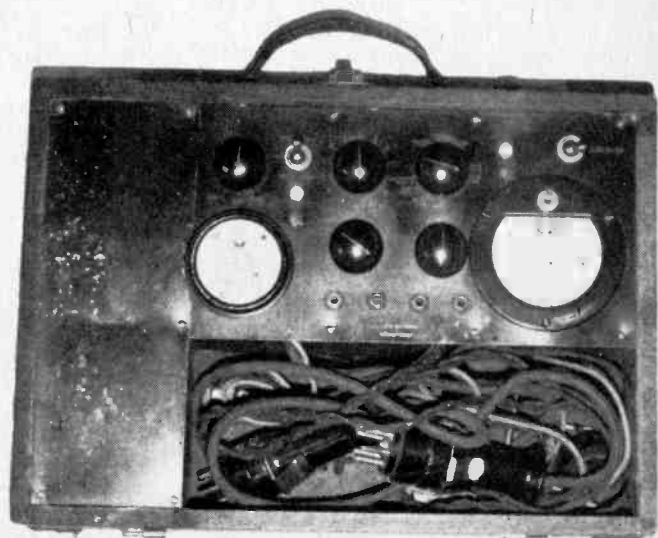

Conference. The Readrite Model 1000 set analyzer (above right) is one of the oldest pieces of equipment in the author's collection.

BUILD IT YOURSELF & SAVE

get more for your money with over 350 Heathkit products

Heathkit Solid-State AM Portable...14.95

Great kit for beginners — 2 evenings gets it together. 8 transistors, 4 diode circuit with 3½" speaker has RF stage for extra sensitivity. Neat "domino" case styling in hi-impact plastic, 4" H x 8" W x 2" D. Requires 9v. battery. Kit GR-1008, 2 lbs., mail.

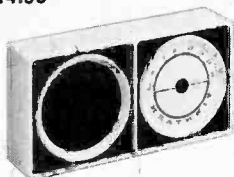

Heathkit Windshield Wiper Delay...14.95

Ends constant turning on and off of wipers. Front panel control of normal or delay modes; sweep period adjustable from .5 to 10 seconds, delay between sweeps adjustable from 5 to 30 seconds. Molded plastic case for on or under dash. Kit CH-1068, 2 lbs., mail.



Heathkit Ultrasonic Burglar Alarm...54.95

Styled like a book titled "The Informer," its soundless signal fills a room; any movement triggers it to turn on external alarm or light. Has automatic or manual reset and time delay to let you enter without setting it off. Kit GD-39, 5 lbs., mail.



Heathkit Digital Car Clock/Timer...62.95

4 electronic digits with automatic dimming, AM-PM indicator. Quartz crystal accuracy. 20-hour timer reads minutes and seconds to 9:59 and hours and minutes to 19:59. Use either function without disturbing the other. Kit GC-1093, 2 lbs., mail.



Heathkit Digital Alarm Clock...59.95

Electronic digits glow brightly to tell time to the second in 12 or 24 hour format. Electronic "beep" wakes you — with repeatable "snooze" switch. Black plastic cabinet with teak-finish vinyl decorator panels. Kit GC-1005, 4 lbs., mail.



Heathkit 3-in-1 Tuneup Meter...29.95

Checks dwell angle on 4-cycle, 3, 4, 6, or 8 cyl. engines with conventional ignition. Shows RPM to 4500. Measures voltages to 20VDC. Use with 6 or 12v. systems, pos. or neg. ground. Powered by engine under test. Kit CM-1073, 5 lbs., mail.



Heathkit Portable Emergency Monitor...54.95

Handy 152-174 MHz FM receiver lets you listen in on all the action... Fire, Police, Weather. Hi-sensitivity solid-state circuit with built-in antenna and speaker. Uses 6 "C" cells, not supplied. Kit GR-88, 5 lbs., mail.

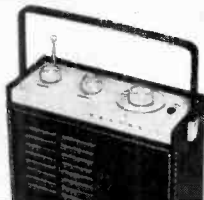

Heathkit CD Ignition System...39.95

Improves performance, saves plugs & points, extends tune-up miles on cars, trucks, I/O & outboard engines. Use with conventional battery/distributor/coil, neg. gnd. systems. Has override switch. Easy to build & install. Kit CP-1060, 4 lbs., mail.

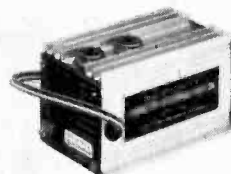

Heathkit Fish Spotter® Sounder...69.95

Spots single fish and schools down to 240'; doubles as depth sounder. Solid-state circuit with noise rejection; bright flash you can see even in sunlight. Uses 2-6v. batteries, not supplied. Kit MI-2900, 9 lbs., mail.



Heathkit Garage Door Operator...114.95

Powerful ¼ hp. chain drive operates 7' std. track doors by radio control. Self-locking, automatic reversing. Adjustable "privacy" tone coding. Kit GD-309A inc. mechanism, receiver & 1 transmitter. Kit GD-309B @ 129.95 has 2 transmitters. Both 51 lbs., mail.



Heathkit Treasure Finder...69.95

Finds metal objects as small as a dime. Stays silent until object enters field of coils... meter and speaker or optional ear-phone indicators. Solid-state. Telescoping shaft. Uses 9v. battery, not supplied. Easy to build. Kit GD-48, 6 lbs., mail.



Heathkit Electronic Photo Timer...35.95

What well-equipped darkrooms need... split-second timing of exposures. 2 ranges: 0-9.9 secs. in 0.1 sec. steps & 0-99 secs. in 1 sec. steps. Has AC outlets for enlarger and safelight. Accuracy repeatable to 2%. Kit PT-15, 4 lbs., mail.

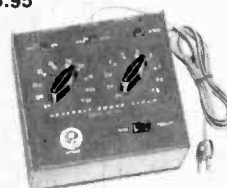

Use this coupon to order or send for catalog



See these and over 350 other Heathkit products including Color TV, Organs, Stereo, Test, Short-wave, Marine, and others in this FREE catalog. Send today.

Heath Company, Dept. 139-07
Benton Harbor, MI 49022

HEATH
Schlumberger

() Please send FREE Heathkit Catalog.

() Enclosed is \$_____ plus shipping charges. Please send models _____

NAME _____

ADDRESS _____

CITY _____

STATE _____

ZIP _____

PRICES & SPECIFICATIONS SUBJECT TO CHANGE WITHOUT NOTICE.
ALL PRICES ARE FACTORY MAIL ORDER, F.O.B. FACTORY.

CL-565

CIRCLE 1 ON READER SERVICE COUPON

IT'S TOUGH DXING!

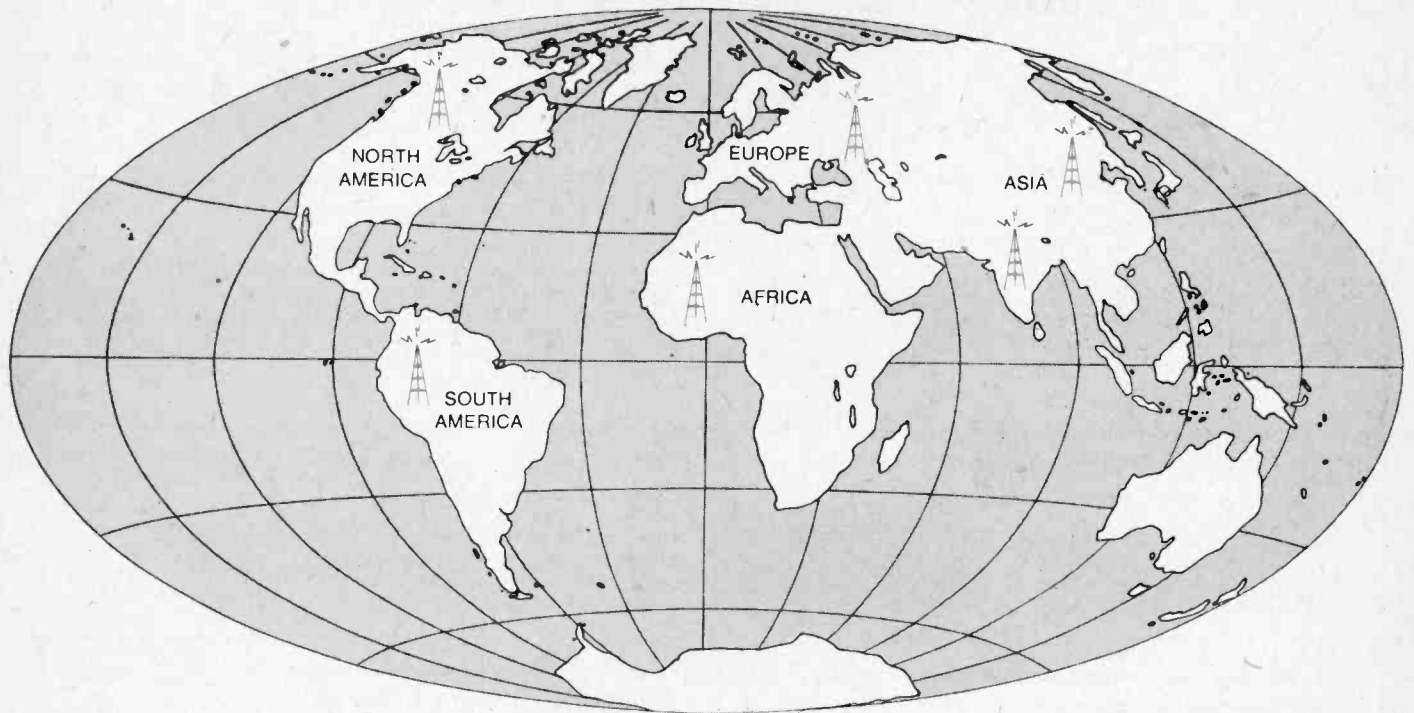

WHEN'S THE LAST TIME you went into a Chinese restaurant and ordered a hamburger? Would you bring a portable radio and listen to the VOA while at a bullfight? Would you plunk down the required three-grand to fly to Fiji and then spend all your time in an Americanized motel room, reading U.S. history?

Of course not! You'd miss all the local color and atmosphere. Well, don't let this get out, but the same often holds true when tuning some of the shortwave biggies. The problem is that since these broadcasts are aimed at American listeners, the programming is tailored to appeal to North American ears, too. And that's why the Beirut dec-jay on the Lebanon international service sounds as though he could probably get a job in Hoboken, N.J.

The answer, then, is to jump onto the "second circuit" for that elusive taste of other cultures. By passing up the offerings of high-power external services, you'll actually be eavesdropping on the inside doings of some pretty remote corners of the globe.

Top Twenty. To get you started, we've prepared a list of our choices of some of the circuit's more prominent members. Most welcome reports and verify promptly—an added bonus. Tuning will require a more discriminating ear, but the results pack twice the punch!

Africa. The "dark continent" offers a

The Second Circuit

Alongside international broadcasters you can find pip-squeak cousins intended for local consumption only. Here's how one DXer chases 'em down!

By Ralph W. Perry

myriad of powerful shortwave voices, but this is one place the second circuit is pervasive. One of the most familiar shortwave visitors is the Radio Ghana international Service on 11850 kHz, from 2000-2100 GMT. But to hear what Ghanaians themselves wake up to, try the morning show from the GBC National Service, 4915 kHz, signing on at 0530 GMT. This one is well-heard throughout the USA.

For the second stop on the circuit, we swing down the African coast to the Republic of South Africa. You've probably heard Radio RSA's North Ameri-

can service (local evenings in the 31 meter band), but how about the domestic commercial radio service, Springbok Radio? Springbok, complete with commercials for "Peter Stuyvesant cigarettes" has been holding its own on 4810 kHz, around 0400 GMT.

Heading up the east coast of Africa, we make a stop in Ethiopia—probably familiar to you as the home of ETLF, the "Radio Voice of the Gospel." But most Ethiopians are probably tuned to Radio Ethiopia, the national radio station which you can hear on good openings at 0330 GMT on 6185 kHz. The announcements are in Somali, which sounds like a slower, choppy Arabic. Wild flute music and droning chants are the tip-off on this one.

Heading out into the Indian Ocean, we find the large island republic of Malagasy. Many shortwave buffs have logged this one by getting Radio Nederland's relay station there. But opting for the second circuit, you can hear an English broadcast from Radio-TV Malagasy on 17,730 kHz, shutting down at 1600 GMT.

By jumping across the Mediterranean (no mean feat!) we find ourselves planted in the midst of a second circuit stronghold: Europe.

Europe. One of the most rewarding of all the stops on the circuit is a flea-powered pair of transmitters in Austria which even the most grizzled of DXers

would prize hearing. The first is a distant relative to the Osterreichischer Rundfunk (ORF), the outfit that signs on its North American service with a bar from "The Blue Danube." Located in the city of Aldrans, a 1000-watter meant for the nearby European audience, broadcasting on 6000 kHz, sits waiting. Scheduled from 0430 GMT sign-on to a 2305 GMT shutdown, the peak times for reception are probably at those times.

The second Austrian member of the circuit is fighting words to a lot of North American listeners: the Austrian Army Radio station, OEY21/52, in Vienna. Although the schedule is no longer certain, some pros have heard them in the past around 0500 GMT.

After polishing off those toughies, the next one will be a breeze. Try for the Stimme der DDR (home service for E. Germany) on 7185 kHz. It's only a 5000-watter, but the frequency is some-

times nice and clear after 0600 GMT. It's a whale of a lot rougher than Radio Berlin International, but well worth it.

One of the best-kept secrets in DXing is the fact that the football at the "toe" of the Italian peninsular boot, Sicily, can be heard on shortwave. Tune Caltanissetta, Sicily, on 6060 kHz after 0500 hours GMT. Be careful, though, before that time; a transmitter in Rome is on the frequency and can be mistaken.

A more challenging way to log Mo-

TWENTY TOP LOCALS—SHORTWAVE OUTLETS FOR INSIDE CONSUMPTION

Station/nation	Frequency	When to Listen	QSLs
AFRICA			
1. Ghana Nat. Svc., Accra, Ghana	4915 kHz	0530 GMT s/on like a local!	prompt, from P.O. Box 1633, Accra
2. Springbok R., Rep. of S. Africa	4810 kHz	0400 GMT and later . . . easy!	good, from Box 8606, Johannesburg
3. R. Ethiopia	6185 kHz	0330 GMT s/on . . . toughie!	irregular, from Box 1020, Addis Ababa
4. RTV Malagasy, Malagasy Rep.	17730 kHz	until 1530 GMT; English service.	fair/good, from Box 442, Tananarive
EUROPE			
5. ORF-Aldrans, Austria	6000 kHz	0430 GMT s/on and 2100-2305 GMT s/off	good, P.O. Box 2000, A-1043, Vienna.
6. Austrian Army R.	6255 kHz	0500 GMT . . . maybe!	acknowledges all letters. Gussriegelstrasse 45, A-1100, Vienna
7. Stimme der DDR, Germ. Demo. Rep.	7185 kHz	after 0600 GMT Patience here!	good, from Nalepastrasse 18-50, Berlin 116, GDR
8. R. Monte Carlo, Monaco	7135 kHz	around 0700 GMT	spotty, from Box 128, Monte Carlo
9. R. Riga, Latvia, USSR	5935 kHz	after 0300 GMT regularly	good, from Square 8, Riga, Latvian SSR, USSR
ASIA			
10. Ankara Polis Radio, Turkey	6340 kHz	0500 s/on (0600 in winter, from Dec. 1)	prize-winner card, when they'll answer. Addr: Ankara, Turkey.
11. PLA-Fukien, China	3200 kHz 3400 kHz	Mornings, after 1100 GMT fade-in.	some, from Fouchou, Fukien Prov., China
12. Nihon SW Bc. Co., Japan	6055 kHz	around 1300	very good, 1-9-15 Akasaka, Minatoku, Tokyo
13. National Radio, Papua, New Guinea	4890 kHz	from 1030 GMT.	good, from VLT4, Pt. Moresby, Papua, New Guinea
14. RRI Ujung Pandang, Indonesia	4720 kHz	from 1230 GMT an e-z catch.	regular, from 1 Ujung Pandang, Box 103, Ujung Pandang, Celebes, Indonesia
15. Thai TV Co., Thailand	7107 kHz	some morns around 1200 GMT	yes! from Mansion B Rajadamnern Klang Rd., Bangkok 4.
AMERICAS			
16. CFRX-Toronto, Canada	6070 kHz	local evenings	excellent, from 2 St. Clair Ave., West, Toronto, Ont.
17. CHNX-Halifax, N.S., Canada	6130 kHz	mornings around 1300 GMT . . . on good days.	good, from Box 400, Halifax
18. CKFX-Vancouver, Canada	6080 kHz	once every blue moon, shoot for it local evenings.	fair, for all we know. addr.: 1275 Burrard St., Vancouver 1, B.C.
19. Voz de Atitlan, Guatamala	2390 kHz	1030 GMT, often heard	fair, from: Santiago Atitlan, Dept. de Solola, Santiago, Guatamala
20. R. Nac. Espejo, Ecuador	4679 kHz	often all night with good signal	a "comer." Addr.: Casilla 352, Quito, Ecuador.

e/e TOUGH DXing

naco than by hearing the Trans World Radio station there is to shoot for the ninth stop on the circuit: Radio Monte Carlo, 7135 kHz. This 41-meter frequency sometimes pays off with a decent signal after the 0600 GMT sign-on. Programming is in French.

Nine times out of ten, when a listener wanders across the bands in the early evening, he bumps into Radio Moscow. For a little "back door" number on the USSR, try listening to 5935 kHz around 0300 GMT and later. That Russian fare is actually a mixed schedule of the Moscow home service and Radio Riga's own program, from the Latvian S.S.R. Yep, they verify. Fast, too.

Asia. We've traversed half the circuit, and now we enter the largest of the continents. The first on the Asiatic checklist is the foremost station on the top twenty.

If the idea of listening to a radio show from the Turkish "fuzz" intrigues you, forget the Turkish Radio and TV transmissions, and concentrate on Ankara Polis Radio. Direct to you from downtown Ankara, this station transmits on 6340 kHz—a little off the beaten path!—from 0600 GMT sign-on in the winter, 0500 GMT the rest of the year. They were well heard twice last fall in the central USA. The verification is an all-time classic. It resembles a large white diploma. Obviously, those who possess one are Doctors of DX!

On the other end of the continent, the Middle Kingdom beckons. Radio Peking may be no great trouble to log, but the circuit offers an intriguing alternative—the People's Liberation Army stations, from Fukien Province. Try for these about 1100 GMT on 3200 kHz, 3400 kHz, and 6400 kHz, for starters.

Radiodiffusion de la République Rwandaise

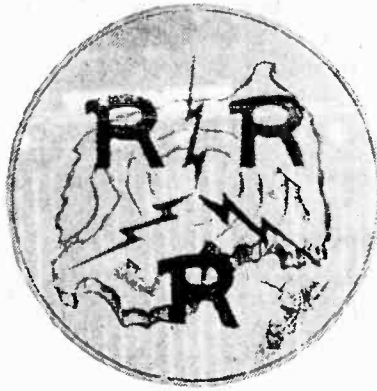

B. P. 83, Kigali
Tél. : 442, 417
Télégrammes Radio Rwanda

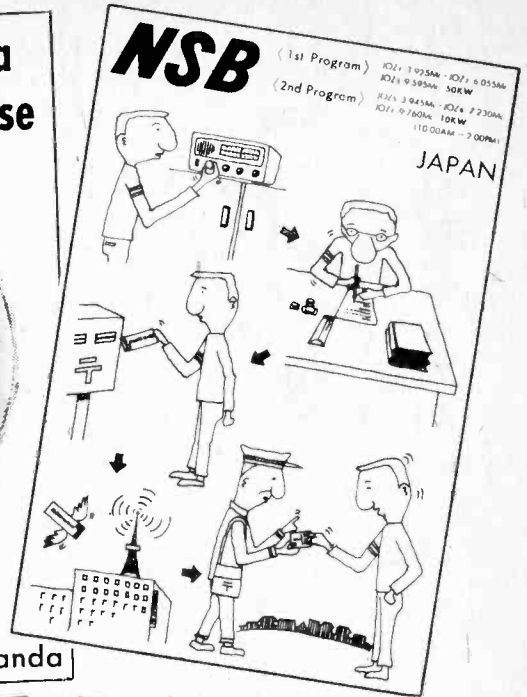

While a strict policy of nonverification has been in force for regional Chinese stations, a few PLA "veries" have been trickling into the states in the past year.

Leaving the mainland, we come to the home of Nippon Kyokai (NHK)—Japan's potent shortwave giant. But we're interested in another island dweller, the NSB (Nihon Shortwave Broadcast Co.,

Ltd.) The NSB is a regular visitor in the 49 meter band around 1300 GMT, on 6055 kHz. The QSL policy is top-notch, too.

And while you're up before the birds, you may want to bag an alternate to the Australian Broadcasting Co. A number of stations operate from Papua New Guinea, a newly-independent former possession of Australia. Listen to the national service on 4890 kHz anytime after 1000 GMT; it is one of the best-heard Pacific stations and comes in like a ton of bricks.

For something a bit more exotic, a bit further down the 60-meter band there's a well-heard Indonesian regional station. This second circuiter, in fact, is usually better strength than the Voice of Indonesia international service. We're referring to RRI Ujung Pandang, 4720 kHz, which is heard with South Seas music, some country and western tunes, and announcements in lilting "bahasa Indonesia." Make sure you enclose some IRCs for return postage for your QSL.

There may not be any cowboys-and-Indians shows, but Thai TV Co. is

(Continued on page 88)

RADIO MOROBE

**NIUELA REDIO STESIN BILONG YUMI LONG
MOROBE DISTRIK LONG TAIM EM I OP YU
KEN PAINIM LONG REDIO BILONG YU**

EM OLSEM LONG HIA

	53	60	70	80	100	120	140	160	180
M	2.3	2.6	3	3.5	4	5	6	7	8
SW	2.3	2.6	3	3.5	4	5	6	7	8

SORT WAIV

e/e checks out a...

RADIO SHACK TELEPHONE AMPLIFIER SYSTEM

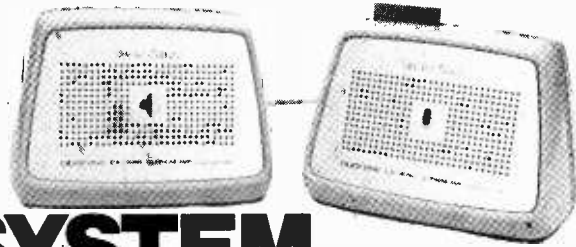

Hold hands-free two way phone conversations—automatic rapid switching between speaker and microphone is the key!

□ You've seen it in the movies a dozen times. The telephone rings, some big shot reaches out to press a button, and the telephone call is broadcast to a room full of people, any of whom can speak right from where they are seated.

The device that allows you to simultaneously talk or listen on the phone from anywhere in the room goes by a variety of names: conference phone, hands-free telephone, speaker-fone, etc. Whatever it's called, it's been expensive. For the only way to get one was through the telephone company on a monthly charge basis; and, as everyone well knows, anything that's "only pennies a day" becomes a stiff budget-breaker by the end of the year.

But now you can have your own conference phone for much less than pennies a day. In fact, the Radio Shack Telephone Amp (Cat. No. 43-270) conference phone costs only \$29.95 to own. No monthly charges, no installation fee (forgot that zinger, eh?), no nothing. You unpack the equipment from the box, plug it in to your telephone jack, and it's yours at no extra cost.

The telephone amp is very similar to the latest telephone-type conference phones. It consists of two separate units. One is the transmitter or microphone, the other is the receiver or loudspeaker. Unlike telephone-type conference phones, the Radio Shack telephone amp does not require a power supply mounted on your wall. Power is provided by three D-cells¹ inside the speaker unit. The transmitter unit contains the microphone and electronics. Both units are permanently connected via a telephone-type cord. A second cord has a bridging connector that closely resembles the standard connector supplied with plug-in telephones.

The difference is that the Radio Shack connector has both the standard male terminal pins plus a jack on the back. You remove the existing telephone plug, plug in the conference phone, and then plug the telephone into the rear of the connector. (If your telephone wiring isn't plug and jack it's best to have jacks installed by the local phone company.)

On the top of the transmitter unit you will find a volume control and a touch-bar switch. The control adjusts the volume of the incoming signal. The touch-bar switch provides the connect/disconnect and power on-off for the system. When your phone rings you

can either answer with the normal handset and then switch the conference phone on, or you can simply depress the touch-bar to answer the call directly with the conference phone. The only thing you cannot do is dial out when the conference phone is switched on, as its line seizure prevents the dial interruptions needed for dialing.

Works Well Too. For many years Ma Bell's conference phone was not the most convenient or effective device. Most hobbyists (and many radio stations) built the phase-cancelling Australian hands-free telephone circuit, very similar to a project we ran in e/e about 5 years ago. With the perfection

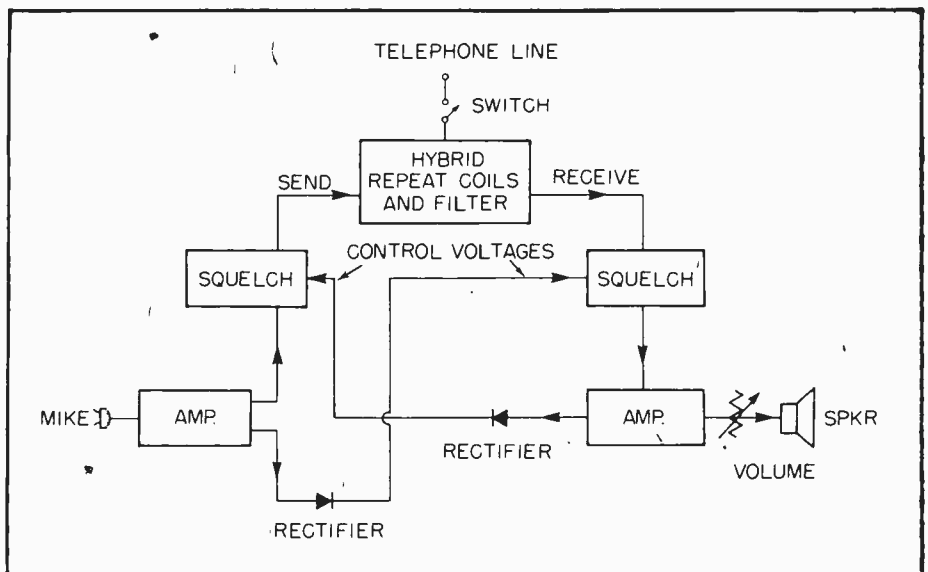

In basic VOX operated hands-free telephone, squelch circuits prevent acoustic feedback between the microphone and speaker. Signals from the mike are fed to the telephone line and a rectifier. The rectifier's DC control voltage is used to squelch the signal from the telephone line to the speaker amplifier.

When a message is being received the output of the speaker amplifier also feeds a rectifier whose DC control voltage is used to squelch the output from the microphone amplifier. At the instant of turn-on there can be a tendency for acoustic feedback, but the instant it starts there is a DC control voltage and one amplifier—usually the speaker amp—is squelched; the user does not hear howling.

Hybrid repeat coils provide extra electrical attenuation between the send and receive circuits.

¹The Radio Shack 43-270 electronic telephone amplifier system is from Radio Shack, 2617 W. 7th Street, Fort Worth, TX 76107. Price is \$29.95. Circle No. 74 on the reader service page for more information.

e/e TELEPHONE AMP

of solid-state devices, most hobbyists made their own conference phones using VOX (voice operated transmit) switching, the same system used in the Radio Shack telephone amp and the newest Ma Bell models; so the Radio Shack model is right up there with the latest technology.

VOX works this way. Normally, if you had both a microphone and speaker amplifier(s) connected to a single pair of cables, the system would break into immediate howling caused by a feedback loop between the speaker and microphone (remember Ma Bell's older conference phones?). The only way to keep the feedback howling down is by keeping the volume levels down and a lot of distance between the speaker and mike. Or, you could electronically trigger the speaker and microphone amplifiers so that neither is on at the same time. If the triggering is fast enough you can get a two-way conversation going with little loss of message content. Trigger systems which are keyed by voltages developed from the speech signal are said to be VOX'd—voice operated transmit.

How It's Done. A basic VOX system is shown in the figure. When the microphone picks up an input signal



A standard size desk telephone gives a good idea of the conference phone's scale. In actual use there's no need for the conference phone to be near the regular telephone as the call can be answered directly at the conference set. The receiver has a combination power/line on-off switch and a receive volume control on top of the cabinet. The switch is push-for-on/push-for-off.

(your voice) the mike amplifier develops two output signals: an audio signal fed to the line and a DC control voltage which is simply part of the audio output passed through a diode rectifier. The DC voltage is used to squelch (turn off) the line feed to the speaker amplifier. (When no one is talking there is no DC voltage and the speaker amplifier is on.) A signal feeding from the line to the speaker amplifier also develops a

DC voltage, which is used to squelch the microphone amplifier. In this manner, either the microphone or speaker can be on at any given moment, but not both.

The attack and release of the squelch circuits is very fast—something easily done when dealing with the limited frequency response of telephone circuits—so a normal two-way conversation

(Continued on page 89)

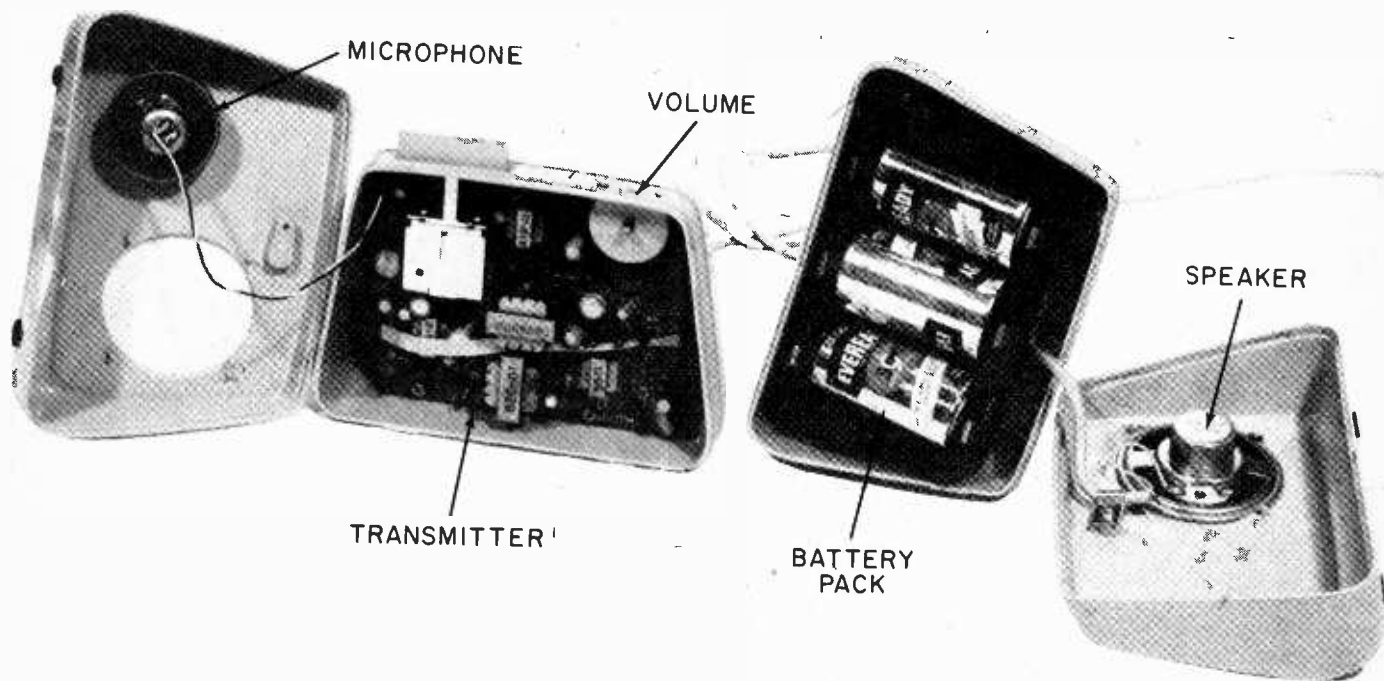

Both cabinets can be opened by twisting a coin in the slot on the bottom of each cabinet. The receiver houses only the speaker and a holder for three D-cells. The transmitter unit contains all the electronics and the microphone. There are no user adjustments in the transmitter; all are made at the factory. The user must adjust the receive volume level only.

BGNRS FET IC BCB AM RCVR*



*beginners field effect integrated circuit broadcast band amplitude modulation receiver

THE BEST WAY for the newcomer to radio to learn about receivers is to build one! The easiest type of receiver to build that will be reasonably selective and sensitive is the type that grandad built back in the golden days of radio—the regenerative receiver. But this one has been brought up to date. Instead of old-fashioned tubes, this receiver uses a field effect transistor (FET) regenerative detector and an integrated circuit (IC) for the audio amplifier.

Our model tunes the broadcast band from 550 kHz to 1600 kHz; it provides very reliable reception for the beginner. The receiver is built in a handy metal cabinet, runs on two dry cells, and is designed for simplified construction with perf board mounting of components. The receiver can be used with earphones for digging out the broadcast band DX, and it will operate a speaker when tuned to strong local stations.

Circuitry. Signals from the antenna at J1 are coupled via the antenna trimmer capacitor C1 to the tuned circuit L1-C2 and then detected and amplified by the gate-leak detector Q1. Some of the RF energy is fed back from Q1 to L1-C2 via the tickler coil L2, then detected and re-amplified again by Q1. The amount of RF energy feedback is adjusted by the REGEN control, R1, in shunt with the tickler coil L2. When there is too much feedback, the gate-leak detector Q1 circuit will oscillate, an undesirable condition.

Detected signals from Q1 are coupled through C7 to the integrated circuit and amplified. The amplification is controlled by R7, and the audio output is coupled to J3 for an external speaker (8 to 45 ohms), or earphones. A 3-volt battery or DC power supply is connected to J2 to supply the necessary electrical power for the receiver circuits.

Construction. The FET-IC receiver is built in a 5¼-in. deep by 3-in. high by 5⅞-in. long metal cabinet. Most of the components are installed on a 4¼-in. by 4½-in. perf board section. The remaining parts are mounted on the front and back panels of the cabinet. The parts placement is not critical, but for best performance follow our component layout and wiring placement.

The RF coil L1 is wound on a 2-in. long section of 1¼-in. (outside diameter) plastic tube. A type of plastic tube used for protecting golf clubs—obtainable in sporting goods stores—is used for our coil form. But a cardboard mailing tube 1¼-in. in diameter can also be used.

Begin construction by tightly winding #28 enameled copper wire in a single layer over 1½-in. of the coil form. It's not necessary to count the turns, as the coil may have to be modified to fit your particular antenna. Connect the wire ends through holes at each end of the coil form and connect the wires to two solder lugs mounted at one end of the coil form (see photos).

Set the coil aside.

Install the front and rear panel components as shown in the photos. Capacitor C2 is mounted on two ½-in. metal spacers on the box bottom and as close as possible to the front panel. Mount the 4¼-in. by 4½-in. perf board on the box bottom with a ⅜-in. spacer at each corner.

To Continue. Temporarily position the trimmer capacitor, C1, at the rear corner of the perf board (located as shown in the photos) and mark and drill a ⅜-in. access hole in the rear panel for the C1 adjustment screw. Mount the RF coil L1 on the perf board near C2 by soldering one of the coil lugs to a ground lug installed on the nearby corner mounting screw, and solder the other coil lug to a push-in clip on the perf board. Wind two turns of hookup wire around the base of L1 (in the same direction as the L1 winding) and connect the start of the winding to the ground lug, and the finish of the winding to a push-in clip on the perf board. This winding is the tickler coil L2, and may have to be adjusted for best operation.

Lay out and wire the perf board components as shown in the photos and schematic drawing. In our model, the leads of IC1 are flattened out and soldered to push-in clips for connections to the circuit. Of course, an IC socket can be used if mounted on the board by soldering its contacts to push-in clips. (Continued)

e/e FET RECEIVER

Connect the front and rear panel components to the perf board circuits as shown in the schematic. Make sure that the connecting leads to C1, L1, L2, R1, C3 and the "gate" lead of Q1 are as short and direct as possible. Keep these leads up in the air and away from all the wiring of IC1. Complete the wiring of the receiver. Make sure that all wiring is fastened so that it will not move about.

Operation. For best reception, an outside long wire antenna and a good ground (fastened to a cold water pipe) are required. The antenna should be as long as possible and mounted high up in the air. The mail order houses have antenna kits available which come complete with the necessary insulators and lead-in wiring.

Connect the antenna lead to the ANT terminal of J1 and connect the ground lead to the J1 GND terminal. Connect

either a 3-volt DC supply or two 1½-volt dry cells in series to J2. Make sure that the positive supply lead is connected to the (+) terminal and the negative lead is connected to the (-) terminal. Plug in a pair of high impedance earphones (1000 ohms or more) to J3.

Set the volume control R7 to maximum amplitude position (fully clockwise), and adjust REGEN control R1 to mid-range. Tune C2 until you hear a station in your earphones; it may be received as a "whistle" or beat note. This is the undesired condition mentioned before and is caused by the oscillation of the gate leak detector circuit of Q1—the result of too much RF feedback. Therefore, adjust R1 until the whistle disappears and the station is heard. Retune C2 for best reception. Practice will be necessary for good results.

Simple diagram of wavetrapp as it is connected to the receiver. Simple parallel tuned circuit provides an extra measure of selectivity.

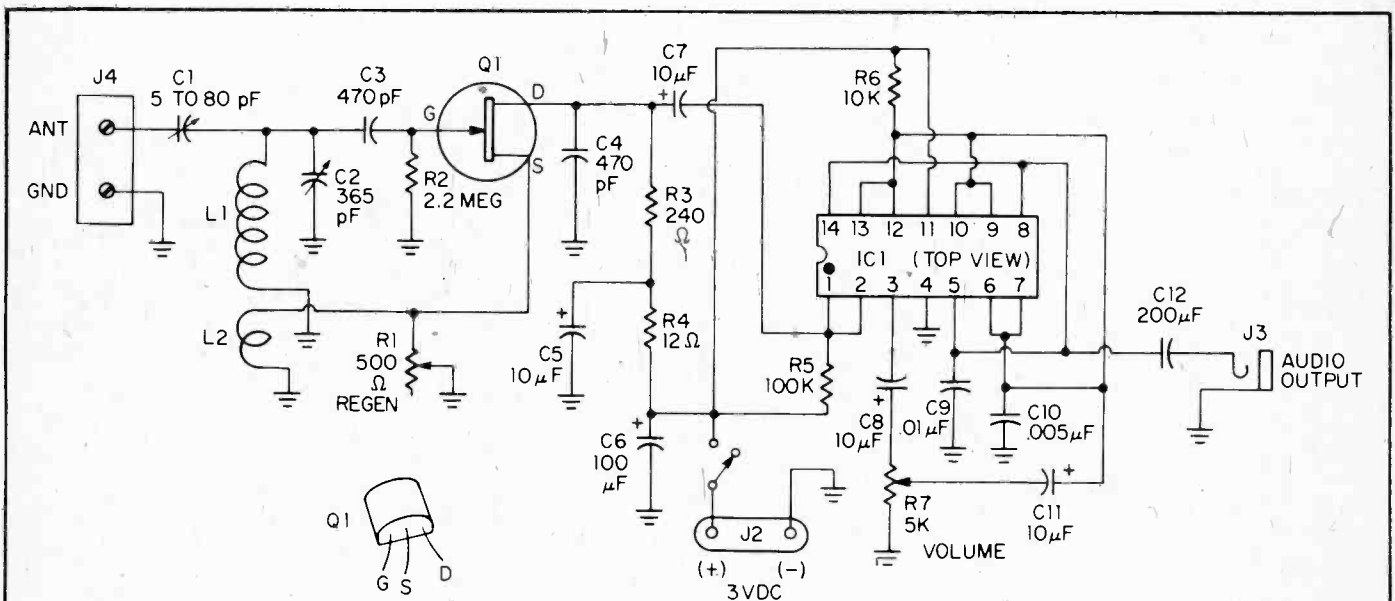
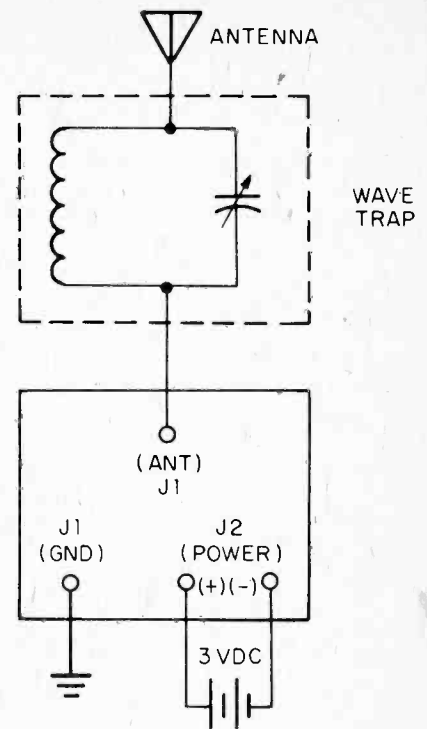

PARTS LIST FOR BEGINNER'S FET-IC BCB RECEIVER

- C1—5 to 80-pF trimmer capacitor (see text)
- C2—365-pF variable capacitor (Radio Shack 272-1344 or equiv.)
- C3, C4—470-pF ceramic or mica capacitor (Radio Shack 272-125 or equiv.)
- C5, C7, C8, C11—10-uF, 3-VDC or better electrolytic capacitor (Radio Shack 272-1002 or equiv.)
- C6—100-uF, 3-VDC or better electrolytic capacitor (Radio Shack 272-1005 or equiv.)
- C9—0.01-uF capacitor (Radio Shack 272-1065 or equiv.)
- C10—0.005-uF capacitor (Radio Shack 272-130 or equiv.)
- C12—220-uF, 3-VDC electrolytic capacitor

- (Radio Shack 272-1006 or equiv.)
- IC1—quad 2-input gate, RTL-type (Motorola HEP570 or equiv.)
- J1, J2—screw-type terminal strip (Radio Shack 274-663 or equiv.)
- J3—phone jack (Radio Shack 274-252 or equiv.)
- L1—RF coil: #28 enamel wire wound 1½-in. on 1¼-in. dia. coil form (see text)
- L2—tickler coil: 2 turns hookup wire wound on L1 (see text)
- Q1—FET (Motorola HEP802 or equiv.)
- R1—500-ohm linear-taper potentiometer with spst switch (Radio Shack 271-066 or equiv.)
- R2—2.2-megohm, ½-watt resistor (Radio Shack 271-000 or equiv.)

- R3—240-ohm, ½-watt resistor, 5%
- R4—12-ohm, ½-watt resistor, 5%
- R5—100,000-ohm, ½-watt resistor (Radio Shack 271-000 or equiv.)
- R6—10,000-ohm, ½-watt resistor (Radio Shack 271-000 or equiv.)
- R7—5,000-ohm audio-taper potentiometer (Radio Shack 271-1720 or equiv.)
- Misc.—metal cabinet 5½ x 3 x 5⅞-in. (Radio Shack 270-253 or equiv.), perf board and push-in clips, 1¼-in. dia. coil form (see text), metal spacers, hookup wire, knobs, 3-volt battery or 3-VDC power supply, high-impedance earphones (Radio Shack 33-180 or equiv.) or speaker (see text), wire, solder, etc.

The most sensitive and selective point of the R1 adjustment is just below the point of oscillation. After tuning in a station, use R7 for comfortable audio volume; R1 should not be used since it reduces selectivity as well as audio volume.

Adjust the antenna trimmer C1 for best sensitivity over most of the band. This setting may have to be changed for best results at the band ends. If necessary, the value of C1 may have to be changed to a different maximum capacity to better match your particular antenna length. Also, you may have to

adjust the position of the L2 tickler coil, or add or subtract turns to cover the entire band. Do not be afraid to experiment with this coil. If you do not hear any signals that "whistle," reverse the circuit connections to L2. Also, try moving the tickler coil further up L1.

Speaker operation for personal listening can be achieved with strong local stations. A 45-ohm speaker (the type that is used in intercom systems) is best for this receiver. Other lower impedances down to 8-ohms will result in lower audio volume.

A Modern Wave Trap. The regener-

ative type of receiver is sensitive, but since it only uses one tuned circuit (unlike a multi-stage superhet receiver), it is subject to overload by strong local radio stations. To overcome this effect back in the golden days of radio, grandad used a device called a "wave trap." This consisted of a tuned circuit in series with the antenna that attenuated the interfering station's signal and allowed weaker signals to be received.

If there is a strong local station interfering with your reception, construct a duplicate of L1 and connect it in parallel with a variable capacitor of

Study this picture with its callouts of parts carefully before you begin wiring.

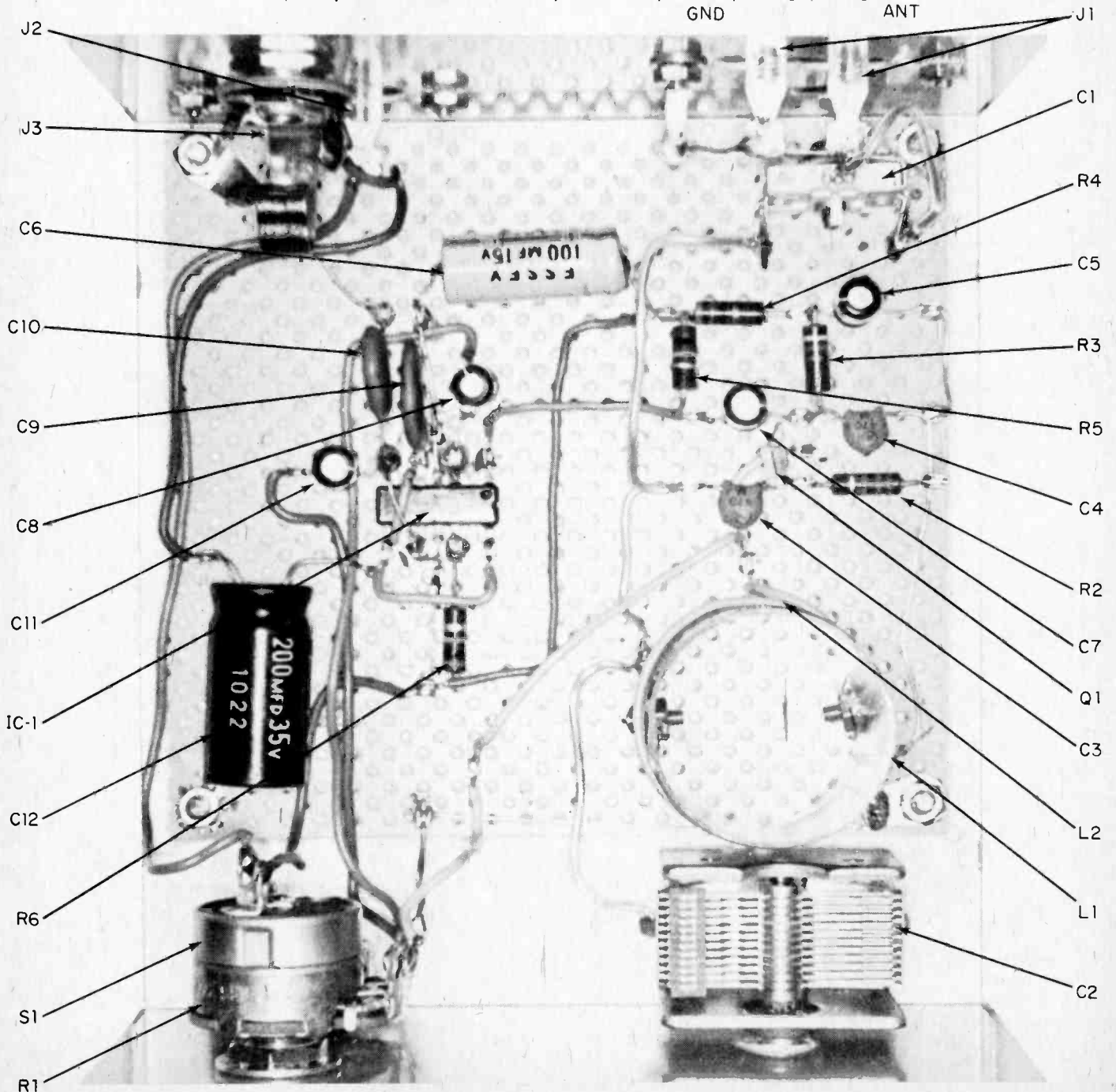

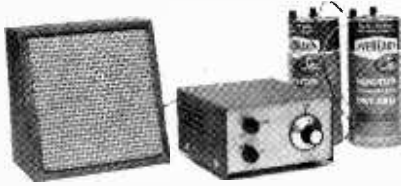

Alternate method of listening to your radio. Although audio power output is low, strong local stations produce a reasonable sound.

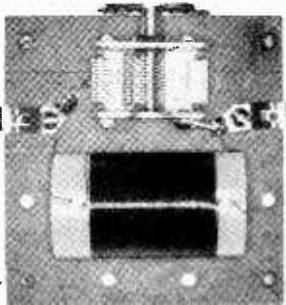

Use a short piece of wire to connect one terminal of the wave trap to the radio. Clip your longwire antenna to the other wave-trap terminal and tune out interference.

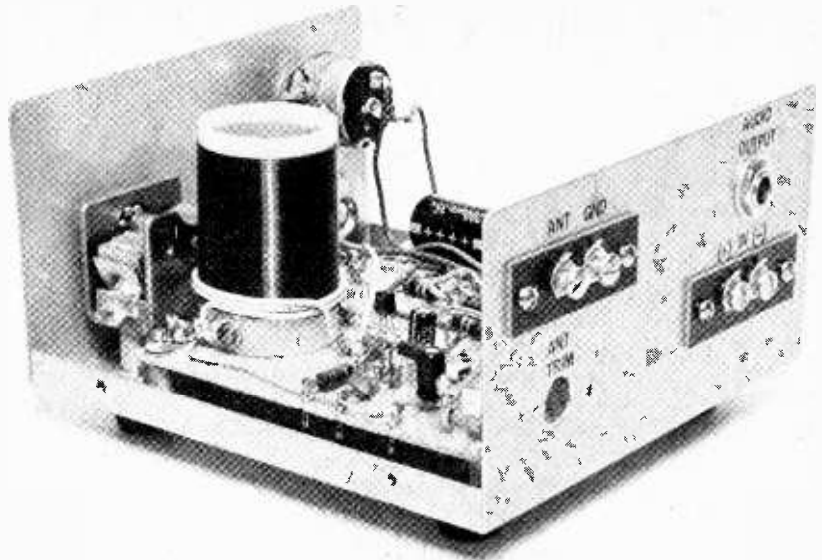

Use perf board and push in clip construction for your receiver. It's simple and avoids the pitfalls of loose components and shorting wires. Solder lugs are bolted to opposite sides of the coil form and then soldered to two push in clips.

the same value as C2 to serve as a wave trap (see drawing and photo). Tune the wave trap variable capacitor to the same frequency as the interfering station. The easy way to do this is to

first tune your receiver for *maximum* received signal of the *interfering* station; then tune the wave trap (connected in series with your antenna lead) for *minimum* received signal. ■

oldies but goodies

by Jack Schmidt



"I finally got the junk man to clean out all that old radio stuff in the basement."



"It's a crystal radio... not much in reception, but the sound really tickles your ears."



"Let me tell you, this very set carried F.D.R.'s second inauguration!"



"Three years ago I refinished it and made it look new... now I'm making it look old again."



"That's a heck of a lot better, Ed, but I still think transmission requires more wax on the string."



"Be careful, Marvin... that old Victrola lid weighs a ton!"

e/e checks out a...

BUDGET STEREO SYSTEM YOU CAN BUILD YOURSELF!



An inexpensive Heath receiver/speaker system with FM performance that rivals "tuners" costing twice the price.

□ We get many requests to recommend high fidelity stereo systems in the \$150 to \$250 price range. Unfortunately, less than \$300 isn't going to purchase much in the way of hi-fi if the system is going to have loudspeakers. We couldn't even find decent, pleasant-sounding equipment in this price range because what's sold in department stores as a *stereo system* generally has all the money in the packaging—fancy chrome panels, oversize knobs, and "solid" wood cabinets. Sound quality comes, if at all, at the end of a long list of visual attractions. So, e/e has never recommended any low-cost stereo systems—until now.

With the introduction of Heathkit's budget line, which they call *Valu-Components*, it is now possible to assemble a decent-sounding stereo system at rock-bottom prices; a system we at e/e can recommend for smaller installations such as playrooms, college or

camp dormitories, even for a teenager's general use.

The Valu-Component line features several different styles specifically tailored for the budget-minded. The basic component on which the system is built is the AC-1118 AM/FM-stereo receiver (\$139.95 in kit form). For those who like continuous music, the same receiver is available with a built in 8-track tape player as the AC-1120 (\$179.95). Moving up another step, there is a 4-channel version, the AC-1122, with a built in SQ decoder, the 8-track (stereo/4-channel) player, as well as AM/FM (\$239.95). For those who dig 4-channel/stereo but have no need for AM/FM, there is the AT-1124 (\$169.95) which is a 4-channel/stereo amplifier with SQ decoder and 8-track (stereo/4-channel) tape player.

Since each of the components utilizes either the amplifiers or tuners of the AC-1118, you can expect the same general sound quality in each of the basic packages (we'll get to the test results below).

The accessory turntable/pickup and speakers are matched to the basic AC-

1118. The turntable/record changer is a standard brand model supplied with many higher-cost stereo systems, and comes equipped with a ceramic pickup (with diamond stylus), a 45-rpm adaptor, base, and dust cover. The entire turntable package is priced at \$44.95.

The real key to the success of the Valu-Components are the matching speakers. Unlike the usual speakers supplied with budget stereo systems, which utilize a thin composition cabinet and possibly no real baffling for a good solid bass, the Heathkit AS-1140 speaker system (\$34.95 per pair) has a solid cabinet made of wood-grain finished particle board (the same material used in top quality speaker cabinets), fiberglass acoustic insulation and flexible joint sealant. (How Heathkit can offer these quality speakers for \$35 a pair is a wonder.) The speakers themselves are 4½-in. diameter units with oversize ceramic magnets. Speaker efficiency is matched to the amplifier so that considerable volume with good bass response is available, even though the amplifier is no heavyweight by today's standards when it comes to power output.

The Basic Receiver. This basic AM/FM-stereo receiver is rated for *consumer equipment*, which is somewhat different from the usual hi-fi specifications you might be used to. Heathkit's power output claim is 4½ watts RMS per channel 50 to 15,000 Hz at 1 percent THD (total harmonic distortion) with both channels driven. As we'll show, the frequency response extends beyond this range, but the response is spec'd to the capabilities of the speakers, pickup, and typical records and pre-recorded tapes.

The receiver features a stereo beacon, AFC (automatic frequency control), phase-lock multiplex (stereo) demodulation, phono jack speaker outputs (to match the cable and phono

The AC-1118 AM/FM budget stereo receiver kit is from Heath Company, Benton Harbor, MI 49022. Catalog price less shipping is \$139.95. Circle No. 1 on the Reader Service page for more information.

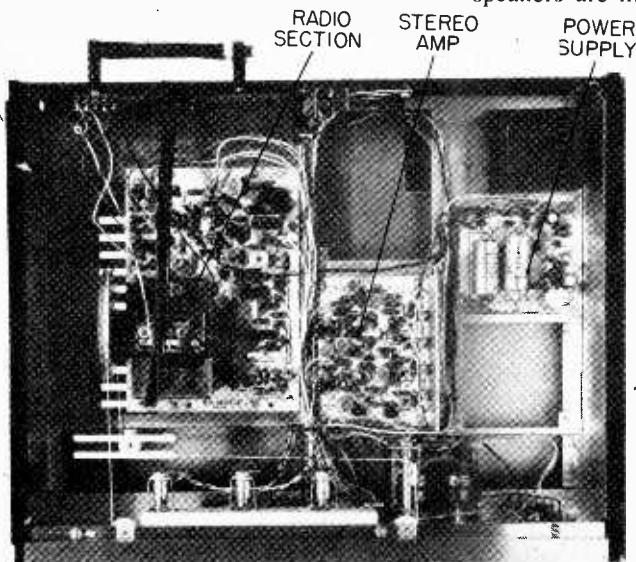

Three relatively large printed circuit boards contain most of the circuitry. Note the extra frame cutouts, which we assume are used for amplifier and decoder in the 4-channel model.

e/e BUDGET STEREO

plug pre-wired to the speakers), and a blackout dial.

There are inputs for aux and ceramic phono. Outputs are provided for one speaker system and headphones.

There are individual linear controls for left and right volume, and standard controls for tuning, input selection, ganged bass, and ganged treble. Switches for *power on*, *speakers on*, and *mono-stereo*.

The FM antenna input is 300 ohms. A rod antenna mounted on the rear is provided for AM. Overall dimensions of the AC-1118 are 16¾-in. wide x 4½-in. high x 15-in. deep. Weight is 9 lbs.

Looking inside there isn't much to see because Heathkit has used many modern solid-state multi-function com-

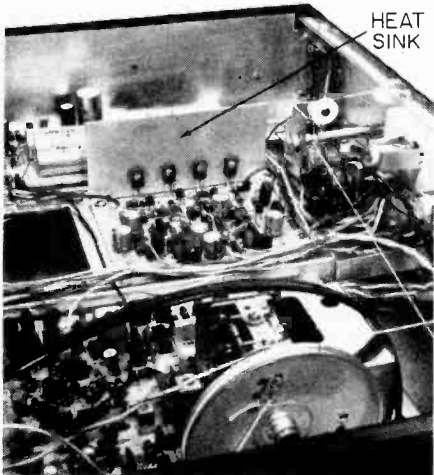

HEAT SINK

Construction is simplified so the receiver can be easily assembled by a beginner. For example, the four output transistors share a single metal plate serving as a heat sink. The transistor leads line up directly with the printed circuit board, thereby avoiding a complex cabinet-type heat sink mounting with extended connections.

ponents. For example, two transistors and two crystal filters make up the AM IF amplifier, while the FM IF amplifier uses two ceramic filters with one IC for selectivity and amplification. Another IC is the FM demodulator and yet another IC is the multiplex demodulator. They don't look like much to the eye, but the tuner's performance is a lot better than you'd expect—as good as in some hi-fi tuners.

● **FM Tuner:** The sensitivity measured 1.8 μ V IHF with full limiting at 4 μ V. The monophonic sensitivity which produced 60 dB quieting was 12 μ V, while it took 150 μ V for 55 dB stereo quieting—and that's as good as some high-fidelity tuners in the \$250-\$300 price

range. The frequency response within Heathkit's specified 50 to 15,000-Hz range measured ± 1 dB, (and was 3 dB down at 25 Hz). Again, really fine performance. Distortion at 100 percent modulation was 0.48 percent THD mono, 0.82 percent THD stereo—well below Heathkit's spec'd 1 percent THD. The AFC popped in very hard, as evidenced by the fact that distortion could not be improved by manual tuning. Also, the stereo separation produced by the AFC was 35 dB—right on specs—and manual tuning could deliver only a slight improvement to 38 dB. The excellent automatic tuning characteristics are also due in part to the phase-lock MPX demodulator which eliminates the need for the extremely precise tuning generally required by budget tuners. The selectivity was as good as that seen in high fidelity tuners at twice the price of the AC-1118 receiver. Overall, the FM performance was quite good, easily the equal of much higher priced equipment we've seen.

● **AM Tuner:** Surprisingly good, with lower than average background noise.

● **Amplifier:** The power output per channel at the clipping level with both channels driven 50 to 15,000 Hz into 8 ohms was right on 4.5 watts RMS. The frequency response at 4.5 watts/8 ohms measured ± 1.5 dB from 50 to 15,000 Hz at a distortion no higher than 0.52 percent THD at any frequency. The frequency response at the upper and

lower limits was down 3 dB at 26 Hz and 1.7 dB at 20,000 Hz. We show the values only to indicate the general overall quality of this receiver. The tone control range from the "center" control settings measured +14/-18 dB at 50 Hz and +8/-12 dB at 10,000 Hz. The phono input signal to noise ratio measured 62 dB; separation was 61 dB.

Summing Up. Overall, the Valu-Component's performance is most impressive for the price. Admittedly, 4½ watts per channel is not going to rattle the windows, let alone the wall, but anyone who expects thunderous sound for under \$200 is letting his imagination run wild, or has read too many newspaper advertisements extolling *peak* power. Heathkit's 4½ watts per channel is legitimate usable output power. Until the FTC cracked down on inflated ads, this was the same amount of power output mass merchandisers used to tout as "eighteen watts of peak stereo power." The difference between the two is that Heathkit gives it to you straight—telling it like it really is.

The sound level you can get from 4½ watts per channel is highly dependent on speaker efficiency; and as a general rule, as speaker quality goes up, efficiency and sound output go down.

The AS-1140 speakers, which are specifically matched to the receiver's power capability, provide a good balance between output volume and qual-

(Continued on page 88)

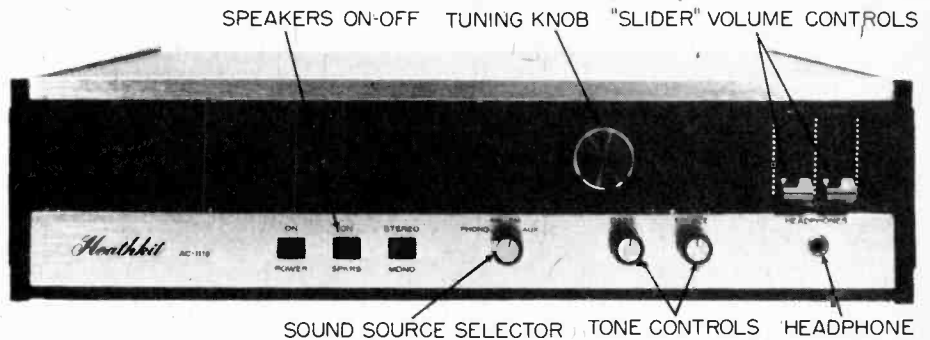

SPEAKERS ON-OFF TUNING KNOB "SLIDER" VOLUME CONTROLS

SOUND SOURCE SELECTOR TONE CONTROLS HEADPHONE

A full blackout dial, the same as used on highly styled low-cost stereo systems, provides a mirror surface concealing the dial and stereo indicator until the power is turned on. Linear volume controls are provided for both the left and right channel; there is no separate balance control since each channel can be adjusted individually.

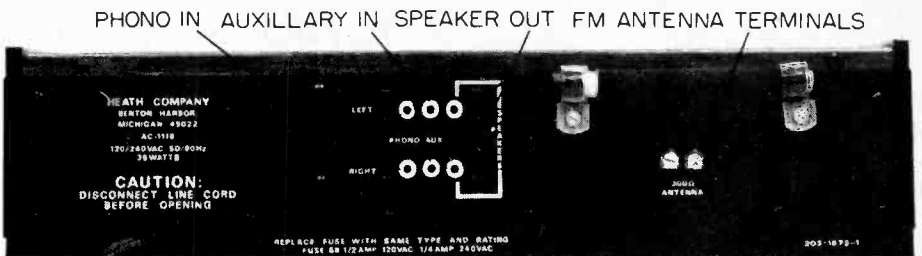

PHONO IN AUXILLARY IN SPEAKER OUT FM ANTENNA TERMINALS

Connecting external accessories couldn't be easier as there are only three sets of jacks, one of them for the speaker system which comes supplied with wire and a matching phono plug. The AM rod antenna is fixed to the rear of the cabinet.



It means a lot more than "Saturday Night at the Movies"

We look at a color TV from the National Radio Institute.

by Peter L. Deksnis, Technical Editor

WHEN YOU'RE READY to delve into the innards of a television receiver there are a number of ways to go. Jump right in. That's one very basic and interesting technique for anyone who's likely to be reading **ELEMENTARY ELECTRONICS**.

Trouble is, it doesn't teach you much. Sure, you're going to know where the mounting screws go. But when you come down to basics you need information that takes you from the ground up—not something that just skims the surface.

While Back. Some years ago, when the TV wonder-how-it-works bug hit me, I was between second and third semester of tech school. So I worked on a summer project to give me a jump on upcoming TV courses scheduled for the following semester.

My goal was to build a full-feature black-and-white television receiver in as small a space as possible (at that time—May 1959—I had seen a color TV in operation exactly twice!). The project was begun with three junked, late '40s TV sets and a small, maroon suitcase. The sets were for parts; the suitcase would turn the home-brew TV into an instant portable.

To start; I gathered together all the TV schematics I could lay my hands on, then drew a composite schematic of

what I hoped was a working television set based on the most interesting circuits and what was available to strip from those old chassis. A lot was guesswork to be sure, but that schematic was gleaned from past experimenting with radio, a few electrical courses, many hours of planning, studying "TV Engineering," "Basic TV" and other related texts.

Solder 'n Smoke. Actual construction took many months of spare time. Since I had virtually no test equipment available to me (other than a buy-it-on-time-for-seven-bucks-a-month vacuum tube voltmeter), I cheated a little in "building from scratch." It was almost impossible to construct a 12-channel tuner, so rather than build a single channel "front end," I simply stripped a working tuner from an old TV carcass. Since there was a nice and simple 3-tube IF strip too, up that came to serve as my "intercarrier" IF strip. That, a rather conventional transformer from another small TV, a newly-wired video detector and a diode sync separator were all I needed for my first important decision.

After a TV signal is "detected" in a modern set, there is a three way split since there are three signals in a black-and-white TV transmission: *video* (picture) information, *synchronization* (pulses to "lock" the receiver to the transmitter), and *audio* (sound for the picture). I chose, as the logical branch, to build the sound circuitry first since

it was most comfortable to me technically and it was the only branch with which I had any previous experience.

As it turned out, a 4.5-MHz sound trap lifted from the old carcass, a few new parts such as bypass capacitors and 1/2-watt resistors, and a lot more time went together by late July and did what it was supposed to. There was genuine home-brew TV audio, tuned on that old 12-channel tuner, and played through an equally old, torn, 4-in. speaker lying on the floor.

The method had worked; tackle the problem a little at a time keeping one's feet on as firm a technical foundation as possible. Plus, the success of that first section gave me determination to press on and get the whole package *percolating*.

On And On. So the next sections to be built were the horizontal and vertical sweep oscillators and amplifiers (any of you old timers think these sections can each be built with a single 6J6? They can!). Since B&W TV sweep frequency fundamentals are in the audio range, 15,750 Hz and 60 Hz respectively, a brief "tap" of the speaker lead to each sweep amp output was enough, I thought, to confirm its correct operation. (As it turned out, it didn't.)

And so it went, until late in that winter of '59-'60. When you put that much time and sweat into something, and it turns out right, you remember it. The first thing I saw on my 2-in.

For the full NRI home training in electronics story, write to NRI Schools, 3939 Wisconsin Avenue, Washington, D.C. 20016 or circle number 71 on Reader Service page 17.

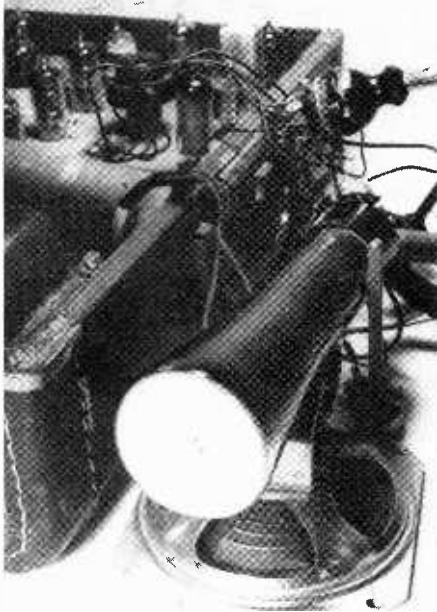

One of a kind. You can bet this is the only one around. Its 4-in. speaker dwarfs 2-in. diameter picture tube of home-brew Tee-Vee. round, black-and-green screen, was an episode of the then-new TV hit "The Real McCoys."

Actually, the picture wasn't quite right. It was all there, but it was folded in half—a mirror image of the right side superimposed over the left side of the picture. A slight miscalculation! (I didn't yet understand the nature of, or reason for, the sawtooth-forming capacitor, but a bit more plodding through the books soon set me and the waveform "ramp" straight.)

Another Thing. Two inch black and green; what happened to black and

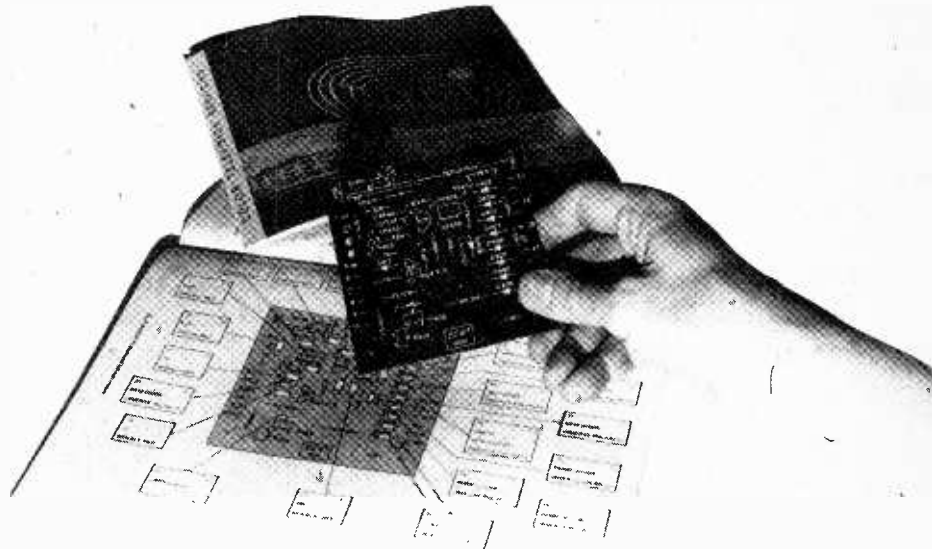

All major circuits are on PC boards, all of which are plugged into the main chassis connectors. The system doesn't waste time with verbiage when it comes to soldering components to a PC board. A drawing is right there with a box for each step.

white? My only big cost was a cathode ray tube with a green phosphor normally used for oscilloscopes—the 2APIA. It cost \$16.50 new and was used to keep sweep power and high voltage requirements low.

As you can imagine, that work put me well ahead of the game that year at tech school. And in more than TV because so many electronic systems are used in TV. Those same principles lead into all phases of electronics: radar, broadcasting, 2-way radio, digital instrumentation, to name a few.

If you have followed my story this far, you certainly have more than a passing interest in electronics. If so, TV construction is certainly one way to advance that interest into sound

knowledge and practical knowhow—as discovered.

The Pitch. For interested e/e readers we checked into a home-study program from the National Radio Institutes. NRI is a correspondence school that uses TV construction—including a modern, solid-state 25-in. color TV receiver kit—for training with techniques that parallel those used so successfully over a dozen years ago. No, I don't claim credit for the NRI course. To tell the truth, I didn't even know their technique followed my own until I began looking at the NRI program some months ago.

Of course, the NRI TV training technique isn't the only way to learn TV
(Continued on page 84)

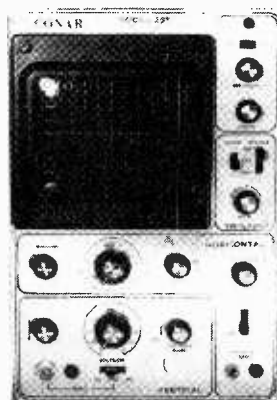
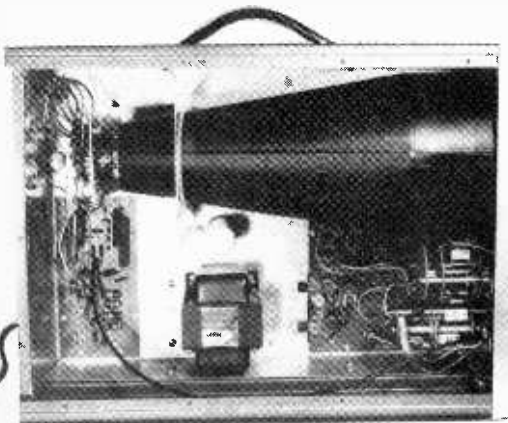

For a full understanding of electronics; a good technician must have a close association with test equipment use and fundamentals. NRI courses 3 and 4 for TV/AUDIO include this wide-band "triggered" oscilloscope, shown at left and center, and the color bar/dot/cross-hatch generator shown on the right. Finger points to channel 3 crystal; it controls the modulated oscillator.



BASIC COURSE IN ELECTRICITY & ELECTRONICS



This series is based on BASIC ELECTRICITY/ELECTRONICS, Vol. 1, published by HOWARD W. SAMS & CO., INC.

HOW YOU MEASURE ELECTRICITY

What You Will Learn. Since volts and amperes are units of measurement, some device must be used to measure them. Devices used for this purpose are called meters. You are now going to learn about the different types of meters and how to use them to measure voltage and current. The precautions to take when handling these instruments are also discussed.

HOW DO METERS WORK?

Meters, like motors, convert electrical power into mechanical motion. In a motor, current-generated magnetic fields cause the armature to rotate. In most meters, similar magnetic fields cause a pointer to move across a scale. The position of the pointer (sometimes called a needle or indicator), when it comes to rest on the scale, indicates the amount of current flowing through the meter.

Most homes or cars without "idiot" lights have meters similar in principle to those that will be discussed. An electrical meter measures consumption of house current. The gasoline, temperature, amp, and other automobile gauges are all basically meters measuring current flow. The quantities being measured are converted to equivalent values of current.

QUESTIONS

1. Voltage and current are measured by
2. The reading of a meter is taken where a pointer comes to rest on a
3. Pointer movement is caused by

ANSWERS

1. Voltage and current are measured by **meters**.
2. The reading of a meter is taken where a pointer comes to rest on a **scale**.
3. Pointer movement is caused by **magnetic fields**.

READING METERS

The illustration shows how a meter is connected to a circuit to measure the amount of current flowing.

Meters are read by noting to which number (or divi-

Measuring Current Drawn By A Lamp

ALL CURRENT IN THE
CIRCUIT FLOWS THROUGH
THE METER

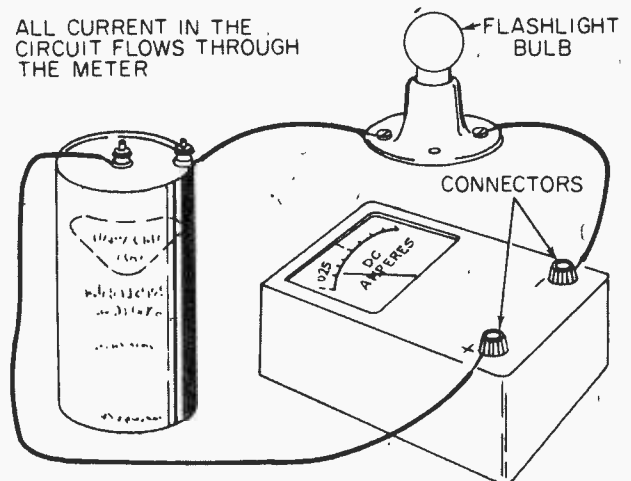

sion "mark" between numbers) the needle is pointing.

If the needle points to a division mark between two numbers, the value of the division is added to the lower number.

QUESTIONS

4. What is the reading for scale 1?
5. What is the value read on scale 2?
6. How many amps according to scale 3?
7. What does scale 4 read?

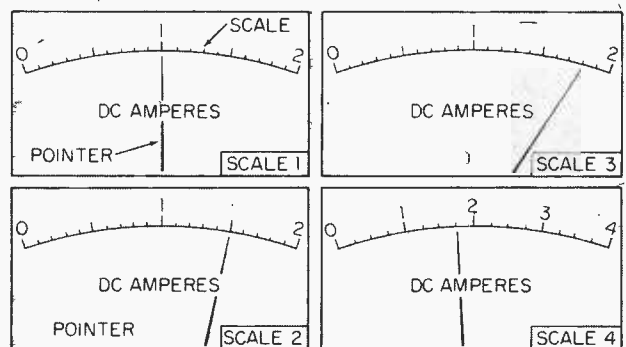

ANSWERS

4. The reading for scale 1 is **1 amp**.
5. The value read on scale 2 is **1.5 amps**. (Note the pointer is halfway between 1 and 2 on the scale.)



6. There are **1.8 amps** registered on scale 3. (There are ten equal division marks between numbers 1 and 2. The pointer rests on the eighth division, indicating a current of 1.8 amperes. Counting of the divisions is shown in the illustration below.)

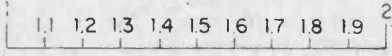

7. Scale 4 reads **1.75 amps**. (This scale has four divisions between the numbers. Thus, each division has a value of 1/4 or 0.25 amp as shown in the following illustration. Since the pointer is on the third division between 1 and 2, its reading is 1.75 amps.)

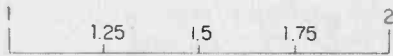

VOLTMETERS

Voltmeters are used to measure voltage. When the voltmeter is connected across the terminals of a voltage source, a current proportional to the source voltage flows through the meter mechanism. The meter scale is graduated in (marked to indicate the value of) voltage. The procedure for reading a voltmeter scale is similar to that of the current scale you have just done.

PRECAUTIONS

There are two basic types of voltmeters—one for measuring DC voltage and the other for AC voltage. Be sure to use the correct one for the type of voltage to be measured. When an AC voltmeter is applied to a DC source, an incorrect measurement will occur. But when a DC meter is used to measure AC voltage, the meter may be damaged.

READING A VOLTMETER

A voltmeter scale is similar to a current-measuring scale. Values between numbers are read in the same manner as a current-reading scale.

VOLTAGE RANGES

Voltmeters are designed to read to certain maximum values. From zero to a maximum voltage is called the range of a voltmeter. Some commonly used ranges are 0 to 1.2 volts, 0 to 10 volts, 0 to 50 volts, 0 to 250 volts, or 0 to 1,000 volts.

Always be sure that any voltage to be measured is within the range of the voltmeter you are using. A meter may be damaged if used to measure a voltage greater than the maximum value for which it is designed. Excess voltage will cause excess current to flow. As a result, the pointer may be bent in trying to move beyond the end of the scale, or meter circuits may overheat and damage delicate parts.

QUESTIONS

8. What type of meter is used to measure DC voltage?
9. What may happen if a voltmeter is used to measure voltages beyond its range?

ANSWERS

8. A **DC voltmeter** is used to measure DC voltage.
9. A **meter may be damaged** if used to measure voltages beyond its range. Either the pointer will be

bent and/or delicate parts within the meter will be ruined.

AMMETERS

A current-reading meter is called an ammeter. It can only be used to measure amperes.

CURRENT RANGES

Commonly used current ranges for work on electrical appliances are 0 to 10 amps and 0 to 30, amps. When working with electronic devices, ranges such as 0 to 500 microamps, 0 to 10 milliamps, and 0 to 250 milliamps may be required.

PRECAUTIONS

Ammeter precautions are the same as for voltmeters. Never use DC meters for AC, or AC meters for DC. Do not measure a current value that is beyond the range of the meter.

The first rule can be observed if you know the type of voltage source supplying the current. For example, you know that batteries supply DC and most wall outlets supply AC.

The second rule can be followed as you gain experience. If your meter has a selection of ranges, always use the highest range first. Then switch to the appropriate range to obtain the most accurate reading. Quickly remove the meter leads if the pointer swings beyond the limits of the scale.

A third rule must be added to the above. Never use an ammeter to measure voltage nor a voltmeter to measure current. Each meter is designed to measure only certain electrical values. If either type of meter is used for measuring other values, it may be damaged.

MULTIMETERS

A multimeter is a combination voltmeter and ammeter. It can be used to measure either AC or DC voltages and currents. A multimeter is also called a volt-ohm-milliammeter (VOM) or a circuit analyzer.

READING MULTIMETERS

A multimeter face has a combination of scales that may include several ranges of voltage and current readings. A typical multimeter scale having three ranges is shown.

Typical Multimeter Face

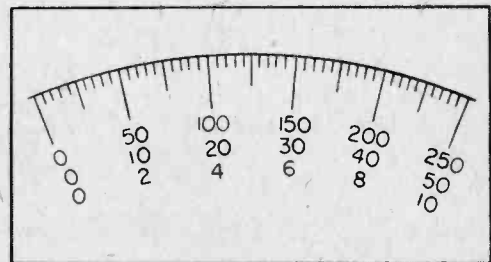

By proper front-panel settings, a multimeter can be used to measure AC and DC current and voltage.

QUESTIONS

10. To measure current, use a(an)
11. State three precautions that must be observed when using ammeters or voltmeters.

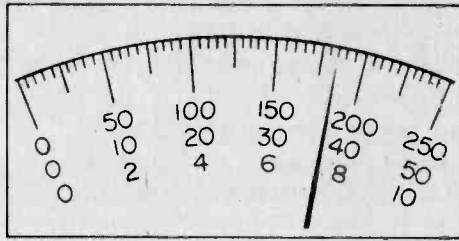

12. Shown here is a portion of the scale illustrated above. What is the reading on the 0 to 10 range?
 13. What is the reading on the 0 to 250 range?

ANSWERS

10. To measure current, use an **ammeter**.
 11. Brief statements of the three meter precautions are:
 1. **Never use DC meters for AC, or AC meters for DC.**
 2. **Do not measure a value beyond the range of the meter.**
 3. **Do not use a voltmeter to measure current or an ammeter to measure voltage.**
 12. The reading is **7.4** on the 0 to 10 range.
 13. The reading is **185** on the 0 to 250 range.

MULTIMETER CHARACTERISTICS

Experiments are often described in BASIC COURSE. Most of them require the use of a multimeter. You need not perform these experiments unless you wish to do so since the text describes the results of each one. However, you can obtain a better understanding of principles and a great deal of experience working with electrical parts and tools by performing the experiments.

A Typical Multimeter

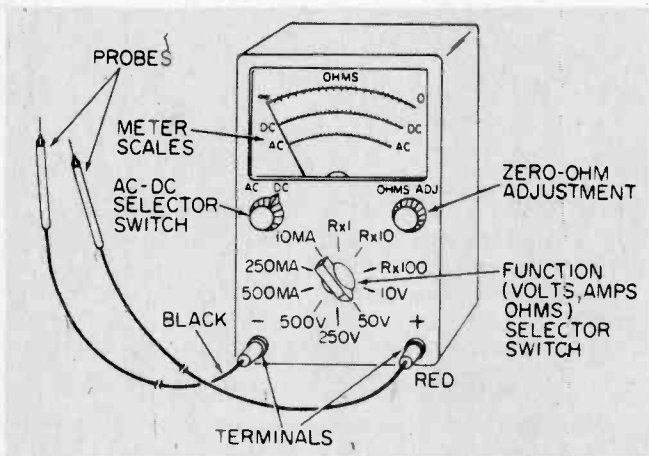

Although you may not desire to purchase a multimeter until a later date, you should have some knowledge of what to look for. A good multimeter can be purchased in most electronic parts stores for around \$25.00. Or it can be ordered from one of the catalogs of the many mail order companies.

A multimeter from which you can obtain suitable

accuracy and which has useful ranges should have the following characteristics. **Sensitivity:** 5,000 to 10,000 ohms/volt on AC and 20,000 ohms/volt on DC. **Voltage Ranges:** 0 to 10, 0 to 50, 0 to 250, and 0 to 500. **Current Ranges:** 0 to 500 microamps, 0 to 10 milliamps, and 0 to 250 milliamps. **Current and Voltage:** Both AC and DC. **Resistance Ranges:** 0 to 10K, 0 to 100K, and 0 to 1 Meg.

A typical multimeter is shown. Study it to become familiar with the location and names of the various parts, controls, and scales. Next, we describe each in detail.

Of course, not all multimeters look like this one. Each, however, has a similar means of accomplishing the same measuring tasks.

QUESTIONS

14. A good multimeter can generally be purchased for less than \$.....00.
 15. A multimeter having an AC sensitivity of 10,000 ohms/volt will have (suitable, unsuitable) accuracy for most purposes.
 16. If the AC-DC Selector Switch in the illustration were set on DC, you would read the position of the pointer on the (top, middle, bottom) scale.
 17. What is the meaning of the "10V" marking on the Function Selector Switch?
 18. What are the tip ends of the two test leads connected to the meter called?

ANSWERS

14. A good multimeter can be purchased for less than **\$25.00**.
 15. A multimeter having an AC sensitivity of 10,000 ohms/volt will have **suitable** accuracy for most purposes.
 16. You would read the position of the pointer on the **middle** scale.
 17. It indicates a setting at which a voltage **between 0 and 10 volts** may be read.
 18. The tip ends of the leads are called the **probes**.

VOLTAGE MEASUREMENTS

The term multimeter means literally many meter. It is, in fact, a single instrument performing many measuring functions. The multimeter shown measures AC volts, AC amps, DC volts, DC amps, and ohms (to be discussed shortly).

Learning to use a multimeter properly requires you to think only of the particular function for which you are using the instrument. If you are measuring DC voltage, think DC voltmeter. If the next measurement is AC amperes, change your thinking to an AC ammeter. By concentrating in this manner, you are more certain to make the proper settings and observe the appropriate measuring precautions. For this reason, the multimeter will be discussed in terms of its separate measuring functions.

VOLTMETER CONNECTIONS

The voltmeter, like other electrical devices, has two **terminals**. Both terminals are connected into a circuit when using the instrument. The terminals are sometimes colored red (+) and black (-).

Voltmeter With Test Leads

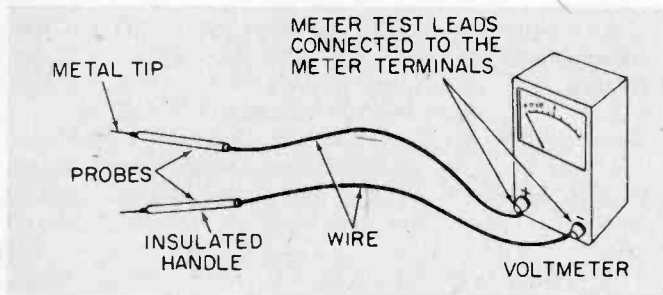

A voltmeter requires a pair of **test leads** to connect the meter to the circuit being tested. Test leads are lengths of flexible insulated wire. One end has a means of joining the lead to the voltmeter terminal. The other end has a metal probe encased in an insulated handle.

When measuring voltage, the metal tips of the probes are touched to the terminals of the voltage source or device. A voltage measurement is always taken across the terminals, and is never made between a terminal and an open wire.

Measuring DC Voltage

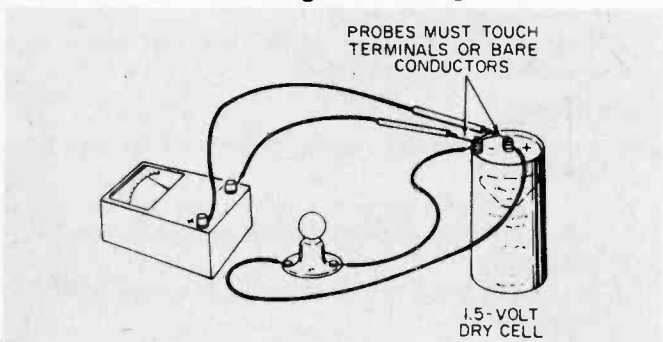

QUESTIONS

19. List the five electrical quantities that a typical multimeter will measure.
20. How are AC and DC different?
21. When measuring battery voltage, how should you think of a multimeter?
22. How are the positive and negative terminals of some voltmeters identified?
23. What part of a test lead is placed in contact with the circuit being tested?
24. A voltage is always measuredthe terminals of a source or a device.

ANSWERS

19. AC volts, AC amps, DC volts, DC amps, ohms.
20. AC changes its direction of flow periodically; direct current (DC) flows in only one direction.
21. When measuring battery voltage, think of the multimeter as a **DC voltmeter**. (You will be more certain to safely make the correct measurement.)
22. The positive and negative terminals of some voltmeters are colored **red** and **black** to indicate **positive (+)** and **negative (-)** connections.

23. The **probe end** of a test lead is placed in contact with the circuit being tested.

24. A voltage is always measured **across** the terminals of a source or a device.

DC VOLTMETER CONNECTIONS

You should know that a DC voltage source has both a negative and a positive terminal. The distinction between negative and positive voltage is identified by the term polarity. The polarity of a DC voltage source (a battery, for example) is usually indicated in some way at its terminals; one is negative and the other positive. In a DC circuit, the terminal polarity of an operating device is the same as the supply source.

The terminals of a DC voltmeter are either colored or marked to indicate the polarity. A red color or a plus (+) mark identifies a positive terminal. Black or minus (-) indicates a negative terminal. The negative terminal of a DC voltmeter is connected through a test lead to the negative terminal (source or device) of the circuit. The other test lead is connected to the corresponding positive terminal of the meter and of the circuit.

Always observe this rule: The polarity marking of the DC voltmeter terminal must be the same as the polarity of the voltage being measured.

If you disobey the rule, the scale pointer will move opposite to its normal direction and may be damaged. The rule does not apply when measuring AC voltage.

The illustration shows the proper connections to be made when measuring DC voltage.

Connection To A Voltmeter

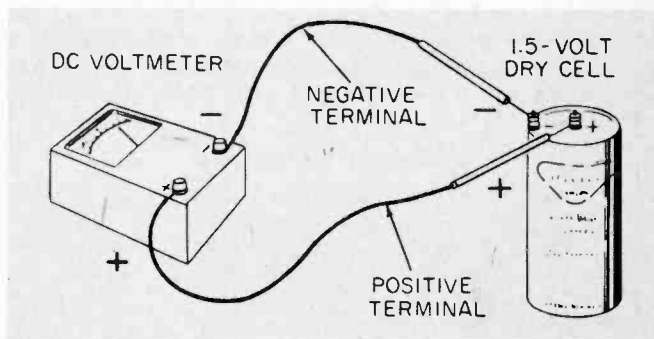

MULTIMETER VOLTAGE MEASUREMENTS

A multimeter can be adjusted by means of selector switches to measure either AC or DC voltage, and some designs use multiple jacks on the meter. You simply plug in the test lead plug to the jack which corresponds to the particular meter function you want.

CURRENT MEASUREMENTS

Methods used to measure current with an ammeter or multimeter are different from those used to measure voltage.

AMMETER CONNECTIONS

An ammeter, like a voltmeter, has two terminals. Both terminals must be connected into the circuit when using the meter.

To measure current, the ammeter must be connected in series with the the circuit (in such a way as to

allow the current being measured to flow through the meter).

CURRENT MEASUREMENTS WITH A MULTIMETER

Multimeter connections for measuring current are made as if the instrument were an ammeter. The circuit must be opened (usually at a terminal) and the probes inserted, one on either side of the break.

When measuring DC current, a polarity rule must be observed: DC current should enter the negative terminal of a DC ammeter and leave by its positive terminal. Since you know that DC current flows through a circuit from the negative to the positive terminals of a power source, current direction can easily be determined.

If you plan to do many experiments that require measuring currents, the board shown should be worth constructing. The ammeter probes are inserted into the Fahnestock clips.

Experimenter Board For Current Measurement

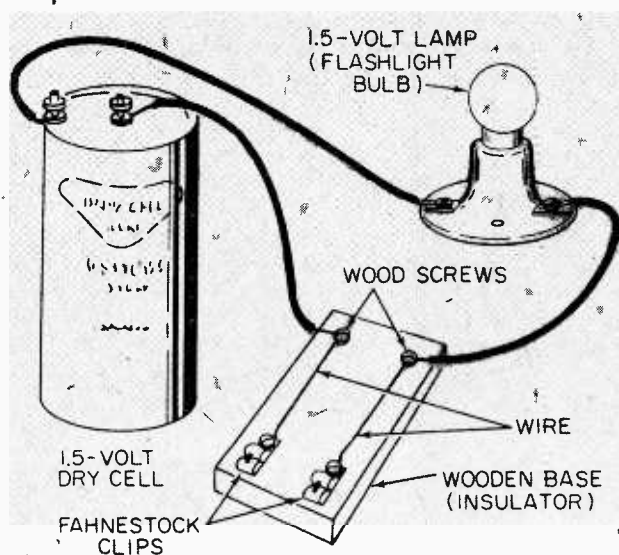

When a multimeter is used as an ammeter, the function switch is set to the appropriate range. In addition, the AC-DC switch is set for the kind of current (AC or DC) to be measured.

QUESTIONS

25. What is the difference between connecting a voltmeter and an ammeter into a circuit?
26. DC current should enter the terminal of a DC ammeter.

ANSWERS

25. Voltmeter measurements are made across the terminals of a device or source. Ammeters are inserted into a circuit so that the circuit current flows through the meter.
26. DC current should enter the **negative** terminal of a DC ammeter.

MULTIMETER SAFETY RULES AND PRECAUTIONS

Rule 1: When not in use, always set the selector

switches to the highest AC voltage position.

There are two reasons for this rule. First, a multimeter contains batteries; at the voltage position the batteries are disconnected from the internal circuits and will not be supplying current. Second, this position of the selector switch provides the best protection for the delicate meter movement in the event the probes should accidentally come in contact with an energized circuit.

Rule 2: When the meter is in use, forget that it is a multipurpose instrument and think of it only in terms of the function for which you are using it.

A multimeter with its many switch positions and multiple scales can be confusing and can lead even the best technician into making unnecessary errors. Regard the instrument each time as a particular single-purpose meter.

Rule 3: When measuring any voltage or current, always use the highest range available first.

This advice not only provides the best protection to the meter, but it also quickly identifies the best range scale you should use. If the quantity being measured on this or any range causes the needle to move past the end of the scale, immediately remove the probe from the circuit.

QUESTIONS

27. A multimeter should be stored with the switches in what position?
28. Make all measurements first at the setting.

ANSWERS

27. Before storing a multimeter, set the AC-DC switch to AC and the function selector switch to the highest voltage range.
28. Make all measurements first at the **highest range** setting.

WHAT YOU HAVE LEARNED

- Meters are used to indicate the quantity or value of voltages and currents.
- Meters are read by noting the position of a pointer on a marked scale.
- The range of a meter is indicated by the highest marking on the scale. The range is read as zero-to-some number. For example, 0 to 150 volts.
- Never connect a meter to measure a quantity known to be above the meter range. Meter damage may result. You should have some idea of the maximum value of the quantity before making the measurement.
- A multimeter is a multipurpose meter. A typical instrument will measure AC volts, AC amps, DC volts, DC amps, and ohms. It will measure each of these functions in several ranges.

This series is based on material appearing in Vol. 1 of the 5-volume set, BASIC ELECTRICITY/ELECTRONICS, published by Howard W. Sams & Co., Inc. @ \$22.50. For information on the complete set, write the publisher at 4300 West 62nd St., Indianapolis, Ind. 46268.

NRI Color TV

(Continued from page 78)

and electronics. Others have found training and learning techniques just as successful elsewhere. But it is a technique I know, used, and with which I was successful.

How It Works. The people who designed the NRI TV training course will have you build a basic section, go over the circuitry in text, then apply power and get the section working *before* moving on to the next section. By building small segments of your TV at a time, you logically build your knowledge in parallel with your TV. When the final steps are reached, there's no doubt in your mind that what you built will function as intended. You've checked it, and learned it, every step of the way. You know you can handle problems because you are, for all practical purposes, a skilled TV technician.

About The Course. There are courses for nearly every budget and level of technical proficiency in NRI's TV/AUDIO servicing program. They range from courses for the beginner *without* TV construction to advanced color TV

The editor's home-brew TV discussed in the article uses a total of thirteen tubes plus rectifier and 2-in. picture tube. When it was fired up recently (the first time in about seven years) the sound popped right

(COURSE 5) for those with previous TV/electronics experience. You can, if you wish (or your budget requires it) elect a basic "starter" course that does not include TV construction. It is, in fact, the same one that is included with all but the advanced TV program and includes seven kits—from test equipment you need to a table model radio.

But whether you select a beginner's course with or without TV construction, or whether you elect to get your hands-on experience from a budget 12-in. black and white set (COURSE 2), or 19-in. or 25-in. color sets (COURSES 3 or 4 respectively), you nonetheless will begin with the 7-kit starter course which introduces basics of electricity, electronics, test equipment, radio and TV. With seven kits, even this fundamental first-course serves its theory with a full measure of the kit makers craft including the basic staples of test equipment, radio experiments, tube and transistor fundamentals.

Important First. An up-to-date version of the technician's basic measurement tool, the volt-ohmmeter, is yours to build and use. It is constructed, tested and then used in support of more advanced experiments. In this manner the course builds upon practical knowledge and closely allied supporting theory until you are ready for the next "link" in the learning chain. Your TVOM, transistorized volt ohmmeter, can be the most important and often used instrument you will ever

own. It's a fact that a good man with a basic volt-ohmmeter can out-troubleshoot a tenderfoot with an oscilloscope. Since it is so basic and yet has so much potential in the hands of a well trained technician or engineer, expect a good basic electronics course to get one into your hands right away.

About The Kits. Packaging of individual parts for these kits uses a technique which keeps "brown bagging" to a minimum. Most parts, and virtually all the small items including hardware, are sandwiched between a cardboard backing and a thin film of sturdy, transparent polyethylene. In this manner, all parts are on view and can be selectively removed from the "sandwich" as needed while the remaining pieces can stay put. It's a system that is less efficient space-wise than the brown bag method, but one that pays off in fewer "lost" parts and time. When you're looking for something like a chroma-processing IC or horizontal output transistor, they are packed right-side-up with all pertinent identification clearly visible.

On The Spot. NRI itself gladly points to graduates it has trained with its technique and even invites you to contact them. So to follow up for this report, I called people, listed in the NRI literature, in my area. (Keep in mind that this was not an independent sample, but rather former students which NRI itself lists in its literature.)

The first of three numbers called on a Sunday afternoon was a recorded

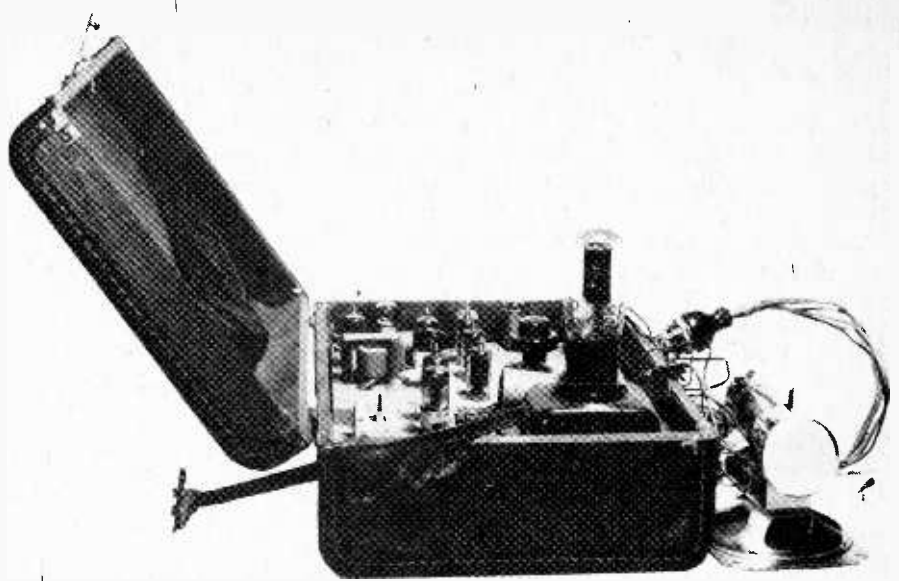

Degaussing coil for automatically demagnetizing larger color cathode ray tubes is part of the NRI 25-in. TV kit and your training.

message from Traver's TV Service, the second was answered by a retired gentleman "ten or eleven years out of the business," and a "never got into TV repair other than my own TV, stereo," from a Joe Swiderski, my third call. Incidentally, the first thing I asked when I called was "... do you guys get anything from the NRI for this?" The universal answer was "no," while the call to retired Al Cicerone (my second call), who wasn't sure at first that this caller was even referring to an NRI listing, was surprised to hear that his name was on the list. He still maintains his membership in the alumni association, though, which was his apparent connection with the published list.

Each former student made the same point in his own way. He singularly agreed that success lies with the motivation of the individual. If training to develop a skilled electronics or TV technician were a snap, breeze, push-over, or whatever, there'd be a glut of highly skilled technicians. Well, it's not and there's not.

Wrap Up. No matter how well a course is designed, presented and supported, it can't graduate a piker. If you don't really want to knuckle under (as my old man would say) save your money. But if you are ready to advance your electronic skills, NRI offers course material written to develop your knowledge in step with the kit as it is constructed. It is the interplay between a theoretical presentation on the printed page and hands-on experience with actual hardware that turns time spent into a foundation of useful knowledge and skill for both immediate and future use.

The course planners, writers, and editors at NRI have prepared a complete information booklet (the size of this magazine) with more than enough full color illustrations to make an editor green with envy. We've boiled down some of the basics here, but if you think you want to check further into this home-style learning system, simply circle number 71 on the Reader Service coupon on page 17, mail it with your name and address to us and we'll do the rest.

Incidentally, I took my working creation, shown in this article, to school that Fall and demonstrated it after class to TV instructors and students. Extra credit? I got nothing more than a passing shrug from the instructors as they left for home. My buddies appreciated the work all right, but Temple Tech instructors, if you are listening, I hope you've changed your ways. If not, here's the last laugh on you! ■

Pro Power Supply

(Continued from page 43)

addition, a 3-prong plug should be used with the ground prong going to the cabinet—as with any properly protected electrical tool. Capacitor C1 may be increased to 2000 μ F if better regulation is desired. It is best to use a 4-pin socket for D3 and a mini-DIP socket for the IC to avoid heating the devices themselves when soldering.

The heat-sink for Q1 can be mounted directly on the perf board. Mounting hardware and a socket (see parts list) should be used to hold the device firmly to the heat-sink. The mica insulator in the mounting kit can be coated with silicon heat-sink compound to aid in cooling Q1. To further aid in cooling Q1, holes should be drilled in the bottom of the cabinet, and holes should be present along the top or sides of the box. Q2 can be nearly any transistor with a gain of at least 50 and a rating of 40 volts and 25 mA. The Q2 suggested here does not require a heat-sink.

Major circuit/component areas include heat sink and Q1 which is on perf board pre cut to "wrap around" transformer T1 and the optional meter. Electronic regulator circuitry is wired in the small perf board area just to the left of Q1. Filter cap C1 is held to the board with hefty wire tied to the perf board securely.

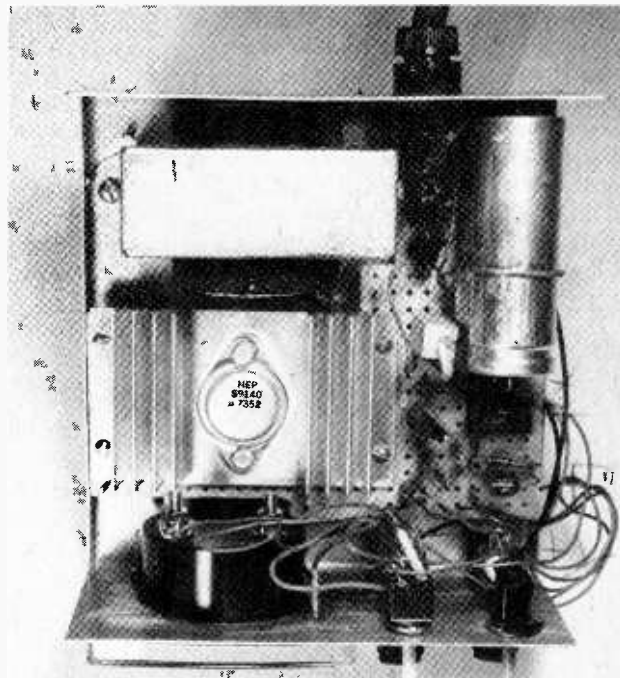

This timely project, designed by an electrical engineer, gives you know-how to build a full-feature experimenter/hobbyist's power supply with professional, lab-grade power supply specifications that rival commercial equipment. A big plus is the return you realize for dollars spent: the cost performance. Using standard hobbyist's parts you build a unit with such professional features as short-proof output protection, and power and current limiting. Plus, the modern circuit uses sensitive op amp methods to sense voltage changes for a high gain darlington series regulator element. All these things and more are possible on an experimenter/hobbyist's parts budget.

Finally, a voltmeter is *not* needed in the cabinet since once the voltage is set with an external meter it will not change unless the pre-set current limit or power limit (20 watts) is exceeded. If a meter is desired, however, the schematic shows how one can be connected to serve as both an ammeter and a voltmeter.

Calibration. To calibrate the voltage control, R1, connect an external meter, turn R1 to different voltage levels, and mark these voltages on the panel next to R1. To calibrate the current limit control, R6, set R1 to 10 volts, apply a 10-watt, 10-ohm load and turn R6 down until the voltage just begins to drop. This is the 1-ampere point; it can be marked on the panel next to R6. To get the 0.1-ampere mark, change the load to 100 ohms at 10 volts (1-watt resistor). Turn R6 until the voltage begins to drop, and you've got the 0.1 amp limit. Current limit points in between are obtained in similar fashion.

This power supply takes about four hours to assemble and should provide years of stable performance. ■

Antique Radio Corner

(Continued from page 64)

tell you how to build a companion "B" power supply. The "B" supply was also designed and first built by E. E. Taylor of Indianapolis, Indiana. Several other collectors have built power supplies from these plans so you should have no problem building yours.

Power transformer T1 specified in the parts list has a 6.3-volt winding that isn't used in this design. Full-wave rectifier D1 supplies pulsating DC which is filtered by capacitor C1. The 6-watt, 120-volt lamp I1 serves a double purpose. Mounted with a bull's-eye lens on the front panel, I1 indicates when the power supply is turned on. If there is a short in the receiver, I1 glows brighter indicating a short. Lamp I1 will limit the current to prevent damage to rectifier D1 and transformer T1.

From past experience Mr. Taylor has found that applying more than 90 VDC to an old receiver can be hazardous. The old audio transformer windings and loudspeaker coils tend to short out when higher voltages are applied. For satisfactory operation it is best to use the lowest "B" voltage practical, even though some of the radios have terminals marked 135 V or 180 V. The single "C" voltage will be adequate for most radios. Zener diodes D2 through D5 are half-watt units. Higher wattage zeners may be substituted if you wish.

Both the "A" battery eliminator de-

scribed in the May-June issue of ELEMENTARY ELECTRONICS and this "B-C" battery eliminator may be combined in one cabinet. Since they are solid-state devices they will not generate a lot of heat. They were designed to operate most 3-dial tuning, 5-tube receivers. These power supplies provide regulated, hum-free power to the old-time radios.

Many radio collectors like to play tapes of old radio programs through their antique radios. Some use an old phono oscillator that broadcasts a signal near 1500 kc (kHz) which can be received through the aerial (antenna) post of the radio. There is a new miniature 9-volt battery operated "broadcaster" that you can buy and plug into the ear-phone outlet jack on your tape recorder or tape player. This makes it very convenient to play tapes of old radio programs through your old-time radios. It broadcasts on an adjustable frequency between 1500 and 1600 kc (kHz). There is one small drawback: It doesn't have an off-on switch, but you can easily add one.

You can order the "broadcaster" from J. C. Whitney and Co., 1917-19 Archer Avenue, P.O. Box 8410, Chicago, IL 60680. Ask for stock number 90-2953R at \$9.79 plus shipping charges. This information was supplied by George Hausske of Wheaton, IL.

About the Wunderlich Tube. Several readers have written to me asking, "What is a Wunderlich tube?"

The Wunderlich tube is a unique detector amplifier tube often used as the second detector in a superheterodyne

radio. The tube structure consists of a heater, a cathode, two inter-meshed grids equally spaced from the cathode and from the plate, and a single plate. Each grid is provided with a separate support. The tube was designed for use as a detector and also as a power amplifier. The two grids connect to both ends of the IF transformer secondary and the center tap of that winding connects through the regular grid leak and condenser (capacitor) to the cathode. This is shown on the tube wiring diagram. The primary of the audio transformer is connected between the single plate and B+.

This is how the Wunderlich tube works: When a signal is tuned in, one grid becomes positive while the other becomes negative, and vice versa. Therefore the plate current does not vary, as far as the IF signal is concerned, since both grids are always at exactly the same potential but of opposite polarity, i.e., one grid tends to increase the plate current while the other tends to decrease it an equal amount. The net IF plate current change is zero. However, each of the grids becomes positive once during each cycle. Each time this happens the positive grid draws grid current which flows through the leak and condenser (capacitor); on the other half-cycle the other grid draws grid current, which also flows through the leak. In this manner the potential of both grids decreases according to the audio variations of the modulated signal, and the plate current changes accordingly. In other words, the IF plate current changes are zero, but the audio voltage built up across the grid leak and condenser (capacitor) is applied to both grids in parallel, since they are in the common leg, and vary the plate current at an audio rate in accordance with the program material modulating the IF signal. This is the advantage of the meshed duo-grid tube; the plate current varies only at an audio rate, thus preventing RF or IF from entering the audio system and generating what is

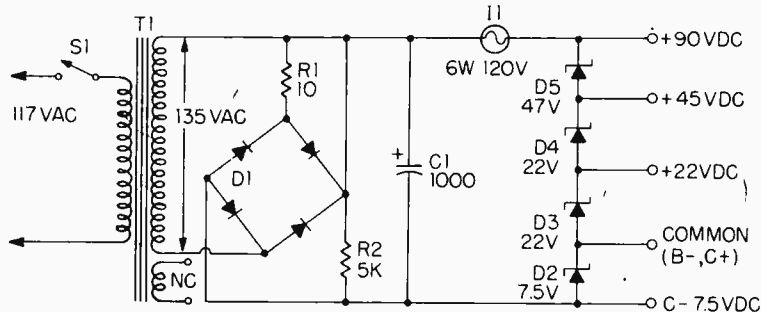

PARTS LIST FOR "B-C" POWER SUPPLY

- C1—1100-µF, 150-volt capacitor (Mallory CG112U150K1 or equiv.)
- D1—bridge rectifier (Radio Shack 276-1154 or equiv.)
- D2—7.5-volt, ½-watt zener diode (Mallory ZB7.5 or equiv.)
- D3, D4—22-volt, ½-watt zener diode (Mallory ZB22, HEP-Z0231 or equiv.)
- D5—47-volt, ½-watt zener diode (Mallory ZB47 or equiv.)

- I1—6-watt, 120-VAC lamp
- R1—10-ohm, 5-watt resistor
- R2—5000-ohm, 10-watt resistor
- S1—spst, off-on switch (Radio Shack 275-615 or equiv.)
- T1—117-VAC primary, 135-VAC secondary transformer (Stancor PA8421 or equiv.)
- Misc.—cabinet 6 x 5 x 4-in. approx, socket and bull's-eye lens for lamp I1, wire, solder, etc.

This is the schematic diagram for the "B-C" Power Supply (battery eliminator) described fully in the text. The zener diodes (D2-D5) serve to regulate voltage and provide a small amount of "bleeder" current which is necessary for positive voltage regulation.

NEW 1975 FACT SHEET

Collectors of antique radio and wireless equipment can get an updated Fact Sheet from ELEMENTARY ELECTRONICS which includes information on antique radio publications and clubs, and a listing of public and private radio and wireless museums. To get your copy send a long stamped self-addressed envelope to Antique Radio Corner, ELEMENTARY ELECTRONICS, 229 Park Avenue South, New York, NY 10003.

NEWSCAN

(Continued from page 39)

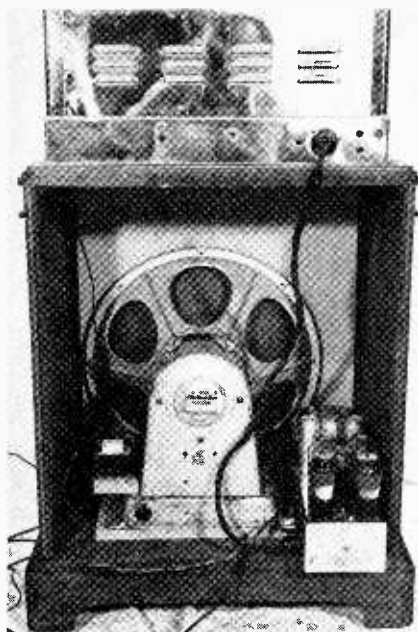

Many readers wanted to know what the inside of a McMurdo Silver speaker cabinet looked like. Here it is (above left), with the huge speaker taking up most of the room. Likewise, readers have asked to see the inside of the Scott Philharmonic cabinet (above right), Scott was way ahead of its time, as you can see, with two tweeters.

known as "fringe howl."

Even though the Wunderlich tube had a high output rating as a power detector tube with low distortion it was never used in many sets. Why this was, I do not know. Some of the deluxe or classic radios used this tube. I only have one of these tubes in my collection. It is a blue Arcturus tube.

A Blue Glow. Another tube that readers often ask about is the Raytheon type BA, BH, and BR rectifier tube. This is the type that was used in Majestic "B" eliminators. These tubes have no filament and are sometimes called "cold cathode" rectifiers. This type depends for its action entirely upon the effects of ionization by collision. The tube consists of two elements or plates inside a glass bulb under a reduced pressure of helium gas. Without going into a detailed explanation of the elec-

tron flow and collisions let's just say that the electrons collide with ionized gas particles and new electrons and positive ions are produced. Rectification in this tube is not complete because some current flows in both directions, although the reverse current is very low in value. There is a faint blue glow inside the tube while it is operating. This blue glow is the result of voltage surges which can produce noise in a receiver operated with the Raytheon rectifier. A modern-day version of this tube was the OZ4 rectifier used in millions of auto radios produced by the Delco Radio Division for General Motors cars.

So long for now! If any reader has a question that would be interesting to other readers he can send it in and I will discuss it further in Antique Radio Corner.

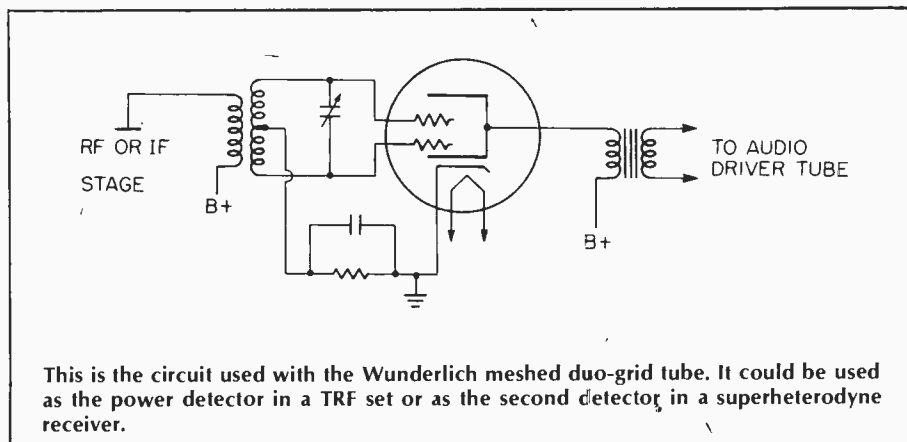

man, the FAA, the Air Transport Association and United. It used United's extensive weather forecasting and computerized flight planning facilities at United's corporate headquarters in suburban Chicago.

The simulated eastbound flight took 2 hours and 53 minutes, and the westbound flight took 3 hours and 48 minutes, the difference in flight time being caused by temperature and wind differentials.

By meticulous flight and route planning, United was able to take advantage of the most favorable meteorological conditions that prevailed. Cruising speeds were as high as mach 1.34, with simulated altitudes ranging from 29,000 to 57,000 feet. The 2,103 mile route was selected so that any shock wave trailing back from the aircraft was reflected below and bent back into the atmosphere.

The computer simulation was conducted in "real time," meaning that observers were able to follow the aircraft's performance minute by minute as indicated by a computer readout on a CRT (cathode ray tube) display screen.

Boynton Beckwith, United's chief meteorologist, said that planning for the flights involved application of weighted values to each geographical area along the selected flight path according to prevailing weather. A safety margin was then added.

With a continuing flow of meteorological data going into the flight planning computer, the plan was updated and modified while the simulated FB-111s were en route. A two-way data link allowed transmission of more current information to a computer in the two aircraft and permitted controllers on the ground to monitor the flights' progress, Beckwith said.

Not once did United's meteorologists' calculation show that a sonic boom reached the ground on the simulated flights, Beckwith stated. In theory, actual jets could do the same thing, in addition to saving time.

Beckwith said that the typical simulated flight plan developed by United in its studies calls for a cruising level of 57,000 feet at mach 1.21 (692 knots) for a flight between San Francisco and Washington, DC. This cuts an hour off the elapsed time, for today's actual United flight 130, a DC-8 operating at 37,000 feet at mach .80, between San Francisco and Dulles International Airport.

Heath Budget Stereo

(Continued from page 76)

ity. We found there was sufficient output level to deliver loud sound levels in smaller areas, such as playrooms, bedrooms, etc. The sound quality itself is on the mellow side, with a slightly enhanced upper bass. A most pleasant overall sound. While not wideband hi-fi, it is the best we've heard at rock-bottom prices, and it's the first low cost system e/e can recommend.

Putting It Together. The Valu-Components have obviously been designed

for the beginner, for the construction manual is precise in every detail, right down to the last screw, lockwasher, and nut. One important feature is something new to Heathkit—the way they provide separate packaging for each assembly group. For example, package #4 contains the parts for the AM/FM circuit board. You don't have to look through a stack of components just for the few needed—they're all together in one place.

Most of the kit is assembled on four printed circuit boards. The boards fit on a main frame which obviously is used for other units, for there are extra cut-outs in the frame. Just be certain you install the boards in the correct

cut-outs the first time.

As is typical of Heathkits intended for the beginner, complete alignment is carried out without instruments. Should you run into an assembly problem, the dial lamps are used as "test lamps," for which the manual contains an illustrated chart showing the normal on-off, or brightness for various test points in the circuit.

While the term "best buy" is somewhat shopworn—one we don't like to use—the Heathkit Valu-Component system would certainly qualify as a best buy in low-cost stereo systems.

For additional information circle No. 1 on the reader service coupon on page 17. ■

Install CD Ignition

(Continued from page 49)

ance possible with the CD system you'll find the Tiger instruction manual usually suggests increasing the points dwell approximately 30 percent, increasing the plug gap and advancing the timing (Fig. 8). These three changes by themselves further improve the car's per-

formance with a CD ignition; however, you cannot cut back to standard ignition and expect factory specified performance. But once you've got the CD adjusted to a "gnat's eyelash" there's no need to ever use the standard ignition; why burn extra gas, plugs and points?

Often, a CD system produces erroneous readings on a standard tach-dwell meter—the real reason CD's have a

selector switch for standard ignition. The Tiger 500, however, can be used with just about any tach-meter—built in, or portable. Instructions and pictorials are provided for using several different types of tachs with the Tiger 500 in the CD mode. You even get a decal (Fig. 9).

Now get out the drill, pliers and screwdriver, follow the simple directions you'll beat those robber-barons yet. ■

Tough DXing

(Continued from page 68)

nonetheless interesting. Course, you can only hear em! Try 7107 kHz around dawn in your area.

Five More. The last on the going-the-big-boys-one-better list are all located in the Americas, and three of these are within the borders of our northern neighbor, Canada.

If Radio Canada International is getting too easy for you, try your hand on some of the province stations. Best bets are CFRX Toronto, on 6070 kHz (heard during the evenings and some-

times the afternoon), and CHNX Halifax, Nova Scotia, noted some mornings on 6130 kHz.

But roll up your sleeves if you choose to hunt CKFX Vancouver, 6080 kHz. This station in British Columbia is one of the most sought-after stations of them all, mainly because of its midget-sized transmitter (10 watts) and a killer frequency.

Heading south for an earful of good marimba music, we come to Guatemala. Many listeners have logged the religious station TGNA, but for man-sized DX with the Latin flair, tune way way down to 2390 kHz. About 1030 GMT, you can hear the 120 meter band "La Voz de Atitlan," from Santiago, Guatemala, with a marimba wake-up show.

We've saved this one for last because

it is an alternate to what is probably the first-logged station of many listeners—HCJB, in Quito, Ecuador. While the "Voice of the Andes" is a powerhouse, it doesn't serve up that "flavor of the Andes" like our second circuiter, Radio Nacional Espejo. Try 4679 kHz throughout the evening for a taste of true Andes flute music, unlike any other in the world.

Espejo QSLs? Well, this used to be one of the world's toughest to confirm, but signs are pointing to a change in that policy. A midwest DXer recently received a horde of QSLs for a number of reports over the years!

That's e/e's top twenty on the second circuit. Give it a try. Take your receiver one step beyond the international broadcasters. ■

CB Goes FM

(Continued from page 61)

ceiver is "squelched out."

For minimum distortion the carrier frequency must be centered in the demodulator (FM detector). Many NBFM transceivers have a signal meter that indicates when the received signal is precisely centered. If the meter reads other than zero, either the receiver

needs retuning or the transmitting station must trim the frequency of the transmitting crystal. A centered signal is also a requirement when operating into a repeater—termed "netting"—and the center deviation meter is an aid to insuring everyone in the group is operating on the same frequency.

Another benefit of FM is the *capture effect*, meaning one received signal takes complete interference-free control of the receiver. With AM, an interfering signal need be only 1/100 as strong as the desired signal to cause

objectionable interference. For example, as in Class D CB, if the desired station is coming in at 100 uV, another station on the channel received as only 1 uV will nearly obliterate the message. With NBFM modulation, modern design produces interference-free reception if the stronger station is only two to four times stronger than the interfering station. For example, if the desired station is received at 100 uV, an interfering signal of 50 uV or 25 uV probably won't even be heard. (Of course, if the weaker signal is the one

you want to receive, you're wiped out, but you'd be wiped out in AM or SSB too.) The capture effect is illustrated in Fig. 3. Note that there is no interference to the FM signal once it captures the receiver.

Other Advantages. NBFM has other incidental benefits which serve to sharply increase readability at the receiving station, as well as keeping overall costs down.

Firstly, it's very easy to build in an effective limiting amplifier that sharply increases talk power for a given deviation,

so most FM rigs have a limiter. Secondly, because speaker output is the same for a given amount of deviation regardless of signal strength, AGC (automatic gain control) systems can be minimal—just enough to keep the RF and IF amplifiers from breaking into oscillation or causing cross-modulation, yet there is no speaker blasting as the user changes from channel to channel. Finally, FM modulation is applied to the oscillator or one of the low power buffer amplifiers as phase modulation.

When will you get a chance to go FM? Just as soon as the FCC makes up its mind, for right now E. F. Johnson, Regency, Pace, Genave, Lafayette and a whole slew of other top manufacturers have MF transceivers for the 144 MHz and 220 MHz amateur bands, as well as commercial frequencies in this range. Just as soon as the FCC gives the go-ahead all they need to do is plug in the right crystals and the new FM gear will be waiting for you, waiting to give a whole new dimension to hobby communications. ■

Darkroom Printing Meter

(Continued from page 59)

suggest 20 seconds as it will become your standard exposure, and will be sufficiently long to allow moderate dodging. When you are certain you have a print exactly the way you want it, and without disturbing the enlarger's controls, place the printing meter's sensor under the *brightest* light falling on the easel—it produces black (maximum shadow) on the final print. Now turn on the printing meter and allow about five seconds for warm up. Adjust speed control R2 so the meter pointer indicates any meter reading you want to use as a reference. It doesn't matter what the reading is as long as you always use the same reference for the standard exposure time. For example, 0.2 on the meter scale is a good choice because it is well illuminated by the meter lamps. But you might just as easily select mid-scale as the reference meter reading. It doesn't make any difference; just be consistent.

Once you have adjusted the speed control for the reference meter reading note on a piece of paper or in a notebook, the dial reading from the

speed control's calibrated knob. This is the reference speed value for the particular printing paper. For example, let's say you made the test print on Polycontrast using the #2 filter, and the speed knob indicates 5.6. Next time you want to print using Polycontrast with a #2 filter you simply set the speed knob to 5.6, put the sensor under the darkest shadow area and adjust the lens diaphragm for a reference meter reading. Everything will be set for your standard exposure time.

Changing Filters. Kodak provides a speed rating for all their papers and you can easily work out the correct (or close) speed control settings without making a "perfect" test print for each type and grade of paper. For example, changing from a #2 to #4 filter usually means increasing the exposure by a 3.5X factor. If your #2 exposure is 10 seconds, the #4 exposure will be 35 seconds—somewhat long. You can, however, open up the lens diaphragm for a 3.5X light increase (close enough value) and adjust the speed control for the reference meter reading. The new speed control setting is the speed value for the #4 filter. You can do this with variable contrast filters or numbered printing paper.

While the most pleasing print usually has some black, there are times when there can be no black, such as snow scenes, portraits, etc. You can peg the speed control's calibration to a grey corresponding to a skin tone, or any other degree of grey you might desire. The only thing you cannot do is calibrate the meter for highlights, since the meter might not have enough sensitivity for slow papers, and highlights can completely fool the meter.

If desired, you can take a speed control calibration reading for each type of paper (using your standard negative) for both shadow detail and intermediate grey. This way, you can quickly set up for typical snapshots, scenics, or portraits.

Keep In Mind. The sensor has a slight light memory, so we suggest the sensor be turned face down when not being used and the power switch be turned on and off in the dark, though you can keep the darkroom illuminated by a safelight with the power switch on. Meter readings, however, must be taken with all room lights off; only the enlarger should be on and the print meter should be positioned so that its meter lamps do not illuminate the sensor (even slightly). ■

Telephone Amp

(Continued from page 70)

can be carried on. As you might expect, if both parties are talking at the same time, one or the other is going to be squelched out; but since the squelch can release between words—sometimes between syllables—it's possible to hold a normal conversation. Rarely do users notice the squelching action, in the more expensive units.

The Radio Shack telephone amp, however, is not a gold-plated special; if anything, it's rock-bottom priced, and part of the lower cost is reflected in the microphone squelch which is partially affected by the incoming line level. If

the voice level coming down the line is loud, it produces a partial squelch of the first words said into the microphone. However, if you take a half-breath pause before interrupting the other party, no words are muted. It's a very small price to pay for what is otherwise a very effective and excellent hands-free telephone.

In normal operation the transmitter and receiver units are placed on either side of the regular telephone, or spaced about two feet apart. If the units are too close the signal from the speaker—picked up by the mike—sets the transmitter squelch too hard, and you might have to raise your voice to break the squelch. This is a common feature of VOX-operated circuits and not typical only to the Radio Shack model. Alter-

nately, you might need more line signal to release the speaker squelch, but again, this is typical of VOX circuits.

In a typical desk arrangement in both home and office, the Radio Shack telephone amp gave excellent results, essentially as good as a standard telephone company model.

No difficulty was experienced with normal home and business telephone circuits having jack connections. Some users who tried the unit on multi-line phone circuits claimed it wouldn't work. Investigation showed they had removed the supplied plug and wired the device directly to the connections inside the telephone. What they did not realize was that their multi-line phones used a wall-mounted control box (telephone company equipment) and they

were connected on the user side of the "cards." There were two serious errors here. First, they had modified existing telephone equipment, which is a definite no-no! Secondly, they were not connected directly to the line.

Bottom Line. Our recommendation is to follow Radio Shack's advice and connect the system exactly as described, with the plug/jack connector supplied with the unit. If necessary, have your local telephone company install the

proper jacks.

Do it the right way and you'll get 100% satisfaction from the Radio Shack Telephone Amplifier System. We did.

For more info, circle No. 74 on the reader service coupon on page 17. ■

Upgrade That Stereo

(Continued from page 47)

even worse, peaks in the mid-range response. This roughness in the mid-range adds to the "loud" quality so evident in nearly all cheap sets.

Almost any kind of absorptive material will help damp internal reflections. Old fuzzy rags will do, but fiberglass or polyester batting is ideal. If the material is porous, such as the batting, you can loosely fill the enclosure with it. But don't compress it or you may overdamp the speaker. Loose batting actually adds to the *effective* cubic volume of the box.

When I placed a 2- to 3-inch blanket of fiberglass material in the ported enclosures mentioned earlier, it tamed the violent peaks in port response. Port output was evident in the 200 to 400 Hz region, but it rolled off above that except for one subdued peak around 2000 Hz. In both the ported enclosures and the smaller partially open plastic boxes the addition of damping material produced a smoother mid-range. Listeners found the modified speakers easier to listen to than the original speakers.

Install High Compliance Drivers.

The advisability of buying a new speaker for a cheap set depends on whether you can find a high compliance speaker at a suitable price. The ones shown in the photo were available at a bargain counter for \$3.39 each. There's a chance this step may be forced on you at some time because of the high failure rate of cheap original equipment speakers. Such speakers usually have a voice coil diameter of about 9/16 inch and a magnet weight of about 2 oz. They are easily damaged by excessive power, even that of the marginal amplifiers in cheap sets.

If you make the change, try to get a speaker with at least a 3/4-inch diameter voice coil and a more compliant suspension. It should have the same impedance rating as the old speaker. Most sets have either 8- or 16-ohm speakers. A 16-ohm speaker may have been used simply because it was available, but the manufacturer may have chosen the higher impedance value to limit current flow or reduce distortion in the output stage of the amplifier. To be safe, replace 16-ohm models with another 16-ohm speaker.

Higher compliance speakers can make a significant difference in the bass response of a set with ultra compact enclosures. In the two sets I tested, the bass improvement was just noticeable in the larger set but dramatic in the small plastic boxes. The cubic volume of those boxes, about 100 cubic inches, was much too small for the original stiff-coned speakers. The original system resonance occurred at about 400 Hz. With the new speakers it was about 200 Hz, even with the boxes sealed, giving a full octave of added bass.

In some cases, such as with the larger enclosures described here, the improvement made by changing drivers will be more one of quality than frequency range. You will get better transient response and cleaner sound plus whatever gain occurs in the frequency bandwidth. Whether, in larger enclosures, this kind of improvement is worth the expense depends on the cost as well as the experience and attitude of the listener.

When installing high compliance speakers, you should seal the enclosures. Even if this raises the bass cut-off frequency of the speaker system, there is a good chance that you will get more usable bass response with the closed box. The reason for this apparent contradiction is that system resonance may occur at a point within

the amplifier bandpass rather than outside (below) it. The speaker system resonance can then reinforce a falling amplifier response. It is pointless to have a speaker that is flat to 50 Hz if your amplifier, as in most cheap sets, rolls off in response above 100 Hz. And the closed box will permit the speaker to be driven harder without distortion or damage.

The final response range and overall sound character will depend on the quality of your amplifier. Amplifiers in cheap sets typically have a limited power output capability of from a fraction of a watt to a couple of watts or more per channel. Their frequency response is limited, sometimes purposely and for good reasons. For one, the poorly filtered power supplies of these sets would produce considerable hum if bass response permitted it to pass through the system. Cheap tape and record players add their mechanical inaccuracies too. So you may find that you can get somewhat better performance from the radio section of your set, if it has one.

Don't Forget. Check the polarity of your speaker wiring before you permanently screw down the backs of the enclosures. You can use the flashlight battery test, or plug the speakers into your set and listen. Reverse the leads to one speaker and choose the connection with the better bass and smoother sound.

You'll find that the speakers of almost any cheap stereo set will show a sharp improvement after you have applied the three modifications outlined here. Even if their frequency response isn't significantly altered, you will surely notice a change in your own response—a reduction in that common reflex action, the elbow jerk. The one which normally flips the fingers against the on-off switch of poor audio systems. ■

Sour Note

(Continued from page 55)

frequency; the higher frequencies are *upper partials* or *overtones*. When the frequencies of the overtones are exact multiples of the fundamental, the partials are called *harmonics*. When they are not exact multiples, they are called *inharmonic partials*.

Dissonance. An octave is a musical interval of the highest possible consonance, or to put it another way, an interval having the least dissonance. Why this should be so is made evident by Fig. 11. Compare the fundamental and overtone frequencies of the "low note" (middle C) with those of the octave note C¹. Note that every frequency in the higher octave matches exactly some

overtone of the low note. (The fourth octave overtone would match the 9th overtone of the low note.) If you accept the fact that the low note, C, would exhibit no dissonance if sounded alone, you can see that the addition of the octave C¹ adds nothing that is not already present, and therefore cannot produce dissonance.

What about the beating effect between

CONSONANCE AND DISSONANCE IN RELATION TO BEAT FREQUENCIES

Tone Interval	Tones	Frequencies	Beat frequency	Sound quality
Fifth	G ₂ -C ₂	98.0— 65.4	32.6	Consonant
Major 3rd	E ₃ -C ₃	164.8— 130.8	34.0	Consonant
Tone	D ₄ -C ₄	293.7— 261.7	32.0	Dissonant
Semitone	C ₅ #-C ₅	554.6— 523.4	31.2	Most dissonant
<hr/>				
Semitone	C ₆ #-C ₆	1109.2—1046.8	62.4	Dissonant
Semitone	C ₅ #-C ₅	554.6— 523.4	31.2	Most dissonant
Semitone	C ₄ #-C ₄	277.3— 261.7	15.6	Dissonant
Semitone	C ₃ #-C ₃	138.6— 130.8	7.8	Dissonant
Semitone	C ₂ #-C ₂	69.3— 65.4	3.9	Least dissonant

Fig. 12. Consonance and dissonance in relation to beat frequencies. Note that beat frequency itself apparently has little bearing on whether sound is consonant or dissonant.

DISSONANCE AND CONSONANCE FREQUENCY RELATIONSHIPS

Note	Low	High		
		Octave	5th	7th
Fundamental	262	524	392	494
First overtone	524	1047	785	988
Second overtone	785	1570	1178	1482
Third overtone	1047	2094	1570	1976
Fourth overtone	1309	2617	1963	2470
Fifth overtone	1570			
Sixth overtone	1832			
Seventh overtone	2094			

Fig. 11. Dissonance and consonance frequency relationships between middle C and its various overtones. Underlines indicate frequencies having exact counterparts.

the overtones themselves? The smallest frequency difference is 262 Hz (524 — 262); this beat frequency is too high to produce a sensation of musical roughness or dissonance.

What happens when the higher note is lowered a semitone to produce an interval of a seventh? The situation is now very much different. Note one of the overtones of the seventh matches an overtone of the low note. Moreover, the difference between certain overtones is now much smaller. For example, the beat frequency between the seventh fundamental (494 Hz), and the first overtone of the low note (524) is 30. This beat frequency is in the range that is most likely to produce dissonance. And facts confirm theory; the seventh is recognized as an extremely dissonant interval.

Now drop down to the fifth. Note that the first and third overtones of the fifth correspond to the second and fifth overtones of the low note. This corre-

lation is conducive to the consonance, or lack of dissonance, associated with musical fifths.

The Surface Only. The mathematics of music as a whole—or even of a single aspect such as dissonance—is so complex that only the briefest introduction can be given here. But let's consider one more musical curiosity mainly to whet the appetites of those who think they might enjoy delving deeper into this fascinating subject.

Study Fig. 12. Note that in the upper half of the chart all of the selected tone intervals have almost identical beat frequencies. Yet the fifth and major third are consonant, while the tone is dissonant and the semitone is even more dissonant. Why? Good question.

In the lower half of the chart a number of identical semitones (C-C) in different octave ranges are compared. Observe that the beat frequency is lowest in the lowest octave range and that this produces the least amount of dissonance.

But it doesn't follow that the greatest amount of dissonance occurs in the octave range having the highest beat frequency. For the C#-C semitone at least, the greatest dissonance is observed in the octave range producing a beat frequency of about 31. Why? Another good question.

Intrigued? Then in all fairness, this warning: If you have enough curiosity to dig out the answers to these two questions, you'll almost surely be hooked forever by the mathematics of music—and not because it will help you play the piccolo any better. Perhaps it's because the arbitrariness of music adds a certain spice to the game of musical mathematics. Just when you're sure that two plus two equals four, you find that it actually equals 3.99 or 4.01—and you want to know why.

FIND BURIED TREASURE

Powerful electronic detector finds buried gold, silver coins, etc. Write or call for free catalog. Dealer inquiries invited.

Financing Available
Phone day - night (713) 682-2728
RELCO, Dept. DD-28
BOX 10839, HOUSTON, TEX. 77018



VISTA 20 Hz-20 kHz FUNCTION GENERATOR

One IC 3-way generator kit features simultaneous sine, triangular, and square wave outputs. Less than 1% THD typical. Includes 80381C, circuit board (drilled & etched) external components and assembly guide. \$13.95 postpaid

VISTA ELECTRONIC KITS
P.O. BOX 139, NEW YORK, NY 10016

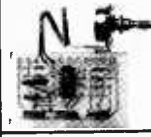

TECHNICAL INVESTMENT ADVICE
Comprehensive Coverage for the Sophisticated Market Technician

Over 20 investment services that choose stocks and time their purchases on charts and other technical approaches. Receive short 1-5 issue current trials to over 20 different technically oriented investment advisory services from SELECT INFORMATION EXCHANGE, America's leading financial publications subscription agency covering almost 800 different investment publications. Send your name and address together with this ad and your \$18 remittance to receive all 20 publications.

DAVIS PUBLICATIONS INC. Dept. EE78
229 Park Avenue South
New York, N.Y. 10003 Package #11

ELEMENTARY ELECTRONICS INDEX TO ADVERTISERS

READER SERVICE NO.	ADVERTISER	PAGE NUMBER
5	Antenna Specialists	8
6	Avanti Research	24
	Bell & Howell Schools	10-13
	Circuit Specialists	8
29	Cleveland Institute of Electronics	2nd Cover, p. 3
7	Cobra, Div., Dynascan Corp.	37
	Cornell	36
20	Edmund Scientific Co.	6
8	Electronics Dist. Corp.	38
1	Heath Co.	65
	International Correspondence Schools	3rd Cover, p. 98
28	International Crystal	39
33	E. F. Johnson	15
23	Locksmithing Institute	34
24	Midland Electronics	18
	McGee Radio	38
	National Radio Institute	20-23
	National Technical Schools	30-33
9	New-Tronics	7
17	Pace, Div., Pathcom	26
11	Pearce-Simpson	25
26	Perma-Power	14
	Photolum Corp.	8, 91
22	Poly-Paks, Inc.	35
21	Progressive Edu-Kits	5
4,31	32 Radio Shack	4th Cover, 19, 27, 40
	Relco	91
12	Royce	9
14	Shakespeare Antennas	36
18	Siltronix	29
15	Tab Books	28
16	Teletronics of America	34
	Vintage Radio	24
	Western Radio	39

ELEMENTARY ELECTRONICS—is published Bi-monthly. The rate per word for CLASSIFIED ADVERTISEMENTS is \$1.15 payable in advance—minimum ad \$15.00. Capitalized words 40¢ per word additional.

ADDITIONAL INCOME

AEROSOL FIRE EXTINGUISHERS \$2.98 and \$3.98. Distributors quantity price 87½¢ and 99¼¢. Sample of each \$4.50. Trial Case of each \$34.50 Postpaid. **AUTOMOBILE SIXTY SECOND TIRE FIXER**. No Tools, No Jack—Dealers Invited. Sample and Details, \$4.98. Trial Case \$35.00 Postpaid. Warren, 6922 Congress, Detroit 48207.

GAMBLERS—FREE Details—Win lifetime income from Dice, Roulette, Thoroughbred, Harness, Dog Racing. Guaranteed. Research, Box 551 EE, Mineola, NY 11501.

FREE information. How to make money with second income. DUBOIS, 20 Pine Street, Wolcott, CT 06716.

WRITE TECHNICAL ARTICLES: Step-by-step instructions. Send \$5.00: TECHMAT-1, P.O. Box 518, Moses Lake, WA 98837.

AGENTS WANTED

BEAUTIFUL SEA SHELL NECKLACES—SELLING TODAY FOR \$3 AND UP—\$10.95 PER DOZEN POST PAID—SAMPLE PACK OF 3, \$2.95—A GREAT FAST BUCK ITEM—RUSH MONEY ORDER TO A. GRAY COMPANY, DEPT. E, 321 W. 24 ST., NEW YORK, NEW YORK 10011.

SELL: Personalized, Colored, Social Security Plates. Big Profits! Free Sample! DRS Specialties, 73-F, Hunter Place, Pompton Lakes, New Jersey 07442.

AUTHOR'S SERVICE

PUBLISH your own book! Join our successful authors: publicity advertising promotion, beautiful books. All subjects invited. Send for free manuscript report and detailed booklet. Carlton Press, SMS, 84 Fifth Avenue, NY 10011.

BIG MAIL

RECEIVE mail galore! National listing \$1.00. Sullins, Box 1313-EE, Brunswick, GA 31520.

BLUEPRINTS, PATTERNS & PLANS

EXPERIMENTAL PYRAMID. Build from household materials. Plans and experiments \$2.00. Box 7, Kilbourne, OH 43032.

NEW CRAFT PRINT CATALOG—Choose from over 100 great easy-to-build plans. Send \$1.25 (completely refunded with your first order). **BOAT BUILDER**, (CP Div.)—229 Park Avenue South, New York, NY 10003.

BOOKS & PERIODICALS

BOOKS! 70% off. Send for Free Catalog. NRDS Mail Order, 745 Gough St., Apt. G, San Francisco, CA 94102.

BUSINESS OPPORTUNITIES

I MADE \$40,000.00 Year by Mailorder! Helped others make money! Free Proof! Torrey, Box 318-TT, Ypsilanti, MI 48197.

MAKE Magnetic Signs. Big Profits. Details. Universal, Lenora, KS 67645.

100% PROFIT Bronzing Baby Shoes. Free Literature. NBC-DG, Gower, MO 64454.

HOW To Make Money Addressing, Mailing Envelopes. Offer Details 10¢. Lindbloom Services, 3636 Peterson, Chicago 60659.

FREE Secret Book "2042 Unique, Proven Enterprises." Fabulous "Little Knowns" Work Home! HAYLINGS-E14, Carlsbad, CA 92008.

FREE BOOK "999 Successful, Little-Known Businesses" Work Home! Plymouth 14FE, Box 1056, Weston, CT 06880.

MAILORDER Dealers Wanted. Earn outstanding profits using tested promotions! Executive type business. Rutward-LW, Georgetown, CT 06829.

MAKE YOUR CLASSIFIED AD PAY. Get "How to Write a Classified Ad That Pulls." Includes certificate worth \$2.00 towards a classified ad in this publication. Send \$1.25 (includes postage) to R. S. Wayner, Davis Publications, Inc., Dept. CL, 229 Park Avenue South, New York, NY 10003.

BUSINESS OPPORTUNITIES—Cont'd

MAILORDER BEGINNERS LIBRARY. Learn Professional Secrets Inexpensively! Write: HOW, Box 4457DC7, Downey, CA 90241.

SELL Carded Merchandise: Combs, Novelties, Carleton House (I.O.), La Marque, TX 77568.

BECOME our Mail Order Distributor with \$150 investment. Free brochure. Audit Controls, 35 Brookside Av., Fair Lawn, NJ 07410.

MAILORDER Millionaire helps beginners make \$500 weekly. Free Report reveals secret plan! Executive 1G7, 333 North Michigan, Chicago 60601.

ANNOUNCING: How to Raise \$100.00 to \$1,000,000.00!! Capital-EE, Dawsonville GA 30534.

PHOTO Button Machines. Sample Button, Brochure \$1.00. Coffman, 1973H, Glenhaven, Abilene, Texas 79603.

OWN Your Own Business! Correspondence Club Magazine, Information, Details 25¢. Destiny, Box 5637-BC Reno, Nevada 98503.

ESTABLISH Successful mailorder business. Free samples! Mears-BC, 5363 Essex, Alexandria, VA 22311.

FREE MAILORDER OPPORTUNITY PARTICULARS—CUTLER, Rockland, DE 19732.

LAZY? Produce oil portraits in seconds! Details 25¢. JiffyPortrait, 2830BT-Gaffey, San Pedro, CA 90731.

OVER \$16.50 an hour. Spare time at home! Rubber Stamp industry needs small manufacturers. We furnish all equipment and know-how! Particulars free! Write: Roberts, Room RC-107-EH, 1512 Jarvis, Chicago, Illinois 60626.

WE NEED GINSENG GROWERS! \$3,000-\$30,000 annually! We Buy Your Crop. Send \$2. For seed sample and information, Glass's Ginseng Exchange, Box 336, Rochdale Station, Jamaica, NY 11434.

ASK For Money (never repay) International, 2148 Lawrence Drive, Benton Harbor, MI 49022.

BORROW ANY AMOUNT. Enjoy A-1 credit. Keep money in bank, get 80% more. Send Stamp. Vernon, Box 75010-HH, Oklahoma City 73107.

AMAZING!! Own Collection Agency!! \$1,000.00 Monthly Possible. Master-EE, Dawsonville, GA 30534.

\$30.00 HUNDRED Stuffing Our Circulars Into Stamped Addressed Envelopes. Immediate Earnings. Beginners Kit \$2.00 COLOSSI, 1433-61 Street, DC-6, Brooklyn, NY 11219.

MUG and Photo Button Machines. Brochure, Sample Button \$1.00. Coffman, 1973H Glenhaven, Abilene, TX 79603.

\$150 WEEKLY stuffing our sales letter into stamped addressed envelopes. Immediate income! Details 25¢. Lily, Box 4967-F57, NYC 10017.

BEAT The Recession, Manuscript of opportunities, risks, rewards. \$3.95. Talam, Box 231, Franklin Square, NY 11010.

\$27,000 RETURN on \$250.00 Real Estate Investment. I'm doing it. You Can Too! Complete easy-to-follow, step-by-step instructions, written by an attorney. ONLY \$3.00 postpaid. Satisfaction Guaranteed. Harry M. Gilling, 2624 Northeast 26th Avenue, Fort Lauderdale, FL 33306.

AMAZINGLY PROFITABLE! MAKE EXOTIC CANDY. Details: Avlarx, 3141 Greely, San Diego, CA 92113.

\$200 WEEKLY—Guaranteed Easy, Immediate. Sparetime Earnings—Free Proof. Research, Box 90133-IO, Atlanta, GA 30344.

MONEY—MASTER'S MANUAL reveals secrets of the insiders. Write: Ritchie, 1914 Rudolph Ct., Eau Claire, WI 54701.

NO INVESTMENT Needed. Fast Growing Business needs Distributors. Refundable \$1.00 onings details. SBS, 1625 Orange, Redlands, CA 92373.

500/THOUSAND. Stuffing Envelopes, Details 25¢. Malarich, 1047 Goldenrod St., Homestead, PA 15120.

COLLECT MONEY!! Your Own Collection Agency—Details—\$2.00. Suncoast, 309 Oakridge, Dept. IDPIO, Daytona Beach, FL 32018.

THE BEST OPPORTUNITY IN VINYL REPAIR AND RECOLORING EVER: FREE INFORMATION. Autodye, 2327 Brookview, Parma, OH 44134.

BUY IT WHOLESALE

NEW GIANT WHOLESALE CATALOG Unusual items \$2.00 refundable with first order. Winchester Enterprises, 2807SS Hargrave Street, Philadelphia, PA 19136.

25 TRANSISTORS (Tested) for \$1.25. Clarence Maneer, 330 Duane, Glen Ellyn, IL 60137.

DETECTIVES

CRIMEFIGHTERS! Investigators-Detectives-Police. Catalog \$1.00 Refundable. Don-Q, Box 548, Seattle, Washington 98111.

DO IT YOURSELF

PLEASE be sure to include your zip code when ordering merchandise from classified advertisements. You'll receive faster delivery.

FIGURE CONCRETE SIMPLIFIED METHOD. Send \$1.00. David Childers, Box 4995, CO 1, Odessa, TX 79760.

SAVE Do It Yourself! TV repair pamphlet 40 problems made easy. Get your copy now! Send \$2.00. A service called saved is a dollar earned. Read's of Utah, 3412 South 7860 West, Magna, UT 84044.

PETRIFY for fun and profit, anything porous. Formula \$2.00. Pennell, Box 11253, Portland, OR 97211.

REPAIR motorcar RADIATORS rapidly wherever problems occur. Kit \$5.98. A. L. Mar-Shall, Box 626, Richmond, CA 94808.

EDUCATION & INSTRUCTION

ACUPUNCTURE TRAINING Correspondence Course. Supplies! Tsang, Box 219W, Toronto, Canada M6M 4Z2.

COLLEGE DEGREES BY MAIL. Free Information. Write: Success Institute, 1435 North Belford, Dept. BTEE, Pasadena, CA 91104.

USED Courses! Books! List 10¢. Smith's 124 Marlborough, Salem, MA 01970.

COLLEGE Degrees By Mail, Free Details Box 3199D, Pasadena, CA 91103.

FREE Details about highly effective and thorough course in Digital Electronics. Cost of course—\$10.00. Your success guaranteed or \$11.00 refunded! Dynasign, POB 60EE, Wayland, MA 01778.

YOUR \$60,000. BUSINESS the profession of accounting bookkeeping. 24 sections of instructions at \$6. When completed we furnish plan in use for years that could within 12 months be grossing \$60,000. Annually. Remit \$6 for first section now. No cost inquiry. MelCole Inc., 5098 Matilda 111, Dallas, TX 75206.

UNIVERSITY DEGREES BY MAIL! Bachelors, Masters, Ph.D.s. Free revealing details. Counseling, Box 1425-EE-7, Tustin, CA 92680.

IMPROVE YOURSELF! 290 practical booklets tell how to gain success, knowledge self-help. DETAILS FREE! Ridge Associates, 25-D Cherry Lane, Ramsey, New Jersey, 07446.

UNLOCK Your Future. Become professional Locksmith by spare time homestudy \$13 in an hour possible. All tools, equipment included. Facts Free. Send name. Locksmithing Institute (Homestudy), Dept. 1372-075, Little Falls, New Jersey 07424.

HOW to choose ideal occupation—get best job—and keep it. Free details. Crothers, Box 852-A, La Mesa, CA 92041.

FREE Catalog, 300 Personal Improvement Books. Expert Guidance. Curry Enterprises, Box 444, Bothell, WA 98011.

FREE. Lifetime Ordination, become Bishop, Chaplain, Missionary, Evangelist (200 Churches). Bible Church, Box 333E, Rillton, PA 15678.

ELECTRONIC EQUIPMENT & SUPPLIES

PROFESSIONAL QUALITY GLASS-EPOXY PCB for experimenters and builders. 3 x 9 inches of versatile track configuration. 64 tracks with 188 drilled holes. See display ad in "101 Electronic Projects—1975". \$3.95 ppd. Illinois residents add 20¢ tax. Quantity Discounts Available. DESIGN TECHNICS 11, Box 3366, Merchandise Mart, Chicago, IL 60654.

FREE 36-page catalog, updated 5 times a year. Everything for the electronics hobbyist—from TV antenna wire to the latest stereo music equipment. ELECTRONIC DISTRIBUTORS, INC. 4900 N. Elston Ave., Chicago, IL 60630 EE-4.

THERE IS NO CHARGE FOR THE ZIP CODE—PLEASE USE IT IN YOUR CLASSIFIED AD

PLACE

Classified

To be included in the next issue, please send order and remittance to R. S. Wayner,
ELEMENTARY ELECTRONICS, 229 Park Avenue South, New York, N.Y. 10003

ELECTRONIC EQUIPMENT & SUPPLIES

SHORT WAVE from your AM transistor radio. Send only \$3.00 to: Box 482, Dover, OH 44622.

GREAT BARGAIN on Surplus Transformers! P-117V, 60HZ, Sec. 113.7 VAC @ 11MA and 16.5 VAC @ 40MA. Hurry! Limited Supply! \$3.00 each p/d. Staco, INC., 625 South "G" Street, Richmond, IN 47374.

FARMS, ACREAGE & REAL ESTATE

GOVERNMENT LANDS DIGEST. A Monthly review of government Real Estate offerings throughout the U.S.A. . . . Free subscription information! . . . DIGEST, Box 25561-DP, Seattle, WA 98125.

FORTUNE in DELINQUENT USA tax properties. Booklet \$3.00. LAND, 296DP, Port Richey, FL 33568.

FOR SALE—MISCELLANEOUS

NEW SAFETY LIGHTER! Lights cigarette in seconds while driving. No more fumbling with red hot lighter. Eyes stay on road. \$6.95 free gift w/ order. Or write: free details. Overseas Trade Co., Box 10233, Taft, FL 32809.

FOR THE HOME

FOR anyone who wants the satisfaction and economy of repairing, furnishing and maintaining the furniture in his home. Send \$1.25 to FURNITURE, 229 Park Avenue South, New York, NY 10003.

HELP WANTED

HOW To Apply For A Job—AND GET RESULTS. \$1.00. Wayne Floyd, Rt. 1, Fayetteville, TN 37334.

HI-FI EQUIPMENT

CANADIANS—Free HI-FI discount catalog. Name brands, immediate delivery from our huge stock. Etc., Dept. AA, Box 741, Montreal "A".

HOBBIES & COLLECTIONS

FREE CATALOG: Electronic supplies—kits for the hobbyist. Low prices. Anklam Electronics, 4709 nth, 6th St., Wausau, WI 54401.

"COLLECTORS" Genuine Mink and Sable Roses, Two Scent Floral Bouquets, Electronic Calculators, Novelties, 40% off wholesale. No Duty U.S. Customers. Catalogue \$3.00. Kings Crown Agencies, Box 1432, Bonnyville, Alta, Canada.

COLLECTORS! Original WWII German Helmets. \$21.95. Other Military collectibles. FREE CATALOG. Unique Imports, Dept. EE, 610 Franklin St., Alexandria, VA 22314.

ELECTRONIC educational kits. Build electronic games. Information 10¢. NBL-A, Box 1115, Richardson, TX 75080.

HOME WORKSHOP SUPPLIES

NUTS, Bolts, Screws, Washers, Parts Cabinets, Assortments of all kinds. Save Money. Send 60¢ for Catalog. Nutty Co., 1576SMS, Fairfield, CT 06430.

25 WEEKEND BUILD-IT PROJECTS—Practical designs for home/shop buffs who enjoy working with wood, tools, materials and techniques. Send \$1.25 for your copy (includes postage) to Davis Publications, Inc., 229 Park Avenue South, New York, NY 10003.

HYPNOTISM

AMAZING self-hypnosis record releases fantastic mental power. Instant results! Free trial! Write: Forum (AFT), 333 No. Michigan, Chicago 60601.

FREE Fascinating Hypnosis Information! Startling! DLMH, Box 487, Anaheim, California 92805.

INDIAN RELICS, GOODS & CRAFTS

GENUINE INDIAN JEWELRY. Wholesale Details \$1.00. Lange-IO, 6031 North 7th Street, Phoenix, AZ 85014

INVENTIONS WANTED

CASH—Royalties for patented, unpatented inventions. Global Marketing Service 139-D Lake Merced Hill South, San Francisco, CA 94132.

MACHINERY, TOOLS & SUPPLIES

NEW DEVICE. Pencil Shaped Engraving Tool. Tungsten Carbide. Never Needs Sharpening. Mark property against loss or theft. \$3.00 each. Kiefers, 2077 Morningview, Dubuque, IA 52001.

MAGNETS

FREE flexible magnetic strip with, 20 disc, or 10 bar, or 2 stick, or 8 assorted magnets, \$1.00. Any 5 sets \$4.50. Magnets, Box 192-FE, Randallstown, MD 21133.

MAIL-ORDER OPPORTUNITIES

AMAZING FORTUNE BUILDING SECRETS, for Mail-Order beginners. Details Free. Ephemer, 850 Seventh Avenue, Suite 705-EE, New York, N.Y. 10019.

MISCELLANEOUS

FREE SAMPLE INCENSE: Chubb, 1800 Market. San Francisco 94102.

MULTIPLE RESTRIKE IGNITION. Repetitive Spark Improves Combustion Efficiency. Free Brochure. LABTRONICS, 3635-C Hillside, Ypsilanti, MI 48191.

JOIN International Parks Club. Details 25¢. 8226 23rd NE, Seattle 98115.

WEALTH-HAPPINESS PRINCIPLES! Free Details. Arteric-DPB, Box 5025, Fresno, CA 93755.

FREE UNIQUE COLLECTION TECHNIQUE for Business with pastdue accounts. Write: Raymond Fry, 1702 S. Palm, Ontario, CA 91761.

MONEYMAKING OPPORTUNITIES

STUFF MAIL ENVELOPES!! \$250.00 profit per thousand possible. Offer details: Stamped self-addressed envelope. Kings, B-21487K-75, Ft. Lauderdale, FL 33316.

STUFF ENVELOPES \$500/Thousand. Send stamped addressed Envelope. Mantor House, Dept. 8, SM9, Minoa, NY 13116.

MAKE YOUR CLASSIFIED AD PAY. Get "How to Write A Classified Ad That Pays." Includes certificate worth \$2.00 towards a classified ad. Send \$1.25 (includes postage) to R. S. Wayner, Davis Publications, Inc., 229 Park Avenue South, New York, NY 10003.

BECOME NOTARY PUBLIC—Have a dignified sideline! Free details. Stationers Exchange, P.O. Box 617, Kilgore, TX 75662.

HOW to Make Money Writing Short Paragraphs. Information Free. Barrett, Dept. C-21-D, 6216 N. Clark, Chicago 60660.

"EASY homework earnings Addressing Envelopes," newest report teaches many profit procedures: start spare time; build for future. Information. Hughes, Route #1, Box 4-B7, Senoia, GA 30276.

STUFF ENVELOPES \$500/THOUSAND! FREE SAMPLES! Rush stamped-addressed envelope. Jackson, 2150-IE, Prospect, Cleveland, OH 44115.

GAMBLING Secrets Revealed! My Amazing Professional Correspondence Course Guarantees Fantastic Extra Income. Free Information! Willing, Box 256-B, North Hollywood, CA 91603.

MONEYMAKING OPPORTUNITIES—Cont'd

UNIVERSITY Degrees By Mail! Free details. Counseling, Box 1425-SM3, Tustin, California 92680.

STUFF Envelopes, \$250/thousand, immediately. Free supplies, rush stamped addressed envelope. Olson's Enterprise, Box E, Prineville, OR 97754.

WORK HOME SPARE TIME using Tested Methods. Details Free. Barber Enterprises, Box 1047, Jacksonville, N.C. 28540.

RECEIVE 100 letters a day, each containing \$1.00. You keep the money. Will send copy of the plan Plus 6 formulas for \$1.00. Rush dollar to: Mr. Adams, P.O. Box 192, Phelps, New York 14532.

CASH clipping newspaper articles! Complete Instruction Book \$1.00. Sunny, Box 579A, Plaistow, NH 03865.

\$1,000 MONTHLY!! Stuffing Envelopes And Clipping Newspaper: Send Stamped Addressed Envelope, JOY, Box 936-A, Hyattsville, MD 20783.

LOW-Cost mallorder know-how books: Huge listing! Leemarr-I.O., Patterston, West Virginia 24863.

STUFF ENVELOPES 500/THOUSAND! SEND STAMPED Addressed Envelope. Kelly's Korner, Dept. 41-A, Matlydate, N.Y. 13211.

HOMEWORKERS \$800 Possible. Details 35¢. Bill Eldred, Rt. 6, Abingdon, VA 24210.

TREMENDOUS PROFITS: CLIPPING NEWS-PAPER ITEMS for US. DETAILS 50¢. DIAZ, BOX 642-DP, MARLBORO, MA 01752.

\$100.00 WEEKLY POSSIBLE! Stuffing, mailing commission circulars! Information, send stamped self-addressed envelope. Wright, 949 Broadway, 602-IO2, NYC 10010.

MUSIC & MUSICAL INSTRUMENTS

SONG HITS! How To Write And Sell. Details \$1.00 (Refundable). Rockway, DB7, Rt. 11, Box 145, Pasadena, MD 21122.

VIOLIN and Guitar Makers—send for latest Free Catalog of woods & accessories. International Violin, EE, 4026 W. Belvedere Avenue, Baltimore, MD 21215.

PERSONAL

JAPANESE introductions! Girls' photographs, descriptions, brochure, details, \$1.00. INTER-PACIFIC Box 304-SC, Birmingham, MI 48012.

SINGLE? Widowed? Divorced? Nationwide introductions! Identity, Box 315-DC, Royal Oak, MI 48068.

JAPANESE Girls Make Wonderful Wives. We have large number of listings. Many interested in marriage. Only \$1.00 brings application, photos, names, descriptions, questionnaire. Etc. Japan International, Box 1181-AA, Newport Beach, CA 92663.

CONTRACEPTIVES for Men—by mail! Thirty top brands—Trojan, Nuform, Jade, and many more. Twelve assorted samples: \$3. Deluxe sampler: \$6. Free illustrated catalogue with every order. Plain Satisfaction guaranteed or your money refunded in full. package assures privacy. Fast and reliable service. POPLAN, Box 2556-Dept. DCG-2b, Chapel Hill, NC 27514.

"DATE WITH DIGNITY" Professional Matching. Drawer 6765, Fort Worth, 76115 (817) 921-0281 Anytime.

BEAUTIFUL MEXICAN GIRLS Wanting American Boy-Friends. Details. Photos "Free." World, Box 3876-DC, San Diego, CA 92103.

ADVICE ON JOB HUNTING. I Have Some Startling Information. Not Commonly Known. Price \$1.00. (Ohio Residents Add 5 Cents Sales Tax). W. J. Wagner, Dept. 517, 5715 Chevrolet Blvd., Parma, OH 44130.

MORE 

For Greater Classified Savings... Results... and Profits...

Place your ad in one of our SPECIAL COMBINATIONS: Business Group, Science & Mechanics, or Davis Combination. Each Combination is designed to give your ad the largest audience available. For further information write to R. S. Wayner, Classified Advertising Manager, Davis Publications, Inc., 229 Park Avenue South, New York, N.Y. 10003.

Classified Continued

PERSONAL—Cont'd

MARRY Me: 1200 Lonely Ladies, Fotos/Details free. International Partners: Box 737, Ft. Lauderdale, FL 33302.

X-FILMS—Lovelace, Others. Sample \$1.00 (Refundable). Action, 217DP, Port Richey, FL 33568.

ESCAPE from debts and bill collectors! Have AAA-1 credit everywhere. Free report reveals secret plan! Credit 4G5, 333 North Michigan, Chicago 60601.

DATES GALORE! Meet exciting singles—anywhere. Free application: DATELINE, Alpha, OH 45301.

AMAZING New Gateway to Spiritual Fulfillment. Know God Better. Only \$2.00 Reverend Williams, Box 1257, Hurst, TX 76053.

"X-RATED" Films, Magazines, Cards, Specialties! Fabulous Catalog! Explicit Photos! Rush 25¢ Handling. M.B. Imports, Box 237E, Bronx, N.Y. 10463.

PHOTOGRAPHY—PHOTO FINISHING & SUPPLIES

SAVE HUNDREDS OF DOLLARS!!! Make your own S & M Densitometer. Send \$3.00 for detailed drawings and instructions. A must for successful photography in your darkroom. Order direct: S & M Instruments, Dept. EE7, 229 Park Avenue South, N.Y., NY 10003.

RADIO & TELEVISION

TV TUBES 36¢ each. Send for Free 48 page color catalog. Cornell, 4217-W University, San Diego, California 92105.

"DISTANCE Crystal Set Construction" Handbook—50¢. "Coil Winding"—50¢. Catalog 25¢, refundable. Laboratories, 1477-G Garden Grove, CA 92642.

RADIO & TELEVISION—Cont'd

A NEW CANADIAN MAGAZINE, "Electronics Workshop." \$5.00 yearly, sample \$1.00. ETWCO, Box 741 "A" Montreal, Canada.

FREE Electronics Catalog! Plans, Kits, Tubes, Security Equipment, etc. McCord Electronics, Box 276-F, Sylvania, Ohio 43560.

HEAR POLICE/FIRE Dispatchers! Catalog shows exclusive Directories of "Confidential" channels. Receivers. Send postage stamp. Communications, Box 56-DA, Commack, N.Y. 11725.

ANTIQUE Radios for sale. Lots of battery sets, horns. Atwater Kents, 2008 A Huntington, South Pasadena, CA 91030 213-799-0311.

SECRETS of CB radio revealed. Underground Transmitter, monthly newsletter, \$1.00 for sample copy, \$10 for 1 year sub.. Box 12519, Tucson, AZ 85732.

REMAILING SERVICE

EXOTIC HAITI, Remalls \$1.00. O. Luedicke, Box 593, Port Au Prince, Haiti, West Ind.

ASTONISHMENT, Remalls from Georgia 25¢. Pawala, 2636 Milledgeville, Augusta GA 30906.

SALESMEN—DISTRIBUTORS

AUTOMATIC Fishhooks, Profitable samples, \$2.00 (refundable), Arons, 61 Mastic Beach, New York 11951.

30% COMMISSION Selling Imports. Nalette, Dept. 101, 40 Applegate, Bennington, VT 05201.

SCIENCE & CHEMISTRY

FIREWORKS, Spectacular novelties. Simplified manufacturers textbook, \$5.00. Guaranteed. Tropic, Box 95M4, Palm Bay, FL 32905.

SONGWRITERS

EXCITING offer! Send poems, songs. Crown Music, 49-RX West 32, New York 10001.

SONGWRITERS—Cont'd

SONGPOEMS! SONGS! URGENTLY NEEDED. 50-50 Agreement. Betty's Music Makers, 970E Chatham Park Drive, Pittsburgh, PA 15216.

STAMP COLLECTING

100 DIFFERENT World Wide 25¢ Approvals on Request. B. Malover, Box 841, Southfield, MI 48076

START YOUR OWN BUSINESS

FREELANCE NONFICTION WRITING is highly profitable! Cash in on your talent! Details airmailed. **WRITER'S UTOPIA,** Box 2606EE, Vancouver, WA 98661.

SURPLUS EQUIPMENT

GIANT Bargain Packed Canadian Surplus Catalogs \$1.00 Etco Electronics-DG, Box 741, Montreal "A".

TIPS FOR THE HOME, ETC.

PRACTICAL tips for home, garden and workshop are in "1001 How-To Ideas." Send \$1.00 for your copy includes postage to 1001 How-To Ideas, 229 Park Avenue South, New York, NY 10003.

TOYS, GAMES & ENTERTAINMENT

ELECTRONIC YO-YO lights as it spins. Exciting! New! Amazing! \$2.00. Guaranteed Luzio Co., 6601 Church Lane, Upper Darby, PA 19082.

WATCHES, WATCHMAKING & REPAIRING

WATCH and clock repairing books, tools, materials. Free catalog. North American, Box 77, IO-7, Fox River Grove, IL 60021.

WELDING EQUIPMENT & SUPPLIES

ELECTROPLATING EQUIPMENT, Portable Platers, Supplies, and "Know-How". Build your own tanks for nickel, chrome etc. Easy-to-install PVC liners. Rectifier components—all sizes Schematics, parts lists, formulas, operating instructions for all plating. Guaranteed to save you 25%-75%. Some good used units for sale. Free details. Platers Service Company, 1511-EE Esperanza, Los Angeles, CA 90023.

YOU'LL MAKE MONEY

SAVE MONEY TOO— BY READING and ANSWERING THESE CLASSIFIED ADS

HOW TO SOLVE YOUR STORAGE PROBLEMS WITH A TOUCH OF STYLE

- #J-TA—Tape Album (holds 6)
- #J-R7—45's (holds 20)
- #J-R10—10" Records (holds 20)
- #J-R12—12" Records (holds 20)

**RECORD
AND
TAPE
CASES**



Decorative, sturdy, in rich leatherette. Exclusive design on back is gold tooled on Black, Brown, or Green—sides black. Center divider separates records up to 20 in original jackets. Tape Cases hold 6 tapes in their original boxes.

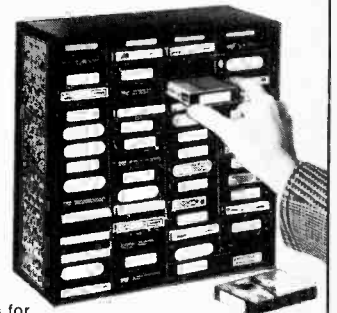

DELUXE CASSETTE STORAGE CASES
(Includes presensitive labels for titling)

#JC-60 holds 60 Cassettes. 13½" high, 12¾" deep, 5½" wide. Storage slots are tilted to keep cartridges from falling out. Outer case embossed in gold on black, brown or green.

#JC-30 holds 30 Cassettes. 5½" high, 6½" deep, 5½" wide. Same color choices.

JESSE JONES BOX CORP., Dept TH-JF75 P.O. Box 5120, Phila., Pa.19141
(POSTAGE PREPAID IN USA ONLY)

quantity _____
 #JC-30 \$11.95 ea., 3 for \$33. Black Brown Green
 #JC-60 \$16.95 ea., 3 for \$48. Black Brown Green
 Check colors for the items below Black Brown Green
 #J-TA—Tape Album \$5.95 each, 3 for \$17 **EE78**
 #J-R7—45's \$5.95 each, 3 for \$17
 #J-R10—10" Records \$6.50 each, 3 for \$18.50
 #J-R12—12" Records \$6.50 each, 3 for \$18.50

I enclose check or money order in amount of \$ _____

Name _____

Address _____

City _____ State _____ Zip _____



LITERATURE LIBRARY

101. Kit builder? Like weird products? *EICO's* 1975 catalog takes care of both breeds of buyers at prices you will like.

102. *International Crystal* has a free catalog for experimenters (crystals, PC boards, transistor RF mixers & amps, and other comm. products).

103. See brochures on *Regency's* 1975 line-up of CB transceivers & scanner receivers (for police, fire, weather, & other public service emergency broadcasts).

104. *Dynascan's* new B & K catalog features test equipment for industrial labs, schools, and TV servicing.

105. Before you build from scratch, check the *Fair Radio Sales* latest catalog for surplus gear.

106. Get *Antenna Specialists'* cat. of latest CB and VHF/UHF innovations: base & mobile antennas, test equipment (wattmeters, etc.), accessories.

107. Want a deluxe CB base station? Then get the specs on *Tram's* super CB rigs.

108. Compact is the word for *Xcelite's* 9 different sets of midget screwdrivers and nut-drivers with "piggyback" handle to increase length and torque. A handy show case serves as a bench stand also.

115. *Trigger Electronics* has a complete catalog of equipment for those in electronics. Included are kits, parts, ham gear, CB, hi fi and recording equipment.

111. *Midland's* line of base & mobile CB equipment, marine transceivers & accessories, and scanner receivers are illustrated in a new full-color 16-page brochure.

112. The *EDI (Electronic Distributors, Inc.)* catalog is updated 5 times a year. It has an index of manufacturers literally from A to X (ADC to Xcelite). Whether you want to spend 29 cents for a pilot-light socket or \$699.95 for a stereo AM/FM receiver, you'll find it here.

113. Get all the facts on *Progressive Edu-Kits* Home Radio Course. Build 20 radios and electronic circuits; parts, tools, and instructions included.

116. Get the *HUSTLER* brochure illustrating their complete line of CB and monitor radio antennas.

117. *Teaberry's* new 6-page folder presents their 6 models of CB transceivers (base and mobile): 1 transceiver for marine-use, and 2 scanner models (the innovative "Crime Fighter" receiver and a pocket-size scanner).

118. CBers, *GC Electronic's* 8-page catalog offers the latest in CB accessories. There are base and mobile mikes; phone plugs; adapters and connectors; antenna switchers and matchers; TV1 filters; automotive noise suppressor kits; SWR Power and FS meters, etc.

152. Send for the new, free descriptive bulletin from *Finney Co.* It features the Finco line of VOM multi-testers (and accessories) for electronics hobbyists and service technicians.

128. A new free catalog is available from *McGee Radio.* It contains electronic product bargains.

119. *Browning's* mobiles and its famous Golden Eagle base station, are illustrated in detail in the new 1975 catalog. It has full-color photos and specification data on Golden Eagle, LTD and SST models, and on "Brownie," a dramatic new mini-mobile.

120. *Edmund Scientific's* new catalog contains over 4500 products that embrace many sciences and fields.

121. *Cornell Electronics'* "Imperial Thrift Tag Sale" Catalog features TV and radio tubes. You can also find almost anything in electronics.

122. *Radio Shack's* 1975 catalog colorfully illustrates their complete range of kit and wired products for electronics enthusiasts—CB, ham, SWL, hi-fi, experimenter kits, batteries, tools, tubes, wire, cable, etc.

123. Get *Lafayette Radio's* "new look" 1975 catalog with 260 pages of complete electronics equipment. It has larger pictures and easy-to-read type. Over 18,000 items cover hi-fi, CB, ham rigs, accessories, test equipment and tools.

124. *Mosley Electronics* reports that by popular demand the Model A-311 3-element CB beam antenna is being reintroduced. Send for the brochure.

125. *RCA Experimenter's Kits* for hobbyists, hams, technicians and students are the answer for successful and enjoyable projects.

127. There are *Atanti* antennas (mobile & base) for CB and scanner receivers, fully described and illustrated in a new 16-page full-color catalog.

129. Semiconductor Supermart is a new 1975 catalog listing project builders' parts, popular CB gear, and test equipment. It features semi-conductors—all from *Circuit Specialists.*

130. There are over 350 kits described in *Heath's* new catalog. Virtually every do-it-yourself interest is included—TV, radios, stereo & 4-channel, hi-fi, etc.

131. *E. F. Johnson's* new full-color catalog for CB transceivers and accessories is now available. Send for a free copy. They also have a free brochure on their line of scanner receivers.

150. Send for the free *NRI/McGraw Hill* 100-page color catalog detailing over 15 electronics courses. Courses cover TV-audio servicing, industrial and digital computer electronics, CB communications servicing, among others. G.I. Bill approved, courses are sold by mail.

132. If you want courses in assembling your own TV kits, *National Schools* has 10 from which to choose. There is a plan for GIs.

133. Get the new free catalog from *Howard W. Sams.* It describes 100's of books for hobbyists and technicians—books on projects, basic electronics and related subjects.

134. *Sprague Products* has L.E.D. readouts for those who want to build electronic clocks, calculators, etc. Parts lists and helpful schematics are included.

135. The latest edition of *Tab Books'* catalog has an extensive listing of TV, radio and general servicing manuals.

137. *Pace* communications equipment covers 2-way radios for business, industrial and CB operations. Marine radiotelephones and scanning receivers are also in this 18-p. book.

138. *Shakespeare's* new pocket-size catalog lists and describes their full line of fiberglass CB antennas, mounts and accessories offered in 1975.

144. For a packetful of material, send for *SBE's* material on UHF and VHF scanners, CB mobile transceivers, walkie-talkies, slow-scan TV systems, marine-radios, two-way radios, and accessories.

145. For CBers from *Hy-Gain Electronics Corp.* there is a 50-page, 4-color catalog (base, mobile and marine transceivers, antennas, and accessories). Colorful literature illustrating two models of monitor-scanners is also available.

147. *Telex's* 4-page, 2-color folder illustrates their new line of boom microphone head-sets for CBers and hams, as well as their line of communications headphones.

142. *Royce Electronics'* new full-color catalog updates information on their CB transceivers (base, mobile, handheld). It also describes new product lines—CB antennas and a VHF marine radiotelephone.

**Elementary Electronics, Box 886
Ansonia Station, New York, N.Y. 10023**

Please arrange to have this literature whose numbers I have circled at right sent to me as soon as possible. I am enclosing 50¢ to cover handling. (No stamps, please.) Allow 4 to 6 weeks for delivery.

Indicate total number of booklets requested.

Sorry, only 10 circled items maximum.

Are you a subscriber to this magazine? Yes No

83 Enter my subscription for 9 issues at \$4.97 and bill me.

101	102	103	104	105	106	107	108	111	112	113	115
116	117	118	119	120	121	122	123	124	125	127	128
129	130	131	132	133	134	135	137	138	142	144	145
149	150	152									

NAME (print clearly)

ADDRESS

CITY
J/A75

STATE

ZIP

Not Valid After December 19, 1975

YOUR BRAIN MORE THAN

FOR EVERY DOLLAR A COMPUTER ASSEMBLER MAKES, A SYSTEMS ANALYST MAKES TWO.*

FOR EVERY DOLLAR A CONSTRUCTION LABORER MAKES A CONSTRUCTION SUPERINTENDENT MAKES TWO.**

FOR EVERY DOLLAR A RETAIL CLERK MAKES, A PURCHASING AGENT MAKES TWO AND A HALF.*

FOR EVERY DOLLAR A CAB DRIVER MAKES, AN INDUSTRIAL TRAFFIC MANAGER MAKES THREE.*

FOR EVERY DOLLAR A CASHIER MAKES, AN ACCOUNTANT MAKES THREE AND A HALF.*

FOR EVERY DOLLAR A DESK CLERK MAKES, A HOTEL MANAGER MAKES FOUR.*

*Figures Reported By: U.S. Bureau of Labor Statistics Occupational Outlook Handbook '72-'73;

**Treasurer of leading American contractor.

Salaries are average and should not be interpreted as your potential for earning.

That could be more or less depending on your training, ambition and local opportunities.

IS WORTH YOUR HANDS.

Working with your hands can be very rewarding. And you'll never have to starve.

Working with your brains is not only more satisfying, it can be much more financially rewarding.

For one thing, your head gets a workout every day, solving problems that keep changing all the time.

For another, there are no arbitrary limits on how much money you can make; it's not set by anyone other than you.

As an accountant, a business manager, hotel or motel manager, or an engineer — once you reach management, you can keep on going as far as your ability takes you. Because these are all growing fields.

In the next ten years, America will need over half a million more engineers, over a quarter of a million more accountants, and thousands of business managers in every business you can name. (In banking alone, 100,000 new managers will be needed.)*

When you work in a growing field, your salary has a better chance to grow along with it. (And with inflation, that's important.) You also have a better chance to enjoy benefits like company-paid travel, expense account privileges, a nice office. And the more responsibility you take on, the more authority you get. The more authority, the more money. It's almost always that way.

If you think you'd like a piece of this kind of action, maybe we can help.

We're ICS.

International Correspondence Schools.

We've helped train plenty of successful accountants, engineers and business managers, like Walter Chrysler and the former heads of Eastern Airlines and General Motors as well as the heads of other large and small companies. Since 1890, over 8½ million ambitious men and women have enrolled with us.

Not only that, companies like GE, IBM, Dupont use ICS to train their own employees for advancement. And ICS is approved for veterans' training.

As an ICS student, you train at home, in your spare time. (We recommend a systematic one hour a day but you can arrange your own schedule.) You don't have to travel to classes or miss a single pay check while learning.

You get all the help you need from skilled, interested instructors. Easy to follow texts. Professional equipment.

And if you get stuck with a lesson or have any questions, you can call us, any time, from any place, toll-free.

If you want to train for a career — not just a job — in Business Management, Accounting, Motel/Hotel Management, or Engineering, just check off the field you're interested in on the postage-free card, and mail it.

We'll send you our free career guidance booklet and a demonstration lesson.

Switching fields (or even pushing ahead in your present one) won't be the easiest thing you've ever done.

But it might be the best.

ICS

International Correspondence School
Scranton, Pa. 18515

NEW FREEDOM OF SPEECH on your phone with Radio Shack's DUOFONE electronic telephone amplifier

Amplifies calls to room filling volume!



only **29⁹⁵** per set

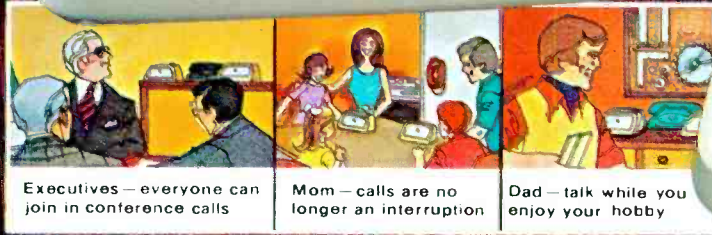

Executives — everyone can join in conference calls

Mom — calls are no longer an interruption

Dad — talk while you enjoy your hobby

FREE New 1976 Radio Shack Catalog

OVER 2000 PRODUCTS
EXCLUSIVES ON EVERY PAGE
BEAUTIFUL FULL COLOR

Stereo • Quadraphonic • Phonographs
TV Antennas • Radios • Citizens Band
Kits • Recorders • Tape • Tools
Auto Tune-Up • Electronic Parts
Test Instruments • More!



164 pages of the finest in home and hobby electronics. Respected brand names like Realistic, Micronta, Archer, Science Fair — and they're available only at Radio Shack stores and dealers nationwide! See what's really new in electronics by getting this catalog now.

SEND FOR YOURS TODAY!
FILL OUT COUPON BELOW

1976 Mail to Radio Shack, P. O. Box 1052, 539
Catalog Ft. Worth, Texas 76101. (Please print.)

Name _____ Apt. No. _____

Street _____

City _____

State _____ ZIP _____

Hands-free use — talk and listen as if the other party were in the room with you

DUOFONE[®] is the first low-cost amplifier system that lets you write, work, even walk around as you talk on your phone. Its ultra-sensitive microphone picks up your normal conversational voice from anywhere in the room. And its solid-state amplifier lets you hear callers as clearly as listening to a radio. Volume control, reliable battery operation, stylish molded enclosures. Our Jack-In-A-Plug makes installation instant with most phones. #43-270. There's only one place you can find it... Radio Shack!

Freedom of travel, too! DUOFONE automatic telephone answerer



Never miss another call while you're away. DUOFONE answers up to 20 calls with a 15-second message recorded in your own voice. And it records each caller's reply. Change your message anytime using the built-in recorder. With batteries, adapter for hookup to most standard private line phones w/ outrewiring. #43-250. **79⁹⁵**

Customer-owned equipment connected to telephone company equipment may be subject to local tariff.



Master Charge or BankAmericard at participating stores

Radio Shack

A TANDY CORPORATION COMPANY

3000 STORES • 50 STATES • 8 COUNTRIES

Retail prices may vary at individual stores

Prices and products may vary in Canada