

BUG YOUR PLANTS - THEY CAN TALK BACK!

©

02342

MARCH - APRIL

1974

75c

# elementary Electronics

HOW TV  
MAKES A PICTURE

OUR BASIC COURSE

Including Electronics Digest\*

## Gasoline Savings Start with an IC Chip

Build our More-Mileage Meter and give yourself  
200 bonus gallons this year!  
Complete plans on page 59!



3-Band Booster for SWLs • Resistance Cu  
• Kathi Checks Out the Realistic PRO-4 Poch  
Totable P.A. • Power Failure Alarm • Sho

12-69 6608 KRA46FEJ-1 Y1005  
J KRAUSLACH JR  
146 FREDERICK ST  
PITTSBURGH PA 15210

# One of our most successful students wrote this ad!

Harry Remmert decided he needed more electronics training to get ahead. He carefully "shopped around" for the best training he could find. His detailed report on why he chose CIE and how it worked out makes a better "ad" than anything we could tell you. Here's his story, as he wrote it to us in his own words.

## By Harry Remmert

"AFTER SEVEN YEARS in my present position, I was made painfully aware of the fact that I had gotten just about all the on-the-job training available. When I asked my supervisor for an increase in pay, he said, "In what way are you a more valuable employee now than when you received your last raise?" Fortunately, I did receive the raise that time, but I realized that my pay was approaching the maximum for a person with my limited training.

"Education was the obvious answer, but I had enrolled in three different night school courses over the years and had not completed any of them. I'd be tired, or want to do something else on class night, and would miss so many classes that I'd fall behind, lose interest, and drop out.

### The Advantages of Home Study

"Therefore, it was easy to decide that home study was the answer for someone like me, who doesn't want to be tied down. With home study there is no schedule. I am the boss and I set the pace. There is no cramming for exams because I decide when I am ready, and only then do I take the exam. I never miss a point in the lecture because it is right there in print for as many re-readings as I find



Harry Remmert gives his CIE Electronics course much of the credit for starting him on a rewarding career. He tells his own story on these pages.

necessary. If I feel tired, stay late at work, or just feel lazy, I can skip school for a night or two and never fall behind. The total absence of all pressure helps me to learn more than I'd be able to grasp if I were just cramming it in to meet an exam deadline schedule. For me, these points give home study courses an overwhelming advantage over scheduled classroom instruction.

"Having decided on home study, why did I choose CIE? I had catalogs from six different schools offering home study courses. The CIE catalog arrived in less than one week (four days before I received any of the other catalogs). This indicated (correctly) that from CIE I could expect fast service on grades, questions, etc. I eliminated those schools which were slow in sending catalogs.

### FCC License Warranty Important

"The First Class FCC Warranty\* was also an attractive point. I had seen "O" and "A" manuals for the FCC exams, and the material had always seemed just a little beyond my grasp. Score another point for CIE.

\*CIE backs its courses with this famous Money-Back Warranty: when you complete a CIE license preparation course, you'll be able to pass your FCC exam or be entitled to a full refund of all tuition paid. Warranty is valid during completion time allowed for your course.



"Another thing is that CIE offered a complete package: FCC License and technical school diploma. Completion time was reasonably short, and I could attain something definite without dragging it out over an interminable number of years. Here I eliminated those schools which gave college credits instead of graduation diplomas. I work in the R and D department of a large company and it's been my observation that technical school graduates generally hold better positions than men with a few college credits. A college degree is one thing, but I'm 32 years old, and 10 or 15 years of part-time college just isn't for me. No, I wanted to *graduate* in a year or two, not just *start*.

"When a school offers both resident and correspondence training, it's my feeling that the correspondence men are sort of on the outside of things. I wanted to be a full-fledged student instead of just a tag-a-long, so CIE's exclusive home-study program naturally attracted me.

"Then, too, it's the men who know their theory who are moving ahead where I work. They can read schematics and understand circuit operation. I want to be a good theory man.

"From the foregoing, you can see I did not select CIE in any haphazard fashion. I knew what I was looking for, and only CIE had all the things I wanted.

### Two Pay Raises in Less Than a Year

"Only eleven months after I enrolled with CIE, I passed the FCC exams for First Class Radiotelephone License with Radar Endorsement. I had a pay increase even before I got my license and *another* only ten months later.

"These are the tangible results. But just as important are the things I've learned. I am smarter now than I had ever thought I would be. It feels good to know that I know what I know now. Schematics that used to confuse me completely are now easy for me to read and interpret. Yes, it is nice to be smarter, and that's probably the most satisfying result of my CIE experience.

### Praise for Student Service

"In closing, I'd like to get in a compliment for my Correspondent Counselor who has faithfully seen to it that my supervisor knows I'm studying. I think the monthly reports to my supervisor and generally flattering commentary have been in large part responsible for my pay increases. My Counselor has given me much more student service than "the contract calls for," and I certainly owe him a sincere debt of gratitude.

"And finally, there is Mr. Tom Duffy, my instructor. I don't believe I've ever had the individual attention in any classroom that I've received from Mr. Duffy. He is clear, authoritative, and spared no time or effort to answer my every question. In Mr. Duffy, I've received everything I could have expected from a full-time private tutor.

"I'm very, very satisfied with the whole CIE experience. Every penny I spent for my course was returned many

times over, both in increased wages and in personal satisfaction."

Perhaps you too, like Harry Remmert, have realized that to get ahead in Electronics today, you need to know much more than the "screwdriver mechanics." They're limited to "thinking with their hands" . . . learning by taking things apart and putting them back together . . . soldering connections, testing circuits, and replacing components. Understandably, their pay is limited—and their future, too.

But for men like Harry Remmert, who have gotten the training they need in the fundamentals of Electronics, there are no such limitations. He was recently promoted, with a good increase in income, to the salaried position of Senior Engineering Assistant working in the design of systems to silence submarines. For trained technicians, the future is bright. Thousands of men will be needed in virtually every field of Electronics from two-way mobile radio to computer testing and troubleshooting.

### Send for Complete Information — FREE

Many men who are advancing their Electronics career started by reading our illustrated school catalog, "Succeed in Electronics." It tells of the many electronics careers open to men with the proper training. And it tells which courses of study best prepare you for the work you want.

If you're "shopping around" for the training you need to move up in Electronics, this interesting book may have the answers you want. We'll send it to you FREE. With it, we'll also include our other helpful book, "How To Get A Commercial FCC License."

To get both FREE books, just fill out and mail the reply card. For your convenience, we will try to have a representative call. If card is missing, use coupon below.

### APPROVED UNDER G.I. BILL

All CIE career courses are approved for educational benefits under the G.I. Bill. If you are a Veteran or in service now, check box for G.I. Bill information.

## CIE Cleveland Institute of Electronics, Inc.

1776 East 17th Street, Cleveland, Ohio 44114

Accredited Member National Home Study Council

### Cleveland Institute of Electronics, Inc.

1776 East 17th Street, Cleveland, Ohio 44114

Please send me your two FREE books:

1. Your school catalog, "Succeed in Electronics."
2. Your book on "How To Get A Commercial FCC License."

I am especially interested in:

- |   |  |
|---|--|
| <input type="checkbox"/> Electronics Technology                 | <input type="checkbox"/> Electronic Communications |
| <input type="checkbox"/> Broadcast Engineering                  | <input type="checkbox"/> Industrial Electronics    |
| <input type="checkbox"/> First Class FCC License                | <input type="checkbox"/> Electronics Engineering   |
| <input type="checkbox"/> Electronics Technology with Laboratory |  |

Name \_\_\_\_\_ (Please Print)

Address \_\_\_\_\_

City \_\_\_\_\_

State \_\_\_\_\_ Zip \_\_\_\_\_ Age \_\_\_\_\_

Veterans & Servicemen: Check here for G. I. Bill information

EL-46

### For men with prior electronics training . . . Electronics Engineering Course

. . . Covers steady-state and transient network theory, solid-state physics and circuitry, pulse techniques, computer logic and mathematics through calculus. A college-level course for men already working in Electronics.

CIRCLE NO. 6 ON PAGE 17 OR 103

ELEMENTARY ELECTRONICS including ELECTRONICS DIGEST (Vol. 14, No. 2) is published bi-monthly by Davis Publications, Inc., at 229 Park Ave., S. New York, N.Y. 10003. One year subscription (six issues)—\$3.95. Second class postage paid at New York, N.Y. 10003 and at additional mailing office.

MARCH-APRIL, 1974



# elementary Electronics

Dedicated to America's Electronics Hobbyists

## PROJECTS WITH A DIFFERENCE

- ☆ 31 Gain-A-Boost—*with this 3-band shortwave booster*
- ☆ 34 Give Your Plants a Voice—*science fiction strikes pay dirt?*
- 65 Power Lost—*a footstomper's toe stubber stopper*

## GET THE MOST FROM DRIVING

- 47 Moving Sound—*here's a way to ease the pain*
- ☆ 59 Professional Dwell/Tach—*build it to help stretch those 10 gallons*
- ☆ 69 Put together a Porta-Mobile Public Address System

## IN OUR BASIC CORNER

- ☆ 41 R-Cubed Lets You Shoot the Works
- ☆ 43 Getting Filter Design to Come Easy
- 81 Slip-n-Clip—*beginner's basic breadboard*
- ☆ 83 Basic Course—*TV receiver insights*

## KATHI AND THE BOYS

- 24 DX Central Reporting—*Don Jensen has shortwave listening data*
- 28 Ask Hank, He Knows—*your electronics answer-man is Hank Scott*
- ☆ 67 Kathi's CB Carousel—*Kathi tries a pocket scanner*
- 76 Hey Herb—*Herbie comes up with some sound answers*
- ☆ 77 Antique Radio Corner—*Jim Fred is our young old-timer*

## TRY SHORT CIRCUITS

- ☆ 58 Takes Two to Couple—*keep TV mismatch to a minimum*
- 64 The Sound of STG—*chromatically speaking, it's a bust!*

## PLUS ALL THIS

- 8 Hey, Look Me Over—*our new products column*
- 17 Reader Service Page
- 22 Bookmark
- 52 It's Your Move—*to turn to page 52*
- 80 Newscan
- 103 Reader Service Page

☆  
Cover  
Highlights

Cover  
photograph  
by  
Walter  
Herstatt

## AUTHORS IN THIS ISSUE

R. G. Cooper, Norman Crawford, Frank Curucz, James A. Fred, Herb Friedman, B. W. Grandjean, Charles Green W6FFQ, Don Jensen, C. R. Lewart, Marshall Lincoln, Kathi Martin, Joe Rolf K5JOK, Jack Schmidt, Hank Scott, Shinri Sensei, William R. Shippee, R. L. Way, and the ELEMENTARY ELECTRONICS editorial staff.





# BUILD YOUR OWN RADIO

## and Electronics Circuits

### PROGRESSIVE HOME RADIO-T.V. COURSE

Now Includes

- ★ 12 RECEIVERS
- ★ 3 TRANSMITTERS
- ★ SQ. WAVE GENERATOR
- ★ SIGNAL TRACER
- ★ AMPLIFIER
- ★ SIGNAL INJECTOR
- ★ CODE OSCILLATOR

- ★ No Knowledge of Radio Necessary
- ★ No Additional Parts or Tools Needed
- ★ EXCELLENT BACKGROUND FOR TV
- ★ SCHOOL INQUIRIES INVITED
- ★ Sold In 79 Countries



Reg. U.S. Pat. Off.

Training Electronics Technicians Since 1946

### YOU DON'T HAVE TO SPEND HUNDREDS OF DOLLARS FOR A RADIO COURSE

The "Edu-Kit" offers you an outstanding PRACTICAL HOME RADIO COURSE at a rock-bottom price. Our Kits are designed to train Radio & Electronics Technicians, making use of the most modern methods of home training. You will learn radio theory, construction practice and servicing. THIS IS A COMPLETE RADIO COURSE IN EVERY DETAIL. You will learn how to build radios, using regular schematics; how to wire and solder in a professional manner; how to service radios. You will work with the standard type of punched metal chassis as well as the latest development of Printed Circuit chassis. You will learn the basic principles of radio. You will test equipment. You will learn RF and AF amplifiers and oscillators, detectors, rectifiers, test equipment. You will learn and practice code, using the Progressive Code Oscillator. You will learn and practice trouble-shooting, using the Progressive Signal Tracer. Progressive Signal Injector, Progressive Dynamic Radio & Electronics Tester, Square Wave Generator and the accompanying instructional material.

You will receive the following for the Novice, Technician and General Classes of F.C.C. Radio Amateur Licenses. You will build Receiver, Transmitter, Square Wave Generator, Code Oscillator, Signal Tracer and Signal Injector circuits, and learn how to operate them. You will receive an excellent background for learning in the field of Electronics.

Absolutely no previous knowledge of radio or science is required. The "Edu-Kit" is the product of many years of teaching and engineering experience. The "Edu-Kit" will provide you with a basic education in Electronics and Radio, worth many times the low price.

### THE KIT FOR EVERYONE

You do not need the slightest background in radio or science. Whether you are interested in Radio & Electronics because you want an interesting hobby, a well paying business or a job with a future, you will find the "Edu-Kit" a worth-while investment. Many thousands of individuals of all

ages and backgrounds have successfully used the "Edu-Kit" in more than 79 countries of the world. The "Edu-Kit" has been carefully designed, step by step, so that you cannot make a mistake. The "Edu-Kit" allows you to teach yourself at your own rate. No instructor is necessary.

### PROGRESSIVE TEACHING METHOD

The Progressive Radio "Edu-Kit" is the foremost educational radio kit in the world, and is universally accepted as the standard in the field of electronics training. The "Edu-Kit" uses the modern educational principle of "Learn by Doing." Therefore you construct, learn schematics, study theory, practice trouble shooting—all in a closely integrated program designed to provide an easily-learned, thorough and interesting background in radio.

You begin by examining the various radio parts of the "Edu-Kit." You then learn the function, theory and wiring of these parts. Then you build a simple radio. With this first set you will enjoy listening to regular broadcast stations, learn theory, practice testing and trouble-shooting. Then you build a more advanced radio, learn more advanced theory and techniques. Gradually, in a progressive manner, and at your own rate, you will find yourself constructing more advanced multi-tube radio circuits, and doing work like a Professional Radio Technician.

Included in the "Edu-Kit" course are Receiver, Transmitter, Code Oscillator, Signal Tracer, Square Wave Generator and Signal Injector Circuits. These are not unprofessional "breadboard" experiments, but genuine radio circuits, constructed by means of professional wiring and soldering on metal chassis, using the new method of radio construction known as "Printed Circuitry." These circuits operate on your regular AC or DC house current.

### THE "EDU-KIT" IS COMPLETE

You will receive all parts and instructions necessary to build twenty different radio and electronics circuits, each guaranteed to operate. Our Kits contain tubes, tube sockets, variable electrolytic, mica, ceramic and paper dielectric condensers, resistors, tie strips, hardware, tubing, punched metal chassis, Instruction Manuals, hookup wire, solder, selenium rectifiers, coils, volume controls and switches, etc.

In addition, you receive Printed Circuit materials, including Printed Circuit chassis, special tube sockets, hardware and instructions. You also receive a useful set of tools, a Professional electric soldering iron, and a self-powered Dynamic Radio and Electronics Tester. The "Edu-Kit" also includes Code Instructions and the Progressive Code Oscillator, Tester. The "Edu-Kit" also includes Code Instructions and the Progressive Code Oscillator, Tester. In addition to F.C.C. Radio Amateur License training. You will also receive lessons for servicing with the Progressive Signal Tracer and the Progressive Signal Injector, a High Fidelity Guide and a Quiz Book. You receive Membership in Radio-TV Club, Free Consultation Service, Certificate of Merit and Discount Privileges. You receive all parts, tools, instructions, etc. Everything is yours to keep.

### PRINTED CIRCUITRY

At no increase in price, the "Edu-Kit" now includes Printed Circuitry. You build a Printed Circuit Signal Injector, a unique servicing instrument that can detect many Radio and TV troubles. This revolutionary new technique of radio construction is now becoming popular in commercial radio and TV sets.

A Printed Circuit is a special insulated chassis on which has been deposited a conducting material which takes the place of wiring. The various parts are merely plugged in and soldered to terminals.

Printed Circuitry is the basis of modern Automation Electronics. A knowledge of this subject is a necessity today for anyone interested in Electronics.

### FREE EXTRAS

#### • SET OF TOOLS

- SOLDERING IRON
- ELECTRONICS TESTER
- PLIERS-CUTTERS
- VALUABLE DISCOUNT CARD
- CERTIFICATE OF MERIT
- TESTER INSTRUCTION MANUAL
- HIGH FIDELITY GUIDE • QUIZZES
- TELEVISION BOOK • RADIO TROUBLE-SHOOTING BOOK
- MEMBERSHIP IN RADIO-TV CLUB: CONSULTATION SERVICE • FCC AMATEUR LICENSE TRAINING
- PRINTED CIRCUITRY

### SERVICING LESSONS

You will learn trouble-shooting and servicing in a progressive manner. You will practice repairs on the sets that you construct. You will learn symptoms and causes of trouble in home, portable and car radios. You will learn how to use the professional Signal Tracer, the unique Signal Injector and the dynamic Radio & Electronics Tester. While you are learning in this practical way, you will be able to do many a repair job for your friends and neighbors, and charge fees which will far exceed the price of the "Edu-Kit." Our Consultation Service will help you with any technical problems you may have.

### FROM OUR MAIL BAG

J. Statatits, of 25 Poplar Pl., Waterbury, Conn., writes: "I have repaired several sets for my friends, and made money. The "Edu-Kit," paid for itself, I was ready to spend \$240 for a course, but I found your ad and sent for your Kit."

Ben Valerio, P. O. Box 21, Magna, Utah: "The Edu-Kits are wonderful. Here I am sending you the questions and also the answers for them. I have been in Radio for the last seven years, but like to work with Radio Kits, and like to build Radio Testing Equipment. I enjoyed every minute I worked with the different kits: the Signal Tracer works fine. Also like to let you know that I feel proud of becoming a member of Your Radio-TV Club."

Robert L. Shuff, 1534 Monroe Ave., Huntington, W. Va.: "Thought I would drop you a few lines to say that I received my Edu-Kit and was really amazed that such a bargain can be had at such a low price. I have already started repairing radios and phonographs. My friends were really surprised to see me get into the swing of it so quickly. The Trouble-shooting Tester that comes with the kit is really swell, and finds the trouble. If there is any to be found."

Progressive "Edu-Kits" Inc., 1189 Broadway, Dept. 566DJ Hewlett, N.Y. 11557

Please rush me free literature describing the Progressive Radio-TV Course with Edu-Kits. No Salesman will call.

NAME .....

ADDRESS .....

CITY & STATE ..... ZIP .....

### PROGRESSIVE "EDU-KITS" INC.

1189 Broadway, Dept. 566DJ, Hewlett, N.Y. 11557

CIRCLE NO. 4 ON PAGE 17 OR 103



# Telex CB headphones... they keep you in touch.

For people who keep two hands on the wheel, two eyes on the road and an ear for the dispatcher, Telex has the citizens' band headsets that provide the ultimate in hands free mobility and convenience.

Features include a fully adjustable boom mic that limits surrounding noise pick-up, an easy to reach inline push-to-talk switch and a clear, distraction free signal at your ear.

For information write Telex Communications, Inc., 9600 Aldrich Avenue South, Minneapolis, Minnesota 55420.

PRODUCTS OF SOUND RESEARCH  
**TELEX**  
COMMUNICATIONS, INC.

CANADA: Double Diamond Electronics Ltd.,  
Scarborough, Ontario

INTERNATIONAL: Telex Export Dept., 9600 Aldrich Avenue South,  
Minneapolis, Minn. 55420 U.S.A.

7313

CIRCLE NO. 22 ON PAGE 17 OR 103

# elementary Electronics

March/April 1974 Vol. 14/No. 2  
Dedicated to America's Electronics Hobbyists

*Editor-in-Chief*

**JULIAN S. MARTIN, WA2CQL**

*Technical Editor*

**PETER L. DEXNIS, WA3LOQ**

*Audio Editor*

**STEPHEN B. GRAY**

*News Editor*

**JEFFREY APTER**

*Citizens Band Editor*

**KATHI MARTIN, KA1Ø614**

*Workbench Editor*

**HANK SCOTT**

*Art Director*

**JIM MEDLER**

*Cover Art Director*

**IRVING BERNSTEIN**

*Associate Art Director*

**ANDY STEIGMEIER**

*Art Associate*

**RALPH RUBINO**

*Advertising Director*

**DAVID J. MILLER**

*Production Director*

**CARL BARTEE**

*Production Manager*

**GERTRUD BORCHARDT**

*Assistant Production Manager*

**MARILYN BONILLA**

*Newsstand Circulation Director*

**DON GABREE**

*Subscription Circulation—Marketing Director*

**ROBERT V. ENLOW**

*Subscription Circulation Manager*

**GEORGE ROWELL**

*Instruments Division Manager*

**WILFRED M. BROWN**

*President, Chairman of the Board (1957-1972)*

**B. G. DAVIS**

*President and Publisher*

**JOEL DAVIS**

*Vice-President and General Manager*

**LEONARD F. PINTO**

*Vice President and Treasurer*

**VICTOR C. STABLE, KBPØ681**

ELEMENTARY ELECTRONICS is published bi-monthly by Davis Publications, Inc. Editorial and Executive offices: 229 Park Ave. So. New York NY 10003; all Subscription orders and mail regarding subscriptions should be sent to P.O. Box 2600, Greenwich CN 06830. One-year subscription (six issues)—\$3.95; two-year subscription (12 issues)—\$7.95; three-year subscription (18 issues)—\$11.95; and four-year subscription (24 issues)—\$15.95. Add \$1.00 per year for postage outside the U.S.A., its possessions and Canada. For change of address, please advise 4 to 6 weeks before moving. Send us your current mailing label with new address. Advertising offices: New York, 229 Park Avenue South, 212-673-1300; Chicago, 520 N. Michigan Ave., 312-527-0330; Los Angeles; J. E. Publishers' Rep. Co., 8732 Sunset Blvd. 213-659-3810. Second-class postage paid at New York NY and at additional mailing office. Copyright 1974 by Davis Publications, Inc.

ELEMENTARY ELECTRONICS





# 'golden anniversary Messenger® 250

**AN ENTIRELY NEW SLANT  
ON CB BASE STATION  
PERFORMANCE**

From its professional sloping control panel, to its special golden trim cabinetry, you know this is an extraordinary CB radio. But it's when you get it on-the-air that you'll see why Messenger 250 is the new criteria for 23-channel base station performance. Then you'll appreciate its all solid-state chassis — the most powerfully efficient we've yet developed. And its advanced circuitry, including built-in electronic speech compression, "steep skirt" mechanical filter, fully automatic noise limiting and sophisticated automatic gain control. Plus the operational flexibility of the built-in PA function, remote speaker option, and the dual 117 VAC/12 VDC power supply that can keep you on-the-air with battery power if need be. It's quite a radio — but we wouldn't have made it our Golden Anniversary model if it wasn't.



**\$239.95** suggested price complete with high capacity, ceramic element, panc-type microphone.



## **E. F. Johnson Co.**

Waseca, Minnesota 56093

*Excellence through half a century of experience.*

®

Circle No. 33 On Reader Service

[www.americanradiohistory.com](http://www.americanradiohistory.com)



only from **!!!**

**HUSTLER** ■■■

GET PERFORMANCE OF  
**4** MOBILE ANTENNAS  
from ONE with the  
**Monitor Match!**



Use your regular  
outside mounted  
or windshield  
car antenna!

Get functions of four antennas with Monitor-Match for reception of AM—FM plus low-band, high-band and UHF monitor radios. Excellent performance. Connect and operate.

MODEL 5M5 \$14.95

HEAR IT **ALL** WITH  
THE **DISCONE** BASE  
ANTENNA!



NO ADJUSTING  
NO CUTTING  
NO SWITCHING

**40 to 700 MHz** Total  
Coverage

Get superior all directional reception on low-band, high-band and UHF including 88-108 MHz FM entertainment radio with this 50" antenna. Includes SO-239 coax connector and mounting hardware.

MODEL DCX \$14.95

only from

**HUSTLER**

foremost in CB,

Amateur and Monitor Antennas

From all distributors who recognize the best!

**NEW-TRONICS CORP.**

15800 COMMERCE PARK DRIVE  
BROOK PARK, OHIO 44142

CIRCLE NO. 14 ON PAGE 17 OR 103

Hey,  
look me over

Showcase of New Products

### Three-Way Audio Switcher

A new tape recorder selector switch which expands the tape monitor facilities of amplifiers and receivers to accept up to three tape recorders or other line level audio devices is available from Russound, manufacturer of audio accessories and switchgear. The TMS-1W connects to the tape monitor inputs and outputs of the amplifier or receiver and allows three recorders to be used simultaneously for

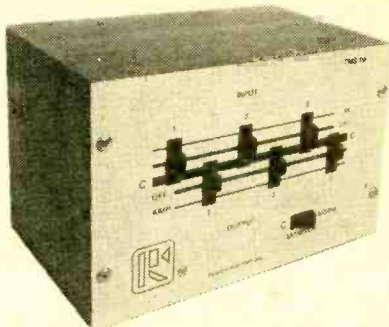

recording, copying, editing, etc. The TMS-1W can also be used to interface such accessories as graphic equalizers, noise reduction units, synthesizers and other signal processing equipment. The unit increases the flexibility of the home hi-fi system by making it possible to conveniently switch equipment in and out without the constant hooking and unhooking of audio cables usually required. The TMS-1W is packaged in a walnut finish case and is available from audio dealers at \$32.95. It is also available direct from the factory at an additional shipping charge of \$1.50. Russound/FMP, Inc., Box 204, Stratham, New Hampshire 03885. For more information and a spec sheet, circle No. 150 on Literature Library Coupon.

### Now Hear This

The new Heathkit AS-1039 Speaker System was designed to bring out the best in low power amplifiers. Just five watts is enough to drive it at a booming volume. The system uses an 8-in. woofer in vented bass-reflex enclosure and an exponential rectangular horn tweeter with its own level control knob

ELEMENTARY ELECTRONICS



# IT'S TIME TO MAKE

# YOUR

# MOVE



## UP TO SILTRONIX

Now is the perfect time to begin enjoying the CB game. And you can, with a SSB Citizen Band transceiver from SILTRONIX. There will be more action to join in, during 1974, than ever before. CB enthusiasts throughout the nation are realizing that it's time to "get it all together". Be sure you have what it takes, and that begins with the equipment you use.

Old fashioned AM equipment is too much of a hassle on crowded channels, it just doesn't have the power to be a winner. You won't waste energy if you use single sideband communications. By choosing equipment bearing the SILTRONIX label, you're assured of quality in design and workmanship. After all, quality is the name of the game when you want performance.

Check with your authorized SILTRONIX dealer for the full scoop on our line-up of 1974 products . . . there's a lot to choose from.

**Choose a winner — Choose SILTRONIX!**

### **SILTRONIX**

A Cubic Corporation Company  
221 Via El Centro • Oceanside, CA 92054  
(714) 757-8860

Dealers interested in adding quality merchandise to their stock are invited to inquire on their letterhead.

For the name of your nearest SILTRONIX dealer, write to Lorelei c/o SILTRONIX, 221 Via El Centro, Oceanside, CA 92054 — or call (714) 757-8860

CIRCLE NO. 8 ON PAGE 17 OR 103

# CALECTRO panel meters



A SIZE AND SHAPE  
FOR EVERY NEED

## LEVEL METER AND BATTERY CHECKER

Precision construction. Features D'Arsonval movement, jeweled bearings, and hand calibration.



MINIATURE EDGEWISE  
PANEL METERS

NEW  
One Hole  
Mount

## MINIATURE PANEL METERS

Full range of panel mini-meters featuring single hole mounting. Simply bore hole for movement and that's it. Thread nut onto back of meter. Meter in line—every time.

## PRECISION PANEL METERS

Rugged construction — 2% accuracy. Hand calibrated and linear dial scales. D'Arsonval movement with jeweled bearings. Crystal clear plastic cover plate.

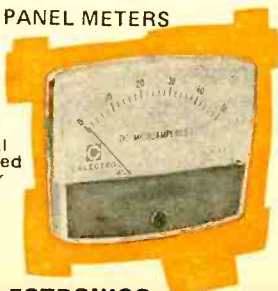

**GC ELECTRONICS**

DIVISION OF HYDROMETALS, INC.   
ROCKFORD, ILLINOIS 61101 U.S.A.

CIRCLE NO. 10 ON PAGE 17 OR 103

## HEY, LOOK ME OVER



mounted on the back panel. Magnets are 10 ounces for the woofer and 1.47 ounces on the tweeter. Frequency response is 70 to 15,000 Hz with crossover at 3,500 Hz. The AS-1039 has nominal impedance of 8 ohms, and can handle up to 25 watts. The one-piece cabinet with removable grill cloth provides a solid vibration-free housing while also simplifying kit building. The cabinet comes fully assembled and finished. Installation of the crossover circuit and speakers can be easily accomplished in one evening. System dimensions are 21½-in. high x 12-in. wide x 10½-in. deep. Price of the Heathkit AS-1039 is \$44.95 mail order. For additional information and full-color catalog, circle No. 1 on Reader Service Coupon.

## Built Like Speaker Systems

Pioneer's new Model SE-505 stereo headphones has a two-way speaker design with both woofer and tweeter in each earpiece, using polyester film diaphragms to deliver consistently excellent transient response. The woofer is 1<sup>25</sup>/<sub>32</sub>-in. in diameter while the tweeter diaphragm is 1¼-in. To improve response linearity, the tweeter has an aluminum voice coil. Pioneer's SE-505 stereo headphones also have independent volume and tone controls for both right and left channels. Designed for comfort and appear-

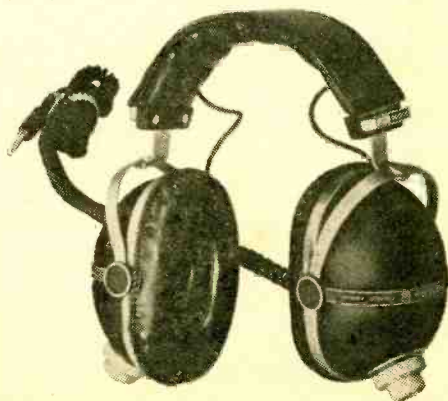

ELEMENTARY ELECTRONICS



# BE AMAZED! ADD REALISTIC® FOUR-CHANNEL SOUND TO ANY STEREO...HOME OR CAR...THE EASY, LOW-COST RADIO SHACK WAY!



Flush-Mount



Surface-Mount

## HOME ADD-ON SYSTEM

Your stereo system is ready and waiting for easy updating to the "Sound of the Seventies": Our Quatravox four-channel synthesizer and two Solo-103 speakers recover ambient sound previously "hidden" in ordinary stereo records, FM and tapes . . . from right, left, front and rear, just as it's "reflected" in theaters, clubs, concert halls. No internal rewiring. Six audio cables and plugs are included. Save \$6.90. \$62.95\*

Realistic Quatravox Alone.

Add quatravox and two extra speakers to your present system for four-channel enhancement of all stereo. \$29.95\*

## AND ONE FOR THE ROAD

If you already have stereo in your car, there's no need to miss out on the fun of four-channel. Our Auto Quatravox, plus two flush-mount speakers, connects easily to your present stereo radio or tape player for startling four-channel enhancement of any program or recording. Listen to front speakers only, rear only, or balance all four. 18-foot cables, hardware included. Save \$6.90. \$16.99\*

Above with Surface-Mount Speakers.

Just hang speakers anywhere in car without installation. Save 10%. \$16.99\*

Realistic Auto Quatravox Alone.

Just add two speakers of your choice. Takes minimum space, only 5½x 2½ x 1-3/4". \$9.95\*

\*Price may vary at individual stores.

Exclusive at 2000 Stores in All 50 States

# Radio Shack®

and ALLIED RADIO STORES

A TANDY CORPORATION COMPANY

P. O. Box 1052, Fort Worth, Texas 76107

FREE '74 CATALOG! AT YOUR 356  
NEARBY STORE OR MAIL IN THIS COUPON  
180 pages! Stereo Hi-Fi, CB, Ham, Kits, Radios, More!  
Name \_\_\_\_\_ Apt. # \_\_\_\_\_  
Street \_\_\_\_\_  
City \_\_\_\_\_ State \_\_\_\_\_ Zip

CIRCLE NO. 32 ON PAGE 17 OR 103



**Build your own  
circuit designer, with  
all the outstanding features  
of expensive models . . .  
now at a very low budget price!**

This compact package contains a regulated 5VDC supply, selectable frequency clock, EL-socket, dual bounce-free pushbuttons (pulsers), 4 slide switches for voltage/ground, plus 4 independent "logic lights" for on/off states of various logic circuitry. Exclusive Breadboarding Pins offer input/output connections to socket eliminating all soldering. Use any 22 gage solid wire. Send check or M.O. today for your choice of two models.

## THE DIGI DESIGNER

**DD1-K, Kit Form (incl. p.c. boards, all components, instruction manual) \$49<sup>95</sup>**  
**DD1-A, Assembled ready for use \$95<sup>00</sup>**

- Add \$2 postage, handling
- 25% deposit on C.O.D.s



**ASK FOR NEW  
FREE  
IDEA-PACKED,  
ILLUSTRATED  
CIRCUIT DESIGN  
CATALOG!**



**EL INSTRUMENTS, INC.**  
61 First St., Derby, Conn. 06418  
Telephone: 203/735-8774

**4579C**

CIRCLE NO. 7 ON PAGE 17 OR 103

## HEY, LOOK ME OVER

ance, the speaker unit casing is handsomely finished in black tone leather, with a contrasting aluminum die-cast sliding headband. The unit impedance is 8 ohms for each channel. Frequency range is 20 to 20,000 Hz with a sensitivity of 108 dB/0.3 volt. The maximum input power is 500 milliwatts (each channel). Without the connecting cable the weight of the SE-505 is 1 lb. 8 ounces. A 16-foot coiled cord and permanent storage case is included. Price: \$59.95. If you wish, write directly to Pioneer, 178 Commerce Rd., Carlstadt NJ 07072 and request the information and their catalog.

### Matched Stereo Speakers

Utah Electronics unveils two new car stereo kits featuring matched 6x9-in. high fidelity speakers and deluxe satin black die-cast aluminum grilles. The speakers, which fit many existing rear deck cutouts, boast 10-oz. magnets (in the SA69-10A kit) and 16-oz. magnets (in the SA69-16A kit), and have power capacities of 15 and 16.5 watts,

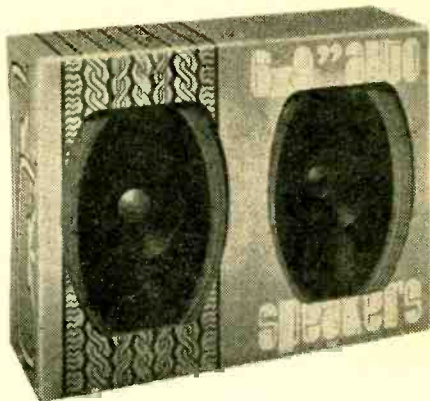

respectively. The heavier magnets, 1-in. voice coils, and damped cloth edge rolls assure solid bass, while the separate treble cones deliver smooth highs. For enduring elegance, the deluxe aluminum grilles are warp-proof and dent-proof. Packaged in a protective, film-wrapped display pack, each stereo kit includes two matched 6x9-in. speakers, deluxe grilles, wiring, mounting hardware, templates, and illustrated instructions for fast installation. Impedance is 8-10 ohms. The SA69-10A lists at \$40.70, and the SA69-16A at \$46.95. Utah Electronics is located at 1124 E. Franklin St., Huntington IN 46750. If you wish, circle No. 151 on the Literature Library Coupon. (Continued on page 14)

*Be sure to use Reader Service Coupons on pages 17 and 103, and Literature Library Coupon on page 98.*



# LIVE IN THE WORLD OF TOMORROW...TODAY!

(And our FREE CATALOG is packed with exciting and unusual ecological & physical science items—plus 4,500 finds for fun, study or profit . . . for every member of the family).

## A BETTER LIFE STARTS HERE

### KNOW YOUR ALPHA FROM THETA!



For greater relaxation, concentration, listen to your Alpha-Theta brainwaves. Ultra-sensitive electrode headband slips on/off in seconds—eliminates need for messy creams, etc. Attach'd to amplifier, filters brainwaves, signals beep for ea. Alpha or Theta wave passed. Monitoring button simulates Alpha feedback. Reliable, easy-to-use unit—comparable to costlier models. Completely safe. Comprehensive instruction booklet. . . \$128.00 Ppd. No. 1635EK (8x3x4"; 24 oz.)

Stock No. 71,809EK (LOW COST "STARTER" UNIT) \$49.95 Ppd.

### SEE THROUGH WALLS, PARCELS!

Our exclusive hand-held metal detector is so responsive it will pick up a staple in a letter, and its sensitivity adjusts to big pipes & cables! "See" through brickwork, concrete, timber, tiles—locate studs, trace wires, pipes, any ferrous and nonferrous metal safely. Avoid danger too—use this lightweight wonder to detect bombs in letters, parcels (non-invasive search)! Has very visible neon alarm, req. 9v rect. batt. (not incl.) Instrs.

Stock No. 1938EK . . . \$49.95 Ppd.

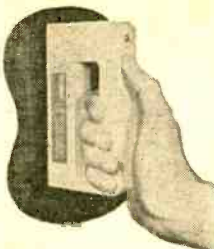

### 130 EXPERIMENTS IN OPTICS . . .

and photography! Optix® Experiments Kit is a complete optical & photography lab for 130 exciting experiments. Lets you recreate the periscope, telescope, microscope, kaleidoscope! Build a 35mm reflex camera with interchangeable lens system! Make, develop photographic film! Enjoy the fun and fascination of having your own optics lab. Fully illust' 112-pg manual, 8 1/2"x11", clearly explains usage of this stimulating kit's 114 precision engineered components.

Stock No. 71,646EK . . . \$22.50 Ppd.

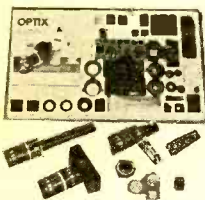

### 3-CHANNEL COLOR ORGAN KIT



Easy to build low-cost kit needs no technical knowledge. Completed unit has 3 bands of audio frequencies to modulate 3 independent strings of colored lamps (i.e. "lows", "reds", "middles"-greens, "highs"-blues. Just connect hi-fi, radio, power lamp etc. & plug ea. Jump string into own channel (max. 300w ea.). Kit features 3 neon indicators, color intensity controls, controlled invidiv SCR circuits; isolation transformer; custom plastic housing; instr.

Stock No. 41,831EK . . . \$17.50 Ppd.

### ELECTRONIC DIGITAL COMPUTER KIT!

Solve problems, play games, predict weather with this actual working model of giant electronic brains. Amazing new fun way to learn all about computer programming . . . logic, decimal, binary systems. Laws of Sets—even do your own programming after completing simplified 116 page instructive booklet. Includes step-by-step assembly diagrams. Circuits easily changed. Read-out from illuminated control panel. Req. 2 "D" batt. (not incl.). Best model we've seen—for home, school, industry. No. 71,434EK . . . (11"x12 1/2"x4") . . . \$31.50 Ppd.

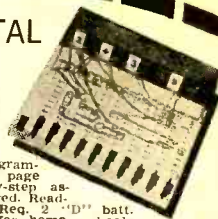

### CONVERT EVERYTHING TO METRIC!



Be ready for the metric system. Absolutely best, most complete kit available enables you to instantly convert length, weight, area, volume, fractions/decimals, temp. "Must" for labs, workshops, engineers, teachers, hobbyists. Amazingly low-priced kit incl. 9" dia. pocket calculator 3-6" rules for avoirdupois, fraction/decimal, cent./Fahr; 2m (6"7") retract metal tape meas.; fifty 100 cm self-stick tape, lam. wallet card. 54 pg. "U.S.A. Goes Metric".

Stock No. 71,844EK . . . \$5.00 Ppd. (10 or more . . . \$4.50 each)



## MAIL COUPON FOR GIANT FREE CATALOG!

180 PAGES • MORE THAN 4,500 UNUSUAL BARGAINS

Completely new Catalog. Packed with huge selection of telescopes, microscopes, binoculars, magnets, magnifiers, prisms, photo components, ecology and Unique Lighting items, parts, kits, accessories — many hard-to-get surplus bargains: 100's of charts, illustrations. For hobbyists, experimenters, schools, industry.

EDMUND SCIENTIFIC CO.  
300 Edscorp Building, Barrington, N. J. 08007  
Please rush Free Giant Catalog "EK"

Name \_\_\_\_\_  
Address \_\_\_\_\_  
City \_\_\_\_\_ State \_\_\_\_\_ Zip \_\_\_\_\_

## ORDER TODAY! COMPLETE AND MAIL

EDMUND SCIENTIFIC CO.  
300 Edscorp Building, Barrington, N.J. 08007

How Many	Stock No.	Description	Price Each	Total

PLEASE SEND  GIANT FREE CATALOG "EK" MERCHANDISE TOTAL \$ \_\_\_\_\_  
ADD HANDLING CHARGE \$1.00  
ON ORDERS UNDER \$5.00; 50c  
ON ORDERS OVER \$5.00. TOTAL \$ \_\_\_\_\_



I enclose  check  
 money order for \$ \_\_\_\_\_

NAME \_\_\_\_\_  
ADDRESS \_\_\_\_\_  
CITY \_\_\_\_\_ STATE \_\_\_\_\_ ZIP \_\_\_\_\_

## HEY, LOOK ME OVER

### Cook's Radar

A new portable microwave oven that can prepare a cornucopia of food in minutes instead of hours is now available from Litton Microwave Cooking Products, a division of Litton Industries. The compact *Minutemaster* Model 200 is the lightest microwave oven sold in the United States—53 pounds—and is aimed at the under-\$300 market. It features built-in carrying handles and can be plugged into any



110-volt outlet in the kitchen, family room, beside the pool, at the cabin, or in a recreational vehicle. The deluxe Model 201 features a large see-through door of tempered glass, 14-minute easy-to-set timer, easy-clean interior, convenient push-bar door release. It has a suggested retail price of \$299. Available at better department stores and appliance dealers nationwide.

### Slurps Solder

Desolder any connection quickly and cleanly with Soder-Wick from GC Electronics. Soder-Wick absorbs molten solder instantly and eliminates component damaging heat build-



up. It leaves no residue, nor is there a danger from flux contamination. Pictured is the miniature printed circuit board size, Catalog No. 684. GC Electronics offers a complete line of solder accessories as well as printed circuit construction materials including chemi-

## avant's Astroplane gives CBers Performance to brag about.

*The unique construction features are exceptional.*

4.46 db gain over isotropic is, and provides, a stronger transmit and a stronger receive.

To make use of the better signal, the Astroplane radiates the signal from higher up than other CB antennas and at a better angle. According to Dr. Alva Todd of the Midwest College of Engineering, "it possesses an unusually low angle of maximum radiation." This low angle of radiation means that your power is radiated at the horizon and not up into the clouds.

You'll also get long lasting, trouble-free performance because it is compact in design—without long drooping radials, without coils to burn or

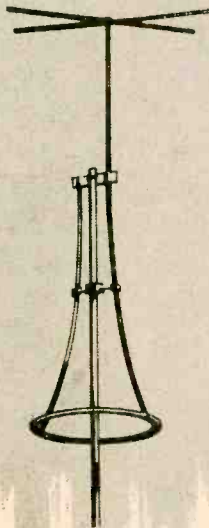

short out, and with direct ground construction for positive lightning protection and static dissipation.

\$29.95 Sugg. Retail

Gain 4.46 over isotropic  
Power Capacity 2KW  
Lightning protection D.C.  
Ground  
V.S.W.R. 1.2:1  
Length 12 Ft.  
Diameter 30 in.

*Free 16 page color catalog*

**Write: Avant R & D, Inc.**  
35 W. Fullerton  
Addison, Illinois 60101

**avanti**  
RESEARCH AND DEVELOPMENT, INC.

creators of the  
famous



CIRCLE NO. 11 ON PAGE 17 OR 103



# Could've been the mike



It happens. A good rig gets condemned when it's not at fault. The set can have plenty of carrier power, but it's just not getting enough modulation input. Without modulation, a set can't punch out a readable signal for any distance.

The answer? A Turner amplified mike. Here's what a few CB'ers that have switched say: "Everybody I talk to says I have the clearest talkin' set in the valley . . . I can set the dial at three, transmit as far as 50 miles, and almost knock my wrecker driver out of his truck . . . This (+3) was a real boost to my set . . . The +2 gives me maximum modulation with low voice effort . . . Like getting a new radio. Great improvement . . ."

A green one would match my interior better . . . Makes a noticeable difference . . . You guys make a helluva good mike . . ."

Find out what they're all talking about. See a Turner dealer, or write to Turner, 909 17th St. N.E., Cedar Rapids, Ia. 52402

## TURNER MICROPHONES



**+2**  
\$60 list

**+3**  
\$75 list

**Super  
Sidekick**  
\$80 list

**CONRAC  
CORPORATION**

CIRCLE NO. 24 ON PAGE 17 OR 103

# The great new **Super Scanner**

It scans 360° in milliseconds with 5.75 dB gain. Or beams an 8.75 dB gain signal where and when you want it—**instantaneously.** (Otherwise, it's just another beautiful base antenna.)

MODEL MS-119 Super Scanner electronic beam, incl. control console—sugg. price, ~~199<sup>95</sup>~~

**the antenna specialists co.**

Division of ORION INDUSTRIES, INC.  
12435 Euclid Ave., Cleveland, Ohio 44106  
Export: 2200 Shames Dr.,  
Westbury, L.I., New York 11590  
Canada: A. C. Simmonds & Sons, Ltd.

CIRCLE NO. 5 ON PAGE 17 OR 103

## EXPERIMENTER

International EX Crystal and EX Kits

OX OSCILLATOR

**\$2<sup>95</sup>**



**OX OSCILLATOR** Crystal controlled transistor type. Lo Kit 3,000 to 19,999 KHz Hi Kit 20,000 to 60,000 KHz (Specify) **\$2.95**

**MX-1 TRANSISTOR RF MIXER** A single tuned circuit intended for signal conversion in the 3 to 170 MHz range. Lo kit 3-20 MHz. Hi kit 20-170 MHz. **\$3.50**

**SAX-1 TRANSISTOR RF AMP.** Amplifier to drive MX-1 mixer. Lo kit 3-20 MHz. Hi Kit 20-170 MHz. **\$3.50**

**PAX-1 TRANSISTOR RF POWER AMP.** A Single tuned output amplifier to follow the OX oscillator. 3,000 to 30,000 KHz **\$3.75**

CIRCLE NO. 19 ON PAGE 17 OR 103

EX CRYSTAL

**\$3<sup>95</sup>**



**EX CRYSTAL** Available from 3,000 KHz to 60,000 KHz. Supplied only in HC 6/U holder. Calib. is  $\pm 0.2\%$  when operated in International OX circuit or its equivalent. (Specify frequency) **\$3.95**

**BAX-1 BROADBAND AMP.** May be used as a tuned or untuned amplifier in RF and audio applications 20 Hz to 150 MHz. **\$3.75**



**INTERNATIONAL**  
CRYSTAL MFG. CO., INC.  
10 NO. LEE • OKLA. CITY, OKLA. 73102

Write for **FREE** Catalog

## HEY, LOOK ME OVER

icals, tools, drafting aids and kits. Get all the facts by writing directly to GC Electronics, 400 So. Wyman, Rockford, IL 61101.

### The Tune is Light!

Radio Shack's new high-intensity timing light kit lets you check ignition timing, synchronization of double-breaker arms, automatic spark advance and distributor cam wear to keep any 4, 6, or 8-cylinder, 6 or 12 volt engine running its best. The Archerkit Timing Light kit can be assembled in an evening. It has a



powerful 600-volt flashtube that delivers up to 1250 flashes per minute that are bright enough to be seen in daylight. The timing light features a built-in DC power supply, high-impact case with trigger switch and includes insulated clips, cables and spark plug adapter. The kit is priced at \$19.95. Archerkit automotive accessory and hobby kits are available at more than 1800 Radio Shack and Allied Radio Stores. For more information and complete catalog, circle No. 32 on Reader Service Coupon.



ELEMENTARY ELECTRONICS



# ELEMENTARY

● The Editor of ELEMENTARY ELECTRONICS offers readers an easy way to get additional information about products and services advertised in this issue. Just follow the instructions below and the material you requested will be sent to you promptly and at no cost..

# ELECTRONICS

● The coupon below is designed for your convenience. Just circle the numbers that appear next to the advertisement that interests you. Then carefully print your name and address on the coupon. Cut out the coupon and mail to: ELEMENTARY ELECTRONICS, Box 886, Ansonia Station, New York, N.Y. 10023. Do it today!

# READER SERVICE PAGE

MARCH/APRIL 1974

Void after AUGUST 15, 1974

## ELEMENTARY ELECTRONICS

Box 886, Ansonia Station, New York, N.Y. 10023

Please send literature for the numbers I have circled. I understand this is a free service.

1	2	3	4	5	6	7	8	9	10	11	12	13
14	15	16	17	18	19	20	21	22	23	24	25	26
27	28	29	30	31	32	33	34	35	36	37	38	39

Do you now own Police/Fire/Aero receiver(s)? 50  Yes 49  No

If your answer is yes, please check appropriate box:

45  Mobile 46  Base 47  Portable 48  Used in your work

Are you a subscriber to this magazine? Yes  No

51  Enter my subscription for 9 issues at \$3.97 and bill me.

Name (Print Clearly) \_\_\_\_\_

Address \_\_\_\_\_

City \_\_\_\_\_

State \_\_\_\_\_

Zip Code \_\_\_\_\_

# Discover the ease and excitement of learning Electronics with programmed equipment NRI Sends you

When you train at home with NRI, you train with your hands as well as your head. You learn the WHY of Electronics, Communications, TV-Radio the NRI pioneering "3-Dimensional" way. NRI training is the result of more than half a century of simplifying, organizing, dramatizing subject matter, and providing personal services unique for a home study school. You get the kind of technical training that gives you priceless confidence as you gain experience equal to many, many months of training on the job.



*NRI—The Leader in Electronics Training for more than Fifty Years*

## APPROVED UNDER NEW GI BILL

If you served since January 31, 1955, or are in service, check GI line in postage-free card.

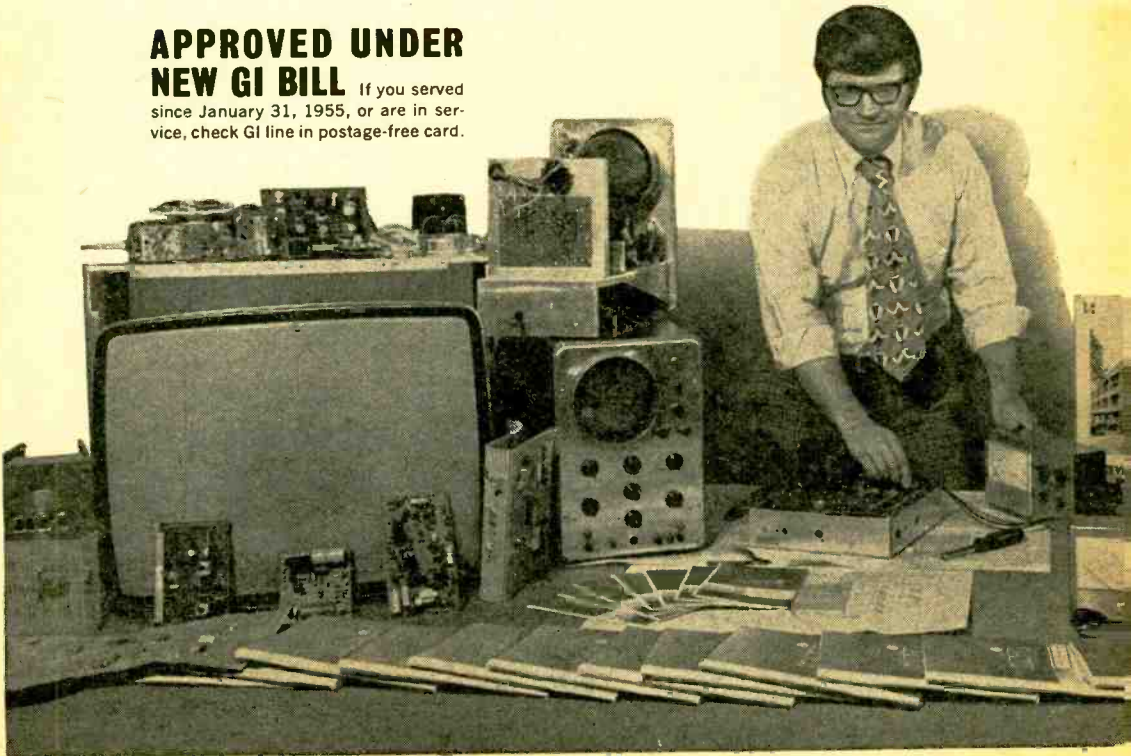



*Earn \$5 to \$7 an hour  
spare or full time in*

## **TV-RADIO SERVICING**

Color television sales are soaring. And so is the demand for trained repairmen. If you can service TV sets, portable radios, tape recorders, hi-fi sets, phonographs and auto radios, you'll always be in demand. It's one of your best routes to spare-time earnings, a good paying job or a business of your own. NRI trains you quickly and expertly, showing you how to get started in servicing soon after you enroll, earning as you learn. NRI trains you in today's method of installing and repairing all electronic equipment for the home—including solid state Color TV. You even build, experiment with and keep to enjoy your own solid-state radio plus your choice of black-and-white or the new 25" solid state Color TV receiver NRI developed from the chassis up for training. Like thousands of others, you can soon be earning good money in your spare time . . . the easy NRI way.

*There's money and  
success awaiting you in*

## **BROADCASTING— COMMUNICATIONS**

The experience you gain from intensely practical NRI training in Complete Communications equals as much as two years of training on the job. With NRI, you can train for a choice of careers ranging from mobile, marine and aviation radio to TV broadcasting and space communications. You learn how to install, maintain and operate today's remarkable transmitting and receiving equipment by actually *doing* it. You build and experiment with test equipment, like a VTVM you keep. You build and operate amplifier circuits, transmission line and antenna systems, even build and use a phone-cw transmitter suitable for transmission on the 80-meter amateur band. Whichever of five NRI Communications courses you choose, you prepare for your FCC License exams, and *you must pass your FCC exams or NRI refunds your tuition in full.*

## *Move ahead in America's fast growing industry as* **ELECTRONICS TECHNICIAN**

Electronics touches everyone's lives. This vast field of opportunity is open to you with NRI training. Industrial/Military Electronics training—like all NRI courses—prepares you quickly, thoroughly the practical "hands on" way. You build with, and learn to understand the functions of, today's miracle solid-state components like printed circuits, diodes and transistors. You build and experiment with Electronic circuitry used in automation, data processing, ultrasonics, telemetry. Bite-size texts make studying easier. Whatever your interest in Electronics, NRI training can fill your needs. Prove to yourself what nearly a million NRI students could tell you . . . that you get more for your money from NRI. Check the postage-free card and mail it today for your FREE NRI Color Catalog. NO SALESMAN WILL CALL. NRI Training, 3939 Wisconsin Ave., Washington, D.C. 20016.

# **YOU GET MORE FOR YOUR MONEY FROM NRI**



## **NRI Kits and Equipment**

Dollar for dollar, you get more value from NRI training kits, because they are designed as educational tools. In the TV-Radio Servicing Course, for instance, the end product is a superb 25" color TV your whole family will enjoy. The set is designed so that, while building it, you can introduce and correct defects . . . for trouble-shooting and hands-on experience in circuitry and servicing. The kits include, at no additional cost, a wide-band service type oscilloscope and color crosshatch generator, and other valuable equipment that will let you start earning money in your spare time making repairs . . . even before the course is completed.

# 7 WAYS TO HELP YOU EARN MORE MONEY.

Now you can get started in one of these 7 careers, at home in your spare time. It's easier than you may think. Let ICS send you a free career guide and free demonstration lesson to prove it.

- 1. Accounting.** Salaries for trained men at all-time high. Work as an auditor, staff accountant, etc.
- 2. Air Conditioning.** Skilled mechanics in demand. Earn up to \$7 an hour.
- 3. Electrician.** Work in Construction, Industry, or Utilities. Hourly pay among highest in the building trades.
- 4. Business Management.** As business expands more trained managers and supervisors will be in demand.
- 5. Engineering.** Specialize in Civil, Mechanical, Chemical, Industrial or Electrical Engineering. Enjoy high salaries and satisfaction.
- 6. TV Servicing.** Salaries to \$6.50 an hour—or start your own business and earn even more.
- 7. Automotive.** Skilled mechanics are in demand. Average \$5 an hour.

© 1973 ICS

**ICS** International Correspondence Schools  
Scranton, Pa. 18515

Yes I want a free career guide and free demonstration lesson for the field checked above. I am under no obligation. XA667P

Name \_\_\_\_\_ Age \_\_\_\_\_

Address \_\_\_\_\_ Apt. No. \_\_\_\_\_

City \_\_\_\_\_

State \_\_\_\_\_ Zip \_\_\_\_\_

APPROVED FOR VETERANS TRAINING



BOOKMARK  
BY BOOKWORM

*Power Problems? Troubleshooting Solid-State Electronic Power Supplies* describes both the operation of, and the troubleshooting techniques for, many types of power supplies. Beginning with the very basic types, the content progresses to complex supplies using semi-

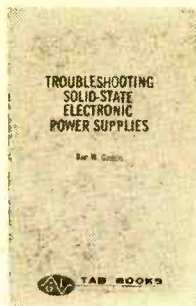

Soft cover  
208 pages  
85 illustrations  
\$4.95

conductor regulators. Without mathematics, and in clear language, the book proceeds through various levels of increasing complexity, from the most basic to the most sophisticated circuits. For the experienced technician, this book will serve to extend his knowledge. For the beginner—even one who has no knowledge of electron tube circuits—this volume will serve as a springboard directly into solid-state circuitry. Want more facts on this book and others by Tab Books? Then circle No. 162 on the Literature Library Coupon on page 98.

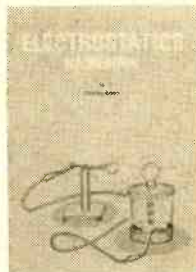

Soft cover  
128 pages  
\$4.25

*All Charged Up.* Here's a new and completely up-to-date book filled with the history and evolution of one of the great natural forces—*Electrostatics Handbook* by Charles Green. Static electricity is awesome in the form of lightning, annoying in the form of a small electric shock, and fun when put to use in projects. Each chapter of this book includes

(Continued on page 95)

ELEMENTARY ELECTRONICS



**MORE BARGAINS IN SURPLUS ELECTRONICS from B & F ENTERPRISES**  
 Just off the press our Best Catalog yet with 104 illustrated pages of surplus Electronics, Optics, and Much More...

**DIGITAL CLOCK CHIP**

These large scale integrated (LSI) chips eliminate 14 to 20 MSI TTL chips in the design of an electronic clock. Features 12 or 24 hour operation, 6 digits, internal multiplexing, operated on 50 or 60 Hz input, or a schematic is provided for crystal control. Logic gates between the counter allow setting at the rate of one hour digit per second, or, one minute digit per second. A "hold" input allows stopping the chain. The multiplexer samples the outputs of the hours, minutes and seconds counters (in the six digit model), routing this data to a programmable read only memory (ROM), which is programmed to provide BCD and seven segment outputs. All outputs are compatible with bipolar devices, necessitating few external components for the display interface. Only one power supply is required for operation.

- 5314 chip (24 pin plastic) used for 7 segment displays such as LED's, minitrons, minitrons and Sperry displays. Price \$9.95
- 5311 chip (28 pin ceramic) includes BCD output to allow for interface to mixers, computer inputs, etc., in addition to 7 segment outputs. Price \$14.95

**1/4-Watt RESISTOR ASSORTMENT!!**



Brand-new 5% tolerance resistors, individually bagged 5 to a bag, each bag marked with values. 70 different values, 10 ohms to 10 megohms in a 1, 5, 22, 33, 47, 68, 1 sequence. A complete laboratory supply of resistors at less than 5 cents apiece.

Sh. Wt. 2lbs	1/4WRA	\$15.00
4 bags for \$55.00	1/4WRA	\$55.00/4

**KEYBOARDS:**



Teletype format ASCII coded keyboard, with parity check line (see fig. A). Coding is by means of a built in diode matrix, which can be modified from ASCII by inserting or removing diodes. Keys are 26 characters, all numbers, plus shift, ctrl, alt, line feed, car return, rept, brk, rub out, hase is, and usual typewriter symbols. Mfr controls research and microswitch. Requires +5 volts. TTL circuitry, compatible with DTL or TTL. 52 keys; 3 integrated circuits, about 200 diodes. Brand new, guaranteed. 15 pin connector. On 10" cable. Price \$44.50

- KB-01 Non-decoded alphanumeric keyboard, Figure "C", single form, SPST contact on each key. Price \$24.50
- KB-3 Figure "D", calculator keyboard in calculator case, pressure sensitive elastomer contacts, manufactured for Arias. Price \$9.50
- KB-4 Touch-tone keyboard, Figure "E", manufactured by Chromerics. No electronics included. Price \$9.00
- KB-5 Desk calculator keyboard, Figure "F", manufactured by Controls Research. Price \$15.75

**RT 270A/GRC TRANSCEIVER**

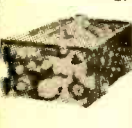

This is a prime government surplus item, until recently in scarce supply and selling for hundreds of dollars. Consists of a double console, VHF/UHF receiver-transmitter and a FM transmitter linked thru a common antenna circuit. Range is 47 to 58.4 MHz continuous. Size is 7/8 x 4 3/16 x 12-15/16. Built-in calibrator and beat oscillators permit fast alignment.

- RT 270A/GRC New, including 1 MHz crystal \$35.00
- RT 2700A/GRC Used, excellent, less crystal \$20.00
- \*\*\* 1 MHz crystal only \$5.00

**TRANSISTORIZED FLUORESCENT CAMPING/EMERGENCY LIGHT KIT!**



This transistor inverter-powered camping and emergency light will provide a bright portable light from a 12-Volt D.C. battery. A cigarette lighter adapter is provided for automotive operation, or the unit may be run from other 12-Volt lantern batteries. The advantages of this unit over more conventional incandescent lamps is the vastly greater light output for equivalent power input and the superior distribution and color of the light. The camping/emergency light is enclosed in a weather-tight plexiglas tube, with the electronics built into the tube. Completion time should be less than two hours, making it a nice evening's project, even for the beginner. Sh. Wt. 3 lbs. Price \$12.50

**ATTENTION MANUFACTURERS -- LED RIOT!**

B & F has bought over 500,000 7-segment LEO numeric displays and over 1,000,000 LED lights. These are available in manufacturing quantities for immediate delivery.

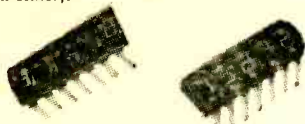

**5082 - 7400 SERIES DIGITS FROM HEWLETT PACKARD**

Hewlett Packard, one of the world's largest manufacturers, has sold us his surplus of multiple digit clusters with one bad digit per cluster. They were for use in the HP35 calculator, 870A DVM, and other products. The remaining digits are guaranteed perfect in all respects and are intensity graded (marked on the back with letters A thru F) and matched, so that several strips can be combined and still result in a perfect match. These monolithic GaAs displays require as little as 7 mW per digit, are highly readable at arm's length, and lend themselves well to hand-held portable applications.

Applications include hand-held calculators, digital thermometers, stopwatches, darkroom timers, DVM's, clocks and watches, or any other product requiring low cost, low power, long lifetime indicators.

The unit is common cathode, set up for multiplexed operation. Two decimal point styles are available; center decimal for PN 7804/05, and right decimal for PN 7814/15, as illustrated. The following configurations are available, where "B" represents a perfect digit, "X" a nonfunctioning digit:

X8888	7405-1 or 7415-1	X888	7414-1
8X888	7405-2 or 7415-2	8X88	7414-2
88X88	7405-3 or 7415-3	88X8	7414-3
888X8	7405-4 or 7415-4	888X	7414-4
8888X	7405-5 or 7415-5	8888X	7556-1

All products are available at the following price rate:

1 - 24 digits	\$1.875/digit
25 - 99 digits	\$1.50/digit
100 - 499 digits	\$1.25/digit
500 - 999 digits	\$1.00/digit

Higher quantity price on request.

For the following applications we recommend the following configurations:

Pocket calculators: 7405-1 & 7405-5, which results in X8888888X, eight consecutive perfect digits @ \$1.875 = \$15.00.

Recommended Calculator chips:  
 Nortec 4204 @ \$19.75 (\$15.00 when ordered with displays).  
 Caltex 5005 @ \$9.75 (\$7.50 when ordered with displays).

Clocks: 7405-3 & 7556-1, which results in 88X88X88X, six perfect digits at \$1.875 = \$11.25.

Recommended clock chips:  
 National MM5314 @ \$8.75 (\$7.50 ordered with displays).  
 National MM5316 @ \$19.75, includes alarm, (\$15.00 ordered with displays).

For only hours and minutes, order 7405-3 only.  
 Digital thermometers, DVM's, stopwatches, darkroom timers, frequency counters, etc., order 7415-1 or 7415-5 for four digits (\$7.50) or 7414-1 or 7414-4 for three digits (\$5.60).  
 Use Solitron CM 4102AE 3 1/2 digit counter decoder @ \$19.00, (\$15.00 ordered with displays).

Schematics for calculators, clocks and counters using these components free with order.

**LED SOLID STATE LAMPS**



Plastic encapsulated gallium arsenide phosphide light emitting diodes. Designed for low power consumption, as low as 8 milliwatts. Red diffused lens.

10 pcs. . . . .	\$2.00	100 pcs. . . . .	\$19.00
		1000 pcs. . . . .	\$100.00

Higher volume prices on request.

**SUPER QUALITY I.C. SOCKETS**



Sockets made by T.I. and Cinch. All are low-profile, compact types.  
 14 Pin Dip Solder Tail Sockets  
 3 for \$1.25 16 for \$5.00  
 16 Pin Dip Solder Tail Sockets  
 2 for \$1.00 13 for \$5.00  
 14 Pin Dip Gold Wire Wrap Socket  
 2 for \$1.25 10 for \$5.00  
 16 Pin Dip Gold Wire Wrap Socket  
 2 for \$1.50 8 for \$5.00  
 10 Pin to 5 Gold Sockets (Cinch)  
 2 for \$1.00 13 for \$5.00

New available 24, 28, & 40 Pin sockets Only \$1.00 ea.

Larry Steckler, Editor Radio-Electronics

Dear Larry,  
 Due to a variety of circumstances in past months, some customer orders, refunds and exchanges have been lost or otherwise "misad". I would like to take this opportunity to point out that we have now solved our internal difficulties to the point where we can and will take immediate action on any such complaints. Any such complaints have no problem can be assured prompt action by writing to Ms. Lynn Chase, Customer Relations Director, B & F Enterprises, 119 Foster St., Peabody, Massachusetts, 01960.

Without making excuses, I think some of your readers might be interested in the changing nature of the "surplus" business, which I believe we were instrumental in changing. In early 1970 electronic manufacturers were in the doldrums, due to the changover from military to commercial business. Items (particularly TTL integrated circuits and other semiconductor items) were sold to original equipment manufacturers, (OEM's) at a fraction of catalog price, to stimulate business. This prompted us to negotiate directly with manufacturers for large quantities of items at low cost, and to offer these to hobbyists and electronic experimenters who buy in small quantities, at a fraction of catalog price. This was the element that revolutionized the surplus business, and we became more "cut-rate distributors" than "surplus dealers".

There were some problems, though. First, the commercial business took a wild upswing, and manufacturers who were begging us to accept products suddenly found they couldn't supply enough material, and deliveries became slow or non-existent. Second, with slow deliveries, the amount of paperwork and handling to ship orders in two or three partial shipments became overwhelming. With a small mark-up on sales, it simply was impossible to devote much time to correspondence. Third, quite frankly, was that Pat and myself as engineers, were not used to the problems of inventory control and shipping management. And our rate of growth, while still good, is at a sufficiently slow pace now so that we can solve problems as we encounter them. As a parting word, I would like to say that we are interested in getting feedback from readers on these matters. What would you like to see us carry? We welcome any other comments that will help us improve service. Thank you in advance.

At the present time, I truly believe we have our problems solved, and can offer our customers both good service and low prices. We have been shipping all stock items within 48 hours. We have refrained from advertising any items not in good inventory. And our rate of growth, while still good, is at a sufficiently slow pace now so that we can solve problems as we encounter them. As a parting word, I would like to say that we are interested in getting feedback from readers on these matters. What would you like to see us carry? We welcome any other comments that will help us improve service. Thank you in advance.

Very truly yours,

*Franklin G. Fink*  
 Franklin G. Fink, Partner  
 B & F Enterprises

**NEW - COSMOS INTEGRATED CIRCUIT**



Said to be the "New Wave" in integrated circuits of the future. Ultra low power drain (microwatts)

<input type="checkbox"/> 4000AE	Dual 3 Input Nor & Inv	\$ .99
<input type="checkbox"/> 4001AE	Quad 2 Input Nor	\$ .99
<input type="checkbox"/> 4002AE	Dual 4 Input Nor	\$ .99
<input type="checkbox"/> 4006AE	18 Stage Static Shift Register	\$4.99
<input type="checkbox"/> 4007AE	Dual Complementary Pair & Inv	\$ .99
<input type="checkbox"/> 4009AE	Hex Buffer, Inverting	\$2.19
<input type="checkbox"/> 4010AE	Hex Buffer, Non Inverting	\$2.19
<input type="checkbox"/> 4011AE	Quad 2 Input NAND	\$ .99
<input type="checkbox"/> 4012AE	Dual 4 Input NAND	\$ .99
<input type="checkbox"/> 4014AE	8 Stage Static Shift Register	\$5.99
<input type="checkbox"/> 4017AE	Decade Counter W/Decoder	\$5.99
<input type="checkbox"/> 4020AE	14 Stage Binary Ripple Counter	\$5.99

Send in an order and get on our special customer Mailing List.

CATALOG: Check reader's card or write.  
 ALL ITEMS (WHERE WEIGHT IS NOT SPECIFIED) POSTAGE PAID IN THE U.S.A.  
 CHARGES WELCOME!

Phone in charges to 617 531-5774 or 617 532-2323. BankAmericard MasterCard. \$10.00 minimum. No C.O.D.'s please.

**B.&F. ENTERPRISES** Mass. 01960  
 Phone (617) 531-5774  
 119 Foster Street  
 Peabody, Mass. 01960

CIRCLE NO. 27 ON PAGE 17 OR 103

# DX central reporting

A world of SWL info!

BY DON JENSEN

□ WYFR is the newest, yet one of the oldest, shortwave broadcasting stations in the United States. By now maybe you've already heard the station's religious programs while tuning the bands.

The call letters are new. They first were heard last October 20, when Family Stations, Inc., Oakland, California, purchased WNYW, Radio New York Worldwide from Bonneville International, another religious corporation owned by the Mormon Church. Before that, the Family Radio programs, produced by Family Stations, Inc., had been aired on WNYW on a time-purchase basis since January 1973. The station's sale had been

rumored for many months.

Family Stations also runs a string of Gospel format FM outlets in San Francisco, Sacramento and El Cajon, California, Newark and Camden, New Jersey, and in Annapolis, Maryland. The corporation has applied for an AM station in Cambridge, Massachusetts.

Though the Family Radio programs are produced in studios in Oakland, the shortwave transmitters of WYFR remain where they have been for years, on a 28-acre site at Scituate on Massachusetts' Atlantic coast.

New, but old, that's WYFR. The beginnings of this private SWBC station really date to the end of World War I, when a young naval lieutenant, Walter Lemmon, was assigned to accompany President Woodrow Wilson to the Paris Peace Conference.

Lemmon returned from Paris with an idea, the idea of using shortwave radio for cultivating international broadcasting. He called it a university of the air. But it wasn't until 1931 that Lemmon received an experimental broadcasting license for WIXAL.

The World Wide Broadcasting Foundation was formed in 1935, with grants from the Rockefeller Foundation and several other philanthropic sources. That led to the establishment of Radio Boston, WRUL. The call letters stood for World Radio University and in its day, WRUL was a broadcasting giant, with transmitters of 50 and 100 kilowatts. In 1939

QUALITY  
PERFORMANCE  
VALUE

## SBE

## CB AM MOBILE RADIO

**SBE CORTEZ—sweepingly new—brilliantly designed AM radio**

23 channels, no crystals to buy • Full 4 watts output • Advanced solid state w/FET's, I-C's • Sensitive, double conversion receiver • Panel metering: Power out/modulation; signal strength • "Anti-blast" AGC • Dynamic mic. w/plug/coil cord • Noise limiter with On-Off switch • Big audio—3WI • PA/Hailer provision • Operates 12VDC w/positive or negative ground • Compact!

Write for full line brochure



**LINEAR SYSTEMS, INC.**  
220 Airport Blvd. Watsonville, CA 95076

CIRCLE NO. 18 ON PAGE 17 OR 103

## SEMICONDUCTOR SUPERMART

**FREE CATALOG**

NAME BRAND—  
PRIME QUALITY  
SEMICONDUCTORS

- MOTOROLA
- FAIRCHILD
- NATIONAL
- RCA
- HEP
- SIGNETICS

Other Parts For Elementary Electronics Projects

**CIRCUIT SPECIALISTS CO.**

Box 3047 Scottsdale AZ 85257

**NEW!**

**CONVERT TV TO  
6 FT. WIDE SCREEN!**

**Easy Do-It-Yourself Kit**

Project a giant 5'x6' picture onto wall or screen. B&W/Color. Kit contains detailed plans, Inst., and Precision Lens System. Only \$12.95 ppd., or write for Free illustrated details. The Macrocoma Co., Dept. ID Washington Crossing, PA 18977



**Guaranteed to Work!**

## DO YOU OWN A LOW COST SCOPE? IMPROVE IT!

Professional results. By building an "Easy to Use Vista Kit".

All solid-state, using the latest op-amp IC's. Parts, controls, all semi-conductors, circuit board and instructions included.



**\$20.00 PREPAID  
U.S.A. & CANADA**

**Vista Trigger Sweep Generator**

PHOTOLUME CORPORATION  
BOX 139, NEW YORK, NY 10016



# Science Fair P-Box<sup>®</sup> kits have helped launch 1000's of careers in electronics



## Our "Goofy-Lite" kit is just one reason why

The "fun" kit—the low-voltage neon lamp flasher that's 100% safe to build and use—works on 6 VDC. Five lamps fire at random for a madness in motion effect or in sequence. Wire it with or without soldering. Like each P-Box, it includes instructions that let you learn as you build, molded Perfboard chassis and all parts. #28-130.

ONLY  
**5<sup>95</sup>**

*Here are 22  
more reasons why . . .*

- |                        |                       |
|------------------------|-----------------------|
| Light Transceiver      | Wireless AM Mike      |
| Electronic Organ       | Transistor AM Radio   |
| Electronic Metronome   | One-Tube AM Radio     |
| Telephone Amplifier    | 2-Transistor FM Radio |
| IC AM Radio            | 3-Transistor SW Radio |
| Voice Controlled Relay | Solar-Power AM Radio  |
| Electronic Thermometer | WWV Tuner-Converter   |
| Metal Locator          | 3-Way Code Oscillator |
| AC/DC Power Supply     | "OTL" Audio Amplifier |
| Siren Kit              | Light Operated Alarm  |
| Photo Night Light      | "Heads & Tails"       |

Retail price may vary at individual stores.

**Science Fair<sup>®</sup>**  
at  
**Radio Shack<sup>®</sup>**  
and ALLIED RADIO STORES  
A TANDY CORPORATION COMPANY

P.O. Box 1052, Fort Worth, Texas 76107

CIRCLE NO. 32 ON PAGE 17 OR 103



**FREE '74 CATALOG** 353  
**AT 2000 RADIO SHACKS OR  
MAIL THIS COUPON**

180 Pages . . . Full Color! Hi-Fi, CB, Kits,  
Recorders, Antennas, Parts. More!

PLEASE PRINT CLEARLY

Name \_\_\_\_\_ Apt. # \_\_\_\_\_

Street \_\_\_\_\_

City \_\_\_\_\_ State \_\_\_\_\_ ZIP

# PACE makes another BREAK THROUGH



## 23 CHANNEL CB TRANSCEIVER

- ALL crystals supplied
- 5 Watts of Transmit
- Pace plus modulation
- Ceramic microphone
- Locking latch rack

## Pace Model 223

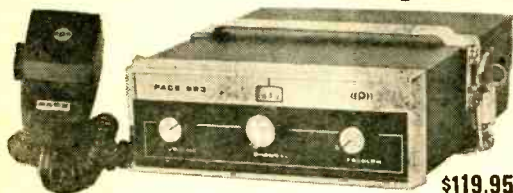

**\$119.95**

From the PACE U. S. Engineering Team that introduced the first all transistor CB transceiver, the Model 223 offers another breakthrough in both Price and Quality. Taking advantage of U. S. mass production techniques and engineering knowhow, the PACE Model 223 provides the truly great bargain for today's CB operator who wants performance and price with the quality guarantee of a U. S. manufacturing firm. With a NO compromise design approach the PACE engineers built a double conversion receiver with a full 6 section tuned filter network for maximum receiver performance even under adverse conditions - we can guarantee performance for 2 years because we shake every one in the roughest QC test procedure ever designed for 2 way radios.

If you compare before you buy you'll join the Proud Pace owner's club!

## ((P)) PACE COMMUNICATIONS

Division of PATHCOM INC. 24049 South Frampton Ave.  
Harbor City, California 90710 • (213) 325-1290  
Export: 2200 Shames Drive, Westbury, New York 11590

CIRCLE NO. 21 ON PAGE 17 OR 103

## DX CENTRAL REPORTING

the station was moved from Boston, some 20 miles southeast to Scituate.

The station was widely listened to in Europe and the Middle East during World War II. After the war, in 1951, new studios were established in New York City, and a commercial broadcasting firm, Metromedia, bought station WRUL.

In the early '60s, the station again changed hands when it was purchased by Bonneville International. It was in 1966 that the 30-year-old call was changed to WNYW, Radio New York Worldwide. And it remained WNYW until October.

The station has four transmitters of 50 and 100 kilowatts, but reportedly there are plans to add a fifth. WYFR has been using the following frequencies at various times of the day, 11,805, 15,130, 17,755, 17,760, 17,845, and 21,525 kHz.

Reception reports may be sent to WYFR, Family Radio, 290 Hegenberger Road, Oakland, California 94621.

**Tip Topper.** This month's featured station is *Radio Vila*, certainly one of the hardest to hear of the Pacific stations. Every now and again, though, DX Central spotlights a bit of ultra-DX to really challenge our more experienced SWLs.

Radio Vila is located on one of a curious group of Pacific islands known as the New Hebrides. The odd thing about the New Hebrides is that they are jointly administered, condominium fashion, by two countries, France and Great Britain.

With two separate but parallel governments, it's a wonder that things get done at all. But when it comes to broadcasting, at least, they do. It is the British, it seems, who operate Radio Vila, a small station running only two kilowatts of power on 3,945 kHz.

The station's home until about a year and a half ago was a tiny, cluttered building, only 11 by 30 feet in size. At last word, operations were being carried out from a somewhat larger facility in the local high school, pending construction of a new building. It employs only four full-time staffers.

Why is Radio Vila so hard to hear? The low power is one reason. A second factor is the frequency, smack-dab in the middle of the QRM-riddled 80 meter ham band. And, thirdly, its schedule is such that you'd better resign yourself to losing some post-midnight shuteye.

You've got an edge if you live west of the Rockies, but Radio Vila has been logged, on occasions, in the midwest and eastern states. Best time to tune seems around 0830 GMT. Lotsa luck!

**Bandsweep.** (Times in GMT, frequencies in kHz) 1205—An African medium wave outlet heard in the midwest? Right! A sharp DXer in Belleville, Illinois, recently logged the *Sierra*



*Leone Broadcasting Service* station with rather good signals at 0600 sign on . . . **2428**—A new station just heard on the west coast is *Radio New Ireland*, one of a series of stations operated by the Administration Broadcasting Commission of Papua and New Guinea Territory. This difficult catch was made just prior to 1100 sign off . . . **5015**—The former Windward Islands Broadcasting Service at St. George's, Grenada in the West Indies now goes by a different name. Look for *Radio Grenada's* English programs around 0030. QRM may be difficult at times . . . **6110**—Some DX Central fans have written to ask where they can find the American Forces Radio and TV Service, our country's voice to GIs overseas. Listen around 1300 for AFRTS, aired by the *Voice of America* facilities at Delano, California . . . **9645**—Here's a Latin American station for SWLs who shy away from Spanish language broadcasts. TIFC in San Jose, Costa Rica, has English religious broadcasts at 0300 . . . **9570**—Here is how you can log three East European stations in an afternoon and evening, all broadcasting in English. First try this frequency at 2000 for Romania's *Radio Bucharest* . . . **9700**—Next, a few hours later at 0000, listen for *Radio Sofia, Bulgaria* . . . **9833**—And finally, *Radio Budapest, Hungary* can be found on this spot at 0300 . . . **15435**—Finally, on our bandsweep, here's *Radio Tanzania*, Dar es

Salaam in East Africa. A good time for listening is 1945, when you'll find English programming.

(Credits: Roger Giannini, IL; Bill Sparks, CA; William Paschke, WI; Bill Britton, FL; Bob Zilmer, WI; Jack Jones, MS; National Radio Club, Box 127, Boonton, NJ 07005; SPEEDX, Box 321, Santa Ana, CA 92702; North American SW Assn., Box 8452, S. Charleston, WV 25303.)

**Backtalk.** Digging into the mailbag, I've got a letter here from George Overby, St. Paul MN, who began DXing about 50 years ago.

"In the early days of radio," George writes, "some medium wave stations verified reception reports with what were called EKKO stamps, with their call letters printed on them. Recently I discovered I still have some of these verification stamps. Are there others who collected them way back then? What monetary value would they have today?"

EKKO stamps, a unique sort of verification from the past, are still well remembered by longtime MW DXers. And there are a number of listeners, I know, who still have their collections of EKKOs tucked away for safekeeping. Value is a matter of supply and demand. There might be enough radio nostalgia buffs to create a demand, George, but I've never heard of anyone willing to part with his EKKO collections.

(Continued on page 108)

# All-New Lightweight Heavyweight

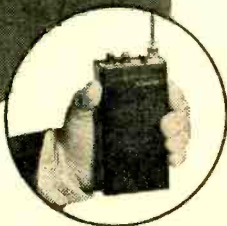

Put Midland's newest high-performance 4-channel POCKET SCANNER on your belt and keep in touch with what's happening.

Look what it has for you. Operation on economical "AA" penlight or nicad cells (external power and charger jacks too). Telescopic and wire antennas, or use optional rubber antenna. Manual or automatic operation with a Channel 1 bypass switch. Wide range 150-170 MHz VHF high band dual conversion superheterodyne receiver with squelch. Even an earphone jack. It's Midland's Model 13-904 and includes a holster-style carrying case—at your Midland dealer.

**MIDLAND**  
ELECTRONICS COMPANY®

Write for Free Midland Scanner Brochure  
P.O. Box 19032, Kansas City, Missouri 64141

CIRCLE NO. 20 ON PAGE 17 OR 103

# 4 Money-saving reasons to buy EICO's Solid State Test Equipment.



**EICO 242 FET-TVOM.** Peak-to-peak measurements of AC volts and milliamps. 6 1/2" meter. 7 non-skip ranges. High input impedance. Low 1 volt scale. DC/AC Multi-Probe. AC or battery operated. Kit \$79.95, Wired \$109.95.

**EICO 330 RF Signal Generator.** 5 bands cover a range from 100 kHz to 54 MHz. Calibrated modulation adjustment control. 400 Hz audio output. Provision for modulating RF with internal or external signal source. Kit \$64.95, Wired \$99.95.

**EICO 379 Sine/Square Wave Generator.** Simultaneous sine and square wave outputs. Covers 20 Hz to MHz in five ranges. Low distortion sultzer feedback circuit. Square wave rise time better than 0.1 microseconds. Kit \$74.95, Wired \$109.95.

**EICO TR-410 Triggered Sweep Scope.** 100% solid state. DC to 10MHz bandwidth. Sweep synchronized gate output. Z-Axis input. Use as vectorscope for color TV servicing. One probe for direct and 10:1 measurements. Wired \$429.95.

## FREE 32 PAGE EICO CATALOG

For latest catalog on Eico Solid State Test Equipment, Automotive and Hobby Electronics, Burglar-Fire Alarm Systems, Stereo, and name of nearest EICO Distributor, check reader service card or send 25¢ for fast first class mail service.

EICO, 283 Malta Street, Brooklyn, N.Y. 11207



CIRCLE NO. 2 ON PAGE 17 OR 103

# NEW 5-ELEMENT

## CB MINI-BEAM Model GA-5D

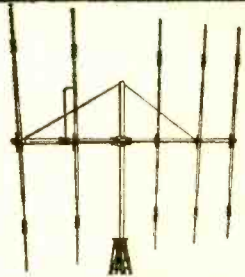

### 9.5db Gain .... 500 Watt Power Rating

The secret of success in this five-element miniature beam is in its coils. Ten High "Q" coils molded on each element-extension limit the mechanical size of the GA-5D without limiting its electrical capability.

These coils are built to take a powerful beating----in fact, the same coils are used in the construction of 10-meter amateur antennas. The GA-5D is lightweight. Erect on TV antenna mount and turn with an inexpensive TV rotor. Get all the facts: see your Dealer or write factory direct, Dept. 211-RTV

*Mosley Electronics Inc.*

4610 N. LINDBERGH BLVD., BRIDGETON MO. 63044

CIRCLE NO. 17 ON PAGE 17 OR 103



# ASK HANK, HE KNOWS!

## Beep, Are You There?

How does an FM radio-pager receiver work? —J.O., St. Louis MO

There are two basic types in use. One type issues a "beep" sound when actuated by a correctly coded signal. The other type issues a "beep" that is followed by a voice message. Both types of receivers contain a decoder that responds to a specific code transmitted by the FM base station. It's the decoder that switches on the beep signal when actuated and allows voice signals to pass.

## Clicks Alot

I can hear key clicks in my crystal headphones even when they are unplugged from the receiver. The most I ever push my transmitter is 300 watts. What's wrong? —J.S., Macon GA

Too much soup in the shack. Check all ground circuits. Use #12 copper or #10 aluminum ground wires from every appliance to ground. Also, check the SWR of your antenna system. If everything is okay, your transmitter is at fault. Do other hams comment on your key clicks? If so, you'd better find the problem quick.

## Paid too Much

I bought a twelve dollar warning system for my car. Whenever I back up a buzzer goes off, warning kids to get out of the way. Why don't you publish the plans for a project like this? It'll save lives.

—F.M., Franklin Square NY

Good idea. Use your ohmmeter to find the hot circuit that comes on when your car's back-up lights come on. Connect an ordinary 12-volt buzzer (value about \$1.50) to this circuit. Attach the buzzer to the trunk door. When the buzzer comes on, the entire door will pass the loud sound to the street for anyone to hear. No kidding—you spent twelve bucks?

## Socket to 'Em

Where can I get IC sockets? —L.M., San Diego CA

Visit your local parts distributor. Everybody is carrying them now. Lafayette, Radio Shack, Calctro and others. The IC supply picture is clearing a bit.



Hank Scott, our Workshop Editor, wants to share his project tips with you. Got a question or a problem with a project you're building—ask Hank! Please remember that Hank's column is limited to answering specific electronic project questions that you send to him. Sorry, he isn't offering a circuit design service. Write to:

**Hank Scott, Workshop Editor  
ELEMENTARY ELECTRONICS  
229 Park Avenue South  
New York NY 10003**

### The Tip Is Left

What is the standard for connecting left and right stereo channels to a stereo phono plug? I want to rewire a stereo headset?

—D.L., Denver CO

The metal tip on the stereo phono plug is for the left channel, the metal ring immediately behind the metal tip is for the right channel, and the remainder of the plug's shaft is common ground for both channels. I've never found a stereo headset wired incorrectly; however, many are not marked and can be worn backwards.

### Good Question

What is "type acceptance"?

—M.S., Bonners Ferry ID

When a transmitter has been type-accepted by the FCC, it means that the manufacturer has submitted documentary evidence to the FCC which certifies that the transmitter meets the technical standards established by the FCC. Type acceptance will become more and more important as the radio bands get crowded. Also, it helps to eliminate cheap equipment of inferior design.

### Pi in the Works

What value of  $\pi$  should I use in my electronic calculations?

—N.B., Seattle WA

I like 22/7 or 3.14. Better still, there's a little mark on my slide rule for  $\pi$ . I use that a lot. However, if you are in school, ask your teacher what value he wants you to use. In case you're fussy, use 3.14159265 for  $\pi$ . If you do, you'll be right on with significant figures.

### Oh Boy, Oh Boy

In the July-August 1973 issue of ELEMENTARY ELECTRONICS, the Cap Rapper requires T1, to be a low voltage transformer, 12.6 volts C.T., 120 mA. The article suggests using the Radio Shack 273-1505 which is not only too large for the board, but is rated at ten times the current needed by the circuit. Who blew it?

—J.M., Fairmont MN

Somebody on the editorial staff blew it. We suggest you try the Stancor P8362 or equiv. Forgive the editors, they try, and work hard! Most of the time they're right. ■

## NOW A PROFESSIONAL BURGLAR-FIRE ALARM SYSTEM YOU CAN INSTALL YOURSELF.



ONLY \$139.95

Save hundreds of dollars in alarm installation and monthly service charges. The EICO SS-500 "install-it-yourself" burglar-fire alarm system offers you the kind of professional protection you have been looking for, at a price you can afford. The SS-500 has been designed on the EICO "Expandability Concept" that enables you to "add-on" protection to meet your own special needs. Before you purchase any security system, we suggest you read the EICO Security Handbook and see how easy EICO makes it to "Do-it-Yourself."

### FREE EICO CATALOG/SPECIAL OFFER!

Security handbook (Reg. \$2.95) only \$1.50 with this ad. Includes a catalog on EICO Security Systems, Test Instruments, Stereo, Hobby Kits and name of nearest distributor. For catalog only, check reader service card or send 25¢ for first class mail service.

EICO, 283 Malta Street, Brooklyn, N.Y. 11207



CIRCLE NO. 2 ON PAGE 17 OR 103



- THE SHOPPING CENTER FOR ELECTRONICS (our catalog index of Mfrs extends from ADC to XCELITE)
- HOBBYISTS . . . EXPERIMENTERS . . . SERVICE TECHNICIANS . . . ENGINEERS •



Your Satisfaction is Our Target

Top Name Brands . . .  
Low Prices

AMPLE STOCKS—including those hard-to-find Parts

whether you want a 15¢ capacitor, a \$50 FET-VOM, or a \$450 stereo system—you can get it at EDI!

Send for your FREE catalog Today.



RUSH FREE CATALOG

Name \_\_\_\_\_

Address \_\_\_\_\_

City \_\_\_\_\_

State \_\_\_\_\_

Zip Code \_\_\_\_\_

**ELECTRONIC DISTRIBUTORS INC.**

Dept. TA-2, 4900 Elston

Chicago, Ill. 60630

CIRCLE NO. 12 ON PAGE 17 OR 103

# Put "Dyna-Mike" in your talkpower

Noise Limiter and Noise Blanker to cut down on your own and others' ignition noise and interference

CB/PA switch lets you use audio output to drive a PA horn

Extra-large illuminated meter

Modulation Light shows you're modulating to maximum

Transmit Light shows you're on the air



"Dyna-Mike"  
Gain Control  
for maximum  
modulation to  
cut through noise

Squelch  
threshold  
adjusts to  
below 1  $\mu$ V

Delta Tune helps you tune  
in off-frequency signals

Full audio output you can  
hear even over road noise

RF Gain cuts back strong  
signals when the skip is in

## PLUS...

Positive or negative ground operation, plug-in microphone, output for extension speaker and the quality that COBRA is famous for! Send for more details or see your dealer.

**COBRA & 29**  
**\$180<sup>00</sup>**

PRODUCT OF DYNASCAN CORPORATION • 1801 W. Belle Plaine • Chicago, Ill. 60613

CIRCLE NO. 29 ON PAGE 17 OR 103



Shortwave Listeners...

# Gain-A-Boost

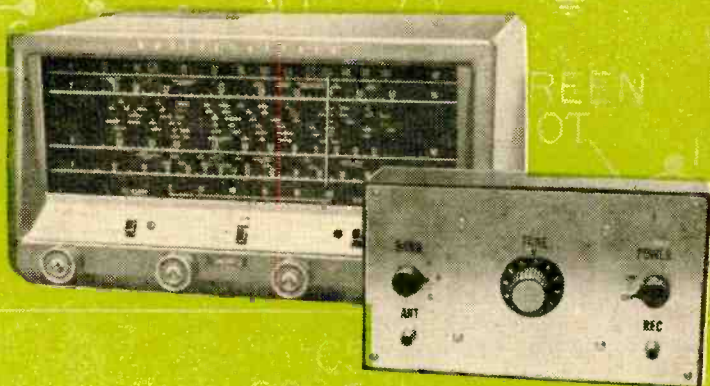

Try this three-band preselector in front of your receiver.  
 Full SWL band coverage from 1.7 through 36 megahertz

by Charles Green W6FFQ

**A** preselector is a tuned RF amplifier unit separate from the receiver. The preselector is tuned to the received signal to give a greater signal to noise ratio and a better image rejection. In the old days of ham radio and SWLs, commercial preselectors were available, but now the emphasis on compact solid-state shortwave receivers has nearly made the preselector a kin to the extinct dodo bird.

But many solid-state SW receivers have fairly broad tuning in their front ends and can use an additional stage of selectivity. Also, many older lower-priced receivers can use a bit more gain and an increased image rejection to dig out the DX stations.

Our preselector project will add both selectivity and additional gain to both SWL and ham receivers, as well as to the experimenter's home-constructed SW regen receivers. This preselector has a resistance-coupled output (the signal for your receiver is developed across R1) and can be connected to all types of receiver antenna input terminals and impedances.

*(Continued overleaf)*

# GAIN-A-BOOST

Normally, construction of a tuned RF amplifier is difficult for the average experimenter and SWLer. But our project uses an integrated circuit that is designed for IF or RF amplification with the equivalent of three transistors, two diodes and two resistors included inside its miniature package. It has low internal feedback that provides a highly stable amplifier for RF. This integrated circuit is the type 703.

The preselector project covers a frequency range of approximately 1.7 MHz to 36 MHz in three bands. A bandswitch is included for easy operation instead of plug-in coils. Construction is simplified by the use of commercial SW coils, so that you don't even have to wind coils.

With perf board and push-in clip construction used for easy building, most of the components mount on the board. This unit is an ideal first construction project for the novice. The preselector is built in a compact box with a battery power supply.

**About The Circuit.** Signals from the antenna at J1 are coupled via S1A to the primary winding of one of the antenna coils L1, L2 or L3; Band A (L1) is tuned by C1 from approximately 1.7 MHz to 5.5 MHz, Band B (L2) from 5.5 MHz to 18 MHz, and Band C from 12 MHz to 36 MHz.

S1B (ganged with S1A) connects C1 and the input circuit of IC1 to the secondary winding of the antenna coils where the signals are tuned. Amplified signals from IC1 are connected via C4 to the external SW receiver via J2. S2 controls the DC power to the IC1 circuits from B1. Capacitors C2, C5 and C3 act as RF bypass capacitors for the internal amplifiers of IC1, and R1 is the output load resistor.

**Construction.** The preselector is built in a 7 $\frac{3}{4}$ -in. long by 4 $\frac{3}{8}$ -in. wide by 2 $\frac{3}{8}$ -in. deep bakelite utility box with an aluminum panel. All of the components (with the exception of B1) are mounted behind the aluminum panel which provides some RF shielding for the circuits. Most of the components are installed on a 1 $\frac{1}{4}$ -in. by 3 $\frac{1}{2}$ -in. section of perf board with push-in clips for easy construction. Because of the high fre-

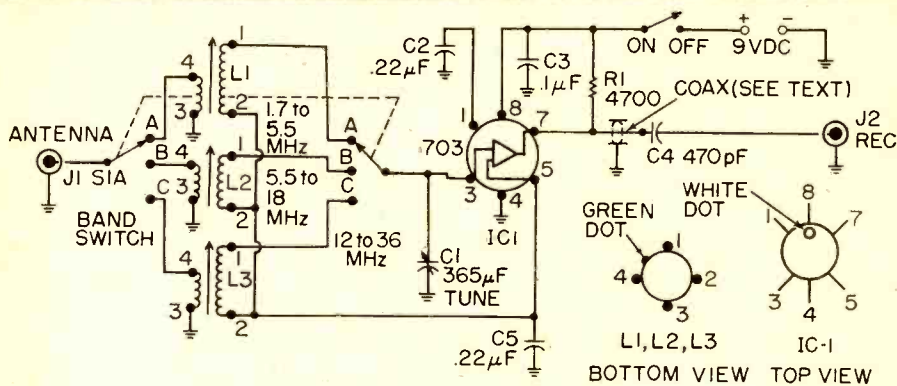

### PARTS LIST FOR GAIN-A-BOOST

- |  |  |
|--|--|
| B1—9-volt battery or DC power supply (see text)                                  | L2—5.5 to 18 MHz antenna coil (J.W. Miller C-5495-A)   |
| C1—365 pF miniature variable capacitor (Radio Shack 272-1341 or equiv.)          | L3—12 to 36 MHz antenna coil (J.W. Miller D-5495-A)  |
| C2, C5—0.22 $\mu$ F capacitor, 12 VDC or better (Radio Shack 272-1070 or equiv.) | R1—4700-ohm, $\frac{1}{2}$ -watt resistor (Radio Shack 271-000 or equiv.)  |
| C3—0.1 $\mu$ F capacitor, 12 VDC or better (Radio Shack 272-1069 or equiv.)      | S1A, S1B—2-pole, 3-position rotary switch (Mal-lory 3223J or equiv.)   |
| C4—470 pF capacitor, 12VDC or better (Radio Shack 272-125 or equiv.)             | S2—SPST rotary or toggle switch (Radio Shack 275-606 or equiv.)  |
| IC1—703-type integrated circuit (Radio Shack 276-008 or equiv.)                  | Misc.—Cabinet and metal panel 7 $\frac{3}{4}$ -in. x 4 $\frac{3}{8}$ -in. x 2 $\frac{3}{8}$ -in. deep (Radio Shack 270-232 or equiv.), perf board and push-in clips, $\frac{3}{4}$ -in. metal spacers, coax cable (RG-59A or equiv.), battery connector, knobs, wire, solder, etc. |
| J1, J2—Phono jacks (see text)  |  |
| L1—1.7 to 5.5 MHz antenna coil (J.W. Miller B-5495-A)                            |  |



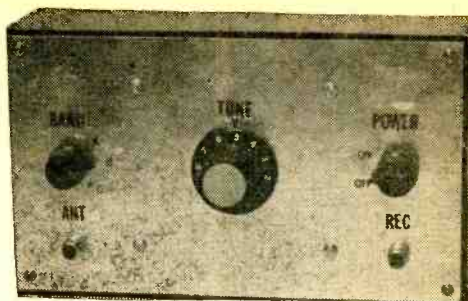
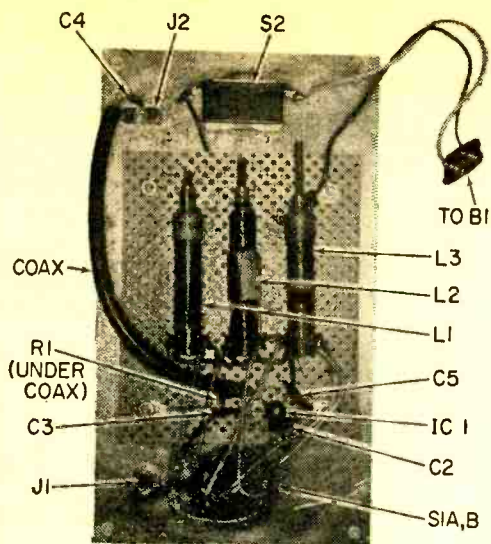

This full range 3-band booster gives a kick to shortwave receivers; it can also be put together for just one band. Eliminates the bandswitch S1A, B and two unused "L" coils. Use parts layout photo when building yours.

quency operation of the circuits, the parts placement is critical, and for best performance follow our component layout and wiring placement.

Begin construction by mounting C1 in the center of the aluminum panel as shown in the front panel photo. Then, cut the perf board section to size and mount it with 3/4-in. metal spacers at the board corners over C1. Locate and mount the switches S1A,B and S2 as shown in the photos and then install J1 and J2 on the panel below the switches.

The three antenna coils L1, L2 and L3 are mounted on the perf board by soldering #2 and #3 terminals to push in clips, and the top end of the coils are held on with a single turn of wire around the threaded bushing and soldered to a push in clip. Connect the push in clips holding the top end of the coils to a ground lug mounted on one of the screws holding the perf board. Make sure that the coils are positioned with the green index dot on the top and as shown in the board photo.

**Next The IC.** Fan the leads out of IC1 as shown in the drawing on the schematic and locate the white index dot marking the #8 lead. Mount IC1 on the lower left section of the perf board (on the side just below S1A,B), with #4 lead connected to a ground lug and the remaining leads connected to push in clips positioned around the IC as shown in the board photo. Make sure that the connecting leads are as short as possible and cut off the excess lengths.

Mount and wire the remainder of the components on the perf board as shown in

the board photo and schematic. Then, one lead of C4 is mounted to the center terminal of J2 with the other lead connected to a length of coax whose remaining end is connected to the junction of R1 and #7 lead of IC1. Ground the coax at the ground lug of J2, and position the other end over R1 to act as an electrostatic shield for this lead connection to IC1. Connect the S1A,B terminals to L1, L2 and L3 with short, direct leads spaced over IC1 as shown in the board photo.

Complete the wiring of the preselector circuits, and then mount B1 with a metal strap on the bottom of the box so that it will not touch any of the board components or wiring. If desired, you can connect the B+ and B- lead to a terminal strip mounted on the side of the box for connection to an external 9-volt DC power supply in place of B1.

**Hook Up.** The preselector unit should be connected to your receiver antenna and ground terminals with as short a section of coax as practicable. We used a 6-inch section of RG-59A soldered to a phono plug at one end and with 1 1/2-inch leads at the other. For intermittent use of the preselector, the internal battery will be ok. But for long term operation, a 9 VDC external power supply should be used. The preselector draws approximately 7 mA at 9 VDC.

Connect your SW antenna to the center connector of J1, and connect an external ground to the outside (shell) of J1. Connect J2 to your receiver external antenna

*(Continued on page 102)*





# Give Your Plants A Voice

by Joe Rolé, K5JOK

**C**AN PLANTS REALLY TALK? That was the subject of a report by M. Gronk in the November/December 1972 issue of *e/e*. Of course, no one knows for sure; but *this* author's experience with this project indicates some basis for recent articles on the subject ranging from *e/e* to the Ann Landers column! So that you can investigate this intriguing subject yourself, *e/e* presents an easy experimenter's project. It can help you make up your own mind while providing a multitude of interesting experiments related to plant response.

**A Type Of Lie Detector.** Proponents of the idea that plants have feelings—that plants can respond to human thought and may even have the ability to remember and think—have found that by measuring plant skin resistance, in much the same manner as the polygraph measures human skin resistance, changes are detected that can be interpreted as logical responses to psychic and physical stimuli. The instrument in this project is a high sensitivity ohmmeter which, when connected across a resistance of from 100,000-ohms to 1-megohm, will detect resistance changes in the order of 0.5 percent.

Checking the schematic we see the circuit is simply a battery-operated "709" operational amplifier in a differential configuration across an adjustable bridge. Bridge imbalance is amplified by the op-amp and displayed on a sensitive meter or, if you're lucky enough to have a borrow one, a chart recorder.

One half of the bridge consists of the specimen resistance connected to terminals

J1 and J2, an adjustable coarse zero control, and R1 and R2. The second arm of the bridge consists of R4, R6, and the fine zero control, R5. Since the resistance across J1 and J2 can range from 100,000-ohms to 1-megohm, R1 (in combination with R2) is adjusted to equal the resistance of the specimen. Control R5 permits final zero adjustment of the bridge. Once balanced, any change in specimen resistance will apply a voltage change to the amplifier which is amplified and displayed by the meter or other indicating device.

**Selecting A Meter.** R10, in series with the meter movement, permits adjustment of the meter sensitivity. Diodes D1 and D2 protect the movement during zero adjust and provide a nonlinear meter function which makes the meter more sensitive near zero than at full scale.

Since the most expensive component in this project is the meter movement, two meter options are given. You may want to use a 50-0-50 millivolt movement in your model, or a re-scaled 0-50 millivolt movement as used by the author. The latter is more easily obtained, and has the advantage of providing a 0-25 millivolt indication when re-scaled to put zero in the middle of the scale. Since the bridge can be balanced at any point on the meter scale, it is a simple matter to carefully re-scale a 0-50 millivolt movement. If you are not inclined to make this modification, which entails removing the meter face and relabeling the scale, a 50-0-50 millivolt movement can be used.

(Turn page)



**Construction For Good Looks.** The polygraph is compactly constructed in a readily available 7¾-in. x 4¾-in. x 2¾-in. experimenters Mini Utility Box (Radio Shack 270-232) with all components mounted to the aluminum front panel. Batteries B1 and B2 are secured to the top of the front panel with a plastic cable tie and adhesive pad to permit easy removal of the entire unit from the back enclosure.

The amplifier circuit, for simplicity of construction, is built on a 2 x 3½-in. perfboard chassis and mounted to the front panel with a small aluminum bracket. Construction is simple and straight forward and can be accomplished with simple hand tools.

A test stand, such as that illustrated, is suggested and can be constructed of plywood, a piece of lucite, and two banana jacks. Connections to the plant are made by fine phono wire and two gold or silver plated "earring findings" obtained from a local hobby supply house. Another photo illustrates the connection made to the specimen used by the author. A good steady con-

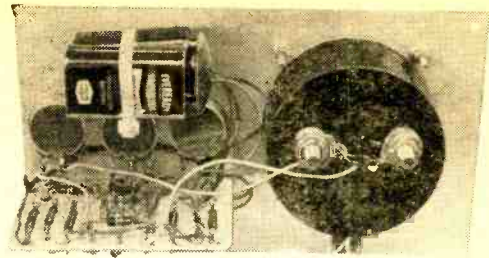

**All electronic wiring and components can be easily assembled on a single perfboard. Bi-polar battery supply simplifies project**

nection to the specimen is important since the response and sensitivity of the instrument can render readings useless if there is the slightest movement of the specimen probe. Adjust the earring finding so that it holds the leaf tightly and firmly between its jaws. Conventional banana leads can be used to connect the instrument to the jacks of the test stand.

**Operational Set-Up.** With a specimen in place and connected, set the meter *sensitiv-*  
(Continued on page 40)

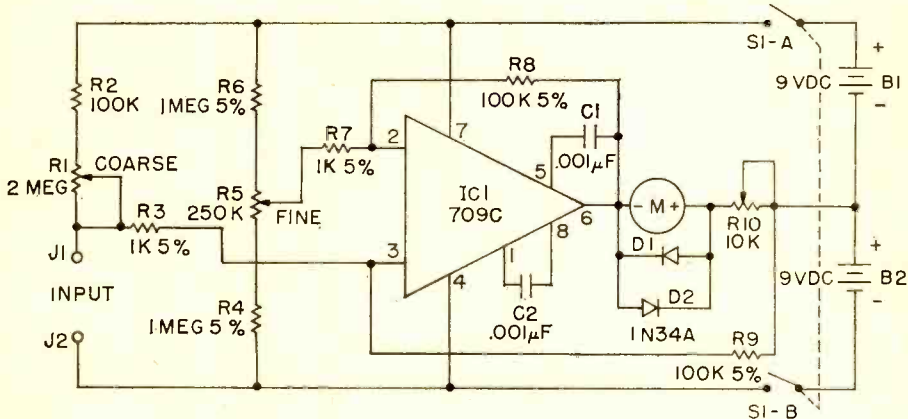

**PARTS LIST FOR GIVE YOUR PLANTS A VOICE**

- B1, B2**—9-volt battery (Radio Shack 23-464 or equiv.)
- C1, C2**—0.001 µF (10,000 pF) disc capacitor, 50, VDC or better (Radio Shack 272-131 or equiv.)
- D1, D2**—1N34A diode (Radio Shack 276-821 or equiv.)
- IC1**—Type 709 integrated circuit (Radio Shack 276-017 or equiv.)
- J1, J2**—5-way binding posts (Radio Shack 274-661 or equiv.)
- M1**—Meter, 0-50 millivolts DC, Triplett 320G or equiv. (see text)
- R1**—2-megohm potentiometer, linear taper (Radio Shack 271-093 or equiv.)

- R2, R8, R9**—100,000-ohm, ½-watt resistor (Radio Shack 271-000 or equiv.)
- R3, R7**—1,000-ohm, ½-watt resistor (Radio Shack 271-000 or equiv.)
- R4, R6**—1-megohm, ½-watt resistor (Radio Shack 271-000 or equiv.)
- R5**—250,000-ohm potentiometer, linear taper
- R10**—10,000-ohm potentiometer, linear taper (Radio Shack 271-1715 or equiv.)
- S1**—Switch, DPST or DPDT (Radio Shack 275-666 or equiv.)
- Misc.**—Perfboard, push-in clips, battery connectors, wire, solder, Minicase (Radio Shack 270-232), etc.

Why a Sylvania home training program may be

# your best investment for a rewarding career in electronics

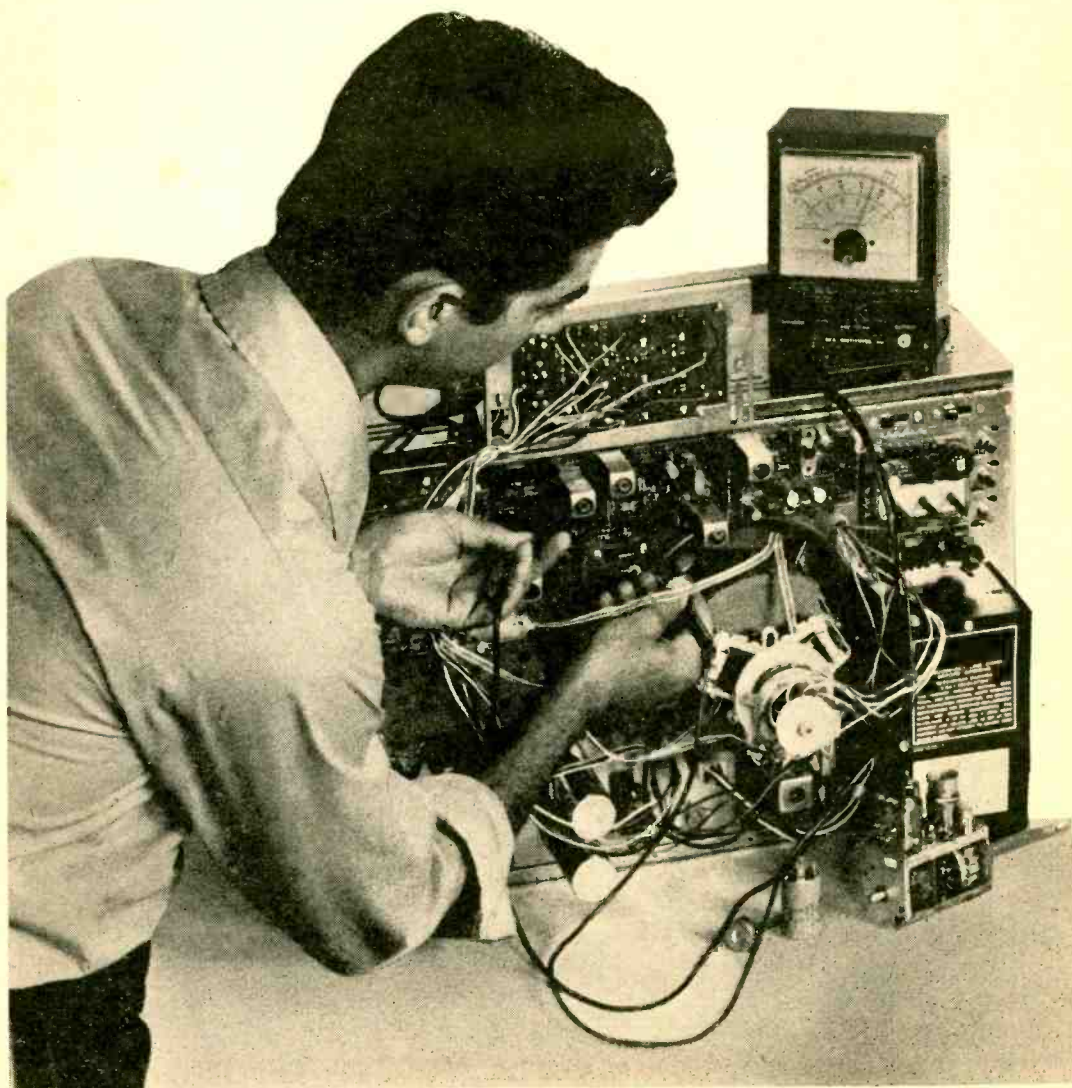



## 1 LEADER IN ELECTRONICS TRAINING

Over the years, Sylvania Resident Schools have trained thousands of men and women for key positions in the electronics field. Now, through Sylvania Home Training, you can receive the same high-quality career training at home. In your spare time. While you hold your present job. Remember, this training is designed with one purpose in mind — to give you the background you need to land the electronics job you really want!

## 2 AUTOTEXT TEACHES YOU ELECTRONICS RAPIDLY, EASILY.

AUTOTEXT, offered exclusively by Sylvania, is the proven step-by-step method of home training that can help you learn the basics of electronics quickly and easily.

## 3 CASSETTE SYSTEM

This innovative learning-by-hearing approach is a special option that adds an extra dimension to AUTOTEXT. It's almost like having an instructor in your own home. As you play the cassette tapes, you'll have an instructor guiding you through your AUTOTEXT lessons. Explaining the material as you read it. Going over schematics with you, reinforcing the basic electricity and electronics study materials with you. Everything you need to know to get you started towards a highly regarded position as an electronics technician — all in an easy-to-understand, conversational tone.

## 4 SPECIALIZED ADVANCED TRAINING

For those already working in electronics or with previous training, Sylvania offers advanced courses. You can start on a higher level without wasting time on work you already know.

## 5 PERSONAL SUPERVISION THROUGHOUT

All during your program of home study, your exams are reviewed and your questions are answered by Sylvania instructors who become personally involved in your efforts and help you over any "rough spots" that may develop.

## 6 HANDS-ON TRAINING

To give practical application to your studies, a variety of valuable kits are included in many programs. In Sylvania's Master TV/Radio Servicing Program, you will actually build and keep an all solid-state black and white TV set, and a color TV set. You also construct an oscilloscope which is yours to keep and use on the job.

## 7 FCC LICENSE TRAINING — MONEY BACK AGREEMENT

Take Sylvania's Communications Career Program — or enter with advanced standing and prepare immediately for your 1st, 2nd, or 3rd class FCC Radio Telephone License examinations. Our money-back agreement assures you of your money

back if you take, and fail to pass, the FCC examination taken within 6 months after completing the course.

## 8 CONVENIENT PAYMENT PLANS

You get a selection of tuition plans. And, there are never any interest or finance charges.

**SEND ATTACHED POSTAGE PAID CARD TODAY! FREE DESCRIPTIVE BOOK YOURS WITHOUT OBLIGATION!**

If reply card is detached send this coupon

<b>SYLVANIA TECHNICAL SCHOOL</b>	
Home Study 909 Third Avenue New York, N.Y. 10022	
Please send me FREE illustrated career catalog. I understand that I am under no obligation.	
Name _____	
Address _____	
City _____	
State _____	Zip _____
Age _____	
Veterans: Check here <input type="checkbox"/> 246-403-0	

Sylvania Technical Systems, Inc.

**GTE SYLVANIA**

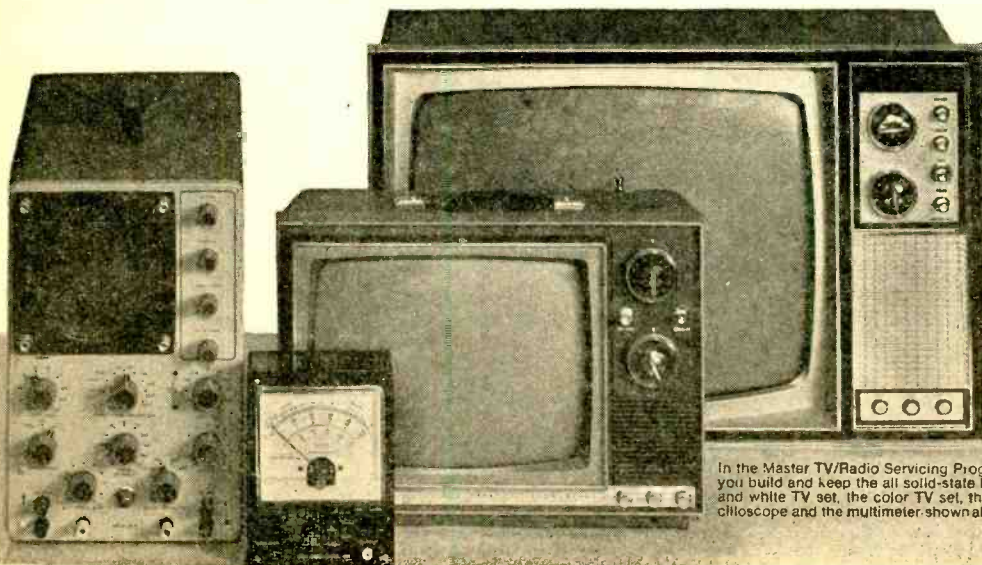

In the Master TV/Radio Servicing Program, you build and keep the all solid-state black and white TV set, the color TV set, the oscilloscope and the multimeter shown above.

Continued from page 35.

These graphs were made with an automatic chart recorder. On left, major change at 2:45 AM was unexplained by author. However, center graph at 6:30 AM peaks when author's family had breakfast. Plant showed major change when watered at about 10:30. Plant subject was an African Violet

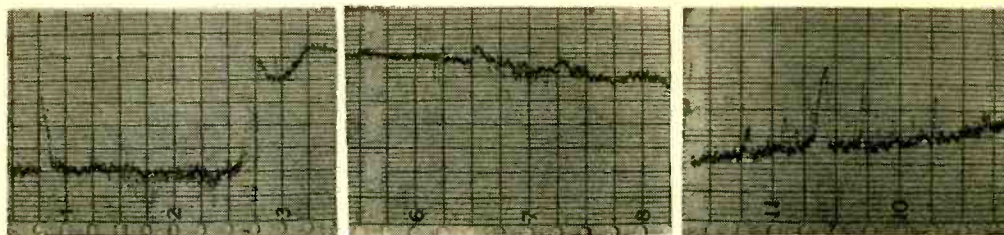

ity control to full counter-clockwise and turn the plant polygraph to the *on* position. Set the *fine* control knob at center position, and slowly adjust the *coarse* zero adjustment until the meter is near center scale. Make the final adjustment to zero with the *fine* control. The full scale sensitivity of the meter can now be adjusted by rotating the meter *sensitivity* control clockwise and re-adjusting to zero with the *fine* zero control.

Some experimentation may be necessary in adjusting the meter sensitivity and fine zero adjust control, depending upon the specimen and the resistance across the two test points. The author found that plants in poor health make very bad subjects, while the responses of healthy plants is much more pronounced and rapid.

A good indication that meter sensitivity is properly adjusted is when a slight bouncing of the meter movement is noted either side of zero. If the meter movement continually goes off scale during your experimentation, reduce the meter sensitivity and

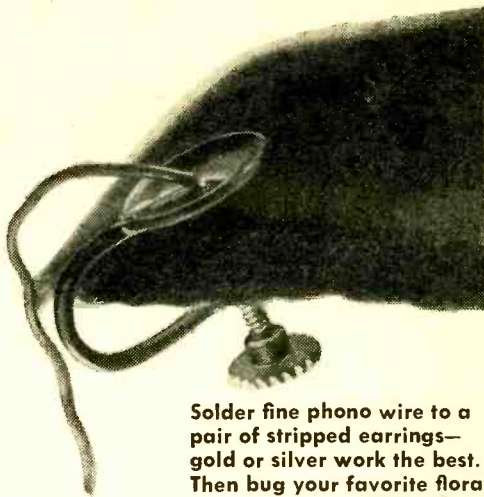

**Solder fine phono wire to a pair of stripped earrings—gold or silver work the best. Then bug your favorite flora!**

re-zero the bridge.

**What You See.** Interpretation of meter fluctuations is largely a matter of experience and repeated experimentation. The figures  
(Continued on page 96)

The February 1973 *Readers Digest* reprinted an article by James Lincoln Collier from the *Baltimore Sunday Sun*. The article describes experiments since 1966 by Cleve Backster of New York indicating the ability of plants to respond to human actions as well as possibly possessing some forms of biological memory and thought processes.

Botanists have long acknowledged the ability of plants to respond to external stimuli as light, temperature, and moisture but the strange results of the Backster experiments in plant response may have startling implications. Consider, for instance, several of Backster's experiments as reported in the *Reader Digest* article:

In one experiment, Backster attached a polygraph to a plant to determine if the rate at which water rose from the root to the leaves could be measured in terms of plant skin resistance. He found that it could. But, more startling, in a subsequent experiment, he decided to stimulate the plant by burning a leaf and found that a dramatic and prolonged polygraph response occurred at the exact moment he made his decision. In other words, it appeared as though the plant had actually read his mind!

In a second experiment, two plants were put in a room and, by means of secret instructions, one of six persons

was instructed to enter the room alone and destroy one of the plants. Later, each person was brought into the room separately and, unerringly, the remaining plant identified the murderer!

Other Backster experiments seem to indicate that plants can determine whether a person is telling the truth or not, and can even respond to human thoughts at great distances!

What do these experiments imply? In the first, it implies that plants may actually have the ability to respond to human thought processes. In the second, and even more fantastic, it implies that plants may possess some type of memory, and thus biological thought process!

To date, these experiments and the possible implications have not been scientifically proven or fully explained. Consider, however the practical application of this knowledge if plants can, in fact, respond to humans or have basic thought processes. One application is a whole new world of electro-biologic sensors that could be employed by science.

Do plants feel? Can they think? They might, as experiments by people such as Cleve Backster indicate, but at the present the question goes unanswered and the concept is only a theory!



# R-Cubed lets you Shoot the Works

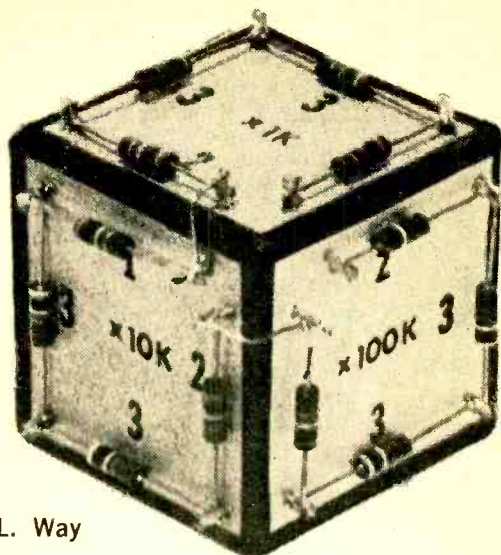

by R. L. Way

LOOKING for the right resistor during a circuit mockup, or breadboarding, sometimes becomes annoying: dim light makes color band reading impossible; fumbling fingers can't pick up 1/4-watt resistors fast enough; and, of course, you are always out of the resistance size you want to use. So get with it with R-Cubed—the experimenter's toy block that makes bench work seem like child's play.

R-Cubed is not so much a device as it is a method for keeping on hand, in an orderly manner, a collection of standard-value resistors that can be used singly with clip-leads, or in series with clip-leads to provide most needed values of resistance. The 24 resistors that can be mounted and series-connected on the faces of a small cube will give resistance values of 1 to 9 ohms and all multiples of 10 of these values through 100,000. Thus, if all 24 resistors are used, resistance values from 1 ohm to 900,000 ohms will be available. The author's unit contains only 12 resistors, since only values

from 1000 to 100,000 ohms were desired. In addition, some intermediate values of resistance (for instance, 42 ohms, 780 ohms, 95,000 ohms, etc.) can also be obtained from the R-Cube arrangement, as will be explained later.

One-half-watt, 5% resistors were used to keep down the cost, but the same idea can be applied to 1% resistors, or to 1- or 2-watt resistors. The only other expense, aside from cardboard for the cube, paint, etc., is for a box of vector-board mini-clips, and a pair of alligator clip-leads. (The Editors took exception to the author's construction technique and went their own way using a child's toy play block and some brass brads—but more on this later.)

**Knocking It Together.** Four resistors form a decade (10, 100, 1000, 10K, 100K, and 1M), and each decade is mounted on one of the six faces of the cube. The resistors are all multiples of 1, 2, and 3 (that is, 10, 100, 1000, etc., 20, 200, 2000, etc., and 30, 300, 3000, etc.). Henceforth, all numbers in a

The resistors in each set for each face are valued at 1, 3, 3, 2-ohms each multiplied by a factor for that face. The diagram at right is for the X100K face of the cube. Therefore each resistor is valued at 100,000-ohms or a multiple thereof.

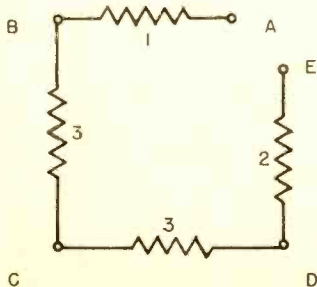

#### TO OBTAIN

- 1 ohm
- 2 ohms
- 3 ohms
- 4 ohms
- 5 ohms
- 6 ohms
- 7 ohms
- 8 ohms
- 9 ohms
- 10 ohms

#### CONNECT LEADS AT

- A and B
- D and E
- B and C
- A and C
- C and E
- B and D
- A and D
- B and E
- A and E

Go to next higher decade

decade will be stated as 1-digit numbers, with the understanding that they are multiples of 10, 100, 1000, etc., according to the decade in which they are used. By wiring the four resistors of a decade end-to-end in the order 1, 3, 3, 2, as shown in Fig. 1, any value of 1 to 9 can be obtained by connecting clip-leads between the appropriate mini-clips. This can be better understood by looking at Fig. 1 and its accompanying table.

In order to get resistance values between those available on a single decade, the decades are connected to each other end-to-end. The following intermediate values (and all their multiples of 10) are thus available: 12, 15, 18, 19, 42, 45, 48, 49, 72, 75, 78, 79, 92, 95, 98, and 99. Fig. 2 shows how the decades should be laid out on a flat piece of cardboard before assembling the cube so that the proper ends of the decades are ad-

jacent, and the connections to make between the faces. The accompanying tables give a few examples (but not all of the combinations possible) of terminal connections for obtaining different intermediate resistance values.

The cube is constructed of "artist-board" since it is inexpensive and easy to work with, but wood, plastic, or any other insulating material can be used. The mini-clips press fit into the artist-board without requiring glue or crimping, and provide convenient right-angle mounting of two resistors and a good electrical connection for the clip-leads. The cube in the photo measures two inches on a side, but could be made either larger or smaller. Measure an equal distance in from each corner and drill a  $\frac{1}{16}$ -in. pilot hole for each mini-clip, push the clip in with a pair of pliers, and orient each one so that it is parallel to the others.

The cube is best laid out in two flat pieces, as shown in Fig. 2, then cut and scored, and the two pieces glued together. Each face of  
*(Continued on page 102)*

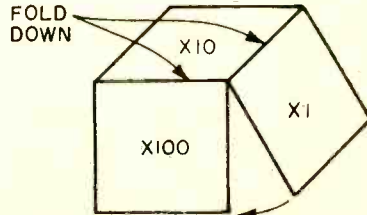
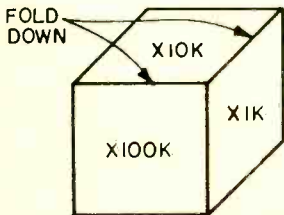
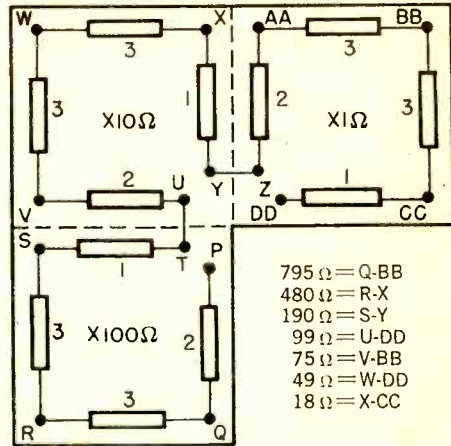
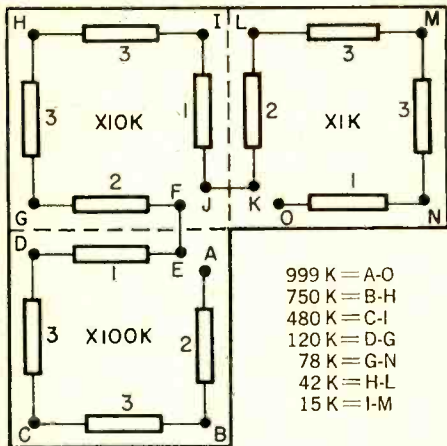

Here's how the cube fits together and what resistors go on what face. Note that terminals E-F, J-K, U-T and Y-Z are connected by means of a jumper. Not shown is jumper for O-P.



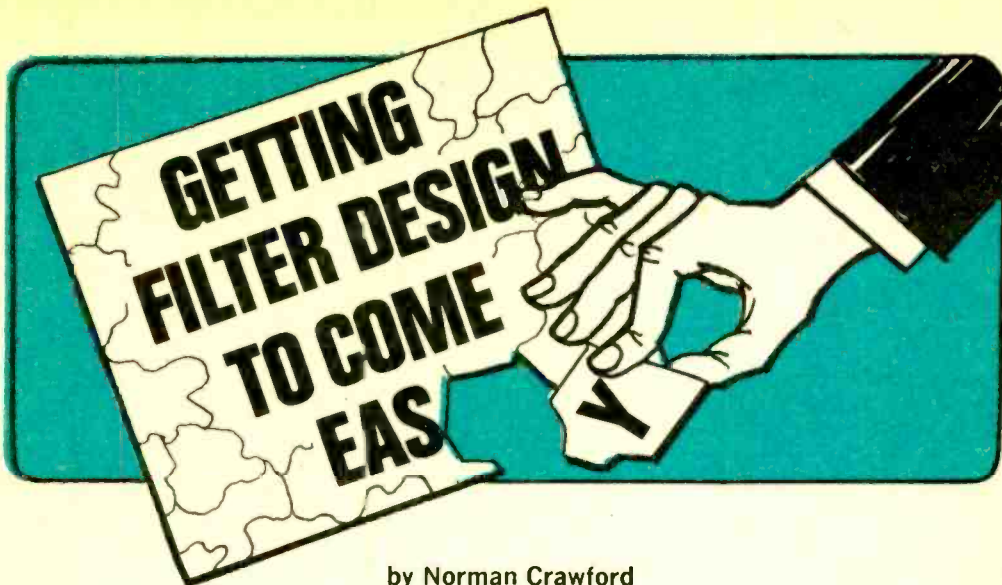

by Norman Crawford

**W**E ARE COVERING all our bets when we say you know something about simple filters like low-pass, high-pass, band-pass and band-eliminate types. If you're a reader of **ELEMENTARY ELECTRONICS** you should have some basic knowledge about filters, especially after reading our last issue's story, *Get In The Swing Of Simple Filters*. But we all tend to forget some of the things we read, so we hedged our bet by including a brief review of that story before we go on to bigger and better filter theory in this article. If you missed the last issue, don't worry, just keep on reading.

In the first article in this series, we discussed the four basic types of filters—low-pass, high-pass, band-pass, and band-eliminate—and told what was to be expected when one of these filters was dropped into a circuit. We also showed how to measure the frequency response of a filter in a lab set-up, and we explained why the graph of frequency response is usually plotted in decibels (dB) and in decades of frequency (that is, in equal increments of 1,000 Hz, 10,000 Hz, 100,000 Hz, etc.). We then proceeded to design a simple low-pass filter, using only a resistor and a capacitor, to obtain the desired passing of low frequencies and the elimination of high frequencies.

**Review of Low-Pass Filter.** In our design of the simple low-pass filter we arrived at the circuit values shown in Fig. 1A and the frequency response shown in Fig. 1B.

The filter circuit in Fig. 1A was designed to have a *corner frequency* of 3,000 Hz, meaning that it would pass all frequencies *below* 3,000 Hz rather well, but eliminate those *above* this frequency. What if we desired the opposite of this effect? What if, instead, we wished to pass all frequencies *above* 3,000 Hz, and eliminate those *below* this frequency? A circuit having these characteristics is called a *high-pass filter*, and its frequency response would

be as shown in Fig. 2.

**Flipped Circuit for a Flipped Response.** In one sense, the frequency response of Fig. 2 is a flipped-over version of the low-pass response shown in Fig. 1A. It should not be too surprising then to learn that the circuit producing this flipped-over response is itself a flipped-over version of the low-pass filter. The two circuits are compared in Fig. 3.

If the same values are used (.82  $\mu$ F and 62 ohms) in the flipped circuit, it yields the same corner frequency (3,000 Hz) as the low-pass design, except the roll-off (the part of the response that goes down-hill) goes down to the left instead of to the right. Just like its low-pass

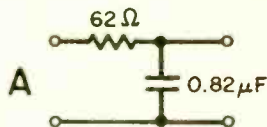

Fig. 1

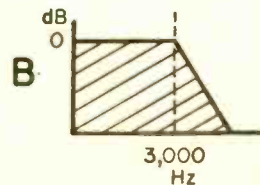
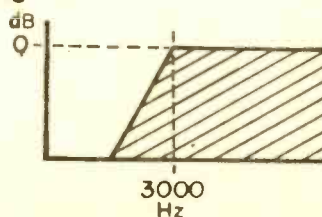

Fig. 2



# e/e FILTER DESIGN

cousin, this high-pass circuit likes to be driven from a low impedance (the same 6-ohm voice coil would do nicely) and it likes to drive into a high impedance (the same 600-ohm headset would also be suitable). However, the SWL who designed the low-pass in our first article would be very disappointed in this filter. Instead of cutting out unwanted high-frequency noise to enable him to hear the signal from that distant station, this filter would cut out the signal and let him hear the noise! Of course, there are many applications where this high-pass frequency response produces a desired result. If the corner were at 20 Hz, for example, it could help diminish the effects of turntable rumble in a high-fidelity system.

**Designing by Flipping.** If it's a high-pass filter you need, there is almost nothing to the design. You simply design the "cousin" low-pass, using the formulas in the first article, and then "flip" it to be a high-pass, as in Fig. 3B. Just choose the corner frequency for the "cousin" to be the same corner frequency that you desire in the final high-pass.

For example, let's design a high-pass filter to eliminate the hum (60 Hz) on a 600-ohm phone line before we connect it into a 100,000-ohm input of a public address (P.A.) amplifier. In this case, we would choose a corner frequency for our high-pass which was well above the 60-Hz hum, to be certain of eliminating enough of the hum. Choosing a 240-Hz corner frequency, we proceed to design the low-pass just as we did in the first article:

First, compute R as follows:

$$R = \sqrt{R_s R_L} = \sqrt{600 \times 100,000} = \sqrt{60,000,000} = 7,760 \text{ ohms}$$

Next, compute C:

$$C = \frac{159,000}{f_c R} = \frac{159,000}{240 \times 7,500} = 0.089 \text{ } \mu\text{F}$$

You would be quick to admit that the values 7,760 ohms and 0.0089  $\mu\text{F}$  for a resistor and capacitor, respectively, are difficult to find. Therefore, select the nearest stock EIA values, which are 7,500 ohms and 0.091  $\mu\text{F}$ .

Although we designed this using the low-pass formulas, we can directly draw the high-pass circuit and plug in the calculated values. See Fig. 4.

It is here that the shortcomings of these very simple filters first become apparent. We tried to make this filter eliminate 60-Hz hum from the telephone line, while still passing voice, speech, and music well enough to yield a good-sounding audio signal. However, the roll-off—is so gradual in these very simple filters that you must start it rolling down very far above the unwanted frequency in order to make sure that

it gets down far enough to be effective in eliminating the unwanted frequency. In this filter (Fig. 4) we started the roll-off on its way at 240 Hz, which is right in the middle of some very important audio frequencies. Consequently, some important low frequencies will be lost, and the output of the system will sound "tinny."

**A Simple Band-Pass Filter.** So far, we've discussed and designed filters which either passed low frequencies and eliminated highs, or passed the high frequencies and chopped off the low. A third type of filter, called a *band-pass* filter, passes a selected group of frequencies. Fig. 5 shows clearly how the responses of low-pass, high-pass, and band-pass filters compare.

We have established a relationship between high-pass and low-pass filters, that is, one has the *flipped-over* response of the other, and their circuits are *flipped-over* versions of each other. (Figs. 1, 2, and 3). But what is the relationship between a low-pass filter and a *band-pass* filter? We've said that all the filters are *cousins* of the low-pass filter, and can be easily derived from it. But the band-pass filter clearly has no flipped-over response, and we would expect its circuit to be quite different from its low-pass cousin.

**Enter Resonance.** If we make a low-pass circuit as shown in Fig. 6 we find that it passes frequencies from zero Hz (essentially DC) to its corner, 8 kHz. Since the frequencies passed occupy a band 8 kHz wide, this filter is said to have a *bandwidth* of 8 kHz. If we now put

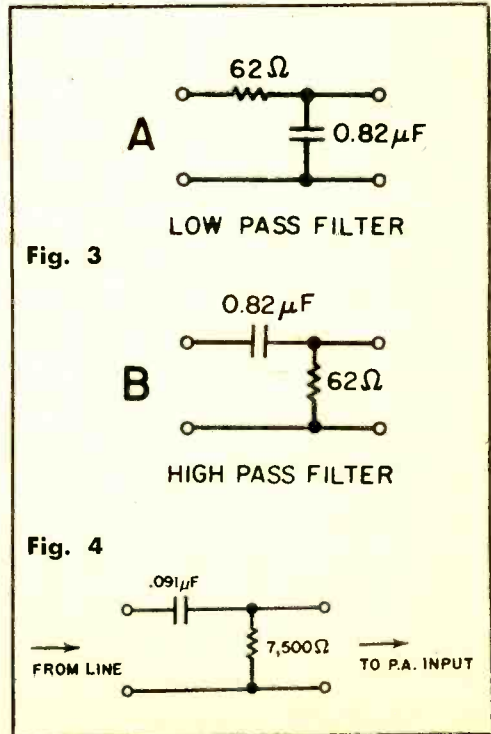



a coil across the capacitor as shown in Fig. 7, our knowledge of tuned circuits tells us that this coil and capacitor combination will *resonate*, that is, will be particularly responsive to a certain frequency, called the *resonant frequency*. It will also respond rather well to nearby frequencies slightly above and below the resonant frequency. If we graph the frequency response of this new resistor-capacitor-coil circuit, we find that we have made a band-pass filter, as can be seen from the response in Fig. 8. And here is the most important fact: since we started with a low-pass filter (Fig. 6) which had a bandwidth of 8 kHz, our new, derived band-pass *also* has a bandwidth of 8 kHz.

To derive a band-pass filter from its low-pass cousin, then, we need only shunt the capacitor with a coil of the right inductance, and the result will be a *band-pass* filter of the *same bandwidth* as the original low-pass, but *moved up in the frequency band* to the resonant frequency of the coil/capacitor combination.

For example, let's assume we need a band-pass filter which will pass a band of frequencies

from 101 kHz to 109 kHz. This means that we need a bandwidth of 8 kHz, which we determined by a subtracting 101 from 109. We therefore must first design a low-pass filter of 8 kHz bandwidth, using the formulas and methods of the first article in this series. We will assume that this has been done, and the result is the 8-kHz low-pass of Fig. 6. Now, we must convert this low-pass to a bandpass by the following steps:

1. Determine the resonant frequency needed by the formula

$$f_R = \sqrt{f_U f_L}$$

where  $f_U$  is the upper frequency of the band-pass, and

$f_L$  is the lower frequency, and

$f_R$  is the resonant frequency desired.

In the present example,

$$f_R = \sqrt{109 \times 101} = \sqrt{11,009} = 104 \text{ kHz}$$

Note that the frequencies in the formula may be Hz, kHz, or MHz, as long as they are all the same.

2. Determine the inductance of the coil to be

Fig. 5

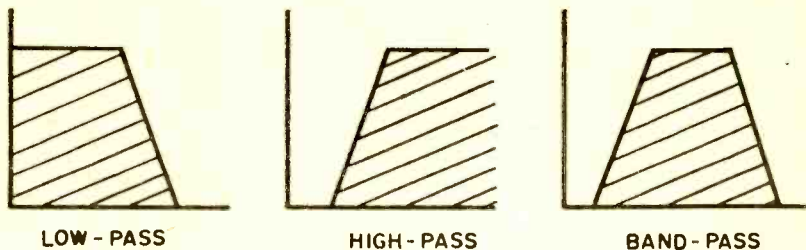

Fig. 6

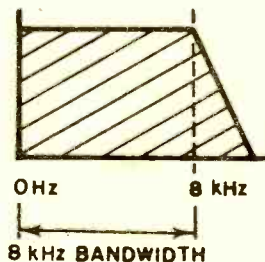
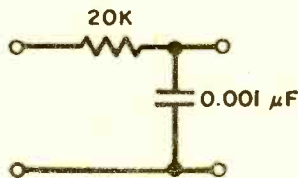

Fig. 7

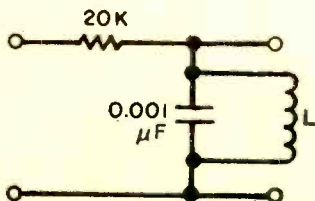
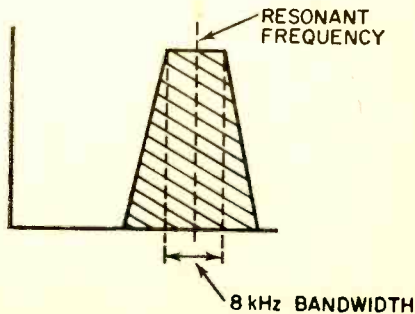

Fig. 8



# ⓐ/ⓐ FILTER DESIGN

placed across the capacitor by the formula

$$L = \frac{1}{C} \left[ \frac{159}{f_R} \right]$$

where L is the desired inductance in henries, C is the capacitor in the low-pass, in  $\mu\text{F}$ , and  $f_R$  is the resonant frequency in Hz.

In the present example,

$$L = \frac{1}{.001} \left[ \frac{159}{104,000} \right] = 1,000 \times [.00153]$$

$$= .0025 \text{ henry}$$

$$= 2.5 \text{ millihenry}$$

With that, the design is complete, and the circuit of the filter, with its response, is as in Fig. 9.

**Only One Left.** Of the four basic types of filters, we have now shown how to design three, leaving only the band-eliminate filter for the end of the discussion. If we graph the frequency response of a band-eliminate filter side-by-side with the response of the band-pass filter just designed above, we note, in Fig. 10, an

interesting similarity . . . or should we say dissimilarity?

**Flipped Again.** The response of the band-eliminate filter is a flipped-over version of the band-pass filter, just as the high-pass was a flipped version of the low-pass. This raises in our minds the question, can the band-eliminate version of the filter be a flipped version of the band-pass circuit?

The answer is a resounding *yes!* To make the band-eliminate filter, simply interchange the locations of the resistor and the coil/capacitor combination in the bandpass, and, presto! . . . we have a band-eliminate circuit. See Fig. 11 for its circuit and response.

Our flipped version will *eliminate* the frequencies from 101 kHz to 109 kHz, and will pass all others. This is the exact opposite of the band-pass action. To design a band-eliminate filter then, you merely design a band-pass filter and interchange the components as in Fig. 11.

The filters described thus far have one thing in common: they are extremely simple, using only two to three components to perform the filtering function. Of course, it simply isn't possible to get something for nothing, so you might suspect that these very simple filters are lack-

(Continued on page 99)

**Fig. 9**

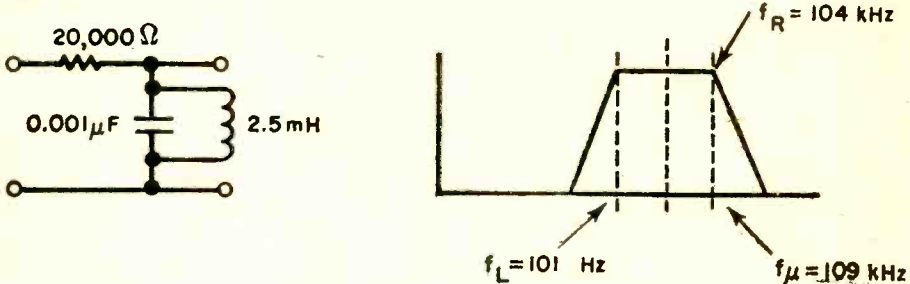

**Fig. 10**

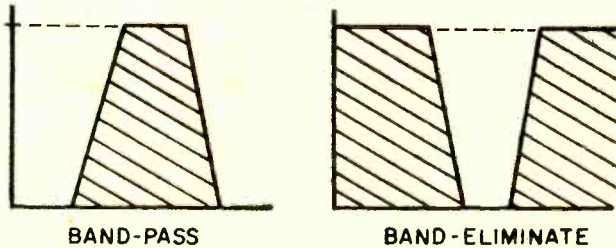

**Fig. 11**

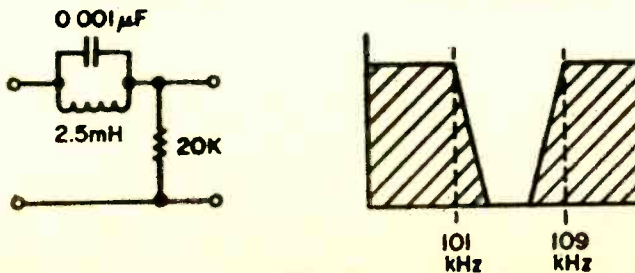





# MOVING SOUND

Keep the 55 mph pace  
tolerable with  
prerecorded tape

by Shirri Sensei

**T**he programming is often deadly dull, the sound quality is usually strictly from hunger—high fidelity it is not. But it is the hottest selling component in the high-fidelity marketplace. I refer, of course, to automobile tape cartridge and cassette players.

Ever since Lear figured out how to squeeze eight tracks into a push-in package, manufacturers have been hard-pressed to meet the demand for automobile tape players. Even retail outlets find themselves backlogged with Saturday installations, and it is not uncommon to wait several days to get shop time for a car installation.

The reason for the popularity of automobile tape players is obvious: between the endless minutes of radio announcers hard-selling products and listening to their own mellifluous voices through monitoring headphones are short mo-

## e/e MOVING SOUND

ments of what the station managers call "mass audience programming," usually the Top 40 records. Whether your taste is for hard rock, folk, country, mood-music, or classical, you're not likely to find more than a snatch of musical pleasure in an hour's worth of radio listening.

As an added bonus in this coming age of energy conservation, tape listening in the car will help pass the hours away when the speedometer pointer is pegged at 55 *mph*. (*Exact speed limit not determined at this writing.*) The tape program selection should be determined by the trip's length, and how tired you may become. Foot stomping Sousa marches should be scheduled for the end of trips, to make the last mile an alert mile.

**Go Tape Today.** So you take a giant step and get a tape player. Now you can drive along listening to the music *you* enjoy, your own Top 40, without the hash generated by a rapid-talking sing-song announcer trying to imitate what he thinks is a "Big Town

DeeJay." (Why is it the smaller the station the faster the announcer and the longer his patter routine?)

Now even if you're one of those esoteric types with an FM radio in the car, so you never have to listen to the AM garbage, an automobile tape player still means an extra in listening pleasure. If you have a cassette or cartridge recorder in your home you probably have a thorough collection of what you enjoy most. So why keep it restricted to the home. For considerably less than \$100 (if you do your own, easy installation) you can play the tapes in the car, getting double value from your recordings.

Automobile cartridge and cassette players are available in just about every price range, with the *features* rather than the sound performance generally determining the price. In addition, there's extra hardware available so these models can become radios, or accommodate another tape format.

The very basic equipment is the stereo cartridge player, often available for under \$50, less speakers. This is a very small package intended for mounting, like all other tape players, under the dashboard or on the

### 8-TRACK CARTRIDGE PLAYERS



Automatic Radio's Rover 101 packs fine tuning for accurate tape playback plus program repeat for continuous playing of same track. Circle No. 154 on Literature Library Coupon (p. 98).

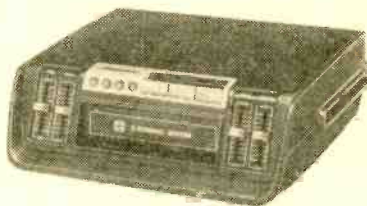

The CX-601 from Panasonic is a 4-channel and stereo player that slides into an optional adaptor for home use. Sliding volume and tone controls. Circle No. 155 on Lit-Lib Coupon.



Here's Hitachi's CS-4000, a 2/4-channel rig that plays either automatically by sensing notches on cartridges. Get the facts by circling No. 156 on Literature Library Coupon.



Pioneer's TP-777 has both automatic and manual track change, repeat button, slide controls, and fast forward. Circle No. 157 on Lit-Lib Coupon found on page 98.



## CASSETTE PLAYERS



Featuring automatic shut-off in fast forward and rewind models, Sony/Super-scope's TC-30 features automatic reverse. Circle No. 158 on page 98.

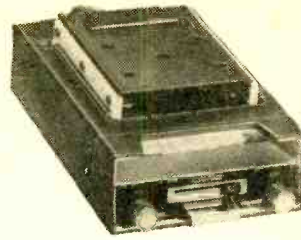

Craig 3508 features auto-reverse, for automatically playing both sides of a cassette. Regulated motor keeps speed with varying battery voltage. Circle No. 159 on Lit-Lib Coupon.



Pioneer KP-333 can fit in your car's glove compartment. Has auto-reverse, lamp direction indicators, manual direction changer. Get the facts by circling No. 157 on Lit-Lib Coupon.



Try Heathkit if you want to record when on the road. The CT-1001 comes in easy-to-wire form that almost anyone can do. Get all the facts by circling No. 1 on the Reader Service page.

The Panasonic RS-248 Joplin is a floor-mounted rig that's great for the hump in foreign and compact cars. Has its own storage compartment. Circle 157 on Coupon on Page 98.

driveshaft tunnel (the *hump* between the driver and passenger), though some cartridge players, and some cassette players also, are small enough to fit into the glove compartment. The basic stereo 8-track cartridge player has volume and balance controls and a program change button or lever. Push the cartridge in and the player starts, playing program after program endlessly until the cartridge is ejected. The only control the user has is volume level, balance, program change, and eject.

**Extras for Dollars.** As the price starts to edge upwards a few dollars at a time you

get extra convenience features, though sound quality stays the same. For example, a few dollars more buys program indicator lights or mechanical numerals which show which of the four programs is playing. A little more expense might provide automatic eject after the last program is played. Also, as soon as you move up from the very basic model you get a tone control. Moving further up the price ladder you find cartridge players with built in FM-stereo radios and even a front panel control for head alignment, though any well-made machine should not call for a user alignment.

# e/e MOVING SOUND

In most instances the price differential between various models of 8-track cartridge players represents substantially the differences in power output, with 1 watt *rms* per channel typical of the low end of the price scale and 8 watts *rms* per channel typical of the high end. This comparison will be somewhat confusing because, unlike hi-fi equipment, the auto equipment crowd is hung up on *peak power* ratings—the larger the number the greater the user interest, or so they think. As an example, a player rated 16 watts peak power output is only 4 watts *rms* per channel. Four watts is adequate for most listeners, particularly in view of the fact that most speakers supplied for auto use go to pieces well below 4 watts input level.

**There's More.** Once you have the basic cartridge player there are several accessory

options you can add at a later date. The most common is the plug-in FM-stereo converter or "tuner cartridge," priced around \$40 to \$60. The "tuner cartridge" closely resembles the tape cartridge in size and appearance, though it has a dial on the front (or top front) and a tuning knob. It simply plugs into the cartridge slot and requires no connections to the tape player as the output signal is inductively coupled to the player's stereo head. Power for the tuner is generally provided by an internal transistor radio battery.

A plug-in cassette adaptor is another accessory. Again, looking almost like a standard 8-track cartridge, the cassette adaptor permits cassettes to be played in a cartridge player. Power is usually provided by an internal transistor radio battery. The tape drive is through a roller pressing against the player's capstan. Panasonic models do not use a battery and have contacts which automatically plug into the cartridge player's

## CARTRIDGE OR 8-TRACK PLUS RADIO

A combination fold-back dial scale and dust-cover door is featured on the Tenna RR-62MPX, with FM-stereo radio. Player is the 8-track type. Circle No. 160 on Lit-Lib Coupon on page 98.



Realistic 12-1825 Mobile Music Center switches to tape play when cassette is inserted and back to FM at end of tape. Circle No. 32 on pages 17 or 103.

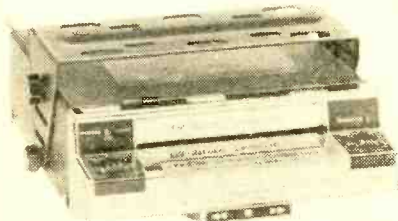

Offering FM radio and a cassette player, Craig's 3506 has automatic stop at end of tape, fast forward for program search, and ejects cassette when power is off. Circle No. 159 on Literature Library Coupon on page 98.

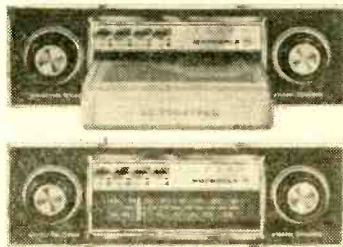

Two views of Motorola's TF852AX that plays a cartridge when pushed into its AM/FM-stereo radio dial face. FM has local/distant switch for improved FM reception. Circle No. 161 on Literature Library Coupon found on page 98.



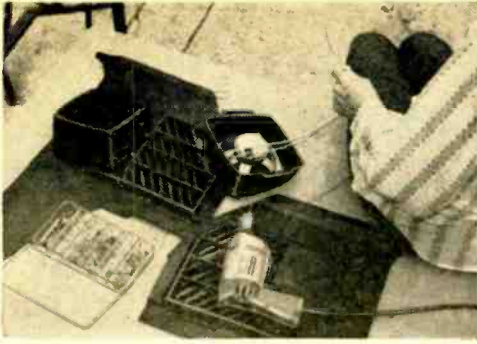

Adding speakers for mono or stereo playback is easy when you mount them on the removable side kick panels.

power supply. In most instances the signal from the cassette is inductively coupled to the player's head, as it is in the tuner cartridge(s). The cassette adaptors presently available have only a *play* drive, there is no fast forward or fast reverse. At the end of play the user manually turns the cassette over to play the second track.

**Options and More Options.** Unlike the cartridge player, which is simply a basic model with step up features, automotive cassette players are available in several configurations. Firstly, there is the radio-adaptor; this device has no internal amplifiers. The cassette signal modulates a small radio signal generator whose output is fed into the car radio—an AM radio, so it's not stereo. The radio is tuned to the adaptor's frequency and the cassette signal is therefore tuned in just as if it were a radio signal. Needing no power amplifier, the adaptor's cost is well below \$50. As with the 8-track player cassette adaptor it simply plays in one direction.

**Cassettes Are Big.** One of the lowest cost complete stereo cassette players is the *auto-reverse* model, which has tone, volume, and balance controls. It has only the *play* mode; there is no fast forward or reverse. At the end of play the drive automatically reverses and plays the next track, repeating until shut off by the user. The auto-reverse models are very small, and if you live in an area prone to theft of cars or equipment these small units are very attractive as they are easily concealed in the glove compartment.

Higher in price we find the complete cassette player with play, fast forward, and fast reverse, but no auto-reverse. There are two versions. In one the cassette drops in

from the top just as it does in a home cassette player. Usually, there are one or more speakers built into the case, or the case has a storage compartment where internal speakers would be. Because of the top loading the unit is relatively large and requires access from above, so it must be mounted on the floor, usually on the drive tunnel.

Coming into much more prominent use is the *Staar* cassette mechanism where the cassette loads in through a slot in the front of the player—just as an 8-track cartridge loads. Because top access is not required the player can be mounted under the dashboard. (Auto reverse players also use the *Staar* loading.) These front loading players have play, fast forward, fast reverse, and automatic eject at the end of play, but not usually at the end of fast forward and fast reverse. The cassette can be ejected at any time by simply pressing the eject button. It is even possible to get an auto cassette recorder which has stereo play and mono record.

**4-Channel on Wheels.** With 4-channel equipment becoming commonplace in the home it was only a matter of time before you could surround yourself with sound on the highway. While it hasn't reached the proportions of a thundering herd you now have a reasonable selection of 4-channel cartridge equipment for the car. Basically, the 4-channel cartridge players are stereo models with an extra pair of amplifiers for the rear speakers and a few extra volume and balance controls. Surround-sound hasn't yet made it in cassettes, but advance word is that discrete 4-channel cassette players (and recorders) aren't far off (there might be a model available when you read this), and if someone puts out 4-channel cassette gear for the home you know it will soon be available for your car.

**Installing Speakers.** The quality of stereo car speakers generally ranges from poor to worse. Most of the speaker hardware looks good, and that's the problem. The money is in a fancy chrome plated grill or trim and not in the speaker. You will get the best sound quality by getting the largest size *name brand speakers*, since, though size is by no means a guide to speaker quality, in car speakers an extra inch or so can be the difference between a decent, or acceptable, bass and a thin, screechy sound.

There are three more-or-less standard  
(Continued on page 96)

# IT'S YOUR MOVE

by B. W. Grandjean



Novel Electric Checkerboard Directs Typewriter to record moves!

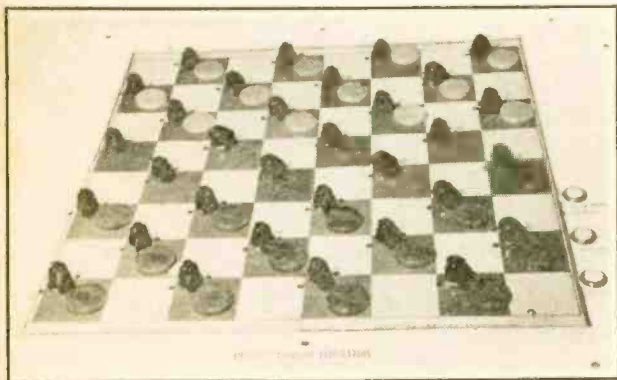

The electric checkboard (above) is all set to go, with checkers at the ready. As a piece moves from one square to another, the switches in each square are actuated to record the move.

**A**N electric checkerboard to automatically record the moves of a checker game has been built by the editor of the American Checker Federation's bimonthly *ACF Bulletin*. Editor B.W. Grandjean frequently must prepare accurate copy of tournament games for publication. The raw games are handwritten copy created by the players at the time of playing the match, and are often inaccurate. Normally, these rough draft records must be tediously edited at a board at the same time the record is being typed.

Now, the electric board can minimize errors in run-up and typing—a move on the board is automatically transferred to a typewritten record. A rotary switch at each square transmits three sequenced electrical pulses to one of 11 miniature solenoids mounted in a special rack over a typewriter keyboard—the solenoids actuate appropriate keys. Mounted in this special checkerboard are 32 rotary switches, one for each numbered playing square (01 through 32), with each switch powered with 24 VDC input, and each having three output contacts. As a piece is played *from* a square, its switch



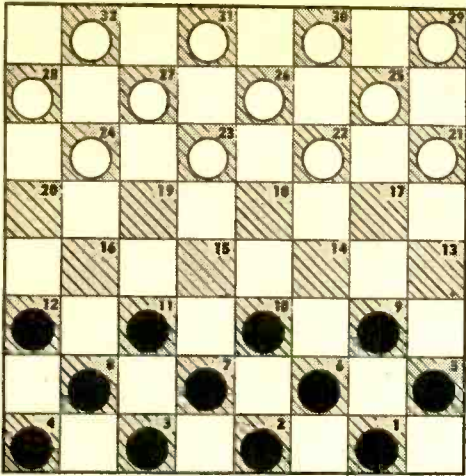

In checker game notation, each square of the board has an assigned standard number as shown in the diagram (left). Game moves are then recorded by recording the number of the square moved from and the square moved to. A sample of a few moves looks like this:

Black	White
11 15	23 18
08 11	27 23
04 08	23 19
09 14	18 09

The game can also be recorded in line notation: 11 15, 23 18, 08 11, etc.

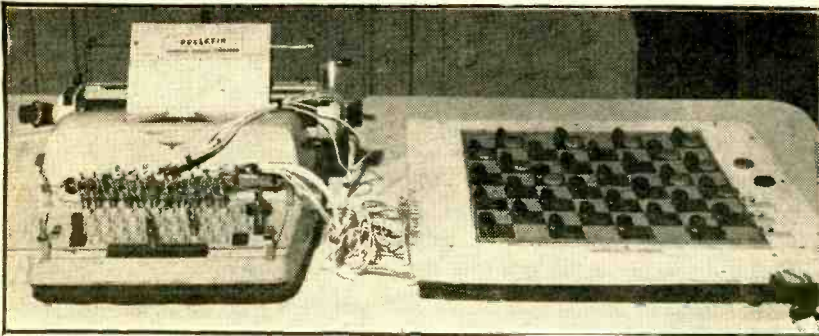

is manually rotated 360°, and as the piece is played to a square, that switch is similarly rotated. The first contact point of the rotary switch energizes one of 10 solenoids for the 10's digit key, the second contact energizes the solenoid for the 1's digit key, the third contact energizes the solenoid actuating the space bar, and the fourth position returns the switch to "off." Three pushbutton switches are also mounted at the edge of the board to provide individual actuation for a dash, spacing, and carriage return.

In its present form, the electric checkerboard is bulky and is used only in the office of the checker editor. However, a speculative redesign envisions electronic sequencing activated by first the placing and then the removing of a piece, and coupled to a small electronic printer instead of a mechanically-actuated typewriter. This design would be portable and useful at tournaments and matches. And the same apparatus could be used at chess tournaments and matches if algebraic chess notation is used (as in correspondence systems) instead of the conventional piece-name notation. ■

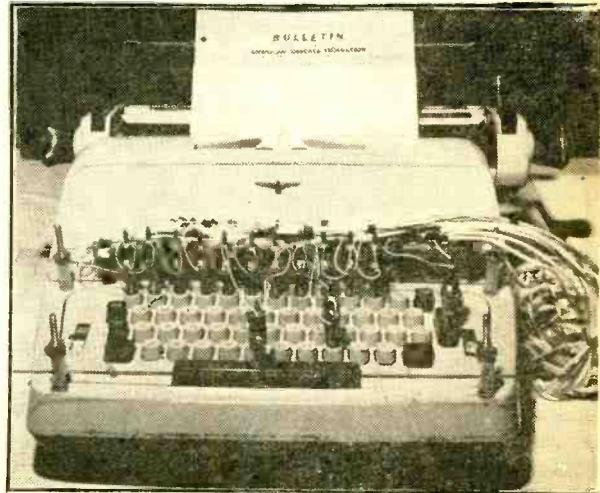

A plastic sheet is mounted above the keyboard. Electrically actuated solenoids are located on the plastic sheet directly over the typewriter keys they will strike. There's no need for the touch of a human hand!

# The all-new digital-design

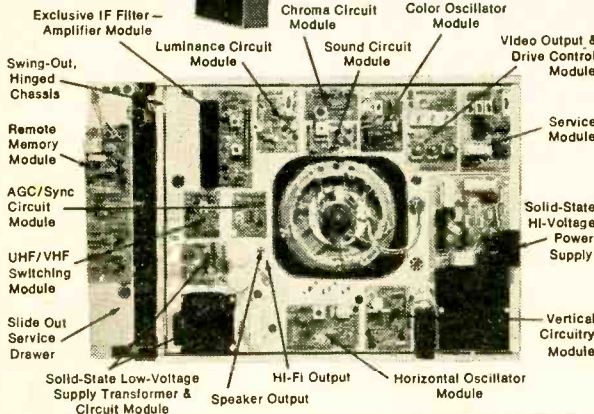
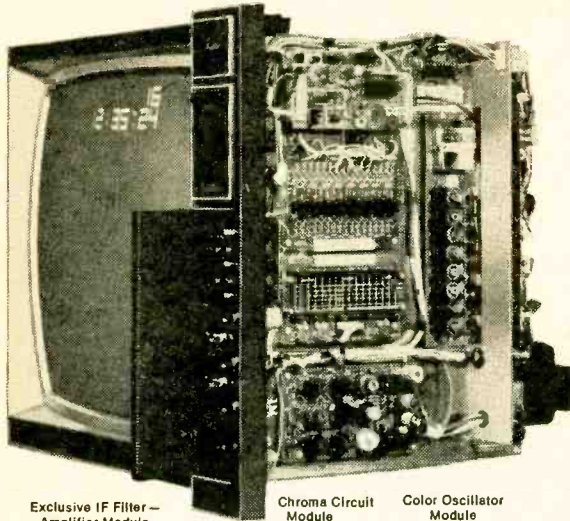

It offers you these important advances in technology, quality, and performance:



Programmable Channel Selection through digital up-down counter with computer-like programming board.

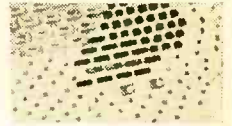

100% Solid-State Design — the picture is the only tube-type device.



Silent All Electronic Tuning with new combination UHF/VHF Varactor Tuner located inside the chassis — completely shielded.

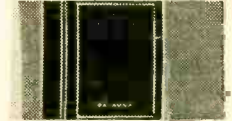

Touch Tuning at front panel (or remote) — touch to change channels up or down — hold in to sweep all channels.

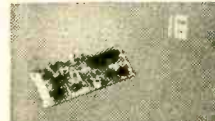

On-Screen Channel Readout — big, bright 1 1/2" numerals for both UHF and VHF.



On-Screen Clock Readout gives time in 4 or 6-digit format, 12 or 24 hour time.



Fixed Filter IF totally eliminates instrument IF alignment forever.



19 Integrated Circuits simplify kit building and permit ultra-sophisticated technology with long-term reliability.



Solid-State Hi-Voltage Supply in tripler configuration for efficiency and long life.



Solid-State Low-Voltage Supply has short-circuit proof integrated circuit regulators.

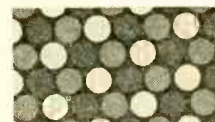

New Deluxe Black (Negative) Matrix Picture Tube — fully illuminated color dots with black background matrix for greater brightness and contrast — new, etched, face plate reduces glare.



New Vertical Sweep Design gives better picture interlace, improved picture detail; complementary power transistors eliminate output transformers for better linearity.



True Digital Design Dot Generator makes picture convergence easier and more precise.



Twelve Wiring Harnesses — pre-fabricated, connectors installed, pre-stripped, ready to solder — this TV is easier to build.

## Eleven-Function Touch-Tune Remote Control for the Heathkit GR-2000 ... 79.95\*

This all solid-state ultrasonic system utilizes 13 integrated circuits, 28 transistors to give you wireless arm-chair control of on and off, volume, VHF/UHF channel selection, up or down color intensity, and tint. Plus, a touch of the volume button automatically recalls the digital readout to the screen. Kit includes receiver for in-chassis mounting and hand-held transmitter. Operates from 20-feet away from set.

Kit GRA-2000-6, 4 lbs. .... 79.95\*

## Optional Digital Clock for your GR-2000

In just a couple hours' time you can build the GRA-2000-1 Digital Clock Accessory. Everything mounts on one small board that plugs into the readout board in the GR-2000 service drawer. That's all there is to it. Clock circuit board has slow, fast and hold pushbuttons for setting time, jumper wire for selecting 12 or 24-hour format. You set your on-screen display for hours and minutes, or hours, minutes and seconds using the programming circuitry on the channel readout board. Order with your GR-2000, or add it on later, if you prefer.

Kit GRA-2000-1, Digital Clock Accessory, 1 lb. .... 29.95\*



# Heathkit GR-2000 Color TV

Three years ago, in response to your requests, we set out to design a truly unique color TV. We have. It uses digital design techniques unusual to TV technology. The result is spectacular.

The 100% solid-state GR-2000 25V color TV — it silently selects channels with digital-logic accuracy — it displays the channel digits on the screen — it displays the time digits on the screen — it uses a fixed filter IF that never needs alignment — it uses more integrated circuitry than any other set. Yet the kit-building process is now easier than ever.

**Silent, All-Electronic Touch-Tuning** — no knobs to turn, no noisy turrets, no humming motors and no mechanical contacts to clean. Now you just touch a button on the front panel or optional remote control transmitter and the new programmable Digital Counter silently sweeps up or down through any 16 preselected stations. Release the button and the new UHF/VHF Varactor Tuner is precisely locked-in on the channel of your choice.

You program up to 16 channels into the Touch-Tune System located in the convenient slide-out service drawer. You can program any channels in any sequence, interspersing UHF with VHF, even programming the same channel to appear more than once if you like.

After you have programmed a channel-selection sequence, Automatic Fine Tuning keeps picture and color consistent from station to station. The UHF/VHF Varactor Tuner is positioned inside the chassis, away from the control panel. This helps keep the picture free of spurious signals that find their way into front-mounted tuners.

**The channel number is seen on the screen** — The Heath-designed On-Screen Electronic Digital Channel Readout has bright white numerals that are easy to see — from across the room, from any viewing angle. Each time you change channels, using the Touch-Tune button either on the set or on the remote control, illuminated digits (adjustable brightness) identify the UHF and VHF stations as you cycle through the channels. After stopping at a desired program, the readout remains on for as long as you want, up to 1½ minutes, or stays on all the time...the choice is yours. You pre-program the Digital Channel Readout to your requirements with a computer-like programming board located in the service drawer. When the readout is timed to shut off after a few moments, it can always be recalled by changing channels or by tapping the volume "down" button. What's more, you can position the readout anywhere you want it on the 25V screen and adjust its brightness for optimum contrast with the overall picture. The digital readout generator uses a custom designed MOS large scale integrated circuit containing the equivalent of over 2000 transistors, plus diodes, and resistors.

The new Heath Electronic Digital Channel Readout completely eliminates the confusion often found with mechanical tuning devices — especially when trying to find an elusive UHF station. And it makes across-the-room remote control tuning easier than ever.

**We even changed the way you adjust the sound** — With the GR-2000 a touch of either of two buttons automatically raises or lowers the sound in a series of small steps. Just hold the button down until the sound level is right where you want it. This also controls the volume of the Hi-Fi Sound Output (to your separate amplifier) so you can control it with your remote transmitter.

**Build-in an optional Electronic Clock with Digital On-screen Readout** — true digital circuitry gives you the time in four-digit, six-digit, 12-hour or 24-hour format. A programming board in the slide-out service drawer lets you set your clock to display time the way you want to see it. The on-screen display appears directly below the channel numeral in same-size 1½" digits. And when you add the clock option, it becomes an integral part of the channel display, responding to the same controls. It can be positioned anywhere on the screen with the channel digits, remains on for the same pre-set length of time, or remains on constantly. For setting the time, Hold, Fast and Slow pushbuttons are located in the service drawer. And once set, the electronic clock continues to run even when the set is off, unless the set's Master Switch has been turned off. In normal operation, whenever the set is turned on and the on-screen display is activated, the time is right to the second.

**A Heath-designed IF Filter sets this TV apart from all others** — You wanted truly superior color reception, particularly in urban areas where multiple transmitters are located or where multi-channel cable service is available. So we designed a fixed LC-type filter with an IC IF amplifier...a "first" in the television industry, and you can

have it now with the Heathkit GR-2000. This unique circuitry produces an ideally shaped bandpass that greatly reduces adjacent-channel interference. And, this totally new approach to IF design gives the GR-2000 another equally important plus — a consistently excellent color picture, year after year with no need for periodic instrument alignment. The GR-2000 IF system eliminates the highly critical traps that go out of adjustment because of normal component value changes through aging. In short, the Heathkit GR-2000 will maintain its best picture longer than any set with ordinary IF design.

**Add Total Touch-Tune Remote Control** — it's an all solid-state ultrasonic system that lets you select UHF/VHF channels, control volume, color tint and intensity, on and off. And you do so from as far as 20 feet from the set. The channel selector and volume buttons on the remote also may be used to return the channel and clock readouts to the picture screen whenever you wish.

**The easiest-to-build color TV we've ever offered** — We said 100% solid-state. And for the GR-2000 that means 19 integrated circuits (33 including the remote and clock), 71 transistors, all of which mount in sockets; 20 glass-epoxy circuit boards; and 12 cables. Imposing? Perhaps, but actual assembly operations for this kit have been greatly simplified. The GR-2000 has fewer point-to-point connections, more ICs, more modular circuit boards, more prefabricated wiring harnesses and cables, and fewer chassis-mounted parts to make it easier to build.

Here's what all those solid-state components do for you to produce truly exceptional color entertainment. To start off, there is DC controlled contrast for less picture interference. An IC color amplifier for truer colors. An IC color oscillator and automatic phase control for more precise and reliable tints. An IC automatic gain control for improved sensitivity, stability and noise immunity. Improved picture interlace for remarkable image definition and crispness. A new solid-state high voltage rectifier. Short-circuit-proof IC regulators eliminate component damage through accidental shorts. Dual VHF antenna inputs, 300 ohm balun for your twin-lead antenna, true 75-ohm for proper cable TV and coax hook-up. Exclusive Heath Magna-Shield Chassis to keep stray magnetic fields from interfering with picture quality.

**New, latest-design picture tube** — a deluxe Black (Negative) Matrix 25V picture tube now with fully illuminated dots with black "surround" and new, etched, face plate...it all adds up to brighter, more vivid pictures with reduced glare and reflections and greater contrast.

**New exclusive Heath self-service features** — no other manufacturer offers them to you at any price. Built-in service facilities such as a new digital-design true dot generator, purity and convergence adjustments; test meter; new vertical and horizontal centering circuits; new Top-Bottom-Sides pincushioning corrections; new "Service" circuit board puts everything in an easy-to-find place.

We set out to design the most advanced and unique color TV available today...we believe the performance of the set will speak for itself. The new digital-design Heathkit GR-2000...it will change your mind about color TV.

**Kit GR-2000, 147 lbs. .... 649.95\***

Four new cabinet designs from \$139.95\*, see catalog.

**Send for FREE Heathkit catalog.**

## HEATHKIT ELECTRONIC CENTERS

Units of  
Schlumberger Products Corporation  
ARIZ.: Phoenix; CALIF.: Anaheim, El Cerrito, Los Angeles, Pomona, Redwood City, San Diego (La Mesa), Woodland Hills; COLO.: Denver; CONN.: Hartford (Avon); FLA.: Miami (Hialeah), Tampa; GA.: Atlanta; ILL.: Chicago, Downers Grove; IND.: Indianapolis; KANSAS: Kansas City (Mission); KY.: Louisville; LA.: New Orleans (Kenner); MD.: Baltimore; ROCKVILLE: MASS.: Boston (Wellesley); MICH.: Detroit; MINN.: Minneapolis (Hopkins); MO.: St. Louis; NEB.: Omaha; N.J.: Fair Lawn; N.Y.: Buffalo (Amherst), New York City, Jericho, L.I., Rochester, White Plains, OHIO: Cincinnati (Woodlawn), Cleveland, Columbus; PA.: Philadelphia, Pittsburgh; R.I.: Providence (Warwick); TEXAS: Dallas, Houston; WASH.: Seattle; WIS.: Milwaukee.

HEATH Schlumberger	
HEATH COMPANY, Dept. 139-3 Benton Harbor, Michigan 49022	
<input type="checkbox"/> Please send FREE Heathkit Catalog	
<input type="checkbox"/> Please send model(s) _____	
Enclosed is \$ _____ plus shipping.	
Name _____	
Address _____	
City _____	
State _____ Zip _____	
* Mail order prices; F.O.B. factory. CL-494R	

CIRCLE NO. 1 ON PAGE 17 OR 103

# TAKES TWO TO COUPLE

by William R. Shippee

**G**otta be! Just about every home has two TVs. Gotta be! But the number of homes with two set couplers falls way short of what would be considered a reasonable number. So let's equalize the situation a bit by offering our readers a simple, easy-to-build two-set coupler that everyone can build and use with delightful reception results. We call it the TSC—obviously from *Two-Set Coupler*.

The TSC may be used to couple two TVs, two FM sets, or a TV and an FM set from a single antenna. Several of these couplers may be connected to a single antenna system for more than two receivers. Insertion loss is less than 2.5 dB and the set-to-set isolation is about 6 dB.

Start building the TSC by winding coil L1 as shown in the drawing and with the information given in the Coil Data. Close-wind (no space between turns) the No. 22 enamel wire, and use care when making the taps to assure a good connection, since the signal level is very low. Check the completed coil with an ohmmeter to make sure the taps are soldered properly. Check the coil visually to be certain that none of the turns are shorted! A shorted turn in coil L1 will make it practically useless.

Keep all leads as short in length as practical, make sure all connections are

mechanically sound before soldering, and, if an enclosure is to be used, make it wood or plastic or some other non-metallic material. Coil L1 is designed to be non-resonant when operated in a twin-lead, 300-ohm antenna line, but there is some possibility that resonance may occur. This will either give much greater signal on one channel (frequency) or drop the signal level appreciably. To remedy this, simply install a resistor valued at approximately 300 ohms from one tap to the other. The author has constructed several TSCs and has run into this problem only once.

Best way to hook up the antenna is to solder directly to the coil ends. Alas, some people like screw posts, so spring for some brass screws (aluminum or nylon are also o.k.) to keep down magnetic fields near the coupler. Solder the leads from the TV antenna terminals directly to the TSC for the same reason.

Parts are easy to come by. No. 22 enameled wire is available in 1/4-pound spools (Radio Shack 287-003). 47-ohm resistors (Radio Shack 271-1800 1/4-watt jobs are best) and 100 pF disc capacitors (Radio Shack 272-123) are available everywhere and are probably in your spare parts box right now. So get on with it, boy, for the TSC has got to be!

## CONSTRUCTION DETAILS

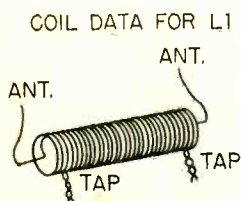

Use Bakelite or wood form 5/8-in. diameter about 1-in. long. Use No. 22 enamel copper wire close-wound for 24 turns. Taps located at 3 and 21 turns.

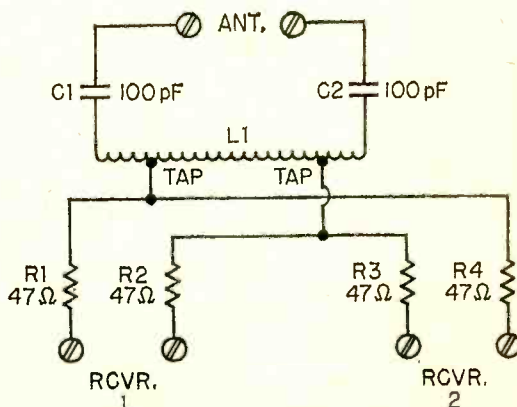

Construction is simple provided you keep it simple! Avoid iron hardware—brass is best, but keep its use down. Install the coil and resistors in a plastic box and fill with "gunk" after wiring is complete. Resistors need be 10% tolerance only.



Stretch more miles from  
your gas supply . . .

# BUILD A PROFESSIONAL DWELL/TACH



Plus tune-up tips by C. R. Lewart

**W**ITH gasoline prices going up, and with the growing concern about air pollution caused by automobile exhaust, a well tuned car becomes a must. One of the essential tools for a tune-up is a dwell/tachometer that helps you adjust your engine to its optimum specs. What we describe here is a dwell/tach based on a newly-developed integrated circuit. It's easy and inexpensive to build, but with the IC it will also be more precise and easier to handle than most currently available commercial units. You may either put the unit in a portable case, as we have done, for use as a diagnostic tool, or you may mount it permanently on the dashboard.

The main advantages of the circuit are readings basically independent of the battery voltage, temperature, and the shape of the voltage at the points.

**How Does It Work?** First let's consider the shape of the voltage at the distributor points. When the points open there is a sharp spike of 100 to 300 volts followed by damped oscillation settling at the battery voltage as shown in the illustration. When

the contacts close, ground is applied to the bottom of the ignition coil, and voltage across the points drops to zero as current flows in the ignition coil primary.

In the integrated circuit there is a temperature-compensated monostable pulse generator section, an amplifier-limiter section, and a voltage regulator section.

For the tachometer mode, the input circuit (R1, R2, R3, D1 and C1) assures that only the initial high-voltage spike caused by the opening points triggers the pulse generator. The generator produces a single rectangular pulse whose amplitude is determined by the IC parameters, and whose pulse width is determined by R4, R5, and C2. The pulses are amplified and fed into a one-milliamperemeter which reads the average current. The higher the RPM, the more pulses, and the higher the meter reading.

In the dwell meter mode we bypass the pulse-generator section of the IC and apply the signal directly to the amplifier-limiter section. The meter reading then corresponds directly to the percentage of time the points







Clip "meter" wire from dwell/tach to ignition coil minus terminal. Look for "distributor" wire. It runs from the (-) terminal to the base of your distributor.

for a 6-cylinder engine between approximately 1200 and 6000 rpm.

A dwell meter adjustment is done with R7. When the input (points) lead is disconnected, the meter should read full scale. Due to excellent voltage regulation in the IC, this potentiometer should not need adjustment after your initial setting. Full scale automatically corresponds to a 45-degree angle for an 8-cylinder engine, 60 degrees for a 6-cylinder, and 90 degrees for a 4.

**Operation.** Connect plus and minus power input leads to your 12 volt car battery. Switch S1 to the dwell function and adjust if necessary for a full scale meter reading. Then connect the third lead to the points (thin wire going from coil minus to the distributor housing). Now you are ready to take measurements.

**Auto Ignition Info.** Let's define some of the points about ignition points. A term used very widely is distributor contact dwell. Degrees of distributor dwell are the degrees of rotation during which the breaker, or contact points, remain closed. This is commonly referred to as dwell angle or cam angle. Correct distributor contact dwell is essential for good ignition performance and point life. Distributor contact dwell in effect is the amount of time that the points remain closed; during this interval of time, magnetic energy builds up in the ignition coil which, when the points open, generates the high voltage pulse that arcs across the spark plug electrode. Generally a longer

dwell period (larger dwell angle) is more advantageous for high speed operations.

Replacing ignition points is a simple matter of unscrewing the point retaining plate and screwing down the new one. This is just the beginning of a good tune-up. To check dwell reading you should have a dwell meter. Like most, ours is combined with a tachometer. With the engine running and the dwell meter/tachometer connected you should observe the dwell meter reading. If the dwell reading is within specifications for the engine then you can assume you have the correct gap, and that point contacts are in satisfactory condition. If the dwell reading is not within specifications, the point gap may be incorrect, the cam worn, the rubbing block worn or the moveable contact arm may be distorted.

**Mini Lube Job.** Distributor lubrication is

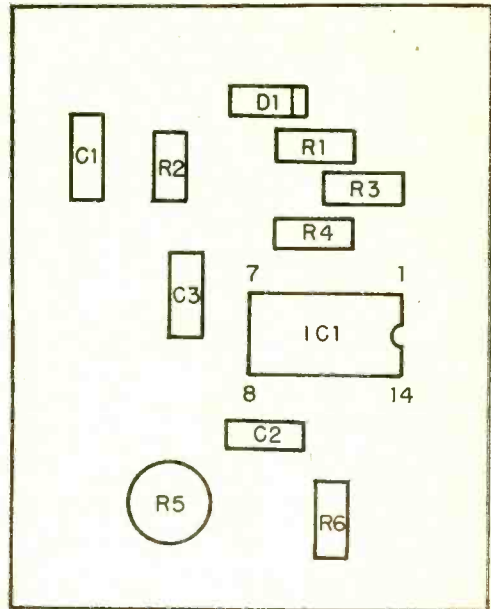

Use perfboard construction and lay out circuit components as shown. Components R7, S1, and M1 are located on front panel.

something which is usually overdone. If the distributor has an oiler on the outside of the distributor base add three or four drops of SAE10W motor oil to the oiler. If there is a felt wick under the rotor at the top of the distributor cam, use three to six drops of SAE 10W oil. All grease should be wiped from the distributor cam and rubbing block. It's very important that the ignition points be free of grease or oil.

Many ignition systems use dual breaker points. These dual breaker point systems are designed for long life and good high speed performance. They are handled in the same way as single ignition points with the following exceptions: One set of contacts should be blocked open with a clean insulator. A match book section makes a good clean insulator for this. Adjust the opposite set of points to specifications using a dwell meter. Loosen the stationary contact block screw just enough so that the stationary contact can be moved with a light touch otherwise it will be difficult to set the contacts accurately. When the one set of contacts has been adjusted for the correct clearance, tighten the stationary contact lock screw. Block the adjusted set of contacts with an insulator and adjust the other set of contacts in the same manner as the first set. Remove the insulator and recheck the tightness of the stationary contact lock screw. If the contacts have been properly adjusted the dwell should be as specified for both contact sets. Again you must make sure that the gap and the dwell specifications are met for both sets of points.

**Don't Overlook The Carb.** A list of malfunctions caused by a sick carburetor reads like a "Who's Who of Auto Ailments." It includes hard starting, flooding, delays acceleration, poor gas mileage, stalling, rough running, fouled spark plugs, and the gas leaks at the carburetor.

Not all of these problems, however, result only from an ailing carburetor. For this reason you should make sure spark plugs, ignition parts, compression, and timing are all in good condition before beginning carburetor service. In short, make sure your engine is

correctly tuned, because your carb depends on proper operation of the rest of the engine.

All types of carbs—no matter how many barrels—have only one throttle adjusting screw. Two- and four-barrel units, however, have two idle adjustment screws—one for each idle system.

Warm the engine to operating temperature and have the choke valve completely open when adjusting. Start the engine and let it idle. If it stalls, turn the throttle screw in until the engine is running steady without

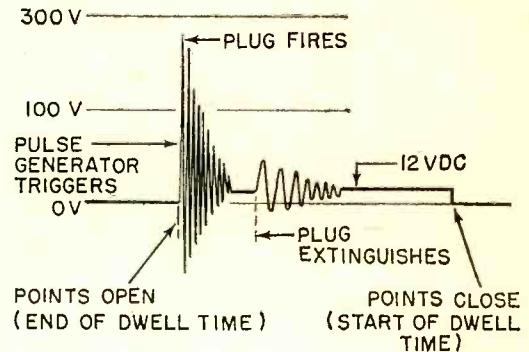

A pulse generator in your dwell/tach is designed to trigger just once each time the points open and a plug fires. Often, erratic behavior in some non-electronic tachometers is due to this complex wave.

any foot pressure on the accelerator.

The idle mixture should be adjusted to give a smooth idle. Missing is a sign of too lean an idle mixture while rolling or loping indicates too rich a mixture. Turning the screw in leans the mixture. It may be necessary to readjust the idle speed and mixture after the air cleaner is installed.

(Note: late model smog-controlled cars usually have a plastic limiter that restricts the movement of the mixture screw. An acceptable mixture adjustment should be pos-

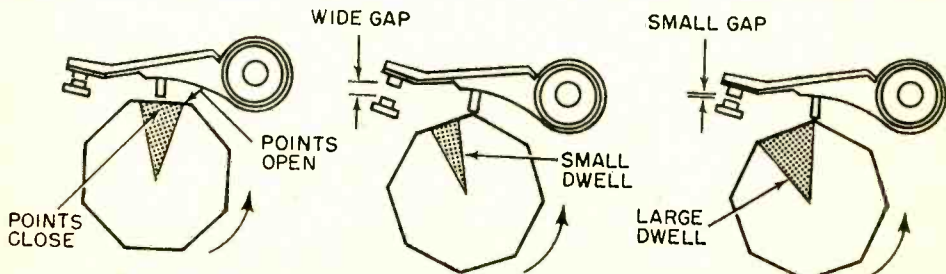

As a gasoline engine runs, a normally closed switch called the "points" is constantly being pushed open by a cam. Whenever the points open, a high voltage is generated by the ignition coil to "fire" a spark plug. Dwell shows how many degrees the cam turns before it opens the points.



sible within its limits.)

Turn the idle adjusting screw in slowly until the engine is about to stall. At this point, turn it out about a half-turn. If the engine seems to race, turn the throttle adjusting screw out slowly until the speed comes down.

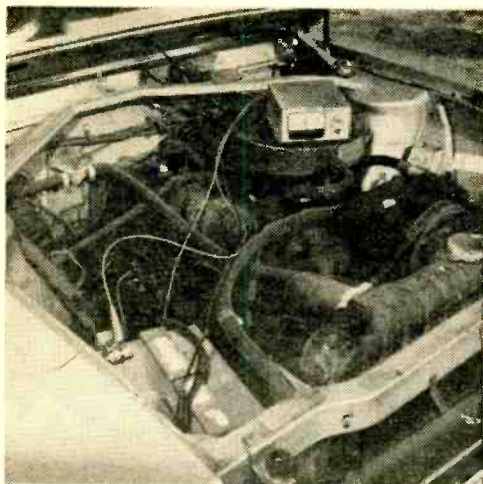

Tune-up helped this overdrive equipped '68 Rambler increase mileage from 21 to over 25 mpg at today's 50-mph speeds. They laughed when I ordered overdrive back in 1968. Now one tank gives us a 375-mile driving range!

**Service Your Plugs.** Be extremely careful how you apply the socket wrench over the spark plug insulators. While they can resist the sledge-hammer blows under extreme temperatures and load that take place inside the cylinder each time they fire, they can be cracked by carelessly banging them with a wrench either taking them out or putting them in.

After removing your spark plugs, you have three things you can do: put them right back in the engine, have them cleaned and regapped and reinstalled, or replace them with new spark plugs.

In the first case, you may merely want to examine the general condition of the plugs or check to see if the heat range is correct for the particular engine. Choice number two would be normal if spark plugs have only been used for around 5,000 miles and show normal wear. Clean and regap after 5,000 miles of use. Choice three would normally apply to spark plugs that have 10,000 miles of use or more on them.

Assuming that no particular complications exist, soak the spark plugs in a good parts cleaner for a few minutes to remove

any oily deposits that exist.

To remove carbon deposits, use a small knife or any other small tool which will fit up inside the plug along the insulator. Be careful not to chip the ceramic and avoid the use of a wire wheel, which will completely ruin the plug.

Hard carbon formations are often impossible to remove. As you examine the plugs, you may notice such a condition, or possibly a burned condition of the electrodes. In such a case, it's advisable to install a new set of spark plugs as you'll need them soon anyway.

If the condition of the spark plugs is satisfactory after cleaning, open the gap. File the electrode sparking surface with an ignition

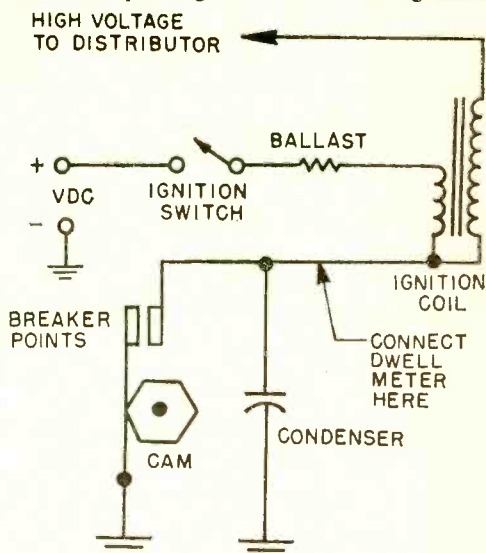

This is a typical non-electronic ignition system used for nearly all auto and truck engines since Henry Ford dropped buzzer ignition for his Model A. Additional part of ignition switch usually shorts out the ballast for more spark during starting.

point file before opening up the gap. You will get better firing from clean, flat surfaces, so this is an important part of spark plug servicing. Finally, adjust the gap to the manufacturer's specifications (Check the owners manual).

Making sure you have the right spark plugs installed and that they are in good condition is vital to good ignition system performance. But it's only part of the story. Other parts of the system must be working properly if the plugs are to do their job. Wiring, distributor components, and coil condition all affect the production of a healthy spark. ■

# The Sound of STG

BY FRANK KURUCZ

□ Play a simple melody on our Simplicity Tone Generator—you guessed it, we call it the STG. Actually, the circuit is a modified CPO (code practice oscillator) that has been BUed (beefed-up) with the simplest of keyboards. The leads of resistors used to generate individual tones are pressed against a copper wire—that's the simple and *cheap* keyboard. Price is kept down using just about any npn and pnp transistor in your junk box, including most of the other parts.

The circuit operation for the STG is as follows: depressing any one, or any number of resistors, forward biases Q1 transistor, which in turn drives Q2. Transistor Q2 is in series with the voice coil of the loudspeaker; the current passing through both

drives the speaker cone to produce sound. Capacitor C1 establishes a feedback to the base (b) of Q1 to sustain the switching action of that transistor. The tone frequency is mainly dependent upon the value of C1 and R1 plus RA to RZ.

Resistors RA through RZ (actually about 12 will be enough for a simple tuner) are selected to obtain the desired tone. Start with a 100,000-ohm resistor for the first tone. Make other tone-resistor selections by playing it by ear. High power operation can be achieved by taking a pair of wires from the loudspeaker to the input of an audio amplifier. Any type of insulating board may be used to mount components. No on/off switch for STG is needed since the battery terminal can be disconnected quickly. ■

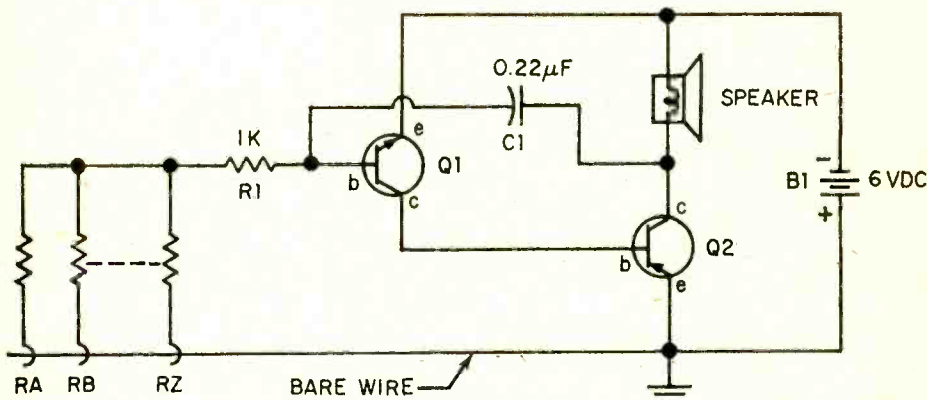

Wire the parts shown in the schematic diagram to flea-clip terminals pressed into a small piece of perf-board. Point-to-point wiring is best, transistor sockets need not be used at all. The keyboard is assembled with the tone resistors (RA . . . RZ) ends jutting slightly over a bare bus wire closing the circuit on touch.

### PARTS LIST FOR SIMPLICITY TONE GENERATOR (STG)

- B1—6-volt lantern battery (Radio Shack 23-066 or equiv.)
- C1—.22 µF capacitor (Radio Shack 272-1058 or equiv.)
- Q1—nnp transistor (Radio Shack 276-2004 or equiv.)
- Q2—pnp transistor (Motorola HEP-240 or equiv.)

- R1—1,000-ohm, ½-watt resistor (Radio Shack 271-000 or equiv.)
- RA-RZ—selected values of ½-watt resistors (Radio Shack 271-000 or equiv.)
- SPKR—4-ohm, 3-in. dia. loudspeaker, replacement type (Radio Shack 40-1201 or equiv.)





by Robert L. Way

## A Nightlight Blackout Alarm

**H**EAVY rains, electrical storms, drifting snow, and high winds and the energy shortage can cause a power failure to your home just when you urgently need electricity to operate your furnace, freezer, sump pump, clocks, etc. After I experienced a flooded basement due to a power failure during a heavy rain, I built this power failure alarm.

This small and inexpensive device will 1—

sound a battery-operated buzzer to wake you up, 2—light a pilot lamp (flashlight bulb) so that you can locate the unit in a darkened room (you will want to shut off that darn buzzer!), 3—remind you to “re-set” it after power is restored (the lamp stays lighted continuously until house current is applied to the device), and 4—provide you with a portable trouble-light (you can unplug the alarm and take it anywhere).

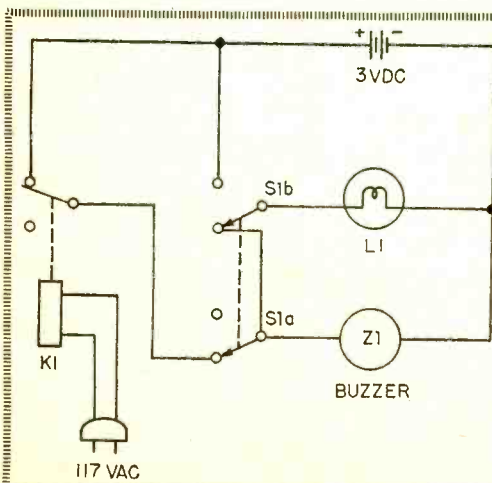

### PARTS LIST FOR POWER LOST

**B1**—Batteries, two C cells in series (see text)

**K1**—Relay, normally closed or DPST contacts (Radio Shack 275-205 or equiv.)

**L1**—Lamp, PR-2 flashlight lamp (Radio Shack 272-1120 or equiv.)

Note: You can also use a 222-type pre-focused penlight lamp (Radio Shack 272-1124 or equiv.) in a Calctro E2-400 socket. It draws one-half the battery power of a PR-2 and beams the light for a flashlight effect.

**S1**—DPDT toggle switch (Radio Shack 275-666 or equiv.)

**Z1**—Buzzer for 3-volt operation (Radio Shack 273-004 or equiv.)

Misc.—Wire, case (Radio Shack 270-233), power cord, battery holder for C cells (Radio Shack 270-385), solder, etc.

# e/e POWER LOST

After you have built the alarm and installed it (under your bed is a good place), how do you know that it will work OK when that power failure hits? Testing its operation is quick and easy. Simulate a power failure by momentarily disconnecting the unit from the wall socket. If the buzzer and lamp both come on, plug it back in and rest assured that it's ready to alert you when a real power failure occurs.

The alarm is built into a ready-made box that measures 2 $\frac{5}{8}$ -in. x 5 $\frac{1}{10}$ -in. x 1 $\frac{5}{8}$ -in. It costs about \$10 to build, if all new parts are purchased, and about 6¢ per month to operate. It can be built for even less if you have on hand any parts that can be used, if you elect to fabricate your own box, or if you solder the batteries and lamp permanently into the circuit, thus eliminating the cost of a battery holder and lamp socket.

The gadget uses about 2 kilowatt-hours (kWh) of electrical power per month; in many localities electric power costs about 4¢ per kWh (most electric bills show the number of kilowatt-hours used per month—divide this figure into the amount of your bill to get your effective rate).

**How It Works.** As shown in the schematic diagram, the buzzer and lamp are wired in

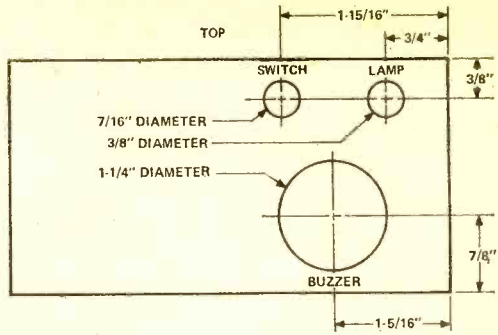
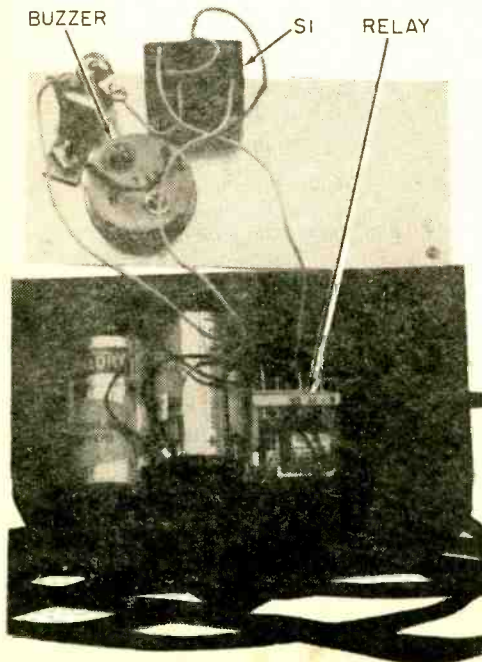

**Cut out the top metal plate of your box to these specifications. One additional hole is drilled in the side for the power cord.**

parallel and are connected, through the switch and normally-closed relay contacts, to the battery (two C cells). When the power cord is plugged into any household outlet, the relay coil is energized and the contacts open to interrupt battery power to the buzzer and lamp. When a power failure occurs, the relay contacts close and complete the buzzer-lamp-battery circuit.

Section A of the DPDT switch opens the buzzer circuit to shut it off; simultaneously, section B applies battery power directly to the lamp, which cannot be switched off. The lamp is wired in this manner to provide a reminder to switch the buzzer back to the *on* position after power is restored so that the alarm will be ready for the next power failure. If a switch were connected between the buzzer and lamp to turn just the buzzer off, you might forget to turn it back on after the emergency (the lamp would go out when the relay was energized again).

If parts are substituted for those shown in the parts list, first check to see that all components will fit in the box or case to be used, including clearance for those parts that will be mounted on the cover. In the unit shown there is adequate room for everything, of course, but it's a reasonably tight squeeze and even a slightly larger part might give you a packaging problem. Also, if you've substituted parts it would be well to hay-wire everything together to see if the battery(s) you've chosen will deliver enough current to operate both the buzzer and lamp consistently and reliably. The buzzer in the  
*(Continued on page 95)*

**Inside the black box a couple of parts can give you instant blackout warning. A buzz alerts sleepers during nighttime failures.**





by Kathi Martin KAI0614

# KATHI'S CB CAROUSEL

**H** EY THERE you REACT, Alert and Rescue Team CBers, Kathi's come up with a gadget that's better than a two dollar pistol on a Saturday night. If your rescue operation has a tie-in to any of the public service agencies with their transmitters on the VHF (148-174 MHz) band, this handy-dandy device will put you right on top of their emergency calls no matter where you're hiding—from inside an elevator to that basement your local church so kindly donated for your outfit's "Radio Central."

What is it? The Realistic PRO-4 *pocket sized* VHF scanner! That's right, a scanning receiver for the VHF band that can slip right into a shirt pocket, or it can be hung on your belt from its integral belt clip.

The PRO-4 is about one and one-half times the size of an ordinary pack of cigarettes, measuring 2 $\frac{5}{8}$ -in. x 1 $\frac{1}{4}$ -in. deep x 5 $\frac{1}{2}$ -in. high. Its power supply is two self-contained 9 volt transistor radio type batteries or an external supply through a power jack.

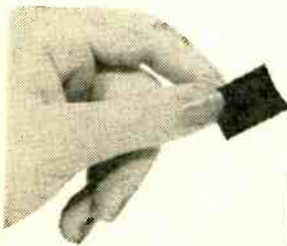

This pocket scanning monitor from Radio Shack uses from one to four crystals for rock-steady reception of the VHF Hi-band.

Optional AC power supply and 12 VDC power cord can be connected, in place of the internal battery pack, to this jack.

## KATHI'S CAROUSEL

A really outstanding extra feature is an adjustable squelch. In the past, one of the main problems with low cost pocket-sized VHF receivers was a total lack of squelch, allowing interstation and no-carrier noise to grind away until you were ready to climb the walls. In the Realistic PRO-4 the squelch completely mutes the receiver's output, releasing only when a transmission is received. If the scanner is *on*, it stops on the received station and does not resume scanning until about two seconds after the end of transmission. This insures that you will receive a return call from another station in the same network. This contrasts to scanners without the release-hold which allows scanning to resume instantly; in the brief interval between calls the scanner skips to the next channel and the return call is lost. Obviously, the release-hold in the PRO-4 insures continuity of communications.

**A Lot Of Guts.** Though the PRO-4 is about the size of a small inexpensive transistor radio, it's jam-packed with circuitry you'd find in the best base-station type VHF scanners. The receiver is double conversion—10.7 MHz and 455 kHz, with a ceramic filter in both the 10.7 MHz and 455 kHz I.F. amplifiers. As you'd expect, this type of hardware delivers razor sharp selectivity, actually 60 dB of adjacent channel rejection. The overall sensitivity checked out at almost exactly 1 microvolt for 20 dB quieting (standard test). I connected an antenna to both the PRO-4 and one of the highest rated base station scanners and they delivered almost identical performance, the only essential difference was the very bright, cutting sound quality of the PRO-4 caused by the two inch speaker.

I got a chance to use the PRO-4 on a team drill, and the receiver did an outstanding job on a 5-mile radius from the transmitter using its own internal antenna. Good reception to about 8-miles was possible by locking the receiver on-channel and releasing the squelch. For greater dependable range an outdoor or external antenna was required.

The Realistic PRO-4 pocket scanning monitor for the VHF-Hi band is from Radio Shack, 2617 W. 7th Street, Fort Worth TX 76107 and sells for \$99.95. For more information circle No. 32 on the Reader Service Coupon.

My only gripe with the PRO-4 is the battery life. It uses two 9-volt batteries connected in parallel because the LED (light emitting diodes) used for the channel indicators take a fair amount of juice. Using ordinary type 216 batteries, I got about 20 hours dependable operation; the standby no-signal battery current is 38 mA, peaking over 100 mA when receiving with the volume turned up. (Figure the batteries are gone when you can no longer set the squelch control to mute the receiver.) Using the 50% Long Life batteries that came with the rig I got about 30 hours operation.

This is one case where I suggest you don't try to skimp on pennies. Use the best possible Long Life batteries if you want them to last through a long emergency run. If you use the PRO-4 for base station monitoring I strongly suggest you use an AC power supply such as the Realistic 270-1531. An optional Auto Adapter Cable is also available under part number 270-1532.

**It's A Winner.** If you think I'm enthusiastic about the Realistic PRO-4 then you're getting my message 10-4. From any viewpoint it's a winner all the way—even the price of \$99.95. The crystals run \$6.95 each, the AC power supply is \$8.95 and the Auto Adapter Cable is \$6.95.

When you order crystals keep the frequencies within 4 MHz on either side of 153 MHz, for that is the factory-set maximum sensitivity range—8 MHz total. For maximum sensitivity on band segments outside this frequency range the receiver's RF amplifier must be retuned, though you can operate with somewhat reduced sensitivity even if the receiver isn't retuned.

For additional information circle number 32 on the Reader Service Coupon on page 17 or 103. ■



All controls are mounted on top including individual lock-out for each VHF channel.

ELEMENTARY ELECTRONICS



# PUT TOGETHER A PORTA-MOBILE

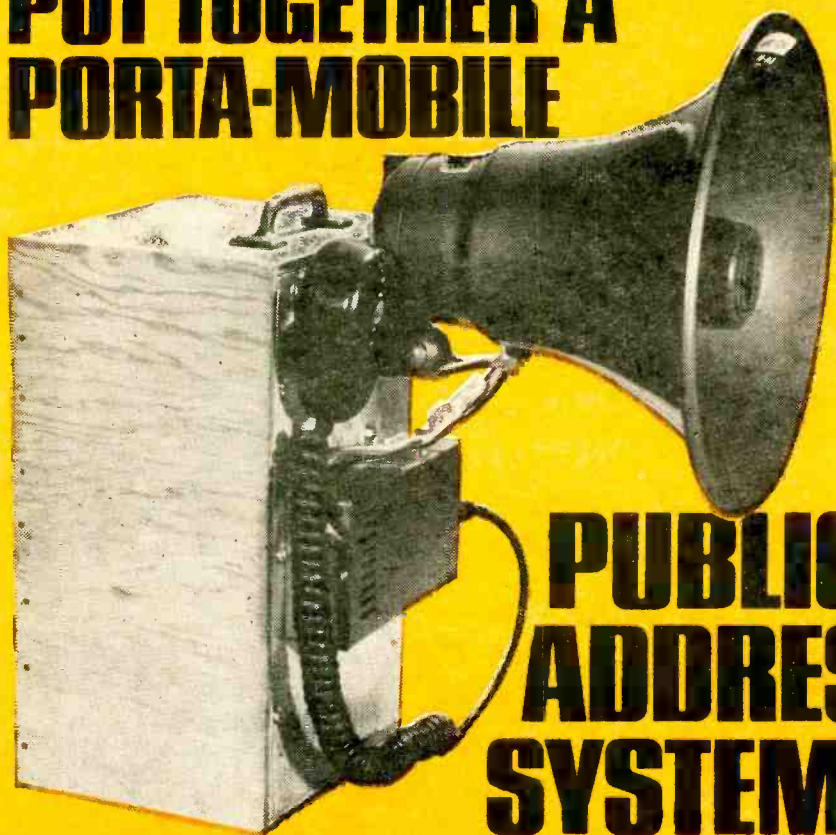

## PUBLIC ADDRESS SYSTEM

by Marshall Lincoln

**W**ITHOUT EXTENSIVE KNOWLEDGE of electronics, you can easily build this go-anywhere portable public address system.

You can carry it easily when you need a battery-powered portable PA, and you can quickly plug it into your car or truck, where it will be instantly usable, no matter whether you're driving or parked.

You'll find it handy for use at meetings, sports events, outdoor activities, school or civic club functions, recreational outings, parades, or emergency situations.

This simple and useful workshop project enables you to take advantage of modern solid state technology which has shrunk audio amplifiers from the cumbersome, suitcase-sized units of former years to tiny boxes that fit the palm of your hand. This same technology has freed public address systems from the necessity of an electric power outlet, so they can be operated from

batteries.

Modern, compact, efficient speakers make the old-fashioned trunk-sized bass-reflex cabinet or washtub-sized trumpet speakers unnecessary for any public address requirements of the average person.

Transistors can pump out a considerable audio punch without requiring a high voltage power supply, which was a necessity with the old, bulky vacuum tube amplifiers. Consequently, transistor PA systems can be built to operate from 12 volts, making them usable in a motor vehicle without any special batteries or generators. Since transistors don't require power for heating filaments or operating high-voltage supplies as tubes do, a moderate power public address amplifier can be operated from dry batteries, with the entire system light enough for you to carry in one hand.

**And Easy Assembly.** Add to all these advantages the fact that such amplifiers are

**NEW FROM  
BELL & HOWELL  
SCHOOLS...**

**THE REVOLUTIONARY  
25-INCH DIAGONAL  
DIGITAL  
COLOR TV  
YOU ACTUALLY  
BUILD YOURSELF!**

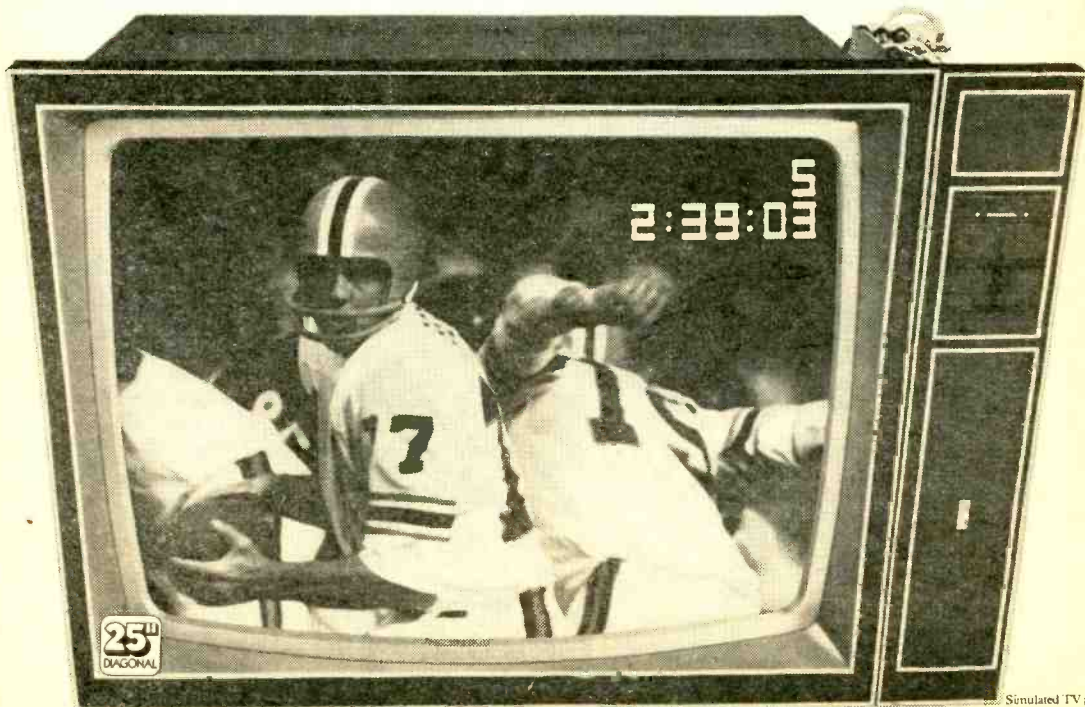

Simulated TV picture





Simulated TV picture

**Build and keep one of today's most advanced color TV's!  
It's the perfect spare time project . . .  
an enjoyable way to learn about the exciting new field of digital electronics!**

Digital electronics is a fascinating world to explore! It's a new technology that's changing not only our clocks, wristwatches and pocket calculators, but now, color TV!

By building Bell & Howell's new big-screen digital color TV you not only learn all about this new field, first-hand, but you'll have a remarkable color TV to keep and enjoy for years! And, you'll take special pride in it because you built it yourself!

**You get a color TV ahead of its time . . .  
with revolutionary features like:**

**Channel numbers that flash on the screen**

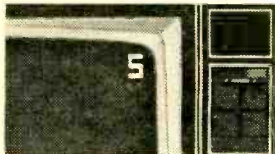

Wait until the neighbors see that *your* TV has channel numbers that actually flash on the screen! You can even pre-set how long you want them to stay on before fading.

**Automatic pre-set channel selector**



With just the push of a button, your favorite channels come on in the sequence you pre-set. All "dead" channels are skipped over.

**Digital clock flashes on the screen**



Imagine pushing a button and seeing the correct time on your TV screen! The hours, minutes and seconds appear in clear, easy-to-read digital numbers.

What's more, Bell & Howell's digital color TV has all-electronic tuning, reliable integrated circuitry and a 100% solid-state chassis for a bright, sharp picture with long life and dependability.

"Electro-Lab" is a registered trademark of the Bell & Howell Company.

**You don't have to be an electronics expert to build it!**

That's one of the beauties of this TV! All you need is a few simple household tools and our step-by-step instructions. You can also take advantage of our toll-free phone-in assistance service throughout the program and in-person "help sessions" held in major cities throughout the year where you can "talk shop" with your instructors and fellow students.

**You also build and keep Bell & Howell's exclusive new Electro-Lab<sup>®</sup> electronics training system**



Includes building the three professional instruments you'll need to test your TV and other digital equipment. You'll use the digital multimeter (pictured here), solid state "triggered sweep" oscilloscope and

design console throughout the course and later, perhaps, in a full or part-time business of your own.

PLUS...for immediate "hands on" experience right from the start, you'll get a Lab Starter Kit, which will help you understand many of the fundamentals of electronics.

**The skills you learn can lead to part-time income or a business of your own**

This new digital technology opens up a world of opportunity for people with the right know-how. Let us show you how Bell & Howell Schools' new at-home program can lead to extra income part time. Or, if you're thinking bigger, we even include a complete volume on how to start a TV servicing business of your own!

**Mail the postage-free card today  
for full details, free!**

If card has been removed, write:  
An Electronics Home Study School  
DEVRY INSTITUTE OF TECHNOLOGY

ONE OF THE  
**BELL & HOWELL SCHOOLS**  
4141 Belmont, Chicago, Illinois 60641

509

# HEY HERB

## THE AUDIO ANSWER MAN

by Herb Friedman



**HEY HERB:** I've been looking over the quad equipment for CD-4 and I notice that some demodulators have a 30 kHz adjustment in addition to left and right separation adjustments, while other models don't have the 30 kHz control(s)—just the separation controls. Is there any difference in performance caused by the 30 kHz adjustment?

*Not really.* The 30 kHz adjustment control is an inherent part of a particular circuit design. Some of the new circuits utilize a phase lock loop, obviating the need for a 30 kHz adjustment. It's six of one, half a dozen of the other as far as sound quality is concerned.

**HEY HERB:** I figure on paying my way through college by doing laboratory-quality audio servicing and installations. I've purchased top-quality instruments, but I've tried several digital AC voltmeters (to calculate power output) and they are all less accurate at the extreme lower frequencies than a cheap audio voltmeter. Some are even inaccurate at 20 Hz. Aren't digital voltmeters supposed to be more accurate than the analog type?

*Digital multimeters* (that's what you probably purchased) are extremely accurate within their specified frequency range. Few priced below \$1000 are really accurate below 40 Hz, and some poop out above 10 kHz. I've tried just about all, and the best, most accurate choice for 20 to 20,000 kHz audio servicing is the Heath IM-102. Forget the Heath specs: The IM-102 is as "flat" as the AC voltmeter in the Hewlett-Packard HP 334A N&D meter, and that's as accurate as you're ever going to need for laboratory-quality audio work; and I'm just talking about dB or power conversions 20 to 20,000 kHz. The Heath IM-102, within the 20 to 20,000 kHz range, is a lot more accurate than many "laboratory" DVMMs.

**HEY HERB:** My cassette recorder has a new problem. I hear the second track playing in reverse almost as strong as the selected track. I've tried adjusting the small screw next to the record/play head but it just seems to muffle the sound; I still hear the two tracks. How can I get back to hearing only one track at a time?

*You're on the right track* but the wrong adjustment. Somehow the head is overlapping

tracks and all you need to do is to center the head on the desired track, but you're turning the alignment screw. Look for a screw that moves the head assembly up and down. Play an older, known-good cassette and adjust the height screw for maximum output. Then adjust the alignment screw for maximum high frequencies. You might have to alternate the adjustment to the two screws several times to get minimum crosstalk coincident with optimum alignment.

**HEY HERB:** I'm starting to upgrade my stereo system. Is it worth the extra money to get a tuner or receiver with built-in FM Dolby?

*Why stereo?* Go quad if you're getting new gear. But if you insist on stereo check whether your local FM stations use Dolby. Few do, and if there's no Dolbyized FM station in your neck o' the woods the extra expense of a straight Dolby de-emphasis processor isn't going to do you much good. If you have a local Dolbyized FM station then by all means you'll need a Dolby processor if you don't want to have screaming highs drilling through your ears. But why not use the extra money for a complete record/play Dolby adaptor which you can use for both the FM stations and your tape recorder(s). Fact is, the new Marantz 4230 stereo/4-channel receiver has strapped quad amplifiers (stereo now, 4-channel later), pre-wired compartment for an add-on SQ decoder, FM Dolby and record/play Dolby. Everything you want—or should want—in one package.

**HEY HERB:** I would like to be able to compare matrix vs CD-4 sound, but it's almost impossible to make A/B comparisons with several different records. Is there any record that has both matrix and CD-4 encoding?

*Nope, not yet.* But Enoch Light's Project 3 outfit now has several records available in both SQ and CD-4 encoding—the same program (musical selections) in the two popular formats. One series is Future Sound Shock. But be very careful when selecting the records; for some strange reason the numbers on the record cover are the same, only the record label indicates SQ or CD-4. I assume later production will clearly indicate the matrix or CD-4 process on the album cover;

*(Continued on page 94)*





# ANTIQUE RADIO CORNER

by James A. Fred

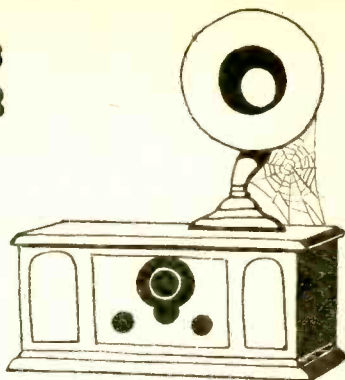

**H**ELLO out there in Radioland! Here we are again to talk about collecting antique radio and wireless equipment. Your letters are very welcome and provide encouragement for me to continue this column. However I must emphasize very strongly your placing your address on every letter you write. I am receiving many letters with no return address. You probably put a return address on the envelope, but the letter is removed from the envelope in the mail room and the envelope is discarded. I have two orders with checks for Vintage Radio Books, but without an address. Please write and let me know what subjects you would like me to cover in future columns.

**WW II Surplus Antique Radios.** There are a number of collectors that specialize in collecting war surplus radio equipment. Obviously there isn't much WW I surplus around, and not too much WW II surplus is attrac-

tive to collectors. However, I received a surplus catalog from Fair Radio Sales of Lima, Ohio and discovered a very interesting radio. This is a BC-229, AM, TRF receiver that tunes from 201 to 398 kc and from 2500 to 4700 kc by use of plug-in coils. The set uses a type 37, a 38, and four type 39 tubes.

Right away you will note three significant facts. First, it is a TRF (tuned radio frequency) receiver. Most of the pre-1928 battery sets were TRF sets. Second, the receiver uses plug-in coils. Plug-in coils were used in all the multi-band receivers during the 1920's and the communication sets used plug-in coils until the 1940's. Third, note the tube types. These tubes—37's, 38's, and 39's—were used in the very first car radios and small table radios of the early 30's. Buying a receiver of this type is a step back in radio history, but best of all is the pre-



John T. Mullins poses with first (1924) recording microphone. Panel at right is W.E.'s first electrical phono recording apparatus.

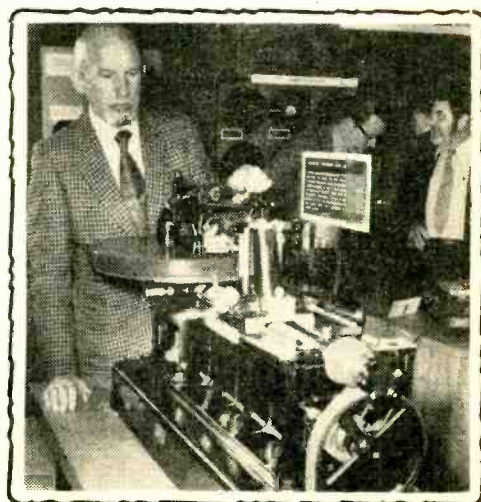

Here's John again with a 1926 Vitaphone recording lathe. It was used to cut the sound discs for the first talking movies.

# e/e ANTIQUE RADIO CORNER

inflation price of \$9.95 for an unused set, with tubes and coils, plus shipping charges.

The frequency band of 201 to 398 kc was called the longwave band, and these frequencies are now used for aeronautical weather broadcasts and aircraft communications. The other band of 2500 to 4700 kc covers present shortwave broadcasting and amateur frequencies. I recently ordered one of these receivers and will write a report on it in a later column.

**Sound Recording Equipment.** A working display of sound recording equipment spanning the 80-year history of the industry was exhibited at the annual meeting of the Audio Engineering Society in Los Angeles.

The display consists of more than 40 pieces of working equipment, photos, old records and other items, and was assembled for exhibition by John T. Mullin. Mullin owns about 90 per cent of the equipment.

The collection includes one of the first recording microphones (circa 1924); a wire recorder; one of the first production Ampex audio tape recorders; and the 1926 Vitaphone recording lathe used to cut sound on disc for the first talking motion pictures, including "The Jazz Singer."

**Tube Replacements.** A question sent in by one reader concerns tube type numbers such as 301A, 201A, 01A, etc. He wants to know if tubes numbered in this way can be used interchangeably. The answer is a qualified yes.

In the beginning of radio there were very few companies making vacuum tubes for

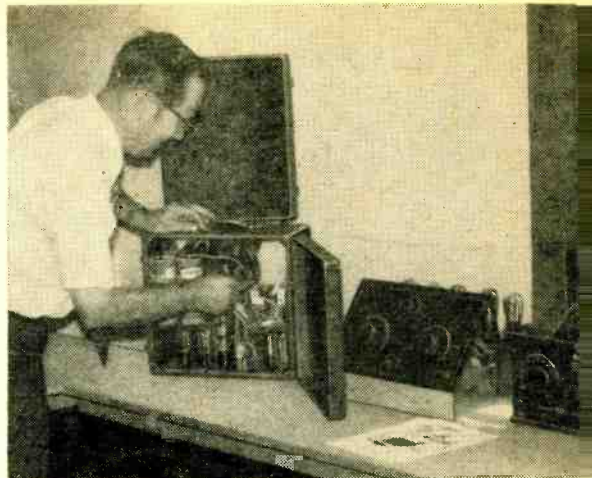

Ross Smith, Prez of the Indiana Historical Radio Society, makes an adjustment to his 1925 Trav-Ler portable radio.

## ANTIQUÉ RADIO FACT SHEET

Collectors of antique radio and wireless equipment can get a Fact Sheet from Elementary Electronics which includes information on antique radio publications and clubs, and a listing of public and private radio and wireless museums. To get your copy send a long stamped self-addressed envelope to Antique Radio Corner, ELEMENTARY ELECTRONICS, 229 Park Avenue South, New York NY 10003.

home radios. For a time the Cunningham tube company branded their tubes with a 3 preceding the actual tube type numbers—380, 301A, 327, 371A, etc. The RCA company branded their tubes with a 2 preceding  
(Continued on page 105)

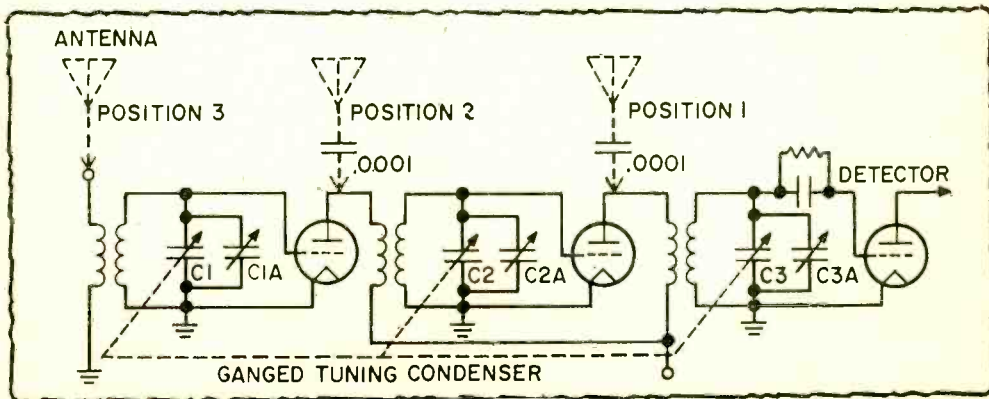

Circuit shows the method of connecting the antenna to the various stages of a TRF receiver during the process of aligning the tuning capacitors in the RF amplifier stages,



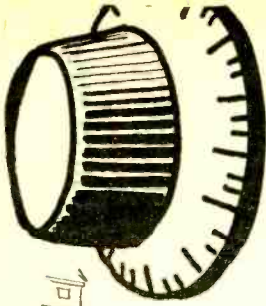

# TWIST OFF HISTORY

by Jack Schmidt

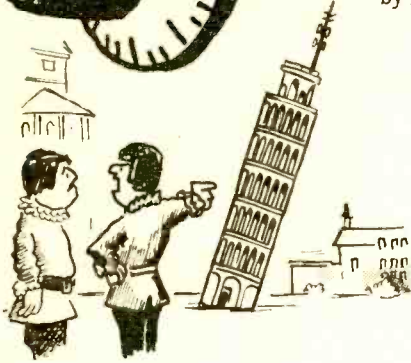

"I told you, Guglielmo, to place the antenna tower in the center . . ."



"Hey, Mr. Bell, I'd like to show you something my friend Eddie invented."

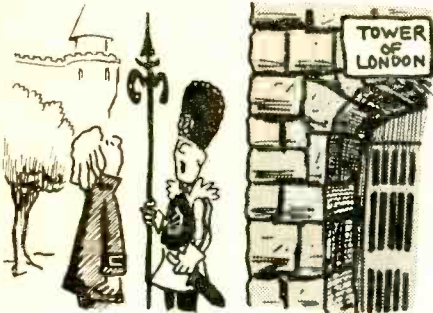

"I do believe it has something to do with improving His Majesty's telly."



"Custer's men are jamming our channels!"



"Plymouth Radar reports a ship full of Pilgrims entering the bay now!"



"Mount this depth finder on your chariot, oh mighty Pharaoh, and follow Moses anywhere!"

# newscan

Electronics in the News!

## A Sign of Our Times

The coin telephone has long been a favorite victim of thieves and vandals. Standing alone on isolated street corners and roadside areas, it has been approached by furtive-looking men



Western Electric's indoor version of the Sentry a, new vandal-proof mounting for coin telephones. Made of tough, tubular steel, the Sentry features a recess that protects the sides and top of the phone from the strong-arm tactics of the thief and the vandal.

who have gagged its coin return chute, picked its lock, ripped off its handset and even wrenched it from its mounting.

Over the years, the Western Electric Company has made improved coin telephones that are less vulnerable to chute-gagging and more resistant to lockpicking and handset-ripping. Now the company is purchasing for the Bell System a new mounting called the Sentry. The mounting consists of a sturdy steel post with a recess in which a single-slot coin phone is inserted. The mounting screws and upper lip of the phone are covered by the recess, where neither screwdriver nor crowbar can reach them.

The mountings, available in both walk-up and drive-up heights, may be connected to either a surface-mounted pedestal base or one

that is buried in concrete. The indoor model may be equipped with a writing shelf; the outdoor version features a quarter-inch-thick aluminum hood that affords protection from the weather and also limits further the accessibility of the sides of the phone. An overhead lamp enclosed in the hood furnishes light for the sign, the telephone, and the area surrounding the station.

## Cool Spin

A miniature turbine-alternator, spinning at 100,000 rpm at a temperature within a few degrees of absolute zero, has set a new low-temperature record for machines of its type. The device is a critical component in a super-cold refrigerator that could be used in such industrial applications as chilling superconducting motors and generators for ship and magnetically-levitated train propulsion, and AC power generation.

In a three-hour test, the pocket-sized turbine-alternator was cooled from room temperature to 9.8° Kelvin (minus 442°F; absolute zero is 0°K or minus 460°F) while operating at 100,000 rpm and producing 13.2 watts of electricity. The unit provides the cooling necessary to reach cryogenic temperatures by removing



Engineers at the General Electric Research and Development Center operated a miniature turbine-alternator at minus 442°F—only 18 degrees above absolute zero. Under the direction of its designer, GE engineer Duard B. Colyer (background), the turbine-alternator was cooled to minus 442°F and tested at 100,000-mp for three hours.

energy from the refrigeration system in the form of electricity. During the test the turbine-alternator was cooled and driven by helium gas vaporized from liquid helium.

Designed by GE engineer Duard B. Colyer  
(Continued on page 94)

ELEMENTARY ELECTRONICS



# SLIP-N-CLIP

## A SIMPLE BREADBOARD

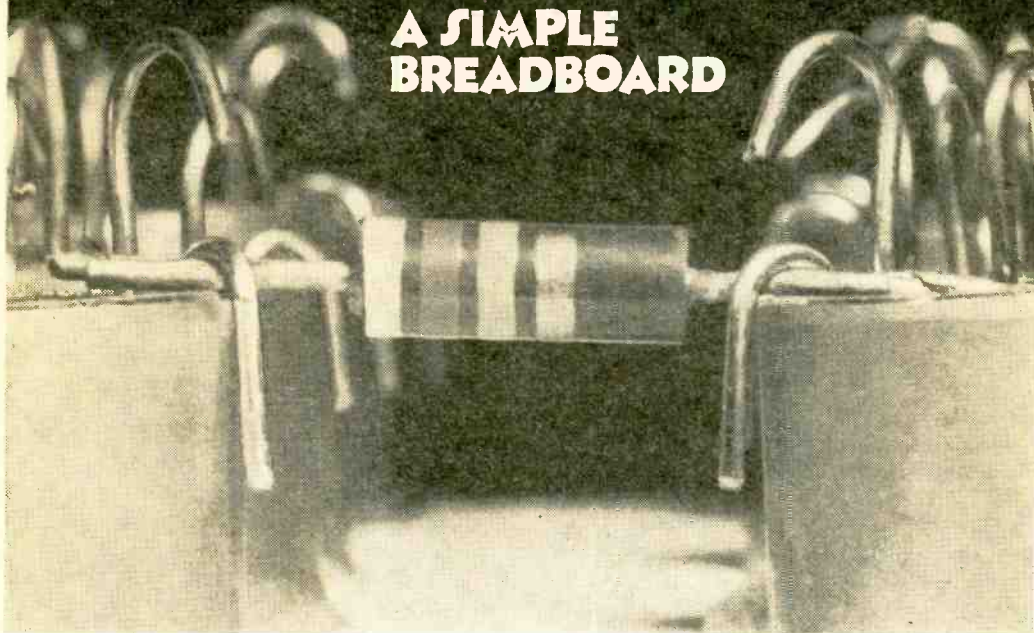

by R. G. Cooper

**A** dyed-in-the-wool, like me (and maybe you) experimenter/hobbyist doesn't always need a simple breadboard. He has the wire, push-in clips, perfboard and solder needed to whip up a quick project. But if you're just starting in the fascinating area of hobby electronics, this no-solder, matrix style rubber band and copper pipe-type breadboard may just be for you. It goes together quickly, parts are simple to find, and it's handy to use. Here are some of the features it has to offer.

Connections are solid and always make very good contact. Each lead is clamped independently. Making one connection does not disturb another. The completed circuit is solid and can be used *as is* if desired. When the circuit has been optimized it can be lifted component by component to an identical configuration on one of the island type circuit boards. This is as near as you can get to a gilt-edged guarantee that the circuit will perform.

A two foot length of 1/2-in. copper pipe, a package of rubber bands, a box of regular size (No. 3) paper clips, and a small piece of 1/2-in. or 3/4-in. plywood, are all the materials you need.

The 4 x 3 board used as an illustration can be made quickly with a minimum cost. After you've used it you will very likely want to make a number of different sizes. Once you've boarded a circuit you might just want to leave it that way. A 6 x 8 matrix will accommodate quite an elaborate circuit and is probably as big as you will ever need. Very complex circuits are best split into a number of sub-circuits on smaller boards.

**Construction.** The author's boards were



Twelve holes on one-in. centers make a base for the short pipe lengths that form your junction points. Auger type drill is used.

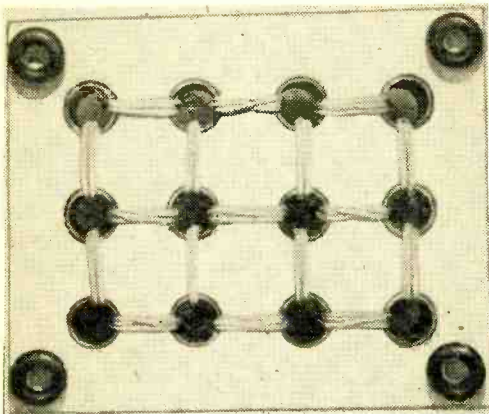

Bottom of 3 by 4 board shows rubber bands looping through adjacent copper junctions. Modified paper clips hold wires to pipes.

drilled on a 1¼-in. grid giving a 5⁄8-in. space between pipes. This distance was chosen to utilise a junkbox of components with somewhat short leads. If you will be using standard lead lengths you could increase the center-to-center distance to 1¾-in. and make it easier to install components at the cost of a larger board. Leave a ½-in. margin around the outer pipes to protect the circuit and provide a space for labelling.

For ½-in. plywood 1-in. pipe lengths are about right. If you want to utilise some ¾-in. plywood scraps, increase the pipe lengths to 1¼-in. If you wish, you can use an adjustable bit to drill holes of just the right size to enable you to force-fit the pipe into place.

By using a standard 5⁄8-in. bit, and epoxying the pipe in the holes, you eliminate the slight possibility of shorting between pipes.



Three old nails and a block of wood form your paper clips like this.

The use of both copper pipe and copper paper clips provides low resistance junction points while still maintaining enough flexibility to make quick component changes.

Whichever method you use, be sure to drill only until the pilot penetrates the far side, then complete the drilling from the reverse side to eliminate splintering.

Any finishing on the board should be done after drilling and before installing the pipe sections. Spraying with white enamel is one approach that adds to the visibility and looks neat. When you're using fast-setting epoxy, mix only enough for three or four junctions at a time. Lay the board on a sheet of plastic—some epoxy is bound to leak through.

The component clamps are easy to make once you have constructed a simple jig with three beheaded nails and a scrap of wood. Open up the large loop of a No. 3 paper clip. Place the small loop on the center nail and bend the large loop backwards, first around the bottom and then around the top nail. Trim with needle-nosed pliers and snip both ends with diagonal cutters in the general form shown.

The rubber bands should be such as to provide good tension on both clamps without overstraining them. A band 1½-in. long, used doubled, is about right. Two clamps joined by a double rubber band are placed opposite one another in adjacent pipes.

When you have completed all adjacent pairs you will have two clamps on each corner, three on the remaining side junctions, and four on all the remainder. This is normally ample, but if you need an extra pair while breadboarding it's a simple matter to add one. Rows and columns should be identified with a label maker and rubber feet added to provide clearance for the rubber bands.

You will probably need some outboard accessories such as battery clips, pots, and relays. These are best made up as you have need of them and then kept on hand. The

*(Continued on page 104)*





# e/e's

## ALL NEW BASIC COURSE in ELECTRICITY & ELECTRONICS

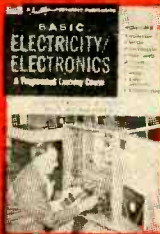

This series is based on  
**BASIC ELECTRICITY/ELECTRONICS,**  
Vol. 1, published by  
**HOWARD W. SAMS & CO., INC.**

## HOW TV MAKES A PICTURE

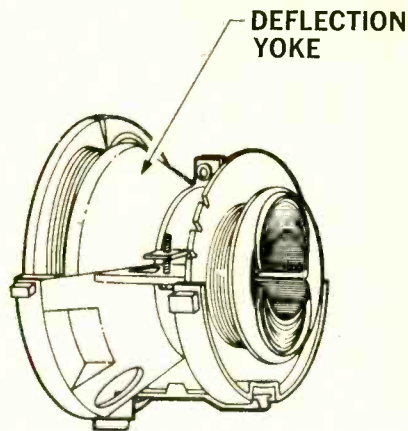

**W**hat you will learn In this course you will become familiar with the television receiver. You will be introduced to the system used to "paint" a picture on the face of a cathode ray tube used as a TV picture tube. Synchronization signals that lock a TV receiver with the master oscillators at the station are also discussed.



## HOW TV MAKES A PICTURE

There are many different models of TV receivers. They differ in the types and numbers of circuits used, as well as in the size of picture tube and style of cabinet. Since they all must process the same signals from a TV transmitter, the function of their circuits must be identical.

A single antenna brings both the FM carrier and the AM video (picture) carrier to the TV set. This is satisfactory since the sound and video carrier frequencies are fairly close together (the sound carrier is 4.5 megahertz higher).

### TV RECEIVER SECTIONS

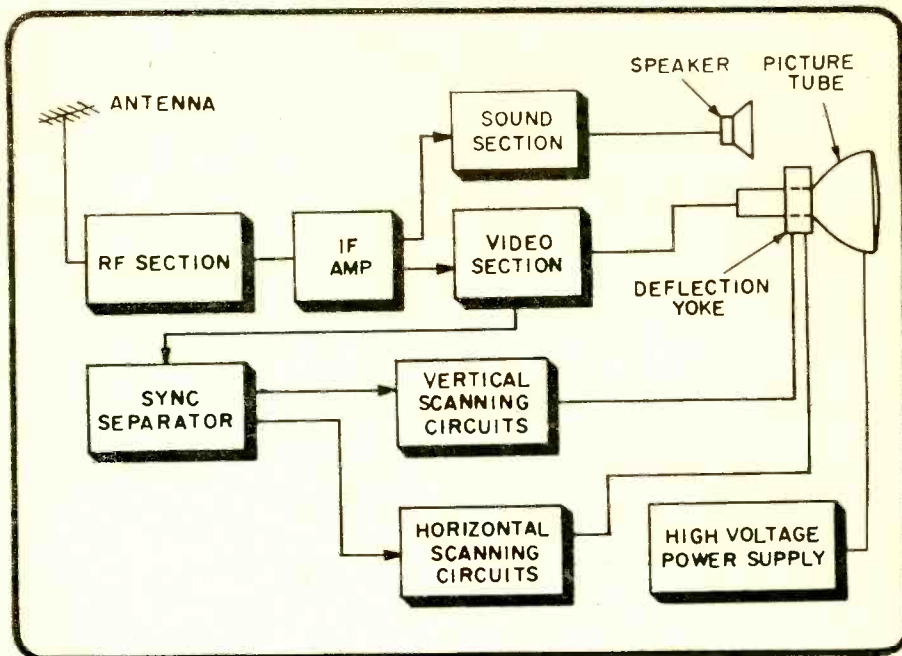

Both carriers are amplified and converted to an intermediate frequency (IF). The IF signals are amplified and sent to their audio and video detectors. In the sound section, the audio component of the frequency-modulated wave is detected, amplified and sent to the speaker. In the video section, the picture signals and blanking pulses are taken from the amplitude-modulated wave and sent to the cathode-ray (picture) tube.

Synchronizing (sync) pulses also present in the video signal control the frequency of oscillators in the vertical and horizontal circuits. Outputs of these stages cause the image to be placed on the screen of the cathode-ray tube.

### Scanning

There are 525 horizontal lines in a complete picture on a TV screen. Each line represents an image line scanned by the TV camera. The entire 525 lines are called a frame.

In the discussion thus far, video signals and blanking pulses have been fed to the cathode-ray tube for each scanned line of the picture waveform entering the set. The video portion of the waveform controls the intensity of the electron beam, while the periodically appearing blanking pulses shut the beam off at proper intervals called the retrace period.



Some method is needed to move the beam on the receiver screen from side to side and top to bottom in synchronization (in step) with the action that takes place in the camera. Each of the video waveforms (two are shown in the diagram) represents one particular scan line among the 525 lines that appear on the screen of a complete picture.

### TWO VIDEO WAVEFORMS

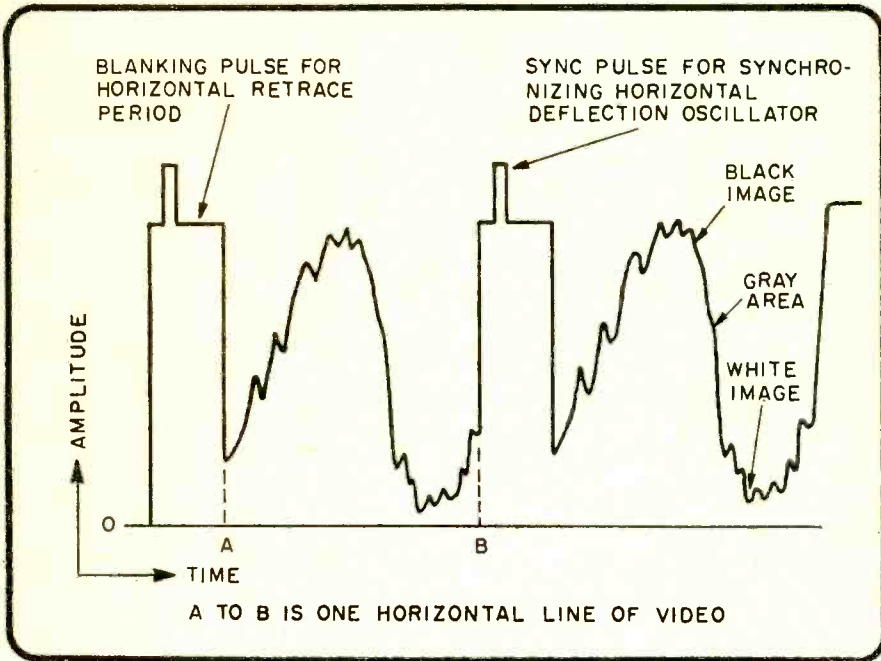

The camera scans every other line (interlaced scanning) for viewing ease (eliminates flicker). The receiver beam must do likewise, sweeping every other line precisely in sequence with the camera. In the first pass, the beam must start in the upper left-hand corner and trace every odd line, ending at the middle of the bottom line for a total of  $262\frac{1}{2}$  lines called a field ( $\frac{1}{2}$  of 525). The beam must then return to the top center of the screen and sweep each even line in sequence, completing  $262\frac{1}{2}$  lines of the field at the right end of the bottom line.

In the process, the beam must excite the fluorescent screen with the correct intensity indicated by the corresponding portions of the video waveforms. At the end of each line, the beam is blanked and must be rapidly returned to the left to start the next line of the picture. When the beam reaches the bottom of the screen, it must be blanked again and rapidly returned to the correct position (left or middle) at the top to sweep the next field. It must complete a field ( $262\frac{1}{2}$  lines) in precisely  $\frac{1}{60}$  of a second and a full frame (complete picture) in  $\frac{1}{30}$  of a second.

#### QUESTIONS

- Q1. The start and the position of each scan line on the CRT screen are controlled by the .....
- Q2. There are --- lines to a field and --- fields to a frame.

#### ANSWERS

- A1. The start and the position of each scan line on the CRT screen are controlled by the sync pulses.
- A2. There are  $262\frac{1}{2}$  lines to a field and two fields to a frame.



## Moving the Electron Beam

You know that a negative voltage repels and a positive voltage attracts electrons. The cathode-ray tube (CRT) uses this effect to send an electron beam to the screen and control its movement.

The basic construction and connections of a magnetically deflected CRT are shown. At the left end an electron gun shoots a narrow stream of electrons toward the screen. To speed the electrons on their way, the inner surface of the flared portion of the tube has a conductive coating energized with a voltage that is several thousand volts positive with respect to the electron source.

### TV CATHODE RAY TUBE

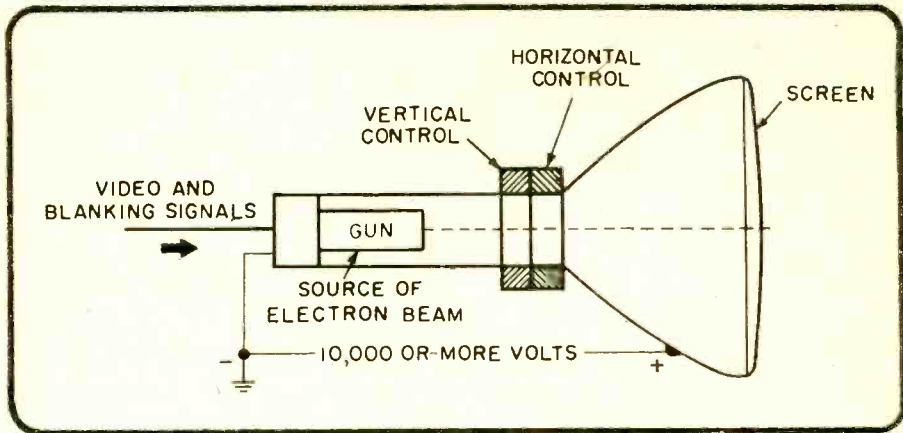

The CRT is connected to the output of the last video amplifier from which it receives the video and blanking signals. The CRT element which controls the number of electrons responds to the varying amplitude of the video and releases the required quantity of electrons. This element also *stops* the flow of electrons when the blanking pulse appears.

During the time a video signal is present, the beam must be moved from left to right across the screen. When the beam reaches the right side, the blanking pulse shuts off the electrons and the beam moves back to start the next line.

### MAGNETIC DEFLECTION

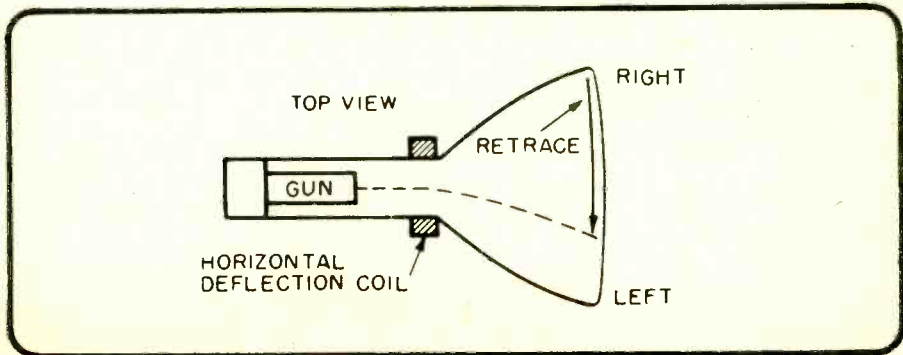

A horizontal-deflection coil through which the neck of the tube is inserted moves the beam from side to side. Current moving through the coil sets up a magnetic field which has



an attracting and a repelling effect on electrons similar to positive and negative voltage. The stronger the field, the greater is its effect on the beam. To increase the strength of the field requires an increase in current through the coil. The illustration shows the beam during retrace.

The change in strength of the magnetic field during a sweep must coincide with the time duration of the scanned line. A gradual rise of current within the coil during this time period accomplishes this. The starting time is triggered by the sync pulses that ride on the blanking pulses. If the current decreases rapidly at the end of each line (during the blanking pulse), the sudden drop in magnetic field strength returns the beam to the left very quickly.

A similar magnetic field is set up by a second coil (the *vertical-deflection* coil) which controls the movement of the beam line by line from the top of the screen to the bottom. On completion of a field (262½ lines), the beam quickly retraces to the top.

### QUESTIONS

- Q3. The sweep of the receiver beam must be ..... with the camera beam.
- Q4. The electron beam in the CRT is generated by an .....
- Q5. Electrons are drawn to the screen of the CRT by a .....
- Q6. .... move the CRT beam.
- Q7. An increase in current through a deflection coil (increases, decreases) the magnetic field.

### ANSWERS

- A3. The sweep of the receiver beam must be **synchronized** with the camera beam.
- A4. The electron beam in the CRT is generated by an **electron gun**.
- A5. Electrons are drawn to the screen of the CRT by a **positive voltage**.
- A6. **Magnetic fields** move the CRT beam.
- A7. An increase in current through a deflection coil **increases** the magnetic field.

## Sync Control Circuits

The beam movement is accomplished by steadily increasing the current flow in each of the deflection coils during precise time intervals. The starting times for these intervals are controlled by the sync pulses.

### SYNC CONTROL CIRCUITS

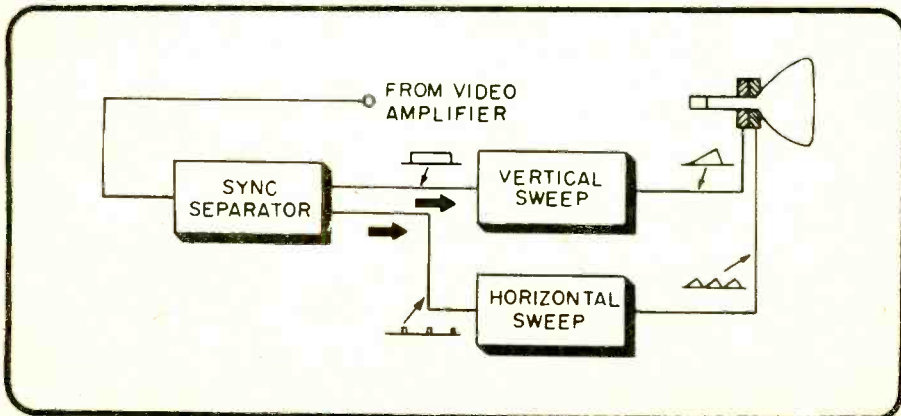

Video waveforms arrive at the sync separator from the video amplifier. There is one narrow sync pulse for each line of scan. This pulse is intended to control the starting time of each horizontal sweep across the screen. When one field of 262½ lines has been completed, the video waveforms are followed by a sync pulse many times wider than the



horizontal sync pulses.

This wide pulse is the trigger that develops a vertical sweep to move the beam from line to line down the face of the screen. Every other vertical sync pulse starts in the middle of a video waveform, accounting for  $262\frac{1}{2}$  lines in each field of interlace scanning.

The illustration shows the comparative widths of the horizontal and vertical sync pulses and the relative starting times of the second and third fields. The sync pulses are recovered from the complete video waveform by a sync separator.

The narrow and wide pulses are distributed to the appropriate sweep circuits (horizontal and vertical) after sync separation accomplished by capacitor and resistor combinations which can distinguish between voltage waveforms with short time durations and those with long durations. The short sync pulses are sent to the *horizontal* sweep circuit and the long pulse to the *vertical* sweep circuit.

### TV SYNC PULSES

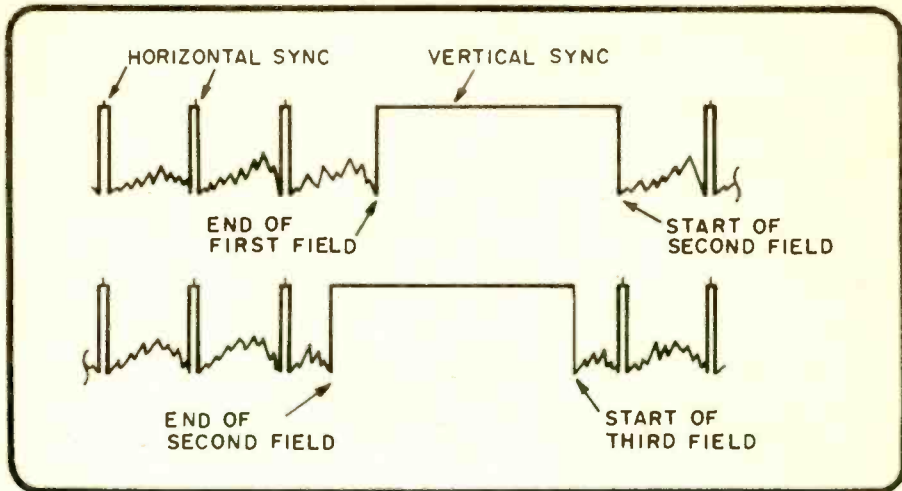

### QUESTIONS

- Q8. Timing of the magnetic field developed in the ..... and ..... deflection coils is controlled by .... pulses extracted from the video waveform.
- Q9. The sync separator separates the narrow and wide timing pulses from the video waveform. The narrow pulses control ..... deflection and the wide pulses control ..... deflection.
- Q10. Horizontal sync pulses occur during the horizontal ..... portion of the video waveform.

### ANSWERS

- A8. Timing of the magnetic field developed in the horizontal and vertical deflection coils is controlled by sync pulses extracted from the video waveform.
- A9. The sync separator separates the narrow and wide timing pulses from the video waveform. The narrow pulses control horizontal deflection and the wide pulses control vertical deflection.
- A10. Horizontal-sync pulses occur during the horizontal blanking portion of the video waveform.

### Sweep Circuits

The two sweep circuits (horizontal and vertical) generate a linear rising voltage each time they receive a sync pulse. The horizontal-sweep circuit is triggered  $262\frac{1}{2}$  times during the same time the vertical-sweep circuit is triggered once. Horizontal sweep is produced



by an oscillator which generates a slowly rising and rapidly decaying sawtooth waveform, whether the set is tuned to a transmitting station or not. This accounts for the *raster* (lines on the screen) when the TV receiver is on but no signal is being received.

The purpose of the sync pulse is to trigger an oscillator to start at the same time as the line scan in the camera. Capacitor and resistor combinations convert the oscillations to the sawtooth waveshapes shown in the diagram above. Rise time of the sawtooth causes the current in the horizontal-deflection coil to increase gradually, moving the beam across the screen in step with the line scan in the camera. At the end of the line, coil current decreases rapidly, returning the beam (which is now blanked) to the left of the screen. There are 525 lines to each frame, so the frequency of the horizontal oscillator must be 15,750 cycles per second (525 x 30).

The vertical sweep oscillator and amplifier are almost identical to those in the horizontal sweep section. The main difference is that the frequency of oscillation is much lower—60 times a second, to match the frequency at which each field is swept. The rise time (plus a short decay time) of the vertical sawtooth lasts for 1/60 of a second before another vertical sync pulse arrives to start the next waveform. Gradual increase in current in the vertical deflection coil moves the beam from the top to the bottom of the screen. The decay of the vertical sawtooth waveform brings the beam back to the top in time for the next sync pulse.

### HORIZONTAL SWEEP CIRCUITS

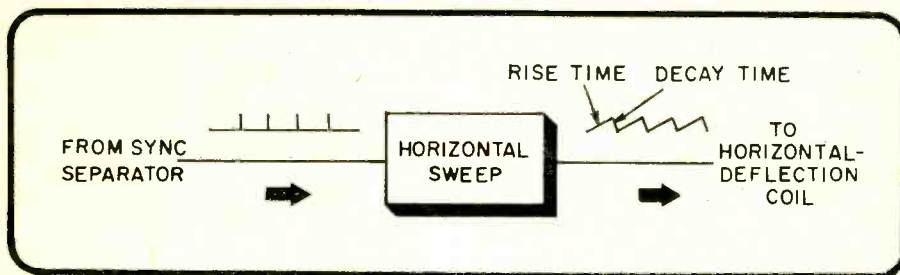

#### QUESTIONS

- Q11. What is the horizontal sync pulse frequency?  
 Q12. What is the frequency of the vertical sync pulses?

#### ANSWERS

- A11. The horizontal sync frequency is 15,750 Hz.  
 A12. The vertical sync frequency is 60Hz.

### WHAT YOU HAVE LEARNED

1. A TV receiver contains many circuits that can be grouped into a few electronic functions. These include the RF section (front-end), IF section, sound section, video section, vertical-sync control, horizontal-sync control, cathode-ray tube, and low- and high-voltage power supplies. Many of the functions are similar to those found in a radio receiver.
2. The RF amplifier, mixer, and oscillator select the desired channel among the many appearing on the antenna and convert the sound and video-carrier frequencies to appropriate intermediate frequencies.
3. The video section contains circuits to extract the video signal and amplify it to a level required for operating the beam-control portion of the CRT

This series is based on material appearing in Vol. 1 of the 5-volume set, BASIC ELECTRICITY/ELECTRONICS, published by Howard W. Sams & Co., Inc. @ \$22.50. For information on the complete set, write the publisher at 4300 West 62nd St., Indianapolis, Ind. 46268.

# Kiss that "nothing" job good-bye forever!

We'll show you how to be a "somebody" in  
the dynamic world of **ELECTRONICS**.

Send for this **FREE** sample lesson.

Why stay in a job with a limited future when there are so many opportunities in the big, exciting world of electronics? That's where the action is today. We'll send you a free sample lesson to demonstrate how LaSalle's practical method can train you at home for entry into the field.

#### Thousands of technicians in demand

Electronics technicians are needed at all levels in TV and radio broadcasting. And in the fascinating new areas of electronic crime detection, electronic factory automation, electronic medicine, and other "world of tomorrow" fields. No wonder there are so many opportunities at all levels for the man who knows electronics. With LaSalle training and subsequent on the job experience, you'll have every chance to move ahead in electronics.

No previous experience is necessary for LaSalle electronics training. Experienced instructors teach you basic principles, then lead you step-by-step to practical applications. You learn to build your own electronic equipment. Emphasis is on modern techniques. And, if you choose the communication field, LaSalle will prepare you to pass the FCC first class radio-telephone operator license exam.

LaSalle has enrolled more than 2,000,000 men and women in its many career programs. It gives you a great feeling of confidence to know that your training is in the hands of a leader in home study.

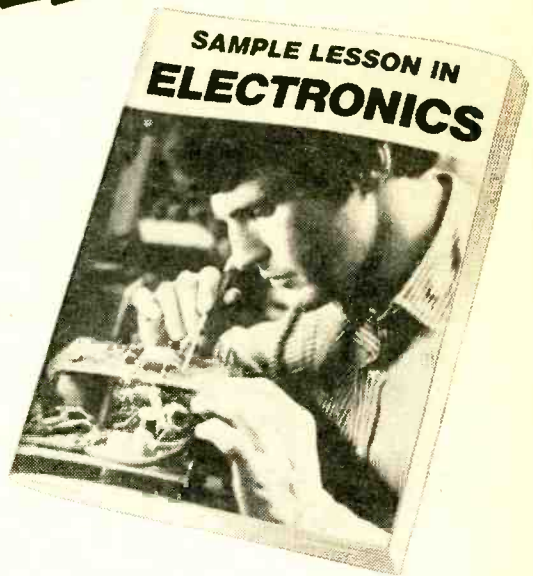

#### Send for **FREE** lesson and booklets

Get with it today! You owe it to yourself to find out how LaSalle can prepare you for a future in electronics. Mail the attached card for free sample lesson and also free booklets shown on facing page. No postage stamp needed. There's no obligation. If card is missing, write to: LaSalle, 417 South Dearborn Street, Chicago, Illinois 60605.



**LA SALLE EXTENSION UNIVERSITY**  
A Correspondence Institution • 417 S. Dearborn Street, Dept. 51-011, Chicago, Illinois 60605

© 1974 LaSalle Extension University • A Correspondence Institution





**Here's where it's  
all happening...and  
you can make it  
happen to you.**

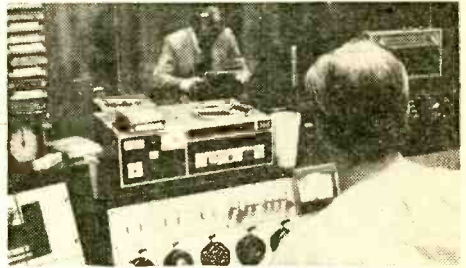

**COMMUNICATIONS** — Growing field includes servicing radio, television, CATV, mobile or aircraft broadcast equipment, public address, industrial and crime control systems.



**AUTOMATION** — More and more manufacturing processes are controlled by electronic systems —from food processing to toolmaking. Technicians are needed to inspect, maintain and repair equipment.



**INSTRUMENTATION** — Well-paid jobs servicing sophisticated electronic devices used in hospitals, laboratories, space centers, computer installations, many other fields.

**also  
Free**

**These 2 valuable booklets**

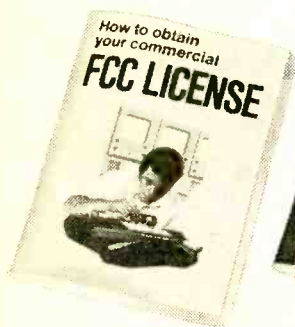

Gives information on getting a Federal Communications license, and provides typical FCC exam questions and answers. *Yours free.*

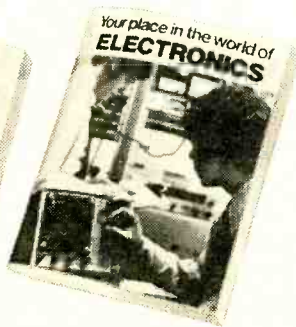

Tells about opportunities in electronics, what you need to know, how LaSalle prepares you at home to start a career. *Yours free.*

**MAIL ATTACHED CARD, NO OBLIGATION**

CIRCLE NO. 15 ON PAGE 17 OR 103

## Hey, Herb

Continued from page 76

until then, do not take the salesman's word for anything—check the record label. As far as I can tell the musical selections are similar but optimized for the particular quad system. They are excellent for A/B comparisons between the various quadrasonic techniques.

**HEY HERB:** I heard discrete surround-sound through my neighbor's system which included a JVC CD-4 demodulator. I purchased a receiver with a built-in CD-4 demodulator but the sound isn't the same. I get noise from the very same records that sound good on my neighbor's equipment. Yet the same record on my receiver, when played in stereo, sounds very good. What causes the noise?

Normally, noise from CD-4 records—usually evidenced by a hiss—is caused by the record itself or a noisy demodulator. If some records are noisy and others aren't then the noise is probably not from the demod. But, and it's a big *but*, your demod and records might be virtually noise free—the noise might be caused by high frequency losses in the connecting shielded cables between the pickup and the demod. Your neighbor has a JVC add-on demod, which is supplied with low capacity cables to be substituted for the turntable's standard shielded cables. I have yet to see any receiver with a built-in CD-4 demod supplied with the low capacity cables, or any mention made of such cables in the instruction manual. (I have not been given one good reason why a CD-4 receiver priced well over \$500 can't be supplied with a couple of low capacity shielded cables.) I really don't know where you can get low capacity cables (GC Electronics-Audiotex will soon make them available), but I suspect they're the answer

**HEY HERB:** I'm a stereophile and an amateur photographer. I do a lot of field recording on cassettes but the sound is strictly from hunger. Isn't there any battery-powered cassette equipment that will record with the same fidelity as the recorder I use at home?

*Lucky you.* Just this month (when this column is being written) Sony released their model TC-152SD AC/DC-powered Dolbyized cassette recorder. Using only six D-cells the Sony turns out a truly hi-fi recording from batteries. The secret behind the TC-152SD's success is that it was designed as a high performance recorder using a battery supply, with AC being the optional power source—not vice versa. How does the motor stay on-speed as the batteries wear down? Simple. The TC-152SD has a servo (feedback) motor such as used in the new high-performance electronic-controlled turntables; it stays on-speed over a broad voltage supply range. ■

## NewsScan

Continued from page 80

with major contributions from engineer W. Russell Oney and cryogenics specialist Raymond K. Terbush, the unit features helium gas bearings that allow it to operate in extreme cold.

The gas bearings utilize the rapid rotation of the turbine shaft and the viscosity of the helium to drive a lubricating wedge of gas between the turbine shaft and a tiny metal pad.

### How Long Is a Moon Beam

U.S. scientists have succeeded in measuring variations in the 235,000-mile distance to the moon with an accuracy of about 6 inches. In the next year or so they hope to narrow this to about 1 inch.

Their purpose is to provide better data on the relative motions of the earth and moon. This information then can be used to study continental drift, to measure the wanderings of the earth's poles, to learn more about the complex phenomena inside the earth, and to determine the mass distribution in the interior of the moon.

The distance between the earth and the moon is measured with unprecedented accuracy by firing short pulses of laser light at special mirrors on the moon and measuring the time it takes for the pulses to return to earth. Since the earth-moon distance is not constant, and one of the major goals of the work is to acquire data on the motions of the dynamic earth-moon system, the experiment isn't a one-shot



Laser retro-reflectors similar to this were placed on the moon by Apollo 11, 14, and 15. Each dark circle contains one corner reflector.



affair. Data taken over a long period is needed for comparison with mathematical models (equations) of the system; the models can then be used to generate more accurate ephemeris (position and distance prediction) tables essential to a variety of types of research.

In order to get a measureable and localized reflection from the moon, the lunar ranging experiment uses special kinds of reflectors placed by the astronauts of Apollo 11, 14, and 15 at different places on the moon's face. These reflectors are not flat like the mirrors in your bathroom, but are rather like the shape you would have if you cut off a corner of a solid glass cube. One hundred to three hundred of these "corner reflectors," mounted in frames located at these three Apollo sites, serve to return a laser beam precisely on its own path. Their action is much like the bicycle reflector that returns light from a headlight to the driver.

The laser beam is generated by high-powered ruby laser and is directed at the reflector array by a large telescope. About 1/4 seconds after

the pulse of light is sent out it arrives at the moon, having spread to a diameter of about 2 miles. It is then reflected toward the sending telescope by one of the reflector arrays. By the time it arrives back on earth it has spread to a diameter of about 10 miles. Since the reflector and telescope intercept only a small portion of the beam in each case, the received light is only a tiny fraction of the original pulse (one part in a billion billion, to be precise). A clock, capable of measuring the elapsed time to a billionth of a second, starts to run at the instant the pulse leaves and is stopped electronically by the pulse's return. The pulses are sent once every 3 seconds for a 10-minute period, in order to get enough data to be statistically significant. By averaging many shots, we obtain more accurate results than we would get by measuring only one or two.

We are lucky the moon isn't much farther away, because if it were, the reflected pulse would be so weak there would be no detectable reflection on most shots. ■

## Bookmark

*Continued from page 22*

projects that cover different aspects of electrostatic electricity generation, detection, and use. The projects are designed for easy construction with a minimum of specialized tools and materials. Some of the projects included are a rotary friction generator, Van de Graaff generator, gold-leaf electroscope, electrostatic voltmeter, Franklin motor, cloud chamber, and

smoke removal precipitator. Franklin's Leyden Jar Dielectric experiment and a simulated lightning rod experiment are among others described. (Many have been published previously in ELEMENTARY ELECTRONICS.) Seven comprehensive chapters explain electrostatic generators, detectors, and motors, electrostatics and radiation, modern electrostatic devices, and Leyden Jars and capacitors. It's a great guide for the project builder and home experimenter. Published by Howard W. Sams & Co., Inc. For catalog of Sams books, write to the publisher, 4300 W. 62nd St., Indianapolis IN 64268. ■

## Power Lost

*Continued from page 66*

parts list draws about 500 mA of current and the lamp about 50 mA less.

The buzzer selected may require some adjustment. As shown in the photo, there are two adjustment screws on the back of its case. Tighten or loosen these screws as required for best operation (tightening the screws will raise the pitch of the note emitted, but if they are too tight the buzzer will not operate).

**Put It Together.** Start actual construction by drilling a 3/16-in. hole in one end of the box, threading the line-cord through the hole, tying a knot in the cord for strain relief, and soldering the conductors to the relay coil terminals. A diagram of the terminals comes with the relay. The box in the

parts list is made of plastic and aluminum. The relay case and battery holder are plastic. Therefore the latter parts are best mounted by gluing them to the bottom of the box. With sandpaper, roughen up the bottom of the box, the bottom of the battery holder, and one side of the relay case to provide a better surface for the glue. Spread a couple of drops of Testors model cement (or Ducco cement or Elmer's Glue) on the roughened surfaces, press into place in the positions shown in the photo, and let them dry while mounting the other parts. You can put the batteries in the battery holder to help weight it down while the glue dries.

The buzzer, switch, and lamp are mounted in holes drilled in the aluminum cover, and are positioned as shown in the drilling template and photo. Then, interconnect all components as shown in the schematic diagram. Wire those on the cover first, and make the 3 leads that go into the box long

enough so that the cover can be moved well out of the way for replacing the batteries or lamp. The relay in the parts list is a 4PDT unit, although only one normally-closed set

of contacts is used in the alarm circuit. The extra contacts can be used as convenient soldering lugs for some of the wires if desired. ■

## Give Your Plants a Voice

*Continued from page 40*

give some indication of the types of responses you will see. Most of the characteristic resistance changes illustrated in these photographs can be observed by recording meter fluctuations of fixed time intervals, or through a graphic recording instrument such as the one used by the author (borrowed from a friendly high school teacher). The latter is invaluable in making long term observations.

Many short term experiments, however, are possible without the aid of a recorder. You may water the plant, for instance, and observe the same type of resistance change shown. A gradual rate of change will be noted with temperature and light intensity changes as well as rapid changes from abrupt stimuli. As to whether plants can read thoughts, like some people and dislike others, react to people miles away, or remember an experience, you'll have to devise your own experiments and make your own deductions. But be careful, you may be pleasantly surprised at what you come to see and to believe! ■

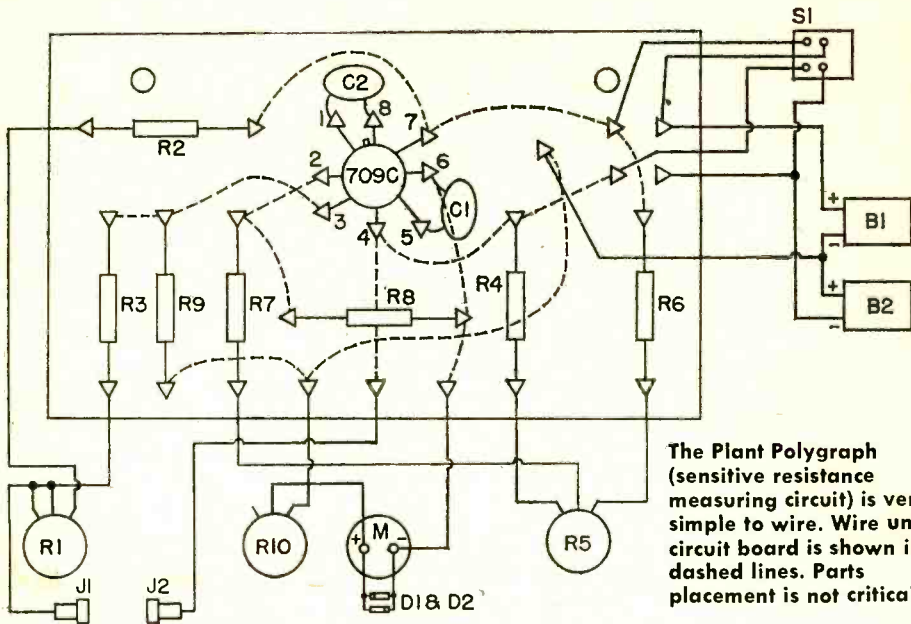

**The Plant Polygraph** (sensitive resistance measuring circuit) is very simple to wire. Wire under circuit board is shown in dashed lines. Parts placement is not critical.

## Moving Sound

*Continued from page 51*

types of auto speakers. One is a small speaker pre-mounted in a plastic cabinet that is mounted on top of the dash or on the shelf behind the rear seat (the rear deck). Another type is a kit containing speakers and trim rings that are mounted in the doors—not the easiest job for an amateur. The door

kits are also often mounted in the passenger compartment front fender covers—the plastic or hardboard panels that conceal the car's internal wiring. The final speaker kit consists of an oval speaker and a matching grill, intended for installation on the rear deck. Modern cars already have the rear deck's steel cut for speakers, and the soft cover the passenger sees might even be scribed for the speaker cutout. You reach under the rear deck, press up through the hole in the steel and the soft cover pops out.



You put the speaker on the bottom (inside the trunk) and the grill on top of the deck. Some late model cars already have the deck grilled, and you simply tear out a cardboard shield from inside the trunk.

As a general rule, rear deck speakers where the speaker is actually in the trunk give the best bass; you cannot get good bass from a small speaker in a small plastic box.

If your car is already equipped with an FM-stereo radio you have stereo speakers built into the car. You can add a switch under or in the dash which will switch the tape player to either the FM radio or the player. The cost of the switch installation is a fraction of the cost of new stereo speak-

ers. These switches with attractive name-plates are available wherever electronic parts are sold from peg-board displays.

**Brand Names Are Best.** Just about every well known manufacturer of tape recorders for the home also makes car equipment. Your best bet is to stick with these brands or with equipment from the major mail order distributors. The reason for buying by brand name is *replacement parts and service*.

The car player market is virtually flooded with unknown brands which are here today and gone tomorrow, and trying to locate a replacement part for these "gypsy" brands can reduce the strongest person to tears. I have seen many instances where \$25, \$50, and even \$75 worth of auto player had to be scrapped because a special part worth a dollar or two was unobtainable. By the time you're finished buying the player, speaker and tapes you'll have an investment of between \$50 and \$100 or more dollars, so I can't too strongly suggest you stick to brand name equipment.

**Record Your Own.** In closing, I suggest you record your own cartridges and cassettes. Much of the available pre-recordings are cheapies with deadly dull programming, shoddy recording quality, or shortened versions of standard stereo records. And, particularly, "budget" cartridges are notoriously prone to jamming or wow and flutter. Buy yourself some branded blank cartridges and cassettes and record exactly what you want on your home equipment. You'll get the best programming and the highest, most dependable quality. ■

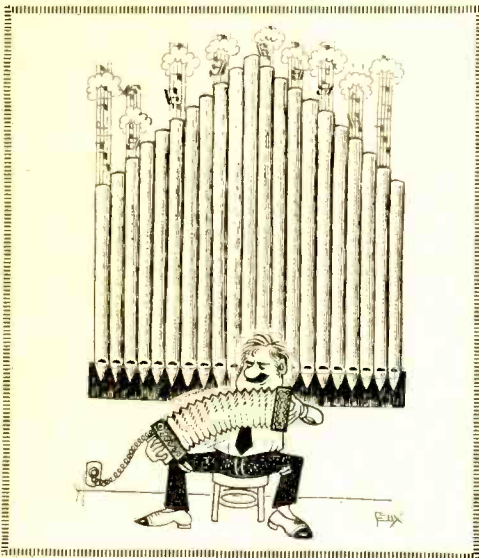

## Porta P.A.

*Continued from page 71*

never turn on the power to the amplifier unless you have a speaker connected to the amplifier output. If you fail to observe this precaution, you may burn out the output transistors in the amplifier.

This cannot happen if you use the plug system illustrated here, which incorporates the amplifier's battery wires and speaker wires into the same multi-contact plug. This means you will be automatically connecting the speaker to the amplifier at the same time you connect the amplifier to its battery power, no matter whether you're using the unit in your vehicle or with a

portable battery pack.

Any available set of male and female cable connectors having four or more connector pins may be used for connecting the amplifier to the speaker and batteries. The plug shown here connected to the amplifier is a Cinch-Jones metal cable plug such as often used in mobile radio equipment. A six-pin plug was available in the author's junk box, but four pins are all that are required. (The 4-pin male plug is Cinch-Jones type P-304-CCT and the matching female socket is the S-304-CCT.) Use the male plug on the wires from the amplifier, and a female socket on the wires going to the portable batteries and speaker, and another female socket on the wires to the car's electrical system and under-the-hood speaker. In this way, when the unit is un-



# LITERATURE LIBRARY

101. Kit builder? Like weird products? EICO's 1974 catalog takes care of both breeds of buyers at prices you will like.

102. *International Crystal* has a free catalog for experimenters (crystals, PC boards, transistor RF mixers & amps, and other comm. products).

103. See brochures on Regency's 1974 lineup of CB transceivers & VHF/UHF receivers (public service/business bands—police, fire, etc.)

104. *Dynascan's* new B&K catalog features test equipment for industrial labs, schools, and TV servicing.

105. Before you build from scratch, check the *Fair Radio Sales* latest catalog for surplus gear.

106. Get *Antenna Specialists'* cat. of latest CB and VHF/UHF innovations: base & mobile antennas, test equipment (wattmeters, etc.), accessories.

107. Want a deluxe CB base station? Then get the specs on *Tram's* super CB rigs.

108. Compact is the word for *Xcelite's* 9 different sets of midget screwdrivers and nutdrivers with "piggyback" handle to increase length and torque. A handy show case serves as a bench stand also.

109. *Bomar* claims to have C/B crystal for every transceiver... for every channel. The catalog gives list of crystal to set interchangeability.

110. A *Turner* amplified mike helps get the most from a CB rig. This free brochure describes line of base & mobile station models.

111. *Midland's* line of CB (base and mobile) equipment, and marine transceivers and accessories are illustrated in a new 4-color 24-page folder. There's also a separate 8-page, 4-color flyer on scanners.

112. *ED!* (*Electronic Distributors*) has a catalog with an index of manufacturers' items literally from A to Z (ADC to Xcelite). Whether you want to spend 29 cents for a pilot-light socket or \$699.95 for a stereo AM/FM receiver, you'll find it here.

113. Get all the facts on *Progressive Edu-Kits Home Radio Course*. Build 20 radios and electronic circuits; parts, tools, and instructions included.

114. *Olson Electronics'* 244-page fully-illustrated 1974 catalog carries leading national brand products in all electronics categories.

115. *Trigger Electronics* has a complete catalog of equipment for those in electronics. Included are kits, parts, ham gear, CB, hi fi and recording equipment.

116. Get the *HUSTLER* brochure illustrating their complete line of CB and monitor radio antennas.

117. *Teaberry's* new 6-page folder presents their 6 models of CB transceivers (base and mobile): 1 transceiver for marine-use, and 2 scanner models (the innovative "Crime Fighter" receiver and a pocket-size scanner).

118. *Burstein-Applebee's* 1974 catalog has 276 pages of radio/TV electronics bargains. Selling for \$2, it is offered free to our readers.

119. Besides *Browning's* colorful leaflet on their Golden Eagle Mark III base station, their packet includes other surprises. The LTD is pictured in actual size on a card for you to test on your car's dash. Specifications are given for both the SST and LTD.

120. *Edmund Scientific's* new catalog contains over 4000 products

that embrace many sciences and fields.

121. *Cornell Electronics'* "Imperial Thrift Tag Sale" Catalog features TV and radio tubes. You can also find almost anything in electronics.

122. *Radio Shack's* 1974 catalog for electronics enthusiasts has 180 pages, colorfully illustrated—a complete range (kits & wired) of hi-fi, CB, SWL equipment and parts.

123. It's just off the press—*Lafayette's* all-new 1974 illustrated catalog packed with CB, hi-fi components, test equipment, tools, ham rigs, and more.

124. *Mosley Electronics* reports that by popular demand the Model A-311 3-element CB beam antenna is being reintroduced. Send for the brochure.

125. *RCA Experimenter's Kits* for hobbyists, hams, technicians and students are the answer for successful and enjoyable projects.

126. *B&F Enterprises* has an interesting catalog you'd enjoy scanning. There are geiger counters, logic cards, kits, lenses, etc.

127. *Avanti* antennas (mobile and base for CB and VHF/UHF) are fully described and illustrated in new catalog.

128. A new free catalog is available from *McGee Radio*. It contains electronic product bargains.

129. *Semiconductor Supermart* is a new 1974 catalog listing project builders' parts, popular CB gear, and test equipment. It features semiconductors—all from *Circuit Specialists*.

130. *Heath's* new 1974 full-color catalog is a shopper's dream—chockful of gadgets and goodies everyone would want to own.

Elementary Electronics  
Box 886  
Ansonia Station  
New York, N.Y. 10023

Please arrange to have this literature whose numbers I have circled at right sent to me as soon as possible. I am enclosing 50¢ to cover handling. (No stamps, please).

Indicate total number of booklets requested  
Sorry, only 10 circled items maximum.

M/A74

- |     |     |     |     |     |     |     |     |     |     |
|-----|-----|-----|-----|-----|-----|-----|-----|-----|-----|
| 101 | 102 | 103 | 104 | 105 | 106 | 107 | 108 | 109 | 110 |
| 111 | 112 | 113 | 114 | 115 | 116 | 117 | 118 | 119 | 120 |
| 121 | 122 | 123 | 124 | 125 | 126 | 127 | 128 | 129 | 130 |
| 131 | 132 | 133 | 134 | 135 | 136 | 137 | 138 | 139 | 140 |
| 141 | 142 | 143 | 144 | 145 | 146 | 147 | 148 | 149 | 150 |
| 151 | 152 | 153 | 154 | 155 | 156 | 157 | 158 | 159 | 160 |
| 161 | 162 | 163 | 164 | 165 | 166 | 167 | 168 | 169 | 170 |

Are you a subscriber to this magazine? Yes  No   
51  Enter my subscription for 9 issues at \$3.97 and bill me.

NAME \_\_\_\_\_

ADDRESS \_\_\_\_\_

CITY \_\_\_\_\_

STATE \_\_\_\_\_ ZIP \_\_\_\_\_

Not Valid After August 15, 1974



plugged, the battery terminals will not be exposed. (For the flush-mounted female socket on the portable battery box, use a Cinch-Jones S-304-AB socket.)

Four Ray-O-Vac No. 918 6-volt lantern batteries or their equivalent will provide ample power for the portable PA. Construction of the battery box can be varied to suit your own preference and your choice of available materials. The box shown is made of 1/4-in. plywood, reinforced with 3/4-in. pine cleats glued and nailed in the corners. Spacers of 3/4-in. pine attached to the inside provide ample material for gripping the wood screws which are inserted to hold the top panel onto the box. The speaker and amplifier each are supplied with mounting brackets which may be attached to the top panel. The amplifier can be attached with thumb nuts, if desired, so it can be removed easily and transferred to your car, truck, or even a boat. Most mikes come with a hanger bracket which may be attached to the wood top panel. A duplicate hanger bracket may be obtained at most radio and audio stores for installation in your vehicle. A male phone plug is included with the amplifier for installation onto whatever mike you use. ■

## Filters

*Continued from page 46*

ing in some aspect of their performance. Such suspicions are correct; the filters are deficient in having a very slow roll-off. This means that frequencies which you would like to have totally rejected by the filter are only half-heartedly rejected. This is especially true for frequencies fairly close to the corner frequency, as pointed out in the discussion of the high-pass filter trying to reject 60-Hz hum. Even though the corner was placed at 240 Hz, the rejection of the unwanted hum was still rather poor.

In the case of band-pass circuits, the roll-offs on both sides are problems. From the shape of the response these roll-offs are sometimes referred to as "skirts"; for good performance the skirts should be as steep as possible.

However, we are rapidly leaving the domain of simple filters. Before we go astray, let's bring this article to an end. The editors strongly recommend you re-read not only this article but go back to the filter theory feature that preceded it in the January/February 1974 issue of **ELEMENTARY ELECTRONICS**. You can get a copy direct from the publisher by sending your request and one dollar to **ELEMENTARY ELECTRONICS**, 229 Park Ave. So., New York NY 10003. Hang in there—filter theory comes up  
(Continued on page 102)

## Use Coupon on Left!

131. E. F. Johnson's 1974 full line of CB transceivers and accessories equipment is featured in a new 16-page brochure. A 4-color folder on monitor scanner line is also offered.

132. If you want courses in assembling your own TV kits, *National Schools* has 10 from which to choose. There is a plan for GIs.

133. Get the new free catalog from *Howard W. Sams*. It describes 100's of books for hobbyists and technicians—books on projects, basic electronics and related subjects.

134. *Sprague Products* has L.E.D. readouts for those who want to build electronic clocks, calculators, etc. Parts lists and helpful schematics are included.

135. The latest edition of *Tab Books'* catalog has an extensive listing of TV, radio and general servicing manuals.

136. *Leader's* catalog features "Instruments to Believe In." They have a complete line for industry, education and service, featuring oscilloscopes/vectorscopes, many generators, accessories, etc.

137. *Pace Communications* has a packet of information for you. The "Citizens two-way radio" answers all the questions from how to operate one to how much they will cost to operate. A booklet on Pace's scan/monitors to keep you informed is included.

138. *Pearce-Simpson* has a booklet, "Citizens Band Radios & Scanners," which pictures and describes the various models in this line. A section on CB antennas is included.

139. For the latest information on CB transceivers by *Courier*, send for their literature.

140. Featured in *Siltronix's* brochure are single sideband/AM citizen band transceivers, pictured and described with extra features and specifications listed. VFO sliders for monitoring are pictured as well as export models of linear amplifiers.

141. *Lee Electronics Labs* has an inexpensive circuit analyzer, which is featured in this catalog.

142. Available from *Royce Electronics* (a new name in electronics manufacturing) is a 16-page catalog for CB'ers. See their base and mobile transceivers, accessories and test instruments.

143. A set of *Abraxas/4* speakers contains a rugged 12-inch long-throw woofer with a 22-oz. Alnico magnet, a 5-inch sealed-back rub-

ber-damped midrange, and two 3-inch dome tweeters from *Designers Audio Products*.

144. For a packetful of material, send for *SBE's* material on UHF and VHF scanners, CB mobile transceivers, walkie-talkies, slow-scan TV systems, marine-radios, two-way radios, and accessories.

145. For CB'ers from *Hy-Gain Electronics Corp.* there is a 50-page, 4-color catalog (base, mobile and marine transceivers, antennas, and accessories). Colorful literature illustrating two models of monitor-scanners is also available.

146. *Robyn International* has 4-color "spec" sheets for each model of their CB (base and mobile) transceivers and monitor-scanner lines.

147. *Telex's* 4-page, 2-color folder illustrates their new line of boom microphone head-sets for CB'ers and hams, as well as their line of communications headphones.

148. *American Trading Corp.* offers you two catalogs in 4-color. One features their *Electronics 2000/Contact CB*, pictured with descriptions and specifications. Their *Monitor/Scanner, Surveyor Model 4H 4U*, is featured in the second catalog.

149. *Cush Craft* has a catalog on *Citizens Band Antennas* for every purpose. The *Ringo* base antenna is featured, as is the new *Superfire 8* element horizontal/vertical power beam.

# CLASSIFIED Market Place

Classified Ads 95¢ per word, each insertion, minimum 15 words, payable in advance.  
For information on Classified ads—to be included in our next **ELEMENTARY ELECTRONICS**  
—write to R. S. Wayner, Classified Ad Manager, 229 Park Ave. South, N. Y. 10003.

## ADDITIONAL INCOME

WIN \$1,000,000.00 in the New Jersey State Lottery. Rush \$3.00 for complete details and instructions. Satisfaction Guaranteed. Davidson's, Box 274-SM, Belleville, Illinois 62222.

## AUTO PARTS & ACCESSORIES

AIRMASTER Gas Saver. Fits All Cars. \$14.95. Airmaster, Lenora, Kansas 67645.

## BLUEPRINTS, PATTERNS & PLANS

NEW CRAFT PRINT CATALOG—choose from over 100 great easy-to-build plans. Send \$1.25 (completely refunded with your first order). BOAT BUILDER, (CP Div.)—229 Park Avenue South, New York, N.Y. 10003.

## BOOKS & PERIODICALS

WIRETAPPING Expose! Your Privacy Invaded. Details \$1.00 (Refundable). Don-Q, Box 548, Seattle, Washington 98111.

FIREWORKS NEWS Magazine covers commercial—Display Fireworks. Sources, Construction, Literature, Pyro-technical Supplies. Free Catalog! Pyro Press, Box 12010 (K), Lexington, Kentucky 40511.

## BUSINESS OPPORTUNITIES

I made \$40,000.00 Year by Mailorder! Help others make money! Start with \$15.00—Free Proof! Torrey, Box 318-T, Ypsilanti, Michigan 48197.

MAKE Magnetic Signs. Big profits. Details. Universal, Lenora, Kansas 67645.

FREE Secret Book "2042 Unique, Proven Enterprises." Fabulous "Little Knowns" Work home! Haylings-E14, Carlsbad, California 92008.

100% PROFIT Bronzing Baby Shoes In Your Home. Free Honest Facts. NBC-DG. Gower, Missouri 64454.

HERBALISM! The home gold mine! Free lesson. Seeds. Herbalism Institute-D. Box 968, Glendora, Ca. 91740.

HOW To Make Money Addressing. Mailing Envelopes. Offer Details 10¢. Lindbloom Services, 3636 Peterson, Chicago 60659.

ELECTRONIC Assembly Business. Big profits. Start home, spare time. Investment, knowledge, experience unnecessary. Free illustrated literature. Barta, Box 248AQ, Walnut Creek, Calif. 94597.

## BUSINESS OPPORTUNITIES—Cont'd

INSTANT Money! Plastics are the wave of the future. Big Profits Now! At Home! Spare time! Materials costing 11¢ bring back \$2.98 profits immediately! Free information. Rush name on postcard to: Warner, Room LC-5-107-DB, 1512 Jarvis, Chicago, Illinois 60626.

DO Simple Addressing-Mailing. Receive \$12.95 orders. Keep \$8.00 profit. Details Free! Quality, Box 9-DC, East Rockaway, New York 11518.

\$26.00 HUNDRED Addressing Envelopes. Details Send \$1.00 and stamped addressed envelope. Keen, Box 9965DC, San Diego, Calif. 92109.

IMPORT-MAILORDER OPPORTUNITY FREE AT OUR RISK AND EXPENSE FOR ONE FULL YEAR. Earn \$15,000 or pay nothing. Details. Northeast Imports, World Trade Division, Box 111E3, Fremont, N. H. 03044.

NEW STUFF Envelopes \$24.95 Hundred. Complete Kit \$1. (Refundable). Trade-1C82, 3047 University, San Diego, Calif. 92104.

JEeps \$60.00, TYPEWRITERS \$4.00, boats, guns, cars fraction of cost. How to buy for own use or resale. Booklet \$1.00. RAY SMITH, 916 ROME STREET, BOSSIER CITY, LA. 71010.

## DO-IT-YOURSELF

DISCOVER how to avoid calling the serviceman. Save by servicing home equipment yourself. Send \$1.25 for magazine. RADIO-TV REPAIR—229 Park Avenue South, New York, New York 10003.

## EDUCATION & INSTRUCTION

"LOGIC newsletter, design and construction, sample copy, \$1.00. Logic Newsletter. POB 252, Waldwick, N.J. 07463."

ORDINATION. Details Free. Ministry of Service. Box 526, Seymour, Texas 76380.

ACUPUNCTURE TRAINING Home Study Course! Tsang, Box 219W, Toronto, Canada M6M 4Z2.

BIG profits in publishing. Learn how. Details free. Stevenson Enterprises, 4808 Santa Monica Ave., San Diego, Ca. 92107.

## ELECTRICAL EQUIPMENT & SUPPLIES

METERS New, used, panel, portable. useful list 25¢. Measuring Instruments Servicer, 2261 N.W. 7th Street, Miami, Florida 33125. Dept. 1043.

## EMPLOYMENT INFORMATION

EXCITING Overseas Jobs. Directory \$1.00. Research Associates, Box 889-CE, Belmont, California 94002.

## FARMS, ACREAGE & REAL ESTATE

GOVERNMENT LANDS DIGEST. A Monthly review of government Real Estate offerings throughout the U.S.A. Free subscription information! . . . DIGEST, Box 25561-DP, Seattle, Washington 98125.

## FOR INVENTORS

PROSECUTE Your Own Patent Application. All Material Necessary—Write: Inventors Service, Box 3574, Washington D.C. 20007.

FREE "DIRECTORY of 500 CORPORATIONS Seeking New Products." For information regarding development, sale licensing of your invention, write for your FREE "INVENTOR'S KIT No. A-35." It tells how ideas become reality! RAYMOND LEE ORGANIZATION, 230 Park Avenue, New York, N. Y. 10017.

## GOODS THAT PLEASE

FREE Gift Catalog. Distinctive Items for Everyone. Penn Gifts, 1574 Shoemaker, Wyoming, Pa. 18644.

BEST Reading in Mechanical Field—Science & Mechanics! \$4.00 for year's subscription. Science & Mechanics, P.O. Box 2600, Greenwich, Conn. 06830.

## HEARING AIDS

HUGE SAVINGS! BUY DIRECT! Eliminate dealer markups 20 days FREE Trial Terms arranged. No salesman will call. LLOYD S-79, Rockford, Illinois 61108.

## HOME WORKSHOP SUPPLIES

25 WEEKEND BUILD-IT PROJECTS—Practical designs for home/shop buffs who enjoy working with wood, tools, materials and techniques. Send \$1.25 for your copy (includes postage) to Davis Publications, Inc., 229 Park Avenue South, New York, N.Y. 10003

IDEA book for re-doing or adding to your kitchen and bath improvements. Send \$1.25 to KITCHEN & BATH IMPROVEMENTS—229 Park Avenue South, New York, N.Y. 10003.

MORE

## For Greater Classified Savings . . . Results . . . and Profits . . .

Place your ad in one of our **SPECIAL COMBINATIONS**: Business Group, Science & Mechanics, or Davis Combination. Each Combination is designed to give your ad the largest audience available. For further information write to R. S. Wayner, Classified Ad Manager, Davis Publications, Inc. 229 Park Avenue South, New York, N.Y. 10003.



# CLASSIFIED MARKET PLACE

(Continued from page 100)

## HYPNOTISM

**HYPNOTIZE STRANGERS** in 30 Seconds! Most powerful hypnotic device ever created! Complete easy instructions included! Guaranteed only \$2.00. From: **WORLD-31C3**, 3047 University, San Diego CA 92104.

## INVENTIONS WANTED

WE either sell your invention or pay cash bonus. Write for details: **Universal Inventions**, 298-3 Marion, Ohio 43302.

## LOGIC

**LOGIC NEWSLETTER**, Design, Theory, Construction. Sample copy \$1.00. Logic Newsletter, POB 252, Waldwick, N.J. 07463.

## MAGIC TRICKS, JOKER NOVELTIES & PUZZLES

**WOW!** Largest selection. Newest, best tricks, jokes. Giant 150 page catalog 25¢. **Abracadabra-EE**, Colonia, New Jersey 07067.

**VENTRILOQUISM**—Profitable Hobby or Career! **FREE INFORMATION!** Dummy Catalog 25¢. **Maher**, Box 9037DC, Denver, Colorado 80209.

## MAGNETS

**TWENTY** Disc, or ten bar magnets, \$1.00. **Magnets**, Box 192-E, Randallstown, Maryland 21133.

## MISCELLANEOUS

**GIVEAWAY Bonanza!** Lists over 350 sources. Gifts, catalogs, magazines, free samples. \$2.00. **Douglas Enterprises**, Dept. 66, Box 5689, Toledo, Ohio 43613.

## MONEYMAKING OPPORTUNITIES

**GUARANTEED** Home Income raising chinchillas. 25¢. **Chinchilla**, 11DC2, Fort Richey, Fla. 33568.

**JOIN** "Money-Getters Guild" 25¢. **Russell Advertising**, Box 612-D, New Philadelphia, Ohio 44663.

**HOMEWORKERS** \$185.00 Weekly. Send 25¢ + stamped self addressed envelope. **Odyssey**, Box 12560DC, Philadelphia, Pennsylvania 19151.

**MAKE** Your Classified Ad Pay. Get "How to Write A Classified Ad That Pulls." Includes certificate worth \$2.00 towards a classified ad in this publication. Send \$1.25 (includes postage) to **R. S. Wayner**, Science & Mechanics, 229 Park Avenue South, New York, N.Y. 10003.

\$40.00 **DAILY** possible tying fishing flies at home. Details 25¢. **Flyco**, Box 481-EE, Albany, Oregon 97321.

**MAKE** \$1.00 PER SALE selling engraved metal Social Security plates. **FREE SALES KIT**. Engraving plates, Box 10460-202 Jacksonville, Florida 32207.

**SELECTED** 100 **MONEYMAKING OPPORTUNITIES**. Send \$1.00. **Fulk**, 7003 Birch Drive, Cocoa, Florida 32922.

## MOTORCYCLES, MOTORSCOOTERS, BICYCLES, KARTS & SUPPLIES

**AMAZING ELECTRONIC BICYCLE ALARM LOCK**. Rycro Howler shrieks alarm for 1 hour if cable cut or lock box tampered with. Heard up to 1/4 mile away. \$12.95. Protect your bicycle today. **Harvey And Sons**, 3920 Five Mile Road NE, Grand Rapids, Mich. 49505.

## OF INTEREST TO WOMEN

\$25.00 **DAILY** Possible addressing-stuffing envelopes Typewriter-longhand, also Clipping News items at home information. Send stamped addressed envelope. **Ame-7**, Box 310, Le Mars, Iowa 51031.

## OPTICAL GOODS—TELESCOPES

**EYEGLASSES Wholesale**—Free Catalog **A-Z Optical Company**, Box 175 Dept. 28 G, Bay Station, Brooklyn, N.Y. 11235.

## PERSONAL

**NEVER BEFORE SO MUCH** for so little. Buy everything you'll ever need below: wholesale! Full particulars **FREE**. Write Today. **Warner Room CC-107-DD**, 1512 Jarvis, Chicago, Ill. 60626.

**PICTURE BOOK OF SEXUAL LOVE**. Over 195 photographs, many in color, of a young couple in various positions. Over 225,000 hardbound copies sold at \$15. Now available for only \$4.95 from: **Population Planning**, P. O. Box 2556-Dept. DCG12, Chapel Hill, N.C. 27514.

**SINGLE? Widowed? Divorced?** Nationwide introductions! **Identity**, Box 315-DC, Royal Oak, Michigan 48068.

**BECOME** Ordained Minister. Free information. **Church**, Box 324, Daytona Beach, Florida 32015.

**JAPANESE** introductions! Girls' photographs, descriptions, brochure, details. \$1.00. **INTER-PACIFIC**, Box 304-SC, Birmingham, Michigan 48012.

**SINCERELY** interested in Marriage? Fourteen Years experience. **Social Introduction Service**. Box 1547, Eugene, Oregon 97401.

**FREE!!** 2,000 **ORIENTAL PENFRIENDS**. Complete Details, P. O. Box 657, Singapore

**FREE BROCHURE! SELF-IMPROVEMENT BOOKS! CUSTOM CRAFTS OF CALIFORNIA**. Box 1218, Rohnert Park, California 94928.

**BEAUTIFUL MEXICAN GIRLS** Wanting American boy-friends, "Free" details. **World**, Box 3876-SMC, San Diego, Ca. 92103.

**SINGLE? Nationwide** introductions! Refined, confidential service! Free information! **Identity**, Box 315-EL, Royal Oak, Michigan 48068.

## PHOTOGRAPHY—PHOTO FINISHING

**SAVE HUNDREDS OF DOLLARS!!** Make your own S&M Densitometer. Send \$3.00 for detailed drawings and instructions. A must for successful photography in your darkroom. Order direct from **S & M Instruments**, Dept. EE3, 229 Park Avenue South, New York, New York 10003.

## RADIO & TELEVISION

**TV TUBES** 36¢ each. Send for Free 48 page color catalog. **Cornell**, 4217-W University, San Diego California 92105.

"**DISTANCE One Tuber**" Handbook—50¢. 15 Distance one tube plans—25¢ Catalog 25¢, refundable. **Laboratories**, 1477 G, Garden Grove, California 92642.

**FREE** Catalog lists resistors, tubes, transformers, rectifiers, condensers, tools, tuners, etc. etc. **Hytron Hudson**, Dept. EE, 2201 Bergenline Avenue, Union City, New Jersey 07087.

**HEAR POLICE/FIRE** Dispatchers. Catalog shows exclusive official directories of "confidential" channels; receivers. Send 6¢ stamp. **Communications**, Box 66-EE, Commack, N.Y. 11725.

**NEW FM Deviation Meters** \$75.00. Free Information. Write: **ECM**, 412B N. Weinbach, Evansville, Indiana 47711.

**NEW TV Filter**. Reduces outside noise, interference, improves reception. Easy installation. \$1.98. Request catalog, **1-EE**, **Mark Anthony's**, 3841 Hammel, Los Angeles, California 90063.

**90% OF TV REPAIRS UNNECESSARY**. Save your money. Full info. **Electronic Reports**, 7202 Longfield, Cincinnati, Ohio 45243.

**DIAGRAMS**. Radio-Television, 17 volumes, 2,880 large pages, \$42. value. Only \$14.95. **Publications**, 1780 Balsam, Highland Park, Illinois 60035.

**VOICE Activated Switch**, plans 25¢. Complete Kit, includes Microphone. \$2.50 **Lectronix**, Box 42, Madison Heights, Michigan 48071.

## STAMP COLLECTING

**500 DIFFERENT** Stamps \$1.00 Approvals. **Golden Stamp Services**, Box 651, Golden E. C., Canada VOA-1HO.

## SURPLUS EQUIPMENT

**GIANT** 120 Page Canadian Surplus Catalog \$1. Etc. Dept. DG, Box 741 Montreal.

## TIPS FOR THE HOME, ETC.

**PRACTICAL** tips for home, garden and workshop are in "1001 How-To Ideas." Send \$1.25 for your copy (includes postage), to 1001 How-To Ideas, 229 Park Avenue, South, New York, New York 10003.

## TREASURE FINDERS—PROSPECTING EQUIPMENT

**FREE FACT-FILLED CATALOG**. World's largest line of metal detectors. Models as low as \$49.50 and up. Two year Guarantee. Three factory locations, U.S. and Canada, plus over 1,000 dealers and 35 Service Centers from coast to coast. No finer instruments made at any price. Budget terms. Write: **WHITE'S ELECTRONICS, INC.**, RM #399, 1011 PLEASANT VALLEY ROAD, SWEET HOME OREGON 97386.

THERE is no charge for the Zip Code. Please use it in your Classified Ad.

**YOU'LL MAKE MONEY**

**SAVE MONEY TOO—BY READING and ANSWERING THESE CLASSIFIED ADS**

## Pollution: it's a crying shame



But does it have to be? Not if you do something about it. So the next time you see pollution point it out to someone who can do something about it.

**People start pollution.  
People can stop it.**

**Keep America Beautiful**

99 Park Avenue, New York, N.Y. 10016



A Public Service of This Magazine &  
The Advertising Council

**Opening doors  
for the  
handicapped  
involves more  
than just  
being polite.**

**Hire the handicapped.**



PUBLIC ADVERTISING SYSTEM  
A DIVISION OF THE SCHOOL OF VISUAL ARTS



in almost every project. Why not know what you are building and how you can make it better? ■

### R-Cubed

*Continued from page 42*

the cube is painted with the appropriate color-code to indicate the decimal multiplier (same as the last color band on each resistor in the decade), and the numbering is all done with press-on numbers. One or more decades can, of course, be omitted, and can always be added later if desired.

**Had to Be Different.** The Editor's approach to building R-Cube was similar, but we used a wooden block. Brass brads about 3/4-inch long were used in place of the flea clips. Before you hammer them in place, practice on a scrap piece of wood. If all the brads were inserted at the same location on the three faces at each corner, they would meet, bend and chip the wood. A bit of off-set is required. We licked the problem by hammering the brads in at an angle to avoid in-wood collision of brad points. The brads make good mechanical and electrical connections. In fact, it withstood the 10 1/2 EEE crunch of some klutz. That's ruggedness! Build your R-Cube today, build two, build several—they beat resistor substitution boxes and stack even better. ■

### Gain-a-Boost

*Continued from page 33*

terminals with a short section of coax (do not use the audio type of shielded cable). If your receiver does not have external antenna and ground terminals, try a turn of hook up wire around the receiver internal loop antenna. Or, if your receiver uses a built-in whip antenna, clip the center conductor of J2 (through the coax) to the whip, and push down the whip to its shortest length. If the receiver is an AC-DC type (with a "hot" chassis) connect the outside shield of the coax from J2 in series with a 470 pF capacitor and the receiver chassis. Do not connect the shield directly to the chassis in this type of receiver or there may be an electrical shock hazard.

**Operation.** Set S1A,B (band switch) to the desired band of operation that your receiver is tuned to, and set S2 to on posi-



# ELEMENTARY

● The Editor of ELEMENTARY ELECTRONICS offers readers an easy way to get additional information about products and services advertised in this issue. Just follow the instructions below and the material you requested will be sent to you promptly and at no cost..

# ELECTRONICS

● The coupon below is designed for your convenience. Just circle the numbers that appear next to the advertisement that interests you. Then carefully print your name and address on the coupon. Cut out the coupon and mail to: ELEMENTARY ELECTRONICS, Box 886, Ansonia Station, New York, N.Y. 10023. Do it today!

## READER SERVICE PAGE

MARCH/APRIL 1974

Void after AUGUST 15, 1974

### ELEMENTARY ELECTRONICS

Box 886, Ansonia Station, New York, N.Y. 10023

Please send literature for the numbers I have circled. I understand this is a free service.

1	2	3	4	5	6	7	8	9	10	11	12	13
14	15	16	17	18	19	20	21	22	23	24	25	26
27	28	29	30	31	32	33	34	35	36	37	38	39

Do you now own Police/Fire/Aero receiver(s)? 50  Yes 49  No

If your answer is yes, please check appropriate box:

45  Mobile 46  Base 47  Portable 48  Used in your work

Are you a subscriber to this magazine? Yes  No

51  Enter my subscription for 9 issues at \$3.97 and bill me.

Name (Print Clearly) \_\_\_\_\_

Address \_\_\_\_\_

City \_\_\_\_\_

State \_\_\_\_\_

Zip Code \_\_\_\_\_

## SQUARE WAVE GENERATOR KIT \$8.00

Complete kit nothing else to buy, including power supply, with quality etched and drilled printed circuit board, integrated circuit, diodes, resistors, capacitors, etc. ready to wire. Constant amplitude over wide frequency range 2Hz-200KHz. Fall time characteristics better than 200 nsecs. 18 volts p-p, with variable duty cycle. Also included very complete instructions on assembly, applications, and theory. Kit shipped prepaid same day order received.

**PHOTOCIRCUIT CONSULTANTS Dept. EE-50**  
2309 Thurman, St. Louis, Mo. 63110

## HIGHLY PROFITABLE ONE-MAN ELECTRONIC FACTORY

Investment unnecessary, knowledge not required, sales handled by professionals. Ideal home business. Write for facts today! Postcard will do. **Barta-EB, Box 248, Walnut Creek, CA 94597.**

WRITE NOW FOR

## McGEE'S BIG SPEAKER CATALOG 1001 BARGAINS IN

SPEAKERS—PARTS—TUBES—HIGH FIDELITY COMPONENTS—RECORD CHANGERS—Tape Recorders—Kits—Everything in Electronics  
1901 McGee Street, Kansas City, Missouri 64108

## "LISTEN IN" TO POLICE-FIRE RADIO CALLS IN YOUR CAR!

WORKS with ANY CAR—Portable or HOME RADIO! Just PLUGS in—No wiring—3 minute hookup! Switch instantly from regular to ALL POLICE-FIRE-EMERGENCY-COMMERCIAL-TAXICAB-STATE-CITY-GOV'T 2 way Radio calls in YOUR AREA. DUAL-HI-LOW BANDS—36/50-150/175 MHz. OVER A MILLION Radio Cars/stations USE Everywhere—Anytime—always work!

**SEND ONLY \$2.00** (cash, Ck, M.O.) and pay post-man \$9.99 plus OOD post or send \$11.99 for pnd. Del. in USA. COMPLETE, ready to use with instructions. One Year service Warranty—10 DAY MONEY BACK TRIAL (if retnd) AMAZING OFFER good only by mail—WESTERN RADIO Dept. BE-3, KEARNEY, NEBR. 68847



**PARTS! CORNELL TUBES!**

FREE Send For FREE  
CORNELL'S New Color Catalog  
48 Pgs. New Items

**33¢** per tube  
IN LOTS OF 100

**36¢** per tube  
ORDER FREE IF NOT SHIPPED IN 24 HOURS!

4219 E. UNIVERSITY AVE. SAN DIEGO, CALIF. 92105

**BUY U.S. SAVINGS BONDS**

tion. Tune C1 (tune control) for maximum received signal. If you have a problem with oscillation on the highest frequencies of Band C, reduce the value of R1 and adjust the coil slugs as necessary for band coverage.

## Slip & Clip

Continued from page 82

leads of all accessories are terminated by soldering on a No. 3 paper clip.

You may want a few transistor sockets and jumpers though, before you start breadboarding. Make all the leads of solid wire of sufficient length to span the board. Jumpers between adjacent junctions are of stiff uninsulated wire and are installed the same as components.

**Planning The Layout.** You will save a great deal of time by doing your trial layouts on paper first. Squared paper is handy for this, or you could make a replica of each board using white sheet plastic, such as is used for siding. With holes drilled to represent the junctions, and rows and columns marked identically to the breadboard, you could pencil in and erase component placement.

Working from the schematic, first reduce it to a set of junctions. The number of junctions will tell you the minimum size of board you need. Disregarding transistors and outboard components, plan the layout for economy of junctions and jumpers. While it is not easy to obtain the simplest layout, your ability will improve with practice and the task is not nearly as difficult

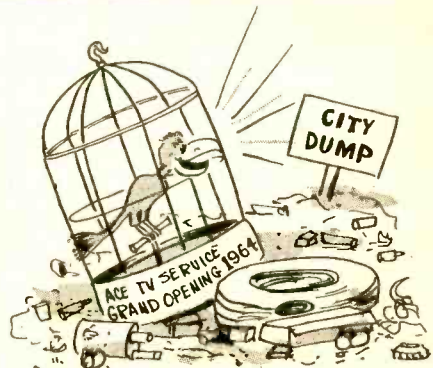

"House calls anytime, only \$2.00 plus parts;  
house calls anytime, only \$2.00 plus parts;  
house calls any. . . ."



as designing even the simplest printed circuit.

**Using The Board.** Installing components on the board is easy and fast. Resistors, capacitors, diodes and other small two-lead components are mounted first. Resist the temptation to lift clamps with your fingers. If the clamp tension is right they may tend to slip through your fingers and you'll end up fishing for them. By using a coathanger-wire loop, you will have no problems and can easily position the component with your free hand.

The outboard accessories are added next. The paper clip terminals should be turned so that the longer loop goes inside the pipe. If you leave an apron on the front of your boards the outboard components can be mounted here using contact cement. Auxiliary equipment may be connected with clip leads. Transistors and long jumpers are added last. The solid wire allows them to bridge the board without interference.

With a few of these boards on hand you'll quickly be turning out simple circuits. ■

### Antique Radio Corner

*Continued from page 79*

ing the tube type number—280, 201A, 227, 271A, etc. They did this as a means of promoting their own brand of tubes.

As more companies entered the market—the prefix was dropped and vacuum tubes were simply branded 80, 27, 01A, 71A, etc. If you must replace the old tubes you can assume that any tube with the same last two digits and/or a letter will work in the radio as well as the original. Now, two exceptions are the UV and UX 99 and the WD11 and WD12. In this case the tubes actually have different pin locations in the base. This is why I gave a qualified yes.

**Aligning The Old TRF Sets.** Several readers have written in to find out how to align a tuned radio frequency (TRF) receiver. I will describe a method that can be adapted to most any set without using a signal generator. This description must be general in nature, because of the many various types of designs there were for receivers with one-dial tuning.

Initially the variable condenser must be mechanically adjusted so the end of rotation for each condenser is exactly the same, and the rotor plates should be spaced exactly midway between the stator or fixed plates.



**FREE**  
1974 LAFAYETTE  
CATALOG 740  
*Ready Now!*

### Your Complete Electronics Buying Guide

- Stereo/Hi-Fi Components • CB Transceivers & Walkie-talkies • PA Systems • Tools & Test Equipment
- Police/Fire Monitor Receivers • Antennas • Photography Equipment • Ham Gear • Books, Parts, and More!

**Send Today!** Lafayette Radio Electronics  
P.O. Box 10, Dept. 25034  
Syosset, L.I., N.Y. 11791

25034

NAME \_\_\_\_\_

ADDRESS \_\_\_\_\_

CITY \_\_\_\_\_

STATE \_\_\_\_\_ ZIP \_\_\_\_\_

CIRCLE NO. 16 ON PAGE 17 OR 103

### CODE PRACTICE SET & TAPES



**TG-34 KEYSER:** Code practice set used to reproduce signals previously recorded on inked paper tape. Variable speed motor, keying oscillator with speaker & phone jack. Power required: 115 V. 50/60 cym. Comes in portable carrying case: 15 x 10 x 10".

WT: 40 lbs. Used, serviceable: \$24.95. Checked: \$29.50

#### 15 TAPES TO A COMPLETE PRACTICE SET:

- |   |                      |
|---|----------------------|
| #1 thru #4 cover different groups of wide space letters | #9 12WPM Coded/Gr.   |
| #5 Wide space numbers and letters                       | #10 12WPM Tact/Mess. |
| #6 5WPM Numbers & letters                               | #11 12WPM Tact/Mess. |
| #7 7WPM Numbers & letters                               | #12 15WPM Tact/Mess. |
| #8 10WPM Coded Groups of 5                              | #13 15WPM Tact/Mess. |
|   | #14 20WPM Tact/Mess. |
|   | #15 20WPM Tact/Mess. |

TAPES PRICE: \$2.00 Each • All prices F.O.B., Lima, Ohio  
SEND TODAY FOR BIG FREE CATALOG! Dept. EE

**FAIR RADIO SALES**  
1016 E. EUREKA • Box 1105 • LIMA, OHIO • 45802

**FIND BURIED TREASURE**

Powerful electronic detector finds buried gold, silver coins, etc. Write or call for free catalog. Dealer inquiries invited.



Financing Available 19.95 to 198.50  
Phone day-night (713) 682-2728  
**RELCO, Dept. D-58**  
BOX 10839, HOUSTON, TEX. 77018

There must be no contact between the rotor and stator plates for this will produce static when the rotor is turned or will short out the stations completely.

The radio sets made after 1928 will have trimming condensers placed in parallel with each stator section of the ganged tuning condenser. To align the tuning condenser when trimming condensers are present proceed as follows.

Tune in the strongest local station you can receive. Remove the second tube downstream from the antenna terminals and connect the antenna wire through a small fixed condenser of about .0001  $\mu$ F capacity to the plate terminal of the socket from which you removed the tube. The small fixed condenser is used to minimize the added capacity of the antenna. You then adjust the trimming condenser C3A (see the schematic drawing) for the loudest signal. You may have to turn the volume control full on to hear the station. After the second tube is replaced, the first tube is removed and the antenna wire and the small condenser are connected to the plate terminal of this socket. The trimming condenser C2A is then adjusted for the loudest signal. Next this tube is replaced and

the antenna wire is placed in the antenna binding post without the .0001  $\mu$ F condenser. Now adjust the trimming condenser C1A for the loudest signal. The alignment of the tuned circuits is now complete for the frequency used, and will be uniform over the broadcasting range if the tuned circuits track with each other.

**Rocky Mountain Antique Wireless Club.** The fall meeting was held in the home of William S. Miller at Greeley, Colorado.

Discussions were held on the election of officers, and the possibility of holding joint meetings with Colorado area amateur radio clubs. There was an interesting discussion on the 100th anniversary of the birth of Dr. Lee De Forest, the "Father of Radio."

After the business meeting members toured and admired Mr. Miller's collection of 35 radios, speakers, and old phonographs.

If there is a radio collectors' club near you plan to attend a meeting and join the group. You will be glad you did.

Next time we will talk about old radio test equipment, how to remove transformers, etc., from potted containers, and we will have a story about the De Forest Museum in Council Bluffs, Iowa. ■



## DISCOVER A NEW HOBBY !

Collecting old time wireless and radio is fascinating, fun and a challenge. Vintage Radio opens the door for you.

### VINTAGE RADIO, 1887-1929

This book brings you pioneer days of wireless and radio in pictures and words. It's the collector's and historian's bible. Great browsing. Packed with old ads, old photos and vintage equipment. Over 1,000 photos, 263 pages. Handbook or deluxe hard cover.

### McMAHON'S 1921-1932 GUIDE

Collectors: Our 1921-1932 Guide is a must! Over 50,000 facts, 264 pages. Lists radio models by maker and year introduced, with original price, style and circuit type.



AVOID DELAY; SEND TODAY.

Mail check to Vintage Radio, Dep't. E,  
Box 2045, Palos Verdes Peninsula, Calif., 90274

Vintage Radio, hard cover	\$6.95	<input type="checkbox"/>
Vintage Radio, handbook	4.95	<input type="checkbox"/>
Radio Collector's Guide	3.95	<input type="checkbox"/>

California residents add 5% State Sales Tax.

Name \_\_\_\_\_  
Street \_\_\_\_\_  
City \_\_\_\_\_ State \_\_\_\_\_ Zip \_\_\_\_\_

## ENJOY THE OLD DAYS !

CIRCLE NO. 9 ON PAGE 17 OR 103



# Radio Shack is Electronic Parts Paradise!

We're "The Parts Place"  
for Magazine Projects &  
Do-It-Yourself Experiments!



**Auto Siren Alarm Kit.** For 24-hour protection against would-be car thieves or vandals. Shriill alarm sounds if hood, trunk or doors are tampered with. 6 switches, 2 keys, lock, wire/hardware included. For 12-volt DC neg. ground. **21<sup>95</sup>**



**12-Volt Power Converter.** Converts 120 VAC to 12 VDC. Use to charge 12-volt batteries or as a battery eliminator when servicing 12 VDC equipment. Output: 12V at 1.75 amps continuous, 5 amps surge. Blow-out protected. **18<sup>95</sup>**

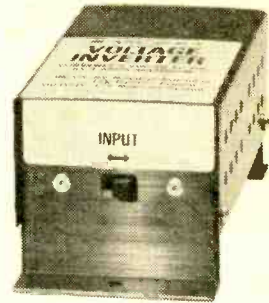

**6 to 12 VDC Inverter.** Converts 6-VDC input to 12-VDC output. Dual inputs—6 V neg. & 12V pos. grd. Output: 12V neg. grd. at 3 amps. Solid state, fuse protected. Ideal for use in VW's, dune buggies, etc. **18<sup>95</sup>**

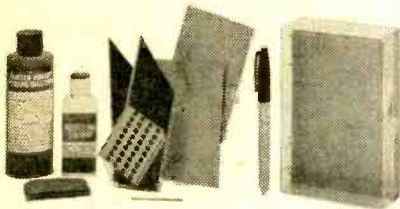

**Printed Circuit Kit.** All you need to custom-design your own circuits. Two 4½x3" copperclad boards, resist-ink solvent with pen, 6-oz. bottle of etchant, layout strips & circles, scouring pad, 1/16" drill bit, 4½x6¼x2¼" plastic etching tank. Safe to use. **6<sup>95</sup>**



**Etchant Solution.** Takes copper off perfboard without damage to the board. Safe, easy to use. A "must" for hobbyists, builders & experimenters. 16 fluid oz. **1<sup>69</sup>**



**Hook-Up Wire.** Five 100' coils in assorted colors. Sizes #18 thru #22. Solid & Stranded types. **3<sup>69</sup>**



**Transistor Substitution Guide.** Indispensable for technicians. Lists up to 15,000 types, foreign & domestic. Also has biasing diagrams, polarities, etc. **1<sup>00</sup>**



**SPST Magnet Contact Switches.** Rated 0.5 A at 125 VAC. **1<sup>99</sup>**



**"Mini" Size Filament Transformers.** From 6.3V to 24V. 300 mA DC rated. Low as **1<sup>29</sup>**



**Aluminum "Mini" Boxes.** Lightweight, sturdy. Many sizes available. Low as **1<sup>19</sup>**

\*Price may vary at individual stores

**FREE '74 CATALOG! AT YOUR NEARBY STORE OR MAIL IN THIS COUPON**

*CB, Stereo Hi-Fi, Ham, Kits, Radios, Recorders, Tools, More!*

Name \_\_\_\_\_ Apt. # \_\_\_\_\_

Street \_\_\_\_\_

City \_\_\_\_\_ State \_\_\_\_\_ Zip

**Radio Shack®**

and ALLIED RADIO STORES

A TANDY CORPORATION COMPANY

P. O. Box 1052, Fort Worth, Texas 76107

CIRCLE NO. 32 ON PAGE 17 OR 103

## INDEX TO ADVERTISERS

READER SERVICE NO.	ADVERTISER	PAGE NUMBER
5	Antenna Specialists	16
11	Avanti Research & Development, Inc.	14
	Barta	104
27	B&F Enterprises	23
	Bell & Howell Schools	72-75
6	Cleveland Institute of Electronics	2nd Cover & page 3
	Circuit Specialist	24
	Cornell Electronics, Co.	104
29	Cobra Communications, Div., Dynascan Corp.	30
13	Edmund Scientific Co.	13
12	Electronic Distributors, Inc.	29
2	Eico Electronics	28 & 29
7	E.L. Instruments	12
	Fair Radio Sales	105
10	GC Electronics	10
1	Heath Company	54-57
	I.C.S.	3rd Cover & Page 108
19	International Crystal Mfg. Co.	16
33	E.F. Johnson Co.	7
16	Lafayette Radio	105
15	LaSalle Extension University	90-93
20	Midland Communications Co.	27
	Macromsoma Co.	24
17	Mosley Electronics, Inc.	28
	McGee Radio	104
	National Radio Institute	18-21
14	Newtronics Corp.	8
21	Pace	26
	Photocircuit Consultants	104
	Photolume Corp.	24
4	Progressive Edu-Kits, Inc.	5
3 & 32	Radio Shack	4th Cover & 11, 25, 107
	Reico	105
18	S.B.E. Lineyard Systems, Inc.	24
8	Sitronix	9
22	Tetex Communications	6
24	Turner Div., Conrae Corp.	15
9	Vintage Radio	166
	Western Radio	104

### DX Central Reporting

*Continued from page 27*

"Dear Don," writes Charlie Everett, Sag Harbor NY, "I've logged some tricky medium BCB stations that might prove a challenge to nighttime DXers. They are WLW, 700; WCKY, 1530, both in Cincinnati; CKLW, 800, Windsor, Ontario; and CBL, 740, Toronto, Ontario."

All right, Charlie, there's your challenge in black and white. Now I'll just step back out of the way. We've got a lot of mighty sharp BCB listeners out there!

Robert Lapierre, Westfield MS, tells DX Central that he owns a shortwave receiver with four tuning ranges; .538-1.6, 1.55-4.6, 4.6-13 and 12-34 MHz.

"Why can't I receive police or fire calls," asks Bob?

There was a time when your receiver's second band, 1.55-4.6 MHz, would have brought in plenty of police transmissions, especially in the frequency range just above 1.6 MHz. Today, however, almost all such transmission are in the VHF and UHF frequency ranges. Your SW rig just doesn't tune that high in the frequency spectrum. But there are many "hot" VHF/UHF sets on the market today. Check the ads in this issue and other issues of e/e. ■

# Let ICS mail you a FREE demonstration lesson without obligation... to prove that you can learn TV servicing at home.



Credit towards a Certified Electronic Technician (C.E.T.) rating will be granted by the National Electronics Association to ICS students upon completion of the ICS Career Program in TV Service/Repair.



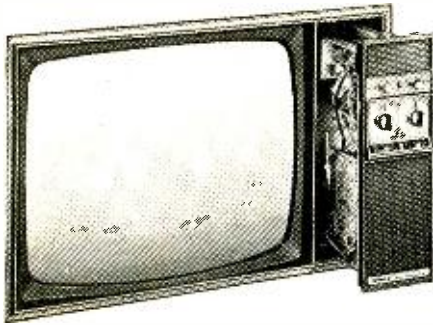

**Practice on a new 25"  
MOTOROLA QUASAR II® chassis.**

TV Servicing is a satisfying career . . . and the pay is great. Qualified men are needed now to maintain the 93 million sets in U.S. homes. And prospects for the future are even brighter.

Now . . . here's an opportunity for you to prove to yourself that you can learn TV Servicing . . . at home, in your spare time. ICS, the world's most experienced home-study school, will send you a **FREE** Demonstration Lesson (complete with sample questions) if you will merely fill out the coupon below and mail it to us.

In addition to your free demonstration lesson, we'll send you . . . also **FREE** . . . a brochure that describes the 25" (diagonally measured screen) **MOTOROLA QUASAR II®** Color TV chassis that we include in our TV Service Training Program.

This chassis with automatic fine tuning control is ideal for training purposes because it combines solid state devices with vacuum tubes to give you both kinds of practical experience. All parts carry Motorola's two year replacement guarantee!

The QUASAR II chassis comes to you in three basic sub-assemblies . . . **NOT AS A KIT** . . . because we want you to learn how to *repair* TV sets, not build them.

Our free literature also describes the fully assembled test equipment you receive such as the Deluxe 5" Solid State Oscilloscope, the tools and the learn-by-doing kits, all of the finest quality.

And we're going to tell you about eight other career opportunities in Electronics and the ICS Career Programs that can help prepare you for them.

All you've got to do is mail the attached postpaid card or coupon—today!

**ICS**

International Correspondence Schools  
Since 1890  
**School of Electronics**  
Scranton, Pa. 18515

Approved for Veterans' Training. Eligible Institution under the Guaranteed Student Loan Program. Accredited Member National Home Study Council. Canadian residents use coupon address for service from ICS Canadian, Ltd. In Hawaii: 931 University Ave., Honolulu, Hawaii 96814

**ICS School of Electronics  
International Correspondence Schools  
Scranton, Pa. 18515**

YES, I want you to mail to me without obligation, the **FREE DEMONSTRATION LESSON** and complete literature on the career program checked below. (Please check one.)

- |  |  |
|--|--|
| <input type="checkbox"/> Color TV Servicing & Repair | <input type="checkbox"/> FCC Licensing                   |
| <input type="checkbox"/> Computer Maintenance        | <input type="checkbox"/> Communications/<br>Broadcasting |
| <input type="checkbox"/> CATV/MATV Technician        | <input type="checkbox"/> Hi-Fi Sound Systems             |
| <input type="checkbox"/> Telephony                   | <input type="checkbox"/> Industrial Electronics          |
| <input type="checkbox"/> Electrician                 |  |

AA614P

Name \_\_\_\_\_ Age \_\_\_\_\_

Address \_\_\_\_\_

City \_\_\_\_\_

State \_\_\_\_\_ Zip \_\_\_\_\_

# Realistic® introduces the first low-cost VHF pocket scanner with every big feature

The exciting new Realistic® PRO-4—the palm-size scanner that lets you take the 148-174 MHz VHF “action band” wherever you walk, drive, work or live. It gets police, fire and marine calls—and continuous weather in many areas—just as good as the big sets. Scans up to 4 crystal-controlled channels in less than a second and locks in on each active frequency until the message ends—scan-delay prevents missed replies. You won’t miss a thing—it’s like 4 radios in one, each tuned to a different channel. Only 5-1/2 x 2-3/4 x 1-1/2” — there’s nothing else like it for the money! Crystals extra, batteries included. #20-168.

**99<sup>95</sup>**



WEATHER



FIRE



POLICE



MARINE

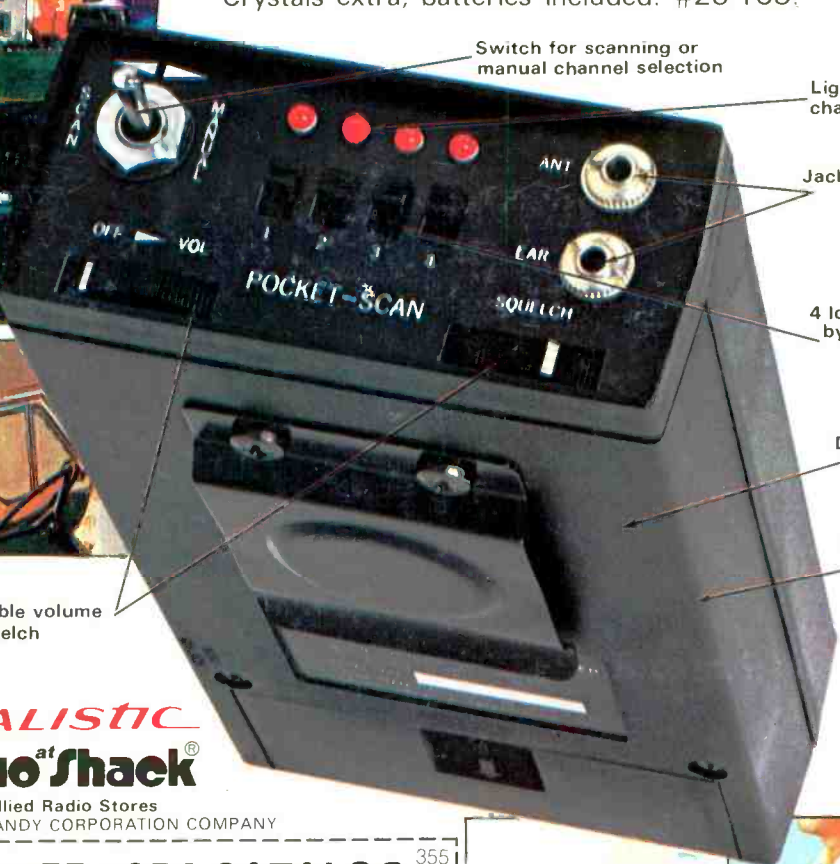

Switch for scanning or manual channel selection

Lighted (LED) channel indicators

Jacks for earphone and antenna

4 lockout switches bypass unwanted channels

Dual-conversion receiver

Built-in speaker and antenna

Adjustable volume and squelch

**REALISTIC**  
**Radio at Shack®**

and Allied Radio Stores  
A TANDY CORPORATION COMPANY

**FREE 1974 CATALOG**  
AT 2000 RADIO SHACK STORES

OR MAIL TO Radio Shack, P.O. Box 1052, Fort Worth, TX. 76107

180 Pages—Full Color! Hi-Fi, CB, Kits, Recorders, Antennas, Parts, Much More!

Name (print) \_\_\_\_\_ Apt. # \_\_\_\_\_

Street \_\_\_\_\_

City \_\_\_\_\_ State \_\_\_\_\_ ZIP \_\_\_\_\_



Clips to belt

Fits in pocket

Retail price may vary at individual stores

CIRCLE NO. 3 ON PAGE 17 OR 103