

02342

JANUARY-FEBRUARY

1974

75c

elementary Electronics

**UNDERSTANDING
TELEVISION
TRANSMISSION**

OUR BASIC COURSE

Including Electronics Digest®

Tune In

Varactor diode lets you tune this regen by varying a DC voltage!



Switch Off

Get the correct time interval for photo enlargements and 3-minute eggs!



Right On

Tower Power for TV • Let a LED Find
• Kathi Checks Out the Royce CB Rig
TV Hazard Alarm • Experimenter's F

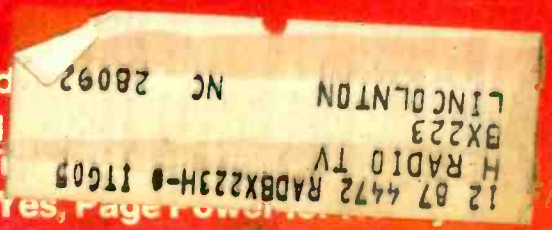

From Cleveland Institute of Electronics

learn by doing!

Perform more than 200 exciting experiments
with CIE's fascinating **ELECTRONICS**
LABORATORY PROGRAM!

Put theory... into practice

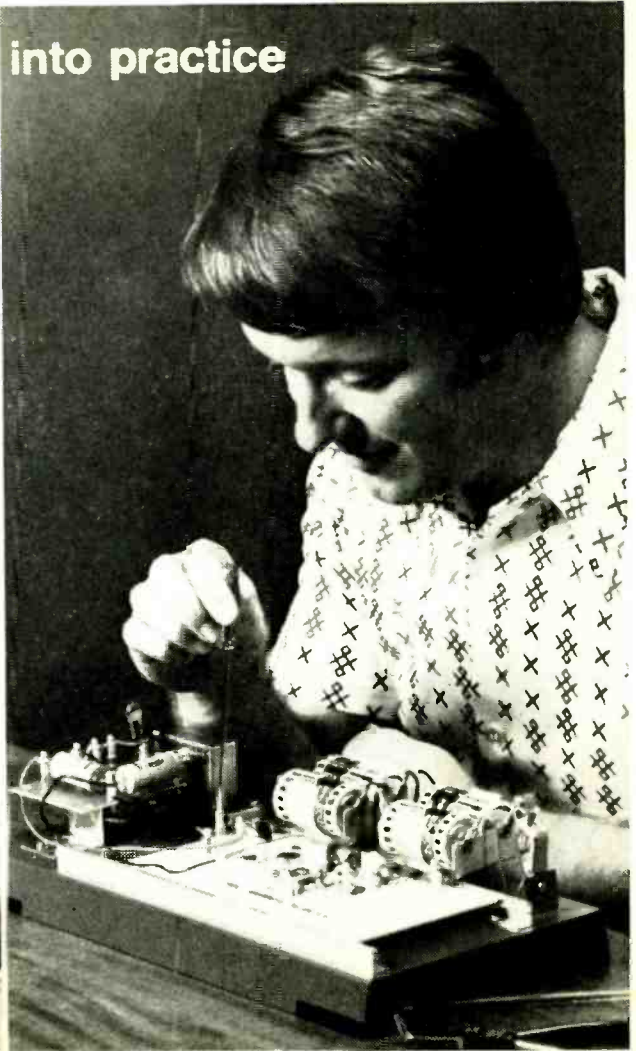

You get your own 161-piece electronics laboratory... with authentic electronic components used by industry!

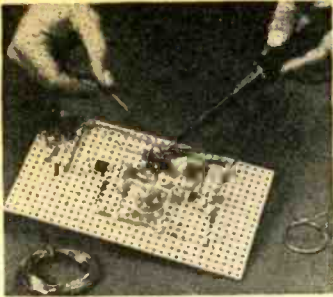

You learn how to construct circuits and connect them with a soldering iron, which is part of your CIE laboratory equipment. This "hands on" experience is extremely valuable in applying what you learn.

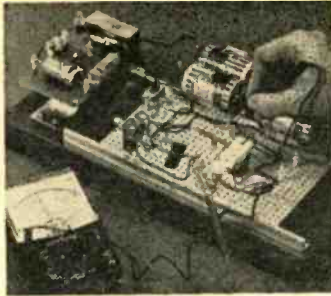

Testing and troubleshooting are an important part of your learning experience. Included in your laboratory is a precision "multimeter" to diagnose electrical and electronic troubles quickly and accurately.

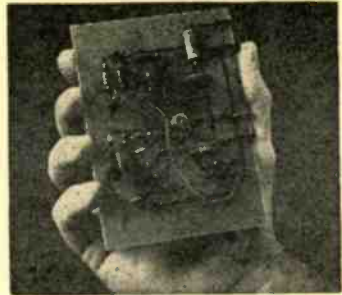

Modern space-age components like this IC (integrated circuit) are professional quality and can be used again and again in many of your projects. Lesson by lesson, piece by piece your knowledge grows!

Prepare now for a high income career in Electronics...the Science of the Seventies.

Electronic miracles are changing today's world with breathtaking speed.

And with this growth in electronics technology has come a brand new need... a demand for thousands of electronics technicians, trained in theory and practice to build the products, operate them and service them during the Seventies.

Don't just wait for something to "happen" in your present job. Get ready now for a career you'll really enjoy with a good income and plenty of opportunity for advancement.

Experience with experiments is your best teacher

"Hands on" experience helps to reinforce basic theory. When you learn by doing, you discover the "how" as well as the "why." You'll find out for yourself the right way as well as the wrong way to use electronic components. How to construct your own circuits, to discover trouble spots and learn how to fix them. And with CIE's special Auto-Programmed[®] Lessons, you learn faster and easier than you'd believe possible.

CIE's fascinating course, Electronics Technology with Laboratory, teaches you Electronics by making it work before your eyes. And you do it yourself, with your own hands.

Importance of FCC License and our Money-Back Warranty

Many important jobs require an FCC License and you must pass a Government licensing exam to get one.

But, a recent survey of 787 CIE graduates reveals that better than 9 out of 10 CIE grads passed the FCC License exam.

That's why we can offer this famous Money-Back Warranty: when

you complete our Laboratory Course, which provides FCC License preparation, you'll be able to pass your FCC exam or be entitled to a full refund of all tuition paid. This warranty is valid during the completion time allowed for your course.

You get your FCC License - or your money back!

You'll have high paying job opportunities

Electronics is still young and growing. In nearly every one of the new exciting fields of the Seventies you find electronics skills and knowledge are in demand. Computers and data processing. Air traffic control. Medical technology. Pollution control. Broadcasting and communications. With a CIE Diploma and an FCC License you can choose the career field you want... work for a big corporation, a small company or even go into business for yourself.

Here's how two outstanding CIE students carved out new careers: After his CIE training, Edward J. Dulaney, President of D & A Manu-

facturing, Inc., Scottsbluff, Nebraska, moved from TV repairman to lab technician to radio station chief engineer to manufacturer of electronic equipment with annual sales of more than \$500,000. Ed Dulaney says, "While studying with CIE, I learned the electronics theories that made my present business possible."

Marvin Hutchens, Woodbridge, Virginia, says: "I was surprised at the relevancy of the CIE course to actual working conditions. I'm now servicing two-way radio systems in the Greater Washington area. My earnings have increased \$3,000. I bought a new home for my family and I feel more financially secure than ever before."

Send now for 2 FREE BOOKS

Mail the reply card or coupon for our school catalog *plus* a special book on how to get your FCC License. For your convenience, we will try to have a representative call. If coupon is missing, write: Cleveland Institute of Electronics, Inc., 1776 E. 17th St., Cleveland, Ohio 44114. Do it now!



Approved under G.I. Bill

All CIE career courses are approved for educational benefits under the G.I. Bill. If you are a Veteran or in service now, check box for G.I. Bill information.

CIE Cleveland Institute of Electronics, Inc.
1776 East 17th Street, Cleveland, Ohio 44114
Accredited Member National Home Study Council

Please send me your two FREE books:

1. Your illustrated school catalog, "Succeed in Electronics."
2. Your book, "How to Get a Commercial FCC License."

I am especially interested in: Electronics Technology with Laboratory
 Electronics Technology Industrial Electronics
 Electronic Communications First Class FCC License
 Broadcast Engineering Electronics Engineering

Name _____ Age _____
(PLEASE PRINT)

Address _____

City _____ State _____ Zip _____

Veterans and Servicemen: Check here for G.I. Bill information.

EL-45

CIRCLE NO. 6 ON PAGE 17 OR 103

ELEMENTARY ELECTRONICS including ELECTRONICS DIGEST (Vol. 13, No. 7) is published bi-monthly by Davis Publications, Inc., at 229 Park Ave., S. New York, N.Y. 10003. One year subscription (six issues)—\$3.95. Second class postage paid at New York, N.Y. 10003 and at additional mailing office.

JANUARY-FEBRUARY, 1974



elementary Electronics

Dedicated to America's Electronics Hobbyists

PROJECTS ON THE COVER

- ☆ 31 Experimenters, Tune this Radio with a Voltage Divider—old circuit, new twist
- ☆ 49 Universal Power Timer—darkroom developing or 3-minute eggs are its domain

PROJECTS FOR BEGINNERS TO SUPER BEGINNERS

- ☆ 47 Build a LED Flashlight for Your Key Chain
- 48 Quickly Vacuum-Tube Filament and Continuity Checker
- 67 Pot Box—a dreamy way of beating reality
- 72 Two-Step Audio Filter for Restoring Old 78 Sound
- ☆ 77 Build Our TV Hazard Alarm—keep the red in your color TV picture tube

KEEPING CONTACT WITH COMMUNICATIONS

- 22 DX Central Reporting—for SWLs only
- 40 AM Clear Channel Stations for North America
- ☆ 41 Sky Hooks Start at Ground Zero—let your antenna top off this tower project
- ☆ 45 Kathi's CB Carousel—the scoop on the Royce 1-590 CB transceiver
- ☆ 65 DXing the World in 80 Minutes—let's see you beat our time
- 83 DXing the Locators—radio pagers are a new hobby listening area

SOLID THEORY SERVED SOFTLY

- ☆ 69 Getting the Swing of Simple Filters—a college subject returned to the hobbyist
- ☆ 87 e/e's Basic Course—understanding the fundamentals of television transmitters

HIGH-FIDELITY FOR EVERYBODY

- 53 4-Ways to 4-Channel—what's new in audio's newest
- 59 e/e Checks out the Leader LSG-231 FM Stereo Signal Generator
- 61 e/e Checks Out the Dual 701 Single-Play Automatic Turntable
- 82 Hey Herb—our audio answer man

ODD BALL ODDITIES

- 30 The Learning Experience—our funny page
- 58 Nothing to Spitz At—electronics in the pool
- 75 Pity the Poor Man Who Sat at Home
- 81 Blinking Teddy is a Bloomin' Friend

e/e REGULARS

- 8 Hey, Look Me Over—new products on parade
- 17 Reader Service Page—same as on page 103
- 28 Literature Library—freebies by mail
- 25 Newscan—electronics in the news
- 27 Ask Hank, He Knows—our Mr. Answerman
- ☆ 63 Antique Radio Corner—what's up in the world of ancient radio
- 80 Bookmark by Bookworm—take a book to lunch this month
- 103 Reader Service Page—same as on page 17

☆
Cover
Highlights

☆
Cover
photograph
by
Walter
Herstatt

AUTHORS IN THIS ISSUE

Norman Crawford, Peter L. Dexas—WA3LOQ, Thomas R. Fox, James A. Fred, Herb Friedman, Charles Green—W6FFQ, Joe Gronk, Don Jensen, C. R. Lewart, Tony Mancuso, Kathi Martin, Jack Schmidt, Hank Scott, R. L. Way and the ELEMENTARY ELECTRONICS staff.



EDU-KIT 20 RADIO

and Electronics Circuits

PROGRESSIVE HOME RADIO-TV COURSE

Now Includes

- ★ 12 RECEIVERS
- ★ 3 TRANSMITTERS
- ★ 5Q. WAVE GENERATOR
- ★ SIGNAL TRACER
- ★ AMPLIFIER
- ★ SIGNAL INJECTOR
- ★ CODE OSCILLATOR

- ★ No Knowledge of Radio Necessary
- ★ No Additional Parts or Tools Needed
- ★ EXCELLENT BACKGROUND FOR TV
- ★ SCHOOL INQUIRIES INVITED
- ★ Sold In 79 Countries



Reg. U. S. Pat. Off.

Training Electronics Technicians Since 1946

FREE EXTRAS

- SET OF TOOLS
- SOLDERING IRON
- ELECTRONICS TESTER
- PLIERS-CUTTERS
- VALUABLE DISCOUNT CARD
- CERTIFICATE OF MERIT
- TESTER INSTRUCTION MANUAL
- HIGH FIDELITY GUIDE • QUIZZES
- TELEVISION BOOK • RADIO TROUBLE-SHOOTING BOOK
- MEMBERSHIP IN RADIO-TV CLUB; CONSULTATION SERVICE • FCC AMATEUR LICENSE TRAINING
- PRINTED CIRCUITRY

YOU DON'T HAVE TO SPEND HUNDREDS OF DOLLARS FOR A RADIO COURSE

The "Edu-Kit" offers you an outstanding PRACTICAL HOME RADIO COURSE at a rock-bottom price. Our Kit is designed to train Radio & Electronics Technicians, making use of the most modern methods of home training. You will learn radio theory, construction practice and servicing. THIS IS A COMPLETE RADIO COURSE IN EVERY DETAIL. You will learn how to build radios, using regular schematics; how to wire and solder in a professional manner; how to service radios. You will work with the standard type of punched metal chassis as well as the latest development of Printed Circuit chassis. You will learn the basic principles of radio. You will construct, study and work with RF and AF amplifiers and oscillators, detectors, rectifiers, test equipment. You will learn and practice code, using the Progressive Code Oscillator. You will learn and practice trouble-shooting, using the Progressive Signal Tracer, Progressive Signal Injector, Progressive Dynamic & Electronics Tester, Square Wave Generator and the accompanying instructional material. You will receive training for the Novice, Technician and General Classes of F.C.C. Radio Amateur License. You will build Receiver, Transmitter, Square Wave Generator, Code Oscillator, Signal Tracer and Signal Injector circuits, and learn how to operate them. You will receive an excellent background for television, Hi-Fi and Electronics. Absolutely no previous knowledge of radio or science is required. The "Edu-Kit" is the product of many years of teaching and engineering experience. The "Edu-Kit" will provide you with a basic education in Electronics and Radio, worth many times the low price you pay. The Signal Tracer alone is worth more than the price of the kit.

THE KIT FOR EVERYONE

You do not need the slightest background in radio or science. Whether you are interested in Radio & Electronics because you want an interesting hobby, a well paying business or a job with a future, you will find the "Edu-Kit" a worth-while investment. Many thousands of individuals of all

ages and backgrounds have successfully used the "Edu-Kit" in more than 79 countries of the world. The "Edu-Kit" has been carefully designed, step by step, so that you cannot make a mistake. The "Edu-Kit" allows you to teach yourself at your own rate. No instructor is necessary.

PROGRESSIVE TEACHING METHOD

The Progressive Radio "Edu-Kit" is the foremost educational radio kit in the world, and is universally accepted as the standard in the field of electronics training. The "Edu-Kit" uses the modern educational principle of "Learn by Doing." Therefore you construct, learn schematics, study theory, practice trouble shooting—all in a closely integrated program designed to provide an easily-learned, thorough and interesting background in radio. You begin by examining the various radio parts of the "Edu-Kit." You then learn the function, theory and wiring of these parts. Then you build a simple radio. With this first set you will enjoy listening to regular broadcast stations, learn theory, practice testkit and trouble-shooting. Then you build a more advanced radio, learn more advanced theory and techniques. Gradually, in a progressive manner, and at your own rate, you will find yourself constructing more advanced multi-tube radio circuits, and doing work like a Professional Radio Technician. Included in the "Edu-Kit" course are Receiver, Transmitter, Code Oscillator, Signal Tracer, Square Wave Generator and Signal Injector Circuits. These are not unprofessional "breadboard" experiments, but genuine radio circuits, constructed by means of professional wiring and soldering on metal chassis, plus the new method of radio construction known as "Printed Circuitry." These circuits operate on your regular AC or DC house current.

THE "EDU-KIT" IS COMPLETE

You will receive all parts and instructions necessary to build twenty different radio and electronics circuits, each guaranteed to operate. Our kits contain tubes, tube sockets, variable electrolytic, mica, ceramic and paper dielectric condensers, resistors, tie strips, hardware, pre-punched metal chassis, Instruction Manuals, hook-up wire, solder, selenium rectifiers, coils, volume controls and switches, etc. In addition, you receive Printed Circuit materials, including Printed Circuit chassis, special tube sockets, hardware and instructions. You also receive a useful set of tools, a professional electric soldering iron, and a self-powered Dynamic Radio and Electronics Tester. The "Edu-Kit" also includes Code Instructions and the Progressive Code Oscillator. In addition to F.C.C. Radio Amateur License training. You will also receive lessons for servicing with the Progressive Signal Tracer and the Progressive Signal Injector, a High Fidelity Guide and a Quiz Book. You receive Membership in Radio-TV Club, Free Consultation Service, Certificate of Merit and Discount Privileges. You receive all parts, tools, instructions, etc. Everything is yours to keep.

FROM OUR MAIL BAG

J. Statalis, of 25 Poplar Pl., Waterbury, Conn., writes: "I have repaired several sets for my friends, and made money. The 'Edu-Kit' paid for itself. I was ready to spend \$240 for a Course, but I found your ad and sent for your Kit." Ben Valerio, P. O. Box 21, MaMa, Utah: "The Edu-Kits are wonderful. Here I am sending you the questions and also the answers for them. I have been in radio for the last seven years, but like to work with Radio Kits, and like to build Radio Testkit Equipment. I ordered every minute I worked with the different kits; the Signal Tracer works fine. Also like to let you know that I feel proud of becoming a member of your Radio-TV Club." Robert L. Shuff, 1534 Monroe Ave., Huntington, W. Va.: "Thought I would drop you a few lines to say that I received my Edu-Kit, and was really amazed that such a bargain can be had at such a low price. I have already started repairing radios and phonographs. My friends were really surprised to see me get into the swing of it so quickly. The Trouble-shooting Tester that comes with the Kit is really swell, and finds the trouble, if there is any to be found."

PRINTED CIRCUITRY

At no increase in price, the "Edu-Kit" now includes Printed Circuitry. You build a Printed Circuit Signal Injector, a unique servicing instrument that can detect many Radio and TV troubles. This revolutionary new technique of radio construction is now becoming popular in commercial radio and TV sets. A Printed Circuit is a special insulated chassis on which has been deposited a conducting material which takes the place of wiring. The various parts are merely plugged in and soldered to terminals. Printed Circuitry is the basis of modern Automation Electronics. A knowledge of this subject is a necessity today for anyone interested in Electronics.

Progressive "Edu-Kits" Inc., 1189 Broadway, Dept. 565DJ Hewlett, N.Y. 11557

Please rush me free literature describing the Progressive Radio-TV Course with Edu-Kits. No Salesman will call.

NAME _____
 ADDRESS _____
 CITY & STATE _____ ZIP _____

PROGRESSIVE "EDU-KITS" INC.
 1189 Broadway, Dept. 565DJ, Hewlett, N.Y. 11557

CIRCLE NO. 9 ON PAGE 17 OR 103

NEW 5-ELEMENT

CB MINI- BEAM

Model GA-5D

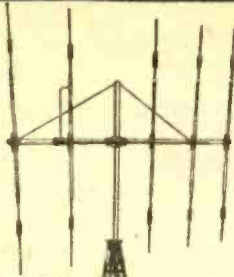

9.5db Gain 500Watt Power Rating

The secret of success in this five-element miniature beam is in its coils. Ten High "Q" coils molded on each element-extension limit the mechanical size of the GA-5D without limiting its electrical capability.

These coils are built to take a powerful beating---in fact, the same coils are used in the construction of 10-meter amateur antennas.

The GA-5D is lightweight. Erect on TV antenna mount and turn with an inexpensive TV rotor. Get all the facts: see your Dealer or write factory direct, Dept. 211-RTV

Mosley Electronics Inc.

4610 N. LINDBERGH BLVD., BRIDGETON MO. 63044

CIRCLE NO. 17 ON PAGE 17 OR 103

everybody's gain

If you operate AM on a tube set, you might need all the gain you can get. On a transistorized SSB rig, you probably need just a little. That's what's so super about the new Super Sidekick. You get a modulation-boosting match for any set and a dynamic cartridge for clarity.

See a Turner dealer for details, or write to Turner, 909 17th St. N.E., Cedar Rapids, Ia. 52402.



Super Sidekick
List Price \$80

TURNER
MICROPHONES

CONRAC

CIRCLE NO. 24 ON PAGE 17 OR 103

elementary Electronics

Jan./Feb. 1974

Vol. 14/No. 1

Dedicated to America's Electronics Hobbyists

Editor-in-Chief

JULIAN S. MARTIN, WA2CQL

Technical Editor

PETER L. DEXNIS, WA3LOQ

Audio Editor

STEPHEN B. GRAY

News Editor

JEFFREY APTER

Citizens Band Editor

KATHI MARTIN, KAIØ614

Workbench Editor

HANK SCOTT

Art Director

JIM MEDLER

Cover Art Director

IRVING BERNSTEIN

Associate Art Director

ANDY STEIGMEIER

Art Associate

RALPH RUBINO

Advertising Director

DAVID J. MILLER

Production Director

CARL BARTEE

Production Manager

GERTRUD BORCHARDT

Assistant Production Manager

MARILYN BONILLA

Newstand Circulation Director

DON GABREE

Subscription Circulation—Marketing Director

ROBERT V. ENLOW

Instruments Division Manager

WILFRED M. BROWN

President, Chairman of the Board (1957-1972)

B. G. DAVIS

President and Publisher

JOEL DAVIS

Vice-President and General Manager

LEONARD F. PINTO

Vice President and Treasurer

VICTOR C. STABILE, KBPØ681

ELEMENTARY ELECTRONICS is published bi-monthly by Davis Publications, Inc. Editorial and Executive offices: 229 Park Ave. So. New York NY 10003; all Subscription orders and mail regarding subscriptions should be sent to P.O. Box 2600, Greenwich CN 06830. One-year subscription (six issues)—\$3.95; two-year subscription (12 issues)—\$7.95; three-year subscription (18 issues)—\$11.95; and four-year subscription (24 issues)—\$15.95. Add \$1.00 per year for postage outside the U.S.A., its possessions and Canada. For change of address, please advise 4 to 6 weeks before moving. Send us your current mailing label with new address. Advertising offices: New York, 229 Park Avenue South, 212-673-1300; Chicago, 520 N. Michigan Ave., 312-527-0330; Los Angeles, J. E. Publishers' Rep. Co., 8732 Sunset Blvd. 213-659-3810. Second-class postage paid at New York NY and at additional mailing office. Copyright 1973 by Davis Publications, Inc.

*Your ideal
traveling
companion . . .*

"Miss Goldie Eagle"



browning[®] LTD

SSB/AM MOBILE

We've designed LTD as a compact little beauty ready to go anywhere! LTD's petite 2.36" × 6.49" size means a perfect fit under the dashboard of your car, camper or boat. Its handsome gold and walnut-grained exterior comes with built-in performance muscle—a 15-watt PEP input that really delivers!



FREE FOR THE ASKING. . .

Get the complete LTD story—a full-color brochure that folds down to an actual size paper model for test fitting under your dash. Pick it up at your local Browning distributor or write:

browning[®] laboratories inc.

1269 UNION AVENUE
LACONIA, NEW HAMPSHIRE 03246
TELEPHONE (603) 524-5454

CIRCLE NO. 3 ON PAGE 17 OR 103

THE MOST IMPORTANT
DIMENSION
OF AN ANTENNA
IS

dependability

HUSTLER

**HAS BEEN
FOREMOST
FOR MORE THAN A
DECADE!**

You will find 100% American material and precision workmanship to cover your requirement in Citizen-band, Amateur, Monitor and Business-Radio antennas and antenna hardware. Systems designed for application, performance and dependability at reasonable cost.

HUSTLER

*available from all
distributors and dealers
(more than 3000)
who recognize the best!*

**NEW-TRONICS
CORPORATION**

15800 COMMERCE PARK DRIVE
BROOKPARK . . . OHIO, 44142

CIRCLE NO. 11 ON PAGE 17 OR 103

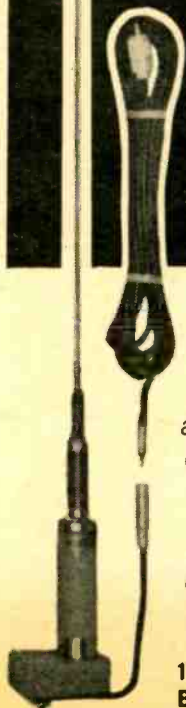

Hey, look me over

Showcase of New Products

Shelves to Order

System Plus is the new easy do-it-yourself shelf idea from PMI. A low cost easy shelf system is now available to the consumer for office furniture, library, hobbyist or furniture supplier with System Plus. System Plus is excellent for organizing or storage of test



equipment, station gear or hi-fi. The design allows anyone to assemble a completely designed area in only a few minutes. System Plus is free-standing, easily moved or redesigned as requirements may change. Color coordinated fittings with shelves that can be painted, stained or left natural gives System Plus a professional custom appearance in any area used. The shelves are made of particle (compressed chips) board, and three sizes are available, 12-in. x 12-in., 12-in. x 16-in., and 12-in. x 32-in. Fittings are available in four colors, red, white, blue, and gold. More information from PMI is yours for the asking by circling No. 67 on Reader Service Coupon.

For Wheels

Once someone has become accustomed to good stereo sound, he wants it everywhere: his car, boat, camper, trailer, and virtually every other vehicle available. And the Sanyo F8412 Tachrad AM/FM stereo car radio system is designed to do the job. The F8412 stereo system is still another improvement on Sanyo's tachrad styling which resembles a racing car tachometer for the face of the radio. Included is an acoustically matched pair of high fidelity speakers for in-door or rear-shelf mounting. The system has special features such as tone control, lighted dial, windshield antenna and a locking system with

MORE BARGAINS IN SURPLUS ELECTRO-OPTICS from B & F ENTERPRISES
 Just off the press our Best Catalogue yet with 104 Illustrated Pages of Surplus Electronics, Optics, and Much More.

NICKEL CADMIUM BATTERIES

- 0.5 ampere hour 1.25 volt sealed button cell 2 for \$1.00
- Vented 4.0 ampere hour cell, plastic case \$2.75
- 24 volt pack, sealed cells, mfg. some-tions, size 12" x 1 1/2" x 1 1/2" capacity 0.6 ampere hours \$11.75

MOLEX SOLDERCON CONNECTIONS

- Molex soldercon connections for I.C.'s. With these you can build low cost I.C. sockets by just cutting off the number of connections required, i.e., two strips of seven for 14 pin sockets.
- 500 Molex soldercon \$4.75
 - 1000 Molex Soldercon \$7.50

LED READOUTS

Popular OPCA SLA-7, without decimal point, 0.27" numeral height, we formerly sold these at \$4.25, and they sold extremely well. Because of a fortunate purchase we can offer them at a super-low price. Use for clocks, counters, calculators

SLA-7 Readouts \$2.50

GIANT NIXIE TUBES ALPHANUMERIC

Burroughs B7971 alphanumeric nixie tube. Giant 2 1/2" character height. Forms all letters of the alphabet, and numerals 0 thru 9. Consists of 15 segments in "star" matrix. When used as numeric display only, it is wired as a seven segment display, requires 170 volts D.C.

This is the same unit we use in our Giant Clock.

B7971 tube, brand new with used socket \$7.50

B7971 tube, removed from equipment \$2.50

Socket for above (only with tube) \$5.00

4 for \$7.50

LOW COST/HIGH QUALITY COPY LENSES

We have two new lenses available, both in production quantities. Excellent for opaque projectors, copy cameras, and inexpensive enough to have around the lab for all kinds of optical breadboarding.

Copy Lens 1, 1 1/2" dia. mount, 4 1/2" focal length, speed F 5.6, Covers 5" x 5", 9 x 9 at 1:1 conjugates. Manufactured by Ednalite.

LCED 1 \$6.00

Copy Lens 2, 2-11/16" dia. mount, 9 1/2" focal length, speed F 5.6, Covers 9 x 9 inches at infinity, 14 x 14 at 1:1 conjugates. Manufactured by Ednalite.

LCED 2 \$9.00

Both lenses for \$13.50
 Two(2) of each type for \$25.00

POWER RESISTOR ASSORTMENT

We are always getting requests for power resistors to use in testing amplifiers, power supplies, etc. This is an assortment of resistors of various values ranging in power from 5 watts to 100 watts. If you use just one, it is easily worth twice the cost of the entire assortment.

Sh.Wt. 2 lbs. PRA (10) \$1.00
 6 lbs. of 10 6PRA (10) \$5.00/6

2.25 AMPERE VARIAC

This is a useful item to have for variable power supplies, testing, heater control, etc. 0-115 vac in, 0-130 volts out. Removed from equipment \$6.00
 Add \$1.00 for postage and handling.

LOUPOSEAKER SYSTEM COMPONENT SPECIAL

We have made an excellent purchase of an excess inventory of a local manufacturer's speaker systems, although we are not allowed to mention the mfg.'s name, the specs should make it self-evident. The woofer is a 12" free-ledge (acoustic suspension) unit, with 2" voice coil and a No. 2 magnet. The mid-range is a 5" sealed back speaker and 3 1/2" flare dome tweeter for best high frequency dispersion.

Crossover between woofer & mid-range is by an R-L-C network, while high frequency crossover is by an R-C network. Balance controls are provided for both mid-range and tweeter. Plans for a suitable enclosure are provided. The level controls provide frequency response to suit room acoustics, with realism that will delight even the most critical listener. Response - 25 to 20K x Hz. Power - 40 watts RMS. Impedance - 8 ohms.

- Sh.Wt. 12 lbs. \$36.00
- LSCS 2 for \$66.00
- 2LSCS 2 for \$66.00

TESLA COIL KIT

Here's a truly basic kit for those who like to "roll their own." All the parts for an exciting adventure - high frequency, high voltage. Add your own metal housing - a small chassis or universal base is ideal.

Tesla coils are patterned after the design of Nikola Tesla (1857-1943) an American electrical genius who built versions many feet tall. His dream was to light and power entire cities with energy radiated from such coils - but no luck!

Today's Tesla coils are popular with experimenters and students, and especially for science fair and educational demonstrations. Ours is a high-frequency push-pull oscillator coupled to a television flyback transformer, which steps up an external 12 VDC power supply to many thousands volts.

SPECIAL NOTE: Although current output is relatively low, some hazard is inherent in all high voltage devices. This kit is intended for the experimenter who is mature enough to observe reasonable precautions in its use.

TESLA COIL KIT \$7.50

DECADE COUNTING UNITS WITH READOUTS

Always one of B & F's most popular items, now revised to include drilled boards, I.C. sockets, and right angle sockets for readout. Arranged so that units can be stacked side by side and straight pieces of wire tussled through for power ground and reset. Several different units are available as follows:

- 7490 Basic 10 MHz counter. Used in frequency counters and events.
- 74196 Same as 7490 except presettable 50 MHz unit. Used where higher speed and/or presettable is required.
- 74192 Bi-Directional Counter, 32 MHz operation. Has two input lines, one that makes the unit count up, the other down. Uses include timers, where the counter is preset to a number and counts down to zero, monitoring a sequence of events, i.e. keeping track of people in a room by counting up for entries and down for departures.
- 7475 Adds latch capability. Used in counter so displays continue displaying information while new frequency is being counted for uninterrupted display.
- 7447 Basic decoder module. Drives basic seven segment display which is included for all modules.

NEWEST DCU'S

This DCU combines all of the features of our other counting units, that is, high speed counting, up-down operation, storage, and preset. In addition it includes a comparator and a thumbwheel switch in order to provide comparison and preset capability. With this combination you can do the following:

1. Count up or down at speeds to 33 MegaHertz
2. Store previous count during new MegaHertz
3. Preset to any number, count down (or up) and generate a logic level when count of zero is reached. Stack several units and generate logic level for any count greater than zero.
4. Preset to zero, count up (or down) and generate a logic level for any number greater or equal to the number preset in the thumbwheel switch. Stack several DCU's and generate a logic level showing whether number is greater than, equal to, or less than numbers preset on switches.

- 910 K 7490-7447 Counter \$8.25
- 910 LK 7490-7475-7447 Counter \$9.25
- 911 LK 74196-7475-7447 Counter \$10.25
- 912 K 74192-7447 Counter \$9.25
- 913 K 74192-7475-7447-7485 Universal DCU \$14.50

I.B.M. POWER SUPPLY REGULATOR PARTS

Like-new assembly surplus from the I.B.M. Company contains the following (6) 150-Watt transistors, (6) heat sinks, (6) 1 1/2 5W resistors, 12V, 20 Amp circuit breaker, a 16-ohm 10-Watt resistor, 50-Watt resistor, terminal strip, (2) 16pin P.C. edge connectors for regular cables. An 8000 mfd, 15V computer grade capacitor is also provided. All in a nice mounting looks as if it could be a neat unit to make a lab-type power supply. Unit is sold as an assembly, or in parts. Quantity is limited.

- Sh.Wt. 20 lbs. 18MPSRA \$7.50
 - 3 for \$20.00 18MPSRA \$30.00/3
 - 8 for \$52.00 18MPSRA \$52.00/8
- Heat sinks capable of dissipating 150 watts of power!
- Price \$1.00 ea.
 - Transistors, 2N441 or 2N442 type, TO-36 case \$1.00 ea.
 - Heat sink with transistor \$1.50 ea.
 - 8 for \$5.00/8 \$5.00/8
 - Connectors, 2 for \$1.50 \$15.00/2
 - Capacitor, \$1.50 \$1.50 ea.

HEWLETT PACKARD SOLID STATE NUMERIC INDICATOR



These fantastic L.E.D. indicators have built-in decoder-driver with memory. They use a 4 x 7 dot array for much better readability. They are packaged in a standard Dual-In-Line (DIP) package with built-in contrast filter. Completely D.T.S. TTL compatible. HP part number 50B2-7300 (right hand decimal) HP 50B2 \$9.75

COMPACT 1mW LASER TUBE

Large manufacturer tells his over-stock tubes to us, all guaranteed to be in perfect condition. Most compact 1mW laser tube (TEM) on the market, only 8 1/2" long, uses a special tapered bore design, unique in the industry. Cavity design, internal hemispherical mirror system with coaxial mounting of all elements, maintain beam alignment and power stability under mechanical stress and changes in temperature. SPECIFICATIONS: red laser, 1mW power, TEM, 632.8nm wavelength, 1.10mm beam diameter, 0.35 mrad divergence, linear polarization, sliter 8.5 x 1.75" diameter. These can be useful for alignment systems, measurement systems, and for illumination, etc. In equipment such as levels, transits, rangings, inspection displays, holography, etc. Operation life beyond 10,000 hours. This is not a toy tube, but a laser designed to meet rigid industry standards. List price is over \$200.00 each.

Sh.Wt. 3 lbs. C1mWLT \$97.50

2 for \$180.00 C1mWLT \$180.00/2

10 for \$850.00 C1mWLT \$85.00/10

100 for \$7500.00 C1mWLT \$75.00/100/10

Portable supply - operates from 12 vdc input. Useful for field experiments with laser. Available only with purchase of tube. Price \$25.00

AIRCRAFT AUTO BOAT QUARTZ CRYSTAL CHRONOMETER



Revolutionary! was the reaction of our customers when they saw our latest kit. Measuring only 2 1/2" x 2 1/2" x 2 3/8", and accurate to 1/10 seconds a month, this chronometer promises to entirely replace mechanical clocks in cars, boats and airplanes.

Fits into a standard 2 1/2" instrument panel cutout. The displays are bright L.E.D., displays that should last a lifetime. Setting controls are recessed and operate from a pointed object such as a pencil point or paper clip, in order to keep non-authorized hands off. The clock should only have to be reset at very great intervals, or in the event of power loss (i.e., replacing battery in car). The clock is wired so that the timing circuits are always running, but the displays are only lit when the ignition is on, resulting in negligible power drain. The low power is only possible because of a new one chip CMOS clock. Operates from 10-15 vdc D.C. An accessory unit which mounts on the back adds the unit 59 20 28 volts for twin engine aircraft and larger boats using 24 Volts ignition. Know how disgruntled you are with the usual car clock? Order this fine unit now for rallying, sports events, navigation, or just to have a fine chronometer that will give you a lifetime of superbly accurate time.

- Quartz Chronometer, Kit Form \$69.50
- Quartz Chronometer, Wired \$99.50
- 24 Volt Adapter \$10.00

New Style AUTO/BOAT/PLANE QUARTZ CRYSTAL CHRONOMETER

As you can see from the illustration, we have provided a new enclosure for our most popular kit, the ARIES Model AR-720K Quartz Crystal Chronometer. This enclosure can be mounted in many convenient variations, i.e., over the dashboard, over the center drive tunnel, or under the roof above the windshield.

- Automotive style quartz crystal chronometer \$75.00
 - Same assembled, calibrated, tested \$99.00
- Send in an order and get on our special customer customer Mailing List.

CATALOG: Check reader's card or write:

ALL ITEMS (WHERE WEIGHT IS NOT SPECIFIED) POSTAGE PAID IN THE U.S.A.

CHARGES WELCOME!

Phone in charges to 617 531-5774 or 617 532-2323. BankAmericard - Mastercharge. \$10.00 minimum. No C.O.D.'s please.

B & F ENTERPRISES Mass. 01960
 Phone (617) 531-5774
 Dept E
 119 Foster Street
 Peabody, Mass. 01960

Please send for our 116 page catalog.

CIRCLE NO. 20 ON PAGE 17 OR 103



CALECTRO®

DIGITAL DISPLAYS AND LOGIC

**ATTENTION
HOBBYISTS!**

**BUILD THIS
DIGITAL
COUNTER/ L.E.D.
DISPLAY
KIT.**

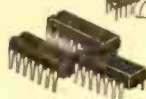

Everything needed to build a complete decade counter (0-9) including a printed circuit board. Operates from a 5 Volt D.C. supply. Can be used in hundreds of applications.

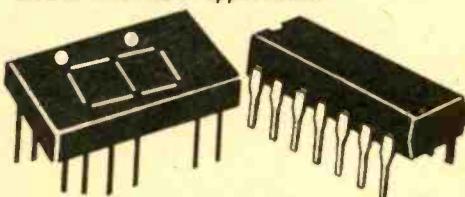

See your nearby CALECTRO distributor for all the most popular digital displays and integrated circuits. Also, get your copy of the new CALECTRO DIGITAL PROJECTS HANDBOOK!



GC ELECTRONICS

Division of Hydrometals, Inc.
Rockford, Illinois 61101 U.S.A.

CIRCLE NO. 5 ON PAGE 17 OR 103

HEY, LOOK ME OVER



a key. It may also be connected to an existing antenna. The F8412 is priced at \$135.95. For more information, circle No. 72 on Reader Service Coupon.

Voltage Indicator

Procon has recently introduced a Voltage Indicator that plugs into any standard wall outlet. It provides an instant warning when the power falls below a safe level for operating household appliances. The attractive unit has



a color coded dial which indicates *Lo*, *Normal*, and *Hi* readings. It can be moved throughout the home or left plugged into one convenient outlet for constant monitoring of incoming power. Two models are available, the *Voltage Guard* for household use at \$7.95 and the *Voltage Monitor* with 1% accuracy for precision applications at \$12.95. Both are post-paid. For information, circle No. 74 on Reader Service Coupon.

Looks and Sounds Good

The *Advent/2*, a new low-cost loudspeaker system designed for high performance-per-dollar, is housed in a molded thermo-set

Science Fair P-Box® Kits have helped launch 1000's of careers in electronics!



ONLY
5⁹⁵



Our IC AM Radio Kit is one good reason why.

Battery powered—use it indoors or out!
Delivers great sound from plug-in
earphone (included). Fun, safe & easy to
build—wire it with or without soldering.
Like each P-Box, it includes instructions
that let you learn as you build, unique
Perfboard chassis, and all parts except
battery.

Other Exciting P-Box Kits

- | | |
|------------------------|-----------------------|
| Light Transceiver | Wireless AM Mike |
| Electronic Organ | Transistor AM Radio |
| Electronic Metronome | One-Tube AM Radio |
| Telephone Amplifier | 2-Transistor FM Radio |
| "Goofy-Lite" Flasher | 3-Transistor SW Radio |
| Voice Controlled Relay | Solar-Power AM Radio |
| Electronic Thermometer | WWV Tuner-Converter |
| Metal Locator | 3-Way Code Oscillator |
| AC/DC Power Supply | "OTL" Audio Amplifier |
| Siren Kit | Light Operated Alarm |
| Photo Night Light | "Heads & Tails" |

Price may vary at individual stores



FREE '74 CATALOG 319
AT YOUR NEARBY STORE OR
MAIL THIS COUPON

180 Pages . . . Full Color! Hi-Fi, CB, Kits,
Recorders, Antennas, Parts, More!

PLEASE
PRINT
CLEARLY

Name _____ Apt. # _____

Street _____

City _____ State _____ ZIP

Science Fair®
at
Radio Shack®
and ALLIED RADIO STORES
A TANDY CORPORATION COMPANY

P.O. Box 1052, Fort Worth, Texas 76107

CIRCLE NO. 32 ON PAGE 17 OR 103

The great new
Super Scanner

It scans 360° in milliseconds with 5.75 dB gain. Or beams an 8.75 dB gain signal where and when you want it—**instantaneously.** (Otherwise, it's just another beautiful  base antenna.)



MODEL MS 118 Super Scanner electronic beam, Incl. control console—~~599.95~~ price, **199.95**



the antenna specialists co.

Division of ORION INDUSTRIES, INC.
12435 Euclid Ave., Cleveland, Ohio 44106
Export: 2200 Shames Dr.,
Westbury, L.I., New York 11590
Canada: A. C. Simmonds & Sons, Ltd.

CIRCLE NO. 21 ON PAGE 17 OR 103

EXPERIMENTER

International. EX Crystal and EX Kits

OX OSCILLATOR
\$2 95



OX OSCILLATOR Crystal controlled transistor type. Lo Kit 3,000 to 19,999 KHz. Hi Kit 20,000 to 60,000 KHz (Specify) **\$2.95**

MX-1 TRANSISTOR RF MIXER A single tuned circuit intended for signal conversion in the 3 to 170 MHz range. Lo kit 3-20 MHz. Hi kit 20-170 MHz. **\$3.50**

SAX-1 TRANSISTOR RF AMP. Amplifier to drive MX-1 mixer. Lo kit 3-20 MHz. Hi kit 20-170 MHz. **\$3.50**

PAX-1 TRANSISTOR RF POWER AMP. A Single tuned output amplifier to follow the OX oscillator. 3,000 to 30,000 KHz **\$3.75**

EX CRYSTAL
\$3 95



EX CRYSTAL Available from 3,000 KHz to 60,000 KHz. Supplied only in HC 6/U holder. Calib. is $\pm 0.2\%$ when operated in International OX circuit or its equivalent. (Specify frequency) **\$3.95**

BAX-1 BROADBAND AMP. May be used as a tuned or untuned amplifier in RF and audio applications 20 Hz to 150 MHz. **\$3.75**



CRYSTAL MFG. CO., INC.
10 NO. LEE • OKLA. CITY, OKLA. 73102
Write for FREE Catalog

CIRCLE NO. 7 ON PAGE 17 OR 103

HEY, LOOK ME OVER

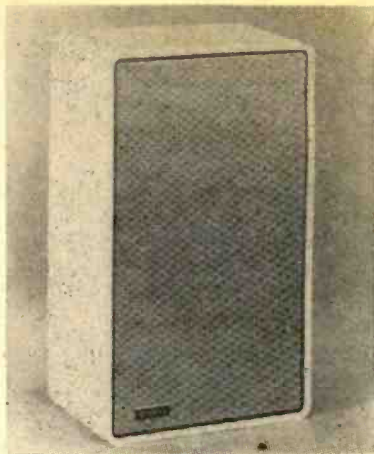

plastic cabinet, uses drivers associated with speakers of twice the cost to produce wider range, higher efficiency, and greater power handling than other systems in its price class. The aim is more fully satisfying sound from lower-cost complete stereo systems than ever before. The system employs an acoustic suspension woofer and two direct radiator tweeters, arranged in an acoustic array that provides maximum dispersion with no interference effects between drivers. System resonance is 58 Hz. The nominal crossover point is 1500 Hz, and the impedance is 8 ohms. Recommended minimum power is 10 watts per channel. The suggested retail price of the Advent/2 is \$58.00. Dimensions are 11½ x 19 x 7¼ in. deep. For more data, circle No. 73 on Reader Service Coupon.

TV Go Around

Saxton Products, Inc., manufacturers of a complete line of antenna rotators, has a new brochure on *All Weather Antenna Rotators*. The new rotators feature "Automatic Com-



mand" for exacting synchronized antenna positioning to pick up normally weak signals or neighboring television transmissions. Each rotator is housed in a high tensile, one piece aluminum alloy, similar to aircraft aluminum and is capable of operating in temperatures ranging from -35°F. to 140°F. Added features include built-in line surge protection, high wind locking system, heavy duty motor and

If you have stereo, you already own half a 4-channel system! Add the 2nd half for 164.95. By Realistic.



Baffle-Speakers With Walnut Finish Enclosures, 28.50 each

INCLUDED
Two 4-Channel Demo Records, Audio Cables, Speaker Wire.
Reg. 15.50.

24-Watt Stereo Amplifier, 69.95

SQ-II Decoder, 39.95

Save 17.45 off our "each" prices for everything you need to move up to true quadraphonic sound!

Your stereo components are ready and waiting for easy updating to 4-channel. Our SQ-II Decoder unscrambles all matrixed 4-channel records, tapes and FM broadcasts and even gives a 4-channel effect to regular stereo. Add it, and our SA-175B Amplifier

plus two deluxe Baffle/Speakers to your system, and hear sound from front and rear, left and right—the way you hear actual "live" music. Simple hookup, no internal rewiring. Get a demonstration at any of 2000 Radio Shack stores in all 50 states!

We're near you, wherever you are—see your phone book.

FREE! '74 CATALOG 321
AT YOUR NEARBY STORE OR MAIL THIS COUPON
 180 Pages . . . Full Color! Hi-Fi, CB, Kits, Recorders, Antennas, Parts, More!
 PLEASE PRINT CLEARLY
 Name _____ Apt. # _____
 Street _____
 City _____ State _____ ZIP _____

REALISTIC[®]
 at
Radio Shack[®]
 and ALLIED RADIO STORES
 A TANDY CORPORATION COMPANY
 P. O. Box 1052, Fort Worth, Texas 76107
 Prices may vary at individual stores.

CIRCLE NO. 32 ON PAGE 17 OR 103

EXAMINE ANY TAB BOOK ON 10-DAY FREE TRIAL!

BRAND-NEW BOOKS...JUST PUBLISHED

- Cassette Tape Recorders—204 pps.—over 160 ill.—\$4.95
- Miniature Proj. or Ext. Hobbysts—168 p., ill.—\$3.95
- Experimenting With Electronic Music—180 pps., 103 ill.—\$4.95
- Electrical Wiring & Lighting for Home/Office—204 pps.—\$4.95
- FM Stereo/Quad Receiver Servicing Man.—192 p., 120 ill.—\$4.95
- Electronic Measurements Simplified—252 pps., ill.—\$4.95
- Solid-State Circuits Guidebook—252 pps., 177 ill.—\$5.95
- 10-Min Test Techniques For PC Svcng.—216 pps., 114 ill.—\$4.95
- TV Bench Servicing Techniques—228 pps., 177 ill.—\$4.95
- How To Be A Ham—Incl Latest FCC Rules—192 p., 34 ill.—\$3.95
- 125 Typical Elect. Cir. Analyzed & Repaired—208 pps.—\$4.95
- Handbook of Semiconductor Circuits—448 pps.—\$5.95
- Everyman's Guide to Auto Maintenance—192 p., ill.—\$4.95
- Introduction to Medical Electronics—272 pps., 128 ill.—\$6.95
- N.A.T.V. Systems Handbook—76 pps., 91 ill.—\$4.95
- Landsajille from RC Models to the Big Ones—171 p.—\$4.95
- Trblshg. Solid-State Wave Gen./Shaping Cir.—192 p.—\$4.95

A UNIQUE CONCEPT IN KITS—TAB ELECTRONIC BOOK KITS

For the price of a kit alone, you get an appropriate projects book—PLUS a complete kit to help you start building and learning. Guaranteed to work!

- Audio Mixer, \$7.95 5-Watt Hi-Fi Amplifier, \$9.95 Electronic Fortune Teller, \$4.95 AM Wireless Mike, \$6.95 Electronic Touch Switch, \$6.95 Garage Light Control, \$9.95 Audio Signal Generator/Injector, \$5.95 Low-Voltage DC Power Supply, \$4.95 Diode Tester, \$3.95 High Power Lamp Dimmer, \$4.95 20W Four-Channel "Quad" Amplifier, \$19.95 Electronic Siren, \$4.95 Intrusion Alarm, \$7.95 Tunable Electronic Organ, \$9.95

BEST SELLERS...INVALUABLE TO ALL IN ELECTRONICS

- Pictorial Guide to CB Rad. Inst. & Rep.—256 p., ill.—\$4.95
- Understanding & Using the VOM & EVM—192 p., ill.—\$4.95
- Mobile Radio Handbook—192 pps., 203 ill.—\$4.95
- Pictorial Guide to Tape Recorder Repairs—256 pps., ill.—\$4.95
- Acoustic Techniques for Home & Studio—208 p., ill.—\$4.95
- Understanding & Using the Oscilloscope—256 p., ill.—\$4.95
- Basic Audio Systems—272 pps., 203 ill.—\$4.95
- The Complete Mini-Bike Handbook—320 pps., 143 ill.—\$5.95
- Pictorial Guide to Color TV Circ. Troubles—256 pps.—\$4.95
- Simplified TV Trouble Diagnosis—320 pps., 229 ill.—\$5.95
- Dictionary of Electronics—420 pps., 467 ill.—\$3.95
- Marine Electronics Handbook—192 pps., 121 ill.—\$4.95
- FM Repeater Circuits Manual—305 pps., 182 ill.—\$5.95
- Basic Electronic Circuits Simplified—352 pps., 170 ill.—\$5.95
- How to Read Electronic Circuit Diagrams—192 p., ill.—\$3.95
- 4-Channel Stereo—From Source to Sound—178 p., ill.—\$3.95
- Basic Electronic Test Procedures—416 pps., 178 ill.—\$6.95
- Basic Math Course for Electronics—192 pps., ill.—\$4.95
- Basic Electricity & Beginning Electronics—256 pps.—\$4.95
- Computer Technician's Handbook—480 pps., 400 ill.—\$7.95
- Small Appliance Repair Guide—224 pps., 400 ill.—\$4.95
- How to Repair Small Gas Engines—256 pps., ill.—\$4.95
- CATV Systems Engr.—3rd Ed.—256 pps., ill.—\$12.95
- Electric Motor Test & Repair—160 pps.—hardback—\$6.95
- Model Car Racing by Radio Control—224 p., ill.—\$3.95
- How to Build Solid-State Audio Circuits—320 pps., ill.—\$5.95
- RTTY Handbook—320 pps., 230 ill.—\$5.95
- Des. & Maint. CATV & Small TV Studio—256 p.—HB—\$12.95
- How to Become a Radio Disc Jockey—256 pps.—HB—\$7.95
- IC Proj. for Amateur & Experimenter—192 p., 105 ill.—\$4.95
- Stereo Quads & Projects—192 p., ill.—\$4.95
- Electronic Musical Instruments—192 pps., 121 ill.—\$4.95
- VHF Proj. for Amateur & Experimenter—224 p., ill.—\$4.95
- Pulse & Switching Circuits—256 pps., 184 ill.—\$4.95
- Using Electronic Testers for Auto Tune-up—256 pps.—\$4.95
- Digital Electr.: Prin's & Practice—288 p., 191 ill.—\$5.95
- Servicing Electronic Organs—196 pps.—hardback—\$7.95
- Basic TV Course—224 pps., 128 ill.—\$5.95
- Beginner's Guide to Computer Program's—480 p., ill.—\$6.95
- How to Repair Home & Auto Air Conditioners—208 pps.—\$4.95
- Basic Color Television Course—420 pps., 300 ill.—\$6.95
- Fire & Theft Security Systems—176 pps., over 100 ill.—\$4.95
- CB Radio Operator's Guide—224 pps., ill.—\$3.95
- How to Repair Solid-State Imports—184 pps., ill.—\$4.95
- New IC FET Prin's. & Projects—160 p., 60 ill.—\$3.95
- Basic Electronics Course—384 pps., 275 ill.—\$5.95
- A.M. Radio Novice-Class Lic. Study Guide—180 p.—\$3.95
- 64 Hobby Projects for Home & Car—192 pps., 159 ill.—\$3.95
- How to Test Almost Everything Electronic—160 p., ill.—\$3.95
- Radio Control Handbook—3rd Ed.—320 pps., 238 ill.—\$6.95
- Basic Radio Course—224 pps., ill.—\$4.95
- Designing & Building Hi-Fi Furniture—224 pps., ill.—\$4.95
- Electronic Hobbysts Handbook—160 pps., 124 ill.—\$2.95

ALL-IN-ONE COLOR & B&W TV SCHEMATIC/SERVICING MANUALS

Each volume contains complete service data, including full-size schematic diagrams, and all other info needed. Each 8 1/2 x 11", 196-212 pps.: COLOR TV: Adm. Vol. 1 Vol. 2 G-E Vol. 1 Jan. Vol. 1 Vol. 2 Vol. 3 Magnavox Vol. 1 Vol. 2 Motorola Vol. 1 Vol. 2 Philco RCA Vol. 1 Vol. 2 Syl. Vol. 1 Vol. 2 Zenith Vol. 1 Vol. 2 Vol. 3 Serv. Modular Rec'v. Vol. 1 Vol. 2 B & W TV: Adm. G-E Japanese Magnavox Motorola Philco RCA Sylvania Zenith

SEE THESE HELPFUL BOOKS AT YOUR PARTS DISTRIBUTORS', OR CLIP THIS AD AND order on FREE 10-DAY Trial, or attach payment and save postage. Fully guaranteed or money back! Pa. add 6% tax. Foreign 10% (EE-14)

TAB BOOKS

BLUE RIDGE SUMMIT, PA. 17214

CIRCLE NO. 23 ON PAGE 17 OR 103

HEY, LOOK ME OVER

long life self lubricating gears. Rotators are available with automatic or semi-automatic indoor controls to govern antenna positioning. For further information, circle No. 91 on Reader Service Coupon.

Quiet Please

Here is a unique remote control telephone device which will disconnect *only* the bell on any extension telephone to combat late night and early morning crank calls. Made by Saxton, the Silent-Knight was conceived to bring

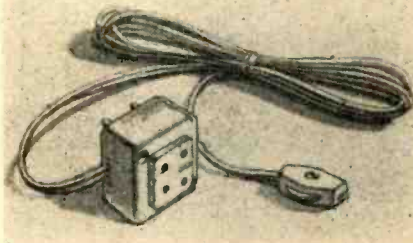

peace and restful sleep back to the telephone user's control. The Silent-Knight has a remote control on/off switch which can be conveniently operated from edge of bed, recliner, or night table. Switch on during daylight to hear the telephone ring. Switch off at bedtime or for afternoon nap. In the off position, the Silent-Knight will not otherwise affect outgoing calls or any other telephones in the house. Heart of the unit is Saxton's exclusive "Jack-In-A-Plug," which fits between the telephone wall jack and the extension telephone. Complete instructions accompany each unit. For further information, circle No. 69 on Reader Service Coupon.

Dual FET VOM

VTVM accuracy as well as battery-operated portability are among the principal features of the new solid state model LV-71 FET Volt/Ohm meter made by Leader Instruments



Build yourself a better car!

Build an Archerkit™ from Radio Shack



"After an hour or so of driving we noted that the engine was acting the way it did two years and 20,000 miles ago... a definite improvement in performance. Acceleration, specifically, was much improved." Popular Electronics, May, '73

Radio Shack's Deluxe Capacitive Discharge Ignition puts more "Go" in every gallon! It delivers 50% more spark power for faster acceleration and more complete combustion. That means you get better gas mileage, and your points and plugs will last 3 to 10 times longer. An in/out button lets you make instant performance comparisons with your old ignition. And it makes tuneups easier. The thorough step-by-step manual makes it easy for even a first-time kit builder to assemble and install—no wires to cut. Improves any 12-volt negative ground vehicle. #28-3203.

Deluxe, High-Intensity Timing Light Kit



Tune-up aid for any engine. For full power & economy. Bright flash is visible even in daylight! #28-4016.

1995 With All Cables

Retail prices may vary at individual stores.



FREE '74 CATALOG 320
**AT YOUR NEARBY STORE OR
MAIL THIS COUPON**

180 Pages . . . Full Color! Hi-Fi, CB, Kits,
Recorders, Antennas, Parts, More!

PLEASE PRINT CLEARLY

Name _____ Apt. # _____
Street _____
City _____ State _____ ZIP _____

ArcherKit

by

Radio Shack®

and ALLIED RADIO STORES
A TANDY CORPORATION COMPANY
P. O. Box 1052, Fort Worth, Texas 76107

FREE!

LAFAYETTE 1974 CATALOG 740



Ready
Now!

The World's Largest Consumer Electronics Catalog

Everything in Electronics for
Home, Business, Industry

• Stereo/Hi-Fi Components • Musical Instruments and Amplifiers • CB & Ham Equipment • Tools and Test Equipment • Police and Fire Monitor Receivers • Public Address Systems • Photography Equipment • Semiconductors, Books, Parts • Plus Much More!

Your Complete Electronics Buying Guide

Send
Today!

Lafayette Radio Electronics
P.O. Box 10, Dept. 25014
Syosset, L.I., N.Y. 11791

Send FREE 1974 Catalog 25014

NAME _____

ADDRESS _____

CITY _____

STATE _____

ZIP _____

CIRCLE NO. 8 ON PAGE 17 OR 103

HEY, LOOK ME OVER

Corp. The LV-71 offers a wide range of operational conveniences and features dual FET (differential) amplifier circuitry in addition to a polarity reversal switch, battery condition switch, and diode overload meter protection. DC impedance is 10 Megohms, with AC impedance to 1 Megohm. There is a zero center scale on a large 4½-in. meter with taut band construction. Other features include 12 voltage ranges DC, 7 steps, from as low as 0.3 full scale to 1200V; and AC, 5 steps, to 600V. DC current is from 0.3 mA full scale to 300 mA. Resistance is in 4 steps from R X 1 Ohm to R X 1 Megohm. Dual Scale output readings are from -20 to +17 dB; +15 to +31 dB. Price is \$64.95. For more information on the LV-71 and other Leader products, circle No. 68 on Reader Service Coupon.

Multimeter Kit

A new 3½ digit multimeter kit has been introduced by Nobex Electronics. The result of intensive research, development, engineering and testing, the new instrument contains



many innovative features. One of these innovations is apparent when the box is opened. The exclusive package has been engineered so that all components are in separate tray compartments according to assembly sequence. Thus, building procedure is simplified and the kit is self-contained at all times through completion. Accuracy of 0.5% is assured by oven control making the Nobex multimeter as reliable as many high priced industrial instruments. Full details and specifications are contained in a color brochure available from the manufacturer. To get your copy, circle No. 71 on Reader Service Coupon.

Big Stick

Channel Master has introduced a new telescoping antenna mast constructed of its extra-strength "Golden Duratube" special process steel. The product also features new Contour Guy Rings whose unusual type of construction eliminates sharp, wire-fraying edges. Previously available only in straight 5

(Continued on page 97)

ELEMENTARY ELECTRONICS

READER SERVICE PAGE

• The Editor of ELEMENTARY ELECTRONICS offers readers an easy way to get additional information about products and services advertised in this issue. Also, if you would like more information about any new product mentioned in our column "Hey, Look Me Over," it's yours for the asking. Just follow the instructions below and the material you requested will be sent to you promptly and at no cost.

• The coupon below is designed for your convenience. Just circle the numbers that appear next to the advertisement or editorial mention that interests you. Then, carefully print your name and address on the coupon. Cut out the coupon and mail to ELEMENTARY ELECTRONICS, Box 886, Ansonia Station, New York, N.Y. 10023. Do it today!

JANUARY/FEBRUARY 1974

Void after JUNE 30, 1974

ELEMENTARY ELECTRONICS

Box 886, Ansonia Station, New York, N.Y. 10023

Please send literature for the numbers I have circled. I understand this is a free service and I am limited to 12 circled numbers.

1	2	3	4	5	6	7	8	9	10	11	12	13
14	15	16	17	18	19	20	21	22	23	24	25	26
27	28	29	30	31	32	33	34	35	36	37	38	39
40	41	42	43	44	45	46	47	48	49	50	51	52
53	54	55	56	57	58	59	60	61	62	63	64	65
66	67	68	69	70	71	72	73	74	75	76	77	78
79	80	81	82	83	84	85	86	87	88	89	90	91

Are you a subscriber to this magazine? Yes No

Do you now own Police/Fire/Aero receiver(s)? 92 Yes 93 No

If your answer is yes, please check appropriate box:

94 Mobile 95 Base 96 Portable 97 Used in your work

Name (Print Clearly) _____

Address _____

City _____

State _____

Zip Code _____

NOW you can train at home building a NEW 25" DIAGONAL Solid State Color TV engineered by NRI for learning and trouble-shooting

So much better for learning TV servicing than any hobby kit, because NRI designed and created it as an educational tool.

Unlike hobby kits which are designed for creating a TV set as the end product, NRI built its exclusive 25" Diagonal Solid State Color TV kit as a real training kit. You can introduce and correct defects . . . for trouble-shooting and hands-on experience in circuitry and servicing. The kits include a wide-band oscilloscope, color bar crosshatch generator, transistorized volt-ohmmeter and other valuable equipment that can soon have you earning \$5 to \$7 an hour servicing color sets in your spare time.

Handsome woodgrain cabinet, at no extra cost. (Offered only by NRI)

New square-cornered Sylvania picture tube

100% solid state chassis

6-position detented UHF channel selector



Modular construction with plug-in circuit boards

Automatic degaussing

Automatic fine tuning

Automatic tint control

Automatic color control

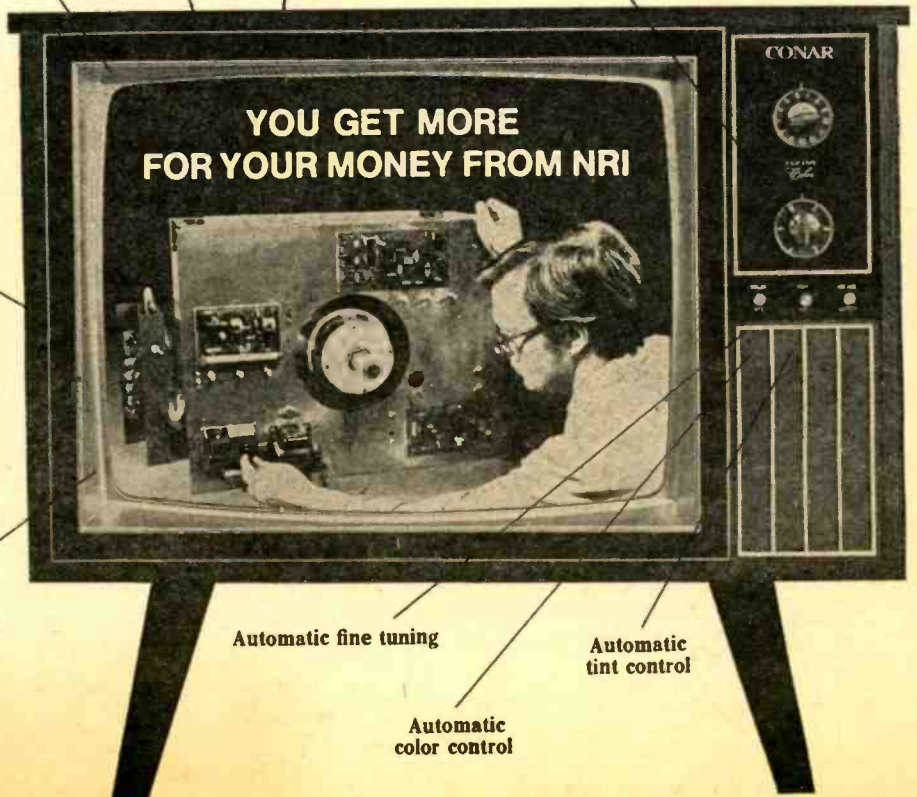

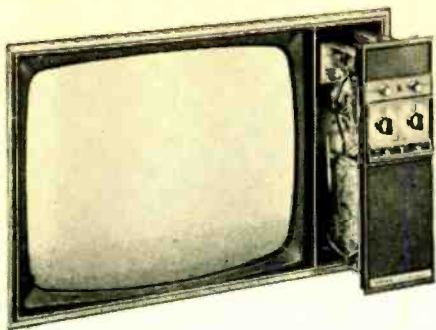

Practice on a new 25" MOTOROLA QUASAR II® chassis.

TV Servicing is a satisfying career... and the pay is great. Qualified men are needed now to maintain the 93 million sets in U.S. homes. And prospects for the future are even brighter.

Now... here's an opportunity for you to prove to yourself that you can learn TV Servicing... at home, in your spare time. ICS, the world's most experienced home-study school, will send you a **FREE** Demonstration Lesson (complete with sample questions) if you will merely fill out the coupon below and mail it to us.

In addition to your free demonstration lesson, we'll send you... also **FREE**... a brochure that describes the 25" (diagonally measured screen) MOTOROLA QUASAR II® Color TV chassis that we include in our TV Service Training Program.

This chassis with automatic fine tuning control is ideal for training purposes because it combines solid state devices with vacuum tubes to give you both kinds of practical experience. All parts carry Motorola's two year replacement guarantee!

The QUASAR II chassis comes to you in three basic sub-assemblies... **NOT AS A KIT**... because we want you to learn how to *repair* TV sets, not build them.

Our free literature also describes the fully assembled test equipment you receive such as the Deluxe 5" Solid State Oscilloscope, the tools and the learn-by-doing kits, all of the finest quality.

And we're going to tell you about eight other career opportunities in Electronics and the ICS Career Programs that can help prepare you for them.

All you've got to do is mail the attached postpaid card or coupon—today!

ICS

International Correspondence Schools
Since 1890
School of Electronics
Scranton, Pa. 18515

Approved for Veterans' Training. Eligible Institution under the Guaranteed Student Loan Program. Accredited Member National Home Study Council. Canadian residents use coupon address for service from ICS Canadian, Ltd. In Hawaii: 931 University Ave., Honolulu, Hawaii 96814

ICS School of Electronics International Correspondence Schools Scranton, Pa. 18515

YES, I want you to mail to me without obligation, the **FREE** DEMONSTRATION LESSON and complete literature on the career program checked below. (Please check one.)

- | | |
|--|--|
| <input type="checkbox"/> Color TV Servicing & Repair | <input type="checkbox"/> FCC Licensing |
| <input type="checkbox"/> Computer Maintenance | <input type="checkbox"/> Communications/
Broadcasting |
| <input type="checkbox"/> CATV/MATV Technician | <input type="checkbox"/> Hi-Fi Sound Systems |
| <input type="checkbox"/> Telephony | <input type="checkbox"/> Industrial Electronics |
| <input type="checkbox"/> Electrician | |

AA674Q

Name _____ Age _____

Address _____

City _____

State _____ Zip _____

EVEN IF THEY NEVER SEE YOUR SLEEK NEW COBRA 135, THEY'LL KNOW YOU HAVE THE BEST.



They'll know by listening. Because you'll send with all the power allowed—15 watts P.E.P. input. Plus the extra authority of 100% modulation with Dynabooast speech compression.

You'll transmit on 23 AM and 46 SSB modes. Two separate transmitters give you the best of each, with overload protection.

Your own ears will confirm what we say. This Cobra has the crispest, cleanest

sound ever. Over 60 dB cross modulation interference rejection completely eliminates bleedover.

Cobra's drift-free Voice Lock lets you locate and lock-in sideband signals over a wide range. Three filters—one crystal, two ceramic—keep adjacent channels under wraps.

And Cobra's noise blanker really punches holes in noise, both AM and SSB.

The control console has everything. Adjustable AM/SSB RF gain control. Backlit RF output/SWR/S meter. 24-hour digital-leaf clock. Illuminated mode selector. And full-function controls.

Both talking and listening, it's the first base station to combine all the features you want in one package. And as for looks—wow!

Ask your CB dealer to show you the best. Cobra 135.

COBRA 135

AM/SSB

\$450⁰⁰

microphone included

Product of Dynascan Corporation, 1801 West Belle Plaine Avenue, Chicago, Illinois 60613

CIRCLE NO. 29 ON PAGE 17 OR 103

NRI FIRSTS make learning Electronics fast and fascinating—to give you priceless confidence

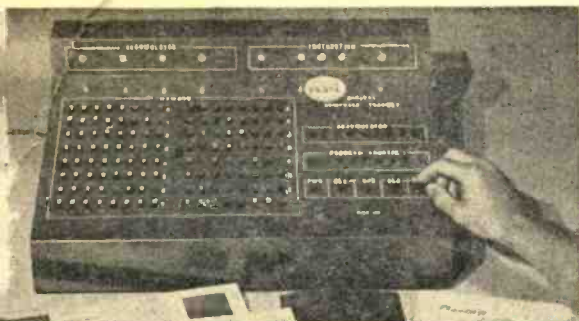

FIRST to give you a complete programmable digital computer, with memory, you build yourself... to learn organization, operation, trouble-shooting and programming. This remarkable computer is one of ten training kits you receive with the new NRI Complete Computer Electronics Course.

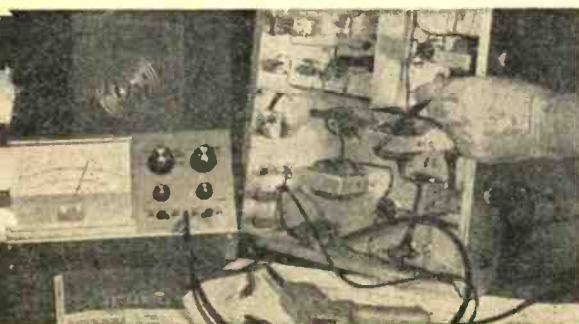

FIRST to give you true-to-life experiences as a Communications Technician. Every fascinating step you take in NRI Communications training, including circuit analysis of your own 15-watt, phone/cw transmitter, is engineered to help you prove theory and later apply it on the job. Studio equipment operation and trouble shooting become a matter of easily remembered logic.



FIRST to give you completely specialized training kits engineered for business, industrial and military Electronics Technology. Shown is your own training center in solid-state motor control and analog computer servo-mechanisms. Telemetering circuits, solid-state multivibrators and the latest types of integrated circuits are included in your course.

The NRI color TV and digital computer kits are the latest in a long line of "firsts" for NRI. For more than fifty years, NRI has been providing unique 3-dimensional home-study training that has helped hundreds of thousands of students reach their goals quickly and easily.

What NRI provides is a combination of kits and bite-size texts that give you hands-on experience while you are learning. The texts average only 40 pages each, and they are fully illustrated. You are taken step-by-step from the first stages into the more advanced theory and techniques... with an expert instructor ready at all times to provide valuable guidance and personal attention. (The level of personal attention provided is more than you would receive in many classrooms.) Once you've grasped the fundamentals, you move with confidence and enthusiasm into new discoveries in the fascinating world of electronics.

You start out with NRI's exclusive Achievement Kit, containing everything you need to get moving fast. Lessons have been specifically written so that experiments build upon one another like stepping stones. You can perform a hundred experiments, build hundreds of circuits... as you learn to use the professional test equipment provided, building radios and TV sets, transmitter or computer circuits. It's the priceless "third dimension" in NRI training... practical experience.

Train with the leader—NRI

Compare training kits, texts, techniques and overall training... and you'll find that you get more for your money from NRI. Whatever your reason for wanting more knowledge of Electronics, NRI has an instruction plan that will meet your needs. Choose from major programs in Advanced Color TV Servicing, Complete Computer Electronics, Industrial Electronics and the other special courses designed to meet specific needs. With NRI home training, you can learn new skills while you're still working at your present job... and turn yourself into the man in demand.

GET FACTS ABOUT GI BILL

If you have served since January 31, 1955, or are in service now, check GI line on postage-free card.

Send for free NRI catalog

MAIL THE POSTAGE-FREE CARD FOR THE FREE NRI CATALOG IN THE FIELD OF YOUR CHOICE. YOU WILL BE UNDER NO OBLIGATION. NO SALESMAN WILL CALL.

If the card has been used, write direct to:



NRI TRAINING
3939 Wisconsin Ave.
Washington, D.C. 20016



SCIENCE · OPTICS · ELECTRONICS
UNUSUAL & HARD BARGAINS
 NEW PRODUCTS · NEW MATERIALS · NEW METHODS

KNOW YOUR ALPHA FROM THETA!



For greater relaxation, concentration, listen to your Alpha-Theta brainwaves. Ultra-sensitive electrode headband clips on/off in seconds—eliminates need for messy creams, etc. Attach to amplifier, filters brainwaves, signals beep for ea. Alpha or Theta wave passed. Monitoring button simulates Alpha sound; audio & visual (L.E.D.) feedback. Reliable, easy-to-use, unit—comparable to costlier models. Completely safe. Comprehensive instruction booklet. No. 1635EK (8x3x4", 24 oz.)

No. 71809EK... Low Cost "Starter" Unit \$124.50 Ppd.
 \$49.95 Ppd.

ELECTRONIC DIGITAL COMPUTER KIT!



Solve problems, play games, predict weather with this actual working model of giant electronic brains. Amazing new fun way to learn all about computer programming... logic, decimal, binary systems. Laws of Sets—even do your own programming after completing simplified 116 page instructive booklet. Includes step-by-step assembly diagrams. Circuits easily changed. Read-out from illuminated control panel. Req. 2 "D" batt. (not incl.). Best model we've seen—for home, school, industry. No. 71434EK... (11"x12 1/4"x4") \$31.50 Ppd.

130 EXPERIMENTS IN OPTICS



and photography! Optix® Experiments Kit is a complete opt. & photography lab for 130 exciting experiments. Lets you recreate the periscope, telescope, microscope, kaleidoscope! Build a 35mm reflex camera with interchangeable lens system! Make, develop photographic film! Enjoy the fun and fascination of having your own optics lab. Fully illustr. 112-pg manual. 8 1/2"x11", clearly explains usage of this stimulating kit's 114 precision engineered components. Stock No. 71648EK \$22.50 Ppd.

ELECTRONIC DIGITAL STOPWATCH



Most precise, error-free timer ever! Obsolesces mechanical stopwatches. Not only clocks to 1/100 sec. w/instr. big bright readout, but times unlimited no. of intervals while clocking overall event. Time 2 or more participants simultaneously! Solid state, unchangeable accuracy (± 0.001%) w/6 running digits always shown clearly under any conditions; quartz crystal gives lifetime reliability. Incl. 4 "C" batts., leather case (\$12.50 val.). 2-yr. war. warranty. Stock No. 1645EK (16-oz.) \$195.00 Ppd.

3-CHANNEL COLOR ORGAN KIT



Easy to build low-cost kit needs no technical knowledge. Completed unit has 3 bands of audio frequencies to modulate 3 independent strings of colored lamps (i.e. "lows", reds, "middles", greens, "highs", blues. Just connect hi-fi, radio, power lamp, etc. & plug ea. lamp string into own channel (max. 300w ea.). Kit features 3 neon indicators, color intensity controls, controlled individ. SCR circuits; isolation transformer; custom plastic housing; instr. Stock No. 41831K \$17.50 Ppd.

MAIL COUPON FOR GIANT FREE CATALOG!

164 PAGES • MORE THAN
4,500 UNUSUAL BARGAINS

Completely new edition. Dozens of electrical and electro-magnetic parts, accessories. Enormous selection of astronomical Telescopes, Microscopes, Binoculars, Magnifiers, Magnets, Lasers, Lenses, Prisms, ecological and unique lighting items. Many war surplus items for hobbyists, experimenters workshop, factory.

EDMUND SCIENTIFIC CO. Barrington, N.J. 08007
 PLEASE SEND FREE CATALOG "EK"

NAME _____
 ADDRESS _____
 CITY _____ STATE _____ ZIP _____

EDMUND SCIENTIFIC CO. 300 EDCORP BLDG.
 BARRINGTON, NEW JERSEY 08007
 ORDER BY STOCK NUMBER - SEND CHECK OR MONEY ORDER - MONEY-BACK GUARANTEE

CIRCLE NO. 19 ON PAGE 17 OR 103

DX central reporting

A world of SWL info!

BY DON JENSEN

□ Ever DX a blimp? Well, it's possible when you tune the VHF (very high frequency) aeronautical band.

Sure, like other aircraft flying the friendly skies over the U.S., Goodyear's gasbag, the "Mayflower," makes use of those rarified frequencies up around 118 to 132 MHz. In the case of the "Mayflower," it has been heard, using the call N1A, on a frequency of 120.5 Mhz.

You may not hear these blimp broadcasts when you dial the domestic aero frequencies, but you're bound to hear plenty of other airborne action. Commercial jet aircraft, corporate planes and private Sunday afternoon pilots all can be heard in this VHF range of frequencies. And it can make fascinating listening.

First, we must point out that VHF frequencies can't be tuned on your ordinary shortwave receiver, whose coverage ends at about 30 MHz. But there are some inexpensive transistorized receivers and some more costly rigs that will let you tune in on the jet set. Or perhaps you can construct your own converter. Aero VHF DX use AM, not FM, as do other VHF public service communicators.

If you live near a major airport you'll find plenty of aero action as planes take off and land. But with aircraft flying at 20 to 40 thousand feet these days, you may be able to hear planes several hundred or more miles away.

Major airports are hubs of activity for aero band listeners, since most have perhaps a half dozen different frequencies in use at one time. There are approach control, departure control, and ground taxing channels. Some use different frequencies depending on which direction—north, south, east or west—the plane is arriving or departing from.

Commercial jetliners usually identify by the name of the airline and flight number, such as Eastern 925, National 117. A few have their own special flight designations. Pan Am calls its flights "Clippers"; e.g. Clipper 74. Canadian Pacific uses "Empress" to identify its flights. And British Overseas Airways has its "Speedbirds." Private planes, from single-seater jobs to executive jets, use aircraft identification num-

bers, usually a six digit-letter combination beginning with the letter "N".

Most of the aeronautical transmissions are heard in the 118 to 132 MHz range, but you may find signals as low as 108 MHz and as high as 136 MHz. One of the frequencies used by New York's Kennedy International Airport is 115.40. Regular weather broadcasts by the FAA from New York, and by Canadian authorities, from Gander Newfoundland, can be heard on 132.72 MHz.

For the DXer who wants to listen to aeronautical transmissions, but isn't ready to invest in even a cheapie VHF receiver, overseas flights use shortwave frequencies you can monitor on any SW radio.

Here are some of the many shortwave frequencies you can try: 4650-4750; 5450-5730; 6525-6765; 8815-9040; 11175-11400; and 13200-13360 kHz.

Tip Topper. We had favorable reactions when we spotlighted the stations in an entire country, the Dominican Republic, a few months back. So let's do it again, taking a bird's-eye view of another small Latin American nation, Guatemala.

For beginning DXers, your best bet for logging Guatemala may be TGNA, a religious station, also known as *Radio Cultural*, in Guatemala City. The reason? TGNA has a full hour of English programs nightly, from 0300 to 0400

GMT. If you're nervous about tackling the Spanish language stations, try this one on 5950 kHz. TGNA recently activated another transmitter on 3300 kHz, but it's a bit tough to hear.

Though programs are in Spanish, chances are you'll get better signals from the government radio outlet in Guatemala City, TGW, *La Voz de Guatemala*, broadcasting on 6180 kHz. A good tipoff to this, and other Guatemalan stations, is the lovely marimba music so typical of the country.

Less often heard, but still not too tough for the more experienced Latin American DXer, are two Guatemalans that operate in the 90 meter band. One is TGVN, *La Voz de Nahuala*, another religious station which transmits on 3360 kHz. It is located in the town of Nahuala in Guatemala's Solola Department.

Just 20 kHz up the band on 3380 kHz, is another station whose programs run toward the educational and informational, geared to the country's Indian population. It is TGCH, *Escuelas Radiofonicas*, located in the town of Jocotan.

Bandsweep. Times in GMT, frequencies in kHz 3200—Ok exotica lovers if you dig the top ten on the Chinese hit parade try for the *Fukien Front Station*, the voice of Mainland China's People's Liberation Army . . . 3400—And if you don't find this Chinese outlet on 3200, try this channel about local dawn during

avanti's Astroplane gives CBers Performance to brag about.

The unique construction features are exceptional.

4:46 db gain over isotropic is, and provides, a stronger transmit and a stronger receive.

To make use of the better signal, the Astroplane radiates the signal from higher up than other CB antennas and at a better angle. According to Dr. Alva Todd of the Midwest College of Engineering, "It possesses an unusually low angle of maximum radiation." This low angle of radiation means that your power is radiated at the horizon and not up into the clouds.

You'll also get long lasting, trouble-free performance because it is compact in design—without long drooping radials, without coils to burn or

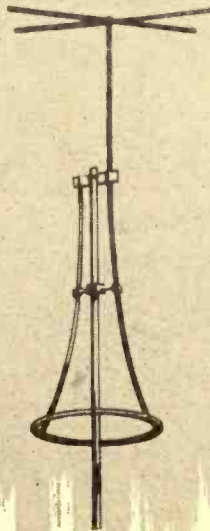

short out, and with direct ground construction for positive lightning protection and static dissipation.

\$29.95 Sugg. Retail

Gain 4.46 over isotropic

Power Capacity 2KW

Lightning protection D.C. Ground

V.S.W.R. 1.2:1

Length 12 Ft.

Diameter 30 In.

Free 16 page color catalog

Write: Avanti R & D, Inc.

35 W. Fullerton

Addison, Illinois 60101

avanti

RESEARCH AND DEVELOPMENT, INC.

creator's of the
famous

MOONRAKER

CIRCLE NO. 27 ON PAGE 17 OR 103

free
1974 Olson
240 big page
catalog



93
FAMOUS
BRANDS!
240
BIG PAGES!
MANY
IN FULL
COLOR!

SAVE on the NEWEST
and BEST in famous-
name product lines . .

A superstore of electronics at your fingertips
 • Stereo/4-Channel Sound Systems • Tape Recorders and Accessories • Radios • Phonos • Kits • Amateur and Shortwave Gear • Citizens Band • Antennas • Police/Fire VHF-UHF Radios • Electronic Calculators and Timepieces • Security • Test Equipment • 1000's of Parts, Tubes, Batteries, Wire, Hardware

Exclusive TELEDYNE and OLSON Audio Products

mail this coupon today



Olson Electronics Dept. TQ
 260 S. Forge St., Akron, Ohio 44327

Send me my **FREE** 1974 Olson Catalog

Name _____ Apt. _____

Street _____

City _____ State _____ Zip _____

Send a Catalog to my friend

Name _____ Apt. _____

Street _____

City _____ State _____ Zip _____

CIRCLE NO. 10 ON PAGE 17 OR 103

DX CENTRAL REPORTING

the winter . . . 4832—Costa Rica's *Radio Capital* is one of the loudest Latin Americans on the band during the evening hours. Though in Spanish, its clear signal makes picking out the "kah-pea-TAHL" ID easy . . . 5960—*The Northern Service* of the Canadian Broadcasting Corporation is directed daily to Canada's Arctic lands. It can be heard most every evening in English, French, and get this, Eskimo . . . 5970—Having trouble logging Peru? Mike Hardester of California reports hearing his first station in this Andean country, *Radio El Sol*, OBX4Q, in Spanish about 0500 . . . 7220—*Radio Budapest*, Hungary is one of a number of East European broadcasters that direct programs in English to North America each day. You can hear this one on this frequency at 0300 . . . 9590—One of the more difficult Central American lands to DX on shortwave is Nicaragua. A tough shot, admittedly, but why not try for *Radio Mar*, YNTP, at Puerto Cabezas. It is sometimes heard with popular Latin American music around 1300 to 1500 . . . 11710—In Spanish its *Radiodiffusion Argentina al Exterior* but when the station announces in English about 2300, the ID is *Argentina National Radio*. The location, naturally, is Buenos Aires . . . 11890—ETLF, the *Radio Voice of the Gospel*, at Addis Ababa, Ethiopia has been putting in solid signals lately on this channel. Look for this station, transmitting in English, around 0530 . . . 15165—Perhaps the most popular shortwave station in Europe a decade or so ago was *Radio Denmark*. But Denmark, unlike its tiny neighbor, Holland, no longer seems very interested in reaching a worldwide, English-speaking shortwave audience. Still, Denmark's radio can be heard with at least an English language identification at 1815. (Credits: Bob Zilmer, Wisconsin; Bill Flynn, California; Bill Cleveland, California; David Witkins, Illinois; SPEEDX P.O. Box 321, Santa Ana, California 92702)

Backtalk. "My biggest thrill in Dxing," writes Ron Fox of North Augusta, South Carolina, "was receiving a QSL from WAOTBU Aeronautical Mobile, a ham station aboard a U.S. Coast Guard Lockheed C-130. It was flying 340 knots at 28,000 feet, between Wake Island and Guam, when I heard it in the 10 meter band on my DX-150."

A nice catch, indeed, Ron.

From Norwalk, California, Emilio De La Vina writes: "I am a regular subscriber to **ELEMENTARY ELECTRONICS**. Where can I get a copy of the annual *World Radio and TV Handbook*?"

A good question, Emilio, and one I'm happy to answer as often as it comes up in the DX Central correspondence basket. WRTH is termed by many, the "DXers Bible," and rightly so. Each issue, published in Denmark every winter, is packed with information on stations,

(Continued on page 96)

newscan

Electronics in the News!

For Whom the Bell Tolls

In a business office there are apt to be any number of telephones, each of which rings dozens of times daily. And somehow, everyone in that office usually knows what his or her phone sounds like. If three people are standing at a water cooler when a phone rings, invariably one will say "That's my phone," and leave to answer it.

The reasons for this phenomenon, while technical, are nonetheless simple. Brass is used for the bell portion, or gong, in a phone's ringer mechanism. While brass emits the pleasant tone that telephone companies want, it also is a metal of varying tolerance or strengths; the stronger the brass, the higher the tone. And there's the size of the gong itself. In the manufacturing process, stamping machines punch out the gongs, and each gong varies minutely in size and thickness, depending on which ma-



"I think you have a toll call, padre!"

chine made it. Again because of the properties of brass, the larger the gong, the deeper the tone. Finally, a telephone ring is activated by an electrical impulse, which changes the polarity in a phone's electromagnet, which in turn controls the clapper. In theory, the clapper then moves swiftly back and forth, striking the two gongs inside each phone and producing the ring. But sometimes, inexplicably, the clapper will strike only one gong for a second or two before it reverses direction. This produces another distinctive type of ring.

The variable strength of brass, the variable size of the gong, and a sometimes-stubborn bell clapper: together they can make a ringing sound so distinctive that no one need ask for whom the bell tolls . . . it tolls for you!

versatile new 14-Piece, 1/4" Sq. Drive socket wrench set drives fasteners 7 different ways



REVERSIBLE RATCHET — Precision made, long life, fully enclosed mechanism. Short handle swing for close quarter work.

UNIQUE SPINNER/EXTENSION — 5-3/4" overall. Plastic (UL) handle with 1/4" sq. drive socket insert for ratchet. Use also as regular nutdriver.

2" DRIVE EXTENSION — Fits on ratchet or either end of spinner/extension.

RUGGED, HEAT TREATED, ALLOY STEEL SOCKETS — Nine for hex sizes 3/16" thru 1/2". Two dual purpose for hex and square sizes 1/4" and 5/16".

FREE STICK-ON INITIALS personalize the sturdy plastic case and help prevent loss or mix-up.

REQUEST
BULLETIN N770

No. 1001 SET



*nationwide availability
through local distributors*

Made In U.S.A.

XCELITE

XCELITE, INC. • 80 BANK ST., ORCHARD PARK, N.Y. 14127
Send Bulletin N770 on 1/4" Square Drive Socket Wrench Set.

name _____

address _____

city _____

state & zone _____

CIRCLE NO. 25 ON PAGE 17 OR 103

AUTO AIDS

Do-It-Yourself—Save Time, Money, Gas.



EICO 1064 Dual purpose Battery Eliminator and Charger incorporating an extra low ripple filter circuit. Ideal for servicing and powering 6-12 volt auto and marine equipment. \$64.95 Kit \$84.95 Wired

EICO 888 Portable Universal Engine Analyzer. Keeps your car or boat engine in tip-top shape. Complete with "How-to-Use" tune-up and troubleshooting manual. Kit \$54.95 Wired \$79.95

EICO 1080 200 watt Solid State Power Inverter and Battery Charger. Converts 12 volts DC to 117V AC current. For use in cars, mobile homes and boats to operate recorders, appliances, etc. Kit \$44.95 Wired \$59.95

EICO 889 Solid State C-D Ignition System adds power to any engine. Boosts gas mileage up to 20%. Points and spark plugs last up to 5 times longer. instant cold weather starting. Kit \$29.95 Wired \$39.95

FREE 32 PAGE EICO CATALOG

For latest catalog on EICO Test Instruments, Stereo, EICOCRAFT Projects, Environmental Lighting, Burglar/Fire Alarm Systems, and name of nearest EICO Distributor, check Reader Service Card or send 25c for First Class mail service.

EICO, 283 Matta Street, Brooklyn, N.Y. 11207



CIRCLE NO. 2 ON PAGE 17 OR 103

SQUARE WAVE GENERATOR KIT \$8.00

Complete kit nothing else to buy, including power supply, with quality etched and drilled printed circuit board, integrated circuit, diodes, resistors, capacitors, etc. ready to wire. Constant amplitude over wide frequency range 2Hz-200KHz. Fall time characteristics better than 200 nsecs. 18 volts p-p, with variable duty cycle. Also included very complete instructions on assembly, applications, and theory. Kit shipped prepaid same day order received.

PHOTOCIRCUIT CONSULTANTS Dept. EE-50
2309 Thurman, St. Louis, Mo. 63110

CIRCLE NO. 22 ON PAGE 17 OR 103

HIGHLY
PROFITABLE

ONE-MAN ELECTRONIC FACTORY

Investment unnecessary, knowledge not required, sales handled by professionals. Ideal home business. Write for facts today! Postcard will do. Barta-EB, Box 248, Walnut Creek, CA 94597.

CIRCLE NO. 4 ON PAGE 17 OR 103

NEWSCAN

Dear Mr. Computer

"Mr. Computer" has joined the staff of the New York State Education Department's Division for Handicapped Children. Invented at the General Electric Research and Development Center, "Mr. Computer" is a computer language that can be used by any teacher, with only a half-hour of instruction, to design individualized daily lessons for special education students. Students can then learn their lessons



Mr. Computer is a unique computer language, invented at the General Electric Research and Development Center in Schenectady, NY, that allows special education teachers to tailor daily reinforcement lessons for their individual students. The students can then learn their lessons by "talking" to Mr. Computer through a computer terminal equipped with a typewriter keyboard.

by "talking" to Mr. Computer through a computer terminal with a typewriter keyboard.

When Mr. Computer talks, he makes sense, and he offers help and encouragement to the student. A typical lesson might read as follows:

"Hi. What's your first name?" The student would enter his name, "Bob." "I am happy to know you, Bob. I am the GE Computer. Today, we are going to practice some addition: $5 + 2 = ?$ " If the student does well on a series of problems, Mr. Computer may be programmed to go on to problems of greater difficulty. "You're doing well, Bob. Let's try some harder ones: $2 + 5 = ? + 4$." If the student answers incorrectly, Mr. Computer can be programmed to give a hint: "No, remember that $5 + 2 = 7$ and $4 + 3 = 7$."

Mr. Computer can be programmed for a wide range of subjects, and can be directed to individualize the lesson further as it proceeds. For example: "What is your favorite color?" When the student enters his choice "blue," then Mr. Computer says: "Really? Blue is my favorite color, too. Now let's try some problems.

(Continued on page 95)

ELEMENTARY ELECTRONICS



**ASK HANK,
HE KNOWS!**

Wind a Coil

I have a problem with a small project I'm building. It calls for an inductance coil wound of 10 turns of #16 wire on a 3/8-in. diameter form spaced 1-in. end to end. But I have great difficulty trying to obtain this wire. I have been told that I may be able to use 18 gauge wire, but more turns would be needed and resistance of the coil would increase. What should I do?

—J.L.C., West Wyo. PA

In most projects, the wire size of the coil can be varied at least one size up or down without serious consequences. If the project calls for #16 wire and #18 is used, pinch the overall length inward a bit to compensate for the smaller diameter (less capacitance) wire. Resistance—forget it! The difference can't be measured. Any solid wire can be used, enameled, cotton coated or bare.

Tower Power

I'd like to know just exactly how much difference the antenna height makes. For example, let's say you can get channel 36 (but it drifts) would raising the antenna 60 feet up from the roof help any?

—R.G., Danville VA

Try to analyze your situation. If the obstruction blocking line-of-sight reception is local, and 60 feet of antenna will do the job, go ahead. But, height alone can't always do the job. It takes a three point program that includes height, the antenna type and proper lead-in. Improvement may be immediate by installing a high gain antenna with mast-mounted amplifier and coax lead-in wire. Proper termination transformers (75 to 300-ohms) are necessary also. Most antennas are mounted to low (short masts)—a minimum of 10 feet of clearance above your own roof is a minimum installation requirement. Nearby TV antennas, either mounted on the same mast, within ten feet, or in front of the antenna on the same roof kills reception. Now if all this does not help, up the tower. (See page 41)

TV Service Headache

What is the best, simplest way to test a deflection yoke, without elaborate equipment?

—B.C., Eden NC

If you have a schematic circuit handy, check the
(Continued on page 29)

Great Products Make Great Gifts!



EICO TH-30 Find buried gold, silver, coins, etc. with this Solid State Metal Locator. Add fun, excitement and profit to weekends. **Kit \$29.95 Wired \$37.50**

EICO TA-12 Two way Solid State Telephone Amplifier enables you to talk "Hands Free." Ideal for message taking or business conferences. Includes extension speaker and battery. **\$17.95**

EICO TD-8 Update your home

music system to play 8-track stereo tape cartridges with this deluxe solid state tape deck. Easily connects to your stereo amplifier or receiver. AC synchronous motor. **\$49.95 Wired**

EICO WR-1 Unique solid state radio is preset to monitor the official U.S. weather station broadcasts. Listen to continuous 24 hour weathercasts by simply pushing a button. 3 3/4" cube design. **\$15.95 Wired**

FREE 32 PAGE EICO CATALOG

For latest catalog on EICO Test Instruments, Stereo, EICOCRAFT Projects, Environmental Lighting, Burglar/Fire Alarm Systems, and name of nearest EICO Distributor, check Reader Service Card or send 25c for First Class mail service.

EICO, 283 Maiba Street, Brooklyn, N.Y. 11207



CIRCLE NO. 2 ON PAGE 17 OR 103

• THE SHOPPING CENTER FOR ELECTRONICS
 (our catalog index of Mfrs extends from ADC to XCELITE)
 • HOBBYISTS . . . EXPERIMENTERS . . . SERVICE
 TECHNICIANS . . . ENGINEERS •

Your Satisfaction Is Our Target
 Top Name Brands . . .
 Low Prices

AMPLE STOCKS—including those hard-to-find Parts
 whether you want a 15¢ capacitor, a \$50 FET-VOM, or a \$450 stereo system—you can get it at EDI!

Send for your **FREE** catalog Today.

RUSH FREE CATALOG

Name _____

Address _____

City _____ State _____ Zip Code _____

ELECTRONIC DISTRIBUTORS INC.
 Dept. TA-2, 4900 Elston Chicago, Ill. 60630

CIRCLE NO. 15 ON PAGE 17 OR 103



LITERATURE LIBRARY

101. Kit builder? Like weird products? EICO's 1974 catalog takes care of both breeds of buyers at prices you will like.

102. International Crystal has a free catalog for experimenters (crystals, PC boards, transistor RF mixers & amps, and other comm. products).

103. See brochures on Regency's 1974 lineup of CB transceivers & VHF/UHF receivers (public service/business bands—police, fire, etc.)

104. Dynascan's new B&K catalog features test equipment for industrial labs, schools, and TV servicing.

105. Before you build from scratch, check the Fair Radio Sales latest catalog for surplus gear.

106. Get Antenna Specialists' cat. of latest CB and VHF/UHF innovations: base & mobile antennas, test equipment (wattmeters, etc.), accessories.

107. Want a deluxe CB base station? Then get the specs on Tram's super CB rigs.

108. You'll want Xcelite's new ratchet socket wrench set the moment you lay eyes on it. It has eleven sockets from 3/16 inch through 1/2 inch. The set includes a reversible ratchet handle with two spinner extensions—2 inches regular and 5 3/4 inches.

109. Bomar claims to have C/B crystal for every transceiver... for every channel. The catalog gives list of crystal to set interchangeability.

110. A Turner amplified mike helps get the most from a CB rig. This free brochure describes line of base & mobile station models.

111. Midland's line of CB (base and mobile) equipment, and marine transceivers and accessories are illustrated in a new 4-color 24-page folder. There's also a separate 8-page, 4-color flyer on scanners.

112. EDI (Electronic Distributors) has a catalog with an index of manufacturers' items literally from A to Z (ADC to Xcelite). Whether you want to spend 29 cents for a pilot-light socket or \$699.95 for a stereo AM/FM receiver, you'll find it here.

113. Get all the facts on Progressive Edu-Kits Home Radio Course. Build 20 radlos and electronic circuits; parts, tools, and instructions included.

114. Olson Electronics' 244-page fully-illustrated 1974 catalog carries leading national brand products in all electronics categories.

115. Trigger Electronics has a complete catalog of equipment for those in electronics. Included are kits, parts, ham gear, CB, hi fi and recording equipment.

116. Get the HUSTLER brochure illustrating their complete line of CB and monitor radio antennas.

117. Teaberry's new 6-page folder presents their 6 models of CB transceivers (base and mobile): 1 transceiver for marine-use, and 2 scanner models (the innovative "Crime Fighter" receiver and a pocket-size scanner).

118. Burstein-Applebee's 1974 catalog has 276 pages of radio/TV electronics bargains. Selling for \$2, it is offered free to our readers.

119. Besides Browning's colorful leaflet on their Golden Eagle Mark III base station, their packet includes other surprises. The SST transceiver is claimed to have unparalleled design in the CB world. The LTD is pictured in actual size on a card for you to test on your car's dash. Specifications are given for both the SST and LTD. All literature is in full color.

120. Edmund Scientific's new catalog contains over 4000 products

that embrace many sciences and fields.

121. Cornell Electronics' "Imperial Thrift Tag Sale" Catalog features TV and radio tubes. You can also find almost anything in electronics.

122. Radio Shack's 1974 catalog for electronics enthusiasts has 180 pages, colorfully illustrated—a complete range (kits & wired) of hi-fi, CB, SWL equipment and parts.

123. It's just off the press—Lafayette's all-new 1974 illustrated catalog packed with CB, hi-fi components, test equipment, tools, ham rigs, and more.

124. Mosley Electronics reports that by popular demand the Model A-311 3-element CB beam antenna is being reintroduced. Send for the brochure.

125. RCA Experimenter's Kits for hobbyists, hams, technicians and students are the answer for successful and enjoyable projects.

126. B&F Enterprises has an interesting catalog you'd enjoy scanning. There are geiger counters, logic cards, kits, lenses, etc.

127. Avanti antennas (mobile and base for CB and VHF/UHF) are fully described and illustrated in new catalog.

128. A new free catalog is available from McGee Radio. It contains electronic product bargains.

129. Semiconductor Supermart is a new 1974 catalog listing project builders' parts, popular CB gear, and test equipment. It features semiconductors—all from Circuit Specialists.

130. Heath's new 1974 full-color catalog is a shopper's dream—chockful of gadgets and goodies everyone would want to own.

ELEMENTARY ELECTRONICS

Box 886

Ansonia Station

New York, N.Y. 10023

Please arrange to have this literature whose numbers I have circled at right sent to me as soon as possible. I am enclosing 25¢ to cover handling. (No stamps, please).

- | | | | | | | | | | |
|-----|-----|-----|-----|-----|-----|-----|-----|-----|-----|
| 101 | 102 | 103 | 104 | 105 | 106 | 107 | 108 | 109 | 110 |
| 111 | 112 | 113 | 114 | 115 | 116 | 117 | 118 | 119 | 120 |
| 121 | 122 | 123 | 124 | 125 | 126 | 127 | 128 | 129 | 130 |
| 131 | 132 | 133 | 134 | 135 | 136 | 137 | 138 | 139 | 140 |
| 141 | 142 | 143 | 144 | 145 | 146 | 147 | 148 | 149 | |

Indicate total number of booklets requested
 Sorry, only 12 circled items maximum.

Are you a subscriber to this magazine? Yes No

NAME _____

ADDRESS _____

CITY _____

STATE _____ ZIP _____

Not Valid After June 30, 1974

J/F74



ASK HANK, HE KNOWS

coils with an ohmeter. Shorted coils cannot be detected this way. So, call in a serviceman if you can't pin-point the fault.

Lungers Appraised

I have recently received a Tung-Sol CTL-705A rectifier tube. It is from 1943 and is still operating. I would like to know if this tube is worth anything?

—H.R., Sparks NV

Wait till it blows, then you'll find out for sure.

Wants 4 on the Floor

How can I add another speed to my (cheap) cassette tape recorder? It has only one speed now (1 7/8). How about a switch to place a resistor in series with the motor?

—R.H., Port Calborne, Ont.

Can't do. A series resistor will slow the speed but ruin the regulation. Wow will be very high. Some cassettes may even stall the drive mechanism. To make the cassette tape travel faster is done by increasing the capstan diameter, but you may need a machine shop to fabricate the parts. The odds are against you.

Antique Newcomer

Where can I buy an old time receiver? I don't care if I have to restore it.

—H.T., New Orleans LA

One man's junk is another man's riches. Visit

a local flea market and see what you can buy. Never can tell what you will find.

Hold that Check

I think it's unfair to charge \$20 for a CB license. I moved and now I've got to let the FCC know. Another \$20 shot to H- L!

—K.M., Kansas City KA

Save your money, pal! The Communications Fuzz does have a heart. There is no charge for a license modification because of a residence change.

It Bugs Him

My question is about ecology and the role electronics can play in the farmer's life. Why can't farmers use a portable electric insect killer in the fields instead of the chemicals they now use?

—G.C., Greenville SC

Sounds like a good idea, but what will the farmer do about the fumes from the portable electric generator that is gasoline driven? I do believe the price is high and the bugs would not cooperate by flying to the device and committing suicide.

Send 'em Letters

I'm afraid to contact mail order schools advertised in your magazine. Are they really good?

—P.M., Boise ID

I was once afraid of sex. Yes, they really are good. ■



Use Coupon on Left!

131. E. F. Johnson's 1974 full line of CB transceivers and accessories equipment is featured in a new 16-page brochure. A 4-color folder on monitor scanner line is also offered.

132. If you want courses in assembling your own TV kits, National Schools has 10 from which to choose. There is a plan for GIs.

133. Get the new free catalog from Howard W. Sams. It describes 100's of books for hobbyists and technicians—books on projects, basic electronics and related subjects.

134. Sprague Products has L.E.D. readouts for those who want to build electronic clocks, calculators, etc. Parts lists and helpful schematics are included.

135. The latest edition of Tab Books' catalog has an extensive listing of TV, radio and general servicing manuals.

136. Leader's catalog features "Instruments to Believe In." They have a complete line for industry, education and service, featuring oscilloscopes/vectorscopes, many generators, accessories, etc.

137. Pace Communications has a packet of information for you. The "Citizens two-way radio" answers all the questions from how to operate one to how much they will cost to operate. A booklet on Pace's scan/monitors to keep you informed is included.

138. Pearce-Simpson has a booklet, "Citizens Band Radios & Scanners," which pictures and describes the various models in this line. A section on CB antennas is included.

139. For the latest information on CB transceivers by Courler, send for their literature.

140. Featured in Siltronix's brochure are single sideband/AM citizen band transceivers, pictured and described with extra features and specifications listed. VFO sliders for monitoring are pictured as well as export models of linear amplifiers.

141. Lee Electronics Labs has an inexpensive circuit analyzer, which is featured in this catalog.

142. Available from Royce Electronics (a new name in electronics manufacturing) is a 16-page catalog for CB'ers. See their base and mobile transceivers, accessories and test instruments.

143. A set of Abraxas/4 speakers contains a rugged 12-inch long-throw woofer with a 22-oz. Alnico magnet, a 5-inch sealed-back rub-

ber-damped midrange, and two 3-inch dome tweeters from Designers Audio Products.

144. For a packetful of material, send for SBE's material on UHF and VHF scanners, CB mobile transceivers, walkie-talkies, slow-scan TV systems, marine-radios, two-way radios, and accessories.

145. For CB'ers from Hy-Gain Electronics Corp. there is a 50-page, 4-color catalog (base, mobile and marine transceivers, antennas, and accessories). Colorful literature illustrating two models of monitor-scanners is also available.

146. Robyn International has 4-color "spec" sheets for each model of their CB (base and mobile) transceivers and monitor-scanner lines.

147. Telex's 4-page, 2-color folder illustrates their new line of boom microphone head-sets for CB'ers and hams, as well as their line of communications headphones.

148. American Trading Corp. offers you two catalogs in 4-color. One features their Electronics 2000/Contact CB, pictured with descriptions and specifications. Their Monitor/Scanner, Surveyor Model 4H 4U, is featured in the second catalog.

149. Cush Craft has a catalog on Citizens Band Antennas for every purpose. The Ringo base antenna is featured, as is the new Superfire 8-element horizontal/vertical power beam.



THE LEARNING EXPERIENCE



by Jack Schmidt



"And then he gets the electrons excited in the wachamacallit and they fly away."



"That was a 'hot wire,' Marion, not a 'hot circuit!'"

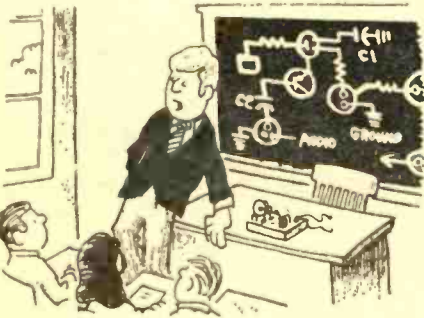

"... and then the capacitor. . . er . . . ah . . . capacits!"

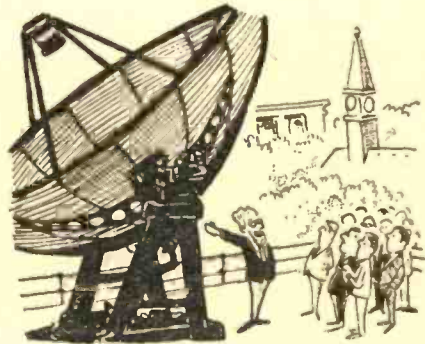

"It picks up radio waves from gaseous nebulae, and blacked out professional games"



"... then the radar waves bounce off your speeding car back to the little black box in my car."

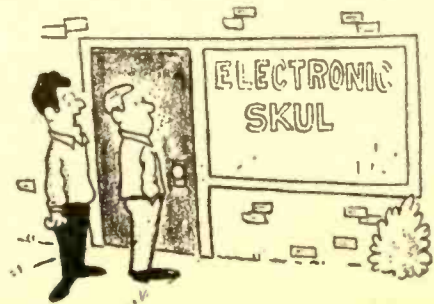

"It doesn't look like a good school to me, Harry!"

Tune This Radio with a Voltage Divider!

by Charles Green W6FFQ

TUNE IN with the new space-age solid-state components that have transformed receiver technology. The old reliable tuning capacitor that was used in the old tube receivers is still with us and is still almost as large in size. Attempts at size reduction, decreasing the air gap between plates or using a mica dielectric, still are not enough.

But in the last few years, a solid state equivalent to the tuning capacitor has been developed to the point of enough capacity to tune the broadcast band and will be put into use soon. This solid-state device is called the Varactor, and is a type of semi-conductor diode.

You can experiment with varactors with our simplified broadcast band receiver. The old reliable regenerative detector circuit is used for simplicity, and is brought up to date with a field effect transistor (FET) used as the detector. An audio amplifier module is included that drives a small speaker mounted on the front panel. The receiver is built using an rf

breadboard style of construction

(Turn page)



e/e VARI-CAP TUNING THE BCB

for some very easy experimentation on a 7-in. x 5-in. x 2-in. metal chassis. Information is given for the use of selected silicon diodes as varactors in addition to commercial varactors.

About The Circuit. RF signals from the antenna are connected via J1 to the primary winding of coil L1 which, in turn, is tuned by the varicap diode with tuning control R4. Signals from the tuned circuit are detected and amplified by a FET version of the grid-leak—the *gate-leak* detector Q1. Some of the rf energy from the source circuit of Q1 is fed back from the tickler winding, detected, and re-amplified. When there is too much feedback, the gate-leak detector circuit of Q1 will oscillate. The amount of feedback is therefore controlled by the *Regen* control R2 and adjusted to just below the point of oscillation for maximum sensitivity and selectivity of BC band signals.

The detected signals from Q1 are coupled via T1 to volume control R6 and the amplifier module. Further amplification of the signals is performed by the module and the signals are heard on the 8-ohm speaker.

What's a Varactor? The varactor diode is a semiconductor junction diode that behaves like a capacitor when reverse voltage bias is applied. The capacitance is formed by the space charge or depletion region around the internal P-N junction of the diode, and the amount of capacity is changed by varying the reverse voltage bias. This type of diode is also known as a voltage-variable capacitance diode or as a vari-cap.

The basic semiconductor junction diode is formed of a material such as silicon that

has two portions of the material *doped* in manufacturing by adding controlled amounts of chemicals. The doped portions have opposite electrical characteristics; "P" type with an excess of positive electrical charges (or hole) and "N" type with an excess of negative electrical charges (electrons). As shown in the drawing, the boundary between the two types is called a P-N junction, and there is a depletion layer (or region) that is also called the space charge region. This region is in an area along both sides of the P-N junction.

This space charge region is an area that acts as an electrical insulator (electrons will not normally flow across it) when no external bias voltage is applied, and therefore bars the passage of an electric current through the P-N junction. When an external voltage bias is applied the space charge region will narrow and disappear. This will permit the diode to conduct (electrons will flow across the P-N junction). As shown in the drawing of a diode being used as a rectifier; the space charge region will vary from very narrow (and disappearing) to very wide, when the alternating voltage changes polarity and gives the diode a reverse bias.

Solid Tuning. As also shown in the drawing, a diode has an internal capacity between the P and N type materials with the non-conducting space charge region acting as the capacitor dielectric. When the diode has a low reverse bias voltage, the space charge region is narrow, and the capacity effect is the same as if the plates of a tuning capacitor are close together—high capacity. If the diode has a high value of reverse bias voltage, the space charge region is wide, and the effect is as if the plates of a tuning capacitor were moved apart—low capacity. The actual capacity depends upon the physical and electrical

Start Here. Back off volume to a low level until station is tuned and regeneration is properly adjusted.

Then. Rotate tuning control until a whistle is heard indicating the presence of a broadcasting station. Rock control back and forth to tune radio to center of channel as indicated by the loudest whistle.

Finally. Back off the regeneration control until the whistle just disappears. This control should be adjusted as near to the point of oscillation (audio whistle) as possible. Increase volume control as required. If the unit again breaks into oscillation, back off the regeneration control to a stable setting.

characteristics of the particular diode, and commercial varactors are specially manufactured and selected semiconductor diodes.

When a varactor diode is connected into a tuned circuit as shown in the diagram, the capacity of the diode can be varied by a tuning potentiometer which changes the

value of the reverse bias voltage of the diode. When the bias voltage is high, the tuned circuit is at the highest frequency of operation, and when the voltage is low, the frequency is low. Capacitance "C" is an rf bypass capacitor for the tuning potentiometer.

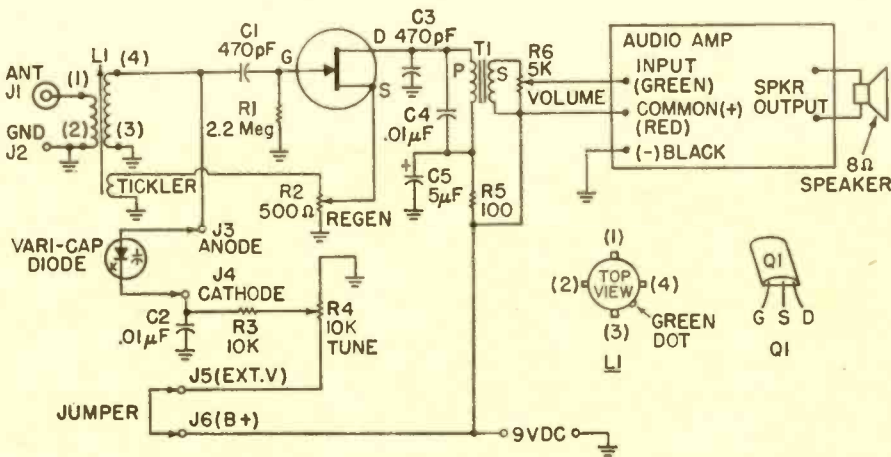
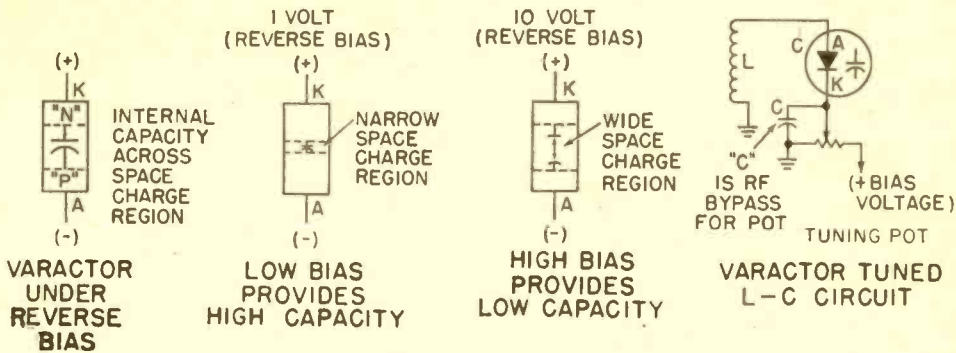

PARTS LIST FOR VOLTAGE-TUNED RADIO

AA1—Audio amplifier, 100 mW, 4 to 8-ohm output (Radio Shack 277-1240 or equiv.)
 C1, C3—470 pF disc capacitor, 12 VDC or better (Radio Shack 272-125 or equiv.)
 C2, C4—.01 μF disc capacitor, 12 VDC or better (Radio Shack 272-1065 or equiv.)
 C5—5 μF electrolytic capacitor, 12 VDC or better (Radio Shack 272-1001 or equiv.)
 J1—Phone jack or binding post for antenna terminal (Radio Shack 274-661 or equiv.)
 J2 to J6—Fahnestock clips for binding posts (Radio Shack 270-393 or equiv.)
 L1—BC Band antenna coil with three-turn tickler winding; see text (Miller A-5495-A)
 Q1—FET, HEP-802 (Motorola)
 R1—2.2-megohm, ½-watt resistor (Radio Shack 271-000 or equiv.)
 R2—500-ohm potentiometer, linear taper (Radio Shack 271-066 or equiv.)

R3—10,000-ohm, ½-watt resistor (Radio Shack 271-000 or equiv.)
 R4—10,000-ohm potentiometer, linear taper (Radio Shack 271-1715 or equiv.)
 R5—100-ohm, ½-watt resistor (Radio Shack 271-000 or equiv.)
 R6—5,000-ohm potentiometer, audio taper (Radio Shack 271-1720 or equiv.)
 T1—Transformer, 10,000-ohm primary, 2,000-ohm secondary (Radio Shack 273-1378 or equiv.)

Misc. 8-ohm speaker, 7-in. x 5-in. x 2-in. chassis, 5-in. x 7-in. perfboard, push-in clips (Radio Shack 270-1394 or equiv.), 4-in. x 7-in. front panel (metal or copper-backed phenolic), knobs, Vari-cap diodes (see text), 9-volt battery or 9 VDC power supply, hookup wire, solder, etc.

e/e VARI-CAP TUNING THE BCB

When a varactor is used in a tuned circuit, the amount of the change in capacitance of the semiconductor diode with the applied reverse bias voltage becomes important. In a tuned circuit (LC) the frequency ratio varies directly as the square root of the capacitance ratio. A varactor must therefore have a capacitance ratio of 4 to 1 if the tuned circuit is to be tuned over a range of 2 to 1.

Simple Building Hints. The receiver is built breadboard style with the components mounted on a perf-board. Even though the receiver operates on the BC band, wiring of the Q1 regenerative detector circuit may be critical. For best results, follow our photos for parts placement.

Start construction by cutting out the top of a 5 x 7 x 2-in. aluminum chassis to a 1/2-in. rim all around. Slot and bend up two 1 1/2-in. tabs at each end of the front rim of the chassis and drill mounting holes for the front panel. Our front panel is a 4 x 7-in. copper-backed phenolic section of the type used for printed circuits, but any size metal panel can be used as well. Cut a perf board section to size to fit the top of the chassis and install it with sheet metal screws to the rim of the chassis.

Coil L1 is mounted on the perf board by soldering the terminals to push-in clips. Remove the 10 pF ceramic capacitor supplied with the coil before mounting, and make sure that the coil is positioned for the shortest connections (as shown in the schematic). Q1 is also mounted with push-in clips soldered to the leads and positioned close to L1. T1 is installed on the board with push-in clips soldered to the transformer mounting tabs.

Install the remainder of the parts on the perf board and chassis, then wire them as shown in the schematic. Wind three turns of hookup wire around the top end of the L1 secondary winding for the tickler and twist the leads together to hold them in place on the coil.

The amplifier module is mounted on the perf board with machine screws and 1/4-in. spacers. Make sure that you connect the common (+) red wire to B+ as shown in the schematic. Clip off the unused red wires that normally are connected to a switch. (See the schematic supplied with the module for details.) The amplifier module black (-) wire should be centered to B- (common ground).

Check The Tickler. Connect a good outside antenna to J1 and a ground connection to J2. Connect the red wire (B+) to the (+) terminal of a 9-volt battery or dc power supply, and connect the black (B-)

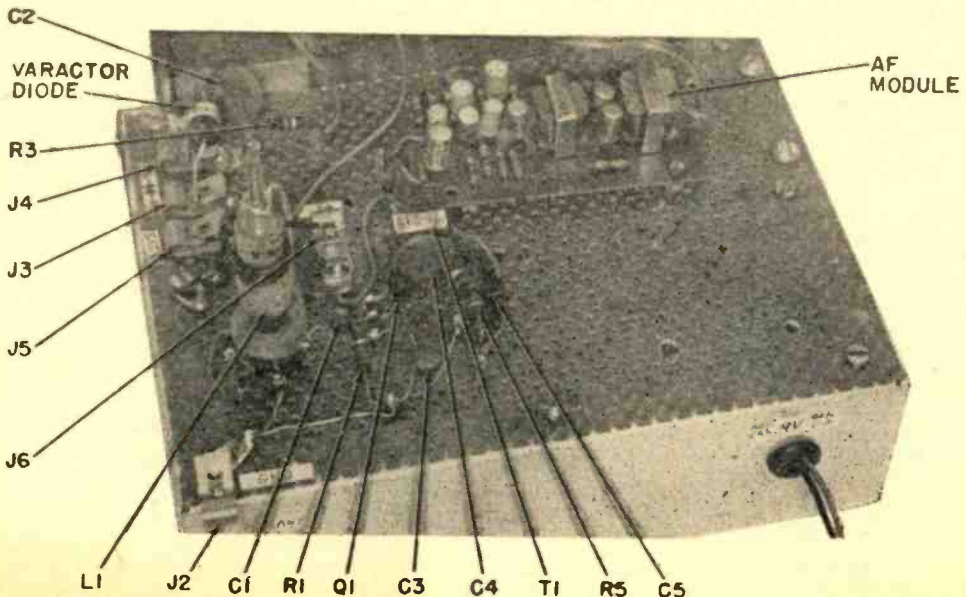

If you place your components in approximately the same location as the author, you will have an excellent chance for success with your project. Note "tickler" at top of L1.

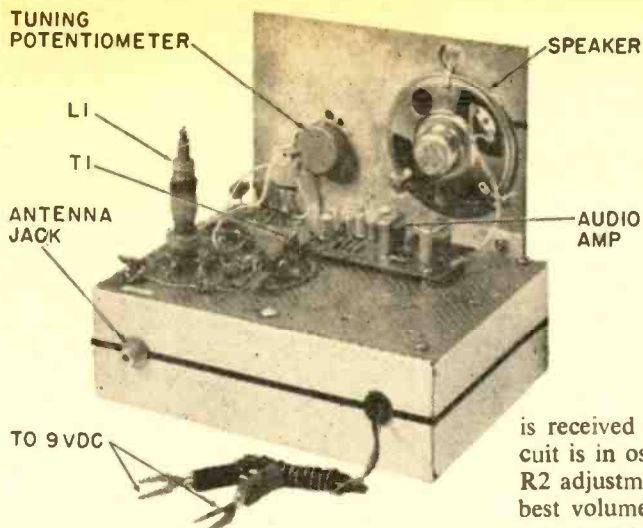

To this simple circuit tuning in stations means varying a reverse bias voltage to the varactor diode which increases capacitance in proportion to the decrease in reverse bias. Varactors are solid-state variable capacitors that can take the place of the usual mechanical variety.

receiver wire to the (-) terminal. Connect a 100 pF capacitor to J3 and J4 (in place of a varactor), and adjust the tuning slug on L1 until you hear a received signal in the speaker. Adjust R6 for a convenient audio volume, and then adjust R2 until the signal

is received as a whistle (the Q1 regen circuit is in oscillation). Then back off on the R2 adjustment until the signal is received at best volume and selectivity. It may also be necessary to readjust the L1 tuning slug. If the signal can not be received as a whistle, reverse the connections to the tickler winding.

You can connect a 365 pF variable tuning capacitor in place of the 100 pF capacitor.
(Continued on page 40)

TUNING THE 50 STATES ON MEDIUM WAVE

Because the CBB band is so crowded with stations, logging all 50 states is tougher than it used to be. But, with patience and luck, you can do it. Here are your best bets.

State	Call	Freq. (kHz)	State	Call	Freq. (kHz)
Alabama	WYDE	850	Montana	KXLF	1370
Alaska	KFQD	750	Nebraska	KFAB	1110
Arizona	KTAR	620	Nevada	KOH	630
Arkansas	KAAY	1090	New Hampshire	WKNE	1290
California	KFBK	1530	New Jersey	WPAT	930
Colorado	KOA	850	New Mexico	KOB	770
Connecticut	WTIC	1080	New York	WABC	770
Delaware	WDOV	1410	North Carolina	WBT	1110
Florida	WQAM	560	North Dakota	KFYR	550
Georgia	WSB	750	Ohio	WLW	700
Hawaii	KORL	650	Oklahoma	KOMA	1520
Idaho	KGEM	1140	Oregon	KEX	1190
Illinois	WLS	890	Pennsylvania	KDKA	1020
Indiana	WOWO	1190	Rhode Island	WPRO	630
Iowa	WHO	1040	South Carolina	WCSC	1390
Kansas	WREN	1250	South Dakota	WNAX	570
Kentucky	WHAS	840	Tennessee	WSM	650
Louisiana	WWL	870	Texas	WOAI	1200
Maine	WCSH	970	Utah	KSL	1160
Maryland	WBAL	1090	Vermont	WHWB	1000
Massachusetts	WBZ	1030	Virginia	WRVA	1140
Michigan	WJR	760	Washington	KGA	1510
Minnesota	WCCO	830	West Virginia	WWVA	1170
Mississippi	WOKJ	1550	Wisconsin	WKOW	1070
Missouri	KMOK	1120	Wyoming	KWYO	1410

When you give of yourself



**B) New Heathkit
4-Channel Amplifier . . . 179.95***



**A) New Heathkit
4-Channel Receiver . . . 249.95***



**C) New Heathkit
B & W Portable TV . . . 129.95***



**E) New Heathkit/
Thomas Electronic Organ . . . 1045.00*
less rhythm section**



**D) New Heathkit
Ultrasonic Cleaner . . . 54.95***



**F) New Heathkit
Digital Thermometer . . . 59.95***



**H) New Heathkit
Pocket Calculator . . . 69.95***



**G) New Heathkit
Home Weather Station . . . 89.95***

you give a lot more

Eight exciting new HEATHKIT products to help you build new meaning into Christmas

A) Heathkit AR-2020 4-Channel Receiver . . . 249.95*

A highly sophisticated 4-channel receiver at an incredibly low kit-form price. The new AR-2020 offers 25 watts music power per channel, a built-in decoder for reproducing matrixed 4-channel material, and an AM/FM tuner that boasts 2 μ V sensitivity, 2dB capture ratio. For custom-tailored sound there are individual front panel controls for all four speakers plus a "master" control, pushbuttons for all modes of operation and inputs to accommodate phono, tape and auxiliary source in stereo or 4-channel combinations. The solid-state circuitry mounts on modular plug-in boards for easy assembly and self-service. And the low kit price includes the cabinet, tool Mailing weight, 31 lbs.

B) Heathkit AA-2005 4-Channel Amplifier . . . 179.95*

For the 4-channel purist, the 100-watt amplifier section from the AR-2020 with integrated pre-amp and complete control package. The AA-2005 also gives you built-in encoder circuitry to handle all the matrixed 4-channel material currently available. The sophisticated front-panel control section provides access to 25 watts of music power per channel in just about any combination you can imagine, including stereo and mono modes. Individual level controls, plus a master volume, further enhance the flexibility of the AA-2005. Modular solid-state design with plug-in circuit boards simplifies assembly and makes trouble-shooting a breeze. And the slim-line cabinet is part of the bargain. Mailing weight, 28 lbs.

C) Heathkit GR-104C 12V black & white TV . . . 129.95*

One of the most popular kit-form TVs ever — now with total detent tuning on all UHF and VHF channels so you lock-in on each station the first time, every time. Plus the 104C retains all the great features that make it the number-one kit-builder's portable. All solid-state circuitry with "up-front" speaker and secondary controls. Go-anywhere capability lets you use it in the home, on the road with the 12-volt adapter supplied, or outdoors with optional rechargeable battery pack. The high-impact beige and black cabinet has built-in carrying handle, UHF and VHF antennas. But best of all it's a TV you can build — in six enjoyable evenings — so you know how it works and how to keep it working for years. Mailing weight, 35 lbs. Optional battery pack and sun shield, Kit GRA-104-3, 9 lbs., 42.95.*

D) Heathkit GD-1150 Ultrasonic Cleaner . . . 54.95*

This newest idea in labor-saving electronics makes quick work of items you hate to clean. Art and decorator paint brushes, intricate jewelry, watches, glasses and contact lenses, dentures — just about anything except pearls and plastic. Just fill the tank with a safe detergent or solvent, set the 0-5-min. timer and switch the unit on. Ultrasonic waves generate millions of tiny cleansing bubbles in the solution and force them into every little corner . . . Uniquely gentle, you can use it for all those delicate valuables. And in Heathkit-form, Ultrasonic cleaning is a great buy, too. Build your GD-1150 in one or two easy evenings. All components mount on just one board. Mailing weight, 5 lbs.

E) Heathkit/Thomas Organs . . . 995 and 1045*

The most beautiful organ kits we have ever offered. And they sound as magnificent as they look. The TO-1260 series takes the successful Heathkit/Thomas collaboration to a new musical high. Features include two 44-note over hanging keyboards, and a 13-note Radial Arc pedal board. Behind the soaring stereo sound are two powerful 35-watt rms solid-state amplifiers and two specially designed wide-range 12-inch heavy duty speakers. Also, there is a convenient accessory panel for quick installation of cassette recorder, earphones and external tone cabinet. Cabinets come preassembled and finished. Contemporary model, TO-1260W, (not shown) \$995. Mediterranean, TO-1260M, (shown) \$1045. Express freight, 203 lbs. Optional Rhythm Section, TOA-60-1, 5 lbs., 249.95*.

F) Heathkit ID-1390 Digital Thermometer . . . 59.95*

Now digital electronics can tell you the temperature indoors and out — accurately, unmistakably. The new ID-1390 continuously monitors two different temperatures at sensors placed inside and outside your home. A rear-panel switch lets you set the bright digital readout to alternately display indoor and outdoor temperatures at four second intervals, or to continuously show just one temperature. A second switch sets your electronic thermometer for Fahrenheit or Centigrade readings. Display includes plus and minus and indoor/outdoor indicators. Includes 85 feet of cable and two sensors. (Styled to match Heathkit Digital Clock \$54.95). Mailing weight, 5 lbs.

G) Heathkit ID-1290 Home Weather Station . . . 89.95*

Now you can build your own professional-type home weather station — at kit-form savings! The new ID-1290 features 5 functions, solid-state circuitry, plus weatherized wind-cup & wind vane that mount in minutes to your TV mast or anywhere handy. Barometer has special movement with 2 1/2 times greater pointer deflection — shows as little as .02 in. of change without squinting. 8 compass points light up on the wind direction indicator to give you 16-point resolution. Wind speed indicator has switch-selected 0-30 and 0-90 mph ranges for more accurate readings. And the thermometer gives you the temperature indoors or outdoors at the flip of a switch. Handsome simulated walnut housing with black & gold instrument cluster mounts either vertically or horizontally on wall, or sits on desk with end panels provided. Kit includes informative weather book — goes together in just a few evenings. Mailing wt., 9 lbs. 50 ft. cable, 5.95*, 2 lbs.; 100', 9.95*, 4 lbs.; 150', 14.95*, 6 lbs.

H) Heathkit IC-2006 Pocket Calculator . . . 69.95*

This battery-powered beauty is less than one inch thick yet performs all mathematical functions with results up to eight digits. A constant (K) switch permits fast repetitive work when multiplying or dividing. 1/2" LED display reads-through bright and clear with no distorting magnifier. Uses readily available 9-volt battery or optional AC converter for desk-top operation. It's a rewarding stocking stuffer for businessman, housewife or student. Mailing weight, 2 lbs. GRA-43-1, AC converter, 1 lb., 3.95*.

Visit your nearest Heathkit Electronic Center . . . or send for **FREE** catalog

HEATHKIT ELECTRONIC CENTERS — ARIZ.: Phoenix; CALIF.: Anaheim, El Cerrito, Los Angeles, Pomona, Redwood City, San Diego (La Mesa), Woodland Hills; COLO.: Denver; CONN.: Hartford (Avon); FLA.: Miami (Hialeah), Tampa; GA.: Atlanta; ILL.: Chicago, Downers Grove; IND.: Indianapolis; KANSAS: Kansas City (Mission); KY.: Louisville; LA.: New Orleans (Kenner); MD.: Baltimore, Rockville; MASS.: Boston (Wellesley); MICH.: Detroit; MINN.: Minneapolis (Hopkins); MO.: St. Louis; NEB.: Omaha; N.J.: Fair Lawn; N.Y.: Buffalo (Amherst), New York City, Jericho, L.I., Rochester, White Plains; O.: Cincinnati (Woodlawn), Cleveland, Columbus; PA.: Philadelphia, Pittsburgh; R.I.: Providence (Warwick); TEXAS: Dallas, Houston; WASH.: Seattle; WIS.: Milwaukee.



World's largest selection of electronic kits

HEATH COMPANY, Dept. 139-1 Benton Harbor, Michigan 49022		HEATH Schlumberger
<input type="checkbox"/> Please send FREE Heathkit Catalog.		
Enclosed is \$ _____, plus shipping.		
<input type="checkbox"/> Please send model(s) _____		
Name _____		
Address _____		
City _____	State _____	Zip _____
* Mail order prices; F.O.B. factory. CL-487		

CIRCLE NO. 1 ON PAGE 17 OR 103

VARI-CAP TUNING THE BC8

(Continued from page 35)

tor for easier signal tuning or to allow reception of signals at the lower end of the band for this test. This test will show that the basic receiver circuits are operational. At the conclusion of the test, remove the capacitor from J3 and J4, and then connect a short jumper wire between J5 and J6. This jumper is necessary to provide a B+ connection to the R4 tuning control.

Selecting Your Varicap Diode. The receiver can be used with either commercial varactors or selected ones from your stock of surplus or used semiconductor diodes. Some transistors will also operate as varactors. The commercial varactors may not be easily available to the experimenter, as they may have to be specially ordered from local parts houses that handle industrial electronic components.

The following are some varactors that can be used with this receiver: Motorola—MV1401 ("EPICAP") 550 pF at 1-volt bias, 10:1 ratio; Motorola MV1405 250 pF at 2-volt bias, 10:1 tuning ratio; HEP R2505 100 pF at 4-volt bias, 3:1 ratio; and Radio Shack; 276-676 (5 varactor diodes kit) 10 to 50 pF. There are many more types by different manufacturers, but at this time not much information is available for the experimenter. Unfortunately, most of the commercial varactors do not have enough capacity to tune over the complete BC band; they are more suitable for short wave and UHF operation. But industry is

still in the process of developing varactors for use in home radios (as well as TV sets) and more varactors should be available for experimentation.

You can also experiment with ordinary silicon rectifiers used as varactors with this receiver. Since the properties of a diode that go to make a good varactor are not necessarily that of a good rectifier, it is necessary to test the diodes for varactor operation. Also varactor qualities may vary a lot. Even when one of a particular type or manufacture is found to have varactor operation, other diodes of the same type may not work at all. It may be considered to be a sort of treasure hunt to find varactors among your surplus and used diodes.

Best way to test diodes for varactor operation is to connect them to the receiver—the diode anode to J3 and the cathode to J4. Then, tune R4 and see if signals can be received over the BC band for a rough check.

It was found that a GF-X4 rectifier diode worked ok, and several of the Radio Shack 276-599 kit of untested diodes operated as varactors. Disconnect the connection between J6 and J5 and try operating the varactors with the external dc power supply (+) terminal connected to J5, and the (-) terminal to J2 for a greater capacity tuning ratio range. Try various higher voltages within the maximum voltage rating of the diode.

Try experimenting with transistors as varactors. Connect them as follows: *emitter* of an NPN type to J4, *base* to J3; or *collector* to J4 and *base* to J3. Connect the *base* of a PNP type to J4, *collector* to J3; or *base* to J4 and *emitter* to J3. ■

AM CLEAR CHANNELS FOR NORTH AMERICA

540 Clear (Canada)	780 Clear	1010 Clear (Canada, Cuba)	1170 Clear
640 Clear	800 Clear (Mexico)	1020 Clear	1180 Clear
650 Clear	810 Clear	1030 Clear	1190 Clear (U.S., Mexico)
660 Clear	820 Clear	1040 Clear	1200 Clear
670 Clear	830 Clear	1050 Clear	1210 Clear
680 Clear	840 Clear	1060 Clear (U.S., Mexico)	1220 Clear (Mexico)
690 Clear	850 Clear	1070 Clear (U.S., Canada)	1500 Clear
700 Clear	860 Clear (Canada)	1080 Clear	1510 Clear
710 Clear	870 Clear	1090 Clear (U.S., Mexico)	1520 Clear
720 Clear	880 Clear	1100 Clear	1530 Clear
730 Clear (Mexico)	890 Clear	1110 Clear	1540 Clear (Bahamas)
740 Clear (Mexico)	900 Clear (Mexico)	1120 Clear	1550 Clear
750 Clear	940 Clear (Mexico, Canada)	1130 Clear (U.S., Canada)	1560 Clear (Cuba)
760 Clear	990 Clear (Canada)	1140 Clear (U.S., Mexico)	1570 Clear (Mexico)
770 Clear	1000 Clear (U.S., Mexico)	1160 Clear	1580 Clear (Canada)

SKYHOOKS START

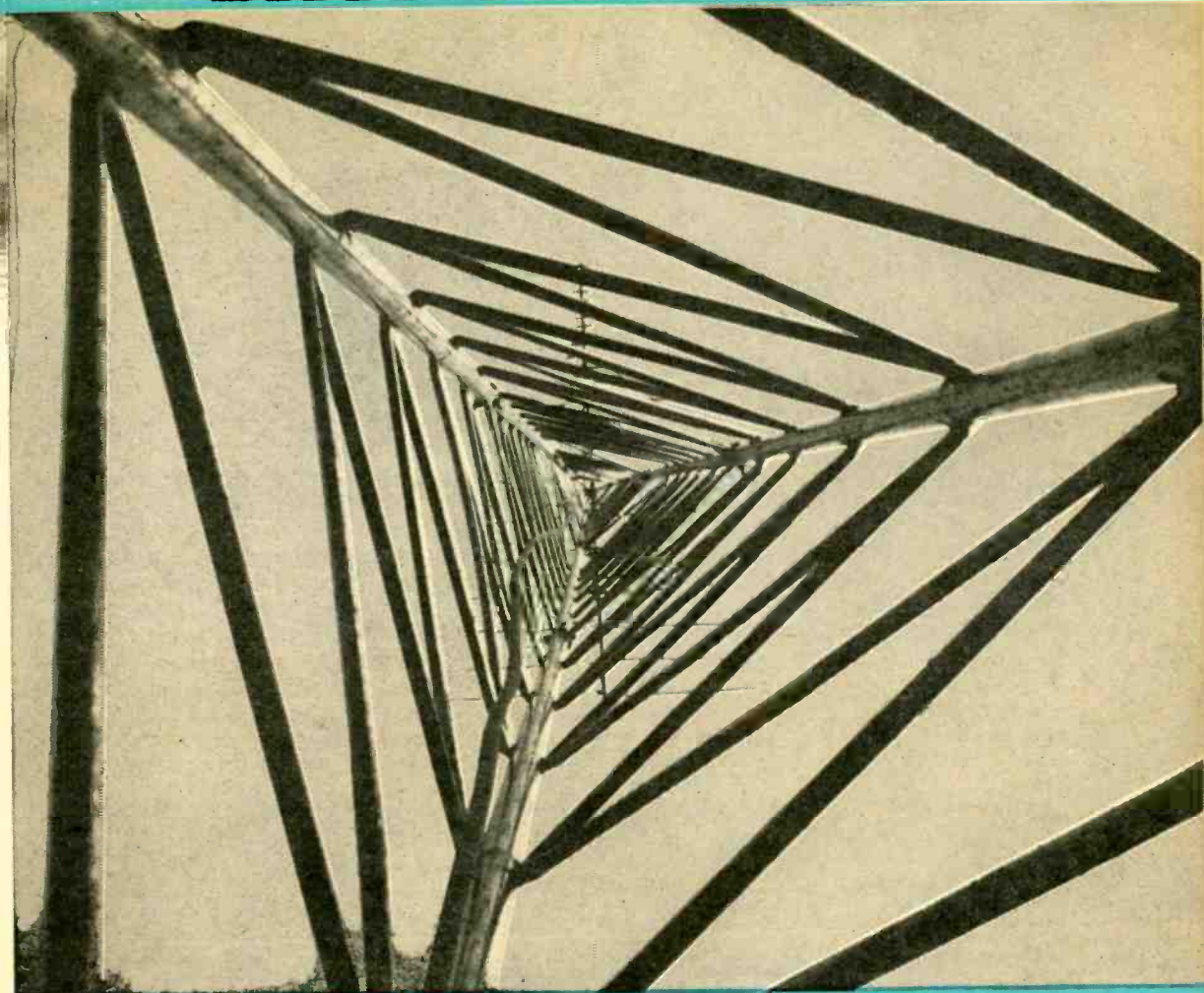

AT GROUND ZERO!

Here's a maintenance free antenna tower you erect yourself...with your feet on the ground

by Peter L. DEXNIS, WA3LOQ—Technical Editor

“HOW CAN I IMPROVE MY TV RECEPTION?” To look for an answer to this key question often asked by readers, let's go to the TV transmitter site. A broadcaster knows that ERP (effective radiated power, a product of antenna gain and transmitter power) and antenna height above average terrain play important parts in his station's coverage area. Broadcasters' antennas must be high because VHF

and UHF wavelengths assigned to TV broadcasters by the FCC cannot travel (propagate, as radio engineers say) much beyond the horizon seen by the antenna. If a broadcaster increases the height of his transmitting antenna, the distance to his “radio horizon” increases and a greater coverage area for his station exists.

We can't do much about ERP at our end,
(Continued on next page)

e/e ANTENNA TOWER



Ascom/Universal aluminum towers come in various heights and wind load factors ranging from 30-ft. with a 35-sq ft. wind load to a giant 90 feet and 2 sq ft wind loading. We selected a 50 ft model delivered as you see it above, telescoped into two packages easily carried by one person. Total weight is only about 97 pounds. Full information on all models is yours by circling No. 76. ▼



Bolt the lower 10 feet of tower to the base and place it in the hole. Be sure tilt direction is common for all base legs and oriented properly as concrete is poured. Here you have a choice. An average tower requires 2 cubic yards or less of concrete. You can mix your own, but having ready mix delivered costs about the same if you consider the cost of renting equipment. ▼



Cut or unwind the wire binding each package and lay out each ten foot section end to end in proper sequence; begin by placing the bottom section where the tower will stand. This checks for enough clearance when you later walk the tower up to standing position. Digging the proper size hole, here a 3 x 3 x 4 foot deep pit, is the most energetic part of your project.

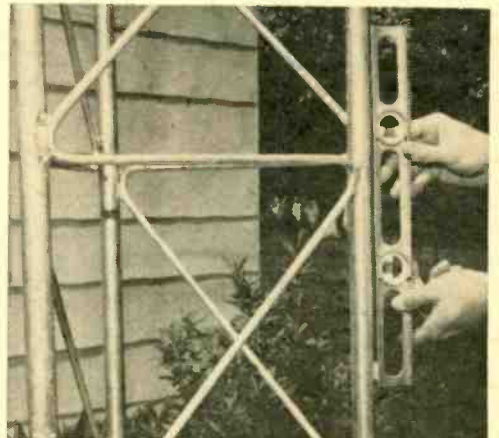

Get it plumb! This very important step insures your vertical dimension. You have a good hour, under normal circumstances, to plumb (make perfectly vertical) the lower 10 feet or tower. Remember it's important to keep the base pivot points three inches above the concrete. Also, be sure to use the 3500 mix concrete for your base. It usually costs no more than a lighter mix.

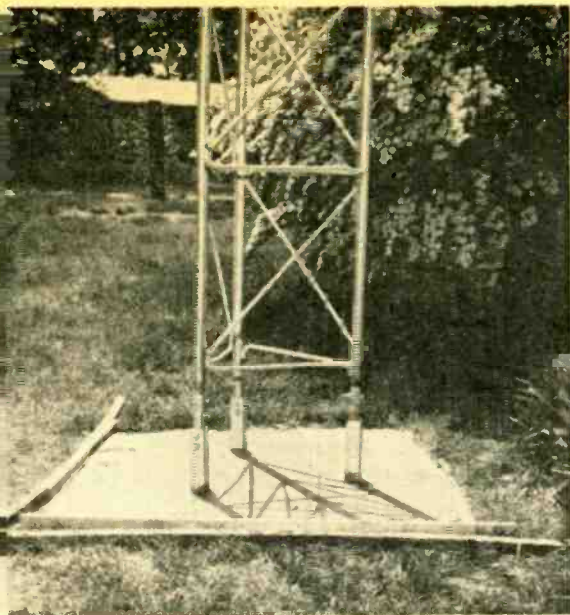

Do a neat job of smoothing the top of your concrete base, and shore up the sides with pieces of flat molding, before or after the concrete has been poured, for neat edges. Remember your first ten feet of tower hold tripod base poles in the correct position during 3 to 4 day wait for the concrete to set. Do not put undue pressure on this first assembly. ▼

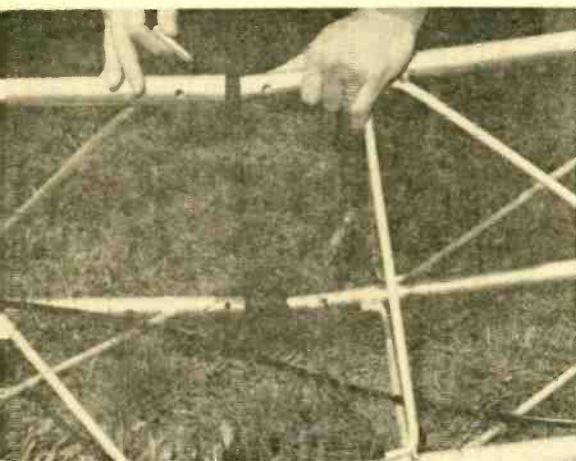

When concrete has set, fit and lock the ten foot upper sections together. Run cable inside tower and fasten your antenna to the upper section with a 5-foot steel pipe. Taping at intervals keeps cable still during windy weather. But be sure to use proper lead in. Do not use 300-ohm ribbon cable. Use only 75-ohm coax—if antenna accepts it—or shielded 300-ohm twin lead.

but if we boost our antenna *height* just a little, we may be able to snag some of his signal as it propagates out into space beyond his radio horizon.

Fortunately, you don't need the kind of height he has to greatly improve your fringe area reception. The broadcaster did most of the work already. Unless you're way down the wrong side of a mountain, a better signal is up there—often just a few tens of feet above the surface—waiting to be grabbed by the electronic tentacles of a multi-element antenna.

Incidentally, there's nothing in the rule book that says you can't mount your Action Band monitor antennas on your tower. You can benefit from the extra antenna height when copying mobile stations on the move. Characteristic flutter on mobile VHF transmissions, coupled with the relatively low power of mobiles, can interrupt reception to the point of "closing over" the signal by your receiver's own squelch. If that's your problem, a thirty foot or more boost to a gain-type antenna can make a big, big difference. Also, as this is being written, there is a docket before the FCC to raise the 20-foot height restriction of CB transmitting antennas to a towering 60 feet! (There's no general restriction, by the way, on CB antennas used for receive only.)

On the following pages we show how easy it is to erect a sturdy ASCOM antenna tower. Based on a simple two-point pivot and aluminum construction, it gives you a tilt-up tower that can be assembled on the ground and "walked up" into position by one, two at the most, people. You can also order tower accessories for roof guyed towers, and rotor mounts to support popular antenna rotators.

Take a tip from broadcasters. Boost *your* antenna and give a natural boost to fringe area reception. And remember, if you're fifty, sixty or more miles from a large metropolitan area—even though you may have a local station or two—there's a good chance a whole 'nother set of channels is up there just waitin' to be plucked! Take a drive through the Northeast section of Philadelphia, PA. You'll see a large number of tall skyhooks and super-fringe antennas pointed to good old NYC ninety miles away. Guess the Mets have some mighty loyal fans even in Philly land! (*More photos next page*)

e/e ANTENNA TOWER

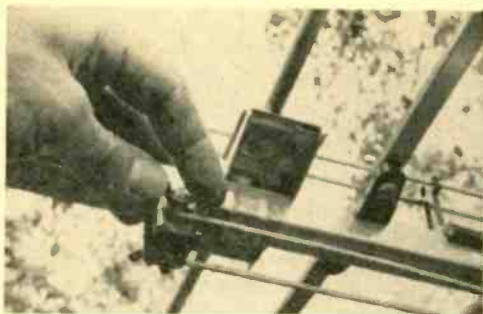

Poor connections at the antenna can make your entire system inefficient. Tighten securely and use tape to remove all pressure from connection.

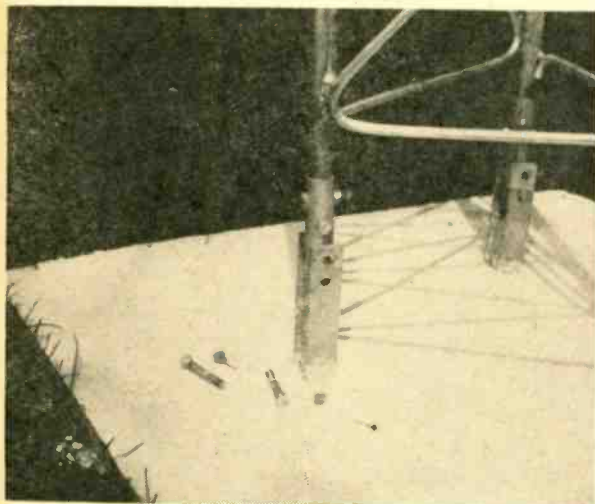

Remove bolt from each front leg and both from rear as shown. Tilt 10 foot section to ground and make final connection to upper part of tower. Walk up tower after orienting antenna in direction of distant station. Replace bolts.

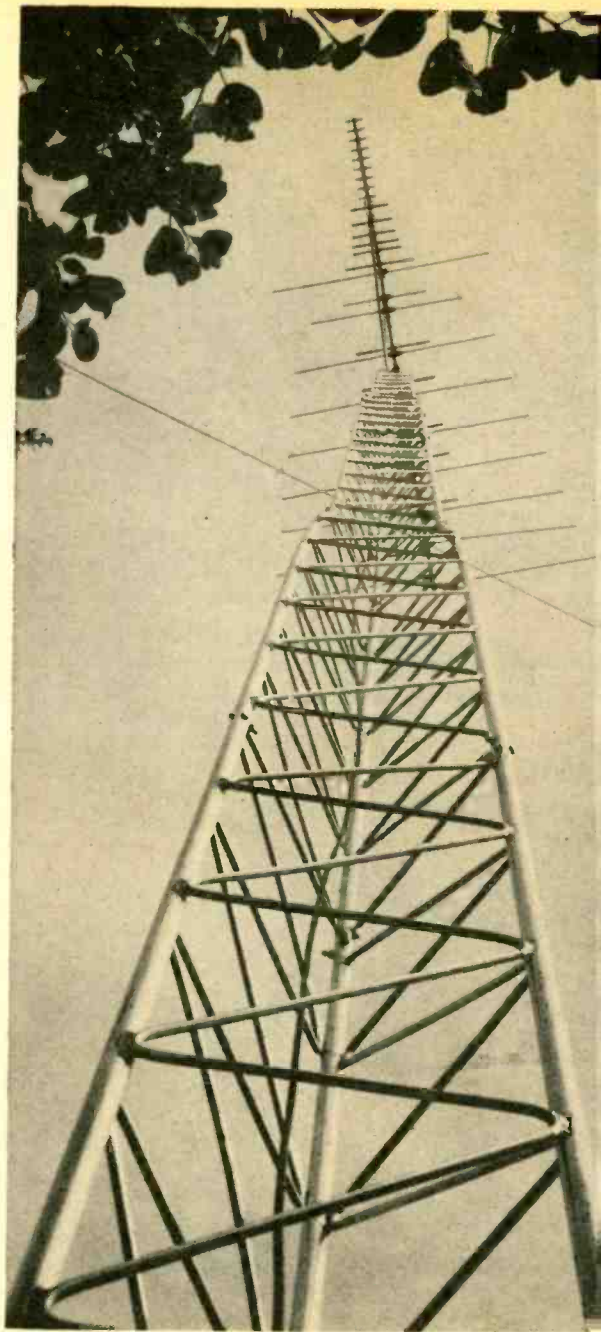
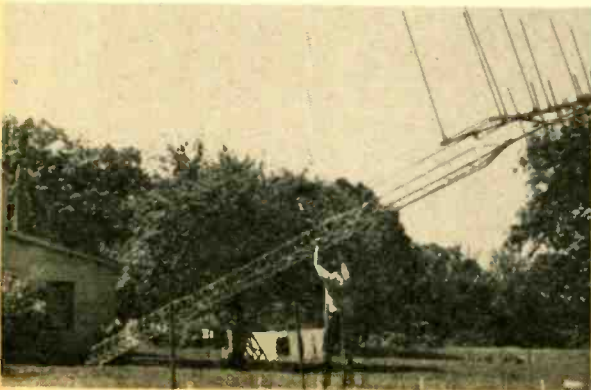

Perched a full 53 feet above ground zero, a long range UHF/VHF TV antenna "looks" over nearby trees to provide full-time reception from transmitters 70 miles away. Antenna model 70-23B is one of the 70 Series color spectrums from Finco. Get more info from Finco, circle No. 75. For more Ascom/Universal tower products info, circle No. 76 on Reader Service page 17 or 103. ■



by Kathi Martin KA10614

KATHI'S CB

CAROUSEL

LISTENING IN to the Citizen's Band often gives a distorted overall picture of what's happenin' now! Hearing pile-ups 10 deep and the sidewinders squawking away with SSB often gives the impression that every CB'er is hot for a full-feature 23 channel powerhouse. But as many letters to "Old Kathi" attest, there is much interest in a rig just for channel 9, or channel 9 with one or two additional channels for car to home communications.

The basic idea, of course, is rock-bottom priced equipment for the (we hope) occasional call for assistance on channel 9. Or, for an infrequent shout back to the house for information. In short, why spend a couple of hundred clams for fantastic performance when all that might be needed is enough electronics for a short range contact? (We fail, quite frequently, to see the trees for the forest.)

The Royce 1-590 is from Royce Electronics Corporation, 1142 Clay Street, North Kansas City, MO 64116. Suggested retail price is \$69.95.

Full power, mini-size plus low initial cost means a great little performer for Channel 9 emergency and RV use. Campers and boaters will find it a fine way to get the safety factor 2-way radio can add to recreation vehicles. For additional info read on, then circle No. 86 on the Reader Service Page.

Well, for those of you want just a channel 9 rig, or something which can carry your voice back to the house from the local shopping center, I've come up with a winner from the new '74 CB transceivers—the Royce Model 1-590.

Heading the list of features of the Royce 1-590 is its size, 2½-in. high x 4-in. wide 6½-in. deep. That's right, actually smaller than many 100 mW walkie-talkies, yet the Royce is a full-5 transceiver. It's so small you can actually tuck it into the smallest glove compartment and close the door, or slip it under the driver's seat. If you prefer the usual under-dash position you can use the supplied mobile mounting bracket. Looking at the front panel you see that operation couldn't be easier. There is a three position *Channel* selector, an *Off/Volume* control and a linear slider-type *Squelch* control. That's the whole bit on the business end. The rig is normally supplied with crystals for channel 9 (Aha!). Because the receiver is single conversion, crystals are

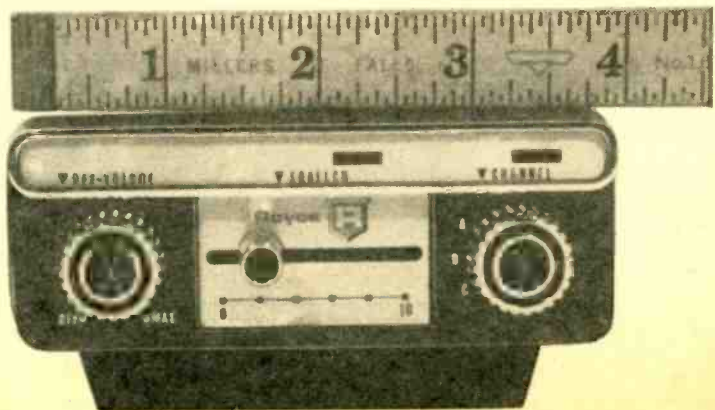

e/e KATHI'S CAROUSEL

available just about anywhere at budget prices for channels you might want to add at a future time.

To add or change crystals you need only remove the four screws that secure the bottom of the case, drop the bottom with its attached speaker and insert the new crystals. A rubber support keeps the crystals in place even though the sockets are upside down.

Once the case is open you'll notice some unusually good construction for equipment so small and inexpensive, which is reflected in the notably good performance (which I'll get to later). First, the modulation transformer is relatively large; it has a lot of *iron*, which is reflected in its excellent modulation. Transistor heat sinks are the extruded industrial type, rather than dinky bits and pieces of metal; jacks are obviously of better quality and the capacitors are the same Mylar type you'll find in industrial equipment. Even the clip terminals used for the speaker wires are heavy duty—they look like they'll carry 10 amperes.

A Big Voice. The receiver section is single conversion with a ceramic filter in the IF amplifier. The sensitivity measured 0.5 μ V for a 10 dB signal plus noise to noise ratio (10 dB S + N/N), and that's a whole lot of sensitivity at any price. The selectivity measured 45 dB adjacent channel rejection—good for a single conversion receiver! Image rejection was 16 dB, similarly good for single conversion, and the AGC action for an input signal range of 2 to 10,000 μ V was a very good 5 dB. Best of all, the output sound quality was excellent, crisp and very clean.

The more or less conventional transmitter

delivered 3.3 watts RF output into 50 ohms. Modulation was limited to 100% and the microphone sensitivity was -13 dB, meaning you have to keep the mike in close or raise your voice for full modulation; but not having super-gain means the background road noise won't grind away under your message.

Power supply requirement for the Royce 1-590 is 12 VDC with a negative ground. The power supply leads are attached, as is the microphone. A fuse holder is integral with the positive battery wire. Extra features include a remote speaker jack and a user adjustable TVI filter.

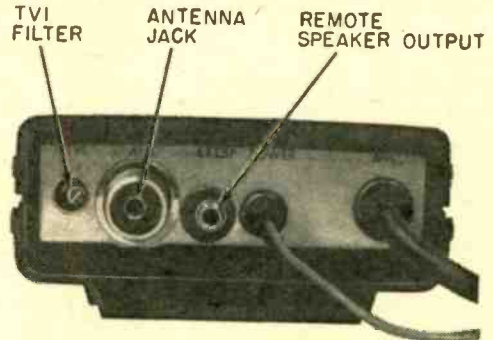

This rig is particularly well suited to a temporary mobile or portable installation with its 2-wire power cable. Some CB sets require a direct chassis ground connection

Summing up. All in all, the Royce 1-590 is a very attractive package for the CB'er needing less than 23 channel coverage. Though its plain black plastic cabinet doesn't look like much, there's a lot of performance packed inside. When we speak of low-cost channel 9 rigs, the Royce 1-590 is the way it should be done. For additional information circle number 86 on the Reader Service Card. ■

This is a 3-channel rig with crystals for channel-9 supplied. Add one or two channels by adding crystals available from CB dealers and mail order catalogs.

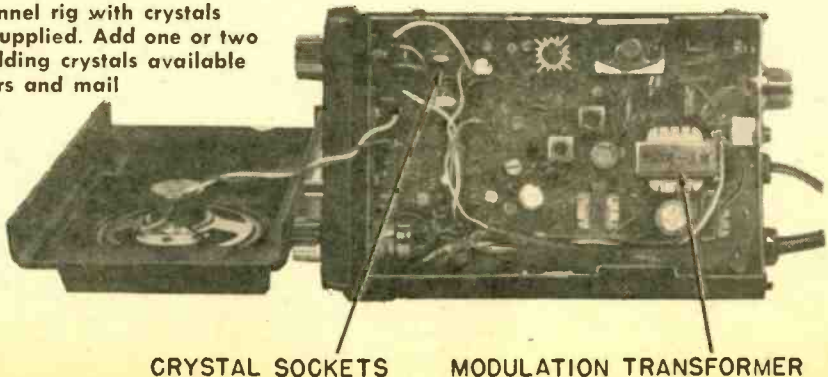

CRYSTAL SOCKETS

MODULATION TRANSFORMER

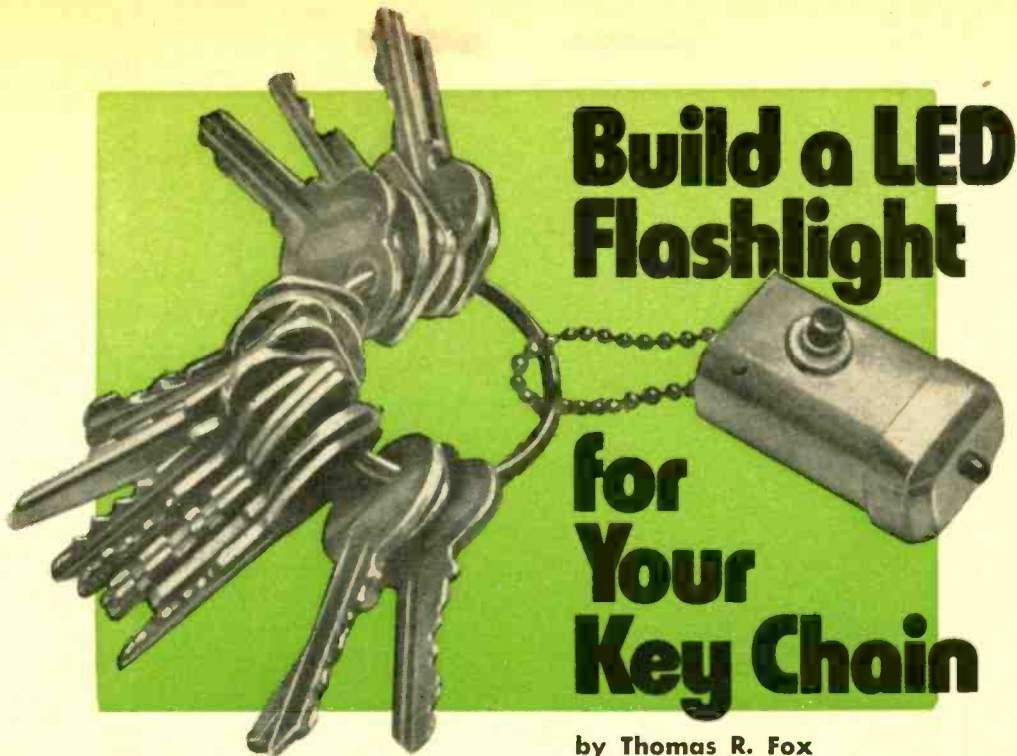

Build a LED Flashlight

for Your Key Chain

by Thomas R. Fox

A miniature flashlight, attached to a key chain, is an extremely useful device. The trouble is, most key chain flashlights use standard filament light bulbs, which are notorious current hogs and have rather short lifetimes. Because of its minute size, almost unlimited lifetime and very low current consumption, the LED (Light Emitting Diode) is, to date, the best device to use in such a flashlight.

The LED is a revolutionary new solid state lighting device that has no filament to heat up and burn out. Instead, it produces a 'cold light' like fireflies do. It is basically a forward-biased diode composed of gallium arsenide instead of the more usual silicon or germanium. Since it generates most of its

light in a narrow bandwidth, the LED is only a step away from being a LASER. Also, its nearly monochromatic properties, the color of the LED is quite unusual and many have a rubylike appearance. See light chart.

Many types of LED's are suitable for such a miniature flashlight. Motorola's MLED600 is a good choice to use in a miniature flashlight since it provides a high light output at a low voltage—1.55 volts is enough to turn it on.

The power supply B1, for the device is two 1.35-volt mercury button cells connected in series to give a total voltage of 2.7 volts. This voltage is then dropped to 2.3 volts by the addition of a 15-ohm resistor. With normal use, these mercury cells should

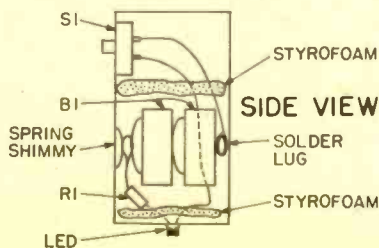

PARTS LIST FOR LED FLASHLIGHT

- B1—1.35-VDC mercury button cell, 2 required (Radio Shack 23-1515, Mallory RM-635TR2, or any pair of cells thin enough to fit the plastic toothbrush tube you use)
- LED—Motorola MLED600, HEP-P2000 (Radio Shack 276-026 or equiv.)
- R1—15-ohm, 1/2-watt resistor (Radio Shack 271-000)
- S1—Subminiature, momentary-contact s.p.s.t. pushbutton switch (Radio Shack 275-1547)
- Misc.—Toothbrush plastic container, solder lugs, wire, styrofoam, silver paint, etc.

e/e LED FLASHLIGHT

The visible light spectrum shows the colors we see and the narrow band of light the LED generates.

last at least a year. Assuming 20 seconds of use a day, the batteries in the LED flashlight might last as long as their shelf life.

Building It. The case for the LED flashlight can be made from the plastic container in which a toothbrush comes. Either the heavy-weight plastic container or the flexible one can be used.

Cut this plastic container 1¼-in from the bottom and save the cover. You now have the case.

Follow the wiring diagram to complete construction. Styrofoam is used as an insulating material and the specified piece of sheet metal is used as a spring shimmy to get a good connection between the solder lugs and the batteries. Since you can't solder to the batteries directly, pressure contact is required.

Before fastening the cover, check out the flashlight to see if everything is working properly. If the LED lights when the switch is pressed, fine; if not, reverse the batteries or solder lugs. LED's, unlike common incandescent lights, are polarized. If it still doesn't work, check battery contacts, mercury cells, switch and LED in that order.

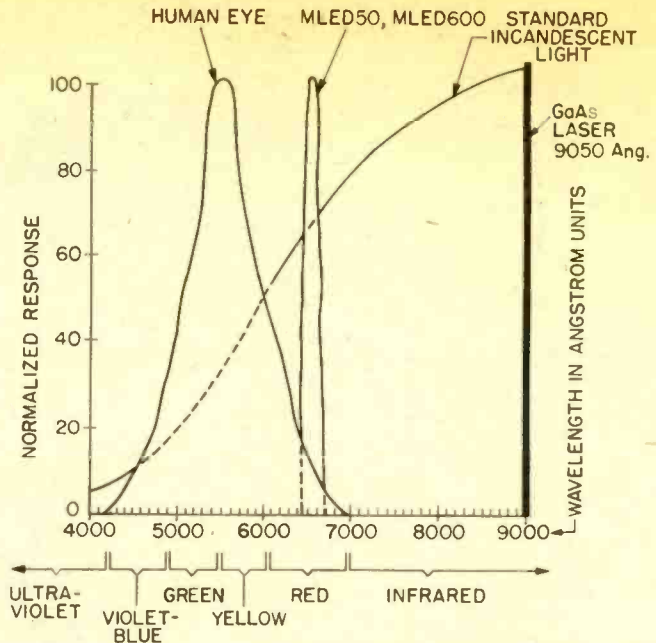

If everything works okay, finish construction by drilling a small hole in the cover. Put a small piece of styrofoam between the batteries and LED. From the inside of the cover, stick the LED through the hole you drilled. Fasten the cover (it might need to be cut down to size) to the case using small sheet metal screws (or even glue, since the batteries rarely need to be replaced). To appear professional, paint the plastic case with aluminum paint. For the final touch, drill two small holes in the bottom of the case and string a key chain through the holes.

Total cost of this ultra-modern miniature flashlight can be as low as \$3.50 including batteries, and it weighs less than 0.5 ounce. ■

Quicky Vacuum-Tube Filament and Continuity Checker

□ Most tube failures are caused by open filaments, so you can save a lot of time when troubleshooting radios and TV sets by using this instant tube checker. Simply plug a tube into the matching socket; if the filament is

okay, lamp I1 will light. If you have any odd-ball tubes that use sockets other than the standard three shown, simply build them into the checker. The continuity test leads allow you to check TV picture tubes. ■

PARTS LIST FOR TUBE CHECKER

- B1—6-VDC lantern battery (Radio Shack 23-066 or equiv.)
- I1—#40 pilot lamp (Radio Shack 272-1128 or equiv.)
- SO1—8-pin octal socket (Allied Radio 713-2810 or equiv.)
- SO2—7-pin socket (Radio Shack 274-1511 or equiv.)
- SO3—9-pin socket (Radio Shack 275-1512 or equiv.)

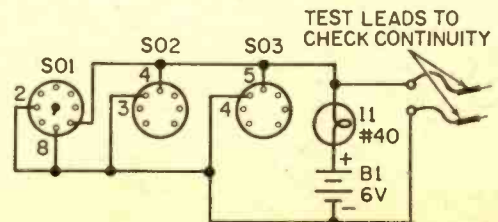

BUILD THIS VERSATILE SOLID-STATE DARKROOM/KITCHEN TIMER . . .



UNIVERSAL POWER TIMER

Switch up to 300 watts to a photo enlarger or use a built in buzzer to time a 3-minute egg!

by C. R. Lewart

THE PROJECT described here should result in an extremely versatile darkroom timer with features not available even in commercial units. The timer can be used to turn on your enlarger for a specified number of seconds; it can also be used as a kitchen timer to sound a buzzer after a specified time has elapsed. The timer has a number of convenience features, such as cycle interrupt (RESET), manual override (MAN/AUTO), optional buzzer (BUZZER ON), touch setting (START) and selection of three timing ranges. These features should make this simple-to-build inexpensive timer a welcome addition to your dark room.

Here now are the main features of the timer in more detail. The solid-state design without relays does away with contact arcing problems. When the timer is set for a specified time period, the time-set control does not have to be returned to zero for subsequent use as is the case with some mechanical timers. Thus, the timing cycle is exactly reproducible!

The touch of a ring on your finger (a push button is optional) will start the timer. This method of operation prevents any shaking of the enlarger. The timing cycle can be set in the following three ranges which are the most convenient for photographic work: 0 - 15 seconds (normal enlarger timing), 0 - 150 seconds (special enlarger timing), 0 - 20 minutes (developer and fixer timing).

One mode of the operation of the timer is to have the enlarger light on *during* the timer cycle. Another mode of operation, se-

e/e UNIVERSAL POWER TIMER

lected at the flip of a switch, is to energize a built-in buzzer *after* a specified time period has elapsed at the end of the timing cycle.

The timing cycle can be interrupted and reset to zero with a push-button switch. A

separate switch (*Manual/auto*) connects ac power directly to the enlarger outlet thus bypassing the timer while you focus and plan your burning and dodging.

How Does It Work? The brain of the timer is a recently developed integrated circuit. This circuit consists of 23 transistors and over a dozen resistors and diodes. The timing cycle is determined by the external resistor R2 and the capacitors C2 through C4, where the timing cycle in seconds equals approximately the value of the resistor in megohms times the value of the capacitor in microfarads, times 1.5. The output of the integrated circuit (Pin 3) is normally low (at the ground potential); it is high (at the positive battery potential) during the timing cycle. The low current buzzer is operated directly from this output to battery plus. The same output also operates a light coupler to ground potential. The coupler consists of a low voltage, low current lamp and a photo cell in one envelope. When the output of the IC is high, the lamp lights, the photocell lowers its resistance, and the Triac conducts the ac power to the

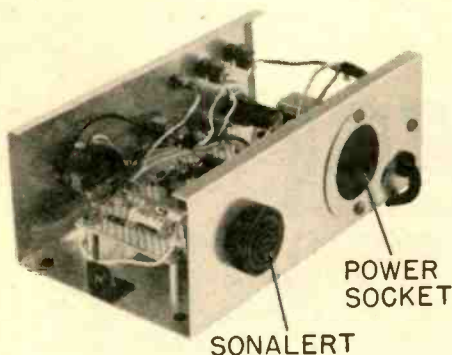

This all electronic timer uses no relays to switch up to three hundred watts AC.

POWER ON (S1)
APPLY PRIMARY POWER TO UNIT THEN PUSH RESET BUTTON TO CLEAR ANY POSSIBLE RANDOM START COMMAND.

MANUAL (S2)
OVERRIDE TIMER CIRCUIT AND APPLY POWER DIRECTLY TO SOCKET ON REAR OF UNIT.

AUTO (S2)
NORMAL OPERATING MODE (TIMER CONTROLS POWER APPLIED TO SOCKET AT REAR OF UNIT).

START (TP1)
TOUCH WITH RING OR PAPER CLIP TO BEGIN SELECTED TIME DELAY. IF S4 IS "ON" BUZZER WILL STOP UNTIL SELECTED TIME HAS PASSED. WITH S2 IN "AUTO" POSITION, POWER SOCKET IS ON FOR DURATION OF TIME PERIOD.



BUZZER ON (S4)
ENABLE AUTOMATIC SONIC ALARM TO SOUND AT ALL TIMES EXCEPT DURING "TIME DELAY" PERIOD.

RESET (PB1)
PUSH THIS BUTTON TO STOP A TIME DELAY PERIOD AT ANY TIME DURING THE CYCLE.

RANGE (S3)
SELECT DESIRED TIME DELAY SCALE.

TIME DELAY
TURN KNOB TO YOUR DESIRED TIME DELAY: ONE SECDND TO TWENTY MINUTES.

enlarger outlet.

Transformer T1 with the diode bridge BR1 and capacitor C1 provide the dc voltage for the integrated circuit. The switches S1 through S4 select the timing range and the various options. Switch S5 can be added in place of touch-to-start if you wish.

Construction. The unit as constructed by the author fits comfortably in a 8-in. x 3-in. x 5-in. cabinet. If you select the touch option for starting the timer, make sure the case is grounded and that you use three-

conductor cable for the ac connection. (The green "neutral" wire is connected to the chassis.) The touch button consists of a metal jack insulated from the cabinet. Body pickup should be sufficient to start the timing cycle. If you plan to use two-wire ac plugs and cables, use the pushbutton option for starting the timing cycle.

Electronic components fit on a 3-in. x 4-in. piece of perf board. We recommend using a socket for the IC. The Triac can handle a 300 watt lamp without a heat sink.

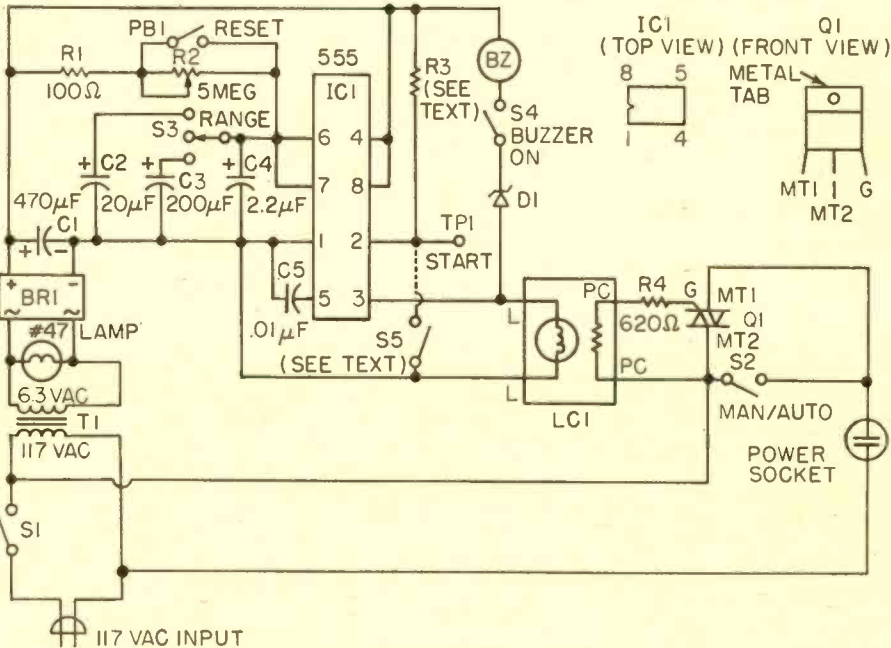

PARTS LIST FOR UNIVERSAL POWER TIMER

- BR1—Bridge rectifier, ½-amp or better (Radio Shack 276-1151 or equiv.)
- BZ—Buzzer, low current sonalert, Mallory type SC628 (Allied Radio 854-6502)
- C1—470 or 500 µF, capacitor, electrolytic, 16 to 55 VDC (Radio Shack 272-1030 or equiv.)
- C2—20 or 22 µF, capacitor, electrolytic, 10 to 50 VDC (Radio Shack 272-953 or equiv.)
- C3—200 or 220 µF, capacitor, electrolytic, 10 to 50 VDC (Radio Shack 272-9560 or equiv.)
- C4—2 to 2.2 µF, capacitor electrolytic, 10 to 50 VDC (Radio Shack 272-1040 or equiv.)
- C5—0.01 µF, capacitor, 50 VDC or better (Radio Shack 272-1065 or equiv.)
- D1—Zener diode, 3 to 4 volts, ½-watt (Radio Shack 276-620 or equiv.)
- IC1—Integrated circuit timer, Signetics 555 type (Radio Shack 276-1722 or equiv.)
- L1—Pilot light for 6.3 VAC such as Radio Shack 272-318 with No. 47 bulb.
- LC1—Light coupler, Sigma 301T1-6B1 (available

- from Allied Radio, their number 917-1417)
- PB1—Pushbutton, normally open (Radio Shack 275-1547 or equiv.)
- Q1—Triac, GE SC141 type, 200-volt, 8-amp (Radio Shack 276-1084 or equiv.)
- R1—100-ohm, ½-watt resistor (Radio Shack 271-000 or equiv.)
- R2—5-megohm potentiometer, linear taper (Allied Radio 753-8193 or equiv.)
- R3—33,000 to 470,000-ohm, ½-watt resistor, see text (Radio Shack 271-000 or equiv.)
- R4—680-ohm, ½-watt resistors (Radio Shack 271-000 or equiv.)
- S1, S2, S4—Switches, SPST (Radio Shack 275-324 or equiv.)
- S3—Switch, center-off, SPDT (Radio Shack 275-325 or equiv.)
- T1—Power transformer, 117 to 6.3 VAC, 250 mA or better (Radio Shack 273-050 or equiv.)
- Misc.—Knobs, cabinet, single flush-mounted grounded outlet, wire, solder, etc.

e/e UNIVERSAL POWER TIMER

If you plan to use a larger lamp, use a heat sink. Make a dial out of a piece of white cardboard with three concentric circles for the three timer ranges.

Calibration. Calibrate the three timer ranges separately. Use a stopwatch or a watch with a second hand. Make marks on the dial with a pencil to indicate minutes and seconds.

If you use the touch option to start the

timer, choose the value of R3 between 33K and 470K. A larger resistor will make the starting button more sensitive to the touch, however, if the sensitivity is too high, the timer may start unexpectedly when there is a "spike" on the ac line. We found the value of 47K best (this value should also be used for the push-button option). The "touch" sensitivity is then such that the starter will not operate if your finger is dry, but if you wet your finger, or even better, if you touch the button with a metal object (coin, key chain, ring, etc.) the timer will start reliably. ■

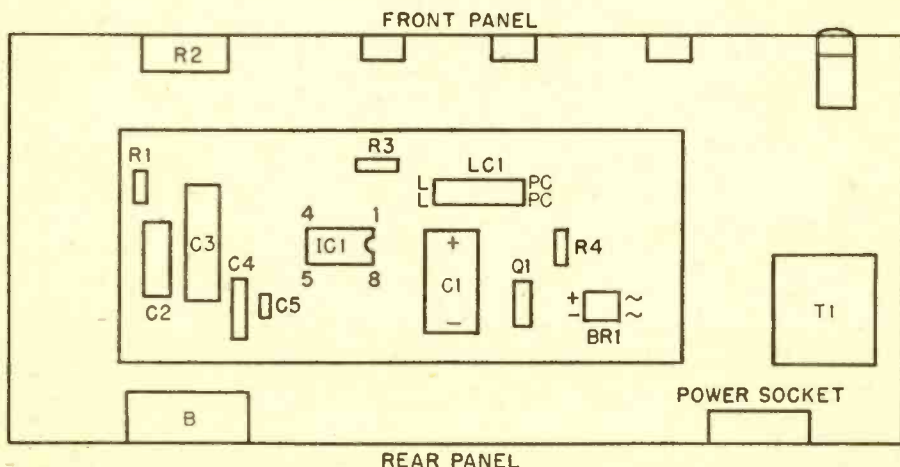

Component layout of the author's timer is shown in drawing and photograph. Place front panel switches according to photo on the second page of this article.

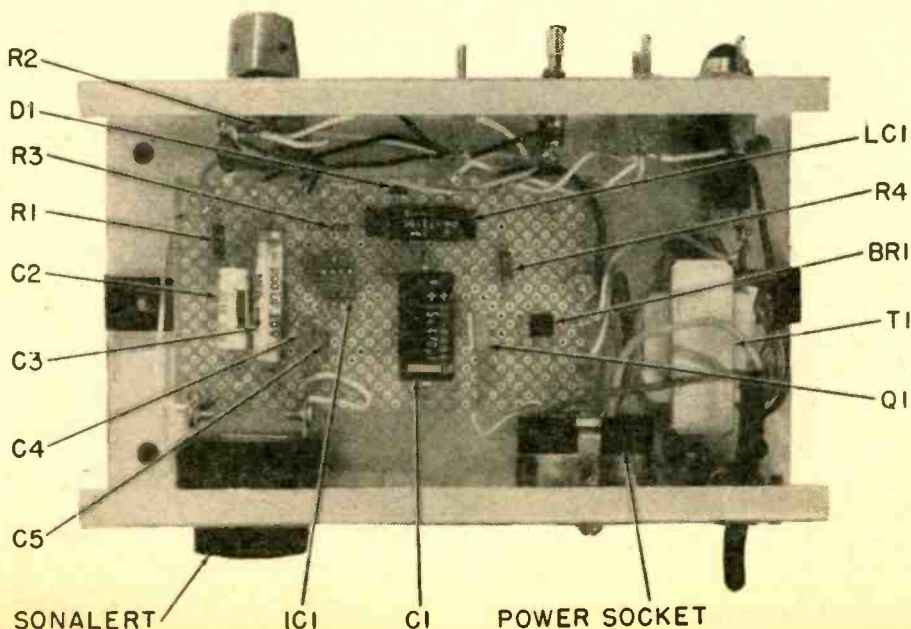

Four Ways To 4-Channel



◀ Pioneer's QX-646 receiver can decode and reproduce all current 4-channel sources, with a built-in CD-4 demodulator as well as RM and SQ matrix decoding circuitry. In 4-channel mode, the rating is 10 watts continuous power per channel; \$499.95. Circle No. 87 on the Reader Service Page.

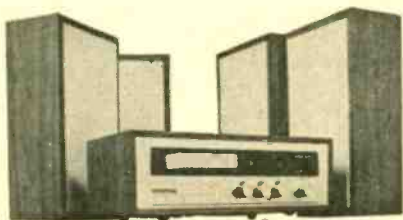

◀ The Dokorder MS-70A is a 4/2-channel 8-track cartridge tape player system, plays either 4-channel or 2-channel cartridges automatically, and has a repeat switch that automatically repeats a program until released. The four speaker systems each contain a 5-inch full-range cone-type speaker, and are about 14¼ inches high; \$149.95. Circle No. 88 on the Reader Service Page.

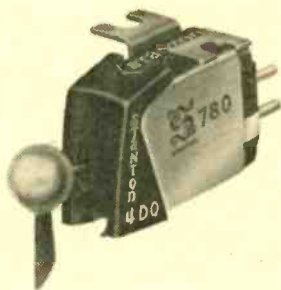

◀ From Stanton, the 780/4DQ discrete 4-channel phono pickup has the new Quadrahedral stylus, which reduces record and stylus wear with a shape that allows for the proper scanning radius. The frequency response is 10 to 50,000 Hz, the channel separation 35 dB, the tracking force 1 to 3 grams, and the price \$125.00. Circle No. 89 on the Reader Service Page.



◀ Akai's GX-280D-SS is a professional-grade 4-channel tape deck with two speeds (7½ and 3¾ ips), and four GX glass and crystal heads with a focused field that permits making high-density recordings. A repeat circuit permits automatic reverse and continuous 4-channel playback. The GX-280D-SS is \$799.95. Circle No. 90 on the Reader Service Page.

Build your own Bell & Howell solid-state 25-inch diagonal color TV!

It's an enjoyable way to learn valuable skills in the exciting new field of *digital electronics* and also get a brand-new color TV you build yourself! For free information, mail the postage-free card today!

Enjoy the personal satisfaction of building your own color TV

It's not an ordinary accomplishment. You can take pride in it because you did it all yourself. And you'll find *digital electronics* a fascinating world to explore. It's an absorbing way to spend your spare time . . . tinkering with the equipment . . . reading up on electronic principles . . . and finding out how they work in practice.

Not just a kit—a complete at-home learning program in home entertainment electronics

Skilled instructors at Bell & Howell Schools have carefully prepared a program that starts you off with the basics and guides you smoothly through the course with step-by-step instructions. You'll enjoy the challenge of learning something new that could lead to extra income opportunities for you.

Attend special "help sessions" ... talk to your instructors in person

A unique advantage of your learn-at-home program is the "help session." Scheduled regularly at Bell & Howell Schools and in cities around the country, these informal seminars give you face-to-face, personal assistance from our instructors. You'll meet other students and enjoy talking shop.

Master the most up-to-date solid-state and digital technology

As color TV moves closer toward total solid-state, and as the more accurate and reliable digital systems begin to appear in home entertainment gear, you'll be thoroughly familiar with the most

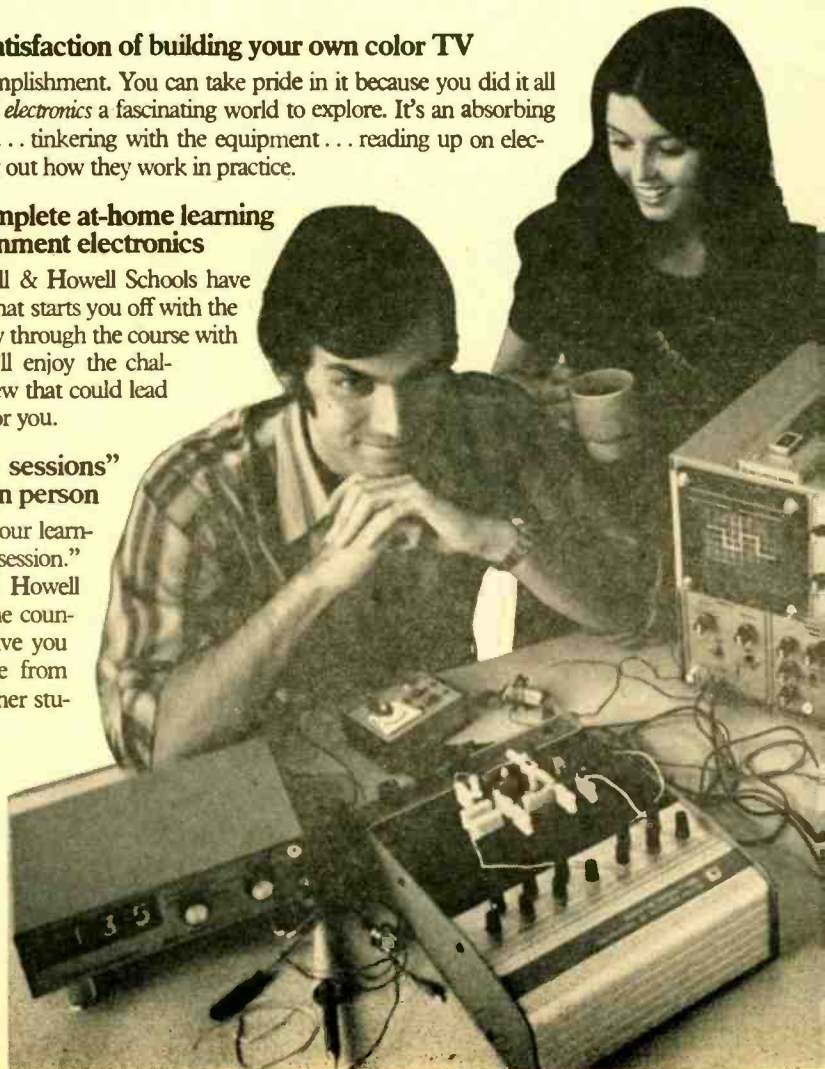

advanced troubleshooting techniques for these sophisticated circuits.

Digital electronics is growing everyday — and you can cash in on it!

Digital clocks and pocket calculators are already on the market. Soon, everything from speedometers to stereos to kitchen stoves will have digital readout and control systems in place of conventional dials and needles. During your program, you can gain the know-how to build, service or repair this new digital equipment, part-time or full-time!

You also build and keep the NEW Electro-Lab® electronics training system

Three professional instruments . . . a digital multimeter, design console and solid-state oscilloscope designed exclusively for Bell & Howell students . . . provide you with necessary practical experience during your program. It's the equipment you need to successfully analyze and master the principles of today's digital technology.

Earn extra income part-time or get ready for your own service business

We'd like to tell you more about this fascinating *digital electronics* program — and how it can lead to a promising future — full or part-time. Mail the attached card today and get all the facts.

NEW from Bell & Howell Schools . . . first time ever offered!

When you build your color TV, we include a complete volume on the "Guidelines For Starting Your Own Repair Business." It gives you all the basics including setting up shop, basic bookkeeping and income tax, small business legal requirements and customer relations. It's just another way we can help people get going in electronics.

FOR FREE INFORMATION, MAIL CARD TODAY!

If the card has been removed, write: *An Electronics Home Study School*
DeVRY INSTITUTE OF TECHNOLOGY

ONE OF THE
BELL & HOWELL SCHOOLS
4141 Belmont, Chicago, Illinois 60641

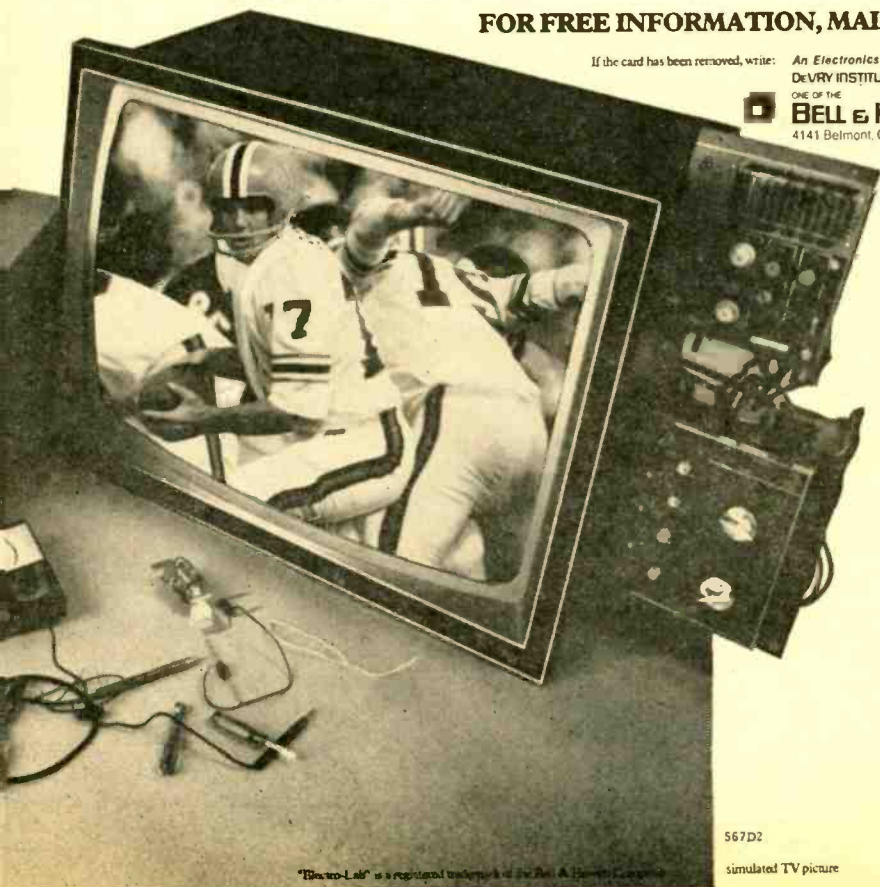

567D2

simulated TV picture

"Electro-Lab" is a registered trademark of the Bell & Howell Companies

NOTHING TO SPITZ AT!



Swimming coach remains dry as he shouts in aquanaut's ear!



BY JOE GRONK

THE latest in "far out" electronics communications systems is a novel underwater radio link between an English swimming coach and his Olympic trainees—while they are actually in the water, or even under it! The system is being used at the Southampton Swimming Club, where Britain's entries in the Olympics undergo arduous training. When in use, a loop of special cable is laid around the inside of the swimming pool, and the two ends of the cable are connected to a transmitting amplifier powered by a 12-volt battery. Each of the swimmers wears a close-fitting headset which contains a miniature audio amplifier to which two small earphones are attached. The headset is made of soft plastic, and provides a minimum of inconvenience to the wearer.



This system enables the coach to transmit clear information to his trainees all the time that they are within the perimeter of the loop cable—whether above or under the water. As the system does not use VHF or normal radio signals, but instead works from the inductive loop around the pool, there is no interference. The success of this device has inspired planning for other uses: firemen, sprinters, and jockeys! ■

Swimmer's headset (top) contains amp and loop of wire in headband. Coach (below) uses audio amp to maintain contact.

e/e checks out the...

Leader LSG-231 FM Stereo Signal Generator



QUALITY grade service on hi-fi receivers and tuners requires what is essentially a lab-grade stereo signal generator, one whose level of performance is at least equal to the best in stereo receivers, if not better, for it is impossible to perform a proper checkout and alignment if the service generator's performance is less than that of the receiver. And facing facts squarely, for the past few years even the so-called budget FM receivers and tuners have far outclassed the standard service-grade stereo generators.

But the necessary lab-grade signal generators are expensive—well beyond the means of the average audio experimenter and technician; at least they were expensive until the introduction of the Leader Model LSG-231 FM Stereo Signal Generator.

Priced at only \$299.95 the Leader LSG-231 has turned out to be the surprise of the year as far as a test equipment is concerned. With a total cost of well under the usual \$1000 for a lab-grade generator—and even lower in cost than some outdated but still sold service-grade FM generators—the LSG-231 delivers a performance level that would be accepted in any lab, service or R&D.

The Leader LSG-231 FM Stereo Signal Generator is from Leader Instruments Corp., 37-27 27th Street, Long Island City, New York 11101 and sells for \$299.95. For more information, circle No. 77 on Reader Service Coupon.

What It Is. The LSG-231 is basically a miniature FM transmitter (or station) with all the signal sources needed for complete check-out and adjustment of stereo FM and SCA receivers. (Yes, SCA equipment too.)

To start, an internal 1,000 Hz oscillator is used to provide basic stereo composite signals (which can be fed to an external standard signal generator) of *Left, Right, L + R* (mono), *L - R*, or 67 kHz (SCA). In addition, the SCA subcarrier can be modulated by an external signal source (test tone or program) through a jack on the rear apron.

The 19 kHz pilot signal is controlled by a front panel switch and has its own output jack which is used for alignment purposes (a very important feature we'll get to later).

For those who want to test stereo receivers with a stereo program or other test frequencies besides 1 kHz, there are independent *Left* and *Right* external modulation jacks and a *pre-emphasis selector*. The external modulation can be applied "flat" (no pre-emphasis), with 75 *usec.* pre-emphasis (standard American), or with 50 *usec.* pre-emphasis (European).

Built into the LSG-231 is a 100 MHz ± 1 MHz oscillator that can be modulated by any of the internal signal sources: stereo, mono, 67 kHz SCA unmodulated or SCA

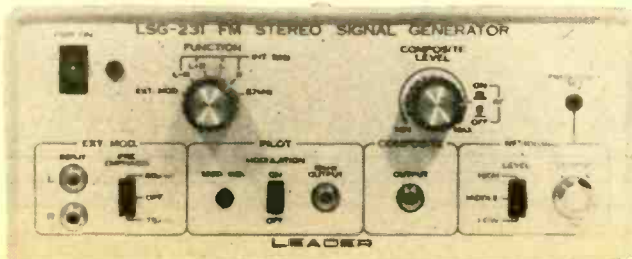

A lab and service instrument of extreme quality, it easily exceeded our own lab's test generator for stereo separation across the full 50 Hz to 15,000 Hz audio bandwidth. With a built-in RF oscillator it's actually a miniature FM stereo station when external audio modulation is applied.

LEADER STEREO GENERATOR

with modulation. The oscillator's output is fed through a three-level attenuator to a BNC output connector. A matching output cable is terminated in a special matching device that provides 75 and 300-ohm output impedances terminated or unterminated.

What Makes It Great! Now all these features might sound like nothing's new, for many stereo generator's have more or less the same features (except for the SCA modulation). What makes the LSG-231 so outstanding is that complete calibration can be done by the user with only service grade instruments. For example, the most important part of a stereo generator is the phase match between the 19 kHz pilot and the 38 kHz subcarrier, generally a formidable adjustment procedure. But the LSG-231 has special oscilloscope phase correction built in: you simply make connection from the indicated jacks to virtually any type of scope, rotate the indicated control for a straight line on the CRT and the scope is calibrated. Flip a switch and two loops appear on the CRT. Adjust the modulator phase control so the loops cross (as we show in the photographs) and the generator's phase is calibrated. It is simple as that—two to five minutes at most.

The other adjustments are similarly as easy. For example, let's assume you haven't used your LSG-231 for a while and you're not certain it's in calibration. Just connect an ordinary audio voltmeter to the composite output jack, flip a switch and check for 10 mV rms pilot signal. If it's off, just turn a trimmer for 10 mV. Similarly, the composite output is checked for 1 V rms. Note that all checks and adjustments are nice *round* numbers—you're not stuck with an adjustment like "1.21 times the output

voltage", or something equally as confusing.

Simple All the Way. Simplification of voltage outputs is also carried throughout the rest of the instrument, with internal pads being used to provide the correct operating voltages—in this manner the user isn't bogged down in oddball values. For example, the external *L* and *R* input jacks take a 100% modulation reference level of about 1 V rms, the SCA modulation is about 150 mV rms for 7.5 kHz deviation—there are no oddball voltage values.

The operating control layout is similarly well thought out, with all connectors and switches sectionalized on the front panel so you cannot inadvertently reach for the wrong control. Even the small frequency set trimmer for the FM oscillator is marked into the RF section.

Performance Plus. But features alone are not enough for the payoff must be in performance, and that's where the Leader LSG-231 really stands out. To say the performance was *good* would be an understatement—the performance in all modes is outstanding. To start off, the stability is almost phenomenal. Set the rf oscillator frequency after a short warm-up and it stays right on frequency with no discernable drift. Similarly, the stereo separation and phasing adjustments were as good after two months use as the day we got it in. The 67 kHz SCA subcarrier is within 20 Hz, a lot better than the specified 5% tolerance. The internal 1 kHz oscillator can be used as an audio test signal through its associated output jack,

(Continued on page 95)

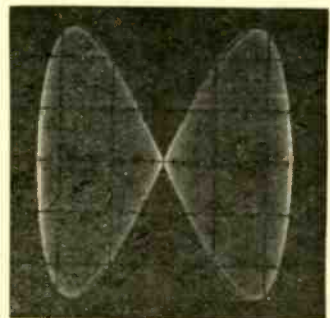

Best separation is obtained when modulator adjustment is set for overlap of two loops at their baseline. Built in scope alignment circuits can be used with oscilloscopes of general service grade quality.

e/e checks out the...

DUAL 701 SINGLE-PLAY AUTOMATIC TURNTABLE



DUAL has been one of the leading manufacturers of high performance automatic turntables for many years. And though Dual automatics were basically record changers, a manual mode was secured by replacement of the automatic elevator spindle with a short *single-play* spindle. The true hi-fi purist, however, has no need for automatic operation, for he wouldn't be caught dead grinding one LP into another when the records drop, so it was only a matter of time before Dual offered a single play turntable specifically intended for the connoisseur.

Feature Packed. In the single-play Dual 701 we still find the features common to all the high performance Dual turntables: the micrometer adjust tonearm counterweight, the finely, and accurately, calibrated stylus force gauge (0-3 grams), the anti-skate force adjustment calibrated for both conical and elliptical styli, the plug-in pickup shell with matching overhang gauge, a tonearm lift and a pitch control providing approximately 8 percent speed variation. To all these common features, however, Dual has added two big pluses; the first is a built in strobe on the underside of the platter which is under full-time illumination and mirror reflexed to the top deck where it is continuously displayed in a prism viewer; the second, and much more important plus-feature—particularly in these times of abominable electric service—is an electronic speed-controlled motor providing 33 and 45 rpm at the flick of a switch.

Though the Dual 701 is a single play turntable all the automatic features of their "record players" have been retained. Move the tonearm off the rest and the motor starts. Move the arm back to the rest and the motor stops. For full automatic operation simply

move the start-stop level to start: the motor starts, the arm moves from the rest, lowers to the record and plays to the end. At the end of play the arm rises, returns to its rest and the motor turns off . . . completely automatic.

All operations are controlled by two levers located in front of the pickup: one lever is the start-stop selector, the other lever selects the 33 or 45 motor speed and sets the tonearm indexing to 7 in. for 45 rpm and 12 in. for 33 rpm. Concentric with the center of each lever is a small knob (two knobs total) that serve as the pitch controls, one for 33 and one for 45.

One feature sure to go unnoticed by the average user is what appears at first glance to be a rather convoluted tonearm counterweight, looking somewhere between a lobster trap and a space vehicle lying on its side. According to Dual, this counterweight incorporates two mechanical filters which damp the tone arm resonances.

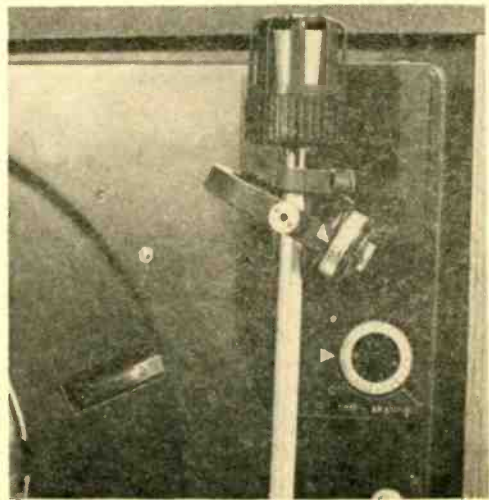

Outstanding Dual features we liked are the automatic electronic speed control, this mechanically damped tonearm counterweight.

The Dual Single-Play Automatic Turntable is distributed by United Audio, 120 So. Columbus Avenue, Mt. Vernon, New York 10553, and sells for \$350.00. For more information on the 701, circle No. 80 on the Reader Service Coupon.

e/e DUAL 701 TURNTABLE

Looking Inside. Getting back to the electronic speed control: removing the player's base exposes a somewhat massive electronic assembly which takes up a substantial part of the underside of the deck. Fact is, there is no motor to be seen, only a crescent shaped plastic housing for the electronics, which turns out to be the back of the motor. Unlike conventional AC motors which rotate at high speeds and must be coupled to the platter by speed reducing gears, pulleys or belts, the Dual 701's motor rotor itself rotates at the selected speed of 33 or 45. In this manner the platter is driven directly by the motor without the flutter generation caused by speed reduction devices. (The platter sits directly on the motor rotor.)

The motor is a DC type, receiving its drive energy from a regulated power supply. Sensing devices attached to the rotor trigger switching semiconductors which produce a rotating electric field in the motor's field coil. Any attempted variation in motor speed is instantly (and continuously) corrected by a feedback network so that a fixed speed is maintained regardless of the load on the platter or variations in the applied line voltage. (Just imagine how this would have paid off during last summer's brownouts when many turntables slowed to a virtual crawl—this cannot happen with the Dual

701, which keeps running on-speed regardless how badly the local electric utility louses up the service voltage.)

Two standard potentiometers are on the other end of the 33 and 45 pitch control knobs, and they provide electrical correction to the speed control circuits to obtain the desired 8 percent *off-speed* values.

Performance is AAA. Our first test was the electronic speed control, for that is the 701's highlight features. First step was to stop the platter for several minutes by hand; this produced no grinding, humming, squealing or blown fuses. The motor took the hold in stride just as if nothing happened. When the platter was released it came up to operating speed in slightly more than two revolutions—one revolution if push-started as they do in radio stations.

With the applied line voltage varied between 90 and 140 volts, there was but a slight drift in speed, which was barely perceptible on the built-in strobe and measuring under 1 percent. Within the normal operating voltage range of a typical brownout there was no measurable drift in speed. Any drift, should it occur because of poor power-line regulation, can be easily corrected with a slight twist of the pitch control knob(s).

The wow and flutter—combined, and without resort to one of those weighting electronic filters that makes a pig's ear into a silk purse—was an outstanding 0.04%. The stylus force gauge was accurate within 0.1
(Continued on page 95)

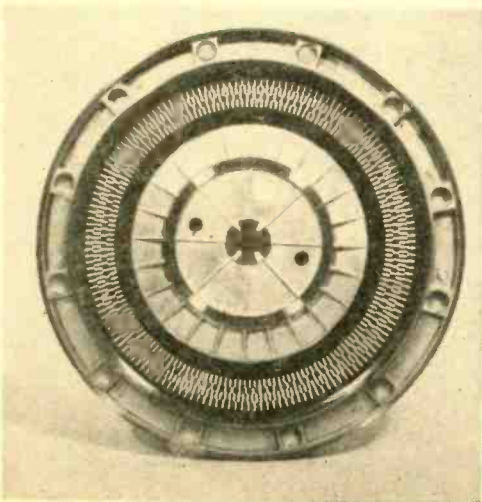

The latest UFO sighting? Modern art? Nope, but it is a strobe pattern printed under a 701 platter for precise speed adjustment.

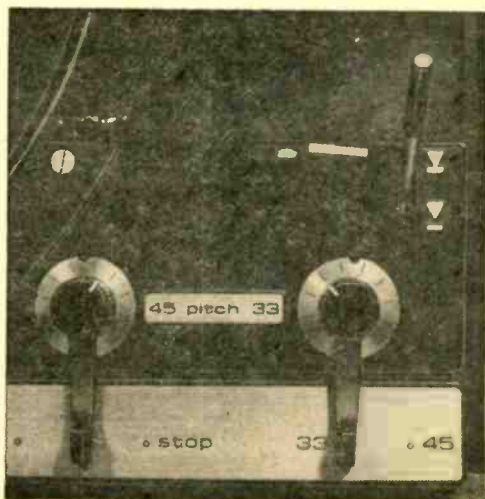

Pitch control knobs shown above are placed on potentiometers located on the turntable interior along with electronic circuitry.

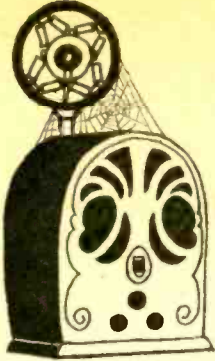

ANTIQU RADIO CORNER

by James A. Fred

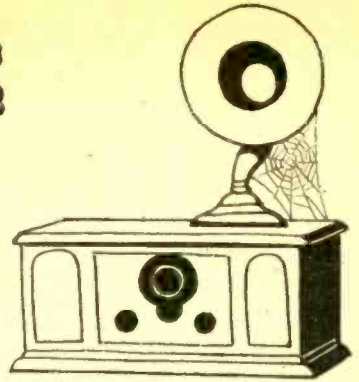

□ Hello out there in radio land! It's time for another meeting with all the collectors of antique radio and wireless equipment.

I hope you were all able to lay in a good supply of the Progress in Electronics stamps while they were available at your local post office. It would be fine if you had a years supply because such an opportunity may not come up again.

News Is Needed. I would like to report what the collector clubs around the country are doing, but to do this I must hear from club secretaries. Come on fellows, you really don't want to keep your meetings a big secret do you?

The Indiana Historical Radio Society held their summer meet on Sunday, June 24, at Battle Ground, Indiana. A large display of old radio equipment was a feature of the meeting. There were horn and cone speakers, radio receivers, and spark equipment. The display was open to the general public. A family-style picnic was enjoyed by members and their guests. Several visitors from Illinois signed membership applications before they left.

Books Reviewed. We received copies of the second edition of *Vintage Radio* by Mor-

gan McMahon. The book has been revised, corrected, and added to with additional photographs and facts of interest.

The second edition contains 263 pages and over 1000 illustrations of radio equipment made between 1887 and 1929. The soft cover *Vintage Radio* sells for \$4.95 while the hard cover library edition sells for \$6.95.

A companion soft cover book titled *McMahon's 1921-1932 Radio Collectors Guide* is available for \$3.95. The collectors guide lists details on most of the radio receivers manufactured from 1921 to 1932. It lists over 9,000 radio models by make and year introduced, the original selling price, type of cabinet, number of tubes, and type of circuit used. The publisher claims that over 50,000 facts are presented.

I believe these books will be a worthwhile addition to every collector's library. These books are available postpaid from Antique Radio Publication, P.O. Box 42, Rossville, IN 46065.

Another book I received for review was *The Radio and Wireless Antiquer's Directory*, compiled by Brent Dingman. It is a loose leaf, plastic covered booklet. It should be very helpful to beginning collectors since it contains a list of publications, clubs for collectors, museums, hints on where to find old radios, and names and addresses of several hundred people interested in old radios. Copies are



Pequod Pizza Restaurant has about 200 antique radios and speakers on display. All the details are given at the end of this column.

e/e ANTIQUE RADIO CORNER

available from Midco Enterprises, Dept ARP, Box 15370, Longbeach CA 90815.

Taylor's Electrical Archives. Ed Taylor, a long-time collector, had a desire to share his collection with fellow hobbyists, so he built a combination museum and instrument laboratory in Indianapolis, Indiana. The stained board and batten siding was chosen to match his nearby early 1900's home. In addition to the perfectly restored radio receivers the collection includes a tangent galvanometer, circa 1860, carbon filament light bulbs, electro-medical machines (shocking), a complete set of Orphan Annie's decoder pins, a scanning disc TV, ring and spring microphones, telegraph keys, model electric motors, clocks, hot air motors, and even an electrical tattoo needle. An authentic 1920's ball aerial on the front gable still gives surprisingly good reception. The antique radio receivers actually pick up old radio programs which are laboratory broadcasts by a wireless oscillator fed by a cassette tape recorder. Ed's 1500-volume technical library is used by students to research and authenticate electrical and radio artifacts. Ed is a member of the AWA and a charter member and Treasurer of the Indiana Historical Radio Society. He welcomes visitors to view his collection if a prior appointment is made. The address of the museum is 245 North Oakland Ave., Indianapolis, Indiana 46201. You may call 317-638-1641 for an appointment to visit the museum.

ANTIQUÉ RADIO FACT SHEET

Collectors of antique radio and wireless equipment can get a Fact Sheet from Elementary Electronics which includes information on antique radio publications and clubs, and a listing of public and private radio and wireless museums. To get your copy send a long stamped self-addressed envelope to Antique Radio Corner, ELEMENTARY ELECTRONICS, 229 Park Avenue South, New York NY 10003.

A Night Light from a dud. Richard M. Cane of Passaic, N.J. has a good idea on how to use the dud tubes most radio collectors seem to accumulate. Start by selecting one of the old pear-shaped glass bulbs with a loose base. Grasp the bulb gently in one hand and the base in the other hand and twist until they come apart. Remove the solder from the base pins and pull off the base. Run a 6-32 tap through one of the larger pins and a 4-40 tap through the opposite small pin. The wires from a bulb will come through the other two pins.

For a mounting base use a metal or plastic container from electrical tape. Now center the tube base on top of the can and run a small nail through each of the pins to mark the hole centers for drilling. Drill the 6-32 screw hole with a No. 28 drill, and the other three with a No. 33 drill. Mount a miniature toggle switch in the side of the bottom half of the can. Cut a notch in the side of the top half so it will fit over the switch. Spray paint the top half of the container.

(Continued on page 104)

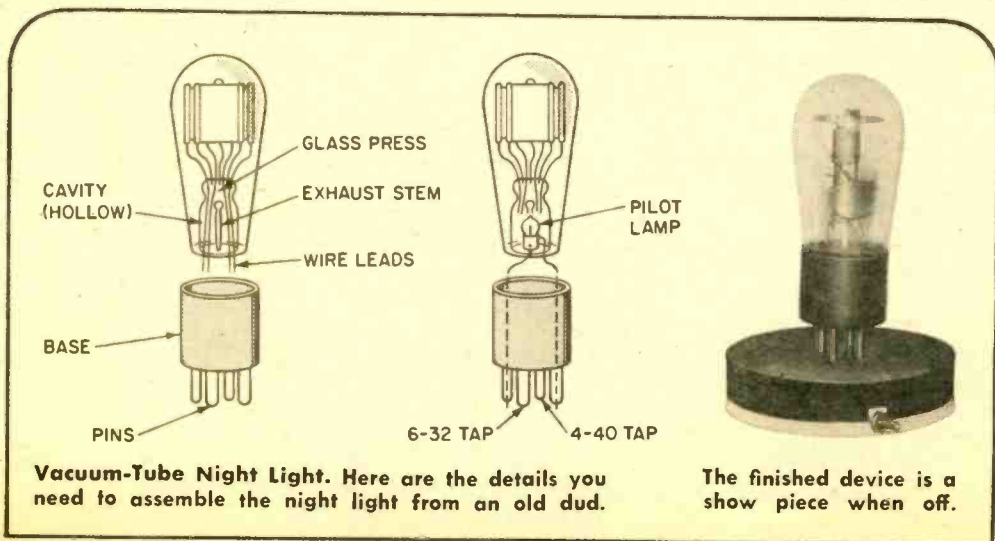

DXing Around the World in 80 Minutes

By Don Jensen



PHINEAS FOGG, remember him? He was the daring and resourceful Englishman who—at least in Jules Verne's classic novel—made a wager than he could go around the world in 80 days.

"Poppycock!" they told old Phineas. In 1872 the idea of circumnavigating the globe in under three months was sheer nonsense. But so sure was Fogg that he bet his last ha'penny, some 20,000 pounds, that he could make the trip. And he did, by railroad and steamer, balloon and elephant-back.

Today, the jet-set can duplicate Phineas Fogg's feat in just a few score hours. And DXers can, by shortwave radio, cut the time to a scant 80 minutes!

To prove it, and to win a wager from a friend—a considerably smaller sum than Phineas, incidentally—I tried one night recently. The object was to begin with a North American station and skip, via the airwaves, across all the six continental areas in sequence, South America, Africa, Europe, Asia and Oceania, logging stations as I went, and winding up again in the U.S., all in a span of an hour and twenty minutes.

As a sporting gesture, and to prove that I was no piker compared to the flamboyant Fogg, I offered to do the trick with a battery-powered shortwave receiver—albeit a quality rig—and nothing more than a three-foot telescoping antenna.

And like Phineas, I won my bet . . . and you could too! This is how it all went.

Get Set, Start! It was 0145 GMT (8:45 p.m. EST) when I switched on the receiver. Though my itinerary would not duplicate Fogg's London-to-London route, I had roughly planned it in advance to make things a bit easier.

I first tuned to 9625 kHz and found the shortwave broadcaster I was looking for, *Radio Canada International's* home service for its Arctic territories. The Northern Service program was already underway and I listened for a few brief moments to a program in a weird-sounding language.

It was a woman announcer speaking in Eskimo! The program, I know, is bi-lingual and if I'd stayed around a few minutes longer I would have heard an English announcement, but time was wasting.



The clock read 0150 GMT and I headed southward, tuning 11,930 kHz to catch the English language service of *Radio Havana Cuba*.

In their own inimitable style, the man-woman announcing team were explaining to a Canadian listener their version of Vietnam truce violations. The program was the mailbag segment known as "Post Office Bx 7026."

A quick scan of the 60-meter band turned up a number of South American stations, mostly in Venezuela and Colombia, but I decided to try for another in English.

It was HCJB, the *Voice of the Andes* in Quito, Ecuador, I found with some lively

daily English program on 9,475 kHz. There was a brief bit of Arabic music, strange and exotic melodies, and an English announcement by a man.

At 0208 GMT pressed on to Europe. This was prime time as far as the European shortwave broadcasters were concerned and there was a wide variety of stations to choose from.

First there was the *Swiss Broadcasting Corporation's* outlet on 9.535 kHz. Again the programming was English and I stayed on frequency long enough to hear a lively Swiss ländler, music from the Basil area of Switzerland, the announcer explained.

I tuned past *Radio Nacional de Espana* in Madrid, transmitting in Spanish. I dialed across London's *BBC* in the midst of a newscast in English.

On 6,040 kHz. I paused long enough to hear a short report on a stamp collector's



Back up your accomplishments with the QSL cards you receive. Mount a complete set in a photo album to preserve forever the DXing thrill of going around the world in 80 exciting minutes.



RADIO RSA

gospel music and English announcements on 15115 kHz.

Next, just at 0200, I found *Radio Nederland's* relay station on the island of Bonaire, just off South America's northern coast. RN's familiar chime melody interval signal ended and the announcer signed on with the station's Spanish program to Latin America. The receiver's dial read 9,590.

Over the Atlantic. Then it was the big jump across the pond to Africa. Things were a bit tougher at first. The African stations wouldn't really start coming in in numbers for another two or three hours. At a minute or so past the hour, I quickly passed South Africa's *Radio RSA* on 9,695, with the station's program to North America. I decided instead on *Radio Cairo*, about the only other powerful African voice audible at that hour.

I found Cairo's radio just launching its

exhibition in Bonn, aired by West Germany's *Deutsche Welle*.

There were signals from Warsaw and Lisbon, but at quarter past the hour I settled on a familiar voice, *Radio Moscow*, broadcasting an English language commentary on 9,690 kHz.

Five minutes later I found my receiver tuned to 11,735 kHz, *Radio Nederland* airing its well-known DX Jukebox program from Hilversum, Holland.

The program was a fascinating report on the doings of the European DX Council, an organization affiliating the major continental DX clubs, and so I listened for a while.

Suddenly I realized that it was 0230. Over half of my allotted 80 minutes had passed and it was time to head east to Asia.

Asia, like Africa, isn't the easiest continent to hear at that particular hour. And,
(Continued on page 100)

POT BOX

Resistance, resistance
everywhere, and
every value handy!

by R. L. Way



FREQUENTLY you could save time and effort on projects you are designing if you had a resistance substitution box. But those handy gadgets, with their many switches and precision resistors, are expensive, whether store-bought or homebuilt. Also, they usually take up too much room on the workbench, and often are not really convenient to use (all those switches to set and reset!) The *Pot Box* described in this article is a “quick-and-dirty” approach that lacks the accuracy of his big brothers. But the device has these advantages: small size, easy operation, inexpensive—usually costs less than \$5, and sufficient accuracy for most projects.

What's Inside. The *Pot Box* is not, as the name might imply, a container for marijuana cigarettes. It is an enclosure containing three potentiometers (or pots) wired in cascade, with alligator clip leads attached at each end for connection to the circuit in which it is to be used.

The author's version of the *Pot Box* measures 2¼ in. x 5 in. x ¾ in. The pots could have been mounted in an even smaller case; the size selected was a compromise between compactness and scale readability. The schematic drawing of the *Pot Box* shows how simple it really is!

Picking Parts. The potentiometers have values of 10,000, 100,000 and 1,000,000 ohms. With these values you can “dial in” approximate resistance values of from 200 ohms or so to greater than 1.1 megohms with 10 percent or less accuracy. If your projects generally call for small resistance values, use pots of 100, 1,000 and 10,000 ohms, to give a total resistance range of from about 2 ohms to better than 11,000 ohms. Linear potentiometers are obviously best for this application; audio taper ones will do, but will result in some scale compression with clockwise rotation. The optional binding posts shown in the schematic diagram for the *Pot Box* provide convenient terminals (BP2, BP3) for connecting a voltmeter to monitor the voltage drop across the substituted resistor or to measure the voltage from either end of the *Pot Box* to ground; or, with no power applied, an ohmmeter can be connected between

e/e POT BOX

these posts to more precisely set the resistance to any desired value. Terminals BP1 and BP2, which are normally jumpered with a length of wire, can be used to insert a milliammeter "in-line," an "on-off" switch, a diode if desired, etc. These binding posts were not included in the *Pot Box* shown in the photos, and if you don't want them, just omit them and solder point x to point y in the schematic diagram.

If you are going to use a ready-made box, the only thing you'll have to fabricate is the face-plate with the 3 resistance scales on it; this can be cut from opaque cardstock or heavy paper. The front and back of the unit are cut from "artist board" and glued to a hollow wooden frame.

After completing the face-plate and mounting the pots, turn the assembly over and do the wiring. For clockwise rotation

of the shafts, you need to use the center terminal and the left-hand terminal (as viewed from the back), the right-hand terminal of each pot is *unconnected*. Tie a knot in each clip-lead where it passes through the hole drilled in the end of the box, to provide strain relief.

The Checkout! Now we're ready for calibration. Turn all 3 pots fully counterclockwise. Mount the knobs on the pot shafts and set the index or pointer of each to the same position at the "0" point, which will be at about the 7 o'clock position on the circles. Connect the alligator clips to an ohmmeter, and slowly advance the knob of the lefthand pot until the ohmmeter reads 1000 ohms. Put a light pencil mark on the circle opposite the knob index, advance the knob until the ohmmeter reads 2000 ohms, mark the circle at this point, and continue on in this manner until the clockwise limit of the pot is reached. Then turn this pot fully counterclockwise, and calibrate the

(Continued on page 97)

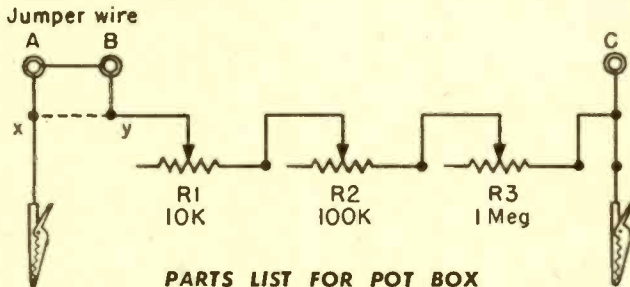

PARTS LIST FOR POT BOX

- BP1, 2, 3—Binding post, 5-way
(Radio Shack 274-661 or equiv.)
- R1—10,000-Ohm potentiometer, linear taper
(Radio Shack 271-1715 or equiv.)
- R2—100,000-Ohms potentiometer, linear taper
(Radio Shack 271-092 or equiv.)

- R3—1,000,000-Ohms potentiometer, linear taper
(Radio Shack 271-211 or equiv.)
- 2—Alligator clip, insulated
(Radio Shack 270-378 or equiv.)

Misc.—3 knobs, wire, box, solder, etc.

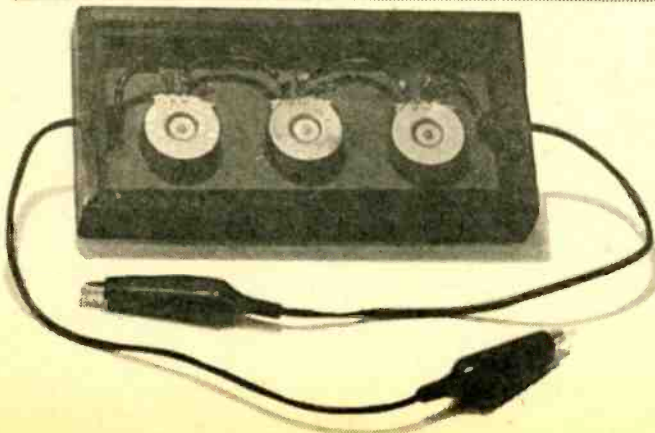

What's up front is also up back! Photo at left shows location of potentiometers mounted in position. The 1000-ohm pot is at the extreme right and 100,000-ohm potentiometer is far left. Hookup is simple. Be sure rubber grommets are inserted in holes from which the leads protrude.

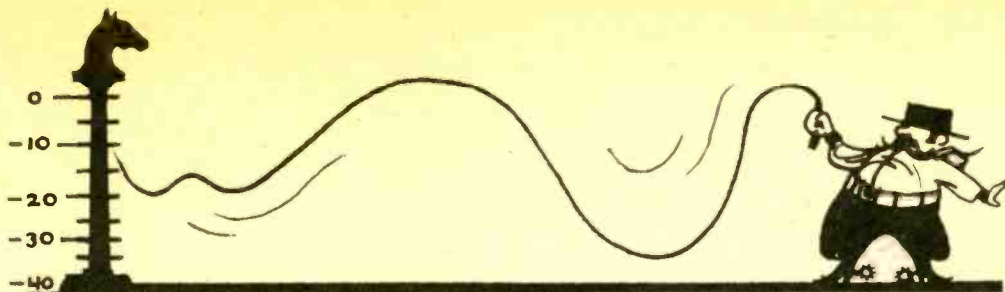

GET IN THE SWING OF SIMPLE FILTERS

by Norman Crawford

FILTERS are perhaps the most widespread type of circuit used in electronics. The tuning circuits which every TV and radio set uses to select the desired station are filters; the IF circuits which shape the bandpass of TV sets are also filters, as are the standard roll-off circuits in tape decks and phonograph amplifiers. FM receivers use filters to remove the pre-emphasis put into the signal at the transmitter, while yet another type of filter is used at the transmitter to provide the pre-emphasis in the first place. And, of course, all electronic circuits drawing power from the AC power line use a filter to smooth the ripple from the pulsating DC delivered by the rectifier.

Although they are found everywhere, filters have long been something of a mystery to the experimenter. For example, if an experimenter needs to design a filter for his circuit and turns to a textbook for assistance, he will be met with a barrage of *poles*, *zeroes*, *s-planes*, *integro-differential equations*, and a host of other subjects, all of which presuppose that he has at least a graduate degree in electrical engineering. So, although these texts certainly contain the information for designing excellent filters, the techniques are so well hidden under the advanced math that the average experimenter can't make use of them.

However, there are some very simple techniques for filter design which may be easily used by anyone with a very elementary math background, to make filters usually more than adequate for the job at hand. In the following pages we shall outline some of these simple approaches to filter design, which should enable you to "roll-your-own" filters as the project requires.

What Is a Filter? A filter is an electronic frequency-sieve. Just as a sieve can hold back large particles in a mixture and pass small ones, a filter can eliminate the low frequencies in a signal and pass the high frequencies. Such a filter is called a *high-pass filter*. Placed at the antenna terminals of a TV set, a high-pass filter can eliminate the unwanted low-frequency interference from nearby amateur or CB transmitters, and pass the wanted, higher-frequency TV signals.

Unlike a normal mechanical sieve, however, a filter can also be built to pass "large particles" (low frequencies) and eliminate "small particles" (high frequencies). Such a filter is called a *low-pass filter*, and can be used, for example, to eliminate the high-frequency scratches, pops, and hisses from a record reproducing system while passing the music signals through to the loudspeaker.

A third type of filter is an even more clever "sieve", for it eliminates both very large and very small particles, (low and high frequencies), passing only particles of a specific size (signals of a particular frequency or group of frequencies). This type is called a *band-pass filter*, for it passes only a narrow band of frequencies, eliminating signals both above and below the desired signal frequency. Every radio and TV receiver uses a tunable bandpass filter at its input, to select signals from the desired station while eliminating all signals on higher and lower channels.

The fourth and final type of filter is the opposite of a band-pass filter, because it eliminates a particular frequency, while passing all others. This is called *band-elimination filter*, or, if the band eliminated is very narrow, it is called a notch filter.

Complex or Simple. Although there are only four basic types of filters—high-pass, low-pass, band-pass, and band-eliminate—the circuits that can perform these functions are many and varied. They can be even more complex than the low-pass filter shown in Fig. 1A or they can be as simple as the two-element low-pass filter shown in Fig. 1B.

Measuring a Simple Filter. To understand what a filter is trying to do, let us make a laboratory set-up to measure the performance of the very simple filter of Fig. 1B, using the test set up of Fig. 2. Here, a variable-frequency oscillator is connected so as to produce any desired audio frequency at the input terminal of the filter, while an audio frequency voltmeter measures the amount of signal emerging from the filter. Starting out with the oscillator set at some very low frequency, such as 10 Hz, we find that the filter has very little effect, passing almost the entire oscillator signal through to

e/e SIMPLE FILTERS

the output meter. This you might expect, since the capacitor is almost an open circuit at low frequencies, and the filter will therefore act almost like a series resistor alone, which, in this circuit, has negligible effect on the signal.

As the frequency is increased, however, the capacitor becomes a lower and lower impedance, effectively shorting out the signal as it emerges from the filter. The degree of "shorting out" depends upon the frequency; at very

scale in addition to its normal voltage scale), and decibels will be used on the graph instead of volts. Also, instead of marking off the frequency scale of the graph in equal steps of 1,000 Hz, 2,000 Hz, 3,000 Hz, etc., we mark it in equal steps of 1,000 Hz, 10,000 Hz, 100,000 Hz, etc. When these changes are made in the graph, a very useful display results, as shown in Fig. 4.

What makes Fig. 4 so useful is that it is essentially two straight lines connected by a short curved line, as shown in Fig. 5 and for purposes of practical design, the frequency response may be approximated by two straight lines, Fig. 6.

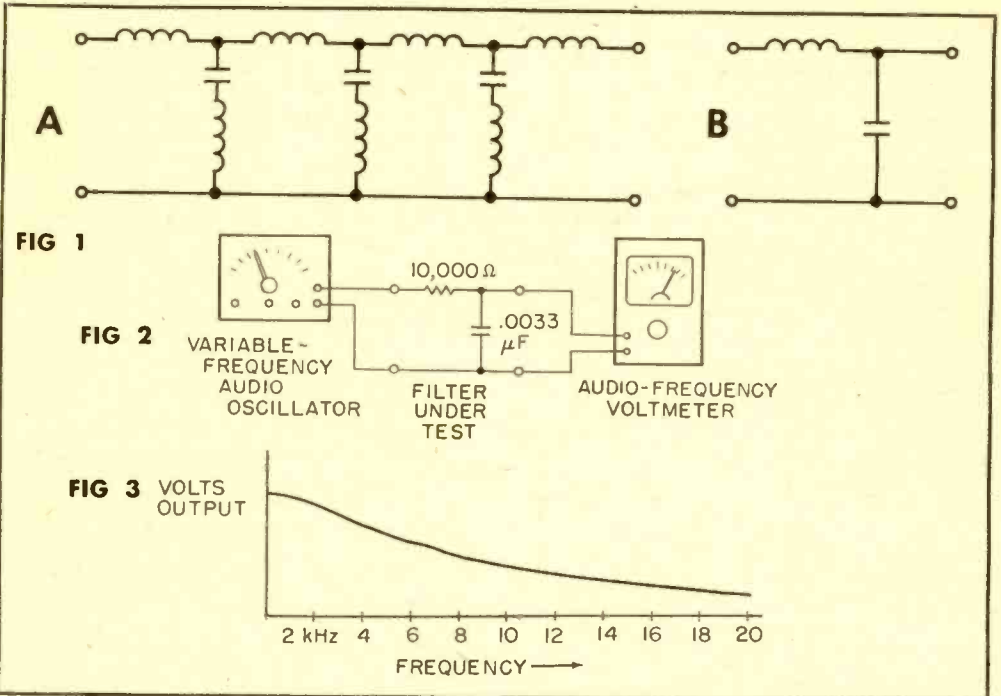

high frequencies almost no signal emerges from the filter.

The clearest display of the behavior of a filter is made by graphing the results obtained in the above experiment. If we plot the meter reading versus the audio oscillator's frequency, we obtain the graph of Fig. 3.

As you can see, the filter is removing the higher frequencies, as shown by the downward sweep of the graph as the frequency is increased. The graph is called the *frequency response* of the filter.

Enter the Decibel. Although the plot of Fig. 3 is easily made and understood, it is not the most useful way to display filter output versus frequency, and hence is not the way frequency response is normally graphed. Usually, instead of reading voltage off the voltmeter's scale, its decibel scale will be read by the experimenter

(every good audio-frequency meter has a decibel

Note that in Fig. 6, a corner is formed where the two straight lines intersect. A perpendicular line, dropped straight down from this corner, hits the frequency scale at a point known as the *corner frequency*. This is a very important frequency, and is generally taken as the cut-off frequency; that is, the frequency above which the filter rejects signals. The corner frequency for the particular filter shown is 5 kHz. Frequencies lower than 5 kHz are passed well by the filter; frequencies above 5 kHz are passed relatively poorly.

Rules for Cornering. To make the straight-line approximation of frequency response for a given resistor/capacitor low-pass filter such as the one measured above, you need know only two facts:

1. The corner occurs at a frequency given by

$$f_c = \frac{159,000}{RC}$$

... where R is in ohms, and C is in microfarads.

2. The downward-sloping straight line falls off at such a rate that between any two decades (such as between 10 kHz and 100 kHz, or between 250 kHz and 2,500 kHz) the line will drop by 20 decibels.

Using these two facts, let us draw the approximate frequency response of a filter with $R=2,000$ ohms and $C=0.22$ microfarads.

First the corner is calculated as

likes to be driven from a low-impedance source, such as a 6-ohm speaker output, and likes to deliver its output to a high impedance such as the base of a transistor amplifier or a pair of high-impedance headphones. Ideally, the high impedance load should be 100 times larger than the low-impedance driving source, although you can get away with as little as a 10 to 1 ratio. At this ratio, however, performance can not be accurately predicted by the simple relationships given in this article.

For a good example of a practical use, consider the case of an SWL who would like to drive a 600-ohm headset from his 6-ohm speak-

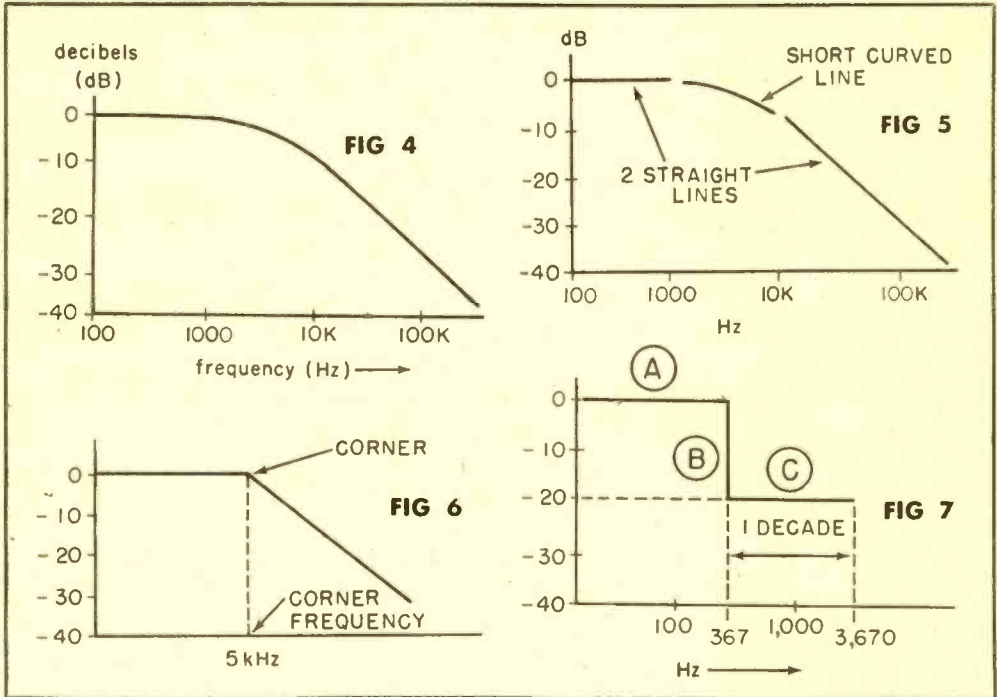

$$f_c = \frac{159,000}{RC} = \frac{159,000}{2,000 \times .22} = 367 \text{ Hz}$$

As shown in Fig. 7, draw a horizontal line A from the zero dB mark out to 367 Hz, then a line B down 20 dB, and then a horizontal line C over a distance of one decade, from 367 Hz to 3,670 Hz. Now draw a straight line D from the point where A and B intersect, through the tip of C, as shown in Fig. 8. You have now sketched a very good approximation to the frequency response of the RC low-pass filter.

Down to Earth. In a real-life situation, a filter doesn't lie on a lab bench, driven from an audio oscillator and having its output measured by a voltmeter, but instead resides in a circuit, where it is driven by a very business-like signal source with a job to do, and delivers its output to a loudspeaker, headphones, telephone line, TV picture tube, or what-have-you. In such a circumstance, our simple RC filter

er output, and wants to filter the output to eliminate the frequencies above 3,000 Hz. The circuit he would use is shown in Fig. 9.

He must first calculate the value of R for his filter, using the formula

$$R = \sqrt{R_s R_L}$$

where R_s is the source impedance, 6 ohms and R_L is the load impedance, 600 ohms. By the formula,

$$R = \sqrt{6 \times 600} = \sqrt{3600} = 60 \text{ ohms}$$

(Use the EIA value, 62 ohms)

He must then calculate the capacity, C, through an algebraic rearrangement of the equation given earlier for corner frequency:

$$C = \frac{159,000}{f_c R}$$

e/e SIMPLE FILTERS

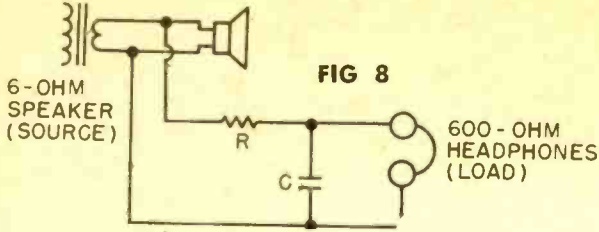

FIG 8

where f_c is the desired corner frequency, 3,000 Hz
and R is the resistance above, 62 ohms
Therefore,

$$C = \frac{159,000}{4,000 \times 62} = .857 \mu F$$

Replacing the 0.857 μF value with the nearest EIA value, 0.82 μF , our SWL can now build his filter.

More Simple Filters. The extremely simple filter just designed for an SWL is a low-pass filter. It removes frequencies above about 3,000 Hz, and would probably make a very noticeable improvement in the noise endured by the SWL as he fished for those weak signals. If he could

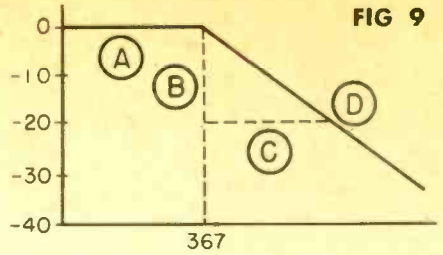

FIG 9

sacrifice some intelligibility for more freedom from noise, he could double the capacitor value, and thereby remove frequencies above 1,500 Hz.

But simplicity is not the only virtue of this filter. As a low-pass filter, it can be considered the "cousin" of three other filters—a high-pass filter, a band-pass filter, and a band-eliminate filter. All these can be derived simply and directly from this simple low-pass filter. In fact, the most common method of deriving high-pass, band-pass, and band-eliminate filters is to design first a so-called "equivalent" low-pass, and then quickly and easily derive the desired high-pass, band-pass, or band eliminate from the low-pass design.

This is a very simple, interesting, and useful procedure which we will discuss in our concluding article that will appear in the March/April 1974 issue of **ELEMENTARY ELECTRONICS**. ■

Two Step Audio Filter for Restoring Old 78 Sound

□ Old 78 rpm collector's-item records cut back in the early days when performers sang in front of a large horn usually have a peak in the midband that drives the sound into your mind like a fingernail scratched across a blackboard. The overall sound quality is easily tamed, and made more modern and natural, by attenuating the shrill peaks with Record Restorer, a passive filter device that suppresses, by high-fidelity standards, the midband frequencies.

Record Restorer should be assembled in a

metal cabinet to prevent hum pickup. Connect the output of your phonograph to the Restorer input. Connect the output of the Restorer to your tape recorder. Set potentiometer R2 to maximum resistance and adjust potentiometer R3 for the most pleasing sound. If R3's adjustment is too little, or too much as evidenced by a "hole" in the sound quality, trim the Restorer with R2 until you get the optimum equalization. A little practice will make you a skilled 78 restorer expert that'll make you very popular with friends—especially if they have old 78s. ■

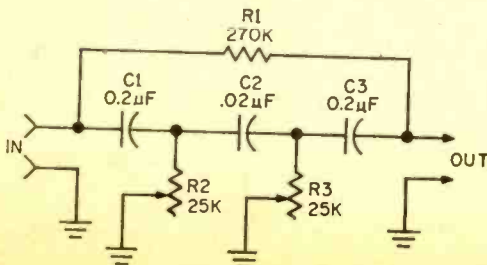

PARTS LIST FOR RECORD RESTORER

- C1, C3—0.2 μF mylar capacitor, 25 VDC or better (Radio Shack 272-1070 or equiv.)
- C2—0.02 μF mylar capacitor, 25 VDC or better (Radio Shack 272-1066 or equiv.)
- R1—270,000-ohm, 1/2-watt resistor (Radio Shack 271-000 or equiv.)
- R2, R3—25,000-ohm potentiometer, linear taper (Radio Shack 271-094 or equiv.)

PITY THE MAN WHO SAT AT HOME



How one man, some friends and electronics hit the road!

by Joseph Gronkowsky

When carlover Eberhard Franz had to have both arms amputated he thought he would never drive again. But now, five years later, he has just reached a driving milestone: 100,000 accident-free miles!

The incident that cost him his arms happened when Franz was 29 years old. He was at that time an electrical engineer. One day, while he was at work on an electrical grid power station, something went wrong and Franz was so badly burned that they had to amputate both his arms. He was in the hospital for several months, and while he was there he was operated on seven times altogether.

"I thought the end had come," Franz says now—with a grin—about that horrifying time. "Disabled for life, no future, no nothing, and at the age of only 29. I was very depressed at the time. But the doctors were wonderful. Apart from the delicate operations they performed, they gave me back the will to go on. I did. I was out of the running for about a year after the accident, but now I'm an industrial safety inspector in the electrical engineering field and I'm doing fine."

Franz was given artificial arms, and these enabled him to begin life over again. But his former work was impossible to do. And driving a car was out. "I loved cars," he says.

"Not for fast driving. Just for pleasure driving. But it seemed to me that driving had to be a thing of the past, and I had to learn to live with the thought that I would never drive again. The doctors, too, told me that I would have to make peace with the thought of never driving a car again, since no car could be modified to suit my new circumstances. But I didn't want to accept this. I couldn't. So I sat down with a few friends to study the problem and we managed to work out a solution—as you can see."

He Started the Ball Rolling. Franz, who is from a small town near Heidelberg, Germany, had letters written to every firm he could find that specialized in modifications for disabled people, in Germany and abroad. He sent letters all over the world. When he got back his answers he studied what was available world-wide, and based on his own needs he came up with a special set of modifications and improvements from what was already on the market. "I wasn't thinking only of myself," Franz explains. There are so many disabled children around who are growing up and would perhaps like to drive later on in life. The modifications I have in my car are all right for my particular case, and I am sure they can be further developed for almost any disability—given the money."

Mr. Franz had to part with almost \$2600

e/e HIT THE ROAD

to modify his car, a Volkswagen 1600. There is no steering wheel. Steering is done with the left foot, which slides into a kind of pedal which can be moved upward and downward (or backward and forward, depending on how you want to look at it). It is electrically powered. The column which looks like the steering column is in fact the brake, which is operated by pushing the body against it. This is also power-assisted. Under the dashboard and attached to it, to the left of the brake stick, is a lever that can be operated with the left knee or leg; this is the starter. The right foot operates the lever for the automatic gears. Once in "drive" nothing has to be done anymore. At the bottom of the brake stick are three large pushbuttons for the lights. These are also operated by the right foot. Attached to the dashboard, about a quarter down at the right side of the brake stick, there is another lever; this one controls both the turn-indicators and the horn.

The Last Stumbling Block. "The licensing authorities were suspicious at first," Franz says. "But a demonstration convinced them that the modified car was all soundly designed and easy to operate. I got a driver's license after all, but I wasn't allowed to do more than 40 MPH at first. This restriction was lifted after I had completed 50,000 accident-free miles. Now I've reached 100,000! It wouldn't be practical, let alone economical, to modify vehicles too often on an individual basis. It's all constructed so that the modifications don't interfere with the engine. So I will change engines when necessary if the bodywork holds, which I think it will. Of course, if my type of modifications could be mass-produced it would all be much cheaper. From what I now know, I think the changes could be made for only a third of what they cost me." ■



Photos show some of the modifications in Mr. Franz's car. At top, column replacing steering wheel is chest pad for activating power breaks. Below, left foot is on steering device. Note starter lever next to left knee.



Right leg is used to control gas pedal as well as shift gears in the automatic transmission. Power assist servos assist driver in several instances to make driving relatively easy and non-fatiguing.



Build our TV HAZARD ALARM

Sleep tight tonight knowing your TV will not go in for barbecuing!

by Tony Mancuso

IT FIRST APPEARED as infrequent news items buried in the back pages of some newspapers; but now we know that thousands of TV color receivers are possible fire hazards, for the announcement to that effect was made by a major manufacturer. And if all the talk of possible color TV fires has got you worrying at night, long after Johnny Carson has faded to black you can put your mind at ease by installing our TV Hazard Alarm on the back of your color set.

The TV Hazard Alarm is triggered by a standard 190° F fire detector, S1, such as used to protect furnace rooms and attics in the home. When excessive heat causes the normally open fire detector contacts to close, relay K1 is activated, simultaneously causing bell Z1 to ring while power to the TV set is removed. In the event an electrical fire short-circuits the receiver's power supply before the heat builds sufficiently to trip the fire detector, fuses inside the Alarm disconnect power from the TV. The fuses, however, are after the alarm circuit so the warning bell will ring even though power is removed from the TV.

Relay K1 is a special hysteresis controlled type; it closes (switches) only when its two control leads are shorted, either by test switch or the fire detector. The control lead voltage is about 30 VAC at very



e/e TV HAZARD ALARM

low current, generated by the relay, and any type of insulated hook-up wiring can be used for connections.

Construction. The Alarm is assembled in a plastic cabinet approximately 4½-in. wide x 2¾-in. high x 7¾-in. deep. Do not use a smaller cabinet! There will be no room for the alarm bell in a smaller cabinet. Mount bell Z1 within about ½-in. of the cabinet top; allow enough room for a hole in the back of the box so a screw can be used to mount the Alarm to the back of the TV set. Relay K1 and the fuse block are installed near the bottom of the cabinet. Jack J1 and test switch S1 are installed on the side of the cabinet.

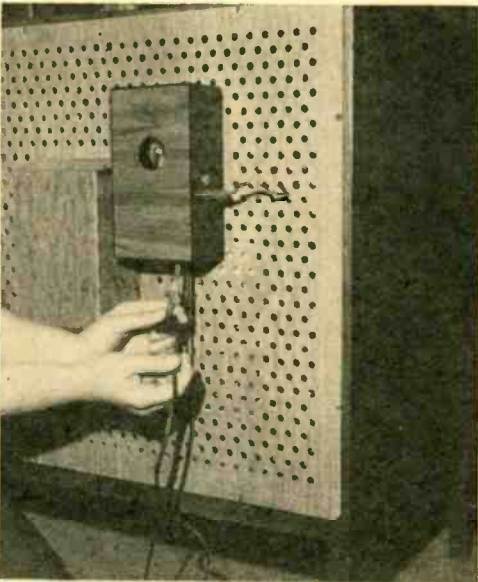
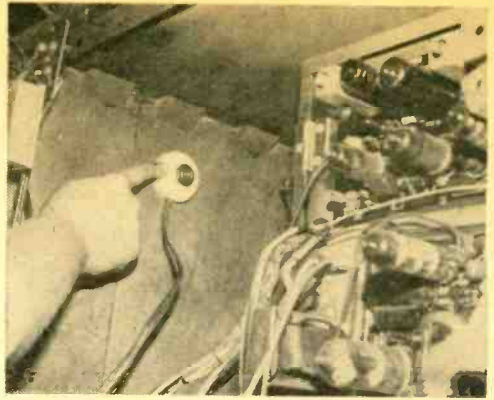

Table top color TV sets are too compact to mount the TV Hazard Alarm inside the cabinet. Mount on rear panel. TV power cord plugs into receptacle in alarm unit.

Nothing about the wiring is tricky, but make certain you do not connect the Alarm's power wiring *after* the fuses; you want the bell to ring even though the fuses blow out. We suggest the wires be connected in the following order to avoid confusion. Yellow wires from K1 to J1 and P1 (no polarity necessary). Blue wire from K1 to one of the wires from the bell. Black wire from K1 and other bell wire to one side of the



The fire detector, S1, is installed inside the cabinet preferably near the hottest location at or near the top of the side wall. Test S1's action with a match.

AC power line. Red wire from K1 to the fuseholder. The final assembly is socket X1 which provides power to the TV; note that both sides of the line are fused. Socket X1 is an ordinary "line tap" available from most hardware stores; the type you simply press-fit onto a length of ordinary zip (lamp) cord.

Open Fire Detector. The only critical part of the TV Hazard Alarm is the fire detector, S1, which must be of the *open circuit type*. This means the detector's contacts are normally open, closing only when the ambient heat reaches the rated value of the detector—in this instance 190° F. Make absolutely certain you do not use a *closed circuit* or *supervised* detector which has normally closed contacts that open when the ambient temperature reaches the rated value.

To check the fire detector, S1, simply connect an ohmmeter across its terminals. If the ohmmeter shows zero or almost zero ohms (a short circuit) you have the wrong detector. The correct detector should indicate infinite resistance across the terminals; heating the detector with a match held nearby will cause the contacts to close. When the detector cools down, the contacts will automatically open and be ready for use again.

Checkout. Temporarily connect detector S1 to jack J1. Connect any houselamp to socket X1 and connect the TV Hazard Alarm to the AC power line. The lamp should go on immediately. (A slight hum from relay K1 is normal.) Pressing test switch S2 should cause the lamp to go out and the bell to sound. If all this doesn't

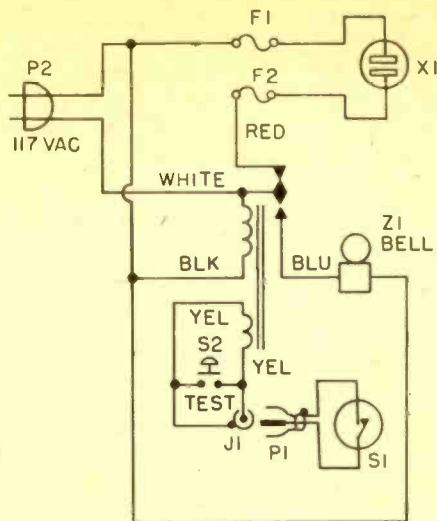
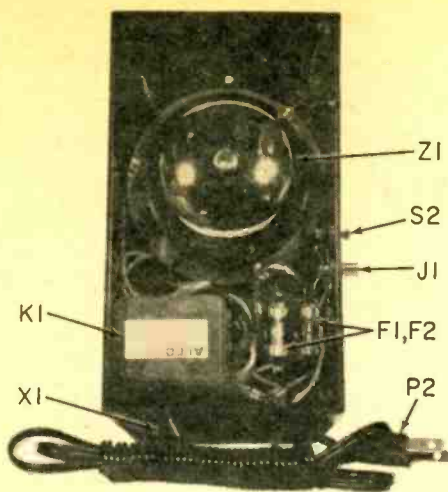

PARTS LIST FOR TV HAZARD ALARM

- F1, F2—Use 3AGC fuses; 3A (Radio Shack 270-1286) or 5A (Radio Shack 270-1287). See text for details.
 2—Clip-in fuse holders for F1 and F2. (Radio Shack 270-739 or equiv.)
 J1—RCA phono jack (Radio Shack 274-1575 or equiv.)
 K1—Alco FR-102 control relay (Lafayette Radio 301-12010) Caution: there are no substitute relays on the marketplace—make no substitutions!
 P1—RCA phono plug (Radio Shack 274-1575 or equiv.)

- P2—AC line plug (Radio Shack 61-2709 or equiv.)
 S1—Normally-open fire detector, rated at 190° F (Lafayette Radio 14/13715 or equiv.)
 S2—Normally-open pushbutton switch (Radio Shack 275-1551 or equiv.)
 X1—AC power receptacle for standard line plug (Radio Shack 270-642 or equiv.)
 Z1—Alarm bell (Radio Shck 273-020 or equiv.)
 1—Bakelite box with removable aluminum cover; 7¼-in. x 4¾-in. x 2¾-in. (Radio Shack 270-232 or equiv.)
 Misc.—Wire, hardware, solder, etc.

happen, you have made a wiring error. Finally, apply the heat of a match to the fire detector. The lamp should go out and the bell should sound off. As soon as the detector cools down (blow on it to hurry things along) the bell, Z1, should stop ringing and the light should go on.

If everything checks out, disconnect the bell, Z1, and test lamp, and drill or punch a hole approximately 1½-in. diameter in the cabinet's metal cover; do not install the cover at this time.

Remove the back cover from the TV and install fire detector S1 inside the cabinet with mounting screws (wood cabinet) or an adhesive such as G.E.'s RTV. Make certain the wires from the detector (ordinary zip cord) do not short to a metal cabinet.

Position the detector, S1, as far as possible from large tubes, or local areas of high heat. A good location is on or near the top of the cabinet near the rear removeable cover.

Pass the connecting wires from the fire

detector through a hole in the TV receiver's rear cover and secure the cover.

Mount the Alarm on the back of the TV cover—a single mounting screw is sufficient—and connect the heat detector's wire to jack J1. Install the alarm's cover. Plug in the TV's line cord to socket X1 and connect the Alarm to the power line.

Turn the TV on, then check operation by pressing test switch S2, which should cause the TV to go off and the bell to ring.

Selecting the correct fuse. Fuses F1 and F2 should be the slow-blow 3AG type (or equal) rated slightly above the TV receiver's power rating. For example, if the TV is rated for 340 watts (almost 3 amperes) use a 5 ampere fuse; if the receiver is rated for 210 watts (almost 2 amperes) use a 3 ampere fuse. Receiver current can be determined by Ohm's law: $I = W/E$, where I is in amperes, W is the rated wattage of the receiver, and E is the line voltage rating. S, not in the equation, is for Safety—install our TV Hazard Alarm and sleep tight tonight! ■

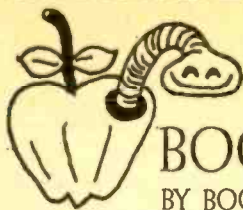

BOOKMARK BY BOOKWORM

When You See Purple Bananas. Chroma circuit trouble-shooting with a rainbow generator is a breeze with *Pictorial Guide to Color TV Circuit Troubles*, a simplified pictorial

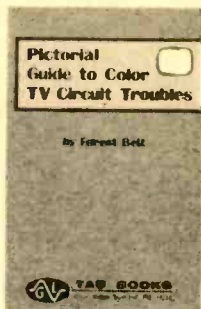

Soft cover
256 pages
262 illustrations
\$4.95

guide by Forest H. Belt. It contains over 200 waveform photos taken directly from operating and malfunctioning color TV sets. By comparing the waveforms in a troublesome circuit with those in this book, the reader can quickly pinpoint the cause of trouble in burst amplifiers, color demodulators, color difference amplifiers, and color-video stages. Published by Tab Books. For more information, circle No. 85 on Reader Service Coupon.

Quick Now! Have you ever wanted to learn about electronics or experiment with a new circuit, but just didn't seem to have the time or space? A copy of *5-Minute Electronic Projects* by Len Buckwalter, a few inexpensive components, and a tabletop could solve both problems. This book is packed with electronic demonstrations and projects that can be set up in a few minutes. The author first discusses simple clip-lead demonstrations, such as the principle of an electric motor or a battery. He then progresses to such perforated board proj-



Soft cover
96 pages
\$3.95

ects as the microphone preamplifier, voltage controller, and crystal calibrator. The final chapter covers electronic modules. The basic amplifier, amplified crystal radio, transmitter monitor, audio and acoustic oscillator, and signal tracer are discussed. Many other projects for fun and practical use are described in detail, and their construction is simplified by pictorial and schematic illustrations. Published by Howard W. Sams & Co., Inc. For more information and book catalog, circle No. 84 on Reader Service Coupon.

Basic Primer. If you're a high school grad, you'll want to own and refer to *Basic Principles of Electronics* by Vester Robinson. This book traces the history of electronic science from the discovery of current flow to the present, while developing the principles of electronics. Further, it develops the basic principles of solid-state electronics in sufficient detail to prepare the student for more advanced courses. Outstanding features include coverage of the essentials of electron tubes including diodes, triodes, bias, amplification, load lines, and

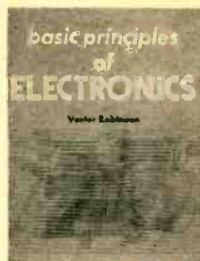

Hard cover
356 pages
\$12.95

cathode ray tubes. The book provides detailed development of solid-state principles and the characteristics of diodes and transistors, while analyzing amplifiers using a great variety of transistor circuits. Published by Reston Publishing Co., Inc. Order direct from your local book store. For catalog information, circle No. 81 on Reader Service Coupon.

Vintage Radio. Step back in antiquity to the story of mankind's great achievements; the ability to talk across the miles to one person or



Hard cover
263 pages
\$6.95

to millions of people. Wireless, radio, and later television, have had the greatest impact on
(Continued on page 97)



BLINKING TEDDY IS A BLOOMIN FRIEND

Nicola Stapleton was only eleven months old when her parents had their fears confirmed—she was virtually deaf. Nicola was a Rhesus baby and, as is often the case with these babies, she was born with defective hearing. Luckily, electronics has come to her aid in the person of a teddy-bear with “talking” eyes—whenever Nicola opens her

mouth and utters a sound Teddy’s eyes light up. This is the only way Nicola can tell that she can talk!

“Many deaf children do in fact have slight hearing—but only in a limited frequency,” explains Mrs. Gwyneth Cobb, Nicola’s teacher. “With earphones and amplifiers we can talk with them. Nicola is one of these children. She can, with the help of high frequency amplifiers, understand my voice.” This is the problem: deaf children may be able to talk, but they cannot hear their own voice! How was Mrs. Cobb to put over to Nicola that she was making a sound with her own voice?

The answer came from an electronics-minded friend, who set about converting a big toy bear into a “visual voice.” Inside the teddy-bear is a microphone linked via an electronic circuit directly to his eyes. Make a sound and the eyes flash bright red.

“Teddy was a success from the word go,” Mrs. Cobb says. “Nicola first hugged the bear then prodded and poked it. At 2½ she was in the gurgling stage where she made sounds from excitement. When Teddy’s eyes lit up for the first time she was



Mrs. Cobb holds mike (above left) for Nicola, while Teddy wears Nicola’s earphones. (Above) Teddy gets his batteries checked.

baffled, but in no time at all she came to realize that it was the sound coming from her that worked the eyes!

Every time Nicola asks “Teddy?” her teddy-bear is put in front of her. Then with creative toys Mrs. Cobb tries to get Nicola to make sounds by herself. The reward is in seeing the eyes flash. Nicola is permanently fitted with tiny ultra-powerful earphones, which can be connected to the frequency amplifier. When she is about 4½ Nicola will start going to a special school. Until then she has Mrs. Cobb and Teddy to be her special friends.

—Joe Gronk

HEY HERB

THE AUDIO ANSWER MAN

by Herb Friedman



HEY HERB: I recently installed a stereo cartridge player in my car with two speakers on the dash and two on the rear deck. What would cause a growling sound (with lots of distortion) when a stereo tape is playing only through the front speakers? This effect occurs at all signal levels, from almost a whisper to the threshold of pain.

Normally, I would say you had acoustic feedback. But if it happens at very low volume levels I suspect the front speakers are different from those used in the rear, and something about the front speakers is *lousing up* the feedback in the tape player's output amplifiers. If the effect goes away when you crack just a smidgen of sound into the rear speakers that's the answer. Either keep the rear speakers partly to full on, or try installing a 1 ohm or 1.2-ohm, 1-watt resistor in series with each front speaker.

HEY HERB: Is there some way I can feed a mono (one speaker) signal to a backyard speaker from my stereo amplifier? I know I can set the amplifier for mono, but I'd like to have it playing stereo in the house while feeding into the back yard.

Personally, I can see no good reason why you can't use two outdoor speakers and have stereo throughout; but if you insist on mono you can use a special; (inexpensive) "blending" transformer which used to be sold by *Alco* and *Microtran*. You simply connect the transformer across the amplifier's stereo output (with the speakers connected) and the transformer output is mono. I don't know if these items are still manufactured but there's no harm in asking your local parts distributor.

HEY HERB: I thought the wavematching full-logic SQ decoder was the ultimate in matrix quadrasound, but now there's something called *Variblend*. What does *Variblend* do to matrix decoding?

Variblend is a modification in Lafayette Radio's new wavematching full-logic decoder. Instead of depending on psychoacoustics (Hal) or front/back logic to enhance the center-front to center-rear separation, the new Lafayette decoder electrically attenuates the center-front signals which appear in the rear amplifier circuits,

hereby obtaining very high CF/CR (center-front/center-rear) separation without the pumping that some listeners (and critics) found objectionable. (Pumping is caused in the older logic circuits because the center gain was actually modified to enhance separation; *Variblend*, on the other hand, does it partly through 180° phase cancellation, which does not cause pumping.) I have heard the system used on some standard SQ recordings and the results are just short of fantastic. I feel that if matrix decoding had started out with this new decoder, CD-4 would never have gotten off the ground because the *Variblend* separation and corner-to-corner effects sound discrete; first time I heard it I thought I was listening to CD-4.

HEY HERB: Enclosed is a recording I made on a Beep cassette. You will find the wow and flutter is unbearable, yet earlier recordings, and pre-recorded cassettes, sound great on my Sony TC-142. Why the sudden appearance of wow?

It isn't wow and flutter. Your cassette, which is one of the best known brands, and well noted for the least trouble, is defective. The tape is *sticking* as it feeds—moving in jumps, and what you think is wow and flutter is simply a jammed cassette. A good rule of thumb when you think a cassette recorder has gone sour is to try another cassette or a different brand of tape.

HEY HERB: According to just about everything I read CD-4 records require a special pickup and stylus, yet I recently tried a Kenwood CD-4 adapter with my Shure V15 type III pickup and the darned thing worked. The sound was quite good. Why then is a special—and somewhat expensive—pickup required for CD-4?

I'll put money on the fact you played the alignment record supplied with the CD-4 demodulator, which has a music sample on one side. The record plays at 45 rpm, so the recorded wavelength is longer. The V15 III has a slightly extended frequency response, and the stereo stylus can track the 45 rpm grooves with reasonably good CD-4 results. The V15 III, and a few other super quality stereo pickups, can also

(Continued on page 101)

DXing the Locators

The next Beep you hear may be the beginning of a new hobby—logging the Radio Pagers

by Don Jensen



BEEP-beep," a two-tone radio signal and a brief message go out over the air. "352, 352, call Mr. Peterson at your office."

Miles away, on the 17th fairway, a manufacturing executive hears the call, thrusts his two-iron into his bag and heads the golf cart back to the clubhouse to phone his company. Duty calls even on his afternoon off.

Similar scenes are repeated daily across the country. Our vice-president, and many thousands more like him, keep in touch with things wherever they are by means of a special communications service known as radio paging.

Doctors and lawyers, salesmen and business executives, and many others, tote tiny transistorized VHF FM receivers. These pocket radios—"The Locators," one equipment manufacturer calls them—alert their carriers to important messages no matter where they are. Radio paging, a selective, one-way very high frequency radio system, is perhaps the ultimate in personal communications for people on the go with a need to know!

Though little known to most people, these radio paging stations have attracted the attention of communications monitors.

Where the Action Is. In recent years, monitoring the VHF action bands, the frequencies between 30 and 300 MHz, has grown by leaps and bounds. DXers have

been snapping up VHF receivers like hotcakes. Usually it is the lure of tuning the action frequencies, police and fire communications, that prompts a DXer to buy a VHF rig. But, before long, monitors discover there are plenty of other signals to be heard on these bands, including the radio pagers.

You may already have heard the tell-tale beeps of the paging stations but haven't known what they were. If so, or if you're just getting started in communications monitoring, this is what it's all about.

Where to Tune. The radio pagers can be heard in both the VHF low band (30 to 50 MHz) and the high band (150 to 174 MHz). Many of the stations are concentrated on about a half dozen frequencies in the VHF low band, especially 35.22, 35.58, 43.22 and 43.58 MHz. Because the "traffic" tends to be rather dull, compared to police and fire department communications, the attraction for the communications monitor is largely the DX factor. They are interesting because, under the right propagation conditions, reception from hundreds of miles away, on occasions more than a thousand miles, is possible on the low band.

There are hundreds of radio paging VHF stations across the nation, in major metropolitan centers and small cities. They are operated by many different firms. Most of the radio paging stations are owned by companies that specialize in the service. Some

e/e DXing THE LOCATORS

are large outfits with stations in a number of cities. Others are small, hometown companies, often outgrowths of regular telephone answering services. They have names like Air Call, Radio Page, Airsignal, Contact, Auto Phone, Radiocall Paging, or simply, Telephone Answering Exchange.

These commercial operations perform a service for subscribers and charge a monthly fee. Their job is to receive messages for clients and alert the subscriber or relay the messages by VHF radio transmissions.

Other radio pagers are private ventures designed to serve only a small, select group of individuals. Some hospitals and medical



clinics operate radio paging equipment for their doctors. Business firms have their own radio pagers to keep in contact with salesmen and executives away from the office or plant.

Beep to You. Radio paging systems vary in operation, but they are characterized by a common factor. They are one-way radio transmissions directed to specific persons. And this is where the "beeps" come in.

The tone signals that precede the messages, are, in fact, electronic "keys" that unlock specific radio receivers. No subscriber wants to constantly receive radio signals for other subscribers. He only wants his pocket receiver activated when there's a message for him.

So these tiny receivers are designed with tone-lock circuitry. They are activated only when they receive their own distinctive



Personal paging equipment keeps the professional and service industries in touch with their personnel no matter where they may be in the broadcasting range of their paging systems. Applications are as various as people's needs. Plant telephone operator (1) initiates calls when she cannot reach top management via phone lines or public address system (left). A computer service technician (2) performs routine service until alerted for emergency service. Surveyor (3) can hardly be expected to hear his phone ring, even if it's in his car nearby. Paging receiver attached to helmet makes the difference.



tones, their "keys." Each subscriber has his own coded tone signal that "unlocks" his receiver. His tiny receiver is silent until there is a message directed to him. And that signal does not "unlock" the receivers of other subscribers, each of whom has his own special activating signal. The communications monitor, whose receiver is not designed with a tone-lock device, hears all the messages, however.

Some radio paging systems have encoding facilities to handle over 800 different and distinctive tone "key" signals.

A few older systems are the simplest. They use only the tone signals, without voice message. All they do is alert the individual subscriber that a message is waiting for him. He must then phone the paging service for his message.

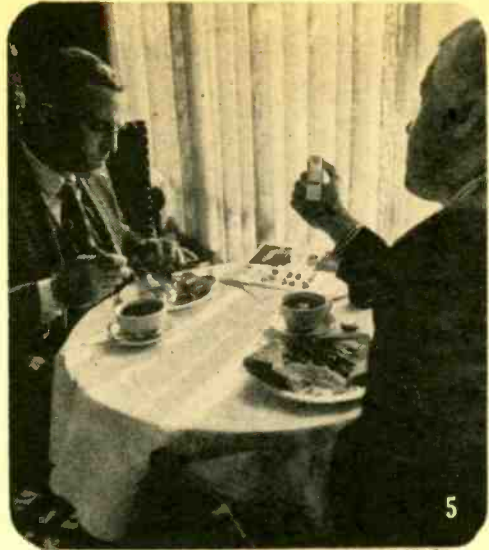

Applications of paging devices vary from every professional use to many personal purposes. For example, the housewife (4) may want to keep in touch with her answering service while she goes about raising funds for charity. Her children know their mother is never farther away than a telephone call. Even businessmen must take time out to relax and eat (5). Sales personnel must never be so far away as not to close a sale by telephone. And, it may seem way out, but it's not, dog training finds new dimension when the dog (6) hears commands and reassuring praises from his master or trainer no matter how remote he is from either.

Most radio pagers now transmit a voice message. The subscriber can be told to call a certain person or phone number, contact his office, return home, or any other pertinent instruction.

More modern equipment, in use in certain larger cities, adds a neat refinement to the voice broadcasts. The subscriber's secretary, or anyone else he has given his special seven-digit number, can pick up a phone and dial him directly. The phone call is automatically patched into the VHF transmitting system and the caller, himself, can deliver the message, without the inconvenience, delay and error possibility of having it relayed by the radio paging operator.

No Ship. Radio paging systems are essentially local. VHF frequencies usually limit the broadcast range to line-of-sight from the transmitting antenna. (Though,



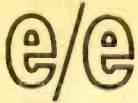

DXing THE LOCATORS

under special conditions, long distance reception is possible.) Most radio pagers claim reliable coverage in about a 20 to 25 miles area. In New York City, though, a firm known as Aircall transmits from antennas atop the Empire State Building. It, and other radio pagers whose antennas are mounted on high buildings, claim regular reception by clients using the mini-receivers at 40 and 50 mile ranges.

Communications monitors, however, may find that they can hear, over a period of time, dozens of radio paging stations in a multi-state area, depending on the sophistica-

tion of their receiving and antenna equipment, special propagation conditions and the like.

Clam Up. A word of caution: All non-program, private communications transmissions, not intended for reception by the general public—including police and fire calls, two-way utility communications and radio paging—are covered by the federal Communications Act of 1934, Section 605, as amended. The law prohibits monitors from divulging or beneficially using information derived from such listening. In other words, you cannot legally tell others what you hear or make some personal beneficial use of what you overhear on the air.

So feel free to DX the radio pagers . . . with your ears open and your mouth shut! ■

LOW-BAND RADIO PAGERS

Call	Location (Operator ID)	Call	Location (Operator ID)
35.22 MHz		KMD347	Stockton CA
KIY757	Montgomery AL (Paging Montgomery)	KAQ606	Denver CO
KCH280	Phoenix AZ	KIF651	Ft. Lauderdale FL
KKX708	Little Rock AR	KIQ510	Jacksonville FL (Radio Dispatch)
KMD342	Fresno CA (Cooks Communications)	KUA217	Honolulu HA
KME438	Orange CA (Radio Page)	KSC645	Chicago IL
KMD305	San Francisco CA	KSC864	Peoria IL
KMD681	San Diego CA	KSD326	Indianapolis IN
KDN407	Colorado Springs CO	KAD927	Wichita KA
KCI299	New Haven CT	KGA807	Baltimore MD
KIN645	Miami FL (All-Florida Communications)	KCC266	Springfield MA (Airphone)
KIY508	Oriando FL (Paging Orlando)	KAH661	Minneapolis MN (Air Signal)
KLF527	Honolulu HA (Hawaiian Telephone)	KFL943	Las Vegas NM (Vegas Instant Page)
KOK344	Boise ID (Radio Paging)	KEC519	Rochester NY
KSA623	Ft. Wayne IN	KKM248	Oklahoma City OK (Radiocall Paging)
KSD320	South Bend IN	KIG837	Nashville TN
KGA807	Baltimore MD (Contact, Inc.)	KKV688	Amarillo TX
KQD303	Detroit MI	KKI445	Houston TX (Radio Paging)
KAH661	Minneapolis MN (Airsignal)	KIG297	Norfolk VA
KEA860	New York NY	43.22 MHz	
KIM905	Charlotte NC (Radio Page)	KMB309	Los Angeles CA
KCC482	Concord NH (Radio Page)	KCI295	Manchester NH
KGC226	Allentown PA	KEC745	New York NY
KGC223	Philadelphia PA	KGC223	Philadelphia PA (Telephone Message Bureau)
KCF341	Salt Lake City UT	43.58 MHz	
KON908	Cheyenne WY	KMD986	Sacramento CA
35.50 MHz		KGA806	Washington DC
KQD607	Grand Rapids MI	KIE367	Miami FL
35.52 MHz		KIG300	Atlanta GA (Decatur Clinic)
WWV335	San Juan PR (Radio Call)	KSC644	Chicago IL
35.56 MHz		KSJ816	Ft. Wayne IN
KGC400	Scranton PA (Telephone Answering Exchange)	KIF656	Louisville KY
35.58 MHz		KCB890	Boston MA
KOF328	Tucson AZ	KQC884	Detroit MI
KMD344	Long Beach CA (Air Page)	KEA777	Buffalo NY
KMB309	Los Angeles CA	KQK593	Cleveland OH
KMA820	San Diego CA	KFJ891	Columbus OH
		KGA804	Philadelphia PA
		KKJ460	Dallas TX

e/e's

ALL NEW BASIC COURSE in ELECTRICITY & ELECTRONICS



This series is based on
BASIC ELECTRICITY/ELECTRONICS,
Vol. 1, published by
HOWARD W. SAMS & CO., INC.

UNDERSTANDING TV TRANSMISSION

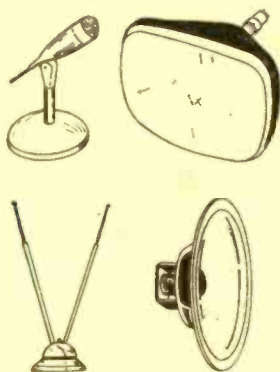

What You Will Learn—You will learn how television stations transmit both picture and sound signals. You will gain more knowledge about antennas and the problems of sending electromagnetic waves through the atmosphere. You will also become familiar with how a television camera takes a picture. Learning the basic principles of television transmitters and receivers is no more difficult than learning the principles of radio; basic electronic principles are the same for both.



TELEVISION

The Federal Communications Commission (FCC) has assigned specific groups of frequencies to different types of communications transmissions.

Commercial transmitters (radio and television, for example) are assigned a transmitting frequency in the appropriate part of the radio-frequency spectrum. Transmitters broadcasting in the home radio band, 535 kHz to 1,605 kHz (kilohertz), are required by law to be on their assigned frequency to within a + or -20 Hz tolerance.

QUESTIONS

- Q1. Radio waves travel from the broadcast station to a receiving antenna at the rate of ----- miles per second.
- Q2. A frequency of 1,000 kilohertz would be assigned to (commercial short-wave) radio.

ANSWER

- A1. Radio waves travel from the broadcast station to a receiving antenna at the rate of 186,000 miles per second.
- A2. A frequency of 1,000 kilocycles would be assigned to commercial radio. (1,000 kilohertz is equal to 1 megahertz.)

The radio transmitter has the single problem of putting sound on a carrier. The TV transmitter must modulate two carriers, one with sound and the other with video (picture). The audio section is in a separate channel of its own. Shown in the TV block diagram is a camera which sends a weak picture signal to the video section to be amplified. The output of this section is a video frequency used to modulate a very high frequency (VHF) transmitter generated in the carrier block. Superimposing the video (picture) on the carrier is done by amplitude modulation, the same used in an AM broadcast band radio transmitter.

TV TRANSMITTER

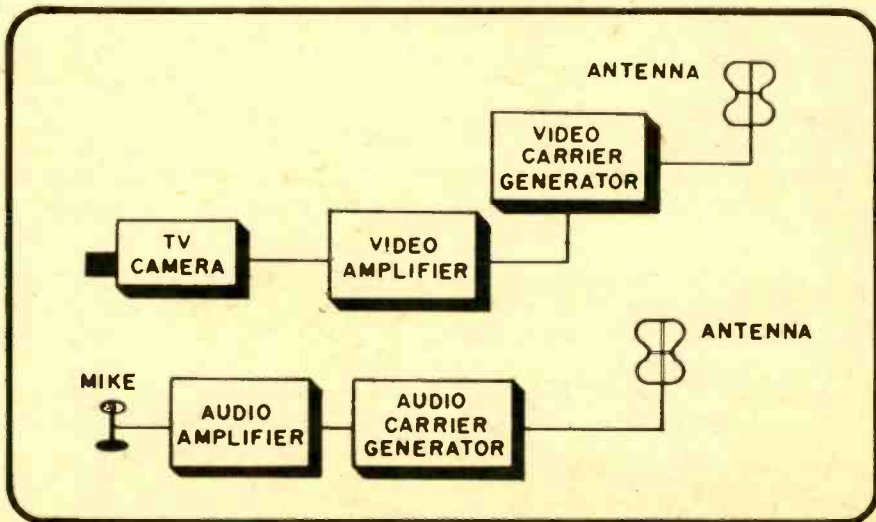

A microphone feeding a signal to the audio-frequency section is shown at the bottom of the illustration. The sound signal from his microphone is amplified and used to frequency-modulate a separate carrier. This modulated carrier is then fed to an antenna. In effect, there are *two* transmitters for TV—one for transmitting the picture and the other for transmitting the sound. In practice, a single antenna is usually used to transmit both carriers.

TV VIDEO TRANSMITTER

In the video section, video signals from the camera are amplified and fed to a power amplifier in the carrier generator section. Here, the carrier is amplitude-modulated by the video signal.

There are several different types of TV cameras. The *vidicon*, *plumbicon*, *image dissector*, and *image orthicon* are examples. The latter is the type most frequently used in TV broadcasts. Although the manner in which they accomplish their purposes differ, their basic operating principles are the same.

The camera, much like its photographic counterpart, deposits a scene through a lens on a plate within the camera. Light rays from all parts of the scene are focused through the lens, reproducing the image on the plate. If the plate were a photographic negative, the light rays would excite deposits of light-sensitive materials in proportion to the intensity of light, varying from white through shades of gray to black.

TV CAMERA

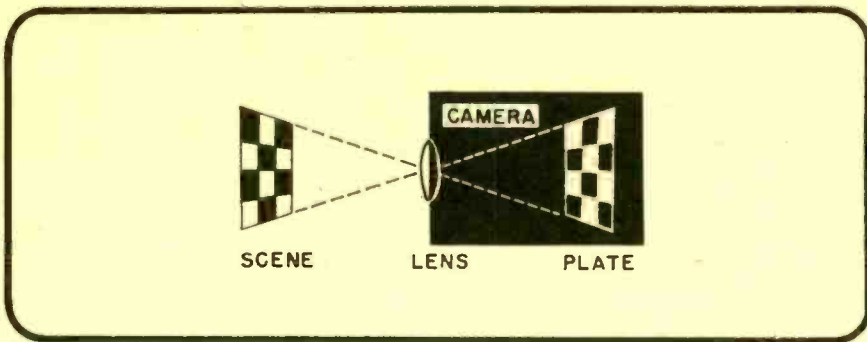

A similar process occurs in a TV camera. The light-sensitive plate receives a picture of the scene. Tiny areas on the chemically treated plate are thereby electrically charged in proportion to the light intensity of that part of the scene.

Scanning

A very narrow beam of electrons is moved back and forth across the plate from top to bottom. The beam samples the intensity of the charge in each of the tiny areas. The amount of each charge indicates whether that portion of the scene is black, white, or some shade of gray.

ELECTRON BEAM SCANNING

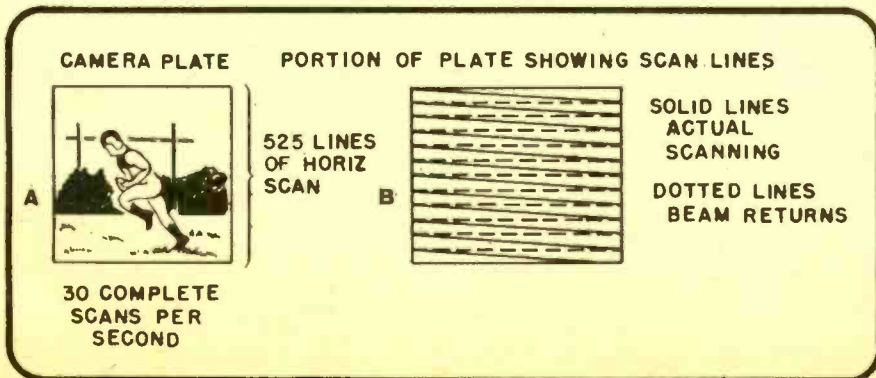



As show in part A, the plate is scanned in a sequence of 525 lines from top to bottom. A complete scan of the plate is made 30 times each second. The same procedure is duplicated on the screen of your receiver. In a TV receiver with a 17-inch screen, the electron beam in the picture tube travels across the screen at the rate of approximately 13,000 miles per hour.

Part B shows how this scanning is accomplished. The beam moves across the plate in the camera from left to right, sampling the intensity of each tiny area it passes. At the end of the line the beam is blanked (shut off) and returned to the left side of the plate to start the next line. The beam is turned on again and samples the second line. This process is continued until the bottom of the plate is reached. The beam is blanked and returned to the upper left-hand corner to start scanning again. When the beam is on and moving from left to right sampling the intensity on the plate, it is said to be scanning. When it is shut off and being returned to a new starting point, it is retracing.

QUESTION

- Q3. The TV tube image plate is by an electron beam.
- Q4. How many lines does the beam trace each second?

ANSWERS

- A3. The TV tube image plate is scanned by an electron beam.
- A4. 15,750 lines per second (525x30).

Interlaced Scanning

Because of problems in controlling the beam and of noticeable flicker to the viewer when line-by-line scanning is performed, the beam is caused to scan every other line.

INTERLACED SCANNING

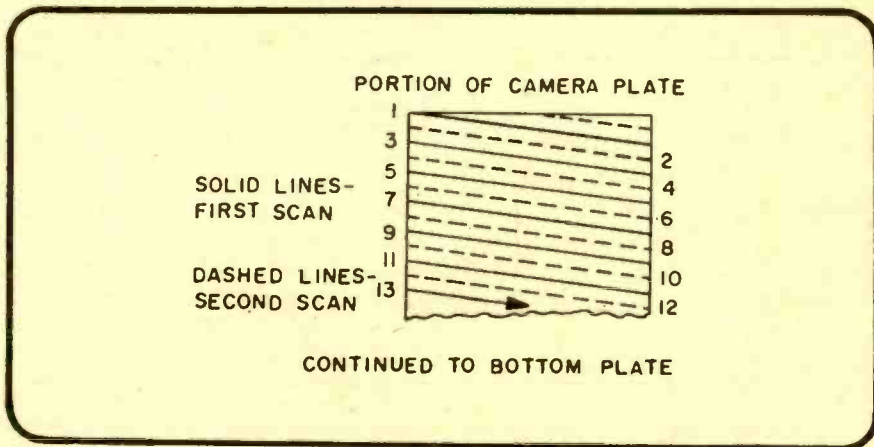

As the illustration shows, the first scan starts at line 1, samples the charged areas, and is retraced to line 3. This action continues to the bottom of the plate, scanning the odd-numbered lines. When it reaches the bottom, the beam returns to the top of the plate and scans the even-numbered lines. Full scan, top to bottom, requires 1/60 of a second. To scan the entire plate, the beam requires two passes, which takes a total time of 1/30 of a second. On the receiver screen a new image is being presented on every other line 60 times a second, a line-tracing frequency that cannot be noticed by the eye. If it were being done at the rate of 30 times a second, the eye might be able to see the changes, which would be recognized as a flicker. This process of scanning every other line is called *interlaced scanning*. The camera thus identifies the light and dark areas of a scene and converts this information to currents and voltages that change in proportion to the light intensity.

Timing Generator

The timing of the scanning events is very critical. The beam of electrons must begin at a precise point near the top of the camera plate and scan every odd-numbered line in $1/60$ of a second. The electron beam must be blanked out precisely at the end of every line and at the end of the field. A complete scan of all the odd-numbered lines (or even-numbered lines) is called a field.

VIDEO STAGES

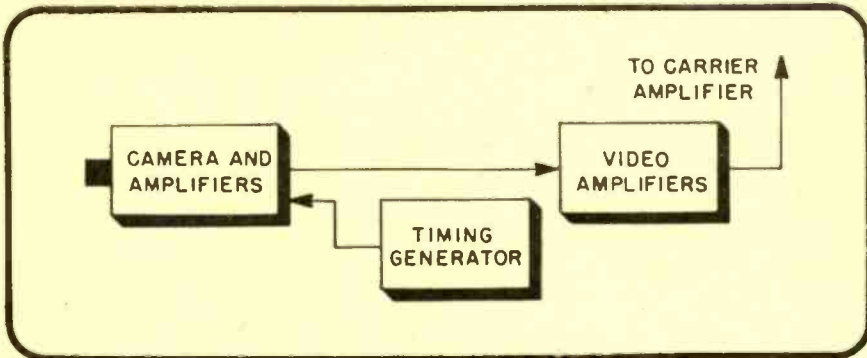

When the odd-numbered field has been completed, the blanked beam must be returned to a new position at a precise time to begin scanning the even-numbered field. Each action and position of the camera beam must be followed precisely by similar action in your TV receiver at home. The stage in the TV transmitter that establishes this precise timing is known as the **timing generator**, sometimes called the **blanking or synchronizing stage**.

The timing generator in the preceding illustration feeds pulse waveforms to the camera. The amplitude and timing of the pulses are such that they synchronize (cause all events to

TWO VIDEO LINES

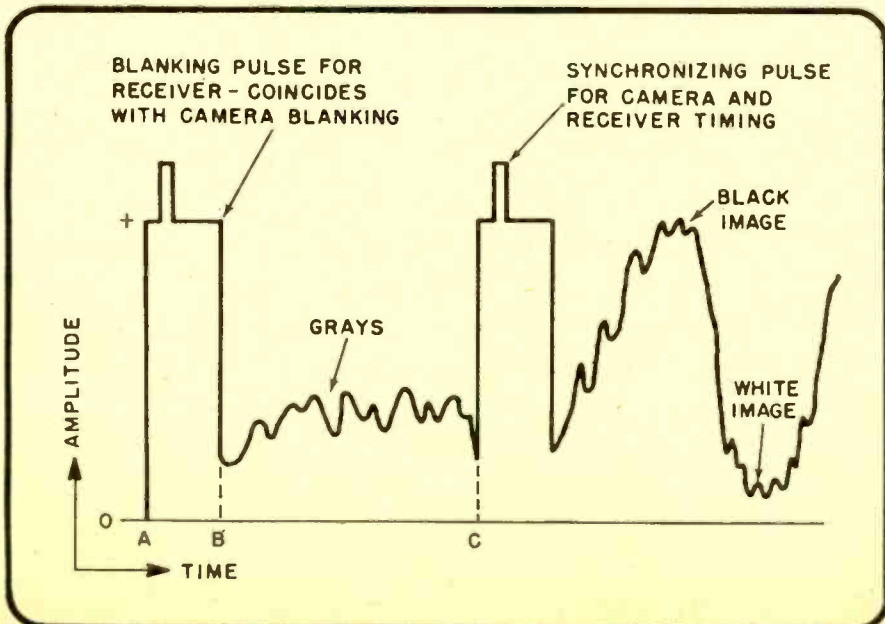



take place at precise time intervals) scanning, blanking, retracing, and positioning of the electron beam. The same timing pulses (for synchronizing the same events in the receiver) are fed, with the amplified video, to another stage of video amplifiers. From this point the entire signal—video and timing pulses—is passed to the final amplifier of the carrier for modulation purposes.

As you have learned from the preceding discussion, a video signal contains a great deal of information. A series of video waveforms is shown. Remember that a waveform is a graph of amplitude and time.

QUESTIONS

- Q5. scanning skips every other line.
- Q6. Scanning is synchronized by a(an)
- Q7. What is contained in the video-output amplifiers?

ANSWERS

- A5. Interlace scanning skips every other line.
- A6. Scanning is synchronized by a timing generator.
- A7. Video and timing pulses.

Video Modulation

The video and timing pulses are placed on the carrier frequency by amplitude modulation.

The carrier-frequency section is similar to the same circuits in a broadcast radio transmitter.

The oscillator generates a continuous and constant frequency. The output of the oscillator is increased in frequency and amplitude by the multiplier and amplifier sections. In the power amplifier, the carrier is raised to the desired power level required by the station, and is amplitude-modulated by the video signal. Today, *linear* amplifiers are used to boost power output beyond that provided by the modulated stage.

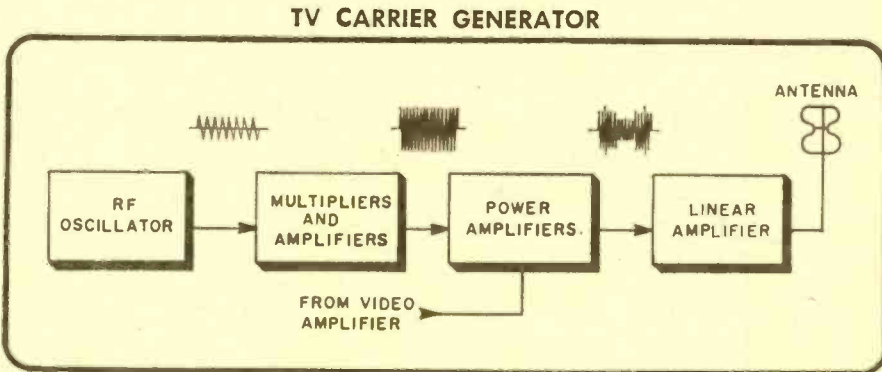

For VHF (very high frequency—channels 2 to 13), the frequency of the carrier is between 54 and 216 megahertz. For UHF (ultra high frequency—channels 14 to 83), the carrier is between 470 and 890 megahertz. Transmission of signals at these frequencies is quite different from that for the lower radio frequencies. High frequencies have short wavelengths. A wavelength is the time duration, or length, of one cycle. The higher the frequency of a signal, the shorter is its wavelength.

QUESTIONS

- Q8. The image scanned by the camera is changed into a(an) frequency.

ANSWERS

- A8. The image scanned by the camera is changed into a video frequency.

- Q9. A video signal has and
 dimensions.
- Q10. VHF has (shorter, longer) wave-
 lengths than UHF.
- Q11. A TV video signal is
 modulated.

- A9. A video signal has amplitude and
 time dimensions.
- A10. VHF has longer wavelengths than
 UHF.
- A11. A TV video signal is amplitude
 modulated.

TELEVISION TRANSMITTING ANTENNAS

An antenna develops an electromagnetic field around itself when current is passing through it. Current flows back and forth through an antenna in accordance with the rise and fall of the carrier-waveform frequency and amplitude.

SKY WAVE SKIP

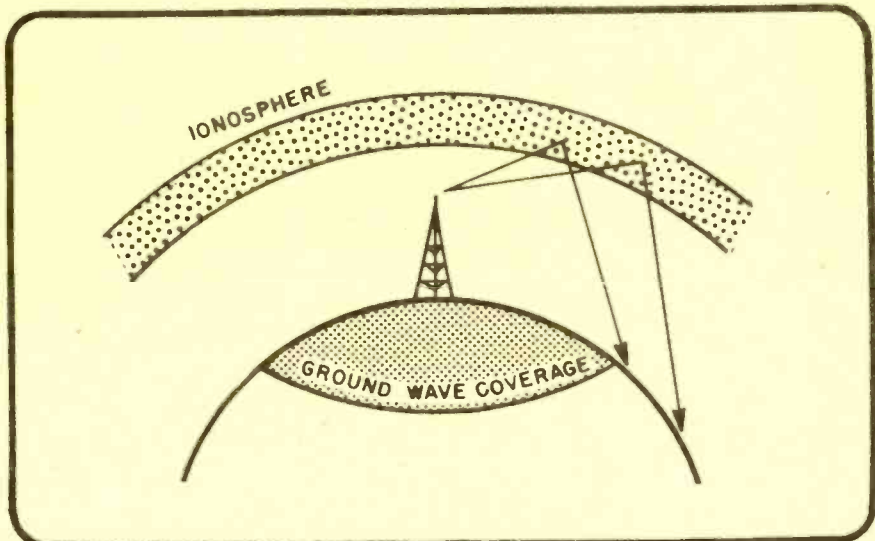

Television Wave Propagation

Since the wavelength of a TV carrier is shorter than that of a radio-broadcast carrier, the length of the TV antenna is correspondingly shorter. There is also a difference in the way short and long wavelengths travel through space.

The diagram above illustrates the propagation (travel of electromagnetic radiation) of waves as they radiate from the antenna of a commercial radio station. Electromagnetic energy radiating into space from medium and shortwave transmitting antennas can, as illustrated above, be reflected by the ionosphere and returned to earth for reception by radio sets far beyond the normal ground wave coverage area. The ionosphere is a name given to the many varying electrical layers found above the atmosphere to a height of about 75 miles. These layers are caused by intense radiation from the sun. A ground wave hugs the ground until the radiated power decreases so much with distance that reception is no longer possible, or until the receiving point drops below the radio horizon.

The short wavelengths of a television transmission depend on a different method of wave propagation.

High frequencies radiate a ground wave and a sky wave. Both of these waves travel essentially in straight lines. To receive a sky wave, the receiving antenna must be within line-

QUESTIONS

- Q12. TV frequencies have --- and
 waves.

ANSWERS

- A12. TV frequencies have sky and ground
 waves.



RADIATED VHF WAVES

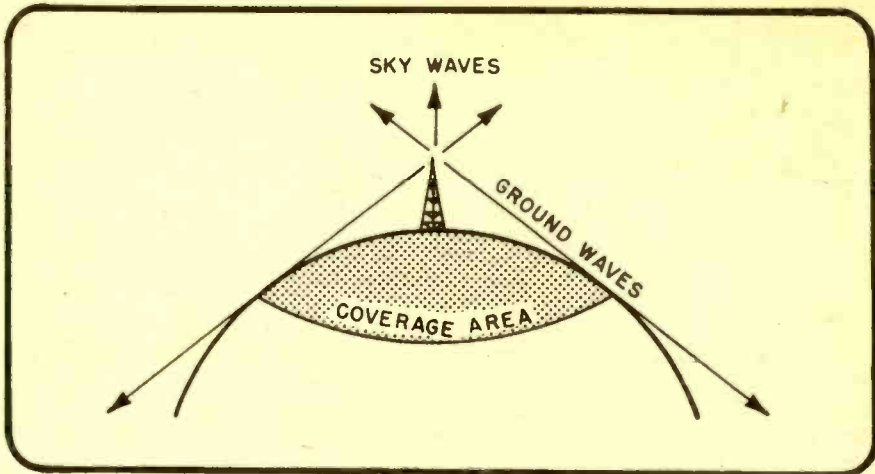

of-sight of the transmitting antenna. If the receiving antenna is beyond the horizon, the wave (if it still retains sufficient power) passes over it.

Sky waves, also traveling in a straight line, head out into space.

WHAT YOU HAVE LEARNED

1. Television transmitters and receivers, like any other electronic equipment, consist of circuits designed to accomplish specific functions. Although there are a large variety of circuits, they all operate in accordance with a basic concept—the effect that voltage, current, and electronic components have on each other. These basic effects can be used to analyze any circuit, providing you understand the underlying principles of each.
2. A television transmitter consists of two sections. One section uses a camera to scan a scene, and a group of circuits to modulate a carrier frequency with the image. The other section takes the output from a microphone and uses it to modulate a second carrier frequency.
3. Video is obtained from the camera as it scans a scene with an electron beam, one line at a time. The video signal, with the addition of blanking and synchronizing pulses, is amplified and then used to modulate the picture carrier frequency. The amplitude-modulated carrier is raised to a specified power level with linear amplifiers and then fed to the antenna.
4. Video and sound carriers are of a high frequency and therefore have short wavelengths. These travel through the atmosphere as either ground or sky waves. Short ground waves travel on a line-of-sight path and cannot normally be received beyond the horizon.

This series is based on material appearing in Vol. 1 of the 5-volume set, **BASIC ELECTRICITY/ELECTRONICS**, published by Howard W. Sams & Co., Inc. @ \$22.50. For information on the complete set, write the publisher at 4300 West 62nd St., Indianapolis, Ind. 46268.

Dual 701 Turntable

Continued from page 62

gram. The overall performance when playing a record was outstanding; rumble was inaudible, tracking was maintained using high performance pickups with a stylus force as low as 0.5 gram, and the overall handling and operating ease was excellent.

As a final note, the Dual 701 is a good choice if you're thinking of going CD-4

quadrasonic. Though the base is solid the top deck is removed by flipping three screws sidewise, exposing plug-in phono output cables. Just pull off the existing cables, plug in a pair of low capacity cables (usually supplied with CD-4 demodulators) and the 701 is set for discrete quadrasonic sound. There's no soldering necessary to change cables nor must you dismantle the base to get at the cables.

The Dual 701 complete with base and dust cover is \$350.00. For additional information circle No. 80 on the Reader Service Coupon.

Leader FM Stereo Generator

Continued from page 60

and though its distortion is rated at less than 0.5% THD, our measurements indicated less than 0.1% THD.

The biggest performance feature is the stereo separation, rated at 50 dB with the internal 1 kHz oscillator, and better than 35 dB 50 to 15,000 Hz from the external inputs. This exceeds the separation required of stereo transmitters and is considerably better than the separation of modern stereo receivers. We could check out the midband separation to be as claimed; unfortunately, our test equipment cannot measure the 35 dB separation (minimum) at 15 kHz, but when used with a receiver known to have 33 dB separation at 15 kHz the total output reading was 33 dB, indicating the LSG-231 had at least 33 dB of separation at 15 kHz—darn good performance.

The Leader LSG-231 is housed in a rugged metal cabinet using the styling found on the most expensive instrumentation, right down to wrap-wire feet for the linecord. At first glance one might assume the LSG-231 is from one of the two biggies in industrial instrumentation.

In fact, as we see it, the styling is the LSG-231's only problem, for combined with its notably excellent performance it's hard to believe that so much can be sold for only \$299. Fact is, if the LSG-231 had a nameplate from one of the biggies in instrumentation and a price tag well in excess of \$500 you'd probably have to go on a three month waiting list to get one—it's that good. For additional information and manufacturer's specifications, circle No. 77 on the Reader Service Coupon. ■

Newsman

Continued from page 26

Suppose you had three boxes and in each box there were seven blue cars. How many blue cars would you have?"

At one of the schools where Mr. Computer is now being used, a typical classroom situation includes five students, a teacher, and a teacher's aide. Because of the students' handicaps, the teacher can work with only one student at a time, while the teacher's aide tries to keep the other pupils occupied. With a computer terminal in the room, however, another student can be working on a lesson with Mr. Computer, and the output of the teacher is essentially doubled.

Balloons to Cosmic Rays

NASA researchers are using a novel way of conducting cosmic ray research to perfect the equipment and procedures to be used aboard the Space Shuttle. The work, being conducted by the Planetary and Earth Sciences Division of NASA's Johnson Spacecraft Center, involves instrumentation for cosmic ray measurements that is lifted to high altitudes by a balloon and is linked via radio to a small computer located at the center. In addition to gathering valuable scientific data, the balloon-borne arrangement is helping to develop experimental procedures that will be employed for similar studies to be carried out aboard the manned space laboratories put into orbit by the Space Shuttle.

The computer, a Digital Equipment Corporation device, is connected to the instrument package in the balloon by a two-way radio-telemetry link. By this arrangement, the computer permits a human researcher to control the "direction" of the experiment. The balloon's instrument package is complex, conducting a number of experiments simultaneously. The computer permits the researcher to determine which of the simultaneous experiments should be analyzed with more precision.

As the experiments are progressing, the data

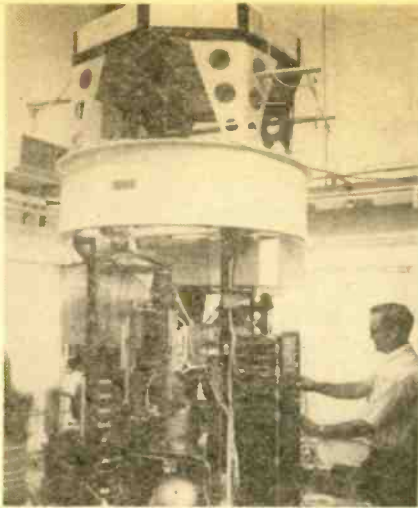

Giant Gondola housing an intricate instrument package for space study balloon undergoes final checkout at the Johnson Space Center in Houston, Texas, in preparation for launch.

is transmitted to the computer over the radio link. The computer analyzes the data and transforms the results into a form of graph on a television-like screen. When something out of the ordinary is seen by the researcher, he signals the computer to have the instruments "pay more attention" to the unusual experiment than to the ones with normal results.

Dr. Robert L. Golden of the Planetary and Earth Sciences Division noted that this technique is a brand new way of conducting cosmic ray research. "I believe that man is a vital part of such experiments," he said, "I'm an experienced accelerator physicist, and have worked for three to four years with the researcher taking part while the experiment is in operation. It's a superior way to do physics."

Checkout Computerized

A new-generation, computer-based electronic checkout system for the supermarket industry,

the NCR 255 Supermarket Terminal System, combines interactive terminals in checkout lanes with an in-store minicomputer and is especially tailored to larger supermarkets' needs. To the shopper this new system will mean faster checkout speeds and greater accuracy. For store management it will provide better control and more information.

A major advantage of the computerized system is its extensive in-store accounting, reporting, and control of cashier, office, and other store funds. This greatly improves management's ability to prevent shortages. The system also provides sales and inventory data as a by-product of its price look-up ability, and accumulates hourly activity statistics to assist in scheduling store personnel. Its automatic store-level reporting greatly reduces end-of-the-period report preparation and store balancing. The system also can incorporate automatic slot or wand scanning which will come with implementation of the recently announced Universal Product Code symbol.

Each 255 interactive checkout terminal is connected with, and controlled by, a compact in-store NCR minicomputer which includes a magnetic-tape-cassette system. The processor can store prices for several hundred separate items. This price look-up ability can be used for store promotions or other special pricing at the option of management. The system also alerts cashiers to shoppers whose checks the store will not cash or whose check-cashing has been limited for some reason.

Although the terminals are computer-controlled, they can operate independently should the computer or its communications fail. Each terminal has the capability to record a customer's purchases, determine the taxable portion of the sale, calculate change and print a receipt. A control total is provided and is transferred to the computer's memory when communications are restored. The system also automatically calculates taxes, extends prices for quantities, and computes "split-package" prices when a customer takes fewer than the advertised number of units. ■

DX Central Reporting

Continued from page 24

frequencies, addresses, schedules, and much more. I'd wager that a majority of the questions asked by our readers who write in could be answered by the DXers themselves if they had a copy in their shack.

One U.S. source for WRTH is Gilfer Associates Inc., P.O. Box 239, Park Ridge, NJ 07656. The 1974 edition should be out shortly.

By the way, DX Central is trying to complete its reference library file of back copies of

WRTH. Any of you old timers out there have a copy from before 1950? If so, please drop us a line!

And, finally, this note from Greg Ravenhorst of Hackensack, Minnesota. "How about a station that ID's itself as 'This is Reykjavik Radio. We are broadcasting for circuit adjustment purposes.'"

Iceland, Greg, Iceland. It is a utility-type communications station operated by The Post and Telegraph Communication Center-Gufunes, Reykjavik, Iceland. You heard a test tape, called a "voice mirror," broadcast by their 5000-watt transmitter. You didn't mention the frequency but I bet it was 12175 kHz, where it is frequently heard in North America. ■

Hey, Look Me Over

Continued from page 16

and 10-foot lengths, "Golden Duratube" now comes in 20, 30, 40 and 50-foot telescoping lengths. Tests show that Duratube is 50% stronger than high-carbon masting of the same gauge, is more resistant to wind stress, and does not get coated with "white rust." The unique Contour Guy Rings, resembling inverted saucers, are made of aluminum. They rest on the swaged shoulder of the mast, and cannot ride up or bind the adjacent telescoping sections. This allows the mast to be firmly guyed before the antenna is finally oriented. For more details and dealer locations, circle No. 70 on Reader Service Coupon.

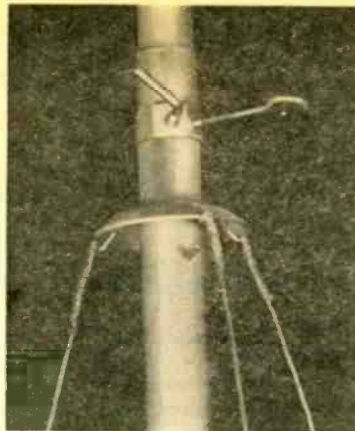

Pot Box

Continued from page 68

middle pot in the same manner, and finally do likewise with the right-hand pot. Reset the ohmmeter range switch when calibrating each pot to get more accurate mid-scale readings.

When calibration of the *Pot Box* is completed, check each setting again; as a final check, set in values on each potentiometer, read the total resistance as closely as possible from the scales, and compare with the ohmmeter reading. (For instance, with the

right-hand pot set at 8, the middle one at 3, and the left-hand one at 5, your ohmmeter should read 835,000 ohms). When all is well, remove the pots from the face-plate and carefully ink in the scales and erase all pencil lines. The lettering can best be done with press-on type letters and the entire face sprayed or painted with a clear fixative.

One word of caution about using the *Pot Box*: carbon composition potentiometers will not dissipate much power; about a quarter of a watt or one-half watt intermittently. If you want greater power-handling capability, use wire-wound potentiometers. ■

Bookmark

Continued from page 80

mass media since the invention of printing hundreds of years ago. It's all in *Vintage Radio* by Morgan E. McMahon. You can enjoy *Vintage Radio* in several ways: recapture the feel of pioneer days of wireless and radio; browse through old-time ads, pictures and trivia; read about the rough-and-tumble days of a new industry. This book is the ideal addition to your library, and is an excellent gift. It is also available in a handbook edition for the convenience of roving collectors. To get more information on *Vintage Radio* published by Vintage Radio press as well as other nostalgic titles, circle No. 82 on Reader Service Coupon.

Hi on Sound. An authoritative new book *Basic Audio Systems* by the dean of audio authors, Norman H. Crowhurst, covers sound systems for every application—indoors and out. *Basic Audio Systems* is an introduction to the

electronic aspects of sound, and more. It's written for the technician who wants to install amplifiers in a church without distortion and

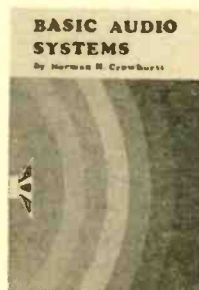

Soft cover
240 pages
203 illustrations
\$4.95

feedback, for the hi-fi enthusiast who wants to install a well-matched two- or four-channel stereo system in his home, for the industrial in-plant technician who wants a public address system that can be heard clearly by all employees, indoors or out. Published by Tab Books. Circle No. 85 on Reader Service Coupon. ■

CLASSIFIED Market Place

Classified Ads 95¢ per word, each insertion, minimum 15 words, payable in advance. For information on Classified ads—to be included in our next **ELEMENTARY ELECTRONICS**—write to R. S. Wayner, Classified Ad Manager, 229 Park Ave. South, N. Y. 10003.

ADDITIONAL INCOME

WIN \$1,000,000.00 in the New Jersey State Lottery. Rush \$3.00 for complete details and instructions. Satisfaction Guaranteed. Davidson's, Box 274-SM, Belleville, Illinois 62222.

Extra Income! Complete Information in Your area—No experience Necessary Details 25¢. Oyewole, Box 4577A, N.Y. 10017.

Stuff Envelopes \$25.00—Hundred. Immediate earnings. Beginners Kit \$1.00 (refundable) Turner, Box 563A, Bronx, N.Y. 10472.

AGENTS WANTED

WATERGATE Items! Big Sellers! Easy money! Personalized Free. Edison, B125, Miami, Fla. 33151.

AUTO PARTS & ACCESSORIES

AIRMASTER Gas Saver. Fits All Cars. \$14.95. Airmaster, Lenora, Kansas 67645.

BLUEPRINTS, PATTERNS & PLANS

NEW CRAFT PRINT CATALOG—choose from over 100 great easy-to-build plans. Send \$1.25 (completely refunded with your first order). BOAT BUILDER. (CP Div.)—229 Park Avenue South, New York, N.Y. 10003.

BOOKS & PERIODICALS

WIRETAPPING Expose! Your Privacy Injured. Details \$1.00 (Refundable). Don-G, Box 548, Seattle, Washington 98111.

FIREWORKS NEWS Magazine covers commercial—Display Fireworks, Sources, Construction, Literature, Pyro-technical Supplies. Free Catalog! Pyro Press, Box 12010 (K), Lexington, Kentucky 40511.

FREE Catalog. Reeds, Tantalums, Transistors, Pots, Leds, Parts, Chaney, Box 15431, Lakewood, Colorado 80215.

JESUS Books. Christ Books. The Metae Company (SM-14), Box 932, Moorhead, Minnesota 56560.

BUSINESS OPPORTUNITIES

I made \$40,000.00 Year by Mailorder! Help others make money! Start with \$15.00—Free Proof! Torrey, Box 318-T, Ypsilanti, Michigan 48197.

MAKE Magnetic Signs. Big profits. Details. Universal, Lenora, Kansas 67645.

FREE BOOK "2042 Unique, Proven Enterprises." Beat inflation with fabulous, successful "Little Knowns." Work Home! Haylings-Ell, Carlsbad, Calif. 92008.

BUSINESS OPPORTUNITIES—Cont'd

1000% PROFIT Bronzing Baby Shoes In Your Home. Free Honest Facts. NBC-DG. Gower, Missouri 64454.

HERBALISM! The home gold mine! Free lesson. Seeds. Herbalism Institute-D. Box 968, Glendora, Ca. 91740.

HOW To Make Money Addressing, Mailing Envelopes. Offer Details 10¢. Lindbloom Services, 3636 Peterson, Chicago 60659.

\$1000 MONTHLY possible from your own home. write Jordan, Box 884, Dept. DC11, Visalia, Calif. 93277.

INSTANT Money! Plastics are the wave of the future. Big Profits Now! At Home! Spare time! Materials costing 11¢ bring back \$2.98 profits immediately! Free information. Rush name on postcard to: Warner, Room LC-5-107-DB, 1512 Jarvis, Chicago, Illinois 60626.

ADDRESSERS and Makers Wanted. Details 25¢. Shields Enterprises, Macunite, Penna. 18062.

DO Simple Addressing-Mailing. Receive \$12.95 orders. Keep \$8.00 profit. Details Free Quality, Box 9-DC, East Rockaway, New York 11518.

\$26.00 HUNDRED Addressing Envelopes. Details Send \$1.00 and stamped addressed envelope. Keen, Box 9995DC, San Diego, Calif. 92109.

IMPORT-MAILORDER OPPORTUNITY FREE AT OUR RISK AND EXPENSE FOR ONE FULL YEAR. Earn \$15,000 or pay nothing. Details, Northeast Imports, World Trade Division, Box 111E1, Fremont, N. H. 03044.

STUFF ENVELOPES \$25.00 hundred. Immediate earnings. Beginners Kit, \$1.00 (refundable). Joti Enterprises (E121E), Box 449, Hawthorne, Calif. 90250.

BUY IT WHOLESALE

BELT BUCKLES, WESTERN Trophy, Turquoise, Silver Dollar, Horses, Bronco, etc. \$3.00—\$5.00 Retail. Send for dozen samples—\$12.00. 6 dozen \$65.00. Zelco Mfg., Box 1934, Studio City, Calif. 91604.

COINS, CURRENCY & TOKENS

4 BUFFALOS \$1.20. 1929S, 1930S, 1934D. 1937S, Rongo, 1265 81st Street, Brooklyn, New York 11228.

DO-IT-YOURSELF

MAKE any window a one-way mirror, you look out, nobody looks in. (11½ x 16) Plastic \$3.00 Palmer, P. O. Box 1244SDC, P. C. Ala. 36867.

DO IT YOURSELF—Cont'd

BUILD Sewer Pipe Wine Rack. Illustrated instructions \$1.00. Minipix, Box 2578, New Brighton, Minnesota 55112.

EDUCATION & INSTRUCTION

"LOGIC newsletter, design and construction sample copy, \$1.00. Logic Newsletter, POB 252, Waldwick, N.J. 07463."

ORDINATION. Details Free. Ministry of Service, Box 526, Sevmour, Texas 76380.

ACUPUNCTURE TRAINING Home Study Course! Tsang, Box 219W, Toronto, Canada M6M 4Z2.

COLLEGE degrees via Mail. Free Information. West Gulf, Box 3199, Dept. D-1, Pasadena 91003.

BIG profits in publishing. Learn how. Details free. Stevenson Enterprises, 4808 Santa Monica Ave., San Diego, Ca. 92107.

\$2.00 BRINGS Book. How To Have Confidence and Power. Speciality Gift House, 53 Locust St., West Haven, Conn. 06516.

MATHEMATICS cassette tapes correlated with printed texts. A new series narrated by a college mathematics professor: Computer Number Bases \$6.95. Sets and Flowcharts \$6.95. Algebraic Expressions \$5.95. Statistics \$7.95. Gambling Theory \$7.95. Sets and Numbers \$5.95. Send Check or Money Order. WILLIAMSVILLE PUBLISHING COMPANY, INC., Dept. VA, Box 237, Williamsville, New York 14221.

COLLEGE Degrees At Home! Complete Directory Accredited Universities offering Correspondence Courses, \$2.00. Research, Box 48533D, Los Angeles, Calif. 90048.

ELECTRICAL EQUIPMENT & SUPPLIES

AUDIO equipment. TV's, calculators, test equipment. List of direct wholesalers. \$2.00. AudioSales, Box 39E, Bluepoint, N.Y. 11715.

EMPLOYMENT INFORMATION

EXCITING Overseas Jobs. Directory \$1.00. Research Associates, Box 889-CE, Belmont, California 94002.

FARMS, ACREAGE & REAL ESTATE

GOVERNMENT LANDS DIGEST. A Monthly review of government Real Estate offerings throughout the U.S.A. Free subscription information. . . . DIGEST, Box 25561-DP, Seattle, Washington 98125.

MORE

FOR GREATER CLASSIFIED PROFITS, RESULTS AND SAVINGS

Place your ad in one of our **SPECIAL COMBINATIONS**: Business Group, Science & Mechanics, or Davis Combination. Each Combination is designed to give your ad the largest audience available. For further information write to R. S. Wayner, Classified Ad Manager, Davis Publications, Inc. 229 Park Avenue South, New York, N.Y. 10003.

CLASSIFIED MARKET PLACE

(Continued from page 98)

FOR INVENTORS

PROSECUTE Your Own Patent Application. All Material Necessary—Write: Inventors Service, Box 3574, Washington D.C. 20007.

NEEDING Assistance? INVENTION DEVELOPMENT FOUNDATION. 155 Kent, Ottawa, Canada K1P 5P3.

HEARING AIDS

HUGE SAVINGS! BUY DIRECT! Eliminate dealer markups 20 days FREE Trial Terms arranged. No salesman will call. LLOYD'S-79, Rockford, Illinois 61108.

HYPNOTISM

HYPNOTIZE STRANGERS In 30 Seconds! Most powerful hypnotic device ever created! Complete easy instructions included. Guaranteed only \$2.00. From: **WORLD-29C1.** 3047 University, San Diego CA 92104.

HYPNOTIZE STRANGERS IN 30 SECONDS. Most powerful hypnotic device ever created! Instructions included. Only \$2.00 (Guaranteed). **ORDER TODAY!** James Green, R. D. 1, Dept. 1D1, Evans City, Pennsylvania 16033.

IMPORTS—EXPORTS

MAILORDER IMPORTS. Report reveals foreign drop-ship sources. World Traders digest. Ideal mailorder items. \$1.00. Witt Enterprises, 4023 Kendall Lane, Waco, Texas 76705.

INVENTIONS WANTED

WE either sell your invention or pay cash bonus. Write for details. Universal Inventions, 298-3 Marlon, Ohio 43302.

LOGIC

LOGIC NEWSLETTER. Design, Theory, Construction. Sample copy \$1.00. Logic Newsletter, POB 252, Waldwick, N.J. 07463.

MAGIC TRICKS, JOKER NOVELTIES & PUZZLES

WOW! Largest selection. Newest, best tricks, jokes. Giant 150 page catalog 25¢. Abracadabra-EE, Colonia, New Jersey 07067.

VENTRILUQUISM—Profitable Hobby or Career! FREE INFORMATION! Dummy Catalog 25¢. Maher, Box 9037DC, Denver, Colorado 80209.

MAGNETS

TWENTY Disc. or ten bar magnets. \$1.00. Magnets, Box 192-E, Randallstown, Maryland 21133.

MISCELLANEOUS

SEE THRU WALLS! New secret two-way super spy device! Instructions included. Guaranteed, only \$2.00. **WORLD-1B29.** 3047 University, San Diego, CA. 92104.

AIR CONDITIONING, "ECONOMIC COMFORT", "TECHNIQUES in Getting You Into A More COMFORTABLE Home". Send \$5.00 pnd to: **KIDWELL ENTERPRISES, P.C.M.H.** Park, Box 6, Pryor, Oklahoma 74361.

PRINTED Circuit Negatives and Boards Prices on request. Technical Services, Box 4027, Huntsville, Alabama 35802.

\$1,000 INTO \$1,000,000 in Ten Years. Simple plan. Send \$3.00. Suite 401, Investment Building, Pittsburgh 15222.

STORIES FOR MOVIES NEEDED. If accepted, we write screen-plays. SEND self addressed stamped envelope and \$2.00 for handling: International Pictures Corp., 1040 N. Las Palmas, Hollywood, Calif. 90038—Stories, etc., not accepted will be returned.

MONEYMAKING OPPORTUNITIES

GUARANTEED Home Income raising chinchillas. 25¢. Chinchilla, 11DC2, Port Richey, Fla. 33568.

JOIN "Money-Getters Guild" 25¢. Russell Advertising, Box 612-D, New Philadelphia, Ohio 44663.

HOMEWORKERS \$185.00 Weekly. Send 25¢ + stamped self addressed envelope. Odyssey, Box 12560DC, Philadelphia, Pennsylvania 19151.

MAKE Your Classified Ad Pay. Get "How to Write A Classified Ad That Pulls." Includes certificate worth \$2.00 towards a classified ad in this publication. Send \$1.25 (includes postage) to R. S. Wayner, Science & Mechanics, 229 Park Avenue South, New York, N.Y. 10003.

\$40.00 DAILY possible tying fishing flies at home. Details 25¢. Flyco, Box 481-EE, Albany, Oregon 97321.

MAKE \$1.00 PER SALE selling engraved metal Social Security plates. **FREE SALES KIT.** Engravplates, Box 10460-202 Jacksonville, Florida 32207.

\$6.00 HOUR Possible Part-Time. Men. Women: show Free Sample. Take Orders for Popular Engraved Metal Social Security Plates. Send Your Name, S-S Number for Free Personalized Sample. **Kit.** Lifetime Products, Box 25489-A, Raleigh, N.C. 27611.

COLLECT COINS FOR PROFIT! ONE ROLL of 1926S BUFFALO NICKELS are NOW WORTH \$13,000.00! CHECK YOUR CHANGE! LIST of VALUABLE coins. How to start WHERE to sell coins. Booklet SM12 75¢. I. D. Clarke, 101-D Clark Street, #8, Brooklyn, New York 11201.

SELECTED 100 MONEYMAKING OPPORTUNITIES. Send \$1.00. Fulk, 7003 Birch Drive, Cocoa, Florida 32922.

FORTUNES in Land! Amazing profits! Acreage, lots few dollars on Signals. Five other fast \$100,000 profit plans. Money-machine brain training! Easy borrowing. Everything \$3.00. **Fortune-Builders.** FDBP-1, Box 25, Marshall, Texas 75670.

YOU Can Make \$4.00 profit on every \$5.00 sale. Details 25¢. Oyewole, Box 4577A, N.Y. 10017.

MUSIC & MUSICAL INSTRUMENTS

RENT New albums for taping. Free details: Custom Record Shop, 929-14th Street, Silvis, Ill. 61282.

OF INTEREST TO WOMEN

\$25.00 DAILY Possible addressing-stuffing envelopes Typewriter-longhand, also Clipping News items at home Information; Send stamped addressed envelope. Ame-7, Box 310, Le Mars, Iowa 51031.

OPTICAL GOODS—TELESCOPE—

EYEGLASSES Wholesale—Free Catalog. A-Z Optical Company, Box 175 Dept. 28 E. Bay Station, Brooklyn, N.Y. 11235.

PERSONAL

CONTRACEPTIVES FOR MEN—By Mail Samples and Catalogue—\$1.00. **POPLAN,** Box 2556-DCG-10, Chapel Hill, N.C. 27514.

BECOME Ordained Minister. Free information. Church, Box 324, Daytona Beach, Florida 32015.

JAPANESE introductions! Girls' photographs, descriptions, brochure, details. \$1.00. **INTER-PACIFIC,** Box 304-SC, Birmingham, Michigan 48012.

SINCERELY interested in Marriage? Fourteen Years experience. Social Introduction Service. Box 1547, Eugene, Oregon 97401.

PERSONAL—Cont'd

HOW would you like to Receive 100 letters daily each containing \$1.00? Plan plus Six Formulas \$1.00. Rush Dollar to: Turner, Box 553A, Bronx, N.Y. 10472.

SINGLE? Nationwide introductions! Refined, confidential service! Free information! Identity Box 315-EL, Royal Oak, Michigan 48068.

GET \$12.00 Orders in every mail—keep \$8.00 on each order for yourself. Details 25¢. Turner, Box 553A, Bronx, N.Y. 10472.

PHOTOGRAPHY—PHOTO FINISHING

SAVE HUNDREDS OF DOLLARS! Make your own S&M Densitometer. Send \$3.00 for detailed drawings and instructions. A must for successful photography in your darkroom. Order direct from S & M Instruments, Dept. EE1, 229 Park Avenue South, New York, New York 10003.

RADIO & TELEVISION

TV TUBES 36¢ each. Send for Free 48 page color catalog. Cornell, 4217-W University, San Diego California 92105.

BUILD Distance Crystal Sets, 10 Plans—25¢; Handbook 18 different—50¢; 20 different—50¢. Catalog 25¢ Refundable. Laboratories, 1477-G, Garden Grove, Calif. 92642.

FREE Catalog lists resistors, tubes, transistors, rectifiers, condensers, tools, tuners, etc. etc. Hytron Hudson, Dept. EE, 2201 Beresville Avenue, Union City, New Jersey 07087.

AMAZING: Precise AC calibration source you can build from ordinary parts. Plans \$2.00. Total, Box 251, Ridgewood, N.J. 07451.

DISCOVER how to avoid calling the serviceman. Save by servicing home equipment yourself. Send \$1.25 for magazine. **RADIO-TV REPAIR—229** Park Avenue South, New York, New York 10003.

HEAR POLICE/FIRE Dispatchers. Catalog shows exclusive official directories of "confidential" channels; receivers. Send 8¢ stamp. Communications, Box 56-EE, Commack, N.Y. 11725.

NEW FM Deviation Meters \$75.00. Free Information. Write: ICM, 4125 N. Weinbach, Evansville, Indiana 47711.

FREE CATALOG—Tremendous electronics bargains: Parts, Kits, Books. Write Today! Pacific, Box 4192A, Mountain View, California 94040.

NEW TV Filter. Reduces outside noise, interference. Improves reception. Easy installation. \$1.95. Request catalog, 1-EE, Mark Anthony's, 3847, Hammel, Los Angeles, California 90063.

WIRELESS Radios Antiquers 1973 Directory & Collectors catalog 2—\$5. Midco, E11, Box 15370, Long Beach, Calif. 90815.

SURPLUS EQUIPMENT

GIANT 120 Page Canadian Surplus Catalog \$1. Etc. Dept. DG, Box 741 Montreal.

TREASURE FINDERS—PROSPECTING EQUIPMENT

FREE FACT-FILLED CATALOG. World's largest line of metal detectors. Models as low as \$49.50 and up. Two year Guarantee. Three factory locations, U.S. and Canada, plus over 1,000 dealers and 35 Service Centers from coast to coast. No finer instruments made at any price. Budget terms. Write: **WHITE'S ELECTRONICS, INC., RM #399, 1011 PLEASANT VALLEY ROAD, SWEET HOME OREGON 97386.**

THERE is no charge for the Zip Code. Please use it in your Classified Ad.

**BUILD
THE
REAL
THING
!**

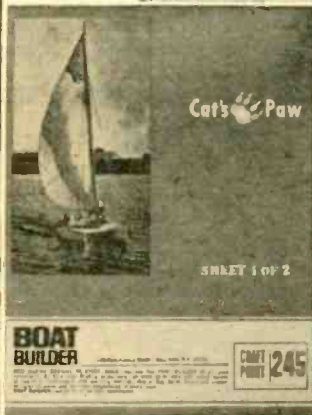

**MAKE
IT
WITH
CRAFT
PRINTS
AND
SAVE!**

362. MORNING STAR is a major project for the experienced builder. Separate fore-and-aft cabins provide accommodations for four adults. The mast is stepped in a hinged tabernacle atop the cabin. Plans show keel and centerboard. L.O.A., 25'11"; beam, 7'11"; draft, 3' sail area, 276 sq. ft. \$7.00

245. CAT'S PAW catamaran provides a stable base for a lot of sail area to make for fast sailing. And she's easy to build because of her straight-sided hulls, flat sheer, and straight bow and stern. It's an ideal boat in which to learn sailing. L.O.A., 12'; beam, 6'2"; sail area, 85 sq. ft. \$6.00

Boat Builder, 229 Pk. Ave. S., NY, NY 10003

Enclosed is \$_____ SATISFACTION GUARANTEED.

- Craft Print #362, \$7
- Craft Print #245, \$6
(add 50¢ for postage and handling)

NAME _____ (please print)

ADDRESS _____

CITY _____ CP-122 STATE _____ ZIP _____

DX the World . . .

Continued from page 66

sure enough, the signals which had been strong a few hours earlier on the higher bands were fading out.

Tough Tuners. My first Asian choice was a Middle Eastern station, the *Voice of Lebanon* in Beirut. I tuned to 11,790 kHz at 0230 in time to catch more of that weird Arabic music. The English language segment began at 0238, with an announcement, a blaring fanfare and the news from Lebanon.

My ports-of-call sequence got a bit fouled up next, as I spun the dial to 15,320 to hear *Radio Australia's* program. But the Down Under broadcaster was fading badly and I knew if I wanted to hear them at all, I had to deviate from my itinerary briefly.

Radio Peking, which a few hours earlier had been putting in a nice signal on 15,060, was gone, but at 0254, I caught the Chinese station just signing off with the communist anthem, "Internationale," on 15,520 kHz.

Into the Oceania region again, I found *Radio New Zealand* a very weak one on 15,110 kHz. It was a pity the signal wasn't better than as I had a couple of spare minutes and the guitar solo was listenable.

The time was 0300 when I tuned in one of my favorite stations, *Tahiti* on 15,170 kHz. It had just signed on and was delivering a fine signal to my speaker. If you're a Polynesian music nut, as I am, you'll like this one too. Brief announcements in French and Tahitian and the ukelele's and drums gave way to some excellent piano jazz.

I nearly forgot the time! The clock read 0304! I had only a minute left of my 80 to hop back across the Pacific to the U.S.

Back Home. Just 110 kilohertz up the dial I found San Francisco's KGEI, *La Voz de Amistad*, the voice of friendship. And KGEI, for one in need, was friend indeed!

It was programming in Spanish, but the identification was easy to make out. The broadcast was one of messages to people living in various rural Mexican towns, recently hit by an earthquake.

It was 0305 GMT, exactly 80 minutes since I'd started my globecircling trip by shortwave. I had done it, *Around the World in 80 Minutes!*

I smiled. My friend looked a bit awed,

but reached for his wallet. The wager was won.

I didn't tell him, of course, but the feat really wasn't that earthshaking, as any veteran DXer knows.

In Truth. It was a bit of showboating, naturally. That's not the way one normally DXes. Normally one spends more than a minute or so with each station in order to take a good log and write a reception report to the stations.

Now shortwave broadcasters are notorious for changing frequencies. You may find, if you try to follow my path, that some have left the listed frequencies by now. But chances are you'll find the same stations elsewhere in the shortwave bands, particularly if you have a good communications receiver and something more efficient than a whip antenna. And, you may find an entirely different set of shortwavers as you tune around the world in 80 minutes. ■

Hey Herb

Continued from page 82

track the outer bands of a standard LP CD-4 record with acceptable sound quality, but they poop out on the inner grooves where the recorded wavelength is relatively small. Also, some CD-4 records just can't be tracked at all with a stereo pickup. If you want good CD-4 sound, get a CD-4 pickup.

HEY HERB: What is meant by a high efficiency speaker?

Basically, speaker efficiency represents the speaker's output level in relation to the input electrical energy. Different speaker system designs have differing efficiencies. For example, using the same input electrical power, a bass reflex speaker system will usually sound much louder than an acoustic suspension system. Of course, many things go into a speaker's overall design, such as frequency response, relative size, cost, etc., and the same techniques used for a particular type of speaker system cannot be used for a physically smaller speaker—assuming a given level of frequency response vs. distortion. There must be trade-offs to obtain "hi-fi" sound from relatively smaller speaker enclosures, and efficiency is one of the first items traded off for sound performance.

HEY HERB: I just purchased a Pioneer T-8800 tape deck and find the V meters indicate a signal level of about -5 VU even before I start dubbing a record. My dealer claims the recorder checks out 100% within specs, and he does not get this no-signal

VISTA WAVEFORM GENERATOR KIT

UTILIZING THE NEW 8038 WAVEFORM GENERATOR IC PRODUCES SIMULTANEOUS SINE, SQUARE AND TRIANGULAR WAVEFORMS. OUR VISTA KIT CONTAINS ALL NECESSARY ELECTRONIC COMPONENTS TO BUILD A 20 TO 20,000 HZ GENERATOR.

8038 WAVEFORM GENERATOR IC—PC BOARD FOR GENERATOR PC BOARD FOR A.C. POWER SUPPLY—POWER TRANSFORMER DATA SHEET, APPLICATION NOTES AND ASSEMBLY GUIDE \$14.95 COMPLETE SEND FOR FREE CATALOG.

PHOTOLUME CORPORATION
118 EAST 28 ST NEW YORK NY 10016

CIRCLE NO. 28 ON PAGE 17 OR 103

SEMICONDUCTOR SUPERMART

FREE CATALOG

NAME BRAND—
PRIME QUALITY
SEMICONDUCTORS

- MOTOROLA
- FAIRCHILD
- NATIONAL
- RCA
- HP
- SIGNETICS

Other Parts For Elementary Electronics Projects

CIRCUIT SPECIALISTS CO.
Box 3047 Scottsdale AZ 85257

CIRCLE NO. 14 ON PAGE 17 OR 103

WRITE
NOW FOR

McGEE'S BIG SPEAKER CATALOG

1001 BARGAINS IN

SPEAKERS—PARTS—TUBES—HIGH FIDELITY
COMPONENTS—RECORD CHANGERS—
Tape Recorders—Kits—Everything in Electronics
1901 McGee Street, Kansas City, Missouri 64108

CIRCLE NO. 12 ON PAGE 17 OR 103

"LISTEN IN" TO POLICE-FIRE RADIO CALLS IN YOUR CAR!

WORKS with ANY CAR—Portable or HOME RADIO! Just PLUGS in—No wiring—3 minute hookup! Switch instantly from regular to ALL POLICE-FIRE-EMERGENCY-COMMERCIAL-TAXICAB-STATE-CITY-GOV'T 2 way Radio calls in YOUR AREA. DUAL-HI-LOW BANDS—36/50-150 17.5 MHX. OVER a MILLION Radio Cars/stations, USE Everywhere—Anytime—always works!

SEND ONLY \$2.00 (cash, Ck. M.O.) and pay postman \$9.99 plus COD post or send \$11.99 for pnd. Del in USA. COMPLETE, ready to use with instructions. One Year service Warranty—10 DAY MONEY BACK TRIAL (if retnd) AMAZING OFFER good only by mail—WESTERN RADIO Dept. 8E-1, KEARNEY, NEBR. 68847

CIRCLE NO. 26 ON PAGE 17 OR 103

FIND BURIED TREASURE

Powerful electronic detector finds buried gold, silver coins, etc. Write or call for free catalog. Dealer inquiries invited.



Financing Available 19.95
Phone day - night (713) 682-2728
to

RELCO, Dept. D-58 198.50
BOX 10839, HOUSTON, TEX. 77018

CIRCLE NO. 18 ON PAGE 17 OR 103

PARTS! CORNELL TUBES!

FREE Send For FREE

CORNELL'S
New Color
Catalog

33¢ per tube

36¢ per tube

ORDER FREE
IF NOT SHIPPED
IN 24 HOURS!

4219 E UNIVERSITY AVE. SAN DIEGO, CALIF. 92105

CIRCLE NO. 13 ON PAGE 17 OR 103

READER SERVICE PAGE

• The Editor of ELEMENTARY ELECTRONICS offers readers an easy way to get additional information about products and services advertised in this issue. Also, if you would like more information about any new product mentioned in our column "Hey, Look Me Over," it's yours for the asking. Just follow the instructions below and the material you requested will be sent to you promptly and at no cost.

• The coupon below is designed for your convenience. Just circle the numbers that appear next to the advertisement or editorial mention that interests you. Then, carefully print your name and address on the coupon. Cut out the coupon and mail to ELEMENTARY ELECTRONICS, Box 886, Ansonia Station, New York, N.Y. 10023. Do it today!

JANUARY/FEBRUARY 1974

Void after JUNE 30, 1974

ELEMENTARY ELECTRONICS

Box 886, Ansonia Station, New York, N.Y. 10023

Please send literature for the numbers I have circled. I understand this is a free service and I am limited to 12 circled numbers.

1	2	3	4	5	6	7	8	9	10	11	12	13
14	15	16	17	18	19	20	21	22	23	24	25	26
27	28	29	30	31	32	33	34	35	36	37	38	39
40	41	42	43	44	45	46	47	48	49	50	51	52
53	54	55	56	57	58	59	60	61	62	63	64	65
66	67	68	69	70	71	72	73	74	75	76	77	78
79	80	81	82	83	84	85	86	87	88	89	90	91

Are you a subscriber to this magazine? Yes No

Do you now own Police/Fire/Aero receiver(s)? 92 Yes 93 No

If your answer is yes, please check appropriate box:

94 Mobile 95 Base 96 Portable 97 Used in your work

Name (Print Clearly) _____

Address _____

City _____

State _____

Zip Code _____

Antique Radio Corner

Continued from page 64

To prepare the bulb, carefully break off the exhaust stem and then grip the stem and bend it until it breaks. Make sure the stem is broken off right up to the glass press. Remove the wires and insert a PR-2 flash-light bulb into the bottom of the tube.

Now solder two small insulated leads to the bulb. Mount the bulb in the tube using a Silicone Seal or bathtub caulking. Run the wires through the untapped tube base pins, put some silicone around the bottom of the tube and place the tube in its base. When it has cured, mount the tube to the base using one 6-32 and one 4-40 screw.

Wire the bulb, and switch in series with two AA pen cell batteries and your night light is complete.

Pizza and Antique Radios. Another antique radio museum is located in the Pequod Pizza Restaurant in Morton Grove, Illinois. There are about 25 radio sets with speakers on display in the restaurant proper with 175 more in an adjoining room. What makes it so amazing is that all 200

sets were collected in approximately 16 months. The collection ranges from crystal sets built in 1914 up to and including Philco 1941 models and a Pilot 3-inch TV receiver.

Burt Katz and his partner Dave Antilla are ready to welcome you with good food and a look into the past. Mr. Katz said, "The greatest enjoyment I get out of our collection is watching other people enjoy it."

Next time we will have stories on tube replacements, also on how to substitute the VT-24/864 tube for UV or UX 99's; there will be club news, technical tips on how to remove transformers, chokes, and condensers that are imbedded in pitch, and other things to make the hobby of collecting radios more fun.

Several readers have written in to request schematic drawings of old radios. This isn't feasible at the present time, because to be of any value the drawings should be as large as a page in this magazine. It would be unfair to the other readers to use that much space when the drawing can be found elsewhere.

I want to thank you for your cards and letters so keep them coming. They will help me plan the subject matter for future columns to meet your needs. ■



DISCOVER A NEW HOBBY !

Collecting old time wireless and radio is fascinating, fun and a challenge. Vintage Radio opens the door for you.

VINTAGE RADIO, 1887-1929

This book brings you pioneer days of wireless and radio in pictures and words. It's the collector's and historian's bible. Great browsing. Packed with old ads, old photos and vintage equipment. Over 1,000 photos, 263 pages. Handbook or deluxe hard cover.



McMAHON'S 1921-1932 GUIDE

Collectors: Our 1921-1932 Guide is a must! Over 50,000 facts, 264 pages. Lists radio models by maker and year introduced, with original price, style and circuit type.



AVOID DELAY; SEND TODAY.

Mail check to Vintage Radio, Dep't. E,
Box 2045, Palos Verdes Peninsula, Calif., 90274

Vintage Radio, hard cover \$6.95

Vintage Radio, handbook 4.95

Radio Collector's Guide 3.95

California residents add 5% State Sales Tax.

Name _____

Street _____

City _____ State _____ Zip _____

ENJOY THE OLD DAYS !

CIRCLE NO. 16 ON PAGE 17 OR 103

only 31¢ per adventure!

Radio Shack's Science Fair 65-in-1 Electronic Project Kit



1995

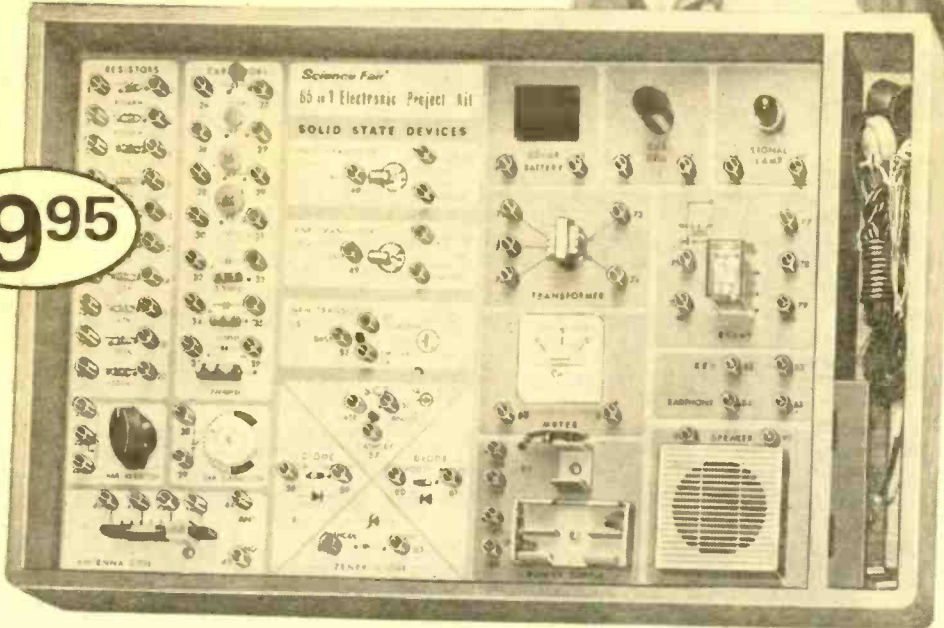

Fun! Exciting! Educational—a great way to start learning electronics! Hook up radios, computer & test circuits, alarms, an AM transmitter—even SOLAR POWERED experiments. 65 projects in all. Solderless connectors—never anything to clean up. Battery power—100% safe. With solar cell, photocell, code key, meter, earphone, speaker—everything but batteries. Attractive fitted case—makes an impressive gift. #28-250.

Price may vary at individual stores.

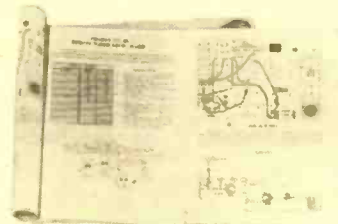

Giant Lab-Type Manual
Explains Each Circuit



FREE '74 CATALOG 322
AT YOUR NEARBY STORE OR
MAIL THIS COUPON

180 Pages . . . Full Color! Hi-Fi, CB, Kits,
Recorders, Antennas, Parts, More!

PLEASE PRINT CLEARLY

Name _____ Apt. # _____
Street _____
City _____ State _____ ZIP _____

Science Fair[®]

at

Radio Shack[®]

and ALLIED RADIO STORES
A TANDY CORPORATION COMPANY

P. O. Box 1052, Fort Worth, Texas 76107

CIRCLE NO. 32 ON PAGE 17 OR 103

Let ICS mail you a **FREE** demonstration lesson without obligation... to prove that you can learn **TV Servicing** at home.

Credit towards a Certified Electronic Technician (C.E.T.) rating will be granted by the National Electronics Association to ICS students upon completion of the JCS Career Program in TV Service/Repair.

