

CC

MARCH-APRIL  
1973  
75c

# elementary Electronics

FOR BEGINNERS ONLY  
**BASIC  
COURSE**  
How to Use  
Multimeters

02342

## Electronics for Weekend Mechanics

Analyze your car's performance using meters and scope pictures. Know what needs fixing before you turn a screw or replace a plug!

## Restore that Antique Radio

Spared from the scrap heap, ancient radios can add beauty and sound to your living room!

Introducing our ...

## Super DX Booster

Peg your S-Meter with a 20 to 40 dB signal boost from 5 to 21 MHz.

## Honest John Test Reports

- ArcherKit C-D Ignition System
- Lafayette HB-23A CB Transceiver
- MITS 1440 14-Digit Calculator Kit
- Regency TME-16H/L/U Action Band Scanner

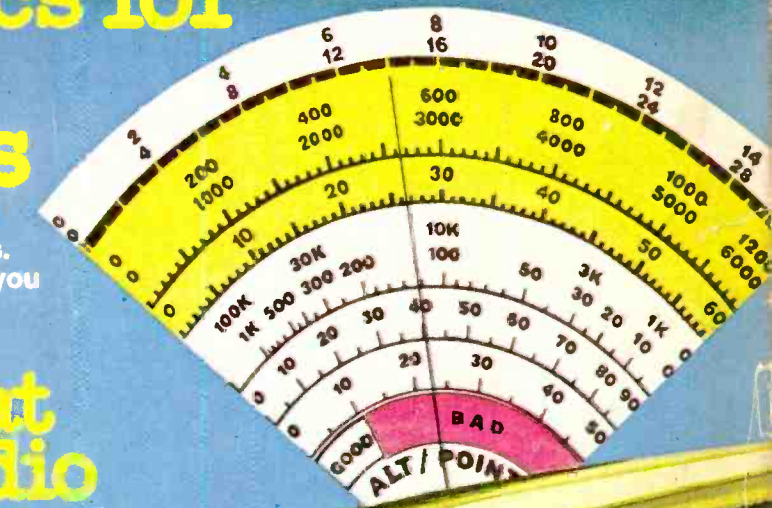

# He has to hear what you want to hear...

Over a third of the Duo-Scan® FM monitor receivers we make are purchased by police, fire departments, and other professionals... because they can't settle for less than Johnson performance! After all, since we engineer and build professional FM 2-way radios, we just naturally know how to build a better FM scanner: With integrated circuit symmetrical limiting to make it really quiet. Dual ceramic filters to reject interference. Ultra-sensitive "front end" circuitry to pull in the weakest signals. And a true noise-operated squelch that's crisp and clean... just like in a regular police radio. If you want to hear all the action, you want the scanner the professionals use!

Duo-Scan for low and high band VHF ..... \$169.95  
Duo-Scan for high band VHF and UHF ..... \$179.95  
Mono-Scan for high band VHF ..... \$139.95  
Mono-Scan for UHF ..... \$149.95



## The professional monitor: Duo-Scan

EXCELLENCE



THROUGH HALF A CENTURY OF EXPERIENCE.

# JOHNSON

® Waseca, Minnesota 56093

CIRCLE NO. 8 ON PAGE 17 OF 103

# Super Sidekick, it's everybody's gain

Turner's new amplified Super Sidekick has **two** gain controls: one on the top for normal volume adjustments and another on the bottom for matching the Super Sidekick microphone to your particular transceiver.

If you operate AM on a tube set, you might need all the gain you can get. On a transistorized SSB rig, you probably need just a little. That's what's so super about the new Super Sidekick. You get a modulation-boosting match for any set and a dynamic cartridge for clarity.

Talk it up. The new Super Sidekick amplified microphone lists for \$80, and it does make an understandable difference. See a Turner dealer for details, or write to Turner, 909 17th St. N.E., Cedar Rapids, Ia. 52402.

**TURNER**  
MICROPHONES

**CONRAC**  
CORPORATION



# elementary Electronics

Dedicated to America's Electronics Hobbyists

## FIX, UPDATE, IMPROVE

- ☆ 31 Electronics for Weekend Mechanics—here's how electronics, autos and weekends mix
- ☆ 43 Bringing Back The Ancient Radio—an Atwater Kent in your living room?
- 65 Improve Your World Globe—you already have a good one? See what we mean
- 82 Four Ways To 4-Channel—add-ons, accessories or complete systems—pick one

## CONSTRUCTION THINGS

- 58 Let Your Handicraft Blink Back—Delights the toddler to teenager
- 69 Status Box—a message telegraph to your front door or office
- ☆ 83 Super DXer—a DX Central project soups up SWL receivers

## FROM OUR LAB

- ☆ 41 ArcherKit Capacitive-Discharge Ignition System—automakers too use electronic ignition to cut pollution
- 49 Fisher's Studio-Standard 504 Receiver—Outstanding 4-Channel receiver
- ☆ 61 MITS 1440 Calculator Kit—for the family budget or an engineering lab
- ☆ 67 Regency's TME—16U/H/L—Scan all the Action Bands

## AUDIO, CB, DX COLUMNS

- 24 Ask Hank—he answers your questions
- 25 DX Central Reporting—keeping shortwave listeners up-to-date
- ☆ 51 Kathi's CB Carousel—Lafayette HB-23A checked out by our Miss Kathi
- 63 CB Coffee Break—our Editor shares his experience
- 81 Hey Herb—audio expert answers reader questions

## READABLE FEATURES

- 48 VW Mobile Laboratory
- 53 The Eyes Have It—or do they?
- 64 Microwaves Monitor the Difference
- 76 X-Ray Snooper Foils Skyjackers—thin flexible x-ray plate is cheap, sure and in operation
- 78 The World's Biggest Dish—3,200 tons—and it moves!

## READABLE REGULARS

- 5 Newscan—electronic happenings you should know about
- 8 New Products—new stuff for the electronics buff
- 17 Reader Service Page—get more info free from us, 8 cents at the Post Office—also on page 103
- 22 Bookmark—Late releases with an electronic slant
- 26 Literature Library—See what 2-bits brings
- 30 Cartoon Page—Get the LED out
- 87 Basic Course—Multimeter wrap-up in this issue
- 103 Reader Service Page—Get more info free from us, 8 cents at the Post Office—also on page 17

☆ ☆  
Cover Highlights

Cover illustration by Joe Rack

## AUTHORS IN THIS ISSUE

Emmett Fluffin, James A. Fred, Herbert Friedman, Herbert L. Foster, Imer Gorgenyi, Jorma Hyypia, Don Jensen, Julian S. Martin, Kathi Martin, Jack Schmidt, Hank Scott, and the ELEMENTARY ELECTRONICS editorial staff.



# newscan

Electronics in the News!

## Weather Satellite Forecasting

More than a century ago, the first meteorological observations via telegraph were collected in the United States by Joseph Henry of the Smithsonian Institution. The information was used to construct a weather map for establishing a practical basis for weather forecasts. From this beginning evolved techniques for regularly acquiring and assembling weather information. In 1870, what is now known as the National Weather Service was formed. Stations around the nation gathered weather data, first visually and then later with instruments—both land-based and those carried aloft by balloons, kites and sounding rockets.

However, as late as 1960, meteorology was still plagued with serious gaps in worldwide weather observation. There was no way of systematically acquiring weather data over more than 80 percent of the globe on a timely and routine basis. Storms and other weather phenomena over seas, deserts and other undeveloped land areas were frequently not detected or studied until long after they had formed, if at all. And, whatever weather information was available from such areas usually was limited since it came from ships and aircraft passing through, or other sources not equipped to gather the precise data needed by meteorologists.

*(Continued on page 29)*

ESSA-9 Weather Satellite Photo  
Hurricane Agnes — West of Florida  
June 18, 1972

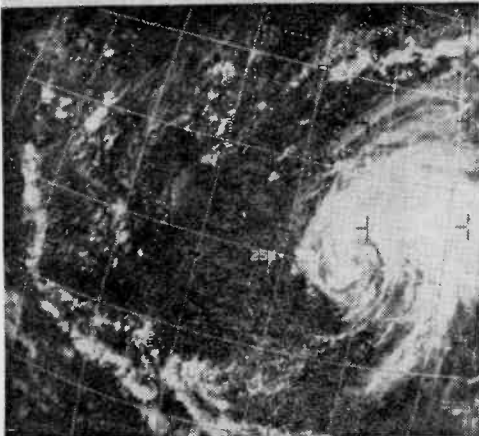

*Pull in  
off-center signals  
arrow-sharp*

## New MIDLAND 5-Watt, 23-Channel Mobile Transceiver

This is one CB mobile rig that does it all — at a reasonable price! Full featured and fully equipped for 23-channel operation with no extra crystals to buy.

Transmits with a full 5-watt input. The dual conversion receiver has tuned RF, mechanical filters and AGC to make it fade and blast-free ... plus delta tune that fine tunes AM reception, and switchable noise limiter that cuts static.

Channel selector and extra-large S/RFO meter are lighted. Volume, variable squelch and delta tune have extra large control knobs.

Complete with push-to-talk microphone, mobile mounting bracket and 12-volt DC cable. **SUGGESTED PRICE AT YOUR MIDLAND DEALER \$149.95.** Model 13-867

Write for **FREE** Midland  
CB and Scanning  
Monitor Brochure—  
Box 19032  
Kansas City, Mo. 64141



**MIDLAND**  
ELECTRONICS COMPANY

**SCIENCE · OPTICS · ELECTRONICS**  
**UNUSUAL & HARD TO FIND BARGAINS**  
**NEW PRODUCTS · NEW MATERIALS · NEW METHODS**

**NEW! ELECTRONIC DIGITAL COMPUTER KIT**



Solve problems, play games, predict weather with this actual working model of giant electronic brains. Amazing new fun way to learn all about computer programming . . . logic, decimal, binary systems. Law of Sets—even do your own programming after completing simplified 116 page instructive booklet. Includes step-by-step assembly diagrams. Circuits easily changed. Readout from illuminated control panel. Req. 2 "D" batt. (not incl.) Best model ever seen—for home, school, industry.

No. 71.434EK (11"x1 1/2"x4") \$31.50 Ppd.

**GET POLICE, AIRRAFT CALLS**

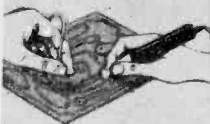

Your standard AM home or car radio can get exciting 2-way police, fire, local aircraft calls, etc. from UHF bands via Converters. No interconnecting wires needed—just put solid state Converter near set. Easy instrs incl. Ea. Kit req. 9v bat (not included).

**POLICE & FIRE CONVERTER KIT—LO BAND.** Operates in the 30-50 MHz band.  
 Stock No. 41.828EK \$8.25 Ppd.  
**AIRCRAFT CONVERTER KIT.** Operates the 108-136 MHz band.  
 Stock No. 41.827EK \$8.25 Ppd.

**BLACK LIGHT FOR REG. SOCKETS**



Real black-light bulb that screws into any regular household lamp or socket. Low in cost, you can use several throughout a room to enhance lighting effects, dramatize nearby posters and displays. 75-watt Edison-base bulb activates fluorescent color for 480-hour life. Ideal for discovering, or adding to, the fun and drama of blacklight almost anywhere . . . in seconds!

Stock No. 41.873EK \$3.25 Ppd.

**BUILD A "PRO" WEATHER STATION**



Meteorology kit can give you the know-how to check your predictions against official forecasts! Has remote reading anemometer w/ windvane. Indoor indicator board flashes neon, shows wind speed, direction. Safety power cord holds current to less than 1 ma. Also sensitive air-tank barometer w/ 2-ft. indicator column; sling psychrometer to measure rel. humidity; rain gauge that measures to 1/100th inch; 100 ft. lead-in wire; cloud chart; forecasting manual.

Stock No. 71.022EK \$15.95 Ppd.

**UNDERWATER MICROPHONE BUY**



Listen to fish "talk" with this gov't surplus Hydrophone! Terrific buy! \$40 value! Make an accurate fish finder, pool splash-alarm, hear dolphins talk, add sound to underwater movies. Use with both high & low impedance amplifiers, tape recorders. Frequency response: 10-8000 Hz. Working depth to 300 ft. Minimum sensitivity 1000 Hz. at depths of 60 or 300 ft. Operating temperature range: 0 to 35°C. Fungus and shock resistant. Includes leads (approx. 8' long) and instrs. Cable not incl. Wt. 2 oz.

Stock No 41.759EK \$5.00 Ppd.

**MAIL COUPON FOR GIANT FREE CATALOG!**

**164 PAGES • MORE THAN 4,000 UNUSUAL BARGAINS!**

Completely new edition. Dozens of electrical and electromagnetic parts, accessories. Enormous selection of astronomical Telescopes, Microscopes, Binoculars, Magnifiers, Magnets, Lasers, Lenses, Prisms, ecological and unique lighting items. Many war surplus items for hobbyists, experimenters workshop, factory.

EDMUND SCIENTIFIC CO. Barrington, N.J. 08007  
 PLEASE SEND FREE CATALOG "EK"

NAME \_\_\_\_\_

ADDRESS \_\_\_\_\_

CITY \_\_\_\_\_

STATE \_\_\_\_\_

ZIP \_\_\_\_\_

**EDMUND SCIENTIFIC CO.** 300 EDS CORP BLDG. BARRINGTON, NEW JERSEY 08007  
 ORDER BY STOCK NUMBER · SEND CHECK OR MONEY ORDER · MONEY-BACK GUARANTEE

**CIRCLE NO. 2 ON PAGE 17 OR 103**

**elementary Electronics**

March/April 1973 Vol. 13/No. 2  
 Dedicated to America's Electronics Hobbyists

Editor-in-Chief

JULIAN S. MARTIN, WA2CQL

Technical Editor

PETER L. DEXNIS, WA3LOQ

Audio Editor

STEPHEN B. GRAY

News Editor

BARBARA E. WILLIAMS

Citizens Band Editor

KATHI MARTIN, KA1Ø614

Workbench Editor

HANK SCOTT

Art Director

JIM MEDLER

Cover Art Director

IRVING BERNSTEIN

Associate Art Director

ANDY STEIGMEIER

Art Associate

RALPH RUBINO

Advertising Director

DAVID J. MILLER

Production Director

CARL BARTEE

Production Manager

GERTRUD BORCHARDT

Assistant Production Manager

MARILYN VARGAS

Newsstand Circulation Director

DON GABREE

Subscription Circulation—Marketing Director

ROBERT V. ENLOW

Instruments Division Manager

WILFRED M. BROWN

Chairman of the Board (1969-1972)

B. G. DAVIS

President and Publisher

JOEL DAVIS

Vice-President and General Manager

LEONARD F. PINTO

Vice President and Treasurer

VICTOR C. STABILE, KBPØ681

ELEMENTARY ELECTRONICS is published bi-monthly by Davis Publications, Inc. Editorial, Business and Subscription offices: 229 Park Avenue South, New York NY 10003. One-year subscription (six issues)—\$3.95; two-year subscription (12 issues)—\$7.95; three-year subscription (18 issues)—\$11.95; and four-year subscription (24 issues)—\$15.95. Add \$1.00 per year for postage outside the U.S.A., its possessions and Canada. For change of address, please advise 4 to 6 weeks before moving. Send us your current mailing label with new address. Advertising offices: New York, 229 Park Avenue South, 212-673-1300; Chicago, 520 N. Michigan Ave., 312-527-0330; Los Angeles, J. E. Publishers' Rep. Co., 8560 Sunset Blvd. 213-659-3810; Long Island: Len Osten, 9 Garden Street, Great Neck NY 516-487-3305; Southwestern advertising representative: Jim Wright, 818 Olive St., St. Louis, 314-CH-1-1965. Second-class postage paid at New York NY and at additional mailing office. Copyright 1973 by Davis Publications, Inc.

# This POSTAGE-FREE COUPON CAN CHANGE YOUR LIFE!

## Mail it right now for 2 FREE BOOKS

about the growing world of Electronics  
... and how you can prepare for  
an exciting, high-paying career.



**CIE** **Cleveland Institute of Electronics, Inc.**  
1776 East 17th Street, Cleveland, Ohio 44114  
Accredited Member National Home Study Council

Name \_\_\_\_\_  
(please print)

Address \_\_\_\_\_

City \_\_\_\_\_ State \_\_\_\_\_ Zip \_\_\_\_\_

Get all the facts. Send in this  
POSTAGE-FREE coupon.  
For your convenience, we  
will try to have a representa-  
tive call. Just follow direc-  
tions and mail TODAY.

Veterans and Servicemen:

Check here for G.I. Bill information.

FOLD  
HERE



NO STAMP NEEDED



DO NOT  
CUT HERE

EL-39

YOU MUST SEAL BEFORE MAILING • NO STAMP NEEDED  
(GLUE, STAPLE OR TAPE)

CUT OUT ON DOTTED LINES • FOLD IN HALF HERE • FOLD IN HALF HERE  
(DO NOT CUT HERE)

**BUSINESS REPLY MAIL**  
No Postage Stamp Necessary if Mailed in the United States

FIRST CLASS  
PERMIT NO. 8685  
CLEVELAND, OHIO

POSTAGE WILL BE PAID BY:

**Cleveland Institute of Electronics, Inc.**  
1776 East 17th Street  
Cleveland, Ohio 44114

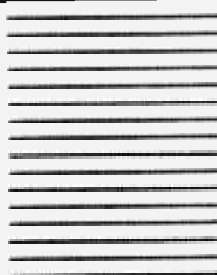

CIRCLE NO. 32 ON PAGE 17 OR 103

To get more from  
your high fidelity  
system...put more  
of yourself in it.



In these days of instant everything, the idea behind Electro-Voice Custom Loudspeakers is a refreshing change of pace.

The custom loudspeaker concept asks you to do more than buy. It suggests that you participate directly in choosing the very best speaker system for your own special listening needs, speaker by speaker.

There's a complete, logical range of woofers, tweeters, mid-range drivers and accessories. And, with the help of your E-V dealer, you create the performance that suits you best.

You have the option of installing the speakers in new or existing furniture, or building them into walls, closets, or wherever.

Write today for our literature and list of E-V Custom Loudspeaker dealers.

ELECTRO-VOICE, INC., Dept. 334EY  
678 Cecil Street, Buchanan, Michigan 49107  
In Europe: Electro-Voice, S. A., Romersstrasse 49, 2560 Nidau, Switzerland  
In Canada: EV of Canada, Ltd., Gananoque, Ontario

**Gulton**  
COMPANY

**Electro-Voice®**

CIRCLE NO. 16 ON PAGE 17 OR 103

Hey,  
look me over

Showcase of New Products

### Bio-Feedback Trainer

Is it possible for humans to learn total relaxation, improve creativity, memory of concentration? Many believe it is through preliminary means of monitoring brainwaves such as the Alpha and Theta with a sensitive electronic Bio-Feedback Trainer. With it, most people can learn Alpha rhythm control, which is said to let one totally relax, in ten to twelve hours. Its wrist and finger contacts amplify heartbeat and skin resistance, permitting the user to observe his or her emotional state, and possibly do something about it. Little wonder the Bio-Feedback Trainer is

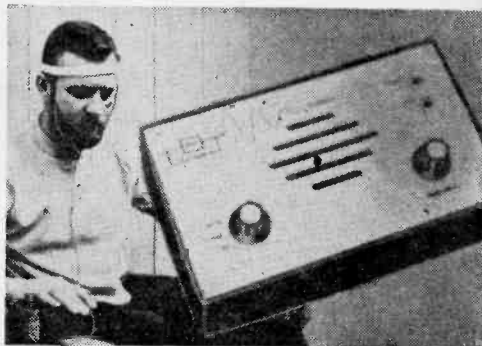

making big news in psychology and physiology. A highly dependable unit (Stock No. 71,606 . . . \$120.00) is available by mail from Edmund Scientific Co. Completely safe for use in the home. Edmund's Bio-Feedback Trainer combines brainwave, heart rate and skin resistance feedback in a compact 2-lb. unit. The head electrodes, hooked up to a high gain amplifier, allow brainwaves to be filtered, signaling an audible beep for each Alpha or Theta wave passed. Wrist and finger electrodes pick up heartbeat and skin response, reproduced as an audible tone. The instrument comes complete with head, wrist and finger electrodes, threshold control, conducting solution, and full instructions. Like everything Edmund sells, it has a 30-day money-back guarantee. For catalog and more information, circle No. 50 on Reader Service Page.



### Receiver With Rhythm Composer

The Kenwood KR-6170 stereo receiver incorporates such unique features as an Electronic Rhythm Composer, Reverberation Unit, front panel jacks for one or two electric guitars, multiple mixing of "live" and source sound, Multi-Presence Control, and an array of level, frequency, volume, balance and tone controls that offer unlimited possibilities for unique effects. The Electronic Rhythm Composer itself is a masterpiece of ingenuity. It plays five electronic percussion instruments (bass drum, conga, claves, snare drum, and



high hat cymbal) in any of 12 different rhythms, including March, Rock, Ballad, Latin, Waltz, Rhythm and Blues, Fox Trot, Shuffle, Mambo, Jazz, and two Bossanovas. Two rhythms can be selected simultaneously to create further variations. A slide lever varies the rhythm tempo from 20 to 200 beats per minute. The Rhythm Composer can be used to accompany one or two electric guitars, with further mixing available through the front panel microphone jacks for voice or additional instruments. The full effect can be recorded through special front panel "mixed recording" output jacks. The KR-6170 is indeed an incredible instrument designed to provide optimum pleasure for the musically inclined or for the audiophile who wants to add a new measure of fun to his stereo system. Priced at \$549.95, it is available at all Authorized Kenwood Dealers. For complete information, circle No. 54 on Reader Service Page.

### Monitor Police with CB Rig

A small, lightweight mobile accessory known as the ASCOM "Translator," adapts any CB radio to receive FM public safety or industrial communications. The translator, made by Antenna Specialists, is especially suitable for CB emergency groups working closely with police, fire, civil defense, Coast Guard, and other emergency authorities.

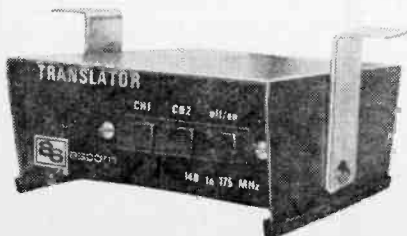

MARCH-APRIL, 1973

only from **HUSTLER** ■■■

GET PERFORMANCE OF **4** MOBILE ANTENNAS from ONE with the Monitor Match!



Use your regular outside mounted or windshield car antenna!

Get functions of four antennas with Monitor-Match for reception of AM—FM plus low-band, high-band and UHF monitor radios. Excellent performance. Connect and operate.

MODEL 5M5 \$12.95

HEAR IT **ALL** WITH THE **DISCONE BASE** ANTENNA!



NO ADJUSTING  
NO CUTTING  
NO SWITCHING

**40 to 700 MHz** Total Coverage

Get superior all directional reception on low-band, high-band and UHF including 88-108 MHz FM entertainment radio with this 50" antenna. Includes SO-239 coax connector and mounting hardware. MODEL DCX \$12.95

only from

**HUSTLER**

foremost in CB,

Amateur and Monitor Antennas

From all distributors who recognize the best!

**NEW-TRONICS CORP.**

15800 COMMERCE PARK DRIVE  
BROOK PARK, OHIO 44142

CIRCLE NO. 21 ON PAGE 17 OR 103

# CALECTRO panel meters



A SIZE AND SHAPE  
FOR EVERY NEED

## LEVEL METER AND BATTERY CHECKER

Precision construction. Features D'Arsonval movement, jeweled bearings, and hand calibration.



## MINIATURE EDGEWISE PANEL METERS

NEW  
One Hole  
Mount

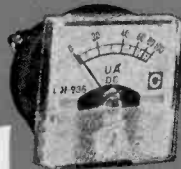

## MINIATURE PANEL METERS

Full range of panel mini-meters featuring single hole mounting. Simply bore hole for movement and thats it. Thread nut onto back of meter. Meter in line—every time.

## PRECISION PANEL METERS

Rugged construction — 2% accuracy. Hand calibrated and linear dial scales. D'Arsonval movement with jeweled bearings. Crystal clear plastic cover plate.



**GC ELECTRONICS**

DIVISION OF HYDROMETALS, INC.   
ROCKFORD, ILLINOIS 61101 U.S.A.

CIRCLE NO. 17 ON PAGE 17 OR 103

## HEY, LOOK ME OVER

Circuitry is designed to operate through CB Channel 9, and interconnection is made simply by plugging into the CB antenna circuitry. When not in use, the Translator in no way impairs performance of the CB set and actually improves sensitivity. Crystal positions for two frequencies are available on each of three models: MON-40 for low band; MON-41 for high band; and MON-42 for UHF. The unit is complete with mobile mounting bracket and interconnecting cable; crystals are not included. Antenna jacks are provided for separate monitoring antennas on the high band and UHF models. Manufacturer's suggested prices are \$39.95 for low band and high band models, and \$44.95 for UHF. For complete information, circle No. 55 on Reader Service Page.

## A Scope That's Smart

Dynascan's expanding line of B&K oscilloscopes now include the Model 1440, a new model that features "Cali-Brain," an advanced approach to the measurement of amplitudes on a scope screen. Here's how "Cali-Brain" works: The CRT screen has a special graticule with two scales, one at each



side of the screen; each is individually lighted. As you select the vertical attenuator range, the correct scale automatically lights up; at the same time, there's a digital display in the panel above the scale selected—giving the exact value of full-scale volts for that scale (for example, .100 volts). To read peak-to-peak volts, this is all you do: (1) Get the desired pattern on the screen; (2) pull out the Cali-Brain knob (vertical position control). This (a) collapses the horizontal sweep, compressing the waveform into a single vertical line; (b) shifts the line to correct scale on the graticules, and (c) gives you a readout of the full-scale volts. (3) Now position the compressed waveform on the base (zero volts) line. (4) Read the peak-to-peak volts directly off the calibrated screen—just like reading volts on a voltmeter! The 1440 is an ideal scope for TV servicing, industrial and school

ELEMENTARY ELECTRONICS

applications. Selling price is only \$299.95, and it is supplied complete with dual-purpose, 10:1/DIRECT probe, Mylar vector screen overlay and handy tilt stand for eye-level viewing. For more information, circle No. 57 on Reader Service Page.

### The Heat's Off

Need a heat sink? Then look at Xcelite's No. 80 Heat Sink designed to absorb and dissipate heat in soldering operations where adjacent, delicate electronic parts might be damaged by overheating. For optimum heat absorption and dissipation, the jaws of the No. 80 Heat Sink are made of copper, with nickel plated surfaces to prevent adhesion of

solder. The spring-loaded gripping surfaces will not slip, yet have a smooth finish to prevent scratching fine wires. An insulating cushion grip permits burn-free handling. Made in U.S.A. to highest quality standards, the heat sink is available as carded display merchandise through Xcelite's nation wide local distributors at a list price of \$2.40. Product Bulletin 572L contains additional information, and may be obtained by circling No. 59 on Reader Service Page.

### Deaf to TV Noise

A new high-gain color TV antenna by Channel Master improves reception by blocking out electrical interference. Called the Quantum, the antenna uses new design principles to prevent interference from reaching the television set. Unseen and unheralded, man-made electrical interference has been spreading rapidly throughout the country, and is now the major cause of poor TV reception quality in most homes. Rustic areas that were formerly "quiet" are virtual hotbeds of "noise", or electrical interference, caused by generating stations and power transmission lines, electric motors and appliances, truck and auto ignitions, factory machinery, diathermy and hospital equipment. The new Channel Master Quantum eliminates up to 90 percent of such interference because it

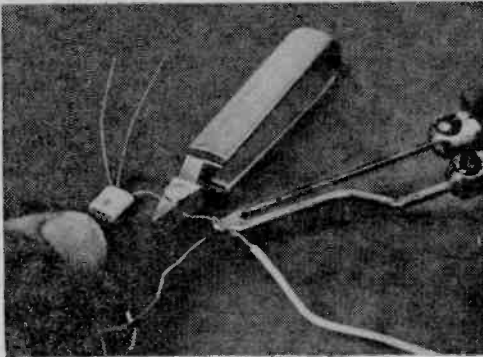

## Tradition of Excellence

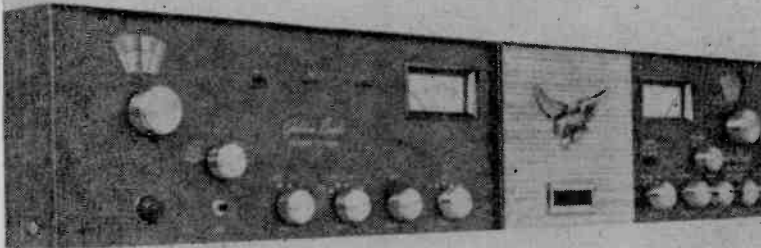

**Golden  
Eagle  
Mark III**

*browning*



**LTD**

1269 UNION AVE. • LACONIA, NEW HAMPSHIRE 03246 • (603) 524-5454

CIRCLE NO. 26 ON PAGE 17 OR 103

# pliers pliers pliers



ALL THE TYPES YOU NEED IN A FULL RANGE OF SIZES.

From 4" miniature electronics to 10" utility. Precision made in USA. Forged alloy steel construction. Cleanly milled, perfectly aligned jaws. Hand-honed, mated cutting edges. Most with Cushion Grip handles.

## NOW INCLUDING

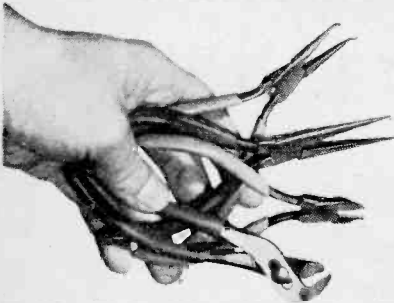

- 5" Bent Thin Chain Nose. For handling fine wires in close quarters. No. 79CG
- 5½" Thin Needle Nose. For firm gripping and looping of wires. No. 57CG
- 4" Full Flush Cutting Diagonals. Snap cuts to the extreme tip. No. 84CG
- 5" Midget Slip Joint. Narrow jaws for close quarters. 3 openings to ½". No. 50CG

*nationwide availability through local distributors*



XCELITE, INC. • 80 BANK ST., ORCHARD PARK, N. Y. 14127  
Send Catalog with information on Xcelite Pliers.

name \_\_\_\_\_  
address \_\_\_\_\_  
city \_\_\_\_\_ state & zip \_\_\_\_\_

CIRCLE NO. 23 ON PAGE 17 OR 103

## HEY, LOOK ME OVER

has the highest front-to-back and front-to-side ratios ever attained in a broad band antenna. In cases where interference comes from the back or side, the Quantum will deliver a 10 dB improvement in signal-to-noise ratio. This is equivalent to a 10 dB increase in antenna gain, and will bring about the same picture improvement as 10 dB addition-

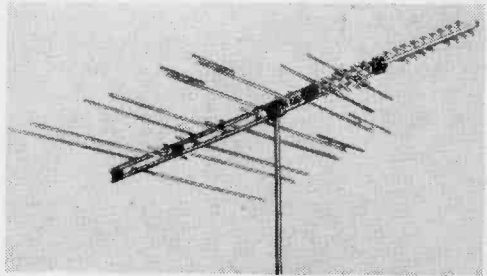

al forward gain, over and above the antenna's already high gain. Transmission line noise pickup is eliminated by the use of coaxial line. An optional, custom-designed balun is available which is mounted within a weatherproof housing on the Quantum's crossarm. A specially designed FM trap also fits within this housing and effectively blocks out FM interference from every direction, providing 25 dB attenuation. There are 15 Quantum models, designed for all reception areas and conditions, from metropolitan to the deepest fringe areas. Seven models cover VHF and FM; eight models also receive UHF, using a tunable antenna that can be adjusted for peak performance on any selected range of channels. For more information, circle No. 61 on Reader Service Page.

### Kit-Tock

For today's "electronic" music, or anything from classical to country & western, now there's an electronic metronome to help

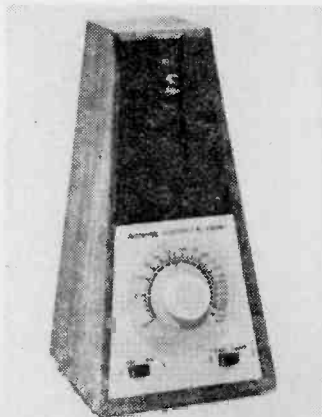

ELEMENTARY ELECTRONICS

keep your timing "right on". The new Archerkit Electronic Metronome provides a range of from 40 to 210 beats per minute with accuracy good enough for professional use. Its solid-state circuit—no springs or mechanical parts—may be easily assembled by beginners, according to Radio Shack. An additional feature of the Archerkit is that if your electric guitar drowns out the audible beat note, you can switch to a flashing green light. It's an indispensable aid for music students learning tempo and pace. The Archerkit products are available at 1500 Radio Shack and Allied Radio Stores. For catalog and more information, circle No. 63 on Reader Service Page.

#### Designed for Mobile!

The E. F. Johnson's new Messenger 122 is a 23-channel CB transceiver with a unique rotary selector drum. This new drum design permits larger illuminated channel numbers for readings at a glance, making it especially easy to change channels while operating mobile. Also featured is pushbutton "instant on" that is entirely separate from the volume and squelch controls. This allows

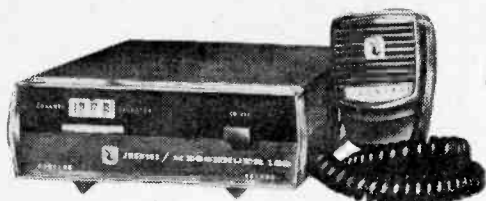

these settings to remain undisturbed, and eliminates the need for readjustment every time the unit is turned on. Both the volume and squelch controls are the new "linear action" type, replacing conventional knobs. Circuitry in the new Messenger 122 is fully solid-state and features a ceramic selectivity designed to reject adjacent channel "bleed over." The new Messenger 122 is available at Johnson dealers now for a suggested price of \$139.95. It comes equipped for operation on all 23 channels, and is supplied with mounting bracket, microphone, and instruction manual. U.S.-made, the radio is covered by a full 1-year parts and labor warranty, which is honored at over 600 Johnson Authorized Service Centers nationwide. Complete details are available from any Johnson dealer, or by circling No. 65 on Reader Service Page.

#### Spinet Organ Kit

Virtually identical to the famous Thomas Spinet Organ on display at fine music stores across the country, Heathkit has added its TO-1160 version to the product line at a savings to the kit builder of hundreds of dollars over the assembled retail price. The TO-1160 has two 44-note keyboards with



## Earn Your DEGREE

Learn Electronics Technology thru HOME STUDY...

Earn your Associate in Science DEGREE, and work as an electronics engineering technician. Grantham School of Engineering is a college-level institution, teaching mainly by correspondence, authorized by the California State Dept of Education to grant degrees, and approved for veterans under the G. I. Bill.

If you are a high school graduate, write for information *Bulletin G-72*. It's free.

### GRANTHAM School of Engineering

1505 N. Western Ave.  
Hollywood, Calif. 90027

CIRCLE NO. 4 ON PAGE 17 OR 103

The original "wedge-type" screwdriver

# QUICK-WEDGE®

SCREW-HOLDING  
SCREWDRIVER

©1972 by Kedma Company



does  
all the job!

**HOLDS, STARTS,  
DRIVES & SETS  
THE SCREW!**

Unconditionally Guaranteed

At Your Dealers or Write

**KEDMAN COMPANY**

Phone (801) 363-4413

P. O. Box 267 Salt Lake City, Utah 84110

CIRCLE NO. 5 ON PAGE 17 OR 103

# EXPERIMENTER

International EX Crystal and EX Kits



OX OSCILLATOR  
**\$2<sup>95</sup>**

**OX OSCILLATOR** Crystal controlled transistor type. Lo Kit 3,000 to 19,999 KHz Hi Kit 20,000 to 60,000 KHz (Specify) **\$2.95**

**MX-1 TRANSISTOR RF MIXER** A single tuned circuit intended for signal conversion in the 3 to 170 MHz range. Lo kit 3-20 MHz. Hi kit 20-170 MHz. **\$3.50**

**SAX-1 TRANSISTOR RF AMP.** Amplifier to drive MX-1 mixer. Lo kit 3-20 MHz. Hi Kit 20-170 MHz. **\$3.50**

**PAX-1 TRANSISTOR RF POWER AMP.** A Single tuned output amplifier to follow the OX oscillator. 3,000 to 30,000 KHz **\$3.75**



EX CRYSTAL  
**\$3<sup>95</sup>**

**EX CRYSTAL** Available from 3,000 KHz to 60,000 KHz. Supplied only in HC 6/U holder. Calib. is  $\pm 0.2\%$  when operated in International OX circuit or its equivalent. (Specify frequency) **\$3.95**

**BAX-1 BROADBAND AMP.** May be used as a tuned or untuned amplifier in RF and audio applications 20 Hz to 150 MHz. **\$3.75**



**CRYSTAL MFG. CO., INC.**  
10 NO. LEE • OKLA CITY, OKLA. 73102  
Write for **FREE Catalog**

CIRCLE NO. 27 ON PAGE 17 OR 103

## THOUSANDS OF BARGAINS TOP VALUES IN ELECTRONIC PARTS

Transistors, Modules, C. B., Speaker, Stereo, Hi-Fi, Photo Cells and Thousands of Other Electronic Parts.

Send for **FREE Catalogue**

**ELECTRONIC DISTRIBUTORS INC.**



**EDI**

Dept. TA-2, 4900 Elston  
Chicago, Ill. 60630

RUSH CATALOGUE

Name .....

Address .....

City .....

State ..... Zip Code .....

CIRCLE NO. 28 ON PAGE 17 OR 103

## PARTS! CORNELL TUBES!

FREE Send For FREE  
**CORNELL'S**  
New Color  
Catalog

48 Pgs. New Items

**33¢** per tube

IN LOTS OF 100

**36¢** per tube

ORDER FREE  
IF NOT SHIPPED  
IN 24 HOURS!

4219 E UNIVERSITY AVE. SAN DJEGO, CALIF. 92105

CIRCLE NO. 14 ON PAGE 17 OR 103

## FIND BURIED TREASURE

Powerful electronic detector finds buried gold, silver, coins, etc. 5 new models. Write for free catalog.



**RELCO**, Dept. D-58

BOX 10839, HOUSTON, TEX. 77018

**19<sup>95</sup>**

CIRCLE NO. 10 ON PAGE 17 OR 103

## HEY, LOOK ME OVER

exclusive Color-Glo keys that light up to show notes and chords to correspond with the "Quick-Play" organ course and sheet music included with the kit. Eleven authentic instrumental voices can be combined to provide hundreds of orchestral combinations. On the upper keyboard are Flute 16', 8' and 4'; Trumpet 8'; Oboe 8', and Violin 8'. On



the lower keyboard are Horn 8'; Diapason 8'; Melodia 8', and Cello 8'. The pedal keyboard provides a Flute 16'-8' combination. Controls include an expression pedal, variable pedal volume, variable manual balance and switch tabs for vibrato and light vibrato. Also, there are convenient front panel jacks for headphones or cassette deck. The cabinet and matching bench are shipped pre-finished and pre-assembled except for bench legs. Construction is of handcrafted selected hardwoods with walnut veneers in a Scandia finish. The famous Heathkit assembly manual reduces assembly to a simple step-by-step procedure, with every major operation fully illustrated. Mailorder kit price is \$689.95. For further information, circle No. 1 on Reader Service Page.

## Tune for No Backfire

Is your car sputtering when it should be spurting? Then maybe you need the new Heathkit CI-1040 inductive pickup timing light. The CI-1040 offers improved convenience to auto tune-up buffs and professional alike. The user simply hooks-up the CI-1040 to the battery terminals and snaps the inductive pickup around the wire to the No. 1 spark plug. There's no need to get at the plug



itself, and the unit can be connected even while the engine is running. The timing light won't interfere with the operation of other tune-up instruments either. Featured are all solid-state circuitry and a high intensity flash that's visible in direct sunlight. High impact focusing lens concentrates beam for greater accuracy. Rugged blue plastic housing insulates against electrical shock. Circuit is protected against reversed polarity. Kit goes together in just a couple of hours and is mail-order priced at only \$29.95. For further information and the Heath catalog, circle No. 1 on Reader Service Page.

#### To Stop a Thief

A new solid-state automotive burglar alarm by Metra Electronics Corporation fits inside of a small plastic case with an on/off switch integral with the case, and can be easily concealed behind the dashboard. The auto alarm senses any current change in the car's electrical system such as the dome light turning on when a door is opened, opening lighted glove compartments, trunks, etc. After a 6-to-8 second delay, the alarm triggers, blowing the car's horn in pulsating blasts. An option-

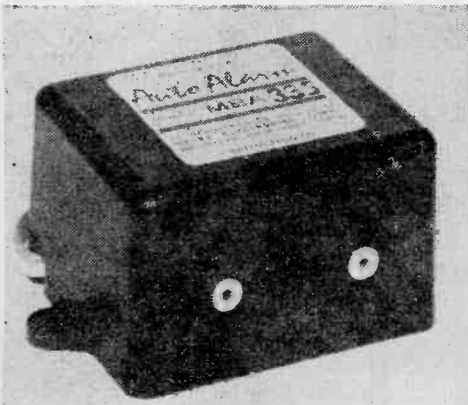

MARCH-APRIL, 1973

# FREE

## LAFAYETTE 1973 CATALOG 730



Ready  
Now!

### The World's Largest Consumer Electronics Catalog

#### Everything In Electronics for Home, Business, Industry

• Stereo/Hi-Fi Components • Musical Instruments and Amplifiers • CB & Ham Equipment • Tools and Test Equipment • Police and Fire Monitor Receivers • Public Address Systems • Photography Equipment • Semiconductors, Books, Parts • Plus Much More!

#### Your Complete Electronics Buying Guide

**Send  
Today!**

Lafayette Radio Electronics  
P.O. Box 10, Dept. 25053  
Syosset, L.I., N.Y. 11791

Send FREE 1973 Catalog 25053

NAME \_\_\_\_\_

ADDRESS \_\_\_\_\_

CITY \_\_\_\_\_

STATE \_\_\_\_\_ ZIP \_\_\_\_\_

CIRCLE NO. 25 ON PAGE 7 OR 103

# avanti MAKES ANTENNAS YOU'LL BRAG ABOUT

... like the revolutionary  
**ASTRO PLANE**  
the only  
omni-directional  
antenna that  
radiates from  
the top.

**\$29.95**

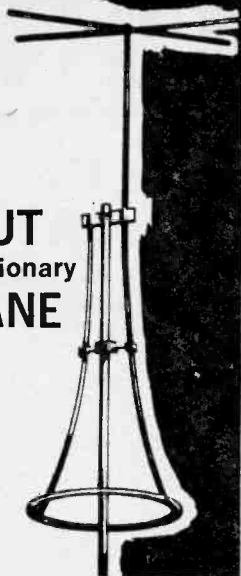

Write for **FREE 16-page color catalog**

**avanti**

creators of the  
famous

RESEARCH AND DEVELOPMENT, INC.  
33-35 W. Fullerton Ave., Addison, Illinois 60101

**MOONRAKER**

CIRCLE NO. 12 ON PAGE 17 OR 103

## SEMICONDUCTOR SUPERMART

### FREE CATALOG

NAME BRAND—  
PRIME QUALITY  
SEMICONDUCTORS

- MOTOROLA • RCA •
- FAIRCHILD • HEP •
- NATIONAL • SIGNETICS

Other Parts For  
Elementary Electronics Projects

**CIRCUIT SPECIALISTS CO.**

Box 3047 Scottsdale AZ 85257

CIRCLE NO. 30 ON PAGE 17 OR 103

## HEY LOOK ME OVER

al parking-light flasher. The alarm has two model designations—type MBA-335 for AMC, Chrysler and GM cars, and model MBA-335R for Ford-made cars and foreign cars that do not have a horn relay. The underdash horn alarm carries a suggested list price of \$18.95 for the MBA-335, and \$20.95 for the MBA-335R. For further information, circle No. 67 on Reader Service Page.

### Courier's Comet

A new deluxe 23 channel mobile unit, Comet 23 has been added to the Courier line of CB equipment. Packaged in a sturdy chrome housing, with detachable noise cancelling mike, Comet 23 is a composite of the most advanced silicon solid state circuitry, full 100% signal modulation, switchable auto

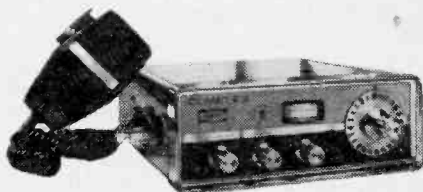

noise limiter, easy-to-read RF and signal strength meter and squelch control TVI suppression trap. The Comet utilizes delta tuning and includes a built-in PA system and auxiliary speaker phase jack. Complete with crystals, Comet 23 lists for \$179.00. Courier will send you the facts if you circle. No. 48 on the Reader Service Page.

### Best Price Yet

Now you can enjoy the effect of four-channel sound from your present car stereo tape player or stereo FM radio with the new Realistic Auto Quatravox 4-Channel Synthesizer from Radio Shack. A 4-channel effect is created with the Quatravox by placing the rear speakers out of phase with the front. This eliminates sound common to both stereo channels, leaving only ambient sound from the rear. The Realistic Auto Quatravox 4-Channel Synthesizer is priced at \$9.95. Includes mounting hardware, 18-ft. speaker cables and instructions. Realistic products are available at more than 1500 Radio Shack and Allied stores in all 50 states and Canada, and through Radio Shack Authorized Sales Centers, nationwide. For more information, circle No. 40 on Reader Service page.





## READER SERVICE PAGE

• The Editor of ELEMENTARY ELECTRONICS offers readers an easy way to get additional information about products and services advertised in this issue. Also, if you would like more information about any new product mentioned in our column "Hey, Look Me Over," it's yours for the asking. Just follow the instructions below and the material you requested will be sent to you promptly and at no cost.

• The coupon below is designed for your convenience. Just circle the numbers that appear next to the advertisement or editorial mention that interests you. Then, carefully print your name and address on the coupon. Cut out the coupon and mail to ELEMENTARY ELECTRONICS, Box 886, Ansonia Station, New York, N.Y. 10023. Do it today!

MARCH/APRIL 1973 Void after July 31, 1973

**ELEMENTARY ELECTRONICS**  
**Box 886, Ansonia Station, New York, N.Y. 10023**

Please arrange to have literature whose numbers I have circled at right sent to me as soon as possible. I understand that this is a free service offered by the magazine.	1	2	3	4	5	6	7	8	9	10
	11	12	13	14	15	16	17	18	19	20
	21	22	23	24	25	26	27	28	29	30
	31	32	33	34	35	36	37	38	39	40
	41	42	43	44	45	46	47	48	49	50
	51	52	53	54	55	56	57	58	59	60
	61	62	63	64	65	66	67	68	69	70

• Please limit circled items to 12 maximum.

Name (Print Clearly) \_\_\_\_\_

Address \_\_\_\_\_

City \_\_\_\_\_ State \_\_\_\_\_ Zip Code \_\_\_\_\_

# Discover the ease and excitement of learning Electronics with programmed equipment NRI Sends you

When you train at home with NRI, you train with your hands as well as your head. You learn the WHY of Electronics, Communications, TV-Radio the NRI pioneering "3-Dimensional" way. NRI training is the result of more than half a century of simplifying, organizing, dramatizing subject matter, and providing personal services unique for a home study school. You get the kind of technical training that gives you priceless confidence as you gain experience equal to many, many months of training on the job.



*NRI—The Leader in Electronics Training for more than Fifty Years*

## APPROVED UNDER NEW GI BILL

If you served since January 31, 1955, or are in service, check GI line in postage-free card.



Earn \$5 to \$7 an hour  
spare or full time in

## TV-RADIO SERVICING

Color television sales are soaring. And so is the demand for trained repairmen. If you can service TV sets, portable radios, tape recorders, hi-fi sets, phonographs and auto radios, you'll always be in demand. It's one of your best routes to spare-time earnings, a good paying job or a business of your own. NRI trains you quickly and expertly, showing you how to get started in servicing soon after you enroll, earning as you learn. NRI trains you in today's method of installing and repairing all electronic equipment for the home—including solid state Color TV. You even build, experiment with and keep to enjoy your own solid-state radio plus your choice of black-and-white or the new 25" solid state Color TV receiver NRI developed from the chassis up for training. Like thousands of others, you can soon be earning good money in your spare time . . . the easy NRI way.

There's money and  
success awaiting you in

## BROADCASTING— COMMUNICATIONS

The experience you gain from intensely practical NRI training in Complete Communications equals as much as two years of training on the job. With NRI, you can train for a choice of careers ranging from mobile, marine and aviation radio to TV broadcasting and space communications. You learn how to install, maintain and operate today's remarkable transmitting and receiving equipment by actually *doing* it. You build and experiment with test equipment, like a VTVM you keep. You build and operate amplifier circuits, transmission line and antenna systems, even build and use a phone-cw transmitter suitable for transmission on the 80-meter amateur band. Whichever of five NRI Communications courses you choose, you prepare for your FCC License exams, and you must pass your FCC exams or NRI refunds your tuition in full.

Move ahead in America's  
fast growing industry as

## ELECTRONICS TECHNICIAN

Electronics touches everyone's lives. This vast field of opportunity is open to you with NRI training. Industrial/Military Electronics training—like all NRI courses—prepares you quickly, thoroughly the practical "hands on" way. You build with, and learn to understand the functions of, today's miracle solid-state components like printed circuits, diodes and transistors. You build and experiment with Electronic circuitry used in automation, data processing, ultrasonics, telemetry. Bite-size texts make studying easier. Whatever your interest in Electronics, NRI training can fill your needs. Prove to yourself what nearly a million NRI students could tell you . . . that you get more for your money from NRI. Check the postage-free card and mail it today for your FREE NRI Color Catalog. NO SALESMAN WILL CALL. NRI Training, 3939 Wisconsin Ave., Washington, D.C. 20016.

# YOU GET MORE FOR YOUR MONEY FROM NRI



## NRI Kits and Equipment

Dollar for dollar, you get more value from NRI training kits, because they are designed as educational tools. In the TV-Radio Servicing Course, for instance, the end product is a superb 25" color TV your whole family will enjoy. The set is designed so that, while building it, you can introduce and correct defects . . . for trouble-shooting and hands-on experience in circuitry and servicing. The kits include, at no additional cost, a wide-band service type oscilloscope and color crosshatch generator, and other valuable equipment that will let you start earning money in your spare time making repairs . . . even before the course is completed.

## CODE PRACTICE SET & TAPES

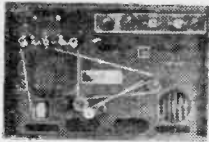

**TG-34 KEYS:** Code practice set used to reproduce signals previously recorded on inked paper tape. Variable speed motor, keying oscillator with speaker & phone jack. Power required: 115 V. 50/60 cyc. Comes in portable carrying case: 15 x 10 x 10"

Wt.: 40 lbs. Prices—FOB, Lima: Used, serviceable: \$24.95  
Checked: \$29.50

### 15 TAPES TO A COMPLETE PRACTICE SET:

- |   |                       |
|---|-----------------------|
| # 1 thru # 4 cover different Groups of wide space letters | # 9 12WPM Coded/Gr.   |
| # 5 Wide space numbers and letters                        | # 10 12WPM Tact/Mess. |
| # 6 5WPM Numbers & letters                                | # 11 12WPM Tact/Mess. |
| # 7 7WPM Numbers & letters                                | # 12 15WPM Tact/Mess. |
| # 8 10WPM Coded Groups of 5                               | # 13 15WPM Tact/Mess. |
|   | # 14 20WPM Tact/Mess. |
|   | # 15 20WPM Tact/Mess. |

PRICE FOB, Lima: \$2.00 Each Tape • Dept. EE • FREE CATALOG!

## FAIR RADIO SALES

1016 E. EUREKA • Box 1105 • LIMA, OHIO • 45802

CIRCLE NO. 3 ON PAGE 17 OR 103

## LICK THAT DX PROBLEM

DON JENSEN REFERS YOU TO PART-RIDGE OF ENGLAND AND THEIR—WORLD RECORD AWARD WINNING JOY-STICK V.F.A. THE WORLD'S MOST VERSATILE AND COMPACT GENERAL COVERAGE ANTENNA SYSTEM—SWL-DX-AMATEUR-CB-MARS

FREE BROCHURE BY AIR MAIL FROM—

**PARTRIDGE ELECTRONICS LTD.**  
BROADSTAIRS, KENT, ENGLAND

CIRCLE NO. 7 ON PAGE 17 OR 103

## DESIGN . . BUILD . . TEST . . YOUR OWN OP-AMP CIRCUITS

MULTI-PURPOSE KIT WITH IC'S, SEMICONDUCTORS, ETCHED REUSABLE BREADBOARDS, OTHER PARTS. BOOKLET OF TYPICAL SCHEMATICS AND CIRCUITS INCLUDED. \$10.00 PREPAID

### PHOTOLUME CORP.

118 EAST 28th STREET NEW YORK, N. Y. 10016

CIRCLE NO. 9 ON PAGE 17 OR 103

WRITE NOW FOR

## McGEE'S BIG SPEAKER CATALOG

### 1001 BARGAINS IN

SPEAKERS—PARTS—TUBES—HIGH FIDELITY COMPONENTS—RECORD CHANGERS—Tape Recorders—Kits—Everything in Electronics  
1901 McGee Street, Kansas City, Missouri 64108

CIRCLE NO. 19 ON PAGE 17 OR 103

## "LISTEN IN" TO POLICE-FIRE RADIO CALLS IN YOUR CAR!

WORKS with ANY CAR—Portable or HOME RADIO! Just PLUGS in—No wiring—3 minute hookup! Switch instantly from regular to ALL POLICE-FIRE-EMERGENCY-COMMERCIAL-TAXICAB-STATE-CITY-GOV'T 2 way Radio calls in YOUR AREA. DUAL-HI-LOW BANDS—36/100/170/175 MHz. OVER a MILLION Radio Cars/stations, USE Everywhere—Anytime—always works! SEND ONLY \$2.00 (cash, Ck, M.O.) and pay post-man \$7.99 plus COD pkg or send \$9.99 for ppd. Del in USA. COMPLETE, ready to use with instructions. One Year service Warranty—10 DAY MONEY BACK TRIAL (if retnd) AMAZING OFFER good only by mail—WESTERN RADIO Dept. BE-3, KEARNEY, NEBR. 68847



CIRCLE NO. 11 ON PAGE 17 OR 103



## BOOKMARK BY BOOKWORM

**For Your Listening Shack.** Introducing the DX'ers *Confidential Frequency List*, a who's who of unusual radio stations published by Gilfer Associates, Inc. This book is the first major compilation of AM, CW, SSB, RTTY and FAX non-broadcast stations made available to the general public. Frequencies, callsigns,

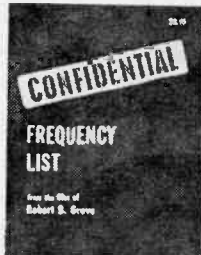

Soft cover  
64 pages  
\$3.95

locations, schedules and radiated power are shown for thousands of radio stations operating between the broadcasting and ham bands from 12 to 27,240 kHz. Prepared by Robert B. Grove, WA4PYQ, the *Confidential Frequency List* reveals radio frequency and callsign information heretofore kept under wraps. There are 34 separate listings including: Interpol, CIA, RTTY Press, USAF Global Aero, and Number stations, radiobeacons, weather broadcasters, AMVER, Flying Doctor Service, foreign embassy networks, hurricane hunters, etc. Get all the facts from the publisher by circling No. 45 on the Reader Service Page.

**About Some Words.** *Dictionary of Electronics* by Harley Carter will be extremely useful in whatever connection the reader has with electronics. This dictionary defines most all of the electronic terms that come up during everyday reading—from alpha particles through zoom lens. It defines the terms needed and used most

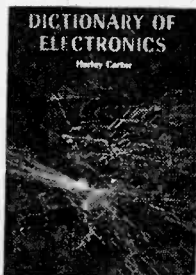

Soft cover  
420 pages  
487 illustrations  
\$3.95

ELEMENTARY ELECTRONICS

often, including those found in radio, TV, communications, radar, electronic instrumentation, broadcasting, industrial electronics, etc. The concise but clearly-written definitions from all the various branches of electronics are of value to technicians, engineers, hobbyists, experimenters, and students. Appendix material provides still more information—an extensive list of units and abbreviations, graphic symbols used in schematics, component color codes, db conversion tables, data on the electromagnetic spectrum, tube base diagrams, etc. Published by *Tab Books*. Get more info by circling No. 52 on Reader Service Page.

**Our Boy Makes Good.** When a good friend of ours who has also published many magazine articles in this magazine writes a book, we are mighty proud indeed. Charles D. Rakes has assembled *Solid-State Electronic Projects*, a book designed to appeal to a wide range of project

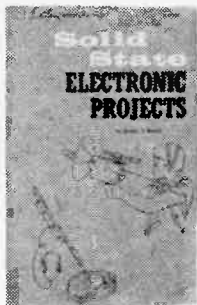

Soft cover  
128 pages  
99 illustrations  
\$3.95

builders. Included are a variety of burglar alarms, metal locators, and a long-range listening device, to mention a few. Detailed circuit descriptions and schematic and pictorial diagrams are used to aid the novice in the projects' construction. All of the projects have been built, tested, and debugged; therefore no major building problems should be experienced. Published by Howard W. Sams & Co., Inc., you'll get all the facts by circling No. 42 on Reader Service Page.

**Electronic Watchdogs.** Now, in one book, is everything the reader needs to know to break into the challenging field of installing and

*(Continued on page 104)*

Installing & Servicing  
Electronic Protective  
Systems *By Harvey Swanson*

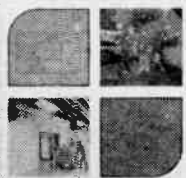

Soft cover  
256 pages  
160 illustrations  
\$4.95



## NEW 5-ELEMENT

### GB MINI- BEAM Model GA-5D

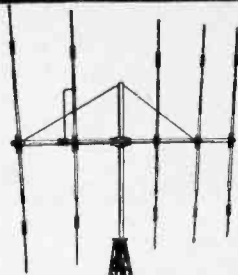

#### 9.5db Gain .... 500 Watt Power Rating

The secret of success in this five-element miniature beam is in its coils. Ten High "Q" coils molded on each element—extension limit the mechanical size of the GA-5D without limiting its electrical capability. These coils are built to take a powerful beating—-in fact, the same coils are used in the construction of 10-meter amateur antennas. The GA-5D is lightweight. Erect on TV antenna mount and turn with an inexpensive TV rotor. Get all the facts: see your Dealer or write factory direct, Dept. 211,

*Mosley Electronics, Inc.*

4613 N. LINDBERGH BLVD., BRIDGETON MO. 63044

CIRCLE NO. 29 ON PAGE 17 OR 103

**Free!**  
**1973**  
**Eico catalog**  
OVER 200 INSTRUMENTS • KIT & WIRED!

NEW! TR-410 Solid State Triggered Sweep Scope  
NEW! 300C "Clamp-On" Current Tester  
NEW! TD-88 Track Stereo Tape Deck  
NEW! SS-200 "Time Delay" Burglar Alarm System  
NEW! ASA-300 Electronic Siren Auto Alarm

Build all professional Eico Kits and save up to 50%. The more you know about electronics, the more you'll appreciate Eico. Over 2500 local Eico dealers offer you all the top brands, personal technical counsel, fast off-the-shelf service. Free catalog includes Test Equipment, Stereo, Eico-craft Projects, Burglar/Fire Alarm Systems and name of nearest Eico distributor, check reader service card or send 25¢ for first class mail service.

EICO, 283 Malta St., Brooklyn, N.Y. 11207  
Leadership in creative electronics since 1945

CIRCLE NO. 33 ON PAGE 17 OR 103



**ASK HANK,  
HE KNOWS!**

Hank Scott, our Workshop Editor, wants to share his project tips with you. Got a question or a problem with a project you're building—ask Hank! Please remember that Hank's column is limited to answering specific electronic project questions that you send to him. Sorry, he isn't offering a circuit design service. Write to:

**Hank Scott, Workshop Editor  
ELEMENTARY ELECTRONICS  
229 Park Avenue South  
New York NY 10003**

### Can't Find ICs

*I'm having lots of trouble buying ICs. HEP units are easy to buy, but after that—I give up—Where can I go?*

—G.H., Denver CO

In this issue of ELEMENTARY ELECTRONICS you'll find an advertisement for Circuit Specialists Co. Why not send them a letter today. And tell them Hank Scott sent you.

### Relay This Message

*My big brother draws diagrams for his boss that looks like a schematic diagram filled with capacitors, capacitors with lines through them, and coils. He kids me by refusing to tell what they mean. I copied one and here it is! What's it all about?*

—K.V., Seattle OR

Your big brother designs relay and switch circuits. A different notation is used than would normally appear in schematic diagrams because they are easier to understand. Below, I have drawn a conventional circuit diagram and below that I've drawn the shorthand your brother uses.

By the way, K is the letter used to denote relays. Switches S1 and S2 are pushbutton switches with spring return shown in the non-depressed position. All relays are shown in the non-energized position. Can you figure out when I1, I2 and I3 are and are not illuminated? Answer next month.

### He Just Didn't Know

*This may be a dumb question, but what is a turns tile antenna?*

—H.M., San Francisco CA

Dumb is right—you mean *turnstile*. The way it's told, these two TV technicians are racing to the same antenna installation job and they crash at an intersection. The fenders weren't damaged too badly, but the dipole antennas they carried, one each as the story goes, stuck together—the first turnstile antenna. Actually, two dipole antennas arranged in right-angle combination and phased by quarter-wave stubs are used to provide 360° reception for FM receivers in the boon docks. Multipath reception is a major drawback.

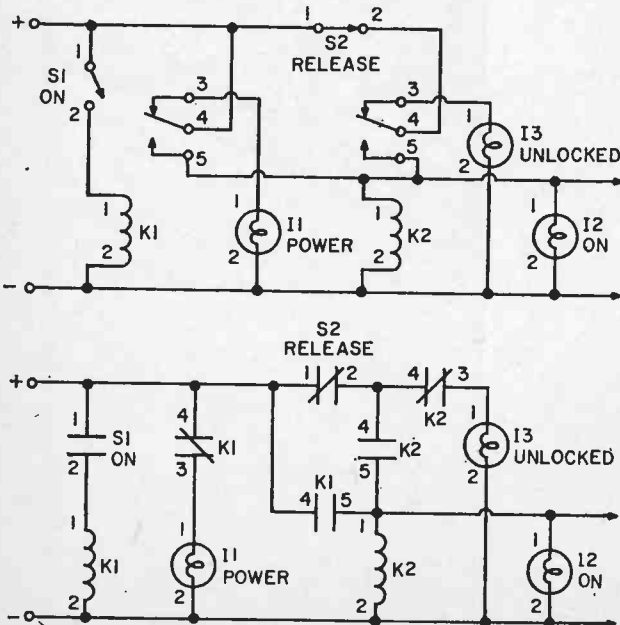

### Everybody's Problem

*Hank, I spent over \$20 on an engineering circuit reference guide and it ain't worth a damn. Unless I spend \$35 for a transistor, and I have to buy 1000 of them, I can't use the circuit. What do I do?*

—P.K., St. Louis MO

I know what you mean. In fact, most of these so-called reference guides are only reprints of manufacturers' data sheets in which they specifically state that the circuits may not work! How do you like those apples? My advice to you is pick up the latest copy of 101 ELECTRONIC PROJECTS at your favorite newsstand or direct from us for only \$1.25. Our circuits work—well, 99 out of 101—and the parts are a whole lot easier to come by.

(Continued on page 101)

# DX central reporting

A world of SWL info!

## Happy 25th birthday, SCDX!

Yes, it was a quarter century ago, February 8, that Sweden Calling DXers, the popular weekly program specifically directed to SWL's around the world, went on the air for the first time. And, today, some 1,200 programs later, SCDX still is going strong.

Sweden Calling DXers wasn't quite the first DXer's program on shortwave. That honor belongs to Radio Australian DXers Calling, which predated SCDX by about a half a year. But SCDX has grown, over the years, to become one of the most popular shows of its type.

If you haven't caught SCDX you may wonder what a DX show is all about. It is something like a weekly, broadcast version of DX Central's own *Bandsweep*, a collection of tips on what shortwave stations are being heard by other SWL's, where they're tuning them, and when. DXers find these up-to-the-minute tuning tips of great help in logging new stations and keeping tabs on schedule and frequency changes. Though broadcast by Radio Sweden, the information certainly isn't limited to Sweden stations.

The man behind Sweden Calling DXers, then and now, is Arne Skoog, "Mr. DXing" to thousands of listeners around the globe. The first SCDX, with Skoog, at the mike, went out over the air from Radio Sweden's 12 kilowatt transmitters at Motala 25 years ago. At first it was an independent production, a 15 minute show of DX info and records. Later it became a regular weekly part of Radio Sweden's English language service.

In 1952, when Radio Sweden began using two new and powerful shortwave stations at Horby, near Malmo, SCDX became much easier to hear. So the audience grew . . . and grew. As it became more popular, DXers in many lands requested SCDX programs in their own languages. Currently these are DX broadcasts from Radio Sweden in English, French, German, Portuguese, Spanish and Russian.

SCDX can be heard during Radio Sweden's English programs to East Coast U.S. and Canada from 0030 to 0100 GMT and 0200 to 0230 GMT on 6,175 kHz. and to the West Coast

(Continued on page 28)

## EXAMINE ANY BOOK ON 10-DAY FREE TRIAL!

### BASIC, GENERAL, & SECURITY ELECTRONICS

- DICTIONARY OF ELECTRONICS—420 pgs.—\$3.95
- Basic Electronic Test Procedures—416 pgs.—\$6.95
- Basic Electronic Circuits Simplified—332 pgs.—\$5.95
- Handbook of Electronic Tables, 2nd Ed.—224 pgs.—\$4.95
- Electronics Data Handbook—2nd Ed.—256 pgs.—\$4.95
- Installing/Servicing Electronic Protect. Syst.—256 pgs.—\$4.95
- Basic Color Television Course—420 pgs.—\$6.95
- Basic Electronics Course—384 pgs.—\$5.95
- 1972 Popular Tube-Transistor Sub. Guide—256 pgs.—\$2.95
- Beginner's Guide to TV Repair—176 pgs.—\$3.95
- Fire & Theft Security Systems—176 pgs.—\$4.95
- Basic Electronics Problems Solved—192 pgs.—\$4.95
- How To Read Electronic Circuit Diagrams—192 pgs.—\$3.95
- Electronics Reference Databook—232 pgs.—\$4.95
- Basic Transistor Course—224 pgs.—\$4.95
- Basic TV Course—224 pgs.—\$5.95
- Basic Radio Course—224 pgs.—\$4.95
- Basic Math Course for Electronics—152 pgs.—\$4.95

### AUDIO, HI-FI & MUSICAL INSTRUMENTS

- 4-Channel Stereo—From Source to Sound—172 pgs.—\$3.95
- Selecting & Improving Your Hi-Fi System—224 pgs.—\$4.95
- How to Repair Musical Instrument Amplifiers—256 pgs.—\$5.95
- How to Build Solid-State Audio Circuits—320 pgs.—\$5.95
- Hi-Fi for the Enthusiast—176 pgs.—\$3.95
- Electronic Musical Instruments—192 pgs.—\$4.95
- Installing Modern Hi-Fi Stereo Systems—248 pgs.—\$4.95
- Handbook of Magnetic Recording—224 pgs.—\$4.95
- Installing & Servicing Home Audio Systems—256 pgs.—\$4.95
- Tape Recording for Fun & Profit—224 pgs.—\$4.95
- Audio Systems Handbook—192 pgs.—\$4.95
- Hi-Fi Troubles—160 pgs.—\$3.95
- Installing Hi-Fi Systems—224 pgs.—\$5.95
- Designing & Building Hi-Fi Furniture—224 pgs.—\$4.95
- Elements of Tape Recorder Circuits—224 pgs.—\$4.95
- Servicing Record Changers—224 pgs.—\$5.95
- Pictorial Guide to Tape Recorder Repairs—196 pgs.—\$4.95

### A UNIQUE CONCEPT IN KITS—TAB BOOK/KITS!

For the price of a kit alone, you get a book by an expert who opens the world of electronics to you—PLUS a complete kit to help you start building and learning

- Audio Mixer, \$7.95  5-Watt Hi-Fi Amplifier, \$9.95
- Electronic Fortune Teller, \$4.95  AM Wireless Mike, \$6.95
- Electronic Touch Switch, \$6.95  Garage Light Control, \$9.95
- Audio Signal Generator/Injector, \$5.95
- Low-Voltage DC Power Supply, \$4.95  Diode Tester, \$5.95
- High Power Lamp Dimmer, \$4.95

### HAM RADIO, CB & BROADCASTING/CATV

- The 2-Meter FM Handbook—312 pgs.—\$5.95
- You're On The Air!—224 pgs.—\$7.95
- Designing & Maint. the CATV/Small TV Studio—256 pgs.—\$12.95
- Understanding & Using Radio Comm's. Rcvrs.—192 pgs.—\$3.95
- VHF Projects for Amateur & Experimenter—224 pgs.—\$4.95
- RTTY Handbook—320 pgs.—\$5.95
- The Business of Radio Broadcasting—400 pgs.—\$12.95
- The Fascinating World of Radio Comm's—176 pgs.—\$3.95
- Commercial & FCC License Handbook—432 pgs.—\$5.95
- Citizens Band Radio Service Manual—228 pgs.—\$4.95
- Television News Handbook—256 pgs.—\$9.95
- How to Become a Radio Disc Jockey—256 pgs.—\$7.95
- Video Tape Production & Communication—256 pgs.—\$12.95
- Guide to Professional Radio & TV News—224 pgs.—\$9.95
- Organization & Operation of Broadcast Stations—256 pgs.—\$12.95
- Guide to Radio-TV Broadcast Eng'g Practice—288 pgs.—\$12.95
- Power Technique for Radio-TV Copywriting—224 pgs.—\$9.95
- Guidelines for News Reporters—192 pgs.—\$9.95
- How to Sell Radio Advertising—320 pgs.—\$12.95
- AM-FM Broadcast Station Planning Guide—92 pgs.—\$12.95
- Modern Radio Operating Guide—256 pgs.—\$12.95
- CB Radio Operator's Guide—224 pgs.—\$3.95
- Managing Today's Radio Station—288 pgs.—\$12.95
- VHF Ham Radio Handbook—176 pgs.—\$3.95
- CATV System Engineering—3rd Edition—256 pgs.—\$12.95
- The Man Behind the Mike—288 pgs.—\$7.95
- Radio News Handbook—2nd Edition—192 pgs.—\$7.95
- CATV System Management & Operation—256 pgs.—\$12.95
- CATV System Maintenance—192 pgs.—\$12.95

AMATEUR RADIO LICENSE STUDY GUIDES:  Incentive, 160p. \$3.95  Advanced-Class, 199p. \$3.95  Extra-Class, 224p. \$4.95  General, 320p. \$5.95  Novice, 160p. \$3.95

### ALL-IN-ONE SCHEMATIC/SERVICING MANUALS

Each volume contains complete service data, including full-size schematic diagrams, and all info needed. Each volume:

- 8 1/2 x 11", 192 pgs.: COLOR TV: Adm. Vol. 1  Vol. 2
- G-E Vol. 1  Japan. Vol. 1  Vol. 2  Magna. Vol. 1
- Vol. 2  Motorola Vol. 1  Vol. 2  Philco  RCA Vol. 1
- Vol. 2  Sylvania Vol. 1  Vol. 2  Zenith Vol. 1  Vol. 2
- B&W TV: Adm.  G-E  Japan  Magna.  Motorola
- Philco  RCA  Sylvania  Zenith

SEE THESE HELPFUL BOOKS AT YOUR PARTS DISTRIBUTORS. OR CLIP THIS AD AND order on FREE 10-DAY Trial, or attach payment and save postage. Fully guaranteed or money back! Pa. res. add 6% tax. Foreign 10% (EE-33)



**TAB BOOKS**

BLUE RIDGE SUMMIT, PA. 17214

CIRCLE NO. 34 ON PAGE 17 OR 103



# LITERATURE LIBRARY

101. Kit builder? Like weird products? EICO's 1973 catalog takes care of both breeds of buyers at prices you will like.
102. International Crystal has a free catalog for experimenters (crystals, PC boards, transistor RF mixers & amps, and other comm. products).
103. See brochures on Regency's 1973 lineup of CB transceivers & VHF/UHF receivers (public service/business bands—police, fire, etc.)
104. A pamphlet from Electra details the 6 models of the Bearcat III, a scanning monitor receiver.
105. Dynascan's new B&K catalog features test equipment for industrial labs, schools, and TV servicing.
106. Before you build from scratch, check the Fair Radio Sales latest catalog for surplus gear.
107. Get Antenna Specialists' cat. of latest CB and VHF/UHF innovations: base & mobile antennas, test equipment (wattmeters, etc.), accessories.
108. Want a deluxe CB base station? Then get the specs on Tram's super CB rigs.
109. Pliers galore, from miniature electronic types to hefty 10-in. utilities, are shown in Xcelite's hand tool catalog. They are ideal to hold, twist or cut wire and other materials.
110. Bomar claims to have C/B crystal for every transceiver... for every channel. The catalog gives list of crystal to set interchangeability.
111. A Turner amplified mike helps get the most from a CB rig. This free brochure describes line of base & mobile station models.
112. Midland has recently published a 4-color brochure that folds out to 17"x21", printed on both sides. Over 40 CB and scanner products are featured.
113. For everything in electronics—get the 1973 catalog from EDI (Electronic Distributors, Inc.). 152 pages of leading brands at bargain prices.
114. Get all the facts on Progressive Edu-Kits Home Radio Course. Build 20 radios and electronic circuits; parts, tools, and instructions included.
115. Olson Electronics' 188-p. fully-illustrated 1973 catalog has leading national brands, all in the electronic product categories.
116. Trigger Electronics has a complete catalog of equipment for those in electronics. Included are kits, parts, ham gear, CB, hi fi and recording equipment.
117. Get the free, new twenty-four page HUSTLER CB and Monitor antenna catalog featuring improved antennas and accessories for base station and mobile operation.
118. Teaberry Electronics has information on CB radios—Twin "T," Big "T," Mini "T" II, and Five by Five; also information on Scan "T" Monitor radio receiver.
119. Burstein-Applebee's new 1973 catalog has over 280 pages of Radio-TV/Electronics bargains. Selling for \$2, it is offered free to our readers.
120. For a colorful leaflet on the Golden Eagle Mark III SSB receiver and the Mark III SSB transmitter, write to Browning Laboratories.
121. Edmund Scientific's new catalog contains over 4000 products that embrace many sciences and fields.
122. Cornell Electronics' "Imperial Thrift Tag Sale" Catalog features TV and radio tubes. You can also find almost anything in electronics.
123. Radio Shack's 50 Anniv. cat. has 180 pages, colorfully illustrated, of complete range of hi fi, CB, SWL, ham equip. and parts (kits or wired) for electronics enthusiasts.
124. It's just off the press—Lafayette's all-new 1973 illustrated catalog packed with CB gear, hi-fi components, test equipment, tools, ham rigs, and more.
125. Mosley Electronics, Inc. is introducing 78 CB Mobile Antenna Systems. They are described and illustrated in a 9-page, 2-color brochure.
126. RCA Experimenter's Kits for hobbyists, hams, technicians and students are the answer for successful and enjoyable projects.
127. You can become an electrical engineer only if you take the first step. Let ICS send you their free illustrated catalog describing 17 special programs.
128. Avanti antennas (mobile and base for CB and VHF/UHF) are fully described and illustrated in new catalog.
129. A new free catalog is available from McGee Radio. It contains electronic product bargains.
130. Semiconductor Supermart is a new 1973 catalog listing project builders' parts, popular CB gear, and test equipment. It features semiconductors—all from Circuit Specialists.
131. Heath's new 1973 full-color catalog is a shopper's dream—chockful of gadgets and goodies everyone would want to own.
132. E. F. Johnson's 1973 line of CB transceivers and CB accessory equipment is featured in a new all-line brochure. Send for your free copy today.
133. If you want courses in assembling your own TV kits, National Schools has 10 from which to choose. There is a plan for GIs.
134. Free 1973 Catalog describes 100s of Howard W. Sams books for the hobbyist and technician. It includes books on projects, basic electronics and many related subjects.

## ELEMENTARY ELECTRONICS

Box 886

Ansonia Station

New York, N.Y. 10023

Please arrange to have this literature whose numbers I have circled at right sent to me as soon as possible. I am enclosing 25¢ to cover handling. (No stamps, please).

M/A-73



- |     |     |     |     |     |     |     |     |     |     |
|-----|-----|-----|-----|-----|-----|-----|-----|-----|-----|
| 101 | 102 | 103 | 104 | 105 | 106 | 107 | 108 | 109 | 110 |
| 111 | 112 | 113 | 114 | 115 | 116 | 117 | 118 | 119 | 120 |
| 121 | 122 | 123 | 124 | 125 | 126 | 127 | 128 | 129 | 130 |
| 131 | 132 | 133 | 134 |     |     |     |     |     |     |

Indicate total number of booklets requested  
Sorry, only 12 circled items maximum.

NAME \_\_\_\_\_

ADDRESS \_\_\_\_\_

CITY \_\_\_\_\_

STATE \_\_\_\_\_ ZIP \_\_\_\_\_

Not Valid After July 31, 1973



# You'll read it first in



Here is your introduction to this great magazine of automobiles, home improvement, science, new products and new ideas. S&M brings you each issue for even less than the low, low single copy price... plus the latest issue of **DIRECTORY OF FREE GIFTS** (\$1.00 retail) —yours absolutely free. (See coupon below.)

### Why we make this unprecedented offer to new readers

Science & Mechanics is fast becoming the favorite recreation magazine for people who want to have fun with all new developments in the "mechanical" field today... without any mechanical experience needed!

And the one issue you bought at the newsstand (or borrowed) is not enough to show you how Science & Mechanics reports to you about your special recreation interests. Not just cars, but boats, motorcycles, airplanes, all-terrain vehicles, surf-sailing, snowmobiles, motor homes and campers... as well as fields of current concern, such as ecology, black-outs, transportation, many more with a scientific or mechanical basis.

Until you actually read the first few issues, you'll find it hard to believe that every month Science & Mechanics brings you such an enormous variety of useful information and reading pleasure. You'll read it just for enjoyment... use it for the

wealth of helpful, money-saving hints and ideas it offers. Science & Mechanics is the single magazine that can stir your imagination if you're the kind of person who is curious about things that might concern you or your family. Or if you're just interested in what's happening as a result of today's fast-moving science achievements.

### Know where to find the answers—subscribe now

In Science & Mechanics, you discover things you can find nowhere else. And if you can find it elsewhere—**YOU'LL FIND IT FIRST IN S&M!**

And, unlike other magazines in the field, Science & Mechanics doesn't just write about well-known personalities. You'll find such newsmakers as Mario Andretti, Andy Granatelli, Don Garlitz, Raymond Loewy, Cotten Owens, Mark Donohue, Senator Proxmire, Senator Brooke often writing about themselves for S&M.

Try Science & Mechanics. Try it under the no-risk subscription offer shown in the coupon. Just fill it in, and mail the coupon to Science & Mechanics, 229 Park Avenue South, New York, N.Y. 10003. Send your subscription in **TODAY.**



This latest copy of **DIRECTORY OF FREE GIFTS** is yours **ABSOLUTELY FREE** if you enclose payment for your introductory subscription now.

SAVE WITH THIS INTRODUCTORY OFFER

**ACT NOW!**

**10 fascinating months \$2.97**

- Enter my trial subscription for 10 months. **PAY CASH—GET VALUABLE BOOK FREE!**
- My payment is enclosed. Include the latest issue of **DIRECTORY OF FREE GIFTS** (\$1.00 retail) free with my subscription.

Name \_\_\_\_\_ (please print)

Address \_\_\_\_\_

City \_\_\_\_\_ State \_\_\_\_\_ Zip \_\_\_\_\_

Mail coupon Today to: **SCIENCE & MECHANICS**  
229 PARK AVENUE SOUTH • NEW YORK, N.Y. 10003

**B999**

## DX CENTRAL REPORTING

*Continued from page 25*

on 9,725 kHz from 0330-0400 GMT. While as far as the Swedes are concerned those times are on Tuesdays, remember that it's really Monday night in North America. Or, try Tuesday morning, actually 1400 to 1430 GMT, on 21,485 kHz. The SCDX program segments will be heard during these transmission periods.

Almost from the beginning, Sweden Calling DXers offered an additional service to SWL's. It's the SCDX bulletin, a mimeographed sheet of top DX items summarized from the broadcasts. Issues of the bulletin are airmailed to some 1,400 participating DXers around the world every two weeks.

The best thing about the SCDX bulletin is that it's free. It will be sent to you without cost if you keep SCDX informed regularly about the stations you're hearing on shortwave.

Sound interesting? Then drop a line to SCDX, Radio Sweden, S-10510 Stockholm, Sweden.

**TIP TOPPER.** This month's prize tip is a shortwave station in one of Portugal's overseas territories. Mozambique? Angola? No! Try the other side of the world. Macau? Wrong again!

Our sooper-scoop concerns a little-known station called Emissora de Radiodifusao de Timor Portugues. This station with a dilly of a name is located, appropriately enough at Dili, capital of Portuguese Timor, a territory that's only half-an-island big, tucked away in the heart of Indonesian waters.

A brief pause here to allow you to look it up in your atlas.

See, you can't find a spot much more exotic or out-of-the-way than Timor. And, until very recently, you couldn't find many SWBC stations harder to hear than Emissora de Radiodifusao de Timor Portugues! It ran very low transmitter power and its frequency was one of those ill-starred spots on the shortwave dial that are plagued with interference.

But last fall things changed. The station installed a new 10,000 watt transmitter that puts out a somewhat heftier signal across the Pacific. And it chose an off-beat, but clearer frequency, 3,668 kHz.

Suddenly, a number of alert DXers began hearing the station for the first time. And with patience, skill and luck you can too. While about ten times easier to hear than it once was, make no mistake about it, Timor is still a pretty great DX catch! If you manage to snare it, you've got something to be proud of!

Best time to try is about dawn, a little before or a little after. That will, of course, vary depending on where you live in the U.S. or Canada. That may be around 1200 to 1300 GMT in the east, as late as 1500 GMT for westerners. Programming is in Portuguese or a local dialect and musical fare may be either Portuguese songs or aging American pop recordings.

**BANDSWEEP.** (Frequencies in kHz, time, GMT): **4,775**—There's a station in the Dominican Republic, *Onda Musical* by name, that's currently one of the strongest Latin American broadcasters on the 60 meter band. Give a listen for "the musical (air)wave", for that's what *Onda Musical* means in Spanish, any evening . . . **6,200**—Most Iron Curtain countries don't come on as strong with the propaganda blasts as they did a few years back. *Radio Tirana*, Albania is one of the exceptions, however. It should be heard easily around 0230 . . . **6,250**—Equatorial Guinea is one of those emerging African nations whose broadcasts are filling the shortwave bands. *Radio Santa Isabel* is an interesting catch on this frequency during the afternoon, stay until 2230 . . . **8,893**—This strange frequency is one westerners may wish to try around 1230. A California has heard Mongolia's *Radio Ulan Bator* with music, English talks and requests for mail . . . **12,020**—Another strange frequency, this one used by Hanoi's *Voice of Vietnam* for its English language programming at 1300 . . . **15,110**—*Radio New Zealand* is not as widely heard as its down-under brother, *Radio Australia*, but it is one of those stations whose programs are genuinely listenable. Tune for RNZ around 0400 . . . **15,165**—Seldom can you hear an English language identification from *Radio Denmark*. Your best bet seems to be at 1600, just before Copenhagen goes into its Danish newscast and musical program.

(Credits: Don Johnson, California; Lynn Hyndman, Indiana; R. Stephen Dildine, Virginia; Robert Zilmer, Wisconsin; William Shaw, Pennsylvania; SPEEDX, P.O. Box 321, Santa Ana, California 92702)

**BACKTALK.** "Who says you have to listen at 2 a.m.?" asks Jim Soya of Throop, Pennsylvania. "I picked up the pirate broadcaster, Radio Nordsee International on 6,205 kHz at 2330 GMT with my SONY portable and whip antenna."

Right, Jim. There's DX to be heard somewhere on the bands anytime, night or day. And RNI is nifty nugget of DX treasure, especially on a portable rig. This station broadcasts quite without authority from a ship anchored in international waters off Holland. Unlicensed by any country, technically illegal, it has to remain at sea, beyond the clutches of the European broadcasting authorities.

RNI has a fantastic QSL card and the address, as Jim notes, is Radio Nordsee International, P.O. Box 113, 8047 Zurich, Switzerland.

What's your biggest DXing thrill?

According to Tim Verthein, St. Anthony, Minnesota, his was getting his first QSL card. Tim verification was from the standard time and frequency station, WWV, Ft. Collins, Colorado. He heard it on his Heathkit GR-81 receiver. ■

## NewsScan

Continued from page 5

An answer to meteorology's blind spots was launched into orbit from Cape Kennedy, FL. On April 1, 1960, TIROS 1, the world's first weather satellite, was launched by NASA and within a few hours it had taken and transmitted the first view of earth's weather as seen from the vantage point of a space orbit.

The drum-shaped spacecraft, developed by RCA's Astro-Electronics Division, ushered in a new and revolutionary era in weather observation. It was followed by nine more TIROS (Television Infrared Observation Satellite) experimental satellites, nine operational Environmental Survey Satellites (ESSA) and two second generation operational spacecraft—the Improved TIROS Operational System (ITOS). The latest in the ITOS series, ITOS-D, carried three-dimensional environmental sensors to provide vertical as well as horizontal readings of meteorological data. ITOS-D was launched October 9.

The weather sentinels over the past 12½ years have helped prevent countless losses of lives and property due to storms by providing data for advance warnings. Airlines, shipping and other weather-sensitive commercial enterprises also now use the satellite pictures routinely.

The U.S. space program employed the space-

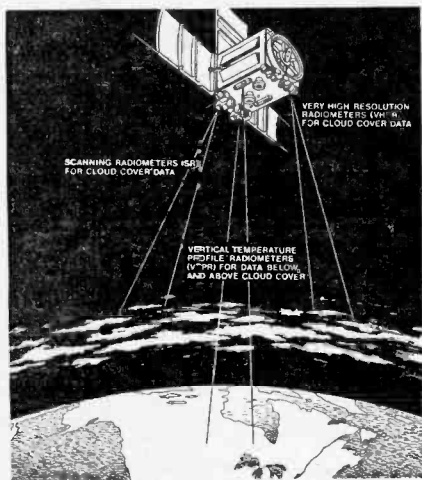

Artist's rendering shows the RCA-built environmental satellite that provides the first operational three-dimensional information on the world's weather. NOAA-2 carries Very High Resolution Radiometers (VHRR) and Scanning Radiometers (SR) to provide daytime and nighttime images of the earth's cloud cover. Simultaneously, the Vertical Temperature Profile Radiometer (VTPR) takes atmospheric readings above the clouds and to the earth's surface in clear areas.

craft to keep tabs on conditions in the launch and recovery areas during manned missions around earth and to the moon. The satellites have even been used to chart sea ice to aid shipping in the Gulf of St. Lawrence.

The 21 TIROS, ESSA and ITOS satellites to date—all built by RCA—have returned over 1,800,000 TV views of the weather and have accumulated over 44 years of useful life in orbit. All these spacecraft have met or surpassed their mission goals—an unprecedented record among unmanned space programs.

## Bicycling for Health

A series of tests now being conducted with volunteers ranging in age from 18 to over 80 may ultimately enable doctors to determine how age affects the heart's response to physical stress and provide advance warning of a heart

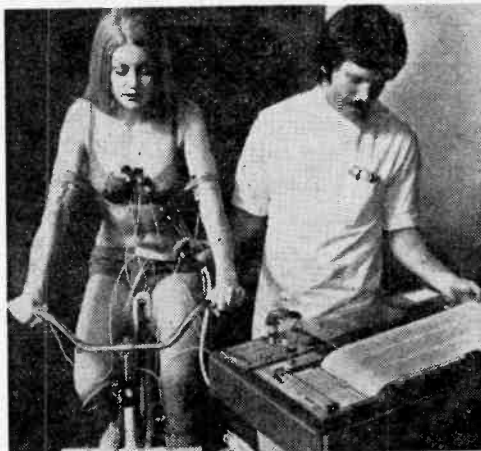

A special exercise bicycle at the Fifth Avenue headquarters of the Orentreich Foundation for the Advancement of Science, New York City, as part of a volunteer group aiding researchers in tests to determine how age affects the heart's response to physical stress. The wires attached to her body feed signals into a system known as the Compu-Gram which reads and analyzes electrocardiograms by computer. Technician Lincoln Shaw is administering the test.

attack. The subjects first submit to an EKG before pedalling a stationary bicycle. Additional EKGs are recorded immediately after pedalling and at one minute intervals for seven minutes.

Using an initial group of 100 people who are pre-determined to be medically normal, the volunteers are subjected to cardiac stress by having them pedal the bike at a fixed speed, load-factor and period of time. This technique provides a known stress and is independent of the weight of the volunteer.

In the screening process for subjects, the researchers discovered a number of volunteers with abnormal heart conditions. They were

(Continued on page 101)

# GET THE **L E D** OUT!

by Jack Schmidt



"It's all tuned up and lubed, Mr. Hogg, but for the gas gauge and speedometer repairs, you'll have to go to an electronics shop!"



"I don't care that it's synced to WWV—it's still 10 minutes to lunch!"

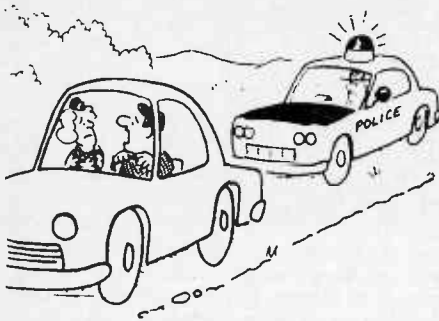

"Is he mad! I blew out all the numbers on his radar indicator."

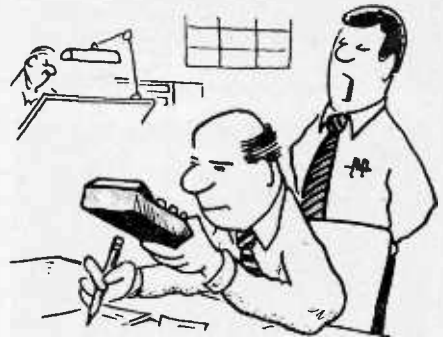

"Those numbers are big enough for most of us to see . . . admit it, Ed, you just need glasses!"



"Lemme tell you . . . they're not any easier to wake up to!"



"Very nice, Albert . . . are you planning to change your house number often?"

# ELECTRONICS FOR

## WEEKEND MECHANICS

by Jorma Hyypia

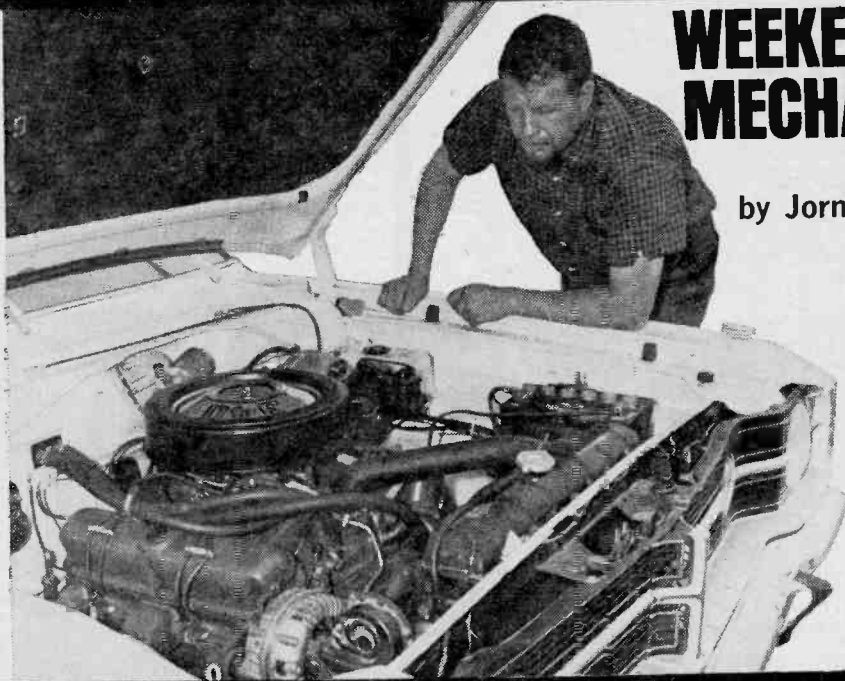

**Improved automobile tune-up analyzers keep the family buggy operating at peak performance!**

**E**ver have a secret desire to sneak out into the garage on a dark night and sabotage your own car? Maybe mess up a spark plug, or loosen a couple of distributor cables? Stupid question? Not if your new electronic engine analyzer has just told you, for the tenth time, that your car engine couldn't be healthier. After all, what's the fun in having nice, new troubleshooting equipment if you can't find any trouble to shoot?

But fear not. Sooner or later your fondest hopes will be realized. One day you'll hear an unusual burp or wheeze from under the hood, and your engine analyzer will confirm that the beast has an electrical head cold. What's more, you will be able to determine exactly what causes the ailment—and that's more than your family doctor can usually do when you complain of a headache.

Question: Why spend money on automotive diagnosis equipment if you don't happen to know enough about car engines to make your own repairs? Answer: a professional repairman won't be able to sucker you in to paying for un-needed repairs if you can tell *him* what's wrong with the engine. Moreover, you will soon discover that many service jobs related to engine tune-up or other electrical systems functions are ridiculously easy to do yourself. For example, there's no trick to replacing a spark plug; but you have to know which spark plug needs cleaning or replacement.

Every piece of equipment described in this article can be connected to the car engine in seconds, *without* removal of engine parts that might be difficult to replace. Also, each test instrument comes with clear, step-by-step instructions. You will be able to per-

## e/e WEEKEND MECHANIC

form engine tests correctly on the first try, and you will understand what the test results mean. If you are unfamiliar with automotive test equipment, your main problem is deciding what type of equipment would be most useful to you. It's easy to go overboard and buy too much test gear; or you can err by wasting money on equipment that will not serve all your needs. This round-up of automotive tune-up analyzers will clue you in on the types of instruments that have the broadest general appeal and usefulness. But you should do some extra looking around in shops where the analyzers are sold, and study catalog specs to make sure that you are getting the most per dollar invested.

Three "musts" for engine tune-up testing are: a tachometer to measure engine rpm; dwell meter to measure the performance of the cam that operates the distributor breaker points; and a timing light to determine whether the No. 1 spark plug is sparking at the correct time in relation to piston position on the compression stroke. To test the car's electrical system more completely, you should also have a DC voltmeter, DC ammeter reading up to 90 amperes, and an ohmmeter for resistance checks. If you already own some or all of the types more common variety of electronic test equipment, just look for a timing light, and for tach and dwell meters—either as separate or combined instruments. If you lack all or most of the desired equipment, you can save money by investing in an engine analyzer that combines all of these test functions in one portable unit.

If you are already confused by some of

the automotive terminology, get a couple of library books and read up on automotive ignition systems. Also check your electronics supply store for informative paperbacks; for example, Tab Book No. 604, *Using Electronic Testers for Automotive Tune-Up*.

**Timing Lights.** Each engine spark plug must fire at precisely the right time, in relation to its piston position; if spark timing is off, the engine may overheat, suffer loss of power, exhibit poor acceleration, waste fuel, and perform poorly in other respects. To check the all-important spark timing you need a stroboscopic timing light.

One cable of the timing light is connected to an AC or DC (car battery) power source, depending on the type of light; the other cable is connected to the No. 1 spark plug. Very low cost neon timing lights require only one connection, to the spark plug. Each time the spark plug fires, the timing light flashes. This flashing light is aimed at a stationary, calibrated marker and at a moving indicator mark located on the engine's crankshaft pulley, or flywheel. As the indicator mark spins around, the stroboscopic light makes it *appear* to stand still at a specific point next to the marker scale. If the timing is off, the indicator mark will appear to be in the wrong position. This



**Heathkit's Inductive Pickup Light** is powered by the car battery. Pickup can be attached to spark plug lead even with engine running.

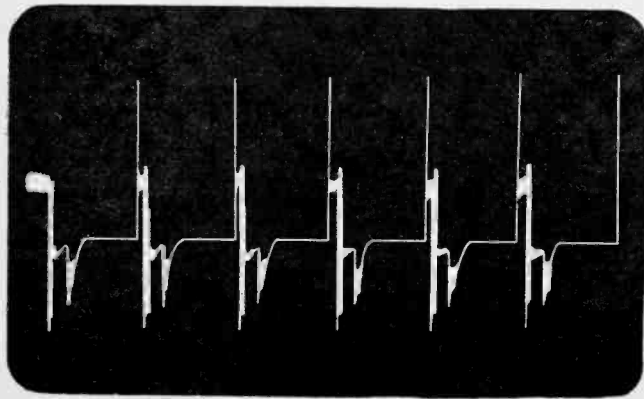

**Normal "parade" pattern** of auto ignition for a 6-cylinder engine. Each re-occurring pattern should be identical for engine operating normally.

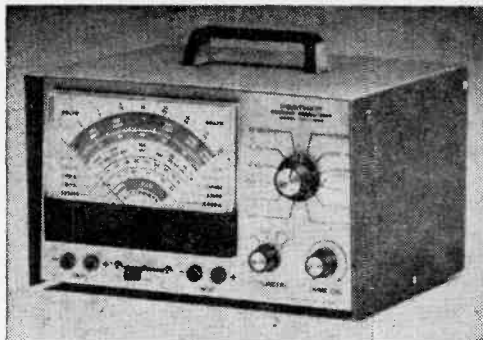
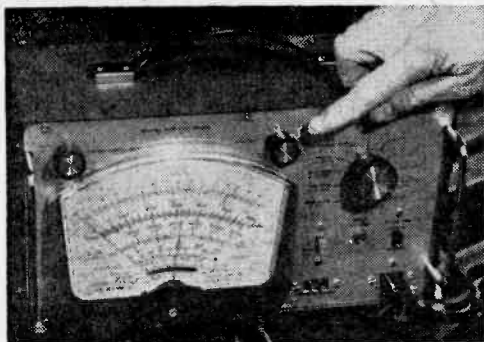

Two kits by Archer (Radio Shack) and Heath let you assemble your own engine analyzer. Get catalogs by circling 1 and 51 on Reader Service Page.

initial timing test is usually performed with the distributor vacuum hose disconnected. If the timing needs correcting, all you need do is loosen a hold-down bolt on the distributor and twist the distributor body slightly until the indicator mark moves to the proper scale position. It's that easy. So why waste time and money hiring a garage mechanic to perform this simple job?

The same timing light can be used to make a *rough* check of the centrifugal and vacuum advances of spark timing. More accurate testing and adjustment of these advances requires the use of a special ignition advance tester—a timing light having a built-in meter. You might want an advance tester some day, but chances are you can get along nicely with the basic timing light.

You can buy a *neon* timing light for under \$5, but the red light is so weak that you will probably have to use it in a darkened garage or under a blanket thrown over the car hood. These lights are completely accurate; you merely save money by sacrificing convenience. You can find these neon lights in department and discount stores having automotive sections, and in auto supply stores. Lafayette Radio offers one neon light for only \$3.39, and another with a remote starter cord for \$7.50.

*Powered* timing lights that use high-voltage (300-600 VDC) *xenon* flash tubes can be used in broad daylight without eye strain. These lights are also connected to the No. 1 spark plug which acts as a trigger mechanism for the synchronized flashing. Some lights work off a 110-volt AC power line, others draw power from the car battery. The AC jobs are usually priced lower than the DC models which can be used anywhere. For example, Radio Shack sells a DC power timing light for \$21.95, and Lafayette

has a similar unit priced competitively at \$22.95; Lafayette's AC light sells for only \$12.95. You can save more money by purchasing the Lafayette lights in kit form for \$16.96 for the DC model or \$10.95 for the AC version. Lafayette also offers a ready-to-use Karcheck Professional DC Power Timing Light for \$26.95.

To further illustrate the variety of timing lights available on the market, we might mention a Penske DC Power Timing Light sold by Sears for \$26.95. Incidentally, Sears also offers a neon light for only \$3.98, a DC-boosted neon light for \$5.99, and an AC "white" light for \$16.98.

**Heath Has a Bright Idea.** We chose Heathkit's new 12-volt Deluxe Timing Light (Model CI-1040, priced at \$29.95 F.O.B. factory) as our test unit because it utilizes an additional convenience feature—a new-style, low-voltage inductive trigger pickup that clips onto the spark plug cable even when the engine is running. You don't have to fuss with spark plug adapters of the kind that must be used with other types of timing lights. A coil inside the clamp picks up triggering pulses from the spark plug cable without actual physical contact with the ignition circuit.

Following Heathkit's characteristically clear assembly instructions, the author's 13-year old son put the timing light together in a few hours; an experienced kit-builder can do the job in a couple of hours. You should run into no problems assembling the simple solid-state inverter circuit and xenon flash tube, and the inductive pickup. To balance the triggering circuit, you adjust a 200-ohm control in the circuit using a built-in neon indicator or a voltmeter as voltage indicator to obtain the required 600 VDC. If for some reason the timing light fails to function

properly after these adjustments, do not assume that some component is defective. The assembly manual doesn't mention this additional step that saved us from wasting time checking perfectly good components. Just connect the light to the car engine as for a normal timing test (but with the unit's

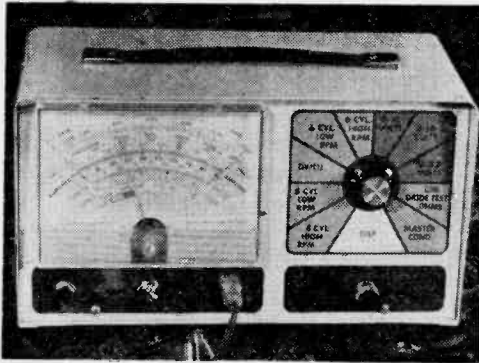

**Lafayette's solid-state engine analyzer includes a tach, dwell meter, VOM and master condenser for substitution testing.**

case open), start the engine, and again adjust the 200-ohm control. Chances are you will have the timing light flashing normally within seconds.

Incidentally, if thirty bucks seems a bit too much for a timing light having these obvious convenience features, you can settle for Heathkit's CI-1020 model selling for \$19.95. This light also features solid-state circuitry and a bright-light xenon flash tube: but it lacks the convenience of the inductive pickup.

**Engine Analyzers:** Engine tune-up equipment, including dwell meters and tachometers, come in a bewildering variety of model types ranging from simple, hand-held jobs serving limited test functions to more costly multi-functional unit. If you already own conventional electronic test equipment (voltmeter, ohmmeter and DC ammeter) perhaps all you need to buy is a relatively inexpensive combination dwell meter and tachometer. Because there are just too many choices to permit detailed listing here, we can only suggest that you consult the catalogs of such mail-order houses as Sears, Lafayette and Radio Shack, and that you prowl about in local auto supply outlets.

Assuming that many readers might be more interested in the multi-functional analyzers, we selected a Radio Shack kit and a Lafayette factory-wired model for comparative examination. These units are modestly priced when compared to, say, Penske analyzers sold by Sears for \$85 and \$129.

Heathkit's new CM-1050 Engine Analyzer (\$64.95), is worthy of serious consideration. This "professional-grade" instrument tests conventional, magneto, transistor, and most capacitive discharge ignition systems regardless of voltage or type of grounding. Its functional components include a tachometer, dwell meter, voltmeter, ohmmeter, ammeter, substitution condenser, and provision for testing spark output. Except for ohmmeter adjust, no in-use recalibration of the instrument is required. Accuracy is claimed to be + 3% on all measurement ranges, and metal-film resistors are used at critical circuit locations to ensure stability over wide temperature range. The analyzer operates off three C cells.

**Radio Shack Analyzer.** Radio Shack's ArcherKit Universal Auto Analyzer kit (\$54.95) went together easily in about six hours, and performed without hitch on the first try. In addition to clear assembly and operational instructions, you get a 56-page engine specifications manual detailing useful tune-up information for both domestic and foreign cars, and trucks made in the 1960 to 1970 period.

The 7-inch, 10-scale meter is easy to read. All scales (except the ohms scale) read from left to right, and each scale is color-coded to the proper position of the function selector switch. The completely portable instrument is powered by four C cells located in a rear compartment that is also used to store two connecting cables and reference literature.

There are two rpm scales (0-1200 and 0-6000 rpm ranges) and four selector switch positions for choosing the right range and to adjust the circuitry for 4, 6 or 8 cylinder engines. This tachometer requires preliminary calibration which is accomplished with a special cable that provides a 60Hz signal from the house power line; this is a one-time calibration. However, to ensure accurate rpm readings, you must use the RPM CAL and RPM SET controls to adjust the meter pointer to full-scale indication before each rpm measurement. It's a simple procedure requiring only seconds to accomplish.

Two cam dwell scales provide 0-45, 0-60



## WHAT THE IGNITION ANALYZER SHOWS

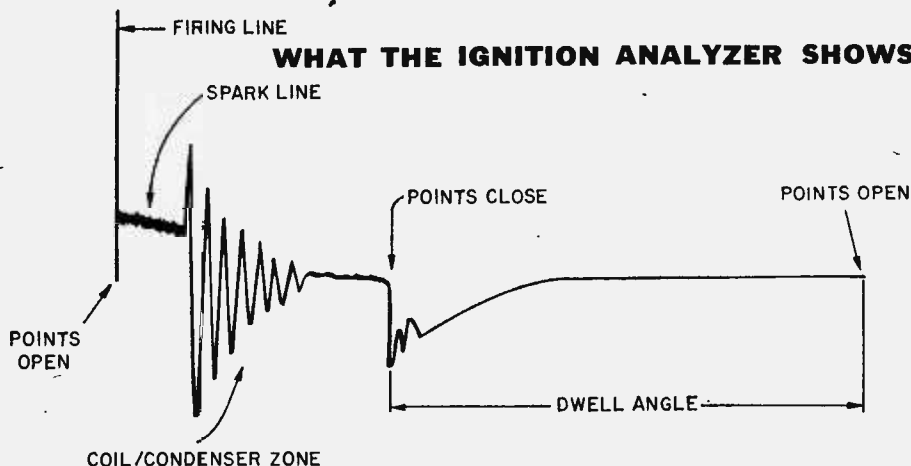

Shown above is a normal secondary ignition pattern, for a standard ignition system, as seen on the CRT screen of an ignition scope. Aberrations in the indicated zones reveal the malfunctions listed below. The pattern produced by a capacitive-discharge ignition system is different, but it too can be used to diagnose ignition problems.

**Firing Line:** Shows voltage needed to break down plug and rotor gaps; these lines should be about the same for all cylinders.

**Spark Line:** Indicates the voltage needed to sustain the spark. Depending on whether this line is too long and low, too short and high, slanted, broken or absent, the following problems can be spotted: shorted or fouled plug; too close or too wide plug gaps; defective resistance wire to spark plug; excessive gap between end of rotor and spark plug wire contact in distributor cap; open plug or wire; defective distributor; resistive plug or wire; defective distributor rotor.

**Coil-Condenser Zone:** Reveals dissipation of energy after the spark plug fires. If these

oscillations are low or absent, look for a defective condenser or coil.

**Points Close Signal:** Breaker points close. If the first oscillation is not the largest, points are not closing properly. Excessive cam wobble is indicated if the degree of variation in this area is greater than specified by the manufacturer.

**Dwell Angle:** Length of this section indicates the time during which the breaker points are closed. Use the CRT screen scales to measure the dwell angle. Random flashes along the dwell line indicate a loose connection in the primary circuit, anywhere between breaker points and distributor and battery.

**Points Open Location:** Breaker points open. Look for a sharp 90-degree rise indicating desired production of high voltage (the "Firing Line" for the next cylinder). Intermittent flashing at this location indicates that points are arcing.

**Jittery Pattern:** If the entire waveform has the jitters, look for a loose or corroded high-tension lead.

and 0-90 degree measurements for 8, 6 and 4 cylinder engines respectively. The separate 0-3.2 VDC and 0-16 VDC scales are used to test battery voltage or battery capacity (make voltage readings while cranking the engine); also for checking voltage drop in cables, to check solenoid operation, and to pinpoint broken or loose connections in the low-voltage point and distributor wiring.

The ammeter, which has a 0-90 ampere range, is used to check the car regulator, generator or alternator system; a special connecting cable, with shunt bar, is provided for this purpose.

The ohmmeter (0-20,000 ohm range) is

used to check the ignition coil, the resistance of spark plug resistance wire, open circuits in fuses and bulbs, and electrical continuity in any wiring circuit.

A "Hi-Lo" diode/leakage scale provides a quick test for condenser leakage. Another sure way to test a suspected condenser is to use the substitute condenser contained in the analyzer. Diodes used in alternators are also tested using the diode/leakage scale. And, finally, there's a spark output indicator light on the front panel; this and the Hi-Lo spark scale are used to compare the relative potencies of sparks in different engine cylinders.

(Continued on page 40)

# Great careers

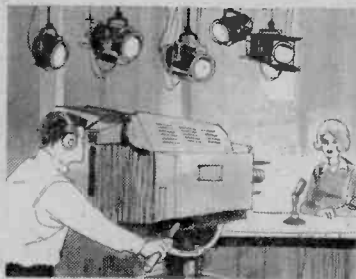

## Join the high-paid electronics technicians who got their start through NTS Home Training.

Your home can become your own private classroom-workshop. NTS sends you everything you need to learn valuable technical skills in electronics. You get easy-to-grasp lessons, comprehensive kit manuals, large fold-out charts, and more. Plus the finest professional equipment available today. It's all included in your tuition, yours to keep.

You'll work with commercially-designed equipment, and school training material. Cash in on the tremendous opportunities in the expanding, exciting world of electronics.

If your field is television, you might decide to join a first-class TV repair center. Or start a shop of your own. Or specialize in Industrial applications of television. Once you master an area of electronics, the direction you take is really up to you. And you'll be able to use the test instruments you built yourself.

It all begins at home, with NTS Project Method Training. Check card or coupon today for free full-color NTS Catalog and complete details. No obligation. No salesman will call.

### NTS COLOR AND B&W TV SERVICING

Build the largest most advanced color TV made! It's a Heath! Over-all solid-state design, 315 sq. in. ultra-rectangular screen, 24 channel detent UHF/VHF power tuning, matrix picture tube, built-in self-servicing features, "Instant On," A.F.T., solid-state VHF tuner, and much more! This is a commercial set, the kind you'll encounter in the field — and not for training purposes only. Also build and keep AM-SW Radio, Solid-State Radio, FET Volt-Ohmmeter, and Electronic Tube Tester. Learn trouble-shooting, stereo multiplex systems, radio, color and B&W TV servicing.

**Solid-state B&W TV**  
74 sq. in. picture (cabinet included)



Learn advanced solid-state circuitry as you build this B&W TV receiver. Course covers the full range of home entertainment electronics.

### NTS AUDIO ELECTRONICS SERVICING

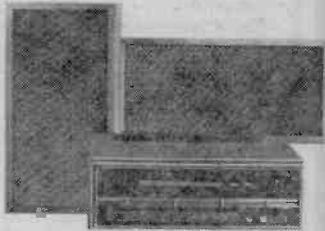

**Solid-state Heath Stereo Receiver and Speakers**

Learn sound theory — how it works in home radio, 4-channel, and more! Set up a spectacular music system. Learn about sound distortion, amplification and control, loud-speaker baffles, problems of system installation, etc. Included is Volt-Ohmmeter, In-Circuit Transistor Tester and solid-state Radio. Prepare yourself for great opportunities in the Home Entertainment Industry!

# begin at home.



New solid-state  
315 sq. in. color TV

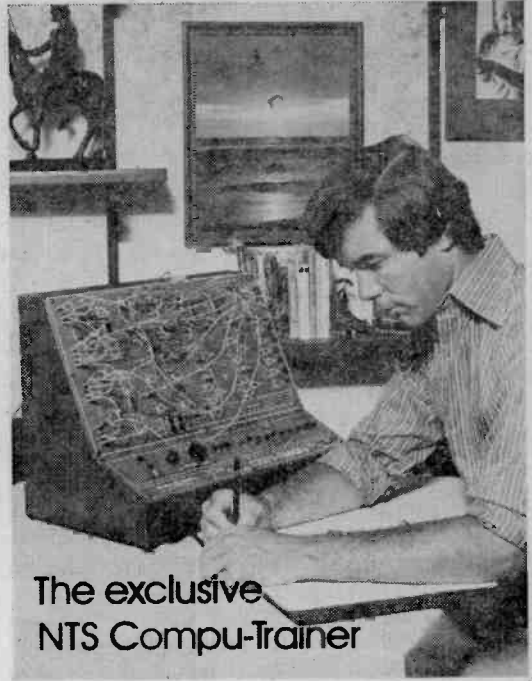

The exclusive  
NTS Compu-Trainer

## NTS COMPUTER ELECTRONICS

Build and operate the exclusive NTS Compu-Trainer! Loaded with integrated circuits, it teaches you the how, what, and why of computers — faster, more thoroughly. You perform all wiring and patch-cording. No shortcuts! No pre-wired circuit boards. Also receive an FET Volt-Ohmmeter and a 5" wide-band Solid State Oscilloscope.

## NTS ELECTRONIC COMMUNICATIONS

Gain the prestige and earning power of owning an FCC First Class Radio Telephone License! Two exciting courses in the fields of transmitting and receiving. Experiment with an amateur phone 6-meter VHF transceiver, NTS exclusive 6-transistor solid-state radio and a fully transistorized volt-ohmmeter.

5-watt AM  
transmitter/  
receiver.



## NTS AUTOMATION/ INDUSTRIAL ELECTRONICS

Systems automation is the future of the industry — and you can play an important role! Enter the age of electronic controls by training on the NTS Electro-Lab — a complete workshop. Also receive a Solid State 5" wide-band professionally rated Oscilloscope. Build five industrial controls to regulate motor speed, temperatures, pressure, liquid level and much more.

5" Solid State  
Oscilloscope

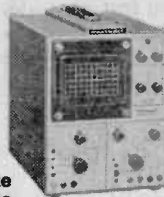

## CLASSROOM TRAINING AT LOS ANGELES

You can take classroom training at Los Angeles in sunny Southern California. NTS occupies a city block with over a million dollars in facilities devoted exclusively to technical training. Check box in coupon.

## APPROVED FOR VETERAN TRAINING

Accredited Member: National Association of Trade and Technical Schools; National Home Study Council.

## NATIONAL TECHNICAL SCHOOLS

World-Wide Training Since 1905  
Resident & Home Study Schools  
4000 S. Figueroa St., Los Angeles, CA 90037

Please rush Free Color Catalog and Sample Lesson, plus information on course checked below. No obligation. No salesman will call.



### National Technical Schools

World-Wide Training Since 1905  
Resident & Home Study Schools  
4000 S. Figueroa St., Los Angeles, CA 90037

- Master Course in Color TV Servicing
- Color TV Servicing (For Advanced Technicians)
- Master Course in B&W TV & Radio Servicing
- Master Course in Electronic Communications
- Practical Radio Servicing
- FCC License Course
- Master Course in Electronics Technology
- Automation & Industrial Electronics
- Computer Electronics
- Basic Electronics
- Audio Electronics Servicing

Dept. 222-033

Name Age

Address

City State Zip

- Check If Interested in Veteran Training under new G.I. bill.
- Check If Interested ONLY in Classroom Training at Los Angeles.

CIRCLE NO. 20 ON PAGE 17 OR 103

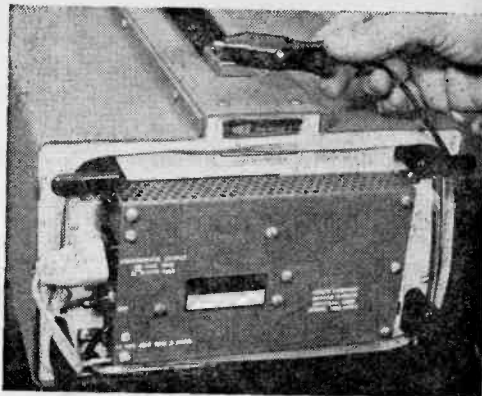
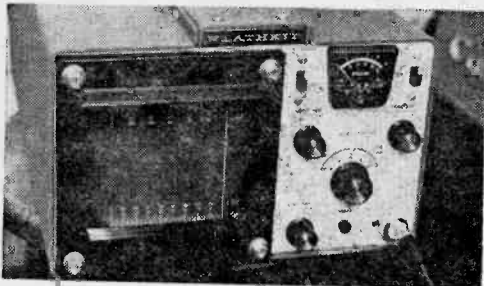
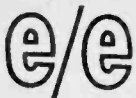

**Heathkit ignition Analyzer CO-1015 displays ignition system waveforms on CRT screen. Optional 12-volt inverter (right) fits on back of analyzer.**

**Lafayette Analyzer.** The Deluxe Solid-State Engine Analyzer (\$49.95) sold by Lafayette is a factory-assembled unit that is quite similar to the Radio Shack analyzer just described. It features a 6-inch d'Arsonval meter with nine easy-to-read scales which are very prominently color-coded with the function selector switch. Every attempt has been made to keep the number of controls at a minimum. Aside from the function selector, you find only an ohms-adjust knob and a toggle switch that selects either the general test input or the amperes input jack.

The two voltage scales handle three ranges—0-3.2, 0-16 and 0-32 volts. The DC ammeter has a -5 to +90 range, and the ohmmeter has a 0-100,000 ohms range. These three functions have broader ranges than those found on the Radio Shack analyzer. However, the dwell and rpm ranges are comparable, and there's a substitute test condenser, a capacitor and coil testing scale, but no spark output indicator. Diodes are tested by measuring the resistance in two directions, as with the Radio Shack analyzer, but a separate diode Hi-Lo scale is not provided. There's no need to preset the meter pointer before each rpm measurement.

The Lafayette analyzer is powered by a single size D cell located in a rear compartment which is also used to store cables and reference material.

The instrument can be used to test all 4, 6 and 8 cylinder engines. Test readings on an 8-cylinder engine, using the Lafayette and Radio Shack analyzers, yielded virtually identical results. Both units are equally simple to connect to the engine. For example, to measure dwell angle or rpm, just fasten one alligator clip to ground and the other to

the primary terminal of the coil, set the function selector switch to the proper position, and start the car engine. A very minor shortcoming of the Lafayette analyzer is the relatively modest engine specifications booklet provided with the instrument. But this information is easy to acquire for any car; in fact, most of the specs you need are on a label somewhere near your radiator or engine.

**Heathkit Ignition Scope.** Most weekend mechanics can get along very nicely with the types of tune-up instruments already described. But if you ever see an ignition oscilloscope in operation, you are going to want one—for sure. The only problem is that a factory-wired, professional scope costs upward from \$250, a bit too much for most amateur mechanics. But if you can swing a relatively modest outlay of \$129.95, you can have an excellent scope by assembling Heathkit's CO-1015 Solid State Ignition Analyzer. Thanks to the excellent assembly instructions, and provision of a special wiring harness, the kit goes together easily. And when you get through, you have a really spiffy-looking instrument that's almost too nice to take into a greasy garage. The scope is powered by 110-volt AC current, but for an extra \$24.95 you can have an optional power pack (COA-1015-1) that permits operation of the scope off the car battery for road tests; just plug into your car cigar lighter, and you're in business. If you build this scope, you won't throw your other test equipment out of the window; but the scope is the *first* instrument you will reach for when an ignition check is in order.

This solid-state scope, in a housing mea-  
(Continued on page 99)

e/e checks out  
Radio Shack's...

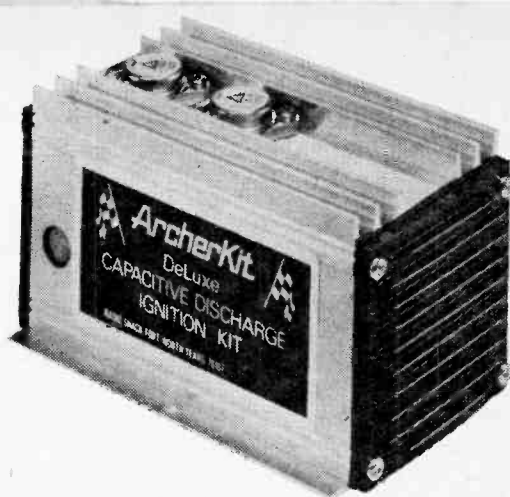

## ArcherKit Capacitive Discharge Ignition System

A \$39.95 gadget we connected to a Chrysler,  
a Rambler, a VW and an International truck.  
Turned 'em all into snappy starters!

OF ALL THE GIMMICKS AND GADGETS that are supposed to increase automobile performance and gasoline economy, only one, the capacitive discharge ignition—or C-D as it is commonly termed—really works. And of all the various C-D systems on the market, only the system used in Radio Shack's 28-3203 C-D Ignition System Kit is really advantageous.

As you most likely know, the high voltage that fires the spark plugs is generated by a high tension (ignition) coil. The top

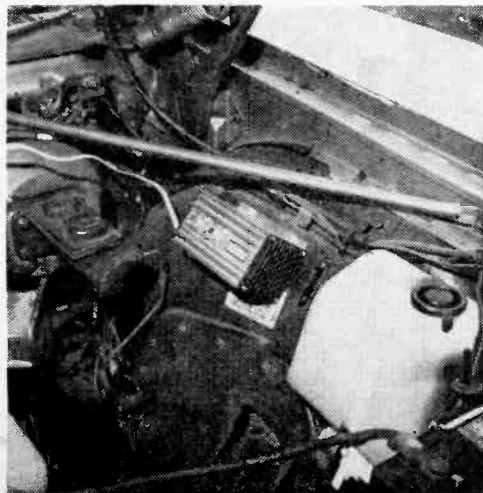

end of the coil's primary section connects to the 12-volt car battery. The bottom end connects to ground through the distributor points. When the points are closed the coil is electromagnetically "charged" by battery current. At the instant the points open, the magnetic field around the coil collapses, inducing a high voltage in the coil's secondary, which fires a spark plug.

As long as the points remain closed for a reasonable length of time, the coil gets fully charged, and maximum output voltage is developed for the plugs. But as the engine speed increases, the time the points remain closed is drastically shortened, reducing the amount of charge in the coil primary. Hence the higher the engine speed, the lower the high voltage delivered to the spark plugs; yet it is at the higher speeds that you need maximum voltage for engine power-surges as you attempt to accelerate or pass. (The time the points are closed is measured in degrees of rotation and is expressed as "dwell angle".)

**New System Performance.** Unlike the Nestled between the Power Brake and Window Washer reservoirs, this ArcherKit CD Ignition system easily installs in a few minutes with ordinary tools. And it is simple enough to be a "first kit."  
For more information, circle No. 68 on page 17

## e/e CD IGNITION KIT

typical ignition system, the C-D system delivers essentially the same high voltage to the spark plugs regardless of engine speed, and high speed engine performance is maintained at optimum value even as you floor the accelerator; there's no engine dropout as you attempt to pass. Another advantage of the C-D ignition system is a much hotter spark that sharply improves frigid-weather starts. Rare is the car that won't start better with a C-D ignition.

Instead of points to close and open the ignition coil primary circuit, the plugs are fired by discharging a high voltage capacitor into the coil. The ignition points only serve to switch the small current needed to fire an SCR (silicon controlled rectifier) that causes the capacitor to discharge. A side benefit results because the points control only a small current, so they will usually last from 25,000 to 50,000 miles. Actually, the contacts never burn out; generally, the rubbing block attached to the points wears out long before the points.

**Inside Info.** Inside the C-D unit there is a high frequency transistor oscillator that develops from 200 to 300 VDC. This voltage is applied to a capacitor which is in series with an SCR and the ignition coil. When the SCR fires, the capacitor discharges into the coil, which then magnetically transforms the hundreds of volts to many thousands of volts. That's the whole bit.

Since the high voltage supply can recharge the capacitor to essentially full voltage regardless of engine speed, the full high voltage is available for the spark plugs at all engine speeds.

Just about every C-D ignition system delivers essentially equal performance. The difference between the Radio Shack 28-3203 and some other C-D units is two-fold: first, the Radio Shack kit has an integral by-pass switch that restores the original

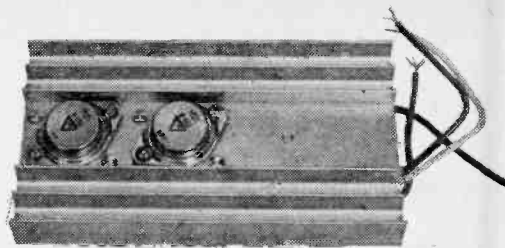

Power transistors are supplied mounted to heat sink. Don't attempt to "run it cool" by moving unit into passenger compartment. It's a headache and SCR burnout can result from an improper unit-to-chassis heatsink.

points wiring; secondly, the Radio Shack unit is supplied with pre-wired connector blocks for the ignition coil—you don't have to cut or splice ignition wires. Total installation time including mounting the unit in the car is about 10 minutes.

The importance of the by-pass switch cannot be understated. Many tune-up meters and tachometers connect from the distributor points to ground, or across the ignition coil. They cannot be used with the usual C-D system (they might even be damaged). It is therefore necessary to rewire the standard ignition when doing a tune-up on the car; then the C-D must be rewired when the tune-up is completed. With the Radio Shack unit, however, you simply press a switch to restore the original points connection, make your measurements and adjustments, and then release the switch for the C-D circuit. Also, the Radio Shack 28-3203 has a special internal transistor trigger that allows *full-time* connection of a tachometer, something you can't usually do with a standard C-D system.

The Radio Shack 28-3203 C-D system is available only in kit form for \$39.95. As shown in the photographs it's a relatively  
(Continued on page 104)

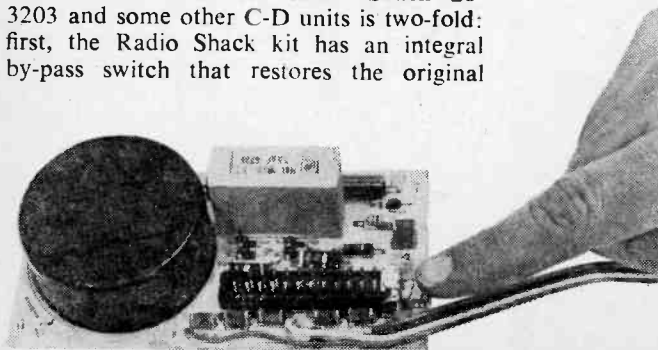

Switch from standard to CD ignition at the push of a button. This dual ignition capability boosts reliability, provides means to "A-B" systems, thus demonstrating improvement with CD systems. As points open, SCR turns on, cap discharges via SCR into ignition coil. That boosts voltage to 20 kV or more. Cap is rectangular unit, center of board, round transformer is sealed for all-weather use.



## BRINGING BACK THE ANCIENT RADIO

by Harry Stavert

Here's how to restore an Atwater Kent receiver to new condition—and make it work, too!

**W**ith nostalgia being the in thing for these times, how would you like to rekindle some of the adventure of the 1920's when everyone was a DX hound? Those were the early days of radio when your grandfather didn't care a hoot about hi-fidelity. The big thing in his life was to twiddle those many dials (the more the better) and edge a little closer to the horn speaker and try to catch those faint call letters of a distant radio station.

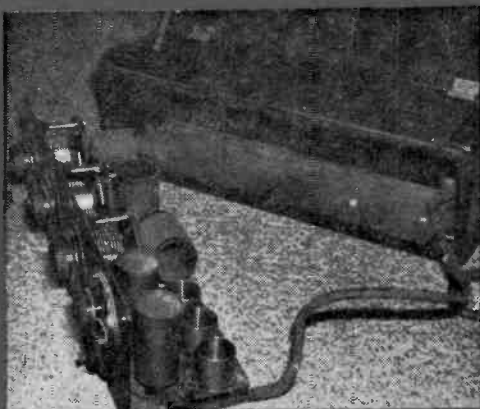
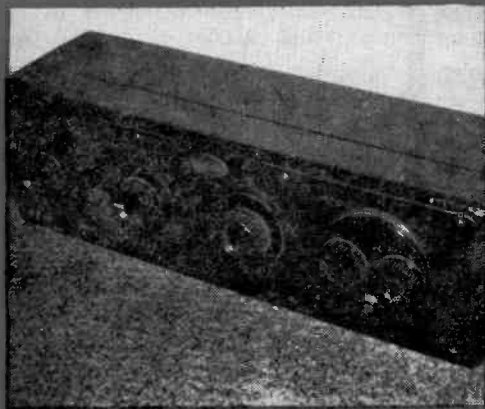

What good is good luck in finding an old, worn-out Atwater Kent receiver (left) if you don't know what to do with it. First, inspect it carefully outside and inside (right) before you buy it. Make sure all the parts are there!

# e/e ANCIENT RADIO

Restore an antique radio and you will have a conversation piece that won't quit. Don't think for a minute that restoration is difficult for these vintage radios were the height of simplicity. Take a quick look at the typical circuit diagram and you will agree, for it is an ordinary TRF (tuned radio frequency) with inductively coupled RF amplifiers, a demodulator or detector, followed by transformer coupled audio frequency amplifiers. This type of circuit was called a *neutrodyne* and was representative of most early broadcast band receivers. The superhet had made its appearance in 1923 but it was too expensive, and too difficult to tune (at that time), for the average homeowner so he was content with his neutrodyne.

**Start the Hunt.** Part of the fun of restoration is the search for the radio set. Do a little nosing around junk shops or flea markets or talk to a radio ham from the older crowd who might have one or two tucked away. Some collectors I know have found hundreds of sets this way. When you make your find don't expect your set to look too shipshape. Remember it is at least 45 years old and probably has been kicking around in someone's attic for most of that time. Be on the lookout for components obviously missing. If you see a lot of bare wires going nowhere then that's a dead giveaway that someone already rifled some of the parts.

Take a pocket ohmmeter along and check the tubes for filament continuity. You'll find that they are likely to be 201-A's, and the

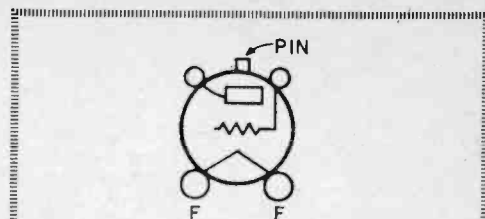
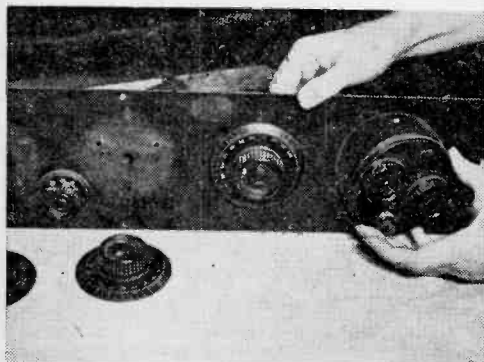

(VIEWED FROM BOTTOM)

FILAMENT VOLTS	5.0 VOLTS DC
FILAMENT CURRENT	0.25A
MAX PLATE VOLTS	135 VOLTS DC
PLATE CURRENT	3.0mA
AMPLIFICATION FACTOR	8.0
PLATE RESISTANCE	10000Ω
POWER OUTPUT	250mW

**The 201-A vacuum tube did multiple duty in the Atwater Kent receivers. Replacements may be hard to find so handle those you have carefully.**

two fat prongs are the filament. If you read about 2 to 10 ohms you're in business. Usually, with a good filament, you'll find that the 201-A's will work okay. Strangely enough the big tube companies still list 201-A's and may be purchased from some of the smaller mail order firms. Send a few postcards to them requesting tube lists.

**Technique is Important.** Restoring an antique radio involves the same treatment as for an antique car. Both should look like they just came out of the factory. This is all done very simply by refurbishing all the component parts. The one described here is an Atwater Kent Model 20, but the techniques described can apply to any of this vintage. This model adorned many living rooms in the mid-1920's and sported the



**Restoration is easy and a simple process that any amateur can tackle. Begin by removing chassis from cabinet. Next, remove knobs and front panel plates. Then, tear down rear assemblies. Save the screws.**



# TYPICAL ROARING TWENTY ATWATER KENT RADIO RECEIVER

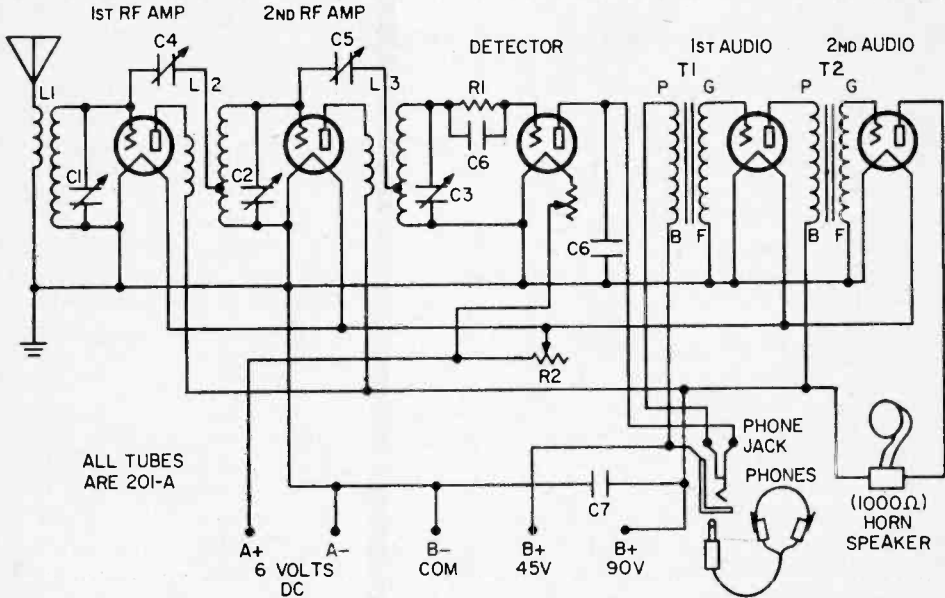

The Atwater Kent Model 20 broadcast band receiver uses five vacuum tubes powered by dry and wet cell batteries. Capacitors C1, C2, and C3 tune the front end much in the manner of later day TRF's except that each capacitor was tuned independently.

three large tuning dials which was typical of the front panel appearance of most sets in this period. (The techniques which allowed the use of a ganged tuning capacitor was yet unknown.)

You are more likely to find one of the Atwater Kent models because thousands were built during that era. How much should you pay? That is almost impossible to an-

swer. As a guide, the Model 20 should go for \$10 to \$50, depending on condition. Actually, if you take your wife along most of the cost will go for the little vases and trinkets she will find. In getting started, make a hand sketch of the parts arrangement and where all the wires go.

If you were lucky you might acquire a set with shiny square bus bar wire all neatly

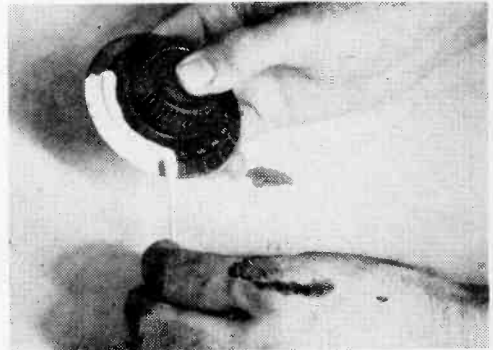
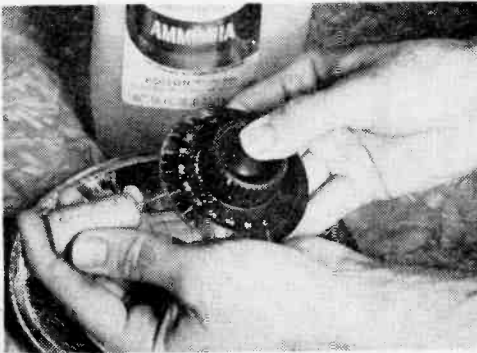

Restore dials by first cleaning them thoroughly. Sewing needle stuck in a wine-cork handle scrapes old lacquer and dirt from dial scale. After cleaning, cover indentations with white lacquer and turn page.

## e/e ANCIENT RADIO

bent and shaped to make everything look parallel. Even in the most elaborate sets there are not many wires and you will find the sketching easy to do. Most models were hand-crafted and parts were held in place using 6-32 machine screws. This makes it easy to accomplish the next step which is to take the whole set apart. Mix up a batch of 1 part sudsy ammonia and 4 parts water and give all the parts a bath except the dials. Don't let the coils stay in too long for it will dissolve the shellac and you will then have a room full of wire. Rinse in clear water and dry by playing a heat lamp over them. Be careful—do not overheat. The tube sockets can be disassembled and the brass shell and prongs polished with ordinary brass polish.

**Maintenance.** After the parts have been cleaned up, how do you check them? The whole set is predominately RF coils and audio transformers, so a simple resistance check of windings will usually show if anything needs attention. The circuit diagram in this story shows the approximate value in DC ohms. If you find an open RF coil, it is usually the wire terminations on the soldering lugs which can be easily repaired. If you find an open interstage audio transformer it takes a little more work unless it has an obvious broken lead. Allied Electronics has a modern replacement No. 705-0805 that works very nicely and sells for under four dollars.

Of course you can't plop a modern looking transformer among all the antique parts. A mere suggestion of this would cause an

antique radio buff to suffer a cardiac arrest. Fortunately most all early audio transformers were enclosed in a metal can or case and are a thing of beauty with a fancy nameplate, binding posts, etc. Remove the lamination assembly from the case. If you have an Atwater-Kent this might mean that the laminations are potted so this requires gentle heating of the can while tugging on the wires. Soon the whole works will pull out encased in a black compound. Drop the new one in and seal it off with paraffin. Even the most practiced eye will not be able to tell it from the original.

**Now for the Dials.** The biggest impression one gets from restored antique radios is big brightly shiny new looking dials. And it is not hard to get them looking that way. However, test the dials to see if they are made of restorable bakelite. This is done by rubbing a paper towel moistened with lacquer thinner on the back of the dials. If you get a very black deposit on the towel this means it is a so-called composition type and is not restorable by ordinary means. However, this is rare. Most sets have bakelite dials and yours will probably come with this type.

Next, pick up a small can of white lacquer from the paint store. Be sure it is snow-white by first painting some on a board. Now soak the dials in the sudsy ammonia for a few minutes to help loosen the old white lacquer imbedded in the dials' numbers and graduations, all of which has to be removed. Borrow a *Q-tip* from the baby's nursery and paint over the dial's indentations as shown in the photo. After the drying period, the next trick is to remove all the excess white lacquer and leave just that in the numbers and graduations. The photo

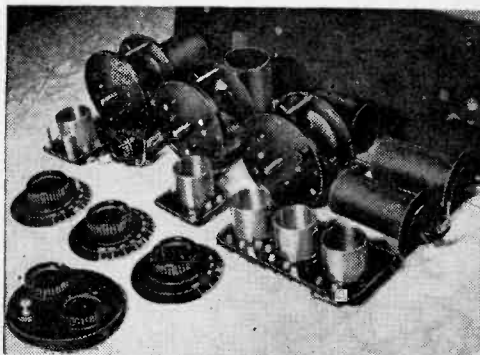

Moisten a paper towel in lacquer thinner—not too wet—and gently rub across dial (left) to remove excess white lacquer. After all parts are cleaned as described in the text, your receiver should stack up like ours (right).

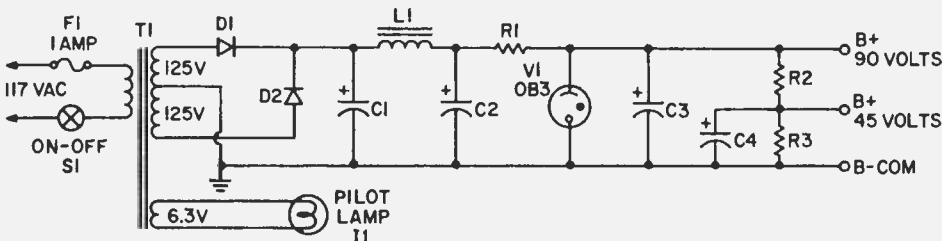

**PARTS LIST FOR B+ (PLATE)  
POWER SUPPLY FOR ANTIQUE RADIOS**

- C1, C2, C3—30  $\mu$ F electrolytic capacitor, 250 VDC
- C4—1.0  $\mu$ F electrolytic capacitor, 150 VDC
- D1, D2—Silicon rectifier, 100 mA, 500 PIV or better
- I1—Pilot lamp, 6.3 V unit (G.E. #47, etc.)
- L1—Filter choke, 1 Henry, 30 mA, 100-ohms DC approx. (use secondary filament winding of

- inexpensive 117/6.3 V transformer)
- R1—2,700-ohm, 7 W wire-wound resistor
- R2, R3—10,000-ohm, 7W wire-wound resistor
- T1—Power transformer: 117 V pri.; 250 V CT at 25 mA, 6.3 V at 1.0 A sec. (Stancor PS8416 or equiv.)
- VI—OB3 voltage regulator tube

**Feel free to use overrated transformer and electrolytic capacitors.**

shows you how and while removing the lacquer you might notice that ordinary paper towels are sufficiently abrasive to polish the bakelite. Actually, stiff felt blocks were used, soaked with lacquer thinner, in the old days.

Some experimenters are so tickled with the results of the dial's restoration, that they are content to stop here! But, you can spray a lasting finish by using high gloss clear polyurethane varnish available in spray cans everywhere. Actually this spray finish will also immensely improve the appearance of all bakelite parts like the tube socket bases, etc. When you have them disassembled try hitting one with the spray and you'll be convinced. Remember, we are

trying to make everything sparkle.

**What's Up Front that Counts.** The front panel needs attention next. If it is metal it can be repainted with the many antique type finishes available. If it is bakelite, clean it first using a gentle spray of ammoniated window cleaner. Then rub it down with a paper towel moistened in lacquer thinner. If it is engraved, restore the markings the same way as for the dials, except don't spray with the varnish.

**Power.** If your radio was built before 1928, it doesn't have a built-in power supply. It is now necessary to sift through the junk box and dig up enough parts for a replacement for the big B batteries that used to provide the plate voltage. The circuit is

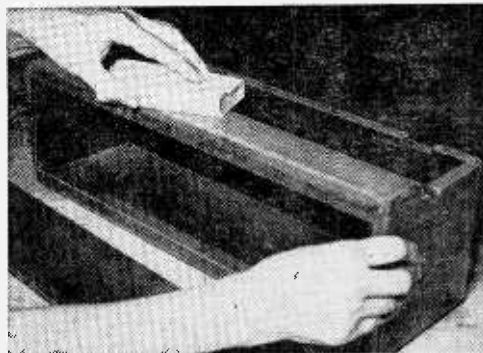
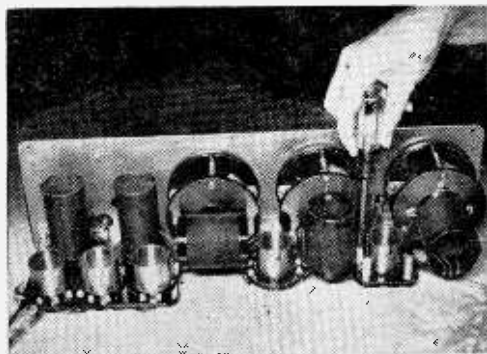

**Re-assemble the radio (left) carefully. Don't worry about lost screws—only 6-32 brass jobs were used in those days. Refinish the cabinet following advice of your paint dealer. Sand first (right) for smooth finish. Turn page.**

## e/e ANCIENT RADIO

shown.

We did not provide a diagram for a filament supply which was a 6-volt car battery back in the old days. A normal compliment of five 201-A tubes would draw 1.25 amps which takes a pretty healthy (and expensive) transistor regulator. Most of the listening to your radio will be to demonstrate to friends and a 6-volt lantern battery suffices very well.

Your radio is now ready to go. Main tuning is accomplished by tracking C1, C2,

and C3. Capacitors C4 and C5 (condensers to the antique radio buff) are for neutralizing out the squeals and squacks prevalent in the RF amplifiers. Your Atwater Kent might not have these. They are adjusted by tuning in a strong station, then killing the filament voltage to the preceding tube and adjusting for minimum signal.

So have fun with your restored antique radio. You'll need some kind of an antenna (preferably a long wire) and a ground connection. If you did a good job on the restoration you can re-create some of the high adventure enjoyed by granddad and tune in stations from coast to coast. ■

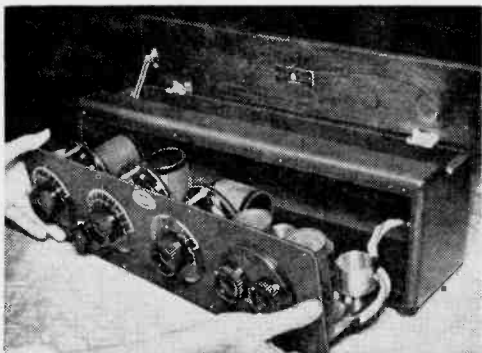

Carefully install the receiver chassis and front panel into the cabinet (left) Photo at right shows the completed Atwater Kent in restored condition and ready to play. Note B+ power supply and filament battery behind unit.

### ● VW Mobile Laboratory

A \$400,000 mobile laboratory built for Volkswagen to measure automobile exhaust emissions is on a coast-to-coast tour. First stop was at Port Newark, NJ, where it will spot check clean air controls on new VW's at their port of entry. The two-part lab is made up of a custom-built semi-trailer unit and a 33-foot bus loaded with electronic measuring instrumentation.

The mobile testing unit will be used to measure exhaust emissions of new and used Volkswagens at various authorized Volkswagen dealerships and will check new cars at ports of entry. Emissions for Volkswagens operated at numerous altitudes and in virtually every kind of climate will be tested.

The 44-foot-long trailer features pull-out sides that allow it to expand to a 16-foot width. It serves as a controlled-temperature "test

track". The test car goes into the trailer where it is put on a chassis dynamometer to be driven to a prescribed schedule of speeds and times.

Emissions from the exhaust are transferred to the bus—either directly through a metal "umbilical" tube or by means of a collecting bag. Inside the bus "mission control", a bank of complex measuring instruments analyzes the exhaust mixture. A computer, also in the bus, instantly calculates the analysis, printing out the emissions of hydrocarbons, nitrogen oxides and carbon monoxide in terms of grams per mile.

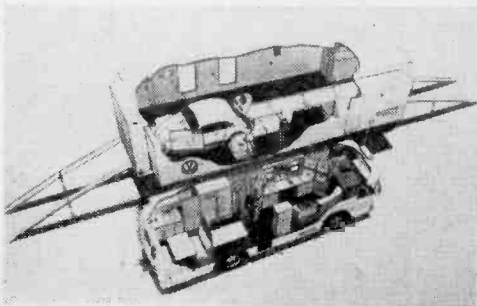

Volkswagen's \$400,000 mobile automobile exhaust emission laboratory is composed of a semi-trailer testing unit (top) and a 33-foot "Mission Control" bus.

e/e checks out  
Convertible  
2/4-Channel sound...



# Fisher's Studio-Standard 504 Receiver

Because of the dubious opinion by many "experts" as to the value of surround-sound, many stereo-philes cannot decide between upgrading their present stereo equipment or taking the full jump into 4-channel. Of course, you must bear in mind that many of these same "experts" spent years hassling over the value of a mono to stereo conversion, and many misguided listeners missed out on the overwhelming stereo experience while waiting for their new monophonic equipment to depreciate in value.

But there's no need for you to be caught in the same bind. Even if you're turned off by the endless arguments over which matrix system is best, or whether matrix or discrete CD-4 is more natural, with a Fisher 504 you can upgrade to a top-quality stereo receiver that is ready for 4-channel at no extra cost. When the time comes that you see for yourself that surround-sound is to stereo as stereo is to mono, you'll be able to make the conversion by simply flipping a switch on the 504's front panel. (Of course, you will need two more speakers for the rear channels.)

**What It Is.** The Fisher 504 is basically an AM/FM-stereo receiver with discrete power amplifiers; one pair making up the front stereo channels, the remaining pair providing the rear output. While this sounds like just another 4-channel receiver, there is one major difference. The 504 has automatic internal circuitry that combines the available rear channel power output with that of the front; the result being a high-power basic stereo amplifier.

Since each channel of the Fisher 504 is rated for 32 watts rms into 8 ohms (40 watts into 4 ohms), the total available power output is 4 x 32 or 128 watts. Now this does not mean that 128 watts are avail-

able for stereo operation. Because of various amplifier characteristics, the total power output, when the rear power is combined with the front, for standard stereo is a whopping 2 x 90 watts or 180 watts rms into 8 ohms across the full bandwidth (not just at 1000 Hz). When the time comes and you're ready to move into surround-sound, just flipping a switch will put 64 watts total into the front channels and another 64 watts into the rear channels. Because of psycho-acoustic effects, 64 watts front plus 64 watts rear sound a lot louder than 128 watts of stereo. Our lab turned up even better performance than Fisher's ratings (105.6 Watts per channel into 8 ohms, Stereo mode); see bottom of next page.

For those who want to step up directly to surround sound, the 504 also features an SQ decoder and an input selector labeled QUADRADISC—which is nothing more than an extra aux input for a CD-4 decoder. And to accommodate possible future 4-channel discrete FM broadcasts, the 504 also includes an FM-detector output and an accessory input for the FM decoder. (The FM-detector output can also be used for your own SCA multiplex background music adapter)

**One Knob Balance.** The Fisher 504 also includes two rather unusual features. The first is a joystick that replaces the usual balance control(s) found on stereo and 4-channel receivers and amplifiers. The front panel-mounted joystick instantly selects the balance desired by the user, the position of the joystick indicating that overall spatial perspective. For example, push the joystick center-front and the power output is balanced between the front speakers. Position the joystick to center-rear and the power output shifts between the two rear speakers. Center the joystick and all channels operate

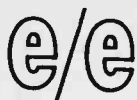

## FISHER 504 RECEIVER

at equal gain. Naturally, intermediate joystick positions can be used for optimum balance.

The second unusual feature is the four signal-powered lamps arranged in a square that Fisher has termed an *audio display*. These lamps indicate the power distribution of the four output amplifiers. If all glow equally, the user has established overall amplifier balance. If one or more lamps are of greater intensity than the others, the predominant power output (balance) is towards those matching speaker locations.

The AM/FM-stereo receiver section features a stereo beacon, center-channel FM and signal-strength AM/FM tuning meters and an FM mute. A two-channel (stereo) input is provided for a magnetic phono. Discrete 4-channel inputs are provided for aux 1, aux 2, accessory and tape. Outputs are provided for 4-channel tape, main and remote front and rear speakers and front and rear phones.

Graphic-type controls are provided for *master volume*, ganged *front bass*, ganged *front treble*, ganged *midrange*, ganged *rear bass* and ganged *rear treble*. Standard controls are provided for speaker selection, stereo/4-ch/tape monitor and input selection. There are push switches for power, audio attenuator, FM mute, SQ decoder, FM noise filter and audio display.

All *matrix* records can be processed through the internal basic SQ decoder. While optimum results are obtained from

SQ DECODER  
ON-OFF

JOYSTICK FOR  
SPEAKER BALANCE

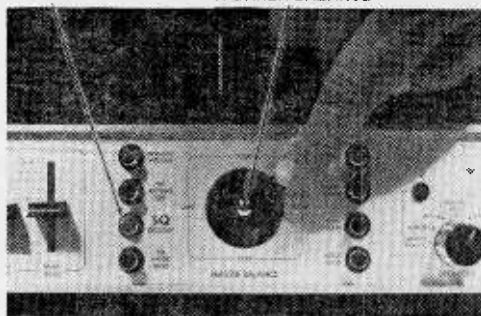

**Joystick-type speaker balance control completely eliminates rotary and slider-type tone controls. You can pan a mono source around the room, balance a stereo signal, and center 4-channel programs in the center of your listening area. Matrix decoder for SQ records is built-in.**

SQ records, the decoder provides pleasant spatial perspective for any type of matrix encoding. Typical of SQ decoders, the ambient sounds concealed within the grooves of a standard stereo record or tape will also be extracted for the rear output, the rear output being the so-called "synthesized" or "enhanced" sound.

**Summing Up.** The Fisher 504 is particularly attractive for the listener who can't decide between upgrading his stereo, or plunging into surround-sound. With the 504 he gets top stereo performance now, and surround-sound when desired by just connecting two more speakers and flipping a switch. Most of all, the Fisher 504 will not be made obsolete by some new overnight development in 4-channel sound. ■

### PERFORMANCE DATA FROM OUR TEST LAB

**FM Tuner:** The sensitivity measured 1.4  $\mu$ V IHF with full limiting at 3.5  $\mu$ V. The high-fidelity sensitivity (60 dB quieting) was 8  $\mu$ V. Full mute release was obtained with 3.5  $\mu$ V. At standard test level the frequency response measured +0.2/-1.2 dB from 20 to 15,000 Hz at a distortion of 0.29% THD with a 69.5 dB signal-to-noise ratio. Stereo separation was 36 dB.

**AM Tuner:** Like wow! Excellent noise-free reception Sensitivity well above average. The dynamic noise limiter is very effective on weak stations and completely suppresses interstation noise.

**Amplifier:** In the stereo mode with the rear amplifier power added to that of the front, the power output per channel at the clipping level with both channels driven measured 79.2 watts rms into 4 ohms, 124.4 watts into 8 ohms and 82.8 watts into 16 ohms. The maximum power output per channel at 20 Hz into 8 ohms was 105.6 watts. The 20-20,000 Hz response at 105.6 watts/8 ohms measured +0.2/-1 dB at a distortion no higher than 0.74% THD at any frequency.

In the 4-channel mode with both channels of a stereo pair (front or rear) driven, the power output per channel at the clipping level measured 72.3 watts rms into 4 ohms, 47 watts into 8 ohms and 27.6 watts into 16 ohms. The maximum power output at 20 Hz into 8 ohms was 40.5 watts. The frequency response at 40.5 watts/8 ohms measured +0.2/-1 dB from 20 to 20,000 Hz at a distortion no higher than 0.22% THD at any frequency.



by Kathi Martin KA1O614

# KATHI'S CB CAROUSEL

□ Just because I've been so carried away by all the new high-performance specialized CB gear, don't think I've forgotten about all you who *don't* work in rescue teams or have need for long-range SSB transmissions. As many who recently wrote have said, there is still a need for an inexpensive, hot-performance rig with capability for operation on just a few channels, and the emphasis in this instance is on *inexpensive*.

Well I've done your shopping for you and have come up with an inexpensive rig that lets you start off small, but one you can easily expand to full 23 channel coverage if the need arises. This month's unit is the Lafayette HB-23A, priced at a rock-bottom \$99.95. Hey, don't tune out! I know the HB-23A is a 23 channel transceiver, but just because the dial shows 23 channel coverage doesn't mean you have to pay for it now.

**One Means Two.** The HB-23A is a full 23 channel transceiver, but its \$99.95 price tag includes crystals for only three chan-

nels—emergency 9, and channels 13 and 19. Since crystals represent a healthy part of transceiver cost, you save a bundle on the crystals you don't need for the present—that's how the price of this hot-performance rig is kept under a hundred clams. And that's the only difference between the HB-23A and full channel coverage. All the other components are there, including extra crystal sockets. If you find you need coverage on other channels, you simply add the low cost crystals as you need them, and if you need full 23 coverage, you buy just 10 crystals, because the HB-23A synthesizer gives you receive and transmit performance. For example, only one receive/transmit crystal provides operation on channels 1 and 5, or 10 and 14, or 20 and 23, etc. In short, you start out at budget prices paying only for the facilities you presently need.

**Features 'n Form.** The HB-23A is a mobile unit powered by the car battery; an optional AC pedestal (base) is available for \$23.50. A portable power pack is also

**Just the thing for today's tight budgets. A hot full-performance mobile rig that saves on crystal costs now, lets you add full 23 channel coverage later. And today's HB-23A gives you extra protection with its built-in burglar alarm. For more info, circle No. 64 on page 17 or 103**

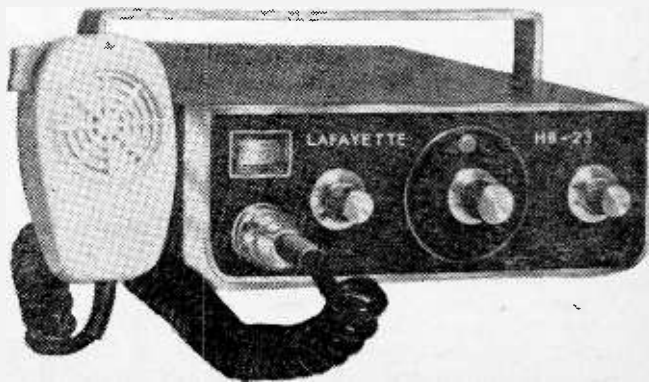

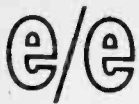

## KATHI'S CAROUSEL

optional. An unusual feature is a built in burglar alarm triggered by the gimbal mounting screws. Two wires coming from the back of the transceiver are connected to the auto horn circuit. Inside the transceiver these wires are connected to a leaf switch that is normally held open by one gimbal mounting bracket screw. If someone attempts to steal the transceiver, he must loosen the gimbal screw which, in turn, causes the leaf switch to close and sound the horn.

The HB-23A is housed in a 6-in. W x 2-in. H x 8-in. D cabinet. Front panel controls are provided for *volume*, *squelch* and *channel/PA* selection. A microphone socket and a miniature tuning/power output meter are also mounted on the front panel, while the rear apron contains the antenna jack, PA and external speaker outputs, power receptacle and burglar alarm wires.

The receiver section features double conversion and a mechanical filter in the second IF amplifier. Performance levels were typical of high-performance equipment. Our lab tests turned up a sensitivity of 1  $\mu$ V for a 10 dB S+N/N ratio, while selectivity checked in with a sharp 58 dB adjacent channel rejection. Image rejection measured 46 dB; the AGC action was 6 dB, meaning, of course, your ears won't be shattered if a local opens up on your channel.

The transmitter is more or less conven-

tional; it pumped 3 watts into a 50 ohm load. Transmitter modulation is limited to 100 percent, and the microphone sensitivity for 100 percent modulation slid in at -26 dB, the average value for an average voice level.

**Upgrading The HB-23A.** Upgrading the HB-23A to full-23 coverage, or just adding

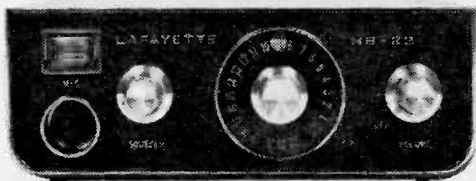

Although the HB-23 has a full 23 channel selector, it is supplied with crystals for only 3 channels; you add extra crystals as needed. So you save now, operate 23 later.

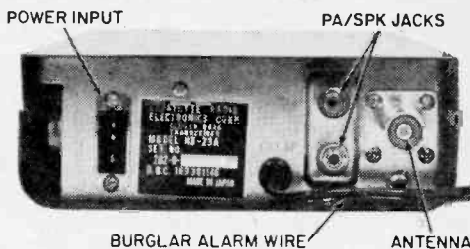

An optional accessory gives you 5-watt outdoor mobility—the HB-507 battery pack; it uses either Alkaline or Ni-Cad "C" cells. Alarm wire connects to car horn wiring and sounds horn if transceiver is ever removed

a channel or two, is a snap. Simply remove the four screws that hold the bottom cover in position and lift the cover from the case to expose the crystal sockets. All sockets are out in the clear, and even ten thumbs would have no difficulty installing extra crystals. The services of a technician are not required when adding crystals because there's no circuit tuning. Simply plug in the crystals and the rig is ready to go.

**Summing Up.** If you're looking for a way to save a buck on your CB gear, but you don't want to compromise performance for price, then the HB-23A is right up your alley; for the savings are made in channel coverage, not in performance. Best of all, if you need more channels you don't have to buy a new transceiver, nor must you purchase channel coverage you don't need. Upgrading the HB-23A costs you just the price of a crystal, \$3.45, and you get two channels for the price of one.

For additional information circle No. 64 on the Reader Service Page. ■

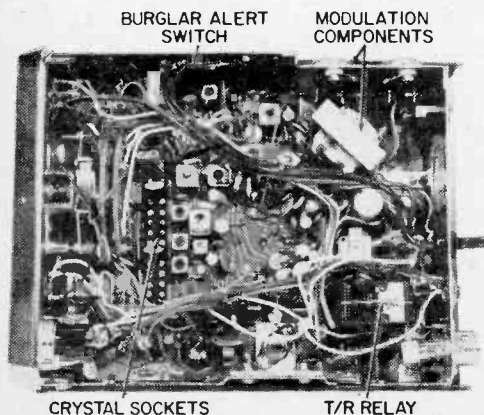

To add frequency coverage, you simply plug the needed crystals. One crystal provides transmit and receive operation on two more channels. Only ten additional crystals are required for all-channel T/R CB operation.



# The Eyes Have It- or Do They?

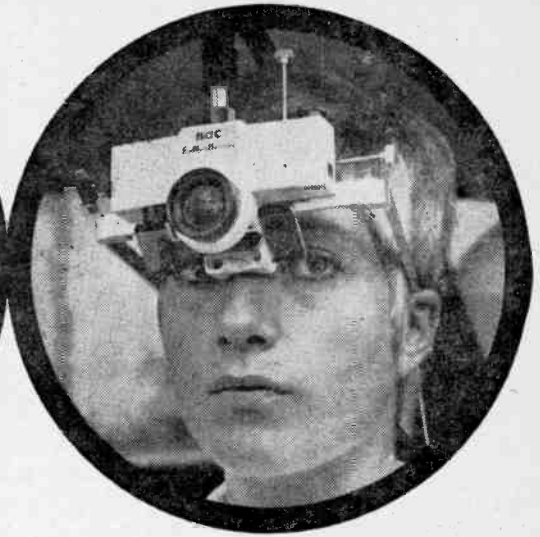

□ You see what you do not think you see. Or, you do not see what you think you see. Accidents of different kinds which happen to people, have brought these facts out and the question therefore is, what do you really see and what do you think you see but do not really see?

A number of instruments have been designed to find answers to the problems. A new American designed, Japanese manufactured instrument called the Eye Mark Recorder NAC-III is now available and used especially in traffic research.

Car drivers are known to absorb up to 6 impressions per second. Superficially seen, this looks like a lot. Yet, accidents happen and the defense often is that this or that wasn't seen. Yet it was there, but the reason why the accident happened nevertheless is that this reason was perhaps visual impression

No. 7, 8 or higher. The Eye Mark Recorder helps in the field of visual research. It records exactly what a person wearing it, really sees. The instrument can be connected to a film camera or television unit and one can thus see later what one didn't see sooner.

Referring to the photo of the VW car. The driver in the car following the VW obviously had to watch that VW and what that driver intended to do. The latter wanted to go left and signaled. However, the Eye Mark Recorder shows that the eyes of the driver were not looking at the signal lamp all of the time. The eyes were not even fixed on the traffic per se, but on a spot marked with a white circle. Just above this white circle is precisely the spot which the driver saw and is one of the up to 6 visual

*(Continued on page 100)*



**How we observe events. These photos, taken from a video recording, show a shift in actual point of view of driver, although little change in panoramic view takes place.**

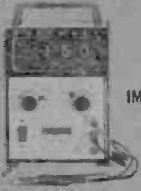

IM-1202



AA2010



GO-39



CP-1460



GR-271



AD-2022



Kit GR-110



GC 1005



IB-1100



CM-1050

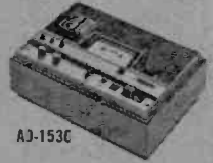

A3-153C



T0-1160



# 12 exciting new Heathkit® projects you can assemble yourself ...and save!



(There are 350 more in your  
free '73 Heathkit Catalog)

## NEW Heathkit 21V Color TV — Solid-State Plus Detent UHF Tuning... 499.95\* less cabinet

Power detent selection of all VHF and any 12 pre-selected UHF channels; exclusive angular tint control for consistently better flesh tones; voltage controlled varactor UHF tuner & MOSFET VHF tuner for unmatched sensitivity; black matrix tube, built-in dot generator, convergence panel and volt-ohm meter — full remote control options, too. It's Heathkit TV at its finest in a space-saving size. Kit GR-271, less cabinet, 121 lbs.

Assembled GRA-501-21, table model cabinet shown,  
tough walnut Marlite® finish, 33 lbs. .... 54.95\*

## NEW Heathkit 30 MHz Counter ... 169.95\*

Gives 1 Hz to over 30 MHz counting on a full 5-digit readout with 8-digit capability. The lighted overrange indicator makes misreading virtually impossible. Stable timebase circuitry assures accuracy better than ±3 ppm from 22° to 37° C. Diode protected J-FET gives improved triggering over 100 mV to 150 V input range. Solid-state circuitry mounts on one large board. Kit IB-1100, 6 lbs.

## NEW Heathkit 2½-Digit VOM ... 79.95\*

Four overlapping ranges to measure voltages from 10 mV to 1000 V on DC (either polarity), 10 mV to 700 V rms on AC, 10 uA to 2.5 A on AC or DC current. Five resistance ranges measure from 1 ohm to 2 megohms. Front panel polarity switch reverses inputs without changing leads. Kit IM-1202, 6 lbs.

## NEW Heathkit/Thomas Spinet Organ with two 44-note keyboards ... 689.95\*

Full 44-note keyboards for Solo and Accompaniment, exclusive Color-Glo keys that light up to indicate notes and chords. There are six solo stops, five accompaniment stops, plus both regular and a new "light" vibrato effects. Other features include keyboard jacks for private earphone listening or use of a tape cassette deck. Cabinet is shipped fully assembled, includes bench. Kit TO-1160, 211 lbs.

## NEW Heathkit 4-Channel Amplifier with "Universal" decoder circuitry ... 359.95\*

You select discrete 4-channel, or switch-in the "Universal" decoder for reproduction of all the matrixed 4-channel discs now on the market, plus "derived" 4-channel from conventional stereo. Four solid-state amplifiers produce 200 watts (4x50 IHF) into 8 ohms, with power bandwidth on all channels from less than 5Hz to greater than 45 kHz at 0.25% distortion. Kit AA2010, 37 lbs.

AAA-2004-1, pecan cabinet, 7 lbs. .... 24.95\*

## NEW Heathkit "Universal" 4-Channel Decoder ... 39.95\*

Reproduces all matrixed discs, plus "derived" 4-channel from conventional stereo material. Plug it into your receiver's tape monitor circuit, add a second stereo amp and speakers and you're set. Kit AD-2022, 4 lbs.

## NEW Heathkit Ultrasonic Intrusion Alarm ... 49.95\*

Disguised as an ordinary library book, this novel device fits unobtrusively anywhere in the home or office, yet detects any significant movement in the room, ultrasonically. The transmitter disperses a 41 kHz signal which bounces off walls & returns to the receiver where it's monitored for any change in amplitude. The device triggers lights and any conventional alarm device — just plug them into AC outlets on the rear panel. Can be installed anywhere there's a 120 VAC outlet. An enjoyable 2-evening kit ... for a lifetime of reliable home security. Kit GD-39, 5 lbs.

## NEW Heathkit 8-Channel VHF Band- Scanning Monitor with digital readout ... 119.95\* less crystals

Crystal-controlled monitor tunes any selected 9 MHz segment of the 146 through 174 MHz band — gives you police, fire, marine, ham 2-meter, etc. Features manual or automatic scanning with numerical readout; priority channel; built-in speaker and rear-panel jack for remote speaker; gimbal bracket for either base-station or mobile use. Operates on either 120/240 VAC or 12 VDC. Includes crystal OSC/Mixer signal source for easy alignment. Order up to eight Crystal Certificates with kit. Kit GR-110, 9 lbs.

GRA-110-1, Crystal Certificate, postpaid ..... each 4.95\*

## NEW Heathkit Engine Analyzer ... 64.95\*

For 3, 4, 6 and 8-cylinder engines. Includes leads and accessories for testing conventional, transistor, and magneto ignition systems, regardless of voltage or grounding. Uses 3 "C" batteries (not included). Kit CM-1050, 9 lbs.

## NEW Heathkit C-D Ignition System ... 39.95\*

Increases spark-plug and point life up to 50,000 miles on any car or truck using a 12-volt, negative ground system. Automatically varies spark duration. Screw-on terminals make installation easy; external pushbutton lets you override system without removing leads. Kit CP-1060, 4 lbs.

## NEW Heathkit 6-Digit Electronic Alarm Clock ... 54.95\*

Displays hours, minutes and seconds on highly visible cold-cathode readout tubes. A gentle "beeper" alarm can be set for 24-hour cycle and features a snooze switch that gives you seven more minutes of sleep before the alarm sounds off again. Conventional 12-hour or 24-hour international time display. Kit GC-1005, 4 lbs.

## NEW Heathkit AD-1530 Dolby Cassette Deck ... 249.95\*

A kit-form cassette deck utilizing the famous Delby® noise reduction system. Accommodates the greater fidelity and dynamic range of chromium dioxide cassettes. Independent switches provide Dolby on/off and regular or CrO<sub>2</sub> bias control. Domestic-make tape transport comes preassembled for easy kit building. Kit AD-1530, 21 lbs.

See them all at your nearest Heathkit Electronic Center ... or send for FREE '73 Heathkit Catalog.

HEATH COMPANY, Dept. 139-3 Benton Harbor, Michigan 49022		Schlumberger
<input type="checkbox"/> Please send FREE Heathkit Catalog. <input type="checkbox"/> Enclosed is \$ _____, plus shipping.		
Please send model(s) _____		
Name _____		
Address _____		
City _____ State _____ Zip _____		
Prices & specifications subject to change without notice. *Mail order prices; F.O.B. factory. CL-453R		

HEATHKIT ELECTRONIC CENTERS — ARIZ.: Phoenix, 2727 W. Indian School Rd.; CALIF.: Anaheim, 330 E. Ball Rd.; El Cerrito, 6000 Potrero Ave.; Los Angeles, 2309 S. Flower St.; Pomona, 1555 Orange Grove Ave. N.; Redwood City, 2001 Middlefield Rd.; San Diego (La Mesa), 8363 Center Dr.; Woodland Hills, 22504 Ventura Blvd.; COLO.: Denver, 5940 W. 38th Ave.; CONN.: Hartford (Avon), 395 W. Main St. (Rte. 44); FLA.: Miami (Miami), 4705 W. 16th Ave.; GA.: Atlanta, 5285 Roswell Rd.; ILL.: Chicago, 3462-66 W. Devon Ave.; Downers Grove, 224 Ogden Ave.; IND.: Indianapolis, 2112 E. 62nd Ave.; IOWA.: Des Moines, 18545 W. Eight Mile Rd. & 18149 E. Eight Mile Rd.; MICH.: Detroit, 165 Worcester St.; MINN.: Minneapolis (Hopkins), 11 Shady Oak Rd.; MO.: St. Louis, 9296 Gravois Ave.; N.J.: Fair Lawn, 35-07 Broadway (Rte. 4); N.Y.: Buffalo (Amherst), 3476 Sheridan Ave.; New York City, 35 W. 45th St.; Jericho, 10133 Springfield Pike; Rochester, Long Ridge Plaza; OHIO: Cincinnati (Woodlawn), 3482 Wm. Penn Hwy.; TEXAS: Dallas, 2715 Ross Ave.; Houston, 3705 Westheimer; WASH.: Seattle, 221 Third Ave.; WIS.: Milwaukee, 5215 Fond du Lac.

CIRCLE NO. 1 ON PAGE 17 OR 103

# LET YOUR HANDICRAFT BLINK BACK

by Imre Georgenvi

"Paste" jewelry takes on added sparkle if ruby-like electronic light is added. This simple two transistor circuit gives cat flashing red eyes. Circuit and batteries are inside the young lady's shoulder bag.

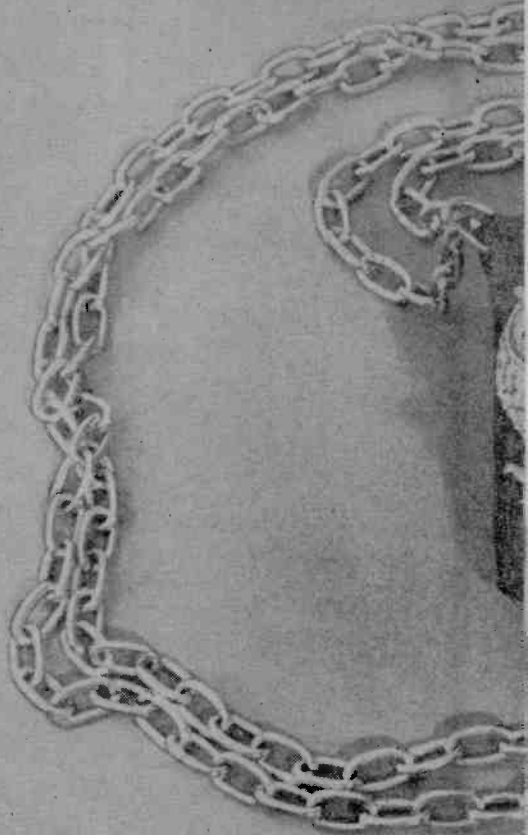

Here's an interesting application for the light emitting diode (LED). Because of fast turn-on time and long life, they are used mostly in digital equipment as an indicator or card reader. These tiny red or green dots of electronic light can be used in unsophisticated circuits for toys, jewelry, or other eye-catching objects that's sure to delight the younger set. Here are some ideas for easy-to-build electronic circuits with a tricky twist or two that shows off your handywork.

**Lady's Handbag.** The easy way to start is to have lots of room for the electronics and battery. The small metal cat (\$1.59 in the drug store) gets two LED's implanted as eyes. The simple circuit makes the eyes blink. Secured to the side of a handbag with epoxy, only the cat is seen while the electronics are hidden inside.

**Toy Firetruck.** Any small model car can be wired up with a pair of LED's in place of the headlights, stoplights or—as in this case—under a small red beacon. Choose a car big enough to hide the battery and the

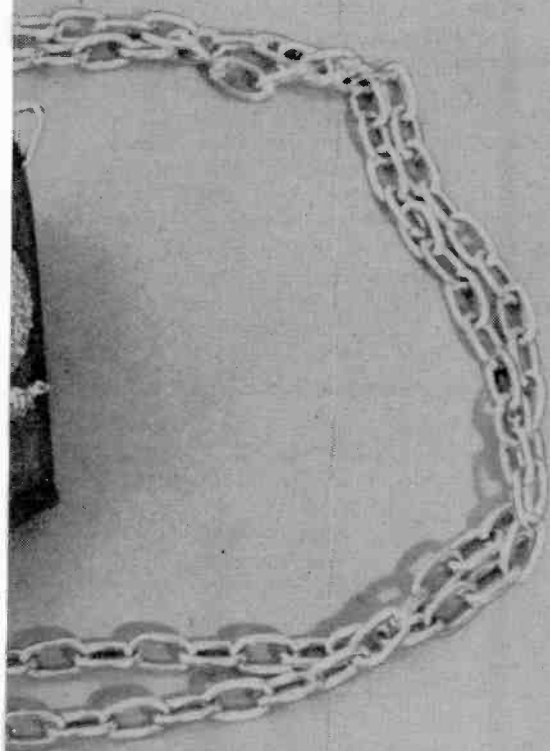

Pendant owl poses greater problem for circuit and battery placement. Author added hollow log perch, mounted circuit inside, and connected long chain. Battery is good for many hours of use.

circuit, but not too large to lose the scale of the small LED's.

*The Owl.* To make a brooch or other small jewelry takes more skill and some patience. My owl is hardly a masterpiece, but it is unique since everyday owls have yellow eyes and this one has red. The problem was where to put the batteries. More expensive camera type disk batteries could be used. Some cells are too bulky to hide behind the brooch, so I decided the owl had to sit on a tree with the whole thing hanging from a chain instead of just being pinned on. My teenage advisors agreed, "It would be cool!"

To construct the perched owl, a two-inch piece of driftwood was hollowed out, then cut lengthwise and glued on the owl. The log contains the batteries and electronics hidden by a covering of black felt material on the back. The felt is held in place with a rubber cement so it can be easily removed to change the battery. There was no place left for a switch, so two small wires have to be twisted together to start the owl blinking.



# e/e HANDICRAFT BLINKER

Readers who like this idea can find many better ways to make blinking jewelry a new handicraft.

**The Electronics.** It is simple as apple pie! There's an astable multivibrator to control flashing that consists of very few components. Two LED's are used instead of the collector load resistors. You should include a 0.001  $\mu\text{F}$  capacitor to eliminate unwanted HF oscillations if long wires are used for the LED's (the eyes.) On the other hand, if this capacitor is omitted, the blinking is more random, creating a special effect.

Build the circuit on a small piece of perf-board. Then try to change the value of the electrolytic capacitors and/or resistors. Finally, disconnect C3 and see what happens. During construction and testing, always connect the LED's with the same length of wire that will be used in the final version. After the circuit works to your specifications, try to make it as small as possible even by omitting the perf-board. Use stiff wires and tape or glue to avoid shorts.

Almost all NPN transistors can be used with a minimum beta of 150. The handbag is easy. Try the other ideas only if time and patience are no problem. Some little or big girl's eyes will light up, if not blink, for a special gift like this. ■

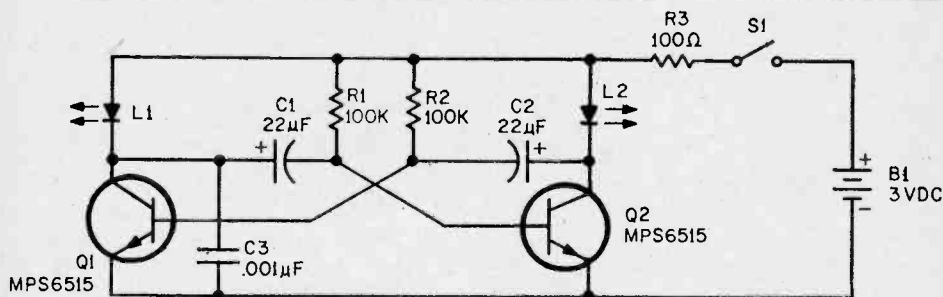

## PARTS LIST FOR WINK CIRCUIT

- B1—3-V A cells (2)
- C1, C2—22  $\mu\text{F}$ , 3 to 6 VDC electrolytic capacitor (try values from 20 to 60  $\mu\text{F}$ )
- C3—.001  $\mu\text{F}$ , 30 V disc capacitor
- L1, L2—Light emitting diode (HEP-P2000 or Motorola MLED600 which are large red plastic units that light red; or HEP-P2001 or MLED-50 which are small clear plastic units

- that light red)
- Q1, Q2—Transistor, audio NPN (Motorola MPS6515, HEP-728, or equiv.)
- R1, R2—100,000-ohm, 1/2-W resistor
- R3—100-ohm 1/2-W resistor
- S1—Slide or toggle miniature switch, SPST

Misc.—Battery holder, hookup wire, solder, epoxy glue, etc.

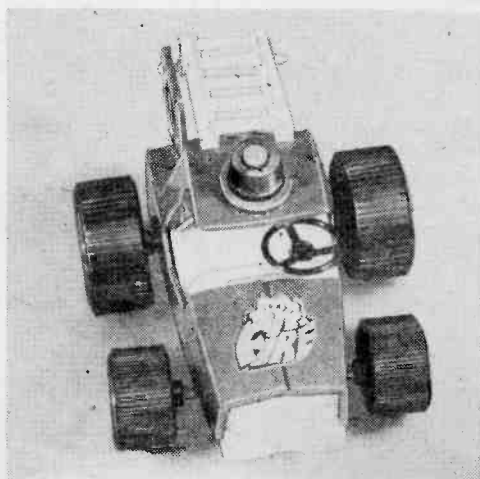
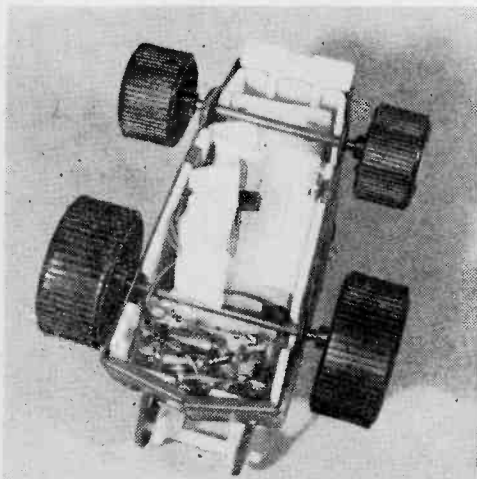

Small toys are a good place to start. A blink circuit in Junior's racer adds realism.



# e/e looks into a MITS 1440 calculator kit

Considering that it's possible to purchase electronic calculators for under \$60, we wondered what there was about the MITS 1440 calculator priced at \$199.95 in kit form (\$249.50 wired) that justified its price tag. Now that we've built and used the 1440, we know what it has going for it—a host of extra features that will outclass run-of-the-mill calculators. And it's particularly well suited for students, technicians and engineers.

**What Do We Mean?** The average calcu-

lator is what is termed a *four function* device; it will add, subtract, multiply and divide. Specifications for the four function calculators often include a host of impressive features. which when boiled down simply means it can do chain calculations such as  $1 + 2 \times 3 \div 4 = 2.25$ .

But chain calculations are the whole bit. The four functions cannot do problems such as  $(1 \times 2) + (3 \times 4) =$  without *you* either carrying some numbers in your head or writing them down. Nor can these four

An electronic tool for the serious experimenter, student, technician and engineer, this MITS 14-digit Model 1440 calculator has light emitting diode readout, memory, square root and more including LSI integrated circuits to keep the cost and complexity down. For more information about the MITS 1440, circle No. 66 on the Reader Service Page.

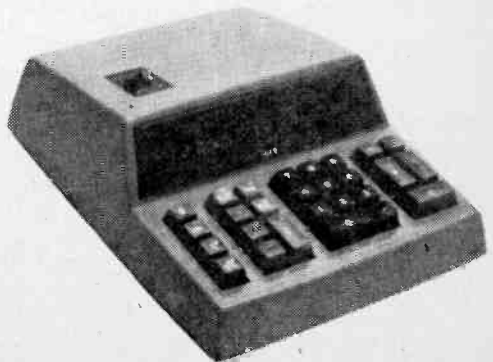

# e/e MITS CALCULATOR

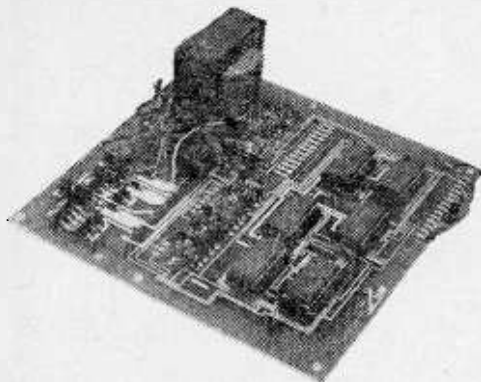

This main circuit board contains a power supply and the LSI ICs used for the arithmetic calculations, input, readout, and memory functions. Unit operates on 117V

function calculators handle square roots, and square root is an important and vital part of many engineering and electrical formulas. Finally, many if not almost all low-cost calculators have a total of 8 digits in the readout, and often only six.

**Almost Double.** The fourteen place MITS 1440 calculator, on the other hand, in addition to the four standard functions, provides up to seven *decimal* places, has automatic squaring and square root, a memory, a constant multiplier, a sign exchange and a problem exchange (such as  $\frac{1}{2}$  exchanged for  $2/1$ , a vital feature when the calculator is equipped with square root). Also, the 1440 has individual clear keys for total *clear*, *clear entry* and *clear memory*. If you make an error in entry you need only clear the entry, all other programming remains. This contrasts to the low-cost calculator which clears everything when an error is made, requiring total recalculation of the problem.

Completely assembled push-button keyboard cuts assembly time to only about 3 hours. All keys with an M are associated with the memory—MR is for memory read, MC is for memory clear. The D key allows you to set the number of decimal places. Push D and 2 to figure in \$ and ¢.

**Memory Storage.** The memory is a vital part of the 1440. Any readout can be stored for future use, and the memory total can be added to, subtracted from, or pulled out for use by depressing the proper key. For example, consider the problem  $(1 \times 2) + (3 \times 4)$ . First, compute  $1 \times 2 = 2$ . The 2 is stored in memory by pressing the M+ key. Then continue with  $3 \times 4 = 12$ . The 12 is entered in memory by pressing the M+ key. Pressing the MR (memory read) key produces 14. Similarly, if the problem were  $(1 \times 2) - (3 \times 4)$ , the 12 would be subtracted from the memory total by pressing the M- key; the readout answer would be -10.

To permit full algebraic solutions, the 1440 also has a sign exchange key so a number can be entered as + or -, so the answer can be algebraically correct. As an example,  $-5 \times -5 = +25$ , while  $-5 \times +5 = -25$ .

**Decimal Placement.** Any number of decimal places up to seven can be set by pressing the decimal key and one numerical key representing the number of desired decimal places. Pressing 2 moves the decimal to two places, pressing 3 provides 3 decimal places, etc. Because the total readout capacity is 14 places, utilizing the full seven place decimal creates no problems, as seven non-decimal digits remain.

If your calculations overload the 14 digit capacity of the 1440, a fifteenth display indicates an "E" for error and the calculator locks up. You don't have to worry whether the displayed numerals are incorrect; you know they are correct as long as no "E" is displayed.

We could describe many other unusual features and functions, but space is short; just note that any problem, if it can be handled by any of the four standard functions, a constant, a memory and/or a square root, can be handled by the 1440. Actually, it's close to an electronic slide rule (models  
*(Continued on page 102)*)





# CB coffee break

THIS ISSUE'S COLUMNIST—JULIAN S. MARTIN, KMD4313

**No Need To Fail.** Popkin's first law of communications states that "Electronic equipment will fail when most urgently needed." Though most philosophers and soothsayers generally take the tack that "if something can fail it will," only Popkin—of all the popular soothsayers—had practical experience with electronic communications equipment; hence, he knew for certain that anything will fail when most urgently needed. He did not sit around waiting for the failure to happen; he expected it as soon as he threw the power switch.

The importance of Popkin's First Law was realized at a recent CB coffee-break I chanced to stumble upon at our local state park. Just about every CBER was trying to outdo the others with horrendous stories of road mishaps for which they could raise no assistance through a shout on channel 9. Each had a tale of woe of how his rig couldn't raise a station booming in at "twenty over nine," or how the receiver conked out, or how the SWR indicator pinned just as he hit the PTT switch. You name it and some CBER had faced the problem.

Now if there is one thing I know for certain it's that CB gear is generally three or four notches better in construction and reliability than the average run of the mill consumer equipment. CB gear just doesn't break down all by itself. Popkin's First Law usually applies to CB only if someone has helped it along by a shoddy installation. So, armed with this knowledge of the ages, I joined into the crying-towel session and offered to prove—through a quick inspection of the mobile installations—that the equipment failures were caused by poor installation rather than poor equipment.

Though most CBERs will defend their technical competence to their last breath, a few were willing to have someone inspect their cars to look for poor workmanship, rather than extol the virtues of the CB installation.

The first car turned up a beautiful installation, everything rigidly mounted to the floor; *except*, the rubber floor mat had folded through the holes drilled in the driveshaft tunnel and had insulated the mounting screws from the car ground. The nuts under the car were tightly clamped against the undercoating, which is an insulator. There was no chassis ground; the rig's entire electrical ground was carried through the antenna's coaxial cable shield which was

hanging by a thread. Under full transmit load, the transceiver was getting a big 8 VDC. This rig was getting enough juice to receive, but barely enough to equal a walkie-talkie's output. But on a test bench, with an AC power supply, it checked out just great.

Next case was an installation made 5 years ago. Everything checked out just fine—good receive and power output, but the modulation was mush. According to the user, he had replaced endless modulator tubes, and even had a test signal run through the mike input. Everything always checked out, but he had trouble making himself understood when his signal faded to S8. I simply grabbed a matching mike from another mobile and *voila*, the mush vanished. Seems this CBER lived near the ocean and left his car on the streets all year. CB mikes are moisture resistant but not forever; when the signal turns to mush the first step is to borrow a mike from someone else and try it.

The brother with the pinning SWR meter was an easy case. His body-mounted antenna was positioned way back on the fender, near the bumper. To avoid damage to the coax by a tool box, he very neatly folded the wire deep down into the fender's well, producing a 3/4-in. diameter bend in the center conductor where it connected to the base of the antenna. Vibration had broken the wire under the insulation. When the car was pitched heavily to the right the connection opened. When our friend had tried to call for assistance on channel 9 he was pulled over on the right shoulder of the road, and he had no antenna connection. But when he was parked on his driveway and checked the wire with an ohmmeter he got solid continuity. The moral? Don't get so neat you cause strain on a component.

Another CBER complained of intermittent operation at night, never during daylight. Inspection showed he had connected the transceiver's power supply to the instrument side of the instrument voltage regulator. Something, which was used only with the lights on, was also at the same tie point and the regulator would try to shed the excess load by cutting out. This guy's car was loaded down with just about every piece of optional "add-on" you can imagine—all user installed, and all of it on the regulator because he wanted a "steady voltage supply". Y'know, it took an hour to convince him to connect equipment to the bat-

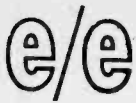

## COFFEE BREAK

tery the way the equipment manufacturer suggested.

Then there was the mobiler who quit smoking. He had no need for the cigarette lighter so he figured he'd use the lighter's socket as a power take-off for the CB rig. After years of puffing the weed, the lighter's center contact was covered with gunk from burned cigarette ashes. The power adaptor was barely making contact; as he drove, the contact would make and break causing a flutter on the transmitted signal. During receive the discharge of the filter capacitors would take up the light power supply loading of the receiver, so there was no receive flutter.

A more difficult problem was the mobile rig that kept blowing power transistors. Seems this CBER suffered from two bits of screwed-up technical expertise. First, he believed the CB rig put a heavy drain on the car battery. Secondly, he wanted a "little more" power

output—like 10 watts. Now solid state rigs can run off a car battery for hours on end without putting a noticeable dent in the battery's capacity. A heavier charge is the last thing in the world a battery needs, but this "expert" readjusted the battery charging regulator to provide a higher voltage from alternator to battery—like almost 17 VDC. And the same 17 VDC was powering his CB rig rated for a nominal 13.8 V. Get the picture? Overvoltage equaled burned out transistors, frequent battery replacement, and oh yes, this CBER sheepishly admitted he ran through a lot of auto lamps. Otherwise he had a very nice installation.

I turned up several other examples of poor installation techniques which created an overall impression of defective equipment, rather than defective installation. It's like I said, with CB gear, Popkin's First Law needs a little help from the user.

Nice thing about CBERs though, even when you point out their mistakes they still break out the six-pack. Nicest coffee-break I ever attended. ■

## MICROWAVES MONITOR THE DIFFERENCE

A newly constructed chamber that stops radar signals from bouncing around is helping General Motors' engineers to develop an experimental radar-sensing system for automobiles. The facility at GM Research Laboratories is called a microwave anechoic (echoless) chamber. It provides a nearly perfect environment for automotive radar studies and represents the latest technological advancement in a continuing GM Research radar development program which was begun in the mid-forties. The concept of a radar-sensing system built into the front end of a car involves the triggering of a light or buzzer when a driver gets dangerously close to another car.

The chamber drastically reduces unwanted radio frequency (RF) energy in a frequency range thousands of times higher than the standard AM radio broadcast band. Inside walls are completely lined with a carbon latex impregnated polyurethane foam which converts all incident RS energy into heat. This chamber will reduce unwanted signals by about 35 decibels, or to 0.03% of their original value. In ef-

fect, any signal present is a signal we generate and control.

A suitable radar-sensing system operating from the front end of a car would keep track of the distance between the car in which it was installed and the car ahead and monitor the rate at which the cars are closing. Also, it would trigger a warning device which will allow the driver to take evasive action if the cars are getting too close for comfort and actuate a dynamic passive restraint system (such as an air bag) if a collision is imminent.

While such a system is not around the corner, the anechoic chamber work could hasten its development considerably.



This newly-constructed facility is called a microwave anechoic (echoless) chamber. It is lined with polyurethane foam which converts all incident radio frequency energy into heat, thus providing a nearly perfect environment for automotive radar studies. Bob Miller of GMR's Electronics and Instrumentation Department is shown here demonstrating the equipment to GM secretary Sharon Slipek.

# You're on top when you...

## IMPROVE YOUR WORLD GLOBE

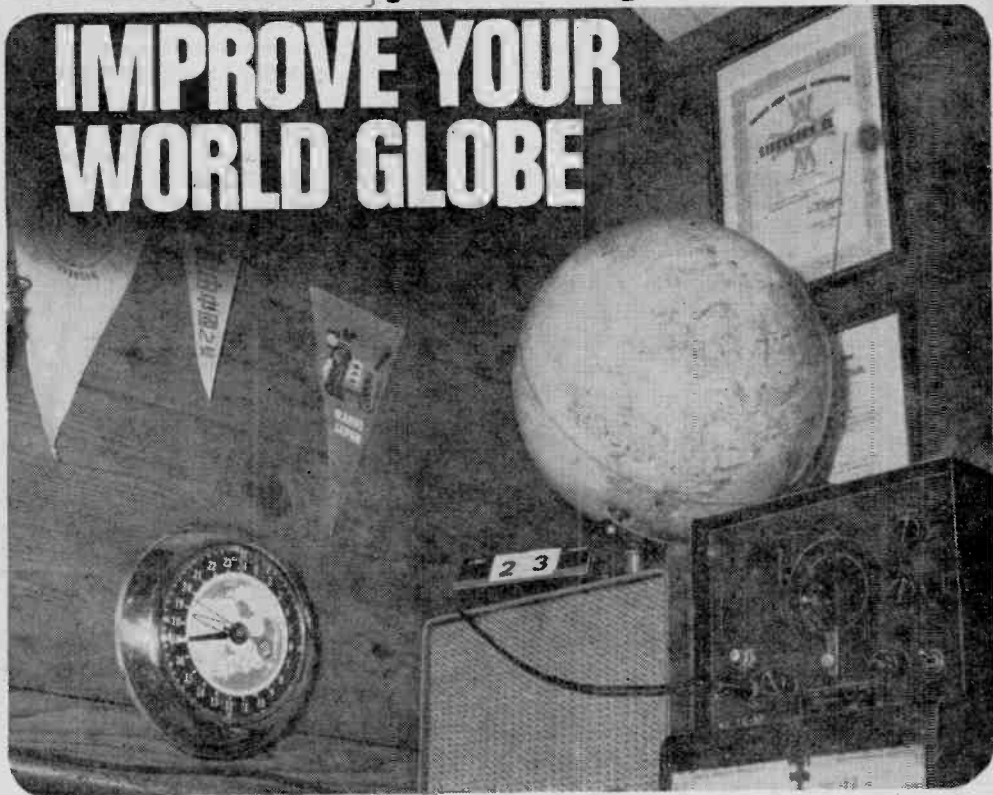

It puts the North Pole in your back yard

by Herbert L. Foster

**I**T HAPPENS ALL THE TIME. Every ham and SWL finds a heck of a lot of reasons for wanting to know the direction and distance from his home to some other place on this planet earth. A ham will need the beam heading, for example, to rotate his cubical quad for best results in a QSO with some Zed Ell down under. Or suppose you're prowling the 19 meter band and pick up a signal showing heavy polar flutter. You want to know who might be coming over the top of the world. Well, shucks, you know the many reasons for wanting a signal bearing just as well as I do.

Now it's fairly common knowledge that a flat map doesn't tell us radio types very much that's useful. That old Mercator projection just doesn't have it. There are several other projections that try to remedy the faults of the Mercator, but they introduce

troubles of their own. You just gotta have a globe. What isn't so commonly known is that the globe you buy, as it comes glistening from its factory carton, can be improved. With a little body and fender work, the globe can be made to tell its secrets more easily and more directly. You can do the job with ease.

**Start.** First, of course, you need a globe. What you're going to do is remove the thing from its mount, and remount it with your own QTH (home) on *top* of the world. Since that's where we'd all like to be anyway, the whole idea takes on added appeal. While almost any old globe can be used here, things will go a little easier if you get a certain type to use as raw material. The kind that's easiest to handle is a globe fashioned from a sphere of heavy grade cardboard. The surface will be hard, shiny,

## e/e YOUR WORLD GLOBE

brightly colored, and heavily lacquered. But under all that war paint is plain old cardboard. It'll usually be mounted on a semi-circular arc of metal which, in addition to holding the globe up, serves as a semi-meridian. The semi-meridian will be altered to provide a mounting point for each of the poles on the globe. A pin through the spot on the globe representing the North Pole and another through the South Pole fasten the semi-meridian to the sphere. This variety of globe is the cheapest type, anyway, and some loot will remain for nonessential items like milk for the baby, shoes for the kids, or perhaps a second dress for the XYL.

**Play Atlas.** Having obtained your globe, you are all set to do the simple modification. If your globe mounts with a pin, just grab the pin with pliers. Hang on tightly, and pull firmly, while rotating it to the left. It'll come right out, unscrewing on a deep spiral thread that makes perhaps one full turn around the solid body of the pin. Do the same thing at the South Pole, and your globe will be free of its mount. The lug mounting type is even easier. While pressing down on the North Pole with one hand, lift up on the end of the semi-meridian. The thing will give enough to lift the lug right out of the North Pole hole. Next push the sphere to one side, and lift it off the South

Pole lug. It's just that simple.

Next, you'll drill two new holes in the sphere for the remounting part of the job. One hole will be drilled through your QTH, and the other will go through the spot on the globe directly opposite the place where you do your dial twiddling. Eggheads call this the antipodes.

To find the place for your second hole, or your antipodes, a little arithmetic comes in handy. Take a map that shows your home town and note the approximate longitude and latitude. Figures taken from a map of your state, or similar geographic area, if you're located outside the U.S., will be close enough for our job. If you happen to have a good world atlas, simply look up your home and the coordinates will be shown directly. That nails down the first hole. Figuring the longitude and latitude for the other hole is where the arithmetic comes in.

You'll subtract your longitude from 180 degrees, and take the remainder in the opposite direction as one coordinate of your antipodes. Your latitude, also taken in the opposite direction, is the latitude of that second spot.

**Now In English.** The easiest way to explain how all this goes is to take a specific example. So consider the case of a SWL who lives in Hastings, Nebraska. Why Hastings, Nebraska? Well, for one thing, it's reasonably close to the center of the country. The numbers we wind up with will be at least vaguely like the numbers you'll get  
(Continued on page 105)

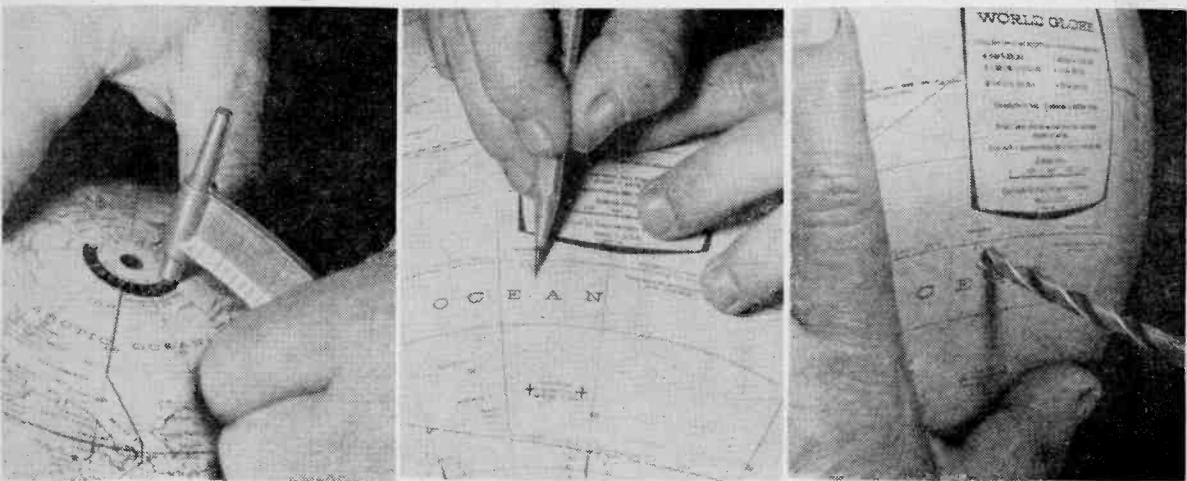

A simple twist of the wrist (left) removes the globe from its mounting; it's the first step of a procedure to give you immediate access to world locations and distances from your home. Center photo shows approximate location of new "South Pole" in Indian Ocean.

e/e checks out  
a 3-band scanner...

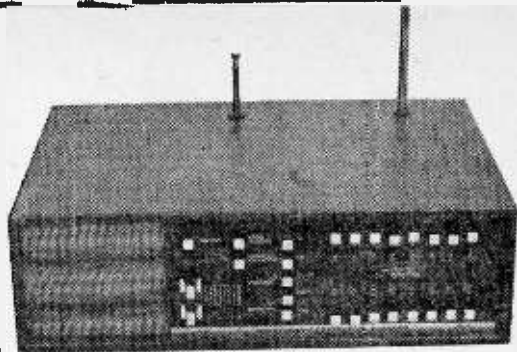

## Regency's TME-16H/L/U

**T**HIRTY YEARS AGO virtually all the public safety radio services combined were not enough to fill a small bit of the frequency spectrum just above the broadcast band. Today, however, there are so many services using two-way radio that we are fast running out of frequencies. First the low band (30-50 MHz) jammed up, then the high band (148-174 MHz) and, finally, we're pushing operations into the UHF band (450-470 MHz). There's such a shortage of available frequency spectrum that communities can no longer group their services within a given band, such as all fire and police on the low or high band. Today, you will find that local public services utilize all three bands, and the old-fashioned single-band "police" receiver just can't hack it.

Even two-band monitorradios are hard pressed to keep up with all the action; even if the local fuzz and firefighters are on the low and high bands, their walkie-talkie operations might be up on UHF.

So, to keep up with all the action, there are three-band monitorradios such as the Regency Model TME-16H/L/U.

**Round-Robin Reception.** The Regency Monitoradio is one of the new breed known as a "scanner", meaning that the receiver automatically switches from frequency to frequency (channel to channel) until it finds one in use. It locks to the in-use station as

long as the station is on the air. When the station ends its transmission the scanning resumes until it finds another station transmitting.

Regency provides full VHF Lo, VHF Hi, UHF coverage through the use of two front-end modules. One front-end covers only the low and high bands through 8 crystal sockets and associated jumpers that are arranged in two parallel rows. Either a low or high band crystal can be installed into a socket; an associated jumper is plugged into a matching pin. In this manner, any VHF Lo, VHF Hi crystal intermix is possible: for example, crystals 1 to 4 might be low band with crystals 5 to 8 high band, or crystals 1, 3, 5, etc. can be high band while crystals 2, 4, 6 are low band.

The UHF front end also has 8 crystal sockets; all must be used for the UHF channels. Crystal sockets in the VHF Lo, VHF Hi tuner are designated as 1 through 8. The crystal sockets in the UHF tuner are designated 9 through 16.

A Regency TME-16H/L/U Monitoradio is housed in a wood-grain metal cabinet 13-in. W x 4-in. H x 8 $\frac{5}{8}$ -in. D. It is supplied with two telescopic antennas (VHF and UHF) which attach through the top of the cabinet. Individual coaxial connectors are provided on the rear apron for outdoor antennas. A remote speaker terminal and

Coaxial jacks for outdoor antennas are located on rear apron while individual whip antennas for VHF (Hi-Lo) and UHF bands screw-in through top of cabinet. A 3-band scanner covers all the action, this one has 16-crystals. For more information from Regency circle No. 70 on pages 17 or 103.

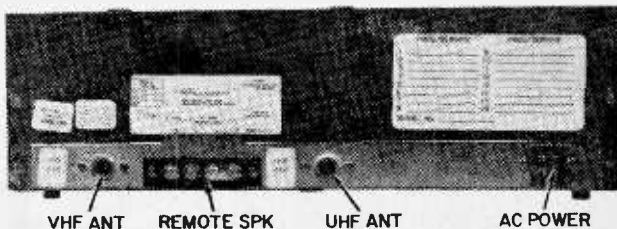

# e/e 3-BAND SCANNER

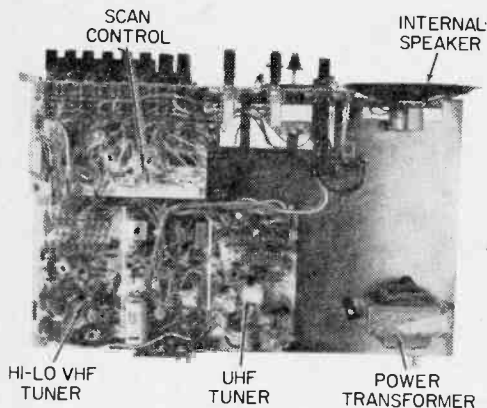

Eight crystal sockets are located in each of the two front end modules. The first 8 are shared by the Lo & Hi VHF front end, and those remaining are exclusively for UHF. Scan control area uses Integrated Circuits

power cord socket are also provided on the rear apron.

**Action Controls.** The front panel contains linear-slider squelch and volume controls plus two banks of push switches, many of which are not usually found on scanners. First, there are two rows of 8 switches, each with associated signal lights; these are the channel selectors and indicators. Switches 1 through 8 select the 8 crystals in the VHF tuner; switches 9 through 16 select the crystals in the UHF tuner.

Then there are pushbutton switches for power, scan/manual and channel selector. When the scan/manual switch is set to scan, the unit automatically scans only those channels punched up by the channel selector buttons. The matching signal light shows which channel is being received at a given instant. When the unit is set to the manual mode, pressing the channel selector button causes the receiver to select the next channel. The receiver stays locked to the selected channel until the channel selector is again depressed.

Finally, there is a row of pushbutton switches labeled HI, LO, HI/LO, UHF and ALL. These buttons determine which channels are scanned. The HI button scans channels 1 to 4 regardless whether low or high band crystals are installed. The LO button scans channels 5 to 8, again, regardless what crystals are installed. The HI/LO but-

ton scans channels 1 to 8. The UHF button produces scanning of channels 9 to 16, and the ALL button produces scanning of channels 1 to 16. Any channel selector not punched up is not scanned. It takes approximately 1 second to scan all 16 channels.

**Performance Check Out.** On the low VHF band, the sensitivity for frequencies inside a 3 MHz bandwidth was nominally 0.5  $\mu$ V for 100 percent copy. On the high VHF band, frequencies inside a 12 MHz bandwidth had a sensitivity of 0.8  $\mu$ V worst-case. On the UHF band, frequencies inside a 12 MHz bandwidth had a worst-case sensitivity of 0.9  $\mu$ V. If you plan to utilize frequencies outside the factory tuned bandwidth, the front end(s) must be realigned for maximum sensitivity. This is typical of scanning monitors.

With both tuners fully loaded with crystals, there were no spurious responses or other forms of interference to the received signals. The sound quality of the built in speaker is crisp and clean, with no microphonics caused by vibration or even tapping the cabinet itself.

Lo and Hi VHF band crystal operation is selected by a mini-plug that connects to either of two pins associated with a crystal socket—sets scanner to desired Hi-Lo VHF band intermix.

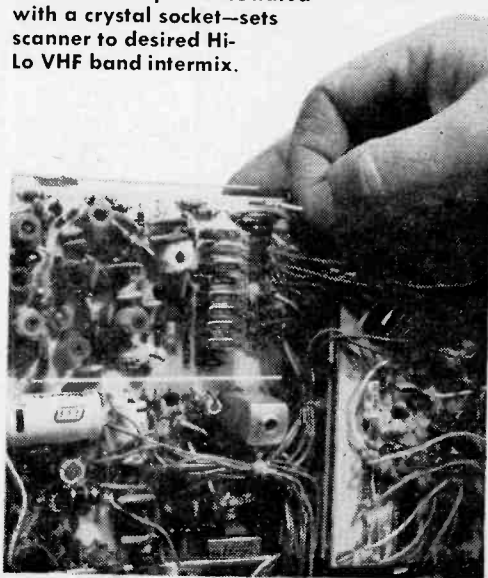

**Summing Up.** The Regency TME-16H/L/U Monitoradio is a "hot" performer that takes you where *all* the action is.

For additional information circle No. 70 on the Reader Service Page. ■

Take the guess work out  
of her job by building our

# STATUS

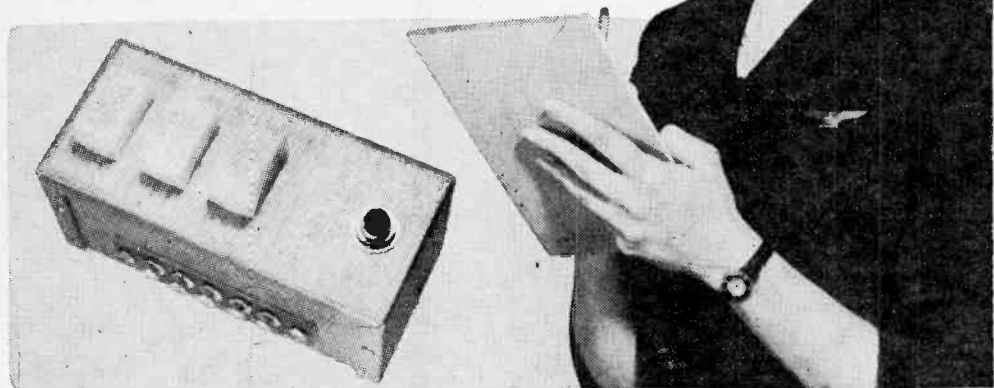

# BOX

Simple to operate—  
she buzzes, you switch,  
it blinks, she winks!

by James A. Fred

**H**ow many times has your secretary blundered into your inner sanctum when she was better off visiting the water cooler? Well, not my secretary, she can barge in any old time. And so could you, if you looked as good as she. But then, there are times you really don't want to be disturbed. You may have a visitor already in the office, or you may be on an important call, or you may just have your feet on the desk taking a five-minute break to calm your nerves. Contrary-wise, you may welcome a visitor because you want interruptions. The problem is that the person on the outside does not know your wishes from the inside.

To alleviate this condition I designed a three-lamp system that the busy executive can use to notify the caller or his secretary by an illuminated message, what his wishes

are. For example: the three messages could be, "You May Enter", "I Am Busy", and "I Am Not In". The first message is self explanatory, the second implies that he will be available in a few minutes and the third message tells the caller to come back in an hour or two.

Simple? It sure is. Read on and you'll get all the facts for this simple inter-office communicator. We call it—the *Status Box!* And it means status for almost everyone. The swinging teenager could install one for privacy in his or her room. Your darkroom sure could use one, and the housewife would like one at the front door to read: "Walk In", "Just a Moment", and "Beat It or I'll Call a Cop"! In fact, any message selected from several can be stenciled on the Status Box. And three is not the limit. You may require

# e/e STATUS BOX

4, 5 or more. You decide on the limit.

**Here's How.** All the components for the Status Box are housed in two aluminum boxes. One box rests on the executive's desk. The other box is mounted on the outside wall near the office door or on the secretary's desk. The *outside* box contains a push-button, three lighted messages, a 9-volt battery, and a five-screw terminal strip. The

inside the office. The executive (that's you) then slides a switch to the proper message and an indicator light comes on as a reminder to the executive. The caller then knows what to do to comply with the lighted message on the outside Status Box. If the executive leaves his office, he slides the switch to "I Am Not In" before he leaves. When he returns he is reminded by the indicator light to cancel the message.

The indicator lamps are low-current types that operate well on 9 volts. The mercury battery is commonly used in small transistor

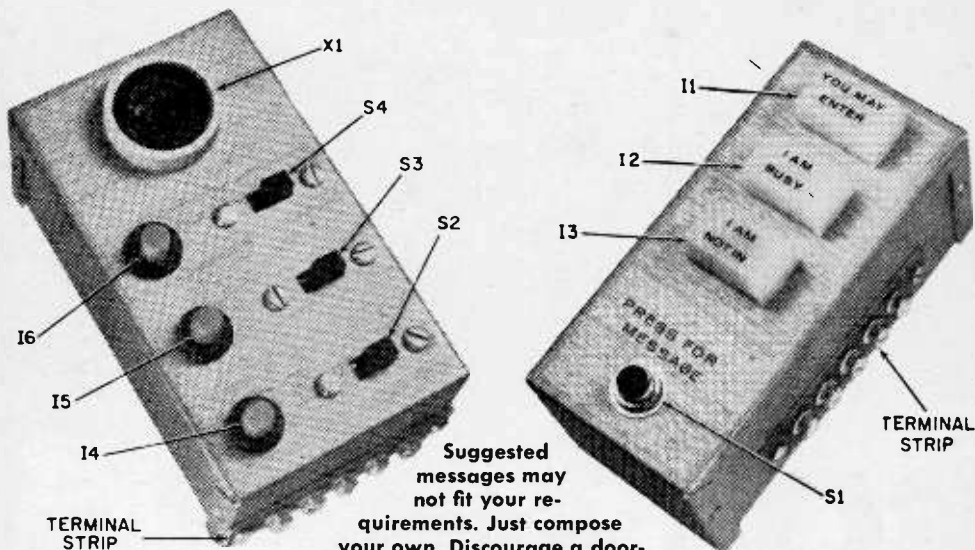

**Suggested messages may not fit your requirements. Just compose your own. Discourage a door-to-door salesman with "Cops on Way" after trying "Not Today, Thanks" and "We Don't Want Any." Sonalert replaces the doorbell.**

*inside* box contains three slide switches, three indicator lamps, a Sonalert, and a five-screw terminal strip. The two boxes are connected with a five-wire cable.

When a visitor approaches the door, they push the button and the Sonalert sounds off

radios. The Sonalert was chosen because it operates well on 9 volts and uses very little power. It has an attention getting tone loud enough for the average office. The message lights are the minimum size that will allow lucid messages to be put thereon. However,

## PARTS LIST FOR STATUS BOX.

- B1—Mercury battery, 9 V (Mallory TR146X, or equiv.)
- D1—1N34 diode, or equiv.
- I1-I6—10-V, low-drain light bulbs (Sylvania 10ESB, Allied 937-3775, or equiv.)
- 6—Lamp sockets for 10ESB above (Sylvania 30152-0, Allied 937-6150, or equiv.)
- 3—Lense for socket above, red, round (Sylvania 30160-0, Allied 937-6160, or equiv.)
- 3—Lense for socket, above, white, square (Sylvania 30173-0, Allied 937-6173, or equiv.)
- S1—Pushbutton switch, DPDT (Mallory 1016 or equiv.)
- S2, S3, S4—Slide switch, SPST

- X1—Sonalert signal device (Mallory SC628, Allied 854-6502, or equiv.)
- 1—Chassis box, aluminum, 5/4 x 3 x 2 1/8-in. (Bud CU2106A, Allied 736-3639, or equiv.)
- 1—Chassis box, aluminum, 5 x 2 1/4 x 2 1/4-in. (Bud CU2104A, Allied 736-3637, or equiv.)
- 1—Battery holder (Keystone Electronics 79, or equiv.)
- 1—Battery connector (Keystone Electronics 72, or equiv.)
- 2—Terminal strip, 5 screw posts
- Misc.—4 rubber feet, solder, hook-up wire, hardware, panel decals, etc.



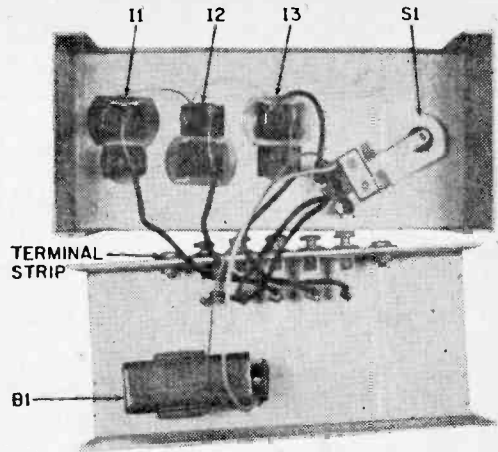
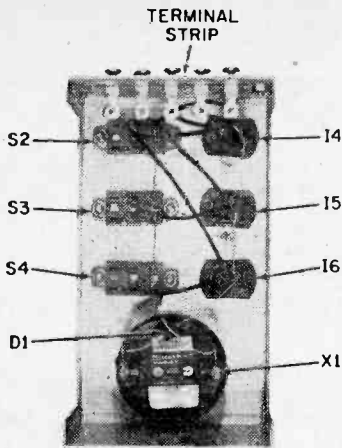

A look inside Status Box reveals very little! Wiring diagrams (below) of actual units (above) show how simple electrical wiring of Status Box actually is. A 5-wire cable connects boxes.

feel free to make substitutions.

The messages are formed by applying press-on letters to the lamp lenses. The lenses are translucent white plastic and are so slick the letters won't stick to them. Secure a piece of wet or dry abrasive paper and rub the lenses face down on the paper until the lense has a uniform frosted appearance. The press-on letters are then applied and adhere very well.

**Building It.** The first step in the construc-

tion is to lay out and make the holes in the aluminum box. If you have a well equipped workshop, the round holes should present no problems, however, the rectangular holes for the slide switches, terminal strips and message lights are difficult. For these holes, drill a number of small holes around the inside of the layout lines. File the holes to the finished size with square and flat files.

After the basic box preparation is finished  
(Continued on page 100)

INSIDE UNIT

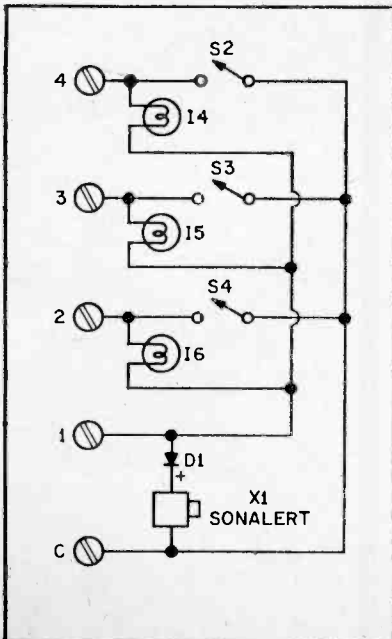

OUTSIDE UNIT

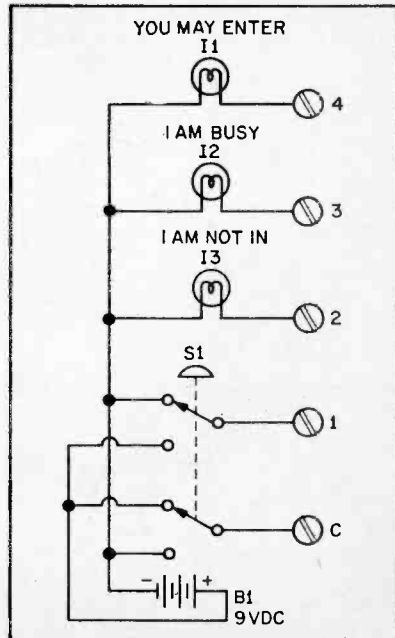

**RCA Institutes Home Training may be**

# **your best investment for a rewarding career in electronics**

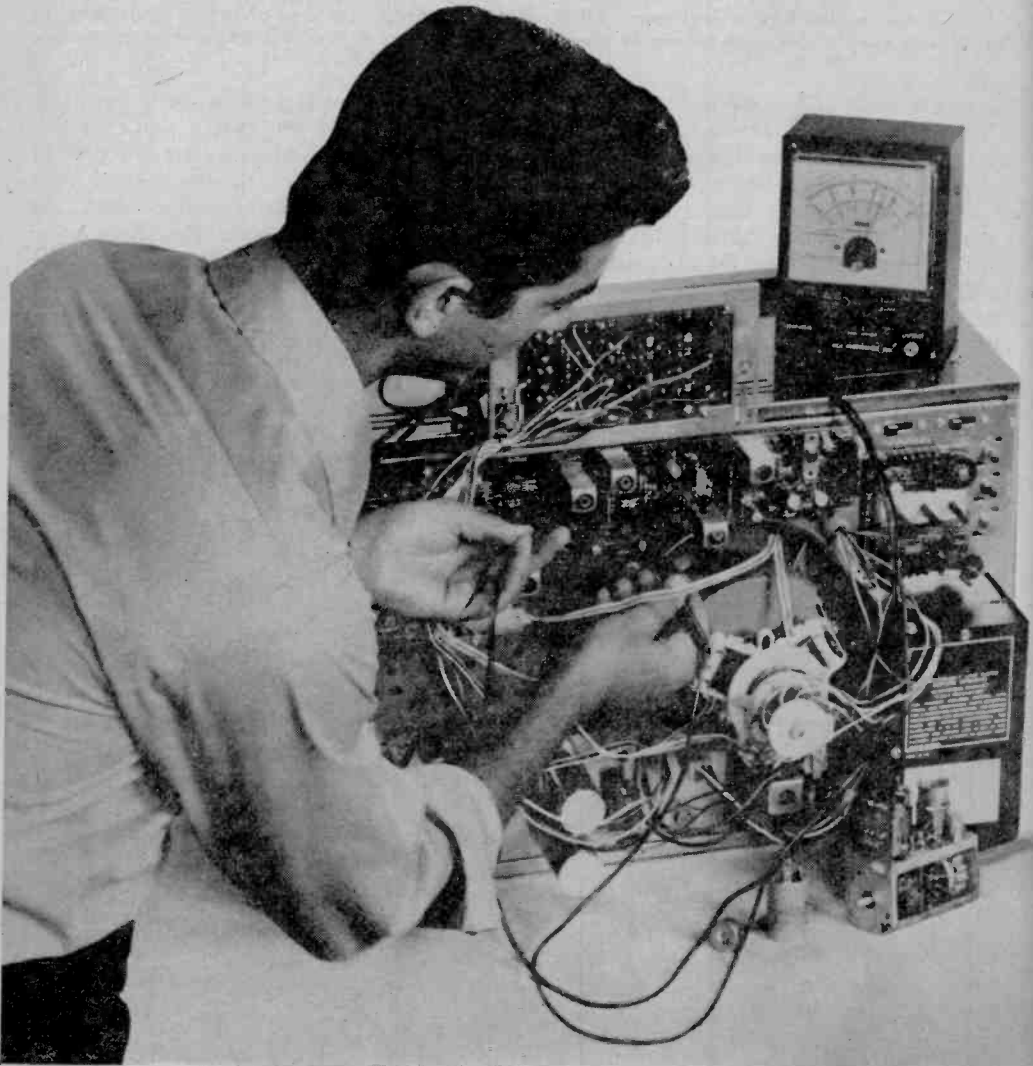

## 1 LEADER IN ELECTRONICS TRAINING

For over half a century, RCA Institutes, Inc., a subsidiary of RCA, has been a leader in resident school technical training in electronics. For many years, it has offered home study training in electronics.

## 2 RCA AUTOTEXT TEACHES ELECTRONICS RAPIDLY, EASILY

Beginner or refresher, AUTOTEXT, RCA Institutes' own method of programmed Home Training will help you learn electronics rapidly, easily.

## 3 WIDE CHOICE OF CAREER PROGRAMS

Start today preparing for an electronics career. On the attached card is a list of "Career Programs," each of which starts with the amazing AUTOTEXT method of programmed instruction. Look the list over, pick the one best suited to you and check it off on the card.

## 4 SPECIALIZED ADVANCED TRAINING

For those already working in electronics or with previous training, RCA Institutes offers advanced courses. You can start on a higher level without wasting time on work you already know.

## 5 PERSONAL SUPERVISION THROUGHOUT

All during your program of home study, your exams are reviewed and your questions are answered by RCA Institutes instructors who become per-

sonally involved in your efforts and help you over any "rough spots" that may develop.

## 6 HANDS-ON TRAINING

To give practical application to your studies, a variety of valuable kits are included in many programs. In RCA's Master TV/Radio Servicing Program, you will actually build and keep an all solid-state black and white TV set, and a color TV set. You also construct an oscilloscope which is yours to keep and use on the job.

## 7 FCC LICENSE TRAINING - MONEY BACK AGREEMENT

Take RCA's Communications Career Program - or enter with advanced standing and prepare immediately for your 1st, 2nd, or 3rd class FCC Radio Telephone License examinations. RCA Institutes money-back agreement assures you of your money back if you take, and fail to pass, the FCC examination taken within 6 months after completing the course.

## 8 CONVENIENT PAYMENT PLANS

You get a selection of tuition plans. And, we are an eligible institution under the Federally Insured Student Loan Program.

## 9 RCA INSTITUTES IS FULLY ACCREDITED

RCA Institutes is licensed by N.Y. State and is accredited by the Accrediting Commission of the National Home Study Council. Its courses of study, faculty and instructional facili-

ties are approved by the State Education Department. In addition, all RCA Institutes courses and programs require the approval of the RCA Institutes Board of Technical Advisers who represent various technical, research and educational activities of RCA Corporation.

Approved by N.Y. State Education Dept. for the training of veterans.

SEND ATTACHED POSTAGE PAID CARD TODAY! FREE DESCRIPTIVE BOOK YOURS WITHOUT OBLIGATION!

If reply card is detached, send this coupon

RCA INSTITUTES, INC.  
DEPT. 246-303-0  
320 W. 31 ST.  
NEW YORK, N.Y. 10001

Please send me FREE illustrated career catalog. I understand that I am under no obligation.

Name \_\_\_\_\_

Address \_\_\_\_\_

City \_\_\_\_\_

State \_\_\_\_\_ Zip \_\_\_\_\_

Age \_\_\_\_\_

Veterans: Check here

# RCA



In the Master TV/Radio Servicing Program, you build and keep the all solid-state black and white TV set, the color TV set, the oscilloscope and the multi-meter shown above.



## The Captain will get **X-RAY SUPER**

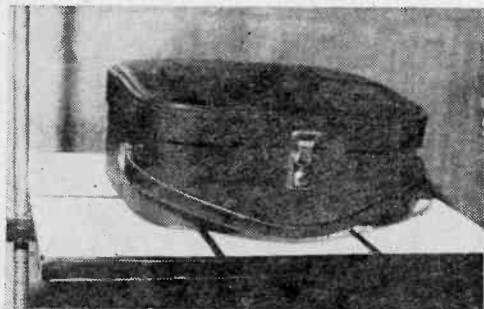

The harmless suitcase (above) is the carrier for a submachine gun and bomb (below) as x-rays indicate. Contents were simulated.

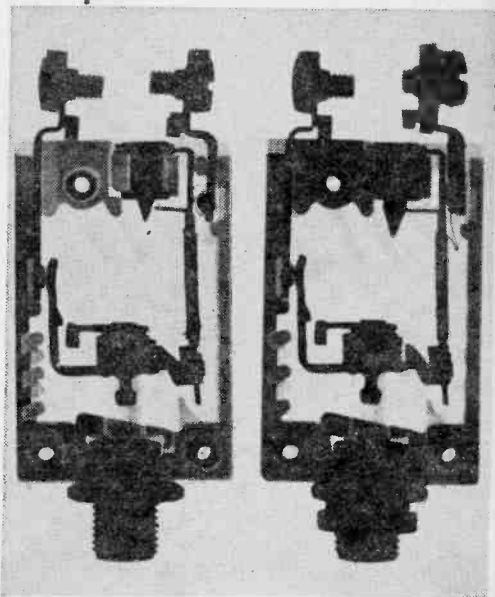
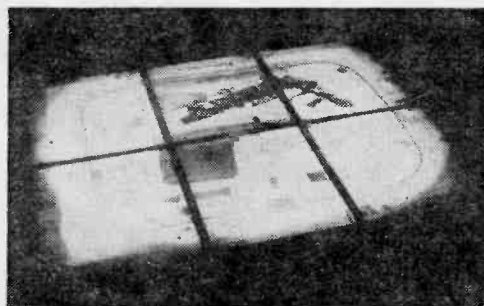

A peaceful application for the new x-ray technique offers industry a chance to quality control electrical parts. Try to find missing wire in circuit breaker (right).

The airport is busy, passengers jam the entrance ramp for a large jumbo jet on a holiday weekend, yet one man carefully checks each piece of luggage for dangerous contraband. In an instant he can spot a revolver, home made-bomb, any gadget a hijacker could possibly use. He sighs a relief as the final check is made seconds before the last passenger boards the plane. And all the credit goes to a new x-ray device which gives an instant positive image (black on white) of the contents of sealed packages, handbags, luggage, just about anything that can be carried or loaded onto an airplane.

The x-ray was the brain child of Dr.

Ranby who works for a leading English electronics firm. The x-ray plate works on the electroluminescent principle and has several advantages over the standard x-ray. The plates, which are portable and which need no processing, may be used in any existing x-ray apparatus. At the present time they are not suitable for medical use, as about four times the normal safe dose of radiation is required to produce an image. However Dr. Ranby's team is working this problem out at present.

Dr. Ranby said that he could foresee this positive instant image plate being used in the industrial as well as law enforcing

*you there because...*

# SNOOPER FOILS SKYJACKERS

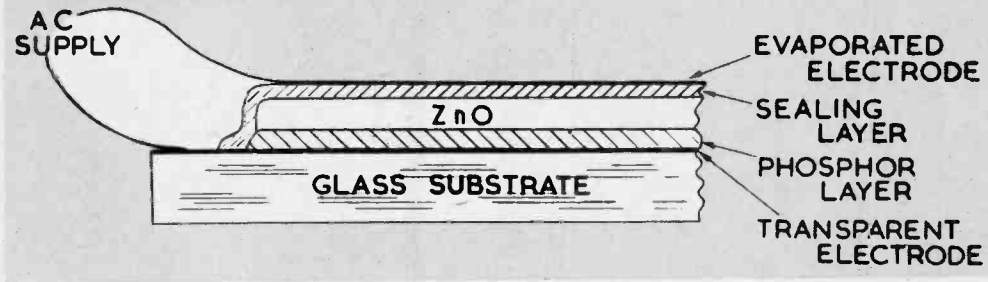

Dr. Ranby (left) and associate flex the pliable x-ray plate. Cross section of plate (above) must be viewed in subdued light.



The next time you climb aboard a jumbo jet, rest easy knowing that everything is being done to limit unauthorized trips to Cuba.

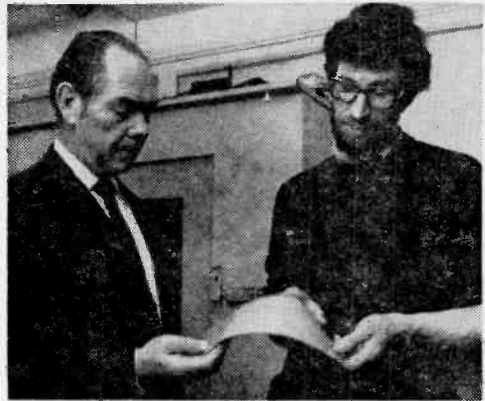

fields. They can be used to check the circuits in the engines of aircraft prior to take-off without having to strip the engines.

The plates are simple to use. The object wanted to be "looked into" is placed on a standard x-ray baseboard. The plate is placed under it and the exposure is made. The exposed plates are then connected to an electric current of direct current between 100 and 200 volts, 50-60 Hz. By increasing the voltage the contrast of the image, which lasts for about 30 minutes, can be changed.

Another feature of the plates is that they can be used time and time again. All the operator has to do is to expose the plate to

an infrared lamp for a minute or two. This wipes the surface clean of the image for re-use. A plate lasts for around the 1,000 uses—quite cheap considering the cost of about \$2.50 per square inch.

The plates are made of two substances—glass and plastic. It is the plates coating of chemicals that infact produces the image. The plastic versions can be bent to cover curved subjects—another feature that the standard x-ray does not have. Taking everything into account, it seems that Dr. Ranby has come up with what might well revolutionise the x-ray world. And Havana airport can return to normal procedures. ■

# THE WORLD'S BIGGEST DISH

It will tune in the Aliens...  
if any!

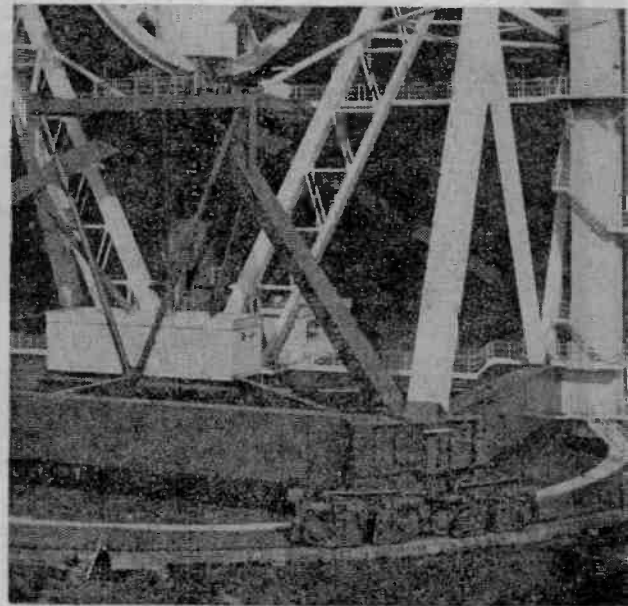
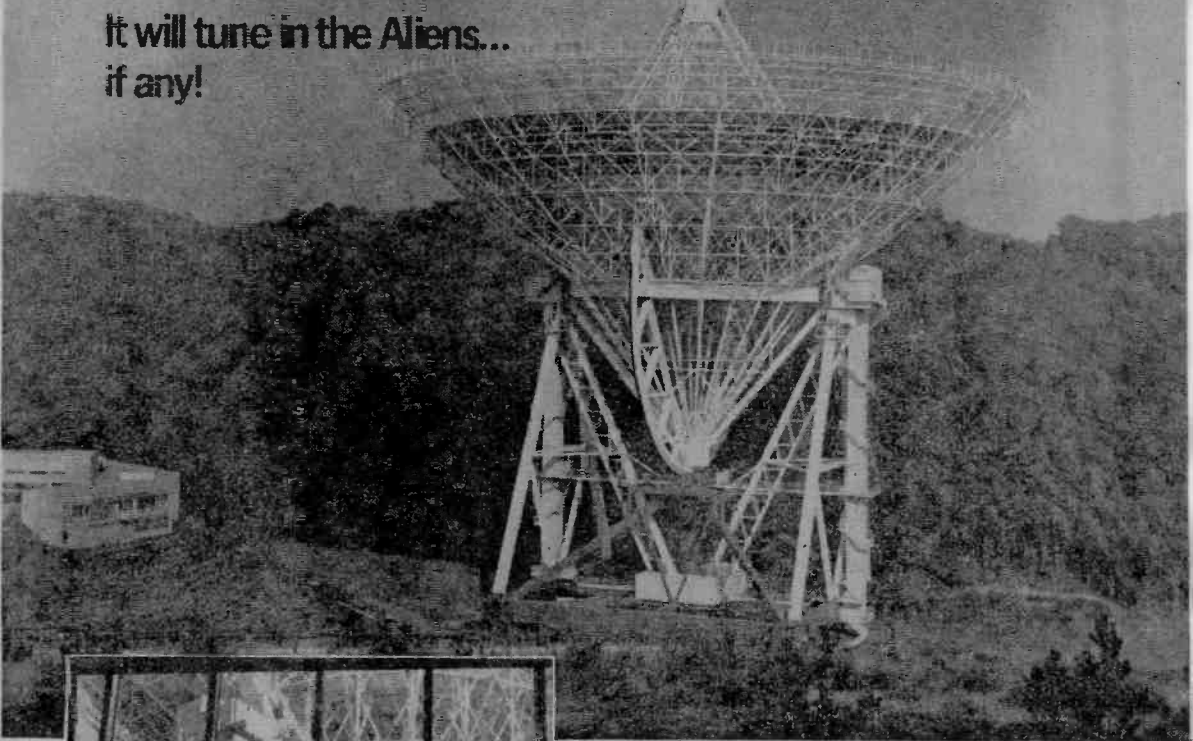

The Effelsberg radio telescope dwarfs the Eifel Mountains which surround it. One operator at the console can rotate the 3200-ton dish on its circular azimuth track, which diameter is approximately 208 feet. The antenna is supported by four sets of 8-wheeled bogies. You get an idea of its size by the heights of the three men near the track.



From the control building (left) the scientist sitting at the control console relies on television to see the entire structure. The precise time is important, too! Scientist (right) peeps into scope while adjusting local clocks to an atomic standard.

The world's largest free-moving radiotelescope stands not in America or Australia, but in the Eifel Mountains in Germany. Its receiving dish is so huge (100 meters—328 ft.) that it even dwarves the surrounding mountainside!

One of the biggest problems in constructing a large radio-telescope is in locating it where there is the least interference from earth-bound radio waves. This makes the location of the Max Planck Effelsberg 100-meter Radio Telescope so perfect. The fully steerable apparatus is located in the Eifel Mountains which act as a natural shield cutting down a great deal of the interference experienced by other giant radiotelescopes such as the famous British 75-meter Jodrell Bank dish.

Over the years scientists have learned more from radio astronomy than from visual observations of the Universe. Visual observations are limited largely due to the earth's atmosphere which blocks out detail, and until there comes a time when visual observatories are manned outside the earth's atmosphere, science is leaning more and more on the shoulders of radio astronomers. Radio waves can penetrate most forms of cosmic dust and gas formations, giving valuable details about non-visual observations at the edge and even beyond the end of our Earth Galaxy.

**It's On the Move.** The Effelsberg antenna is defined as a *fully-steerable paraboloidal*

*reflector*, which means that it can study a number of radio-wave-emission frequencies at one time. It can therefore be pointed at an exact location and with the aid of its guidance computers, it can remain fixed on that point right up to the time when the location disappears below the horizon. In radio astronomy computerisation only applies to the data collecting machinery.

The larger the receiving dish, the better the reception. Hence Effelsberg 100-meter dish, being the largest—is the most receptive and exciting in the world. Radio waves strike the dish and are reflected to a focus which is 30 meters out from the center point of the parabolic dish. At this point all the receiving apparatus are positioned and impulses received, are fed into the computer banks in the nearby control building.

**The Electronics Center.** This building houses a large curved control desk. Here the scientists position the dish to study the required area or location in space. At the mere touch of a button the 3,200 ton radiotelescope, which rides on a 64 meter diameter circular track, standing on four eight-wheeled bogies, moves a millimeter at a time. The movement is perfect without a judder or jolt, which might upset the delicate receiving equipment. The circular track is made to such perfection that a recent correction of 1.1 mm was made on the diameter, at a given point, making the circle 0.1 mm from perfect at this point.

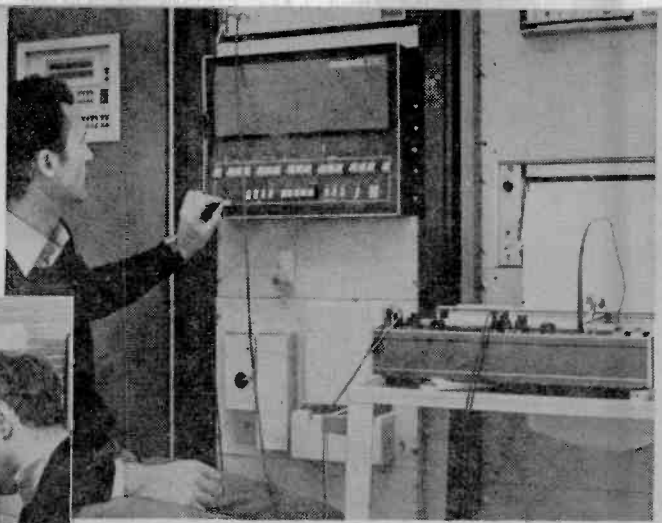
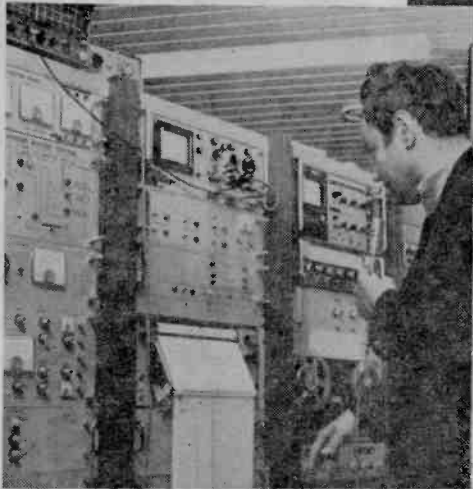

Radio astronomy concerns "sounds and not light transmissions." A scientist (left) observes chart print-out of radio waves received from space. In the spectrum-conversion room (top, right) a scientist studies the various frequencies received to determine what elements and compounds generated the radio waves. At right, the telescope at work, even in daylight.

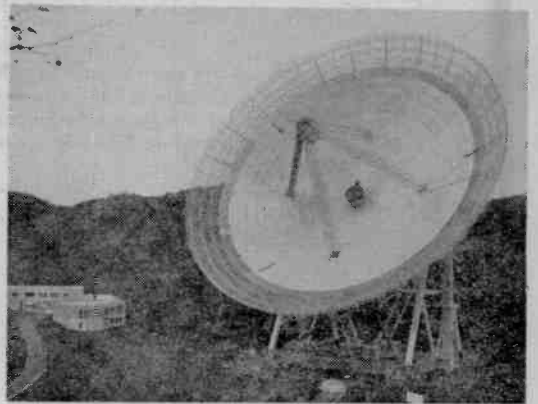

On the control desk are several television monitoring screens which give the astronomer views of the dish which the eye cannot see. The controller looks out of a huge window at the radiotelescope but, unless he presses his nose against the glass, he cannot see the entire structure, which is more than 100 meter tall when the dish is scanning the horizon.

**Vital Specs.** The dish rotates in elevation between 5 and 94 degrees, at a maximum rate of 20 degrees per minute. It spins round on its (azimuth) circular track at a rate of 40 degrees per minute. And all these movements can be made at once from the control building.

The telescope is constructed as a *Gregorian reflector* which means that it can operate both: prime focus work and secondary focus work at the same time. The focal length is the distance from the dish to the receiver which is 30 meters. To help reduce interference a collar was added round the edge of the dish. With the aid of boosters

the effective Gregorian focal length is 360 meters. As the dish is a multi-beam receiver, the dish's surface consists of different materials, each acting as an individual radio-telescope. From the center point to a 60-meter diameter aluminium honeycomb panels 2 millimeters thick glued to a 10 cm thick honeycomb base are used. The 60 to 80-meter diameter reflector band is made of what is called cassette panel aluminium, also 2 millimeters thick. The 80 to 85-meter ring is made of cassette type structure using perforated aluminium sheeting.

The outer mesh is made of stainless steel 6 mm squares—each adjustable with corner screws to make sure that the reception is perfect. The dish is fitted to two A-frame towers, which bring the elevation axis 50 meters above the azimuth track.

With the help of many different types of radio astronomical filters the Effelsberg 100-meter telescope is opening vast new areas of study into the formation and happenings of our galaxy and other galaxies. ■



# HEY HERB

## THE AUDIO ANSWER MAN

by Herb Friedman



**Hey Herb:** I'd like to give 4-channel a try but my stereo rig is an inexpensive Leeds purchased at the local department store. It has a record player but no other inputs. Have you any circuits for cutting in a 4-channel adapter?

*No way!* But you could use a Lafayette SQA-50 4-Channel SQ Decoder/Amplifier. This device is a 4-channel amp that takes drive from inexpensive receiver or amplifier speaker outputs. You use your original two speakers plus two new ones. The SQA-50 provides for SQ decode and discrete 4-channel aux inputs. Total power output for all four channels is about 9 watts, about the same per channel as inexpensive "stereo players." Basically, the overall sound quality will equal your present equipment.

**Hey Herb:** The new Harman-Kardon HK-1000 cassette recorder claims to have peak reading VU meters. Just what is a peak reading meter?

*In order to obtain high signal to noise ratios and a "loud" output signal, cassette equipment was referenced at O-VU record level to tape saturation—about 2% THD. The peaks of every signal showing O-VU record level drives well into saturation because VU meters are damped, showing from 6 to 10 dB less than the true signal peaks. The cassette reference level was a stupid idea from the beginning, and someone should have thrown the standard out a long time ago. To avoid the tape saturation problem Harman-Kardon uses meters that show the true program level peaks (not damped); the equivalent "VU" record level is really from 6 to 10 dB below tape saturation and overall distortion is very low. Fact is, to my ears the HK-1000 turns out a cassette recording the equal of many good reel-to-reel machines.*

**Hey Herb:** What magnetic pickups would you suggest for playing matrix 4-channel records?

*Any good stereo pickup is a good matrix pickup. Occasionally I find a particular pickup is notably good with a specific recording, but on another recording a different pickup gives optimum results. I can't explain why (because I don't know).*

**Hey Herb:** Why do most magazines seem to give a big play to SQ recordings? What happened to the other matrix systems, and why is there little

mention of the RCA discrete recordings? Isn't true discrete a better system?

*Last things first, the CD-4 discrete system has remained the best kept secret since the D-Day invasion plans. Every writer, or editor, or anyone whose fingers get in contact with a typewriter key is buried under press releases concerning matrix SQ. We also get SQ test records and SQ equipment to try. But even pounding on the door won't unstick the CD-4 discrete equipment. Occasionally a piece of CD-4 equipment shows up in someone's hands. But if we can't hear it we can't write about it. The same is to some extent true of some matrix systems. Like all wars, the winner is usually "firstest with the mostest."*

**Hey Herb:** What is meant by "logic" or "wavematching"?

*They are terms applied to matrix decoders. The basic matrix systems were rushed out too early; they all suffer from reduced quadrant separation which requires a listener to favor a centralized listening location (with a lot of psychoacoustic effect). Logic and wavematching circuits sense the predominant program information and alter the quadrant gain to favor a particular sound orientation. The full-logic control—which includes wavematching—can provide an almost discrete-appearing 4-channel effect. The Lafayette LR-4000 4-channel receiver is perhaps the finest example of full-logic matrix decoding. I suggest you give one a listen and hear matrix as it should be done. My personal opinion is that no matrix system or equipment should have been released until the performance level was at least equal to that in the LR-4000. (I just don't go for psychoacoustic effects, though many listeners are well pleased with basic, non-logic matrix performance.)*

**Hey Herb:** What is meant by the term "S-O-S" as applied to tape recorders?

*S-O-S stands for sound-on-sound, and generally means a stereo recorder with individual track recorder interlocks that permit one track to be played while another is recorded. The sound from the playback track can be mixed with another sound source such as a microphone and recorded on the second track; hence the term "sound-on-sound."*

*(Continued on page 100)*

# Four Ways To 4-Channel



◀ Sansui 4-Channel Converter/Amplifier. Owners of existing two-channel stereo systems need add only the QS500 and a pair of rear-channel speakers to be able to accommodate all forms of 4-channel reproduction—discrete, matrixed or synthesized—on discs, tape or FM broadcasts. The Sansui QS500 synthesizer/decoder/amplifier is \$289.95. Circle No. 60 on the Reader Service Page.

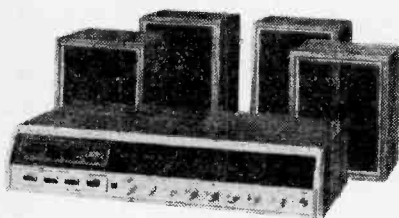

◀ The Motorola FH410HW AM/FM-stereo receiver reproduces discrete and synthesized 4-channel information from any input source, and is \$275.00, including four speakers. Optional adapters enable playing 4-channel discrete FM broadcasts (when available) or disc. Circle No. 58 on the Reader Service Page.

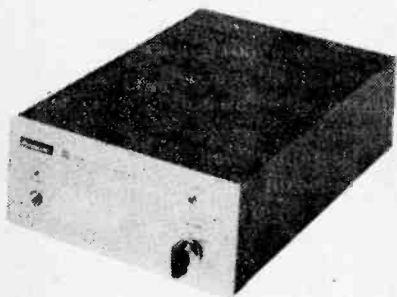

◀ The Panasonic SE-405 demodulator reproduces 4-channel stereo sound from discrete 4-channel disc. It comes with a semiconductor phonograph pickup, the EPC-460C; high-quality magnetic pickups may also be used. The SE-405 may be used with any 4-channel amplifier, and is \$134.95. Circle No. 56 on the Reader Service Page.



◀ Lafayette's LA-150 160-watt stereo amplifier (\$149.95) features a synthesizer circuit that provides derived 4-dimensional sound from regular 2-channel stereo program sources when a pair of rear speakers are added. Controls include Bass, Treble, Volume/Balance, Mode Selector, Input Function Selector, and Speaker Mode. Circle No. 69 on the Reader Service Page.

# a DX central project

# SUPER DX<sub>ER</sub>

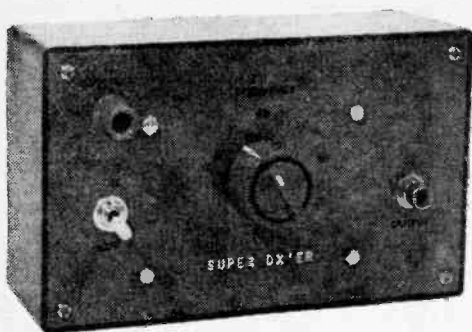

Our outboard rig makes QSL waves—  
adds 20 dB minimum gain  
to any shortwave receiver

**C**AN YOU REMEMBER back to the early days of TV—back to the mid and late 1940's—when the Jones' who had the only TV in the neighborhood would strain to clean-up a snowy, flickering picture by adjusting a “booster” that sat on the top of their 12-in. phosphor cyclops?

Well, more often than not, those outboard boxes, with their 6J6's in push-pull tuneable circuits, didn't amount to the proverbial hill-of-beans! Those World War II vintage tubes were not well suited to the new-fangled wide-band requirements of TV. But later on as the technology advanced, and more powerful transmitters were built, good, solid pictures became the rule.

Unlike old TV boosters, today a good booster for short wave receivers, a preselector, can be designed with all the advantages of the latest solid-state devices—and, to boot, can be simple and very easy to build. It's the easiest way to turn any receiver into an even hotter signal sniffer. You use a booster (a very high gain RF amplifier) between the antenna and the receiver antenna terminals. A good one will also provide sharp image rejection by adding a relatively hi-Q circuit to the receiver input. Image signals (that often take the pleasure out of receivers with low frequency single-conversion IF amplifiers by jamming desired signals) vanish as if by magic when passed through a hi-Q booster or preselector. In short, a top quality super booster such as e/e's SUPER DXER, will add another dimension of performance to any SW receiver.

**What It Can Do.** The SUPER DXER provides from 20 to 40 dB of signal boost—the exact amount is determined by the particular input characteristics of your receiver.

Figuring on 6 dB per S-unit, that's an increase of better than 3 to 6 S-units. In plain terms, the SUPER DXER will bring in stations where all your receiver will pick up running barefoot is its own noise.

The SUPER DXER's input is a diode protected FET (field effect transistor); the protection diodes are built into the FET so that excessively strong input signals, and even static discharges, will not destroy Q1. Since the FET input impedance is many thousands of megohms, there is virtually no loading of the L1/C1 tuning circuit; its “Q” remains high and provides a very high degree of image-signal attenuation.

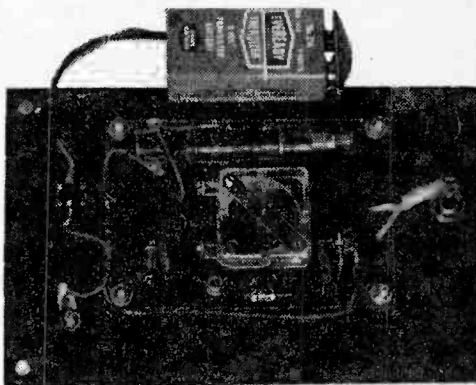

**Add an extra 20+ dB gain to your shortwave receiver. Simple kit-of-parts is available. You supply just the outer case and a knob. Note: Wrap J1 ground wire as shown above.**

The SUPER DXER output circuit is a low impedance emitter follower, and it will match, with a reasonable degree of performance, just about any receiver input impedance. As long as your receiver has two antenna terminals, one “hot” and one ground, you can use the SUPER DXER.

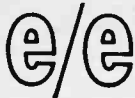

## SUPER DX'ER

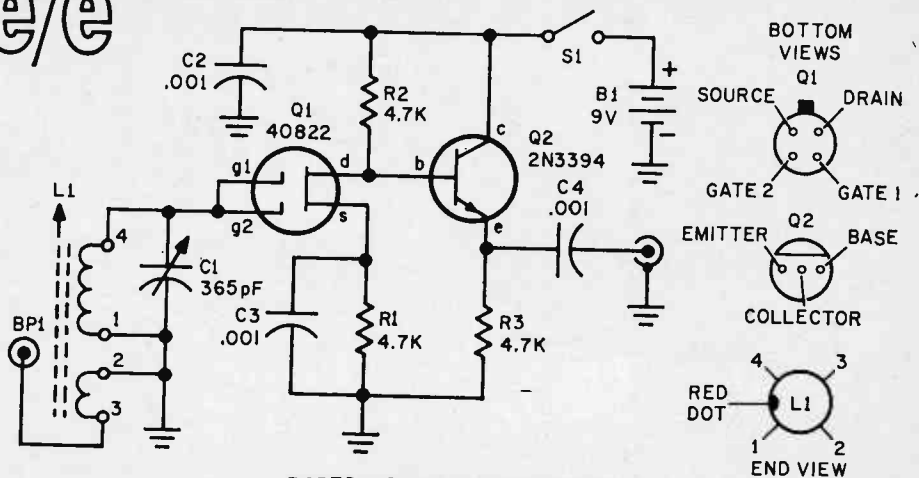

### PARTS LIST FOR SUPER DXER

- B1—9-volt battery (Eveready 216 or equal) and connector
- BP1—Insulated binding post
- C1—365 pF tuning capacitor, subminiature
- C2, C3, C4—0.001 uF ceramic disc, 25 VDC or better
- J1—RCA type phono jack
- L1—5-20 MHz antenna coil, Custom Components SW-520
- Q1—MOSFET, RCA 40822

- Q2—NPN transistor, 2N3394
- R1, R2, R3—4700-ohms, 1/2-watt resistor
- S1—Switch, SPST (power on-off)

A kit of all the above components including the printed circuit board is available from the Electronic Hobby Shop, Box 587, Brooklyn, N.Y. 11202. Price of \$18.95 includes postage. Canadians add \$2. New York State residents must add sales tax. No foreign orders. Postal Money Order speeds delivery.

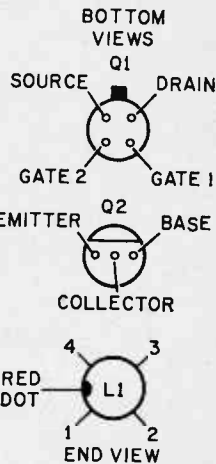

Optimum performance will be obtained if your receiver is equipped with an antenna trimmer. Just as the antenna trimmer peaks the receiver for use with any type of antenna, so too does it add something extra when matching the SUPER DXER.

**Set Bandpass.** The SUPER DXER has a tuning range of slightly more than 3-to-1 between 5 and 21 MHz. That means if the low end is set to 5 MHz, the upper limit will be slightly higher than 15 MHz (3 times 5). If the lower limit is set at 7 MHz, the upper frequency limit will be slightly higher than 21 MHz. Since the slug in tuning coil L1 is adjustable, you can select any operating range between 5 and 21 MHz.

SUPER DXER, though a very high gain device, is absolutely stable if built exactly as shown and described. There will be no spurious oscillations or response. It is possible that changes in the component layout or construction will result in self-oscillation at certain frequencies; hence, make no modifications or substitutions unless you are qualified.

**Getting Started.** Your first step is to prepare the printed circuit board. Using steel wool and a strong household cleanser such

as Ajax or Comet, thoroughly scrub the copper surface of a 2 1/4-in. x 3 1/4-in. copper-clad board. Any type will do—epoxy or fiberglass; the type of board is unimportant. Rinse the board under running water and dry thoroughly.

Cover the copper with a piece of carbon paper—carbon side against the copper—and place under the full-scale template we have provided. Secure the PC board in position with masking tape. Using a sharp pointed tool such as an ice pick, indent the copper foil at each component mounting hole by pressing the point of the tool through the template and carbon paper. Next, using a ball point pen and firm pressure, trace the foil outlines on the template.

After all foil outlines have been traced, remove the PC board from under the template and, using a resist pen, fill in all the desired copper foil areas with resist. Make certain you place a dot of resist over the indents at each of the corner mounting holes. Pour about one inch of etchant into a small container and float the PC board—copper foil down—on top of the etchant. Every five minutes or so gently rock the

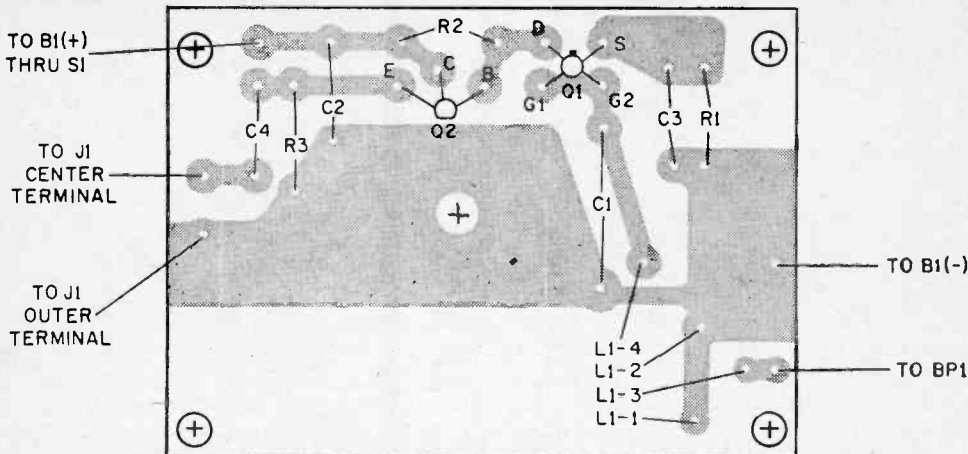

For exact part placement on PC board, see diagram above. View is from component (top) side of your Super DXer board. Layout below shows a completed Super DXer. Pins 3 and 4 of the dual winding coil L1 are shown in an end view for clarity.

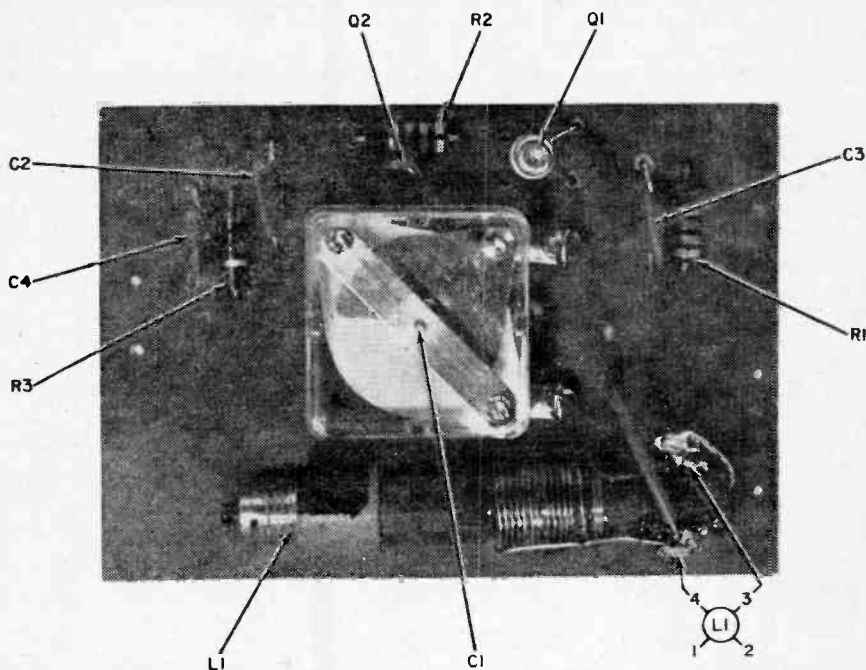

container to agitate the etchant. After 15 or twenty minutes check the PC board to see if all the undesired copper has been removed. When every trace of the undesired copper is gone, rinse the board under running water, and then remove the resist with steel wool or a resist "stripper."

**Continue.** Drill out all the mounting holes marked by an indent with a No. 57, 58 or 59 bit—this includes the corner mounting and C1 mounting holes. Then

drill the corner mounting holes for a #6 screw, and use a  $\frac{3}{16}$ -in. bit for the C1 mounting hole.

Install tuning capacitor C1 first. Tuning capacitor C1 should be the type provided in the kit of parts. It has a plastic dust cover and a long shaft. Do not use the type supplied with a short shaft to which a tuning dial for the broadcast band can be attached. Remove the mounting nut and ground washer from C1's shaft. Then make

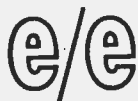

## SUPER DX'ER

certain the shaft's retaining nut is tight. It is usually supplied loose. Discard the ground washer and secure C1 to the PC board with the mounting nut. Then install tuning coil L1. Make note of two things about L1. The terminal end of L1 has a large red dot (ignore any other marks). L1 must be positioned so the red dot faces the bottom edge of the PC board—the edge closest to the coil. Also note that the lug connected to the top of the fine-wire primary is adjacent to the bottom of the heavy-wire secondary. When the red dot is facing the edge of the PC board, both these lugs are against the board. Solder the lugs to the matching holes in the PC board. Use the shortest possible length of wire to connect the remaining primary (fine-wire) terminal to the antenna input printed foil. Connect the remaining L1 terminal (heavy wire) to its matching hole with solid, insulated wire—form a right angle bend in the wire so it doesn't touch L1. Now mount the remaining components.

**Orienting Q.** Note that Q1 is positioned properly when the small tab on the case faces the nearest edge of the PC board. Also note that the round edge of Q2 faces the nearest edge of the PC board. The flat edge of Q2's case should face C1.

Because the printed copper foil faces the front panel when the assembly is mounted in the case, and is therefore inaccessible for soldering, the connecting wires to front panel components should be installed at this time. Solder 6-in. solid, insulated wires to

the antenna, output and output ground, and + 9V foils. Solder the negative (usually black) wire from the battery connector to the ground foil.

The SUPER DXER is mounted in a standard plastic or Bakelite case approximately 6 $\frac{3}{8}$ -in. x 3 $\frac{3}{16}$ -in. x 1 $\frac{7}{8}$ -in. The front panel must be aluminum. If the cabinet is not supplied with an aluminum panel, obtain an optional or accessory metal panel. Do not use a plastic panel.

Drill a  $\frac{3}{8}$ -in. hole in the center of the front panel. Position the PC assembly over the hole with C1's shaft fully inserted through the hole, and mark the locations for the four PC board mounting screws. Drill the panel and temporarily secure the PC board to the panel. Then locate the positions for power switch S1, antenna input binding post BP1 and output jack J1. Make certain J1 is as close to the PC board output terminals as is possible—within 1 $\frac{1}{2}$ -in.

Remove the PC board and drill the holes for the panel components. Power switch S1 can be any inexpensive SPST type such as a slide switch. Install the panel components and then the PC board. To prevent the copper foil on the underside of the PC board from shorting to the panel place a  $\frac{3}{8}$ -in. plastic or metal spacer, or a stack of washers, between the PC board and the panel at each mounting screw. Connect the panel components to the appropriate wires extending from the PC board and the SUPER DXER is ready for alignment.

**Alignment.** Prepare a length of 50 or 52 ohm coaxial cable (such as RG-58) that will reach from the SUPER DXER's output jack to the receiver antenna input terminals.

*(Continued on page 102)*

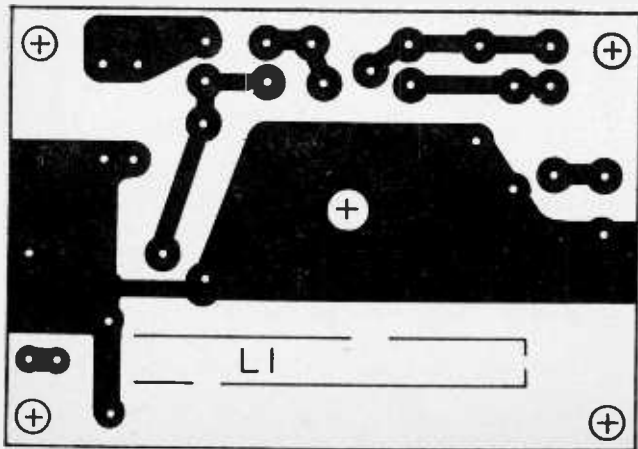

Exact PC board size. Transfer image to copper clad board using carbon paper. This is the bottom (copper) side of your board. Mount it to the front panel with  $\frac{1}{4}$ -in. spacers between board and panel at each mounting screw. Secure the battery to the back of the cabinet with tape.

# E/C's

## ALL NEW BASIC COURSE in ELECTRICITY & ELECTRONICS

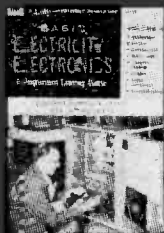

This series is based on  
**BASIC ELECTRICITY/ELECTRONICS,**  
Vol. 4, published by  
**HOWARD W. SAMS & CO., INC.**

## UNDERSTANDING MULTIMETERS PART 2

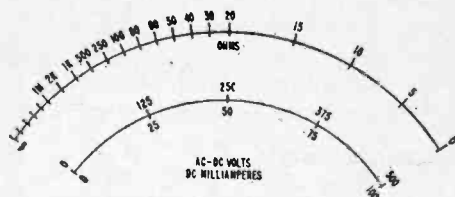

**W**hat you will learn. With this course you can become familiar with the multimeter—the instrument most frequently used by electronic technicians and engineers. It is a basic course that introduces you to the function, internal-workings and operation of the Volt-Ohm Milliammeter (VOM) type of multimeter. In Part 1 of this course, you became familiar with how multimeters work. In Part 2, you will learn how to properly use the instrument for its intended purpose (the transfer of information from the circuit to the technician) by learning how the function and range circuits work during actual measurements.



## USING THE OHMMETER

The basic procedures for measuring resistance are the same for all multimeters. First, set the meter to read ohms. Plug the test leads into the proper jacks. Hold the tips of the test probes together, thus placing a short (zero ohms) across the internal circuit. Turn the zero ohms adjust (sometimes labeled zero adjust) control until the meter pointer rests at zero on the ohms scale.

Each time the meter is set for reading ohms and each time it is switched to a new range, short the test probes and zero the pointer with the ohms adjust control. Never use an ohmmeter to take a resistance reading across an energized circuit. The internal circuit is designed to carry only the current developed by its own battery. Voltage from an external source will usually be larger than this value and will damage either the meter coil or the pointer.

## MULTIMETER CIRCUITS

Understanding how function and range circuits work is important in learning how to use a multimeter properly. Studying these circuits will also help develop your skill in analyzing electronic circuits. For these reasons, multimeter circuits will be studied a portion at a time. As each is discussed, it will be added to the preceding portions until a typical multimeter is developed. Each portion will be diagramed either with a rotary range switch, or as it might appear employing pin jacks.

### Milliammeters

The following schematic diagram shows a typical DC milliammeter circuit with rotary-switch connections. Resistor values are not shown. They will vary according to the multimeter.

#### DC MILLIAMMETER CIRCUIT CURRENT FLOW

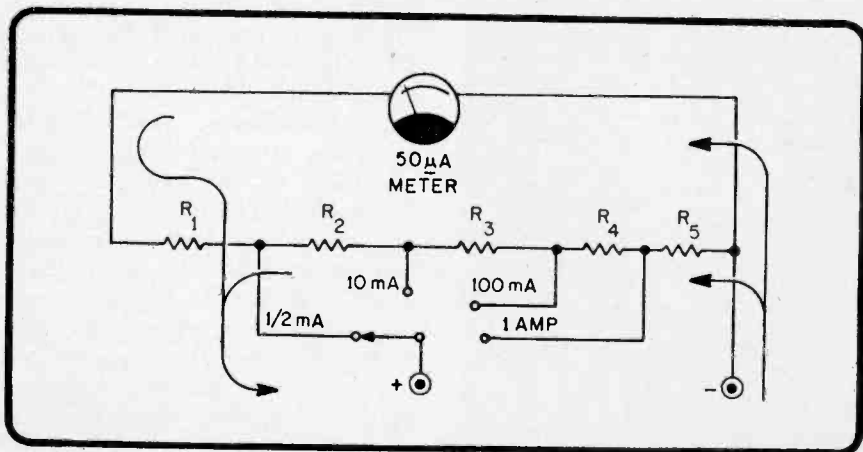

Notice that the arrangement is a parallel circuit in which the resistance can be changed in both branches by rotating a switch. Since the meter has a  $50 \mu\text{A}$  movement (full-scale deflection), the ratio of resistances must be such that  $50 \mu\text{A}$  will be the maximum current flowing in the meter branch at each switch setting.

How much of the total current ( $0.5 \text{ mA}$ ) must flow through the shunt?  $500 \mu\text{A}$  ( $0.5 \text{ mA}$ ) minus  $50 \mu\text{A}$  (maximum meter current) equals  $450 \mu\text{A}$ . This means that the ratio of shunt current to meter current must be maintained at 9 to 1. Therefore, the shunt resistance must be  $1/9$  of the resistance in the meter branch. With some meters, resistor  $R_1$  is included as a part of the basic meter movement to increase its resistance. This is sometimes necessary so



that the shunt resistance for the high-current ranges will not be unreasonably small.

**QUESTION**

Q1. What is the ratio of shunt current in this circuit?

**ANSWER**

$$A1. \frac{I \text{ (shunt)}}{I \text{ (meter)}} = \frac{9,950 \mu A}{50 \mu A} = \frac{199}{1}$$



**Shunt Ohmmeters**

In the drawing below,  $R_M$  represents meter resistance.  $R_A$  is the *ohms adjust* control and is used to set the pointer to zero reading (full-scale deflection). In the  $R \times 1$  range,  $R_M$ ,  $R_A$ ,  $R_6$ ,  $R_7$ , and  $R_8$  form one branch of a parallel network;  $R_9$  forms the other.

The shunt permits external resistances of low values to be read with reasonable accuracy. Without it, the measured resistance would be in series with the resistance in the meter branch, and the same current would flow through all resistances. The total resistance would thus have to be large to limit current flow to the maximum level of  $50 \mu A$ . As a consequence, slight changes of current due to small changes in measured resistances would cause only tiny changes in pointer movement. Markings would be very close together.

**CURRENT FLOW IN OHMMETER CIRCUIT FOR  $R \times 1$  RANGE**

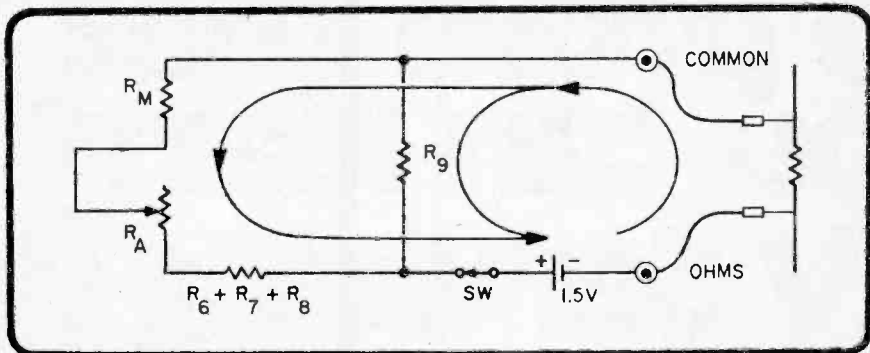

An external resistance equal to the internal circuit resistance would bring the pointer to midscale. With a  $50\text{-}\mu A$  meter and a 1.5-volt battery, Ohm's law shows that the internal resistance must be 30,000-ohms for full-scale deflection, or zero reading. 30,000-ohms of external resistance would halve the current flow and provide a midscale reading. On the  $R \times 1$  range, measurements between 0 and 30,000-ohms would be distributed on one half of the scale and readings would be difficult to estimate with accuracy.

Placing a shunt in the circuit provides a low-resistance current path around the meter branch. Most multimeters using this design have a midscale reading of 10 to 30-ohms, permitting greater accuracy in reading the scale markings.

A typical value for  $R_9$  is 11 or 12-ohms. In round figures, the total resistance of the parallel network would then be about 10-ohms. With the terminals shorted, the 1.5-volt battery will cause a total current ( $I_T$ ) of 0.15 amp ( $150,000 \mu A$ ) to flow. Since maximum current for the meter is  $50 \mu A$ , one part in 3,000 ( $50/150,000$ ) of the total current will flow through the meter branch. The remainder (2,999 parts) flows through  $R_9$ , the shunt path.  $R_A$  is used to adjust the meter branch resistance to produce a 2,999/1 ratio.

When the pin jack position is moved from  $R \times 1$  to  $R \times 10$ , the resistances in the parallel network are redistributed. Compare the schematic with the  $R \times 1$  circuit on the above schematic. The resistance is increased in the shunt branch and decreased in the meter

(Continued on page 94)

**Let ICS mail  
you a FREE  
demonstration  
lesson without  
obligation...  
to prove that  
you can learn  
TV Servicing  
at home.**



Credit towards a Certified Electronic Technician (C.E.T.) rating will be granted by the National Electronics Association to ICS students upon completion of the ICS Career Program in TV Service/Repair.

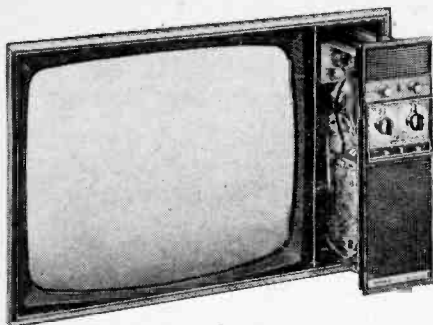

## Practice on a new 25" MOTOROLA QUASAR II® chassis.

TV Servicing is a satisfying career . . . and the pay is great. Qualified men are needed now to maintain the 93 million sets in U.S. homes. And prospects for the future are even brighter.

Now . . . here's an opportunity for you to prove to yourself that *you* can learn TV Servicing . . . at home, in your spare time. ICS, the world's most experienced home-study school, will send you a **FREE** Demonstration Lesson (complete with sample questions) if you will merely fill out the coupon below and mail it to us.

In addition to your free demonstration lesson, we'll send you . . . also **FREE** . . . a brochure that describes the 25" (diagonally measured screen) MOTOROLA QUASAR II® Color TV chassis that we include in our TV Service Training Program.

This chassis with automatic fine tuning control is ideal for training purposes because it combines solid state devices with vacuum tubes to give you both kinds of practical experience. All parts carry Motorola's two year replacement guarantee!

The QUASAR II chassis comes to you in three basic sub-assemblies . . . **NOT AS A KIT** . . . because we want you to learn how to *repair* TV sets, not build them.

Our free literature also describes the fully assembled test equipment you receive such as the Deluxe 5" Solid State Oscilloscope, the tools and the learn-by-doing kits, all of the finest quality.

And we're going to tell you about eight other career opportunities in Electronics and the ICS Career Programs that can help prepare you for them.

All you've got to do is mail the coupon.

**SEND IT TODAY!**

# ICS

International Correspondence Schools  
Since 1890  
School of Electronics  
Scranton, Pa. 18515

Canadian residents use above address for service from ICS Canadian, Ltd. In Hawaii use Post Office Box 418, Honolulu.

Approved for veterans under the new GI bill/approved for federally insured loans/Accredited by the Accrediting Commission of the National Home Study Council.

ICS School of Electronics  
Scranton, Pa. 18515

Dept. BA-201-0

YES, I want you to mail to me without obligation, the **FREE DEMONSTRATION LESSON** and complete literature on the career program checked below. (Please check one.)

- |   |  |
|---|--|
| <input type="checkbox"/> Color TV Servicing   | <input type="checkbox"/> FCC License                     |
| <input type="checkbox"/> Computer Maintenance | <input type="checkbox"/> Communications/<br>Broadcasting |
| <input type="checkbox"/> CATV Installation    | <input type="checkbox"/> Hi-Fi Sound Systems             |
| <input type="checkbox"/> Telephony            | <input type="checkbox"/> Industrial Electronics          |

Name \_\_\_\_\_ Age \_\_\_\_\_

Address \_\_\_\_\_

City \_\_\_\_\_

State \_\_\_\_\_ Zip \_\_\_\_\_

CIRCLE NO. 18 ON PAGE 17 OR 103



(Continued from page 89)

branch.  $R_{12}$  is added as a current-limiting resistance.  $R_{12}$  in the  $R \times 10$  circuit will allow less current to flow than in the  $R \times 1$  circuit. You saw that maximum  $I_T$  in the  $R \times 1$  circuit would be near  $150,000 \mu A$  if the

### DC VOLTMETER CIRCUITS AND CURRENT FLOW

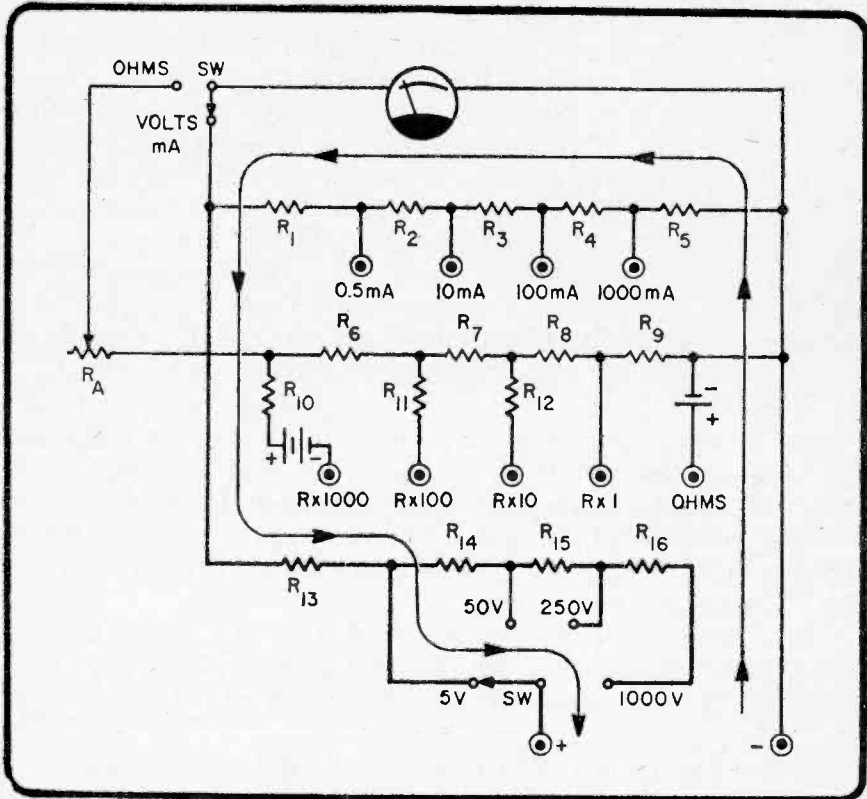

parallel network had a resistance of 10-ohms. Suppose the resistance of the parallel network in the  $R \times 10$  circuit is approximately 100 ohms and  $R_{12}$  is 10-ohms. The 1.5-volt battery is then in a circuit having a total resistance ( $R_T$ ) of 110 ohms. The total current with test leads

### OHMMETER CIRCUIT FOR R X 10 RANGE

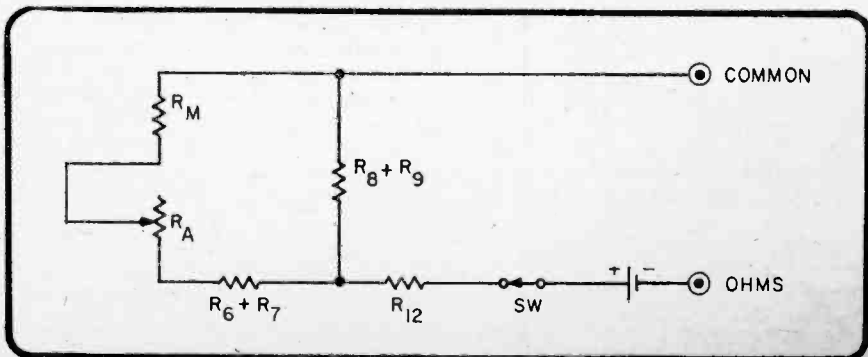

shorted would approach  $15,000 \mu\text{A}$ . Since  $I_M$  must be  $50 \mu\text{A}$ ,  $50/15,000$  or  $1/300$  of the total current flows through the meter.

### CURRENT FLOW IN COMPLETE DC VOLTMETER CIRCUIT

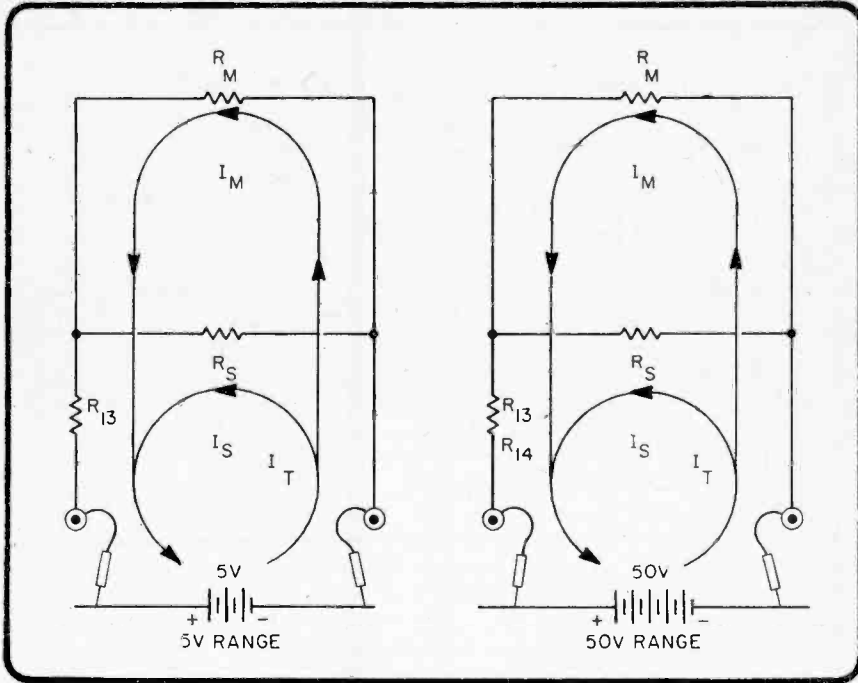

### DC Voltmeter Circuits

The figure shows a typical DC voltmeter circuit added to the circuit of the DC milliammeter and ohmmeter.

As you can see, the DC voltmeter circuit is a network of three resistors in series with the meter-shunt resistor combination. Simplified schematics for the 5 and 50 volt positions are shown in the diagrams.

In the 5 volt position, current flows through  $R_{13}$  and the meter-shunt network. The  $50 \mu\text{A}$  meter has a coil resistance of 2,000-ohms. Since  $R_S$  is very close to the same value, it can be assumed that the total resistance of the parallel network is 1,000-ohms. What must  $R_{13}$  be for a full-scale reading of 5 volts? If  $R_M$  and  $R_S$  are equal,  $I_M$  and  $I_S$  are also equal. Therefore, for  $I_M$  to be  $50 \mu\text{A}$ ,  $I_T$  must be  $100 \mu\text{A}$ .  $R_T$  equals  $5\text{V}/100 \mu\text{A}$ , or 50,000-ohms. Subtracting 1,000-ohms,  $R_{13}$  is 49,000-ohms. To find the value of  $R_{14}$ , apply the same reasoning.

### QUESTIONS

- Q2. If 3.7 volts is measured using the 5 volt circuit, how much current will flow through the meter?
- Q3. If  $R_{14}$  decreases in value, will the 50 volt range read high or low?
- Q4. What is the value of  $R_{15}$  (250 volt circuit)?
- Q5. What is the value of  $R_{16}$  (1,000 volt circuit)?

### ANSWERS

- A2.  $37 \mu\text{A}$ .  $I_M = \frac{1}{2} I_T$  ( $74 \mu\text{A}$ )
- A3. The meter will read high.
- A4. 2 megohms
- A5. 7.5 megohms



## AC Voltmeters

The diagram shows an AC voltmeter circuit. The four multiplier resistances are connected as in the DC voltmeter, but there are differences.

### AC VOLTMETER CIRCUIT CURRENT FLOW

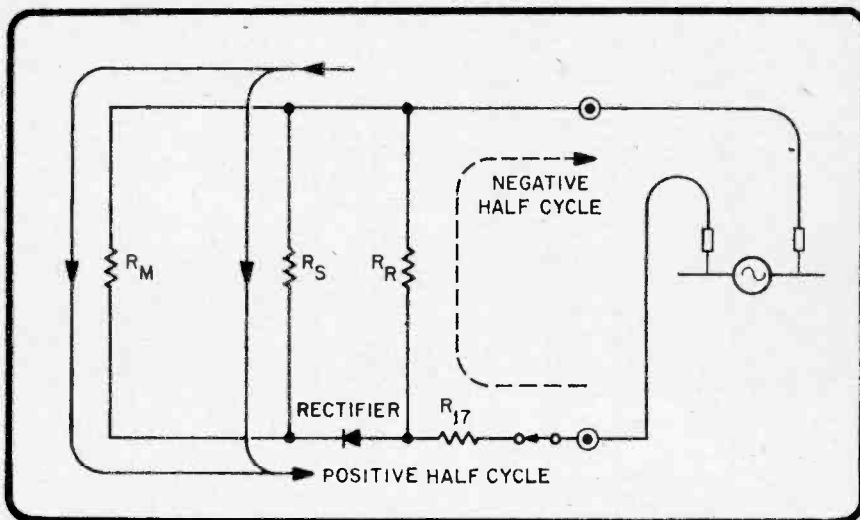

When the polarity of the measured voltage is positive at the plus terminal, current will flow as indicated. It will pass through the rectifier. When the voltage swings in the negative direction, current flow will reverse. The rectifier offers a high resistance to current in this direction. Therefore only a very small amount of current can flow through the meter during this part of the cycle. Consequently, the meter receives a pulsating DC, and the pointer is deflected. If an alternating current passed through the meter in both directions, the pointer would remain at zero.

The rectifier resistance is low in comparison to  $R_R$  when the current flows counterclockwise, but it is high with respect to  $R_R$  when the current flows in the opposite direction.  $R_R$  becomes a path for current during the negative half cycle, thereby preventing a possibly destructive negative voltage from building up across the rectifier.

### USING A MULTIMETER

You have learned a great deal about why a multimeter operates as it does. This knowledge should aid you in using one wisely. However, it might be helpful to list the more important *do's* and *don'ts*.

#### General Precautions

Before using any multimeter, carefully study and apply the information contained in its instruction book. If the book does not contain a schematic diagram of the circuitry, request one from the dealer or manufacturer. Study the diagram and learn how the circuits are connected.

Keep the front panel clean. Dirt or moisture around the jacks may act as a shunt for current. Although it may look rugged, handle the instrument with care.

Always take readings with as much precision as possible. Develop the accuracy habit early. Then, when you need to take precise measurements, you will be able to.

Handle the front-panel controls carefully. Do not try to rotate switches beyond their stops.

Keep your hands away from the metal tips of the test probes. Failure to do so may cause you to receive an electrical shock when measuring current or voltage. Also, the resistance

of your body across the probes can make ohmmeter readings inaccurate on the high resistance ranges.

### Voltmeter and Milliammeter Functions

Have great respect for an energized circuit. Stand on dry, insulating material, and if you must measure voltage of great amounts, (a) turn the equipment off, (b) discharge any capacitors near the test point, (c) clip the meter leads on the test points, (d) turn the equipment on, (e) take the meter reading, and (f) turn the equipment off before removing the meter test leads.

Never place the milliammeter circuit across a voltage source. Even a small amount of voltage may force an excessive amount of current through the meter coil. To measure current, always connect the milliammeter in *series* with the circuit. Always turn the equipment off before removing the meter from the circuit.

### COMPLETE MULTIMETER CIRCUIT

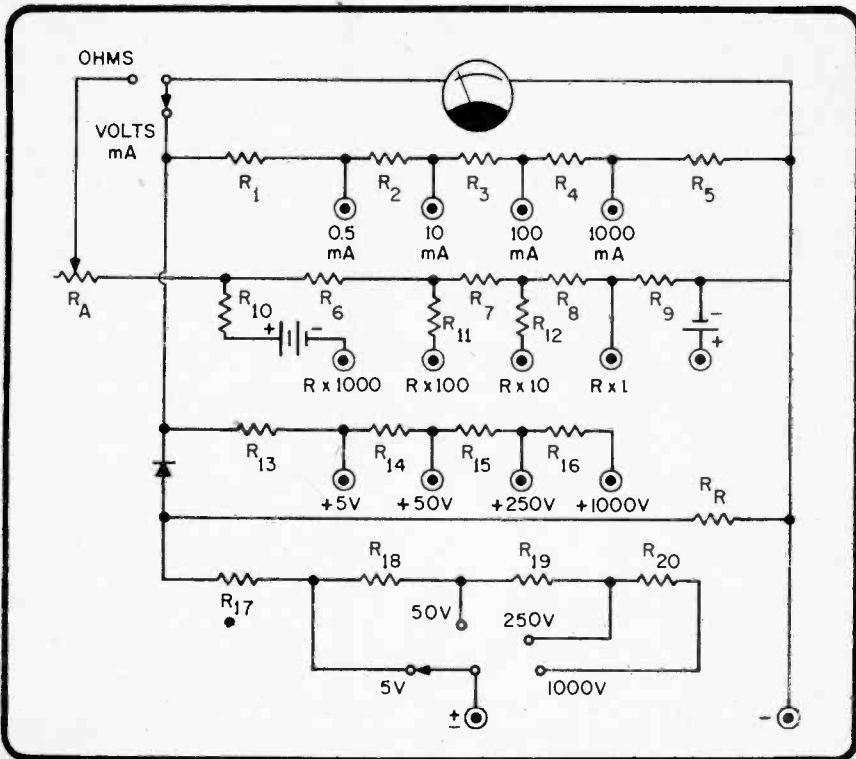

Always connect the voltmeter in *parallel* with the circuit, voltage source, or circuit component.

Observe polarity. Place the negative test probe (usually black) on the negative side of the element and the positive probe (usually red) on the positive side.

### Ohmmeter Function

*Do not measure resistance in an energized circuit!* Turn off the appropriate switches, remove the power plug, disconnect the battery terminals, or take any other measure that will remove voltage from the circuit. A very small voltage added to that of the ohmmeter battery can damage the meter.

Discharge any capacitors in and around the circuit before making a resistance reading.



Remember, capacitors store voltage. The ohmmeter may discharge a capacitor when the meter leads make connection. The metal shaft of a screwdriver may be used to discharge low-voltage capacitors. Rub the blade against all leads or terminals of the capacitor while the shaft rests on the chassis.

Do not measure the resistance of circuit elements that are still hot. Readings taken on parts above room temperature may be inaccurate.

When taking resistance readings in a circuit, determine if the element being measured is shunted by another component. If it is, the reading may be affected. If such a condition exists, you have two choices; either remove one of the component leads from its terminal before measuring, or use the point-to-point resistance values contained in the instruction book or technical manual for the equipment under test.

If your measurements are the same or reasonably close, those components included in the reading may be good. You cannot be absolutely sure, however. For example, a normally high-value resistor may be open. If this resistor is in parallel with low-resistive components, such as a coil, the ohmmeter reading may agree with the chart value. A leaky capacitor across a resistor may also produce a normal reading. However, if you suspect this condition or get an abnormal reading, disconnect one of the leads of the suspected component and make another measurement.

The condition of capacitors can be approximated with an ohmmeter. When testing capacitors other than electrolytics, use the highest resistance range of the meter. This range will supply more voltage than the others. If the capacitor is good, the meter pointer will deflect slightly and then return to infinity as the capacitor charges from the ohmmeter battery. If there is no deflection, the capacitor may be open or have too small a value for the size of the ohmmeter battery. Full-scale deflection with no return indicates a shorted capacitor. Leakage is indicated by a steady deflection to some part of the scale.

## WHAT YOU HAVE LEARNED IN PARTS 1 AND 2

1. Multimeter range circuits are parallel or series-parallel resistive networks. Each range circuit sets up a distribution of resistances in the meter and shunt branches of the network. The resistance ratios are such that no more than the maximum meter current will flow through the meter branch of the network. The excess current is diverted through the shunt branch.
2. Full-scale deflection of the pointer occurs when maximum rated current flows through the meter coil.
3. When the instrument is set up as an ohmmeter, full-scale deflection occurs when the test leads are shorted. This indicates zero ohms.
4. Voltmeter and ammeter scales on the meter face are usually linear. Units of scale markings are equal distances apart. The same scale can be used for measuring both volts and milliamps. On some multimeters a separate scale for each is available.
5. The ohmmeter scale is nonlinear—markings are not equal distances apart. The scale reads from zero (usually at the right end) to infinity.
6. For best accuracy, all multimeter readings should be made in the range position where the pointer will be in the upper-half region of the scale. There is some error present in even the best movement. This difference at full scale will be less of a measurement error than near zero. Also, the markings of the ohmmeter scale are less crowded toward the zero end (full-scale deflection).

This series is based on material appearing in Vol. 4 of the 5-volume set, BASIC ELECTRICITY/ELECTRONICS, published by Howard W. Sams & Co., Inc. @ \$22.50. For information on the complete set, write the publisher at 4300 West 62nd St., Indianapolis, Ind. 46268.



## Weekend Mechanic

Continued from page 40

suring about 7 x 10 x 17 inches, features a circuit with 24 transistors, 9 diodes and a 5-inch diameter CRT display tube contained in an anti-magnetic shield. A connecting cable, 12 feet long, terminates in four different clamps that can be attached quickly to the car engine. Alligator clips are used for ground and coil primary connections, a T-clamp is for the coil's high-tension lead, and an inductive pickup, very much like the one used with the Heathkit timing light, clamps onto the No. 1 spark plug wire. The scope can be used on 3, 4, 6 or 8 cylinder engines having standard, transistor, or capacitive-discharge ignition systems.

Most of the information is displayed as a waveform on the CRT screen, but there's also a small tachometer having 0-1000 and 0-5000 rpm ranges. You will want to use the larger scale on your more conventional tachometer for accurate rpm measurements, but the scope tach is handy for checking rpm while making other observations or measurements with the scope.

You can select waveforms representing either the primary or secondary circuits of the ignition system. The primary pattern is mainly useful for locating poor electrical connections between the vehicle battery and grounded side of the breaker points. The secondary pattern is the real workhorse because it provides a wealth of information about what is going on in the engine. You can view the waveform three different ways. In the so-called "parade" pattern the waveforms for all cylinders are shown simultaneously in their normal firing sequence; thus you can instantly compare all cylinders and spot such malfunctions as a mis-firing spark plug—and know which spark plug is at fault. Another way to detect malfunction that is not immediately evident through observation of the parade pattern is to superimpose all cylinder waveforms to create one composite pattern: if one or more cylinders are out of step, you know it immediately. The third method of analysis is to go back to the parade pattern, then use the horizontal expand and position controls to enlarge the pattern of any one cylinder for closer inspection. It is this capability that makes the instrument such a unique diagnostic device. You can easily measure the cam dwell angle

using scales on the CRT screen, and by comparing various portions of the overall waveform with reference drawings provided in a comprehensive manual that comes with the instrument you can spot all sorts of ignition troubles.

The chart that accompanies the drawing of a normal waveform for a standard ignition system reveals the remarkable versatility of an engine analyzer scope. The waveform produced by a capacitive-discharge ignition system has a different shape, but it can be used in similar fashion to spot malfunction in the ignition circuitry. After testing our Heathkit scope we could think of only one significant improvement that you can easily add. If you use the scope in an unusually bright area, you will be able to see the scope pattern more easily if you construct a viewing tube—from wood, metal or cardboard—that you can place between the scope screen and your eyes. This is a minor problem because the trace is plenty bright enough to be easily visible under most observation conditions. And one more advisory comment. If you buy the optional power pack and use the scope for road tests, be sure to place the instrument where the driver cannot possibly see the screen; the CRT display is so fascinating to observe that the most well-intentioned driver won't be able to resist frequent glances. And that could lead to an accident and more serious and costly repairs than just touching up the ignition system. ■

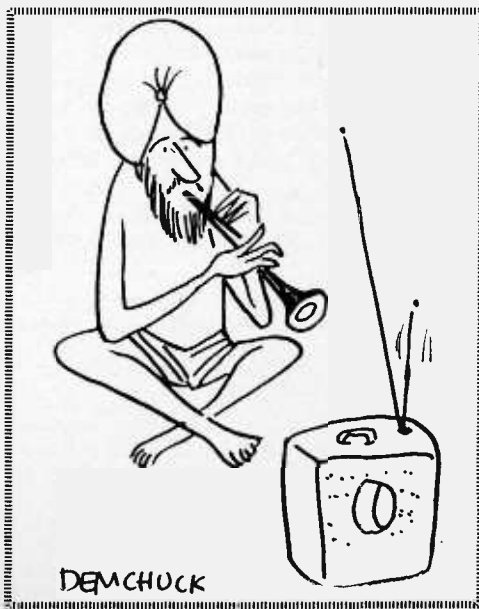

## Status Box

*Continued from page 71*

you can attach the rubber feet to the desk box and count all the parts in both boxes. The Sonalert has its own knurled ring nut for mounting. The three slide switches and the terminal strips mount with machine screws. The indicator lights and message lights mount with push on sheet metal fasteners. The battery holder can be mounted with 2-56 screws and nuts, but a neater job can be done with .093 diameter brass eyelets. Make all connections with number 20 hookup wire.

A word about the lamps. You may find that the lamps specified are difficult to obtain, and you may have to buy at least ten.

If this troubles you, redesign the unit for whatever cheaper and available lamp with plastic flat indicator you can find. You can replace the battery with a filament transformer and use conventional panel lamps that are cheaper and easier to find. Shop around.

**Putting It To Use.** After assembly, wiring, and soldering, visually inspect all the parts and solder joints to be sure they are done properly. If all is OK, you are ready for a quick test before making a permanent installation. Interconnect the boxes on the workbench and operate the switches and buttons. If the correct response is indicated, you are ready for the permanent installation.

After your office or home has been equipped with the Status Box, you will find the time saved and convenience worth far more than the cost of the whole project. Excuse me now, here comes my secretary. ■

## The Eyes Have It

*Continued from page 53*

impression per second which the human eye is capable of registering consciously per second.

The VW now wants to turn left behind the truck. The Eye Mark Recorder shows that the eyes were not fixed on traffic, but at the rear of the truck itself. Meanwhile a car at the right side of the VW overtook this VW and the driver didn't know about it at the moment of the passing, as the eye was fixed at the rear of the truck.

The Eye Mark Recorder is helping traffic psychologists discover the true way we see as we drive. No longer do they rely on written accident reports and eye witness accounts. Future traffic laws and regulations, and highway design, will reflect what they discover making street and highway driving safer. ■

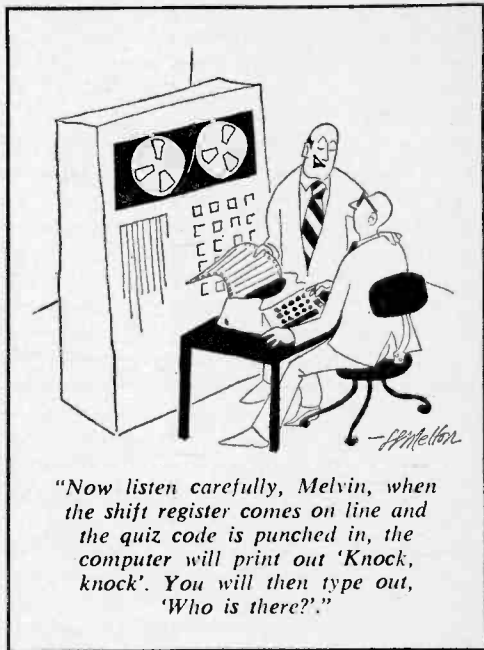

*"Now listen carefully, Melvin, when the shift register comes on line and the quiz code is punched in, the computer will print out 'Knock, knock'. You will then type out, 'Who is there?'"*

## Hey Herb

*Continued from page 81*

**Hey Herb:** Why is it the top rated automatic turntables are often supplied with pickups other than the very best?

*Pickups must be matched to the arm. The high performance pickups all have very high compliance and soft stylus suspensions, and they cannot withstand the extra forces required by automatic*

tone arms—forces needed to operate the changing or auto mechanism. You will often find that the stylus of high compliance pickups used in automatic turntable arms get bent out of shape. Also, auto tone arms usually—not always—require at least 2 grams tracking force, which is just too much for the stylus mounts on high compliance pickups designed to operate in the 0.5 to 1.5 gram range. For this reason, every major manufacturer such as ADC, Empire, Pickering, Stanton and Shure makes available high performance pickups specifically designed for use in automatic

turntables. The performance level of these pickups is very close to their top-of-the-line models and in many instances actually outperform the top-of-the-line in automatic turntables. With auto turntables optimum performance is generally secured by using the arm/pickup combination suggested by either the turntable or pickup manufacturer. You usually cannot improve the sound quality regardless how much extra you spend.

Herb would like to answer all the questions our readers send. However, he can only sample the questions received and answer as many as possible through this column. Sorry, it's impossible to answer questions by return mail. Questions of a personal listening nature cannot be answered. Send your questions to Hey Herb, ELEMENTARY ELECTRONICS, 229 Park Avenue So., New York, NY 10003.

## NewsScan

*Continued from page 29*

eliminated from the panel and referred to their physicians for treatment.

The project began in early February and tests of the first group of 100 persons representing each decade of age from teens to eighties are expected to be completed in two months. Larger groups will be added as the program progresses to broaden the sample for the general population. This will be the first time that a sufficiently large amount of highly accurate measurements of hearts under stress will be available for detailed EKG computer analysis of aging effects on cardiac performance.

Hopefully, these data should eventually provide extremely accurate information concerning the physiological age of the heart as compared to its chronological age. With this base line of information, advance warning of a heart attack will be more easily determined.

The Compu-Gram system, developed by Cro-

Med Bionics Corp., is the only one in which the computer not only reads but actually provides a complete diagnosis of an EKG. It provides a physician with a fully detailed print-out of the measurements and analysis of a patient's condition in as little as two minutes after the test is taken. Before this system came along, these tests would not have been feasible. Even a team of cardiologists would not have been able to make the necessary numerical comparisons between a heart's physiological and chronological age. There are just too much data to be analyzed. All told, several thousand different measurements must be made for each subject. Only a computerized system can assimilate and analyze all this data.

In technical terms, the testing determines changes in *T* amplitude and duration, *ST* elevation and depression, *PR* intervals, *QRS* amplitudes and duration and many other parameters of heart rate from rest to stress and recovery.

Once a sufficient mass of population stress data is obtained, it should be possible to predict a tendency for heart attack from the ratio of the physiological to the chronological age.

## Ask Hank

*Continued from page 24*

### Needs More Experience

*While tuning the bands with my Realistic DX-150 receiver, I have noticed that on certain occasions there is a great deal of atmospheric static. This characteristic is especially present in the summer months. My problem is finding a way to eliminate this atmospheric noise. I've tried to eliminate this noise by adding a Lafayette antenna tuner but the noise is still present.*

—W.K., Milford CN

You can bet the noise is present. All the Lafayette unit can do is boost the noise along with the signal. What you need to do is switch to a band with no, or less, noise. The DX-150 is a good unit. Learn to use it correctly.

### An Organizer

*A few of my SWL buddies are thinking of forming a DX club, and wonder if we could get in touch with the North American Short-*

*wave Association. Where can we get in touch with this well known club? Thanx for any help you may give.*

M.A., Waldwick NJ

The address for the NASWA is P.O. Box 8452, So. Charleston WV 25303. If you read Don Jensen's DX Central Reporting column, you'll notice a SWL club mentioned in each issue. Read what Don has to say. He really knows his business, or is it hobby? ■

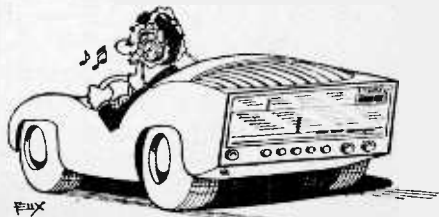

## Super DXer

Continued from page 86

Solder a standard phono plug to one end. Take care that you do not use ordinary shielded cable such as used to interconnect hi-fi equipment: coaxial cable is a must.

Connect the coax between the SUPER DXER and your receiver. Rotate the C1 shaft fully counterclockwise and install a pointer knob so that the pointer extends to the left (9 o'clock position). Connect your antenna to binding post BP1. Then, set L1's slug so the *bottom* of the screwdriver slot is level with the very *top* of L1. This will provide a frequency range of approximately 5 to 15 MHz. If you back out the slug  $\frac{1}{4}$ -in., the frequency coverage will be from approximately 7 to 21 MHz. You can use any in-between slug adjustment.

Turn on the receiver and booster, and set the receiver tuning to 5 MHz, or whatever frequency you selected for the "bottom end." Adjust C1 for maximum received signal or noise and mark the panel accordingly. Repeat the procedure at approximately 7, 10, 14 and 15 (or 20) MHz. The panel markings are important because the SUPER DXER tuning is so sharp it must be preset to near the desired frequency or you'll re-

ceive nothing—neither signal nor noise. The panel markings complete the adjustments.

**Pull 'em In** To prevent self-oscillation, you must keep the antenna wire as far as possible from the coaxial output cable. To receive a signal, set C1 to the approximate desired frequency and then tune-in the signal on the receiver. Finally, peak C1's adjustment for maximum signal strength as indicated on your receiver S-meter, or listen carefully for an increase in speaker volume. Keep in mind that, if the signal is sufficiently strong to begin with, the receiver AVC will "absorb" the SUPER DXER's boost, and the speaker volume will probably remain the same, though the S-meter reading will increase. SUPER DXER's boost will be most apparent on very weak signals, digging out those signals below the receiver's usual threshold sensitivity, making them perfectly readable.

Don't worry about strong signals overloading your SUPER DXER; it is virtually immune to overload even from excessively strong signals. However the booster's output can be so high as to overload the input of some budget receivers. If this occurs simply reduce the booster's output by detuning C1 just enough to drop the overall signal strength below the receiver's overload value. Happy DX'ing. ■

A kit of all the DXer's components including the printed circuit board is available from the Electronic Hobby Shop, Box 567, Brooklyn, N.Y. 11202. Price of \$18.95 includes postage. Canadians add \$2. New York State residents must add sales tax. No foreign orders. Postal Money Order speeds delivery to your doorstep.

## MITS 1440

Continued from page 62

with logs, sine, cosine, etc.), and electronic slide rules are priced much higher than the MITS 1440.

**Building The Kit.** This takes about three hours. There is no alignment or adjustment. The parts packaging is extremely good with all components for a series of steps in the same package or series of packages. If there are any parts left over you have made an error. Another excellent feature is that all parts of the same value are installed as one unit. If step one calls for a 10K resistor, the steps to follow will also call for a 10K resistor until all the 10K resistors are used. This arrangement makes for a virtually goof-proof assembly.

All circuits are assembled on five printed circuit boards. The one for the keyboard matrix is supplied factory assembled and soldered with all switches in place. Nothing about the PC board assembly is difficult, but extreme care must be taken because of numerous LSI (Large Scale Integration) ICs with many, many terminals. A small conical tipped soldering iron is an absolute essential. Also, connections must be triple-checked to make certain they're soldered. (We found that out when our builder goofed!) Factory service indicated he had missed soldering a single IC terminal (One more chance, Charlie!).

**So.** We don't feel the 1440 should be a first kit. Some degree of experience with printed circuit assembly is required; also, though the instruction manual is well illustrated, the builder must, in some places, stop and think. For these reasons you should have one or two printed circuit projects be-

## READER SERVICE PAGE

• The Editor of ELEMENTARY ELECTRONICS offers readers an easy way to get additional information about products and services advertised in this issue. Also, if you would like more information about any new product mentioned in our column "Hey, Look Me Over," it's yours for the asking. Just follow the instructions below and the material you requested will be sent to you promptly and at no cost.

• The coupon below is designed for your convenience. Just circle the numbers that appear next to the advertisement or editorial mention that interests you. Then, carefully print your name and address on the coupon. Cut out the coupon and mail to ELEMENTARY ELECTRONICS, Box 886, Ansonia Station, New York, N.Y. 10023. Do it today!

MARCH/APRIL 1973

Void after July 31, 1973

### ELEMENTARY ELECTRONICS

Box 886, Ansonia Station, New York, N.Y. 10023

Please arrange to have literature whose numbers I have circled at right sent to me as soon as possible. I understand that this is a free service offered by the magazine.	1	2	3	4	5	6	7	8	9	10
	11	12	13	14	15	16	17	18	19	20
	21	22	23	24	25	26	27	28	29	30
	31	32	33	34	35	36	37	38	39	40
	41	42	43	44	45	46	47	48	49	50
	51	52	53	54	55	56	57	58	59	60
	61	62	63	64	65	66	67	68	69	70

• Please limit circled items to 12 maximum.

Name (Print Clearly) \_\_\_\_\_

Address \_\_\_\_\_

City \_\_\_\_\_ State \_\_\_\_\_ Zip Code \_\_\_\_\_

hind you before you tackle the 1440.

**A Computer?** The 1440 is pre-wired for associated programming and printer accessories. Since neither was available at the time we tested the calculator, we cannot comment as to how well the computer/printer conversion works.

**Summing Up.** The MITS 1440 is perhaps

the most valuable low-cost calculator we have yet to see. It is the perfect companion for the engineer, technician and the student. You would have to spend several hundred dollars more to obtain similar performance and features from a "name brand" calculator. For additional information circle No. 66 on the Reader Service page. ■

## C-D Ignition System

*Continued from page 42*

small kit, and can be assembled in about three hours or less. All the difficult-to-mount components such as the power transistors and oscillator coil are pre-assembled at the factory. Basically, the builder simply plugs in components and solders. Even the color-coded wires are supplied cut-to-size.

**Mounting The System.** The cabinet is pre-drilled for the supplied sheet-metal screws. Simply install the unit on a fender near the ignition coil and remove the wires from the two ignition coil terminals. Place a color-coded terminal board on each igni-

tion coil terminal, secure with thumbnuts, and connect the original coil wires to the color-coded terminals. The whole installation is now complete and the unit is ready for use.

Additional performance can be extracted from the C-D system by increasing the spark plug gap as detailed in the instruction manual, but even if you don't regap the plugs, the C-D system will give you a sharp boost in engine performance.

**Summing Up.** As we stated earlier, the C-D ignition system is the only auto accessory we've found with any real value, and the Radio Shack 28-3203 is among the best of all the C-D systems. For additional information circle No. 68 on the Reader Service page. ■

## INDEX TO ADVERTISERS

READER SERVICE NO.	ADVERTISER	PAGE NUMBER
12	Avanti Research & Development, Inc.	16
	Bell & Howell Schools	1-2
26	Browning Labs	11
30	Circuit Specialist	16
32,13	Cleveland Institute of Electronics	7, 108-110
14	Cornell	14
28	EDI	14
2	Edmund Scientific	6
33	Eico	23
16	Electro-Voice	8
3	Fair Radio Sales	22
17	G.C. Electronics	10
4	Grantham School of Engineering	13
1	Heath Co.	54-57
18	I.C.S.	90-93
27	International Crystal	14
8	E.F. Johnson	2nd Cover
5	Kedman Co.	13
25	Lafayette Radio	15
29	Mosley Electronics	23
31	Midland International	5
19	McGee Radio	22
	National Radio Institute	18-21
20	National Technical School	36-39
21	New-Tronics Corp.	9
7	Partridge Electronics	22
9	Photolume Corp.	22
6	Progressive Edu-Kits, Inc.	4th Cover
22	Radio Shack (Allied)	3rd Cover
	R.C.A. Institute	72-75
10	Releo Industries	14
34	Tab Books	25
24	Turner, Div., Conrac Corp.	3
11	Western Radio	22
23	Xcelite Co.	12

## Bookmark

*Continued from page 23*

servicing electronic fire and theft security systems—an up-to-date handbook that not only covers virtually every available system, but also provides guidance for technicians who want to build a career in the growing alarm systems field. *Installing & Servicing Electronic Protective Systems* b/ Harvey Swearer explains how to select just the right system for any particular job, how to estimate costs, how to install and check the system, and even how to build and expand one's business, train help, and finance the operation. The text is supplemented by over 160 photographs and illustrations, including complete schematic diagrams of various protective devices. The publisher, Tab Books, would be pleased to send additional information and catalog provided you circle No. 52 on Reader Service Page.

### ● Quicky Review

*Electronics Data Handbook* by Martin Clifford, published by Tab Books, Blue Ridge Summit, PA 17214; a staggering amount of data compacted into a cleverly indexed volume; soft cover. 256 pages, hundreds of tables, charts, illustrations and formulas, \$4.95.

## Your World Globe

Continued from page 66

when you translate this whole ball of wax for your own stamping grounds. For another thing, a guy I know lives there!

A quick glance at my 1960 encyclopedia shows that this OM in Hastings, Nebraska, is at about 98.5 degrees West longitude, and 40.5 degrees North Latitude. To the nearest half a degree is good enough. He couldn't drill his holes any closer than that anyway. So, that pins down the place where this guy hangs his hat, and it tells him where to drill his first hole.

My SWL pal in Hastings marks the coordinates just obtained on the surface of his globe, and sets the point with an ice pick. He drills the hole, using a drill a trifle under the diameter of the mounting pins or lugs from his globe. (You'll want a nice snug fit when you go to set the pins in your new holes. You can't get too precise when drilling cardboard, and there's no need to. Just be sure to drill a hole that will give a close fit, with no wobble.)

To locate the second hole, my friend will dust off his old 6th grade arithmetic book. He'll begin by taking his longitude, 98.5 degrees, and he'll subtract this from 180 degrees. He'd better get 81.5 for his answer, or he's in trouble. If he now makes a mark with a soft pencil on his globe's equator at 81.5 degrees East longitude, he's half done with this hole locating business. Next, he takes his latitude, 40.5 degrees North, and moves his pencil just that far south of the equator at 81.5 degrees East longitude. That locates the second hole, then, at 81.5 degrees East longitude, and 40.5 degrees South latitude. He marks this spot, and drills his second hole. For the record, it's in the Indian Ocean, about midway between Australia and Africa.

**Finally!** Now, this SWL in Hastings re-mounts his globe using the old semi-meridian and mounting pins (or lugs) and the two new holes. The pin that used to be at the North Pole now goes into his QTH hole. The old South Pole pin goes into the hole in the Indian Ocean. The operation is just the reverse of the disassembly phase.

If my friend feels like getting classy, he can cover the old holes at the poles with almost anything that suits his fancy. He can use a piece of colored cellophane tape. Or a

patch of colored paper will do. Or he can leave the holes empty. They make handy receptacles for pencil shavings. It's really his affair.

One thing remains to be done. The mounting semi-meridian will probably be marked off in degrees of latitude, which isn't exactly applicable anymore. So a strip of paper marked off in miles should be cemented to the meridian. Using the scale printed on his globe, this Hastings chap makes his distance scale in nautical miles, since that works out a little better. Or, he can draw his own scale remembering that 69 miles are about equal to a degree. Any way he slices the thing, he puts his *zero* at Hastings, which is now on top of the world, and lets the scale of nautical miles run down the semi-meridian until it reads about 12,420 miles at the old South Pole, which is now in the Indian Ocean.

**So?** There stands my buddy in Nebraska, gazing fondly at his handiwork and wondering what to do with it. Well, Don, old pal, suppose you're listening to Bombay, India. You might want to know the direction, either from some technical consideration or because you're just nosy. Simply rotate your modified globe until Bombay, India, is under the semi-meridian. Now check to see which way the meridian takes off from Hastings and you have the direction to Bombay. This part is easy, since the markings of the latitude and longitude lines, or parallels and meridians, are still on the globe. These firmly fix the north-south and east-west directions, and the bearing, or direction to Bombay, can be easily estimated. The scale of miles on your mounting meridian will show the distance to Bombay. And that, Don old boy, is all you need to know.

It's about 8,665 miles from Bombay to Hastings, how about your QTH? ■

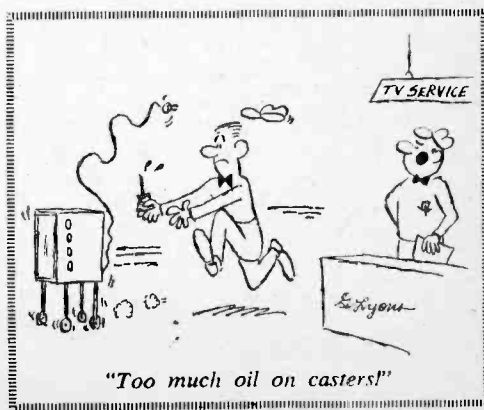

# CLASSIFIED Market Place

Classified Ads 65c per word, each insertion, minimum 10 words, payable in advance. To be included in the next available issue of **ELEMENTARY ELECTRONICS**, copy must be in our New York Office by October 1st. Address orders to R. S. Wayner, Manager, Classified Advertising, **ELEMENTARY ELECTRONICS**, 229 Park Avenue South, New York, N. Y. 10003.

### ADDITIONAL INCOME

**TELEPHONE** Reporters needed immediately. Set own fees. Enjoy prestige. Information \$2.00. Dollarsavers, Ten Paddock, Hudson, New York 12534.

**FORTUNES IN MAIL ORDER.** Start part time. Unlimited Potential. Details \$1.00. Shopper, Box 4198D, South Daytona, Florida 32021.

### AGENTS WANTED

**SELL:** Personalized, Colored, Social Security Plates. Choice of Fifty-nine Emblems! Big Profits! Free Sample! DR's Specialties, Dept. 201C, 73 Hunter Place Pompton Lakes, New Jersey 07442.

### AUTHORS SERVICE

**PUBLISH** your book! Join our successful authors: publicity advertising promotion, beautiful books. All subjects invited. Send for free manuscript report and detailed booklet. Carlton Press, SMH, 84 Fifth Avenue, New York 10011.

### AUTO PARTS & ACCESSORIES

**AMAZING** new. Chemically impregnated auto cloth does over 50 car cleanings—using no water. Guaranteed. \$2.98. AR-NOR, 20 Bulwer Place, B'klyn, N.Y. 11207.

### BOOKS & PERIODICALS

**WIRETAPPING**—National scandal—your privacy invaded. Free brochure. Don-Q, Box 548, Seattle, Wash. 98111.

**FREE** Catalog of Amplifiers, Inverters, Burglar Alarms, Car Accessories, Etc. Write: CPA Radio, 2115 Norris Canyon Road, San Ramon, Ca. 94583.

1001 **THINGS** you can get free. \$1.00. E. Stuart, 411 Pennsylvania, Fulton, Mo. 65251.

**1973 HOBBY ELECTRONICS DIRECTORY.** Hundreds of companies, products, and services. Parts, surplus, test equipment, plans, kits, and more. \$1.50. Newcal Enterprises, Box 323B, El Segundo, Cal. 90245.

**BEST** Reading in Mechanical Field—Science & Mechanics! \$4.00 for year's subscription. Science & Mechanics, 229 Park Avenue So., New York, New York 10003.

### BUSINESS OPPORTUNITIES

I made \$40,000.00 Year by Mailorder! Help others make money! Start with \$10.00—Free Proof! Torrey, Box 318-T, Ypsilanti, Michigan 48197.

**MAKE** Magnetic Signs. Big profits. Details. Universal, Lenora, Kansas 67645.

**1000% PROFIT** Bronzing Keepsakes. Free Literature. NBC, Box C-4-0, Coral Springs, Florida 33065.

### BUSINESS OPPORTUNITIES—Con't.

**FREE BOOK** "999 Successful, Little-Known Businesses." Work Home! Plymouth P3, Brooklyn, New York 11218.

**HERBALISM!** The home gold mine! Free lesson Herbalism Institute-D. 1339 Remuda, Glendora, Ca. 91740.

**MAILORDER BEGINNERS LIBRARY.** Proven Moneymaking Publications. Literature 25c. Refundable. HOW, Box 4457 EE3, Downey, Ca. 90241.

**ADDRESSERS** and Malters needed. Details 10c. Lindbloom Services, 3636 Peterson, Chicago 60659.

**BIG PROFITS** in becoming a supplier to major industry through electroplating small parts and metalizing non-metallies. Write for free particulars: Mason, Room MC-107-CB, 1512 Jarvis, Chicago, IL 60626.

**FREE—Wholesale Catalog** and Sales Plan. JAM Enterprises, 3100M Liberty Avenue, Pittsburgh, Pa. 15201.

**MAKE** Money. Full or Spare time your choice of home income Producing Businesses. Free List low cost books. Health, Wealth, Happiness, Brokaw's Country Corner, Dept. 23, Route 3, Marengo, Ohio 43334.

**GET** Rich fast. Retire Young. Free report and proof. Send Self-addressed stamped envelope. Morgan, Box 25053-AAB, Los Angeles, California 90025.

**AMAZING Profit** on Government Surplus. Send 75¢ today! Leskens, 1709 West Miner, Arlington Heights, Ill. 60005.

\$1000 **MONTHLY** from your own home. Write: Jordan, 27495 Road 176, Dept. DC1, Exeter, Calif. 93221.

**COMPLETE MAILORDER BUSINESS COURSE** \$10.00. Information SASE. Raymond Brooks, 7147D, St. Petersburg 33734.

### COINS, CURRENCY & TOKENS

**COIN SPECIALS.** 1943-P-D-S War Cents 40¢, 4 Different Buffalo's 75¢, 15 Different "S" Cents 75¢, 2 Different Indian Cents 70¢, 5 Different War Nickles 75¢. Lee Heritier, 468 Heritier Rd., Linwood, Michigan 48634.

### DO-IT-YOURSELF

**PROJECTION TV**—Convert your portable to SEVENTY INCH TV projector for under \$10.00. Free details: Macrocoma, Dept. SMC, Washington Crossing, Pennsylvania 18977.

**DISCOVER** how to avoid calling the serviceman. Save by servicing home equipment yourself. Send \$1.25 for magazine. **RADIO-TV REPAIR**—229 Park Avenue South, New York, New York 10003.

### DO-IT-YOURSELF—Con't.

**SOLID STATE & HOBBY CIRCUITS MANUAL** \$1.95 postpaid to your door. The new Manual HM 91 offers over 400 pages of circuits for the hobbyist, engineer, experimenter and do it yourself kit builder. **HURRY—Supply limited.** Free catalog. **FRAZER & ASSOCIATES**, 3809 Surfwood Rd., Malibu, Calif. 90265

**APPLIANCE REPAIR BOOKS.** Written in easy-to-understand language by experts in the service field with illustrations and diagrams! Acclaimed by instructors and professionals alike! How to diagnose and repair refrigerators, air conditioners, washers, dryers, ranges, dishwashers, vacuum cleaners, motors, water heaters, coffeemakers, hair dryers, food mixers, can openers, electric irons, floor polishers and many others. Also, fundamentals of solid state, setting up a shop, using test equipment and a lot more. Only \$2.65 to \$4.90 each! Free price list. C & N, 5841 Montrose, Chicago 60634.

### EDUCATION & INSTRUCTION

**UNIVERSITY Degrees** By Mail. Free Information. Norman, Dept. 63, Box 3199, Pasadena, California 91103.

**HIGH SCHOOL DIPLOMA** for adults. Earn State Diploma. Accepted by Civil Service, business, colleges. Low Cost. No tedious study. Money-back guarantee. Details: H-S Program, Suite 25 24, 1221 Avenue Of Americas, New York, N.Y. 10020.

**LIFETIME Ordination** D.D. Charters. Details 25¢. Life Science, 2207 Cardinal, Rolling Meadows, Illinois 60008.

**AMAZING BOOK HOW TO READ MUSIC IN ONE EVENING** \$3.95. PAM CO., P.O. BOX 11032, PITTSBURGH, PENNSYLVANIA 15237.

"**LOGIC** newsletter, design and construction, sample copy. \$1.00. Logic Newsletter, POB 252, Waldwick, N.J. 07463."

**GOVERNMENT LANDS**—Low as \$125 Acre! Buy, lease or homestead—Free Details! **LANDS DIGEST**, Box 1555-JC, Tacoma, Washington 98401.

### FOR VETERANS

**COLLECT** \$1,000's in G.I. benefits, services! WW-II, Korean, Vietnam veterans still qualify—even 30 years after discharge! Details 25¢. Viscount, Box 620-D, N.Y., N.Y. 10003.

### GIFTS THAT PLEASE

**FREE** Illustrated Gift Catalog. Irving Dunn, Old Turnpike, Woodridge, N. Y. 12789.

**DIGITAL Watch**—17 Jewel—Shock Resistant \$19.95. Lawson's, 403-M Harding, Lyndhurst, New Jersey 07071.

## FOR GREATER CLASSIFIED PROFITS, RESULTS AND SAVINGS

Place your ad in one of our **SPECIAL COMBINATIONS:** Business, Science & Mechanics, or Davis Combination. Each Combination is designed to give your ad the largest audience available. For further information write to R. S. Wayner, Manager, Classified Advertising, Science & Mechanics, 229 Park Avenue South, New York, N.Y. 10003.



# CLASSIFIED MARKET PLACE—Cont.

## GOVERNMENT SURPLUS

**SURPLUS:** 5 Government agencies now sell direct to you. Buy cars, wine, yachts, land. Many locations. Full information, send \$1.00 (Refundable). Diversified Surplus, Box 27177-C, San Antonio, Texas 78227.

## HOME WORKSHOP SUPPLIES

**25 WEEKEND BUILD-IT PROJECTS**—Practical designs for home/shop buffs who enjoy working with wood, tools, materials and techniques. Send \$1.00 for your copy (includes postage) to Davis Publications, Inc., 229 Park Avenue South, New York, New York 10003.

## HEARING AIDS

**HUGE SAVINGS! BUY DIRECT!** Eliminate dealer markups. 20 days FREE Trial Terms arranged. No salesman will call. **LOYD'S-79**, Rockford, Illinois 61108.

## INVENTIONS WANTED

WE either sell your invention or pay cash bonus. Write for details. Universal Inventions, 298-3, Marion, Ohio 43302.

## MAIL-ORDER OPPORTUNITIES

**100% PROFIT. SELL SECURITY** products by mail. Details, samples free. CSA, Dept. 2A, Box 12127, Dallas, Texas 75225.

## MONEYMAKING OPPORTUNITIES

**MAKE BIG MONEY** raising Chinchillas, Cavies, Rabbits for us. Catalog 25¢ Keeney Brothers, New Freedom, Penna. 17349.

**MAKE \$1.00 PER SALE** selling engraved metal Social Security plates. **FREE SALES KIT** Engraving plates. Box 10460-202, Jacksonville, Florida 32207.

**INCOME** Guaranteed raising Chinchillas at home. 25¢. Chinchilla, 11 DCC, Port Richey, Florida 33568.

**MAKE MONEY** Writing Short Articles at Home. Begin immediately! Copyrighted Report Reveals How and Where. Send \$1.00. Jay-Bees Enterprises, Dept. F, 12 New York Avenue, Bergenfield, New Jersey 07621.

**START** small, highly profitable electronic production in your basement. Investment, knowledge unnecessary. Postcard brings facts. Barta-SME, Box 248, Walnut Creek, California 94597.

**Make Your Classified Ad Pay.** Get "How To Write a Classified Ad That Pulls." Includes certificate worth \$2.00 toward classified ad in S & M. Send \$1.25 (includes postage) to R. S. Wayne, Science & Mechanics, 229 Park Ave., South, New York 10003.

## MONEYMAKING OPPORTUNITIES—Con't.

**BANISH** unemployment fears forever. Start now to make steady profits from tiny investments. Amazingly easy. See "An Independent Income for Beginner's in Low Priced Stocks." \$2.98 postpaid. S. D. Rush Company, 306 Ramona Place, Costa Mesa, Calif. 92627. No C.O.D.'s.

## OF INTEREST TO WOMEN

**\$25.00 DAILY** Possible addressing-stuffing envelopes. Typewriter-longhand, also Clipping News items at home. Information; Send stamped addressed envelope. Ame-7, Box 310, Le Mars, Iowa 51031.

## PERSONAL

**ELIMINATE** Debts Without Borrowing! Particulars 25¢. Helper, Box 9308, No. Hollywood, California 91609.

**ORIENTAL** Introductions! Photographs, descriptions, questionnaire, brochure, details. \$1.00. **INTER-PACIFIC**, Box 30 SC, Birmingham, Michigan 48012.

**RECORD** Telephone Conversations Privately—Automatically. Leave recorder unattended. Robert's, Box 49EE, Parkridge, Illinois 60068.

**DON'T DIE** WITHOUT A WILL! **BLANK WILL FORM** PROTECTS YOUR FAMILY. Only \$1.98—guaranteed! Order today! Warnock, 116 Williams, Winder, Georgia 30680.

**LONELY?** Find Your Lifemate! Nationwide Datematching. Details \$1.00—ELITE, Box 64, New York City 10019.

## PHOTOGRAPHY—PHOTO FINISHING

**SAVE HUNDREDS OF DOLLARS!!!** Make your own S & M Densitometer. Send \$3.00 for detailed drawings and instructions. A must for successful photography in your darkroom. Order direct from: S & M Instruments, Dept. EE3, 229 Park Avenue South, New York, New York 10003.

## RADIO & TELEVISION

**TV TUBES** 36¢ each. Send for Free 48 page color catalog. Cornell, 4217-W University, San Diego, California 92105.

"**DISTANCE** Crystal Set, Construction" Handbook—50¢. "Coil Winding"—50¢. Catalog 25¢, refundable. Laboratories, 1477-G, Garden Grove, Calif. 92642.

**HEAR POLICE/FIRE** Dispatchers, catalog shows receivers; exclusive directories of "confidential" channels. Send 8¢ stamp. Communications, Box 56-DA, Commack, New York 11725.

## RADIO & TELEVISION—Con't.

**FREE** Catalog lists resistors, tubes, transistors, rectifiers, condensers, tools, tuners, etc. etc. Hytron Hudson, Dept. EE, 2201 Bergenline Avenue, Union City, New Jersey 07087.

## REMAILING SERVICE

**RECEIVING** - Forwarding - Remailing, monthly rates. Nortex, Drawer 430, Weatherford, Texas 76086.

**ST. PETERSBURG**, Florida, Branch, 25¢, rate information SASE, Raymond Brooks, 7147D 33734.

## SCIENCE & CHEMISTRY

**ANTIGRAVITY** DEVICE Brochure 35¢. AGD, Box 3062-EE, Bartlesville, Oklahoma 74003.

## SPECIAL SERVICES

**INFORMATION** ON anything! Authoritative! \$2.00 (deductible). Metzler Research, Box 2206MM, Long Island City, New York 11102.

## SURPLUS EQUIPMENT

**GIANT** 120 Page Canadian Surplus Catalog \$1. Etc. Dept. EE, Box 741, Montreal.

## TIPS FOR THE HOME, ETC.

**PRACTICAL** tips for home, garden and workshop are in "1001 How-To Ideas." Send \$1.00 for your copy includes Postage. To 1001 How-To Ideas, 229 Park Avenue South, New York, New York 10003.

## TREASURE FINDERS—PROSPECTING EQUIPMENT

**DISCOVER AMERICA'S FASTEST GROWING HOBBY.** White's Electronics, Inc., would like to send you—absolutely FREE, their 42 page, fact-filled catalog on Mineral and Metal Locating Equipment. Amateurs or Professionals select from world's largest line of metal detectors, priced as low as \$79.50, up. Detect Gold, Silver, Copper-Nuggets, Coins, Jewelry, etc. Budget terms available. For your convenience we have three major factory locations in the U.S. and Canada, as well as over 1,000 authorized dealers to serve you. See your local Yellow Pages, under "Metal Locating Equipment" or write: White's Electronics, Inc. Room No. 399, 1011 Pleasant Valley Road, Sweet Home, Oregon 97386-Elk-Air Industrial Park, Dexter Drive, East, Elkhart, Indiana 46514 or White's Electronics Ltd, 33784 Hazel Street, Abbotsford British Columbia, Canada.

**THERE IS NO CHARGE FOR THE ZIP CODE—PLEASE USE IT IN YOUR CLASSIFIED AD**

How to subscribe to:

# elementary Electronics

**SPECIAL INTRODUCTORY OFFERS!**

## MAIL COUPON TODAY AND SAVE!

Simply check the money-saving subscription you prefer.

1 YEAR (6 issues) ONLY \$2.47

Enter my trial subscription for 1 year. (I save \$2.03 off the newsstand price.)

I prefer 1½ years (9 issues) for \$3.67. (On the newsstand \$6.75).

Bill me  Payment enclosed

name \_\_\_\_\_

address \_\_\_\_\_

city \_\_\_\_\_ state \_\_\_\_\_ zip \_\_\_\_\_

8678

Mail to: **ELEMENTARY ELECTRONICS**  
229 Park Avenue South • New York, N.Y. 10003

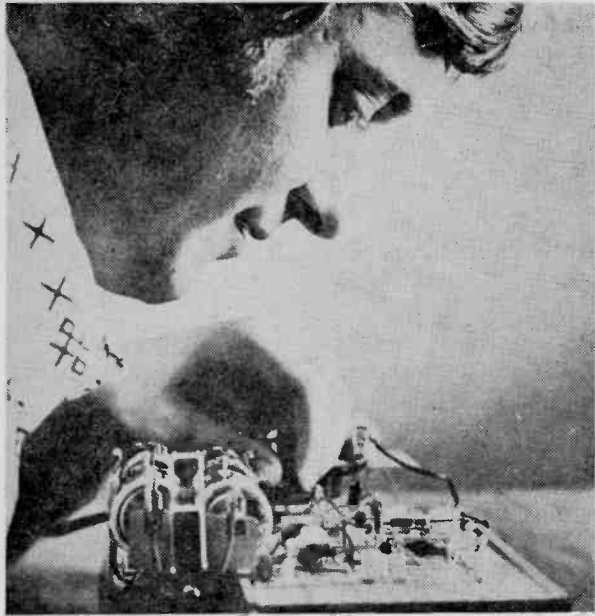

# You Learn to Make Money ...with CIE's Electronics Laboratory!

Now you can learn Electronics by performing more than 200 practical, skill-producing experiments...with authentic industrial components...at home...in your spare time.

You learn by doing! This 161-piece Laboratory includes the up-to-date equipment you'll need — such things as an IC (integrated circuit), printed circuit board, FET (field effect transistor), photovoltaic cell, DC motor, microphone, multimeter, soldering iron and power supply.

You put theory into practice right in your own home...in your spare time...while you go right on pulling down your present pay. It's CIE's exciting space-age "Electronics Technology with Laboratory" program... a unique combination of CIE's special AUTO-PROGRAMMED® Lessons and laboratory equipment. It is the practical way to learn Electronics!

### Prepare for a High-paying Career

You see, when you "learn by doing," you're ready to do...you're armed with the know-how to meet the challenges of a high-paying career in Electronics... prepared to go after an exciting, relevant job in a growing field such as medical technology, pollution control, radio and TV broadcasting, computers...just to name a few. Once you have some experience, you can make \$12,000 a year or more.

But that's not all! When you successfully complete your Electronics Laboratory course, you'll get a CIE Diploma. And, you'll be able to pass the Government FCC examination or be entitled to a full refund of all tuition paid! CIE's Money-Back Warranty is valid during the completion time allowed for your course.

Send today for CIE's 2 FREE BOOKS about opportunities in Electronics. For your convenience, we will try to have a representative call. Mail reply card or coupon to CIE...or write: Cleveland Institute of Electronics, Inc., 1776 E. 17th St., Cleveland, Ohio 44114.

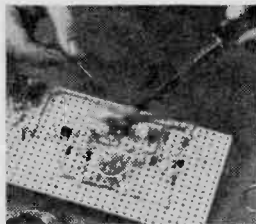

You learn how to construct circuits and connect them with a soldering iron, which is part of your CIE laboratory equipment. This "hands on" experience is extremely valuable.

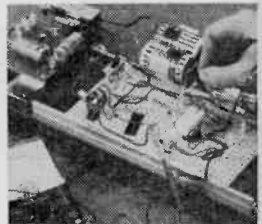

Testing and troubleshooting are an important part of your learning experience. Your laboratory has a precision multimeter to diagnose electronic troubles quickly and accurately.

### APPROVED UNDER G. I. BILL

All CIE career courses are approved for educational benefits under the G.I. Bill. If you are a Veteran or in service now, check box for G.I. Bill information.

## CIE Cleveland Institute of Electronics, Inc.

1776 East 17th Street, Cleveland, Ohio 44114  
Accredited Member National Home Study Council

Please send me your 2 FREE BOOKS—The CIE school catalog, "Succeed in Electronics" and "How To Get a Commercial FCC License."



Name \_\_\_\_\_ (Please Print)  
Address \_\_\_\_\_  
City \_\_\_\_\_  
State \_\_\_\_\_ Zip \_\_\_\_\_ Age \_\_\_\_\_

**Veterans and Servicemen:**  
 Check here for G.I. Bill information.

EL-38

CIRCLE NO. 13 ON PAGE 17 OR 103

# Finding a "Needle in a Haystack" Isn't So Hard Anymore!

These Metal Detector/Locator Kits make your every outing an exciting adventure!

## Our Best! Has Advanced Integrated Circuit Design!

Lightweight, fun, and practical—spots coins and other metal objects up to 6" deep. Has both speaker and meter indication, specially designed Faraday shield for outstanding sensitivity. Great for camping, hiking, exploring, beachcombing, you name it! Use indoors to locate pipes and cables. Operates on two 9-volt batteries. Easy to build. **34<sup>95</sup>**

## Fun to Use Economy Model

For beachcombers on a budget, this is the one that really works! Just set the volume and pitch controls for constant tone, pitch will increase as you near metal object. Has comfortable stereo headphones. Battery operated. **19<sup>95</sup>**

*Strike It Rich!*

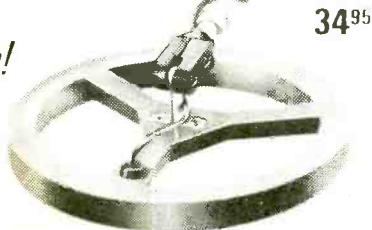

**FREE '73 CATALOG! AT YOUR 147 NEARBY STORE OR SEND IN THIS COUPON**  
 180 pages! Stereo Hi-Fi, CB, Ham, Kits, Radios, Recorders, Tools, More!

Name \_\_\_\_\_ Apt # \_\_\_\_\_  
 Street \_\_\_\_\_  
 City \_\_\_\_\_ State \_\_\_\_\_ Zip

**Radio Shack**  
 and ALLIED RADIO STORES  
 A TANDY CORPORATION COMPANY  
 P. O. Box 1052, Fort Worth, Texas 76107

CIRCLE NO. 22 ON PAGE 7 OR 103

# BUILD 20 RADIO

## and Electronics Circuits

### PROGRESSIVE HOME RADIO-T.V. COURSE

#### Now Includes

- ★ 12 RECEIVERS
- ★ 3 TRANSMITTERS
- ★ SQ. WAVE GENERATOR
- ★ SIGNAL TRACER
- ★ AMPLIFIER
- ★ SIGNAL INJECTOR
- ★ CODE OSCILLATOR

- ★ No Knowledge of Radio Necessary
- ★ No Additional Parts or Tools Needed
- ★ EXCELLENT BACKGROUND FOR TV
- ★ SCHOOL INQUIRIES INVITED
- ★ Sold In 79 Countries



Reg. U. S. Pat. Off.

Training Electronics Technicians Since 1946

#### FREE EXTRAS

##### ● SET OF TOOLS

- SOLDERING IRON
- ELECTRONICS TESTER
- PLIERS-CUTTERS
- VALUABLE DISCOUNT CARD
- CERTIFICATE OF MERIT
- TESTER INSTRUCTION MANUAL
- HIGH FIDELITY GUIDE • QUIZZES
- TELEVISION BOOK • RADIO TROUBLE-SHOOTING BOOK
- MEMBERSHIP IN RADIO-TV CLUB
- CONSULTATION SERVICE • FCC AMATEUR LICENSE TRAINING
- PRINTED CIRCUITRY

#### YOU DON'T HAVE TO SPEND HUNDREDS OF DOLLARS FOR A RADIO COURSE

The "Edu-Kit" offers you an outstanding PRACTICAL HOME RADIO COURSE at a rock-bottom price. Edu-Kit is designed to train Radio & Electronics Technicians, making use of the most modern methods of home training. You will learn radio theory, construction practice and servicing. THIS IS A COMPLETE RADIO COURSE IN EVERY DETAIL. You will learn how to build radios, using regular schematics; how to wire and solder in a professional manner; how to service radios. You will work with the standard type of punched metal chassis as well as the latest development of Printed Circuit chassis.

You will learn the basic principles of radio. You will construct, study and work with RF and AF amplifiers and oscillators, detectors, rectifiers, test equipment. You will learn and practice Code, using the Progressive Code Oscillator. You will learn and practice trouble-shooting using the Progressive Signal Tracer, Progressive Signal Injector, Progressive Dynamic Radio & Electronics Tester, Square Wave Generator and the accompanying instructional material.

You will receive training for the Novice, Technician and General Classes of F.C.C. Radio Amateur Licenses. You will build Receiver, Transmitter, Square Wave Generator, Code Oscillator, Signal Tracer and Signal Injector circuits, and learn how to operate them. You will receive an excellent background for television, Hi-Fi and Electronics.

Absolutely no previous knowledge of radio or science is required. The "Edu-Kit" is the product of many years of teaching and engineering experience. The "Edu-Kit" will provide you with basic education in Electronics and Radio, worth many times the low price you pay. The Signal Tracer alone is worth more than the price of the kit.

#### THE KIT FOR EVERYONE

You do not need the slightest background in radio or science. Whether you are interested in Radio & Electronics because you want an interesting hobby, a well paying business or a job with a future, you will find the "Edu-Kit" a worth-while investment. Many thousands of individuals of all

ages and backgrounds have successfully used the "Edu-Kit" in more than 79 countries of the world. The "Edu-Kit" has been carefully designed, step by step, so that you cannot make a mistake. The "Edu-Kit" allows you to teach yourself at your own rate. No instructor is necessary.

#### PROGRESSIVE TEACHING METHOD

The Progressive Radio "Edu-Kit" is the foremost educational radio kit in the world, and is universally accepted as the standard in the field of electronics training. The "Edu-Kit" uses the modern educational principle of "Learn by Doing." Therefore you construct, learn schematics, study theory, practice trouble shooting—all in a closely integrated program designed to provide an easily-learned, thorough and interesting background in radio. You learn by examining the various radio parts of the "Edu-Kit." You then learn the function, theory and wiring of these parts. Then you build a simple radio. With this first set you will enjoy listening to regular broadcast stations, learn theory, practice testing and trouble-shooting. Then you build a more advanced radio, learn more advanced theory and techniques. Gradually, in a progressive manner, and at your own rate, you will find yourself constructing more advanced multi-tube radio circuits, and doing work like a professional Radio Technician.

Included in the "Edu-Kit" course are Receiver, Transmitter, Code Oscillator, Signal Tracer, Square Wave Generator and Signal Injector Circuits. These are not unprofessional "breadboard" experiments, but genuine radio circuits, constructed by means of professional wiring and soldering on metal chassis, plus the new method of radio construction known as "Printed Circuitry." These circuits operate on regular AC or DC house current.

#### THE "EDU-KIT" IS COMPLETE

You will receive all parts and instructions necessary to build twenty different radio and electronics circuits, each guaranteed to operate. Our Kits contain tubes, tube sockets, variable, electrolytic, mica, ceramic and paper dielectric condensers, resistors, fine wire, solder, hardware, tubing, punched metal chassis, Instruction Manuals, hook-up wire, solder, selenium rectifiers, coils, volume controls and switches, etc.

In addition, you receive Printed Circuit materials, including Printed Circuit chassis, special tube sockets, hardware and instructions. You also receive a useful set of tools, a professional electric soldering iron, and a self-powered Dynamic Radio and Electronics Tester. The "Edu-Kit" also includes Code Instructions and the Progressive Code Oscillator, in addition to F.C.C. Radio Amateur License training. You will also receive lessons for servicing with the Progressive Signal Tracer and the Progressive Signal Injector, a High Fidelity Guide and a Quiz Book. You receive Membership in Radio-TV Club, Free Consultation Service, Certificate of Merit and Discount Privileges. You receive all parts, tools, instructions, etc. Everything is yours to keep.

Progressive "Edu-Kits" Inc., 1189 Broadway, Dept. 560DJ, Hewlett, N.Y. 11557

#### UNCONDITIONAL MONEY-BACK GUARANTEE

Please rush my Expanded Radio-TV Course with "Edu-Kits"® to me.

- Send Course with Edu-Kits postpaid. I enclose full payment of \$34.95.
- I enclose \$5.00 deposit. Send Course with Edu-Kits C.O.D. for balance of \$29.95 plus postage.
- Send me FREE additional information describing Course with Edu-Kits.

NAME

ADDRESS

CITY & STATE

ZIP

#### PROGRESSIVE "EDU-KITS" INC.

1189 Broadway, Dept. 560DJ, Hewlett, N.Y. 11557

#### SERVICING LESSONS

You will learn trouble-shooting and servicing in a progressive manner. You will practice repairs on the sets that you construct. You will learn symptoms and causes of trouble in home, portable and car radios. You will learn how to use the professional Signal Tracer, the unique Signal Injector and the dynamic Radio & Electronics Tester. While you are learning in this practical way, you will be able to do many a repair job for your friends and neighbors, and charge fees which will far exceed the price of the "Edu-Kit." Our Consultation Service will help you with any technical problems you may have.

#### FROM OUR MAIL BAG

J. Stataitis, of 25 Poplar Pl., Waterbury, Conn., writes: "I have prepared several sets for my friends, and made money. The "Edu-Kit" paid for itself. I was ready to spend \$240 for a Course, but I found your ad and sent for your Kit."

Ben Valerio, P. O. Box 21, Magna, Utah: "The Edu-Kits are wonderful. Here I am sending you the questions and also the answers for them. I have been in Radio for the last seven years, but like to work with Radio Kits, and like to build Radio Testing Equipment. I enjoyed every minute I worked with the different kits; the Signal Tracer works fine. Also like to let you know that I feel proud of becoming a member of your Radio-TV Club."

Robert L. Shuff, 1534 Monroe Ave., Huntington, W. Va.: "Thought I would drop you a few lines to say that I received my Edu-Kit, and was really amazed that such a bargain can be had at such a low price. I have already started repairing radios and phonographs. My friends were really surprised to see me get into the swing of it so quickly. The trouble-shooting Tester that comes with the kit is really swell, and finds the trouble, if there is any to be found."

#### PRINTED CIRCUITRY

At no increase in price, the "Edu-Kit" now includes Printed Circuitry. You build a Printed Circuit Signal Injector, a unique servicing instrument that can detect many Radio and TV troubles. This revolutionary new technique of radio construction is now becoming popular in commercial radio and TV sets.

A Printed Circuit is a special insulated chassis on which has been deposited a conducting material which takes the place of wiring. The various parts are merely plugged in and soldered to terminals.

Printed Circuitry is the basis of modern Automation Electronics. A knowledge of this subject is a necessity today for anyone interested in Electronics.