

SEPTEMBER-OCTOBER
1972
75c

elementary Electronics

9
GREAT
IC
CIRCUITS
for Weekend
Experimenters

02342

Keep your personal calls

CONFIDENTIAL

with e/e's exclusive

SCRAMBLER

Complete plans in this issue!

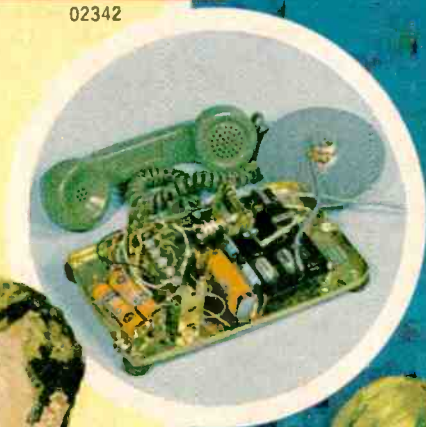

Plus-

Fun with LASERS—

Kits and tips

you should know about!

Special Features on

CB and SWL

hobbying!

More on those fascinating

SCA Adaptor projects

We Test-

TEAC AN-60

Noise Reduction Unit

Teaberry Twin-T

SSB/AM CB Transceiver

Hustler DCX Discone

40-700 MHz Action-Band

Antenna



THE DIFFERENCE BETWEEN BEING HEARD AND NOT BEING HEARD

Have you ever received a signal that hits a strong 9 on your S-meter but is completely unintelligible? That's because the signal is poorly modulated. You can have the strongest CB signal going, but with poor modulation you might as well not be transmitting. Don't let it happen to you. Chances are, the single most effective thing you can do to clear and strengthen your CB signal is to start using a good pre-amplified microphone. If your microphone doesn't do its job, expensive

transceivers and antennas are wasted. But with full modulation, even older and weaker transceivers can chop through the hash and noise. A pre-amplified microphone makes it possible to achieve full modulation.

Be heard. Get a pre-amplified microphone. Get the best. Get a Turner. Write for details. Turner Division, Conrac Corporation, 909 Seventeenth Street N.E., Cedar Rapids, Iowa 52402. Telephone (319) 365-0421.



TURNER
DIVISION OF CONRAC CORPORATION

CIRCLE NO. 22 ON PAGE 17 OR 103

Your paycheck says a lot about you



It tells you more than how much you make. It tells you how far you've come. And if your paycheck looks very much the same as it did last year, or the year before, it simply means that *you* look very much the same as *you* did last year and the year before.

But times change, and you should be changing with them. Old dull jobs are disappearing. New exciting ones are being created. There are challenging new fields that need electronics technicians...new careers such as computers, automation, television, space electronics where the work is interesting and the earnings are greater.

RCA Institutes has one of the nation's largest and most respected home study schools devoted to electronics. They can get you started even if you've had no previous training or experience. RCA Institutes has developed a faster, easier way for you to gain the skills and the knowledge you need for a fascinating, rewarding electronics career. And you don't have to quit work and go back to school. With RCA Institutes Home Study Plan you can do both. You set your *own* pace depending on *your* schedule.

Check over these RCA benefits:

- You get Hands-On Training—as many as 21 kits in RCA's Master TV/Radio Servicing Program.
- You get RCA's unique "Autotext" method of learning—individual programmed instruction, the *easy, faster, simplified* way to learn!
- You get the widest choice of electronics courses and programs—everything from Basic Electronics right up to Digital Technology and Communications Electronics.
- You get a selection of low-cost tuition plans!

Sounds great, and it is! For complete information, without obligation, send in the attached postage paid card...or return the coupon below. That will say a lot about you.

Veterans: Train under new GI Bill. Accredited Member National Home Study Council. Licensed by N.Y. State—courses of study and instructional facilities approved by the State Education Department.

If reply card is detached—send this coupon today

RCA Institutes

Home Study Dept. 246-209-0
320 West 31st Street, New York, N.Y. 10001

Please rush me FREE illustrated catalog.
I understand that I am under no obligation.

Name _____ Age _____
(please print)

Address _____

City _____ State _____ Zip _____

Veterans: Check here

ELEMENTARY ELECTRONICS including SCIENCE & ELECTRONICS (Vol. 12, No. 4) is published bi-monthly by Davis Publications, Inc., at 229 Park Ave., S, New York, N.Y. 10003. One year subscription (six issues)—\$4.00. Second class postage paid at New York, N.Y. 10003 and at additional mailing offices.

SEPTEMBER-OCTOBER, 1972



elementary Electronics

Dedicated to America's Electronics Hobbyists

THE PROJECT EVERYONE HAS BEEN WAITING FOR!

☆ 75 Build e/e's . . . Scramble Phone—only you will know what she is saying

CASTING LIGHT UPON THE DARKNESS

☆ 43 LASER—Build your own from a goof-proof kit and ply into the exciting world of scientific research

PROJECTS FOR EVERYBODY

- ☆ 55 9 Great Integrated Circuit Projects
 - 1—Remote Gain Control
 - 2—Professional Remote Amplifier
 - 3—Protect-A-Volt
 - 4—Super 15 Amplifier
 - 5—Comm-Press Log Amplifier
 - 6—Great Equalizer
 - 7—Stereo Mike Preamplifier
 - 8—Gain Master Mike Preamplifier
 - 9—Micro-Mini Amplifier

☆ 63 Super SCA Adaptor—Our new design really works on weak signals

ACTION FROM THE ACTION BANDS

- ☆ 40 To C or Not to B—Get all the facts on Citizens Band radio and get them straight
- ☆ 47 Kathi Assembles the Hustler DSC Discone—40 to 700 MHz of action-band sky hook
- ☆ 51 Kathi's CB Carousel—Our communications Miss checks out Teaberry's SSB/AM CB transceiver
- ☆ 62 CB Coffee Break—CBers are action oriented to the emergency bands

TUNING IN THE SHORTWAVE BANDS

- ☆ 29 DX Central Reporting—From Radio Nibi Nibi to Radio Amundson
- ☆ 31 All About Shortwave Listening—Get with it by getting facts from pros

HIGH FIDELITY FOR EVERYONE

- ☆ 35 e/e Looks at New Hi-Fi Components
- 49 Hey Herb—e/e's Audio Answer Man
- ☆ 53 e/e Checks out the TEAC AN/60 Dolby Noise Reduction Unit

THE KNOWLEDGE DEPARTMENT

79 Basic Course—All about resistors

FRILLS AND FILLS ON FACTS AND FANCY

- 8 Hey Look Me Over—Gadgets and gizmos
- 17 Reader Service Page
- 25 Literature Library—mail box bonanza
- 26 Ask, Hank, He Knows—Our Q&A expert
- 42 Top Secret Jewelry Hits the Neckline—for men only
- 69 Bookmark—by Bookworm
- 74 Newscan—All the electronic news fit to print
- ☆ 103 Reader Service Page

☆
Cover
Highlights



AUTHORS IN THIS ISSUE

Herb Friedman, Mrytle Gronk, Jorma Hyypia, Don Jensen, Julian S. Martin, Kathi Martin, Charles D. Rakes, Jack Schmidt, Hank Scott, Matt P. Spinello and the ELEMENTARY ELECTRONICS editorial staff.



Cover Illustration
by
Jack
Thurston

FREE...demonstration lesson to prove that you can learn TV servicing at home.

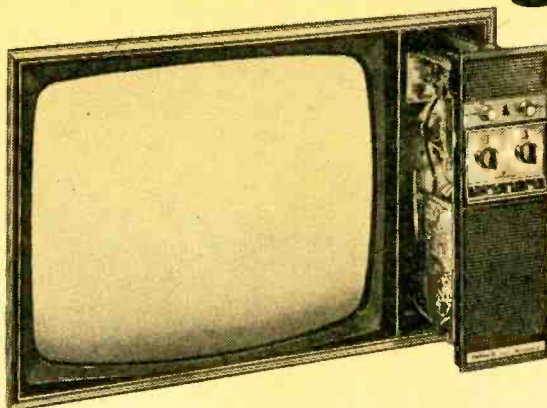

Practice on a new 25" MOTOROLA QUASAR II® chassis.

TV Servicing is a satisfying career . . . and the pay is great. Qualified men are needed now to maintain the 93 million sets in U.S. homes. And prospects for the future are even brighter.

Now . . . here's an opportunity for you to prove to yourself that **you** can learn TV Servicing . . . at home, in your spare time. ICS, the world's most experienced home-study school, will send you a **FREE** Demonstration Lesson (complete with sample questions) if you will merely fill out the coupon below and mail it to us.

In addition to your free demonstration lesson, we'll send you . . . also **FREE** . . . a brochure that describes the 25" (diagonally measured screen) MOTOROLA QUASAR II® Color TV chassis that we include in our TV Service Training Program.

This chassis with automatic fine tuning control is ideal for training purposes because it combines solid state devices with vacuum tubes to give you both kinds of practical experience.

Credit towards a Certified Electronic Technician (C.E.T.) rating will be granted by the National Electronics Association to ICS students upon completion of the ICS Career Program in TV Service/Repair.

ICS

Since 1890
School of Electronics
Scranton, Pa. 18515

Approved for veterans under the new GI bill/approved for federally insured loans/Accredited by the Accrediting Commission of the National Home Study Council.

All parts carry Motorola's two year replacement guarantee!

The QUASAR II chassis comes to you in three basic sub-assemblies . . . **NOT AS A KIT** . . . because we want you to learn how to **repair** TV sets, not build them.

Our free literature also describes the fully assembled test equipment you receive such as the Deluxe 5" Solid State Oscilloscope, the tools and the learn-by-doing kits, all of the finest quality.

And we're going to tell you about eight other career opportunities in Electronics and the ICS Career Programs that can help prepare you for them. All you've got to do is mail the coupon. **SEND IT TODAY!**

**ICS School of Electronics Dept. AA201U
Scranton, Pa. 18515**

YES, I want you to mail to me without obligation, the **FREE DEMONSTRATION LESSON** and complete literature on the career program checked below. (Please check one.)

- | | |
|---|--|
| <input type="checkbox"/> Color TV Servicing | <input type="checkbox"/> FCC License |
| <input type="checkbox"/> Computer Maintenance | <input type="checkbox"/> Communications/Broadcasting |
| <input type="checkbox"/> CATV Installation | <input type="checkbox"/> Hi-Fi Sound Systems |
| <input type="checkbox"/> Telephony | <input type="checkbox"/> Industrial Electronics |

Name _____ Age _____

Address _____

City _____

State _____ Zip _____

CIRCLE NO. 30 ON PAGE 17 OR 103



SCIENCE · OPTICS · ELECTRONICS
UNUSUAL & HARD TO FIND BARGAINS
 NEW PRODUCTS · NEW MATERIALS · NEW METHODS

"IDENTIFY" MARIJUANA, HASH, ETC.



Easy, quick, low-cost way to spot Marijuana, Hashish, Amphetamines. 5-min. test tells if drug is the real thing, detects presence of alien matter. Scientifically accepted reliable method used by testing labs, law enforcement agencies to identify & prevent use of harmful, illegal drugs. Compact test kit (not for children) requires no specific training, permits 30-50 tests (as low as 12¢ ea.) Inst's, incl.
 Marijuana & Hashish)
 No. 71,615EK \$5.95 Ppd.
 (Amphetamines, Opium) \$5.95 Ppd.
 No. 71,617EK

BLACK-LIGHT MIGHTY MITES

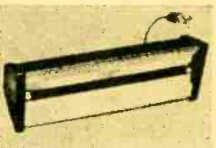

Relatively small (12") fixtures give surprisingly bright blacklight. Mirror-finished reflector makes instant starting. 8-watt, high-intensity bulb look like 40-watt. Up to 5,000 hours of safe, long-wave (9000Å) blacklight to really turn-on parties, light & theatrical shows, psychedelic decors, holiday decorations. Shockproof end-caps remove for safe, easy replacement of bulb and starter. Stands upright or horizontal. Aluminum case.
 Stock No. 71,274EK \$14.95 Ppd.
 DELUXE OUTDOOR INDOOR MODEL
 Stock No. 71,299EK \$19.95 Ppd.

\$8.95 ELECTRONIC STROBE!



Hand-sized solid state electronic strobe light at fantastically low price. Produces bright psychedelic effects like larger, far more expensive Xenon strobes. Yet it's just 2 3/4" X 3" X 1 3/8" thick. Adjustable flash rate, approximately 3-10 flashes per second. Make stop motion effects, posters come alive. Great to take with you to parties, dances, outings, etc. Requires 2 9v transistor batt. (not incl.). Instructions.
 Stock No. 41,443EK \$8.95 Ppd.
 4 REPLACEMENT LAMPS \$1.00 Ppd.
 #41,444EK

ELECTRONIC DIGITAL COMPUTER



Fully assembled! Easy to program—fun to operate. . . solve problems, play games, try to outwit it! You program it, give it problems, get results from electronic readout. Quickly learn "what makes computer tick", how to program . . . soon program with own problems, data. Big 14x15" high impact plastic model features 3 movable registers, patch cords & plugs (to program elect. circuits). Incl 2 manuals: (1) games, experiments; (2) advanced experiments & program, cards, disc, 3-A batt.
 Stock No. 71,608EK \$36.50 Ppd.

STARTS SEEDS IN 3 TO 5 DAYS!

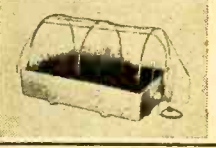

New thermostatically controlled electric greenhouse provides constant 70° growing temperature, accelerates seed germination, helps produce healthy thriving plants ready for outdoor planting. Big 3 sq. ft. planting area—2 1/2" X 1 1/2" X 4 1/2" box holds 1/2 bushel of growing medium. Germinates tomato seeds in 3-5 days; aster, dahlias, petunias, etc. or less. Incl. 3 X 4 ft. clear plastic cover, supports 4 pkgs. of veg. & flower seeds. Uses reg. home current.
 Stock No. 80,153EK \$12.95 Ppd.

AMAZING NEW Wankel Engine Kit!



Build your own see-through motorized model of revolutionary pistonless type engine, rights for which GM recently paid \$50 million! Only one considered modifiable to meet new standards. Replaces piston, cylinder, crank assemblies with rotating discs (sections removed for firing chambers). Greater than conventional; fewer parts, greater reliability, same speed w/ less horsepower. Switch. Req. 2-1.5v batt. (not incl.).
 No. 71,424EK (4 1/2" X 5 1/2") \$6.75 Ppd.
 \$19 Ppd. "Wankel" BOOK—#9439EK \$15.25 Ppd.

"Bright Ideas" in Unique Lighting. Big, new 100 page handbook packed with facts, loaded with illustrations. All latest developments, applications, equipment. 8 1/2" X 11" looseleaf paper fit 3 rings.
 Stock No. 9100EK \$3.00 Ppd.

Order by Stock No.—Check or M.O.—Money-Back Guarantee
EDMUND SCIENTIFIC CO., 300 EDCORP BLDG., BARRINGTON, N.J. 08007

WRITE FOR FREE GIANT CATALOG

148 PAGES!—1000's OF BARGAINS

EDMUND SCIENTIFIC CO., 300 EDCORP BUILDING, BARRINGTON, NEW JERSEY 08007

Completely new edition. Dozens of electrical and electronic parts, accessories. Enormous selection of astronomical Telescopes, Microscopes, Binoculars, Magnifiers, Magnets, Lasers, Lenses, Prisms, ecological and unique lighting items. Many war surplus items; for hobbyists, experimenters workshop, factory.

WRITE FOR CATALOG "EK."

EDMUND SCIENTIFIC CO. 300 EDCORP BLDG., BARRINGTON, NEW JERSEY 08007

ORDER BY STOCK NUMBER · SEND CHECK OR MONEY ORDER · MONEY-BACK GUARANTEE

CIRCLE NO. 2 ON PAGE 17 OR 103

elementary Electronics

Sept./Oct. 1972

Vol. 12/No. 4

Dedicated to America's Electronics Hobbyists

Editor-in-Chief

JULIAN S. MARTIN, WA2CQL

Technical Editor

STEPHEN B. GRAY

Communications Editor

PETER L. DEXNIS, WA3LOQ

News Editor

CAROL J. BRUCKNER

Citizens Band Editor

KATHI MARTIN, KAIØ614

Workbench Editor

HANK SCOTT

Art Director

JIM MEDLER

Cover Art Director

IRVING BERNSTEIN

Assistant Art Director

ANDY STEIGMEIER

Art Associate

ANGELO MARFISI

RALPH ROBINO

Advertising Director

DAVID J. MILLER

Production Director

CARL BARTEE

Production Manager

GERTRUD BORCHARDT

Assistant Production Manager

MARILYN VARGAS

News and Circulation Director

DON GABREE

Subscription Circulation—Marketing Director

ROBERT V. ENLOW

Instruments Division Manager

WILFRED M. BROWN

Chairman of the Board

B. G. DAVIS

President and Publisher

JOEL DAVIS

Vice-President and General Manager

LEONARD F. PINTO

Vice President and Treasurer

VICTOR C. STABILE, KBØ681

ELEMENTARY ELECTRONICS is published bi-monthly by Davis Publications, Inc. Editorial, Business and Subscription offices: 229 Park Avenue South, New York, N.Y. 10003. One-year subscription (six issues)—\$3.95; two-year subscription (12 issues)—\$7.95; three-year subscription (18 issues)—\$11.95; and four year subscription (24 issues)—\$15.95. Add \$1.00 per year for postage outside the U.S.A. and Canada. For change of address, please advise 4 to 6 weeks before moving. Send us your current mailing label with new address. Advertising offices: New York, 229 Park Avenue South, 212-OR 3-1300; Chicago, 520 N. Michigan Ave., 312-527-0330; Los Angeles; J. E. Publishers' Rep. Co., 8560 Sunset Blvd. 213-659-3810; Long Island: Len Osten, 9 Garden Street, Great Neck, N.Y., 516-487-3305; Southwestern advertising representative: Jim Wright, 818 Olive St., St. Louis, 314-CH-1-1965 Second-class postage paid at New York, N.Y. and at additional mailing office. Copyright 1972 by Davis Publications, Inc.

Only RCA Institutes offers you all these advantages:

1 A broad range of courses to help you qualify for good-paying jobs in such rewarding fields as communications, color TV servicing, automation, nuclear instrumentation, space electronics, drafting, computer programming.

2 RCA's exclusive Autotext training method—the easy, faster, simplified way to learn electronics at home.

3 Personal supervision throughout your training.

4 Over 250 experiments and up to 22 kits in some programs

5 Easy monthly payment plan.

6 Over 60 years of leadership in technical training.

7 Recognition from leaders in the field as an RCA Institutes graduate.

Veterans can train under new GI Bill. Licensed by the State of New York. Accredited Member National Home Study Council.

Courses available in Canada too.

If you've ever thought about getting into electronics... you owe it to yourself to see what RCA home training has to offer.

This entire fold-over coupon makes a no-postage-required business-reply envelope. Fill in your name and address ...then cut out along dotted lines...fold, seal and mail.

RCA INSTITUTES, Inc., Home Study School
320 West 31st St., New York, N. Y. 10001

246-209-9

Please send me free illustrated home study career catalog.

Name _____ Age _____
(please print)

Address _____

City _____ State _____ Zip _____

- Check here if interested in Classroom Training.
 Veterans check here

NO STAMP NEEDED

You must seal (Staple, tape or glue) before mailing.

FOLD HERE

DO NOT CUT HERE

FIRST CLASS

Permit No. 10662
New York, N. Y.

BUSINESS REPLY MAIL

No Postage Necessary if Mailed in United States

Postage will be paid by

RCA INSTITUTES

Home Study School
320 West 31st St.
New York, N. Y. 10001

246-209-9

THE MOST IMPORTANT
DIMENSION
OF AN ANTENNA
IS
dependability

HUS-T-LER

**HAS BEEN
FOREMOST
FOR MORE THAN A
DECADE!**

You will find 100% American material and precision workmanship to cover your requirement in Citizen-band, Amateur, Monitor and Business-Radio antennas and antenna hardware. Systems designed for application, performance and dependability at reasonable cost.

HUS-T-LER

*available from all
distributors and dealers
(more than 3000)
who recognize the best!*

**NEW-TRONICS
CORPORATION**

15800 COMMERCE PARK DRIVE
BROOKPARK - - - OHIO, 44142

CIRCLE NO. 12 ON PAGE 17 OR 103

**Hey,
look me over**

Showcase of New Products

Picture Box Radio

Whether it's a birthday, graduation or some other gift-giving occasion—or just a little present for yourself—General Electric's nifty little SoundScene picture radio lets you make it uniquely your own. A quality AM radio in a see-through polystyrene cube, the SoundScene



(model P2755) can be personalized with favorite photos, artwork, a poem or whatever you choose—while at the same time you enjoy good radio listening. All you have to do is twist the top ring to remove it and lift the cube from the base. Insert materials between the pressure tabs and windows, put the base back into the cube and twist the top ring to lock it in place. The radio is almost as easy to operate. Just pre-set volume and tuning knobs on the bottom of the cube and then push On/Off button on top for instant-on sound. The solid-state AM radio operates on a standard 9-volt battery which is included. Available from GE dealers, the SoundScene measures 3¾-inches square. \$12.95 is the manufacturer's suggested retail price.

Dim It!

You can now modernize any lamp in your home to provide exactly the lighting you want for any mood or purpose with the new Archer

(Continued on page 12)

ELEMENTARY ELECTRONICS

CONSTRUCTION KITS by CORTLANDT ELECTRONICS, 16 Hudson St., New York, N.Y. 10013



\$1.95 NIXIE—READOUT TUBES—GE \$1.99

Burroughs 15-segment, 2 1/2" alpha-numeric characters, formerly used on Stock Exchange quotation boards; slip-on socket-contacts included. A 7-segment, 0.4" high, numeric fluorescent display made by G.E., but not equal to their #Y-4075 standards. 1 1/2" lds. Both sold on a money back warranty.



A self-addressed envelope brings you our catalog showing actual photographs of all our electronic kits. We have a full line (at low prices of course) of electronic components such as relays, security-alarm devices, photocells, transistors, capacitors, small motors, etc. Include check or MO plus 25¢ to cover postage with order. No COD please.

VARIABLE-TIME FLASHER #KC-5 \$2.35

0.1 sec. to 3 min.
Learn the principle of the R/C Time-delay circuit. A chart is provided, specifying the resistor value required to control the rate of flash per minute. The booklet explains, in illustrated form, this type of electronics.

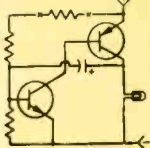

Kit includes:-
8-Resistors
2-Transistors
1-Capacitor
1-Lamp
Perf. board
Colored wire
Spring Clips
Hardware

LIGHT-ACTIVATED RELAY #KC-26

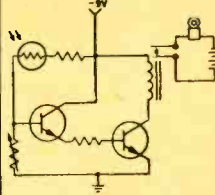

For ALARM, SIREN, FLOODLIGHT or NIGHT LIGHT: battery operated.
Kit includes:- Includes a Clairax Photocell and a Pot to reduce the sensitivity of the photocell. Low battery drain. A regular flashlight at a distance of 30 feet triggers the relay. Relay contacts carry two amperes at 120 volts AC.
1 Relay
2 Resistors
1 Battery clip and colored wires

only \$3.85

Perforated mounting board and a booklet of complete wiring, mounting and operating instructions.

DIODE SWITCH #KC-64

Kit includes:
1 DPNP switch
4 Rectifiers
1 perforated mounting bd.
1 booklet
\$1.35

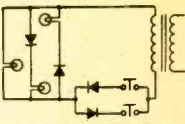

It is possible to individually light either of a pair of lamps using only two wires instead of the three needed up until now. On long distances the saving is worth while, especially if it is desired to extend the existing wires to another location. Other uses are noted in the instruction booklet.

AUTOMOBILE BURGLAR ALARM

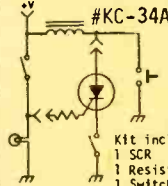

SWITCH with key for both these alarms \$2.40 extra

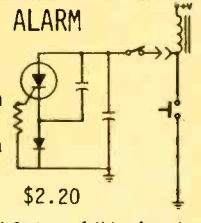

Kit includes:
1 SCR
1 Resistor
1 Switch
\$1.50 10 ft wire

The added feature of this alarm is that it is NOT activated when the door is opened, but when the motor is started. The switch may be hidden inside the car—Under dashboard. Two additional capacitors included plus parts shown at left.

Kit #KC-34B

This alarm is activated by a hidden switch (or key switch) under a mudguard. When the car door is opened the horn blows and stays on until the switch is turned off. The SCR is the important component in this circuit. Both kits include booklet of instructions.

NIXIE HIGH-VOLTAGE SUPPLY only \$1.98

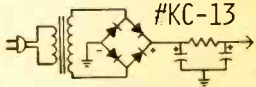

The complete, full-wave rectifier and filter system for an unlimited nixie array at the required voltage.

CODE-PRACTICE OSCILLATOR #KC-50

Many thousands of amateurs practiced their dots and dashes on this type of audio oscillator. Adjustable tone; ideal for door-bell, Bicycle horn, remote-call, Signal systems, etc.
Instruction booklet has additional uses for this fine kit. Price \$1.75

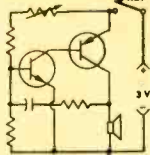

Kit includes:-
1-Speaker
2-Transistors
3-Resistors
1-Capacitor
1-Pot
Mounting board
Colored Wire
\$1.75

NOISE SQUIRTER

With a probe, the signal from this generator (a stable, square-wave audio frequency) which can be injected into various points in electronic gear. Suspected trouble should be detected, either through the Speaker or Scope. The booklet furnishes complete instructions.

Kit includes:-
4-Resistors
3-Capacitors
2-Transistors
Perf. board
Note--Probe not included
\$1.98

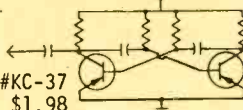

LINE TESTER (NEON TYPE)
Indicates Zebra circuits in power lines; AC or DC; high (or low) voltage in equipment; etc. Kit includes a neon lamp, a probe and four resistors. Booklet describes uses.

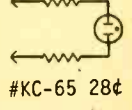

#KC-65 28¢

ELECTRONIC METRONOME #KC-2

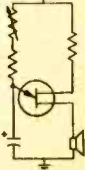

The rate of "clicks" is controlled with a pot--adjustable from 10 to 240 times a minute. This kit includes a speaker and instruction booklet. Easy to assemble.

Price, \$2.65

Kit includes:-
1-Speaker
1-Transistor
2-Resistors
1-Pot
1-Capacitor
Batt. Clip
Perf. Bd.
Colored Wire

DUAL LAMP FLASHER

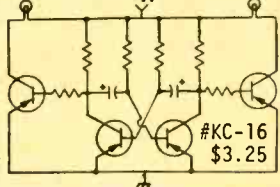

Ideally suited as a signaling or warning device, designed with a stable circuit. The rate-of-flash may be varied from 5 to 60 times per minute. Suitable relays may be substituted for the lamps, making it possible to use large, 120 volt lamps. Works on 3 V. or 4 1/2 V., for relay operation you may use #6 dry batteries--long life. Complete instruction booklet.

Kit includes:-
4-Transistors
2-Capacitors
6-Resistors
2-Lamps
Perf. Board
colored Wire
Price \$3.25
Qual "D"cell batt holder 40¢ extra.

RELAXATION OSCILLATOR

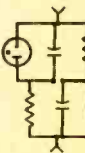

Any number of lamps may be added to this blinker. The rate of flashes is controlled by changing the value of the resistors. Specify the number of lamps you want and we'll send the right number of components.

Two-light kit consists of:-
2-Neon, NE-2
2-Resistors
2-Capacitors
1-Perf. Board
Colored Wires
Booklet Instr.
2 Neons--99¢
3 " " --1.40
4 " " --1.75
6 " " --2.35

REED SWITCH with RELAY #KC-57 \$2.85

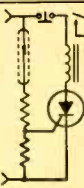

Kit includes:-
1 Reed switch
1 Magnet
1 SCR
1 Relay
1 Switch
2 Resistors
Perf. Board
1 Battery clip
colored wires

The slightest momentary contact of the REED switch will latch the Silicon-Controlled Rectifier and activate the relay until you turn off the power. Wire up a store, factory or an apartment with any number of these REED switches--on windows or doors--set the magnets at any height you wish so that windows may be partially opened. Extra strong magnets are included. This is a reliable, fool-proof circuit. Booklet of instructions and safety suggestions. Extra Alnico magnets & Sw. 39¢ Pair.

CORTLANDT ELECTRONICS, INC. 16 HUDSON ST., NEW YORK, N.Y. 10013

CIRCLE NO. 5 ON PAGE 17 OR 103

New "Computer Tuner"—4 channel amp—electronic



NEW Heathkit "Computer Tuner" — we've brought new digital technology to FM stereo for the man who knows his music

NEW TO CONSUMER ELECTRONICS — pure digital design philosophy brings you one of the most fascinating and satisfying kits you'll ever build. Plus, a piece of precision audio gear that's already the talk of the stereo world. With the Heathkit AJ-1510 "Computer Tuner," you "keyboard" your FM station frequency and, if the broadcast is receivable, you hear it instantly. Numerical display tubes show your location on the FM spectrum. And the "Computer Tuner" automatically center-tunes for optimum reception! Gone are the knob, slide-rule frequency scale and tuning meter. A digital frequency synthesizer, employing phase-lock-loop techniques, does the tuning — with channel frequency accuracy better than 0.005%. The preassembled varactor FM RF tuning unit (front end) uses field-effect transistors to provide high sensitivity (less than 1.8 uV) and low cross modulation with no overload on strong signal local stations. The familiar mechanically-ganged variable capacitor has been replaced by varicaps (voltage variable capacitance diodes) to provide complete electronic tunability. An inductorless digital frequency discriminator of the pulse counting (averaging) type follows two fixed-tuned five-pole LC IF filters thus eliminating all IF and discriminator adjustments while achieving distortion levels of 0.1%.

THREE TOTALLY DISTINCT PROGRAMMING MODES. Besides the exclusive keyboard tuning, you can select your FM with a sweep/scan mode. Push a button and the synthesizer counts down through the band, stopping at each station of listenable quality, or just stereo stations if you prefer. Or, you can pre-program your favorite frequencies on the computer-type punch cards included with the kit. Up to three cards can be inserted simultaneously behind the hinged front panel with instant access to these stations via A, B, C pushbuttons.

AUDIBLY SUPERIOR PERFORMANCE SPECS. Selectivity and IF rejection are better than 95 dB. Image and spurious rejection are better than 90 dB. Signal-to-noise ratio better than 65 dB, separation better than 40 dB. The 55 ICs, 50 transistors and 50 signal diodes mount on 10 modules with seven plugging into a master board for maximum computer modularity. And that makes assembly even easier. Order your "Computer Tuner" and start enjoying the FM sound that only true digital technology can bring.

Kit AJ-1510, "Computer Tuner" less cabinet, 23 lbs. \$39.95*
 AJA-1510-1, optional pecan cabinet, 6 lbs. \$24.95*



The Heathkit AA-2004 Integrated Amplifier — 200 versatile watts for discrete or matrixed 4-Channel sound, and stereo or mono

AA-2004 puts you right in the middle of the 4-channel excitement — without obsoleting all the stereo gear you already own. It serves up a block-busting 200 watts through four channels, with control versatility that lets you put the power into any format — mono, stereo, matrixed 4-channel, discrete 4-channel.

IMPROVES WHAT YOU ALREADY OWN. Thanks to built-in matrix circuitry that decodes matrixed 4-channel recordings and 4-channel broadcasts, the AA-2004 lets you use your present turntable, tape equipment or tuner. Also, the decoder enhances your present stereo record & tape library, and conventional 2-channel FM broadcasts by feeding the "hidden presence" to rear speaker for an extremely satisfying 4-channel effect.

PUTS YOU AHEAD OF TOMORROW'S DEVELOPMENTS. As discrete 4-channel media becomes more prevalent, the AA-2004 is ready. Four conservatively rated and fully protected amplifiers produce 260 watts into 4 ohms (4x65), 200 watts into 8 ohms (4x50), 120 watts into 16 ohms (4x30). Controls are provided for every source, mode and installation. Amplifier sections are

controlled in pairs with one complete stereo system for left & right front speakers and another for left & right rear — so your AA-2004 can be used to power two separate stereo systems if desired. With outputs for both main and remote speaker systems, it can be used to power two 4-channel systems (up to 8 speakers).

PERFORMANCE SPECS YOU'D EXPECT FROM HEATH. Make your own comparison of the AA-2004's impressive specifications: Full power bandwidth on all channels from less than 5 Hz to more than 45 kHz for 0.25% total harmonic distortion. IM distortion less than 0.2%. Damping factor greater than 100. Hum and noise — 65 dB for phono, — 75 dB for tape and aux.

GOES TOGETHER WITH TRADITIONAL HEATHKIT SIMPLICITY. Plug-in circuit boards and preassembled wiring harnesses reduce point-to-point wiring — make the AA-2004 as much fun to build as it is to use. Get with the 4-channel revolution now. Order your Heathkit AA-2004.

Kit AA-2004, 39 lbs., less cabinet \$349.95*
 AAA-2004-1, pecan cabinet, 7 lbs. \$24.95*

calculator—super 25V color TV

And 350 other exciting projects in the FREE Heathkit Catalog

If you're not already into a Heathkit hobby, what's holding you back? Ask around and you'll find a Heathkit builder who can show you the rewards. You'll pay yourself back for your kitbuilding time with better products. Better in terms of price, value, performance specifications, and self-service features. And the Heathkit line-up is bigger and better than ever. Including color TV, stereo/hi-fi, electronic organs, home appliances, engine tune-up tools, radio control, shortwave, marine gear, instruments, hundreds more. They are all in the free '72 Heathkit Catalog. Send for yours now.

NEW Heathkit Electronic Desk-Top Calculator — full-function, 8-digit readout for a low, low kit price

Approximately eight enjoyable hours of your time can give you that calculator you've been wanting for home or office—at a price substantially below any assembled unit with comparable features. The new Heathkit 2008 Electronic Calculator handles addition, subtraction, multiplication and division with up to eight-figure totals displayed on extra-bright 1/2" seven-segment readout tubes. The 2008 accepts both positive and negative numbers. Solves problems in either constant or chain operations. Simply push the K (constant) key and multiply or divide by one preselected number, release the key and you can work a series of multiple-operation problems with the Calculator automatically displaying running sub-totals with each step.

FOOLPROOF CREDIT BALANCER. The IC-2008 automatically displays a minus result to make credit balancing as easy as keying in the credit and debit columns in any sequence. Touch the total key and you have the result with no need to manually sub-total. You can balance the family checkbook in minutes! A thumbwheel sets the decimal in any one of seven fixed positions, or you can select the floating mode for decimal totals carried out to completion. A ninth readout tube at the left of the display indicates plus or minus overflow, as well as a minus sign for negative results. A partial



clearing key allows you to remove the last entry from the circuitry while preserving the rest of the problem.

DEPENDABLE AMERICAN-MADE LARGE SCALE INTEGRATED CIRCUIT is the "brain" of the Heathkit IC-2008 Calculator. Components mount on two roomy circuit boards for quick, neat construction. And you can wire your IC-2008 for either 120 or 240 VAC operation. Figure it out for yourself—the Heathkit IC-2008 is a great kit-form value. Take advantage of it today. Kit IC-2008, 11 lbs. \$129.95*

NEW Heathkit GR-900 25 V Color TV — the most technically advanced set we've ever offered

13 SUB-KITS SIMPLIFY ASSEMBLY—and take you from the first circuit board through final alignment. The result is the largest color picture you can buy anywhere, with a complement of convenience controls found only on the world's most expensive receivers. A soldering iron and a few conventional hand tools are all you need to get your GR-900 together. We supply everything else.

UHF/VHF DETENT POWER TUNING—heads up the impressive list of GR-900 features. Push a button and you scan either UHF or VHF channels, in either direction, with detent action locking in on the 12 VHF and any 12 preselected UHF channels.

NEW VOLTAGE-CONTROLLED VARACTOR UHF TUNER and a newly designed VHF tuner with MOS field effect transistor contribute to better fringe-area reception and increased sensitivity. A new angular tint control for "normal" or "wide angle" color demodulation minimizes tint and flesh tone change when you switch channels or when programs change. And check this list of deluxe features: "Instant on" with override; automatic fine tuning; adjustable tone control; stereo/hi-fi audio output; automatic chroma control; adjustable video peaking; adjustable noise limiting; gated AGC; illuminated channel identification. For total armchair control, there's even an optional wireless remote control.

EXCLUSIVE HEATH MTX-5 ULTRA-RECTANGULAR BRIGHT TUBE measures a full 25 inch diagonal, 315 sq. in. viewing area—has a specially etched face plate to cut glare, with each color dot projected against solid black background for extra crispness.

STATE-OF-THE-ART RELIABILITY. The modular solid-state design utilizes 46 plug-in transistors, 57 diodes, and four ICs, with the majority of the circuitry on plug-in boards. The built-in dot generator and tilt-out convergence panel are periodic adjustment aids you'll find only on Heathkit sets. And further, a built-in volt-ohm meter and simplified troubleshooting section in the manual permit self-servicing should the need ever arise. The '72

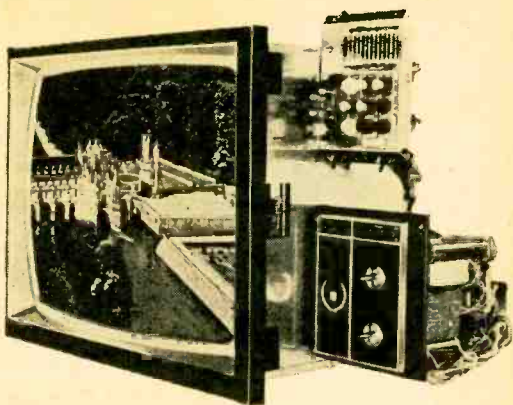

Catalog lists four beautiful cabinets for the GR-900, plus the exciting new Custom Wall Mount that allows you to build the set into a wall. Brighten your life with Heathkit solid-state color entertainment. Order your GR-900 now and know the pride of building and owning the best.

Kit GR-900, TV less cabinet, 125 lbs. \$399.95*
Kit GRA-900-6, wireless remote control, 6 lbs. \$79.95*

See them all at your Heathkit Electronic Center... or fill out the coupon below

HEATHKIT ELECTRONIC CENTERS — ARIZ.: Phoenix, 2727 W. Indian School Rd.; CALIF.: Anaheim, 330 E. Ball Rd.; El Cerrito, 6000 Potrero Ave.; Los Angeles, 2309 S. Flower St.; Pomona, 1555 Orange Grove Ave. N.; Redwood City, 2001 Middlefield Rd.; San Diego (La Mesa), 8363 Center Dr.; Woodland Hills, 22504 Ventura Blvd.; COLO.: Denver, 5940 W. 38th Ave.; FLA.: Miami (Hialeah), 4705 W. 16th Ave.; GA.: Atlanta, 5285 Roswell Rd.; ILL.: Chicago, 3462-66 W. Devon Ave.; Downers Grove, 224 Ogden Ave.; KANSAS: Kansas City (Mission), 5960 Lamar Ave.; MD.: Rockville, 5542 Nicholson Lane; MASS.: Boston (Wellesley), 165 Worcester St.; MICH.: Detroit, 18645 P. Eight Mile Rd. & 18149 E. Eight Mile Rd.; MINN.: Minneapolis (Hopkins), 101 Shady Oak Rd.; MO.: St. Louis, 9296 Gravois Ave.; N.J.: Fair Lawn, 35-07 Broadway (Rte. 4); N.Y.: Buffalo (Amherst), 3476 Sheridan Dr.; New York, 35 W. 45th St.; Jericho, L.I., 15 Jericho Turnpike; Rochester, Long Ridge Plaza; OHIO: Cincinnati (Woodlawn), 10133 Springfield Pike; Cleveland, 5444 Pearl Rd.; PA.: Philadelphia, 6318 Roosevelt Blvd.; Pittsburgh, 3482 Wm. Penn Hwy.; TEXAS: Dallas, 2715 Ross Ave.; Houston, 3705 Westheimer; WASH.: Seattle, 2221 Third Ave.; WIS.: Milwaukee, 5215 Fond du Lac.

HEATHKIT	
Schlumberger	
HEATH COMPANY, Dept. 139-9 Benton Harbor, Michigan 49022	
<input type="checkbox"/> Please send FREE Heathkit Catalog.	
<input type="checkbox"/> Enclosed is \$ _____	plus shipping.
Please send model(s) _____	
Name _____	
City _____ State _____ Zip _____	
Prices & specifications subject to change without notice. *Mail order prices; F.O.B. factory.	
CL-438	

CIRCLE NO. 1 ON PAGE 17 OR 103



It took guts to redesign a CB radio and then put it in the same familiar cabinet.

We know today's CBer is looking for real value. So we redesigned our Messenger 123 where it counts—on the inside. Our engineers gave the model "A" new improved circuitry. With a new acoustically isolated speaker and voice-tailored audio that cuts noise—increases clarity. Plus a new ceramic selectivity filter that rejects adjacent channel chatter. And, of course it has built-in electronic speech compression for famous Johnson "talk power." At \$149.95, the Messenger 123A is a real value. And come to think about it, it's still a great looking CB radio just the way it is.

Messenger 123A.
New where it counts:
Inside.



JOHNSON
 Waseca, Minnesota 56093



Full 1-year parts and labor warranty—backed by over 550 authorized service centers nationwide.
CIRCLE NO. 8 ON PAGE 17 OR 103

HEY, LOOK ME OVER

(Continued from page 8)



Lamp Dimmer Socket from Radio Shack. The lamp dimmer socket installs with just a screwdriver, replacing standard or three-way bulb sockets. Using ordinary light bulbs up to 150 watts, it is continuously variable from off to full-brilliance. The Archer Lamp Dimmer Socket is priced at \$3.95. Available through more than 1000 Radio Shack Stores in 49 states and Canada. Get the straight dope by circling No. 61 on Reader Service Coupon.

White Lightning

Nicknamed "White Lightning", a new Antenna Specialists Model M-325 mobile CB antenna is a top-loaded, white fiber glass whip featuring a tunable tip for minimum VSWR. The whip is made of double-woven fiber glass, giving it exceptional rigidity to maintain vertical position at high speeds, resist abrasion and maintain a gleaming white color under all weather conditions. The base is Antenna Specialists' new 3/8-in. professional mount. Ease of removal for car washes and absolute watertight seal with the antenna removed are two of its features. A slender, heavy

duty stainless steel shock spring of the professional type provides shock protection but holds the antenna vertical at highway speeds. Suggested retail price of the new antenna is \$19.95. For additional information circle No. 64 on Reader Service Coupon.

Messenger from Johnson

The E. F. Johnson Company has put out an improved version of their most popular 23-channel CB transceiver. Called the Mes-

**180 MINUTES—
4 RECORD
ALBUMS—**



**3 FULL HOURS OF
LISTENING PLEASURE**

The TDK C-180LN Cassette. For the first time in any recording medium, a full three hours of unbelievable listening pleasure—the equivalent of four (or more) full disc albums—has been concentrated into a package you can slip into a pocket or cradle in the palm of your hand.

The package is the familiar cassette that has revolutionized tape recording, but the running time is new—and *exclusively* available from TDK, with the same reliability warranty that covers all dependable TDK cassettes. And the tape it carries is TDK's Deluxe Low-Noise, a quality product that surpasses most other high-performance types.

Yesterday—TDK Super Dynamic (SD) cassette tape—"the tape that turned the cassette into a high-fidelity medium."

Today—The *exclusive* TDK C-180LN three-hour, four-album, extra-long-playing cassette.

Tomorrow—Who knows how we'll shake you up next?



TDK

TDK ELECTRONICS CORP.

23-73 48TH STREET, LONG ISLAND CITY, N. Y. 11103 • 212-721-6881

Purity in Sound



CIRCLE NO. 20 ON PAGE 17 OR 103

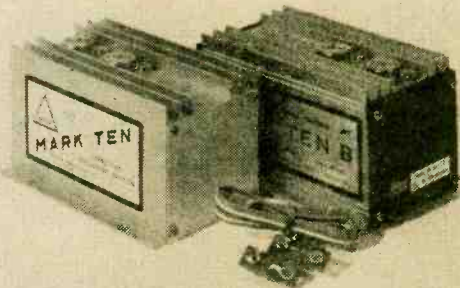

**Keep Your Car
Engine Humming.
Eliminate Three Out
of Four Tune-ups.**

Delta's Capacitive Discharge Ignition (CDI) Systems increase car performance while slashing maintenance costs. Choose from two great systems, the original Mark Ten or the Mark Ten B.

Write today for complete information on how you can save money with a Mark Ten CDI on your automobile.



DELTA PRODUCTS, INC.

P.O. BOX 1147, DEPT. ELE • GRAND JUNCTION, COLO. 81501
PHONE: (303) 242-9000

CIRCLE NO. 4 ON PAGE 17 OR 103

SEPTEMBER-OCTOBER, 1972



avanti

**DON'T BE BULLIED . . . KICK BACK STRONG . . .
BUY AN ASTRO PLANE HIGH PERFORMANCE C.B.
ANTENNA**



33-35 WEST FULLERTON AVENUE
ADDISON, ILLINOIS 60101

**AVANTI RESEARCH & DEVELOPMENT, INC.
MAKERS OF THE FAMOUS "MOONRAKER"**

CIRCLE NO. 3 ON PAGE 17 OR 103

Automatic Tri-Speed Scan Action



16 big channels in three bands with push button program control

Hear it now!

A UHF, High/Low VHF monitor in one handsome, easy-to-operate package.

Our new Monitoradio/Executive Scanner, Model TME-16 H/L/U, doesn't miss a trick on transmission.

It conducts an automatic, or manual, search for active signals on your choice of frequencies in three busy bands. It stops to hear the transmitted action, loud and clear . . . then automatically resumes the search.

Each of the 16 crystal controlled channels is push button equipped for programming any channel "in" or "out" of service. Push buttons, too, for programming either of the three bands.

Tri-speed scan action speeds the signal search to "super-scan" the channels you want most—eliminates signal sampling of channels you choose to temporarily "program-out".

Best of all, it does the complete monitor job that formerly required 3 receivers—only \$219.00. Crystals \$4.95 each.

Hear it now—at your favorite Regency retailer.

Ask for our complete color catalog of 25 monitor models

 **REGENCY ELECTRONICS, INC.**
7900 Pendleton Pike
Indianapolis, Indiana 46226
CIRCLE NO. 25 ON PAGE 17 OR 103

HEY, LOOK ME OVER



senger 123A, it features completely new solid-state circuitry with a ceramic selectivity filter. The filter is designed to reject adjacent channel interference, even from strong nearby signals. Another new feature is an "acoustically isolated" speaker and special audio circuitry that is frequency-tailored for clearer voice reproduction and suppression of noise. An accessory external speaker is also available, for use under exceptionally noisy conditions, such as in an open vehicle. Other accessories available include a power pack with rechargeable batteries for portable operation and a power supply base for desk-top use from 117-volt household current. The Messenger 123A comes complete with mounting bracket, microphone, and crystals for all channels. Suggested price is \$149.95. Complete details are available by writing to the E. F. Johnson Company, Waseca, Minnesota 56093 or circling No. 68 on Reader Service Coupon.

It's Your Move

Now anyone from 8 to 80 years of age can learn how to play "Winning Chess" by studying this new simplified course on an hour-long tape cassette. Furnished with the cassette are instructional diagrams and labels which are affixed to your chess or checkerboard to enable you to follow the moves easily. The cassette tells the history and background of the game, the names and moves of the various pieces, gives examples of good and bad opening moves, and presents sample games which the listener can follow. Included in the sample games are the "Fool's Mate" and "Scholar's Mate" and a variety of ways for checkmating your opponent. The cassette plays in any standard tape cassette



player and is priced at \$5.95 postage paid. From Cassette House, P.O. Box 531, Arlington Heights, Illinois 60006.

Big Beam

The new deluxe Mosley 5-element Mini-Beam (Model GA-5D) is designed to deliver full-size beam performance in a smaller amount of space. The secret of GA-5D's miniature size and big-beam performance is in its coils. Two deluxe high "Q" coils on each element limit

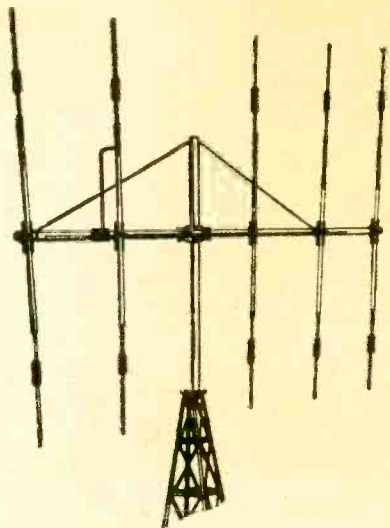

the mechanical size of the GA-5D without limiting its electrical capability. These coils are built to take a powerful beating, in fact, these same coils are used on 10-meter ham antennas. This compact design reduces the area exposed to wind so the antenna can be mounted, without a tower, on a TV antenna mount and turned with an inexpensive TV rotor. Model GA-5D is lightweight, approximately one-half the weight of an ordinary five element beam. You can assemble and install it quickly and easily: Solid-state gamma match, pre-assembled parts and color-coding combine with lightweight and compact size for ease in handling. \$48.83 suggested net. For specifications and performance data, circle No. 70 on Reader Service Coupon.

Solid Inverter

There's a new portable solid-state inverter for the operation of 117-Volt, 60-cycle, AC equipment from 12-Volt, DC storage battery power in automobiles, buses, trucks, trailers, campers, mobile homes, boats, and aircraft. Made by ATR Electronics, this new inverter model 12U-S2A has an output capacity of 275 Watts continuous and 300 Watts intermittent while maintaining stable frequency of 60 cycles with varying load or input voltage. The inverter is recommended for the operation of tape recorders, TV sets, VTR equipment, pub-



another great
new idea

reversible
ratchet handles
for Xcelite "99" tools

These two unique plastic (UL) handles extend the usefulness of all Xcelite Series "99" tools, make welcome additions to any "99" set.

Both regular (99-1R) and Tee (99-4R) types accept more than 60 individually available nut-driver, screwdriver, and special purpose snap-in blades to speed and simplify assembly and service work.

Fully enclosed ratchet mechanism is built to highest socket/wrench quality standards. Recessed reversing shift operates at the flick of a thumb. Patented spring chuck holds blades firmly.

nationwide availability through local distributors

REQUEST BULLETIN N670

Made in U.S.A.

XCELITE

XCELITE, INC. • 80 BANK ST., ORCHARD PARK, N.Y. 14127
Send Bulletin N670 on Series "99" Reversible Ratchet Handles.

name _____

address _____

city _____

state & zone _____

CIRCLE NO. 16 ON PAGE 17 OR 103

EXAMINE ANY OF THESE FINE NEW BOOKS ON 10-DAY FREE TRIAL!



COMPUTERS, SECURITY, ENGINEERING, BROADCAST

- Installing & Serv. Electr. Protect. Sys.—255 pgs.—\$4.95
- Fire & Theft Security Systems—176 pgs.—\$4.95
- Video Tape Production & Comm. Techniques—256 pgs.—\$12.95
- Design & Maint. CATV & Small TV Studio—272 pgs.—\$12.95
- How to Become a Radio Disc Jockey—256 pgs.—\$7.95
- Beginner's Guide to Computer Programming—384 pgs.—\$6.95
- Beginner's Guide to Computer Logic—192 pgs.—\$4.95
- Modern Radar: Theory, Operation & Maint.—480 pgs.—\$7.95
- Industrial Electronics: Principles & Practice—352 pgs.—\$5.95
- Computer Circuits & How They Work—192 pgs.—\$4.95
- Computer Technician's Handbook—480 pgs.—\$7.95
- CATV System Engineering—3rd Edition—Hardbound \$12.95

AUDIO AND HI-FI, SEMICONDUCTORS & TEST EQUIPMENT

- Using Electr. Testers for Auto Tune-up—256 pgs.—\$4.95
- Hi-Fi for the Enthusiast—176 pgs.—\$3.95
- 1972 Popular Tube Trans. Substitution Guide—256 pgs.—\$2.95
- How to Build Solid-State Audio Circuits—256 pgs.—\$5.95
- New IC FET Principles & Projects—160 pgs.—\$3.95
- How to Use Your VOM-VTVM & Oscil.—192 pgs.—\$3.95
- Servicing Modern Hi-Fi Stereo Systems—236 pgs.—\$4.95
- Handbook of Magnetic Recording—192 pgs.—\$4.95
- Tape Recording for Fun & Profit—224 pgs.—\$4.95
- Audio Systems Handbook—192 pgs.—\$4.95
- Electronic Musical Instruments—192 pgs.—\$4.95
- Servicing Electronic Organs—196 pgs.—8 1/2 x 11—\$7.95
- Understanding Solid-State Circuits—192 pgs.—\$4.95
- How to Use Test Instruments In Electronics Servicing—\$4.95
- 99 Ways to Use Your Oscilloscope—192 pgs.—\$4.95
- Working With the Oscilloscope—104 pgs.—8 1/2 x 11—\$4.95

BASIC ELECTRONICS, CITIZENS BAND, HOBBY & HAM RADIO

- Electronics Data Handbook, New 2nd Ed.—256 pgs.—\$4.95
- Commercial FCC License Handbook—432 pgs.—\$5.95
- RTTY Handbook—320 pgs.—\$5.95
- Model Car Racing... by Radio Control—224 pgs.—\$3.95
- Solid-State Projects for the Experimenter—224 pgs.—\$3.95
- Practical Solid-State Principles & Projects—176 pgs.—\$3.95
- Basic Electronics Course—368 pgs.—\$5.95
- The Fascinating World of Radio Commun.—176 pgs.—\$3.95
- Citizens Band Radio Service Manual—192 pgs.—\$4.95
- Radio Electronics Hobby Projects—192 pgs.—\$3.95
- IC Projects for Amateur & Experimenter—192 pgs.—\$3.95
- Electronics Self-Taught with Exper. & Proj.—288 pgs.—\$4.95
- 125 One-Transistor Projects—192 pgs.—\$3.95
- 104 Easy Projects for the Electronics Gadeteer—\$3.95
- CB Radio Operator's Guide—224 pgs.—\$3.95
- How to Read Electronic Circuit Diagrams—210 pgs.—\$3.95
- Radio Control Handbook—New 3rd Ed.—320 pgs.—\$5.95
- Beginner's Guide to TV Repair—160 pgs.—\$3.95
- 64 Hobby Projects for Home & Car—192 pgs.—\$3.95
- Understanding Using Radio Comm.'s Rev.—192 pgs.—\$3.95
- 104 Simple One-Tube Projects—192 pgs.—\$3.95
- Electronic Hobbyist's IC Project Handbook—160 pgs.—\$3.95
- 104 Easy Transistor Projects You Can Build—224 pgs.—\$3.95
- AMATEUR RADIO LICENSE STUDY GUIDES:** Incentive, 160p. \$3.95 Advanced-Class, 192p. \$3.95 Extra-Class, 224p. \$4.95 General-Class, 320p. \$5.95 Novice-Class, 160p. \$3.95

SERVICING COLOR TV, RADIO & APPLIANCES

- How to Interpret TV Waveforms—256 pgs.—\$4.95
- Basic Color Television Course—320 pgs.—\$5.95
- Major Appliance Repair Guide—288 pgs.—\$5.95
- Solid-State Circuit Troubleshooting Guide—224 pgs.—\$4.95
- Modern Radio Repair Techniques—260 pgs.—\$4.95
- 199 TV Tough-Dog Problems Solved—256 pgs.—\$4.95
- Home-Call TV Repair Guide—144 pgs.—\$2.95
- How to Repair Solid-State Imports—160 pgs.—\$4.95
- Small Appliance Repair Guide—224 pgs.—\$4.95
- 81 TV Trouble Symptoms to Repair—24 pgs.—\$4.95
- How to Repair Home & Auto Air Conditioners—\$4.95

ALL-IN-ONE SCHEMATIC/SERVICING MANUALS

Each volume contains complete service data, including full-size schematic diagrams, and all info needed. Each volume 8 1/2 x 11—256 pgs.—\$4.95. **COLOR TV:** Adm. G-E Vol 1 Vol 2 Japan. Vol 1 Vol 2 Magna. Vol 1 Vol 2 Motoro. Vol 1 Vol 2 Philco RCA. Vol 1 Vol 2 Sylvania. Vol 1 Vol 2 Zenith Vol 1 Vol 2 B&W TV: Adm. G-E Japan. Magna. Motoro. Philco RCA Sylvania. Zenith

SEE THESE HELPFUL BOOKS AT YOUR PARTS DISTRIBUTORS, OR CLIP THIS AD AND ORDER ON FREE 10-DAY TRIAL, OR ATTACH PAYMENT AND SAVE POSTAGE. FULLY GUARANTEED OR MONEY BACK! PA. RESIDENTS ADD 6% TAX. EE-92



TAB BOOKS

BLUE RIDGE SUMMIT, PA. 17214

CIRCLE NO. 14 ON PAGE 17 OR 103

HEY, LOOK ME OVER



lic address systems, ham gear, test instruments, phonos, radio sets, small synchronous motors, scientific laboratory and hospital equipment, small AC-DC universal type motors, fluorescent or incandescent lights, and similar equipment. The ATR model 12U-S2A inverter is filtered and comes complete with battery cables ready for operation at a user net price of \$139.50. For more information, circle No. 66 on Reader Service Coupon.

Second Best But Great

Shure Brothers Inc. has added to its M91 cartridge series a new addition which offers trackability second only to the Shure V-15 Type II (improved) cartridge. Called the M91ED, the new cartridge delivers significantly improved high frequency trackability over the present M91E. This is made possible by design advances in the stylus assembly.

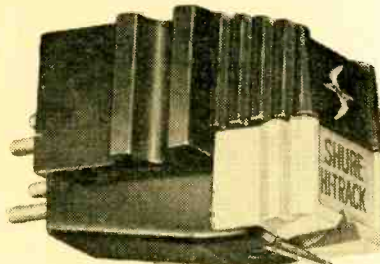

Mounting an ultra-lightweight nude diamond tip directly on the stylus bar and doing away with even the tiny metal bushing used in the M91E, has reduced the stylus tip mass. The result is a smooth, peak-free frequency response. Owners of M91E Cartridges may upgrade their present system by purchasing an N91ED Stylus. Price of the M91ED (Elliptical) is \$54.95; the M91GD (spherical), \$44.95. For additional information, write: Shure Brothers Inc., 222 Hartrey Avenue, Evanston, Illinois 60204 or circle No. 69 on Reader Service Coupon.

Miniature Screwdriver Sets

Two sets of miniature size screwdrivers, called "Mini-Driver Sets," by Xcelite are designed for use by the hobbyist, tinkerer, do-it-yourselfer. Mini-Driver Set M-50 contains five drivers for slotted head screws, with tips

(Continued on page 22)

READER SERVICE PAGE

• The Editor of ELEMENTARY ELECTRONICS offers readers an easy way to get additional information about products and services advertised in this issue. Also, if you would like more information about any new product mentioned in our column "Hey, Look Me Over," it's yours for the asking. Just follow the instructions below and the material you requested will be sent to you promptly and at no cost.

• The coupon below is designed for your convenience. Just circle the numbers that appear next to the advertisement or editorial mention that interests you. Then, carefully print your name and address on the coupon. Cut out the coupon and mail to ELEMENTARY ELECTRONICS, Box 886, Ansonia Station, New York N Y 10023. Do it today!

SEPTEMBER/OCTOBER 1972 Void after January 31, 1973

ELEMENTARY ELECTRONICS
Box 886, Ansonia Station, New York, N.Y. 10023

Please arrange to have literature whose numbers I have circled at right sent to me as soon as possible. I understand that this is a free service offered by the magazine.	1	2	3	4	5	6	7	8	9	10
	11	12	13	14	15	16	17	18	19	20
	21	22	23	24	25	26	27	28	29	30
	31	32	33	34	35	36	37	38	39	40
	41	42	43	44	45	46	47	48	49	50
	51	52	53	54	55	56	57	58	59	60
	61	62	63	64	65	66	67	68	69	70

• Please limit circled items to 12 maximum.

Name (Print Clearly) _____

Address _____

City _____ State _____ Zip Code _____

NOW you can train at home building a NEW 25" Solid State Color TV engineered by NRI for learning and trouble-shooting

So much better for learning TV servicing than any hobby kit, because NRI designed and created it as an educational tool.

Unlike hobby kits which are designed for creating a TV set as the end product, NRI built its exclusive 25" Solid State Color TV kit as a real training kit. You can introduce and correct defects . . . for trouble-shooting and hands-on experience in circuitry and servicing. The kits include a wide-band oscilloscope, color bar crosshatch generator, transistorized volt-ohmmeter and other valuable equipment that can soon have you earning \$5 to \$7 an hour servicing color sets in your spare time.

Handsome woodgrain cabinet, at no extra cost. (Offered only by NRI)

New square-cornered Sylvania picture tube

100% solid state chassis

6-position detented UHF channel selector



Modular construction with plug-in circuit boards

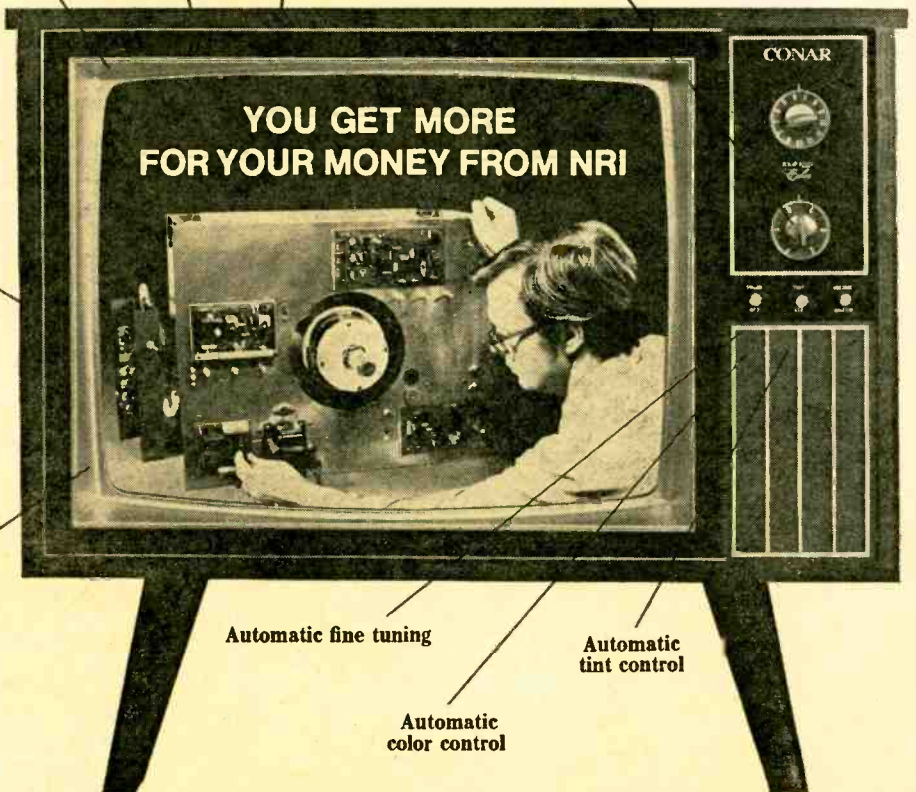

Automatic degaussing

Automatic fine tuning

Automatic tint control

Automatic color control

NRI FIRSTS make learning Electronics fast and fascinating—to give you priceless confidence

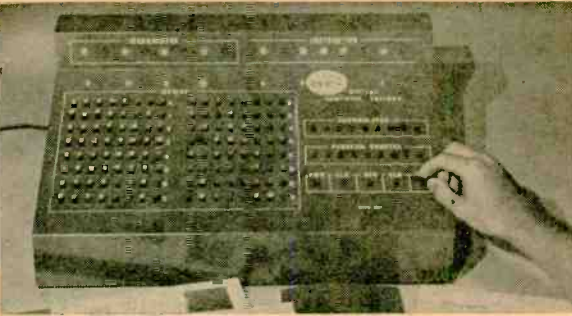

FIRST to give you a complete programmable digital computer, with memory, you build yourself... to learn organization, operation, trouble-shooting and programming. This remarkable computer is one of ten training kits you receive with the new NRI Complete Computer Electronics Course.

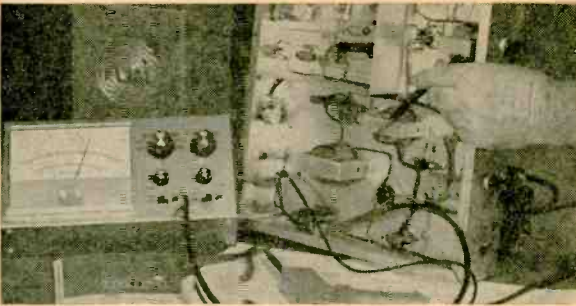

FIRST to give you true-to-life experiences as a Communications Technician. Every fascinating step you take in NRI Communications training, including circuit analysis of your own 15-watt, phone/cw transmitter, is engineered to help you prove theory and later apply it on the job. Studio equipment operation and trouble shooting become a matter of easily remembered logic.



FIRST to give you completely specialized training kits engineered for business, industrial and military Electronics Technology. Shown is your own training center in solid-state motor control and analog computer servo-mechanisms. Telemetry circuits, solid-state multivibrators and the latest types of integrated circuits are included in your course.

The NRI color TV and digital computer kits are the latest in a long line of "firsts" for NRI. For more than fifty years, NRI has been providing unique 3-dimensional home-study training that has helped hundreds of thousands of students reach their goals quickly and easily.

What NRI provides is a combination of kits and bite-size texts that give you hands-on experience while you are learning. The texts average only 40 pages each, and they are fully illustrated. You are taken step-by-step from the first stages into the more advanced theory and techniques... with an expert instructor ready at all times to provide valuable guidance and personal attention. (The level of personal attention provided is more than you would receive in many classrooms.) Once you've grasped the fundamentals, you move with confidence and enthusiasm into new discoveries in the fascinating world of electronics.

You start out with NRI's exclusive Achievement Kit, containing everything you need to get moving fast. Lessons have been specifically written so that experiments build upon one another like stepping stones. You can perform a hundred experiments, build hundreds of circuits... as you learn to use the professional test equipment provided, building radios and TV sets, transmitter or computer circuits. It's the priceless "third dimension" in NRI training... practical experience.

Train with the leader—NRI

Compare training kits, texts, techniques and overall training... and you'll find that you get more for your money from NRI. Whatever your reason for wanting more knowledge of Electronics, NRI has an instruction plan that will meet your needs. Choose from major programs in Advanced Color TV Servicing, Complete Computer Electronics, Industrial Electronics and the other special courses designed to meet specific needs. With NRI home training, you can learn new skills while you're still working at your present job... and turn yourself into the man in demand.

GET FACTS ABOUT GI BILL

If you have served since January 31, 1955, or are in service now, check GI line on postage-free card.

Send for free NRI catalog

MAIL THE POSTAGE-FREE CARD FOR THE FREE NRI CATALOG IN THE FIELD OF YOUR CHOICE. YOU WILL BE UNDER NO OBLIGATION. NO SALESMAN WILL CALL.

If the card has been used, write direct to:



NRI TRAINING

3939 Wisconsin Ave.
Washington, D.C. 20016

FREE

LAFAYETTE 1973 CATALOG 730



Ready
Now!

The World's Largest Consumer Electronics Catalog

Everything In Electronics for
Home, Business, Industry

• Stereo/Hi-Fi Components • Musical Instruments and Amplifiers • CB & Ham Equipment • Tools and Test Equipment • Police and Fire Monitor Receivers • Public Address Systems • Photography Equipment • Semiconductors, Books, Parts • Plus Much More!

Your Complete Electronics Buying Guide

Send
Today!

Lafayette Radio Electronics
P.O. Box 10, Dept. 25092
Syosset, L.I., N.Y. 11791

Send FREE 1973 Catalog 25092

NAME _____

ADDRESS _____

CITY _____

STATE _____ ZIP _____

CIRCLE NO. 6 ON PAGE 17 OR 103

HEY, LOOK ME OVER

(Continued from page 16)

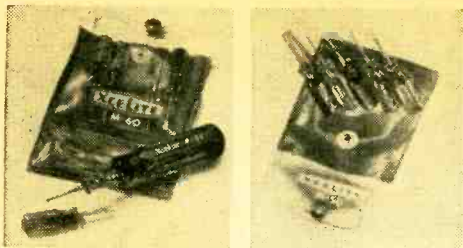

ranging from .040-in. to .100-in. (1 to 2½mm) in width. With an overall length of 2½-in., each driver has a blade length of ⅞-in. and a handle measuring ⅜-in. by 1¼-in. The set is housed in a snap-close, flexible, plastic, see-thru pouch. Mini-Driver Set M-60 consists of the same five flat-tip drivers plus one size 00 Phillips type driver and a piggyback torque-amplifier handle which fits over the handles of any of the six Mini-Drivers, providing better grip, reach, and torque. The pouch for Set M-60 has a separate pocket for the torque-amplifier handle, a snap-close compartment for the Mini-Drivers. Handles of all Mini-Drivers are of clear, durable, color-coded plastic for instant identification. Mini-Driver Sets M-50 and M-60 are fully described in the new complete line Catalog No. 171 which may be obtained from Xcelite by circling No. 55 on Reader Service Coupon.

For Electronic Gardeners

E-M Activator's a naturally-occurring energized ore mixture which electro-magnetically stimulates plant growth. Just stir this mixture into the soil at the root level, and you'll grow bigger, better and healthier plants through the miracle of electromagnetic energy. It is claimed you'll have larger flowers with more fragrant aroma, and more vegetables with extra delicious flavor. E-M Activator is not a fertilizer nor a soil builder. To use it, you must also provide the normal adequate fertilizer and soil nutrients. To get

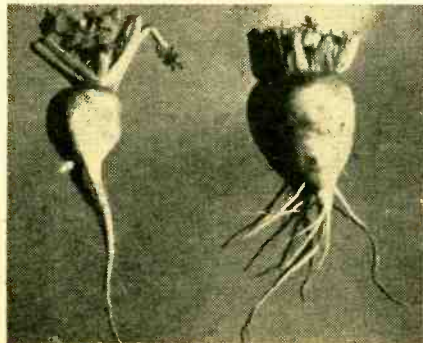

ELEMENTARY ELECTRONICS

your 10-lb. can of "E-M Activator," send \$6.95, (anywhere within the continental United States) to: Kalmar Co. Inc., Box 4343, Santa Fe Station, Denver, Colorado 80204. All sales F.O.B. Denver, but sent to customer postpaid. Complete satisfaction or your money back.

Tune-Up Today

Following the trend among economy and ecology minded people for do-it-yourself auto tune-ups, Radio Shack is offering a new tune-up analyzer which they say is accurate enough for professional use, yet easy enough for the home mechanic to operate. Radio Shack's new Micronta Tune-Up Analyzer has a large 6-in. color-coded scale for reading engine speed and dwell angle on any 4, 6, or

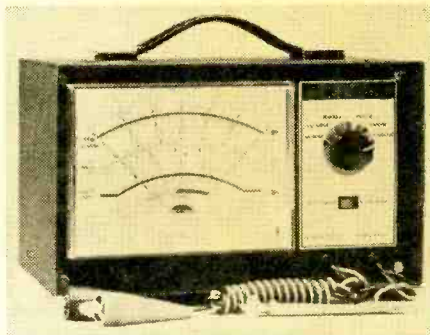

8-cylinder engine. It also has voltage and amperage scales for checking the alternator or generator, regulator, diodes and battery, and a good-bad point condition test. For 6 or 12 VDC. The Micronta Tune-Up Analyzer with detailed instructions and tune-up charts is priced at \$39.95. Micronta products are available through more than 1000 Radio Shack Stores in 49 states and Canada. For more information circle No. 57 on Reader Service page.

SSB CB OK

Introducing Lafayette's new SSB-50, a compact single-sideband transceiver especially designed for mobile CB operation. Measuring only 7-3/16-in. x 27/8-in. x 9-3/16-in., the SSB-50 delivers full 23-channel, crystal-controlled



operation with 46 additional SSB modes of operation (23 upper plus 23 lower sideband). Features 0.5 uV Sensitivity on AM and 0.15 uV on single-sideband with four-section crys-

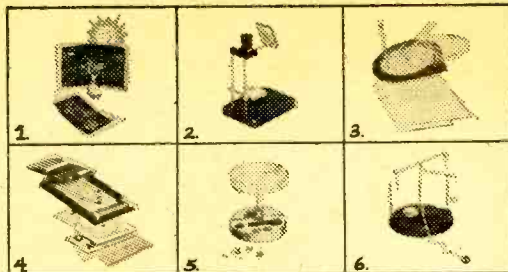

6 Complete Scientific Kits. More Than A Dozen Projects.

In one box, you get six scientific kits that add up to hours of fun. Each project kit is individually packed. The assortment includes (1) Sun Printer: uses sunlight to make actual photo prints. (2) Projector: a combination microscope, periscope, telescope and image projector. (3) Doodle Drafter: for decorating, drawing, sketching and creating your own unusual designs. (4) Silk Screen Printer: works like the real thing, print your own original pictures.

(5) Magnetic Set: rugged pocket carrying case contains magnets, rings, balls, iron particles, all you need for many interesting experiments. (6) Pendulum Set: contains kinetic balls and other necessary parts for making a real working swing-around clock.

Each kit is extremely well made, mostly of plastic and metal. Comparable in value to products double the price.

Money back guarantee.

Only \$7.50 postpaid from T.M.A.

4311 Wilshire Blvd., Los Angeles, Calif. 90010

Calif. residents add 5% sales tax.

No C.O.D.'s please.

CIRCLE NO. 26 ON PAGE 17 OR 103

Hear your police and firemen in action!

Listen on these channels, too...



WEATHER
TRAFFIC
UTILITY
BUSINESS
MARINE
CIVIL DEFENSE

WITH ALL-NEW *Bearcat III*

The Only Monitor Receiver You'll Ever Need

Meets present and future needs in any locality. Scans 1 to 8 FM emergency and business channels you select, in any 1 or 2 bands—low, high, UHF. Stops for any transmission, then resumes search. Plug-in interchangeable RF module for each band. Built-in front speaker. Complete band coverage. Comes with one or two RF modules, mobile mount and cords for AC and DC. American built by Electra, originator of the scanning receiver. At better dealers.

\$139.95 WITH RF MODULE FOR ANY 1 BAND

\$159.95 WITH RF MODULES FOR ANY 2 BANDS

Plus plug-in crystals at \$5 each. Additional modules \$20 each.

Electra COMPANY Div. of Masco Corp.
CUMBERLAND, INDIANA 46229

CIRCLE NO. 27 ON PAGE 17 OR 103

EXPERIMENTER

International EX Crystal and EX Kits



OX OSCILLATOR
\$2⁹⁵

OX OSCILLATOR Crystal controlled transistor type. Lo Kit 3,000 to 19,999 KHz. Hi Kit 20,000 to 60,000 KHz (Specify) **\$2.95**

MXX-1 TRANSISTOR RF MIXER A single tuned circuit intended for signal conversion in the 3 to 170 MHz range. Lo kit 3-20 MHz. Hi kit 20-170 MHz. **\$3.50**

SAX-1 TRANSISTOR RF AMP. Amplifier to drive MXX-1 mixer. Lo kit 3-20 MHz. Hi Kit 20-170 MHz. **\$3.50**

PAX-1 TRANSISTOR RF POWER AMP. A Single tuned output amplifier to follow the OX oscillator. 3,000 to 30,000 KHz **\$3.75**



EX CRYSTAL
\$3⁹⁵

EX CRYSTAL Available from 3,000 KHz to 60,000 KHz. Supplied only in HC 6/U holder. Calib. is $\pm 0.02\%$ when operated in International OX circuit or its equivalent. (Specify frequency) **\$3.95**

BAX-1 BROADBAND AMP. May be used as a tuned or untuned amplifier in RF and audio applications 20 Hz to 150 MHz. **\$3.75**



CRYSTAL MFG. CO., INC.
10 NO. LEE • OKLA. CITY, OKLA. 73102

Write for **FREE** Catalog

CIRCLE NO. 7 ON PAGE 17 OR 103

ANOTHER SUPERB VALUE
from **Olson**
Electronics



ONLY **\$19⁹⁵**

ELECTRIC EYE WARNING SWITCH

Multi-purpose warning system for business, home, warehouse or industry. Electric Eye is used to signal or count someone entering or breaking the beam. You need only plug in a bell, buzzer, counter or any other device.

Olson Electronics, Dept. T10, 260 S. Forge St.,
Akron, Ohio 44308

- I enclose \$19.95 plus \$1 for postage and handling. Send me the SW-364 Electric Eye Warning Switch.
- Send me the next seven issues of the Olson Catalog, without cost or obligation. **FREE**

Name _____
Address _____
City _____
State _____ Zip _____

CIRCLE NO. 13 ON PAGE 17 OR 103

HEY, LOOK ME OVER

tal lattice filter for superior selectivity. Push button "RF Noise Silencer" cuts out impulse type noise, while series gate noise limiting is provided for standard noise reduction. The SSB-50 delivers up to 15 watts PEP effective talk-power on SSB, incorporating automatic modulation control, and added distance on AM with Lafayette's "Range Boost" compression circuitry. Variable squelch assures quiet stand-by. Other features include automatic burglar alarm switch, CB/PA push-button switch, large illuminated front panel "S"/PRF meter, external speaker/headphone jack and built-in power supply for 12.6 volts DC. Supplied with push-to-talk microphone, mounting bracket, and cable. Price: \$309.95. Get the facts by circling No. 63 on Reader Service Coupon.

Flat Shapes

With the new "Flatformer" tool and an ordinary vise, flat metal strips can be bent into virtually any shape. The Flatformer easily handles metal up to 1-in. wide and 1/8-in. thick. It will also form wire up to 5/32-in. thick, in single or multiple layers. Make your own hooks, clamps, mounting brackets, cur-

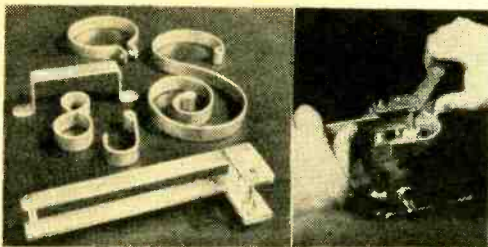

tain rods, numbers, letters, and decorative designs. Perfect for creating wrought iron shapes for furniture, lamps, shelf brackets, book ends, and all sorts of ornamental and artistic uses. Order from Vinkemulder Tool Co., 2223 Estelle, S.E., Grand Rapids, Mich. 49506. \$7.98 includes postage—handling.

Blackout Screwdriver

At last, the handyman's dream . . . the Four Way Tool with a built-in flashlight to illuminate those hard-to-get-at dark spots. This



compact unit consists of a sturdy handle holding a standard screwdriver, a Phillips screwdriver, an awl and a drill. Each tool is nested in an individual compartment, easily accessible by a twist of the cap on the handle. The flashlight lets you see clearly the object you are working on. No more poking

(Continued on page 104)



LITERATURE LIBRARY

71. Kit builder? Like weird products? EICO's 1972 catalog takes care of both breeds of buyers at prices you will like.
72. Want some groovy PC boards plus parts for communication projects? Then get a hold of *International Crystal's* complete catalog.
73. Now available from EDI (Electronic Distributors, Inc.): a catalog containing hundreds of electronic bargains.
74. A pamphlet from *Electra* details the 6 models of the Bearcat III, a scanning monitor receiver.
75. Dynascan's new B&K catalog features test equipment for industrial labs, schools, and TV servicing.
76. Before you build from scratch, check the *Fair Radio Sales* latest catalog for surplus gear.
77. *Hallcrafters'* literature features new American-made FPM-300, 250 watts P.E.P., SSB/CW 5 band amateur transceiver.
78. Want a deluxe CB base station? Then get the specs on *Tram's* super CB rigs.
79. You'll wonder how you ever got along without *Xcelite's* Series "99" reversible ratchet handles. Over 60 "99" blades fit both Regular & Tree.
80. *Bomar* claims to have C/B crystal for every transceiver for every channel. The catalog gives list of crystal to set interchangeability.
81. Pep-up your CB rig's performance with *Tuner's* New M+3 mobile microphone.
82. A fully illustrated brochure from *Midiand* gives readers a look at their new, complete line of radio monitoring receivers and CB transceivers.
83. The *MONitor* antennas—keys to superior reception—are available from *Antenna Specialists* in their catalog.

84. Get all the facts on *Progressive Edu-Kits Home Radio Course*. Build 20 radios and electronic circuits; parts, tools, and instructions included.
85. *Olson's* catalog is a multi-colored newspaper that's packed with more bargains than a phone book has names.
86. *Trigger Electronics* has a 1972 catalog of equipment for those in electronics. Included are kits, parts, ham gear, CB, hi fi and recording equipment.
87. Get the free, new twenty-four page *HUSTLER CB and Monitor antenna catalog* featuring improved antennas and accessories for base station and mobile operation.
88. *Teaberry Electronics* has information on CB radios—Twin "T," Big "T," Mini "T" II, and Five by Five; also information on Scan "T" Monitor radio receiver.
89. Keep up-to-date on latest electronics bargains with *Burstein-Applebee's '72* catalog and supplements.
90. Two leaflets by *R. L. Drake Co.* are available. One is on their SPR-4 communications receiver; the other on the SW-4A international short wave broadcast receiver.
91. *Edmund Scientific's* new catalog contains over 4000 products that embrace many sciences and fields.
92. Pick *Cornell Electronic's* 10th anni. catalog and discover yesterday prices. Tubes go for 36¢ and 33¢. Plus many other goodies.
93. *Radio Shack's* 50 Anniv. cat. has 180 pages, colorfully illustrated, of complete range of hi fi, CB, SWL, ham equip. and parts (kits or wired) for electronics enthusiasts.
94. It's just off the press—*Lafayette's* all-new 1972 illustrated catalog packed with CB gear, hi-fi components, test equipment, tools, ham rigs, and more.

95. *Mosley Electronics, Inc.* is introducing 78 CB Mobile Antenna Systems. They are described and illustrated in a 9-page, 2-color brochure.
96. *RCA Experimenter's Kits* for hobbyists, hams, technicians and students are the answer for successful and enjoyable projects.
97. You can become an electrical engineer only if you take the first step. Let *ICS* send you their free illustrated catalog describing 17 special programs.
98. *Avanti's* catalog describes and illustrates their complete line—mobile base CB antennas, many others.
99. A new free catalog is available from *McGee Radio*. It contains electronic product bargains.
100. *B&F Enterprises* has an interesting catalog you'd enjoy scanning. Goodies like geiger counters, logic cards, kits, lenses, etc. pack it. Get a copy!
101. *Heath's* new 1973 full-color catalog is a shopper's dream—chockful of gadgets and goodies everyone would want to own.
102. *E. F. Johnson's* 1972 line of CB transceivers and CB accessory equipment is featured in a new all-line brochure. Send for your free copy today.
103. If you want courses in assembling your own TV kits, *National Schools* has 10 from which to choose. There is a plan for GIs.
104. Free 1972 Catalog describes 100s of *Howard W. Sams* books for the hobbyist and technician. Includes books on projects, basic electronics and many related subjects.

ELEMENTARY ELECTRONICS
Box 886
Ansonia Station
New York, N.Y. 10023

Please arrange to have this literature whose numbers I have circled at right sent to me as soon as possible. I am enclosing \$2.00 to cover handling. (No stamp please.)

S/072



- | | | | | | | | | | |
|-----|-----|-----|-----|----|----|----|----|----|-----|
| 71 | 72 | 73 | 74 | 75 | 76 | 77 | 78 | 79 | 80 |
| 81 | 82 | 83 | 84 | 85 | 86 | 87 | 88 | 89 | 90 |
| 91 | 92 | 93 | 94 | 95 | 96 | 97 | 98 | 99 | 100 |
| 101 | 102 | 103 | 104 | | | | | | |

Indicate total number of booklets requested
Sorry, only 12 circled items maximum.

NAME _____

ADDRESS _____

CITY _____

STATE _____ ZIP _____

Not Valid After January 31, 1973

AT LAST! PROFESSIONAL HOME PROTECTION EVERYONE CAN INSTALL AND AFFORD.

Model FC-100
\$69.95
WIRED



- Start your custom Burglar/Hold-up/Fire Alarm System with the FC-100. Add on Sensors, Alarms and Accessories to suit your own needs.
- "Do-it-Yourself" Installers Handbook included. No technical knowledge needed—No soldering.
- 100% Professional in Design, Reliability, Performance.



'Fail Safe'-SYSTEM BY EICO
A New Concept in "Do-it-Yourself" Home Protection

FREE 32 PAGE EICO CATALOG

For latest catalog on EICO Test Instruments, Stereo, EICOCRAFT Projects, Environmental Lighting, Burglar/Fire Alarm Systems, and name of nearest EICO Distributor, check Reader Service Card, or send 25¢ for First Class mail service.

EICO, 283 Malta Street, Brooklyn, N.Y. 11207



CIRCLE NO. 21 ON PAGE 17 OR 103

The original "wedge-type" screwdriver

QUICK-WEDGE®

SCREW-HOLDING SCREWDRIVER

©1972 by Kedman Company

does
all the job!

**HOLDS, STARTS,
DRIVES & SETS
THE SCREW!**

Unconditionally Guaranteed

At Your Dealers or Write

KEDMAN COMPANY

Phone (801) 363-4413

P. O. Box 267 Salt Lake City, Utah 84110

CIRCLE NO. 28 ON PAGE 17 OR 103



ASK HANK, HE KNOWS!

Monkey Talk

I bought a Transoceanic Zenith for SWL and it's good on big stations, but on Ham stations it is poor. The voices seem to be talking out of their noses and are garbled. Can you tell me how I can overcome this.

—B.V.D., Smithfield OH

What you are hearing are single-side-band communications. Your receiver is an AM job—you're out of luck. Next time buy a receiver that's truly an SWL rig.

Needs a Skip Filter

How can I stop reception of skip on my CB rig so I won't be tempted to talk with a distant station and lose my license?

—W.S., Charlotte NC

Leave your set alone. Instead, install a skip filter, made by Common Sence Electronics Corp., between your ears—about dead center will be fine.

Short of Cash

I am a teenager and don't have enough money to buy a rotator for my CB beam antenna. All I can do now is work stations in one direction. Any suggestions?

—P.B.T., Prairie Village KS

Get an after-school job. Maybe a local dealer will sell you a rotator on the time-payment plan. Or, why don't you trade your beam for an omnidirectional antenna? What ever you do, don't solve your problem by snatching hub caps, cops are now using unmarked cars.

UHF Boost

I need a booster amplifier for TV Channel 26 (542-548 MHz). Can I build one or should I buy one?

—R.C., Clarendon Hills IL

You can buy a UHF band amplifier for less than \$40. While you could build one, designing and making the coils or resonant lines would take a lot of time and patience.

Red Herring

Our local newspaper ran a big story about marine radio switching over to VHF/FM and SSB. I think I know why. I listen in on the marine band. The Russians have been cluttering up this band for over a year now. How will I

Hank Scott, our Workshop Editor, wants to share his project tips with you. Got a question or a problem with a project you're building—ask Hank! Please remember that Hank's column is limited to answering specific electronic project questions that you send to him. Sorry, he isn't offering a circuit design service. Write to:

**Hank Scott, Workshop Editor
ELEMENTARY ELECTRONICS
229 Park Avenue South
New York NY 10003**

be able to listen to the Coast Guard and ships after they move to another band?

—T.M., Red Bank NJ

The Russians aren't to blame. It's the pleasure craft skipper who uses his marine radio as if he were on CB. The 2-3 MHz marine band will continue to be used for long distance communications. SSB will be used instead of AM because it's better and because it takes up less band space. For short-range communications, FM will be used in the 152-162 MHz VHF band. Many boats already do because there's less noise and channel congestion, and no interference from distant stations. To hear SSB, add a BFO to your AM receiver. To hear FM marine communications, get a 148-174 MHz band monitor receiver or a converter to use with your AM BCB or SW set.

Rules of Order

I have several imported transistor radios and notice that they have a notation imprinted on them as follows: "Design certified as complying with Federal Communications Commission Rules Part 15, in effect as of date of manufacture." I was under the impression that Part 15 of the FCC rules was for walkie-talkies and not for AM/FM portable radios.

—E.W.G., Toledo OH

Part 15 covers unlicensed radiating devices, including receivers. A superheterodyne receiver contains a local oscillator whose signal could be radiated and cause interference unless the receiver is carefully designed. Early TV sets are notorious radiators of signals capable of causing interference. Hence, the FCC requires manufacturers to design receivers so they comply with Part 15 standards.

Just Might Work!

The master antenna system (MATV) in our apartment building is lousy for color TV. The landlord won't let me put up my own antenna. I have a terrace from which I can see the top of the Empire State Building. Is there any kind of TV antenna I can attach to the terrace railing which won't be noticed by the neighbors?

—R.M., New York NY

Get a JFD marine TV antenna. Your dealer can order one for you. It looks like those rabbit ears you see on limousines. It comes with brackets with which you can clamp to the rail-

NEW 5-ELEMENT

CB MINI- BEAM

Model GA-5D

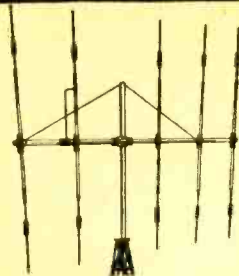

9.5db Gain 500 Watt Power Rating

The secret of success in this five-element miniature beam is in its coils. Ten High "Q" coils molded on each element-extension limit the mechanical size of the GA-5D without limiting its electrical capability.

These coils are built to take a powerful beating----in fact, the same coils are used in the construction of 10-meter amateur antennas. The GA-5D is lightweight. Erect on TV antenna mount and turn with an inexpensive TV rotor. Get all the facts: see your Dealer or write factory direct, Dept. 211,

Mosley Electronics Inc.

4610 N. LINDBERGH BLVD., BRIDGETON MO. 63044

CIRCLE NO. 9 ON PAGE 17 OR 103

Find hidden treasures.

The Treasure Detector flashes a red light when near metal, even if items are buried 12" under sand or earth. This electronic unit is equal in power and construction to units costing much more. The solid state circuitry is enclosed in high impact plastics. Fully assembled. Takes 4-AA batts. (not incl.). 30" extension handle is detachable.

Money back guarantee.
Only \$13.98 postpaid from T.M.A.,
4311 Wilshire Blvd., Los Angeles
90010

Calif. residents add 5% sales tax.
No C.O.D.'s please.



CIRCLE NO. 29 ON PAGE 17 OR 103

FIND BURIED TREASURE

Powerful electronic detector finds buried gold, silver, coins, etc. 5 new models. Write for free catalog.



RELCO, Dept. D-58 **19⁹⁵**
BOX 10839, HOUSTON, TEX. 77018

CIRCLE NO. 18 ON PAGE 17 OR 103

**THOUSANDS OF BARGAINS
TOP VALUES IN ELECTRONIC PARTS**

Transistors, Modules, C. B., Speaker, Stereo, Hi-Fi, Photo Cells and Thousands of Other Electronic Parts. Send for FREE Catalogue

ELECTRONIC DISTRIBUTORS INC.



EDI
Dept. TA-2, 4900 Elston
Chicago, Ill. 60630
 RUSH CATALOGUE
Name.....
Address.....
City.....
State..... Zip Code.....

CIRCLE NO. 23 ON PAGE 17 OR 103

PARTS! CORNELL TUBES!
FREE Send For FREE
CORNELL'S New Color Catalog
48 Pgs. New Items
33¢ per tube
36¢ per tube
ORDER FREE IF NOT SHIPPED IN 24 HOURS!
IN LOTS OF 100

4219 E UNIVERSITY AVE. SAN DIEGO, CALIF. 92105
CIRCLE NO. 17 ON PAGE 17 OR 103

WRITE NOW FOR **McGEE'S**
BIG SPEAKER CATALOG
1001 BARGAINS IN—
SPEAKERS—PARTS—TUBES—HIGH FIDELITY COMPONENTS—RECORD CHANGERS—Tape Recorders—Kits—Everything in Electronics
1901 McGee Street, Kansas City, Missouri 64108

CIRCLE NO. 24 ON PAGE 17 OR 103

"LISTEN IN" TO POLICE-FIRE RADIO CALLS IN YOUR CAR!

WORKS with ANY CAR—Portable or HOME RADIO! Just PLUGS in—No wiring—3 minute hookup! Switch instantly from regular to ALL POLICE-FIRE-EMERGENCY-COMMERCIAL-TAXICAB-STATE-CITY-GOV'T 2 way Radio calls in YOUR AREA. DUAL-HI-LOW BANDS—39/50-150/175 MHX. OVER A MILLION Radio Cars/stations. USE Everywhere—Anytime—always works!
SEND ONLY \$2.00 (cash, Ck, M.O.) and pay post-man \$7.99 plus COD price or send \$9.99 for ppd. Del in USA. COMPLETE, ready to use with instructions. One Year service Warranty—10 DAY MONEY BACK TRIAL (if return) AMAZING OFFER good only by mail—WESTERN RADIO Dept. BE-9, KEARNEY, NEBR. 68847



CIRCLE NO. 15 ON PAGE 17 OR 103

**MAIL EARLY
IN THE DAY!**



MR. ZIP
**ZIP CODE NUMBERS
BELONG
IN ALL ADDRESSES**



YOUR POSTMASTER.

ASK HANK, HE KNOWS

ing. Also, it comes with coax and a box that has a switch for tuning the antenna system. Don't shorten the coax. Coil up the cable if it is too long. Then, there is the old biddy who wrote me to say she used a coat hanger wire hung from her fire escape to pull in the NY Giant games from Connecticut. But I don't believe her, she's a Giant fan!

Strange Request

Where can I get a good-quality monophonic hi-fi amplifier, preferably a kit?

—S.W., St. Paul MN

What's wrong with stereo? If you must use mono for some purpose, then pickup a stereo amplifier and use one channel. For PA use, operate the amp on "mono" and push in the filter buttons (cutting the highs and lows). Use two speakers, one off each output. Results are good and you'll have all the extra inputs you'll ever need.

Here Is Where You Get It!

One of your readers in the May/June issue of *Elementary Electronics* wanted to purchase a 6SF7 and was having trouble finding one. Well Hank, tout him on to Century Electronics Co., Inc., 3759 N.W. 38th Street, Miami, Fla. 33142. You name the oldie: 117N7, 7K7, 5V3, 6AF4, 1A7 and others are available at low prices. Tell all your readers to get a list of tubes by sending a stamped, self-addressed envelope to Century, your readers won't be sorry.

—E.Q., Newark NJ

Thanks old man, I've sent my order out ten minutes ago.

Zap, Zap, Zap . . .

I can hear the static caused by my neighbor's electric fence. I put in an AC line filter, but you can still hear it. The static also affects the TV. I wonder what can be done to stop this.

—T.L., Peoria IL

Sounds like your neighbor is sending time interval signals from a spark generator. Ask him to correct it, if not, call the FCC. An electric fence is an ideal way of penning in large domestic animals. Periodically, a spring wound or electric motor closes a circuit to a spark coil—much like a car's ignition system, but much slower. This discharge causes some of the power to be radiated as RF energy from the wire (antenna) fence. A high voltage mica transmitting capacitor used as an RF by-pass across the fence and ground may do the job. As for the line filter, you don't need one—your antennas are picking up the noise.

A Hank of Wire

I would like to know how to connect an external antenna to a portable AM radio which has no connection for the antenna. I tried to
(Continued on page 102)

DX central reporting

A world of SWL info!

By Don Jensen

Not long ago, a British DXer, who shall remain nameless, reported reception of a new station, *Radio Amundsen*, the Voice of the South. It broadcast, he said, to Europe at 0230 GMT, on 17,765 kHz. The station supposedly—and get this—was located at Mawson, Mac-Robertson Land, Antarctica!

Whoa! Don't rush off to your receiver to log this rare bit of DX. The whole report was a phony. There is no *Radio Amundsen*. The story of this deep-freeze broadcaster was nothing but a hoax!

It wasn't the first, and certainly won't be the last, hoax to be foisted on SWL's. There always seem to be a few characters who report DX catches of their own invention.

When the *Radio Amundsen* story broke in the DX world, many quickly labeled it "another Nibi Nibi." This was curious, since the Nibi Nibi affair occurred nearly 15 years ago, and few know or remember the details of this classic DX hoax. But still, even those who weren't around in those days often use this catch phrase to describe any phony station reports that come down the pike.

Let's go back to 1958. Suppose you read about a new station "heard at fine signal levels in the U.S. and Canada," broadcasting in English and a language called "Aku-Aku," whose tuning signal was "the sound of falling coconuts," and was located on the beautiful Pacific isle of "Nibi Nibi, 12,650 miles southeast of Sheboygan, Wisconsin!"

Would you believe it? Not likely! But that's exactly the sort of thing SWL's read in various DX club bulletins and heard on SWL programs on shortwave.

But rather than dismiss it, or maybe even laugh it off as a joke, these reports prompted a hunt unprecedented in DXing annals. The National Geographic Society was queried. "Is there such a place as Nibi Nibi and where is it?" German federal police were called in to analyze the typewritten letters of the pseudonymous reporter who had submitted the tip to *Deutsche Welle's* DX program.

One rather well known listener hinted broadly that he, too, had heard *Nibi Nibi Radio*, but
(Continued on page 99)

How to subscribe to: elementary Electronics

SPECIAL INTRODUCTORY OFFERS!

Just check below to start your money-saving subscription to EE at once.

- Get 1 Year (six issues) only \$3.33.
 Get 2 years (12 issues) only \$6.66

Bill me.

PAY CASH—GET VALUABLE BOOK FREE!

This \$1.25 copy of *ELECTRONICS HOBBYIST*—yours FREE if you enclose payment for your introductory subscription now.

- Enclosed is \$_____ (Rates apply in all 50 States and Canada)

name _____
address _____
city _____ state _____ zip _____

Mail to: ELEMENTARY ELECTRONICS B658
229 Park Avenue South • New York, N.Y. 10003

Act now and Save!

How to subscribe to:

Science & Mechanics

SPECIAL INTRODUCTORY OFFER!

Just check below to start your money-saving subscription to S&M at once.

- 10 Months for only \$2.97
 Bill me.

PAY CASH— GET VALUABLE BOOK FREE!

This latest copy of *DIRECTORY OF FREE GIFTS* (\$1.00 retail)—yours FREE if you enclose payment for your introductory subscription now.

- Enclosed is \$2.97 (Rates apply in all 50 States and Canada)

name _____
address _____
city _____ state _____ zip _____

Mail to: SCIENCE & MECHANICS B980
229 Park Avenue South • New York, N.Y. 10003



OVER AND OUT FOR VACATION

by Jack Schmidt



"Harry, Alvin just got a little sand in your cassette recorder."



"...and where do you expect me to pack all those sandwiches?"

MUSEUM OF IN
TAPE GUIDED TOURS 50¢



"I'd like to trade this for one with a higher frequency response and no wow!"

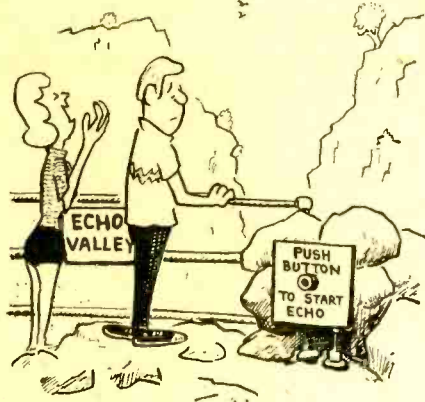

"What a sight! Why those antennas must be over 900 feet high!"



ELEMENTARY ELECTRONICS

ABOUT SHORTWAVE LISTENING

WHAT DO YOU DO when even your best friend can't tell you? If there's no illustrated how-to-do-it manual mailed in a plain manila envelope, how can you learn all those things about shortwave listening—including what it is—if nobody ever tells you? Is DX without fear possible?

Sure, it's a cornball question, but there's nothing shameful about inexperience; even the self-styled experts who brag about their exploits were once beginners. And, if you only dared to ask questions, you'd find many of them redfaced because they're short on answers too.

But shortwave listening is a fascinating, rewarding hobby. Both casual and involved listeners alike can get a first-hand, direct view of foreign countries. Shortwave listening is your chance to sit comfortably at home while you roam the world listening to strange and exotic programs from far away. It can be a challenge to learn, or simply a great relaxer after a tough day.

The secret that closes the information gap is keeping
(Turn page)

Our puzzled beginner asks an old timer

by Don Jensen



e/e SHORTWAVE LISTENING

both your eyes and your mind open. So, pay attention now, and let's rap about SWL and DXing.

● What is DXing?

Listening to *distant* radio stations as a hobby. Also, it usually involves sending reception reports of what you hear and how well you hear it. Hopefully, the stations will reply with a QSL card or letter, verifying the accuracy of your loggings.

● A lot, though, huh?

Some marketing people think not, which explains why few firms make receiving gear specifically designed for the SWL, and why some electronics magazines have given DXers the heave-ho. But maybe raw numbers aren't the whole story. Surveys show that listeners have a tidy chunk of change to spend on the *right* equipment. Incidentally, aren't you glad e/e remembers the DXer? Don't you wish everybody did?

● How important is a shortwave antenna?

"Haven't used one in years!" is one quick answer. Seriously though, while necessary,



Mosley Model SWV-7. Space saving ground level or roof-top installation. Broad-banded, vertical SWL antenna covers six shortwave bands—49, 31, 25, 19, 16, 13 and 11 meters. Overall height is 13 feet, 3 $\frac{3}{8}$ -in. and cost is \$33.71. Circle No. 49 on page 17 or 103.

Drake Model SW-4a shortwave receiver. Designed for SWLs, this is a tube-type receiver with S-meter, under \$300. Circle No. 48 on page 17 or 103.

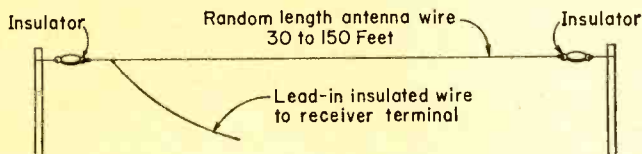

Basic home-brew SWL antenna is used by DXers with space.



● What's the difference between a DXer and an SWL?

Somebody has claimed that an SWL, that's a shortwave listener, is interested only in program content, while a DXer goes after the far-out stations simply because they're far away and out of the ordinary. In practice, the terms are virtually synonymous.

● So what is the difference?

Most veteran listeners call themselves DXers. You'll sound more savvy if you follow suit.

● How many DXers are there in the U.S.?

Over six million radios capable of tuning some portion of the shortwave spectrum are sold each year. But only about 2,000 listeners belong to U.S. and Canadian DX radio clubs. The actual number of DXers is somewhere between those extremes. But how many actually consider their listening a hobby? Who knows?

this link in the communications chain traditionally has been overrated. Great strides have been made in the development of specialized antennas, but DXers have some unique problems. They tune signals coming in from all points of the compass, on a wide range of frequencies. The perfect SWL antenna just doesn't exist; maybe it never will.

● But what about commercially-made antennas?

Most work well, even excellently, on some bands. Some are both compact and neat-appearing. But if funds are a factor, a simple longwire, preferably with an antenna tuning device, can be as good as any. There's more than one guy relying on a piece of lampcord stretched across his bedroom ceiling!

● So the receiver's the key factor, right?

Guess again. Almost any receiver is sensitive enough to pull in DX stations. The more elaborate and expensive ones just

Your Guide to DX Reception

Frequency	Day	Night
A. 100 kHz to 400 kHz	Reception very dependent on power of station. Reliable reception possible at distances of 1000 miles or more.	
B. 400 kHz to 1.5 MHz	Ground wave reception only, usually no more than 200 miles but certain winter conditions can increase this to 1000 miles.	'Skip' takes place and reception of stations up to 1000 miles is common with not infrequent reception of stations at much greater distances.
C. 1.5 MHz to 3 MHz	Similar to B. but distant reception more common.	Varies with conditions but similar to, and usually better than, B.
D. 3 MHz to 8 MHz	Similar to C. but distant stations much easier and more reliable. Distances of several thousand miles especially at night.	
E. 8 MHz to 15 MHz	Generally the best frequencies for DX but ground wave absorption limits local reception.	Often good for long distance reception but depends on conditions and time of year.
F. 15 MHz to 25 MHz	As for E. but DX, although often better, is more dependent on conditions.	Usually poor for long distance reception but dependent on time of year and conditions.
G. 25 MHz to 45 MHz	Highly dependent on conditions—sometimes excellent DX is possible but more often unsuitable.	Local reception only.

make it easier to separate the rare, weak signal you want from the rest of the babel. That quality is called selectivity. A selective communications rig will make it easier to hear the toughies more often, but many top DXers are using downright mediocre receivers. If you can afford the best, fine, but you can do amazing things with that old relic from Grandma's attic (and I don't mean Grandpa!).

● What does separate the men from the boys, DX-wise?

Good old fashioned know-how, that's what. You've got to know when, where and how to tune your receiver to pull in the DX. You should know about propagational conditions that cause a distant signal to reach your antenna. Experience, in short, is the answer. Luckily, that's an inexpensive commodity. It only costs you time and your willingness to learn.

● There's no shortcut to DXing success?

It may come as a blow to those who

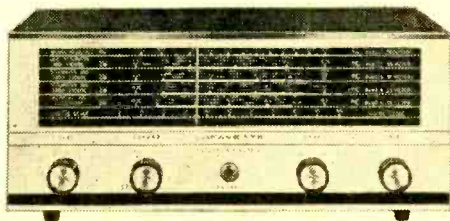

Lafayette Explor-air Mark V. \$54.95.
Circle No. 46 on page 17 or 103.

figure that trading their cheapie sets for plush communications receivers will make them overnight DX pros, but it doesn't work that way. But consider this. You, pennyless soul that you are, don't have to take a back-seat to Charlie Gotzlotz who can afford to sink a thou or more in a new rig! And, hokey as it sounds, learning the ropes is half the fun.

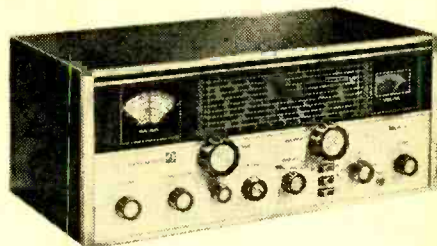

Hallicrafters Model SX-133. \$350.
Circle No. 47 on page 17 or 103 for info.

● Why can't I hear the rare stations?

Who says you can't? But you're not switching channels on the boob tube, you know. Tuning in DX is a real skill, but one you can learn. Assuming you know the right time and place to tune, it still takes persistence and, yes, luck. Maybe you'll have to listen every night for a month, or a year, to hear that really elusive station.

● In the meantime I twiddle my thumbs?

In the meantime you learn all you can about the stations you're hunting. Are you likely to hear Country and Western music

e/e SHORTWAVE LISTENING

from a flea-powered New Guinea station? A French language newscast from the Congo? Toothpaste commercials on a Rhodesian outlet? And when those faltering signals do manage to slip through the noise, you'll be one up by knowing what to expect in the way of programming. (The answers to the questions above, by the way, are all yes.)

● **Why don't I get QSLs from all the stations I report?**

Years ago, an old friend suggested, when I put that question to him, "Maybe your reports were wrong!" I hope he was kidding, but maybe he was right. Mistakes are easy to make. It's all too easy to misidentify the stations if noise levels are high, the signals are weak and the language used is unfamiliar. Many stations use the same frequencies. During the morning, one may be audible, later in the day, another—even though you haven't changed the dial setting. Often two, three or more can be heard mixing it up on the same wavelength at the same time. But at any given time, even on a crowded frequency, one or another of them may pop into the clear.

● **What are you getting at?**

OK, now look, just because a station is

The Canadian Broadcasting Corporation

is pleased to verify your reception on January 27, 1969 of its transmissions from Station CBA, Montreal Frequency 1070 Power 50,000 watts

This station is on the CBC RADIO Network Per Bob Boulton Date 27/2/69



Mr. Bob Boulton
850 Robeson Avenue
Moncton, Quebec

Flip side of SWL card from CBC shows an SWL's personalized reception verification.

listed on 9,550 kHz at 2130 GMT, for instance, it doesn't automatically mean that any signal you hear there and then is that station. Maybe it is another one that shares the same channel and schedule, but breaks through only occasionally. Then too, short-

Broadcasting Bands

Name	Frequency
Long Waves	150 to 285 kHz
Medium Waves	525 to 1605 kHz
90-Meter Band	3.2 to 3.4 MHz
60-Meter Band	4.75 to 5.06 MHz
49-Meter Band	5.95 to 6.2 MHz
41-Meter Band	7.1 to 7.3 MHz
31-Meter Band	9.5 to 9.775 MHz
25-Meter Band	11.7 to 11.975 MHz
19-Meter Band	15.1 to 15.45 MHz
13-Meter Band	21.45 to 21.75 MHz

wavers shift their frequencies. The broadcaster who used 9,575 kHz last month, may now operate on 9,550 kHz, despite what the logs say. Listen carefully and don't jump to conclusions about its identity.

● **But if I correctly identify them, will stations QSL?**

Would that it were so, but some broadcasting stations haven't QSLed a report in years. Maybe it's just too much bother. Maybe they haven't the staff to answer, or



Heath SB-310. Receiver kit. \$259.
Circle No. 1 on page 17 or 103.

are short on funds. Maybe they haven't the foggiest notion of what a QSL card is. Or perhaps they just hate all North Americans. Who knows. But that's the way the cookie crumbles.

● **Any inside tips on QSLing the rare birds?**

Sure. Start with the nitty gritty, a basic solid report. This includes the date, time and frequency, plus information on how well you heard them. Give enough details of programming heard to convince them it was their station you logged.

● **That's all there is to it?**

Then add those extras that make your letter interesting as well as useful. Salesman-
(Continued on page 100)

E/E looks at new... **HI-FI COMPONENTS**



◀ Both round and square end-caps come with the Tenna HL-5106 music center; you select whichever best suits the room decor. At \$259.95, the center features an AM/FM-stereo receiver with an 8-track cartridge recorder that has an automatic tape-head cleaner, and a pair of three-way speakers. Circle No. 51 on Reader Service Page.

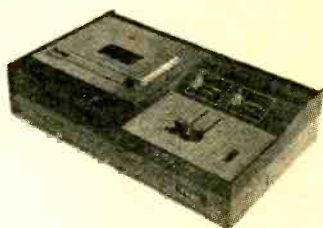

◀ The very simple operation of the TEAC 210 stereo cassette deck is due to fingertip, solenoid-assisted piano-key controls. Advanced preamplifier design provides an expanded dynamic range and full frequency response of 30 to 12,500 Hz. The 210 is \$159.50. Circle No. 52 on Reader Service Page.



◀ A digital clock radio with lighted numbers an inch high—that's General Electric's \$59.95 C4600 FM/AM unit, with a brightness control for adjusting the intensity of the numbers. A sleep switch shuts off the radio automatically and can be set for up to three hours. Circle No. 53 on Reader Service Page.



◀ A new omnidirectional dynamic microphone, with a frequency response of 50 to 10,000 Hz, the Altec 655AL has a flat response to provide faithful reproduction of drums, acoustic guitars, and other musical instruments requiring exacting sound fidelity. The 655AL is \$85.00. Circle No. 54 on Reader Service Page.



◀ Panasonic's CS-880 car/home 8-track stereo tape player, at \$109.95, has a repeat button what permits instant playback of what's just been heard, and controls for exact speaker balance. Circle No. 56 on Reader Service Page.

Changes come fast in electronics.

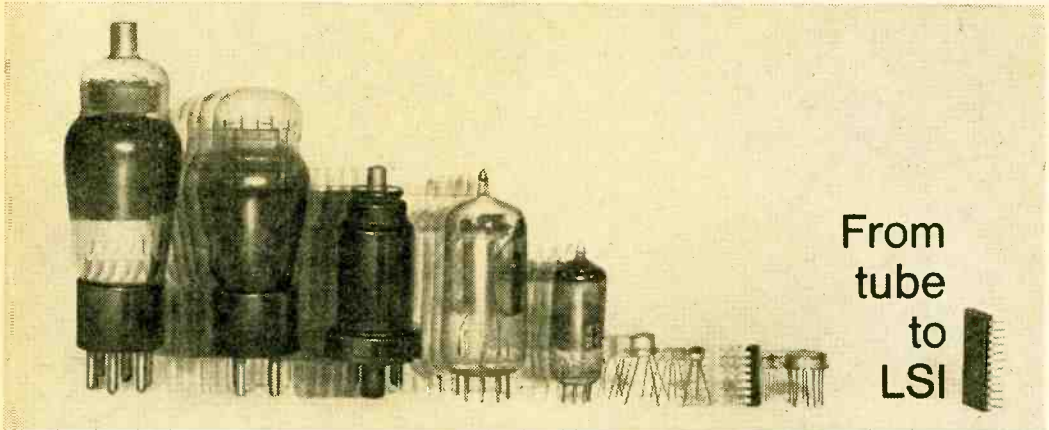

From
tube
to
LSI

Take a look at the race in circuit technology. In the 1960's the tubes at the left made way for the transistors at the right. Today, transistors are surpassed by the large scale integrated circuit (LSI) at the far right. This circuit, less than a quarter inch square, replaces over 6000 transistors!

There's big money to be made by the men who stay ahead of this technology race. Put yourself

ahead with NTS Home Training! You get the latest, most advanced equipment (at no extra cost). More solid-state units, and more advanced technology. Plenty of training with integrated circuits, too! As an NTS graduate, you enter a world of electronics you're familiar with. You have a thorough working knowledge of solid-state circuitry. You're ready to tackle bigger jobs at higher pay!

NTS COLOR AND B & W TV SERVICING

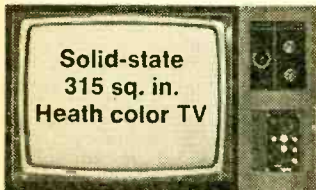

Solid-state
315 sq. in.
Heath color TV

Build and keep the largest, most advanced color TV made! Over-all solid-state design, ultra-rectangular screen, matrix picture tube, built-in self-servicing features, "Instant On," A.F.T., solid-state, 24-channel detent UHF/VHF power tuning, and much more! Also build and keep AM-SW Radio, Solid-State Radio, FET Volt-Ohmmeter, and Electronic Tube Tester. Learn trouble-shooting, hi-fi, stereo, multiplex systems, radio, color and B & W TV servicing.

Learn sophisticated solid-state circuitry as you build this B & W TV receiver. Lo-Silho "Superhet" Radio, FET Volt-Ohmmeter, Solid-State Radio, Electronic Tube Checker, and Signal Generator. TV

and all other equipment are yours to keep.

Solid-state
B & W TV,
74 sq. in.
picture
(cabinet
included)

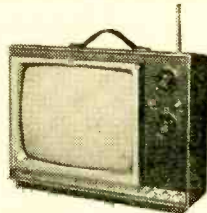

NTS ELECTRONICS & COMPUTER TECHNOLOGY

Build and keep this exclusive NTS Compu-Trainer. It teaches you the

Solid-state
Compu-Trainer
14 integrated
circuits replace
198 transistors!



same principles used in million-dollar systems. Contains 14 inte-

grated circuits! All Solid-State! You perform all wiring and patchcording. No shortcuts. No pre-wired circuit boards. Your training is complete! Also receive an FET Volt-Ohmmeter and a 5" wide-band Solid-State Oscilloscope.

NTS ELECTRONICS COMMUNICATIONS

Gain the prestige and earning power of owning an F.C.C. First Class Radio-Telephone License. Two comprehensive NTS courses cover the big opportunity field of transmitting and receiving.

You build and keep 14 kits, including this amateur phone 6-meter VHF Transceiver, NTS's exclusive 6-transistor Solid-State Radio, and a fully transistorized Volt-Ohmmeter. Also, learn 2-way radio, Citizens Band microwaves, and radar.

5-watt AM
transmitter/
receiver



NTS Home Training puts you in the lead.

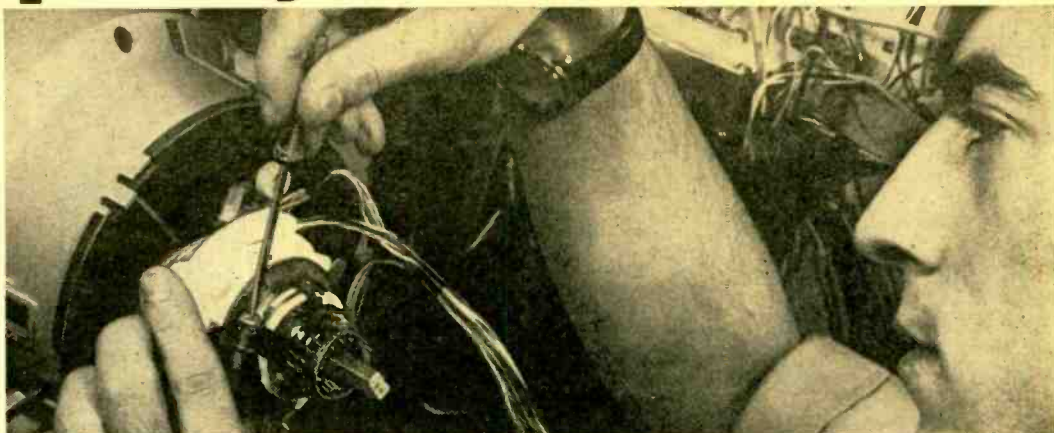

NTS INDUSTRIAL & AUTOMATION ELECTRONICS

Automation is the future of industry and you can play an important part! Learn industrial controls by training on the NTS Electro-Lab (a complete workshop). You also build and operate this 5" Solid-State oscilloscope. And you perform experiments that involve regulating motor speeds, temperature, pressure, liquid level, and much more. All equipment is yours to keep.



NTS AUDIO ELECTRONICS SERVICING

Learn basic sound theory—how it works in home radio, car tape

decks, stereo multiplex component systems, and more! Set up a spectacular music system. Learn about



Build and keep this famous Heath Stereo Receiver and Speakers.

sound distortion, amplification and control, loud-speaker baffles, problems of system installation, etc. Included is Volt-Ohmmeter, In-Circuit Transistor Tester, and Solid-State

Radio. Prepare yourself for great opportunities in the Home Entertainment Industry!

CLASSROOM TRAINING AT LOS ANGELES

You can take classroom training at Los Angeles in sunny Southern California. NTS occupies a city block with over a million dollars in technical facilities. Check box in coupon below.

NATIONAL TECHNICAL SCHOOLS

WORLD-WIDE TRAINING SINCE 1905

4000 S. Figueroa Street
Los Angeles, California 90037

APPROVED FOR VETERANS

Accredited Member: National Association of Trade and Technical Schools; National Home Study Council.

Dept. 222-092

Big, Colorful NTS Guide to new opportunities in Electronics. Yours FREE!



NATIONAL TECHNICAL SCHOOLS
4000 S. Figueroa Street
Los Angeles, California 90037

Please rush me FREE Color NTS Electronics Guide & FREE lesson, plus information on course checked at right. No obligation. No salesman will call.

- MASTER COURSE IN COLOR TV SERVICING
- COLOR TV SERVICING (FOR ADVANCED TECHNICIANS)
- MASTER COURSE IN B&W TV & RADIO SERVICING
- MASTER COURSE IN ELECTRONIC COMMUNICATIONS
- PRACTICAL RADIO SERVICING
- FCC LICENSE COURSE
- MASTER COURSE IN ELECTRONICS TECHNOLOGY
- AUTOMATION & INDUSTRIAL ELECTRONICS
- COMPUTER ELECTRONICS
- BASIC ELECTRONICS
- AUDIO ELECTRONICS SERVICING

NAME _____ AGE _____

ADDRESS _____

CITY _____

STATE _____ ZIP _____

- Check If Interested in Veterans Training under new G.I. Bill.
- Check If Interested ONLY in Classroom Training at Los Angeles

CIRCLE NO. 11 ON PAGE 17 OR 103



There are those who would claim that . . . "The Citizens Band Radio Service is doomed! It is misused, overused, abused! There is flagrant rule-breaking; nothing is being done about it; the channels are overcrowded!" That's what *they* say!

Who *they* are is important if we find justification in their claims. It is equally important that *they* take into account a few positive points: that Citizens Radio is pretty much here to stay; that the Federal Communications Commission, manufacturers and active, public service-minded CB teams are doing something about "conditions," good, bad and/or rumored; and that overcrowding is created by a number of contributing factors. Among them are the following: a few operators continue to "overact" on the air (it takes so dramatically long to tell it like it really was); some rule violators mistakenly burned their draft cards instead of their CB licenses; and hundreds of thousands of licensees find the use of CB radio an effective must in the handling of public service assignments, emergency rescue, and as a communications link between home and auto, office and service vehicle.

Take the Test, Ma! In a very recent survey conducted throughout the United States and Canada, 2,649 respondents to printed questionnaires—in addition to answering 34

questions pertaining to how they applied CB radio in their daily routine—answered ten true or false questions. Only 37% passed with a grade of 70% or higher (seven or more correct answers). How well will you do? Answer the following ten questions by checking either True or False.

1. During the first ten years of CB radio, emergency radio rescue teams from all fifty states logged 481,000 public service assists to local authorities, motorists in distress and through service to disaster victims.

True False

2. It is now considered safe for a driver to transmit while his vehicle is in motion if he is right-handed and the mike is held with the left hand.

True False

3. Technological advances in video system development in Nevilles, France, have produced a lowcost vidicon TV camera that may be legally used for transmission of picture with sound on Citizens Band channels.

True False

4. Experts in transmission devices learned recently that replacement of a coiled microphone cable with a straight cord increases transmission signal, reduces frequency drift and delivers clearer intelligence at the reception end.

True False

5. A 1970 report by a citizens radio manufacturer clarified that unless a warning sign has been posted, it is safe to transmit with any type signal while parked in a gasoline service station or near an explosives supply center.

True False

6. As of January, 1973, the FCC will increase the Citizens Radio license fee to \$25 per year.

True False

7. Active CB radio clubs, emergency rescue teams and associations across the United States now number 4,729.

True False

8. The number of CB club members per association has been averaged out by the Multi-CityTabulators Association as 55.5 per club.

True False

9. The FCC has given type-approval for manufacture of a macro-sized, 5-watt CB transceiver in the shape of a common watch.

You can't believe everything you hear about CB—so get the facts!

The unit, dubbed the "Citizens Wrist Band Watch", will be marketed in time for the 1972 Christmas buying season.

True False

10. 500,000 active CBers attended 4,617 CB Jamborees, coffeekbreaks and rescue team get-togethers in 1971 as compiled from statistics drawn by the Macon 5-Watters of Marengo, Massachusetts.

True False

Tally the Total. How did you fare? If you claimed "true" to any one of questions 1, 3, 5; or 2, 4 or 6; or 7 and 9; or 8 and/or 10, you drew a set of dead crystals. If you answered half of them "true" and half "false," go back to the clubhouse, do not pass "Go"; do not collect 200 QSL cards (CB Genius types or others).

The test above and the paragraph that precedes it are a "tissue of falsehoods." To be exact, they're *lies!* There was no survey recently or otherwise. The 2,649 respondents were figments of fantasy. Nobody passed because nobody took the nonexistent test until it was printed on these pages of ELEMENTARY ELECTRONICS just days before you raced to the nearest newsstand to grab the next-to-the-last copy, or until your favorite mailman delivered it to your door after reading it from cover to cover.

If, however the fictitious facts moved your thinking toward swiping mom's scissors to cut out the "test" for presentation at the next club meeting, or if you began taking mental or written notes for the same or similar purposes, your thinking is in line with thousands of other CB radio enthusiasts and those investigating the use of CB radio for their communications needs.

Veteran CB licensees "in the know" undoubtedly were not conned by the questions related to safety. Two heads might think clearly enough to drive and transmit at the same time; three hands can never be enough. And warning sign, siren, flashing red lights or not, no one *transmits* no where, no how near gasoline pumps, construction demolition units, or other explosive devices. The absent-minded may never get another reminder.

The newcomer to Citizens Radio ranks may not have been sure on the safety questions or some of the others. If he has been on the air at all, he was probably aware that a quick call to a CB club member in his area would verify the validity or falsehood of the

"test." And that's one of several useful functions of the CB club as it's known today throughout the U.S. and Canada. Clubs have become one of the primary sources of information for beginners bound for the air via CB radio. Commercial, private and governmental publications serve as an even greater source of information. Armed with the combination of both, plus an ear turned toward the speaker of a fired-up transceiver, the CB newcomer can veteranize himself in short order.

In the area of new developments—TV cameras and macro-sized CB watches on your wrist—if, and when they happen, manufacturers and publications spread the word before the print is dry. Likewise, on matters of rules changes or increases in license fees. CBers, manufacturers and leading publications will voice their feelings long before changes take place, and have a determining factor on when, how and to what extent they become law. As for removing the coils from a mike cable, most individuals are aware that it would have no bearing on signal, drift or intelligence. As a part of the "test," question 4 was merely stretching it a bit (oops!).

No Put-On Here! With all shenanigans laid aside, go back to the test and review questions 1, 7, 8 and 10. Note that they deal with statistics; the type that draw reactions ranging from a long, low whistle of amazement to a raised eyebrow of surprise. Statistics demand attention. They tell a story and can do much to convert the skeptic who may judge an idea, an approach or a goal on the basis of one thin-line example which seldom presents a fair cross-section of the problem at hand.

CBers have long realized the value of, and have continued to search for, statistics that deal with emergency assistance and active CB teams throughout the U.S. and Canada. They also seek a breakdown on how many emergency teams have actively served in emergency situations, how they participated and what is revealed in the national totals of such volunteerisms. Statistics of that nature can serve to solidify close working relationships between local authorities and CB teams. The statistics can be hand-carried to Washington to reinforce the value and the need for organized CB assistance, and to blow a louder bugle in the direction of rule changes. Information that broad in scope—since the advent of CB radio in 1958

E/E TO C OR NOT TO B

—has not been available from the FCC, the DOT or Fibber McGee.

A Central Source. The amount of inquiries, the reports on CB activity and the requests for statistical information received by ELEMENTARY ELECTRONICS indicates that there is a continuing need for a computer bank of information; possibly a center where input can be fed, evaluated and tabulated, and reported upon. The “what-where-who-when-how” aspects of the statistics can be drawn only from information received from active CB clubs, organized teams such as REACT and ALERT, and from individual CBers.

Were there 1,568 CB assists nationally last year? Are there 2,510 active clubs across the U. S. and Canada? How many lives were saved through the use of CB radio last year; how many flood victims were served; how many tornado and/or hurricane victims were comforted by the actions of CB-equipped radio operators, teams and clubs? Does the average club maintain a membership of 20, 35 or 100 members? How many 5-watt Citizens Band transceivers are there in use throughout the U. S.?

ELEMENTARY ELECTRONICS staffers have prepared a Citizens Radio Survey form (*sans* phony true/false questions) that is available for the asking. From the completed forms received, EE will keep running tabs on team, club and individual CB activity, reporting the statistics as they are accumulated. From such comments that relate emergency activity or unusual CB applica-

tions, EE may elect to spotlight that activity in a feature article.

Citizens Radio clubs, teams and individuals are urged to request the survey form and to return it with complete information as soon as possible. The survey has been designed to eliminate the “guesstimates” of CB radio, like some of the questions in the “test.” It can provide active CBers with information which can aid the service in its present form and help it down any other path it might take in the future. To get a copy of the survey, write to CB Survey, ELEMENTARY ELECTRONICS, 229 Park Ave., New York, N.Y. 10003.



As for “they,” the survey may well show the average Norman Negative that shadows of doom for CB are only in the mind of the beholder. CBers are aware of the good, the usefulness and dependence that has been placed upon organized Citizens Radio. The survey, in its final form, will provide some necessary answers to vital questions. It will boil all the pros and cons down to a finale where *all* users, non-users, for or against, can draw their own conclusions.

“To see or not to be”; isn’t that the question!?” ■

Top Secret Jewelry Hits the Neckline



These women are carrying a top secret—around their necks. It may look like jewelry, but these unusual pieces have had an exciting past. They were once the printed circuits for a top secret English jet which never got off the ground. It was superceded by a newer model, and so these key circuits, carrying the jet’s electronic impulses, were seized. But the grabbers were not spies, only London jewelry designers. Just think of the possibilities from the SST!

—Myrtle Gronk



LIGHT AMPLIFICATION

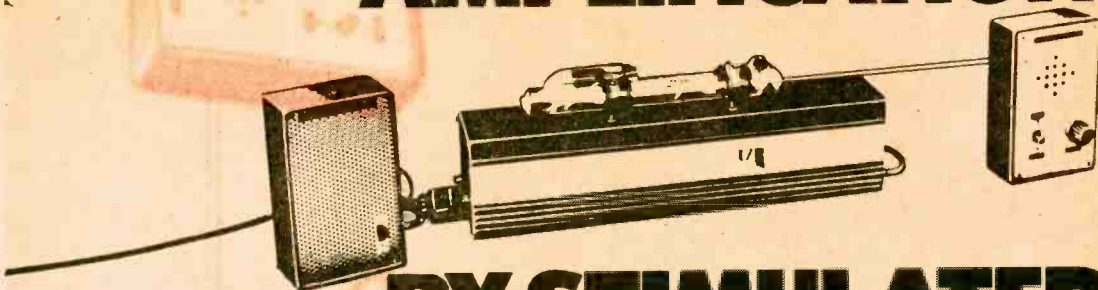

BY STIMULATED EMISSION OF RADIATION

A Helium-Neon laser for the experimenter
by Jorma Hyypia

LASER, the "pencil light" that surveys land, hem-stitches the human retina, offers true 3-D photography and many other space-age wonder achievements, is no longer a curiosity of the laboratory or an expensive industrial tool! The laser can be *your* experimenting tool at home at reasonable costs. *You* can investigate basic scientific principles—polarization, refraction, critical angle, diffraction, interference, Lloyd's mirror, Michaelson interferometer, holography, doppler effect, and many more interesting light phenomena with your own laser. Even talk on a laser beam! A simple laser system can transmit voice or data communications over a distance of several hundred feet, and the line-of-sight range can be extended to several miles by the addition of beam collimating optics. Aside from the privacy that such a system provides, there are other advantages over conventional communications methods. For one, you don't need an FCC license as you do with a CB rig. Nor do you have to pay the telephone company extra revenue for the added service. Once the laser equipment is installed, operating cost is virtually nil because the electrical power consumption of a laser communications system is very modest.

And even if you don't have a crying need for a confidential hot-line, experimenting with laser communication can be a lot of fun—especially since you would be working in an area that is on the verge of a major communications revolution. As you probably already know, laser linkages may eventually solve the problem of increasing congestion

e/e LASER KIT

on some conventional long-distance telephone cables. Already, laser links are used over rough mountain areas to eliminate conventional wires. Other examples of laser communications applications that have arrived, or bide to do so in the near future, include ship-to-shore communications (vital when radio silence must be maintained, or when electrical disturbances garble radio-telephone communications), battlefield communications, law enforcement applications, and the rapid transmission of data between computers.

Kits Save Money. Consider building your own laser system from a kit. The laser communicator used by the author was built from a prototype kit supplied by Metrologic Instruments, Inc. of Bellmawr, New Jersey. While building and testing this system, the folks at Metro came out with a re-designed model offering notable improvements including a streamlined PC circuit, a better instruction manual, and provision for easier installation of the laser tube inside the metal housing containing the electronic circuitry. If you want to put the laser tube outside the housing so that you can watch the fascinating lasing action, make a protective shield from ¼-in. Plexiglas. It not only protects the expensive tube from physical damage, but also protects you from dangerous shocks.

Although the equipment you might now buy from Metrologic is not identical with the prototype equipment shown here, the differences are minor, so you can safely use

this article to decide whether construction of a laser communicator is for you. Metrologic's re-designed communicator kit (model 60-250) includes: an MT 205 laser tube, 60-143 power supply, 60-164 communicator housing, a modulator kit, microphone, silicon photosensor, and a receiver. This kit is priced at \$143 and is expressly designed for voice communications. The MT-205 laser tube has a bandwidth of 60 Hz to 125 kHz. If you already own a helium-neon laser, it may be suitable for use with Metro's 60-203 laser communicator conversion kit (laser beam modulator) which is tagged at a still lower \$75. But before ordering the conversion kit, check with Metrologic to make sure that it is compatible with the laser system you have.

A new completely assembled system for both voice and data transmission is available from Metrologic. It consists of the ML-369 laser priced at \$180 and the model 60-247 receiver priced at \$50. The latter includes a microphone to complete the system. Bandwidth of the ML-369 laser is 300 Hz to 500 kHz. This system is not available in kit form.

This or any other laser construction project is not recommended for those who have trouble putting batteries into a flashlight. The voltages in any laser power pack are lethal—1700 Volts and up, depending on the unit design. But if you have experience fiddling with TV or other high-voltage equipment, the laser poses no unusual construction problems or hazards.

The low power laser beam cannot burn holes into anything, even if you try to intensify it with a lens. But there is potential danger to eyesight if the beam is allowed to enter the eye unattenuated or undiffused.

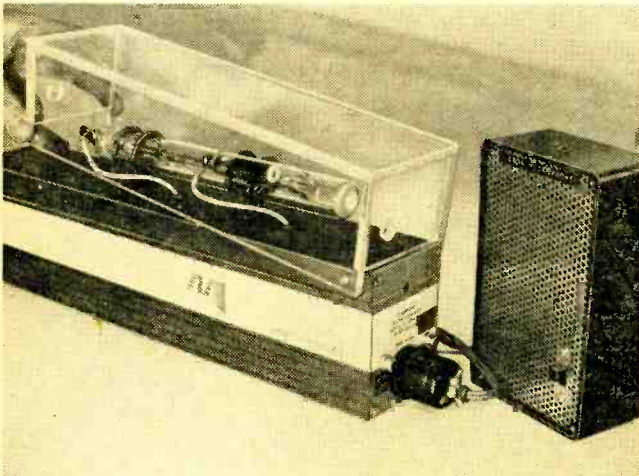

Laser tube can be mounted on top of equipment case. Lets you watch fascinating lasing action. Build a Plexiglas cover as shown for safety. Black case houses Author's microphone—a small speaker.

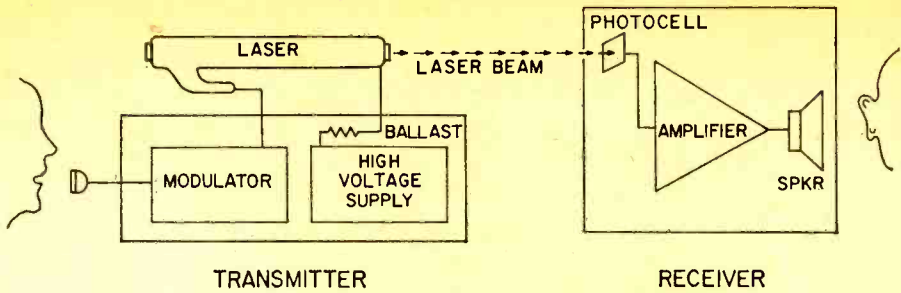

One way laser system for voice communications. Lasers shown in this article are in no way hazardous to the user as long as they are used with common sense. They are approximately as hazardous as sunlight or light of an arc-lamp projector. Take care.

So don't let anyone look directly into the beam, or into a beam reflected from a shiny surface. Viewing the beam from the side is perfectly safe. Just bear in mind that the laser communicator is definitely not a children's plaything.

Pick the Right Laser. Some laser tube designs are more suitable than other designs for communications applications. The type of information you wish to transmit—voice or computer data, for example—should be considered when making a selection.

The helium-neon laser tube shown in the prototype unit we built (Metrologic's Model MT217) offers a modulation capability for such applications as voice or data transmission. When operated with the recommended 1700-volt power supply, it provides 0.3 milliwatts of optical power at a wavelength of 6328 Angstroms (wavelength of red light).

Metro's new communications system (Model ML-369 and model 60-247) utilizes a laser having 15 percent modulation at maximum output (1.5 milliwatts). The input signal level is 200 mV peak-to-peak nominal, and .5V peak-to-peak maximum. If you need 100 percent modulation capability, as

for data transmission rather than for voice, inquire about the company's Model ML-382 100 percent modulated laser.

The light output from the laser tube is intensity modulated by modulating the electrical current that activates the tube. For voice modulation, the MT217 tube is biased at about 3.75 mA DC. The input is AC coupled so that a DC signal applied at the input will not affect the tube bias; however, an AC voltage at a frequency in the 60 Hz to 125 KHz range will make the current change and thereby affect the intensity of the light beam. The tube is driven with a current ranging from 2 mA to 5.5 mA. Above 5.5 mA cathode burnout would be accelerated; below 2 mA the tube becomes unstable.

How It Works. In this one-way communication system a speaker-microphone (or a crystal mike) drives a preamplifier-amplifier integrated circuit. The IC drives a low-voltage current-modulating amplifier (a 2N5220) which in turn drives a high voltage current modulating transistor; it is this transistor that modulates the current flowing through the laser tube. The modulator printed circuit board includes a rectifier-

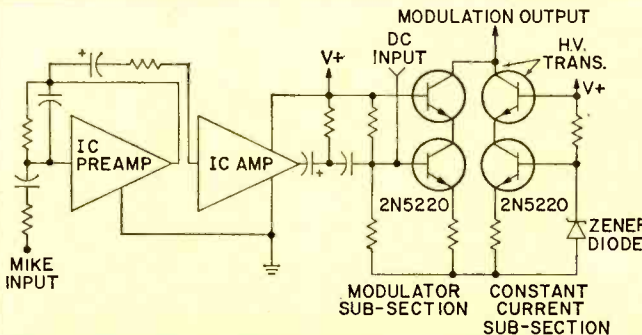

Solid-state laser modulator. Transistors at right maintain constant current through laser tube to maintain lasing action during periods of no modulation. Remaining transistors vary current in proportion to mike input signal to change intensity of beam.

e/e LASER KIT

filter circuit to provide low voltage for the modulator circuit and a constant-current sub-section which maintains a minimum current in the laser tube by use of a separate high-voltage transistor.

The Model 60-247 receiver unit costs an even fifty dollars and contains a photocell which senses the intensity-modulated laser light and demodulates it to a current that is directly proportional to the modulated laser light level. The resulting current signal is amplified and fed to a speaker.

Inputs Can Vary. When the full amplifier section of our prototype modulator system is used, the input can be as low as 2 millivolts AC, in which case the bandwidth is limited to between 150 Hz and 10 KHz. Note the *DC Input* point at the base of the modulator's 2N5220 transistor. If the amplifier section is by-passed by injecting a

± 3 Volt input signal at this point, the bandwidth can be extended from DC to over 125 KHz, with 100 percent modulation.

The light sensor is a large area photocell which permits easy alignment and maximum light-gathering capability. The cell's upper frequency response is limited to about 25 kHz (2 dB down). However, frequencies approaching 1 MHz can be sensed by substituting a higher frequency sensor such as a photo transistor or small area photo diode.

The speaker-microphone shown is equipped with a volume control and a push-to-talk slide switch. An 8-prong plug (only four contacts are used in the one-way system) plugs into a receptacle at one end of the laser tube housing. The housing also has two extra jacks. One provides a connection with the *DC Input* already mentioned; the other provides an input point for such signal sources as a tape recorder, signal generator, or a crystal microphone which could be used in lieu of the speaker-mike for improved speech quality.

Performance. Divergence of the MT217 laser beam is 0.8 mRad and the beam diameter spreads from 1 mm near the tube field to 8 mm at a distance of 30 feet. Transmission up to 100 feet is feasible without use of accessory equipment.

The laser used in the new (ML-369) communicator system has a beam divergence of 1.0 mRad, but since the power output is higher (0.7 mW compared to 0.3 mW for the equipment shown), you should have no trouble communicating over distances well over 100 feet without optical collimating. The manufacturer says that an 8X collimator will boost the working distance up to 1,500 feet, and that a 20X collimator will permit communication up to a distance of 2,500 feet. If you pass the beam through a 4½ inch Palomar type reflecting telescope, the range can be increased to several miles!

If there is a physical obstruction such as a tree or building between the transmitter and receiver, small mirrors can be used to bend the beam around obstructions. Where the beam might be obstructed by passing people or animals, mirrors can be used to elevate the beam to a height that would prevent such interference, and safeguard the eyes of people who do not know the beam is there.

Certain atmospheric conditions (snow, sleet, rain and heavy fog) hamper laser
(Continued on page 99)

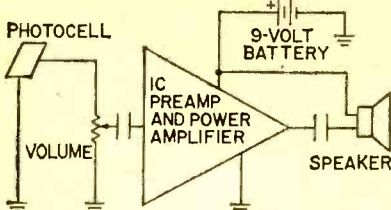

This prototype laser receiver used a 9 volt battery. Current model plugs into 117 VAC outlet, is completely assembled.

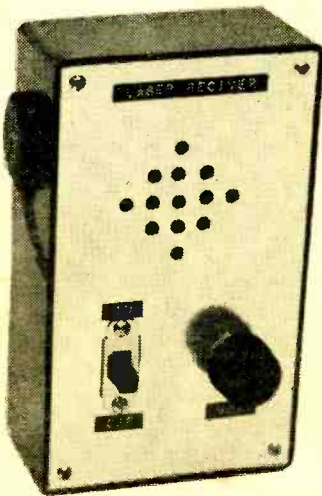

For more information about Metrologic's lasers circle No. 58 on Page 17 or 103.

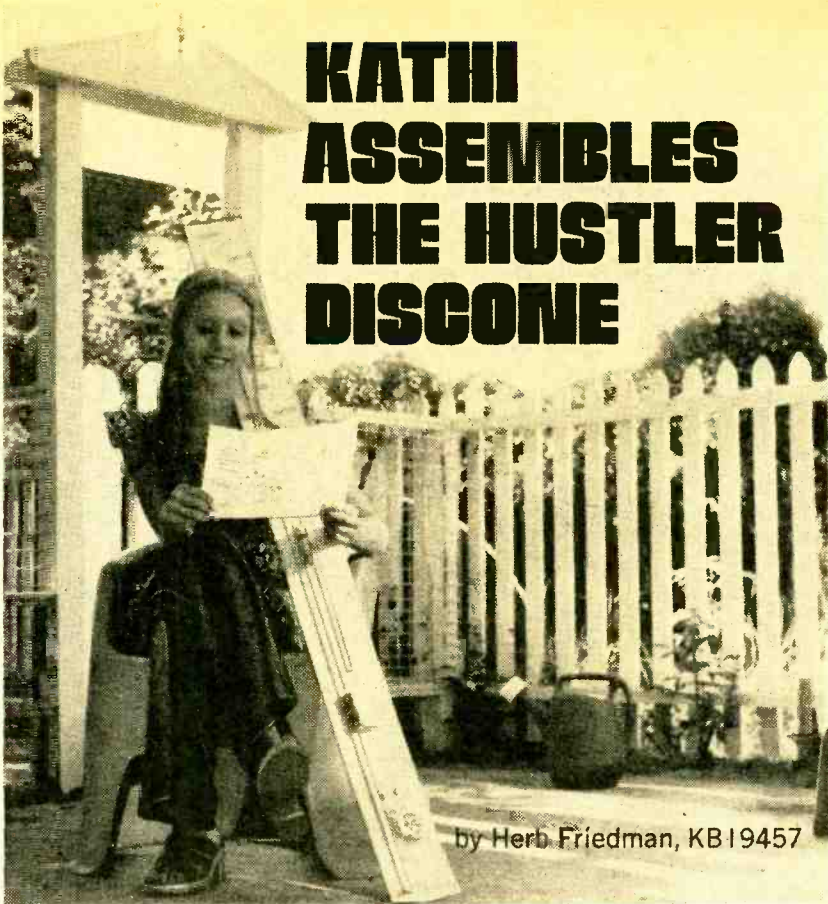

Model DCX broadband monitor antenna covers 40 to 700 MHz

KATHI doesn't do anything small. So when she got hooked on both hi-fi and police-fire monitoring at the same time and insisted she was going to hear every possible signal, the boys in the office visualized several weekends spent erecting an *antenna farm* on the roof of her home.

But leave it to Kathi. She came up with one antenna—the Hustler *Discone*—that receives all frequencies from 40 to 700 MHz! Like man, that covers the TV channels, FM broadcasting, and the public service (police, fire) low, high and UHF bands, not to forget a few dozen “government” bands.

The Discone antenna is not some new untried idea. Basically, it's a broad spectrum antenna—broad in the sense of hundreds of Megahertz—that has been used by government and private agencies, such as airlines, for many, many years. The few hobby applications of the Discone antenna have been limited to the UHF Ham frequencies because of its relatively large size. But by starting the Discone's coverage at 40 MHz, Hustler has provided a single, reasonably sized antenna that effec-

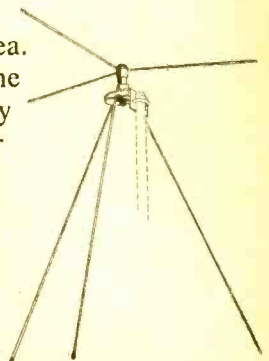

e/e DISCONE ANTENNA

All together, left, Kathi's ready for Herb to do the "On The Roof" bit. Camera-shy Herb shows his handy work with conical-type TV antenna for size comparison.

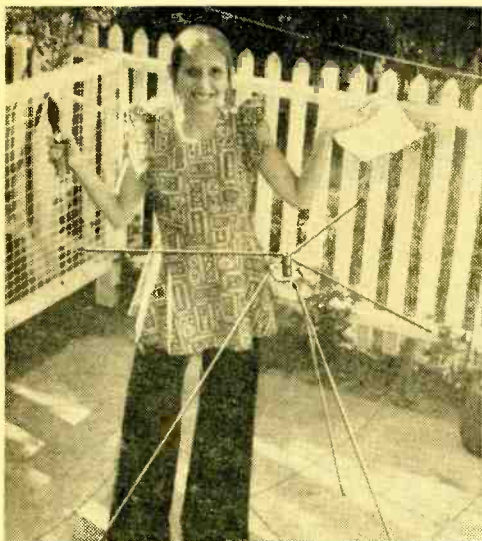

tively and completely can replace multiple antennas that would otherwise be required just to cover public service bands, let alone FM and TV.

The best way to picture what the Discone antenna looks like is to imagine only the groundplane radials of a CB antenna (no vertical element) positioned above the *drooping* ground radials from another groundplane antenna. The Discone's radial elements are 20-in. long; the drooping radials are 55 inches. The entire package adds up to about half the size of a CB groundplane antenna.

Transmission line can be any coax of approximately 50-ohms impedance, such as RG-58 or RG-174. It is connected to the antenna through a standard SO-239 coaxial connector. A TV type U-bracket positioned near the top of the antenna at the coaxial connector is used to secure the Discone to a mast.

On The Roof. The whole bit is such an easy assembly and installation that even taking it slow—giving us more time to look at Kathi—we knocked off the entire installation in less than a morning. A couple of semi-skilled hands can throw up the Discone antenna in less than 2 hours.

Since the Discone's six elements don't look as if they could receive *one* frequency let alone almost 700 MHz of bandwidth,

we talked Kathi into letting us hang around for the afternoon so we could check out the Discone with our Tektronix spectrum analyzer, a device that lets us observe all the signals over a broad spectrum on a TV-like display. Each signal appears as a vertical line on the CRT (cathode ray tube), the height of the line being representative of its signal strength.

One at a time, we connected a turnstile antenna for FM and groundplanes for the three public service bands to the spectrum analyzer, noting the maximum signal strength for several signals on each band. Then we connected the Hustler Discone and again noted the same signals and their strength. There was no real significant difference between the Discone and the individual antennas. As far as we could determine the Discone was covering everything from about the center of the police-fire low band, through the TV channels and the high and UHF public service frequencies (the limits of our checks). The only instance where the Discone did not equal an antenna specifically cut for a particular band was the bottom half of the low band, between 30 and 40 MHz; signals in this range were below that of a "matched" omnidirectional antenna. In some instances the Discone slightly outperformed the "matched" antenna.

(Continued on page 98)

HEY HERB

THE AUDIO ANSWER MAN by Herb Friedman



Hey Herb: For many years I have installed hi-fi equipment. Now, I would like to expand into hi-fi servicing as, quite frankly, many of my customers are willing to pay reasonable service fees. I can get some used quality test equipment at decent prices. Which items would you suggest from the enclosed list?

None! You have enclosed the best list of status symbols I have ever seen, few of which are adequate for hi-fi servicing. The remainder of the items are overpriced. Firstly, much of the test gear, such as the General Radio 1932 distortion meter is quality *broadcast* test gear, and that's the problem. It is FCC type approved, meaning it has a 30 kHz hi-filter and you will not be able to measure amplifier distortion above 15 kHz. As a general rule, signal generators and distortion meters with a 15 kHz top end are broadcaster's items and the distortion is either too high for testing modern hi-fi equipment or the range isn't high enough. Secondly, those items which have the required frequency range are too old. The HP 206A was a terrific signal generator but isn't worth \$500 *to you*. In a million years you will never align it for low distortion, and calibration-lab service fees are astronomical.

I suggest you try to get a Heathkit AG-9 or EICO 378 signal generator, both of which use the NBS circuit. Distortion 20 to 20,000 Hz does not exceed 0.05% THD (user aligned) and only one signal generator priced under \$1000 has less distortion (the Radford). The solid state Heathkit IC-18 generator is even better if modified as described in the *Audio Amateur* (Series 1, 1971).

One of the finest and most reliable THD meters (if you aligned it after burning in the tubes

for 120 hours) was the Heathkit IM-12. A used-price under \$60 is a fantastic buy. I don't know if their new model is the same as the old, but in a different case, so I can't comment on Heath's new distortion meter. EICO, at one time, had a superb THD meter (wired only) that was combined with too many other features. But if you can locate one, latch on to it fast. The low cost instruments I have mentioned are generally as good as "status" brands and some \$500 to \$900 less expensive. In some aspects they are even better than the higher priced models.

Hey Herb: Following the recommendations in most hi-fi publications, I purchased Koss ESP-9 electrostatic headphones. I tried three different models before I asked for my money back as the distortion was much too high; more than in headphones selling for almost \$100 less than the ESP-9. What gives with the so-called test reports?



Koss ESP-9
Electrostatic
Stereophones

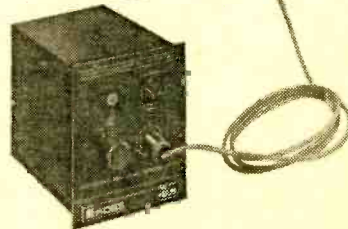

EICO 378 Audio Generator

What gives are inferior amplifiers, pickups and records so bad they should never be released for sale. The ESP-9 is a magnificent headphone that brings out a clarity of sound generally unheard from loudspeakers. Unfortunately, it reproduces *everything* with extreme clarity, even distortion inherent in records and amplifiers, and it pours this distortion directly into the ear. I, myself, have been *ear shattered* by an ESP-9. For exam-

e/e HEY HERB

ple, the mono version of La Belle Helen (Wing Records) when listened to through an ESP-9 is an indescribable adventure in high-fidelity sound. The stereo version of the same program is poorly made or pressed, and the ESP-9 reproduces distortion from the stereo version with even more *fidelity*. In short, the ESP-9 headphone is simply *too good* to be used with inferior equipment. I suggest it might have made more sense to replace your amplifier or pickup rather than the ESP-9.

Hey Herb: I am a music student on a *very tight* budget. I want a reel-to-reel tape system so I can hear myself and spot the errors I make. Having no hi-fi equipment I would like to know which of the items on the enclosed list you would recommend? I realize it's not the best equipment but it's what I can afford.



Tandberg 4000X Recorder

You're wrong; you cannot afford any of it, it's all garbage. For example, adding up the costs of the most expensive microphone, amplifier, recorder, turntable and speakers (on your list) I get a *list* price of \$399.50. That barely covers the cost of a decent recorder. I suggest you do this: Get a good recorder such as the Tandberg 4000X, a pair of ADC 404 speakers and an Electro-Voice electret microphone. The Tandberg has built in power amplifiers of reasonable quality, and has bass and treble controls. It also has a built-in magnetic preamplifier, so it can be used as an integrated amplifier. You'll start off making some professional quality recordings, which is the only way to hear your mistakes. Later, you can add a *quality* turntable and pickup; finally, a high power amplifier. This way you will end up with a *damn good* system. If you start with junk you'll never be satisfied and everything, including those cheap recorders on your list, will have to be replaced.

Hey Herb: I have an SQ decoder, I use SQ discs and yet, I don't hear true 4-channel sound. I like

the effect I get but there isn't really a pinpointing or directional effect; the front is still the front. Do SQ records require a special pickup?

Welcome to the club; I too have been unimpressed by SQ. Using a Lafayette LR-440 receiver that permits instant A-B-C switching between front and rear simultaneous stereo, ambient rear decode, SQ rear decode and 4-channel discreet (from recorders), I agree on this: from certain records ambient decode produces a slight reverb rear effect with almost front sound quality on

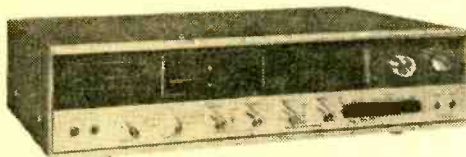

Lafayette LR-440 Receiver

the lower frequencies. SQ decode from standard stereo records is even better than ambient decode. SQ decode from SQ records has a *long, long, very long* way to go before it gets near the 4-channel effect from discreet 4-channel tapes. The SQ from SQ discs appears to have a rising response to the higher frequencies in the rear channel, and an arpeggio will suddenly move from front to rear with reverb; or a lead guitar will wander around the room looking for a home. Also, the particular record determines what becomes of the rear channels. For example, I have a mix-down record (made from individual sound tracks) that has virtually nothing coming out the rear from an ambient decoder, yet an SQ decoder gives a terrific rear "ambient" . . . and this record was cut 8 years before anyone thought of ambient or SQ. I have SQ recordings with a rear channel totally lacking anything relating to decent mike techniques; on the other hand, I have 10 year old records made with two mikes (stereo) at a live concert and the rear ambient and SQ decode is out of this world.

I don't really believe anyone knows what they are talking about once they get past a mathematical analysis of phasing. Anyway, if you would like to try all the types of 4-channel sound I suggest you pack up your own tapes and records, trot down to a Lafayette dealer and ask permission to use an LR-440 set-up.

(By the way, don't ask the Editor for his opinion on SQ. He can swear like a sailor!)

Herb would like to answer all the questions our readers send. However, he can only sample the questions received and answer as many as possible through this column. Sorry, it's impossible to answer questions by return mail. Questions of a personal listening nature cannot be answered. Send your questions to Hey Herb, ELEMENTARY ELECTRONICS, 229 Park Avenue So., New York NY 10003.



KATHI'S CB CAROUSEL

By Kathi Martin, KAI()614

More and more CBers are noticing the change. It's a change that has been filling our airwaves more and more with those Donald Duck-like sounds. As most of you know, a jumble of sound comes from CB sets designed to transmit on a single sideband—SSB for short. It has been a number of years now since the FCC clarified the use of this highly efficient method of communications on Class D channels. And it's been only recently that SSB has begun to take hold. As CBers become more familiar with SSB, they realize just how dependable it really is. For example, if the unmodulated carrier power from a transceiver is 3-watts, then that same carrier fully AM modulated will contain an additional 1½-watts of sideband power. Since there are two sidebands and each contains the same modulation *footprint*, this means only ¾-watt of radio energy is in each sideband.

It's sideband power that is detected by our AM receivers and converted to audio. So, if we can get more of our allowed five watts into the sidebands, we'll have more of that good old talk power. And that's just what SSB rigs do. By completely wiping out the power-gulping carrier (3-watts) and one of the two sidebands (¾-watt) we have an opportunity to increase our *single* sideband power many times up to the legal 15-watt PEP input limit. Why 15-watts all of a sudden? That's a story for another column.

Just remember that an SSB rig packs *all* it's power into one sideband, and one is *all* it takes to communicate. Of course, it takes special circuits in both the transmitter and

receiver to achieve true SSB operation.

The Teaberry Twin "T" sideband transceiver we've checked for this issue is no larger than an ordinary AM transceiver, yet packs the features and performance of the old timers. I guess next year we'll be able to slip a full sideband rig into a hip-hugger back pocket!

Teaberry's Twin "T" features both upper and lower single-sideband and AM operation. The overall size is only 13-in. W x 5¼-in. H x 9⅝-in. D, yet it packs full 23 channel coverage, a built-in S/Rf/SWR meter, crystal filters, noise blanker, tape recorder output and a few other features not usually found in AM transceivers such as a front panel headphone output and a rear apron tape recorder output.

Up Front. The neat and trim front panel is jam packed with controls—an *RF gain*, *volume*, *squelch*, *clarifier*, *USB/LSB/AM* function, *S/POWER/SWR* meter selector and a meter *RF CAL*. There are switches for the noise *blanker* on-off and the *PA/CB* selector. The rear apron has the RF output jack, PA speaker terminals and the power connector; both the AC and 12 VDC power cables are supplied.

In most ways the Twin "T" 's technical *innards* resemble most modern CB sideband gear, with a balanced modulator for sideband generation, and SSB and AM detectors. The *clarifier* is really a delta tune, meaning the frequency of the local oscillator crystal(s) is shifted very slightly by a small trimmer capacitor. In the Twin "T" the delta tune delivers a ±300 Hz variation on either side of the center channel for receiving stations very slightly off frequency. Without the delta tuning, stations even a smidgen off the center of the channel would

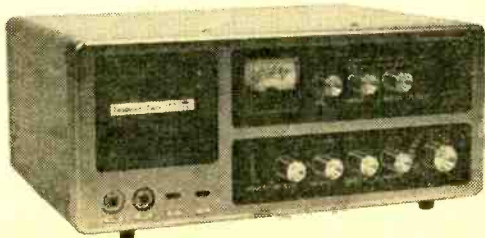

Hey, it's Teaberry's latest SSB rig. Built in AC and DC power supplies, and running a full 15-watts PEP input are just two of the Twin "T" 's many great features. Circle No. 40 on the Reader Service Page.

e/e KATHI'S CAROUSEL

come out sounding like Donald Duck or a barrel of monkeys fighting over the last banana.

A very unusual Twin "T" feature is the use of two separate noise blankers—one for AM and one for sideband. In this manner the noise blanking can be optimized for each operating mode.

Performance. Of course, styling and features take a back seat to performance because performance is what really counts, and the Twin "T" came through with most of its flags flying. The receiver's sensitivity checked in with a signal-inhaling AM sensitivity of 1 μV for a 10 dB S+N/N (signal plus noise to noise) ratio. On sideband the sensitivity was even better—0.5 μV being the minimum readable signal level.

Adjacent channel selectivity was unbelievable, a measured 73 dB. Now I don't believe figures like that so I checked again; sure enough, the lab instruments verified that we were right the first time. So we checked the instruments next, and they were right up to specs. The Twin "T" does

deliver and honest 73 dB adjacent channel rejection; that's T for Tops in any league.

The image rejection is a solid 94 dB. About the only complaint we have is with the AGC action. Over a signal input range of 1 μV to 50,000 μV the AGC action is 22 dB. Over a 2 μV to 50,000 μV input signal range the AGC action is 12 dB. This means if you're listening to a very weak signal, a strong signal coming on the channel is going to blast the speaker. Of course, this is no problem if you're working one station, but I found I was riding the volume control when working in the local REACT net.

The transmitter put out 2.3 watts RF into a 50 ohm load in the AM mode. The microphone sensitivity checked out at -27 dB, which is a little more sensitive than average. AM modulation was not limited to 100%. We didn't measure the PEP (Peak Envelope Power) in the sideband mode, because contrary to what you've read elsewhere, it generally can't be done without burning out the final RF amplifier(s), and I had no intention of damaging this beautiful rig (I want to use it, not repair it). So we did the next best thing and checked it against several other 15 PEP rigs. The Twin "T" put as much soup into the skyhook as any of the others, so I'll say it's running 15 watts PEP.

Operating tests showed the Twin "T" to be very stable, with quite good modulation. When I think of some of the SSB disasters around just a year or so ago, it's a pleasure to see how far we've come so fast.

Summing Up. Priced at \$429 complete with AC and DC power cables, all crystals and microphone the Teaberry Twin "T" is an attractive package for the CB'er trying to get away from the squeals and whistles of AM. I tried it, and I liked it.

For additional information circle No. 40 on our Reader Service Coupon on Page 17 or 103. ■

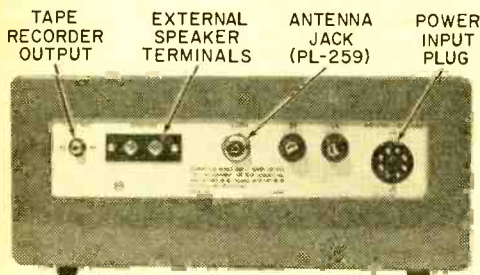

Remember, RG-8 type cable is always better for long (50-ft or more) runs between the antenna jack on your set and your skyhook.

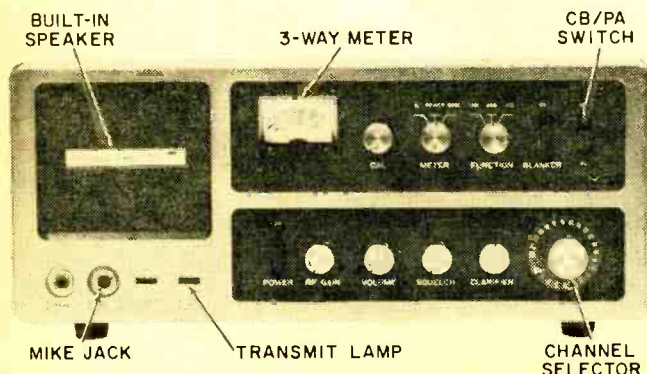

Clarifier is the delta tune control for shifting received frequency about 300 Hz above and below center channel. Adjacent to mike jack and transmit lamp you'll find an earphone jack and receive indicator on this new SSB transceiver by Teaberry.

e/e checks out the...

TEAC AN/60 NOISE REDUCTION UNIT



Dolbyizing on a budget, with a simplified outboard unit

As a general rule, virtually all 4-track reel recorders, cassettes and 8-track cartridge machines have a relatively high hiss (noise) level, easily heard during low-level passages. While there are several excellent Dolby B add-on noise suppressors that will improve the signal-to-noise ratio of any tape system, they are relatively expensive, priced from about \$200 up. The high price is caused primarily to the use of four Dolby amplifier-equalizers in each unit: two for stereo record and two for simultaneous or non-switched playback. The few attempts at low-cost Dolby B add-ons were not outstanding in either performance or convenience, though

they were better than nothing at all.

But by stripping a Dolby B down to its basic and required essentials, TEAC has come up with a budget-priced Dolby B, the AN-60, suitable for any recording system if you are willing to put up with a few minor inconveniences.

The AN-60 measures 6 $\frac{3}{16}$ -in. wide by 3 $\frac{3}{4}$ in. high by 10 $\frac{1}{16}$ -in. deep. Inside the "black box" are only two amplifiers that function either for record or playback; the user must manually switch the mode of operation. Also included is a Dolby calibration oscillator of about 400 Hz. To insure accurate "alignment" so that tapes can be interchanged be-

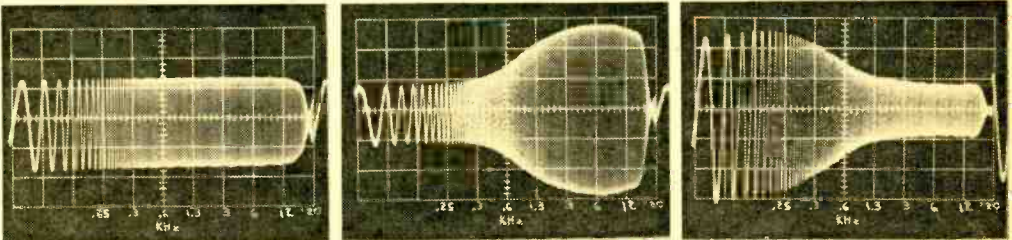

The signal input (left) fed to the AN-60's Dolby circuits is flat except for a "notch" at 19 kHz which suppresses any 19-kHz pilot that might leak through a receiver providing the signal source. This notch is present even when the Dolby circuit(s) are switched out, and appears at the output of the AN-60. In the record mode (center) the AN-60 provides high-frequency boost to low-level signals. The signal level shown is 40 dB below "zero VU"; note that there is a nominal 10-dB boost at 6 kHz. When set to the playback mode (right) the AN-60 attenuates the "weak" higher frequencies in inverse ratio to the record boost. (A non-Dolby tape played through the Dolby de-equalization would be "flat" at the higher sound levels but have the high frequency-attenuated response shown, at the lower signal levels.) The resultant playback output from a Dolbyized tape would be that shown at left.

e/e TEAC AN-60

tween different Dolbyized recorders while retaining a finalized "flat" frequency response, the unit is equipped with a sub-miniature calibration meter and "Dolby level" reel and cassette tapes.

The front panel has controls for L and R record level, Dolby mode (record or play), Dolby in/out, calibration tone on/off, L or R meter and power. There are also screwdriver-adjust recessed controls for L and R play calibration.

Once connected between the recorder and your amplifier, only the AN-60's controls are used for level adjustments. The recorder's record and play controls must not be adjusted.



The recessed playback-level controls (PLAY CAL) are slotted for screwdriver adjust.

A typical "system alignment" is performed as follows. The Dolby test-tape is played on the recorder, and the recorder's output control is adjusted for a zero VU reading on the recorder's meter. Then the output control should be taped in position. If the recorder has no meter, set the output control to its mid position and tape it in place. If the recorder has no output control, just ignore this step. While playing the test tape, you set the AN-60's meter switch to the left channel and adjust the recessed AN-60's play-cal control for a "center" or CAL reading on the AN-60's meter. You next set the meter switch to the right channel and perform the same adjustment, completing the Dolby play alignment.

Set the AN-60's mode switch to "record" and turn on the CAL oscillator. Using blank tape, with the recorder's "line" level control set to approximately two o'clock, record a few seconds of tone. When you play back

the tone, with the Dolby mode switch set to play, note the AN-60's meter. If the pointer isn't centered at the CAL position, change the recorder's line level control (either up or down) until the playback level on the AN-60's meter is centered. Then tape down the recorder's level controls and note the position of the recorder's VU meter pointer—this is the new "zero VU" mark. In the future you must use the record-level con-

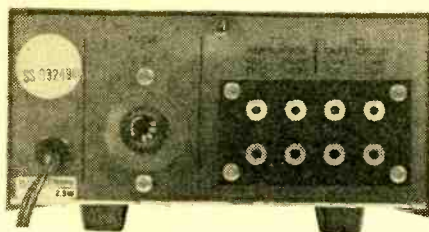

Four stereo circuits access all of the amplifier and recorder functions, including the tape monitor. Circle No. 45 on page 17 or 103 for further info.

controls on the AN-60, always adjusting the record level for the new zero VU mark. It makes no difference what the new zero VU reference is in relation to the meter calibration; you must use the new zero VU reference.

How it works. The scope-trace photos clearly illustrate how the AN-60's Dolby functions. The frequency range is 50 to 20,000 Hz. The trace at left is the input signal applied to the Dolby record equalizer. The "notch" at 19 kHz is caused by a fixed, internal filter used to suppress the 19-kHz pilot from an FM stereo tuner or receiver that would interfere with proper operation of the Dolby circuits if it leaked past the receiver's normal pilot filter. The center trace shows the equalization applied to the input signal being fed to the recorder. Note that the higher frequencies are boosted a nominal 10 dB. During playback, the AN-60's Dolby de-equalizer attenuates the higher frequencies in inverse ratio to the record pre-emphasis, as shown in the trace at right. The resultant output signal is "flat" with a 19-kHz notch, essentially equal to the input signal shown the trace at left. (Any frequency-response variations are a product of the recorder's electronics.) Obviously, when the AN-60 attenuates the higher frequencies to restore the flat frequency response, the noise (hiss) frequencies inherent in tape playback are similarly attenuated, thereby

(Continued on page 104)

GREAT IC PROJECTS

by the ELEMENTARY ELECTRONICS Staff

Integrated circuits are growing bigger every day—while growing smaller. Higher and higher orders of packing density now put major circuits in tiny packages.

The actual function of the IC depends on the overall design. Some ICs, particularly those known as “operational amplifiers,” have their function determined by a simple change in external components or wiring connection. For example, changing just one component of an operational amplifier make the device function as an amplifier, oscillator, or flip-flip multivibrator. It is much more difficult to pull this “change of function” trick with a discrete transistor circuit by simply changing one component or connection.

One difficult problem with ICs the experimenter rarely runs across when dealing with transistors is *high frequency instability*. Many IC devices have extremely wide bandwidths, often extending into the VHF spectrum. Direct Current to 30, 50 or even 100 MHz bandwidth is not uncommon. While transistors have similar bandwidths, they don't have the gain of many linear ICs. Furthermore, they can be stabilized on an individual basis, or the component layout

of individual transistors can be arranged so that various stages are physically isolated. Or shielding or other isolation techniques can be used. This is not necessarily true of ICs where the input terminal is about one-half inch from the output terminal. And, to compound the problem, the open loop (no feedback) gain of many linear ICs run from 5000 to 50,000—and even higher!

All is not roses. When you combine extreme high gain with extreme bandwidth, just the length of the IC's power supply terminal can become a high frequency inductor. The L and C of a bypass capacitor's foil can even become a resonant circuit. This is the reason why some of the IC circuits you build have a 0.1 uF capacitor shown in parallel with the electrolytic power supply bypass capacitor. The 0.1 uF capacitor is installed directly to the IC's plug-in socket terminals and serves as the high frequency bypass.

All ICs used in the projects are currently available as “standard stock.” To avoid the common problem of trying to buy ICs from non-consumer or industrial-only sources, where *you*, the reader, cannot locate the IC, the ICs in this IC projects section are from

e/e NINE GREAT IC PROJECTS

major manufacturers. They make their "line" available through local stocking distributors, in addition to mail order houses such as Newark Electronics, EDI, BA and others.

From time to time you will see ads from surplus or close out distributors offering the ICs for our projects at rock bottom prices. As a general rule, these ICs are either "overruns" or units which did not quite meet manufacturer's specifications. But, for all practical purposes, they are perfectly usable for our projects because the project's design is well within the maximum specifications of the IC. There's no good reason why you can't save a dollar by buying surplus ICs.

For all the projects, we have specified the easiest case configuration to handle. However, if you can get a good buy on one of the other configurations, by all means use it. Keep in mind, however, that the TO-55 and inline configurations are relatively easy to handle. But the flatpack is often more trouble than the whole project is worth, and it should be avoided unless it's impossible to do so. (The flatpack IC is designed only for automated installation at a factory.)

Socket! Though the ICs can be soldered directly into the circuit, they are extremely difficult to remove without damage. And, it generally takes special desoldering equipment to remove an IC from a printed circuit board. Although IC sockets cost just a few cents more, we suggest they be used at all times. Should there be a wiring error, the most you will lose is a low-cost socket—

rather than an expensive IC. Another benefit you'll gain is that the socket also allows you to easily substitute another IC for the first when you have a hanker to experiment with the circuit.

Take particular care in noting an IC's lead arrangement. This is the knottiest problem you'll encounter with ICs as lead arrangement is even less standard than those of transistors. The circular TO-55 type IC has an index tab; however, the terminal number opposite the tab might be the first—or last—terminal. For example, if the IC has 10 leads, the lead opposite the tab might be number 1 or number 10. So note carefully the lead arrangement provided specifically for each project.

Do not assume one manufacturer's lead arrangement is that of another. And further, do not assume one manufacturer has followed the same arrangement on two different IC types. Stick with the arrangement provided for each project!

All the projects presented on the following pages are built around inexpensive and readily obtained ICs. Follow the instructions given for each project, and observe IC base diagrams carefully. Note circuit voltage polarity, and use a 40-watt maximum soldering iron. The projects are:

1. *Remote Gain Control*
2. *Professional Remote Amplifier*
3. *Protect-a-Volt*
4. *Super 15 Amplifier*
5. *Comm-press Log Amplifier*
6. *Great Equalizer*
7. *Stereo Mike Preamplifier*
8. *Gain Master Mike Preamplifier*
9. *Micro-Mini Amplifier*

1—Remote Gain Control

One of the problems of locating a volume control in a remote location is that of hum and noise pickup; as a general rule, the greater the wire length the greater the hum and noise picked up. With an electronic attenuator the entire problem is eliminated, for the volume control wires carry only a DC control voltage which causes an integrated circuit amplifier's gain to vary by as much as 90 dB. Hum and noise picked up in the DC control wires are not impressed on the amplified audio signal. No layout precautions are required and any type of assembly can be used. If desired, the amplifier gain can be voltage controlled by elimi-

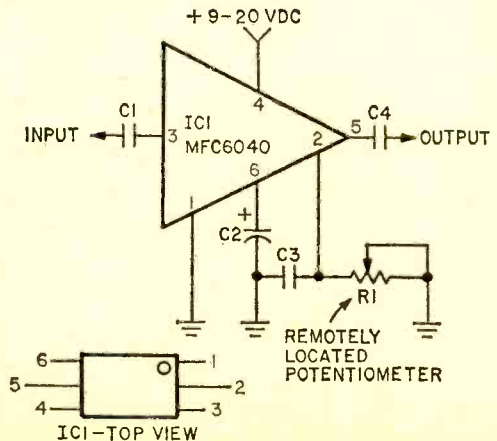

nating potentiometer R1 and applying 3.5 to 6 volts DC directly to pin 2. With 3.5 VDC the amplifier works at full gain. The attenuation increases to a maximum of 90 dB as the control voltage is increased to 6 VDC.

**PARTS LIST FOR
REMOTE GAIN CONTROL**

- C1—0.47 μ F, 25 VDC capacitor
- C2—50 μ F, 25 VDC capacitor
- C3—680 pF, 500 VDC ceramic disc capacitor
- C4—0.1 μ F, 75 VDC Mylar capacitor
- IC1—Motorola MFC 6040
- R1—50,000-ohm potentiometer

2—Professional Remote Amplifier

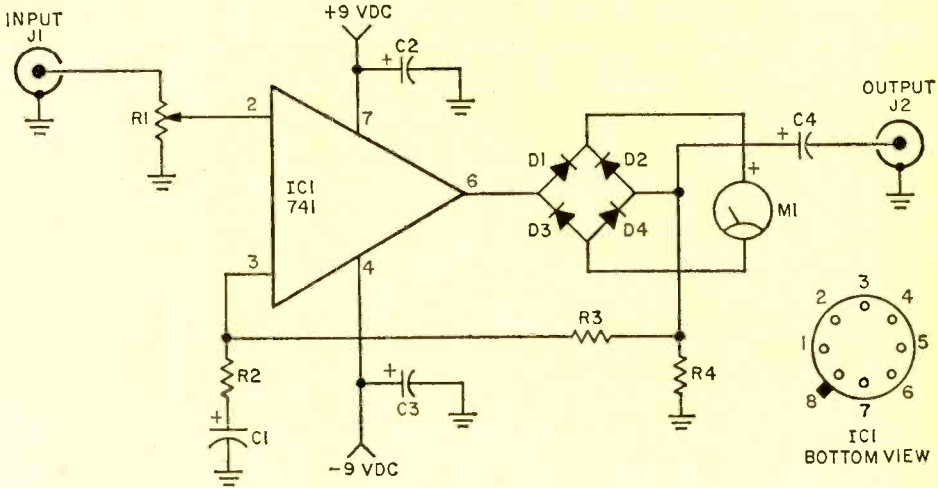

Here's a professional performance remote amplifier suitable for the hobbyist, amateur recordist or professional broadcast engineer. The input is any microphone with an output impedance up to 50,000 ohms, or for professional use, the input can be at line level. When the distance between the remote amplifier and its associated equipment is less than 25 feet the amplifier can be connected to any hi-fi type high impedance input (10,000-ohms or higher). For long line or professional applications, connect a 500/500 line matching transformer to output jack J2. Capacitor C4 is 0.1 μ F for all applications except when used with a line matching transformer. When a transformer is used C4 is 25 μ F. Better results can be obtained with a line matching transformer if the transformer primary replaces R4 (eliminating C4). M1 is a standard VU meter whose internal rec-

tifier has been removed (open the case and unsolder the rectifier). Total current drain is less than 5 mA and the bi-polar power supply can consist of two transistor radio type 9 volt batteries.

**PARTS LIST FOR
PROFESSIONAL REMOTE AMPLIFIER**

- C1—200 or 250 μ F, 3 VDC electrolytic capacitor
- C2, C3—50 μ F, 12 VDC electrolytic capacitor
- C4—0.1 μ F or 25 μ F, 12 VDC capacitor (see text)
- D1 to D4—Diode, general purpose Silicon, HEP-154 or equiv.
- IC1—Type 741 operational amplifier (Fairchild μ A741, Radio Shack No. 276-010)
- J1, J2—Shielded jacks
- M1—VU meter with internal rectifier removed
- R1—50,000-ohm audio taper potentiometer
- R2—100-ohm, 1/2 watt resistor
- R3—15,000-ohm, 1/2 watt resistor
- R4—560-ohm, 1/2 watt resistor

3—Protect-A-Volt

A simple turn of a knob sets Protect-a-Volt's output voltage anywhere in the 3 to 20 volt range—and with full short circuit protection! Should there be a wiring error in the powered project, this supply auto-

matically shuts down the output voltage until the overload is removed. The maximum output current (short circuit protection) has been established by resistor R3's value at 200 mA. Power transformer T1's rating

e/e NINE GREAT IC PROJECTS

should not exceed 200 mA as extra current capacity could not be handled by the integrated circuit. To make this project easy to build, and to sharply reduce total cost, it was necessary to eliminate a fully off, or zero output, setting for voltage adjust control R1. The minimum output voltage is 3V. The maximum voltage from T1's secondary must be 30V rms if the secondary is center-tapped; 15V rms if there is no center-tap and a bridge-rectifier is substituted for sili-

con rectifiers SR1 and SR2. Capacitor C1's voltage rating must be 25 volts minimum. Do not eliminate high-frequency-compensation network components R4/C3.

PARTS LIST FOR PROTECT-A-VOLT

- C1—2000 μ F, 25 VDC (see text)
- C2, C3—0.1 μ F, 75 VDC disc or Mylar
- IC1—Motorola MC-1461R
- R1—50,000 ohm linear potentiometer
- R2—6,800-ohms, 1/2-watt resistor
- R3—3-ohms, 1/2-watt resistor
- R4—27-ohms, 1/2-watt resistor
- SR1, SR2—Silicon rectifier, 50 PIV, 500 mA
- T1—Power transformer; 117 VAC primary, 30 V C.T., 200 mA secondary (see text)

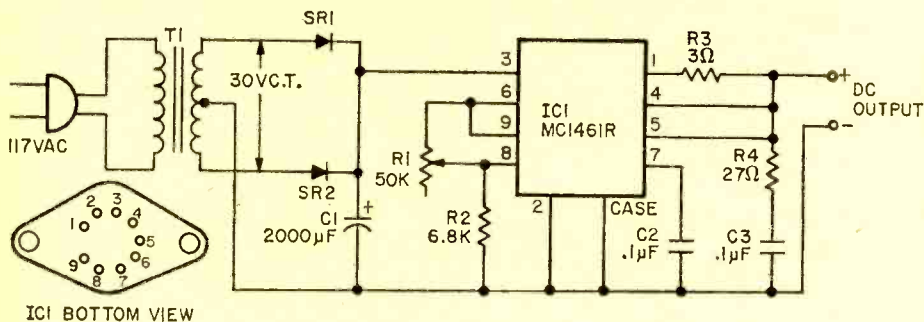

4—Super 15 Amplifier

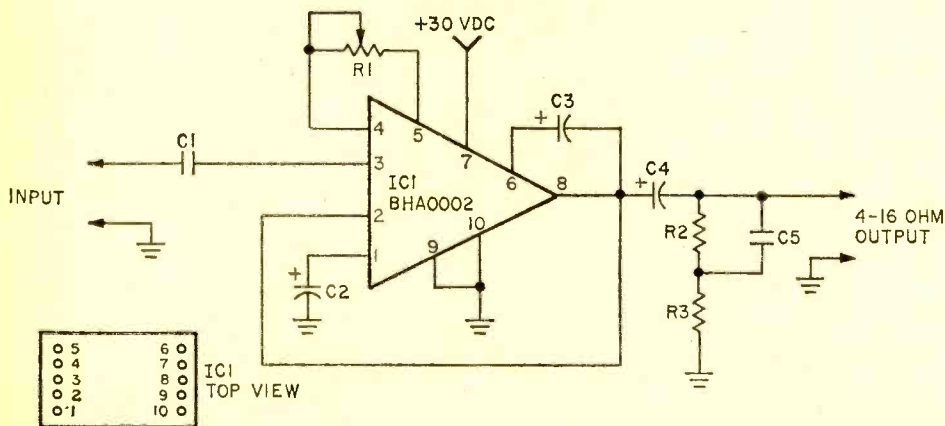

Just 350 millivolts input is all it takes for the Super 15 to push 15 watts output into a 4 ohm load or 10 watts into an 8 ohm load. Frequency response is better than +0/-3 dB 20 to 20,000 Hz and distortion at full power is a smidgen over 0.5% THD. The input impedance is about 20,000-ohms, and should be driven by a low impedance source such as a 600-ohm output transistor pre-amplifier. The power supply should be rated

at least 1.2 amperes for mono and 2.5 amperes for a stereo pair. Bias adjust potentiometer R1 must be set in the following manner—set R1 so the full resistance is in the circuit, then connect a voltmeter (0-25 VDC) from pin 8 to ground. Adjust R1 so that the meter indicates exactly one half the supply voltage; for example, if the supply voltage at pin 7 is 30 volts there should be 15 volts from pin 8 to ground.

PARTS LIST FOR SUPER 15 AMPLIFIER

- C1—0.22 μ F, 75 VDC Mylar capacitor
- C2—250 μ F, 3 VDC electrolytic capacitor
- C3—50 μ F, 30 VDC electrolytic capacitor
- C4—2000 μ F, 30 VDC electrolytic capacitor
- C5—0.05 μ F, 75 VDC Mylar capacitor

- IC1—Solitron BHA0002
- R1—1000-ohm trimmer potentiometer
- R2—470-ohm, 1/2 watt resistor
- R3—22-ohm, 1/2 watt resistor

5—Comm-press Log Amplifier

A log amplifier is a device that takes a large change in input signal and converts it to a small change in output. Hook one into a communications system and both low and loud sounds come out at almost the same level giving you a lot more talk power; it sounds just like the hard-sell commercials on TV. The input level should be about 0.1 volt peak for an output voltage of about 1 volt peak. Since this is a high frequency device, lead dress and good power supply bypassing at the power supply terminals are required. Keep the ground leads short. If a microphone preamplifier is used before the log amplifier, connect a volume control before the log amp's input. Some experimen-

tion will be needed for optimum P.A. operation. Because of the much higher average voice power, a P.A. system using a log amp compressor might appear to be more sensitive to acoustic feedback (howling). Actually, you will have much more voice output before the howling starts.

PARTS LIST FOR THE COMM-PRESS LOG AMPLIFIER

- C1—1 μ F, 6 VDC electrolytic capacitor
- C2—10 μ F, 6 VDC electrolytic capacitor
- C3—0.1 μ F, 75 VDC Mylar capacitor
- D1, D2—Diode, Silicon, 1N914
- IC1—Signetics NE501K
- R1—510-ohm, 1/2 watt resistor

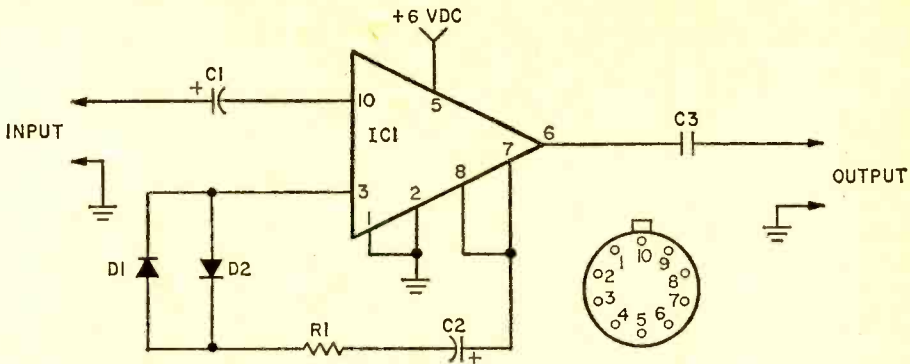

6—Great Equalizer

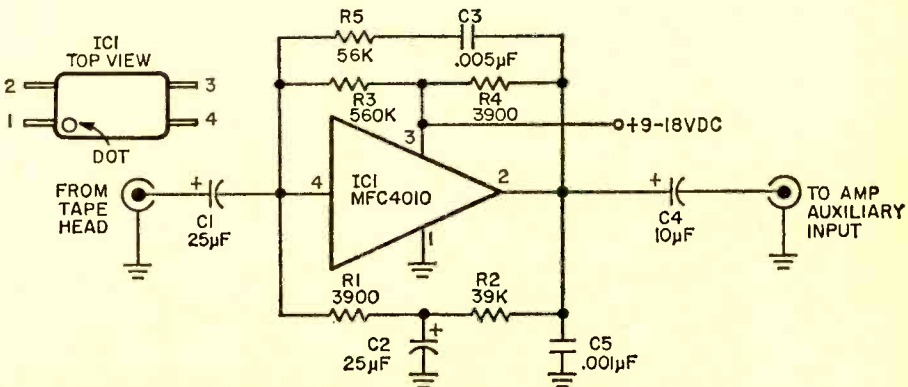

e/e NINE GREAT IC PROJECTS

From time to time you'll find bargains at dealers selling tape and cassette deck mechanisms at rock bottom prices—often less than \$20! Complete with heads, these decks need only the electronics to get them working. The Great Equalizer provides both the amplification and equalization. You can feed its output directly into an amplifier's auxiliary input. The Great Equalizer's over-all frequency response is suitable for cassettes and 3¾ IPS reel-to-reel tapes. Since the actual required equalization is determined partially by the playback head characteristics, it might be necessary to modify or "tailor" the equalization; this is done by small changes in the value of capacitor C3 and resistor R5.

If assembled on a small printed circuit board, the Great Equalizer can be tucked under the tape mechanism's base plate. The power supply can be anything from 9 to 18 volts at approximately 3mA. Transistor type radio batteries will do; if batteries are used they must be bypassed with a 25 μ F capacitor. And, be sure you observe proper battery polarity.

PARTS LIST FOR THE GREAT EQUALIZER

- C1, C2—25 μ F, 6 VDC
- C3—0.005 μ F disc
- C4—10 μ F, 20 VDC
- C5—0.001 μ F disc
- IC1—Motorola MFC-4010
- R1, R4—3,900 ohms, ½-watt resistor
- R2—39,000-ohms, ½-watt resistor
- R3—560,000-ohms, ½-watt resistor
- R5—56,000-ohms, ½-watt resistor

7—Stereo Mike Preamplifier

A dual IC gives our stereo mike preamplifier its hi-fi amplification for a stereo microphone pair. Low distortion and full-fidelity frequency response characterize this mike preamp. With resistors R1 and R2 providing a center-tap for the power supply, the IC can be powered from a standard single-ended power supply or series connected batteries. Be very careful to observe the correct polarity for capacitors C2 and C3. In the event the unit motorboats (low frequency oscillation), install a 0.1 μ F capacitor from pin 14 to ground. The connections for one of the two amplifiers is shown circled; the connections for the second amplifier are un-circled. Pins 7 and 14 are common to both amplifiers. Capacitor Cx's value is determined by the load impedance. It should be

of such value as to provide the desired overall low frequency response; 0.1 μ F is suggested for high impedance output loads (100K and higher), while 10 μ F is suggested for low impedance loads.

PARTS LIST FOR STEREO MIKE PREAMPLIFIER

- C1—0.1 μ F, 100 VDC
- C2, C3—25 μ F, 25 VDC
- C4—680 pF disc
- C5—50 μ F, 25 to 50 VDC
- C6—33pF disc
- Cx—See text
- IC1—Motorola MC1303L
- J1—Microphone jack
- R1, R2—2,200-ohms, ½-watt resistor
- R3, R5—100,000-ohms, ½-watt resistor
- R4—1000-ohm, ½-watt resistor

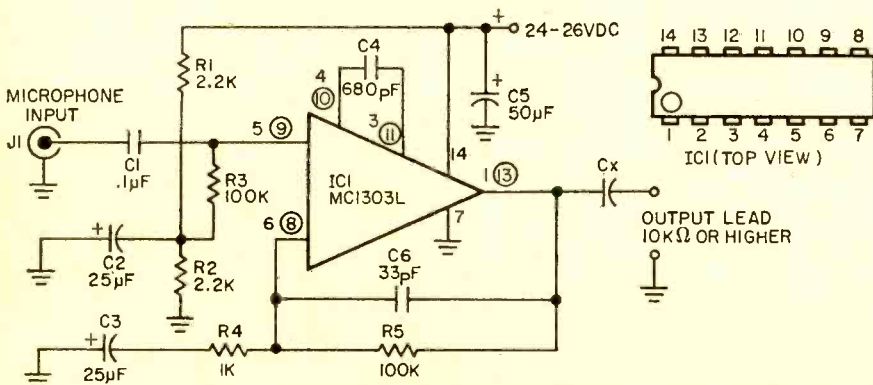

8—Gain Master Mike Preamplifier

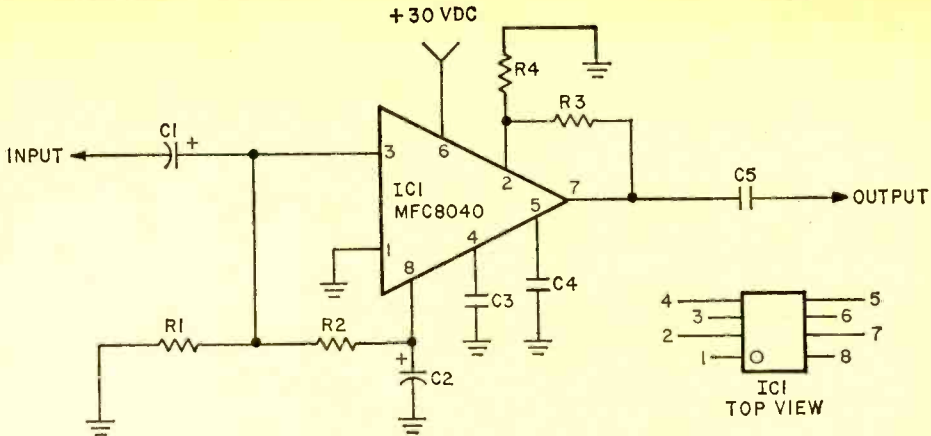

Packing a walloping 60 dB gain with a 7 volt output. This mike preamplifier nevertheless is almost dead quiet. The input impedance is about 75,000-ohms; output impedance about 100-ohms. Actual maximum output voltage depends upon the load resistance, ranging from 7 volts output into a 10,000-ohm load to 4 volts output into a 1000-ohm load. Parts layout is not critical and any type of assembly can be used. The power supply current is typically 8 mA, with a maximum of 12 mA. Use the Gain Master in front of a number of mixer-connected potentiometers to make a high impedance microphone mixer. Passive-type mixers—those using potentiometers only and with-

out a built-in amplifier—are available from electronic parts dealers and through mail order and are relatively inexpensive. With a Gain Master in front of each input, you upgrade these cheapie mixers to full-fledged audio tools.

PARTS LIST FOR THE GAIN MASTER MIKE PREAMPLIFIER

- C1—1 μ F, 3 VDC electrolytic capacitor
- C2—100 μ F, 6 VDC electrolytic capacitor
- C3—0.05 μ F, 75 VDC Mylar capacitor
- C4, C5—0.1 μ F, 75 VDC Mylar capacitor
- IC1—Motorola MFC 8040
- R1—75,000-ohm, 1/2 watt resistor
- R2—270,000-ohm, 1/2 watt resistor
- R3—110,000-ohm, 1/2 watt resistor
- R4—100-ohm, 1/2 watt resistor

9—Micro-Mini Amplifier

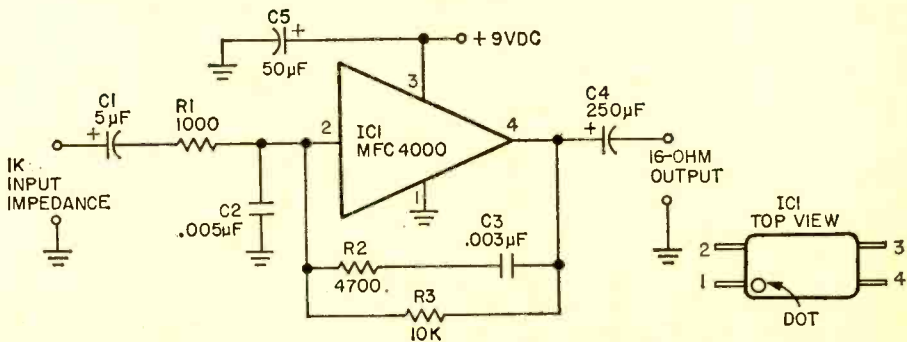

Using an IC no larger than a fly, Micro-Mini Amplifier delivers almost 250 mW into a 16-ohm speaker. A 50 mV input signal coming from a source whose output impedance is 1000 ohms or lower is required for maximum output. The power supply can be a 9 volt type 2U6 battery; the idling current is no higher than 6mA. Best way to keep

things small is to use a printed circuit board assembly.

This amplifier can serve as a general utility amplifier for checking out low-level audio projects, or it can serve as a monitoring amplifier for tape and cassette decks. Even professional-type reel-to-reel recorders with-

(Continued on page 104)

CB coffee break

THIS ISSUE'S COLUMNIST—JULIAN S. MARTIN, EDITOR-IN-CHIEF

One of the fallacies of marketing research is the assumption that if $A = 2$ and $B = 2$, then $A + B = 4$. Somewhere along the line some marketing expert determines that CBers are buying police receivers. Then he assumes that since some CBers are active in "emergency teams" or a REACT program, CBers are buying police receivers so they can lend a hand to government services during an emergency. No one stops to ask if this logic is true: it is simply assumed to be true because it fits the $A + B = 4$ logic.

The next thing to happen is that based on assumptions of the marketing "expert" the CB field is swamped with advertising for police receivers, and many magazine articles appear on how police monitoring can help your club's emergency program. A more deadly-dull subject doesn't exist, and most of the CBers who would actively enjoy monitoring the emergency service frequencies are left stone cold.

In actual fact, most CBers would find emergency service monitoring an *exciting* and *rewarding experience*, but not because it would improve their club's emergency operations.

Consider, for a moment, the average CBER. He is *action oriented*. Very few are stamp or coin collectors. You will find that CBers are generally ballplayers, hunters, campers, clubmen, etc.: their hobbies and interests lean heavily toward *action*.

Now what could be more action oriented than riding side-by-side with cops and firefighters answering an alarm? Or the Coast Guard plowing through the high seas trying to locate a couple of clowns who took out a rowboat in a squall, or smoke jumpers fighting a burning mountain? Or how about the FBI on a stakeout, or the *narcos* closing in for a bust?

In short, because you are a CBER there's an odds-on chance you like *action*—you want to be part of *what's-happening-now*, and *what's-happening-now* is taking place on the public service frequencies. That's why you should want a "police receiver."

Where's It At? The *action* takes place on three public service bands: the low band covering 30 to 50 MHz; the high band covering 152 to 174 MHz (also called the VHF band); and the ultra-high or UHF band covering 450-470 MHz. As a general rule most of the action takes place on the low and VHF bands, though

more and more operations are moving to UHF. Police, fire, government and public service operations are interspersed among the three bands with no specific order, though you will find your local users would tend to be found primarily on one band.

There's lots and lots of equipment available for public service monitoring, in just about every price range. There is even a VHF receiver built into a full-feature CB rig. At the lower end of the price range are the tuneable single-band models: these units can be only manually tuned, though some models are available with one or two crystal positions so that the receiver can be instantly pre-set to a specific frequency. Also at the low end of the price range are the hand-held walkie-talkie styled receivers that are single-band manually tuned with possibly one or two crystal positions—these are for the guy who really likes to get in the middle of things, like a street demonstration.

For More Cash. Moving up the price scale you will find the two-band manually tuned receivers with possibly one or two crystal controlled positions. These models are generally single-band receivers with two separate tuners, one for the low band and one for the VHF band, each tuner having the option of its own antenna for optimum reception. As more operations are moved to the UHF band you are likely to find low cost receivers that also offer UHF coverage.

(Continued on page 97)

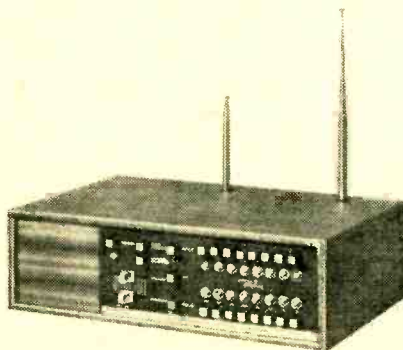

Regency's brand new 16-channel, dual-band VHF scanner (Model TME 16 H/L) scans all channels in one second plus a hair. Price: \$219.00—xtals: \$4.95 each.

SUPER SCA ADAPTOR

by
Herbert Friedman



Hot Enough For DXing

YOU can build a Super SCA detector that's powerful enough for DXing! It's a two-IC circuit in an *amplifier* and *phase locked loop* detector configuration. And it's superior to many other PLL detector circuits because it has an IC amplifier to boost and *lift* the relatively weak 67 kHz sub-carrier signal from the FM signal. That makes it a must for fringe areas.

But let's go back to what SCA is. When a Subsidiary Communication Authorization (known as SCA) is granted to an FM station by the FCC, that station is permitted to transmit a second program *in addition* to its regular program by a special method of modulation. A standard FM radio, even a stereo radio, cannot detect these special broadcasts. The regular listening audience hears only the standard mono or stereo programming. In fact, there is no way of even telling whether or not a station engages in SCA programming. That is, not without a special SCA adaptor that you can build!

If you think you'd like to tune to these hidden broadcasts, we've provided this special project. Special because its high sensitivity permits reception of SCA signals that other low cost adaptors miss.

What You Can Hear. For some time now, SCA has been used to transmit educational programs and continuous weather reports to specialized audiences; however, it is *primarily* used for background music—the type heard in restaurants and shopping centers. For example, in the New York City area there are FM stations with SCA programming in light popular music, while others specialize in music of India and Greece.

Best of all, this pleasant, interesting music is never interrupted by an endless barrage of commercials or the patter of an announcer in love with his own voice.

How it's done. SCA programming is transmitted by a 67 kHz FM sub-carrier that is impressed on the main FM carrier. When a station broadcasting SCA is received by a standard FM tuner, the SCA sub-carrier is simply wiped out—the listener has no idea it exists. To receive SCA, the FM tuner's output is usually passed through a filter that wipes out everything except the SCA sub-carrier and its modulation. When the sub-carrier is demodulated, the output is only the SCA program; to the SCA listener, the standard programming doesn't exist.

Until recently it took a lot of expensive hardware to receive SCA programs: a very sensitive receiver and a rock-steady detector. (A good receiver is needed because the SCA carrier is only 10% of the total FM signal.) Though many low cost SCA



Adaptor above is teamed with Rotel RT-620 AM/FM tuner and Dynaco SCA-80Q amplifier

e/e SUPER SCA ADAPTOR

adaptors have been available in project or wired form, most had a tendency to burp, gargle or distort on the very weak signal level of the SCA.

While the radio-astronomy crowd had a great weak-signal detector known as the phase locked loop, it was also true that the astronomical phase lock detector was astronomical in price. But thanks to modern solid-state techniques, the Signetics Corpor-

ation has come up with a phase locked loop detector specifically intended for SCA detection that is priced well under ten dollars.

Available in the standard 8 pin round and 14 pin DIP IC packages, the Signetics SE/NE565 requires virtually no external hardware for SCA detection. Most important, since the phase lock detector automatically locks on the incoming SCA carrier frequency, the Signetics SE/NE565 will demodulate SCA subcarriers of either 65 kHz or 67kHz without adjustment; whichever subcarrier frequency the broadcasting station uses will be received equally

PARTS LIST FOR SUPER SCA ADAPTOR

- B1,B2—6-volt battery, RCA VSO68 or equiv.
- C1,C9—470 pF disc capacitor, 15 VDC or better
- C2—47 or 50 pF disc capacitor, 15 VDC or better
- C3—0.005 uF disc capacitor, 15 VDC or better
- C4,C7—0.1 uF disc or Mylar capacitor, 15 VDC or better
- C5,C6—100 uF electrolytic, 15 VDC or better
- C8—7 or 10 pF disc capacitor, 15 VDC or better
- C10,C11—0.001 uF disc or Mylar, 15 VDC or better
- C12,C14—0.02 uF disc, 15 VDC or better (see text)
- C13,C17—0.05 uF disc or Mylar, 15 VDC or better
- C15,C16—2000 uF electrolytic capacitor, 15 VDC or better
- IC1—Integrated circuit amplifier, NE531T (Signetics)
- IC2—Integrated circuit PLL, NE565A (Signetics)
- R1,R5,R6—4700-ohms, 1/4-watt resistor, 5%
- R2,R4—47,000-ohms, 1/4-watt resistor, 5%

- R3—470-ohm, 1/4-watt resistor, 5%
- R7—1800-ohm, 1/4-watt resistor, 5%
- R8—5000-ohm potentiometer, PC board mounting
- R9,R10,R11—1000-ohms, 1/4-watt resistor, 5%
- SR1 to SR4—Silicon diodes, HEP-154 or equal
- S1—Toggle or slide switch, SPDT
- T1—Small filament transformer, 12.6 volt center tapped
- Misc.—6 x 3 1/2 x 2-in. case, printed circuit material, etchant, RCA phono jacks, push-in clips, hardware, wire, solder, etc.

The printed circuit board for the Super SCA project is available direct from Electronics Hobby Shop, Box 587, Brooklyn NY 11202 for only \$4.90 (includes postage and handling). Canadian shipments add \$1 extra. New York state residents must add sales tax. No foreign orders, please.

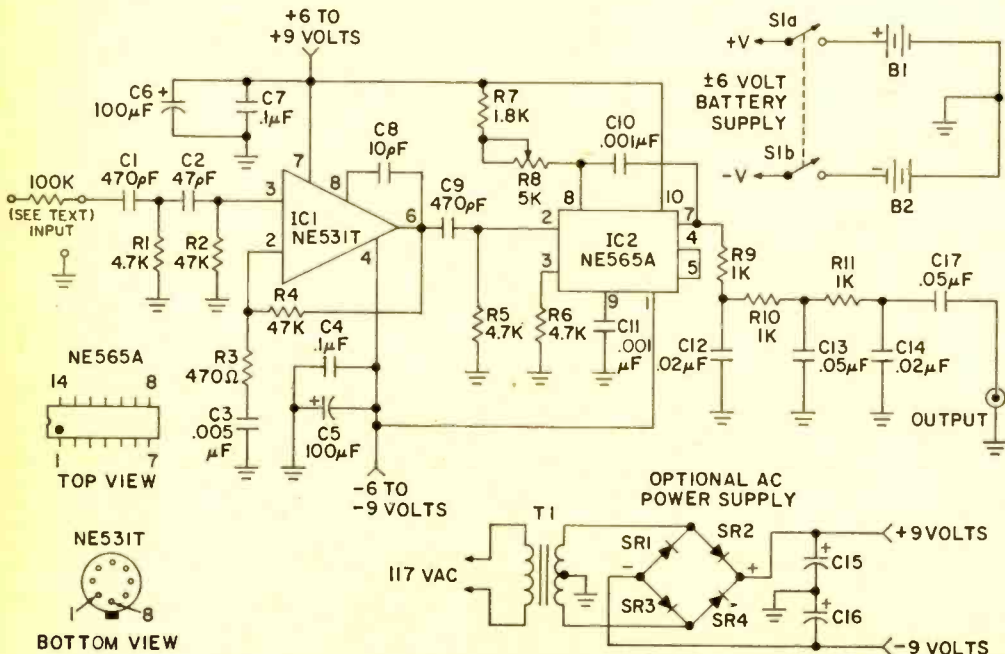

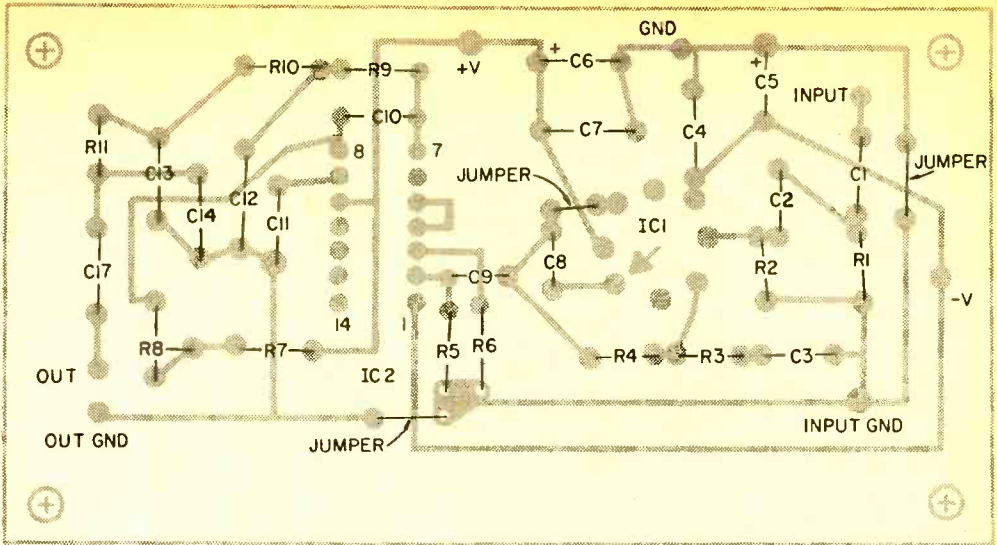

JUMPER WIRES

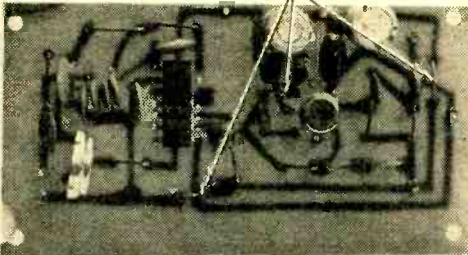

well with this unit.

Combination Gets Results. Unfortunately, the phase lock detector requires at least 80 mV for good reception, and this means that usually only one or two stronger or local SCA stations can be received. To make our SCA adaptor the best there is, we have combined the phase lock detector with a high gain operational amplifier. The result is

Strong backlighting, left, shows printed circuit wiring through a completed circuit board. Layout above and photo on next page show where to place components.

a Super SCA Adaptor that can receive SCA programs on a real cheap FM tuner and an indoor rabbit-ear antenna.

Another plus feature for our Super SCA Adaptor is that no large filter coils are needed to suppress the main channel program. Even SCA programming on stereo stations is received cleanly and with no trace of stereo hash. And because large, bulky coils are not needed, the entire adaptor can be assembled on a 2 1/4-in. x 4 1/4-in. printed circuit board for which we provide the template.

Because our adaptor gain is high, it must be assembled on a PC board exactly as

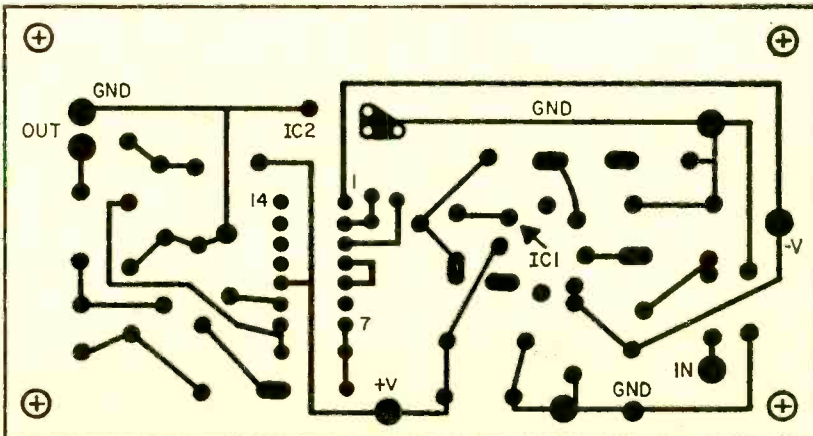

Exact PC board size. Transfer image to copper clad board using carbon paper. This is the bottom (copper) side of your board.

e/e SUPER SCA ADAPTOR

described to insure complete stability.

Some Tech Talk. The signal from your FM tuner's detector before de-emphasis is applied to operational amplifier IC1 through a high pass filter consisting of C1, C2, R1 and R2. The filter's rollover frequency is 60 kHz, which removes a substantial part of the main channel information. Frequency response of the amplifier is tailored by the feedback loop through R3 and C3 to further suppress main channel information. IC1's output is fed through high pass filter C9 and R5 to IC2, the phase lock loop detector. IC2's output is passed through a low pass filter consisting of C12, C13, C14, R9, R10 and R11 which provides de-emphasis and noise suppression. The output level at C15 is about 50 to 100 mV, depending on the signal, and can be fed to your hi-fi or utility amplifier.

Since SCA frequency response is limited to 7 kHz, just about any amplifier can be used.

Note that the adaptor requires a bi-polar power supply in the range of ± 6 to ± 9 volts. The power supply can be either batteries or a power line bridge rectifier using a center-tapped 12 volt filament transformer as shown on the schematic. Since the adaptor requires only about 10 mA of current, any small transformer can be used.

How to Etch a Circuit. Your first step is to prepare the PC board. Since the board must be precise, we suggest you work directly from the supplied template rather than through an intermediate tracing. Cut a section of any type copper clad board to 2 1/4-in. x 4 1/4-in., clean the copper surface with a strong household cleanser such as Ajax or Comet and place a piece of carbon paper, carbon side towards the copper, on the board. Tape the board under the template and, using a sharply pointed tool such as a scribe, indent the copper foil at each component mounting hole by pressing the point of the tool through the template into the foil. (Each indent will serve to mark the hole's location when the board is drilled.) Using a ball point pen and firm pressure, trace the outline of the foil areas.

Continue. . . . Remove the board from under the template, discard the carbon paper and, using a resist pen such as the Kepro RMP-700, available from Allied Radio, fill in the foil areas with resist. Note that some of the IC1 and IC2 pins are not used, though they must pass through the board. Place a drop of resist over the indents so you'll know where to drill after the unwanted copper is etched away. Similarly, mark the indents at the corner mounting hole locations. Make certain you mark IC1 terminal number 8; you can use a drop of resist.

Immerse the PC board under at least 1/4-in. of etchant for about 45 minutes and then inspect the board. If all the unwanted

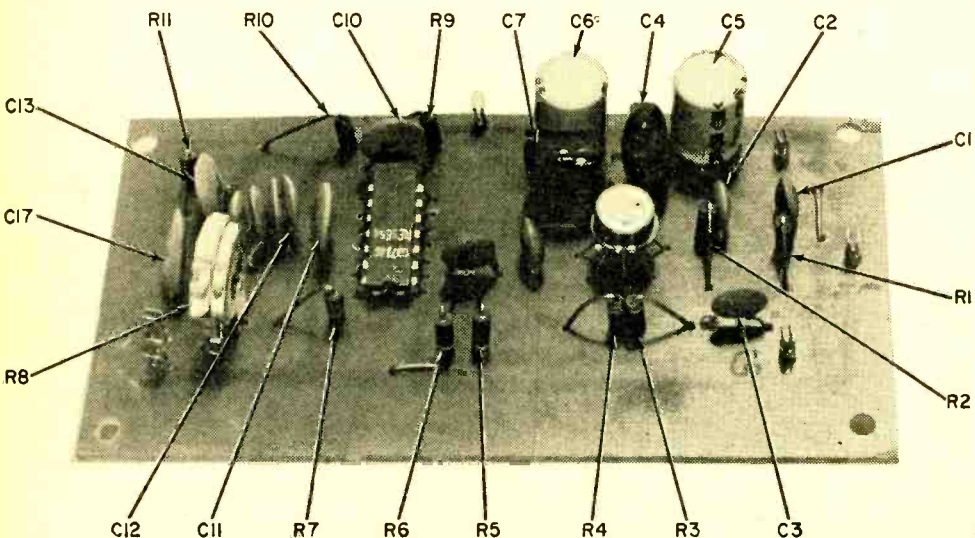

Completed circuit board. Resistor R8 easily adjusts frequency of PLL to 67 kHz.

copper has not been etched away, re-immers the board in five minute intervals until all the copper not protected by resist has been removed. Then rinse the board under running water and remove the resist by scrubbing briskly with a steel wool pad such as Brillo.

Using a #56 drill bit, drill the holes for the connecting terminals (push-in terminals) and trimmer potentiometer R8. Drill the corner mounting holes to clear a #4 or #6 screw and drill the remaining component holes with a #58, #59 or #60 bit.

You Can Buy the Board. You don't have to make a printed circuit board for the Super SCA—you can buy one. The Electronics Hobby Shop is offering the PC board completely etched ready for drilling and assembly. This beats trying to copy the author's board layout exactly, and the mess and expense of etching copper.

Mount the Components. Install IC1 and IC2 before any other components. Note that the IC1 lead opposite the case tab is number 8. Insert the leads (begin with number 8) and push IC1 toward the board until there is about 3/8-in. between IC1 and the board. Solder the wires and cut off the excess.

Hold the PC board so you are looking at the top with IC1 to the left. Hold IC2 so the notch is away from you and insert IC2's leads into the matching holes. *Doublecheck the notch before soldering.* It is correct if the distance from the notch to the edge of the PC board is greater than that of the unnotched end to the opposite edge of the PC board. If all is okay, solder IC2.

Install trimmer potentiometer R8 and solder. Make certain you use sufficient soldering heat to flow solder to R8's terminals.

Then install the three wire jumpers and, finally, the remaining components taking extreme care that the polarity of capacitors C5 and C6 is correct. Note that C5 has the positive lead connected to ground.

While capacitors C12 and C14 are indicated as 0.02 μ F, they are not the easiest to obtain in miniature size. You can substitute two parallel-connected 0.01 μ F capacitors. Simply twist their leads together and insert them into the matching holes. Do not tin the twisted leads prior to soldering as they will not fit into the holes if tinned.

Set-up and Checkout. Either a bi-polar battery power source or a standard bi-polar power supply can be used. Since there is

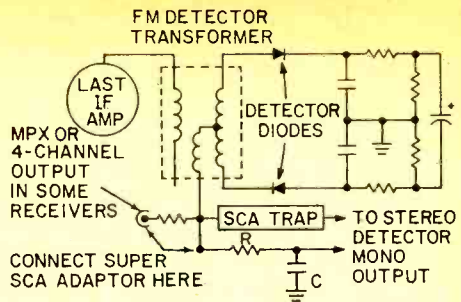

Always connect SCA adaptor before de-emphasis network R, C as shown above. Most tuners, receivers do have an MPX jack for a home SCA, or 4-channel use.

essentially no difference in performance between a ± 6 V and ± 9 V power supply, use whatever you have available. For long-term battery life we suggest Burgess type Z4 6 volt batteries (or their equivalent).

The Super SCA adaptor connects to your mono FM tuner or receiver detector *before* the de-emphasis. If you connect after the de-emphasis network, you will find the 67 kHz subcarrier has been filtered from the signal, so you will get nothing but noise from the adaptor. The figure shows a typical FM detector output, the de-emphasis network and the correct connecting point for the adaptor. Since it is possible the adaptor might load down the detector for normal FM reception, we suggest a switch be installed, so the adaptor can be removed from the circuit for normal FM listening.

The adaptor is most conveniently connected through a phono jack installed in the tuner's rear apron, though you can use a direct wire connection.

Note that if you have one of the older mono FM tuners with an "MPX output" you already have the correct connection as the MPX output is the non de-emphasized detector output. Similarly, if you have a modern FM Stereo tuner with a "4-channel decoder" or a "quadrasound decoder" output you also have the correct connection; they are also non de-emphasized detector outputs.

Connect the tuner's detector output to the adaptor with the shortest possible length of shielded cable or ordinary zip cord, or install the adaptor directly in the receiver if there is sufficient room. Connect the adaptor's output to any high gain amplifier; for example, the microphone input of your hi-fi amplifier, or a utility amplifier is fine, or maybe an old tape recorder.

Ⓜ/Ⓜ SUPER SCA ADAPTOR

R8 Locks Loop. Tune in a station you know is transmitting an SCA program (a call to your local station should get you the info.) and adjust trimmer potentiometer R8 for best sound quality. Normally, the reception will be almost completely garbled, then fade into a clean signal as R8 is adjusted, then fade into garbling again as R8 is further adjusted. Set R8's wiper so it is approximately midway between the two points of garbled sound. Usually, the best sound will occupy a broad part of the R8 adjustment range, so don't try to be too fussy.

If you don't know which station(s) are transmitting SCA, set R8 to the mid position and tune every station very carefully and slowly. When you hear anything that sounds like distorted music, try adjusting R8; if it is real SCA, it will turn *clean* as R8 is adjusted. Some stereo stations might cause sound bursts that you think are SCA.

If adjusting R8 doesn't bring in a clean signal, it's not SCA. Note that once R8 is adjusted there is no stereo hash interference on SCA signals. Hash will only be heard from non SCA signals.

Problems? The high sensitivity of this system may require desensitizing procedures; in the event you cannot receive *any* SCA stations, you either have none in your area or you have made a construction error. If the non-SCA program from the tuned-in station is heard breaking through the SCA programming, follow the suggestions in our troubleshooting box. If your adaptor doesn't work at all, beg, borrow or steal an oscilloscope and check input and output waveforms as shown in the scope photos. Just be sure to return the scope so we don't get in trouble with John Law for inciting a felony!

What's Your Beef? Here are some hints to help you steer clear of trouble—straight toward your musical enjoyment and SCA DXing!

☞ *If your problem is a weak signal re-*
(Continued on page 98)

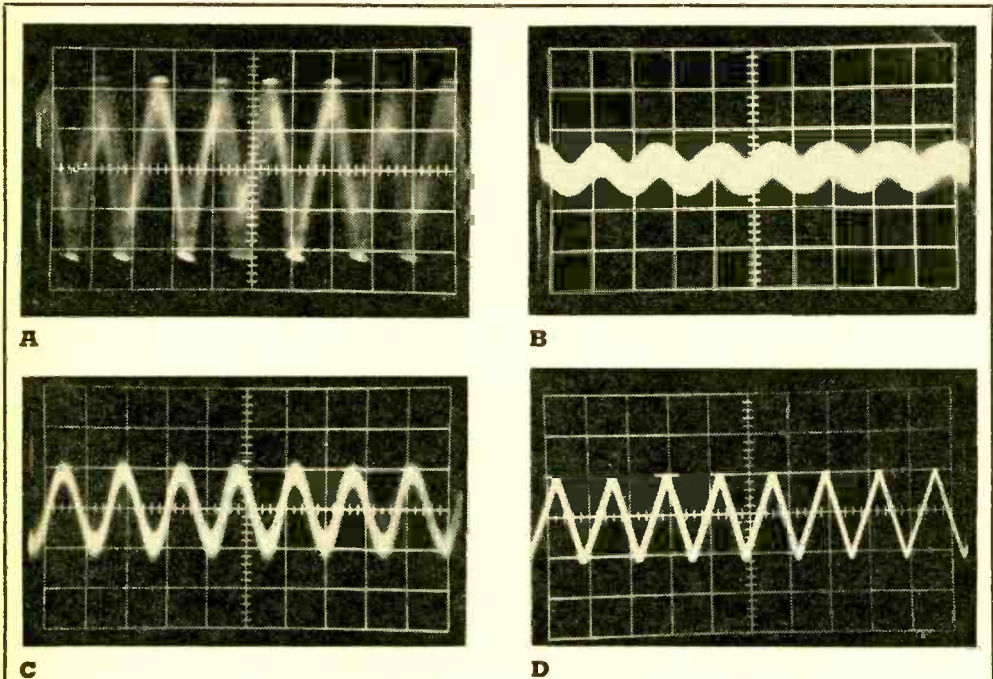

Oscilloscope patterns quickly locate any possible difficulty. You can use a general purpose scope since the signals are under 100 kHz. With "triggered" scopes, set the time base to 10 μ sec/cm. Photos B and C are input and output of IC1, the 67 kHz amplifier. If signal is clipped as in A, main channel program may break through—see text for cures. Normal IC2 pin 9 waveform at D. Vert. sens: B, 20mV/cm; C, 1V/cm.

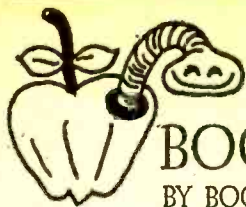

BOOKMARK BY BOOKWORM

Basic Book for Everyone. The revised second edition of *Repairing Transistor Radios*, by Sol Libes is a practical, easy-to-use guide clearly explaining methods and procedures for troubleshooting and repairing the latest types of AM and FM transistor radios, including home,

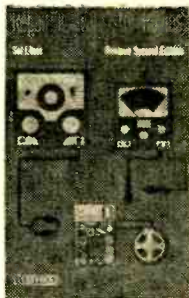

Soft cover
192 pages
\$4.65

portable, and auto radios. The book briefly explains the theory and structure of semiconductor elements, then covers transistor characteristics and types, including junction transistors, field effect transistors, and integrated circuits. Operation and servicing of all types of transistor circuits are discussed in-depth and accompanied by comprehensive, step-by-step troubleshooting charts for each receiver circuit. Published by Hayden Book Company, 116 West 14th Street, New York, NY 10011. For literature circle No. 60 on Reader Service Coupon on page 17 or 103.

Now Hear This. *Hi-Fi for the Enthusiast* by M. L. Gayford offers expert guidance for the audiophile who wants to achieve true hi-fi performance from radio, tape or records. The text's main emphasis is on the efficient selection, assembly and use of modern hi-fi units, modules and construction kits. The enthusiast will be able to build a system that both suits

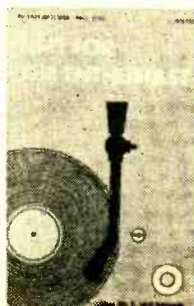

Soft cover
176 pages
42 illustrations
\$3.95

his individual needs and gives a high standard of reproduction, at an economical price. Matters such as room acoustics, amplifiers, pickups and loudspeakers—for both the manufactured and the home-constructed set, are dealt with in detail. Published by Tab Books, Blue Ridge Summit, PA 17214. For more info, circle No. 65 on Reader Service Coupon on page 17 or 103.

R/C for Everyone. In the past, model builders required amateur licenses to practice their hobby. In 1958 the Class C Citizens Band was created by the FCC and the hobby has never been the same since. A fantastic growth has demanded that authors Fred M. Marks and William Winter prepare their revised second edition of *Radio Control for Model Builders*. This text offers to the newcomer and long-time student of R/C methods reliable answers on every phase of the subject, from receivers and transmitters to actuators and batteries. Every popu-

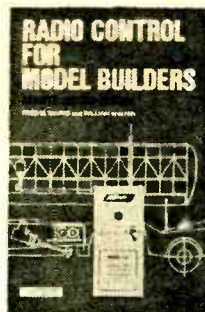

Soft cover
151 pages
\$4.45

lar control system is explained, every application (model airplanes, boats or cars) is covered in detail. Published by Hayden Book Company, Inc., 116 West 14th Street, New York, NY 10011. Write to the publisher or circle No. 67 on Reader Service Coupon on page 17 or 103.

Reviews in Brief. Publishers' addresses are not given when stated previously in this column. *Questions and Answers* by Leo G. Sands, Howard W. Sams & Co., Inc., publisher; handy guide to CB operators with no experience; soft cover, 112 pages, \$2.95.

The Fascinating World of Radio Communications by Wayne Green, Tab Books publisher; describes the exciting hobbies of SWL, CBing and ham radio; soft cover, 176 pages, \$3.95.

Transistor TV Training Course by Robert G. Middleton, published by Howard W. Sams & Co., Inc.; written for the technician.

Semiconductor Diode Lasers by Ralph W. Campbell and Forrest M. Mimms, III, Howard W. Sams & Co., Inc., publisher; an excellent primer on the subject for technicians and advanced hobbyists; soft cover, 192 pages, \$5.95.

Electric Rock by Richard Robinson, Pyramid Books, 919 Third Avenue, New York, NY 10022; an encyclopedia on rock electronic equipment; soft cover, 224 pages, 95¢. ■

HOW WOULD YOU LIKE TO BUILD YOURSELF A COMPLETE BELL & HOWELL ELECTRONICS LABORATORY RIGHT IN YOUR OWN HOME?

This unique Electro Lab® comes with each of the three Bell & Howell Schools programs described on the opposite page. Build it yourself and use it to perform hundreds of fascinating electronics experiments. Mail postage-free card for free facts now. No obligation.



Here's what you build and keep:

■ **Design Console** Use this to rapidly "breadboard" circuits without soldering. Equipped with built-in power supply ... test light ... speaker ... patented plug-in modular connectors.

■ **Oscilloscope** Portable 5-inch wide-band oscilloscope offers bright, sharp screen images ... calibrated for peak-to-peak voltage and time measurements ... 3-way jacks for leads, plugs.

■ **Transistorized Meter** Combines most desired features of vacuum-tube voltmeter and quality multimeter. Registers current, voltage and resistance measurements on a large, easy-read dial. Features sensitive, 4-inch, jewel-bearing d'Arsonval meter movement.

Follow simple, step-by-step instructions

It doesn't matter if you've never had training in electronics before. You start with the basics. You take it one step at a time. You walk before you run. And you move ahead at your own pace.

Attend special "help sessions" if you like

If you run into a sticky problem or two, come in and see us. Meet an expert instructor in person. Talk over any rough spots with him—and with other students, too, if you wish.

Why you should know electronics

Everywhere you look, electronics is becoming a bigger and bigger part of the picture. The day may come when the man without electronics training will be severely handicapped in many industries.

Why you should get your training from Bell & Howell Schools

Each year, Bell & Howell Schools spends over \$200,000 improving programs and materials. Many thousands of people have used these programs as the foundation for new careers and businesses in electronics.

For free information, mail postage-free card today!

ELEMENTARY ELECTRONICS

Your Bell & Howell electronics lab is integrated into each of these three exciting learn-at-home programs. For free facts about all three, mail postage-free card today.

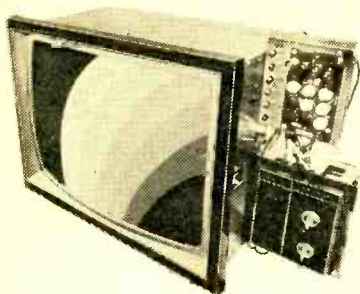

1 Build, keep this Bell & Howell solid state 25-inch color TV

Home Entertainment Electronics Systems

Here's a field that's packed with opportunity! There's a growing demand for skilled technicians to build, install and service solid state color TV's . . . FM-AM radios . . . tape recorders . . . four-channel stereo systems . . . videotape recorders and more. Start preparing now. And build yourself a 25-inch color TV while you're at it. Mail the postage-free card for all the facts.

2 Use over \$1,500.00 worth of actual commercial-grade two-way radio electronic communications equipment right in your own home.

Two-Way Radio Electronic Communications

There are almost two million commercial two-way radio systems in this country. And the FCC requires each to have its equipment checked and serviced regularly by a trained and licensed technician. Bell & Howell Schools offers you the training and experience you need — with \$1,500 worth of real, commercial-grade equipment you use right in your own home. Get all the free facts you need. Mail postage-free card now.



3 Put the controls of an entire manufacturing plant at your fingertips

Electronics Operations Technology and Computer Controls

Automation is sweeping industry. And each of the roughly 90,000 computers in this country requires several highly-trained technicians to keep it working 24 hours a day! Get started on a lifetime career — one in which you can't be replaced by a machine. Mail the postage-free card now for free information. No obligation.

Consider these advantages . . .

Help Sessions We've scheduled "help sessions" every few Saturdays at the Bell & Howell Schools and in many other cities throughout the U.S. and Canada. Top instructors give you expert guidance and you meet other students!

Resident Study After you complete your program, you can transfer to any of the resident schools for more advanced study, if you wish.

Lifetime National Placement Service

When you complete your course, we help you locate a position in the field of Electronics that fits your background and interests. This service is available at any time after you graduate.

Veterans' Benefits We are approved

by the state approval agency for Veterans' Benefits. Check the box for details.

Student Financial Aid We are an eligible institution under the Federally Insured Student Loan Program. Check the box for details.

For free information about all three programs and about the Electro Lab® you build and keep, detach and mail postage-free card today! or write

DELVRY INSTITUTE OF TECHNOLOGY



ONE OF THE

BELL & HOWELL SCHOOLS

4141 Belmont Avenue, Chicago, Illinois 60641

336

newscan

Electronics in the News!

A LOT OF PULL

The world's strongest permanent magnets—two to three as strong as the best previously known—have been produced at the General Electric Research and Development Center, and are now in commercial production. The new magnets, made principally from an alloy of cobalt and samarium, are one of a class of magnetic alloys developed in recent years. These unique materials (the General Electric trade name is GECOR) take advantage of the spectacular magnetic properties that can be obtained by combining cobalt and one or more of the so-called "rare earth" elements.

Although natural permanent magnetic materials, such as lodestone, have been known for thousands of years, the scientific development of such materials has taken place mainly in the past five or six decades. The first major advance came in 1917 with the invention of a cobalt magnet steel with superior properties. The 1930's saw the introduction of the Alnico magnets—alloys of cobalt, nickel, and alumi-



One-fiftieth of an ounce of the new magnet, trade-named GECOR, securely holds a man-sized pipe wrench at right, while a conventional magnet, at left, can't hold onto a much smaller wrench. The new magnets are made principally of a combination of cobalt and one of the so-called "rare earths"—samarium.

num. These were followed by the ferrites—mixtures of iron oxides and one or more oxides of other metals.

In the 1950's, GE began commercial production of another unique magnetic material—Lodex—that owed its properties to the shape of long, thin particles embedded in a lead matrix. Today it is used in products like hearing aids, speedometers, switches, and other applications where good dimensional characteristics and complex shapes are needed.

GECOR magnets are the latest advance in the historical development of magnetic materials. Their unique properties are a result of the exceptional ability of tiny cobalt-rare earth crystals to maintain their magnetized direction independent of the direction of applied magnetic fields. This characteristic promises to result in many applications that are presently unforeseen.

GREAT, BUT WILL IT SELL?

General Motors has revealed the design details of an Experimental Safety Vehicle (ESV) it has built to the U.S. Department of Transportation (DOT) specifications. Two of the five-



Here is the Experimental Safety Vehicle (ESV) General Motors is building to U.S. Department of Transportation specifications for the contract price of \$1. A five-passenger "family sedan," it is a completely new running car now undergoing 50-mile-per-hour barrier impact crash tests prior to its delivery to the government.

passenger "family sedans" will be delivered by GM to the Department of Transportation within a year. GM is one of four manufacturers that were selected to build the ESV.

General Motors' ESV program will include up to a dozen barrier crash tests before two prototype models are delivered to the government in October 1972. Overall, the experimental vehicle is a five-passenger four-door family sedan with a 124-inch wheelbase, 219-inch overall length, 64-inch tread, 79.6-inch overall width and 58-inch height. Its powertrain consists of a 362 cubic-inch displacement V-8 engine, three-speed torque converter, a drive shaft with two universal joints and a coil spring rear suspension. The engine is basically a production unit, but with aluminum cylinder block, heads and intake manifold, which saves about 180 pounds over conventional cast iron. With an 8.1-1 compression ratio, designed to

(Continued on page 97)

build e/e's...

SCRAMBLE PHONE

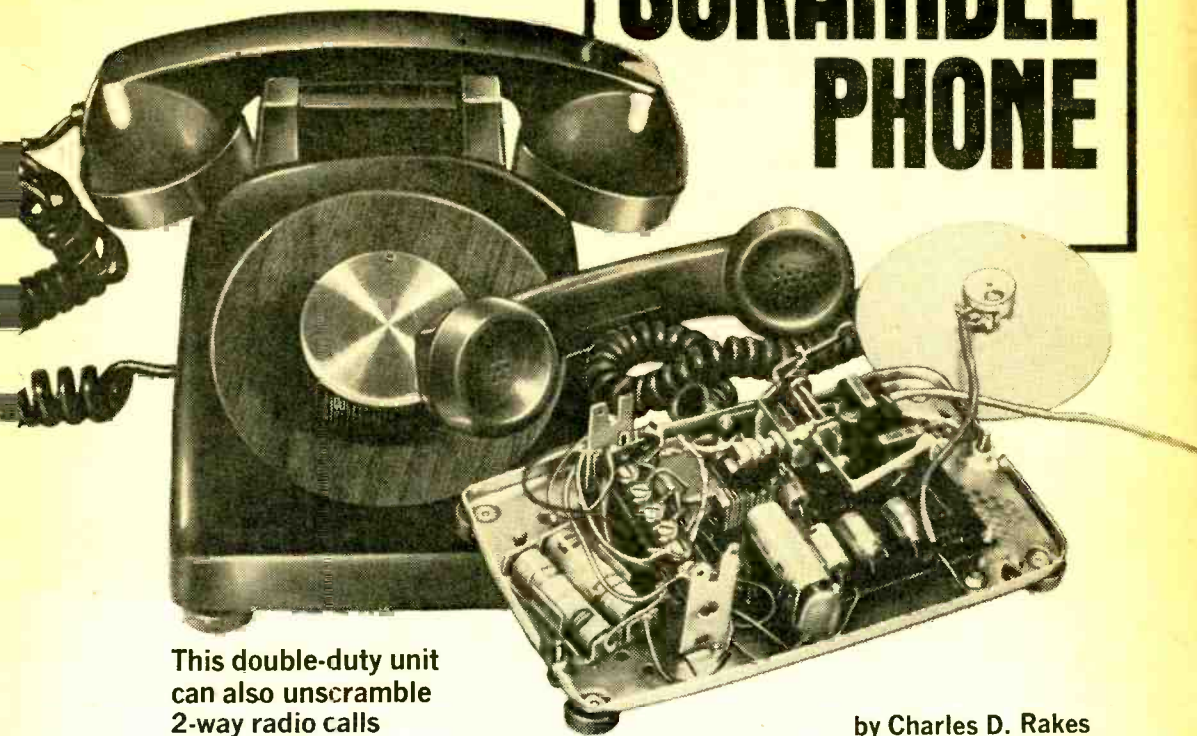

**This double-duty unit
can also unscramble
2-way radio calls**

by Charles D. Rakes

Demand ultimate privacy in your telephone conversations? If so, a secure phone link can be yours with these three easy and exciting steps. 1. Place your call with Ma Bell's instrument. 2. When your party answers, switch to your special scrambler phones. 3. A soft buzz in the ear piece says your security phone link is operational. Your line is secure. Conduct your call in complete privacy no matter how many ears are party-line-listening!

All it takes is a pair of ELEMENTRY ELECTRONICS Scramble Phones. And with this double duty unit, you can try your hand at decoding scrambled conversations that are sometimes heard on radio receivers covering the VHF high band (148-176 MHz). The basic scrambler circuit (available in kit form. see parts list) can be simply modified for radio by removing two fixed resistors and replacing them with a dual-potentiometer.

Wait a minute! Before your soldering iron overheats, let me say that this scrambler will decode information that is encoded in the *single inversion* mode only. The highly sophisticated scramblers that are sometimes

used today can not be decoded with this decoder, but in many areas the single inversion system is still in use and may be decoded with our unit.

How It Works. IC-1 and the associated circuitry form a stable audio tone generator which feeds a buffer amplifier, Q1 and Q2. The tone output is taken from the emitters of the transistor pair to supply a carrier voltage for a balanced modulator made up of four diodes—D1 through D4—and T1 and T2. If the two transformers and the four diodes are perfectly matched (which is almost impossible to achieve and not necessary in any case) no carrier will appear at the input or output of T1 or T2. In a practical circuit, a small amount of unbalance will occur and produce a low-level carrier tone at the input and output of the balanced modulator. This tells you your scramble phone is working.

A telephone carbon mike and ear piece are connected to the low impedance winding of T1, with a three volt battery supplying the necessary mike current. When the mike is spoken into, the carrier voltage is allowed to pass, in part, through transform-

e/e SCRAMBLE PHONE

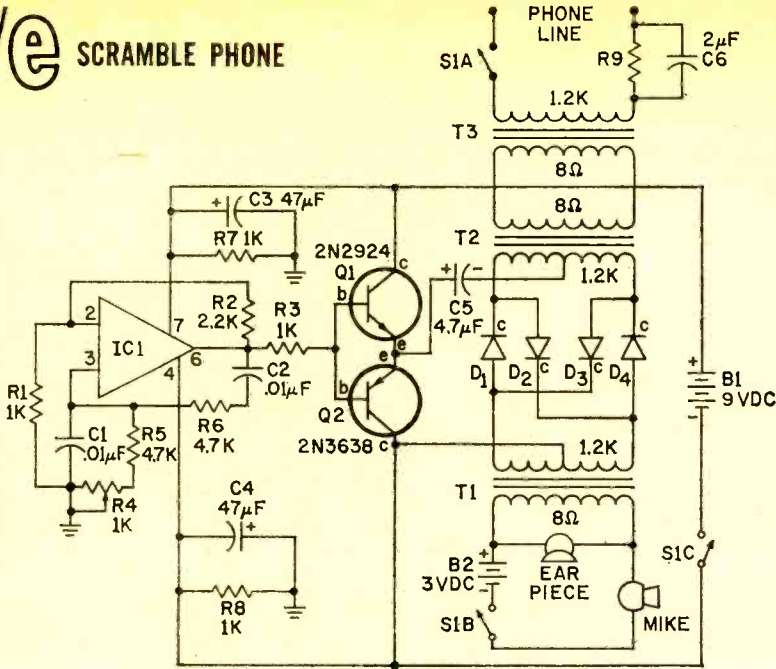

PARTS LIST FOR SCRAMBLE PHONE

- B1—9-volt battery, Eveready 216 or equiv.
 B2—3-volt battery, two AA penlight cells in series
 C1, C2—0.01 μ F polystyrene capacitor, 100 VDC or better
 C3, C4—47 μ F electrolytic capacitor, 25 VDC or better
 C5—4.7 μ F electrolytic capacitor, 25 VDC or better
 C6—2 μ F paper or mylar capacitor, 50 VDC or better
 D1 to D4—Diode, IN914, HEP-156
 IC1—Integrated circuit, Signetics N5741K or equiv.
 Q1—NPN transistor, 2N2924, HEP-724
 Q2—PNP transistor, 2N3638, HEP-716
 R1, R3, R7, R8—1000-ohm, $\frac{1}{2}$ -watt resistor
 R2—2,200-ohm $\frac{1}{2}$ -watt resistor

- R4—1000-ohm potentiometer
 R5, R6—4,700-ohm, $\frac{1}{2}$ -watt resistor
 R9—Limit line current to 25mA (see text)
 S1A, S1B, S1C—Phone hook switch (see text)
 T1 to T3—Small transistor audio transformer; 8-ohm primary, 1,200-ohm center taped secondary.
 Misc.—Surplus telephone (see Lafayette, Radio Shack, EDI, BA catalogs), battery holders, hardware, knob, wire, solder, etc.

An etched and drilled printed circuit board is available for \$4.95 (includes postage and handling). A complete kit of all parts that mount on the PC board, plus the drilled board and R4 are available for \$16.95 (one kit) and \$30.95 (two kits). Add one dollar (Canadians add \$2) for handling when ordering the complete kit(s). Order from KRYSTAL KITS, Box 4232, Little Rock AR 72204.

ers T2 and T3, and on to the telephone network. The only purpose of T3 is to match the impedance offered by most telephone lines.

Trim potentiometer R4 is used to make a fine frequency adjustment of the oscillator so that two scrambler units may be synchronized to the same carrier frequency. Both oscillators must be operating at the same frequency to produce the best decoded speech quality. This control is referred to as the speech *clarity* control.

The best overall carrier frequency range to use for speech scrambling is between 2 kHz and 3.5 kHz.

Listening In. If the scramble phone is to be used for only receiver speech decoding, then only one unit is required. The operation is much the same as for telephone encoder/decoder purposes, with the exception that it is used only as a decoder. The carrier oscillator is made variable so the decoder may be synchronized to the same carrier frequency as is used in the encoder. The output of the receiver is connected to the 8-ohm winding of T2 (T3 is not required for this use) and the decoded information is developed across the 8-ohm winding of T1. A small speaker may be connected across this winding, or a low impedance ear-

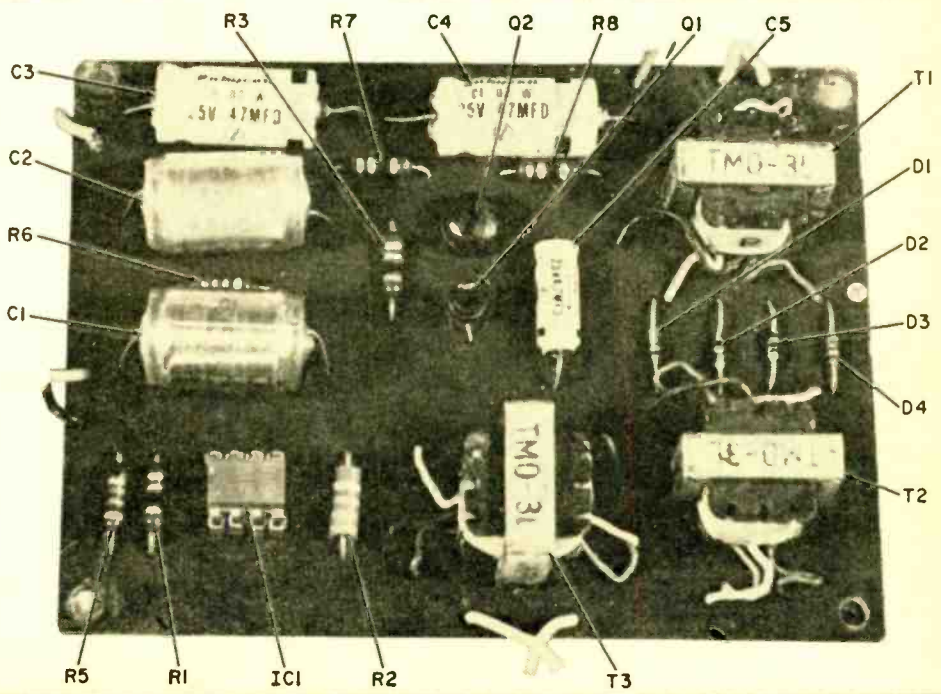
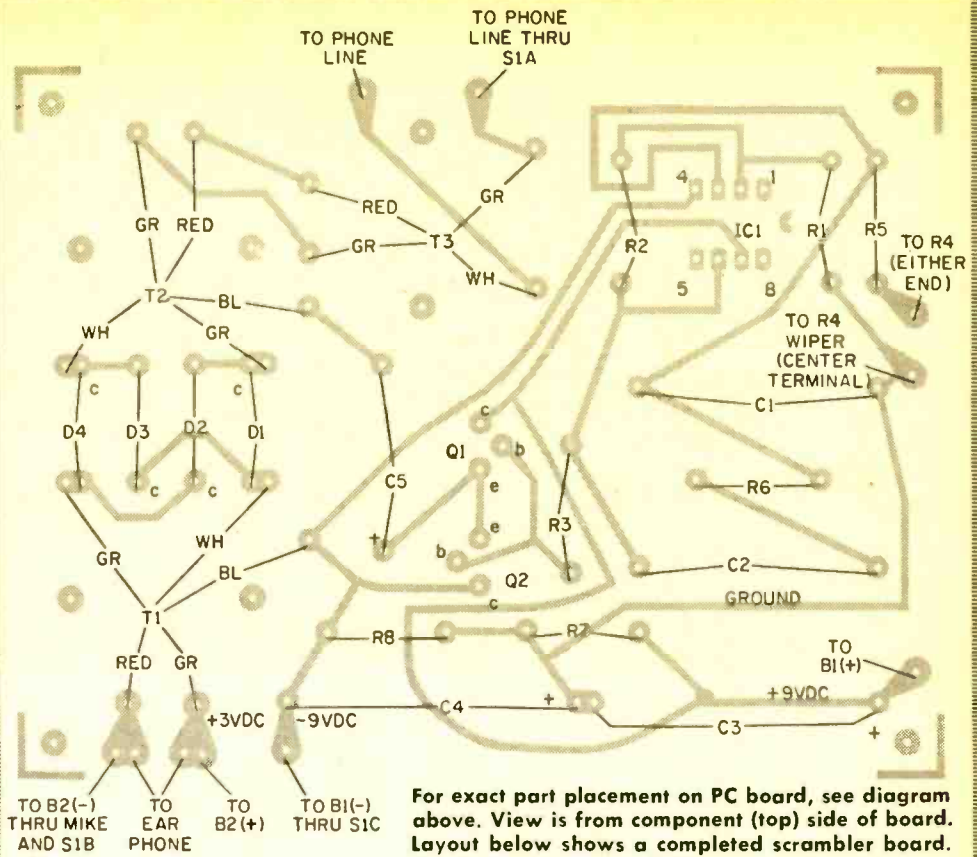

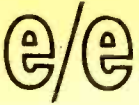

SCRAMBLE PHONE

MODIFICATION 1.

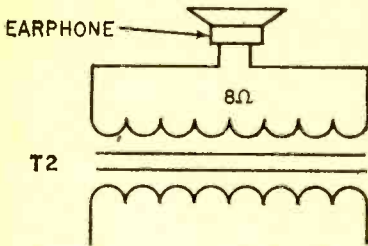

REMOVE T3, ADD EARPHONE

MODIFICATION 2.

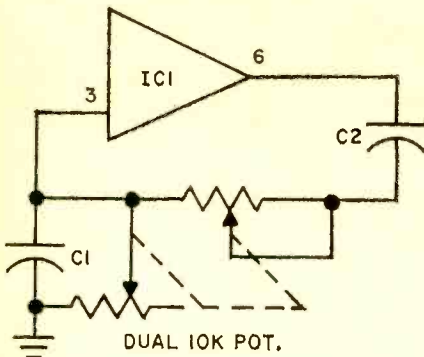

ADD DUAL POT, REMOVE R4, R5 AND R6.

MODIFICATION 3.

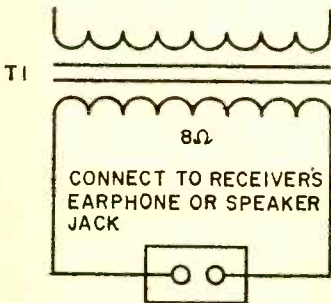

REMOVE PHONE HANDSET AND 3-VOLT BATTERY, ADD TERMINAL STRIP

It is possible to decode some older scrambler systems heard on 2-way radio bands. However, this single inversion mode circuit will not work with multi-inversion systems also in use. Dual pot is Allen-Bradley CJK1N200P103U or equiv.

phone will do for monitoring the decoded speech. No mike or 3-volt battery is necessary for decoding operations.

Putting It Together. The circuit layout isn't critical and any suitable scheme can be followed, but the layout shown for the PC board would be a good one to use. No matter what construction plan is used, PC board or bread board, extra care should be taken when connecting the IC, diodes, and transistors to the circuit. Care should also be taken when connecting the three transformers, so that the low and high impedance windings are not reversed.

The size of the PC board allows the

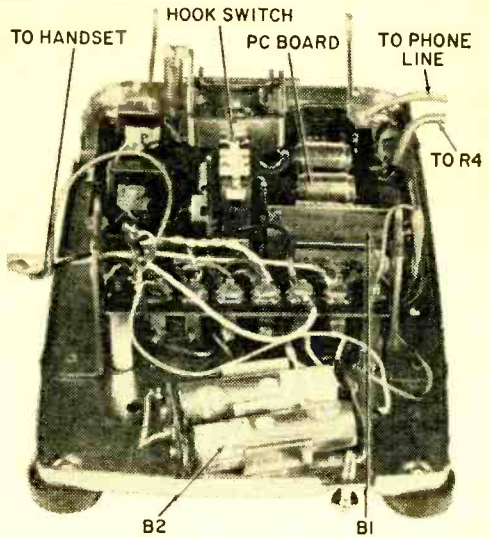

Inside completed Scramble Phone. Surplus phones are available from a number of mail order firms as well as their local stores.

scrambler to be mounted in the base of a standard telephone. All parts located inside the phone, with the exception of the hook switch, can be removed to make the construction job an easy one. Check the pictures when mounting the board and batteries.

In some telephones, the hook switch contains enough switch contacts to function as the three switches, S1A, S1B, and S1C; but if you have one that does not contain enough contacts, a separate switch must be added to switch the battery power. For the scrambler to automatically bridge the telephone line when the handset is off-hook, at least one section of the hook switch must be used for S1A.

If a dial telephone is selected, the dial
(Continued on page 96)



all *NEW*
**BASIC COURSE in
ELECTRICITY &
ELECTRONICS**



ALL ABOUT RESISTANCE

What you will learn. Voltage, current, and resistance are closely related within a circuit. Where you find one, you find the other two. Current cannot flow unless there is voltage. How much will flow is determined by how much voltage and how much resistance are present in the circuit. You will learn what resistance is, what it does, and how it is used.

This series is based on **Basic Electricity/Electronics**, Vol. 1, published by **Howard W. Sams & Co., Inc.**

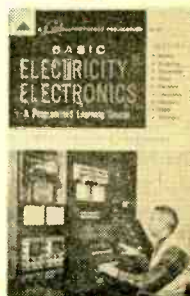

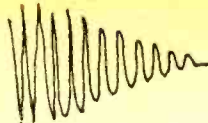
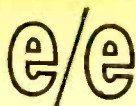
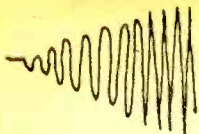

WHAT LIMITS CURRENT FLOW?

You have learned that voltage is a pressure which forces current to flow through a circuit. You also have learned that current has the ability to heat a lamp filament white-hot and thus produce light. But have you ever wondered why a 40-watt lamp produces less light than one rated at 100 watts? After all, the amount of voltage pushing current through both lamps is the same. The answer, of course, is the individual characteristic of each lamp which limits the amount of current that will flow.

The 100-watt lamp glows more brightly because more current is allowed to pass through the filament, heating it to a higher degree, thus causing it to give off more light. Less current is allowed to flow through the 40-watt filament. The reason for the different amount of current through each of the two lamps is an electrical characteristic called *resistance*. Resistance *limits* or *controls* the flow of current.

WHAT IS RESISTANCE?

Resistance is a physical property of all materials and is directly responsible for the amount of current which will flow through a material with a given voltage applied.

Atomic Structure

All matter is made up of invisible particles called *atoms*. There are over 100 different atoms, or *elements*, as the physicist calls them. One of the features that makes one atom different from another is the number of *electrons* each contains. A hydrogen atom has one electron, an oxygen atom has eight, and a uranium atom has 92.

You know that current is a flow of electrons and that electrons are made to move by a voltage. This does not mean that an electron leaves the negative pole of a battery and speeds around the circuit to the positive terminal. Instead, there is a general movement or drift of electrons throughout the complete circuit.

The illustration shows a greatly magnified and exaggerated depiction of a length of wire with four atoms—A, B, C, and D. Actually, in the shortest possible length of a very thin wire there are many millions of atoms.

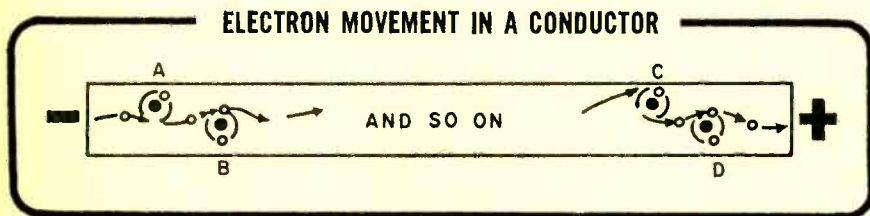

Electron Flow

As shown in the illustration, electrons orbit about the center of an atom. At the instant voltage is applied, two things happen simultaneously—negative voltage at one end of the wire pushes against the electrons, and positive voltage at the other end of the wire pulls them toward that end. In moving, electrons strike other electrons. One electron is bumped out of atom, A, and it in turn pushes another out of atom B. At the positive end, an electron is pulled from

atom D and another leaves atom C to replace it. The atoms of some materials give up their electrons more easily than the atoms of other materials.

Resistance of Materials

There is no perfect conductor. Even the best conductors, such as those having silver or copper atoms, resist the pressure to release electrons. On the other hand, the best insulators have atoms which, under conditions of sufficiently high voltage, give up some electrons. The resistance of a material, then, is *determined by its atomic structure*.

The size of the columns in the illustration shows the comparative resistance of certain materials. Keep in mind that no material is a perfect conductor or a perfect insulator.

Most metals contain atoms that release electrons very easily. These materials, therefore, offer the least resistance to current flow. Insulators have the greatest resistance because their atoms resist the release of electrons. The in-between materials are neither good conductors nor insulators. Among these semi-conductors are the materials from which *transistors* are manufactured.

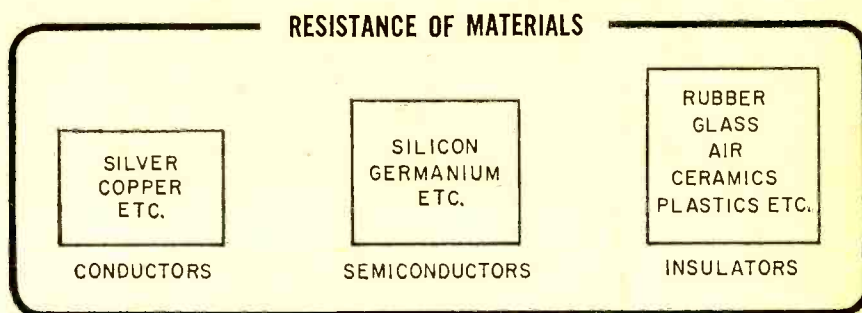

Unit of Measurement

Resistance is measured in *ohms*; the device for conducting such measurement is called an *ohmmeter*. The resistance of a 1.5-volt lamp, for example, is approximately 6 ohms. In other words, the lamp offers 6 ohms of resistance to the electrical pressure of a 1.5-volt cell, and the result is a current flow of 0.25 amp.

- Q1.** What is the difference between a conductor and an insulator?
Q2. The resistance of a material is determined by its - - - - - structure.

Your Answers Should Be:

- A1.** Conductor atoms give up their electrons more easily than insulator atoms.
A2. The resistance of a material is determined by its atomic structure.

Volts, Ohms, and Amperes

Since resistance limits the amount of current that flows and voltage forces an amount to flow, there must be some numerical relationship between them.

You would see current decrease to half its former amount when a second lamp is added in series with the lamp circuit just mentioned. Current is divided by two when resistance is multiplied by two. Mathematicians say, then, that current is inversely proportional to resistance. In other words, *current decreases* by the same amount that *resistance increases*.

You can also discover, by experimenting, what happens to current when voltage

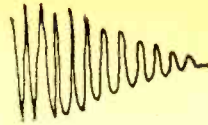
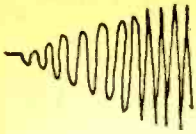

increases. You will find they increase together (they are directly proportional to each other). This makes sense because the pressure of voltage causes current to flow. If the pressure increases, flow increases.

These relationships of voltage and resistance to current can be expressed in an arithmetic statement as:

$$\text{Current in a circuit} = \frac{\text{voltage applied to a circuit}}{\text{resistance of a circuit}}$$

Using mathematical symbols, this statement becomes:

$$I = \frac{E}{R}$$

where,

- I* is the current in amperes,
- E* is the voltage in volts,
- R* is the resistance in ohms.

If voltage (*E*) is increased, current (*I*) will increase. When *E* decreases, *I* also decreases. The relationship between *I* and *R* is just the reverse. A decrease in *R* causes *I* to increase. The larger *R* becomes, the smaller *I* will be. The formula above is known as *Ohm's law*.

TYPES OF RESISTORS

Resistors are classified in two ways: 1) in terms of their construction (wire-wound and composition); 2) in terms of their type or function (fixed, adjustable, variable).

RESISTORS COME IN DIFFERENT SHAPES

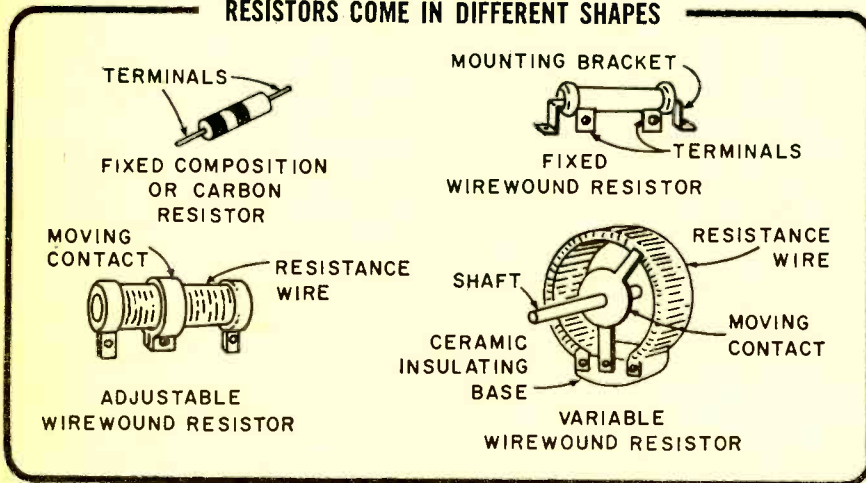

Wirewound resistors are made by wrapping resistance wire around a ceramic or other high-insulation cylinder. The assembly is then covered with enamel glaze and baked. The wire has a known value of ohms per inch. The resistance value desired is then merely a matter of wrapping on the required length of wire.

Composition or Carbon Resistors

Composition or carbon resistors are molded from a paste consisting of carbon (a conducting material) and a filler. Terminal wires (sometimes called *pigtails*) are inserted into the paste before it hardens. The resistor is then covered with a plastic coating. The resistance of a composition resistor is determined by the ingredients (percentage of carbon) and its diameter and length.

Fixed Resistors

A fixed resistor has only one nonvariable ohmic value.

Adjustable Resistors

Adjustable resistors provide a range of resistance within the limits of their total value. When placed in a circuit, the sliding contact can be positioned and secured to accurately provide the required resistance value. This type of resistor is not designed to be continuously variable.

Variable Resistors

Variable resistors are designed for continuous adjustment. A shaft to control the resistance value is usually connected to a knob on the front panel of an electrical or electronic device. The volume control of your radio or TV set is an example.

A rheostat is a variable resistor. The material that the moving contact presses against may be either resistance wire or a carbon mixture.

Typical applications for each kind of resistor are presented below.

- Q3.** Composition resistors are made from a - - - - - and - - - - - mixture.
- Q4.** The control that dims the dashboard lights in an automobile is a(an) - - - - - resistor.
- Q5.** - - - - - and - - - - - resistors are not designed to be continuously variable.

Your Answers Should Be:

- A3.** Composition resistors are made from a carbon and filler mixture.
- A4.** The control that dims the dashboard lights in an automobile is a variable resistor.
- A5.** Fixed and adjustable resistors are not designed to be continuously variable.

RESISTOR APPLICATIONS

Type	Applications
Composition or Carbon	Composition resistors are the least expensive of the types discussed. They are, therefore, the type most widely used. However, composition resistors have certain limitations. They cannot handle large currents, and their measured values may vary as much as 20% from their rated resistance.
Wirewound	Wirewound resistors are more expensive to manufacture. They are used in circuits which carry large currents or in circuits where accurate resistance values are required. Wirewound resistors can be made to within 99% or better of the desired value.

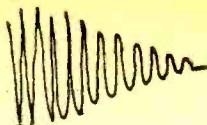
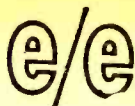
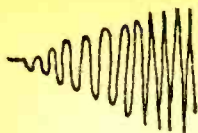

RESISTOR POWER RATINGS

As you already know, current passing through a resistor generates heat. If too much heat is generated, the resistor will be damaged. Wire in the wound resistor will melt and become open, or some of the carbon in the composition resistor will burn away.

The current-carrying capacity of a resistor is rated according to the amount of heat it can safely release in a given period of time. A resistor cannot be used in a circuit where current causes heat to build up faster than the resistor can dissipate it. When such a condition exists, the resistor may become so hot that it will be destroyed. Even if the resistor doesn't melt and become open, the excessive heat may cause a permanent change in its resistance value. In addition, heat from the overloaded resistor may damage other components that are near by.

Since heat is a form of energy, the heat-releasing rate of a resistor is measured in energy units. The unit is a *watt*. A 100-watt lamp dissipates 100 watts of heat. In the process, the lamp also gives off light.

Heat energy depends on the amount of current flowing through a resistor. The arithmetic involved is:

$$\text{Heat energy in watts} = (\text{current in amps})^2 \times (\text{resistance})$$

This means that the number of watts dissipated by a resistor can be found by multiplying the resistance in ohms times the square (a number multiplied by itself) of the current in amperes. The electrical term for heat energy is *power*.

For example, a 10-ohm resistor has three amps flowing through it. What must be its power rating in watts?

$$\text{Power} = (\text{amps})^2 \times (\text{ohms}) = (3)^2 \times (10) = 90 \text{ watts}$$

Composition resistors usually come in power ratings of 1/4 watt, 1/2 watt, 1 watt, and 2 watts. If larger power ratings are required, wirewound resistors are used.

A design engineer determines the value of resistance needed and the amount of current that will flow through it. He then specifies the resistor wattage that must be used. If the value falls between two of the ratings mentioned above, he selects the higher rating.

- Q6. Which of the standard composition-resistor ratings would you select for a resistor of 10 ohms through which 1/10 of an amp flows?
- Q7. A 1-watt wirewound resistor (will, will not) safely carry more current than a 2-watt composition resistor of the same resistance.

Your Answers Should Be:

A6. $\text{Power} = \left(\frac{1}{10}\right)^2 \times 10 = \frac{1}{100} \times 10 = \frac{1}{10} \text{ watt}$

The next highest standard rating is a 1/4-watt resistor.

- A7. A 1-watt wirewound resistor will not safely carry more current than a 2-watt composition resistor of the same resistance.

RESISTOR TOLERANCE

As mentioned previously, a resistor will rarely measure the exact number

of ohms specified by its label. The amount it will vary is called *tolerance*. Every resistor has a tolerance rating.

Resistor tolerance is given as a *percentage value* which indicates the amount that a resistor may vary above or below its labeled value. Standard tolerances for composition resistors are 5%, 10%, and 20%. Wirewound resistors may have tolerances as low as 1 or 2 percent.

Try a 1000-ohm, 10% tolerance resistor as an example. Ten percent of 1000 is 100 ohms. The tolerance factor thus indicates this resistor will measure somewhere between 100 ohms above and 100 ohms below the labeled value of 1000 ohms. This is a range from 900 to 1100 ohms. The same resistor with a 20% tolerance will have a true ohmic value somewhere between 800 and 1200 ohms.

If you have trouble working with percentages, here is another way of computing tolerance:

$$\text{Resistance variation} = \frac{\text{resistance} \times \text{tolerance}}{100}$$

The answer will be the number of ohms the resistor may vary above and below its labeled value. For example:

$$\text{Resistance variations} = \frac{2000 \text{ ohms} \times 10}{100} = \frac{20,000}{100} = 200 \text{ ohms}$$

A 2000-ohm resistor with a 10% tolerance may vary as much as 200 ohms above or below—1800 to 2200 ohms.

Resistor tolerance is not an indication of poor manufacturing. Closer tolerances can be achieved, but at greater expense. As you will discover, for a given ohmic value a 20% tolerance resistor costs less than one rated at 10%. And a 10% tolerance resistor is less expensive than one rated at 5%.

Required resistor tolerance depends on circuit design. If current flow must be controlled within very close limits, the engineer specifies a 1% resistor. On the other hand, a 20% tolerance is satisfactory for circuits which have less critical operating requirements. Your radio or television set, for example, has more 20% resistors than all the other tolerances combined.

RESISTOR COLOR CODES

Wirewound resistors normally have their value in ohms and tolerance in percent stamped on them. For carbon or composition resistors a *color code* is used.

For several years, resistance values have been coded by three colored bands painted around the body of the resistor. If the tolerance is either 5% or 10%, a fourth color band is added. Position of the band is shown in the drawing.

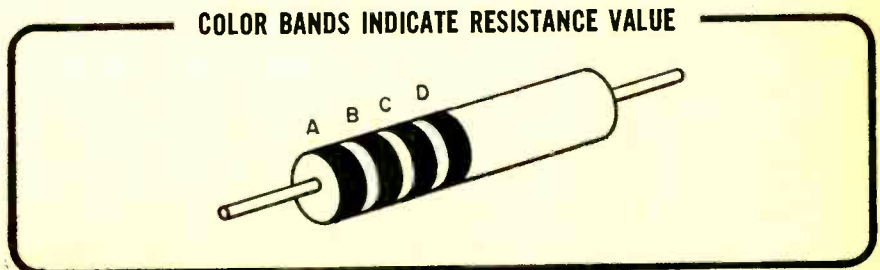

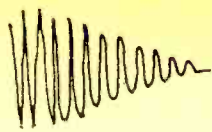
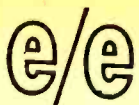
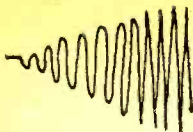

Colors and Numbers

Each of the colors represents one of the ten digits—0 through 9.

Color	Number	Color	Number
Black	0	Green	5
Brown	1	Blue	6
Red	2	Violet	7
Orange	3	Gray	8
Yellow	4	White	9

The order of reading the bands is from the end toward the middle.

The first two colors (A and B in the illustration) indicate the first two digits in the resistance value. The third band (C) indicates the number of zeros that follow the first two digits. Sometimes a fourth band (D) is present. This band indicates tolerance and will be either gold or silver. A gold band denotes 5% tolerance, silver 10%, and no fourth band 20%. Here is an example in reading the first three bands:

Band	A	B	C
Color	Blue	Red	Orange
Numbers	6	2	3 zeroes

The blue-red-orange bands signify 62 followed by three zeroes and would be read as 62,000 ohms. Another example:

Band	A	B	C
Color	Violet	Green	Red
Numbers	7	5	2 zeroes

Digits seven and five are to be followed by two zeroes. Combined to form a number, they read 7500 ohms. Though rare, you may find a resistor with the following colors:

Band	A	B	C
Color	Violet	Green	Black

The resistance value is not 750 ohms. The third band specifies the number of zeroes. Black decoded is zero. So there are *no* zeroes after the first two digits, indicating a value of 75 ohms.

If black appears as the second color, it is read as a digit. Brown-black-red, for example, reveals that the composition resistor has a value of 1000 ohms.

Q8. The color bands are read from the - - - toward the - - - - - of a resistor.

- Q9. The first two bands are decoded as - - - - - .
 Q10. The third band indicates the number of - - - - - .
 Q11. Decode brown-black-green.
 Q12. Decode blue-red-red.
 Q13. What is the color code for a 10k resistor?
 Q14. Decode orange-green-brown-silver.

Your Answers Should Be:

- A8. The color bands are read from the end toward the middle of a resistor.
 A9. The first two bands are decoded as digits.
 A10. The third band indicates the number of zeroes.
 A11. Brown-black-green decoded is 1,000,000 ohms.
 A12. Blue-red-red decoded is 6200 ohms.
 A13. Brown-black-orange.
 A14. 350 ohms, 10% tolerance.

RESISTOR CONNECTIONS AND CIRCUITS

There are only three different ways in which electrical or electronic parts may be connected—*series*, *parallel*, and *series-parallel*.

The illustration shows the three different connections and also the accepted method for labeling components. R stands for resistor; E designates a voltage source. Numbers are used with the letters to identify a specific component.

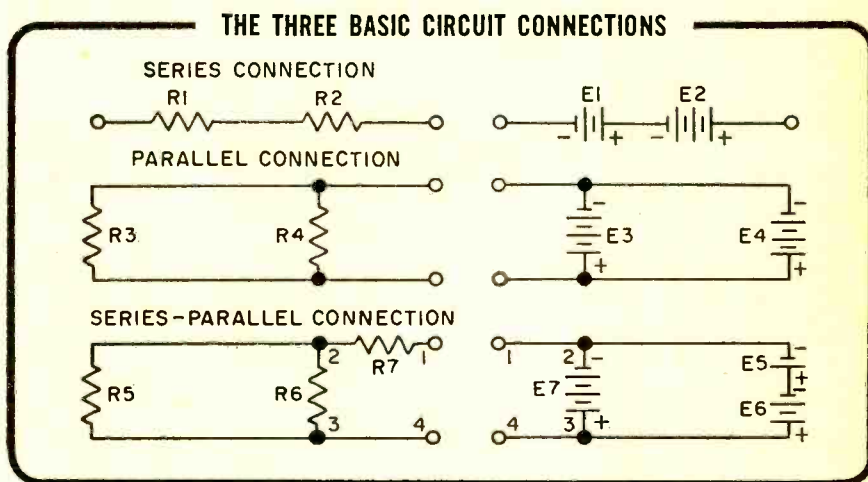

Series Connection

The first figure in the illustration shows components in series. A terminal of one component is connected to a terminal of the other. Since they are connected together in a line, R₁ is in series with R₂. Voltage sources may also be series-connected. E₁ is in series with E₂.

Parallel Connection

The second figure shows components connected in parallel. Each terminal of one component is connected to a terminal of the other. The connections are called *common terminal points*. R₃ is in parallel with R₄; E₃ is in parallel with E₄. In parallel, one component is connected *across* the other.

Series-Parallel Connection

As the third figure shows, series and parallel connections are combined to form a series-parallel arrangement. Two different combinations are illustrated. R₇ is in series with the parallel combination of R₅ and R₆. E₇ is in parallel with the series combination of E₅ and E₆.

SERIES CIRCUITS

If all the components in a circuit are connected one after the other, it is called a *series circuit*. By circuit tracing, you can determine that in the circuit shown, the same current that leaves E_1 flows through the lamp, the ammeter, R_2 , R_1 , and returns to E_1 again. Therefore, the circuit must be a series type.

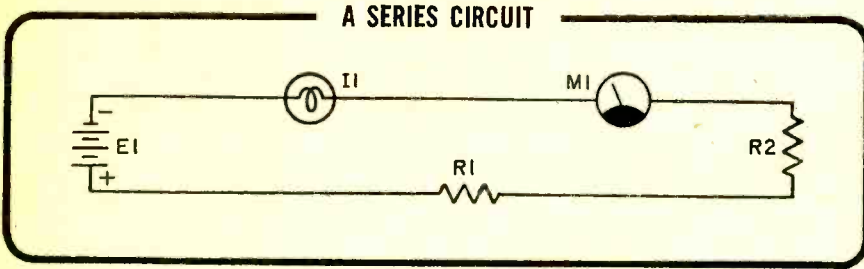

Current in a Series Circuit

It can be proved that the value of current remains the same in all parts of a series circuit by constructing the circuit shown in the next illustration. Fahnestock clips are used as terminal connections.

If the current is measured by connecting the ammeter as shown, the reading should be between 1.6 and 1.7 milliamps. This is the value of the current entering terminal 5.

Connecting the ammeter in series with the two resistors at terminal 4, another reading may be taken. Remember, an ammeter must *always be in series* with the circuit in which current is being measured. In this case, T4 is disconnected and each resistor terminal reconnected to one of the ammeter clips. The same results will be obtained at terminals T3, T2, and T1.

Resistance in a Series Circuit

Total resistance in a series circuit is equal to the *sum of the resistance* of its parts.

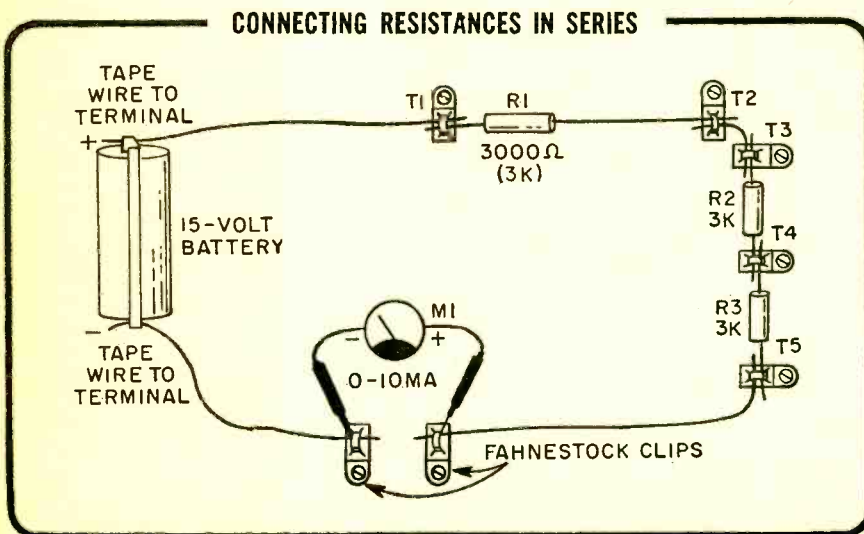

This is logical, because the total resistance in the circuit determines the amount of current allowed to flow with a given voltage source. Therefore, to find the total resistance in a circuit, add the values of the individual resistances.

In the circuit shown, the resistances are 3000 ohms each. Their sum is 9000 ohms. The ammeter also adds resistance in series. But since this resistance is normally less than 1 ohm, it adds so very little to the total that it can be disregarded.

Q15. In a series circuit, all of the parts are connected in - - - - - .

Q16. R_1 and R_2 are connected in series. Their values are 3000 ohms and 1500 ohms, respectively. If current through R_1 is 2 milliamps, what is the value of current flowing through R_2 ?

Q17. Draw a schematic of the three resistors as they are connected in the above diagram. Show how an ohmmeter (schematic symbol) would be connected to read total resistance of the three.

Q18. If the ohmmeter measures 9000 ohms, how much current will flow if the three resistances are connected across a 15-volt battery?

Your Answers Should Be:

A15. In a series circuit, all of the parts are connected in series.

A16. Current through R_2 is also 2 milliamps. (Current through all parts of a series circuit is the same).

A17.

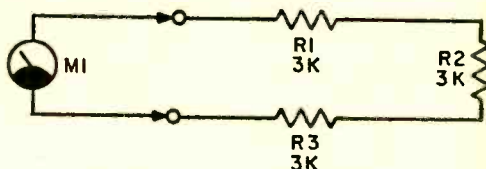

A18. Current = $\frac{\text{voltage applied}}{\text{total resistance}} = \frac{9000}{15} = 0.00167 \text{ amp, or } 1.67 \text{ milliamps}$

Voltage Distribution in a Series Circuit

The voltage of a source is distributed *across and within* any load connected to it. Though this is a simple statement, the concept is often misunderstood.

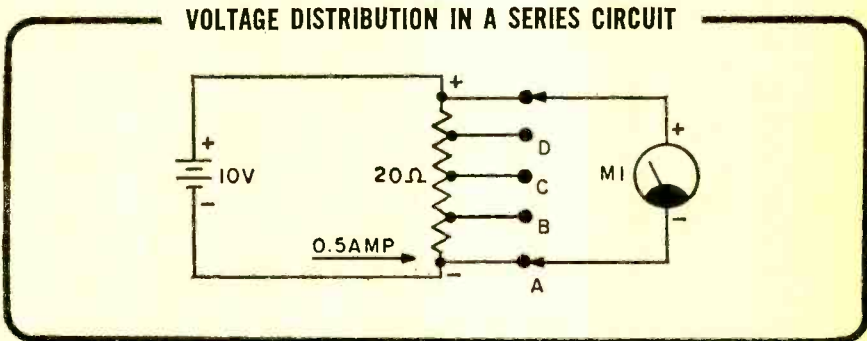

If a 20-ohm resistor is connected across a 10-volt source, as shown in the illustration, a voltmeter reading across the resistor will be 10 volts. This means that the voltage of the source is not only applied *across* the load, but it also exists *within* it.

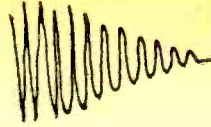
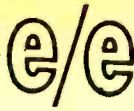
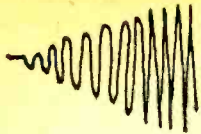

The *taps* (connections) shown are equal distances apart. If the lower test probe is moved to tap B, the voltmeter will be across $\frac{3}{4}$ of the resistor. And $\frac{3}{4}$ of the total voltage is 7.5 volts. Half the resistance (between C and E) will result in a measurement of 5 volts. From D to E is $\frac{1}{4}$ of the resistance and $\frac{1}{4}$ of the voltage, or 2.5 volts.

Can voltage distribution be estimated without making the measurements? Yes, and the reason is based on the familiar relationship that exists between voltage, current, and resistance:

$$\frac{\text{Voltage}}{\text{Current}} = \text{Resistance} \quad \text{or} \quad I = \frac{E}{R}$$

If you do not know the value of voltage applied across a resistance of 20 ohms, but you do know the current through it is 0.5 amperes, how would you determine the voltage? You can find the value of voltage by reasoning that E/R must be a ratio that equals $\frac{1}{2}$. Since R is 20, E would have to be 10 volts. Or you can restate the relationship to read $E = IR$, meaning current multiplied by resistance. To prove that it is the same equality, $\frac{1}{2}$ amp times 20 ohms does equal 10 volts.

Voltage developed across a resistance is termed an *IR drop*, or, substituting E for IR , it may be called a *voltage drop*. This does not indicate voltage has been lost. Instead, it identifies the amount of voltage existing between two points of a resistance when current is flowing.

The IR (or voltage) drop between points A and E in the illustration is 10 volts. IR equals 10 volts. What is the voltage (IR drop) between taps A and B? I is still 0.5 amp. but the value of R is different. It is $\frac{1}{4}$ of the total resistance or 5 ohms. Therefore, $E = IR = 0.5 \times 5 = 2.5$ volts.

- Q19. What is the value of voltage between taps A and C?
- Q20. What is the voltage drop between taps B and E?
- Q21. What is the IR drop between taps B and D?
- Q22. The sum of the resistances in a series circuit is equal to the total ----- of the load.
- Q23. The sum of the ----- in a series circuit is equal to the total voltage across the load.

Your Answers Should Be:

- A19. 5 volts between taps A and C.
- A20. 7.5 volts between taps B and E.
- A21. 5 volts between taps B and D.
- A22. The sum of the resistances in a series circuit is equal to the total resistance of the load.
- A23. The sum of the voltage drops in a series circuit is equal to the total voltage across the load.

PARALLEL CIRCUITS

If all the components are connected across each other, the circuit is a *parallel circuit*. In the example shown, the components are all connected to the same terminal (a wire in this case) and are therefore in parallel.

Polarity across each component is determined by circuit tracing. The terminal that current enters is negative.

A PARALLEL CIRCUIT

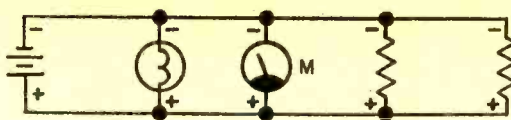

Voltage Distribution in a Parallel Circuit

Each component (the lamp, the voltmeter, and each resistor) is connected across the voltage source. Thus, the voltage drop across each part is the same value as the source. This is true even though the resistance of each component may be different.

Current in a Parallel Circuit

Each component in a parallel circuit draws its own separate current. Each leg is connected directly to the voltage source, which means each leg can be considered as a separate circuit to determine its current.

In the diagram, two equal resistors are shown as being in parallel across a single voltage source.

TWO EQUAL RESISTANCES IN PARALLEL

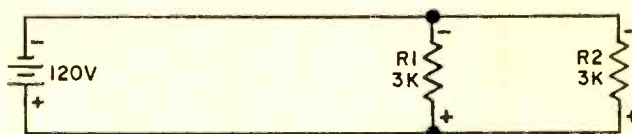

To find the current through R_1 , divide the voltage across the resistor by the value of R_1 . The result of this calculation is 0.04 amp. Since both resistances are equal and have the same voltage source, the current through R_2 must also be 0.04 amp. Both currents are supplied by the same voltage source, so the total current drawn must be 0.08 amp.

TWO UNEQUAL RESISTANCES IN PARALLEL

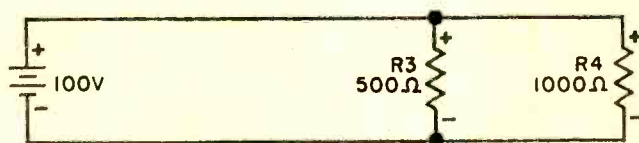

Using the same reasoning ($I = E/R$), it will be found that the current through R_3 in the above circuit is 0.2 amp. The current through R_4 is 0.1 amps. The total current is 0.3 amp.

- Q24. In a parallel circuit, voltage across each leg is (the same as, different from) the voltage at the source.
- Q25. In a series circuit, voltage across each resistor is (the same as, different from) the source voltage.
- Q26. In a parallel circuit, total current is the (same as, sum of) currents in each leg.
- Q27. In a series circuit, total current is the (same as, sum of)

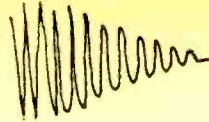
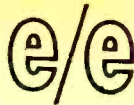
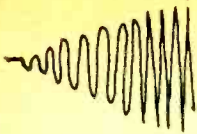

currents in each resistance.

Q28. R_1 (20 ohms), R_2 (40 ohms), and R_3 (60 ohms) are in parallel across a 12-volt DC source. Draw the schematic.

Q29. Find the total current and the current in each leg.

Your Answers Should Be:

A24. In a parallel circuit, voltage across each leg is the same as the source.

A25. In a series circuit, voltage across each resistor is different from the source.

A26. In a parallel circuit, total current is the sum of currents in each leg.

A27. In a series circuit, total current is the same as currents in each resistance.

A28.

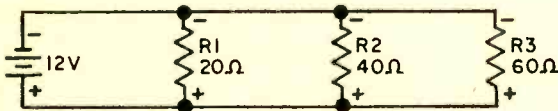

A29. I in $R_1 = 0.6$ amp. I in $R_2 = 0.3$ amp. I in R_3 equals 0.2 amp. Total I = 1.1 amps.

Resistance in a Parallel Circuit

How would you find the total resistance in the parallel circuit you drew in A28 above?

At this point you have used two of the three arithmetic statements that express the relationship existing between voltage, current, and resistance. To find current:

$$I = \frac{E}{R}, \text{ or current} = \frac{\text{voltage}}{\text{resistance}}$$

To find voltage:

$$E = IR, \text{ or voltage} = \text{current} \times \text{resistance}$$

The third way the relationship can be stated is:

$$R = \frac{I}{E}, \text{ or resistance} = \frac{\text{voltage}}{\text{current}}$$

You know the total voltage across the circuit (12 volts), and you found the total current through the circuit (1.1 amps). What is the total resistance of the circuit? Using the resistance formula above, the answer is approximately 10.9 ohms.

As you suspected, total resistance is smaller than the smallest resistance in the parallel network. Total current is the sum of the parallel currents and is therefore an amount that can flow only if the total resistance is smaller than that in any of the legs.

Total resistance cannot be found by adding the values of the individual resistance. The sum would be a resistance much larger than any one of the resistances. This would mean the total current would be smaller than any of the leg currents. Obviously, such a solution cannot be correct. For those who like to work with numbers, total resistance can be obtained by adding reciprocals.

$$\frac{1}{R_T} = \frac{1}{R_1} + \frac{1}{R_2} + \frac{1}{R_3} + \text{etc.}$$

The electrical wiring in your home consists of parallel circuits. This includes the ceiling fixtures, wall outlets, and whatever else is energized electrically. Each parallel circuit is fused. If you plug one too many appliances into a circuit, the fuse blows. You have just learned the reason why. You added one more resistive path that draws current. As a consequence, total current increased beyond the capacity of the fuse, and it performed its job.

Comparisons between series and parallel circuits are shown below:

	Series Circuit	Parallel Circuit
Voltage	Divides across resistances	Same voltage across all resistances
Current Total	Same current through all resistances	Divides through each resistance
Total Resistance	Sum of all the individual resistances	Less than the smallest Resistance

WHAT YOU HAVE LEARNED

1. Resistance is a property of all materials which limits the flow of current.
2. Conductors have a low resistance; insulators have a high resistance.
3. Since voltage causes a certain amount of current to flow and resistance limits the amount that will flow, there is a special relationship between current, voltage, and resistance. This relationship is expressed by the following:

$$I = \frac{E}{R}, \text{ or current} = \frac{\text{voltage}}{\text{resistance}}$$

$$R = \frac{E}{I}, \text{ or resistance} = \frac{\text{voltage}}{\text{current}}$$

$$E = IR, \text{ or voltage} = \text{current} \times \text{resistance}$$

4. The unit of resistance is the ohm. The value of resistance in ohms can be measured with an ohmmeter.
5. Current flowing through a resistance generates heat.
6. Resistors are designated by construction (wirewound or composition) and by intended use (fixed, adjustable, or variable).
7. Resistances are rated by their heat-dissipating capability in terms of watts.
8. Resistor tolerance is given as a percentage value which indicates the amount a resistor may vary above or below the labeled value.
9. Four characteristics of any resistor are type, value, tolerance, and power rating.
10. Wirewound resistors have their value and tolerance stamped on the body. Composition resistors are read by decoding colored bands painted around the body of the resistors.

This series is based on material appearing in Vol. 1 of the 5-volume set, BASIC ELECTRICITY/ELECTRONICS, published by Howard W. Sams & Co., Inc. @ \$22.50. For information on the complete set, write the publisher at 4300 West 62nd St., Indianapolis, Ind. 46268.

Scramble Phone

Continued from page 78

may easily be removed and replaced with a metal or plastic plate. The *clarity* potentiometer can be mounted at any convenient location on the phone's base plate, but be very careful not to let any component interfere with the operation of the hook switch.

Scrambling A Phone. Connect the two scramble phones together (phone line outputs-connected to each other) but separated by at least twenty feet. Lift either of the hand sets and you should hear a low level tone; talk into the mike and you should hear your own unscrambled voice in the ear piece. This reception of your own voice is normal and occurs when using a standard telephone; it is called the *sidetone*.

Have a friend or another member of your family talk over the scramble phone. If your reception isn't clear or sounds like Donald Duck, adjust the *clarity* control for the best voice quality. This simply puts the two oscillators on the same frequency.

Scrambler Hook-Up. This job is a simple one. All that's required is to parallel the output of transformer T3 with the telephone lines. But before doing so, make the following tests. If you are in doubt about which two wires on the telephone terminal block are the telephone circuit, take a DC volt meter and check between pairs until 24 to 48 volts is measured. This test must be per-

formed with the telephone on hook. The second important check to make before connecting the scrambler phone determines the line current. This test is made as follows. Set the VOM to measure DC current on the 50 or 100mA range, and place the meter in *series* with a lead from the high (1.2 K) impedance winding of T3. Pick up the phone. If the circuit current is greater than 25mA, then the resistor/capacitor network C6 and R9 must be added in series with the scrambler phone and the telephone circuit. This should reduce the circuit current to a value close to 25mA, but if not, adjust the value of R9 (start with a 1000-ohm, 1/2-watt resistor) until this current value is reached.

Security Link-Up. After connecting one of the scrambler phones at your location and another at the home of a friend, dial his number with your standard telephone. When the party answers and agrees to go to the scrambler mode, pick up your scramble phone, and have your friend do the same. You can now continue your conversation in complete secrecy. If either of the scrambler oscillators should drift in frequency, just set the *clarity* pot for the best voice quality.

Scrambled Signal Decoding. If you desire to use the ELEMENTARY ELECTRONICS scrambler for receiver speech decoding only, then make the modifications shown. Basically, the resistors, R4, R5, and R6 are removed and replaced with a 10K dual pot to allow the IC oscillator to be tuned over a wide frequency range. Connect the input of

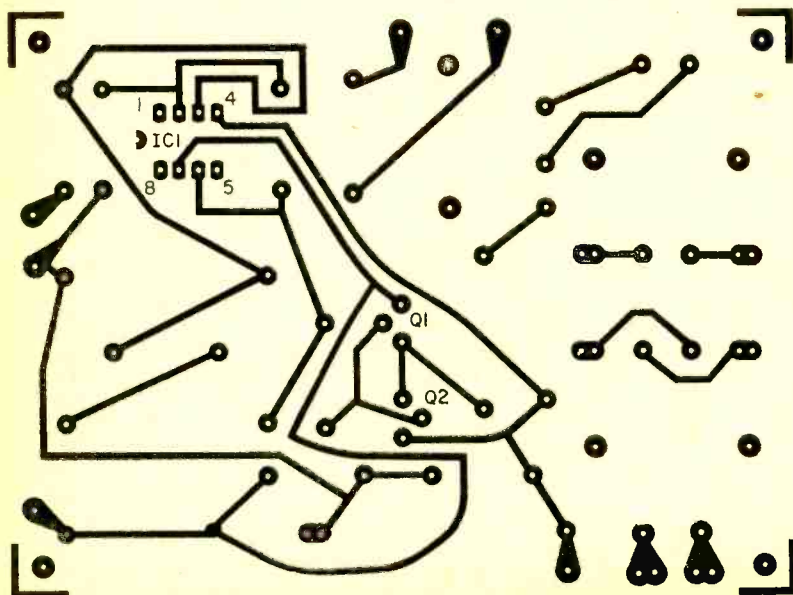

Exact PC board size. Transfer image to copper clad board using a piece of carbon paper. This is the bottom (copper) side of your scrambler board.

T1 to the output of your radio receiver and a small speaker or earphone to the output of T2. Transformer T3 is not required for speech decoding; it can be removed.

Tune the receiver to a station that is using the single inversion mode of speech scrambling, and adjust the oscillator's frequency slowly until the speech begins to sound normal. Even when the scrambled information is decoded, the quality will not be up to hi-fi standards. But if you are able to understand every word spoken, then you're right up town with the troops! Lots of luck—and remember to hang up all four phones when you're through. ■

NewScan

Continued from page 74

run on nonleaded 91 octane fuel, the engine develops 185 horsepower at 4000 rpm.

The 4000-pound (plus or minus 200) weight limit imposed by the government's ESV specifications was not achieved, although General Motors engineers in several instances used special higher strength-to-weight materials than those in current production passenger cars. Over 1000 pounds of aluminum were used. The vehicle weighs 4700 pounds.

One unusual feature was the removal of pillars at either side of the windshield, improving driver vision and reducing the hazard of unrestrained occupants hitting a structural pillar. The ESV has about 10 per cent more glass than a typical current production sedan to provide improved vision.

The ESV's interior has a 30/50 occupant protection system. The design objective is to protect unbelted dummy occupants in 30-mph barrier impacts, without deploying special safety devices. To attain the survivability objectives



This cutaway view shows some of the features of General Motors' ESV. Engineering innovations include increased use of weight saving aluminum in both engine and body components, 10-mile-per hour barrier impact front and rear bumper energy absorbers capable of a 9-inch stroke, the "credenza" or cross-body structure in front of rear-seat passengers and pillarless front upper body design.

in 50-mph barrier impacts without belts or other devices, the air cushion approach is used. The air cushions are included since they are the only experimental device known to approach the performance specifications established by DOT. To achieve the 30-mph barrier performance considerable padding was required and in front of the rear seat passengers a cross-car structure or "credenza" was added. It resembles a counter top in front of and extending over the laps of rear seat passengers.

GM's approach represents an effort to accomplish the objectives in a completely new vehicle, conventional in most respects and designed along the lines of current automotive practice. It is not possible to determine whether or not this arbitrary approach imposed constraints on the performance of the design. It is obvious, however, that there are many questions of practicability that are not resolved by their program.



CB Coffee Break

Continued from page 62

As a general rule, except for some hand-held receivers the low cost models all have squelch controls so you are not bothered by a grinding noise level when there are no signals being received.

Clean Sweep. Obviously, a manually tuned or crystal controlled receiver can only monitor one channel or frequency at a time. If you want to keep on top of all the action going on you can upgrade to a scanner. A scanner is a crystal controlled receiver with provision for between 6 and 10 different frequencies. An internal sweeping circuit constantly switches the crystals in and out, taking from 1/2 second to about 5

seconds to "check" all frequencies. The audio output is squelched as the frequencies are swept. Almost at the instant a frequency is used—when a signal appears on the channel—the sweeper locks onto the signal and it is heard. When the signal goes off the scanner resumes its sweep. Each crystal has its own on-off switch so that any crystal can be turned off; for example, if you have an eight position scanner and six crystals are off the scanner would sweep back and forth between the remaining two crystals.

Scanners can, of course, be locked onto a particular frequency, the same as done by a manually tuned receiver. Depending on the particular model, you can either turn off all crystals except the desired one, or switch to the *manual scan mode*, where you change channels by pressing a button or touch-bar. You simply press the button until the crystal you want to use has its signal lamp illuminated; the receiver will remain on this crystal until you again press the touchbar or set the unit to automatic scanning.

Mix Them Up. Another big plus for scanners is that they usually can intermix two bands, usually the low and high band, though a model is available that intermixes any two of the three public service bands. You simply plug the crystal into sockets corresponding for the particular band; the scanner automatically switches the tuner or tuning along with the crystals. For example, your scanner might have four low-band and five high-band crystals. The scanner will automatically scan each crystal in turn, jumping from band-to-band with no need for you to manually switch from band-to-band. ■

Super SCA Adaptor

Continued from page 68

sulting in high frequency noise.

Change C12 and C14 to 0.05 uF.

☞ *If your problem is background breakthrough from the main program.*

This problem is caused by clipping (white lines on waveform A). Simply change C1 and C9 to approximately 300 pf. This will attenuate the subcarrier and clean up the breakthrough on very strong signals, though very weak signals may get lost (well you can't win or hear em all!).

A second and simple corrective procedure is to put a 100,000-ohm resistor in series with the input from the FM radio. This effectively cuts down on the input signal to eliminate overload.

☞ *If your problem is an inoperative adaptor (even after you've checked*

Kathi Assembles Discone

Continued from page 48

Fun City Ghosts. Though the Discone did cover the TV channels we experienced severe picture ghosting—as would be expected from an omni-directional antenna—because Kathi's home is squeezed between the tall buildings of New York City, and those buildings cause plenty of ghosts on even directional TV antennas.

But for FM and the public service bands the Discone is, as Kathi said, "From Wowsville". Even the price is from "Wowsville," at only \$12.95 complete except for mast and transmission line.

One hassle you might have is trying to simultaneously connect two or more receivers to the Discone's transmission line. One receiver's input will act as a *short* on the second receiver. For multiple receiver connections we suggest you use a *Hustler Monitor Match*, an isolation device that permits simultaneous connection of an FM radio or receiver and up to three monitor receivers. Naturally, the matching device causes a slight loss in signal strength, but not enough to make any important difference in overall performance.

For additional information circle No. 50 on Reader Service Coupon on Page 17 or 103. ■

components, made sure power supply polarity and receiver connection are correct), you must determine at what point in the circuit your signal is at fault or is lost.

The three oscilloscope traces show what you can expect to get if you are tuned to an SCA station. Photo B is the input, IC1 pin 2; note the presence of a 67 kHz carrier. Photo C is IC1 pin 6; note the very strong 67 kHz carrier. Photo D is IC2 pin 9, the phase lock detector's voltage controlled oscillator triangular wave output.

If you don't get photo B, the trouble is the connection between the tuner and the adaptor. If you get photo B but not photo C, the trouble is in the IC1 circuit. If you get photo C but not photo D, the trouble is in IC2.

If you don't get photos C and D, there is most likely a major fault in the assembly; we have specifically designed the adaptor so a defective IC cannot disable another IC. ■

Laser

(Continued from page 46)

communication. Atmospheric temperature variations can also cause the beam to wander off the receiver target; however, such beam wandering can be minimized by use of a simple, large lens.

On the Beam. The best time to line up the transmitter and receiver is at night when the red spot is easy to see. In the daytime, locate the distant spot by keeping it on a cardboard as you walk from the transmitter toward the receiver position. If you wish to use the communicator in other than a single, fixed position during the daytime—and especially over rough terrain where tracking the beam with a cardboard screen would be impossible—consider adding a sighting scope of the type used to put astronomic telescopes on target. Calibrate the scope at night for various distances up

to the range of the communicator.

For more information about the Metrologic's many different types of lasers and accessory equipment, including collimating optics circle No. 58 on Reader Service Coupon on page 17 or 103. ■

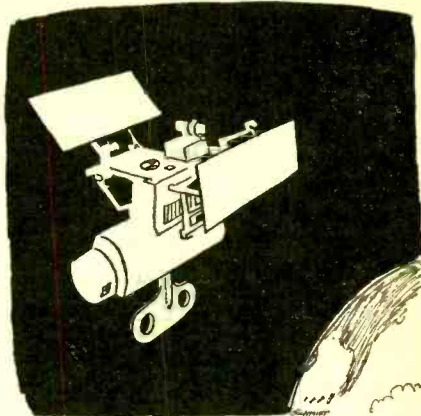

DX Central Reporting

(Continued from page 29)

then beat a hasty retreat, claiming it was actually another Pacific station he'd logged. Needless to say, his reputation wasn't particularly enhanced by this double shuffle.

Once it was established that there was no Nibi Nibi, the hunt began for the perpetrator. Eventually the report was traced to a 16-year-old California SWL. The "beautiful, fabulous Nibi Nibi land," it appeared, was inspired by an earlier satire in a popular humor magazine.

But there was nothing funny about the hoax to those who'd been taken in by it, even if only briefly. It may have started as a joke, but it ended with irate editorials in DX club bulletins.

Maybe SWLs were more naive then. Maybe it was a symptom of the times, the late '50's that sociologists are so fond of studying. Whatever the reason, the reaction to Nibi Nibi was extreme, but more recent hoaxes, such as *Radio Amundsen*, are shrugged off.

The young Californian who dreamed up *Nibi Nibi Radio* was banished from DX clubs, virtually ridden out of the hobby on a rail. Probably not one in a thousand remembers his name today, but Nibi Nibi remains in the DX lexicon as a synonym for hoax. Such is the stuff of legends!

Bandsweep. (Frequencies in kHz, times in GMT) **1540**—ZNS-1, Nassau, Bahamas, may be an easier medium wave catch for some these days. The usual interference, Iowa's *KXEL* is off the air during the pre-dawn hours on Mon-

days. . . . **5,000**—Let's focus our shortwave attention this month on the stations of southern Asia. *WWV* and other standard time stations permanently occupy this frequency, but if you should hear wierd oriental music filtering through the tick-tocks, chances are it is the rare *Radio Nepal*. Time to try is early a.m.'s, naturally. . . . **9,775**—And *Radio Pakistan* can be logged here with an English language newscast to Europe at 2000 GMT. . . . **11,750**—The British Broadcasting Corporation's relay station at Tabrau, Malaysia also can be heard with English programming. Try for this one around 1500. . . . **15,120**—The 19-meter band is radio-active territory for Asian stations these days. Popular U.S. music and some English announcements can be heard from Ceylon's *CBC* around 0030 hours. . . . **15,265**—Swinging up the dial, an exotic catch is *Radio Afghanistan* at Kabul. If *Radio Prague* doesn't cause too much QRM, you may log this one with an English news program at 1800. . . . **15,310**—An opportunity to hear *All India Radio*, Delhi, transmitting news in English may be found around 0130 GMT. . . . **15,520**—The newest of Asian nations is Bangladesh, the former East Pakistan. Dacca's *Radio Bangladesh* has an overseas service, partly in English, beginning at 0230. Try for this one.

(Credits: Robert Zilmer, Wisconsin; Jon Fay, Massachusetts; Larry Magne, Pennsylvania; David Oliphant, Alberta, Canada; J. R. Mappin, Washington; Bob Bundy, Truk, Pacific Ocean; International Radio Club of America, 6059 Essex St., Riverside, California 92504; SPEEDX, P.O. Box 321, Santa Ana, California 92702)

(Continued on the next page)

Backtalk. Bob Park of Vancouver, British Columbia writes that he recently decided to specialize on the low frequency shortwave tropical bands, particularly 60 meters. Between about 4,750 and 5,050 kHz, Bob notes, there is a "veritable gold mine of small, more-or-less local coverage stations."

"But try and catch the call letters as they're rolled out in highball Spanish! A letter B, or C, or D, or T, all sound the same."

Maybe this will help, Bob. In Spanish, the alphabet sounds like this: AH, BEH, SEH, DEH, EH, EH-feh, HEH, AH-cheh, EE, HO-tah, CAH, EH-leh, EH-meh, EH-neh, OH, PEH, COO, EH-reh, EH-seh, TEH, OO, BEH, doh-bleh-OO, EH-keece, YEH, SEH-tah. Capitalized syllables are stressed. OH-CAH!

From Paul Haveman, Pequannock, N.J., comes a few addresses of some commonly heard shortwave broadcasters.

Radio RSA, Box 4559, Johannesburg, South Africa; *Radio Habana Cuba*, P.O. Box 7026, Havana, Cuba; *Deutsche Welle*, The Voice of Germany, Box 100444, Cologne 1, German Federal Republic; and the British Broadcasting Corporation, Box 76, Bush House, Strand, London, WC 2B 4PH, England.

Ok, QSL hunters, go to it!

What was your biggest thrill in DXing? Larry Marshall, San Diego, California, a veteran SWL who recently resumed the hobby after a Navy stint, tells about his:

"My biggest thrill was receiving my first QSL card in the mail. It was from *Radio Brazzaville*, in what was then called French Equatorial Africa, back in June 1961."

The club spotlight falls this month on the

NEWARK NEWS RADIO CLUB
215 Market Street
Newark, N.J. 07101

I read about NNRC in **ELEMENTARY ELECTRONICS'** DX Central Reporting.

Check one: _____ I want to join. Enclosed is (\$7—3rd Class) (\$10—1st Class)

_____ I want to know more about NNRC. I'm enclosing 50 cents for a sample bulletin.

Name: _____

Address: _____

City: _____ State: _____ ZIP: _____

Newark News Radio Club, the granddaddy of all DX organizations. Believe it or not, this organization has been turning out information packed DX bulletins since 1928!

Unlike some clubs, NNRC does not specialize in any one particular phase of the listening hobby. You'll find regular sections on DXing the medium waves, shortwave broadcast, the utility stations, the ham bands and UHF-VHF TV and FM.

With all this ground to cover, it's not surprising that the NNRC bulletin generally runs a hefty 50 mimeographed pages or more each month.

Membership in this veteran club will run you \$7 a year, \$10 if you want your bulletins sent first class mail instead of the slower third class. If you want to look before you buy, 50 cents will bring you a sample of their bulletin.

Interested? Then use the handy blank. ■

About SWLing

Continued from page 34

ship definitely is not a dirty word in the QSL game. Your report has to stand out from the so-so letters from other listeners if you want to verify those tough ones that nobody else manages to QSL. Develop your own techniques. Every successful DXer does eventually. The only caveat is to forget the wise guy approaches and demands for a confirmation of your report. They don't work.

● **Are QSL's the ultimate proof?**

Considering the hard work involved in getting some QSLs, it's too bad the answer has to be, "only sometimes." Many stations issue verifications only after carefully checking the reports for accuracy. But others don't check and automatically reply as a public relations gesture. If the broadcaster

hasn't bothered to check if your list of program details corresponds to what actually was aired at the time, the QSL isn't worth the paper it's printed on. Since there's nothing better in the way of proof of reception, except maybe a tape recording of your reception, SWL's still value their collection of verifications. However, proof positive they aren't!

● **So it's possible there . . .**

. . . are phonies in the hobby? Guys who never hear certain rare stations, fake a report and manage to get a QSL? Sorry to be the one to break the news, but 'tis true. Luckily, there aren't many crumbs like this, mainly because eventually the rest of the DXing fraternity gets wise. And, once caught at it, a listener might as well forget DXing and take up mushroom growing. His name is mud!

● **But what if I make an honest mistake?**

This is a danger, which is why you should

CLASSIFIED Market Place

Classified Ads 65¢ per word, each insertion, minimum 10 words, payable in advance. To be included in the next available issue of **ELEMENTARY ELECTRONICS**, copy must be in our New York Office by June 1st. Address orders to R. S. Wayner, Manager, Classified Advertising, **ELEMENTARY ELECTRONICS**, 229 Park Avenue South, New York, N. Y. 10003.

BOOKS AND PERIODICALS

WILDERNESS Living! Survival, Guerrilla Warfare, Hunting, Firearms, Self-Defense. Books—Vital, Fascinating, Extraordinary! Free Catalog Adobe Hacienda, Route 3, Glendale, Arizona 85301.

FREE AMAZING CATALOG. Gifts And Novelties. Fred Wise Company, 1381 So. Hermosa, Banning, California 92220.

BUSINESS OPPORTUNITIES

I made \$40,000.00 Year by Mailorder! Help others make money! Start with \$10.00—Free Proof! Torrey, Box 318-T, Ypsilanti, Michigan 48197.

MAKE Magnetic Signs. Big profits. Details. Universal, Lenora, Kansas 67445.

1000% PROFIT Bronzing Keepsakes. Free Literature. NBC, Box C-4-0, Coral Springs, Florida 33065.

MAILORDER: How to prepare your own catalog for pennies! Free catalog! Obie-BHI, Brooklyn, New York 11219.

WE NEED GINSENG GROWERS! \$3,000—\$30,000 annually! We Buy Your Crop. Send \$2. For seed sample and information. Glass's Ginseng Exchange, Box 336, Rochdale Station, Jamaica, N.Y. 11434.

MAILORDER Moneymaking Kit. Home Business. Valuable lists, concrete information, detailed steps. Capital unnecessary. Free Details, Pictures, Meadows, Box 327 DC9, Boston 02199.

FREE BOOK "999 Successful, Little-Known Businesses." Work Home! Plymouth BHI, Brooklyn, New York 11218.

START small, highly profitable electronic production in your basement. Investment, knowledge unnecessary. Postcard brings facts. Barta-EEB, Box 248, Walnut Creek, California 94597.

"\$15,000-\$30,000 YEAR. Send \$2.00 BOOK: "Raising Rabbits for Us." Rabbit Ranchers of America, Box 265-DPI, Haysville, Kansas 67060.

\$100 WEEKLY possible addressing, mailing, sparetime. Free details. Send self addressed stamped envelope. Newby, Box 277177-SM, San Antonio, Texas 78227.

I'VE got the horses races beat! Proved over four years. Will reveal. STRAUSS-BNG, Brooklyn, New York 11219.

AMAZING NEW profitable exciting home business. Details free. Catalogs \$2.00 refundable. Act now! Continental Associates, Dept. J182A, Lake Katrine, New York 12448.

MAKE Your Classified Ad Pay. Get "How To Write a Classified Ad That Pays." Includes certificate worth \$2.00 toward classified ad in S & M. Send \$1.25 (includes postage) to R. S. Wayner, Science & Mechanics, 229 Park Ave., South, New York 10003.

BUY IT WHOLESALE

FREE Membership. Wholesale Buying Club. Join Now. Renlee, 215-SM, Golf Lane, Hewlett Harbor, New York 11557.

BUY IT WHOLESALE—Con't.

BIG PROFITS. 8 track stereo tapes, Cassettes, 8 track players, Cassette Players and Recorders. Buy Below Wholesale. Send \$1.00 for Catalogs. (Refundable) Mid-West Tape, 605 North Horace, Rockford, Illinois 61103.

COINS, CURRENCY & TOKENS

COLLECT COINS for Profit! How to Start. Where to Sell. Get our lists of valuable Coins. Send \$1.00. Service Line, 463 Kissel Avenue, Staten Island, N. Y. 10310

DO-IT-YOURSELF

BREW your Beer! Potent simple inexpensive recipe. Guaranteed \$1.00. Cresco, Box 1333-D, Moose Jaw, Sask., Canada.

PLANNING AN UNDERGROUND SPRINKLER SYSTEM? INSTALL YOUR OWN AND SAVE. World famous do-it-yourself Rain Jet Sprinkler equipment. Millions already installed. Available nationally. For free How to Install pamphlet, write Rain Jet Corporation, Dept. SZX, 301 So. Flower St., P.O. Box 868, Burbank, California 91503.

SOLID STATE & HOBBY CIRCUITS MANUAL \$1.95 postpaid to your door. The new Manual HM 91 offers over 400 pages of circuits for the hobbyist, engineer, experimenter and do it yourself kit builder. **HURRY—Supply limited.** Free catalog. FRAZER & ASSOCIATES, 3809 Surfwood Rd., Malibu, Calif. 90265

EDUCATION & INSTRUCTION

UNIVERSITY Degrees By Mail. Free Information. Norman, Dept. 63, Box 3199, Pasadena, California 91103.

U.S.M.C. "Hand To Hand Combat" Manual \$1.50. Books/manuals catalog 25¢. Hillcrest Publications, SMC-9, McDonald, Ohio 44437.

LEARN slide rule on cassette \$5. General Cassette Corporation, 1324 N. 22nd Ave., Phoenix, Arizona 85009.

GIFTS THAT PLEASE

FREE FREE New Illustrated Gift Catalog. The Wee Attie, 1920 East 7800 South, Salt Lake City, Utah 84121.

GOVERNMENT SURPLUS

GET instructions on government surplus buying. Information 50¢. Write: Huerta, Box 26313, Tempe, Arizona 85282.

INVENTIONS WANTED

WE either sell your invention or pay cash bonus. Write for details. Universal Inventions, 298-3, Marion, Ohio 43302.

MONEYMAKING OPPORTUNITIES

MAKE BIG MONEY raising Chinchillas, Cavies, Rabbits for us. Catalog 25¢. Keeney Brothers, New Freedom, Penna. 17349.

MONEYMAKING OPPORTUNITIES—Con't.

OVER \$16.50 an hour. Spare time at home! Rubber Stamp industry needs small manufacturers. We furnish all equipment and know-how! Particulars free! Write: Roberts Room RC-107-BJ, 1512 Jarvis, Chicago, Illinois 60626.

MAKE \$1.00 PER SALE selling engraved metal Social Security plates. **FREE SALES KIT.** Engravplates, Box 10460-202, Jacksonville, Florida 32207.

SONGWRITER—Lyricists: Velocity Music is a service designed to give your material the consideration and exposure it needs. Velocity Music, Box 4904, Pittsburgh, Pennsylvania 15206.

OF INTEREST TO WOMEN

EXCELLENT MONEY addressing in your own home \$45.00 daily possible. Typewriter-Longhand. Send Stamped addressed envelope. AME-9, Box 310, La Mars, Iowa 51031.

OFFICE EQUIPMENT & SUPPLIES

ANALOG COMPUTERS. PLANS. KITS. Economical, practical. Catalog \$2.00 (refundable). Fernwood, Box 2005EE, Lynwood, Wa. 98036.

PERSONAL

ELIMINATE Debts Without Borrowing! Particulars 25¢. Helper, Box 9308, No. Hollywood, California 91609.

ORIENTAL FRIENDSHIP! Photographs, descriptions, questionnaire, brochure, details. \$1.00. INTER-PACIFIC, Box 3045C, Birmingham, Michigan 48012.

PHOTOGRAPHY—PHOTO FINISHING

SAVE HUNDREDS OF DOLLARS!!! Make your own S & M Densitometer. Send \$3.00 for detailed drawings and instructions. A must for successful photography in your darkroom. Order direct from S & M Instruments, Dept. EE, 229 Park Avenue South, New York, N. Y. 10003.

PROFITABLE OCCUPATIONS

CHINCHILLA income guaranteed. Terms 25¢—Bulletin \$1.00. Rainbow, 11DC, Port Richey, Florida 33568.

RADIO & TELEVISION

TV TUBES 35¢ each. Send for Free 48 page color catalog. Cornell, 4217-W University, San Diego, California 92105.

BUILD Distance Crystal Sets, 10 plans —25¢; 18 different—50¢; 20 different—50¢. Catalog 25¢. refundable. Laboratories, 1477-G, Garden Grove, California 92642.

C B LOWEST Prices Catalog 15¢. Puget Sound R/C, 4230 Hoff Rd, Bellingham, Washington 98225.

RECORDERS, SOUND EQUIPMENT, RECORDS

TDR® CASSETTES. Best Value Here! Tried. Free brochure. Paragon House, 1201 Cardinal, Orlando, Florida 32803.

THERE IS NO CHARGE FOR THE ZIP CODE—PLEASE USE IT IN YOUR CLASSIFIED AD

Classified Continued

REMAILING SERVICE

DALLAS Remails 25¢. Economical, Receiving-Forwarding. Nortex, Drawer 430, Weatherford, Texas 76086.

MERCURY REMAILING SERVICE. Receiving-Forwarding. 4929A Dundas St. W. Islington, EE, Toronto, Ontario, Canada.

REMAILING, 25¢ Cella. 912 W. 18th St., San Pedro, California 90731.

SCIENCE & CHEMISTRY

ANTIGRAVITY DEVICE. Brochure 35¢. AGD, Box 3062-EE, Bartlesville, Oklahoma 74003.

SUPER NATURE TABLETS

NO man should be a sexual weakling or failure, for virile Powers can be made to Respond at Will. I have The Amazing Superior Tonic Tablets. Pep for all the things you want to do. 30 for \$3.00. Nina of Germany, 324 So. First Street, Alhambra, California 91802.

TAPES, RECORDERS & SOUND EQUIPMENT

WRITE for our free 32 page catalog. It lists resistors (14 different types, in kits and singly), 1542 tube types, 3024 different transistor types, many transistor kits, rectifiers in kits and singly, condensers of various types, tools, wire, antennae, phonograph cartridges and needles, speakers, CRT boosters, controls, switches, t.v. tuners, yokes, flybacks, etc. Hytron Hudson, Dept. EE, 2201 Bergenline Ave., Union City, N.J. 07087.

be doubly careful about sending a reception report to Station X, when there's even an outside chance it might be Station Y you heard. A report that's a bummer, even though your intentions, unlike the phony's, are pure, can harm not only your chances of getting a QSL, but the hobby in general.

● But there's still so much I don't know.

And there are questions you haven't even thought of yet, and won't until you get some months of DXing under your belt. That's what I meant about it taking time. But patience, Alfie, patience! It'll all come. Join a good DX club. In every issue, *e/e's DX Central Reporting* column spotlights a different club for our readers. Pick up a copy of our sister magazine, *COMMUNICATIONS WORLD*, which is filled with basics for beginners. Invest in a couple of the basic texts on DXing and *read*. You'll find some good ones at your local electronic parts store, or write Gilfer Associates, Box 239, Park Ridge NJ 07656, for a free price list of some of the SWL books available.

And, lest I've made this hobby sound scary, remember it's all for fun. Keep trying to close that DX info gap—that's the real secret of painless DXing. ■

INDEX TO ADVERTISERS

READER SERVICE NO.	ADVERTISER	PAGE NUMBER
3	Avanti Research Development	13
	Autofacts	105
	Bell & Howell Schools	70-73
19	Cleveland Institute of Electronics	106 & 3rd Cover
17	Cornell Electronics	28
5	Cortland Electronics	9
4	Delta Products	13
23	EDI Electronics	28
2	Edmund Scientific	6
21	Eico Electronics	26
27	Electra Co., Div. of MASCO Corp.	23
1	Heath Company	10 & 11
30	I.C.S.	5
7	International Crystal	24
8	E. F. Johnson	12
28	Kedman Company	26
	Kent	89 & 90
6	Lafayette Radio	22
24	McGee Radio Company	28
9	Mosley Electronics, Inc.	27
	National Radio Institute	18-21
11	National Technical Schopls	36-39
12	Newtronics	8
13	Olson Electronics	24
10	Progressive Edu-Kits, Inc.	4th Cover
	R.C.A. Institute	1-3 & 7
25	Regency Electronics, Inc.	14
18	Relco Electronics	27
14	Tab Books	16
20	TDK Electronics	13
26 & 29	TMA	23 & 27
22	Turner Div., Conrae Corp.	2nd Cover
15	Western Radio	28
16	Xcelite Company	15

Ask Hank, He Knows

Continued from page 28

do it a few times but without luck.

—R.T., Fernie, B.C.

Wrap several turns of wire around your transistor radio. Then connect one end to a long wire antenna and the other end to ground. Should help some.

Needs a Tune Up!

When I set my TV receiver to a UHF channel, I can hear truck drivers talking over mobile radio. Why?

J.B., New Brunswick NJ

That's quite possible since in many TV sets the VHF tuner is tuned to around 44 MHz, right smack in the land mobile radio band, when set to UHF. Your set may not be well shielded or the signals get through your UHF tuner. I had an uncle who monitored this band to get the wholesale price on salami—ugh!

One Fat Farad

I was told a one-farad capacitor would be as large as a room. Is this true?

—F.L., Miami FL

False, provided you'll settle for a 3-volt unit. Sprague makes one the size of a quart milk bottle or a bit bigger. I was thinking of buying one but I can't find a reason to do so.

READER SERVICE PAGE

• The Editor of ELEMENTARY ELECTRONICS offers readers an easy way to get additional information about products and services advertised in this issue. Also, if you would like more information about any new product mentioned in our column "Hey, Look Me Over," it's yours for the asking. Just follow the instructions below and the material you requested will be sent to you promptly and at no cost.

• The coupon below is designed for your convenience. Just circle the numbers that appear next to the advertisement or editorial mention that interests you. Then, carefully print your name and address on the coupon. Cut out the coupon and mail to ELEMENTARY ELECTRONICS, Box 886, Ansonia Station, New York N Y 10023. Do it today!

SEPTEMBER/OCTOBER 1972

Void after January 31, 1973

ELEMENTARY ELECTRONICS

Box 886, Ansonia Station, New York, N.Y. 10023

Please arrange to have literature whose numbers I have circled at right sent to me as soon as possible. I understand that this is a free service offered by the magazine.	1	2	3	4	5	6	7	8	9	10
	11	12	13	14	15	16	17	18	19	20
	21	22	23	24	25	26	27	28	29	30
	31	32	33	34	35	36	37	38	39	40
	41	42	43	44	45	46	47	48	49	50
	51	52	53	54	55	56	57	58	59	60
	61	62	63	64	65	66	67	68	69	70

• Please limit circled items to 12 maximum.

Name (Print Clearly) _____

Address _____

City _____ State _____ Zip Code _____

9 Great IC Projects

Continued from page 61

out built-in speaker monitor facilities could make good use of the Micro-Mini. There is plenty of space in those pro machines for a couple Micro-Minis and a pair of 3 x 5-inch general purpose speakers. It'll make recording that high school band or civic chorus from a remote location that much easier.

PARTS LIST FOR MICRO-MINI AMPLIFIER

- C1—5 μ F, 10 VDC
- C2—0.005 μ F, 10 VDC
- C3—0.003 μ F, 10 VDC
- C4—250 μ F, 10 VDC
- C5—50 μ F, 10 VDC
- IC1—Motorola MFC 4000
- R1—1,000-ohms, 1/2-watt resistor
- R2—4,700-ohms, 1/2-watt resistor
- R3—10,000-ohms, 1/2-watt resistor

TEAC AN-60

Continued from page 54

improving the overall signal-to-noise ratio some 6 to 10 dB, depending on the bandwidth of the noise range being measured.

Summing up. The AN-60 performs the Dolby function well. What the low budget price of \$80.50 does affect is convenience. The AN-60 must be manually switched from record to play, and you must get used to monitoring a new zero VU recording level, which can be something of a hassle if your recorder's meter has only a safe-overload, or red-green type of calibration. (You can always paste a reference mark on the meter face.)

Inconveniences aside, the AN-60 is the cheapest and easiest way to upgrade all your tape-recording equipment to Dolby.

For additional information, circle No. 45 on Reader Service Coupon on page 17 or 103. ■



Hey, Look Me Over . . .

Continued from page 24

around in the dark aimlessly to locate the target spot. The Four-Way Tool is individually boxed and sells at a remarkably low price of \$1.95 (plus 25c postage and handling). Battery not included. Write The House of Carson, Dept. 126, 477 Mercer St., Jersey City, NJ 07306.

Stereo Headphone Amplifier

Superex is offering its new solid state stereo headphone amplifier which provides the user with a dual capability—as the heart of a second, personal stereo system and as a headphone amplifier also applicable for 4-channel use. The Model EA-500 is housed

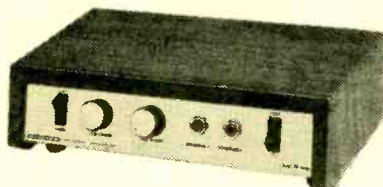

in a compact, oiled walnut cabinet. It is complete with auxiliary speaker output terminals and ample power to drive two high-efficiency speakers. It may be used with any fine quality tuner, tape deck, and turntable and features conveniently located front and rear panel controls. Suggested for use in the den, office, dormitory, music education room or library. Retail price is \$79.95. For all the facts, circle No. 59 on Reader Service Coupon.

Do You Have This One

Deluxe toggle pliers manufactured from forged steel with stainless steel rivets at all pivot points are now available from Welch Drill Bushing Company. Offered with a choice of standard adjustable, neoprene cushions, or swivel foot spindle assemblies, the new pliers feature a corrosion resistant finish, and have a holding pressure of 400 lbs. They are available with or without hardened and ground bushings. For further information, write Welch Drill Bushing Company, Dept. EE, 1630 Flower Street, Glendale, California 91201.

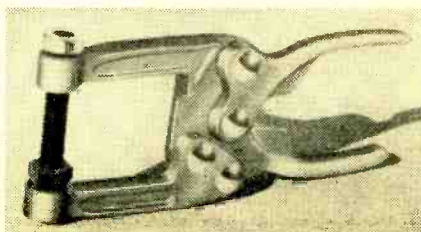

DON'T BUY A NEW CAR!

UNTIL YOU BUY A COPY OF...

AUTOFACTS is a new consumer car pricing guide that gives you the knowledge that can save you hundreds of dollars—as much as \$1,000—on a new car!

In AUTOFACTS you find a complete listing of dealer's cost on all U.S. make cars and options.

For once you see exactly what the dealer's markup is. Quickly and easily you can compare prices of makes and models and in minutes price out the car that fits your pocketbook.

AUTOFACTS puts you in the position to make your own car deal!

With all the latest government approved 1972 model prices in the Summer issue of AUTOFACTS (as shown in this advertisement) and in the same issue the estimated 1973 car prices, you'll know on-the-spot whether you're being offered a good deal or not.

AUTOFACTS MAKES YOU A SMARTER CAR BUYER!

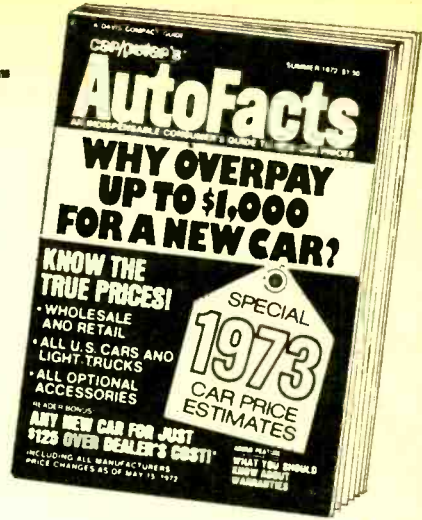

SPECIAL BONUS FOR AUTOFACTS READERS!

*How to get a new car for only \$125 over dealer's cost.

Through the United Auto Brokers' Car/Puter organization, you can take delivery, without delay, of a brand new car for just \$125 over cost. Your purchase includes freight and pre-delivery service. You take delivery of a new-car of your choice from a local dealer and you get the same new car warranty and service as if you had paid full list. The Bonus Coupon in your AUTO-FACTS entitles you to a 20% discount off the Car/Puter 48-hour computerized service that helps you make the best new car deal on your own. * Certain limited production or specialty models priced higher. Some foreign models not available.

SUMMER EDITION UPDATED 1972 NEW CAR PRICES ESTIMATED 1973 NEW CAR PRICES ON SALE NOW AT ALL LEADING NEWSSTANDS

If you prefer, complete and mail this coupon to Car/Puter's AUTOFACTS, Davis Publications, 229 Park Avenue South, New York, New York 10003.

- Summer issue of Estimated New Car Prices. \$1.50 plus 25¢ for postage and handling. Cash-with-order only.
- Fall/Winter Used Car Prices Edition. \$1.50 plus 25¢ for postage and handling. Cash-with-order only.

NOTE: Write publisher for bulk rates. Add \$1.00 per issue for orders outside Continental U.S.A. and Canada.

- I prefer a full year's subscription of 5 issues: Summer issue of 1973 Estimated New Car Prices; actual 1973 New Car Prices issue; 1972 Fall/Winter Used Car Prices edition; next Spring, a revised 1973 New Car Prices edition; 1973 Spring/Summer Used Car Prices edition. \$7.50 for full subscription is enclosed.

name _____ (please print)

address _____

city _____ state _____ zip code _____

AF-AFX



Better than
9 out of 10
CIE graduates
pass their
FCC License
examination!

Cleveland Institute of Electronics
MONEY-BACK
WARRANTY
of success in obtaining a
Government FCC License

The Cleveland Institute of Electronics hereby warrants that upon completion of the Electronics Technology (with or without Lab), Broadcast Engineering, or First Class FCC License course, you will be able to pass the FCC examination for a First Class Commercial Radiotelephone License (with Radar Endorsement);

OR upon completion of the Electronic Communications course you will be able to pass the FCC examination for a Second Class Commercial Radiotelephone License;

AND if you are unable to pass the FCC test for the course selected, you will be entitled to a FULL REFUND of all tuition payments.

This famous warranty is valid during the entire completion period established for the course you are enrolled in.

G. O. Allen
 Dr. G. O. Allen
 President

You can earn more money if you get an FCC License

...and here's our famous CIE warranty that you will get your license if you study with us at home...or your money back!

NOT satisfied with your present income? The most practical thing you can do about it is "bone up" on your Electronics, pass the FCC exam, and get your Government License.

The demand for licensed men is great and still growing. Ten years ago there were more than 100,000 licensed communications stations, including those for police and fire departments, airlines, the merchant marine, pipelines, telephone companies, taxicabs, railroads, trucking firms, delivery services, and so on.

Today, there are nearly two million such stations on the air, and the number is growing constantly. And according to Federal law, no one is permitted to operate or service such equipment without a Commercial FCC License or without being under the direct supervision of a licensed operator.

This has resulted in a gold mine of new business for licensed service technicians. A typical mobile radio service contract pays an average of about \$100 a month. It's possible for one trained technician to maintain eight to ten such mobile systems. Some men cover as many as fifteen systems, each with perhaps a dozen units.

Growth of UHF and CATV

To the 500 or so commercial VHF television stations now in operation and nearly 200 commercial UHF stations, add 200 more educational TV stations. And at the start of the Seventies more than 2,500 cable television stations are serving 4,000 communities.

Opportunities in Industry

And there are other exciting opportunities in aerospace industries, electronics manufacturers, telephone companies, and plants operated by electronic automation. Inside industrial plants like these, it's the licensed technician who is usually considered first for promotion and in-plant training programs. The reason is simple. Passing the Federal Government's FCC exam and getting your license is widely accepted proof that you know the fundamentals of Electronics.

So why doesn't everybody who "tinkers" with electronic components get an FCC License?

The answer: it's not that simple. The Government licensing exam is tough. There is one way, however, of getting the kind of preparation that will help you pass the FCC exam. And that is to take one of the FCC license-preparation courses offered by Cleveland Institute of Electronics.

Our training is so effective that better than 9 out of 10 CIE graduates pass the FCC exams. That's why we can offer this famous Money-Back Warranty: when you complete any CIE course which provides FCC License preparation, you'll get your FCC License or a full refund of all tuition paid. This warranty is valid during the entire completion period established for the course selected. You get your FCC License — or your money back.

There's a reason for this remarkable record. From the beginning, CIE has specialized in electronics courses designed for home study. We have developed techniques that make learning at home easier... even if you've had trouble studying before.

In a Class by Yourself

The CIE Instruction Department gives immediate attention to the lessons and questions you send in. It's like being the only student in the "class." Instructors not only grade your work, they also analyze it. Even your correct answers can reveal misunderstandings that the instructors can help you clear up. The corrections and comments are mailed back to you the same day your assignment is received. You can read the notations while everything is still fresh in your mind.

It Really Works

Our files contain hundreds of success stories of men whose CIE training has gained them their FCC "tickets" and admission to a higher income bracket.

David Ferreira of San Diego, California, boosted his earnings and got a promotion after getting his FCC License. He says, "Even before I finished the course, I passed my First Class FCC License test. Since then I've been able to buy a home, get a camper and travel with my family."

CIE graduate, Rondlay Holmes, broadcast engineer for WKBF-TV, Cleveland, Ohio, passed his First Class FCC License exam on the first try. "Now I'm earning three times what I did before my CIE training," writes Holmes.

Mail Card for Two Free Books

Want to know more? The postpaid reply card will bring you free copies of our school catalog describing opportunities in Electronics, our teaching methods, and our courses, together with our special booklet, "How to Get a Commercial FCC License." If card has been removed, just mail the coupon at right.

CIE HAS CAREER COURSES TO FIT YOUR BACKGROUND

ELECTRONICS TECHNOLOGY with LABORATORY... teaches you the fundamentals. With a 161-piece laboratory you apply the principles you learn by analyzing and trouble-shooting electronics equipment.

ELECTRONICS ENGINEERING... A college-level course for men already working in Electronics. Covers steady-state and transient network theory, solid-state physics and circuitry, pulse techniques, computer logic and mathematics through calculus.

THESE CIE MEN PASSED THE FCC LICENSE EXAM... NOW THEY ARE EARNING MORE MONEY

From Tugboat to Television

"When I started my CIE electronics training, I was working in the engine room of a tugboat. Before finishing, I passed my First Class FCC License exam and landed a job as a Broadcast Engineer at KDJM-TV in Beaumont. I was able to work, complete my CIE course and get two raises... all in the first year of my new career in broadcasting. The course was interesting and well written."—Richard L. Kihn, Anahuac, Texas.



New Job with 40% More Pay

"CIE has taken me from a dull low-pay job with little chance for advancement to one with challenge and a good future. I'm now an Engineering Specialist with National Radio Company, Inc. testing prototype equipment. CIE training gave me the electronics technology I needed to pass the exam for First Class FCC License. I'm already earning 40% more than I could without my CIE training."—Joseph E. Perry, Cambridge, Mass.



APPROVED UNDER NEW G.I. BILL: All CIE career courses are approved for full tuition refund under new G.I. Bill. If you served on active duty since January 31, 1955, OR are in service now, check box on reply card or coupon for G.I. Bill information.

Cleveland Institute of Electronics
1776 E. 17th St., Cleveland, Ohio 44114

Please send me without cost or obligation:

- Your illustrated book, "Succeed in Electronics."
- Your book on, "How to Get a Commercial FCC License."

I am especially interested in:

- | | |
|--|---|
| <input type="checkbox"/> Electronics Technology | <input type="checkbox"/> Electronic Communications |
| <input type="checkbox"/> Broadcast Engineering | <input type="checkbox"/> Industrial Electronics |
| <input type="checkbox"/> First Class FCC License | <input type="checkbox"/> Electronics Engineering |
| | <input type="checkbox"/> Electronics Technology with Laboratory |

Name _____ (PLEASE PRINT)

Address _____

City _____

State _____ Zip _____ Age _____

Veterans & Servicemen: check here for latest G.I. Bill information.

EL-35

CIE Cleveland Institute of Electronics
1776 East 17th Street, Cleveland, Ohio 44114

Accredited Member
National Home Study Council

CIRCLE NO. 19 ON PAGE 17 OR 103

BUILD YOUR OWN RADIO

and Electronics Circuits

Reg. U.S.
Pat. Off.



Training Electronics Technicians Since 1946

PROGRESSIVE HOME RADIO-T.V. COURSE

Now Includes

- ★ 12 RECEIVERS
- ★ 3 TRANSMITTERS
- ★ SQ. WAVE GENERATOR
- ★ SIGNAL TRACER
- ★ AMPLIFIER
- ★ SIGNAL INJECTOR
- ★ CODE OSCILLATOR

- ★ No Knowledge of Radio Necessary
- ★ No Additional Parts or Tools Needed
- ★ EXCELLENT BACKGROUND FOR TV
- ★ SCHOOL INQUIRIES INVITED
- ★ Sold In 79 Countries

YOU DON'T HAVE TO SPEND HUNDREDS OF DOLLARS FOR A RADIO COURSE

The "Edu-Kit" offers you an outstanding PRACTICAL HOME RADIO COURSE at a rock-bottom price. Our Kit is designed to train Radio & Electronics Technicians, making use of the most modern methods of home training. You will learn radio theory, construction practice and servicing. THIS IS A COMPLETE RADIO COURSE IN EVERY DETAIL.

You will learn how to build radios, using regular schematics; how to wire and solder punched metal chassis as well as the latest development of Printed Circuit chassis.

You will learn the basic principles of radio. You will construct, study and work with RF and AF amplifiers and oscillators, detectors, rectifiers, test equipment. You will learn and practice code, using the Progressive Code Oscillator. You will learn and practice Trouble-shooting, using the Progressive Signal Tracer, Progressive Signal Injector, Progressive Dynamic Radio & Electronics Tester, Square Wave Generator and the accompanying instructional material.

You will receive training for the Novice, Technician and General Classes of F.C.C. Radio Amateur License. You will build Receiver, Transmitter, Square Wave Generator, Code Oscillator, Signal Tracer and Signal Injector circuits, and learn how to operate them. You will receive an excellent background for television, Hi-Fi and Electronics.

Absolutely no previous knowledge of radio or science is required. The "Edu-Kit" is the product of many years of teaching and engineering experience. The "Edu-Kit" will provide you with a basic education in Electronics and Radio, worth many times the low price you pay. The Signal Tracer alone is worth more than the price of the kit.

THE KIT FOR EVERYONE

You do not need the slightest background in radio or science. Whether you are interested in Radio & Electronics because you want an interesting hobby, a well paying business or a job with a future, you will find the "Edu-Kit" a worth-while investment.

Many thousands of individuals of all

ages and backgrounds have successfully used the "Edu-Kit" in more than 79 countries of the world. The "Edu-Kit" has been carefully designed, step by step, so that you cannot make a mistake. The "Edu-Kit" allows you to teach yourself at your own rate. No instructor is necessary.

PROGRESSIVE TEACHING METHOD

The Progressive Radio "Edu-Kit" is the foremost educational radio kit in the world, and is universally accepted as the standard in the field of electronics training. The "Edu-Kit" uses the modern educational principle of "Learn by Doing." Therefore you construct, learn schematics, study theory, practice trouble shooting—all in a closely integrated program designed to provide an easily-learned, thorough and interesting background in radio.

You begin by examining the various radio parts of the "Edu-Kit." You then learn the function, theory and wiring of these parts. Then you build a simple radio. With this first set you will enjoy listening to regular broadcast stations, learn theory, practice testing and trouble-shooting. Then you build a more advanced radio, learn more advanced theory and techniques, gradually, in a progressive manner, and at your own rate, you will find yourself constructing more advanced multi-tube radio circuits, and doing work like a professional Radio Technician.

Included in the "Edu-Kit" course are Receiver, Transmitter, Code Oscillator, Signal Tracer, Square Wave Generator and Signal Injector Circuits. These are not unprofessional "breadboard" experiments, but genuine radio circuits, constructed by means of professional wiring and soldering on metal chassis, plus the new method of radio construction known as "Printed Circuitry." These circuits operate on your regular AC or DC house current.

THE "EDU-KIT" IS COMPLETE

You will receive all parts and instructions necessary to build twenty different radio and electronics circuits, each guaranteed to operate. Our Kits contain tubes, tube sockets, variable, electrolytic, mica, ceramic and paper dielectric condensers, resistors, tie strips, hardware, tubing, punched metal chassis, Instruction Manuals, hook-up wire, solder, selenium rectifiers, coils, volume controls and wipers, etc.

In addition, you receive Printed Circuit materials, including Printed Circuit chassis, special tube sockets, hardware and instructions. You also receive a useful set of tools, a professional electric soldering iron, and a self-powered Dynamic Radio and Electronics Tester. The "Edu-Kit" includes Code Instructions and Progressive Code Oscillator, in addition to F.C.C. Radio Amateur License training. You will also receive lessons for servicing with the Progressive Signal Tracer and the Progressive Signal Injector, a High Fidelity Guide and a Quizzer. You receive Membership in Radio-TV Club, Free Consultation Service, Certificate of Merit and Discount Privileges. You receive all parts, tools, instructions, etc. Everything is yours to keep.

Progressive "Edu-Kits" Inc., 1189 Broadway, Dept. 557DJ, Hewlett, N.Y. 11557

UNCONDITIONAL MONEY-BACK GUARANTEE

Please rush my expanded "Edu-Kit" to me, as indicated below:
Check one box to indicate choice of model:

- Deluxe Model \$31.95
- New Expanded Model \$34.95 (Same as Deluxe Model Plus Television Servicing Course and valuable Radio & TV Tube Checker).

Check one box to indicate manner of payment

- I enclose full payment. Ship "Edu-Kit" post paid.
- I enclose \$5 deposit. Ship "Edu-Kit" C.O.D. for balance plus postage.
- Send me FREE additional information describing "Edu-Kit."

Name _____

Address _____

City & State _____ Zip _____

PROGRESSIVE "EDU-KITS" INC.

1189 Broadway, Dept. 557DJ, Hewlett, N.Y. 11557

FREE EXTRAS

• SET OF TOOLS

- SOLDERING IRON
- ELECTRONICS TESTER
- PLIERS-CUTTERS
- VALUABLE DISCOUNT CARD
- CERTIFICATE OF MERIT
- TESTER INSTRUCTION MANUAL
- HIGH FIDELITY GUIDE & QUIZZES
- TELEVISION BOOK, A RADIO TROUBLE-SHOOTING BOOK
- MEMBERSHIP IN RADIO-TV CLUB:
- CONSULTATION SERVICE • FCC AMATEUR LICENSE TRAINING
- PRINTED CIRCUITRY

SERVICING LESSONS

You will learn trouble-shooting and servicing in a progressive manner. You will practice repairs on the sets that you construct. You will learn symptoms and causes of trouble in home, portable and car radios. You will learn how to use the professional Signal Tracer, the unique Signal Injector and the dynamic Radio & Electronics Tester. While you are learning in this practical way, you will be able to do many a repair job for your friends and neighbors, and charge fees which will far exceed the price of the "Edu-Kit." Our Consultation Service will help you with any technical problems you may have.

FROM OUR MAIL BAG

J. Statistis, of 25 Poplar Pl., Waterbury, Conn., writes: "I have repaired several sets for my friends, and made money. The 'Edu-Kit' paid for itself. I was ready to spend \$240 for a Course, but I found your ad and sent for your Kit."

Ben Valerio, P. O. Box 21, Magna, Utah, writes: "The Edu-Kits are wonderful. Here I am sending you the questions and also the answers for them. I have been in the radio for the last seven years, but like to work with Radio Kits, and like to build Radio Testing Equipment. I enjoyed every minute I worked with the different kits; the Signal Tracer works fine. Also like to let you know that I feel proud of becoming a member of your Radio-TV Club."

Robert L. Snuff, 1534 Monroe Ave., Huntington, W. Va., writes: "Thought I would drop you a few lines. I say that I received my Edu-Kit and was really amazed that such a bargain can be had at such a low price. I have already started repairing radios and phonographs. My friends were really surprised to see me get into the swing of it so quickly. The Trouble-shooting Tester that comes with the Kit is really swell, and finds the trouble, if there is any to be found."

PRINTED CIRCUITRY

At no increase in price, the "Edu-Kit" now includes Printed Circuitry. You build a Printed Circuit Signal Injector, a unique servicing instrument that can detect many Radio and TV troubles. This revolutionary new technique of radio construction is now becoming popular in commercial radio and TV sets.

A Printed Circuit is a special insulated chassis on which has been deposited a conducting material which takes the place of wiring. The various parts are merely plugged in and soldered to terminals.

Printed Circuitry is the basis of modern Automation Electronics. A knowledge of this subject is a necessity today for anyone interested in Electronics.