

BATTERIES—How to Pick 'em Correctly

SEPTEMBER-OCTOBER

1971

75c

elementary Electronics

**BASIC
COURSE**

**Understanding
the
Transformer**

INCLUDING *Science and Electronics*

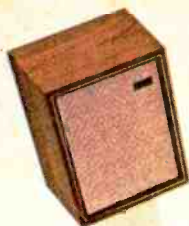

4

Channel Stereo

Get ready for
the avalanche of
new products and
new dimensions
in listening pleasure



8 Great IC Projects for We

12 89 1643 CARJAMESM-9 :T602
MICHAEL CAMPBELL
JAMESTOWN RT
COLUMBIA KY 42728

AMERICA'S GREATEST VALUES IN SCIENCE LABS AND COURSES!

American Basic Science Club's AMAZING KIT-A-MONTH PROGRAM

You Get ALL the following in ten monthly kits!

ELECTRICAL LAB

All the equipment for basic electrical experiments with Wheatstone Bridge (measures resistance), Magnetizer and De-magnetizer, Thermocouple, Mystery Shock Box, Continuity Tester, Induction Voltmeter, Solenoid Coin Tester, Electromagnetic Relay, Neon Lamp, Galvanometer, Induction Coil, Resistors, Chemicals and Electrodes for Plating and Electrolysis. **FOR SAFETY** a step-down isolation Transformer provides required current.



RADIO LAB AND COURSE

YOU BUILD A SHORTWAVE AND BROADCAST RADIO. 3 Subelements in about 150¢. **CARBON MICROPHONE WITH AUDIO AMPLIFIER**, **RADIO TRANSMITTER** for code or voice, **RIPPLE TANK WAVE GENERATOR** with variable frequency. Invaluable in the understanding of wave theory. **CODE PRACTICE OSCILLATOR** with manual. **Steps to a Ham License**. All you need to pass the FCC's 10m License Exam.



ATOMIC ENERGY LAB

ATOMIC CLOUD CHAMBER WITH PROJECTOR ILLUMINATOR. See the vapor trails of alpha and beta particles, and of cosmic rays. **SPINBARISCOPE**. Shows exploding atoms. **SPECTROSCOPE**—metal housed with **Scale and Magnifying Viewer**. Measures back-ground radiation and tests simple sources. **SAFE RADIOACTIVE MATERIALS**, Alpha Source in handy container and Uranium Ore. Full instructions and explanations open up the fascinating field of nuclear physics.



STROBE LIGHT

A Neon Lamp that flashes or intervals you can synchronize with the speed of rotating or vibrating objects in order to "freeze" their motion to permit close study and checking frequencies and RPM. Flashes are timed by a variable frequency oscillator with a range of 20 to 600 cycles per second.



RADIO SERVICING TOOLS

SIGNAL TRACER. A valuable trouble shooting tool which permits you to listen in as you probe through a faulty circuit and you find the trouble spot. **CONTINUITY TESTER**. Pinpoints open circuits and test voltages. The use of both pieces full of details in an easy-to-use manual. **Simplified Radio and TV Servicing**.



SPECTROSCOPE

Analyze spectra of glowing gases. See and identify the Fraunhofer Lines. A quality instrument featuring an **easy-to-read built-in scale** and a powerful condensing system for a bright spectrum. Equipment includes **Alcohol Burner** and a **2 Watt Neon Spectral Lamp**. Full instructions cover theory and use.



ULTRAVIOLET LAMP

140 watt filter type UV LAMP. Heavy metal canner. A **Foot Cord**, **Rotary Switch**. Produces dazzling color effects with its invisible bluish light. Has many uses in the fields of Mineralogy, Crime Detection and Forensics. Accessories include **Ink, Tracer Powder, Fluorescent Crystals**.



PHOTOELECTRIC RELAY

Crystal PhotoCell, **Electronic Amplifier**, **Relay**, **Large Condensing Lens**, **Colloidal Mesure**. Features automatic on-off or holding circuit operation. **Sensitivity Control**. Plug-in **Outlet** for controlled circuit. Use for lamps, counters, etc. Operates on 115V AC. **A basic unit for many exciting experiments.**



ANALOG COMPUTER

Electronic Computer multiplies, divides, calculates powers, roots. Set up the problem on the scales of two potentiometers and find the answer on the scale of third potentiometer as indicated by a sensitive meter. Instructions Manual covers computer theory and practical use. Over 150 simple problems and answers demonstrate use with fractions, trigonometry, logarithms, physics formulas, ballistics, etc.



DC POWER SUPPLY

Changes regulator 110-120V AC to the direct current required for electronic projects and experimenting. Consists of a **Power Transformer**, **Vacuum Tube Rectifier**, **30/20 MFD Capacitor Filter**, **Circuit** and a **potentiometer Voltage Selector**. A **Safe Isolated Power Supply** eliminates the need of expensive multi-volt batteries.



MICROCRAFT LAB

Microprojector shows microscopic subjects enlarged with brilliant detail on wall or screen. **Horizoidal Steel Cabinet**, **Large Condensing Lens** for extra brightness, and a **GE Fluorescent Lamp**. **Microscope** features **Binocular Eyepiece** for wide field viewing, **Substage Light** and **Polarizing Filter**. **Wardens up to 200X**. Includes **Slides, Cover Glasses and Microscopy Manual**.



SURVEYOR'S TRANSIT

A **Practical Transit**. **6X** **exit image telescope** with **Range Finder**. **Bottle** for measuring remote distances and heights. **Vertical** reading for both horizontal and vertical scales. **Leveling Head** with **Thumb Screw** Adjustment and **Spirit Level**. **Clamps** under head hold workless legs of tripod. **Legs** not included. **Instructions** cover elementary surveying, stadia-reading.



LIGHT AND OPTICS LAB

Exciting optical projects for the study of light. Equipment includes **five Precision Lenses**, **Prism**, **Polarizing Filters**, **Diffraction Grating**, **Mirrors**, **Telescoping Tubing**, **Lens Mounts**, **Tube Holders and Brackets**. All the parts and instructions to build a **Camera Obscura**, **Camera Lucida**, **Polycopter**, and many other optical devices.



PHOTOMICROGRAPHY CAMERA

Photographs subjects mounted on microscopic slides. Enlarges up to 100X. Takes clear "snap" pictures of specimens too small to be seen with the naked eye. A **fully self-contained unit** in a **compact case** and **uses standard roll film**, either 120 or 35mm, black and white or color. Make a photographic record of your projects with microscopic subjects.



TELESCOPE AND MOUNT

30X **exit image**. **Extends to 30"** length. **Five ground and coated lenses**. **Removes Eyepiece**. **Sturdy Equatorial Mount** makes it easy to follow the movement of heavenly bodies. **Mount** has **fitting for wooden legs** that hold the tripod legs on regular 1x2's. **See separate kit.**



PHOTOGRAPHY LAB

A **PRECISION 35MM ENLARGER**. Horizontal type with twin condensing lenses and 37 F/11 projection lens. Produces quality enlargements up to 8" x 10". **Contact Print Frame** takes negatives up to 3 1/2" x 4 1/2". **3 Movie Developing Trays**, **Neon Safelight**, **Tray**, **meter**, **Film Clips**, **Developing Chemicals**, **Fixing and Intensifier**, **Pepper and Do-Krown Handbook**. **Make prints for only 2¢**. Full instructions.



LIGHT TRANSMITTER-RECEIVER

The **TRANSMITTER** consists of a **Light Source**, a **Modulating Reflector**, **Diaphragm** and an **Optical Projection System**. The **RECEIVER** is a **Two-Stage Audio Amplifier**, controlled by a **Photo-electric Cell** that catches the projected light beam and causes the original sound waves to be reproduced in the loudspeaker.



WEATHER STATION

A **REMOTE READING ANEMOMETER** and **WIND VANE**. **Flashing Neon Lights** on **rotary indicator board** show wind speed and direction. **Safety Power Cord** makes all connections safe. **100' ft. of Lead-in Wire**. **Plus—Air-Tank Barometer** with **48" indicator column**. **Sling psychrometer** measures relative humidity. **Rain Gauge** measures rainfall to 1/100 inch. **ALSO Cloud Chart and Forecasting Manual**—a complete set up for amateur meteorology.



You get ALL the equipment for ALL the above in ten monthly kits

SEND \$1.00 ONLY TO ENROLL

PAY \$4.95 ONLY FOR EACH KIT THAT YOU RECEIVE

Take as few as you wish—or get all ten... it's up to you!

SOME QUESTIONS ANSWERED

- Q. How is it possible? It seems incredible to be able to get all the equipment shown above in just ten kits — at only \$4.95 per kit!
- A. The direct-to-you, "no middleman", club plan is just part of the answer. The other key is ABSCLUB's especially designed multi-use equipment. For example: the Microprojector quickly and easily converts into the Spectroscope, Photo Enlarger and Cloud Chamber Illuminator. Similarly, the Transit doubles as a Telescope Mount. Such multi-purpose design... plus club plan economy... makes possible this all-science program at a price everyone can afford.

- Q. May members choose the order in which they receive their kits?
- A. Yes. With the first kit members receive a list of the equipment and projects contained in each of the remaining nine kits. With this information they are able to choose the kit sequence that best suits their particular interest.
- Q. Are special tools or skills required?

- A. No. All you need are pliers and screwdriver. No soldering — new connectors make fast, firm joints. All equipment easy to use.

MAKE SCIENCE YOUR HOBBY!

NO EXPERIENCE NECESSARY — IT'S FUN! IT'S EASY!

CIRCLE NO. 1 ON PAGE 17

NO OBLIGATION—NO RISK!

- ★ You take only as many kits as you wish. No minimum—you may cancel anytime.
- ★ Two weeks approval on each kit you take. You may return any kit for full refund.

Send coupon today—get your first kit on its way!

TRIAL MEMBERSHIP COUPON

AMERICAN BASIC SCIENCE CLUB, INC.
104 Heimann, San Antonio, Texas 78205

I wish to try the Kit a Month Program:

I enclose \$1.00 to enroll and \$4.95 for the first kit postpaid.

I enclose \$1.00 to enroll. Send first kit COD. I'll pay COD fee.

I understand if I am not satisfied with the first kit I may return it for a complete refund including the \$1.00 membership fee.

NAME _____

ADDRESS _____

CITY AND STATE _____ (PLEASE PRINT) ZIP CODE _____

AMERICAN BASIC SCIENCE CLUB, INC.

Your paycheck says a lot about you

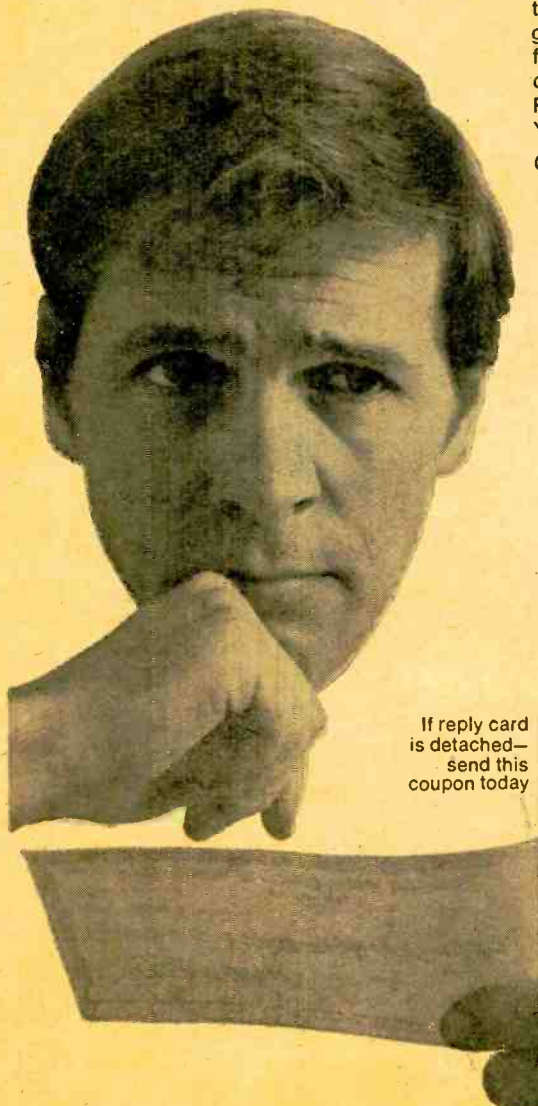

It tells you more than how much you make. It tells you how far you've come. And if your paycheck looks very much the same as it did last year, or the year before, it simply means that you look very much the same as you did last year and the year before.

But times change, and you should be changing with them. Old dull jobs are disappearing. New exciting ones are being created. There are challenging new fields that need electronics technicians...new careers such as computers, automation, television, space electronics where the work is interesting and the earnings are greater.

RCA Institutes has one of the nation's largest and most respected home study schools devoted to electronics. They can get you started even if you've had no previous training or experience. RCA Institutes has developed a faster, easier way for you to gain the skills and the knowledge you need for a fascinating, rewarding electronics career. And you don't have to quit work and go back to school. With RCA Institutes Home Study Plan you can do both. You set your own pace depending on your schedule.

Check over these RCA benefits:

- You get Hands-On Training—over 300 experiments and as many as 25 kits with some programs.
- You get RCA's unique "Autotext" method of learning—individual programmed instruction, the easy, faster, simplified way to learn!
- You get the widest choice of electronics courses and programs—everything from Electronics Fundamentals right up to Solid State Technology and Communications Electronics.
- You get a selection of low-cost tuition plans!

Sounds great, and it is! For complete information, without obligation, send in the attached postage card... or return the coupon below. That will say a lot about you.

Veterans: Train under new GI Bill. Accredited Member National Home Study Council. Licensed by N.Y. State—courses of study and instructional facilities approved by the State Education Department.

If reply card is detached—send this coupon today

RCA Institutes

Home Study Dept. 246-009-1
320 West 31st Street, New York, N. Y. 10001

Please rush me FREE illustrated catalog.
I understand that I am under no obligation.

Name _____ Age _____
(please print)

Address _____

City _____ State _____ Zip _____

Veterans: Check here

ELEMENTARY ELECTRONICS (Vol. 13, No. 4) is published bi-monthly by Science & Mechanics Publishing Co., at 229 Park... 5, New York, N.Y. 10003. One year subscription (six issues)—\$4.00. Second class postage paid at New York, N.Y. 10003 and at additional mailing offices.

CIRCLE NO. 2 ON PAGE 17



elementary Electronics

Dedicated to America's Electronics Hobbyists

BONUS CONSTRUCTION PROJECT

- 27 CB-9 Converter—*tune in channel 9 with a BCB rig and this gadget*

OUR LAB REPORTS

- 57 C-D Ignition system—*Flivvers and Ferraris both benefit from EICO's kit*
77 4-Channel Hi-Fi Amplifier—*the music goes 'round and 'round with Lafayette's LA-44*

HOT WIRE HAPPENINGS

- 24 Newscan—*all that fits that's news to print*
96 Hey, Look Me Over—*throw your shekels after these goodies*

FEATURES FOR THE READER ON THE RUN

- 32 Turn Right at Center and Follow the Signs—*it's not for the backseat driver*
41 Air-to-Air Kamikazes—*Birds!—beware of your fine feathered friend*
50 The Ding-a-Ling that makes Ma Bell Cringe
56 "Watch it, Fatso!"—*dial-away dieting for caloric over-achievers*
70 Blink Break Great Provided You're Not a Blinker
79 It's Been a Pleasure, Mr. Crocodile—*are crocs living better, electrically?*

CONSTRUCTION PROJECTS FOR HOME AND SHOP

- 59 Roll Your Own Capacitors—*custom-built capacitors are easy to make!*
71 Eight Great IC Projects for Weekend Experimenters

FUNNYBONE FOIBLES

- 26 The Home Computer—*cartoon page*

TOWARD A BETTER UNDERSTANDING

- 35 Pickin' Batteries—*how to choose and use batteries and cells*
45 What's in a Pad?—*the theory behind T, L, and H pads*
67 Multivibrators—*these essential electronic circuits set today's pulse*
80 Your TV Set Will Get You If You Don't Watch Out
83 Basic Course—*understanding the transformer*

FROM e/e's CB DESK

- 63 Kathi's CB Carousel—*E. F. Johnson's Messenger 124-M reviewed*

WHAT'S NEW AND DIFFERENT

- 16 Literature Library—*read all about it*
48 You Pick the Name—*4-channel gear round up*

REGULAR DEPARTMENTS

- 7 DX Central Reporting—*SWL dial markings*
14 Stamp Shack—*philatronically speaking*
17 Reader Service Page—*how to learn more about the products and services you've seen in this issue*
22 Ask Hank, He Knows!
82 e/e Etymology—*the story behind the trademark*

AUTHORS IN THIS ISSUE

Jim Ashe, Norman Crawford, Webb Garrison, Charles Green, W6FFQ, Don Jensen, Jack Kaplan, Ted Mann, Jack Schmidt, Thomas R. Sear, WA6HOR, and the ELEMENTARY ELECTRONICS editorial staff.



ON OUR COVER

Lafayette
4-Channel
Products

- LA-44 Amplifier
- RK-48 Cartridge Deck
- Criterion 25A Speakers

Photo by
Koenig/Elliot



indicates
Cover
Highlights

ICS[®]

International
Correspondence
Schools
Division of Intext

ICS, Scranton, Pa. 18515
Canadian residents:
Send coupon to Scranton.
Our affiliate in Canada
will reply.

TAKE YOUR FIRST STEP . . . MAIL THIS COUPON TODAY — ICS, SCRANTON, PA. 18515

4A058H

I'm interested in a program of independent study.
Send me, without cost, your booklet on the principles of success,
sample text demonstrating famous ICS method, and your catalog for _____
(Print name of course. See list.)

Miss _____ Age _____
Mrs. _____
Mr. _____

Address _____ Apt. _____
City _____ State _____ Zip Code _____

Occupation _____ Employed by _____ Working Hours _____ A.M. to _____ P.M.

266 ways to win yourself a RAISE IN PAY

Dozens of new careers are open to you with ICS training. Oldest, largest correspondence institution. 8,000,000 students since 1890. Learn facts, theories, practical applications. Instructors guide you, answer

your questions. Illustrated texts, written by authorities, yours to keep. Famed ICS diploma to graduates. Convenient payment plan. Take charge of your future now. Send coupon for three FREE booklets.

LEADERS IN THE ICS SUCCESS PARADE . . .

<p>Automobile Engine Tune-Up Introduction to Programming the IBM System/360 Computer Business Administration Accounting Civil Engineering Practical Electrician</p>	<p>Radio-TV Servicing Architectural Drafting High School Courses High School Equivalency Refrigeration and Air Conditioning Aircraft and Power Plant Mechanics</p>
<p>ACCOUNTING Accounting (U.S.A.) Accounting (Canadian) Accounting for Business Programmers Accounting for Man'g'm't Decisions Auditing Business Law (U.S.A.) Canadian Business Courses Cost Accounting CPA Review (U.S.A.) General Accounting Income Tax (U.S.A.) Industrial Accounting Junior Accounting Office Accounting Practical Accounting Public Accounting Small Business Accounting (U.S.A.) Starting and Managing a Small Bookkeeping Service (U.S.A.)</p>	<p>Show Card and Sign Prod. Show Card Writing Sign Painting & Designing Sketching and Painting</p> <p>AUTOMOTIVE Automatic Transmission Specialist Automobile Air Conditioning Specialist Automobile Body Rebuilding & Refinishing Automobile Mechanic Automobile Electrician Diesel-Gas Motor Vehicle Engines</p> <p>BUSINESS Advertising Business Administration Business Practice (Cont'd.) Canadian Business Course Direct Mail and Mail Order Advertising Industrial Psychology Inventory Control Magazine & Newspaper Advertising Managing a Retail Business Managing a Small Store Marketing Management Marketing Research Modern Exec. Management Office Automation Office Management Production Management Purchasing Agent Retail & Local Advertising Retail Bus. Management Retail Merchandising Retail Selling Systems and Procedures Analysis</p> <p>BUSINESS: SALES Creative Salesmanship Real Estate Salesmanship Salesmanship Sales Management</p>
<p>ARCHITECTURE AND BUILDING Architectural Drawing and Designing Architecture Building Contractor Building Estimator Building Inspector Building Maintenance Carpenter-BUILDER Carpentry and Millwork House Planning and Interior Design Mason Painting Contractor Reading Arch. Blueprints</p>	<p>COMPUTERS Fundamentals of Computer Programming COBOL Programming Fortran Programming for Engineers Programming for Digital Computers Programming the IBM 1401 Computer Programming the IBM System/360 Computer, Introduction</p> <p>DRAFTING Aircraft Drafting Architectural Drafting Design Drafting Drafting Technology Electrical Drafting Electronic Drafting Introductory Mech. Drafting Mechanical Drafting Pressure-Vessel and Tank Print Reading</p>
<p>ART Amateur Artist Commercial Art Commercial Cartooning Illustrating with Oil: Magazine —Advertising Layout and Illustration Interior Decorating Oil Painting for Pleasure</p>	<p>CHEMICAL Chemical Analyst Chemical Engineering Chemical Laboratory Techn. Chemical Process Equip. Design & Operation Chemical Process Operator Elements of Nuclear Energy General Chemistry Instrumental Laboratory Analysis</p> <p>CIVIL ENGINEERING Civil Engineering Construction Eng'g Tech. Highway Engineering Tech. Principles of Surveying Reading Highway Bl'pr's Reading Structural Bl'pr's Sanitary Engineering Tech. Sewage Plant Operator Structural Eng'g Tech. Surveying and Mapping Water Works Operator</p> <p>COMPUTERS Fundamentals of Computer Programming COBOL Programming Fortran Programming for Engineers Programming for Digital Computers Programming the IBM 1401 Computer Programming the IBM System/360 Computer, Introduction</p> <p>DRAFTING Aircraft Drafting Architectural Drafting Design Drafting Drafting Technology Electrical Drafting Electronic Drafting Introductory Mech. Drafting Mechanical Drafting Pressure-Vessel and Tank Print Reading</p>
<p>ACCOUNTING Accounting (U.S.A.) Accounting (Canadian) Accounting for Business Programmers Accounting for Man'g'm't Decisions Auditing Business Law (U.S.A.) Canadian Business Courses Cost Accounting CPA Review (U.S.A.) General Accounting Income Tax (U.S.A.) Industrial Accounting Junior Accounting Office Accounting Practical Accounting Public Accounting Small Business Accounting (U.S.A.) Starting and Managing a Small Bookkeeping Service (U.S.A.)</p>	<p>BUSINESS Advertising Business Administration Business Practice (Cont'd.) Canadian Business Course Direct Mail and Mail Order Advertising Industrial Psychology Inventory Control Magazine & Newspaper Advertising Managing a Retail Business Managing a Small Store Marketing Management Marketing Research Modern Exec. Management Office Automation Office Management Production Management Purchasing Agent Retail & Local Advertising Retail Bus. Management Retail Merchandising Retail Selling Systems and Procedures Analysis</p> <p>BUSINESS: SALES Creative Salesmanship Real Estate Salesmanship Salesmanship Sales Management</p>

BUSINESS:
SUPERVISION
Advanced Management
Basic Management
Industrial Foremanship
Industrial Supervision
Management, Salesmanship and Sales
Modern Woman as a Supervisor
Personnel Development
Personnel-Labor Relations (U.S.A.)
Supervision

CHEMICAL
Chemical Analyst
Chemical Engineering
Chemical Laboratory Techn.
Chemical Process Equip. Design & Operation
Chemical Process Operator
Elements of Nuclear Energy
General Chemistry
Instrumental Laboratory Analysis

CIVIL ENGINEERING
Civil Engineering
Construction Eng'g Tech.
Highway Engineering Tech.
Principles of Surveying
Reading Highway Bl'pr's
Reading Structural Bl'pr's
Sanitary Engineering Tech.
Sewage Plant Operator
Structural Eng'g Tech.
Surveying and Mapping
Water Works Operator

COMPUTERS
Fundamentals of Computer Programming
COBOL Programming
Fortran Programming for Engineers
Programming for Digital Computers
Programming the IBM 1401 Computer
Programming the IBM System/360 Computer, Introduction

DRAFTING
Aircraft Drafting
Architectural Drafting
Design Drafting
Drafting Technology
Electrical Drafting
Electronic Drafting
Introductory Mech. Drafting
Mechanical Drafting
Pressure-Vessel and Tank
Print Reading

Sheet Metal Layout for Air Conditioning
Structural Drafting

ELECTRICAL
Electrical Engineering
—Electronics Option
—Power Option
Electrical Appliance Ser.
Electrical Appliance Ser. with Equipment Training
Electrical Contractor
Electrical Engineering Tech.
Electrical Home Maint.
Electrical Home Maint. with Equipment Training
Electrical Instrument Tech.
Electric Motor Repairman
Industrial Electrical Techn.
Industrial Electrician
Industrial Maintenance Electrician

Power-Line Design and Construction
Power Plant Operator
—Hydro Option
—Steam Option
Practical Electrician
Practical Electrician with Equipment Training
Practical Lineman
Reading Elec. Blueprints

ENGLISH AND WRITING
Better Business Writing
English for Spanish (U.S.A.)
Free Lingo Writing for Fun and Profit
Introductory Tech. Writing
Modern Letter Writing
Practical English
Reading Improvement
Short Story Writing

HIGH SCHOOL
High School Business
High School (Canadian)
High School General
High School Mathematics
High School Secretarial
High School Vocational
High School College Preparatory—Arts
High School College Prep—Engineering and Science
Preparatory Course for High School Equivalency Test

MACHINE SHOP PRACTICE
Grinder Operator
Industrial Metallurgy
Lathe Operator
Machine Shop Inspection
Machine Shop Practice

Metallurgical Eng'g Tech.
Multicraft Maintenance
Mechanic
Practical Millwrighting
Reading Shop Prints
Rigging
Tool & Die Making
Tool Engineering Tech.
Welding Engineering Tech.
Welding Process

MATHEMATICS
Advanced Mathematics
Math and Mechanics for Engineering Technicians
Math and Physics for Engineering Technicians
Modern Elementary Statistics

MECHANICAL
Mechanical Engineering
Aircraft and Power Plant Mechanic
Hydraulic and Pneumatic Power
Industrial Engineering
Industrial Eng'g Tech.
Industrial Instrumentation
Machine Design
Quality Control
Safety Engineering Tech.
Tool Design
Vibration Analysis and Control

PETROLEUM
Natural Gas Production and Transmission
Oil Well Servicing
Petroleum Production
Reading Improvement
Petroleum Production
Engineering Technology
Petroleum Refinery Oper.

PLASTICS
Plastics Technician

PLUMBING, HEATING AND AIR CONDITIONING
Air Conditioning
Air Conditioning Maint.
Domestic Heating with Gas and Oil
Heating
Heating & Air Conditioning with Drawing
Industrial Air Conditioning
Pipe Fitting
Plumbing
Plumbing and Heating
Plumbing & Heating Est.
Practical Plumbing
Refrigeration and Air Conditioning Servicing

PULP AND PAPER
Paper Machine Operator
Paper Making
Pulp Making
Pulp & Paper Eng'g Tech.

SECRETARIAL
Clerk-Typist
Commercial Secretary, Engineering Sec'y, Legal Sec'y, Medical Secretary, Professional Shorthand
Stenographic Typewriting

STEAM AND DIESEL POWER
Boiler Inspector
Industrial Building Eng'r
Power Plant Engineering
Stationary Diesel Engines
Stationary Fireman
Stationary Steam Eng'g

TEXTILES
Carding and Spinning
Dyeing and Finishing
Loom Fixing
Textile Designing
Textile Mill Superintendent
Textile Mill Supervision

TRAFFIC
Motor Traffic Management
Traffic Management

TV-RADIO-ELECTRONICS
Cable TV Installer
Electronics Technician
Fundamentals of Electronic Computers

General Electronics
General Electronics with Equipment Training
Hi-Fi Stereo and Sound System Servicing
Industrial Electronics
Numerical Control Electronics & Maint.
Radio & TV Servicing
Radio & TV Servicing with Equipment Training
Solid State Electronics
Telephony

APPROVED FOR VETERANS FOR TUITION REFUND
Accredited member, National Home Study Council.
Easy pay-as-you-learn plan.
Special rates to members U.S. Armed Forces.

CIRCLE NO. 3 ON PAGE 17

KEEP PACE WITH SPACE AGE! SEE SPACE FLIGHTS, LANDINGS CLOSE-UP!

AMAZING SCIENCE BUYS for FUN, STUDY, or PROFIT

EXPERIMENTAL FUN WITH TESLA COIL



Now perform spectacular experiments without wires... as Nicola Tesla did 70 yrs. ago. Generator with coil, etc. transmits extremely high frequency electromagnetic radiation (millions of cycles per second)—through space—ionizes gases, performs total of 21 fascinating experiments. Incl. Neon Lamp, discharge electrode, 2 radiation antenna plates. Generates 5,000 V. for 110 V. 60-AC. Meas. 6" x 6". Order #70.301EK \$47.75 Ppd. Stock No. 70.301EK

LOW COST TREASURE FINDER



Discover the fun and profit of treasure hunting inexpensively. Light as a feather (10 oz.) solid-state metal detector finds hidden coins, jewelry, precious minerals. Distinguishes minerals from metal objects. Great for school, beach, campground or backyard. Requires 9V transistor batt.—works with any common AM transistor radio thus eliminating costly extra circuitry, weight, dangling wires. Adjustable multi-purpose plastic handle reduces immediate area metal—adds to efficiency. No tuning needed. Stock No. 71.395EK \$19.95 Ppd.

Stock No. 71.436EK (w/ Radio)

HELIUM BALLOONS MAKE A "BALL"

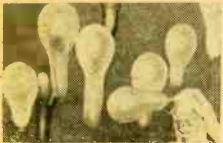

Anytime there's a balloon the air is festive. Especially when the "air" is helium, which makes a balloon perk up and adventurous. Now here's 25 times the fun—25 various colored balloons of 4, 5, or 6" diameter, when inflated. With them, a pressurized (300 lbs./sq. in.) can containing 25 liters of helium to inflate all 25. For adults or kids' parties, giveaways, bazaars or just demonstrating "lighter than air". Helium is a safe non-toxic inert gas. Stock No. 71.289EK \$3.00 Ppd.

NEW! ELECTRONIC DIGITAL COMPUTER KIT!



Solve problems, play games, predict weather with this actual working model of giant electronic brains. Amazing new fun way to learn all about computer programming... logic, decimal, binary systems, Laws of Sets—over to your own programming after completing simplified 116 page instructive booklet. Includes step-by-step assembly diagrams. Circuits easily changed. Readout from illuminated control panel. Req. 2 "D" batt. (not incl.). Best model we've seen—for home, school, industry.

No. 71.434EK (11"X12"X4") \$31.50 Ppd.

1ST LOW-COST VACUUM PUMP!



Nothing like it! Top-quality hand-held pump produces & maintains 25" of vacuum. Has instant release tab, 1 1/8" diam. stainless gauge (0-30"). 100's of uses—siphon noxious liquids, evacuate bell jars and castings, clean, retrieve, lift sterile objects, demonstrate Magdeburg hemispheres, live fuel lines check leaks, etc. Lifts 40 lbs. with included "T" Lifter (2 1/2" diam. cup)—much more w/ larger cup. Stock No. 71.300EK \$12.00 Ppd. No. 71.300EK (without gauge lifter) \$5.50 Ppd.

AMAZING NEW Wankel Engine KIT!



Thrill to the fun of building your own see-through motorized model of revolutionary pistonless type engine. Only engine experts think economically modifiable to meet new pollution standards. Replaces piston, cylinder, crank assemblies with rotating discs (sections removed for firing chambers). Smaller than conventional; fewer parts, greater reliability, same speed w/ less horsepower. Feat. flashing plugs, rubber fan belt, stick-shift on-off switch. Req. 2-1.5V batt. (not incl.).

No. 71.424EK (4 1/2" X 9") \$6.75 Ppd.

VISIT OUR RETAIL STORE!

5 minutes from Jersey Turnpike Exit #3. 15 min. to Phila., either bridge. See 4,000 unusual bargains, plus exclusive Store Sale Items. FREE Light Show every afternoon. Store Hours: Mon.—Thurs. 8 to 6; Fri. & Sat. 8 a.m. to 9 p.m.; Sun. 11 to 6.

Order by Stock No.—Check or M.O.—Money-Back Guarantee
EDMUND SCIENTIFIC CO., 300 EDCORP BLDG., BARRINGTON, N.J. 08007

WRITE FOR FREE GIFT CATALOG

148 PAGES!—1000's OF BARGAINS

EDMUND SCIENTIFIC CO., 300 EDCORP BUILDING, BARRINGTON, NEW JERSEY 08007. Completely new edition. New items, categories, illustrations. Dozens of electrical and electronic parts accessories. Enormous selection of unique lighting items. Astronomical Telescopes, Microscopes, Binoculars, Magnifiers, Magnets, Lenses, Lenses, Prisms. Many war surplus items for hobbyists, experimenters workshop, factory. WRITE FOR CATALOG "EK."

EDMUND SCIENTIFIC CO. 300 EDCORP BLDG., BARRINGTON, NEW JERSEY 08007
ORDER BY STOCK NUMBER • NEW CHECK OR MONEY ORDER • MONEY-BACK GUARANTEE

CIRCLE NO. 4 ON PAGE 17

elementary Electronics

INCLUDING SCIENCE AND ELECTRONICS

Sept./Oct. 1971 Vol. 11/No. 4
Dedicated to America's Electronics Hobbyists

Editor-in-Chief

JULIAN M. SIENKIEWICZ, WA2CQL

Associate Editor

ROBERT WOLLINS

Technical Editor

STEPHEN B. GRAY

News Editor

CAROL J. BRUCKNER

Citizens Band Editor

KATHI MARTIN, KA1Ø614

Workbench Editor

HANK SCOTT

Art Editor and Art Director

JIM MEDLER

Cover Art Director

IRVING BERNSTEIN

Assistant Art Director

ANDY STEIGMEIER

Art Associate

BARBARA ALTMAN

ANTONY BARONOWSKI

Advertising Director

DAVID J. MILLER

Production Director

CARL BARTEE

Production Manager

GERTRUD BORCHARDT

Assistant Production Manager

MARILYN VARGAS

Subscription and Marketing Manager

ROGER G. CAVANAGH

Newsstand Circulation Director

DON GABREE

Instruments Division Manager

WILFRED M. BROWN

Chairman of the Board

B. G. DAVIS

President and Publisher

JOEL DAVIS

Vice-President and General Manager

LEONARD F. PINTO

Vice President and Treasurer

VICTOR C. STABILE, KBPØ681

ELEMENTARY ELECTRONICS is published bi-monthly by Science & Mechanics Publishing Co., a subsidiary of Davis Publications, Inc. Editorial, Business and Subscription offices: 229 Park Avenue South, New York, N.Y. 10003. One-year subscription (six issues)—\$3.95; two-year subscription (12 issues)—\$11.95; three-year subscription (18 issues)—\$15.95; and four year subscription (24 issues)—\$19.95. Add \$1.00 per year for postage outside the U.S.A. and Canada. Advertising offices: New York, 229 Park Avenue South, 212-OR 3-1300; Chicago, 520 N. Michigan Ave., 312-527-0330; Los Angeles, J. E. Publishers' Rep. Co., 8560 Sunset Blvd., 213-659-3910; Long Island; Len Oxen, 9 Garden Street, Great Neck, N.Y., 516-487-3305; Southwestern advertising representative: Jim Wright, 818 Olive St., St. Louis, 314.CH-1-1965. Second-class postage paid at New York, N.Y. and at additional mailing office. Copyright 1971 by Science and Mechanics Publishing Co.

DX central reporting

A world of SWL info!

By Don Jensen

A common problem, and a particularly vexing one for SWL's, is accurate frequency determination. One of the biggest failings of shortwave receivers, including some of the more expensive models, is that the dial markings often are virtually useless.

On many receivers it's hard to tell if you're tuned to 9,600, 9,650, or even, 9,700 kHz. And, how can you find a station on, say, 6,145 kHz, when your set's dial is marked with only a few vague reference points?

Sure, a carload of cash will solve the problem. You can buy a costly receiver with direct frequency readout to the nearest kilohertz. Or, if you're lucky enough to find one and don't mind denting the wallet, you can pick up a surplus frequency meter to pinpoint the reading for you.

But there's a simple method that will cost you only pence and provide a pound of cure! The poor man's frequency meter is nothing more than a series of easy-to-make graphs, one for each of the major SWBC bands.

The graph technique will work with any receiver with a bandspread, or fine tuning, dial. Normally this is calibrated only for the ham bands, which doesn't help the typical shortwave (Continued on page 10)

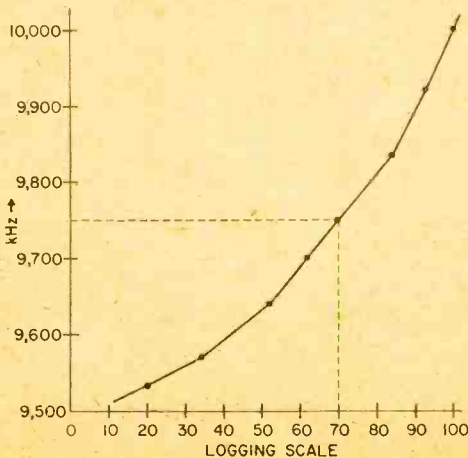

CALL ME!



I'll send you 2 FREE BOOKS describing the opportunities in Electronics. Call me TOLL-FREE **800-321-2155** (in Ohio, call 800-362-2105).

For details about the famous CIE home-study courses in Electronics, see our ad on page 104

Cleveland Institute of Electronics
1776 East 17th Street, Cleveland, Ohio 44114

new deluxe

CB MINI-BEAM

Gamma 323 Miniature 3-Element CB Beam

with deluxe coils -

Mosley

Mini-Size, Mini-Cost,

Maxi-Performance.

Sound too good to

be true? Get the

whole story . . .

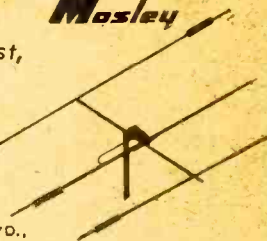

4610 N. LINDBERGH BLVD.,
BRIDGETON MO. 63042

Please send me FREE information about the new Mosley Deluxe Mini-Beam.

Name _____

Address _____

City/State _____ Zip _____

#173A

Mosley Electronics Inc. 4610 N. Lindbergh Blvd.,
Bridgeton Missouri 63042

CIRCLE NO. 5 ON PAGE 17

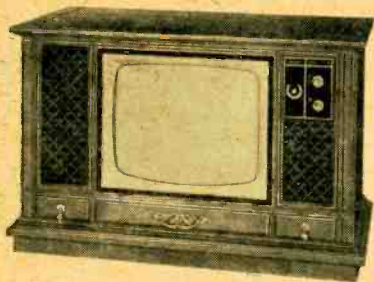

23" GR-370

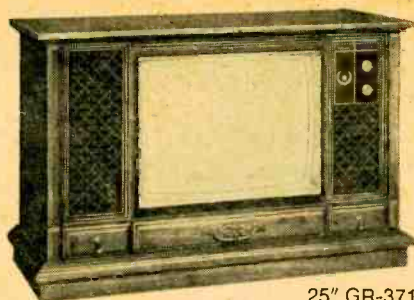

25" GR-371MX



20" GR-270

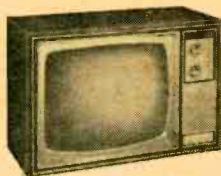

18" GR-269



14" GR-169

There's a Heathkit® solid-state color TV to fit every size and budget need. Think about it.

Consider the choice. Heath offers five different solid-state color TV's in easy-to-assemble kit form, from the portable 14" GR-169 to the largest screen in the industry, the 25" GR-371MX. All offer Heath's famous modular plug-in circuit board design that makes assembly easier. Only two tubes (picture and high voltage rectifier). And Heathkit color TV's are the only sets available at any price that can be serviced by the owner, without special test

equipment or years of training. The famous Heath manual, combined with the special volt-ohm meter supplied, enables you to perform every adjustment required. And each set includes the No-charge 90-day Warranty Service on solid-state modules and 2 year picture tube warranty. Here's the rundown on the Heath series of solid-state color TV's. Think them over, you'll find one just right for your own size and budget requirements.

25" GR-371MX . . . the top of the Heath color TV line. Compare this list of standard features on the 371MX . . . there isn't another set available that offers all these extras at no extra cost. Giant 25" Matrix picture tube delivers the biggest, brightest color picture you'll ever see . . . 315 sq. in. And pictures don't wrap around the sides as before. Specially formulated etched-glass face plate cuts out glare, increases contrast without reducing brightness. Automatic Fine Tuning delivers perfectly tuned picture and sound with a push of a button. "Instant On" circuitry provides sound instantly, picture in seconds. Exclusive Heath MOSFET VHF tuner gives superior reception, even under marginal conditions. VHF Power Tuning is built-in . . . a push of a button lets you scan thru all VHF and one preselected UHF channel. High resolution circuitry improves picture clarity and adjustable video peaking lets you select the degree of sharpness you desire. Adjustable tone control . . . adjustable noise limiting and gated AGC . . . hi-fi sound output . . . 75 & 300 ohm VHF antenna inputs . . . Automatic Chroma Control — all standard. Plus three luxurious optional cabinets to choose from: Mediterranean, Early American or Contemporary. Plenty of reasons to order your new GR-371MX now.
Kit GR-371MX, (less cabinet), 125 lbs. \$579.95*

23" GR-370. Actually the GR-371MX with a smaller picture tube. Features a premium quality bonded face, etched-glass 23" screen . . . 295 sq. in. of viewing enjoyment. Includes the same standard

high performance features as the 371MX above, except the Matrix picture tube is a low cost option.
Kit GR-370 (less cabinet) 127 lbs. \$539.95*
Kit GR-370MX, as above with Matrix picture tube \$549.95*

20" GR-270. In reality, the feature-packed GR-371MX with standard 20" bonded-face, etched-glass picture tube providing 227 sq. in. of colorful TV viewing. See the GR-371MX above for all the other standard features. Easily your best buy in a medium size solid-state color TV, and ideal screen size for smaller living rooms.
Kit GR-270 (less cabinet), 114 lbs. \$489.95*

18" GR-269 . . . the Heathkit "compact" color TV. Has the same highly sophisticated modular solid-state circuitry as the GR-371MX, but modified to accept the popular 180 sq. in. color picture tube. Features AFT, "Instant On", 3-stage IF, MOSFET VHF tuner, switch-controlled degaussing . . . all standard.
Kit GR-269, (less cabinet), 100 lbs. \$399.95*

14" GR-169 delivers console performance with portable convenience. Here's the GR-371MX modular circuitry modified slightly to accept a 14" diagonal picture tube. Features MOSFET VHF tuner, 3-stage IF, switch-controlled degaussing, complete up-front secondary controls, built-in VHF & UHF antennas. Handsome portable cabinet included.
Kit GR-169, 69 lbs. \$349.95*



TO-101 Legato Theater Organ



IO-102 5" Scope



IB-101 Frequency Counter

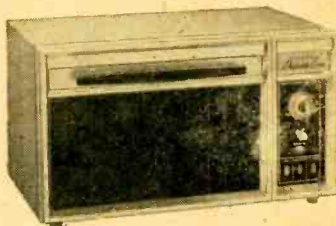

GD-29
Microwave
Oven

And here are a few of the more than 300 other Heathkit thoughts for the budget minded:

New Heathkit "Legato" 25-pedal Theater Organ. Now you can save hundreds of dollars by building this versatile instrument yourself. All solid-state design. Features 15 manual voices, 4 pedal voices. 25-note heel & toe pedal board, range 16' & 8' CO to C3. Two 44-note keyboards; accompaniment range 8', F1 to C5. Solo manual 16', 8', 4', 2', F1 to C7. Color-Glo key lights have you playing like a pro in minutes. Two solid-state amplifiers deliver 200 watts peak power . . . one amp for the rotating 2-speed Leslie, one for the two 12" main speakers. Tape record/playback jack on amp. Bandbox & Playmate accessories available. Bench included.

Kit TO-101, 299 lbs. \$1495*

New Heathkit Microwave Oven . . . tomorrow's cooking revolution here today in easy-to-build kit form. Exclusive patent pending Heath double door interlock prevents oven from being turned on if door is open. Cooks meals in minutes, not hours . . . eliminates dirty pots & pans by cooking on paper, glass, china. Low profile design fits nearly anywhere. 120 V operation.

Kit GD-29, 97 lbs. \$379.95*

New Heathkit 5" Solid-State Scope . . . ideal for all general lab

& shop applications. Wide 5 MHz response, 80 nanosecond rise time and 30 mV/cm sensitivity make the IO-102 a truly high performance, low cost scope. Convenient switch-selected AC or DC coupling. Frequency-compensated 3-position attenuator, FET input provides high input Z (1 megohm) to minimize circuit loading. Recurrent, automatic sync type sweep provides 5 ranges from 10 Hz to 500 kHz with vernier. External horizontal and sync inputs. One volt P-P output. New flat face 5" CRT with removable 6x10 cm ruled graticule. Zener-regulated power supplies give excellent display stability. 120/240 VAC operation. Choose easy to assemble kit or factory-wired version.

Kit IO-102, 29 lbs. \$119.95*

Assembled IOW-102, 29 lbs. \$179.95*

Assembled PKW-101, 1 megohm probe, 1 lb. \$ 19.95*

New Heathkit Solid-State Frequency Counter . . . delivers highly accurate measurement from 1 Hz to over 15 MHz. All IC circuitry for top performance. Automatic trigger level for wide range input without adjustment. Hz/kHz ranges & overrange give 8-digit capability. 1 megohm input Z.

Kit IB-101, 7 lbs. \$199.95*

See these and 300 other Heathkit suggestions at one of the following Heathkit Electronic Centers:

CALIFORNIA: Anaheim, 92805, 330 E. Ball Road; El Cerrito, 94530, 6000 Potrero Avenue; La Mesa, 92401, 8363 Center Drive; Los Angeles, 90007, 2309 S. Flower St.; Redwood City, 94063, 2001 Middlefield Rd.; Woodland Hills, 91364, 22504 Ventura Blvd.; COLORADO: Denver, 80212, 5940 W. 38th Ave.; GEORGIA: Atlanta, 30305, 5285 Roswell Road; ILLINOIS: Chicago, 60645, 3462-66 W. Devon Ave.; Downers Grove, 60515, 224 Ogden Ave.; MARYLAND: Rockville, 20852, 5542 Nicholson Lane; MASSACHUSETTS: Wellesley, 02181, 165 Worcester St.; MICHIGAN: Detroit 48219, 18645 W. Eight Mile Rd.; MINNESOTA: Hopkins, 55343, 101 Shady Oak Rd.; MISSOURI: St. Louis, 63123, 9296 Gravois Ave.; NEW JERSEY: Fair Lawn, 07410, 35-07 Broadway (Rte. 4); NEW YORK: Jericho, L.I., 11753, 15 Jericho Turnpike; New York, 10036, 35 W. 45th Street; OHIO: Cleveland, 44129, 5444 Pearl Rd.; Woodlawn, 45215, 10133 Springfield Pike; PENNSYLVANIA: Philadelphia, 19149, 6318 Roosevelt Blvd.; Pittsburgh, 15225, 3482 William Penn Hwy.; TEXAS: Dallas, 75201, 2715 Ross Avenue; Houston, 77027, 3705 Westheimer; WASHINGTON: Seattle, 98121, 2221 Third Ave.; WISCONSIN: Milwaukee, 53216, 5215 W. Fond du Lac

Retail Heathkit Electronic Center prices slightly higher to cover shipping, local stock, consultation and demonstration facilities. Local service also available whether you purchase locally or by factory mail order.



HEATH COMPANY, Dept. 139-9
Benton Harbor, Michigan 49022 a Schlumberger company

Enclosed is \$ _____, plus shipping

Please send model(s) _____

Please send FREE Heathkit Catalog.

Name _____

Address _____

City _____ State _____ Zip _____

Prices & specifications subject to change without notice.
*Mail order prices; F.O.B. factory.

CL-410R

CIRCLE NO. 6 ON PAGE 17

IDENTICAL TWINS



Professional or CB...we use identical components. You get identical performance.

Police communicators demand the things you want in a mobile antenna. Maximum range. Reliability. Long life. That's why A/S mobile CB antennas are built exactly like their professional counterparts—used by 9 out of 10 police vehicles. Put John Law's experience to work in your mobile.

M-176 Quick Grip®
CB antenna. Only

\$21.95

(suggested resale).



Be an "antenna specialist!" These top quality jackets with safety reflector stripes available only from your A/S dealer—just \$8.95.

the antenna specialists co.



"Stripes of Quality"

Div. of **allen** Electric & Equipment Co.
12435 Euclid Ave., Cleveland, Ohio 44106

EXPORT: 220 Shames Dr., Westbury, L.I., New York 11690
CANADA: A. C. Simmonds & Sons, Ltd.

CIRCLE NO. 7 ON PAGE 17

DX CENTRAL REPORTING

(Continued from page 7)

broadcast DXer. But, in addition, there's usually a logging reference scale, marked from 0 to 100.

To show you how the graph system works, let's start with the 31-meter band. On a sheet of graph paper, label the vertical scale, "kHz", the horizontal one, "Logging", as shown in the illustration. With the bandspread pointer set at 100, use the main tuning to find WWV, the standard time and frequency station on 10,000 kHz, at the top of the band. On the graph, plot the point corresponding to 10,000 kHz and a logging scale reading of 100. Then tune about eight or ten other stations, whose frequencies are known to you or which are announced on the air. Similarly plot points for each of these key stations. Connect these dots with a line, which may be curved or straight, depending on the linearity of your receiver's tuning.

To use the graphs to determine frequency, first be sure that you tune the band so your key reference stations line up precisely where they should on the logging scale. Do this by setting the bandspread pointer to the proper logging scale number and adjust the main tuning until you find the station. Now you're set up to determine any frequency on the band.

When you run across a station whose frequency you want to know, note the logging scale reading. On your 31-meter band graph, move upward from that point until you intersect the curve, then read laterally to the left to find the frequency.

Make similar graphs for the other SWBC bands. If you make and use them carefully, you should be able to read frequencies to within less than five kilohertz.

Tip Topper. It's north to Alaska for this month's Tip Topper? A number of readers have been asking how to log Alaska on shortwave. Well, it can be done, but only if you stray from the normal broadcast bands and try the utility service frequencies. For though Alaska has no shortwave broadcasting stations, there is Anchorage Radio, an aeronautical weather service for jets flying the Pacific and polar routes.

Twice an hour, day and night, Anchorage Radio broadcasts five minute Volmet (aero weather) reports on 2,980, 5,519 and 8,905 kHz. These often can be heard in the U.S., despite the low transmitter powers of three kilowatts. The station is assigned the call, KIS70, but voice announcements are simply, "Anchorage Radio."

Try tuning at 25 and 55 minutes past the hour, especially during the pre-dawn hours. And, as a bonus, if you stick to the same frequencies for at least a half hour, you'll probably hear similar Volmet transmissions from Oakland, California, and Honolulu, and perhaps even Hong Kong and Tokyo. (turn to p. 12)

Only RCA Institutes offers you all these advantages:

1 A broad range of courses to help you qualify for good-paying jobs in such rewarding fields as communications, color TV servicing, automation, nuclear instrumentation, space electronics, drafting, computer programming.

2 RCA's exclusive Autotext training method—the easy, faster, simplified way to learn electronics at home.

3 Personal supervision throughout your training.

4 Over 250 experiments and up to 22 kits in some programs

5 Easy monthly payment plan.

6 Over 60 years of leadership in technical training.

7 Recognition from leaders in the field as an RCA Institutes graduate.

Veterans can train under new GI Bill. Licensed by the State of New York. Accredited Member National Home Study Council.

Courses available in Canada too.

If you've ever thought about getting into electronics...

you owe it to yourself to see what RCA home training has to offer.

This entire fold-over coupon makes a no-postage-required business-reply envelope. Fill in your name and address ... then cut out along dotted lines... fold, seal and mail.

246-009-9

RCA INSTITUTES, Inc., Home Study School
320 West 31st St., New York, N. Y. 10001

Please send me free illustrated home study career catalog.

Name _____ Age _____

(please print)

Address _____

City _____ State _____ Zip _____

Check here if interested in Classroom Training.

Veterans check here

NO STAMP NEEDED

You must seal (Staple, tape or glue) before mailing.

FOLD HERE

DO NOT CUT HERE

FIRST CLASS

Permit No. 10662
New York, N. Y.

BUSINESS REPLY MAIL

No Postage Necessary if Mailed in United States

Postage will be paid by

RCA INSTITUTES

Home Study School
320 West 31st St.
New York, N. Y. 10001

246-009-9

CIRCLE NO. 8 ON PAGE 17

pliers pliers pliers



ALL THE TYPES YOU NEED IN A FULL RANGE OF SIZES.

From 4" miniature electronics to 10" utility. Precision made in USA. Forged alloy steel construction. Cleanly milled, perfectly aligned jaws. Hand-honed, mated cutting edges. Most with Cushion Grip handles.

NOW INCLUDING



- 5" Bent Thin Chain Nose.
For handling fine wires in close quarters. No. 79CG
- 5½" Thin Needle Nose.
For firm gripping and looping of wires. No. 57CG
- 4" Full Flush Cutting Diagonals.
Snap cuts to the extreme tip. No. 84CG
- 5" Midget Slip Joint.
Narrow jaws for close quarters. 3 openings to ½". No. 50CG

nationwide availability through local distributors



XCELITE, INC. • 80 BANK ST., ORCHARD PARK, N. Y. 14127
Send Catalog with information on Xcelite Pliers.

name _____
address _____
city _____ state & zip _____

CIRCLE NO. 9 QN PAGE 17

DX CENTRAL REPORTING

(Continued from page 10)

Anchorage Radio will QSL your reception report if you send it to International Flight Service Station, Federal Aviation Administration, 201 East 5th Avenue, Anchorage, Alaska 99501.

Bandsweep. Times in GMT: 780 kHz—Not far from Puerto Rico there's a little piece of Britain in the Caribbean, the island of Tortola. East coasters, in particular, may find Tortola's medium wave outlet, ZBVI, coming through surprisingly well some mornings around 1000 sign on . . . 4.800 kHz—Here's a toughy! Radio Lesotho, a rare DX bird from southern Africa, has been logged evenings from around 0400 to 0500, most in native lingo. The signal is fairly strong, but heavy radioteletype interference makes for problems. . . . 4.945 kHz—You've heard South Africa's overseas service, Radio RSA. Now try for the harder-to-hear home program, in English and Afrikaans, during the mid-evening hours. . . . 6.250 kHz—There isn't too much competition this high on the 49 meter band, so sometimes Radio Cuzco, in the Peruvian Andes, can be logged with Spanish programming . . . 7.235 kHz—Not as rare as it once was, the Solomon Islands Broadcasting Service is still a nice catch. Tune for this one around 0900. . . . 9.351 kHz—Don't expect strong signals, but Red China's standard time station, BVP, Shanghai, can be heard "beeping" the minutes away around 1155. . . . 11.835 kHz—Uruguay is often a tough country to log. But listen on this frequency around 0200 for Radio Espectador. Programming is in Spanish, of course. . . . 15.170 kHz—A new 20 kw. station at Papeete, Tahiti, has been booming in nightly from 0300 sign on. It switches to French programming at 0500, but the initial two hours of the schedule, with exotic Tahitian music, is far more interesting.

(Credits: A. V. Sizer, Conn.; John Boesse-necker, Cal.; Gerry Dexter, Wis.; Chris Lobdell, Mass.; Gladys Martin, Brooklyn, N.Y.; Richard E. Wood, La.; Midwest DX Club, 6636 Davis Street, Morton Grove, Ill., 60653; National Radio Club, P. O. Box 99, Cambridge, Mass., 02138; North American SW Association, P. O. Box 989, Altoona, Pa., 16603)

Backtalk. Some anonymous wag, who understandably left his letter unsigned, sends along this list of improbable radio stations:

"Tonight I logged XEROX, Radio Duplicado, a Mexican, naturally. Also putting in a good signal was HISS in the Dominican Republic. It's slogan is La Voz de la Viper! Then there was Radio Procrastinado in Nicaragua, YNOW. Get it, Why Now?"

Ok, ok, you don't have to draw me a picture! But top this one if you can! In the DX Central shack we just pulled in one on the 20 meter ham band. It's operated by the amateur radio

Continued on page 96

ELEMENTARY ELECTRONICS

The look, feel, and sound of tomorrow's CB radio...

New "black out" panel — comes alive when radio is turned on with large illuminated numbers for instant channel recognition.

Punch-button on/off and PA controls let you leave volume and squelch setting undisturbed — ready to operate without readjustment.

Punch-button control lets you go from channel 2 to 22 in one second flat! You can "program" up to five citizens radio channels for *instant action*. Even lets you select channels by touch — without taking your eyes off the road.

New ceramic selectivity filter drastically reduces adjacent channel "bleed over" even from powerful nearby stations.



"Linear action" volume and squelch replace conventional knobs — for faster, more responsive control.

Special Johnson voice tailored audio circuits combined with the new acoustically isolated speaker — for the clearest sound you've ever heard from a built-in speaker

Johnson's exclusive voice compression circuitry increases average power output *without distortion* ... for the most penetrating signal on-the-air!

Here today in the all new Messenger 121!

From the engineering that brought you the famous Messenger 100 ... a new generation of citizens radio equipment, with even greater performance, designed for the serious operator who knows his radios. Look at the features! Everything about the new Messenger 121 has been designed for better control — faster action — unmatched performance.

At your local dealer now for just **\$119.95** suggested price.
Complete with channel 11 crystals, mobile mounting bracket, and microphone.



E. F. JOHNSON CO.

Waseca, Minn. 56093

Johnson Quality — backed by over 500 authorized service centers nationwide.

CIRCLE NO. 21 ON PAGE 17

CALL ME!



I'll send you 2 FREE BOOKS describing the opportunities in Electronics. Call me TOLL-FREE **800-321-2155** (in Ohio, call 800-362-2105).

For details about the famous CIE home-study courses in Electronics, see our ad on page 104

Cleveland Institute of Electronics
1776 East 17th Street, Cleveland, Ohio 44114

THOUSANDS OF BARGAINS TOP VALUES IN ELECTRONIC PARTS

Transistors, Modules, C. B., Speaker, Stereo, Hi-Fi, Photo Cells and Thousands of Other Electronic Parts.
Send for FREE Catalogue

ELECTRONIC DISTRIBUTORS INC.



EDI

Dept. TA-2, 4900 Elston
Chicago, Ill. 60630
 RUSH CATALOGUE

Name.....
Address.....
City.....
State..... Zip Code.....

CIRCLE NO. 10 ON PAGE 17

PARTS! CORNELL TUBES!

FREE Send For FREE

CORNELL'S
New Color
Catalog

48 Pgs. New Items

33¢ per tube

IN LOTS OF 100

36¢ per tube

ORDER FREE
IF NOT SHIPPED
IN 24 HOURS!

4219 E UNIVERSITY AVE. SAN DIEGO, CALIF. 92105

CIRCLE NO. 11 ON PAGE 17

"LISTEN IN" TO POLICE-FIRE RADIO CALLS IN YOUR CAR!

WORKS with ANY CAR—Portable or HOME RADIO! Just PLUGS in—No wiring—3 minute hookup! Switch instantly from regular to ALL POLICE-FIRE-EMERGENCY-COMMERCIAL-TAXI-CAB-STATE-CITY-GOV'T 2 way Radio calls in YOUR AREA. DUAL HI-LOW BANDS—66, 50, 150, 175 MHz. OVER a MILLION Radio Cars/stations. USE Everywhere—Anytime—always works!

SEND ONLY \$2.00 (cash Ck. M.O.) and pay post-man \$7.99 plus COD pkg or send \$9.99 for ppd Del in USA. COMPLETE, ready to use with instructions. One Year service Warranty—10 DAY MONEY BACK TRIAL (if retail) AMAZING OFFER good only by mail—WESTERN RADIO Dept. BE-9, KEARNEY, NEBR. 68847



CIRCLE NO. 12 ON PAGE 17

stamp shack

Philatronics Today!

BY ERNEST A. KEHR

●● One of the most unusual stamp sets ever issued was released by Nicaragua on May 15, 1971. The 10 multicolor designs feature as many mathematical equations that are considered to have led to the greatest scientific progress in history.

● The 10-centavo shows an ancient Egyptian holding up two fingers as a pair of hawks flies overhead and "1+1=2" is at the side. Elementary as this equation might seem today, the use of numerals to count had immense consequences for primitive man. It led directly to the science of measurement.

● The 15c is a clever design. Set within half an apple are earth, sun, moon, Saturn, other planets and the heavenly galaxy; "Law of Newton— $f=Gm_1m_2/r^2$ " is at the side. Before Sir Issac Newton's time, folks had not the foggiest idea of what forces held the planets in their orbits around the sun, or what stopped creatures from hurtling off the earth's surface. The discovery of the law of gravity resulted not only in immediate physical understanding but eventually led to man's ability to soar into outer Space and make moon landings.

● The Einstein theory and law ($E=mc^2$) are featured on the 20c value, while the molecular complex of atomic energy is included in an orange mushroom that symbolizes the first blast in New Mexico that resulted from its application.

● The 25c (not shown) has a sextant on ocean waves and poised against the sky with its Big Dipper constellation. This suggests the Law of Napier. It was Napier who gave the world a powerful shorthand system of arithmetic known as logarithms by which multiplication or division could be performed simply by adding or subtracting the logarithms of numbers. It meant that man now could carry out these and more complex operations much faster.

● The impact of logarithms on such sciences as astronomy and navigation were enormous and formed the basis of today's computer revolution.

Ludwig Boltzmann's equation revealed how the behavior of gases depended upon their constantly moving atoms and molecules. Because of the application wherever gases are used in motive power, in modern drugs, plastics and other substances; the understanding of weather, and even violent processes in outer space, his "S-k-log-W" formula is featured on the stamp



ELEMENTARY ELECTRONICS



while its design shows a cross section of a cylinder-driven engine.

● The Pythagorean Theory, which is the subject of the 30c denomination, is the only formula that was previously honored by a postage stamp: that which Greece issued on Aug. 20, 1955. This most widely used theorem in geometry relates to three-sided measurement of right triangles and is responsible for man's ability to survey the land, calculate marine distances and measure buildings' dimensions. The lateral panel shows the equation, $A^2 + B^2 = C^2$, while the main design shows a compass in front of a Greek temple and its floor plans.

● The one-cordoba denomination has a Space craft at liftoff above a fragment of the green earth set within an outline of a lunar module

and two parachutes. It represents the law of Konstantin Tsiolkovski which was developed directly from Sir Isaac Newton's three great laws of motion. It forms the basics for space technology since it gives the changing speed of rockets as they burn away the weight of fuel carried. Without it the launching of Spacecraft would have been impossible.

● Another one-cordoba value pays tribute to the equation of Louis de Broglie which represents the mathematical study of light. It was this law which was used in the development of optical and electronic fields first and later, applied to radio, TV, computers, space conquest and powerful electron microscopes. The design consists of a microscope, console and a rocket set against a lens. (Continued on page 96)



*the tape that
turned the
cassette into
a high-fidelity
medium*



TDK SUPER DYNAMIC (SD) TAPE



TDK

Until TDK developed *gamma ferric oxide*, cassette recorders were fine for taping lectures, conferences, verbal memos and family fun—but not for serious high fidelity.

TDK CASSETTE C-90SD

Today you can choose among high-quality stereo cassette decks.

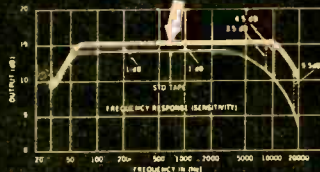

The new magnetic oxide used in TDK Super Dynamic tape distinctively differs from standard formulations in such important properties as coercive force, hysteresis-loop squareness, average particle length (only 0.4 micron!) and particle width/length ratio. These add up to meaningful performance differences: response capability from 30 to 20,000 Hz, drastically reduced background hiss, higher output level, decreased distortion and expanded dynamic range. In response alone, there's about 4 to 10 db more output in the region above 10,000 Hz—and this is immediately evident on any cassette recorder, including older types not designed for high performance. There's a difference in clarity and crispness you can hear.

Available in C60SD and C90SD lengths.

TDK ELECTRONICS CORP.

LONG ISLAND CITY, NEW YORK 11103

CIRCLE NO. 13 ON PAGE 17



LITERATURE LIBRARY

61. Your not receiving like a pro unless you step up with a hot receiver. R. L. Drake Co. model SPR-4 is one communications receiver you should consider—It's a winner.
62. Edmund Scientific's new catalog contains over 4000 products that embrace many sciences and fields.
63. Pick Cornell's Electronics' 10th anni. catalog and discover yesterday prices. Tubes go for 36¢ and 33¢. Plus many other goodies!
64. Allied Radio Shack wants to introduce you to the colorful world of electronics. Discover great buys from wide selections. Get the details from Allied today!
65. It's just off the press—Lafayette's all-new 1971 illustrated catalog packed with CB gear, hi-fi components, test equipment, tools, ham rigs, and more—get your free copy!
66. Get all the facts on Progressive Edu-Kits Home Radio Course. Build 20 radios and electronic circuits; parts, tools, and instructions included.
67. Olson's catalog is a multi-colored newspaper that's packed with more bargains than a phone book has names.
68. Custom Alarms reveals how inexpensive professional alarms can really be. Install one yourself. Circle 3 for exclusive catalog.
69. Pliers galore, from mini-electronic types to hefty 10-in. utilities are listed in Xcelite's hand tool catalog. If there's a wire in your hobby, get this Xcelite Catalog.
70. Troubleshooting without test gear? Get with it—let Accurate Instrument clue you in on some great buys for your test bench.
71. Burstein-Applebee offers a new giant catalog containing 100s of big pages crammed with savings.
72. Here's a free 20-page booklet that tells you how to improve your TV pic and a do-it-yourself approach to installing a Master Antenna TV (MATV) system. Mosley Electronics will wing it your way.
73. RCA Experimenter's Kits for hobbyists, hams, technicians and students are the answer for successful and enjoyable projects.
74. B&F Enterprises has an interesting catalog you'd enjoy scanning. Goodies like geiger counters, logic cards, kits, lenses, etc. pack it. Get a copy!
75. Heath's new 1971 full-color catalog is a shopper's dream. Its 116 pages are chock full of gadgets and goodies everyone would want to own.
76. Get two free books—"How to Get a Commercial FCC License" and "How to Succeed in Electronics"—from Cleveland Institute of Electronics.
77. National Schools will help you learn all about color TV as you assemble their 25-in. color TV kit.
78. You can become an electrical engineer only if you take the first step. Let ICS send you their free illustrated catalog describing 17 special programs.
79. GC Electronics has the part you are looking for! Pick up their free catalog and build again without worry.
80. Free '72 catalog describes 100's of Howard W. Sams books including titles for amateurs, and SWL's on selecting and building antennas, licensing, test gear and other vital subjects.
81. CBers, Hams, SWLs—get your copy of World's Radio Lab's 1971 catalog. Circle 81 now!
82. Hy-Gain's new CB antenna catalog is packed full of useful information. Get a copy.
83. Get your copy of Hallicrafters' "Shortwave Puts You Where It's At." Get started today on shortwave radio for more fun tomorrow!
84. Want a deluxe CB base station? Then get the specs on Tram's super CB rigs.
85. Get the scoop on Versa-Tronics' Versa-Tenna with instant magnetic mounting.
86. Prepare for tomorrow by studying at home with Technical Training International. Get the facts on how to step up in your job.
87. Pep-up your CB rig's performance with Turner's M+2 mobile microphone.
88. CBers, Midland has come up with a neat colorful brochure on their line. Before you buy, check on Midland.
89. CB antenna catalog by Antenna Specialists makes the pickin' easy. Get your copy today!
90. Kit builder? Like wired products? EICO's 1971 catalog takes care of both breeds of buyers at prices you will like.
91. Want some groovy PC boards plus parts for communication projects? Then get a hold of International Crystal's complete catalog.
92. Now available from EDI (Electronic Distributors, Inc.): a catalog containing hundreds of electronic items.
93. Bargains galore, that's what's in store! Poly-Paks Co. will send you their latest 8-page flyer.
94. Get it now! John Meshna, Jr.'s new 96-page catalog is jam packed with surplus buys.
95. Before you build from scratch, check the Fair Radio Sales latest catalog for surplus gear.

ELEMENTARY ELECTRONICS
 Box 886
 Ansonia Station
 New York, N.Y. 10023

Please arrange to have this literature whose numbers I have circled at right sent to me as soon as possible. I am enclosing 25¢ to cover handling. (No stamps, please.)

61	62	63	64	65	66	67	68	69	70
71	72	73	74	75	76	77	78	79	80
81	82	83	84	85	86	87	88	89	90
91	92	93	94	95					

Indicate total number of booklets requested
 Sorry, only 20 circled items maximum.

NAME _____

ADDRESS _____

CITY _____

STATE _____ ZIP _____

Not Valid After March 31, 1972



971

READER SERVICE PAGE

• The Editor of ELEMENTARY ELECTRONICS offers readers an easy way to get additional information about products and services advertised in this issue. Also, if you would like more information about any new product mentioned in our column "Hey, Look Me Over," it's yours for the asking. Just follow the instructions below and the material you requested will be sent to you promptly and at no cost.

• The coupon below is designed for your convenience. Just circle the numbers that appear next to the advertisement or editorial mention that interests you. Then, carefully print your name and address on the coupon. Cut out the coupon and mail to ELEMENTARY ELECTRONICS, Box 886, Ansonia Station, New York N Y 10023. Do it today!

971

Void after March 31, 1972

ELEMENTARY ELECTRONICS

Box 886, Ansonia Station, New York N Y 10023

Please arrange to have literature whose numbers I have circled at right sent to me as soon as possible. I understand that this is a free service offered by the magazine.	1	2	3	4	5	6	7	8	9	10
	11	12	13	14	15	16	17	18	19	20
	21	22	23	24	25	26	27	28	29	30
	31	32	33	34	35	36	37	38	39	40
	41	42	43	44	45	46	47	48	49	50
	51	52	53	54	55	56	57	58	59	60

Name (Print Clearly) _____

Address _____

City _____ State _____ Zip Code _____



nri **firsts**

**make learning
Electronics at home
fast and fascinating —
give you priceless
confidence.**

Some NRI **firsts** in training equipment

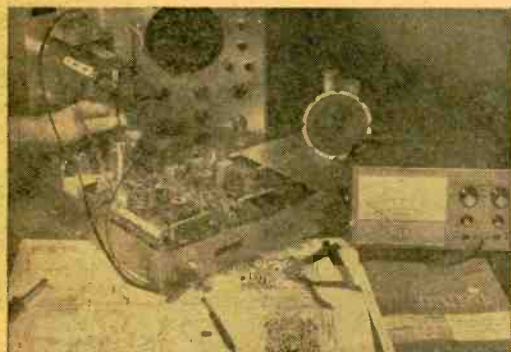

first to give you, Color Television training equipment engineered specifically for education — built to fit NRI instructional material, *not* a do-it-yourself hobby kit. The end product is a superb Color TV receiver that will give you and your family years of pleasure. You "open up and explore" the functions of each color circuit as you build.

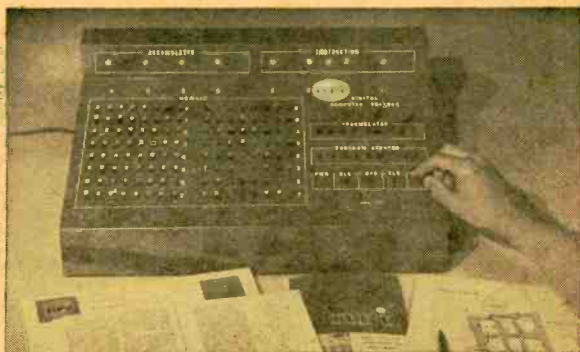

first to give you a unique, exciting digital computer *with memory* built especially for home training. You learn organization, trouble shooting, operation, programming as you build and use it. Performs the same functions as commercial computers. Lessons stress computer repair. You conduct a hundred experiments, build hundreds of circuits. A solid-state VTVM is included among ten training kits.

NRI's "discovery" method is the result of over half a century of leadership simplifying and dramatizing training at home

The FIRSTS described below are typical of NRI's half century of leadership in Electronics home training. When you enroll as an NRI student, you can be sure of gaining the in-demand technical knowledge and the priceless confidence of "hands-on" experience sought by employers in Communications, Television-Radio Servicing and Industrial and Military Electronics. Everything about NRI training is designed for your education . . . from the much-copied, educator-acclaimed Achievement Kit sent the day you enroll, to "bite-size" well-illustrated, easy to read texts programmed with designed-for-learning training equipment.

YOU GET YOUR FCC LICENSE OR YOUR MONEY BACK

There is no end of opportunity for the trained man in Electronics. You can earn \$6 or more an hour in spare time, have a business of your own or qualify quickly for career positions in business, industry, government. And if you enroll for any of five NRI courses in Communications, NRI prepares you for your FCC License exams. *You must pass* or NRI refunds your tuition in full. No school offers a more liberal money-back agreement. The full story about NRI leadership in Electronics training is in the new NRI Catalog. Mail postage-free card today. No salesman is going to call.
NATIONAL RADIO INSTITUTE, Washington, D.C. 20016

APPROVED UNDER NEW GI BILL If you have served since January 31, 1955, or are in service, check GI line on postage-free card.

designed from chassis up for your education

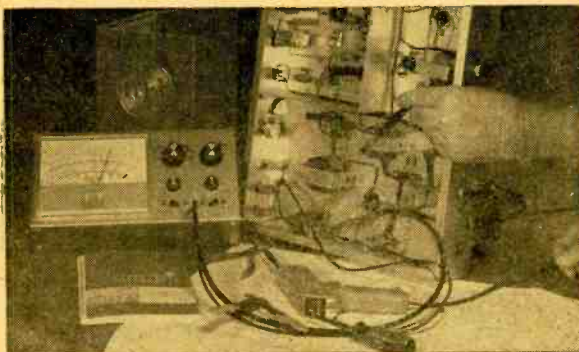

first to give you true-to-life experiences as a communications technician. Every fascinating step you take in NRI Communications training, including circuit analysis of your own 25-watt, phone/cw transmitter, is engineered to help you prove theory and later apply it on the job. Studio equipment operation and troubleshooting become a matter of easily remembered logic.

first to give you completely specialized training kits engineered for business, industrial and military Electronics. Shown above is your own training center in solid state motor control and analog computer servo-mechanisms. Telemetering circuits, solid-state multi-vibrators, and problem-solving digital computer circuits are also included in your course.

CIRCLE NO. 14 ON PAGE 17



Hank Scott, our Workshop Editor, wants to share his project tips with you. Got a question or a problem with a project you're building—ask Hank! Please remember that Hank's column is limited to answering specific electronic project questions that you send to him. Sorry, he isn't offering a circuit design service. Write to:

**Hank Scott, Workshop Editor
ELEMENTARY ELECTRONICS
229 Park Avenue South
New York NY 10003**

Tuning a Single-Channel CB Transceiver

I have an old Gonset G-11 CB transceiver, single-channel transmit and receive. I would like the receiver to be tunable. What circuit would you suggest?

—W.L.H., Rockwood, Mich.

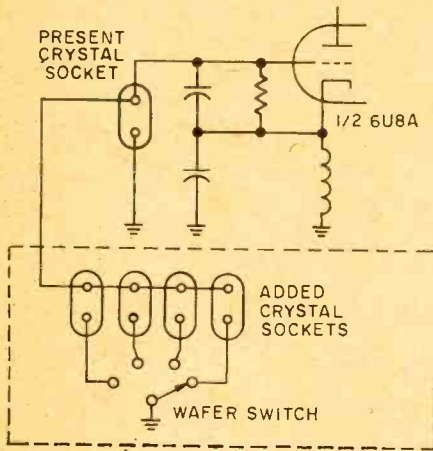

Instead of making it tunable, why don't you add a channel-selector switch, crystal sockets and receive crystals? They can be connected to the existing receiver crystal, as shown in the diagram. When ordering crystals specify the make and model number. Since the receiver is not very selective, the capacitance and inductance of the added components should not affect frequency significantly.

Improving Cheap Stereo

I am dismayed at the "tinny" sound put out by inexpensive stereo equipment. It seems that a true, deep, powerful bass cannot be had without shelling out mounds of money. Is there some sort of circuitry that I can build into my present equipment to strengthen the bass? My present set came equipped with a "bass-treble" knob that is highly efficient in changing the sound from dull to shrill, but leaves me totally unmoved otherwise.

—M.P.M., Imperial Beach, Calif.

Without a schematic we can't tell you how to modify the circuitry. However, as a general rule, replace the speakers with new ones of the same size but having a heavier magnet. Also

replace the one-buck output transformers with better ones.

Why the Big Center Hole?

Please tell me why most 45-RPM records have a large center hole. This has been a puzzle to me for the longest time.

—W.M. LaB., Alexandria, La.

Over 20 years ago RCA developed a simple record changer with a large-diameter spindle which contained the record-release mechanism. At the same time, CBS modified Edison's 33 $\frac{1}{3}$ -RPM record and called it an "LP." The LP was a resounding success, but it had to be played on a conventional record changer. RCA and CBS compromised—both turned out 33's and 45's. But nearly all record changers are designed for small-hole LP's, so you need an adaptor or wafer to play 45's.

It Won't Work!

How many ohms should a potentiometer have for controlling the speed of a 78-RPM phonograph motor as shown in the schematic diagram? I would like to play 16, 33, and 45 RPM records.

T.F., Swoyersville, Pa.



Forget it. The speed of the AC motor in your phonograph is not proportional to the input voltage. Usually, the motor is designed to operate at constant speed when fed from a 60-Hz power line. The speed is changed by varying the frequency. This is impractical in your case. Just buy a 4-speed turntable which uses mechanical means to change speed. The motor speed remains constant and the speed is reduced mechanically.

SOS on the QT

If I happen to hear a distress signal on my shortwave set what should I do?

J.C.O., Independence, Mo.

If it's from other than a ship in distress or an amateur or broadcast station, keep your mouth shut. All other radio transmissions are secret and cannot be revealed!

Learn more about electronics this easy way by mailing the coupon below

EVERY ISSUE of ELEMENTARY ELECTRONICS brings you easy-to-follow aids for better understanding of theory and applications of electricity and electronics... in word and picture with diagrams that are easy to follow... a source of up-to-the-minute information for everyone interested in electronics who wants to increase his knowledge... followed every issue by thousands of CBers, Hams, SWLs, Experimenters.

Save
up to
\$4.00

MAIL THE COUPON below today and you can save up to \$4.00 over the cost of buying copies on the newsstand... and be sure you don't miss a single information-packed issue... because the mailman will bring your copy to your door just as soon as each issue is off the press.



Elementary Electronics, 229 Park Ave. South, New York, N. Y. 10003

I don't want to miss a single issue. Enter my subscription for:

Dept. 617

- 3 years—18 issues—\$9.00
SAVING ME \$4.50 over the newsstand price
- 2 years—12 issues—\$6.00
SAVING ME \$3.00 over the newsstand price
- 1 year—6 issues—\$3.00
SAVING ME \$1.50 over the newsstand price
- I enclose \$ _____
- Please bill me

NAME _____

STREET ADDRESS _____

CITY _____

STATE _____ ZIP CODE _____

Outside U.S. and Canada: Add \$1.00 per year

SPECIAL HALF-PRICE OFFER TO INCOME OPPORTUNITIES ONE FULL YEAR ONLY \$4.48

(REGULAR SUBSCRIPTION PRICE \$8.95)

includes 12 reg. issues plus 2 directories
"I.O." brings you each month America's
best money-making ideas... in franchising
—specialty sales—mail order

MAIL COUPON TODAY

INCOME OPPORTUNITIES Dept. 820
229 Park Avenue So.
New York, N.Y. 10003

Please enter my subscription to "I.O."—for
only \$4.48. I save 50% off the regular sub-
scription price—includes 12 regular issues
plus 2 directories

- New Subscription Renewal Subscription
- Enclosed is \$ _____
- Bill me later

NAME _____
(please print or type clearly)

ADDRESS _____

CITY _____ STATE _____ ZIP _____

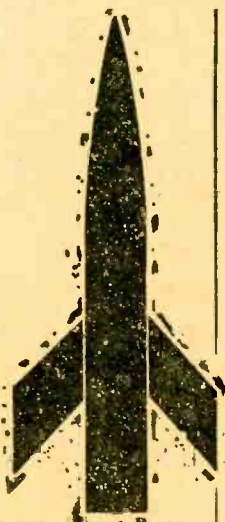

Keep up to date with SCIENCE & MECHANICS

Science & Mechanics—
the only magazine that
keeps you right up to
date on developments
in space technology,
weapons, automobiles,
medicine, boats, planes,
tools, new products,
and exciting world
events.

Keep up to date. Make sure
of your home delivered copy
by returning the coupon today.

SCIENCE & MECHANICS, 229 Park Ave. S., N. Y., N. Y. 10003 923

12 issues \$4; 24 issues \$8; 36 issues \$12. Foreign:
Add \$1 a year.)

Please enter my _____ year(s) subscription.

I enclose _____ Bill me. (No stamps)

Name _____

Address _____

City _____ State & Zip _____

newscan

Electronics in the News!

Balloon Pump for Cardiacs

A new intra-aortic balloon pump that played a vital role in historic heart surgery may open a new era in cardiac therapy. When employed within 30 hours of the onset of chest pain, the new intra-aortic balloon pump has resulted in six survivors out of sixteen cases of acute heart attack complicated by cardiogenic shock. This may not seem like a good "track" performance; however, heretofore, this condition was almost always fatal. The pump was developed jointly by the Avco Everett Research Laboratory, which Arthur Kantrowitz, Ph.D., directs, and Boston's Massachusetts General Hospital. A Massachusetts General Hospital surgical team reported what is believed to be the first successful bypass of a coronary artery with balloon pump assist in a man dying of shock complicating acute heart attack. The historic operation, reported in the *New England Journal of*

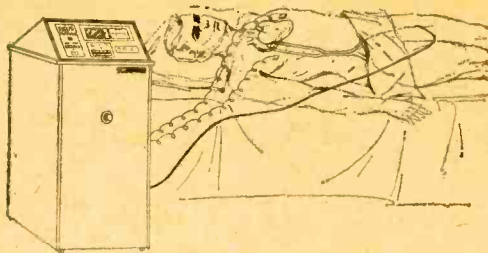

The intra-aortic balloon pump system consists of an implantable balloon-catheter attached to an external drive and control unit which operates in synchronism with the heart. Under a local anesthetic, the balloon is introduced into the arterial system through a small incision in the thigh.

Medicine, employed the balloon pump heart assist device to preoperatively stabilize and maintain the patient in the critical hours of surgery.

The Avco-MGH developed pump system is a temporary heart assist device that consists of a multi-segment balloon catheter attached to an external drive and control console. The balloon is inserted into the aorta, the major artery leading from the heart through an incision in the thigh. The helium gas driven balloon operates on a counterpulsation principle—contracting as the heart empties blood into the aorta and

True 4 Channel Sound

[\$42.50 per 20 watt channel]

There are several components on the market today that will give you true 4-channel sound.

All are expensive. Except ours.

We call ours QAUDIO*. It's an amplifier and player with 4 discrete channels. And we designed it primarily to play the new 8-track 4-channel cartridges.

But it will also play ordinary 8-track stereo cartridges, and make them sound fuller and richer than they ever have before.

Of course it takes a specially recorded 4-channel cartridge to give you the real QAUDIO experience.

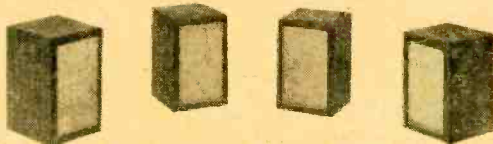

You can experience it today—at a price that's almost as unbelievable as the sound: \$169.95. (That's \$169.95 for a true 4-channel amplifier-player with 80 watts of total music power.) A unit for car/boat is just \$129.95.

We'll be happy to send you the names of dealers near you demonstrating QAUDIO, together with a brochure describing it in detail.

Write to Toyq Radio Company of America, Inc., 1842B W. 169th St., Gardena, Calif. 90247.

QAUDIO
BY TOYO

A SHOCKING EXPERIENCE IN SOUND.

*PRONOUNCED "KWAH-DIO". THE NAME QAUDIO IS BASED ON THE GENERIC "QUADRIPHONIC".

CIRCLE NO. 15 ON PAGE 17

then expanding and forcing blood through the body as the heart relaxes. This action relieves the heart of a significant portion of its workload.

Drawing upon their background in fluid dynamics, Avco scientists conducted experiments that showed a three-segment balloon to be superior to the single segment design. They found that both ends of the single segment balloon inflate before the center. The balloon assumes a "dumbbell" shape and blood is trapped between the ends. Pumping effectiveness is decreased because the trapped blood merely expands the section of the aorta between the balloon ends and is not pumped to the rest of the body. Furthermore, undue stress is placed on this region of the aortic wall. To overcome these effects, Avco designed a three-segment tapered balloon in which the center segment inflates first and blood is forced in both directions without stressing the aortic wall.

To protect against accidental balloon leakage, an isolating piston separates the higher driving pressure in the console from the helium in the balloon. The gas in the balloon is monitored constantly. If a leak occurs in the balloon, the console automatically shuts down and vents the balloon to a safe condition. Serious change in patient condition, equipment malfunction, or power failure also cause the balloon to vent instantly to the atmosphere. The patient is isolated from electrical circuitry and the system has a self-contained battery power supply for use during power failure or for portable operation.

X-Rays Have Come a Long Way

When German physicist Wilhelm Konrad Roentgen could not readily explain the origin of the unseen rays that traced the bones of his hand on a photographic plate he called them X-rays: "X", the scientist's label for the unknown. It was in 1895, 75 years ago, that he made his discovery that opened new horizons to doctors and gave them the power to look inside the human body to assess broken bones, detect abnormalities, and even find coins and safety pins swallowed by patients.

A major focus of interest of today's radiologists is on better ways to control the X-ray beam and limit it to providing useful information by confining it to the size of the film being used. The early experimenters did not sense the dangers inherent in the unknown rays that are among the shortest in wave length of any in the electromagnetic spectrum. The rays are created when an electron is boiled off a negatively charged cathode and propelled by high voltage against a positively charged tungsten target. As the high velocity electrons strike the metal target with great force they dislodge electrons in

(Continued on page 98)

Express Yourself in creative electronics



FREE!

32-page
25th Anniversary
Catalog.

KITS & WIRED

Build all-professional Eico Kits and save 50%. The more you know about electronics, the more you appreciate Eico. Over 2500 local Eico dealers offer you all the top brands, personal technical counsel, fast off-the-shelf service.

- **SOUND N' COLOR®** high fidelity color organs, transmitters, strobes.
- **TEST EQUIPMENT:** new solid state instruments guaranteed 5 years.
- **CORTINA®** solid state stereo receivers, amplifiers, tuners.
- **EICOCRAFT®** solid state jiffy project electronic kits.

Write for FREE catalog to: EICO Electronic Instrument Co., Inc., 283 Malta Street, Brooklyn, N.Y. 11207.

CIRCLE NO. 16 ON PAGE 17



FREE!

Your One Dependable
Source For
Everything In
Electronics

LAFAYETTE

1972 CATALOG 720

- 4-Channel Stereo Equipment
- Cartridge and Tape Players
- CB Gear
- PA Systems
- Tools
- Cameras
- Auto Accessories
- Books
- Musical Instruments and Amplifiers

Lafayette Radio Electronics Dept. 25091
P.O. Box 10, Syosset, L.I., N.Y. 11791

Please Send the FREE 1972 CATALOG 720 25091

Name

Address

City

State Zip

CIRCLE NO. 17 ON PAGE 17

THE HOME COMPUTER

by Jack Schmidt

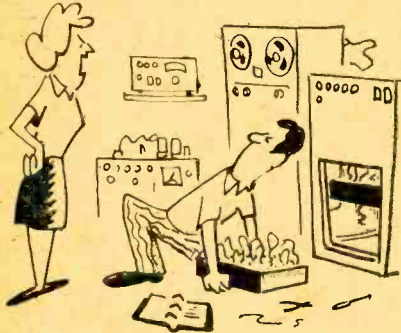

"... and the program you erased had Sunday's dinner on it!"

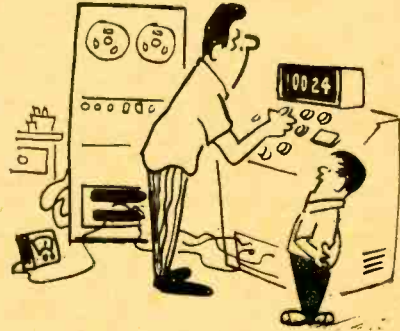

"There's the trouble, Dad... six times seven is forty-two."



"When SWLing is bad, he likes to listen to computer tapes."

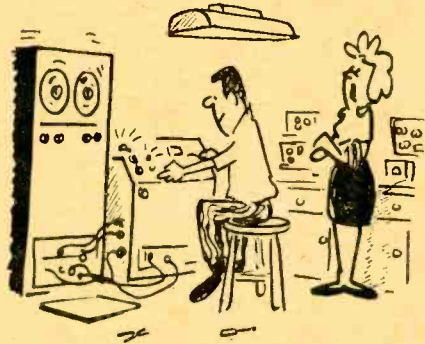

"Has that thing figured out how much it cost us so far?"



"... and now we finally have some sort of logic in that room."

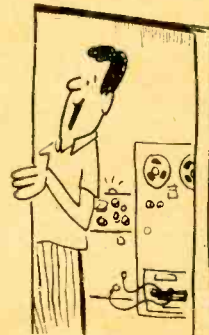

"Hey, Hon, guess how much 2,578,356 times 367,970 is?"

CB-9 CONVERTER

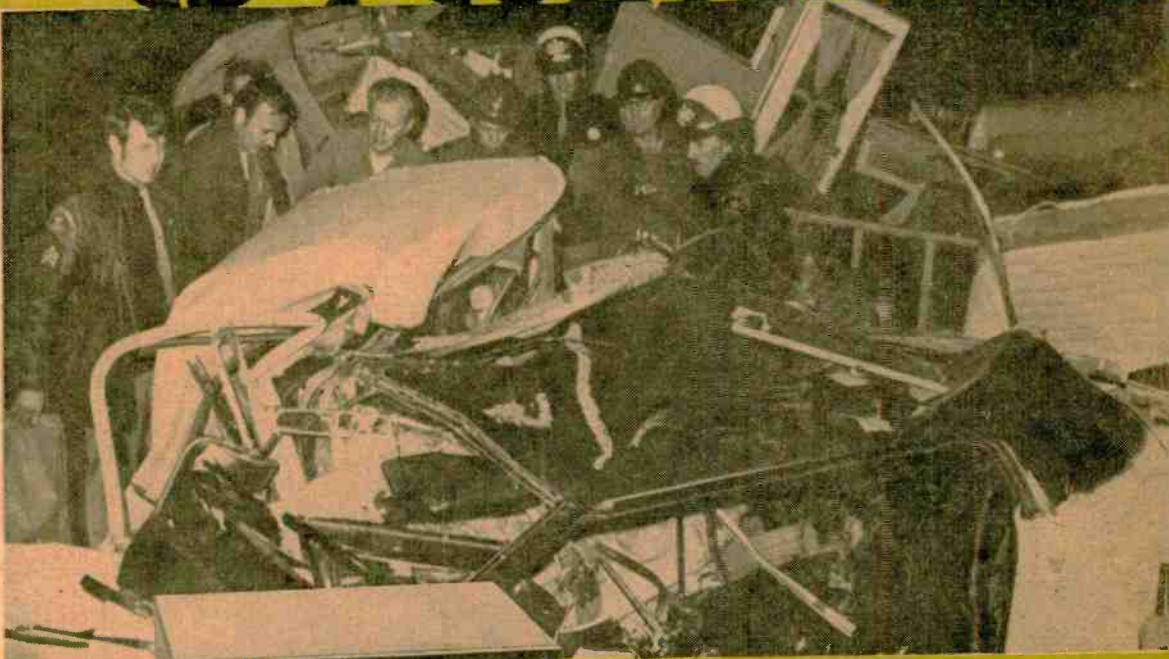

Monitor the Citizens Band's most exciting channel with a BCB rig and e/e's CB-9 Converter

by Charles Green, W6FFQ

He's a jack of all life-saving trades, and he's got to be masterful at them all. If anyone deserves a medal for outstanding citizenship, it surely must be today's dedicated Citizens Band enthusiast. He, or she, is at one and the same time an ambulance driver or tire changing mechanic. And, even a dispenser when the need arises, of coffee and doughnuts—and first aid—at local disaster scenes. The active CBER leads a hectic life, and a few months ago, by Federal decree, his pace quickened.

For obvious reasons, some of the most important documents kept by the CBER are those sundry notices and bulletins mailed by his club that keep him tuned to recent changes at the Federal Communications Commission. One of those biggest changes to affect the 11-Meter enthusiast in recent months is the FCC's redesignation of Channel Nine as the "National CB

e/e CB-9 CONVERTER

Calling Channel." Now, all that the Citizens Bander has to do is to twist his rig's tuning dial to "9", and sit back and wait for the highway action to begin.

And begin it did. Channel 9 is at present one of the busiest segments of the Band. Fact is, as the number of highway emergencies daily edge higher on the police blotter, we can expect to hear of even more CBers tuning to Nine—and then hurrying to the next twisted wreck down the pike.

But, as the Citizens Band enthusiast is finding out, it's not that simple trying to listen for calls for assistance on 9, and working his assigned channels, too. On one hand, he has to rely upon his rig for normal communication chores, and invest in a second rig just so that channel 9 can be monitored. There are the "normal" complications associated with this jash-up that every CBER is aware of. Problems like frying the front end of the channel 9 monitor with the main transceiver's transmitter activated.

Lately, some Citizens Band equipment manufacturers have started to build special monitor receivers into their rigs. While this is an obvious answer to the problem, many CBers cannot afford the luxury of a second rig of this type, just so that their lives are made a little easier at the listening post. Perhaps the answer to this problem lies on the unused equipment shelf in the shack.

Diversiónary Conversions. Don't look now, but one of your unused Broadcast Band radios is the answer to your channel 9 monitor question! Everybody's got at least one of these pocket-sized sports-weather-and-light-music makers gathering dust on the shelf. Why not build a converter especially tuned to receive channel 9, and feed the output of this little "black box" into the BCB receiver? You can listen to your heart's content to the action on 9, and never "lose your place" while trying to work your normal rig.

The components for e/e's *CB-9 Converter* aren't hard to scrounge up, and performance-wise, *CB-9 Converter* plugged into your BCB rig's front end neatly fits the bill for a sensitive—and inexpensive—monitor receiver. The converter uses two mosfets, with a crystal-controlled oscillator circuit assuring maximum stability. Note, too, that the crystal specified has a .005% tolerance—that means *very* little drift once you've

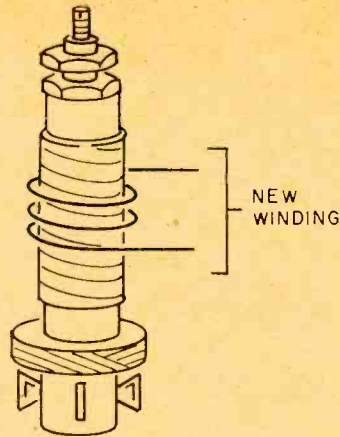

Note position of added output winding on coil L3's primary winding. New winding is permanently affixed to L3 with dab of coil dope.

got *CB-9 Converter* working!

Also note that "NPO-type" ceramic capacitors are used in this project. Reason for this more expensive type of capacitor is, all capacitors normally change value, or drift, as their temperature varies. This would effectively detune the converter. You'd never understand why, after properly tuning for channel 9, the channel seems to slide away into the QRM.

An NPO capacitor, on the other hand, *inversely* changes its capacity with temperature. Results: once you've aligned *CB-9 Converter* to tune in channel 9, you'll never have to play with the frequency-determining components of the converter again!

Look at the schematic to see how *CB-9 Converter* works. Signals from the antenna are connected via jack J1 to the primary winding of RF transformer L1. The signals are tuned by components C1/L1 to channel 9's frequency—27.065 MHz. This signal is fed to the insulated gate of transistor Q1.

This transistor is connected into the circuit as a mixer: a frequency "F1" enters the device, and frequency "F2" leaves it. Also the gate terminal of Q1 is capacitively coupled to the drain terminal of transistor Q2, a special, low-drift oscillator.

Components C8, C9, and L4 and, of course, Q2, comprise the makings of a colpitts-type oscillator. The frequency of this oscillator is partially determined by components L4 and C9: capacitor C8 simply provides enough positive feedback in order to sustain oscillations. But the real frequency-determining element in *CB-9 Converter's* oscillator is crystal X1. It's an

e/e CB-9 CONVERTER

must be scrupulously followed in order to get maximum performance from our *CB-9 Converter*.

Note that the author's prototype model was built into a 5-in. x 6-in. x 4-in. aluminum cabinet. It doesn't matter what size cabinet you whip up for your own converter—only make sure that it, too, is of all metal construction. Forget bakelite cabinets with metal front panels, too.

Most of the components for *CB-9 Converter* are mounted on a 5¼-in. x 4¼-in. perfboard with push-in clips. Also, point-to-point wiring is an absolute must. The reason for all these seeming limitations to your creative genius is that we're working with relatively high frequencies, high-gain, high-impedance transistors, and oscillator circuits. This triple-dynamite combination—if not treated with r.e.s.p.e.c.t.—will invariably lead to an it-doesn't-work trauma. So, follow directions.

Begin construction by cutting the perf board to size. Then make the mounting bracket for L1/L3. This L-shaped bracket is formed from sheet aluminum, approximately 2 ⅜-in. long by ⅝-in. high, with a ⅝-in. mounting lip. Drill two mounting holes in the mounting lip to accept #6 hardware. Then mount RF transformers L1 and L3 on the bracket, approximately 1½-in. apart (center to center). Mount the bracket on the perfboard with 6-32 hardware, about ½-in. from the board edge.

Carefully noting component placement on the perfboard, you mount the remaining parts in place. The author used #24 tinned bus wire to form the ground path. We suggest that you solder nothing home until you've checked all connections; solder each connection with care after your wiring appears correct.

Transistors Q1 and Q2 are mounted upside-down, and are supported by their leads.

CB-9 Converter, before cabinet's other half is buttoned down. Output lead is kept away from input lead; that's why Jacks J1, J2 are so widely separated.

If the prospect of soldering directly to Q1's and Q2's leads doesn't appeal to you, use mounting sockets (of the low-loss variety). Just remember to make sure that you *do not* remove the shorting wire rings from the transistors until the wiring is complete. Static electricity charges from handling, or stray fields generated from a soldering gun, can easily destroy these units, even before power is connected!

Note from the schematic that L3 has a new winding added to it. Wind three turns of number 22 hookup wire over the secondary of L3. Twist the ends to keep the winding in place. After this new winding is in place on the coil, fix it in position with coil winding dope, *not* a general-purpose cement. Coil L2 may be mounted to the perfboard by soldering its lugs to push-in terminals. Position as shown in the photo. Crystal X1 was mounted by the author by plugging it into contacts removed from an old octal tube socket which, in turn, are soldered to push-in clips. You can substitute a conventional crystal mounting socket, instead.

Install components J1, J2, and S1 onto the cabinet's front panel. Battery B1 is mounted onto the cabinet's rear panel with a U-shaped section of aluminum bracket bent into the form of the battery.

Next, cut off the portion of the push-in clips protruding through perf board bottom, and mount the component-laden cabinet bottom with either machine screw hardware or metal standoffs. Whatever method you choose, make sure that no push-in clip bottoms short against the cabinet bottom. The

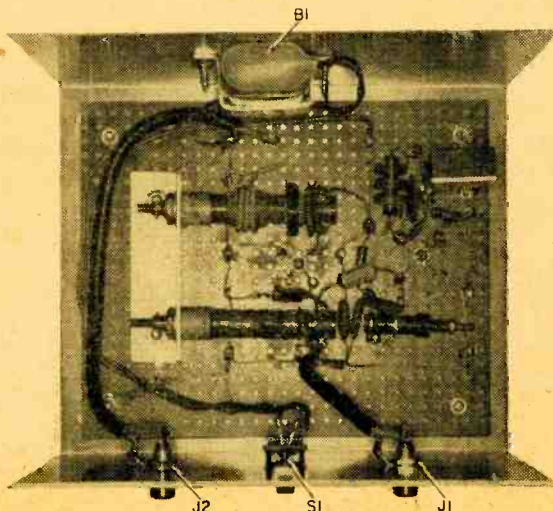

perf board, after mounting, is spaced about 1/2-in. away from the cabinet's bottom in the author's prototype. Be sure to install a couple of ground lugs; these connect the RF transformer mounting plate to the cabinet via mounting hardware. See our photos.

Last phases of construction merely consist of tying the mounted components to both jacks, battery and on/off switch. Connect jacks J1 and J2 to their respective components with short sections of RG-58A/U coaxial cable. Keep both cable lengths as short as possible, and physically separated from each other.

Twist a pair of hookup wires, and solder one end of them to the on/off switch. Solder one lead of the other end to the battery connector's positive terminal; solder the remaining lead to the junction of components C6 and R2. Set S1 to its "off" position, and connect B1 to the connector. Lastly, remove the shorting rigs from both transistors, and install X1 into its holder.

Selecting the Rock. The crystal frequency of X1 in our *CB-9 Converter* is 7040 kHz. This particular choice of crystal yields a resultant frequency of 1095 kHz in the broadcast band. If either adjacent broadcast frequency (1090 or 1100 kHz) is occupied by a local broadcast station, locate a clear frequency on the BC band, and use a different crystal frequency. Calculate this new crystal frequency by adding the channel 9 frequency (27,065 kHz) and the BC band frequency in kiloHertz and then dividing the resultant by 4 to obtain the crystal frequency in kHz.

For example, if a clear BCB frequency in your locale is, say, 935 (this means no BC station on either 930 or 940 kHz), you'd add: $27065 \text{ kHz} + 935 \text{ kHz} = 28000 \text{ kHz}$. Dividing 28000 kHz by 4, the new crystal frequency is 7000 kHz. No matter what crystal frequency you choose, the particular rock you order *must* resonate in its fundamental mode. Also, for maximum frequency stability, it would be wise to order the crystal with a .005% tolerance. See our parts list for a suitable source.

Converter's high gain makes short lead length absolute must. Follow parts placement exactly as shown.

CB-9's Alignment Procedure. After you've checked your soldering, screwed down the cabinet cover, connected the antennal terminals, and hit the on/off switch, tune your BC Band receiver to the selected clear frequency. Run a length of RG-58A/U cable to the external antenna and ground connections between your rig and *CB-9 Converter*. If the receiver does not have external antenna and ground terminals, wind three turns of hookup wire around the antenna loopstick, and connect these leads to the coaxial cable emerging out of jack J2. Be sure there's no connection between the chassis of an AC/DC radio (if that's what you're using), and the chassis of our *CB-9 Converter*.

Connect a signal generator to jack J1. Set the generator controls for a 27.065 mHz tone-modulated output.

First, adjust L2 for maximum tone output from your radio speaker. At this point, you may only hear the tone very faintly. It will be necessary to simultaneously adjust L3 and L2 for maximum tone volume. This is not a tricky procedure; it merely takes patience.

If you own a Volt Ohm Meter, the alignment process may be made a little easier if you connect the vom's leads across the radio's speaker terminals, and adjust coils L2 and L3 for maximum deflection of the vom's meter needle. After you've satisfied that both L2 and L3 are properly adjusted, peak coil L1. Again, either listen for maxi-

(Continued on page 98)

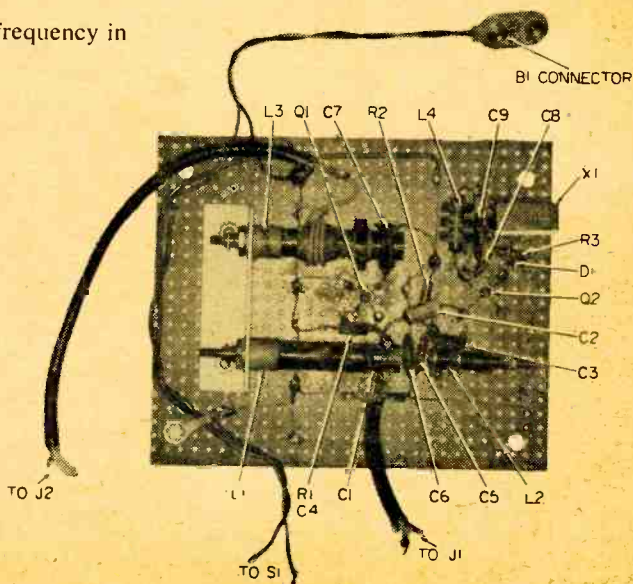

**TURN RIGHT
AT
CENTER ST.
AND
FOLLOW
THE SIGNS**



Those nice drives into the country on unfamiliar roads can be very pleasant if you know the way. But often the driver is completely overwhelmed by those “helpful” road signs, traffic lights, and warnings scattered over the road and above it. Well, it seems that the Federal Department of Transportation has come up with a solution to this problem, based upon studies by the U.S. Bureau of Road Research—“Computerized Geography” (also known as Electronic Route Guidance System—ERGS).

This new electronic guidance system is the result of the application of space-technology for use on America’s vast highway network. Basically, it boils down to getting route directions displayed *in the car* in-

stead of visual signs on the road. The driver travelling towards an unfamiliar destination merely looks up the address desired in a special code-directory in which each listing has a six-letter code. He then dials this code into a control box in his car and sets off on his trip. Along the route are roadside units containing a transmitter/receiver and a decoder. As the driver approaches each intersection rigged into the network, he trips an antenna loop embedded into the roadway. This transmits a radio impulse to another antenna in the car, switching on the control box. In this way, a code signal keying the desired destination is received by the roadside unit, decoded, and the appropriate instructions appear on a display screen on the

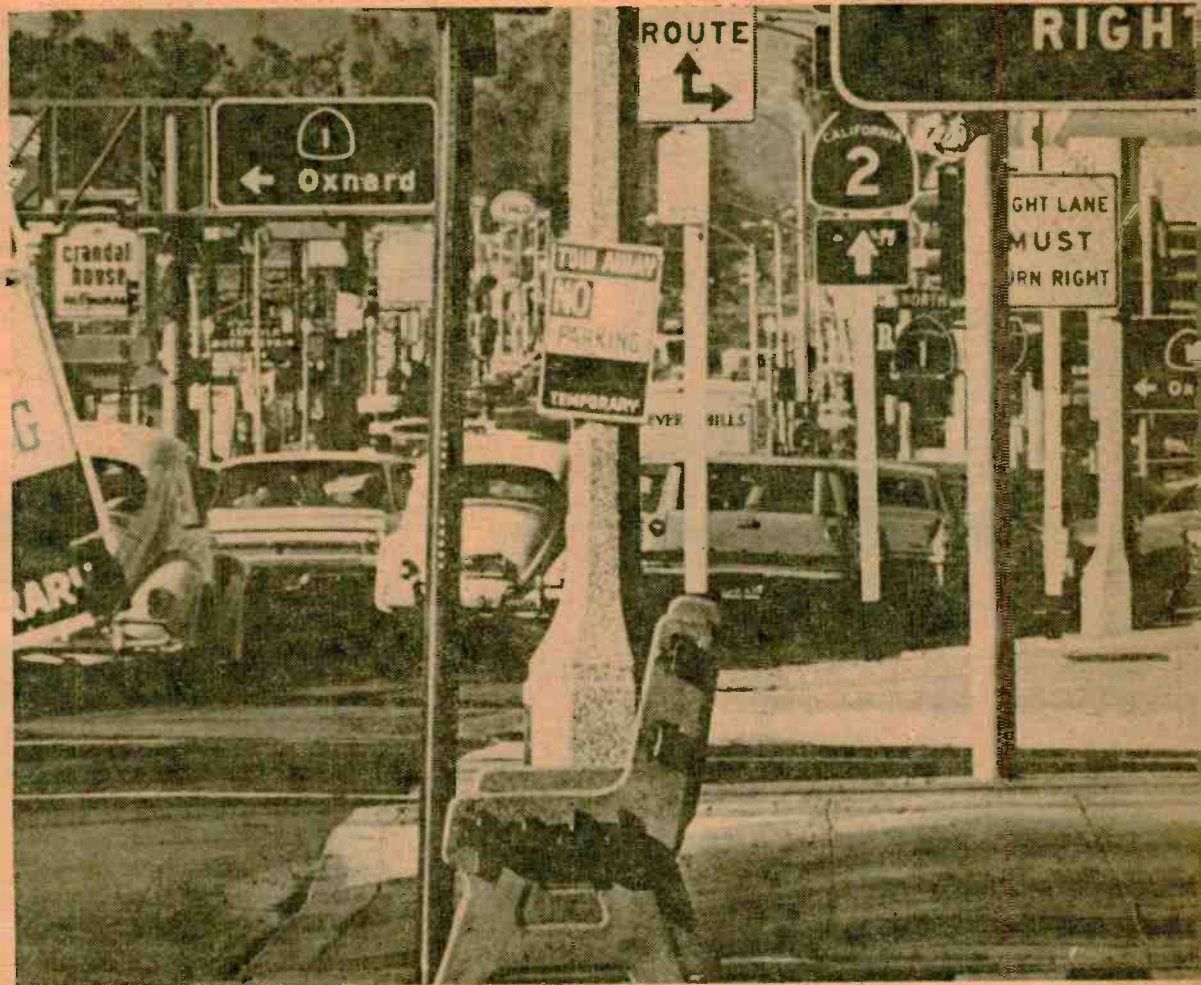

car's dashboard.

For instance, the unit may signal the driver to turn left at the next corner, and then take a righthand turn two blocks later. All this is done by a combination of arrows and words that light up on the screen for several seconds.

If it sounds complicated, just remember what those roadside signs are like! With ERGS all the driver does is to dial or punch in his destination and through electronics his route is automatically programmed for him.

At the present time, tests are underway in the northwest sector of Washington, D.C. Some 50 vehicles and approximately 100 intersections are being fitted with the neces-

sary electronic equipment in order to discover whether this system is feasible. The initial results are encouraging.

Simulated tests are also being conducted. A 1/87th scale model with hundreds of plastic homes, cars, trees, telephone poles has been set up—all together representing normal Washington, D.C. street scenes over a 22-intersection area. In a separate room is an unusual car, with no wheels, but it is equipped with all the necessary ERGS electronics. This car is mounted on a stand in front of a screen.

On a testrun, a high-resolution, closed circuit TV-camera is moved along the streets of the scale-model city and the picture is flashed on the screen. This moving,

e/e TURN RIGHT AT CENTER



This roadside computer (above) feeds directions to drivers hooked-up to ERGS who then receive clear, bright signals on the electronic indicator (left) installed on the dashboard of their car.

projected image gives the person behind the wheel the feeling of actual driving, and he acts exactly as if he were in normal traffic. During these testruns the driver's reactions to the ERGS signals are measured by electrodes that monitor heartbeat rate and galvanic skin response. The driver's stress levels as he responds to the signals are also measured carefully. Results seem to indicate that the stress upon the driver is reduced, backseat drivers excepted.

All these innovations should help to de-

crease the number of accidents resulting from such confusion which presently confronts the driver in unfamiliar driving situations.

It is estimated that ERGS equipment for private vehicles will cost about as much as an automatic transmission, and surveys so far seem to indicate that many would be willing to pay this price. After all, it's not very much considering the wear-and-tear it'll save you on your most invaluable piece of property—Yourself! ■

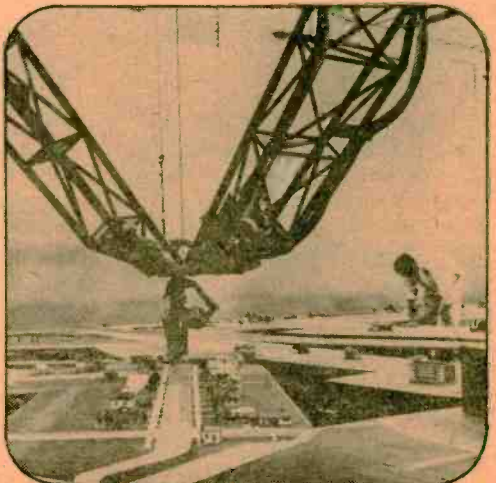
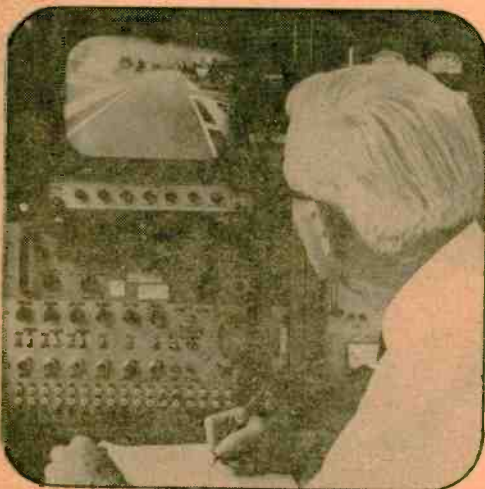

Closed-circuit TV results (left) are carefully screened as a motorist in a wheelless simulator car "drives" down a street. A technician positions cars for a testrun (right) in the scale-model of a 22-intersection area of Washington, D.C. So far, things look good for ERGS.



Pickin' Batteries



How to choose
and use
batteries and cells

by Jim Ashe

Batteries have compelling advantages over power supplies, although they are a fairly expensive way to buy electrical power. They are safe, simple, reliable, and usually noise-free. Two dollars will keep a radio receiver or a test instrument in service for weeks to years, and a three-dollar circuit that pretends to fill two cubic inches can be operated from a comparably sized power source rather than from a transformer and rectifier system. It makes sense. Batteries are a permanent fixture in electronics.

But there are too many types! One commonly available manual runs to 550 pages of specs and engineering data, with notes on 323 different cells and batteries. Allied Radio's catalog #710 offers a mere 168 choices, probably for practical marketing reasons. Prices there range from 10¢ per cell to \$47.25, and if you have no other data there is only size, voltage, and sometimes weight to assist in your choice. It's the same problem everywhere, even in stores.

Also, there are many suggestions and legends about mercury batteries, alkaline batteries, nickel-cadmium batteries, rechargeable cells, and improved Leclanche cells, to name a few. And the cost of battery power is surprisingly high, as shown in Fig. 1. Let's get a general picture of all this, and then

narrow down the field to a few highly appropriate candidates for all-around usage.

Cells and Batteries. When we talk about a cell or a battery, we could be talking about any of a large variety of objects. The chart of Fig. 2 will reduce the confusion.

The opening term, *box*, isn't in common use but we had to start somewhere. A box is one of those packages you get from the store when you ask for a battery. In engineering terms it may be either a *cell* or a *battery*. If it is a battery, it contains many cells, and some batteries can be dismantled into their component cells. One example is

EVEREADY NO. AND TYPE	CAPACITY AND COST *	COST PER KWH.
216 9-VOLT TRANSISTOR BATTERY	2.1 W-H 48¢	\$230.
276 9-VOLT LARGE TRANSISTOR BATTERY	32 W-H \$1.67	\$52.
1050 1.5-VOLT D SIZE CELL (LEAST EXPENSIVE POWER)	7.5 W-H 23¢	\$31.
AC LINE POWER	—	\$.03

Fig. 1. A few rough calculations show that the least expensive battery power still costs very much more than AC line power

e/e PICKIN' BATTERIES

the Eveready 2606 battery, rated at +3, +6 and +9 volts, which if dismantled turns out to be six D-size cells in one package.

The standard D cell, on the other hand, is a complete electrical unit in itself. If we cut one in half as seen in some TV ads, the two halves generate the same voltage as the original cell. If you try this, clean the saw immediately after, because the battery chemicals are corrosive.

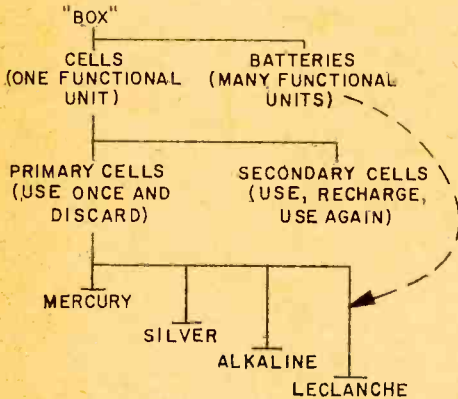

Fig. 2. Proliferating battery and cell types, along with loose usage of terms, have created a confusing situation. This chart should clear things up, and identify the area of interest for this article.

Our next step along the chart brings us to *primary* and *secondary* cells. A primary cell is a one-shot proposition, meant to be used once and discarded in favor of an unused replacement. Any rechargeable cell is a *secondary* cell, and may be used from several to several thousand discharge and recharge cycles. The boundary is rather blurred because you can recharge some primary cells with moderate success, giving them a new lease on life, and because some cells with a familiar primary-cell chemistry have been engineered to limited secondary-cell specifications. The manufacturer's literature tells you about these, and if he hasn't provided any it is best to avoid experiments.

Finally we come to the subject of this article: four varieties of primary cells. The most familiar types, available from catalogs, store shelves, and miscellaneous sources, are mercury cells, silver cells, alkaline cells and Leclanche cells.

Of these, two come in for an honorable mention: mercury cells and silver cells. The

other two are the real workhorses, most useful for providing electrical power with maximum utility, convenience, availability, and minimum cost. These are the alkaline and Leclanche varieties. Now let's examine these, one at a time.

Mercury Cells. Mercury cells consist of a mercuric oxide anode, an amalgamated zinc cathode, and a zincated saturated potassium hydroxide electrolyte. The structure is usually a sealed steel container with an automatic vent to release internal pressures developed when the cell is providing a heavy current.

Mercury cells have a fabulous reputation for an unfailing constant voltage throughout their life, and the same terminal voltage from one cell to the next. This is wrong on both counts. Fig. 3 is a manufacturer's discharge curve for an Eveready E502E mercury cell at quite moderate current. And upon checking a number of cells at a large distributor's, a variety of terminal voltages were clustered around the accepted mean. Scratch two myths.

Also, mercury cells are very expensive, which is a sound reason to avoid them. Finally, they have no practical capacity at temperatures below freezing, as shown in Fig. 4. The low temperatures do not harm the cell, but when frozen it remains practically useless until its temperature gets back over the 40°F mark.

Silver Cells. A fairly recent market

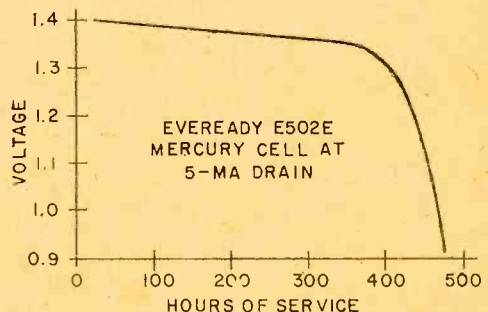

Fig. 3. Eveready's voltage/time discharge curve for their E502E mercury cell at a very moderate current. The voltage falls off with usage.

product, silver cells use silver oxide and zinc electrodes, with a potassium hydroxide electrolyte. Silver cells are used in hearing aids, electric watches, and as voltage reference sources. They are rare at present, but we will probably be seeing more of them on the market in coming months and years.

A typical silver cell has an open-circuit

voltage of 1.6 volts, and this drops to 1.5 volts under normal load. Its internal resistance is very low, which is excellent from an audio or photoflash-unit viewpoint. The manufacturer reports silver cells never leak chemicals, a point toward which I maintain an extremely conservative attitude. The tiny hearing aid and watch batteries listed in Allied's 1970 catalog #290, page 295, may be silver cells. This variety deserves attention, and you may want to research it if you have a difficult application in mind.

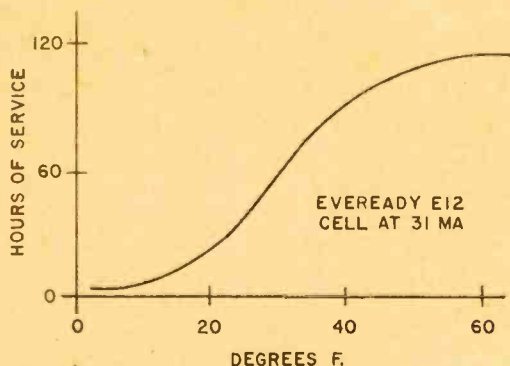

Fig. 4. Mercury cells are nearly worthless at temperatures below freezing. The rolloff is fairly sharp, but the cell will recover its capacity when it warms up again.

Alkaline Cells. Alkaline cells use a zinc anode and a manganese dioxide cathode with a potassium hydroxide electrolyte. They can supply very heavy currents, and are effective at temperatures well under 32 degrees Fahrenheit.

Alkaline cells are reported to be "better than Leclanche cells" but the facts available at the consumer level are not entirely correct. They are better for *some* applications, such as photoflash, heavy-drain audio gear, tape recorders which require high currents at fast forward and reverse, and portable TV sets. Under these special conditions an alkaline cell will provide power at a lower cost than the two or three consecutive Leclanche cells it replaces. Otherwise, as in a flashlight, radio receiver, or test instrument application, the Leclanche cells are more economical if you don't mind changing them. The cost breakover point for D-size cells is around 300-mA drain.

Leclanche Cells. These are the familiar carbon-zinc cells, by their chemical name. It is the name of the man who first built cells and batteries using their chemistry of carbon, zinc, and an ammonium chloride

electrolyte. The initial versions were glass jars full of solution and hardware, but the paste or "dry" variety wins hands down for utility, convenience, and portability.

Leclanche cells are appropriate for light and moderate loads. Their below-freezing performance is poor, but better than that of mercury batteries. In the last section of this article are described various ways to use these common, inexpensive cells in place of more exotic types, making up the differences by adding simple transistor and zener-diode regulator circuits.

Avoid storing cells and batteries, if you can. They deteriorate by inner chemical activity that goes on whether they are in service or not, by a general diffusion of the chemicals, and by drying out. The deterioration process can be minimized by freezing, however, and tests indicate the life of Leclanche or alkaline cells is greatly extended if you store them in the freezer. When stored at low temperatures, cells should be protected from excessive moisture and frost deposits, and perhaps a little grease should be added to the terminals to prevent rusting.

Preferred Types. The magic behind preferred battery types is mostly common sense. One battery is less expensive than some other similar one because it is mechanically simpler or the manufacturer is making more of them. A pencil is only slightly cheaper than the far more powerful D cell because labor and sales costs far exceed the cost of materials.

The more popular cell is likely to be easier to find in the back country or in the middle of a city than is the rare one used in some elite application. If you are building new gear, it is more convenient as well as less expensive if you arrange it to use the same kind of cells or batteries you already use for other applications. If we apply these considerations, and throw in a fudge factor for convenience, what do we wind up with? See Fig. 5.

You may have occasion to add to this short list, but for practically any ordinary application this is all you need on your shelf. Not all gear will take these sizes, you say? Then purchase something else that will, and since most designers and manufacturers are perfectly familiar with the facts described here, you probably will not have to look far for it.

Mounting Batteries. Whoever thinks battery mounting arrangements are not important, is in error. A wrongly mounted battery

e/e PICKIN' BATTERIES

can come loose and batter a valuable circuit into junk. Another battery, if used beyond its capacity, may emit a corrosive jelly that reduces your neat construction job to a greasy mess.

A properly installed battery cannot batter circuits and its mounting system is easily replaced. Good design practice in bench gear construction is to place the mounting assembly at the bottom of the case, or

EVEREADY NO. AND CHEMISTRY	PRICE	RATINGS	SIZE
215 LECLANCHE	48¢	9V 0-8 MA	1 X $\frac{39}{64}$ X $1\frac{7}{8}$ LONG
276 LECLANCHE	\$1.67	9V 0-30 MA	$2\frac{9}{16}$ X $2\frac{1}{3}$ X $\frac{5}{32}$ HIGH
1Q15 LECLANCHE	16¢	1.5V 0-25 MA	$\frac{35}{64}$ DIA X $\frac{31}{32}$ LONG
E91 ALKALINE	40¢	1.5V 0-150 MA	AA PENCELL SIZE
1O50 LECLANCHE	23¢	1.5V 0-150 MA	$1\frac{21}{64}$ DIA X $2\frac{25}{64}$ LONG
E95 ALKALINE	65¢	1.5V 0-650 MA	D CELL SIZE
731 LECLANCHE	\$2.30	6V 0-500 MA	$5\frac{3}{8}$ X $2\frac{7}{8}$ X $4\frac{15}{16}$ HIGH
732 LECLANCHE	\$2.70	12V 0-250 MA	LANTERN BATTERY

Fig. 5. A small number of recommended cell and battery types. These should be available almost anywhere, and are found in consumer catalogs as well as on drugstore shelves and in other places.

better yet, outside on the back. Then dripping chemical slime only spoils the paint and corrodes the sheet metal. Reliance on optimistic claims of "leakproof" is risky and perhaps even justified, until the truly leakproof cell is replaced by another without that elusive virtue.

Batteries to be mounted fall generally into two classes: large batteries with their own clips or terminals, and smaller ones that fit into assemblies. The large batteries should be held firmly in place by metal strips with some padding to take up tension and variations in the sizes of individual batteries. See Fig. 6, which illustrates an Eveready 276 battery in an appropriate scheme for mounting inside a chassis.

Smaller cells are often mounted in commercial holders, which are very widely available nowadays. A table of some con-

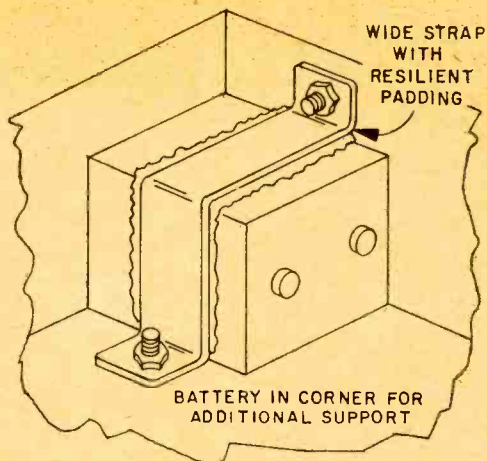

Fig. 6. An Eveready 276 nine-volt battery, solidly mounted by a strap with additional padding.

venient plastic holders for AA cells, supplied by Allied Radio Shack, appears in Fig. 7. A visit to a nearby electronic supplier may turn up a variety of metal and plastic holders, not all equally convenient. If these holders have no mounting provisions, they may be mounted in the same style as large batteries.

If your gear is intended for portable work, the case should be designed with one compartment for the electronics, and an entirely separate one for the batteries. See Fig. 8, a simple box arrangement easily assembled from half-inch plywood.

The acid test for a battery-holder system is what happens if the gear is dropped on the floor. Finally, if you are shipping battery-operated gear, assume the PO will do its worst. I once asked a PO employee if there was a regulation against heaving packages more than thirty feet, and he wasn't sure. Remove the batteries before shipping, and if they *must* accompany the gear then pack them like the massive little chunks they are.

Battery Supply Circuits. For many applica-

ALLIED RADIO SHACK ORDER NO.	NO. OF PENCELLS MOUNTED	PRICE
270B382	2	\$.39
270B383	4	.45
270B384	6	.49
270B387	8	.59

Fig. 7. Here are some very convenient pencell holders, available from Allied Radio Shack. They feature a very sensible standard terminal system.

tions there is no more to do than connect the battery and turn on the power. But this is not the general case, and if you are trying new applications or are troubled by feedback problems or short battery life, some of the following suggestions will help.

The simplest application schematic appears in Fig. 9. This hookup deserves suspicion if your circuit has a lot of signal in

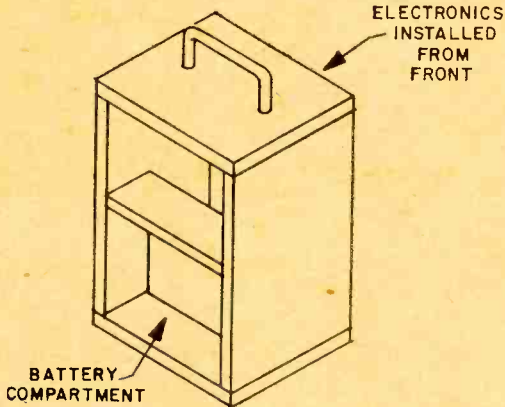

Fig. 8. Suggested battery compartment in a simple half-inch plywood box. Nailed and glued assembly is reliable in rough usage.

its supply leads (check by audio VTVM, scope, or RF probe) or shows signs of instability not caused by parts positioning. But we may be able to work an elementary improvement.

Place a capacitor across the battery or, better yet, across the stage that generates the signal observed on the supply line. 1,000 or more microfarads may be indicated for audio circuits with class-B output stages.

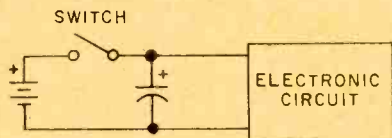

Fig. 9. The simplest battery application system. A capacitor across the battery is excellent practice, and reduces the effect of battery aging upon circuit performance.

The capacitor bypasses signal voltages developed across the battery's output resistance, and additional benefits may be gained by decoupling the supply lines to low-level or input stages.

The *apparent* battery output resistance can be reduced by adding the emitter follower regulator stage shown in Fig. 10, to

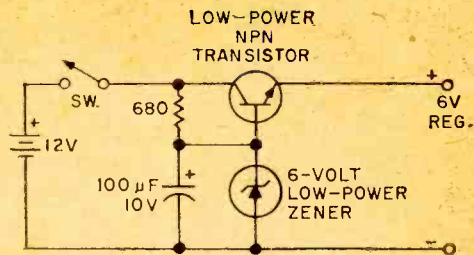

Fig. 10. The battery can be almost completely isolated by an emitter-follower regulator.

isolate the supplied circuit from the battery's resistance and aging idiosyncrasies.

When you begin designing circuits you soon learn the advantages of having a bias voltage in addition to the customary supply voltage. An obvious circuit appears in Fig. 11. Power requirements are minimized, and the circuit can be designed to be relatively unresponsive to temperature changes. Now, suppose your circuit takes +6 supply and -3 volts bias (I am writing from experience) and you estimate it will run 200 hours on a set of D cells. Turns out it stops at 85 hours, which more than doubles cost of operation if we cannot do something about this. Why does it stop?

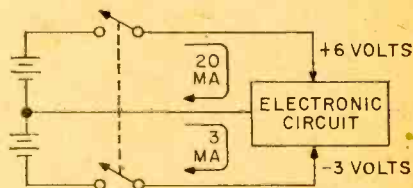

Fig. 11. The basic bipolar arrangement. Note the two circuits do not carry identical currents.

Because the supply side of the battery string delivers much more current than does the bias side. In the circuit where we play off these voltages against each other, the supply side poops out faster than the bias side, which soon wins and turns the circuit off. One simple solution is to add a supplementary load resistor to equalize the current drain.

A solution usable in some applications appears in Fig. 12, where we see a single zener providing a fixed offset of 4.7 volts. If we take the hot end of the zener as circuit ground, then we get -4.7 volts and +7.3 volts, which drops as the battery ages. We haven't gained much here.

We can do it better with the circuit of Fig. 13, using two emitter followers. If

e/e PICKIN' BATTERIES

the sum of our supply voltages is 12 volts, and the battery provides 18 volts when fresh, then it must run down nearly six volts before the system fails. And since all cells see the same current they wear out at equal rates, and we replace all of them on the same schedule. Note the several ways in which the circuit can see the supply voltages, since the batteries are left floating with respect to circuit ground.

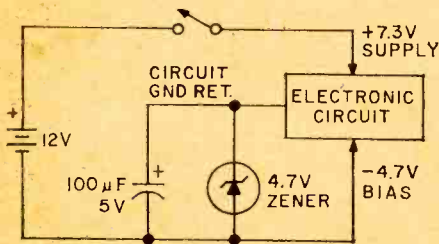

Fig. 12. Partial regulation by a zener may be the answer to some battery-supply problems.

When using zener regulators with battery supply circuits, we must be more conservative than with AC supplies. Here a watt is something to fight for, but with the practically free power from the AC line we may begin to feel uncomfortable with maybe thirty or a hundred watts going off as heat. For battery work, some zeners are better than others because they will regulate at lower currents. A simple circuit, shown in Fig. 14, gives us the necessary information.

At low currents the zener does not regulate, since it is not adequately energized

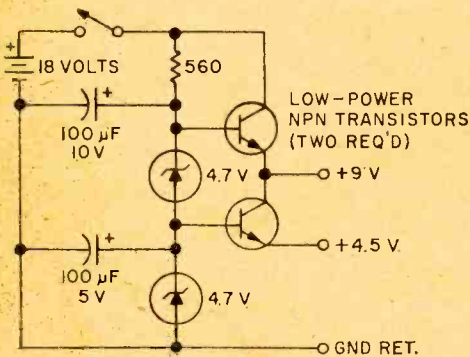

Fig. 13. Two independently stable voltages may be obtained from a single string of batteries. All the batteries see the same current drain.

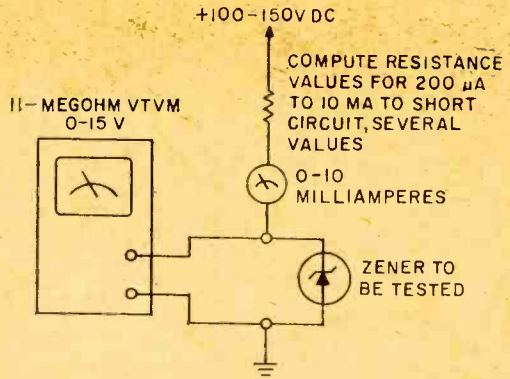

Fig. 14. This circuit checks zeners for low-current performance, and establishes their knee values.

(see Fig. 15). If we compare two apparently identical zeners we may find a crucial difference: one regulates at 500 microamps, and another having the same manufacturer's type number has a knee at 10 milliamperes. Both get by the manufacturer's checking station, since he checks them at, say, 20 milliamperes. You don't know where the knee is until you measure it, and this simple step can save a lot of current and problems.

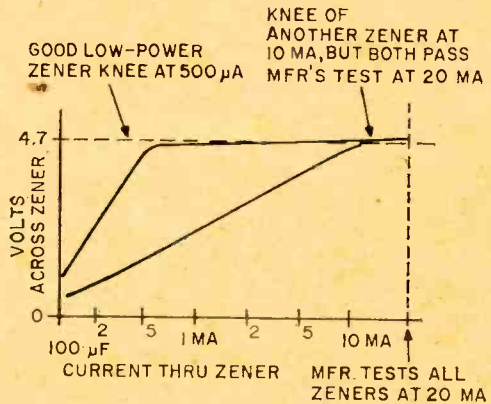

Fig. 15. Test results for some same-type zeners may diverge surprisingly, because the manufacturer is usually interested in typical rather than low-power conditions. Plotting voltage against current is not usual practice, but indicates clearly the minimum zener regulating current.

When choosing zener resistors, remember to select a series resistance that gives adequate zener current after the battery is run down to the limit, and the circuit is drawing its rated maximum current. The capacitor across the zener catches possible zener noise and reduces the supply output resistance to signal current.



air-to-air kamikazes ...BIRDS!

*The airlines seek
electronic relief
from the accidents
and damage
caused by these
feathered projectiles.*

by Webb Garrison

Five years ago a military plane flying over Germany was brought down by a mouse. That's right, a mouse. The tiny animal was dropped directly into the plane's #2 engine when an eagle carrying the mouse in its beak was nearly hit. The pilot managed to land his crippled plane safely.

Tragedy came, though, when a Lockheed Electra hit a flock of starlings during a 1960 take-off in Boston. Sixty-one of seventy-two persons aboard were killed. Crash detectives dismantling the engines found that a number of birds swallowed by the big engines had caused "quick and total loss of power." Airways of the world—civilian and military alike—have become so fowled-up that there's no hope of relief except through use of electronic gear. To be effective, instruments must be especially adapted to deal with birds.

The Damage. How many bird-

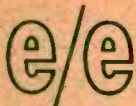

AIR-TO-AIR KAMIKAZES

strikes against aircraft take place annually? What is the dollar damage? No one has global answers. Much of the damage is to military craft of governments that do not release reports. Part of it is to civilian planes and to military jets of nations willing to talk.

Bird/plane collisions take place in the U. S. at a rate of more than 2,000 per year. The U. S. Air Force estimates that annual cost of repairs to engines and aircraft surfaces hit by birds runs "well beyond \$10 million." In Britain, bird damage to planes of the RAF exceeds one million pounds per year. At least five Royal Canadian Air Force jets are known to have been downed by birds. A Pakistan Airlines helicopter hit by a vulture in 1966 took 23 persons to their death.

This little-known menace that poses some degree of danger to every pilot and passenger has grown to such proportions that in late 1969 Canada was host to a World Conference on Bird Hazards to Aircraft. The problem has two major components: bird/plane collisions at or near airports, plus strikes that take place as planes roar along flight paths that are often dangerously fowled-up with migrating birds.

Airports Making Progress. Delegates to the world conference agreed that much progress is being made at major airports. Practically every aspect of bird life has been studied: feeding habits, reaction to lights and noise, seasonal changes in customary time of settling to the ground and of taking to the air. Anything and everything that offers any hope of reducing bird populations near run-

ways is being tried.

Rifle fire has failed to oust flocks of bustards from the U. S. Air Force base at Torrejon, near Madrid, Spain, on Midway Island, U. S. Navy gunners shelled albatross flocks with mortar fire—but birds keep returning to build nests along runways. In both England and the U. S., commanders of military bases have tried to revive the ancient art of falconry. Hawk patrols seemed to offer considerable promise when initiated five years ago; though experimental studies are being continued, attempts at large-scale use of falcons are now generally considered futile. Many airfields have recorded alarm calls of birds, in order to play them through loudspeakers with the hope that flocks will take off on hearing the sounds. Initially effective, the novelty of this device usually wears off quickly.

Jet planes are being redesigned with bird hazards in mind. Fan blades are particularly vulnerable. A four-pound bird sucked into an engine on takeoff generates about 2,000 pounds of residual impact—and fan blades considered standard a few years ago aren't

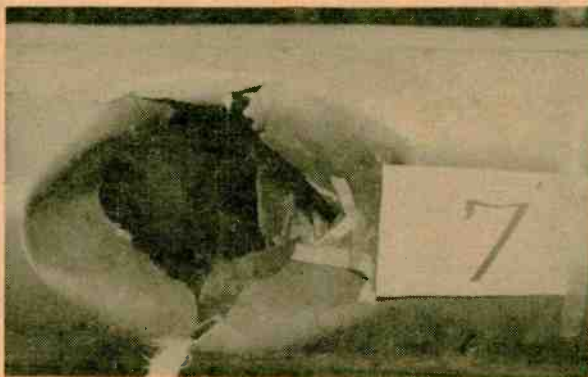

Typical "minor damage" (above right) to leading edge of wing from in-flight bird strike. Compare this with lower photo of laboratory-test holes ripped by bird weighing less than 4 pounds.

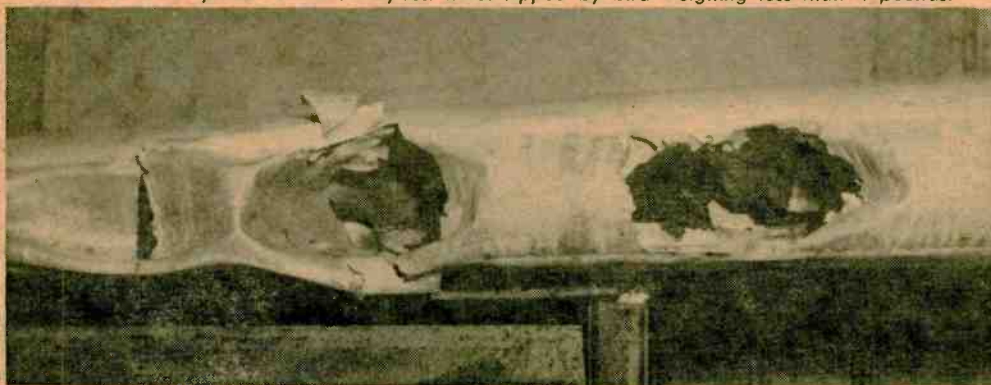

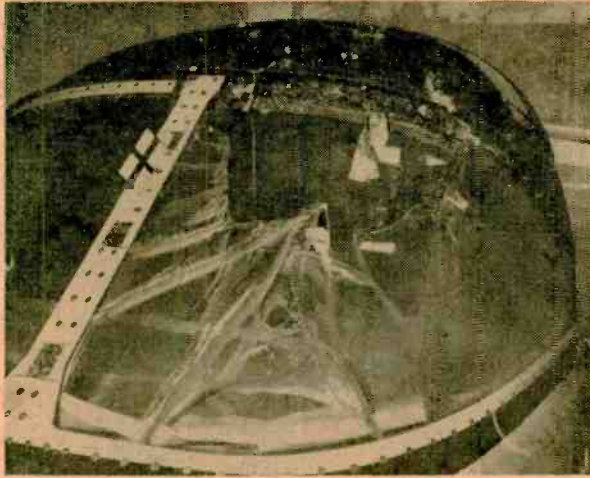

One bird did this to a plane's windshield. Had the plane been hit on the runway, only the bird would have been damaged. But at 600 mph.

built to take that kind of punishment.

Electronic Solutions. Electronic remedies are becoming increasingly common. Some are still experimental; others have proved their worth, but can't enter general use until big amounts of money are made avail-

able. Working with Queen's University, Ontario, the National Research Council of Canada has demonstrated that microwaves are a potential solution to the bird-hazard problem in and near airports. There's no doubt whatever, these experimenters conclude, that birds are far more sensitive to microwaves than to noise from shotguns and firecrackers. Microwave radiation with generator frequency of 9.29 GHz pulsed at 416 Hz with a pulse width of 2.35 μ sec causes behavioral changes easily noted by the naked eye—plus internal changes in the birds.

If birds can't be driven away by microwave radiation or other influences, it becomes vital that they be detected and that their habits be familiar to control-tower personnel. At Bowling Green State University, Bowling Green, Ohio, radar was used to study winter flocking patterns of the common crow. Use of radar at Toledo Express Airport allowed tracking of flyways entering the airport area up to ten miles away.

Bird Behavior. Behavior patterns of birds during final roosting was found to fall within definite light-intensity ranges. A similar relation was noted during morning bird dispersal. *(turn page)*

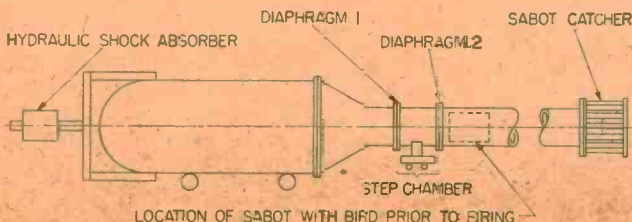
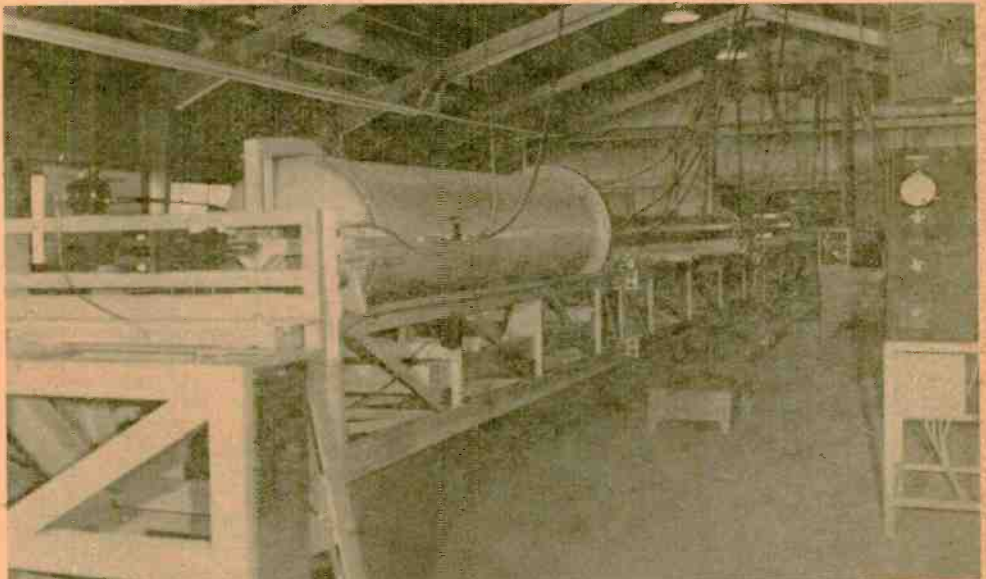

High-pressure pneumatic cannon used in Canadian research to probe for structural weaknesses in planes not designed to withstand the impact of birds. The sabot is a carrier that positions the bird in the tube.

e/e AIR-TO-AIR KAMIKAZES

Many airport mishaps stem from the fact that birds heading for their roosts, or leaving them to hunt food, follow paths that put them on collision courses with planes that are landing or taking off. Worldwide study of habits of many kinds of birds can be undertaken with conventional radar already in use. Operators need special training or experience, though, to make accurate observations of bird movements.

Conventional equipment isn't up to the job of displaying an airfield map showing the presence and magnitude of bird groups on runways and short vegetation in all weather. At Loughborough, England, a research worker in the University of Technology has made substantial progress. Glenn W. Schaefer concluded that a high-resolution X-band radar with an antenna 20 to 30 meters high would perform satisfactorily except during heavy rain. Modification of commercial marine radar to meet his standards cost only \$12,500—less than the cost of a single repair job to one plane suffering minor damage.

The majority of reported civil aircraft-bird collisions occur at or near the airport. On a worldwide basis, gulls involve more strikes of this sort than do any other kind of birds. After colliding with a dense flock, a plane may leave 100 to 300 dead birds on the runway. Experimental use of the radar adapted according to Schaefer's specifications showed that gulls standing on a run-

way can be detected almost instantly. Routine patrols by airport bird-detection radar promises to bring drastic cuts in jet-engine ingestions. Wide application of the technique that has already proved its feasibility waits only on money and personnel.

In-Flight Hazards Remain High. Reduction in the number of reported bird-strikes stems almost entirely from progress in detection and control at airports. So far, no workable way to spot birds from the cockpits of planes has been developed. The best that pilots can do is to try to stay out of known migration paths. Pending the development of on-board radar capable of detecting birds, one important avenue toward greater safety is redesign of aircraft.

At the National Research Council of Canada, flight-research engineers are concentrating on ways to "birdproof" aircraft. Birdproofing consists of increasing the strength and energy-absorbing capabilities of vulnerable parts of aircraft that are likely to be hit. Wing structures are generally thought to be deep enough to take a bird-strike without serious damage. That's not the case, though, with a plane's windshield, jet engine, or empennage (leading edges of tail assembly).

In April, 1969, a Boeing 737 with a full passenger load was coming in for a night landing at Winnipeg's International Airport. The plane was travelling only 335 mph when it ran into a flock of migrating geese at 3,000 feet. Seven of the birds, weighing 10 to 12 pounds each, hit the plane. Both engine cowlings, the fuselage, and the star-

(Continued on page 102)

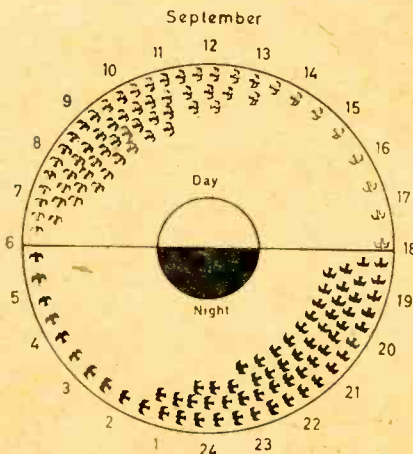
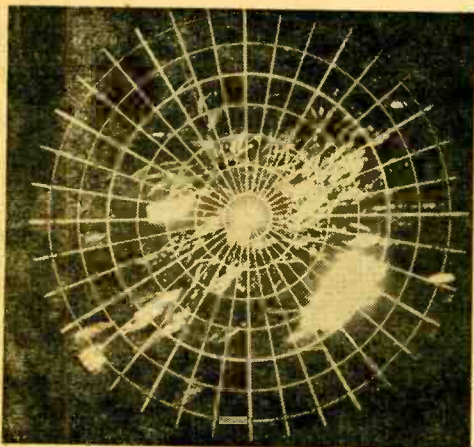

Radar scope (left) shows bird movements as white streaks, while cloud masses show up as heavy white areas. Chart at right shows that the heaviest times of bird migration over North America in September are between 8 and 11 AM, 7 and 11 PM.

e/e PADS

former side of the circuit is perfectly matched with the wiper of R1 located at point A. But as the wiper is moved toward point B, the effective resistance connected across the speaker voice coil decreases, causing a serious mismatch.

This is where the pad network comes in. An ideal attenuator will cause variations in speaker volume without changing the impedance (resistance in this case) across the transformer of the voice coil. A fixed attenuator called a "T-pad" is shown in Fig. 2. In this type of pad, R1 will equal R2, while R3 is some other value selected to match the impedance on both sides of the circuit.

A variable version of the T-pad is shown in Fig. 3. This type of attenuator is commonly used as a local volume control for loudspeakers in high-fidelity installations. Generally, its function is to balance a system for differences in speaker efficiency, room acoustics, and, in the case of extension speakers, act as a volume control at the speaker location. These pads are generally mounted on the speaker cabinet.

Connected a different way, the T-pad is frequently used as a "brilliance" or a "presence" control. Such pads, usually factory-wired into a loudspeaker cabinet, vary the amount of signal that is fed to the high-

frequency speaker.

The three resistors in Fig. 3, R1, R2 and R3 are "ganged." They are all mounted on the same shaft so that as the knob is rotated, all three are varied by the same amount. The arrows in the drawing indicate the direction the wipers (center connections) move when the shaft of the pad is rotated clockwise to turn up the speaker volume. When the knob is turned to the full clockwise position for maximum volume, R1 and R2 are effectively shorted, providing a direct connection between points A and B with no loss. R3 will offer maximum resistance, permitting very little current to flow from one side of the circuit to the other. In this position, the speaker voice coil sees only the impedance of the output transformer secondary coil—just as if there were no pad in the circuit at all.

In the opposite position, fully counterclockwise, R1 and R2 are at their maximum resistance and R3 is at minimum resistance. In this position, very little current can flow through the upper leg of the pad because of the high series resistance. Any current flowing in the lower half is shorted to the upper branch through R3 which has become zero ohms—a direct short. The resistances have been selected so that the total resistance of the pad in this position or any intermediate one, is always the same on both sides. This way, impedance matching is maintained.

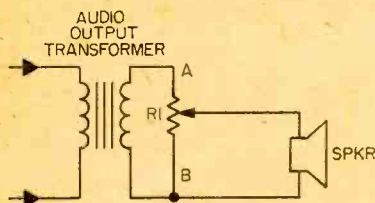

Fig. 1. Fader-type volume control for loudspeaker uses only one pot—but it's not practical in most cases.

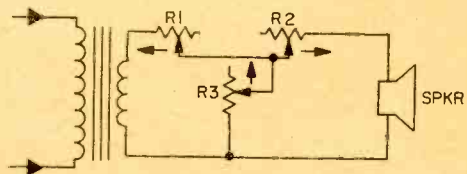

Fig. 3. A variable T-pad gives equal impedance at both sides of audio circuit and offers complete volume/power control.

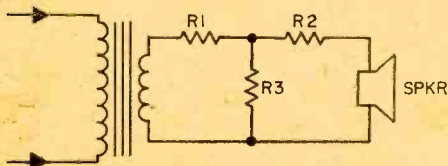

Fig. 2. A fixed T-pad gives equal impedance on both circuit ends—winding and loudspeaker see equal Z.

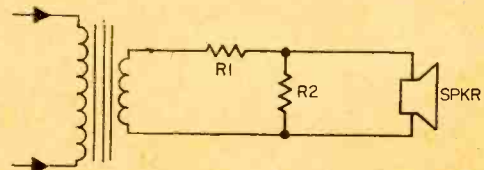

Fig. 4. The fixed L-pad has a very low energy or insertion loss. It's widely used to match two different impedances.

Matching Difference Impedances. A pad is a versatile device and can be used for matching two very different impedances. A frequently used configuration is the L-pad, which is simply a T-pad with one resistor removed, (See Fig. 4.) An application for this pad would be matching an output transformer with a 500-ohm secondary to a 16-ohm speaker.

Another way of looking at an L-pad is shown in Fig. 5. Viewed this way, the pad looks like nothing more than a voltage divider, and that's exactly what it is! The total resistance of R1 and R2 should equal the nominal impedance of the transformer secondary coil. The resistance of R2 alone will equal the impedance of the voice coil. In the case of matching a 500-ohm secondary with a 16-ohm speaker, R1 would equal 492 ohms and R2 would be 16 ohms.

Naturally, whenever any pad (or attenuator, if you will) is placed in a speaker circuit, there will be a certain amount of power loss—the attenuation that gives its name to these devices. Even in the case of a pad with low-value resistors, there will be some loss of energy and this is known as “insertion loss.”

Isolating with Pads. Another application for the pad is isolating of one part of a circuit from another. The need for isolation arises when a circuit has wide variations in impedances (usually due to frequency changes) and the associated circuit must be

kept at a constant impedance. A typical circuit that must frequently be isolated is the equalizing network in a high-fidelity pre-amplifier. Another instance is the output signal from a program source such as a tape recorder that is coupled to an amplifier circuit that requires constant impedance.

Effective isolation is possible with an H-pad shown in Fig. 6. The network resistance is the same at both the input and the output, providing good impedance matching. But the resistance of the network is high enough to prevent any impedance variations from being transferred from one side to the other.

The amount of actual attenuation in any pad depends on the resistance values of the total networks. There will always be a certain amount of insertion loss, even with the so-called “low-loss” types, such as the L-pad.

Signal Dividing. A commonly used pad is the two-set coupler for simultaneously operating two TV sets from the same antenna. The H-pad is usually used. Fig. 6 shows how the connections are made. The input from the antenna is across resistor R1 and the two TV sets (or one TV set and FM tuner) are connected to the two opposite sides of the “H.” Even with careful impedance matching, the insertion loss is so high that couplers of this type are practical only in strong signal areas.

Some manufacturers make “powered-couplers”—signal dividers with a tube or
(Continued on page 99)

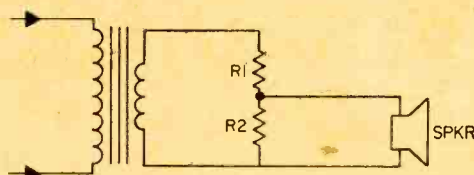

Fig. 5. Here's the L-pad again drawn to look like a voltage divider. R2 and speaker impedance are equal so that $\frac{1}{2}R2$ plus R1 should equal the transformer's secondary winding. Can you prove this statement?

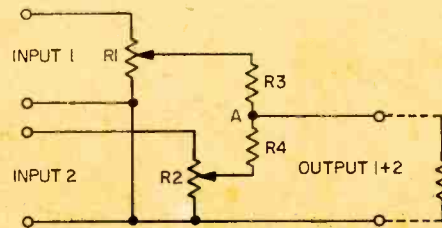

Fig. 6. They call it an H-pad because it looks like one. With the proper selection of resistors, the pad offers 3, 6, 9 or more dB loss while isolating and matching antenna from the two television sets.

Fig. 7. L-pads made from variable resistors are used to mix two (or more) audio signals prior to amplification.



The Lafayette LA-44 4-channel stereo amplifier, for \$219.95, is rated at 170 watts, can be used as two independent stereo amplifiers and thus supply two different stereo programs in two different locations.

YOU PICK THE NAME-

- Quadrisonic**
- Quad-Sound**
- Surround Sound**
- 4-Channel Sound**

Half a dozen different names are already being used by manufacturers of the hottest audio products since stereo hit the market. The simplest name is 4-channel sound. But the hi-fi companies want something out of the ordinary. So Panasonic calls it *quadrisonic*, Toshiba uses the term *quad matrix*, and Motorola says their automobile tape-player provides *wrap-around sound*. Toyo defies the "u after q" rule, calls it *Qaudio*. Sansui says *Quadphonic*, Dynaco prefers *Dynaquad*, and there should be a dozen more new names in the near future.

For the moment, let's call it what Lafayette Radio does—just plain 4-channel sound. One little point should be cleared up right away. True 4-channel sound, from four discrete sources, is currently available from only one source—4-channel tape. No matter how you slice it or what you call it, all other sources, including records and broadcast material, can give

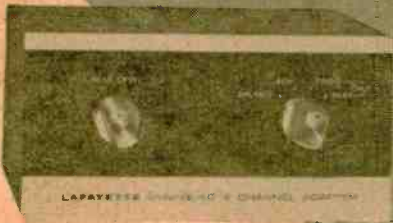

Add either of these to your present stereo system for \$29.95 to get a 4-channel effect from 2-channel source material. The Lafayette Dynaquad 4-channel adapter (left) requires only two additional speakers. Heath's Stereo-4 Decoder kit (right) requires a second stereo amplifier and two speaker systems, is based on the EVX matrixing system.



Circle No. 42 on
Reader Service Page 17



Teco's 702 Qaudio amplifier and cartridge player, at \$169.95, provides either true or derived 4-channel sound, depending on the source.

Circle No. 43
on Reader
Service Page 17

you no more than *simulated* 4-channel sound, also called "derived 4-channel sound" or "4-channel effect."

To get a 4-channel effect from 2-channel sources, ingenious circuits subtract one stereo channel from the other, and drive the two rear speakers with processed signals. Manufacturers say this difference is the ambient or reflected sound caused by the original sound bouncing off objects in the recording studio or concert hall. Feeding this difference to two rear speakers is supposed to give the effect of being in the studio or hall. Whether the effect is that good is a matter of argument between musicians, engineers and hi-fi enthusiasts. The purists say that only four discrete sources will do; others say they like the simulated effect. And the manufacturers like both types, because more and more of them are coming out with 4-channel amplifiers, tape and cartridge players, and decoders. ■



Both these 4-channel stereo cartridge players will also take 2-channel, 8-track tapes, Lafayette's RK-48 (top) at \$79.95 or the JVC Model 1202 (bottom) at \$99.95.



Circle No. 44
on Reader
Service Page 17



Circle No. 45 on Reader Service Page

Panasonic's RS-740US tape deck records and plays back both 4-channel quadrasonic and 2-channel stereo tapes, at \$399.95.



The Ding-a-Ling that Makes Ma Bell Cringe

Annoyance Call Bureaus such as this have been set up in most large telephone centers to handle the problem of anonymous phone calls.



Terror strikes as she lifts the phone only to hear heavy breathing at the other end. Calls like this are so frequent that many telephone companies have set up "Annoyance Call Bureaus" to handle this problem and track down the culprits with advanced electronic devices that "lock in" and "trace" the call. One such device, CHADO or "Call Hold and Dial Out," freezes the incoming call when 2 or 12 is dialed and sets off an alarm at the telephone company. The call can be traced even if the caller hangs up. There are many such devices now in use; all are linked to computers and provide a 10-second recording and tracking route for any call at a central office. All mean protection for you. ■



When triggered, tone set on victim's phone (left) emits a signal alerting security people at the central office. This locks the incoming call as the computer card records the essential data.

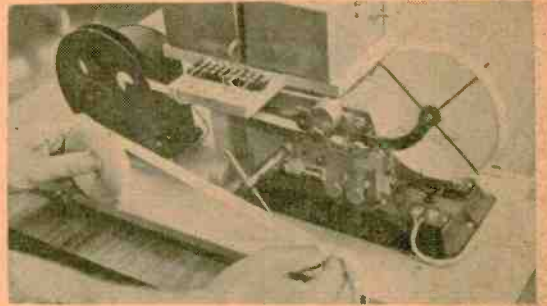

Above, this "pentape register" records the number of calls made by the anonymous caller. Computer cards with vital data (below left) are released by the "Trap Circuit" when the victim's phone transmits a signal to the central detection office.

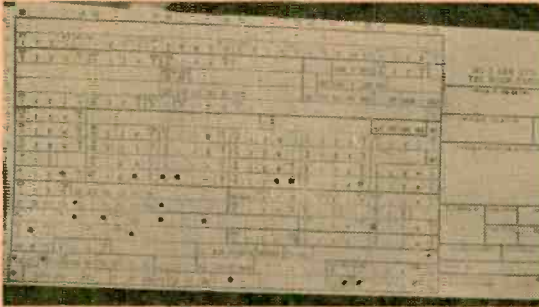

Below, this maze of millions of wires will no longer mask the obscene caller from detection at the central telephone offices. With the help of the new electronic machinery available, agents can now seek out and trap the culprit in a short span of time.



This computerized monitoring board known as MOM (above) punches out a computer card at the central office from a high-speed tracer which is attached to your home telephone.

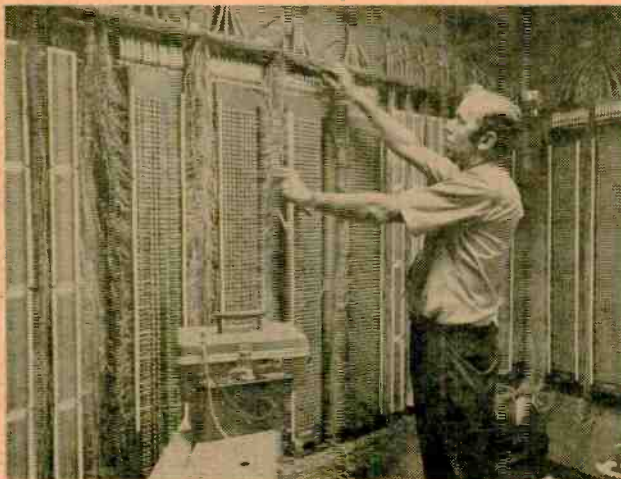



The best way to get electronics into your head

No book ever written can give you the "feel" of electronics.

This is why every NTS course in Electronics includes the most modern, professional training equipment in kit form.

Putting equipment together, kit by kit, can teach you more about electronics than a whole library of bone-dry theory.

Each kit contains illustrated instructions.

You look at the pictures, then you apply what you see as you assemble or service your equipment.

What could be simpler? Or more fun? You'll enjoy every profitable minute.

Here's just some of the equipment you get to build and what you will learn.



Square-Corner
25" Diagonal picture.

NTS COLOR AND B&W TV SERVICING

You receive a big screen color TV with many unique features, including self-servicing equipment so you can make all normal test operations. You also get an AM-SW radio, solid-state radio, field-effect transistor, Volt-Ohmmeter and electronic tube tester. You learn about electronic principles, trouble-shooting, hi-fi, multiplex systems, stereo and color TV servicing.



Solid-state
B&W TV
74 sq. in.
picture
(cabinet
included)

The B&W TV receiver features the latest in *solid-state circuitry*, making your TV training the most modern, most advanced available.

NTS COMPUTER ELECTRONICS

One of the 10 important kits included is this remarkable Compu-Trainer® — an NTS exclusive. It's a fully operational computer logic trainer — loaded with integrated circuits. It introduces you quickly to the how, what, when, and why of computers. This unit is capable of 50,000 operations per second.



Exclusive
Compu-Trainer®

NTS ELECTRONICS COMMUNICATIONS

Two exciting courses in the big-paying fields of transmitting and receiving equipment. Either one qualifies you for your FCC First Class Radio-

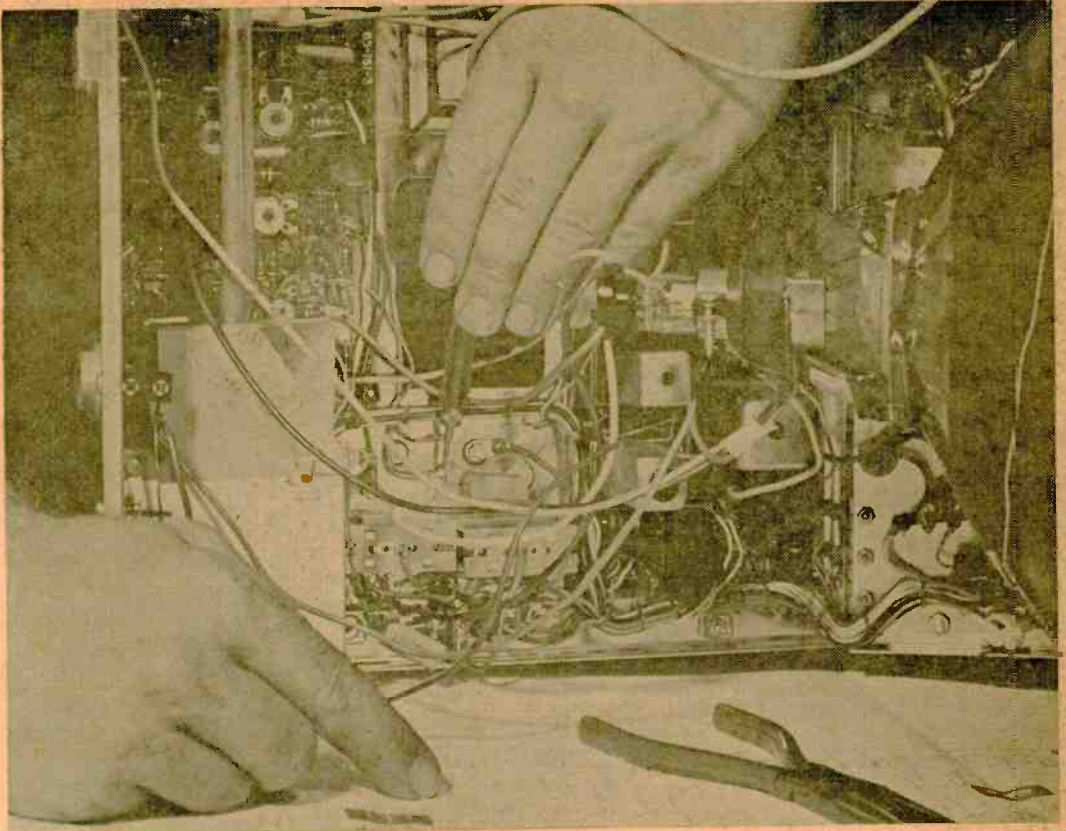

is to have the actual equipment in your hands.

Telephone License. NTS assures you will pass this FCC exam within 6 months after successfully completing your course — or your tuition is refunded. You receive 14 kits to build an amateur phone 6 meter VHF transmitter plus NTS' exclusive 6 transistor solid-state radio and a fully transistorized volt-ohmmeter.

5 watt AM transmitter/receiver.



NTS AUTOMATION/ INDUSTRIAL ELECTRONICS

Let NTS put you into the age of electronic controls. Systems automation is rapidly becoming the emphasis of modern industry. NTS training includes equipment like a 5" wide band oscilloscope. You also get the new, exclusive NTS Electro-Lab — a

complete workshop that lets you build five industrial controls to regulate motor speed, temperatures, pressure, liquid level, smoke, and much more.

5" Oscilloscope



Mail card today for free, full-color catalog that details what each training program offers. (Or if card is missing, send coupon.) No obligation. No salesman will call.

Remember, the best way to get electronics into your head is to have the actual equipment in your hands. The sooner you mail the card, the sooner you'll get your hands on the finest, most advanced electronics home training ever offered.

CLASSROOM TRAINING AT LOS ANGELES You can take classroom training at Los Angeles in sunny California. NTS occupies a city block with over a million dollars in facilities devoted exclusively to technical training. Check box in coupon.

APPROVED FOR VETERANS

Accredited Member: National Association of Trade and Technical Schools; National Home Study Council.

NATIONAL TECHNICAL SCHOOLS

WORLD-WIDE TRAINING SINCE 1905

4000 S. Figueroa St., Los Angeles, Calif. 90037

If card is missing check coupon and mail for free color catalog and sample lesson. Now.

Please rush Free Color Catalog and Sample Lesson, plus information on course checked below. No obligation. No salesman will call.



National Technical Schools

4000 S. Figueroa St., Los Angeles, Calif. 90037

- Master Course in Color TV Servicing
- Master Course in TV & Radio Servicing
- Practical TV & Radio Servicing
- Master Course in Electronic Comm.
- FCC License Course
- Master Course in Electronics Tech.
- Industrial and Automation Electronics
- Computer Electronics
- Basic Electronics

Dept. 222-091

Name _____ Age _____

Address _____

City _____ State _____ Zip _____

Check if interested in Veteran Training under new G.I. Bill. Check if interested only in Classroom Training at Los Angeles.

CIRCLE NO. 18 ON PAGE 17

The
computer
that says --
"WATCH IT



FATSO

Look down, Fatso! What do you see? Is it your toes or your stomach? Well, how would you like to own a computer that helps melt that fat away? That's right, just set the appropriate dials and this mini computer will do the rest—with a little help from you, of course. By correctly setting the eight dials the computer will tell you whether a given meal will make you put on or lose weight. Since it takes eight different factors into account—user's weight, amount of exercise, types of food consumed—it gives a bit of flexibility to your diet. For example, it may even let you have that banana split if you've had enough exercise that day. Not a bad diet! Basically, this device consists of a box with eight dials, meter and a push-button. You record the weights of the various foods to be eaten, your weight, exercise taken before the reading, and then push in the button at the right corner. Your change in weight appears on the scale in tenths of a pound. Of course, don't get us wrong, this battery-operated computer won't let you eat sundaes all the time—it might even say, "Watch it, Fatso, you're eating too much!"

e/e checks out a...

C-D Ignition Kit

Give your car a longer and hotter spark by installing the EICO Model 889 Capacitive Discharge Ignition System.

Trying to squeeze more pep from your car? There are lots of auto bolt-ons that claim to give your chariot more miles per gallon, better cold-weather starting and greater high-speed performance. But, only one "gadget" delivers these claims, and that is *EICO's Model 889 Capacitive Discharge Ignition System* kit.

A capacitive discharge (or C-D system as it is more commonly called) draws out your car's high level of performance by radically changing the method of firing its spark plugs. In a standard, or Kettering, ignition system, the distributor's breaker points first close to complete the ignition coil primary circuit by grounding the negative end of the ignition coil. The positive end of the coil is always connected to the car battery. When the breaker points open, the sudden change in current flowing through the primary magnetically induces several thousand volts into the secondary. This high secondary voltage is fed through the distributor to the appropriate spark plug, where it arcs across the plug's terminals, and ignites the air-gas mixture in the cylinder.

Simple and dependable as it is, the Kettering

system suffers from one major flaw. The faster the engine spins, the faster the breaker points open and close. This means that there's less time for the coil to "charge"; a considerably lower voltage reaches your car's spark plugs, which is just when you need maximum spark!

Thanks to solid-state technology, *EICO* puts the tiger back into your car's tank. Here's how. *EICO's Model 889 C-D* system maintains an almost constant high voltage regardless of speed by depending upon a "charged" capacitor rather than the breaker points to "fire" the ignition. Inside the 889 is a DC to DC converter that steps up the car battery's voltage to approximately 100 Volts. This higher voltage is then used to charge a relatively large capacitor whenever the distributor's breaker points are closed. The capacitor, in turn, is connected in series with the ignition coil and an SCR.

When the breaker points open, the SCR gate's holding voltage also opens (by the points) and the SCR conducts. The capacitor now discharges through the coil. Since coil's primary now "sees" a much greater current, a resulting very high voltage is generated for the spark plugs.

The primary advantage of this system is that the capacitor charges very quickly. At low engine rpm's, it is charged long before the points open. And, at high speeds, this capacitor charges all the time the points are closed—virtually the same charge is available at low and high speeds.

So, first things first. The *EICO Model 889 C-D* system delivers more high speed pep. You'll feel the difference the first time you tromp the gas pedal on the highway. Next, the spark is hotter; there's more vol-

This is an EICO Model 889 Capacitive Discharge Ignition System, which can be installed anyplace under a car hood from where the wires can reach the ignition coil. Most typically, the C-D system is mounted on a wheel well, which is the easiest place to put it.

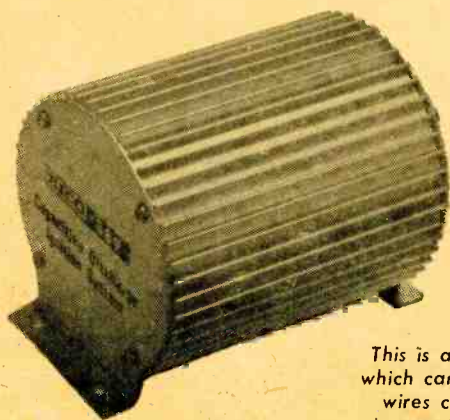

e/e C-D IGNITION KIT

tage, so it becomes a much simpler proposition to start the engine on a cold morning.

Let's look at some of the other benefits from *EICO's* C-D system. Since there is a more intense spark available, you can increase the spark-plug gap, say from .035 to .045 inches. Your car's spark is now even longer, hotter and longer burning! Combustion is improved, and the user starts to realize considerably better cold-weather starting and "pep"—especially if he's being plagued by a gas-guzzling older car. For the new car owner, *EICO's Model 889* C-D Ignition system kit gives his New-Car-Payment Mark III some improvement in mileage, but it's not really significant at other than highway speeds.

Want to realize maximum benefit from the CD system? Follow the supplied instructions for increasing the spark-plug gap. While you can also decrease the breaker

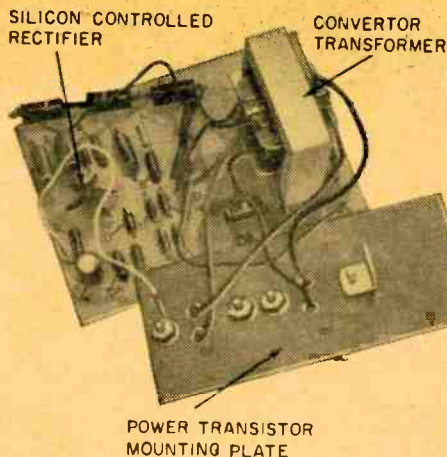

The DC-to-DC-converter power transistors require heavy heat sinking—they get hot. Mounting is on a separate plate.

point gap and advance the overall ignition timing, these procedures should be left to a qualified auto mechanic. Each procedure *does* add that little bit extra to overall performance, but the largest gain is still obtained by simply installing *EICO's* ignition system!

Hot Charge In the Old Heap Tonight. Complete assembly, from the time your tear open the shipping carton, to the point where the 889 is ready for installation in the car, takes
(Continued on page 100)

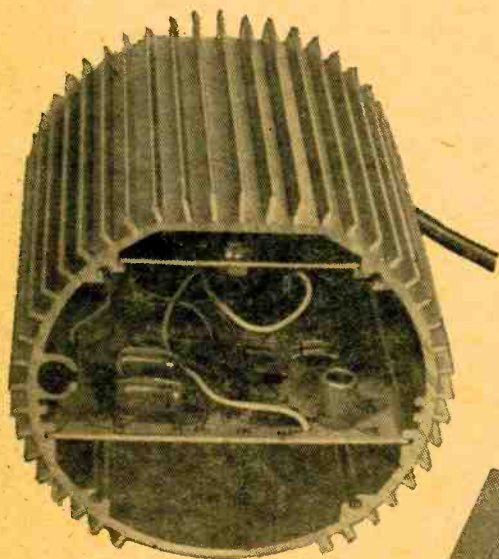

The completed unit (above) with the end plate not installed shows the PC board and power-transistor mounting plate slid into preformed grooves, jamming the transistors against the combination heat-sink and case during final assembly. The kit (right) is no more than a large handful of components.

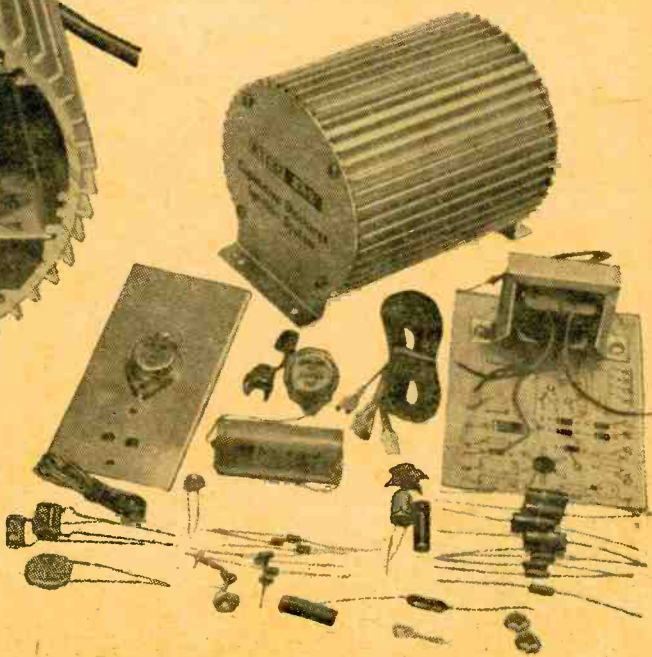



KATHI'S **CB** CAROUSEL

By Kathi Martin, KAIQ614

Believe it or not, many XYLs don't buy their rigs on the basis of shiny front panels wooing them with cutsey round dials and teeny bejeweled lights—and nothing to show in the performance department. Just like their OMs, most CBing XYLs buy their transceivers with but one idea uppermost in their mind—quality first. To hordes of XYLs and OMs punching push-to-talk buttons, one name stands out when they think of first-class CB gear. Right from CB's early days, *E.F. Johnson* has made quite a reputation for themselves as manufacturers of top quality Citizens Band gear. So, it naturally follows that when Band inhabitants started musing over the idea of simultaneous multi-channel monitoring, the fellows back at *E.F. Johnson* heeded the call to action, and showed us how to do it right!

The *E.F. Johnson 124M* CB transceiver lets you monitor two channels at the same time. Although this idea may not seem stupendous to the lone wolf CB operator, it's every REACT and emergency group commander's dream come true. While you operate on one channel, another separate receiver built into this rig allows you to monitor either one of two switch-selectable "monitor channels."

Here's how the *124M* works. When a call is received on one of the two separate moni-

tor channels, either a panel lamp illuminates to indicate a monitored channel is in use, or the monitored signal will "break in," and feed its audio signal to the speaker. You choose either operating mode by fingering a rocker switch labelled *Alert/Auto* on the transceiver's rear panel.

As with any other store-bought rig you're likely to ogle or operate, *E.F. Johnson's 124M* covers all 23 channels. The receiver half of this snazzy style-setter is of the double-conversion variety—keep in mind that this is not an average rig! Simply twist the indirectly-lit channel selector knob on the front panel, and you're in business.

Buried within the receiver circuit is a crystal filter adding its special brand of selectivity to the 4.3 MHz first IF stage.

It was a welcome relief to be able to see the various markings and numbers on the *124M's* S-meter. I didn't have to haul out my contact lenses to read the numbers, and a rocker switch on the *124M's* front panel turns the S-meter into a modulation, power output or SWR indicator. Remember, you can't squeeze that last ounce of performance out of your rig without an accurate meter setup; the S-meter on *E.F. Johnson's 124M* practically begs to be read!

Modulation a la Brawn. I'd call the *124M's* transmitter a meat 'n' potatoes dish.



*To paraphrase song lyric, this rig is delightful to look at, a pleasure to work. Meter's dial reads easily, thanks to big numerals, plus indirect-lighting benefits. Channel selector dial puts the word communicate back into CB with its indirectly-lit dial face, special marking for Channel 9. All controls work smoothly, contributing to this rig's overall operating ease. Most useful feature of *124M* is its built-in monitor receiver.*

KATHI'S CB CAROUSEL

It's electrically beefy and mechanically satisfying for even the critical eyes of our lab tech. Yet, the modulator in the transmitter half of the 124M still managed to satisfy my appetite for a healthy portion of haute cuisine. A real blue plate special, the modulator represents the truly deluxe slice of the 124M's pie. Providing both compression and clipping, the modulator's circuitry is topped off with a fully adjustable *Microphone Gain* control on the front panel. The results? Everybody's bound to win their own private watts-per-mile war armed with *E.F. Johnson's 124M!*

The power supply is the dual-purpose type, allowing operation from 117 VAC or 12 VDC. As expected, normal line voltage or car battery roller-coaster variations are taken in stride by the power supply's inwards.

The microphone's case is *not* connected to chassis ground. This is *E.F. Johnson's* one departure from the beaten path. A specially modified mike provided by the manufacturer should be used. But, if you already own a good microphone, and want to team it up with the 124M, it's a simple matter to modify it in order to work with this rig. Actually, the case of the already-modified *E.F. Johnson* mike is connected to the connecting cable shield through a DC blocking capacitor. My advice to you is

to dig a little deeper into your pocket and buy the optional mike for the 124M.

Spooning out the Gravy. Let me get back to the 124M's real reason for being in a shack—the two-channel over-ride monitor. It's *the* gravy feature. The monitor's input is also connected to the antenna; it's a complete single-conversion receiver that is complete right up to the detector output. Look at the photo showing the front panel of the 124M; you'll see that there are two separate squelch controls provided. One of these controls is for the main receiver, and the other squelch control is for the monitor receiver. Two crystal sockets sitting on the monitor receiver printed-circuit board allow the user to select up to two monitoring channels. A selector switch mounted on the front panel selects one of the two channels.

The audio output of the monitor receiver is fed to a set of relay contacts. These contacts determine whether the audio output from the monitor is fed to the 124M's speaker, or whether the audio from the receiver-half of the transceiver is heard. At the same time the relay is trying to decide which receiver you'll hear, the monitor receiver AGC voltage is sent to an amplifier that serves to drive an audio switching relay or a front panel lamp. This AGC amplifier connection is determined by the *Alert/Auto* switch I spoke of before. When the switch is set to the *Alert* position, the AGC developed by the incoming monitored signal causes the front panel lamp to light. If the switch is set to *Auto*, the AGC voltage causes the relay

Two-channel monitor receiver is attached to its own mounting bracket, over channel selector assembly. Transceiver's chassis is well built, by anybody's standards. Over-engineering, see throughout 124M, contributes to rig rock-steady performance. For instance, power transformer loafs along; it never seemed to warm to our lab technician's touch!

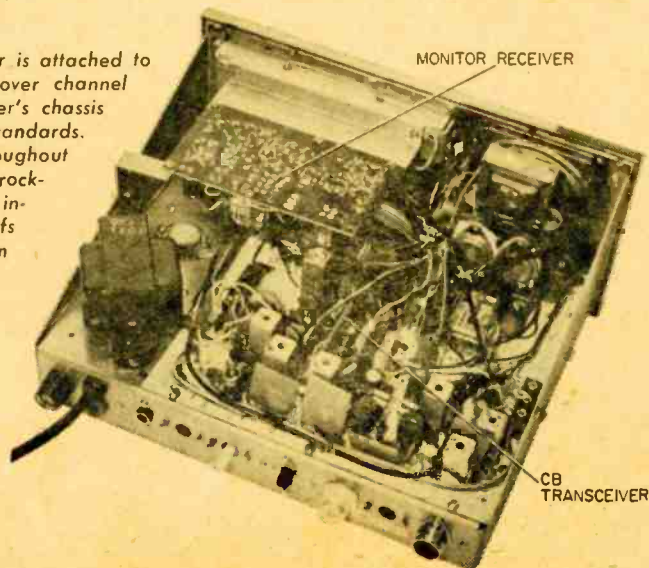

Don't laugh at Tone Control, found on 124M's rear panel. It was one of the better ideas I saw on this rig's rear panel. Continuous exposure to white noise, plus other high-frequency sounds, leads to listener fatigue. Tone control effectively cuts out, or "mellows", these high frequencies. Power, Modulation readings on SWR meter are calibrated with aid of separate potentiometers located on chassis rear panel. Antenna jack is standard type SO-239 coaxial connector.

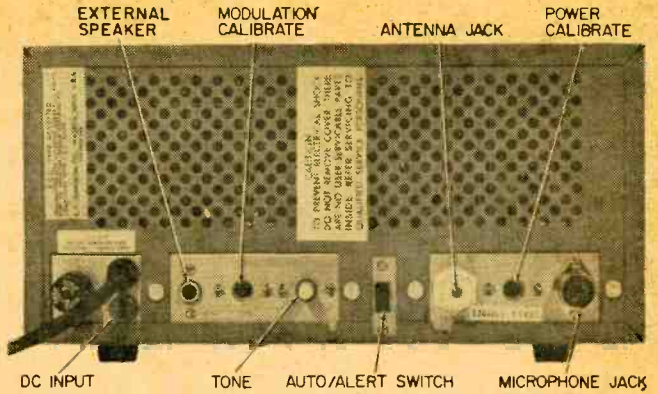

to switch the monitored signal's audio into the main transceiver's audio amplifier.

Remember that squelch control for the monitor receiver I mentioned earlier? It determines the signal level at which the monitor receiver buzzes to life and switches audio or lights the indicator lamp to indicate that a signal is on the monitored channel.

Piecing It All Together. The internal circuitry is admittedly complex, even by my standards. Yet, there are only two more actual operating controls than the CBer usually finds on his own rig. And, swinging around the back of the rig, you'll note that the rear apron packs in some nifty user adjustments, too.

Housed in a 5½-in.H x 11-in.W x 10-in.D cabinet, the 124M's front panel contains the

Meter Selector and Noise Limiter switches. Also, on the front panel are the PA/Squelch and Volume controls, plus controls for Microphone Gain and Monitor Receiver Squelch. A Channel Selector and Channel Monitor indicator lamp round out the front panel finery.

Located on the rear apron are the RF output jack, a microphone input jack, tone control, monitor Auto/Alert switch, external speaker jack, modulation meter calibrate and power meter calibrate controls.

Yes, it sounds very complicated. But take it from an XYL whose only claim to mechanical fame is that she knows how to push-to-talk. Once the microphone gain control is adjusted so that speech peaks indicate half-scale on the meter, you're ready to beat the Band! With the meter switch set to

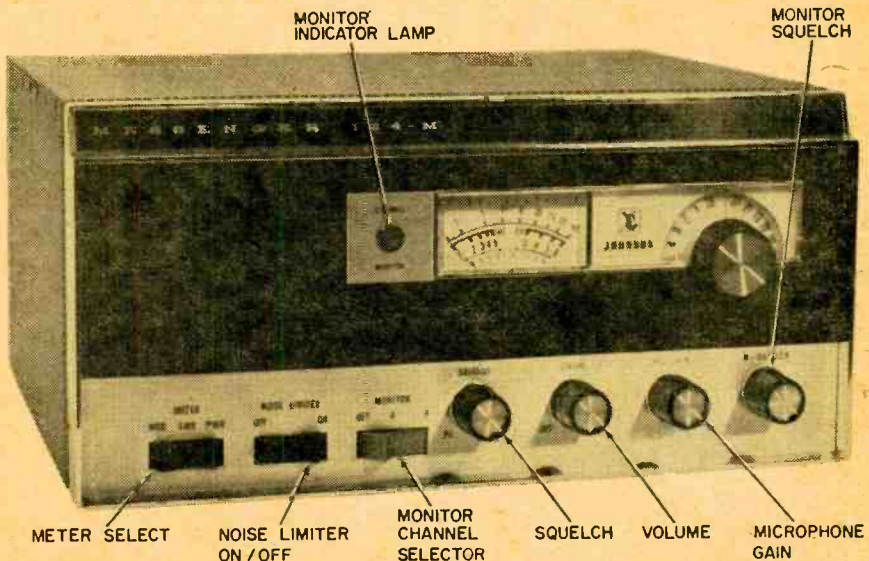

Here's what E. F. Johnson's 124M rig front panel looks like. Only two more controls than CBer usually finds on his rig are present on 124M: Monitor Channel Selector plus Monitor Squelch.

e/e KATHI'S CB CAROUSEL

Power or SWR, the meter directly indicates the power output or SWR. The meter automatically switches to received signal strength when receiving.

A Muscular Performer. Main receiver sensitivity measured 0.9 μV for a 10 dB S+N/N (signal plus noise to noise). Adjacent channel rejection was an outstanding 65 dB, while the image frequency rejection was 55 dB. The AGC action was 10 dB for a 2 to 50,000 μV input signal range. While this is not as compressed as most solid-state AGC systems, it is substantially better than tubed CB rigs.

The received-signal audio quality proved excellent—really sharp and clean. The rear apron tone control provides variable high-frequency cut, so sharp, piercing signals can be “mellowed.”

The monitor receiver section required 4.2 μV for a 10 dB S+N/N ratio. The monitor squelch control can be set so that this receiver starts to perk on signal strengths between 4 and 30 μV . The selectivity was 25 dB adjacent channel rejection; image rejection was 10dB—a typical value for a single conversion rig. Keep in mind that the monitor section performance, though adequate, need not perform like gangbusters because it serves only as an attention getting device.

The 124M's transmitter delivered 3.8 watts into a 50-ohm load. Because of the adjustable mike gain, 100% modulation can be obtained with virtually any voice level—from seductive whisper to Gravel Gerty shout. The modulator really puts out lots of “talk power.” Several stations I worked thought the rig was connected to an illegal linear power amplifier!

The automatic monitoring worked out quite well. When the rig is set to *Auto*, and with a channel 9 rock gracing its holder, any signal on channel 9 would over-ride the station being received on the main receiver. Since the monitor section is squelched, there is no extraneous noise added to the main receiver. You can only hear the monitor section when there is an actual signal in the monitored channel. When switched to *Alert*, there is no interruption of the main receiver; just a bright glow from the panel lamp indicating that there's a signal on the monitored channel.

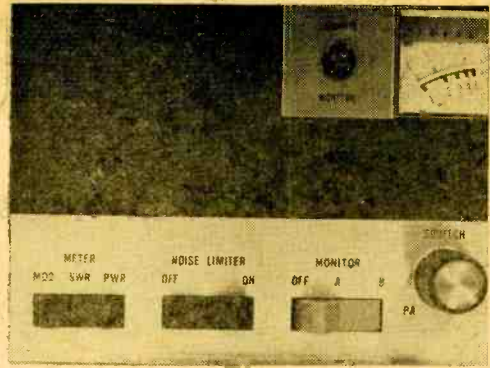

Three rocker switches determine Meter, Noise Limiter, Monitor operating modes of 124M rig.

The Mobile Messenger. Between driving chores and ever-constant squelch control fiddling found necessary with most CB rigs, the average CBER has his hands full simply trying to communicate on one channel at a time. And, in the not-too-distant past, working two or three separate CBERs simultaneously via mobile rig was, for myself, the chore supreme. Yet, with the *E.F. Johnson 124M* transceiver, I really was able to shift into my own high performance slot with this rig mounted mobile. After temporarily installing the 124M into my chariot, I felt that I had almost gained at least two additional sets of eyes and ears. Easy CBing, a last!

The *E.F. Johnson 124M*, priced at \$339.50 less microphone and mobile mount, is really quite a bargain. If you doubt me, try buying a couple of rigs of comparable quality and stringing interconnecting cables between all units for similar performance. And then hope that the first time you throw a transmit switch on one of the rigs, you don't fry the other's receiver in the process. A deluxe base station mike is priced at \$15.95. Extra crystals for the monitor receiver are priced at \$2.50 (specify desired channels).

Also available are accessories like an extra microphone connector, a hand-held microphone and a mobile mounting and installation kit. Needless to say, I was impressed with the performance of *E.F. Johnson's* model 124M. It could very well be the transceiver choice for the CB-active XYL or OM who shops for quality instead of a walnut-appliqued, gee gawed “rig.” Want to see more information on the *E.F. Johnson 124M* CB transceiver? Circle No. 46 on the Reader Service Page 17 and I'll be happy to oblige. ■

MULTIVIBRATORS

an afternoon visit with the first family of industrial electronics

by Norman Crawford

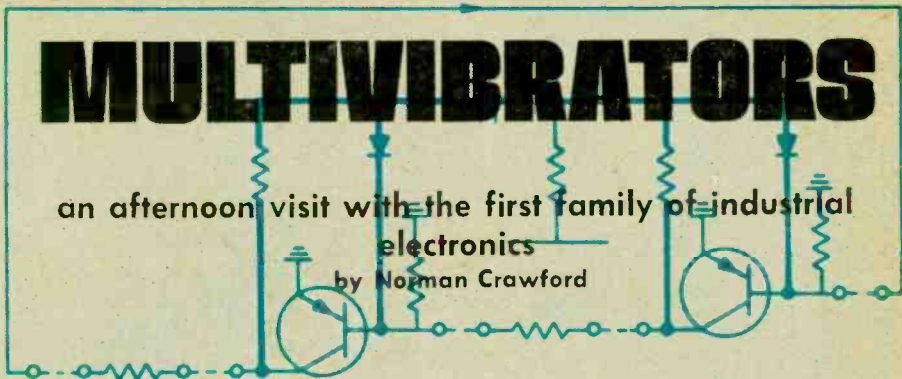

When the conversation turns from the Mets to multivibrators, you may hear all manners of strange words bandied about. Flip-flop, one-shot, astable, and bistable roll off the tongue of the all-knowing. And don't be too surprised if you hear the words free-running, single-step, and monostable—to name just a few—at your next electrified cocktail party. What do all these terms mean? Are there really so many different kinds of multivibrators? And, for that matter, of what use is a multivibrator for the experimenter?

The main job of a multivibrator is to generate square waves and pulses. Period. That's all!

A square wave is often used as a test signal for audio amplifiers to reveal frequency-response problems. In other applications, multivibrators generate short time constant pulses—only a few microseconds in duration. These mini pulses synchronize, or steady, the picture on our TV screens.

Longer pulses—those which are several seconds in duration—control the exposure time of photographic enlargers. Slow multivibrators can also drive the flashing warning lights seen by motorists as they approach roadside hazards. And, in the radio amateur's shack, faster multivibrators running at audio rates train the ham's eye and ear as he works with his code practice oscillator. Or, the same MV, as the multivibrator's also called, doubles duty as an audio signal source. The list could go on and on.

The uses of multivibrators grow daily, limited only by the ingenuity of those who understand their working principles.

The imposing list of names in the first

paragraph creates the impression that there must be almost a dozen different types of multivibrators. Fortunately, this is not so! There are only three basic types. The long list of names merely shows the existence of more than one name for the same type of multivibrator. At worst, this name-it-hodge-podge reflects minor variations of the same type of multivibrator.

The Circuit With an Alias. The three basic types of multivibrators are the *free-running* multivibrator, the *one-shot* multivibrator, and the *flip-flop*. With these three basic circuit types under your belt, you can whip up any of the jobs a multivibrator's capable of doing.

The free-running multivibrator is probably the type most familiar to the experimenter. It is very likely that the square wave generator or oscilloscope on his workbench has a free-running multivibrator buried somewhere in the instrument's circuit. The outstanding characteristic of the free-running multivibrator—and the one from which it earns its name—is that it runs freely. As long as a power supply is connected to it, the free-running MV enthusiastically pumps out a never-ending stream of square waves. This feature consistently earns the title of the Most Popular Circuit whenever John Q. Electronicsbuff needs square waves. See Fig. 1.

In contrast to the free-running MV, the one-shot multivibrator is a very reluctant beast. If fed DC from a power supply, it does not react by joyously bubbling forth a stream of square waves like its enthusiastic free-running cousin. Instead, it sits there, grumpily doing absolutely nothing.

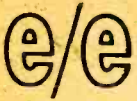

MULTIVIBRATORS

And, it will continue to sit there unless kicked in the right place by an externally generated pulse, called a trigger pulse.

Under this urging, it reluctantly makes one and only one pulse, and then lapses back into its former sullen condition. Until, of course, it's kicked by another trigger. It derives its name—one shot—from the fact that it gives only one pulse in response to a trigger. See Fig. 2.

Flip Out Forget-me-not. The third type of multivibrator, the flip-flop, is a forgetful fellow. It, like the one-shot, gives no output pulse unless urged by a trigger pulse. But its response to a trigger is quite different. It starts out to produce a pulse, but forgets to end it, unless told to do so by another trigger pulse. Strangely enough, this forgetfulness can be turned into a memory. The flip-flop is the heart of the registers system of large computers. See Fig. 3.

How can this be? Because, as Fig. 4 shows, the flip-flop can remember forever (or, at least, until the power is turned off) that a trigger pulse has been applied to it. Using this single basic capability, the registers of giant computers can be constructed.

Some Basic Building Blocks. Circuit diagrams for these three basic multivibrators are surprisingly similar. They're all built from the same basic building blocks. These building blocks are shown in Fig. 5.

The free-running multivibrator combines these basic building blocks. The component values shown in our Fig. 6 will make a free-running multivibrator which runs at 440 Hz. Musicologists know that frequency A above middle C on the piano.

To double that frequency, cut the values of both coupling capacitors in half; to triple it, cut them to one third the value shown, and so on. To hear the square wave, place an ordinary 2,000-ohm headset across either 1,500-ohm collector load resistor. To see the square wave, connect an oscilloscope to the point marked "output."

The one-shot multivibrator is very similar. It is built from pieces stolen from the free-running multivibrator as shown in Fig. 7 by replacing one of the coupling capacitors with a coupling resistor, and one of the "on" amplifiers with an "off" amplifier.

The values shown produce a pulse two seconds long. To double the pulse length, double the capacitor's value; to triple it, triple the capacitor's value, and so on. To hear the pulse, place an ordinary 2,000-ohm headset across either 1,500-ohm resistor.

Momentarily touch the point marked "trigger in" to the power supply. A click will be heard in the headphones as the one-shot begins its solitary pulse. Two seconds later, a second click will be heard as the one-shot ends its pulse. (The actual time may be longer, because large-value capacitors sometimes actually have twice the capacity stamped on their case.)

Fig. 1

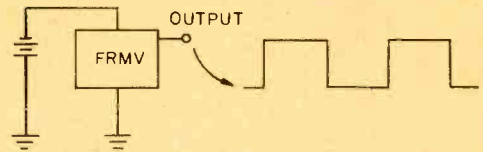

Fig. 2

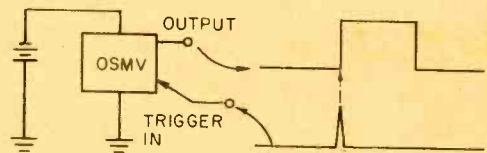

Fig. 3

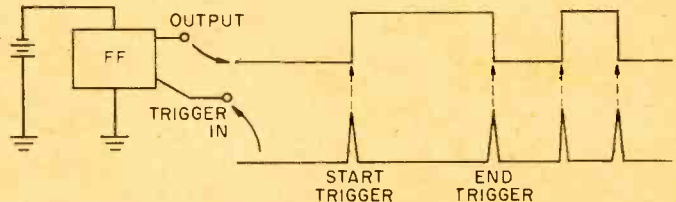
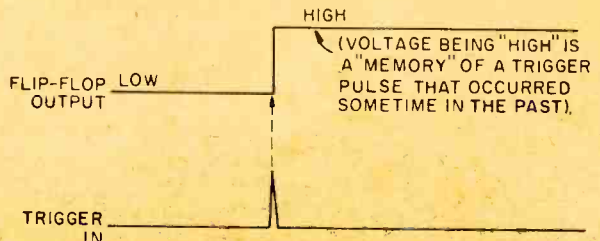

Fig. 4



To see the pulse, connect a voltmeter to the point marked "output." It will indicate -9 volts. Trigger the one-shot as above, by touching "trigger in" to the power supply. The voltmeter's needle will drop to zero volts, remain there for two seconds, and then pop up to 9 volts again.

To change the one-shot schematic to a flip-flop schematic, both pulse amplifiers must be of the biased-off type, and both coupling elements must be resistors. See Fig.

Fig. 5

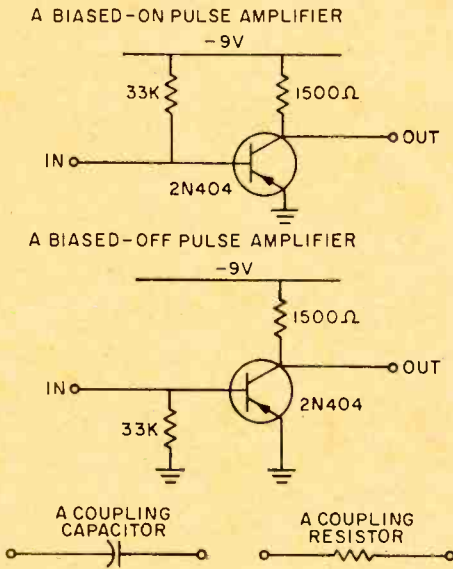

Fig. 6

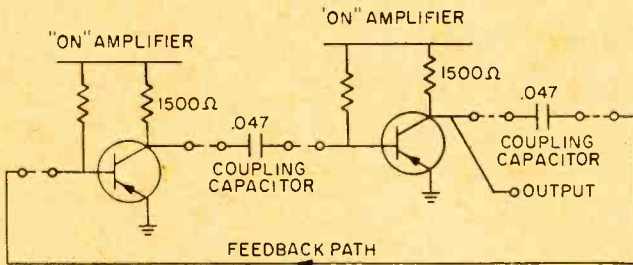
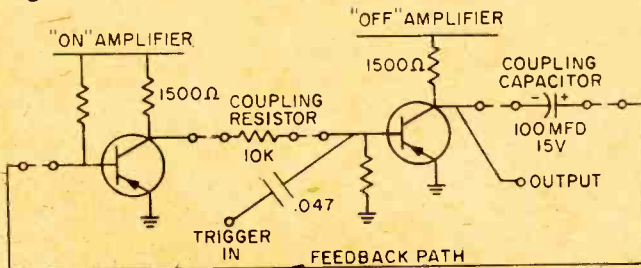

Fig. 7



8. To see the action of this circuit, connect a voltmeter to output #1 or output #2—whichever of the two causes the voltmeter to register -9 volts. Leaving the voltmeter connected, short the output to ground. The voltmeter reading will drop to zero, of course, because there is a dead short right across its terminals. But, the surprising thing is that the reading will stay at zero after the short is removed.

Next, short the other output to ground. The voltmeter reading will rise to -9 volts, and stay there after the short is removed, showing that the flip-flop can remember an occurrence (like shorting one output) even after the occurrence is ended.

Kicked by a Trigger Pulse. Of course, shorting an output to stimulate the flip-flop into action is not the same as running it from a trigger. Triggering circuitry can be added to the basic flip-flop as shown in Fig. 9. Now, leaving the voltmeter connected to one output as above, you can trigger the flip-flop by momentarily connecting the point marked "trigger in" to ground. Each time a trigger is supplied, the output that was at zero volts will jump to -9 volts. A second trigger will cause the same output to revert to zero volts.

Since it takes two triggers to make one complete output pulse from a flip-flop, feeding 500 pulses per second to the trigger input will cause only 250 pulses per second to come from the output. If these pulses are, in turn, fed to another flip-flop, its output will provide only 125 pulses per second. This ability of flip-flops to act as a frequency divider finds very wide usage in applications ranging from computers to TV and electronic organs.

So much, then, for the three basic types of multivibrators. What about that long list of names we bandied about in the first paragraph? Where do they come in?

We can parcel out all those names among the three basic types. For example, the free-running multivibrator is known in formal electron-ese as an *astable* multivibrator. The prefix "a-" tells us that it lacks a stable condition; and hence runs endlessly as long as power is supplied. The one-shot MV also answers to the

(Turn page)

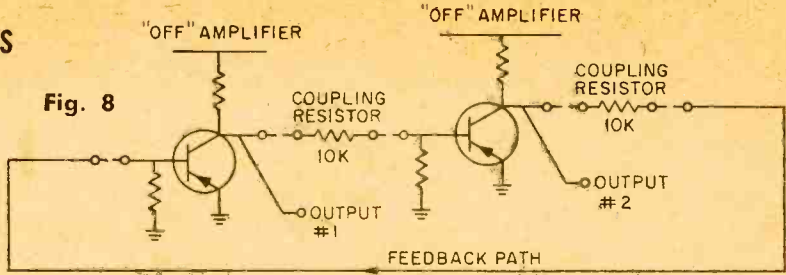

Fig. 8

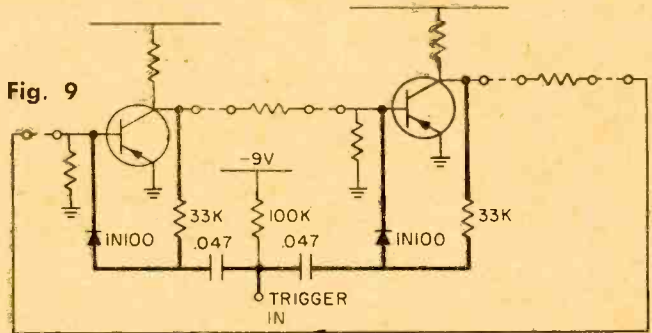

Fig. 9

name *monostable* multivibrators, its one "mono" stable state being the one in which it grumpily sits while awaiting a trigger.

And, the flip-flop is also a *bistable* multivibrator, because it has two, or, "bi-" stable states, and will sit happily forever with a given output either "high" (-9 volts in the above example) or "low" (zero volts).

Other Names, Yet. Other names for the flip-flop include *toggle*, from its action in response to two successive triggers; *binary*, from its ability to rest in either of two states, and *Eccles-Jordan*, after the two men who described the circuit many years ago.

The names *one-step* and *univibrator*, as well as *single-step*, *single-cycle*, and *monovibrator*, are all much less common names

for the one-shot. Similarly, the free-running multivibrator is rather infrequently referred to as an *unstable* multivibrator or an *Abraham-Bloch circuit*.

So, in spite of the abundance of names, there are only three basic types of multivibrators. Call the MV what you will, but the application of these three types reach through to almost every project the electronics hobbyist is likely to conjure up on his workbench. ■

Blink Brake Great Provided You're Not a Blinker

That's right, blink you way to safer driving! Car accidents could often be prevented if reflexes were quicker. Well, with Dr. Vodovnik's eyebrow brake you no longer wait for your eyes to send a message to your brain and then to your foot—that's a lot of time lost. The brake consists of wires extending from a pair of glasses to your eyebrow muscles; the brake works when you blink. So far, there is no special model for contact lenses. ■



8 EIGHT GREAT IC PROJECTS FOR WEEKEND EXPERIMENTERS

by the editors of Elementary Electronics magazine

Integrated circuits, or ICs, are finding their way onto more and more hobbyists workbenches. ICs are inexpensive, have overall uniform electrical quality — and contain considerably more electronics stuffed into them than any other semiconductor of equivalent price. All the projects presented on the following pages are built around inexpensive and readily obtained ICs. Follow the instructions given for each project, and observe IC base diagrams carefully. Note circuit voltage polarity, and use a 40-watt maximum soldering iron.

Stereo Channel Balancing Amp
 Microphone Mixer
 Home Intercom
 1 KiloHertz Audio Oscillator

Heavy Duty Tachometer
 Stereo Phono Preamplifier
 Regulated Power Supply
 Shortwave Booster

PROJECT 1 – Stereo Channel-Balancing Amp

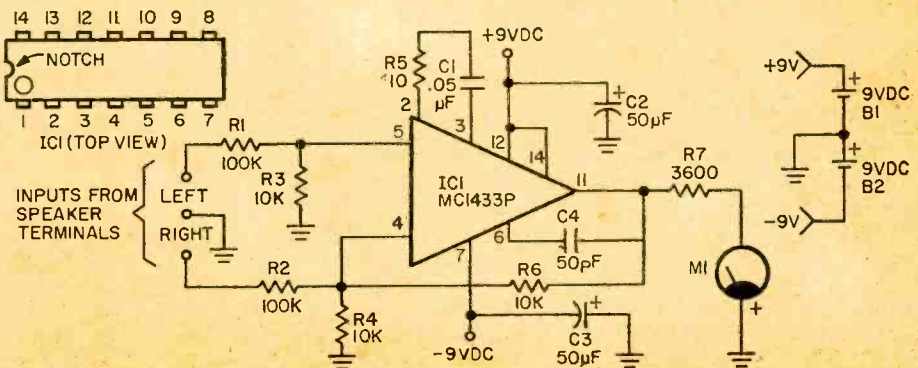

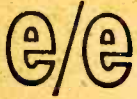

EIGHT GREAT IC PROJECTS

□ Many an audiophile has found that after setting the "Balance" control on his stereo amp to its mechanical dead-center position, more sound still seems to come from one channel. It's truly the audiophile's twist-of-fate working again—try as he may, he can't properly set his amp for electrical balance.

While, perhaps, the only way to find the electrically-flat position of a tone control is by laboriously plotting its effect on frequency response, it's easy to calibrate a not-too-accurate balance control with a stereo differential amplifier. All you do is compare the difference between left and right channel outputs while feeding a monophonic signal into your stereo amp. Then read the differ-

ence in channel output on our differential amp's meter!

Wiring is not critical. The amplifier can easily be battery powered by a couple of 9 Volt transistor batteries connected in a bipolar arrangement.

It's very easy to use this differential amplifier. First, set your stereo amplifier mode switch to "Mono". Then, adjust your amp's balance control until meter M1 indicates a null, or minimum reading. If you can't reach a null, this means that there is phase reversal—which must be corrected—between the signal input and the speaker terminals.

When the stereo amp is in perfect balance, there is no difference in mono output voltage between channels. Therefore, our differential amplifier indicates zero difference on its meter.

PARTS LIST FOR STEREO CHANNEL BALANCE METER

B1, B2—Battery, 9V, type 2U6
C1—0.05 μ F, 10 VDC
C2, C3—50 μ F, 10 VDC
C4—50 pF, 10 VDC
IC1—Motorola MC1433P

M1—VU meter
R1, R2—100,000-ohms, 1/2-watt, 10%
R3, R4, R6—10,000-ohms, 1/2-watt, 10%
R5—10-ohms, 1/2-watt, 10%
R7—3,600 ohms (usually with VU meter)

PROJECT 2 – Mike Mixer

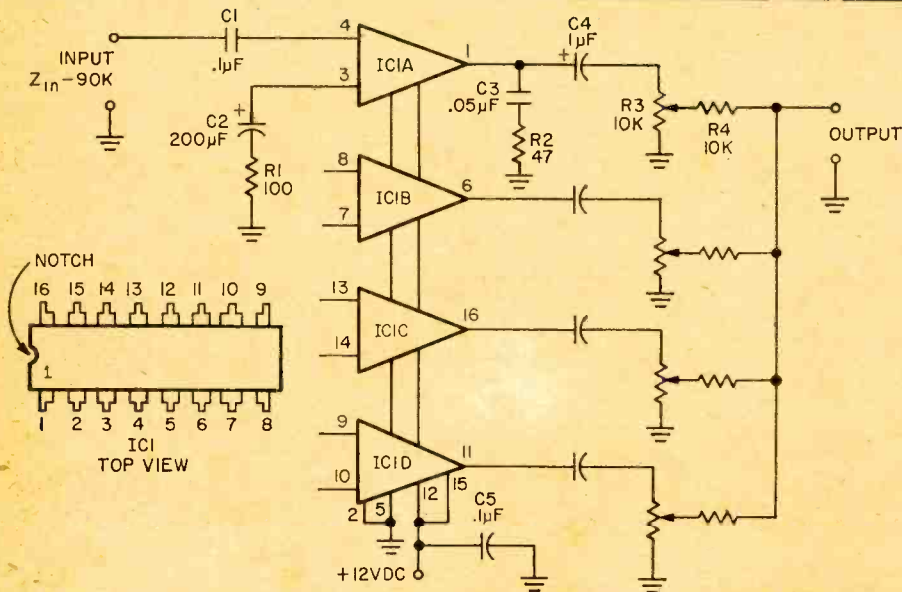

□ The hallmarks of a high quality microphone mixer are high signal-to-noise ratio, and the ability to "mix" each mike channel after amplification takes place. These quali-

ties are combined in a four-channel microphone mixer built around an integrated circuit containing four separate amplifiers.

The mixer achieves its good signal-to-

PARTS LIST FOR AUDIO MIXER

- C1—0.1 μ F, 3 VDC
- C2—200 μ F, 3 VDC
- C3—0.05 μ F, 75 VDC disc
- C4—1 μ F, 15 VDC
- C5—0.1 μ F, 15 VDC
- IC1—RCA CA3052
- R1—100-ohms, 1/2-watt, 10%
- R2—47-ohms, 1/2-watt, 10%
- R3—Potentiometer, 10,000-ohms audio taper
- R4—10,000-ohms, 1/2-watt, 10%

noise performance by placing the mixing potentiometers at the tail end of each amplifier channel. Isolating resistors placed in the circuit after the mixing pots further enhance the mixing action between channels.

Two R/C networks, one in the output of each amplifier, and the other strapped between an internal IC connection and ground, serve to limit the overall bandwidth of each amplifier section. These bandwidth limits—

50 Hz and 400 kHz—are set by these R/C networks. True, no microphone's upper frequency can reach a stratospherically-high 400 kHz! The R/C network yielding this high-frequency cutoff point is inserted into the amplifier's output network to prevent unwanted oscillations taking place. For overall schematic simplification, we've shown only the connections for one of the amplifiers. All other channels are identical in parts value to those values shown for the first, or "A", channel.

Note that the power supply is single-ended 12 Volt, negative ground. It must be well filtered. For best results, use a battery lashup—since total current capacity is only 30 milliamperes. That's a load easily handled by wiring 8 D-size batteries in series. The power supply is connected to all four amplifier sections via substrate wiring in the integrated circuit.

PROJECT 3 – Home Intercom

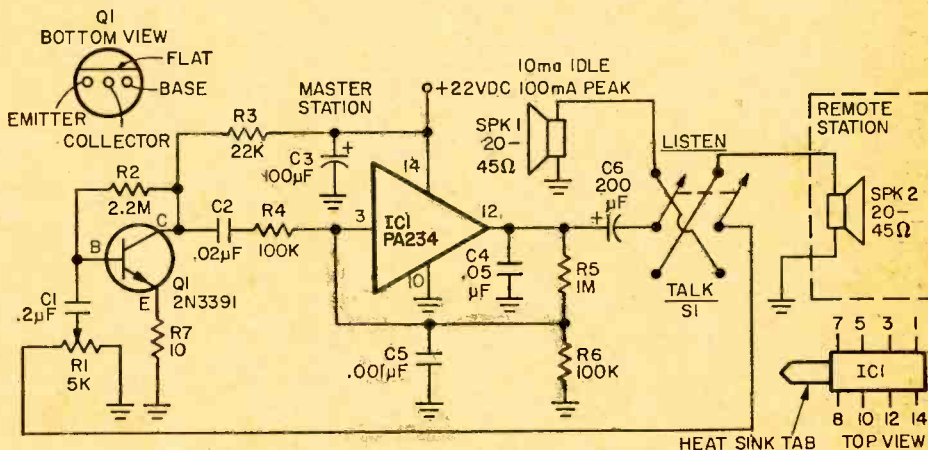

PARTS LIST FOR HOME INTERCOM

- | | |
|---|--|
| <ul style="list-style-type: none"> C1—0.2 μF, 3 VDC C2—0.02 μF, 3 VDC C3—100 μF, 25 VDC C4—0.05 μF, 75 VDC C5—0.001 μF, 10 VDC C6—200 μF, 25 VDC, see text IC1—General Electric PA-234 Q1—NPN transistor, G.E. 2N3391 | <ul style="list-style-type: none"> R1—Potentiometer, 5,000-ohms, audio taper R2—2.2 megohms, 1/2-watt, 10% R3—22,000-ohms, 1/2-watt, 10% R4, R6—100,000-ohms, 1/2-watt, 10% R5—1 megohm, 1/2-watt, 10% R7—10-ohms, 1/2-watt, 10% SPK1, SPK2—Speaker, 20 to 45 ohms, see text S1—Switch, DPDT, see text |
|---|--|

□ It's fun living in the lap of luxury, especially when the lap is solid state. Here's a miniature intercom system you could probably fit behind an ordinary electrical wall plate! Utilizing a 1-watt IC power amplifier, our intercom provides high sensitivity, and a loud, clean output. Wiring and layout are

not critical just so long that capacitors C4 and C5 are installed directly to IC1's terminals.

Capacitor C6's value depends upon how much luxurious sound quality you want. This capacitor's value can be as low as 100 μ F; if you are trying to cut costs and don't

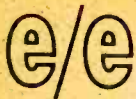

EIGHT GREAT IC PROJECTS

mind giving up a little bass response.

While switch S1 can be standard DPST variety, a spring-return type will keep the Master station always monitoring the Remote. The speakers can be any "intercom type", rated from 20 up to 45 ohms. Though miniature 16 ohm speakers can be used,

they do not have the power handling capacity of the "intercom type" speaker.

Should you experience high-frequency instability, run a shielded wire between talk switch S1 and potentiometer R1. Make a single-shield ground at R1.

An AC power supply is a natural for this project. It must, however, be rated for at least 100 mA drain. If a battery supply is used, figure the 100 mA drain current when specifying battery type.

PROJECT 4 – 1 KiloHertz Audio Oscillator

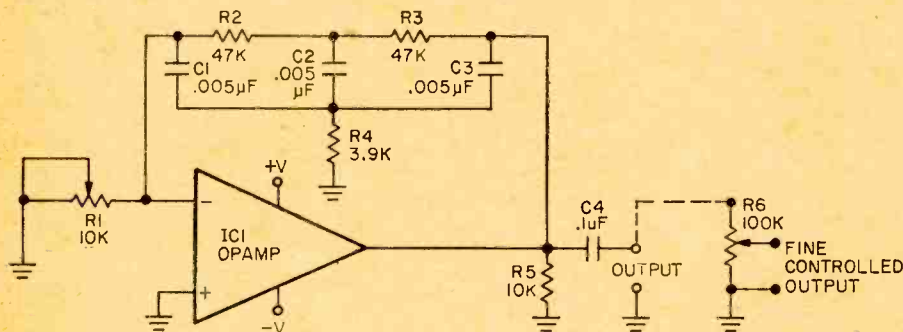

Every experimenter can find a use for an oscillator that delivers a high-purity sinusoidal waveform. Our 1 kHz audio oscillator does just that—and with a minimum of components. This oscillator's useful for testing audio equipment, signal tracing, and even making tape recorder bias adjustments.

We've left the exact details of the integrated circuit up to you. Practically any IC will oscillate in this circuit. Most electronics surplus dealers have supplies of integrated circuits in stock that are either production over-runs, or were rejected by the manufacturer for minute mechanical flaws or electrical discrepancies, tolerance-wise. This is the kind of IC that you can buy very cheaply—and since the frequency we're working at is not high, any IC you can lay your hands on will work!

The 1 kHz notch network from the amplifier output to the inverting, or negative, input determines the output frequency. The oscillator's non-inverting, or positive, input is grounded.

The power supply required is bi-polar. Use any voltage up to the maximum rating of

the IC you buy. Resistor R5 may not be necessary in many instances; its inclusion merely insures that any IC you plug in will start pumping out 1 kHz signals.

Potentiometer R1 sets the output voltage level; its maximum value approaches the total power supply voltage. If fine output control is needed, add potentiometer R6. When connecting the oscillator to a "hot" DC point, connect a blocking capacitor in series with R6's arm.

If the oscillator is to drive circuits of less than 10K ohms impedance, substitute a 1 µF non-polarized capacitor in place of C4, rated at the power supply's voltage.

PARTS LIST FOR 1 KILOHERTZ OSCILLATOR

- C1, C2, C3—0.005 µF, 75 VDC
- C4—0.1 µF, see text
- IC1—"surplus" operational amplifier
- R1—Potentiometer, 10,000 ohms
- R2, R3—47,000-ohms, ½-watt, 5 or 10%
- R4—3,900-ohms, ½-watt, 5 or 10%
- R5—10,000-ohms, ½-watt, 10%, see text
- R6—Potentiometer, 100,000 ohms, audio taper, see text

PROJECT 5 – Heavy Duty Tachometer

Whether you drive a hunk of Detroit iron or a handcrafted Italian racing machine,

sooner or later you're going to need a portable and shockproof tachometer. Here's

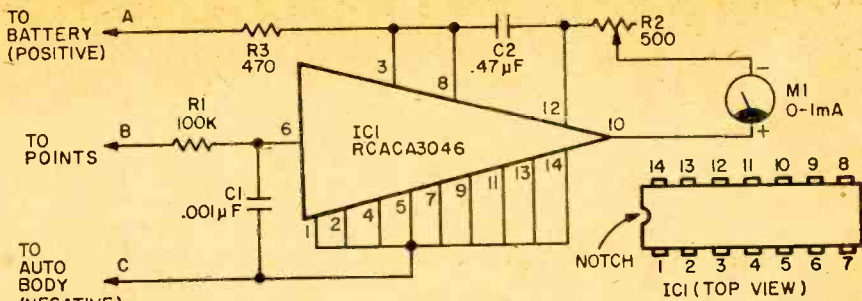

a bolt-on goody that allows you to tune up the engine, set the carburetor, and adjust any slush box's shift points with ease. Furthermore, once you've crawled out from under your car, you're going to need a tachometer—tach, as they're called by the boys at the garage—if you're going to shift the car's transmission at its best engine speed.

The tach described here is the high-range type; its meter's full-scale reading is in the neighborhood of 6000 RPMs. Unless you're in the business of throwing gassers around dirt ovals, this rpm limit should be quite sufficient for any auto legally licensed to use public highways.

Integrated circuit IC1 should be mounted in a cool location—under the dash, or in front of the air-stream under the hood. Follow the component values given in the parts list—combine resistors in series or parallel in order to obtain the correct resistance value if you're spare parts collection is meager.

The tach should be calibrated against an-

PARTS LIST FOR TACHOMETER

- C1—0.001 μ F, 1000 VDC disc.
- C2—0.47 μ F, 25 VDC or higher, see text
- IC1—RCA CA3046
- R1—100,000-ohms, 1/2-watt, 10%
- R2—Potentiometer, 500 ohms linear taper
- R3—470-ohms, 1/2-watt, 10%
- M1—Meter, 0-1 mADC

other of known accuracy. It is only necessary to adjust potentiometer R2 for the correct full-scale reading. Meter M1's scale is linear.

To use the tach, connect lead A to the car battery's positive terminal. Run lead C to the battery negative terminal; lead B to the distributor points. The distributor lead connection is easily made at the ignition coil. Note that one lead running to the coil goes to the battery, and the other to the distributor points.

If lower rpm full-scale readings are required, reduce capacitor C2's value accordingly. Again, calibrate the tach against a unit of known accuracy.

PROJECT 6 – Stereo Phono Preamplifier

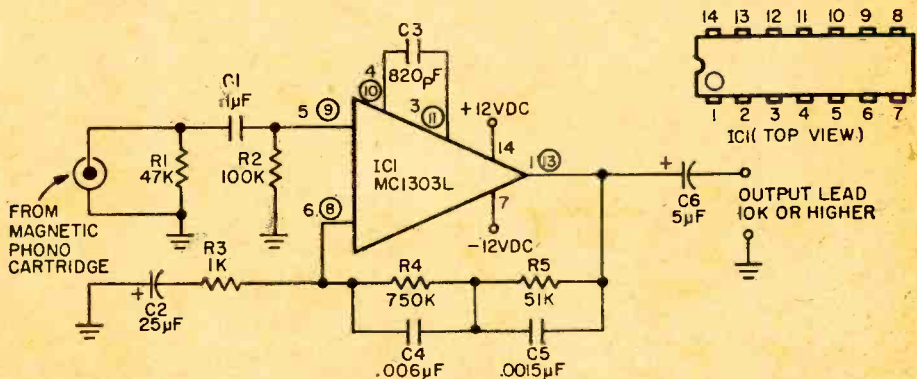

□ Need an additional phono preamp for your stereo system? More than one audiophile's gone out and bought a spanking brand new turntable, brought it home to plug in and play—and found out that his

amplifier didn't have the required additional "phono" position needed for a second turntable.

Our phono preamp/equalizer neatly bypasses the problem. Plug the cables coming

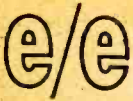

EIGHT GREAT IC PROJECTS

from your phono cartridge into our preamp, and plug the preamp output leads into the "Auxiliary" input of your stereo amplifier. Simple, isn't it!

The integrated circuit specified was specifically manufactured for low-signal level work. Combined with the associated circuit components, the IC provides a fully equalized 1 Volt rms output from any standard magnetic pickup. The terminal numbers circled on the schematic are the connections for one of the two independent amplifiers in the single IC Case. The uncircled numbers are the terminals for the second IC.

Power supply terminals are common for both amplifiers. Note that the power sup-

PARTS LIST FOR PHONO PREAMP

- C1—0.1 μ F, 3 VDC
- C2—25 μ F, 3 VDC
- C3—820 pF, 500V disc
- C4—0.006 μ F, 100V disc
- C5—0.0015 μ F, 100V disc
- C6—5 μ F, 25 VDC
- IC1—Motorola MC1303L
- R1—47,000-ohms, 1/2-watt, 10%
- R2—100,000-ohms, 1/2-watt, 10%
- R3—1,000-ohms, 1/2-watt, 10%
- R4—750,000-ohms, 1/2-watt, 10%
- R5—51,000-ohms, 1/2-watt, 10%

ply must be able to supply ± 12 volts to ground. Two 6-Volt batteries wired in series can be used for each side of the power supply. If batteries are used, a 25 μ F electrolytic capacitor, rated at least 25 Volts must be connected from pins 7 and 14 to ground. Make sure you observe the capacitor's correct polarity, too.

PROJECT 7 – Regulated Power Supply

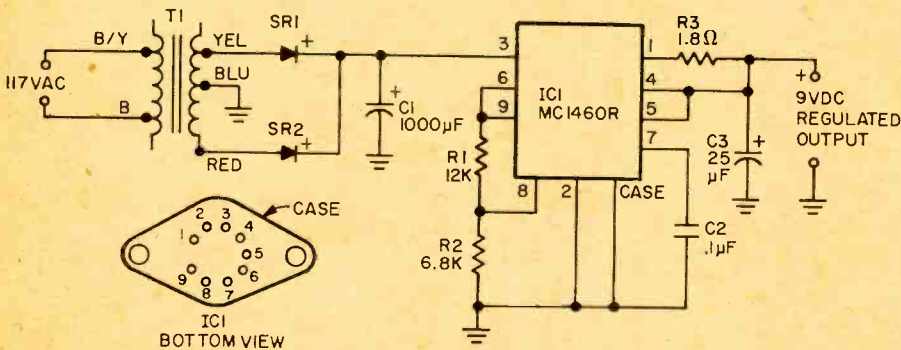

PARTS LIST FOR REGULATED POWER SUPPLY

- C1—1000 μ F, 15 VDC
- C2—0.1 μ F, 15 VDC
- C3—25 μ F, 15 VDC
- IC1—Motorola MC 1460R
- R1—12,000-ohms, 1/2-watt, 5%
- R2—6,800-ohms, 1/2-watt, 5%
- R3—1.8-ohms, 1/2-watt, 5%
- T1—Low voltage rectifier transformer, Allied Radio series 54 A 4731 (1970 catalog)
- SR1, SR2—Silicon rectifier, 750 mA, 50 PIV

□ A regulated power supply is one of the handiest projects any experimenter could own. Especially if the supply's output voltage is rated at the universally-useful level of 9 Volts. Many projects utilizing transistors require a 9 Volt power pack—why not build this one, and save yourself the cost and trouble of always having to buy spare batteries.

Our regulated power supply will deliver up to 300 milliamperes at 9 volts; more than enough for the majority of the projects you're likely to conjure up on your workbench. Also, the supply has an over-current protection feature built into it—thanks to the design of the integrated circuit. Whenever more than 300 mills tries to squeeze itself through IC1, the voltage regulator section of the IC automatically removes the applied voltage from it. The 300 milliam-

pere current rating is not that of the IC; depending upon the power transformer's secondary rating, up to 600 milliamperes can safely be handled by IC1. If this higher current capability is desired, substitute a 0.5 ohm resistor in place of the 1.8 ohm resistance rating of R3.

(Continued on page 99)

e/e
checks
out the
first
economy

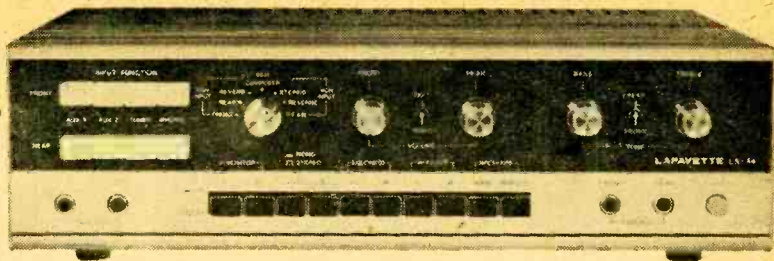

4-Channel Hi-Fi Amplifier

Lafayette's Model LA-44 offers a new dimension in sound, with a great variety of controls!

When does $1 + 1 = 4$? The answer: When you're listening to stereo discs and tapes through Lafayette's LA-44 4-Channel Stereo Amplifier.

Before we go any further and cause confusion, we'd better explain how 2 stereo channels become 4 stereo channels. If you attend a live performance, regardless of where you're seated you hear both the direct sound from the performers and reflections from the walls, floor, ceiling and even the people in the hall. The reflected sound is what is termed "ambient sound"—the sound "generated" by the hall itself. Unfortunately, the ambient sound is mixed in with the direct sound by the recording microphones. To create the effect of a large hall the recording engineer will sometimes place a microphone at the rear of the auditorium and mix the ambient sound into the left and right channels. The more ambient sound mixed in, the greater the degree of "echo" or reverberation on the playback.

No matter how the engineer juggles the direct and ambient sound, the fact remains that the playback is from two speakers "up

front," and two speakers up front are not going to simulate a large concert hall.

It has been discovered that the ambient sound that has been picked up by the recording microphones, and which is normally heard only as a mixture with the direct sound, can be electronically extracted or "decoded." With the proper equipment it is possible to get both the front two channels, and one or two rear channels containing primarily the ambient sound—the sound "generated" by the hall. Now if you feed the decoded ambient sound to two rear speakers, you actually will hear the performance almost the same as if you were in the hall itself. In short, your living room really becomes the concert hall. Close your eyes and you'd be hard-pressed not to imagine you are seated at a live performance.

Another way to create total sound immersion is to actually record the performance on 4 tracks with two (or more) mikes up front for the direct sound and two mikes at the rear for ambient sound. On playback, the tape output is fed to four separate amplifiers and speakers. (A typical

Lafayette's 4-Channel Hi-Fi Amplifier has just about every possible input/output connection imaginable for all four channels. There are four separate amplifier output channels (none of which are simply "derived" from any other channel), input connectors for tape, phono, auxiliary, tuner, plus a special "composer" input/output. Reverb generator can be fed to amp, too.

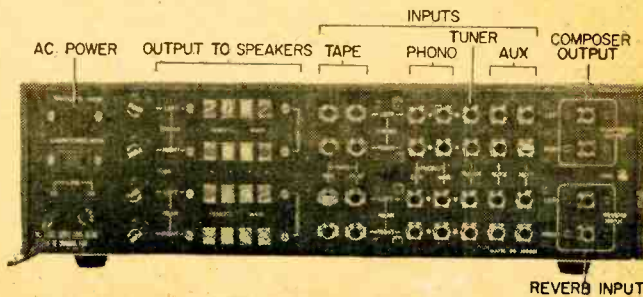

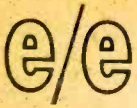

LAFAYETTE 4-CHANNEL AMP

speaker arrangement is shown on the cover).

The Lafayette LA-44 4-Channel Stereo Amplifier is specifically designed to provide the user with 4-channel direct sound (from a tape recorder) or 4-channel *derived* sound, that is, two normal stereo channels and two decoded ambient-sound channels.

Four Amplifiers. Basically, the LA-44 consists of four separate and identical amplifiers in a 13½ in. wide x 4 in. high x 9½ in. deep cabinet. The amplifiers are arranged in stereo pairs labeled "front" and "rear." Each stereo pair has identical independent controls so that each pair can be used independently of the other. For example, it is possible to feed, say, a tape to the "front" main speakers in the living room and a record to the "rear" remote speakers in the playroom.

In addition, the LA-44 has a device called a "composer," which is actually an ambient-sound decoder. When switched *in*, the "composer" automatically feeds the normal stereo to the front-speaker output and the derived ambient sound to the rear speakers. Special "composer" output jacks allow the user to record the full four-channel output on a 4-channel recorder. While this is of no great importance to the LA-44 user, as he can always decode a tape, disc or stereo broadcast, it does allow for the swapping of tapes with other 4-channel audiophiles.

The LA-44 has inputs for magnetic and ceramic phono, tuner, aux 1, aux 2, a reverb unit and a tape recorder. Extra tape-recorder dubbing jacks are provided on the front panel. There are outputs for main and remote speakers, recorder, phones and for the decoded ambient sound.

Two independent sets of pushbuttons are used for input selection of each amplifier stereo pair. Concentric volume controls are provided for the front and rear channels;

concentric bass and treble controls are provided for front and rear. Separate front and rear push-buttons are provided for tape monitor, mono-stereo, loudness compensation, high filter and main and remote speakers.

Finally, there is the 4-channel selector which provides the following sound combinations: 2-channel sound input to the front speakers, 2-channel sound input to the rear speakers, 2-channel reverb input (direct sound to front speakers, reverb sound to rear speakers), 4-channel discrete sound, 4-channel reverse (interchanges front and rear speaker sound), 4-channel F+R (connects front and rear speakers together in stereo pairs), and 4-channel "composer" (direct sound to front speakers, decoded ambient sound to rear speakers).

Using the Amplifier. With all the possible sound combinations available, you might expect an unusually large number of input jacks. And you are correct. The photo of the rear apron shows enough jacks to equip a modern recording studio. Just about every circuit is brought out to jacks, and any equipment interconnection you can dream up is possible on the LA-44.

Performance. The LA-44 was checked using the test procedure of another Davis publication, the "Hi-Fi Stereo Buyers' Guide," a much more difficult and demanding test than the usual IHF (Institute of High Fidelity) tests. In particular, the *Buyers' Guide* power output tests are at RMS, not some
(Continued on page 100)

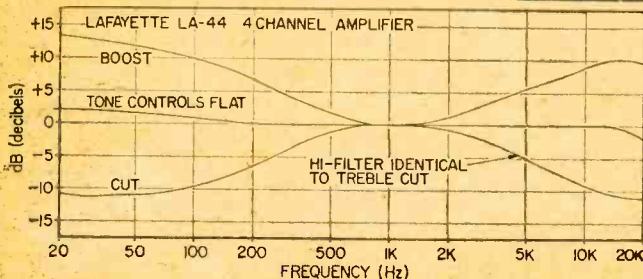
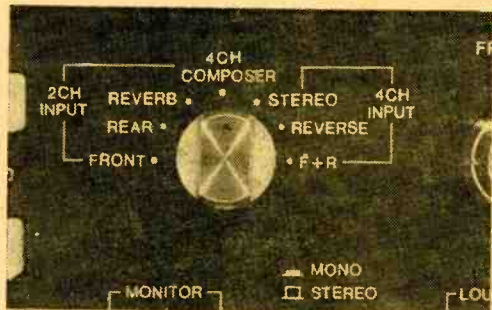

Graph of Lafayette's LA-44 frequency response curve indicates very smooth response. With tone controls set to their "Flat" positions, about 2½ dB's worth of bass boost is evident; for many of today's inexpensive bookshelf speakers, this boost gives them a slightly more rich sound. Output of amplifier is flat out to 15 kHz.

It's been a pleasure, Mr. Crocodile!

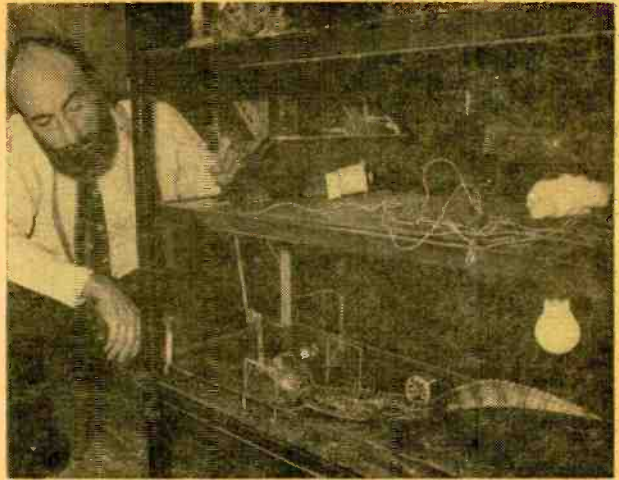

What makes Rameses, a two-foot long crocodile, run? *Pleasure!* Not just sex as Freud had us believe. At least, that's what recent tests at the Institute of Psychiatry in London seem to suggest. Dr. Campbell and his team have found that an animal can only be trained to perform certain actions in sequence if the program gives it pleasure. For instance there is Rameses. Unlike most of his species, he moves around a lot—because of the pleasure he gets from a contraption that looks like a tiny set of goal posts set up in his tank. Actually it's a peripheral self-stimulator. When the light beam between the posts is broken, a tiny electrical stimulus is delivered. Every time Rameses cruises by this he feels on top of the world. (At last count, he was up to 50 trips within 15 minutes!) Experiments are also

being run on other animals to see if there is any other phenomenon analogous to implanted electrodes from which the test animal would feel pleasure. When necessary, the experimenter connects flexible wires from the electrodes to instruments which deliver minute, measured quantities of electricity to the brain. It was thought that the squirrel monkey would get pleasure from light. A 750-watt lamp was placed in front of its cage so that the monkey could turn it on with a lever. Once he understood his connection he pressed the lever all the time—up to 500 times in 15 minutes and didn't want to stop! However, the dimmer the lamp, the lower the response-rate. Man's sources of pleasure are many, not only those linked to the senses. Abstract thought seems to be a source to some—like Dr. Campbell and his staff. Well, Rameses is having a good time while it lasts. ■

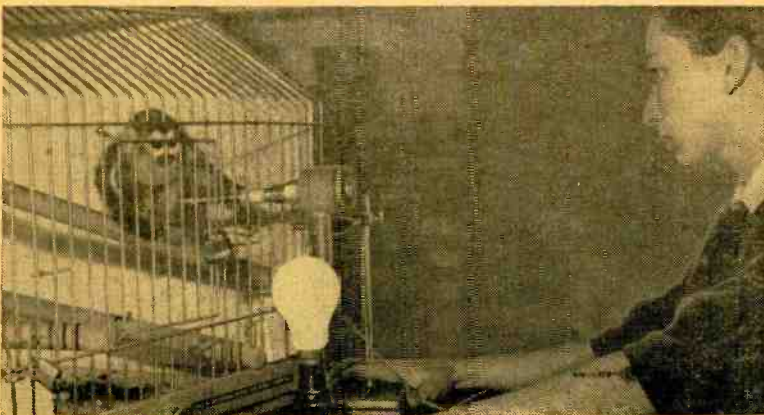

YOUR TV SET WILL GET YOU IF YOU DON'T WATCH OUT

by Jackson Kay



Screaming sirens and tires tear down the street with skinner lights flashing red. Dark red hulks rumble past your home to a conflagration elsewhere. Lucky? You bet your are if you didn't give your television receiver the care and protection it needs and deserves. Ambulances can give you the same scare action as they whiz by, but they are painted white. No matter what the color, keep these emergency vehicles away from your door by following the safety points and tips that'll keep your TV set safe and operable.

Location and Protection

- Never place your TV set on an unstable TV cart or stand. Should it fall, pull out the power plug at once and call your TV service technician. Do not move the set!

- Your TV set has slots in the cabinet for ventilation purposes, to provide adequate convection cooling to prevent overheating. Don't cover these slots with cloth, plastic or any other material.

- Never block the bottom ventilation slots of a portable TV set by placing it on a bed, sofa, plush rug, towel, etc.

- Never place your TV set near or on a radiator, heat register, oven, dishwasher, toaster or any appliance that gives off heat.

- Avoid exposing the TV set to rain or extreme moisture as this may result in a fire or shock hazard. Never operate a TV set if liquid has spilled into it. Have your TV service technician check out the set before you turn the power on.

- When installing an outside antenna, use a lightning arrester which is U. L. listed.

- For added protection during a lightning storm, and when the set is to be left unattended for a long period of time, unplug it. Old man weather can zap your house and TV set with lightning or cause extreme power line surges. Either action will cause damage to your set and possibly start a fire.

Operation and Service

Everyone is a TV set repair expert simply because they own one. Yet everyone has an appendix, but how many friends would you trust to remove yours? Here is some advice on how to operate and service your TV set and stay alive to enjoy it.

- Some sets are equipped with a polarized AC line plug—one blade is wider than the other. This polarized plug will fit into a power outlet only one way. If you have trouble fitting it into a power outlet or require a special polarized extension cord, contact the TV dealer who sold you the set.

- TV sets equipped with a polarized plug or

three-prong plug should not be tampered with to defeat the safety purpose of the specialized plug. Do not replace these plugs with standard two-prong plugs—you'll cause a severe shock hazard in many cases.

- Do not remove the back cover of the TV set as this will expose you to very high voltages. Voltages above 100, 200, 300, even 400 volts are common, not to mention picture tube voltages over 20,000 volts. Remember, 100 volts or more can kill, if not burn or seriously injure your body!

- Never push or poke objects into the TV set through cabinet slots, as it is possible to contact dangerous voltages or short circuits.

- Be sure the TV receiver is turned off before you clean the face of the picture tube. Do not use water or excessive liquids. Do not use scouring powders packaged for sinks—they may scratch the tube.

- Adjust only those controls on the back of the set that are covered in the operating instructions. Mess with anything else and your TV service technician will present you with a larger bill.

- Do not defeat the fuse or circuit breaker by jumping the circuit. When replacing fuses be sure to use the exact replacement.

- Turn the set "off" when it is not being viewed. This procedure will increase the set's useful life.

Call the Service Technician Now!

- There will be a time when your television receiver needs the expert servicing of a technician. You will know this is a certainty when you're unable to restore normal operation by adjusting the user's controls. When this happens, call your TV service technician.

- It is normal for some TV sets to make popping or snapping sounds, particularly when being switched on or off. If sounds are frequent, call your service technician.

- Always request your service technician verify that the replacements have the same safety characteristics as the original part.

- Never add, or permit a technician to add extension speakers, or jacks for record players or tape recorders to a TV set that has not been designed for this purpose. Such additions may result in an electrical shock hazard.

Safety First

One good guide by which you should govern yourself when puttering about an apparently defective TV set, is not to perform any adjustment, poking, prying, snooping, cleaning, etc., that you would not permit a six-year-old child do. After all, why is a child's life dearer than yours when TV service technicians are available to do the task efficiently and safely? ■

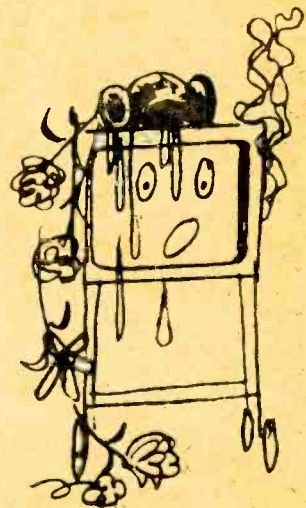
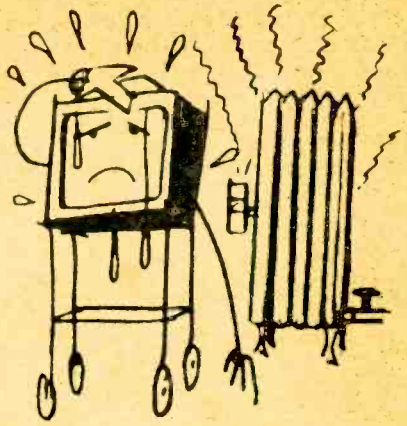

e/e etymology

How about a word with us?

MAZDA

▲ In our technological world, it isn't enough to develop a good product and put it on the market at a price that suits consumers. The pressures of advertising by competitors requires that a device or instrument or commodity have its own unduplicated name.

Since a patent has a limited life span and a registered trade-name does not, role of the latter can be all-important in continuing sales.

Officials of the General Electric Company were keenly aware of this factor when research workers developed a bright, long-lasting electric lamp.

Hundreds of potential names were suggested. Some were dangerously close to common words and would be hard to protect. Others were cumbersome. No name on the list seemed appropriate.

Frederick P. Fish, Boston lawyer and one-time president of the American Telephone and Telegraph Company, was consulted. He admitted to a strong personal preference for trade names with two syllables. One wasn't enough, he said, and three were too many.

Fish felt that there should be some connection, however remote, with the light-giving quality of the product. He turned to classical mythology and considered modifications of names like Apollo, Jupiter, and Jove.

Still not satisfied, he remembered that among the ancient Persians, one of their gods was considered responsible for lighting the heavens. *Ahura Mazda* was vivid and suggestive—but entirely too long.

Fish seized on *mazda* as a potential trade-name, suggested it to GE officials, and won immediate approval. That's how the name of a deity forgotten by practically everyone except students of the Zoroastrian religion came to stand for an electric lamp with tungsten filament.

KODAK

▲ Choice of *mazda* as a name for a lamp that came to dominate the U.S. market was influenced by failure of some earlier trade names and success of others.

George Eastman's *kodak* was (and remains) a conspicuous example of success.

Eastman wanted a name that could not be misspelled, mispronounced, copied or infringed upon. Since *K* was the first letter of his mother's family name, he was attracted to it. "This letter is firm and unyielding," he wrote a colleague.

If one *K* is good, then two must be better, he reasoned. Experimenting with many arbitrary combinations of letters, he devised the world-familiar two-syllable trade-name.

XEROX, CELLOPHANE, ETC.

▲ Inventors, manufacturers, and advertising men face such a jungle of laws that choice of a truly good trade-name is incredibly difficult.

Even success can be a fatal trap—if a single product so dominates the market that its name is adopted into general speech to describe all similar products or devices.

Xerox (instantly revealing its indebtedness to *kodak*) is presently plagued by success. One of the most profitable inventions of this century, the machine that bears this name came dangerously close to edging out all its competitors. This meant that many members of the general public were prone to use *xerox* to name any type of electrostatic copying machine. If the name ever becomes designated by the courts as a descriptive term for all devices of its type, it will be lost as a trade-name.

That's exactly what happened to *cellophane*. Initial development by Swiss chemist Brandenberger was so promising that E. I. du Pont de Nemours & Co. bought rights to the product. They sold such vast quantities that when the patent expired courts decided the material has no other general name.

About the same thing happened with *linoleum*, *kerosene*, and *aspirin*.

Presently, Dow Chemical Company is buying space in writers' magazines to urge that all persons who write for publication take pains to treat *styrofoam* as a trade-name and not a common noun. Manufacturers of *Scotch tape* face the same dilemma.

All of which means that if you invent or manufacture an instrument or machine or a radical new process, you need expert help before trying to register a trade mark. Annually, 20,000 or so are registered. Computers are being used to devise artificial combinations of letters for possible use as trade-names, since the supply from the 26 letters of our alphabet was threatened with depletion.

From *nylon* to *caterpillar-tractor* and from *radiogram* to *tabasco-sauce*, the dictionary is sprinkled with skeletons of trade-names that entered general speech as descriptive labels.

Publishers of good reference books like Handel's *Dictionary of Electronics* (Penguin) are careful to label registered trade-name—*alco-max*® for example. Still, if you value the product of your ingenuity, you'd better be sure it has precisely the right name! ■



all *NEW*
**BASIC COURSE in
ELECTRICITY &
ELECTRONICS ***



**PART 12
UNDERSTANDING
THE TRANSFORMER**

What You Will Learn. Your understanding of AC electricity will now be used to show how two common electrical devices work. You will learn how a transformer transfers power from one winding to another. You will learn how to calculate the change in voltage, current, and impedance produced by a transformer with a known turns ratio, and how to select the proper turns ratio to produce a particular change. You will also learn how a magnetic amplifier controls a large AC current with a smaller DC current.

* This series is based on *Basic Electricity/Electronics*, Vol. 2, published by Howard W. Sams & Co., Inc.



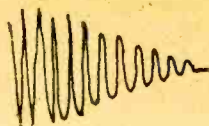
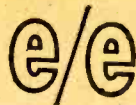
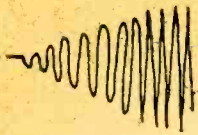

WHAT IS A TRANSFORMER?

A **transformer** is a device for changing the voltage of AC electricity. Transformers work on the principle of induction. Basically, a transformer has two windings—a primary and a secondary—wound on the same core. This core can be laminated iron, ferrite, or air.

Through the principle of **induction**, the alternating current flowing through the primary winding sets up an alternating magnetic field in the core. This magnetic field, in turn, **induces** an alternating voltage in the secondary winding (or windings). In this way, **energy is transferred** from the primary to the secondary.

A transformer that reduces the voltage in a circuit is called a **step-down** transformer. This is true, for example, of a radio-receiver filament transformer, which steps the 117-volt main supply down to 6.3 volts.

A transformer that is used to increase the voltage in the circuit is known as a **step-up** transformer. An example is the high-voltage transformer which produces the several thousand volts needed to operate a television picture tube.

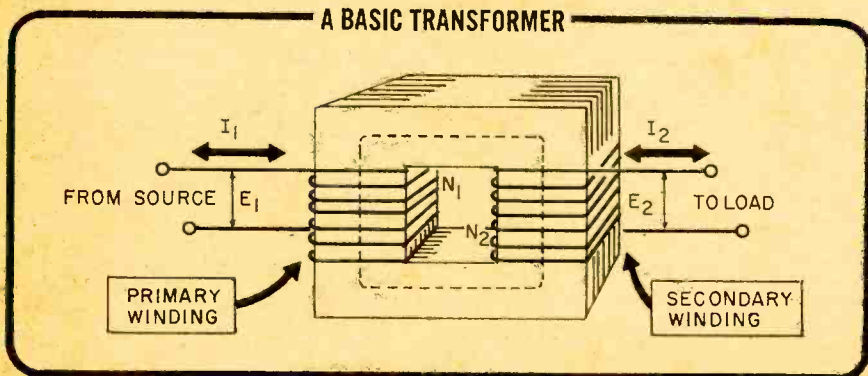

The basic transformer has two windings—primary and secondary—wound on a laminated-iron core. The two windings are insulated from each other and from the core.

The primary winding is connected to the energy source, and the secondary winding is connected to the load. As alternating current flows through the primary, a pulsating magnetic field is set up in the core. As the constantly changing magnetic field cuts the turns of the secondary, a voltage is induced in the secondary winding.

The amount of voltage induced in the secondary winding depends on how many turns of wire the secondary contains compared to the number of turns of wire in the primary winding. So, if the secondary has only half as many turns as the primary winding, the voltage will be stepped down to half its original value. If the secondary has twice as many turns as the primary, the voltage will be stepped up to twice its original value.

The difference in the number of turns is known as the **turns ratio** of the transformer. If the primary winding has N_1 turns and its voltage is E_1 , the secondary winding with N_2 turns produces voltage E_2 .

$$\frac{E_1}{E_2} = \frac{N_1}{N_2}$$

The power consumed in the secondary circuit of a transformer must be supplied by the primary. Since the voltages are constant in each circuit, the current in the primary circuit must vary to supply the amount of power demanded by the secondary. Current in the primary depends on the current drawn in the secondary circuit.

A TRANSFORMER WITH NO LOAD ACTS LIKE AN INDUCTOR

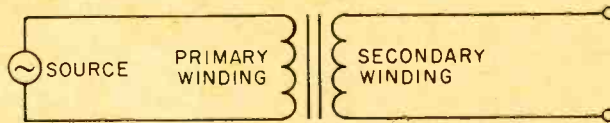

- Q1. If a transformer primary has 1,000 turns and the secondary has 6,500 turns, what is the turns ratio?
- Q2. If 85 volts is applied to the primary winding of the transformer in Question 1, what is the voltage at the secondary?
- Q3. What would happen if the leads were reversed and 85 volts was applied to the 6,500-turn coil?
- Q4. What happens if 130 volts is fed into the 6,500-turn winding of the transformer?
- Q5. Can a transformer be used with DC? Why?
- Q6. What will be the phase relationship between the voltage across the primary of a transformer and the voltage across the secondary, assuming the coils are wound in the same direction?
- Q7. If there is no load between the terminals of the secondary of a transformer, will current flow in the secondary?
- Q8. Will there be a magnetic field produced by current in the secondary?
- Q9. Will there be a magnetic field produced by current in the primary?
- Q10. What effect will this magnetic field have on the impedance of the primary circuit?
- Q11. If the magnetic field were weaker, would more or less current flow in the primary circuit?

Your Answers Should Be:

A1.

$$\frac{N_1}{N_2} = \frac{1,000}{6,500} = 1 \text{ to } 6.5$$

A2.

$$\frac{E_1}{E_2} = \frac{1}{6.5}$$

$$E_2 = E_1 \times 6.5 = 85 \times 6.5 = 552.5 \text{ volts}$$

A3. If you reverse the leads, the turns ratio is:

$$\frac{N_1}{N_2} = \frac{6,500}{1,000} = \frac{E_2}{E_1}$$

The output would be:

(Continued on page 90)

The Perfect Intro to Electronics.. Exciting Projects That Really Work, Really Teach

Science Fair[®]
P-Box Kits..
America's
Favorite!

SW Radio Kit

795
 Post
 Paid



Whether it's our 3-transistor Shortwave Radio Kit or any of 21 others—A Science Fair P-Box is the *fun* way to learn about electronics. Take our SW radio, it features a regenerative high-gain detector with 2 audio amplifier stages and pulls in stations from all over the world. It sounds pretty complicated, but it really isn't—the teacher-written ex-

planation, detailed instructions and pictorials guide you every step of the way. Every P-Box is a working, entertaining circuit that demonstrates fundamental principles—get the satisfaction of a job well done—PLUS a valuable learning experience each time you build. (No wonder we've sold over 500,000 S-F kits!)

Even the Package Is Useful!

No waste! The clear-top cover becomes the "bottom" and the bottom becomes the perfboard chassis "top." The result: a handsome product with real utility, at amazingly low cost! And—each kit includes all parts—no extras to buy!



Goofy-Lite



WWV Converter

Selected P-Box Kits available by mail too—we pay the postage! See facing page. **ALL kits in stock at over 950 ARS stores coast to coast!**





*Experiment with the
Light Fantastic!*

Harness and Transmit Light

With Allied Radio Shack's Exclusive
Plastic and Glass Fiber Optic Kit



Optical Plaque



Numeric Display



Magic Fiber Wand



Plastic/Glass Light Pipe

**FUN! EDUCATIONAL!
EASY TO USE!**

ONLY 9⁹⁵

Brighten-up with our Archer® Light Sensor Kit. Use it to transmit and receive light energy by "multiple reflection" through hair-thin fibers that bend and cut like wire. Everything is included to "pipe" light up walls and around corners, trigger light-sensitive devices, make 3-level optical displays, design numeric displays, decorate with light. Great for model train outfits, sculptured art too—1000's

of uses! The fibers never wear out; "Re-Do" process lets you use 'em over and over. Kit includes 1400 12" and 200 24" fibers, 64 plastic-fiber 24" light pipes, 45-pc. accessory kit with variable color control, instructions. One of many hobbyist deLIGHTs at the ARS store near you. Or you may order by mail—it costs no more because we'll ship postpaid!

Over 950 Stores Nationwide See the Yellow Pages



A TANDY CORPORATION COMPANY

**2725 West 7th Street
Fort Worth, Texas 76107**

- Archer Fiber Optic Kit @ 9.95 ea.
- Science Fair SW Radio Kit @ 7.95 ea.
- Science Fair Goofy-Lite Kit @ 5.95 ea.
- Science Fair DC Radio Kit @ 4.95 ea.
- Science Fair Thermometer Kit @ 8.95 ea.
- Science Fair WWV Converter Kit @ 5.95 ea.

Dept. EE-3

Rush me the checked items postpaid. I enclose check money order for \$_____

Name (print) _____

Street _____

Apt. No. _____ Route No. _____ Box No. _____

City _____ State _____ Zip

CIRCLE NO. 22 ON PAGE 17

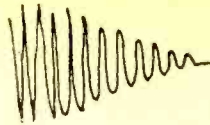
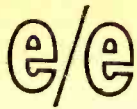
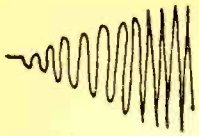

(Continued)

$$E_2 = \frac{1,000 \times 85}{6,500} = 85 \times 0.153$$

$$= 13 \text{ volts (approx.)}$$

- A4. The voltage appearing at the 1,000-turn winding will be $\frac{1,000}{6,500} \times 130 = 20$ volts.
- A5. A transformer cannot be used with direct current. A direct current in the primary does not produce a pulsating magnetic field.
- A6. The voltage across the secondary will be 180° out of phase with the voltage across the primary.
- A7. No current will flow.
- A8. If no current flows, no magnetic field will be produced by the secondary.
- A9. Yes.
- A10. The stronger the magnetic field, the greater will be the impedance of the primary circuit.
- A11. More current would flow in the primary.

TRANSFORMER POWER

If the transformer was 100% efficient, all the power from the primary winding would be transferred to the secondary and delivered to the load.

Suppose a transformer has 1,000 turns in the primary and 6,500 turns in the secondary. If 100 volts is applied to the primary, 650 volts will appear at the secondary. Now suppose the load connected to the secondary is a 65-ohm resistor.

It will draw a current of $\frac{650}{65}$, or 10 amperes, and the power consumed will be 650×10 , or 6,500 watts. This power must be supplied by the primary winding. Assuming no loss in the transformer, the primary winding must supply 6,500 watts. The primary current, therefore, will be $\frac{6,500 \text{ watts}}{100 \text{ volts}} = 65$ amperes.

A TRANSFORMER WITH A LOAD

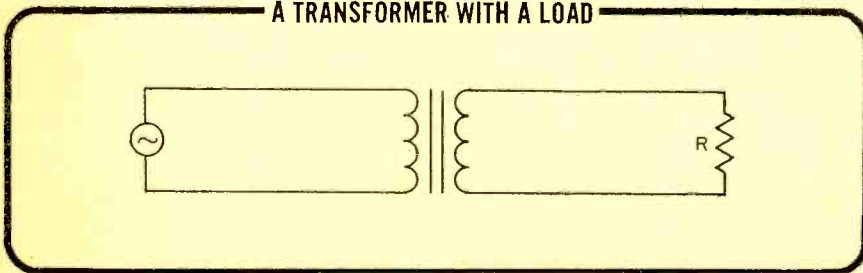

In the example above, the current was stepped down in exactly the same proportion as the voltage was stepped up. The power transferred from the primary to the secondary does not change, however, regardless of the turns ratio. This is true providing the rating of the transformer has not been exceeded and assuming 100% efficiency.

- Q12.** What happens to current in the secondary of a transformer when a load is connected across its terminals?
- Q13.** Will a magnetic field be produced by the current in the secondary?
- Q14.** Will the magnetic field add to or oppose the magnetic field produced by the primary? (Remember the coils are wound in the same direction but the currents are in opposite directions.)
- Q15.** How will the magnetic field produced by current flow in the secondary affect the current drawn by the primary?
- Q16.** What will happen if the load resistance in the circuit above is increased to 6,500 ohms?

Your Answers Should Be:

- A12.** There will be a current in the secondary when a load is connected across its terminals.
- A13.** A magnetic field will be produced by a current in the secondary.
- A14.** The secondary magnetic field will oppose that of the primary.
- A15.** The secondary magnetic field will decrease the total magnetic field acting on the primary and, therefore, will decrease the impedance of the primary circuit. The primary will draw more current.
- A16.** Current in the secondary will be $\frac{650 \text{ volts}}{6,500 \text{ ohms}} = 0.1 \text{ ampere}$.
- Power dissipated in the secondary will be $0.1 \text{ ampere} \times 650 \text{ volts} = 65 \text{ watts}$. Therefore, power drawn in the primary must be 65 watts. The current in the primary will then be $\frac{65 \text{ watts}}{100 \text{ volts}} = 0.65 \text{ ampere}$.

TRANSFORMER EFFICIENCY

So far we have assumed that no power is lost in the transfer from the primary winding to the secondary winding. However, no transformer has absolutely 100% efficiency. Some power is lost in heating the core, and some is lost in the resistance of the windings. But, transformers are very efficient; their efficiency often reaches very nearly 100%. Therefore, for rough calculations, it is permissible to assume 100% efficiency.

As with any other device, the efficiency of a transformer is equal to:

$$\frac{\text{output power}}{\text{input power}}$$

Most transformers have an efficiency in the range of 97 to 99%. So, even if you neglect the losses, your calculations using 100% as the transformer efficiency will still be accurate within 1 to 3%.

TRANSFORMER LOSSES

The power loss in transformers is due to three factors. The first is simply **resistance** in the windings; no winding is a perfect conductor.

The second factor that causes power loss in transformers is **eddy currents**. The iron in the core of a transformer is a conductor. When the changing magnetic field produced by the primary coil cuts through the iron of the core, small currents are generated in the core material. These currents dissipate power as they pass through the resistance of the iron. These currents are called **eddy currents**. This type of loss is held to a minimum by using thin sheets of iron,

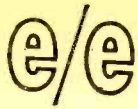
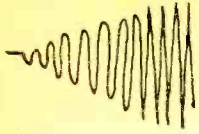

called **laminations**, in the core. These thin sheets are insulated from each other (often by oxidizing the surface of the sheets) and thus shorten the conducting path for the eddy currents.

The third factor that causes power loss in transformers is **hysteresis**. It takes a certain small amount of power to magnetize a piece of iron. This power must be expended again when the magnetic field is reversed. Since the magnetic field in a transformer is reversed many times each second, these tiny expenditures of power add up to a noticeable loss. Hysteresis loss can be reduced by constructing the core with a type of iron that is very easily magnetized and demagnetized.

- Q17.** If a transformer supplies 1.9 amperes at 100 volts to a resistive load in the secondary circuit, and if it dissipates 200 watts of power in the primary circuit, what is the efficiency of the transformer?
- Q18.** This transformer has a relatively (high, low) efficiency.
- Q19.** If the secondary of a transformer supplies 0.99 watt at 1,000 volts and the transformer has an efficiency of 99%, what power will the primary draw at 120 volts?
- Q20.** How could you find the amount of power lost due to resistance in a transformer?
- Q21.** Does an air-core transformer have hysteresis or eddy currents?



Your Answers Should Be:

- A17.** The power dissipated in the secondary will be $1.9 \times 100 = 190$ watts. The efficiency of the transformer will be $190/200 = 95\%$.
- A18.** It has a relatively low efficiency. (An efficiency below approximately 97% is considered to be low.)
- A19.** The voltages have no effect on the problem. The efficiency of the transformer is equal to output power divided by input power.

$$\frac{0.99}{?} = 99\%$$

The input power must be 1 watt.

- A20.** You would have to measure the resistance of both windings and then calculate the power dissipated due to the current in the windings.
- A21.** An air-core transformer has neither eddy-current nor hysteresis losses.

TYPES OF TRANSFORMERS



There are many varieties of transformers, ranging from huge power-station units to tiny subminiature radio-frequency types.

POWER-SUPPLY TRANSFORMER AND RADIO-FREQUENCY TRANSFORMER

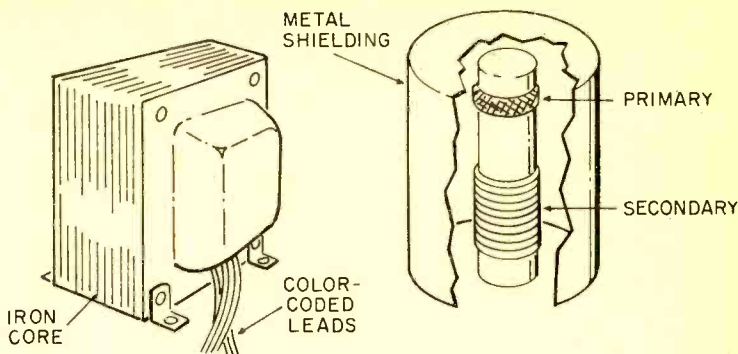

Most transformers are designed to transfer power. Others, however, are built to transfer only signal voltages.

Power distribution transformers are rated in KVA (kilovolt-amperes) rather than in kilowatts or other power units. The KVA rating refers to the apparent power carried by the transformer—the real power is smaller by the load power factor.

Special transformers, wound to precision specifications, are used in metering applications to measure the current and voltage passing through large power-transmission lines.

A step-up transformer increases voltage (which increases impedance) and decreases current (resulting from an increased impedance) at the same time. A step-down transformer decreases voltage (which decreases impedance) and increases current (which results from a decreased impedance) at the same time. Therefore, a transformer changes impedance, but the impedance change is more pronounced than the voltage change. In fact, a transformer changes impedance by the square of the turns ratio:

$$\frac{Z_1}{Z_2} = \frac{N_1^2}{N_2^2}$$

AN IMPEDANCE MATCHING TRANSFORMER

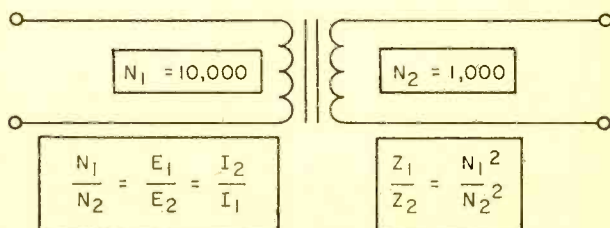

- Q22. If the primary of a transformer has 10,000 turns and the secondary has 1,000 turns, what is the turns ratio?
- Q23. If 100 volts is applied to the primary, what voltage will appear at the secondary?
- Q24. If the load impedance of the secondary circuit is 1 ohm, how much current will flow in the primary?

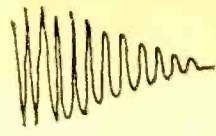
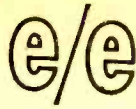
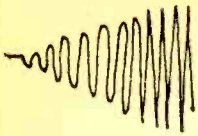

Q25. What is the impedance of the primary?

Your Answers Should Be:

A22. $\frac{10,000}{1,000} = 10$ to 1 turns ratio

A23. $\frac{N_1}{N_2} = \frac{10}{1} = \frac{100}{E_2}$; $E_2 = 10$ volts

A24. Current in the secondary is $\frac{10}{1} = 10$ amperes.

$$\frac{N_1}{N_2} = \frac{I_2}{I_1}; \frac{10}{1} = \frac{10}{I_1}$$

$$I_1 = 1 \text{ ampere}$$

A25. The impedance of the primary circuit is:

$$\frac{E_1}{I_1} = \frac{100}{1} = 100 \text{ ohms}$$

MAGNETIC AMPLIFIERS

Magnetic amplifiers are special transformer-like devices that use a small amount of power to control larger amounts of power, thus acting as amplifiers. They are simple, rugged, and efficient as compared to other forms of amplification.

Magnetic amplifiers take advantage of a special property of iron or steel in a strong magnetic field. To explain how a simple magnetic amplifier works, let's first review the basic principles of a coil.

When a current flows in a coil, a magnetic field (flux) is set up inside and around the coil. If the current is AC, the field also alternates. But, in any case, the strength of the magnetic field (the number of lines of flux produced) depends on the material inside the coil as well as how much current is flowing through the coil.

A very simple type of magnetic amplifier is based on the fact that an iron core normally allows greater changes in the magnetic field and, therefore, increases the inductive reactance of a coil at a given frequency.

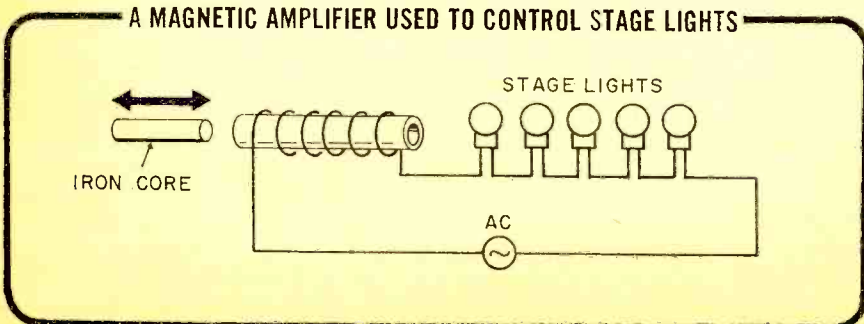

- Q26.** A coil with an air core has a (greater, smaller) inductance than a similar coil with an iron core.
- Q27.** Inductive reactance is the result of a (constant, changing) magnetic field.
- Q28.** How would you increase the inductive reactance of the device illustrated on the opposite page.
- Q29.** What effect would increasing X_L have on the brightness of the lights?
- Q30.** How should the core be set to obtain maximum brightness of the lights?
- Q31.** Would this device work with a DC power supply?

Your Answers Should Be:

- A26.** A coil with an air core has a smaller inductance than an iron-core coil.
- A27.** Inductive reactance is the result of a changing magnetic field.
- A28.** Push the iron core into the coil.
- A29.** Increasing X_L would dim the lights.
- A30.** The iron core should be totally removed.
- A31.** The device would not work with DC.

WHAT YOU HAVE LEARNED

1. The changing magnetic field produced by the primary winding in a transformer induces a changing voltage in the secondary winding.
2. The ratio of the primary voltage to the secondary voltage is the same as the ratio of the number of turns in the primary winding to the number of turns in the secondary winding.
3. If a transformer steps up voltage, it steps down current, and vice versa. The power drawn by the primary winding is equal to the power dissipated in the secondary circuit of an ideal transformer.
4. Most transformers have an efficiency of nearly 100%, so very little power is lost in them.
5. Transformers alter the impedance of a load. The change in impedance depends on the square of the turns ratio.
6. Magnetic amplifiers control the inductive reactance of a coil by altering the magnetic property of its core.
7. A very simple magnetic amplifier is basically a coil with a removable iron core. When the core is inserted, X_L increases, and the power supplied to the load decreases.

NEXT ISSUE: Power Supplies—Part 1

This series is based on material appearing in Vol. 2 of the 5-volume set, BASIC ELECTRICITY/ELECTRONICS, published by Howard W. Sams & Co., Inc. @ \$19.95. For information on the complete set, write the publisher at 4300 West 62nd St., Indianapolis, Ind. 46268.

DX Central

Continued from page 12

club at the Ron Rampant Distillery in Costa Rica. The call? THON! You figure that one out! Anyone else out there "heard" any of these improbable outlets?

"Thanks for the tip on Radio Tahiti in the January column," writes Andrew Kowal of Collingswood, N.J. "Just got my topless mermaid QSL. Wow! By the way, the present address of Radio Tahiti is B.P. 125, Papeete, Tahiti."

For those of you still trying to log this station, check the Bandsweep tip above.

L. E. Waddle, Titusville, N.J., sends along a half dozen frequencies to try during the next Apollo moonshot. He suggests 7.385 and 7.435 kHz, during the evening hours, and 9,440, 10,165, 10,655 and 23.206 kHz, during the day.

For Pros only: Glenn Hauser, San Antonio, Tex., passes along information heard on the BBC's World Radio Club program. EAJ203, in tiny Spanish Sahara, is transmitting on 7,230 kHz. around 0800 GMT. And, Glenn reports hearing a station signing on this frequency at that time. Announcements were in an Arabic-like language.

The DX Central spotlight this month falls on another DX club, the International Radio Club of America, 6059 Essex Street, Riverside,

International Radio Club of America
6059 Essex Street
Riverside, Cal. 92504

I read about your club in ELEMENTARY ELECTRONICS' "DX Central Reporting."

Please send me a sample copy of your bulletin. I am enclosing 25 cents.

I want to join IRCA. I am enclosing \$_____ for one year's membership.

Name _____

Address _____

City _____ State _____ Zip _____

Cal. 92504. IRCA is one of only two North American radio clubs that specialize in medium wave (540-1600 kHz) DXing. Its information filled bulletin is issued 34 times a year, weekly during the top winter season.

Its bulletin, DX Monitor, contains data on members' loggings, hot DX tips and other useful items. A sample copy of the IRCA bulletin is yours for two bits. If you decide to join, annual membership is \$6.50; \$9.50 if you want your bulletin sent first class mail, rather than third class.

If IRCA sounds like it might be your cup of tea, fill in the form above and mail it to the club—not to ELEMENTARY ELECTRONICS. ■

Stamp Shack

Continued from page 15

● Television is the subject of the 2-cor value, with an antenna in front of a viewing screen and waves radiating from it and honors James Clark Maxwell. It was this Scottish mathematician who discovered equations concerned with electricity and magnetism. Living a century ago he could only imagine that his processes would lead to the development of radio, TV, long distance communications, radar and even X-ray progress. All of these are governed by his complicated formula.

● Last of the set is a 2-cordoba air-mail stamp which honors Archimedes, who in the third century before Christ evolved his leverage principle that was one of civilization's first major contributions to science and mathematics. When he said, "give me a place to stand (and a lever) and I will move the world," the ancient Greek revolutionized engineering. The principle is involved in everything from a mere crowbar to bridges, brakes on vehicles, weighing scales, door handles and virtually every tool, as leverage plays a fundamental role in the operation of all of them.

● The new stamps are interesting not only because of their designs, but because on the back of each one of them a brief biography of the person honored is imprinted in black.

●● What's New? More than a century ago, J. W. Scott started his stamp and coin business in New York. During all that time, the firm changed ownership and locations. Now comes word that Duane Hillmer, who purchased the famous philatelic organization from Esquire, Inc., a couple of years ago, is moving it to Omaha, Nebr., where he has other publishing interests. ■

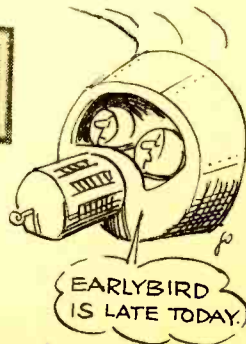

Hey, look me over

Showcase of New Products

Five New Ones

Five high-quality, general purpose RCA Volt-Ohm-Milliammeters (VOM's) with broad hobby applications are available to experimenters from \$9.95 to \$48.00 each. All of the meters in the new line feature meter movements that



RCA VOMs

have protection diodes to prevent damage from accidental overload, precision range resistors ($\pm 1\%$) to insure accuracy, 3-color easy-to-read meter scales and attractively styled high-impact blue plastic cases. The five new RCA VOM's are the WV-516A, WV-517A, WV-518A, WV-519A and WV-520A.

Circle No. 33 on Page 17

Ratchet Gadget

Can you use a new 19-piece, midget reversible ratchet offset screwdriver set with uses in all kinds of assembly, disassembly, adjustment and repair work involving Allen hex type, Phillips, and slotted screws? Then check out Xcelite's No. XL-70 set which includes a $3\frac{3}{4}$ " heavy duty, stainless steel reversible 20-tooth ratchet-



Xcelite Offset Screwdriver Set

ing handle with a turning radius of only 18° , making it ideal for work in confined areas. With a drive socket insert in its handle, a unique 6" spinner/extension can be used for ratchet operation as well as normal hand driving with bits. For additional flexibility, the new set has a $\frac{1}{4}$ " hex to $\frac{1}{4}$ " square adapter bit which permits both the reversible ratcheting handle and spinner/extension to be used with Xcelite Series 1000 or other $\frac{1}{4}$ " square drive sockets. The No. XL-70 set comes in a snap-lock case molded of high impact plastic. Attractive "stick-on" initials, available free from the set manufacturer, can be used to personalize the case.

Circle No. 34 on Page 17

Peps Popped Color

The new B&K-Dynascan IC Digital Color Generator, Model 1246, is billed as the most advanced color generator on the market today—offering broadcast station stability. It has



Dynascan IC Digital Color Generator

crystal-controlled picture carrier oscillators for Ch. 3 and 4; a 4.5 MHz unmodulated carrier (a valuable tuning aid); and red, blue and green color killers. It provides a total of 9 jitter-free patterns, including 1 x 9 and 9 x 1 Crosshatches and the ultra-helpful Center Dot. The 1246 also offers an exclusive: an "Instant-Use" Carrying Case that protects the instrument at all times. A carrying handle is provided, but the 1246 is so compact ($2\frac{1}{4}$ x 7 x $10\frac{3}{4}$ "") it fits right in the tube caddy. Price of the Deluxe Model 1246 is \$149.95.

Circle No. 35 on Page 17

NewsScan

Continued from page 25

the metal atoms. This released energy becomes X-rays.

The early tubes sprayed X-rays in virtually all directions. Enough energy passed through the patient's body and onto the photographic plate on the other side to make a usable image but far more energy irradiated the rest of the patient's body and that of the radiologist.

As more was learned about the generation of X-rays, tubes were developed that gave more specific direction to the X-rays emitted. They learned that there were "soft X-rays" and "hard X-rays." The "soft," or lower voltage rays, tended to be just skin deep. Better pictures were produced when the X-rays could be projected at higher velocities. This created engineering innovations to generate "hard" X-rays. Voltages were increased and the electron bombardment of the metal target within the tube grew so hot that elaborate cooling systems were devised. Fins were added like radiators and finally water jackets and heat exchangers like miniature boilers were added.

In those early days, exposures took many seconds to complete and the patient often was unable to keep from moving so that many pictures had to be repeated. Even that wasn't easy, for the operator had to allow the tube to cool off before reapplying the high voltage.

The metal target inside the tube had just about reached its limit of bombardment when tube engineers found a way to extend its life. Instead of a fixed target, the target was made into a wheel that could be spun at high speed so that the electron beam continuously hit a new area of the target. The bearing arrangements devised were later directly applicable to solving lubrication problems for precision instruments in space vehicles.

Although the early experimenters appreciated the mystique of their unknown rays they failed to afford them the respect that X-rays are given today.

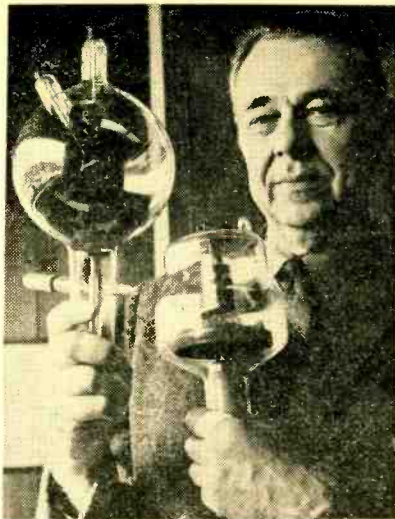

Veteran X-Ray tube engineer Thomas H. Rogers, vice president of Raytheon's Muchlett Laboratories, holds two of his company's tubes that illustrate advances made in X-ray technology since 1895 when Roentgen discovered X-rays. Tube at left is an early model that permitted radiation in many directions. New tube at right has spinning anode to produce sharper pictures with more consistency, fewer retakes, and greater safety for both patient and radiologist.

While "X" for the unknown was a good name for Roentgen's rays 75 years ago, they are far from a mystery today. Radiologists use them with care and understanding to detect diseases like cancer, tuberculosis, and gall bladder malfunctions; they serve as guides to setting broken bones; and by injecting or swallowing opaque fluids they are used to define veins and arteries and the digestive system in the body. Modern X-ray equipment takes pictures in a fraction of a second and "retakes" are far less common. X-rays can be controlled to focus at a certain depth within the body, a feature that enables the use of X-rays for therapy as well as for diagnostic use.

CB-9 Converter

Continued from page 31

num volume from your rig's speaker, or look for maximum meter needle deflection on your vom. While adjusting L1, reduce the signal generator's output level; otherwise, you'll be swamping Q1 with too much signal and invalidating your alignment procedure.

Becoming a CB Samaritan. For best op-

eration, a high-mounted, outside CB antenna is required. Use either a ground plane or beam antenna with coax cable connecting the antenna to your *CB-9 Converter*. If you're only concerned with local signals, a whip antenna will suffice. Sensitivity of reception is largely dependent upon the broadcast receiver you're working with. Also, for long-term monitoring of channel 9, a stable, drift-free rig is your best choice. In fact, a sensitive—and inexpensive—transistor portable radio would be your best bet to use with *CB-9 Converter*. ■

CLASSIFIED Market Place

**FOR BIGGER PROFITS! NEW CAREER OPPORTUNITIES!
READ AND REPLY TO THESE CLASSIFIED ADS**

Classified Ads 65¢ per word, each insertion, minimum 10 words, payable in advance. To be included in the next available issue of **ELEMENTARY ELECTRONICS**, copy must be in our New York Office by Aug. 10th. Address orders to C. D. Wilson, Manager, Classified Advertising, **ELEMENTARY ELECTRONICS**, 229 Park Avenue South, New York, N. Y. 10003.

BOOKS & PERIODICALS

HIGHER INCOME, Security and Power. 256 page book. "Thinking Big" reveals secrets that make men rich! Send \$2.00 for #WB-123. K. Scott, Drawer 147, Dent, SM771, Monroe, North Carolina 28110.

FREE Circulars, unique books. Campbell's, 1800 B. E. Franklin, Evansville, Indiana 47711.

BUILD-IT-YOURSELF

PSYCHEDELIC LIGHTING MANUAL! Make strobes, kaleidoscopes, organs, etc. Send \$2.95 Lightrays, 1315 N. Weaver, Philadelphia, Pennsylvania 19150.

ELECTRONIC Pistol built with under \$20.00 worth of parts. Shoots 1,000 volt pulses through air. Powered by flashlight battery. Plans \$2 Kilmer, Pa. Road, Dept. 3c, Silver City, N. M. 88061.

BUSINESS OPPORTUNITIES

I made \$40,000.00 Year by Mailorder! Help others make money! Start with \$10.00—Free Proof! Torrey, Box 318-T, Ypsilanti, Michigan 48197.

FREE Book "999 Successful, Little-Known Businesses." Fascinating! Work home! Plymouth 411-J, Brooklyn, New York 11218.

I MADE \$2,000.00 MONTHLY by mail order—evenings only. You can too! Free Proof! Kingman, Box 727DC, Erie, Pa. 16510.

MAKE Magnetic Signs. Big profits. Details. Universal, Lenora, Kansas 67645.

\$1000 DAY—150% profit. Selling by mail. No investment in inventory. Part time—full time. Unlimited potential. Complete details \$1.00. National, Box 7212ZH, Chicago, Illinois 60680.

1000% PROFIT Bronzing Shoes. Free Details. NBC, Box 11069-0, Kansas City, 64119.

DOUBLE Money Back if you can't beat horsereaks using my system! Strauss-AJW, Brooklyn, New York 11219.

DO-IT-YOURSELF

BURGLAR—Fire alarm systems and supplies. Free Catalog. Informer Mfg. 300b S. Eden Street, Baltimore, Maryland 21231.

PRACTICAL tips for home, garden and workshop are in "1001 How-To Ideas." Send \$1.00 for your copy includes Postage. to 1001 How-To Ideas, 229 Park Avenue South, New York, N.Y. 10003.

EDUCATION & INSTRUCTION

UNIVERSITY Degree By Mail. Details. Send 10¢. Norman Publishing, Dept. 63, Box 3199, Pasadena, Ca. 91103.

EDUCATION & INSTRUCTION—Cont.

SERVICING Course complete in one book: "Electronic Servicing for the Beginner." Covers troubleshooting TV, Radio, Stereo. Ham, plus homemade gear. Includes building projects. Only \$3.95 at parts stores selling "Sams" publications (Catalog number 20090). Or order autographed copy direct from author J. Stanley, 855 South Fillmore Street, Denver, Colorado 80209. Add 25¢ handling.

FINISH HIGH SCHOOL at home in spare time. Texts furnished. Diploma. Founded in 1897. Also 26 Vocational Courses. Free Brochure. American Schol. Dept. X615, Drexel at 58th, Chicago, Illinois 60637.

FARMS, ACREAGE & REAL ESTATE

10 to 160 Acre tracts—Lake Superior, Marquette, Mich. Area, from \$99 acre. Any terms A-OK. Cabins, trailers, camping welcome. Free pictures, write Hiawatha Forest Lake Acres 3650 Dixie, Drayton Plains, 44 Michigan 48020.

GOVERNMENT SURPLUS

AMAZING SURPLUS BARGAINS. Government Surplus never before offered, for PENNIES ON THE DOLLAR! Hardware, Tools, Motors, Electronics, Optics, Hobby-craft! ILLUSTRATED \$1.00. Refundable. SURPLUS WORLD, Box 785, Rochester, New York 14603.

INVENTIONS WANTED

WE either sell your invention or pay cash bonus. Write for details. Universal Inventions, 298-3, Marion, Ohio 43302.

MAGNETS

MAGNETS—All types. Specials—20 disc magnets, or 10 small bar magnets, or 8 assorted magnets, or 2 stick magnets. \$1.00. Maryland Magnet Company, 8825-R Allenswood, Randallstown, Maryland 21133.

MONEYMAKING OPPORTUNITIES

MAKE Big Money raising chinchillas, rabbits, guinea pigs for us. Catalog 50¢. Keeney Brothers Farms, Inc. New Freedom, Pennsylvania 17349.

HOW MUCH does being your own boss or making \$25,000.00 per year interest you? The Warner breakthrough in the Engraving field could be your future. Write: Warner, Room EC-107-AJ, 1512 Jarvis, Chicago, Ill. 60626.

MAKE YOUR CLASSIFIED AD PAY. Get "How To Write a Classified Ad That Pays." Includes certificate worth \$2.00 toward a classified ad in S & M. Send \$1.25 (includes postage) to C. D. Wilson, Science & Mechanics, 229 Park Avenue South, New York, New York 10003.

MONEYMAKING OPPORTUNITIES—Cont.

MAKE \$1.00 PER SALE selling engraved metal Social Security plates. FREE SALES KIT. Engravaplates, Box 10460-7503, Jacksonville, Fla. 32207.

SAVE!! No stuff. New Christmas Post Card Greetings available. Sales Kit \$2.00. Big profits. HPC, P.O.B. 1401-10, Decatur, Georgia 30031.

PERSONAL

ELIMINATE Debts Without Borrowing! Particulars Free. Helper, P.O. Box 9308, No. Hollywood, California 91609.

LIFETIME ordinations. 25¢ brings details. Life Science Church, 2207 Cardinal, Rolling Meadows, Illinois 60008.

GENERATION GAP? Communicate with MOD Greeting cards! Assortment \$1.00. IGH-RR2, Box 329-DCB, Salem, New Hampshire 03079.

THERE IS NO CHARGE FOR THE ZIP CODE. PLEASE USE IT IN YOUR CLASSIFIED AD.

PROFITABLE OCCUPATIONS

CHINCHILLA income guaranteed. Terms 25¢—Bulletin \$1.00. Rainbow, 11DC, Port Richey, Florida 33568.

RADIO & TELEVISION

RADIO & TV tubes 35¢. Free Catalog. Cornell, 4217 West University, San Diego, California 92105.

FREE electronics catalog. Tremendous bargains. Edu-Kits, Dept. C-548-DJ, Hewlett, New York 11557.

EXCITING Listening! Police—Fire—Emergency calls on your broadcast radio. \$19.95 up. Also receivers, scanners, dual-band high/low, crystals. Saich Company, Woodsboro 1, Texas 78393.

"CRYSTAL Experimenter's Handbook"—50¢. "20 Distance Crystal Plans Handbook"—50¢. Catalog. Laboratories, 745-G Cordone, Reno, Nevada 89502.

SWAP QSL's, KRN-8291 \$1.00 1971 Knob Ct. Cincinnati, Ohio U. S. A. 45225

REMAILING SERVICE

OTTAWA—Remails 50¢ Dependable \$5.00 Monthly Robert, 110, Dagmar Ottawa, Ontario, Canada. KIL-5T4

SAVANNAH Remails 20¢, monthly \$3.00. Dewilco, Box 13063, Savannah, Ga. 31406.

NEW YORK REMAILS 25¢ each—\$3.00 Monthly. Foreign Accounts Welcome. M. Cassidy, 2845 University, New York, N.Y. 10468.

THERE IS NO CHARGE FOR THE ZIP CODE—PLEASE USE IT IN YOUR CLASSIFIED AD

NEW!

Announcing the CIE ELECTRONICS LABORATORY

Light-years ahead of any
other way to learn electronics.



Electronic "kits" are out!

Now you can have your own electronics laboratory.

You'll perform hundreds of exciting experiments like these with authentic electronic components used by industry.



Working with basic single transistor circuit— Student learns best installation and troubleshooting techniques. He has constructed a basic single transistor circuit, first step toward understanding more complex solid-state circuitry.

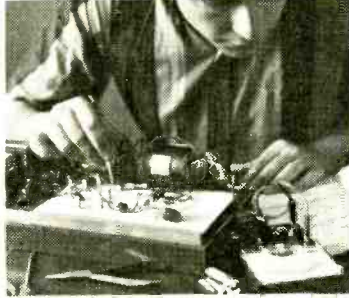

Observing transistor operating as shunt-fed amplifier— Student has installed an oscillator and shunt-fed amplifier. He takes various measurements and observes the transistor operating as an amplifier. This is a typical solid-state circuit.



Assembling integrated circuit on a printed circuit board— Circuit is identical to one used in latest IBM System 360 computers. Student is constructing an oscillator combined with a Darlington pair output amplifier.

Prepare now for a high income career in the fast growing field of electronics.

Electronic miracles are changing today's world with breathtaking speed.

And with this electronics explosion has come a brand new need . . . a demand for thousands of electronic technicians, trained in theory and practice to build the products, operate them and service them.

Don't wait for something to "happen" in your present job. Start working right now to get ready for a career you'll really enjoy . . . at \$10,000 . . . \$12,000 or more a year.

Experience with experiments is your best teacher

Step-by-step learning cannot compare with learning-by-doing. Now you can learn "why" as well as "how." You'll find out for yourself the right way as well as the wrong way to use electronic components, to construct your own circuits, to discover trouble spots and learn how to fix them.

This new CIE course, Electronics Technology with Laboratory, teaches you electronics by making it work before your eyes. And you do it yourself, with your own hands.

Importance of FCC License and our money-back warranty

An FCC License is a legal requirement for many important jobs. And it is not easy to get!

But more than 9 out of every 10 CIE graduates who take the Government licensing exam pass it!

We are so certain that our Laboratory Course will successfully prepare you for a First Class FCC License examination, with Radar Endorsement, that if you fail the exam we will refund all tuition payments.

You get your FCC License, or you get your money back!

You'll have high-paying job opportunities

Electronics is in its infancy. Everywhere you turn you find new products and equipment using space-age circuitry. Computers. Improved radar for air traffic control. Mobile microwave communications. These and many more examples of electronic technology have created thousands of new jobs—in companies like American Airlines, American Telephone and Telegraph, General

Electric, IBM, North American Rockwell, Raytheon and Westinghouse.

Once you're enrolled with CIE you will get a bi-monthly listing of many high-paying, interesting jobs open in designing, manufacturing, testing, operating and repairing.

More and more jobs will be created in the next few years. Start today to get ready for an exciting, new career in electronics . . . the industry of tomorrow.

Don't put it off. Send now for 2 FREE BOOKS

Mail the postpaid reply card for our School Catalog *plus* a special book on how to get your FCC License. If card is missing, use the coupon below, or write to: Cleveland Institute of Electronics, 1776 East 17th Street, Cleveland, Ohio 44114. But do it now!



Approved under new G.I. Bill

All CIE courses are approved under the new G.I. Bill. If you served on active duty since January 31, 1955, or are in service now, check box on card or coupon for G.I. Bill information.

CIE Cleveland Institute of Electronics
1776 East 17th Street, Cleveland, Ohio 44114

Please send me without cost or obligation:
1. Your 44-page book, "How to Succeed in Electronics."
2. Your book, "How to Get a Commercial FCC License."

I am especially interested in: Electronics Technology with Laboratory

- | | |
|--|--|
| <input type="checkbox"/> Electronics Technology | <input type="checkbox"/> Industrial Electronics |
| <input type="checkbox"/> Electronic Communications | <input type="checkbox"/> First Class FCC License |
| <input type="checkbox"/> Broadcast Engineering | <input type="checkbox"/> Electronics Engineering |

Name _____ Age _____
(please print)

Address _____

City _____ State _____ Zip _____

Check here for G.I. Accredited Member National Home Study Council
Bill information. A Leader in Electronics Training . . . Since 1934 EL-28

CIRCLE NO. 19 ON PAGE 17

BUILDTV 20 RADIO

Reg. U.S. Pat. Off.

and Electronics Circuits

PROGRESSIVE HOME RADIO-T.V. COURSE

Now Includes

- ★ 12 RECEIVERS
- ★ 3 TRANSMITTERS
- ★ SQ. WAVE GENERATOR
- ★ SIGNAL TRACER
- ★ AMPLIFIER
- ★ SIGNAL INJECTOR
- ★ CODE OSCILLATOR

- ★ No Knowledge of Radio Necessary
- ★ No Additional Parts or Tools Needed
- ★ EXCELLENT BACKGROUND FOR TV
- ★ SCHOOL INQUIRIES INVITED
- ★ Sold In 79 Countries

YOU DON'T HAVE TO SPEND HUNDREDS OF DOLLARS FOR A RADIO COURSE

The "Edu-Kit" offers you an outstanding PRACTICAL HOME RADIO COURSE at a rock-bottom price. Our Kit is designed to train Radio & Electronics Technicians, making use of the most modern methods of home training. You will learn radio theory, construction practice and servicing. THIS IS A COMPLETE RADIO COURSE IN EVERY DETAIL. You will learn how to build radios, using regular schematics; how to wire and solder in a professional manner; how to service radios. You will work with the standard type of Punched metal chassis as well as the latest development of Printed Circuit chassis. You will learn the basic principles of radio. You will construct, study and work with RF and AF amplifiers and oscillators, detectors, rectifiers, test equipment. You will learn trouble-shooting, using the Progressive Signal Tracer, Progressive Signal Injector, Progressive Dynamic Radio & Electronics Tester, Square Wave Generator and the accompanying instructional material.

You will receive training for the Novice, Technician and General Classes of F.C.C. Radio Amateur License. You will build Receiver, Transmitter, Square Wave Generator, Code Oscillator, Signal Tracer and Signal Injector circuits, and learn how to operate them. You will receive an excellent background for television, Hi-Fi and Electronics.

Absolutely no previous knowledge of radio or science is required. The "Edu-Kit" is the product of many years of teaching and engineering experience. The "Edu-Kit" will provide you with a basic education in Electronics and Radio, worth many times the low price you pay. The Signal Tracer alone is worth more than the price of the kit.

THE KIT FOR EVERYONE

You do not need the slightest background in radio or science. Whether you are interested in Radio & Electronics because you want an interesting hobby, a well paying business or a job with a future, you will find the "Edu-Kit" a worthwhile investment. Many thousands of individuals of all

ages and backgrounds have successfully used the "Edu-Kit" in more than 79 countries of the world. The "Edu-Kit" has been carefully designed, step by step, so that you cannot make a mistake. The "Edu-Kit" allows you to teach yourself at your own rate. No instructor is necessary.

PROGRESSIVE TEACHING METHOD

The Progressive Radio "Edu-Kit" is the "of most educational radio kit in the world, and is universally accepted as the standard in the field of electronics training. The "Edu-Kit" uses the modern educational principle of "Learn by Doing." Therefore you construct, learn schematics, study theory, practice trouble shooting—all in a closely integrated program designed to provide an easily-earned, thorough and interesting background in radio. You begin by examining the various radio parts of the "Edu-Kit." You then learn the function, theory and wiring of these parts. Then you build a simple radio. With this first set you will enjoy it, register broadcast stations, learn theory, practice testing and trouble-shooting. Then you build a more advanced radio, learn more advanced theory and techniques. Gradually, in a progressive manner, and at your own rate, you will find yourself constructing more advanced multi-tube radio circuits, and doing work like a professional Radio Technician.

Included in the "Edu-Kit" course are Receiver, Transmitter, Code Oscillator, Signal Tracer, Square Wave Generator and Signal Injector Circuits. These are not unprofessional "breadboard" experiments, but genuine radio circuits, constructed by means of professional wiring and soldering on metal chassis, plus the new method of radio construction known as "Printed Circuitry." These circuits operate on your regular AC or DC house current.

THE "EDU-KIT" IS COMPLETE

You will receive all parts and instructions necessary to build twenty different radio and electronics circuits, each guaranteed to operate. Our Kits contain tubes, tube sockets, variable, electrolytic, mica, ceramic and paper dielectric condensers, resistors, tie strips, hardware, tubing, punched metal chassis, Instruction Manuals, hook-up wire, solder, selenium rectifiers, coils, volume controls and switches.

In addition, you receive Printed Circuit materials, including Printed Circuit chassis, special tube sockets, hardware and instructions. You also receive a useful set of tools, a professional electric soldering iron, and a self-powered Dynamic Radio and Electronics Tester. The "Edu-Kit" also includes Code Instructions and the Progressive Code Oscillator, in addition to F.C.C. Radio Amateur License training. You will also receive lessons for servicing with the Progressive Signal Tracer and the Progressive Signal Tracer, High Fidelity Guide and a Quiz Book. You receive Membership in Radio-TV Club, Free Consultation Service, Certificate of Merit and Discount Privileges. You receive all parts, tools, instructions, etc. Everything is yours to keep.

Progressive "Edu-Kits" Inc., 1189 Broadway, Dept. 549DJ, Hewlett, N.Y. 11557

UNCONDITIONAL MONEY-BACK GUARANTEE

Please rush my expanded "Edu-Kit" to me, as indicated below:

Check one box to indicate choice of model

- Deluxe Model \$31.95
- New Expanded Model \$34.95 (Same as Deluxe Model Plus Television Servicing Course and valuable Radio & TV Tube Checker).

Check one box to indicate manner of payment

- I enclose full payment. Ship "Edu-Kit" post paid.
- I enclose \$5 deposit. Ship "Edu-Kit" C.O.D. for balance plus postage.
- Send me FREE additional information describing "Edu-Kit."

Name

Address

City & State

Zip

PROGRESSIVE "EDU-KITS" INC.

1189 Broadway, Dept. 549DJ, Hewlett, N. Y. 11557



Training Electronics Technicians Since 1946

FREE EXTRAS

• SET OF TOOLS

- SOLDERING IRON
- ELECTRONICS TESTER
- PLIERS-CUTTERS
- VALUABLE DISCOUNT CARD
- CERTIFICATE OF MERIT
- TESTER INSTRUCTION MANUAL
- HIGH FIDELITY GUIDE + QUIZZES
- TELEVISION BOOK + RADIO TROUBLE-SHOOTING BOOK
- MEMBERSHIP IN RADIO-TV CLUB
- CONSULTATION SERVICE
- AMATEUR LICENSE TRAINING
- PRINTED CIRCUITRY

SERVICING LESSONS

You will learn trouble-shooting and servicing in a progressive manner. You will practice the steps that you construct. You will learn symptoms and causes of trouble in home, portable and car radios. You will learn how to use the professional Signal Tracer, the unique Signal Injector and the dynamic Radio & Electronics Tester. While you are learning in this practical way, you will be able to do many a repair job for your friends and neighbors, and charge fees which will far exceed the price of the "Edu-Kit." Our Consultation Service will help you with any technical problems you may have.

FROM OUR MAIL BAG

J. Stataitis, of 25 Poplar Pl., Waterbury, Conn., writes: "I have repaired several sets for my friends, and made money. The "Edu-Kit" paid for itself. I was ready to spend \$240 for a course, but I found your ad and sent for your Kit."

Ben Valerio, P. O. Box 21, Magna, Utah: "The Edu-Kits are wonderful. Here I am sending you the questions and also the answers for them. I have been in Radio for the last seven years, but like to work with Radio Kits and like to build Radio Testing Equipment. I enjoyed every minute I worked with the different kits; the Signal Tracer works fine. Also like to let you know that I feel proud of becoming a member of your Radio-TV Club."

Robert L. Shuff, 1534 Monroe Ave., Huntington, W. Va.: "Thought I would drop you a few lines to say that I received my Edu-Kit, and was really amazed that such a bargain can be had at such a low price. I have already started repairing radios and phonographs. My friends were really surprised to see me get into the swing of it so quickly. The Trouble-shooting Tester that comes with the Kit is really swell, and finds the trouble, if there is any to be found."

PRINTED CIRCUITRY

At no increase in price, the "Edu-Kit" now includes Printed Circuitry. You build a Printed Circuit Signal Injector, a unique servicing instrument that can detect many Radio and TV troubles. This revolutionary new technique of radio construction is now becoming popular in commercial radio and TV sets.

A Printed Circuit is a special insulated chassis on which has been deposited a conducting material which takes the place of wiring. The various parts are merely plugged in and soldered to terminals.

Printed Circuitry is the basis of modern Automation Electronics. A knowledge of this subject is a necessity today for anyone interested in Electronics.