

THE STRANGE WORLD OF PAID SWLing

© elementary  
**Electronics**

MARCH-APRIL 75¢

The now-it-can-be-told story of flies in the shortwave ointment from Prussia to the Pueblo—see page 33

**MYSTERY-BAND CONVERTOR**

A cinch to build, our add-on unit takes over where your communications receiver leaves off

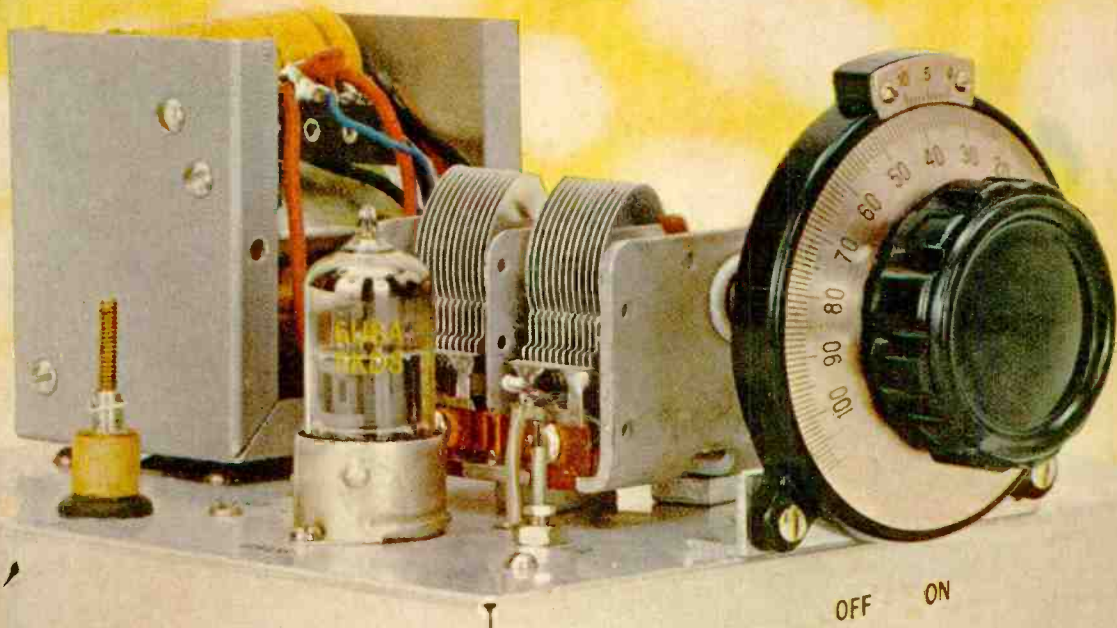

**PLUS MYSTERY-BAND STATION GUIDE**

A region-by-region directory of police, fire, emergency stations in the 30-50 MHz band throughout the U.S.

- EXPERIMENTER'S ELECTROSCOPE—build it!
- POWER-PACKED PAPER BATTERY—it's dry,
- DARKROOM PHOTOGRAPH—sounds off at

5305197 4 520122 568  
 1 MARCH 59  
 123 W 66268RY  
 PENSACOLA FL 32501



# AMERICAN BASIC SCIENCE CLUB'S **ELECTRONICS LAB and RADIO COURSE**

All the Equipment for 65 Exciting Projects, Including  
3 Tube Short Wave Radio, DC Power Supply,  
Microphone and Audio Amplifier, Signal Tracer—only **\$19<sup>95</sup>** COMPLETE LAB AND COURSE

**Get it All in One Complete Shipment —  
or Divided into these 4 Monthly Kits**

### TROUBLE SHOOTING WITH THE SIGNAL TRACER

#### YOU GET A VALUABLE ELECTRONICS LAB

Containing parts by RCA, MALLORY, PYRAMID, GE, CENTRALAB, STACKPOLE, TRIM, CINCH and other reliable manufacturers. Retail value of parts alone is **MORE THAN 25 DOLLARS**

#### PLUS A COMPLETE ELECTRONICS COURSE

**You REALLY LEARN ELECTRONICS.** The progressive "learn by doing" American Basic Science Club system is the **EASIEST, MOST THOROUGH and MOST EXCITING** way to a solid background in electronics. Basic enough for beginners... rewarding enough for experts. **NOWHERE ELSE** is a course of this scope available at this **LOW PRICE!**

#### ENTHUSIASTIC MEMBERS WRITE:

"basic principles unforgettably learned" . . .  
It is only after having completed the experiments in your kits that I can say I have truly and unforgettably learned the basic principles of electronics. **JOHN R. KANIA**, 2 Berkeley Ave., Yonkers 5, N. Y.

"your kits are interesting and rewarding" . . .  
I am an electronics student in the Air Force and find your kits interesting and rewarding. We have not covered anything in the school that you have not covered in the kits. **JOHN G. DILL**, Keesler Air Force Base, Biloxi, Miss.

"far ahead of friend taking another course" . . .  
A friend of mine is taking a correspondence course in electronics, and I have learned more from your first two kits than he has in twenty lessons. **RAY F. BILDEAU**, 139 Exchange St., Leonister, Mass.

"the number of concepts presented is amazing" . . .  
Your kits offer a range of experiments usually performed only in the better high school and college laboratories. The number of concepts presented, and the clarity and concreteness of their development is amazing. **R. M. HELM**, Professor of Physics, East Carolina College, Greenville, N. C.

### 1st KIT — DC AND AC CIRCUITS

Equipment for 26 Projects Including:

- Electroscope • Electromagnetic Relay • Galvanometer
- AC Buzzer • Magnetizer and Demagnetizer • Solenoid Coin Tosses • Safety AC Power Supply with Isolation Transformer.

- Subjects Covered:
- Electron Theory
  - DC and AC
  - Electro-Chemistry
  - Transformer Principles
  - Inductance

**FREE with 1st Kit — Surprise "Mystery Box"**

### 2nd KIT — RESISTANCE, CAPACITANCE AND RECTIFICATION

Equipment for 18 Projects Including:

- Strobe Light - variable pulse Neon Lamp "freezes" the motion of vibrating or rotating objects and checks RPM
- Thermocouple • Wheatstone Bridge (measures resistance)
- Extinction Voltmeter • DC Power Supply (Transformer, Vacuum Tube Rectifier and 20-20 mfd. Capacitor Filter Circuit.)

- Subjects Covered:
- Ohm's Law
  - Rectification
  - Resistance
  - Neon Glow Tubes
  - Capacitance
  - Filter Circuits

**FREE with 2nd Kit — Electric Soldering Iron**

### 3rd KIT — AMPLIFIERS AND OSCILLATORS

Equipment for 14 Projects Including:

- Two Stage Amplifier • Capacitance Burglar Alarm
- Proximity Detector • Variable Frequency Ringle Tank Wave Generator (Produces standing waves, nodal lines, etc. Invaluable in understanding wave theory) • Code Practice Oscillator.

- Subjects Covered:
- Vacuum Tube Amplifiers
  - Frequency and Wave Length
  - Wave Theory
  - Oscillator Circuits

**FREE with 3rd Kit — "Steps to a Ham License" Manual**

### 4th KIT — AUDIO AMPLIFICATION AND RADIO

Equipment for 7 Projects Including:

- Short Wave and Broadcast Radios (3-tube regenerative. Uses 115V AC house current. Complete with Headset) • Carbon Microphone and Two Stage Audio Amplifier • Radio Transmitter • Signal Tracer and Continuity Tester (valuable trouble-shooting tools).

- Subjects Covered:
- Audio Amplifiers
  - Radio Theory
  - Regen. Circuits
  - Tuning Circuits
  - Signal Tracing

**FREE with 4th Kit — Radio-TV Service Manual**

**ALL FOUR KITS IN ONE SHIPMENT ONLY \$19<sup>95</sup> POSTPAID**

**OR—YOU CAN GET THE FOUR KITS, ONE A MONTH**

SEND **\$100** WITH PAY **\$475** PLUS COD POSTAGE  
ONLY COUPON ONLY ON RECEIPT OF EACH KIT

**ALL SHIPMENTS ON 10 DAY APPROVAL.  
YOUR SATISFACTION OR YOUR MONEY BACK.  
WE KNOW YOU WILL BE AMAZED AND DELIGHTED.**

USE THIS "NO RISK" COUPON FOR EITHER PAID IN FULL OR MONTHLY PLAN

AMERICAN BASIC SCIENCE CLUB, Inc., 104 Heiman, San Antonio, Texas 78205

- Send me ABS Club's Electronics Lab in four kits — one a month. I enclose \$1.00 and will pay \$4.75, plus COD postage on arrival of each kit. I understand that all kits will be on 10 day approval with full refund guaranteed and also that I may cancel unshipped kits at any time without obligation.
- Send me ABS Club's Electronics Lab (all four kits) in one shipment. I enclose \$19.95 full payment, postage paid to me. I understand that this will be on a 10 day approval with full refund guaranteed.

NAME .....

ADDRESS .....

CITY and STATE .....



# You can pay \$600 and still not get professionally approved TV training.

## Get it now for \$99.

Before you put out money for a home study course in TV Servicing and Repair, take a look at what's new.

National Electronic Associations did. They checked out the new TV training package being offered by ICS. Inspected the six self-teaching texts. Followed the step-by-step diagrams and instructions. Evaluated the material's practicality, its fitness for learning modern troubleshooting (including UHF and Color).

Then they approved the new course for use in their own national apprenticeship program.

They went even further and endorsed this new training as an important step for anyone working toward recognition as a Certified Electronic Technician (CET).

This is the first time a self-taught training program has been approved by NEA.

The surprising thing is that this is not a course that costs hundreds of dollars and takes several years to complete. It includes no kits or gimmicks. Requires no experience, no elaborate shop setup.

All you need is normal intelligence and a willingness to learn. Plus an old TV set to work

on and some tools and equipment (you'll find helpful what-to-buy and where-to-buy-it information in the texts).

Learning by doing, you should be able to complete your basic training in six months. You then take a final examination to win your ICS diploma and membership in the ICS Servicing Academy.

Actually, when you complete the first two texts, you'll be able to locate and repair 70% of common TV troubles. You can begin taking servicing jobs for money or start working in any of a number of electronic service businesses as a sought-after apprentice technician.

Which leads to the fact that this new course is far below the cost you would expect to pay for a complete training course. Comparable courses with their Color TV kits cost as much as six times more than the \$99 you'll pay for this one.

But don't stop here. Compare its up-to-dateness and thoroughness. Find out about the bonus features—a dictionary of TV terms and a portfolio of 24 late-model schematics.

Get all the facts. Free. Fast. Mail the reply card or coupon below.

**ICS**® Dept. M5484A  
Scranton, Penna. 18515

Yes, I'd like all the details about your new TV Servicing/Repair basic training package. I understand there's no obligation. (Canadian residents, send coupon to Scranton, Pa. Further service handled by ICS Canadian, Ltd.)

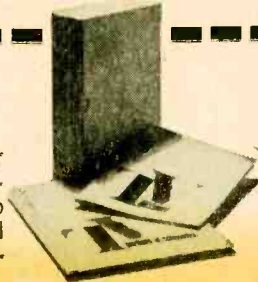

Name \_\_\_\_\_

Street \_\_\_\_\_

City \_\_\_\_\_ State \_\_\_\_\_ Zip \_\_\_\_\_

Prices slightly higher outside U. S. and Canada.



# elementary Electronics

Dedicated to America's Electronics Hobbyists

☆

**EXCLUSIVE REPORT**  
33 The Strange World of Paid SWLing—*Keen on DXing? Think SWLing the grooviest thing going? Then take a gander at the inner world of super spies whose DX prowess brings them chips aplenty!*

☆  
☆

**MYSTERY COMBO FOR SWLs**  
39 Mystery-Band Converter—*opens up a world you've never heard*  
44 Mystery-Band Station Guide—*hundreds of DX targets to try for*

**SCIENCE SPECIALS**  
81 The Monster With One Foot On Mars—*how else to depict the latest in radiotelescopes?*  
91 A Basic Course in Electricity and Electronics, Part VII—*Understanding Transistors*

☆  
☆  
☆

**CONSTRUCTION PROJECTS**  
49 Experimenters' Electroscope—*Ben Franklin, we didn't forget you*  
56 Watt Power On Wheels—*117 VAC in your family flivver*  
59 Photomate—*no undetected light leaks with this sensitive darkroom accessory on hand*  
67 And Now . . . Paper Batteries—*learn how the pros did it, then roll your own*  
71 Patch Up Your Troubles—*a primer on patchcords*  
73 Erecting A Rooftop Tower—*picture power through tower power*

**SWL AND DX FEATURES**  
10 DX Central Reporting—*meet our new columnist*  
46 DXing The Country That Isn't—*windmills, castles, sea, and snow*

**ELECTRONICS IN THE NEWS**  
58 Paper Money Changer—*in goes a buck, out come two packs of . . . what brand you smoking?*  
63 They Find Fugitives In Five Seconds Flat—*fuzz report . . . what else?*

**HAPPENINGS FAR & NEAR**  
32 As The Wife Sees It—*cartoon page*  
78 VTR: Willing Workhorse—*track stars go video*

**AS OUR LAB SEES IT**  
80 EICO PSI-1 Signal Injector Probe  
90 Piezo WX-127 FM Wireless Microphone

**THE REGULARS**  
7 Random Noise—*editorial chit-chat*  
12 Hey Look Me Over—*new products*  
18 NewScan—*misfit news that's fit to print*  
22 En Passant—*chess column for beginners*  
24 Literature Library—*info you can use*  
31 e/e Etymology—*words, words, words*

Cover photo  
by  
Leonard  
Heicklen



☆

Cover  
Highlights

### AUTHORS IN THIS ISSUE:

John W. Collins, Homer L. Davidson, Webb Garrison, Charles Green—W6FFQ, Joe Gronk, Erik Horneman, Jorma Hyypia, Marshall Lincoln—W7DQS, Ron Michaels, Jack Schmidt, C. M. Stanbury II, Dick Strippel, and the ELEMENTARY ELECTRONICS' Editorial Staff.





**SEE YOUR MUSIC IN DAZZLING ACTION with**

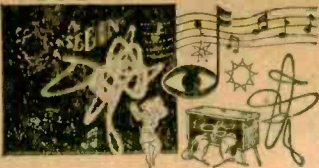

# MUSIC VISION

**Dramatic New Breakthrough  
In Audio-Visual Enjoyment**

Now you can have a thrilling psychedelic "see-in" right in your own home, club, school or business—in fact—anywhere you want to add sensational "mod" effects. Colored light beams dance and prance, whirl and swirl in perfect time with the music—each individual note creating its own unique twisting, radiating shape. Adds a spectacularly wild, new dimension to the world of music and entertainment. Combines electronics, science and art with dramatic results. Attaches in seconds to your radio, tape recorder, hi-fi, or stereo with two alligator clips. Can be used on small screens, large walls, stages and whole auditoriums. Build your own MusicVision™ with low-cost Do-It-Yourself Kit. Loads of fun! Fast! Easy! All you need is a light source. If you don't

have one, the versatile Edmund 35mm 500 Watt Projector is a terrific bargain. All kinds of other uses too—set up to accept motorized accessories. Also available in 15"x18"x27" Walnut Cabinet Model, Tube Unit, or 8" and 12" Sets which include encased 8" or 12" Motionizer, Color Wheel and set of apertures for use with your own 35mm projector. Large 12" set provides fabulous effects for commercial applications. Order by stock number listed below. Money-back guarantee. Complete information in new catalog. If you want additional details now, send 25¢ in coin for fully illustrated, 16-page Booklet No. 9096EK. "Introduction to MusicVision™."

\* Patent pending.

- 8" DO-IT-YOURSELF KIT—Stock No. 71,009EK . . . . . \$22.50 Postpaid
- 8" SET (Motionizer, color wheel, apertures) Stock No. 71,030EK \$45.00 Postpaid
- 12" SET (Same as above w/larger Motionizer) Stock No. 71,032EK \$57.50 Postpaid
- WALNUT VENEERED CABINET MODEL Stock No. 85,181EK . . . . . \$99.50 F.O.B.
- EDMUND 500 Watt 35mm PROJECTOR—Stock No. 71,057EK . . . . . \$24.50 Postpaid



### TOP-QUALITY LOW-COST STROBE

Create spectacular psychedelic lighting effects with this genuine electronic strobe. Terrific for parties, special occasions, experiments . . . perfect for combos, night clubs, dances, exhibitions. Adjusts from 1 to 10 short-duration flashes per second—not a make-shift mechanical device. Amaze friends with old-time movie effects. Best party ice-breaker ever—"freeze" the action and "unfreeze" your guests. Practical too—check section of moderate-speed machinery. Xenon lamp gives one million flashes. 6 1/2" diam. reflector. Uses reg. 110-120 volt A.C. current. Handsome solid walnut cabinet. 9 1/2" x 9 3/4" by 4". Send for Bulletin # 71- describes other new unique lighting effects. Stock No. 70,989EK . . . . . \$79.95 Ppd.



### NEW! LOW-COST COLOR ORGAN

Accompany music with colored lighting that changes in hue and intensity. Create tremendous variety of unusual and beautiful effects. Simply plug in 3 diff. sets of colored lights and place near audio source. Notes picked up by interior "mike" determine which colored lights go on—loudness determines intensity. Surprising number of commercial, display and home uses—control lighting in pools and fountains, window and holiday decorations, great for parties. Tough, compact unit with light intensity control. 4-9/16" x 2 3/4" x 4 1/2". 1 lb. 6 oz. Stock No. 1900EK . . . . . \$39.95 Ppd.

4 CHANNEL DE LUXE 2,000 WATT  
Stock No. 71,103EK . . . . . \$195.00 Ppd.



**KEEP PACE WITH  
THE SPACE AGE!**

# AMAZING BARGAINS

for Fun • Study • Profit  
from  
**EDMUND SCIENTIFIC CO.**  
300 Edscorp Building  
Barrington, N. J. 08007



### LOW-COST OVERHEAD PROJECTOR

If you've always wanted one but couldn't afford to pay \$150 here's your opportunity to get a 5"x8" model ideal for school, home and small audience use. Comes without light source—use your own 35mm projector (or buy ours). Ideal for transparencies, lantern slides, negatives, drawings, unusual lighting effects. 3 1/2 lbs. 8 1/4" x 6 1/4" x 5-9/16". Top-and-bottom mirrors, F/3.5. 16mm F.L. lens, double Fresnel condenser. Easy friction-focusing, Keystone adjustment. Easily portable. Stock No. 71,011EK . . . . . \$29.50 Ppd.  
EDMUND 500 Watt 35mm PROJECTOR  
Stock No. 71,057EK . . . . . \$24.50 Ppd.

### MAGIC JUMPING DISCS

Put one of these quarter-sized crazy buttons down and stand back. In a matter of seconds it'll jump almost 6 feet high. Just like magic . . . but it's really scientific. Actually, the warmth of your hand holding these metal discs makes the trick. After palming a disc, place it on any cool surface and in moments it'll take-off. Loads of fun for kids of all ages. Terrific conversation piece. Package of twelve only \$2.  
Stock No. P-41,150EK . . . . . \$2.00 Ppd.  
Stock No. P-41,180EK (set of 100) \$12.00 Ppd.



### NEW! PROJECTION KALEIDOSCOPE

At last—a low-cost unit complete with 9" diam. liquid wheel. Projects infinite variety of brilliant color patterns which do not repeat. Specially designed wheel, 3" projection lens and Edmund Visual Special Effects Projector make it all possible. Easily operated. Large screen image at short projection distance perfect for photo backgrounds, light shows, parties, dances, etc. Front or rear projection. Incl.: 1 RPM 115V Motor, motor bracket, instructions.  
Stock No. 71,121EK . . . \$94.50 Postpaid  
SOLID Multi-Colored Glass Accessory Wheel (9" Diam.)  
Stock No. 71,122EK . . . . . \$15.00 Ppd.

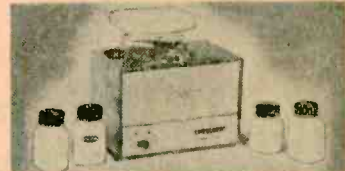

### NEW LOW-COST ULTRASONIC CLEANER

Top-quality 3/4rd pint unit for only \$39.95. Cleans dirt, grime completely, quickly, safely. Small delicate parts, precision electronic items, lab instruments, jewelry, coins, even dentures sparkle like new. American-made—operates on regular house current. Solid state generator w/automatic turn-off. Power regulating knob. No shocks. No radio interference. 6"x4"x2"  
Stock No. 71,003EK . . . . . \$39.95 Ppd.  
LARGE INDUSTRIAL 1 1/2-GAL. SIZE  
No. 85,128EK. (Wt. 37 lbs.)  
. . . . . \$249.95 FOB

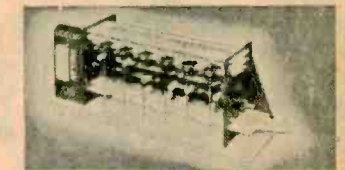

### NEW MODEL DIGITAL COMPUTER

Solve problems, tell fortunes, play games with miniature version of giant electronic brains! Adds, subtracts, multiplies, shifts, complements, carries, memorizes. Colored plastic parts easily assembled. 12"x3 1/2"x4 3/4". Incl. step-by-step assembly diagrams, 32-p. instruction book covering operation, computer language (binary system) programming problems and 15 experiments.  
Stock No. 70,683EK . . . . . \$5.98 Ppd.  
BIG NEW DIGICOMP II  
Stock No. 70,946EK . . . . . \$16.00 Ppd.

### MONEY-BACK GUARANTEE

Order by Stock No.—Send Check or M.O.

## GIANT FREE CATALOG

148 Pages! More than 4,000

### UNUSUAL BARGAINS!

Completely new 1969 edition. New items, categories, illustrations. 148 easy-to-read pages packed with nearly 2000 unusual bargains. Dozens of electrical and electromagnatic parts, accessories. Enormous selection of Astronomical Telescopes.

EDMUND SCIENTIFIC CO., 300 Edscorp Building, Barrington, N. J. 08007, Mail coupon for FREE Catalog "EK"

Name \_\_\_\_\_  
Address \_\_\_\_\_  
City \_\_\_\_\_ State \_\_\_\_\_ Zip \_\_\_\_\_

# ALL NEW!!

## ALSYNCO's LAB TIMER



**2-600 SECONDS!  
TIMED AC!  
TIMED ALARM!  
GUARANTEED!**

**NO GUESSING**—PRINTED CIRCUIT,  
ENLARGING, ETCHING, DEVELOPING,  
SILK-SCREENS

**PERFECT  
EVERYTIME**

**FREE**—KIT BROCHURE!

DEALER INQUIRIES INVITED

**ALSYNCO DEPT. EE**  
171 S. Main, Natick, Mass. 01760  
Rush Lab Timer—\$29.95 enclosed

NAME \_\_\_\_\_

ADDRESS \_\_\_\_\_

CITY \_\_\_\_\_ STATE \_\_\_\_\_ ZIP \_\_\_\_\_

**ONLY  
\$29.95  
Ppd.**

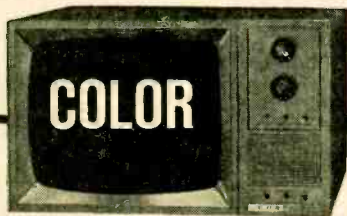

**NEW CONAR All-Channel  
COLOR TV KIT \$366.00**

Model 600UK

- Easier to build because it's designed for learning
- Complete with cabinet—nothing else to buy!

Tops for quality, simplicity of design, ease of building, the new CONAR 600 gives you the latest advances in the art of color TV receiver construction. In addition to 21 tubes, this all-channel receiver incorporates a transistor UHF tuner, transistor noise cancellation circuit and 16 solid-state diodes. Separate gun killer switches and a cross hatch generator are built in. All hardware is engineered for accessibility. Attractive bronze-tone steel cabinet with durable wood-grained vinyl covering.

For information write Dept. CV9C

**CONAR instruments**

DIVISION OF NATIONAL RADIO INSTITUTE  
3939 Wisconsin Ave., Washington, D.C. 20016

WRITE FOR FREE CONAR CATALOG

# elementary Electronics

Mar./Apr. 1969

Vol. 8/No. 1

Dedicated to America's Electronics Hobbyists

*Editor-in-Chief*

**JULIAN M. SIENKIEWICZ**  
WA2CQL, KMD4313

*Managing Editor*

**RICHARD A. FLANAGAN**  
KQD2566

*Technical Editor*

**CLIFFORD L. FORBES**  
KBQ8535

*Art Editor*

**JIM MEDLER**

*News Editor*

**HELEN PARKER**  
KQD7967

*Art Director*

**ANTHONY MACCARRONE**

*Cover Art Director*

**IRVING BERNSTEIN**

*Associate Art Director*

**JOHN YUSKO**

*Advertising Director*

**JIM CAPPELLO**

*Production Manager*

**CARL BARTEE**

*Production Assistant*

**MARILYN VARGAS**

*Instruments Division Manager*

**WILFRED M. BROWN**

*President and Publisher*

**B. G. DAVIS**

*Executive Vice-President and Assistant Publisher*

**JOEL DAVIS**

*Vice-President and Editorial Director*

**HERB LEAVY, KMD4529**

*Vice-President and Production Director*

**LEONARD F. PINTO**

*Vice-President and Treasurer*

**VICTOR C. STABILE, KBP0681**

ELEMENTARY ELECTRONICS is published bi-monthly by Science & Mechanics Publishing Co., a subsidiary of Davis Publications, Inc. Editorial, Business and Subscription offices: 229 Park Avenue South, New York, N.Y. 10003. One-year subscription (six issues)—\$4.00; two-year subscription (12 issues)—\$7.00; and three-year subscription (18 issues)—\$10.00. Add \$1.00 per year for postage outside the U.S.A. and Canada. Advertising offices: New York, 229 Park Avenue South, 212-OR 3-1300; Chicago: 520 N. Michigan Ave., 312-527-0330; Los Angeles: J. E. Publishers' Rep. Co., 8380 Melrose Ave., 213-653-5841; Atlanta: Pirnie & Brown, 3108 Piedmont Rd., N.E.: 404-233-6729; Long Island: Len Osten, 9 Garden Street, Great Neck, N.Y., 516-487-3305; Southwestern advertising representative: Jim Wright, 4 N. 8th. St., St. Louis, 314-CH-1-1965.

EDITORIAL CONTRIBUTIONS must be accompanied by return postage and will be handled with reasonable care; however, publisher assumes no responsibility for return or safety of manuscripts, art work, or photography. All contributions should be addressed to the Editor, ELEMENTARY ELECTRONICS, 229 Park Avenue South, New York, N.Y. 10003.

Second-class postage paid at New York, New York and at additional mailing office. Copyright 1969 by Science and Mechanics Publishing Co.



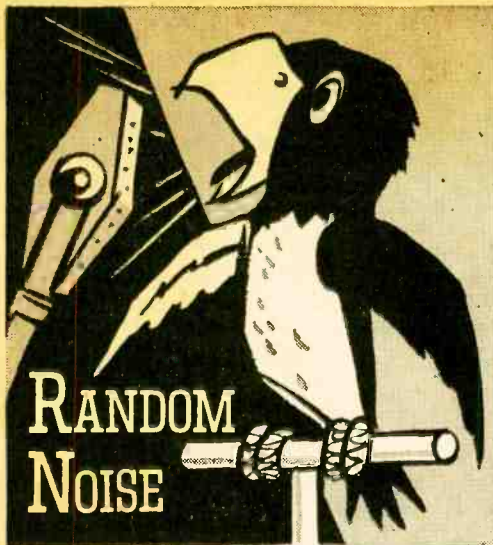

# RANDOM NOISE

By JULIAN M. SIENKIEWICZ, Editor

**M**ars, like the earth, has a distinct iron core, but the core is not as large as that of the earth and is not molten. These conclusions were arrived at by employing highly accurate values for the radius and mass of Mars obtained recently (July 1965) by the Mariner IV Mars fly-by mission. The conclusions are also based on recent findings about the composition and structure of the earth, because certain similarities are assumed to exist between the structure and composition of the earth and Mars. Previous to the Mariner IV mission and the recent findings about the earth's structure, the existence of a core for Mars was highly debatable. Now we know for certain, thanks to a study and report made by Dr. Alan B. Binder, an Associate Scientist with the Astro Sciences Center at IIT Research Institute, Chicago.

A technique called mathematical modeling was used by Dr. Binder in his investigation of Mars' structure. Mathematical modeling involves placing values for known conditions in equations along with trial values for unknown conditions. In this case the unknown conditions involved the internal composition and structure of Mars. When the equations were solved, those equations whose solutions agreed with what is known about Mars were assumed to contain the trial values most likely to be correct. The equations were solved with the aid of a computer.

A series of "successful" models were found. These indicated that Mars probably has an iron core between 980 and 1180 miles in diameter. The models also indicated that the core of Mars accounts for between 2.7 and 4.9 percent of Mars' total mass. A third result of the study was an estimate that the internal temperature of Mars lies between 1930°F and 3180°F. This is considerably cooler than the interior of the earth.

(Continued on page 10)

## now...a dozen tools for dozens of jobs in a hip pocket set!



Really compact, this new nut driver/screwdriver set features 12 interchangeable blades and an amber plastic (UL) handle. All are contained in a slim, trim, see-thru No. 99PS-50 plastic case which easily fits hip pocket. Broad, flat base permits case to be used as a bench stand. Ideal for assembly and service work.

### 7 NUTDRIVERS:

3/16", 7/32", 1/4", 9/32", 5/16", 11/32", 3/8" hex openings.



### 2 SLOTTED SCREWDRIVERS:

3/16" and 9/32" tips.



### 2 PHILLIPS SCREWDRIVERS:

#1 and #2 sizes.



### EXTENSION BLADE:

Adds 4" reach to driving blades.

### HANDLE:

Shockproof, breakproof. Exclusive, positive locking device holds blades firmly for turning, permits easy removal.

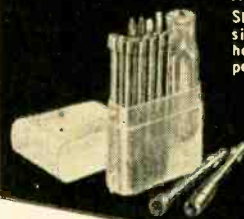

WRITE FOR CATALOG 162

# XCELITE®

XCELITE INC. • 80 BANK ST., ORCHARD PARK, N. Y.

Send Catalog 162 with information on 99PS-50

name \_\_\_\_\_

address \_\_\_\_\_

city \_\_\_\_\_ state & zone \_\_\_\_\_

# "Performance-Plus" Kits For Home And



NEW  
kit AD-27  
**\$169<sup>95</sup>**

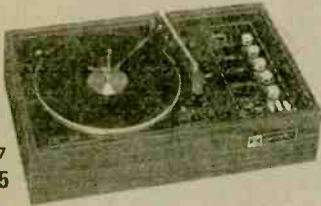

NEW  
kit AD-17  
**\$109<sup>95</sup>**

## HEATHKIT AD-27 FM Stereo Compact

The new Heathkit "27" Component Compact was designed to change your mind about stereo compact performance. How? By sounding as if it were made of top quality stereo components . . . which in fact it is. Heath engineers took their highly rated AR-14 solid-state Stereo Receiver, modified it physically to fit the cabinet, and matched it with the precision BSR McDonald 500A Automatic Turntable. Performance? Here's the AD-27 in detail. The amplifier delivers 30 watts music power . . . 15 honest watts per channel — enough to drive any reasonably efficient speaker system. Response is virtually flat from 12 Hz to 60 kHz, and Harmonic & IM distortion are both less than 1% at full output. Tandem Volume, Balance, Bass & Treble controls give you full range command of all the sound. Select the FM stereo mode with a flick of the rocker-type switch and tune smoothly across the dial, thanks to inertia flywheel tuning. You'll hear stations you didn't know existed in your area, and the clarity and separation of the sound will amaze you. The adjustable phasing control insures best stereo separation at all times. And the automatic stereo indicator light tells you if the program is in stereo. AFC puts an end to drift too. The BSR Automatic Turntable has features normally found only in very expensive units, like cueing and pause control, variable anti-skating device, stylus pressure adjustment and automatic system power too. Comes complete with a famous Shure diamond stylus magnetic cartridge. The handsome walnut cabinet with sliding tambour door will look sharp in any surroundings, and the AD-27 performs as well as it looks. For the finest stereo compact you can buy, order your "27" Component Compact now. 41 lbs.

## HEATHKIT AD-17 Stereo Compact

Using the component approach of the AD-27, Heath engineers took the solid-state stereo amplifier section of the AD-27, matched it with the high quality BSR-400 Automatic Turntable and put both of these fine components in a handsomely styled walnut finish cabinet. The result is the "17" — featuring 30 watts music power, 12 Hz to 60 kHz response, auxiliary & tuner inputs, less than 1% Harmonic & IM distortion, adjustable stylus pressure & anti-skate control and much more. Order your "17" now. 27 lbs.

## HEATHKIT TA-38 Solid-State Bass Amplifier

The new Heathkit TA-38 is the hottest performing bass amp on the market, for quite a few reasons. First, there's all solid-state circuitry for reliability. Then there's the tremendous power — the TA-38 puts out 120 watts of EIA music power, 240 watts peak, or 100 watts continuous. Extremely low harmonic & IM distortion too. Many amps suffer from "blow-out" problems, but not the new TA-38 — *YOU CAN'T BLOW IT* . . . it boasts two 12" heavy duty special design speakers with giant 3 pound 6 ounce magnet assemblies mounted in a completely sealed, heavily damped 3/4" pressed wood cabinet — those speakers will take every watt the amp will put out, and still not blow. Sound? The TA-38 is tailored to reproduce the full range of bass frequencies delivered by bass guitars and its sound with combo organs and other instruments is remarkable. Easy 15 hour assembly to the wildest bass amp on the market. Order one now and surprise the guys with the high-priced gear. 130 lbs.

## HEATHKIT GR-58 Solid-State AM/FM Clock Radio

The easy way to get up in the morning. Choose the morning news & weather on AM or the bright sound of FM music. AFC makes FM tuning easy. The "Auto" position on the Telechron® clock turns only the radio on, or use the "Alarm" setting for both the radio and the alarm. You can even enjoy fresh coffee when you awake in the morning, thanks to the clock-controlled accessory AC socket on the back of the new GR-58. The handy "snooze" alarm feature lets you wake up gradually for ten minutes to the sound of the radio, then the alarm goes on . . . push the "snooze" button to silence the alarm for ten minutes more of music or news — the alarm sounds automatically every ten minutes and the "snooze" button turns it off, cycling continuously until the selector switch is moved to another position. Fast, easy circuit board construction, smart blue hi-impact plastic cabinet and top reliability make this GR-58 the clock radio for you. 8 lbs.

## HEATHKIT 1G-18 Solid-State Sine-Square Wave Generator

A precision source of sine or square waves at a low kit price . . . that's the new solid-state 1G-18 from Heath. Delivers 5% accuracy thru the wide range of 1 Hz to 100 kHz. The sine wave section features less than 0.1% distortion thru the audio range, 8 output voltage ranges from 0.003 to 10V, switch-selected internal 600 ohm load or external load and metered output of both voltage & dB. The square wave section has a 50 nS rise time and three output voltage ranges from 0.1 to 10 V P-P. Both sine & square waves are available simultaneously and the frequency is switch-selected for constant repeatability and fast operation. Circuit board construction makes the new 1G-18 easy to build . . . new Heathkit styling and engineering excellence make it easy to use. Put the new 1G-18 on your bench now. 10 lbs.

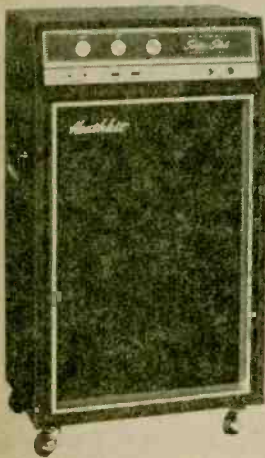

NEW  
kit TA-38  
**\$225<sup>00</sup>**



NEW  
kit GR-58  
**\$47<sup>95</sup>**



NEW  
kit 1G-18  
**\$67<sup>50</sup>**  
Wired IGW-18  
**\$99<sup>50</sup>**



# Hobby... From The Leader



Now There are 4 Heathkit Color TV's...  
All With 2-Year Picture Tube Warranty

## NEW Deluxe "681" Color TV With Automatic Fine Tuning

The new Heathkit GR-681 is the most advanced color TV on the market. A strong claim, but easy to prove. Compare the "681" against every other TV — there isn't one available for any price that has all these features. Automatic Fine Tuning on all 83 channels... just push a button and the factory assembled solid-state circuit takes over to automatically tune the best color picture in the industry. Push another front-panel button and the VHF channel selector rotates until you reach the desired station, automatically. Built-in cable-type remote control that allows you to turn the "681" on and off and change VHF channels without moving from your chair. Or add the optional GRA-681-6 Wireless Remote Control described below. A bridge-type low voltage power supply for superior regulation; high & low AC taps are provided to insure that the picture transmitted exactly fits the "681" screen. Automatic degaussing, 2-speed transistor UHF tuner, hi-fi sound output, two VHF antenna inputs... plus the built-in self-servicing aids that are standard on all Heathkit color TV's but can't be bought on any other set for any price... plus all the features of the famous "295" below. Compare the "681" against the others... and be convinced.

GRA-295-4, Mediterranean cabinet shown..... \$119.50  
Other cabinets from \$62.95

## Deluxe "295" Color TV... Model GR-295

Big, Bold, Beautiful... and packed with features. Top quality American brand color tube with 295 sq. in. viewing area... new improved phosphors and low voltage supply with boosted B+ for brighter, livelier color... automatic degaussing... exclusive Heath Magna-Shield... Automatic Color Control & Automatic Gain Control for color purity, and flutter-free pictures under all conditions... preassembled IF strip with 3 stages instead of the usual two... deluxe VHF tuner with "memory" fine tuning... three-way installation — wall, custom or any of the beautiful Heath factory assembled cabinets. Add to that the unique Heathkit self-servicing features like the built-in dot generator and full color photos in the comprehensive manual that let you set-up, converge and maintain the best color picture at all times, and can save you up to \$200 over the life of your set in service calls. For the best color picture around, order your "295" now.

GRA-295-1, Walnut cabinet shown..... \$62.95  
Other cabinets from \$99.95

## Deluxe "227" Color TV... Model GR-227

Has same high performance features and built-in servicing facilities as the GR-295, except for 227 sq. inch viewing area. The vertical swing-out chassis makes for fast, easy servicing and installation. The dynamic convergence control board can be placed so that it is easily accessible anytime you wish to "touch-up" the picture.

GRA-227-1, Walnut cabinet shown..... \$59.95  
Mediterranean style also available at \$99.50

## Deluxe "180" Color TV... Model GR-180

Same high performance features and exclusive self-servicing facilities as the GR-295 except for 180 sq. inch viewing area. Feature for feature the Heathkit "180" is your best buy in deluxe color TV viewing... tubes alone list for over \$245. For extra savings, extra beauty and convenience, add the table model cabinet and mobile cart.

GRS-180-5, table model cabinet and cart..... \$39.95  
Other cabinets from \$24.95

## Now, Wireless Remote Control For Heathkit Color TV's

Control your Heathkit Color TV from your easy chair, turn it on and off, change VHF channels, volume, color and tint, all by sonic remote control. No cables cluttering the room... the handheld transmitter is all electronic, powered by a small 9 v. battery, housed in a small, smartly styled beige plastic case. The receiver contains an integrated circuit and a meter for adjustment ease. Installation is easy even in older Heathkit color TV's thanks to circuit board wiring harness construction. For greater TV enjoyment, order yours now.

kit GRA-681-6, 7 lbs., for Heathkit GR-681 Color TV's..... \$59.95  
kit GRA-295-6, 9 lbs., for Heathkit GR-295 & GR-25 TV's..... \$69.95  
kit GRA-227-6, 9 lbs., for Heathkit GR-227 & GR-180 TV's..... \$69.95

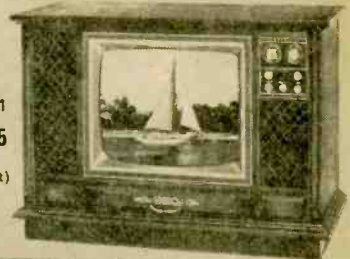

kit GR-681  
\$499<sup>95</sup>  
(less cabinet)



kit GR-295  
now only  
\$449<sup>95</sup>  
(less cabinet)



kit GR-227  
now only  
\$399<sup>95</sup>  
(less cabinet)



kit GR-180  
now only  
\$349<sup>95</sup>  
(less cabinet)



New Wireless  
TV Remote Control  
For GR-295, GR-227  
& GR-180  
\$69<sup>95</sup>

New Wireless  
TV Remote Control  
For GR-681  
\$59<sup>95</sup>



### NEW

### FREE 1969 CATALOG!

Now with more kits, more color. Fully describes these along with over 300 kits for stereo/hi-fi, color TV, electronic organs, electric guitar & amplifier, amateur radio, marine, educational, CB, home & hobby. Mail coupon or write Heath Company, Benton Harbor, Michigan 49022.

HEATH COMPANY, Dept. 139-3  
Benton Harbor, Michigan 49022  
In Canada, Daystrom Ltd.

Enclosed is \$ \_\_\_\_\_, plus shipping.

Please send model (s).  
 Please send FREE Heathkit Catalog.  
 Please send Credit Application.

Name \_\_\_\_\_

Address \_\_\_\_\_

City \_\_\_\_\_

State \_\_\_\_\_

Zip \_\_\_\_\_

Prices & specifications subject to change without notice.

CL-350

## RANDOM NOISE

Certain implications about the physical condition and history of Mars may be drawn from the results of Dr. Binder's Mars modeling study.

For instance, if the internal composition of Mars is similar to that of the earth, then Mars must be composed primarily of minerals containing the elements iron, silicon, magnesium, and oxygen, as is the earth. The valid models for Mars obtained by Dr. Binder had internal temperature ranges below the melting points of these minerals, indicating that there are no molten zones in Mars' interior. Therefore, no volcanic activity can exist on the planet.

In recent years spectroscopic and Mariner spacecraft measurements have shown that Mars has only a very thin atmosphere. The atmospheres of the inner planets (Mercury, Venus, the earth, and Mars) are believed to have been created largely by gases released from the interior of these planets during periods of widespread volcanic activity. Thus, the conclusion that there has been little volcanic activity throughout most of Mars' history is consistent with observations that Mars had a very thin atmosphere.

**More on Thai** Here's a letter from a reader who has the inside story on station HSKN that operated near Khon Kaen in Thailand.

"In your November/December 1968 issue, I read 'DXing the Land of Thai.' I can put some light on the subject of Station R.909, operating on 843 kHz at Sakon Nakhon. At Khan Kaen it was known as HSKN. The transmitter was operated and maintained by U.S. Army Signal Corps personnel of the 201st Radio Broadcasting Co. The Thai government did all of the programming.

"The transmitter was made by Gates. It went into operation in August 1963 and was on each day from 0600 to 1400 hours and again from 1700 to 2230 hours. During the school year English was taught from 1000 to 1200 hours daily. The Thai broadcasters came from Khan Kaen each day to work at the radio station. Then a radio relay was set up on FM, 93 MHz, and the programming was done from the Thai studios in downtown Khan Kaen.

"The transmitter was closed down in 1966. At this time it was sent to Sacramento Army Depot in California for repairs. It was back on station at Sakon Nakhon in August 1967.

"In 1966, when HSKN went off the air, the Australian government had built a radio station a half mile from the site of HSKN and went on the air after HSKN went down. I do not recall the frequency, but the transmitter was 55 kW.

"I hope this puts some light on the mysteries of the radio stations operating on 843 kHz."

Our thanks for this information go to SSG Michael G. Schow, U.S. Army. We especially appreciate receiving letters of this type. Far too often facts and fancy get mixed up and important tid-bits are left out when reported on in the SWL press. Thanks again, Sergeant!

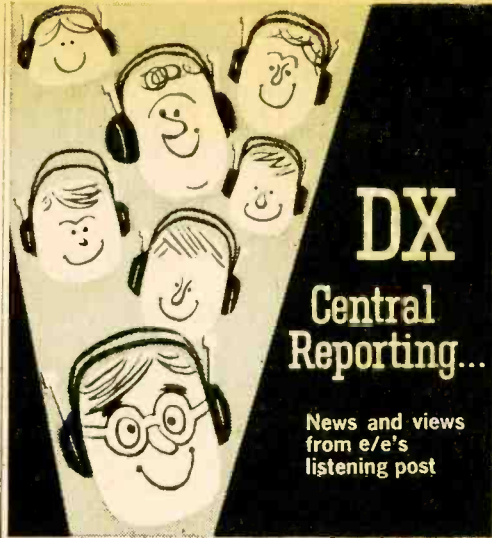

BY DON JENSEN

**K**ilowatts! Megawatts! What's next? With short-wave stations around the world pumping out more and more powerful signals into an already crowded spectrum, the interference problem has become acute. This "power struggle" has resulted only in the creation of a louder jumble of noise on the bands.

Realizing this, some of the world's largest broadcasters have joined the relay race. To supplement existing stations, they have built relay transmitters at strategic locations closer to their intended audiences. These overseas relays receive and rebroadcast programs originating back home.

An early entry in the race was the *Voice of America*. From its Washington studios, programs in 40 languages go out to a worldwide audience. While some are aired by stations in North Carolina, Ohio and California, others are relayed by shortwave facilities in Germany, England, Greece, Morocco, Liberia, Ceylon, Okinawa and the Philippines. Some of these transmitters are portable, permitting rapid relocation to distant trouble spots in less than two weeks.

Also in the race is the *BBC*, with rebroadcasting stations in Singapore, Cyprus and on tiny Ascension Island in the South Atlantic. Spain has built a relay of *Radio Nacional de Espana* in the Canary Islands, while the Portuguese have used a transmitter on Sao Tome, both off the African coast.

Behind the Iron Curtain, Russia also makes full use of relay stations. But stretching halfway around the globe, the USSR has not had to seek extraterritorial sites. The *Radio Moscow* program you hear might be coming from a transmitter near the Russian capital, or maybe from a station on the Kamchatka Peninsula in the Soviet Far East. Not so lucky is China, which has had to establish a relay in satellite Albania



to spread Mao's thoughts to the western communist and free worlds.

Germany's *Deutsche Welle*, several years ago, constructed a modern relay at Kigali, Rwanda, in the heart of Africa. Another is planned for southern Portugal. Seeking to increase its influence in underdeveloped Latin America, Germany has plans for a third outlet in our Central American neighbor, El Salvador.

Not to be outdone, France is following suit. *Radiodiffusion Television Francaise* stations are to be constructed in French Guiana, in Afar, the former French Somaliland, and on the Pacific island of New Caledonia. The latter, reportedly, will receive its programs from Paris via space satellite.

Even little Holland is investing in broadcast relay stations. Recently completed is a powerful facility on the West Indian island of Bonaire. The second lap in the Dutch relay race calls for another station to beam *Radio Nederland* programs to Africa and Asia. For months, the Dutch referred to this projected relay only as "Station X." They now say that it will be constructed in the Malagasy Republic, the Indian Ocean island-nation formerly known as Madagascar. (Turn page)

### Introducing DX Central's New Columnist

Don Jensen tuned his first station, Ecuador's HCJB, at the tender age of 11. That was 22 years ago. Since then he has heard and verified shortwave stations in nearly 200 countries. SWLs have read his articles on shortwave broadcasting in *Radio-TV Experimenter*, *Elementary Electronics*' sister magazine, and in other electronics publications.

Though an ex-ham (KN4ISC) and ex-CBer (18W6098), his first love is DXing. Like most serious listeners, Jensen belongs to DX clubs here and abroad, holding executive positions in several. He has edited SWBC columns in a few radio club bulletins. He founded the Association of North American Radio Clubs, an organization linking all the major listeners clubs in the continent.

He knows DXing and DXers. A former radio and TV staffer, he also knows the broadcaster's point of view. He's visited stations in Europe, South America and the Caribbean and seen how they operate. A newspaper reporter, Jensen relates DX happenings to contemporary world events. He tells it like it is.

The Editor hopes you'll read *DX Central* regularly for the inside story of what's happening in the DXing world today. He believes that Don Jensen's shortwave news and views will become a steady diet for our growing DX-SWL crowd.



# Earn Your F.C.C. LICENSE and DEGREE in Electronics!

In today's world of electronics employment, an FCC license is important—sometimes essential but it's not enough! Without further education, you can't make it to the top. Get your FCC license without fail, but don't stop there. To prepare for the best jobs, continue your electronics education (mostly by home study) and get your Degree in Electronics Engineering.

This is good common sense for those who want to make more money in electronics. It also makes sense to prepare for your FCC license with the School that gives degree credit for your license training—and with the School that can then take you from the FCC license level to the Degree level.

### Accreditation, and G.I. Bill Approval

Grantham School of Electronics is *accredited* by the Accrediting Commission of the National Home Study Council, is *approved* under the G. I. Bill, and is *authorized* under the laws of the State of California to grant academic degrees.

## Grantham School of Electronics

• Established in 1951 •

1505 N. Western Ave.      818 18th Street, N.W.  
Hollywood, Calif. 90027      or      Washington, D.C. 20006

Mail the coupon below for our free Bulletin.

### Grantham School of Electronics      EE-3-69

1505 N. Western Ave., Hollywood, Calif. 90027

Please mail me your free Bulletin, which explains how the Grantham educational program can prepare me for my FCC License, my Associate in Science Degree, and my Bachelor of Science Degree in Electronics Engineering.

Name \_\_\_\_\_ Age \_\_\_\_\_

Address \_\_\_\_\_

City \_\_\_\_\_ State \_\_\_\_\_ Zip \_\_\_\_\_

**Tip Topper.** Though his position in the turbulent Middle East has diminished in recent years, the British lion still roars across the desert sands, thanks to the new 100 kilowatt transmitter of the *Qatar Broadcasting Service (QBS)*.

This effort to bolster Britain's sagging influence in the oil-rich Arab world has given SWLs a hot, new DX target to shoot for.

The prime mission of *QBS*, located in the dusty Persian Gulf capital of Doha, is to counter the daily propaganda barrage of Nasser's *Cairo Radio*. This war of words is waged for the ear of Arabic-speaking listeners, pressed to transistor radios in countless bazaars and bedouin camps.

Convincing diverse elements—desert nomads and dockworkers, oil-field roustabouts and omnipotent rulers—that a strong federation of the tiny shiekdoms is essential for political stability, is the new station's job. Its announcers are polished products of careful British training, not surprising since the *BBC* is the granddaddy of all Arabic-language broadcasting.

*Qatar Broadcasting Service* operates mornings and evenings on 9570 kHz. Western listeners hear the station best after 1500 GMT. DXers in the rest of the country find the time slot following 0330 GMT sign on preferable. Reception reports go to the *Qatar Broadcasting Service*, Box 1414, Doha, Qatar.

**Victory Drum.** Ever wonder about the deep, rolling timpani notes that distinctively mark the *BBC's* European Service? Well, it all began during the dark, early years of World War II, when a Belgian announcer proposed the "V for Victory" symbol in a *BBC* broadcast to his countrymen.

It caught on like wildfire and soon Vs were being daubed on walls throughout German-occupied areas. French fishermen greeted RAF pilots overhead with oars aloft in the V-pattern. Belgian children scrawled chalked Vs on the pavement on their way to school. The two-fingered Churchillian victory salute was imitated everywhere.

In England, a group of radio propagandists, planning the "V for Victory" campaign for the *BBC*, tried to think of ways to further exploit the phenomenon. One day in 1941, C. E. Stevens, an Oxford history don assigned to the Ministry of Economic Warfare for the duration, had an idea.

"Have you ever thought of the letter V in Morse code—dot-dot-dot-dash? It fits the opening bars of Beethoven's *Fifth*." (Those who think themselves unfamiliar with classical music had best think again—everyone knows the motto theme of the world's most popular symphony.)

The booming, four-beat drum signal soon became the recognized symbol of the *BBC's* European Service and so it has remained for 28 years. ■



*Hey, readers! ELEMENTARY ELECTRONICS is your magazine, and Hey, Look Me Over is your department. We'd like to know what you think of our new products column. Send your comments to the Editor, ELEMENTARY ELECTRONICS, 226 Park Ave. So., New York, N.Y. 10003, % Hey, Look Me Over.*

### Drill Away, Me Hearties!

Here's a  $\frac{3}{8}$ -in. drill kit from Wen, Model 820K11. At a list price of \$37.45, the kit consists of their deluxe 820  $\frac{3}{8}$ -in. drill, six quality precision drill bits ( $\frac{1}{16}$ ,  $\frac{1}{8}$ ,  $\frac{3}{16}$ ,  $\frac{1}{4}$ ,  $\frac{9}{16}$ ,  $\frac{3}{8}$ -in.), fitted carrying case, 3-wire 6-ft cord and adaptor, and a  $\frac{3}{8}$ -in. geared chuck with key. The drill comes with a 3.2-A, 117-VAC high torque motor delivering a constant drilling speed of 1100 rpm; needle bearings at heavy load points; ball thrust spindle bearing; and double reduction heavy-duty gear train. It has a machine-gun grip auxiliary handle positioned directly forward of the motor housing. The drill motor has a welded burnout-proof armature; the drill's housing is die-cast aluminum. The drill itself has a locking trigger with safety release built into the pistol-grip handle; overall measurements are  $9 \times 7\frac{1}{4} \times 2\frac{1}{2}$ -in., with chuck. At your dealer, or write to

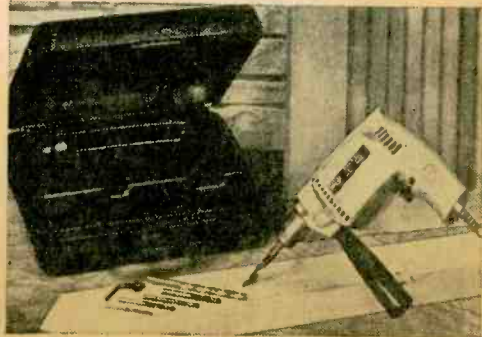

Wen 820K11 Drill Kit



Wen Products, Inc., 5812 Northwest Hwy., Chicago, Ill. 60631.

### Wiping Out Madison Avenue

Here's a gadget, the Background Music Demultiplexer, which you can use to tune all those FM background music stations, sans commercials. Provided you're not going to pipe this music into your restaurant or department store, you can have this device and be commercial-free any time you choose. The Demultiplexer has an

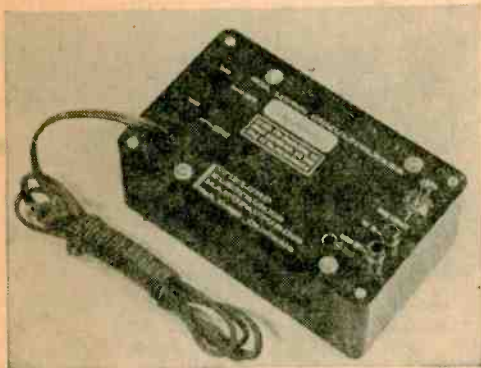

Winlund Background Music Demultiplexer

integrated circuit, and the front panel controls include adjustable mute control, output level control, background music-to-main channel switch, and tuning adjustment. Unit connects to multiplex jack found on most tuners with the two 36-in. shielded cables furnished. If there is no multiplex jack on your radio, a connection is easily made to the detector section of your FM radio—two extra shielded phono jacks are included for this purpose. The unit is warranted for one year. Price is \$29.95, postpaid from Winlund Electronic Mfg. Co., 3496 Kurtz St., San Diego, Calif. 92110.

### Noise-Free Monitoring

Anyone who uses a police- and fire-converter knows one of the drawbacks has been the continuous noise between transmissions. To end the din, here is a Tompkins Radio Products squelch unit, which needs no connections to the AM broadcast radio or converter other than standard coax cable. Featuring complete electronic control without relays, fully adjustable squelch setting, and on/off switch, it measures only 1x4x3 in. and is powered with a 9-V battery or directly off a 12-V auto battery. The unit is available in two models: the Model ST, which fastens to bottom of TRP's Tunerverter; and the

APPROVED  
by  
VETERANS  
under new  
G.I. Bill

THESE **3 BIG**  
**DRAFTING**  
**KITS\***  
**GIVEN**  
**TO YOU!**



\* Precision Drawing Instrument Set, Professional Drafting Board Outfit & Fingertip Tilting Drafting Table are given to you with your complete North American Course in Drafting.

**Earns \$820 Month!**  
"My first position after completing your course jumped my income from \$350 to \$820 per month." — G. W., Tenn.

#### Big Promotion!

I was promoted from the production line ahead of 4 others and got a good pay raise." — W. A., Wisc.

**ALL 4 FREE!**  
Rush Coupon today!



### Coast-to-Coast Shortage of Trained Draftsmen Opens Thousands Big Salary Jobs for Beginners!

Now you can take your pick of thousands of big salary jobs open to Draftsmen (see "help wanted" sections of metropolitan newspapers). Huge nationwide demand... U.S. Dept. of Labor reports "42% more Draftsmen needed in next 10 years—not enough applicants to fill drafting jobs available now!" Our easy "Quick-Learn" Method has helped hundreds toward good income, security and prestige as Draftsmen. Why not you?

#### YOU NEED NO DRAWING SKILL... NO TECHNICAL ABILITY

NASD's staff of Professional Draftsmen guide you step-by-step. With our spare time home-study plan you work on actual projects. Makes learning fun—easy to remember, too. Many graduates have succeeded with only grade school training. Others report good earnings drafting part time while still learning!

...when you train at home with NASD for a  
**HIGH PAY JOB IN DRAFTING!**

#### RUSH COUPON FOR FREE KIT...

Mail coupon today for FREE "DRAFTING CAREER KIT," Sample Lesson, Drafting Aptitude Test including intriguing new 5-Way Drafting Instrument & 20-page Book "Your Future in Drafting"—jam-packed with revealing facts on your opportunities, to win top pay and job security in Drafting. No salesman will call. Everything sent FREE and WITHOUT OBLIGATION. Write today!

North American School of Drafting, Dept. 1353  
4500 Campus Dr., University Plaza, Newport, Calif.

Rush "DRAFTING CAREER KIT", including Book, Sample Lesson, Aptitude Test & Drafting Instrument — ALL FREE! No salesman will call. G.I. Approved.

NAME \_\_\_\_\_ AGE \_\_\_\_\_  
ADDRESS \_\_\_\_\_  
CITY \_\_\_\_\_ STATE \_\_\_\_\_ ZIP \_\_\_\_\_

A home-study program in association with Cleveland Engineering Inst.

# Olson



**\* FREE**

Fill in coupon for a **FREE** One Year Subscription to **OLSON ELECTRONICS' Fantastic Value Packed Catalog—Unheard of LOW, LOW PRICES on Brand Name Speakers, Changers, Tubes, Tools, Stereo Amps, Tuners, CB, and other Values. Credit plan available.**

NAME \_\_\_\_\_  
 ADDRESS \_\_\_\_\_  
 CITY \_\_\_\_\_ STATE \_\_\_\_\_  
 GIVE ZIP CODE \_\_\_\_\_

If you have a friend interested in electronics send his name and address for a **FREE** subscription also.

**OLSON ELECTRONICS**

342 S. Forge Street Akron, Ohio 44308

## FIND BURIED TREASURE!

TREASURE KING

**\$17<sup>88</sup>**

Plus \$1.00 Shipping  
**10-DAY MONEY  
 BACK GUARANTEE**

**SEND ONLY \$3.00.**

Pay \$14.88 plus postage and C.O.D. when delivered, or send \$18.88 for postpaid shipment to

**TREASURE ENTERPRISES**

Dept. K-61 Box 10947, Houston, Texas 77018

Find buried gold, silver, coins, war relics with new sensitive detector. Works for days on a common 60¢ 9-V battery. Fully transistorized. 1969 model. Ideal for beach combing, treasure and coin hunting, prospecting for gold. So sensitive it will detect a single coin or gold nugget. **NOT A KIT.** Complete, ready to operate. Nothing else to buy. Gives loud, clear signal, when metal is detected. Sensitive earphone included for treasure hunting in secrecy. Weighs 2 pounds.

## SECRET PLANS REVEALED

Voice operated control  Electronic Stethoscope  FM transmitter for entertainment  Intrusion alarm  big ear TV microphone  uninterrupted music on FM radio  automobile alarm  "de-bugging" meter. Any one plan for \$2 or any five for \$7.95. Send for free brochure for other exciting plans, Audiotronix Mfg. Co. Dept. EE1, 156 Fifth Ave., New York, N.Y. 10010

**COOPERATE  
 WITH THE ZIP CODE PROGRAM  
 OF THE POST OFFICE DEPARTMENT  
 USE ZIP CODE NUMBERS  
 IN ALL ADDRESSES**

HEY, LOOK ME OVER ★★★★★★★★★★★★★★

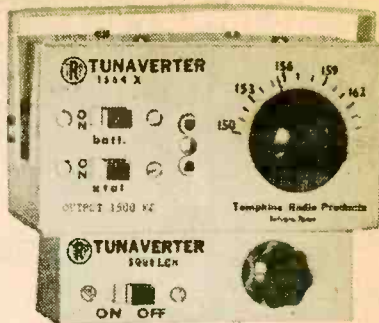

Tompkins Radio Squelch Unit

Model SU, which has its own mounting bracket. Complete with connecting cable, the squelch controls sells for \$17.50 (Model SU is \$1.00 extra). For more information, write Herbert Salch & Co., Marketing Div. of Tompkins Radio Products, Woodsboro, Tex. 78393.

## Nostalgia for Next to Nothing

Now you can find out what your father (grandfather?) was so excited about when he put together his first crystal radio. Radio Shack's Science Fair Crystal Radio Kit has a diagrammed chassis and step-by-step instructions. No soldering is needed, and, naturally, no bat-

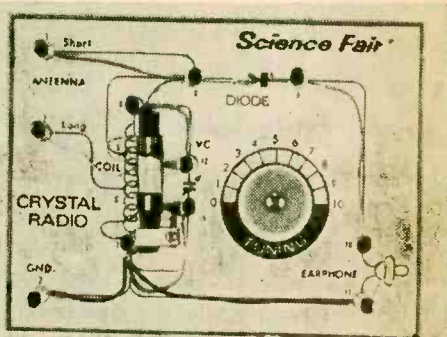

Radio Shack Science Fair Crystal Radio

tery. A crystal diode and variable capacitor (the cat's whisker is gone) tune in local stations loud and clear. All required parts, including antenna coil and earphone, are included in the \$2.95 kit (catalog number 28-207), sold in all Radio Shack stores. Or write Radio Shack, 730 Commonwealth Ave., Boston, Mass. 02215.

## Move Over, Vanilla Fudge!

Amateur combos with non-pro budgets can now have this professional-quality instrument





amplifier with matching speaker system for the relatively modest sum of \$169.95. The Knight-Kit KG-387 90-watt amplifier can be used for one instrument or a combination and will provide "in" sound effects. The speaker system includes two acoustically baffled Jensen 12-in. heavy-duty speakers. The portable amplifier rides piggyback atop the speaker enclosure and is connected with plug-in cord; FETs in the pre-amp stages ensure low noise level. Bass boost, 9 dB minimum at 80 Hz; treble variation, 20



*Knight-kit KG-387 Combo System*

dB at 10,000 Hz. Controls on normal channel include volume, treble, bass; on second channel: volume, treble, bass, tremolo intensity, tremolo rate, reverb depth. Signal-to-noise ratio is 60 dB below rated power output; input sensitivity is 40 mV for rated output; input impedance is 500,000 ohms. Normal channel is designed for lead, rhythm or bass guitar, voice, sitar, etc. Second channel features tremolo with separate intensity and rate controls, and reverberation using the Hammond reverb unit for the concert-hall effect. A foot-switch jack on the control panel permits remote switching of reverb or tremolo with foot switch (included). Separate treble and bass controls allow you to boost or cut either independently. Amplifier measures 5¾ x 19¾ x 8¾ in., speaker enclosure is 26½ x 10 x 22¼ in. Step-by-step instructions and pre-cut wire and solder are included. At Allied stores or write Allied Radio Corp., 100 N. Western Ave., Chicago, Ill. 60680. (Turn page)

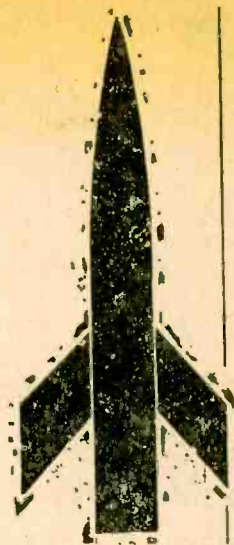

# Keep up to date with **SCIENCE & MECHANICS**

Science & Mechanics—the only magazine that keeps you right up to date on developments in space technology, weapons, automobiles, medicine, boats, planes, tools, new products, and exciting world events.

Keep up to date. Make sure of your home delivered copy by returning the coupon today.

SCIENCE & MECHANICS EE-69  
 229 Park Ave. S., N. Y., N. Y. 10003  
 12 issues \$4; 24 issues \$8; 36 issues \$12. (Foreign: Add \$1 a year.)  
 Please enter my \_\_\_\_\_ year(s) subscription.  
 I enclose \$ \_\_\_\_\_  Bill me. (No stamps)  
 Name \_\_\_\_\_ (Please Print)  
 Address \_\_\_\_\_  
 City \_\_\_\_\_ State & Zip \_\_\_\_\_

*Live Better Electronically With*

## LAFAYETTE RADIO ELECTRONICS

**1969 Catalog 690 FREE!**



**Now OFF PRESS  
BETTER THAN EVER  
Over 500 Pages**

Stereo Hi-Fi • Citizens Band • Ham Gear • Tape Recorders • Test Equipment • TV and Radio Tubes and Parts • Cameras • Auto Accessories • Musical Instruments • Tools • Books

**Featuring Everything in Electronics for  
• HOME • INDUSTRY • LABORATORY**  
 from the "World's Hi-Fi & Electronics Center"  
 LAFAYETTE Radio ELECTRONICS  
 Dept. 25039 P.O. Box 10  
 Syosset, L.I., N.Y. 11791

---

Send me the FREE 1969 catalog 690. 25039

Name \_\_\_\_\_  
 Address \_\_\_\_\_  
 City \_\_\_\_\_  
 State \_\_\_\_\_ Zip \_\_\_\_\_





# Yours FREE

this valuable guide to  
**MONEY-MAKING OPPORTUNITIES**  
with your **NO RISK TRIAL**  
subscription to the new  
**INCOME OPPORTUNITIES**  
Newsletter



**NOT FOR SALE at any price...  
but you can get a copy FREE  
by returning the coupon below.**

**HUNDREDS OF IDEAS** that can mean big money for you assembled by **INCOME OPPORTUNITIES** staff in a special report can be yours **FREE** when you mail the coupon below accepting a **NO RISK Charter** subscription to the new **INCOME OPPORTUNITIES Newsletter**—the new confidential reporting service that brings you exclusive reports of new business breakthroughs **FAR IN ADVANCE** of any other source.

**YOUR FREE SUCCESS GUIDE** contains these powerful profit-makers:

- Success secrets of millionaire mail order professionals!
- 200 high-income, low investment opportunities!
- 55 Businesses you can start right now for under \$500 investment!
- 101 Red-hot novelty items you can sell for phenomenal commissions!

**EACH MONTH** this exclusive confidential newsletter reporting service will bring you exclusive advance news of opportunities in every area... always with the names and addresses of the sources so that you can take full advantage of money making opportunities and can go into action immediately long before anyone else has even heard of them.

**OUR NATIONWIDE STAFF** of reporters and the editors of **INCOME OPPORTUNITIES**, the world's leading magazine in this field, are in constant touch with **EXCLUSIVE** sources of inside information about unusual opportunities of increasing your income... and this information is rushed to subscribers in fast-reading newsletter format... together with special in-depth reports of information you can get nowhere else.

**YOU TAKE NO RISK WHEN YOU SUBSCRIBE SINCE YOU MUST BE 100% SATISFIED**

To get your **FREE** exclusive report on **AMERICA'S BEST MONEY-MAKING OPPORTUNITIES**, all you need do is mail the post card facing this ad or the coupon below to enter your **NO RISK** trial subscription to the new **INCOME OPPORTUNITIES Newsletter**. The cost is less than 5¢ a day... and a single idea you get from it can be worth many times the cost of a year's subscription.

**THESE SPECIAL REPORTS** are included with your subscription as an **EXTRA VALUABLE BONUS**

**22 MAIL ORDER FIRMS THAT WILL PUT YOU IN BUSINESS!**  
Top-notch, reputable firms... each with a profit-producing mail order program. Choose your own hours... work full- or part-time.

**33 SELECT FRANCHISES FOR UNDER \$5,000!**  
Choice franchises selected to return maximum profit for an investment within your means. Restaurants, automotive, stores, and many, many more!

**25 HOME-BASED, SPARE-TIME MONEYMAKERS**  
For anyone who would want additional income—laminating specialty mail order, secretarial services. Full details on how to get customers and how to price your product for profit!

**DIRECT SELLING DIRECTORY!**  
Leaders in the direct selling field—Saladmaster, Tupperware, Stanley, and many others help put you on the path to financial independence selling nationally known products... and earning commissions of up to \$1,000 monthly!

**20 FASTEST GROWING RETAIL BUSINESSES!**  
Survey and report of independent businesses which are currently booming—coin-op car wash, beauty/wig salons, poodle grooming parlors... economic indicators to help you make the wisest choice for a profitable business!

**AND REMEMBER... THIS SUCCESS GUIDE IS NOT FOR SALE, anywhere else, AT ANY PRICE!**

**TO GET YOUR FREE** report on **AMERICA'S BEST MONEY-MAKING OPPORTUNITIES**, mail the coupon below to enter a **NO RISK Charter** subscription to the new **INCOME OPPORTUNITIES Newsletter**—the confidential report that brings you exclusive advance news of money-making opportunities month after month.

**HUNDREDS OF EXCLUSIVE IDEAS YOU CAN USE TO MAKE MORE MONEY**

**THE REASON** we want to send you this valuable report on **AMERICA'S BEST MONEY-MAKING OPPORTUNITIES** as a **FREE** gift with your **NO RISK** subscription to **INCOME OPPORTUNITIES Newsletter** is we know that once you become a reader you will never want to be without it.

#### **22 MONEY-MAKING HOBBIES!**

Hobbies are not only for fun, but can be profitable as well! Here's how to turn your coin/stamp collecting, your tropical fish or even your own art and craft items into a substantial secondary source of income!

**HERE'S THE EXCLUSIVE VALUABLE INFORMATION**

You'll find in your **FREE** copy of **AMERICA'S BEST MONEY-MAKING OPPORTUNITIES**:

**55 BUSINESSES YOU CAN START FOR UNDER \$500!**

Proven profit makers which offer independence and financial security... many can be started on a part time basis... with addresses for obtaining detailed information.

**200 HIGH-PROFIT FRANCHISES!**

Selected franchise profit-making opportunities with initial investment of under \$5,000... covers all major areas such as: services... products... schools... sports and recreation... stores... vending machines... cosmetics... health aids and much more.

**SUCCESS SECRETS OF 23 TOP MAIL ORDER PROS**

The inside success stories behind the big mail order money makers... and full details you can use to get into the big mail order field.

**101 RED HOT NOVELTIES FOR SALESMEN**

How to get your share of the multi-billion dollar advertising specialties industry which offers unlimited opportunities to salesman.

**SEND NO MONEY NOW** to get your **FREE** Money-Making Opportunities Report.

Enter my Charter **NO-RISK** subscription to the new **INCOME OPPORTUNITIES Newsletter** including 6 special reports listed above and send me **FREE** the exclusive report: **AMERICA'S BEST MONEY-MAKING OPPORTUNITIES**. The cost is \$1.50 per month payable annually or semi-annually.

Bill me  Annual Basis  Semi-Annual Basis

I understand I may cancel my subscription at any time and will receive a **FULL REFUND** with no questions asked for all issues still due me at that time. The cost of my subscription is **TAX DEDUCTIBLE** as a business expense.

NAME \_\_\_\_\_ (Please PRINT—it prevents errors)

STREET ADDRESS \_\_\_\_\_

CITY \_\_\_\_\_ STATE \_\_\_\_\_ ZIP CODE \_\_\_\_\_

**CHECK HERE TO GET AN EXTRA MONTHS' SERVICE FREE.**  
Enclose your payment of \$18.00 now and save us bookkeeping costs and we'll add an extra month to your subscription. **SAME NO RISK GUARANTEE.** You may cancel your subscription at any time for a **FULL PROMPT REFUND** for all undelivered issues.

Mail to:  
**INCOME OPPORTUNITIES Newsletter**  
229 Park Avenue South, New York, N.Y. 10003

EE-349

HEY, LOOK ME OVER ★★★★★★★★★★

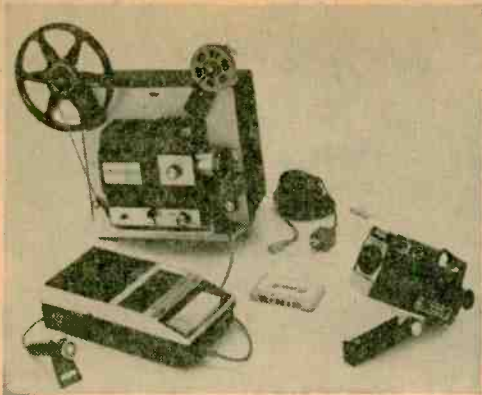

Bell & Howell Filmsound 8 System

to-reel threading, reverse projection control, still picture projection, variable speed control, f/1.5 lens, rapid rewind, and a 400-ft. reel. It's \$169.95; with zoom lens, \$189.95. The Filmsound 450 recorder is used for both movie sound recording and playback with 4-min. tape cassettes. The unit is \$99.95 and the Filmsound tape cassettes, which deliver four minutes of recording time to match the filming time for a standard super 8 cartridge, are \$1.99 each.

Bell & Howell's sound synchronization is achieved via a light device in the camera that marks the edge of the film at the beginning of a scene. During projection, the light mark on the developed film controls starting of the tape recorder and the pulsing signal serves as a speed control for the projector, keeping both picture and sound in frame-by-frame synchronization. For an attractive brochure, "Home Movies That Talk Are Here," write Bell & Howell, 7100 McCormick Rd., Chicago, Ill. 60645.

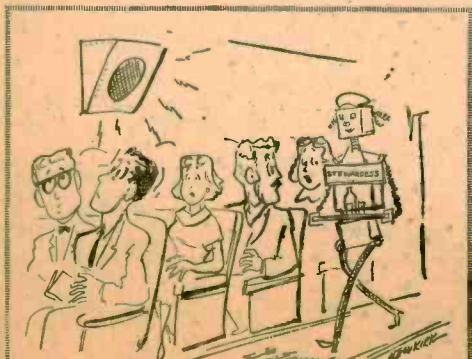

"Attention! You are 20,000 feet above the sea with no pilot! The entire flight has been programmed into a computer. Relax! Nothing can go wrong . . . squeak, wrong . . . squeak, wrong . . ."



☆☆☆☆☆☆

### Looking for Oil, Honest!

A new helicopter-transported oil prospecting device developed by Sinclair Oil Corporation's Tulsa Research Center has been used successfully in the muskeg areas of the Arctic North Slope of Canada where conventional methods are both slow and costly. The device, mounted on a quadrapod, is known as the Helicopter Dinoseis system. It is used in locating underground geologic structures which may contain oil or gas.

Resembling moon vehicles in appearance, the Dinoseis quadrapods are sturdily constructed yet light enough to be transported from one shot point to another by helicopter.



A helicopter approaches a shot point with another Sinclair-developed Dinoseis seismic generator quadrapod for an exploration survey conducted in the Northwest Territories of Canada.





The Helicopter Dinoseis system is composed of a 24-inch diameter expandable seismic energy generator chamber suspended between the legs of a quadrapod and resting on the ground. A confined mixture of oxygen and propane is exploded in the chamber by an electrical spark, driving the bottom steel plate against the ground and imparting high-frequency seismic waves into the earth to subsurface rock formations.

Reflected waves were recorded on analog seismic equipment in the Canadian operations, but may be recorded on digital seismic equipment.

A control module, equipped to serve five exploder units, carries propane and oxygen which fuel the seismic generators, a compressor to provide air used in a recoil system and a generator for power for the control system and radios.

The eight seismic energy generators are fired simultaneously by radio from the recording unit, and may be pulsed each 10 seconds.

In the Canadian operations, the helicopter moved eight quadrapods and their Dinoseis exploders, two control modules, recording equipment, and personnel one-half mile from one shot point to another in 17 minutes.

"We are extremely gratified by results on these initial operations," F. R. Fisher, head of the Research Center, said. "Mechanical operations were excellent, data quality was comparable and cost was significantly lower than the conventional dynamite and shot-hole method. We are encouraged to believe the Helicopter Dinoseis seismic exploration system will provide the answer to the logistical and economic problems of conducting seismic work in the remote areas of the world."

### Finger Snapping EDP

A tape-recorded course in the fundamentals of electronic data processing makes use of pre-recorded cassettes which can be played on miniature tape recorders. The course, designed for the businessman or computer user who wishes to learn computer basics and keep up with the EDP (electronic data processing) field, makes use of audio programmed-learning principles to create a student-teacher relationship. The technique is used by EDP manufacturers to train computer programmers and customers, except that the course provides a broad foundation in EDP terminology for executives in any industry.

While specialized audio courses for computer installations have been extremely successful, they are generally designed for classroom use with reel-to-reel tape recorders. The Dynaphonics basic course is intended for smaller, battery powered recorders using cassettes. Students may take the recorder anywhere and use it during previously wasted time periods. The

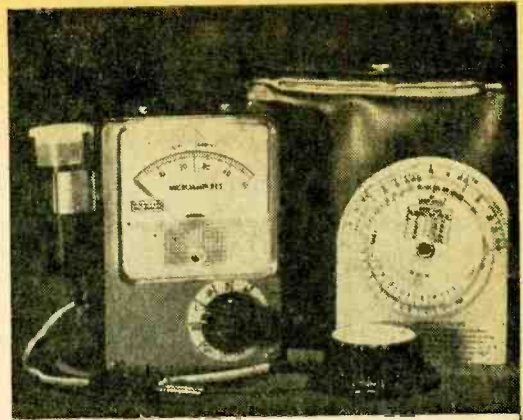

## NOW, BETTER THAN EVER the new and improved S&M supersensitive photo meter

Here is a precision instrument that meets the highest standards of any meter available. It offers consistently accurate readings at very low light levels, which, if required, can be converted to ft.-candles from a graph supplied. Researchers, scientists, educators and hobbyists have confirmed that this meter can read light levels as low as 0.000245 ft.-candles.

The S&M Supersensitive Photo Meter uses the newest Clairex Corp. CL-505L Cadmium Sulfide Light Cell to measure light levels from twilight to bright sunlight at ASA speeds of 3 to 25,000. A new 5/8" high easel type probe and also a miniature probe are now available as accessories. The Computer included gives F stops from .7 to 90; lists exposure time from 1/15,000 sec. to 8 hrs.; 4 range selection; EV-EVS-LV settings; weighs only 10 ounces.

Used extensively in Photo Labs, Physics and Research Labs, Hospitals, High Schools, Universities and numerous industries. Also used with movie or still cameras, microscopes and telescopes and IS A MUST FOR PHOTOMICROGRAPHY.

FREE BOOKLET included on Photomicrography

SCIENCE & MECHANICS—INSTRUMENTS DIV. EE-69  
229 Park Ave., S., New York, N.Y. 10003

Enclosed is \$\_\_\_\_\_ Please send me the new S&M Supersensitive Photo Meter. If I am not satisfied, I may return the meter within 10 days for a complete refund.

(Prices subject to change without notice)

#### Model 102 Photo Meter

- |  |   |
|--|---|
| <input type="checkbox"/> \$36.95 with standard probe + carrying case | <input type="checkbox"/> Add'l. Standard Probe \$7.50 |
| <input type="checkbox"/> Microscope Adapter \$5.00                   | <input type="checkbox"/> \$2.00 carrying case         |
| <input type="checkbox"/> Add'l. Computer \$2.00                      | <input type="checkbox"/> 3/8"-mini Probe \$7.50       |
|  | <input type="checkbox"/> Easel Probe \$7.50           |

Add 10% for Canadian and foreign order. New York City residents add 5% sales tax. (No Stamps)

Name \_\_\_\_\_ (please print)

Address \_\_\_\_\_

City \_\_\_\_\_ State \_\_\_\_\_ Zip \_\_\_\_\_







Oregon State University track coach Berny Wagner points out good and bad points of Olympic sprint prospect Willie Turner's form. Videotape recording system enabled athletes to view themselves in action immediately after a practice run.

sound alone. Recordings may be played back through television sets immediately after the recording, just what our athletes needed in their race for noble medals.

### They Don't Carry Ice Cubes

The Coast Guard icebreaker Glacier, veteran of 13 Antarctic voyages, carried special communications equipment to the Antarctic last winter in a joint Navy-Coast Guard program designed to prove the feasibility of establishing reliable communications with polar regions via satellite. On board the Glacier was a satellite communications terminal designed and produced for the Navy by Electronic Communications, Inc., of St. Petersburg, Fla.

The satellite communications terminal is a duplicate of satellite terminals developed for use in the current Lincoln Experimental Satellite communications relay program. Launched September 26, the space satellite was designed and built by MIT's Lincoln Laboratories in Cambridge, Mass.

The broad objective of the USCGC Glacier tests was to prove the feasibility of satellite communications with units in the Antarctic region,



USCGC Glacier "parked" on ice during an antarctic hot spell. The Glacier has taken part in antarctic exploration program annually since the inception of Operation Deep Freeze in 1953.

## Build this magnificent Schober Theatre Organ

for only  
\* \$1550!



\*Includes finished walnut console. Amplifier, speaker system, optional accessories extra. Only \$1150.50 if you build your own console.

You couldn't touch an organ like this in a store for less than \$3500—and there hasn't been a musical instrument with this vast variety of genuine Theatre Organ voices since the days of the silent movies! If you've dreamed of the grandeur of authentic big-organ sound in your own home, you won't find a more satisfying instrument anywhere—kit or no kit.

You can learn to play it. And you can build it, from Schober Kits, world famous for ease of assembly without the slightest knowledge of electronics or music, for design and parts quality from the ground up, and—above all—for the highest praise from musicians everywhere.

Send right now for your copy of the full-color Schober catalog, containing specifications of the five Schober Organ models, beginning at \$599.50. No charge, no obligation—but lots of food for a healthy musical appetite!

The *Schober* Organ Corp., Dept. EE-4  
43 West 61st Street, New York, N.Y. 10023

- Please send me Schober Organ Catalog and free 7-inch "sample" record.
- Enclosed please find \$1.00 for 12-inch L.P. record of Schober Organ music.

NAME \_\_\_\_\_

ADDRESS \_\_\_\_\_

CITY \_\_\_\_\_ STATE \_\_\_\_\_ ZIP \_\_\_\_\_

Learn of the many money making ideas and low cost/high profit businesses you can start in.

## INCOME OPPORTUNITIES

75¢

on sale now or write Davis Publications, Inc./229 Park Ave. S./New York, N.Y. 10003. Add 25¢ each for postage and handling.

Better yet, enter your subscription and receive 8 issues (one year) for only \$6.00 which includes two \$1.00 Directory issues.

the immediate purpose is to evaluate propagation characteristics from Arctic regions where auroral (northern lights) and other electromagnetic disturbances frequently play havoc with conventional radio communication links not to mention short wave broadcasters.

The satellite communications terminal on board the Glacier had the capability of handling 100 words-per-minute two-way teletype traffic utilizing digital modulation techniques. The installation included a 60-watt UHF transmitter, a power amplifier to generate a 1-kilowatt output, a receiver, modulator-demodulator, antenna, control unit, page printer, keyboard, tape reader and tape reperforator—everything a state-side terminal would have.

The 310-foot Glacier has been modified to serve as an icebreaker and oceanographic vessel. In company with two other Coast Guard icebreakers, its basic mission was to break out McMurdo Sound at the beginning of the antarctic summer to resupply U. S. Naval Support Forces, Antarctica (Task Force 43).

The Glacier carried some 26 scientists and full equipment to dredge the Antarctic bottom, engage in bottom photography, obtain specimens of Antarctic marine life and other oceanographic assignments. Most of its operations were concentrated in the Weddell Sea.

But, of most concern to the readers of this magazine is whether or not satellite communications are feasible in polar regions. If so, the dreaded radio blackout at the high latitudes will be a thing of the past. ■

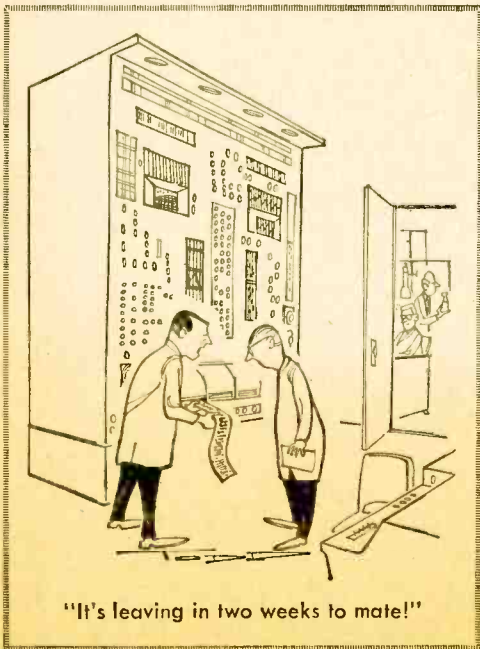

After the opening moves have been rattled off, too often by rote, and a player finds himself in the relatively uncharted wilds of the middle-game, he is apt to ask: "Now what do I do?" What, indeed! The answer is much more difficult than the question, but at least part of it is: "Build up your position, play for the attack, and apply one of the winning tactical motifs." Here are three more of the latter.

**Discover Attack.** This is a move which checks, captures, or threatens with one piece, while simultaneously unmasking the action of another piece. It is like moving two pieces at one time!

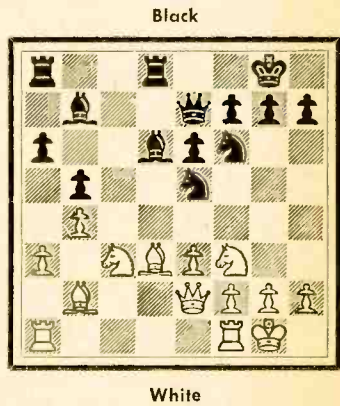

Black moves. 1 ... NxB (to bring White's Queen into an exposed position) 2 QxN (else White will remain a piece behind) BxP#! (the motif) 3 NxB, RxQ! and Black has won Queen and Pawn for only a Bishop.

**Double Check.** Nimzovich wrote: "Even the laziest King flees wildly in the face of a double check." And well he might because this devastating tactic smites from two directions at once.

Black moves. 1 ... RxBP! (putting the Queens face to face) 2 QxQ, RxN mate! With both the Black Rook and Bishop checking,



Black

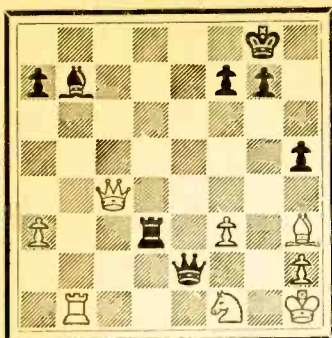

White

White is unable to capture or interpose.

**No Retreat.** When a piece has no mobility, no square to which it can move safely, then it is said to have no retreat. On the side of the board, particularly, this predicament is usually fatal.

Black

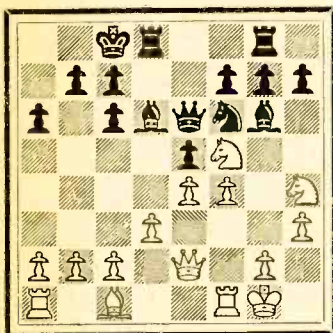

White

The target is Black's Queen Bishop. 1 NxB# QxN (if 1 . . . . PxN 2 P-B5 wins) 2 P-B5, B-R4 (forced) 3 P-KN4 wins the Bishop, which is attacked and has no retreat. As Tarrasch said: "No piece can be so easily won by Pawns as a Bishop."

**Game of the Issue.** Emanuel Lasker (1868-1941), German, author, inventor, philosopher, and mathematician, was World Champion for twenty-seven years. He won the title from Wilhelm Steinitz in 1894 and lost it to Jose R. Capablanca in 1921. He excelled at both match and tournament play, winning first prize in the 1924 New York International Tournament (one of the strongest tournaments ever held), at age fifty-five, and finished third at Moscow, 1935, playing through nineteen gruelling rounds without losing a game, when he was sixty-seven. A biological miracle!

Lasker was a fighter and a psychologist at the

chessboard. His play was determined, tactical, full of ideas, cool, and mathematically precise. In the following game against Steinitz, White, World Championship Match, Moscow, 1896, a Giuoco Piano, he scores with the zugzwang motif.

1 P-K4	P-K4	19 RxP	RxR
2 N-KB3	N-QB3	20 BxR	R-N1
3 B-B4	B-B4	21 P-B4	B-Q4
4 P-B3	N-B3	22 P-N3	K-N2
5 P-Q4	PxP	23 P-KR3	Q-N4!
6 PxP	B-N5#	24 K-R2	R-N3
7 N-B3	KNxP	25 Q-QB2	P-KB3
8 O-O	BxN	26 B-R4	B-B3
9 PxB?	P-Q4	27 P-N4	Q-Q4
10 B-R3?	PxB	28 Q-B2	P-KR4
11 R-K1	B-K3!	29 P-N5	PxP
12 RxN	Q-Q4	30 BxP	P-R5!
13 Q-K2	O-O-O	31 R-KB1	R-N1
14 N-K5	KR-K1	32 Q-Q2	P-R4!
15 NxN	QxN	33 P-R4	R-K1
16 R-K1	R-N1	34 P-B5	R-KN1!
17 R-K5	P-QN3		Resigns
18 B-B1	P-KN4		

Position after 34 . . . R-KN1!

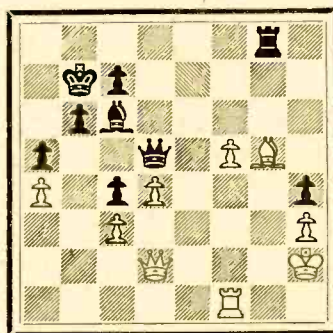

(Continued on page 30)



# LITERATURE

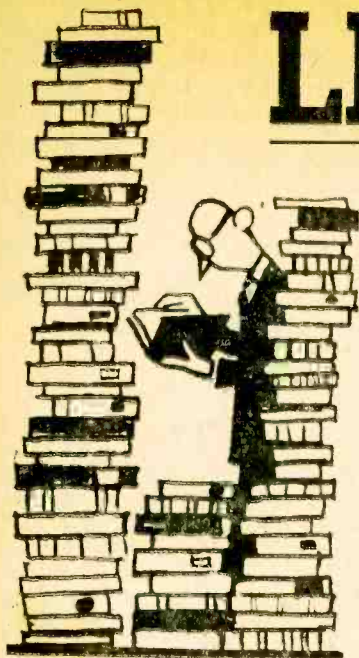

## ELECTRONIC PARTS

★2. Now, get the all-new 512-page, fully illustrated *Lafayette Radio 1969* catalog. Discover the latest in CB gear, test equipment, ham gear, tools, books, hi-fi components and gifts. Do it now!

1. *Allied's* catalog is so widely used as a reference book, that it's regarded as a standard by people in the electronics industry. Don't you have the 1969 *Allied Radio* catalog? The surprising thing is that it's free!

8. Get it now! *John Meshna, Jr.'s* new 46-page catalog is jam packed with surplus buys—surplus radios, new parts, computer parts, etc.

23. No electronics bargain hunter should be caught without the 1969 copy of *Radio Shack's* catalog. Some equipment and kit offers are so low, they look like misprints. Buying is believing.

★5. *Edmund Scientific's* new catalog contains over 4000 products that embrace many interests and fields. It's a 148-page buyers' guide for Science Fair fans.

★4. *Olson's* catalog is a multi-colored newspaper that's packed with more bargains than a phone book has names. Don't believe us? Get a copy.

7. Before you build from scratch, check the *Fair Radio Sales* latest catalog for electronic gear that can be modified to your needs. *Fair* way to save cash.

★135. Get with ICs! *RCA's* new integrated Circuit Experimenter's Kit KD2112 is the first of its kind and should be a part of your next project. Get all the facts direct from *RCA*. Circle 135.

140. How cheap is cheap? Well, take a gander at *Cornell Electronics'* latest catalog. It's packed with bargains like 6W4, 12AX7, 5U4, etc., tubes for only 33¢. You've got to see this one to believe it!

10. *Burstein-Applebee* offers a new giant catalog containing 100s of big pages crammed with savings including hundreds of bargains on hi-fi kits, power tools, tubes, and parts.

11. Now available from *EDI (Electronic Distributors, Inc.)*: a catalog containing hundreds of electronic items. *EDI* will be happy to place you on their mailing list.

106. With 70 million TV and 240 million radios somebody somewhere will need a vacuum tube replacement at the rate of one a second! Get *Universal Tube Co.'s* Troubleshooting Chart and facts on their \$1.50 flat rate per tube.

6. Bargains galore, that's what's in store! *Poly-Paks Co.* will send you their latest eight-page flyer listing the latest in available merchandise, including a giant \$1 special sale.

## TOOLS

★78. *Xcelite's* new "trav Blen" nut-driver sets feature plastic trays that lie flat or sit up on your workbench, or pack neatly in your tool box. All the poop's in *Xcelite's* Bulletin N666—get it!

118. Secure coax cables, speaker wires, phone wires, etc., with *Arrow* staple gun tackers. 3 models for wires and cables from  $\frac{3}{16}$ " to  $\frac{1}{2}$ " dia. Get fact-full *Arrow* literature.

## CB—AMATEUR RADIO— SHORTWAVE RADIO

146. It may be the first—*Gilfer's* speciality catalog catering to the SWL. Books, rigs, what-nots—everything you need for your listening post. Go *Gilfer*, circle 146!

100. You can get increased CB range and clarity using the "Cobra-23" transceiver with speech compressor—receiver sensitivity is excellent. Catalog sheet will be mailed by *B&K Division of Dynascan Corporation*.

141. Newly-designed CB antenna catalog by *Antenna Specialists* has been sectionalized to facilitate the picking of an antenna or accessory from a handy index system. Man, *Antenna Specialists* makes the pickin' easy.

102. No never mind what brand your CB set is. *Sentry* has the crystal you need. Same goes for ham rigs. Seeing is believing, so get *Sentry's* catalog today. Circle 102.

130. Bone up on the CB with the latest *Sams* books. Titles range from "ABC's of CB Radio" to "99 Ways to Improve your CB Radio." So Circle 130 and get the facts from *Sams*.

107. Want a deluxe CB base station? Then get the specs on *Tram's* all new Titan II—it's the SSB/AM rig you've been waiting for!

96. Get your copy of *E. F. Johnson's* new booklet, "Can *Johnson 2-Way Radio* Help Me?" Aimed for business use, the booklet is useful to everyone.

129. Boy, oh boy—if you want to read about a flock of CB winners, get your hands on *Lafayette's* new 1969 catalog. *Lafayette* has CB sets for all pocketbooks.

46. Pick up *Hallcrafters'* new four-page illustrated brochure describing *Hallcrafters'* line of monitor receivers—police, fire, ambulance, emergency, weather, business radio, all yours at the flip of a dial.

116. Pep-up your CB rig's performance with *Turner's* M-2 mobile microphone. Get complete spec sheets and data on other *Turner* mikes.

48. *Hy-Gain's* new CB antenna catalog is packed full of useful information and product data that every CBER should know. Get a copy.

111. Get the scoop on *Versa-Tronics'* Versa-Tenna with instant magnetic mounting. Antenna models available for CBers, hams and mobile units from 27 MHz to 1000 MHz.

45. CBers. Hams. SWLs—get your copy of *World Radio Labs'* 1969 catalog. If you're a wireless nut or experimenter, you'll take to this catalog.

50. Get your copy of *Amphenol's* "User's Guide to CB Radio"—18 pages packed with CB know-how and chit-chat. Also, *Amphenol* will let you know what's new on their product line.

54. A catalog for CBers, hams and experimenters, with outstanding values. Terrific buys on *Grove Electronics'* antennas, mikes and accessories.

101. If it's a CB product, chances are *International Crystal* has it listed in their colorful catalog. Whether kit or wired, accessory or test gear, this CB-oriented company can be relied on to fill the bill.

103. *Squires-Sanders* would like you to know about their CB transceivers, the "23'er" and the new "SSS." Also, CB accessories that add versatility to their 5-watters.

## ELECTRONIC PRODUCTS

144. Hear today the organ with the "Sound-of-Tomorrow," the *Melo-Sonic* by *Whitpany Electronics*. It's portable—take it anywhere. Send for pics and descriptive literature.

143. Bring new life to your hobby. Exciting plans for new projects—let *Electronics Hobby Shack* give you the dope. Circle 143, now.

66. Try instant lettering to mark control panels and component parts. *Datak's* booklets and sample show this easy dry transfer method.

109. *Seco* offers a line of specialized and standard test equipment that's ideal for the home experimenter and pro. Get specs and prices today.

42. Here's colorful 116 page catalog containing a wide assortment of electronic kits. You'll find something for any interest, any budget. And *Health Co.* will happily send you a copy.



# LIBRARY

★ Starred items indicate advertisers in this issue. Consult their ads for additional information and specifications.

128. If you can hammer a nail and miss your thumb, you can assemble *Schober* organ. To prove the point, *Schober* will send you their catalog and a 7-in. disc recording.

145. *Alco Electronic Products* has 28 circuit ideas using their remote control relay. Get 100-and-one odd jobs done at home without calling an electrician. Get all the facts today!

★44. Kit builder? Like wired products? *EICO's* 1969 catalog takes care of both breeds of buyers. 32 pages full of hi-fi, test, CB, ham, SWL, automotive and hobby kits and products—do you have a copy?

126. *Delta Products* new capacitive discharge ignition system in kit form will pep up your car. Designed to cut gas costs and reduce point and plug wear. Get *Delta's* details in full-color literature.

## SCHOOLS AND EDUCATIONAL

142. *Radio-Television Training of America* prepares you for a career—not a job. 16 big kits help you learn as you build. 120 lessons. Get all the facts today!

★74. Get two free books—"How to Get a Commercial FCC License" and "How to Succeed in Electronics"—from *Cleveland Institute of Electronics*. Begin your future today!

3. Get all the facts on *Progressive Edu-Kits Home Radio Course*. Build 20 radios and electronic circuits; parts, tools and instructions come with course.

114. Prepare for tomorrow by studying at home with *Technical Training International*. Get the facts today on how you can step up in your present job.

136. *International Correspondence Schools* has a 384-page manual explaining the function, operation, and objectives of *ICS*. Get the facts on 266 courses of study currently available. Sorry, offer may expire soon.

137. For success in communications, broadcasting and electronics get your *First Class FCC license* and *Grantham School of Electronics* will show you how. Interesting booklets are yours for the asking.

## HI-FI/AUDIO

30. *Shure's* business is hi-fi—cartridges, tone arms, and headphone amps. Make it your business to know *Shure!*

134. Discover *PlayTape*—America's newest tape cartridge and tape players. Unit priced at under \$17 with cartridges at 45-disc prices. *PlayTape* has one of America's largest recorded libraries.

17. Mikes, speakers, amps, receivers—you name it, *Electro-Voice* makes it and makes it good. Get the straight poop from *E-V* today.

99. Get the inside info on why *Koss/Acoustech's* solid-state amplifiers are the rage of the experts. Colorful brochure answers all your questions.

104. You can't hear FM stereo unless your FM antenna can pull 'em in. Learn more and discover what's available from *Finco's* 6-pages "Third Dimensional Sound."

119. *Kenwood* puts it right on the line. The all-new *Kenwood* FM-stereo receivers are described in a colorful 16-page booklet complete with easy-to-read-and-compare spec data. Get your copy today!

26. The all new, lavishly-illustrated, full-color brochure, "At Home With Stereo" clues you in on *H.H. Scott's* 1969 stereo consoles. Discover how to pick a hi-fi console for your living room.

## TAPE RECORDERS AND TAPE

123. Yours for the asking—*Elpa's* new "The Tape Recording Omnibook." 16 jam-packed pages on facts and tips you should know about before you buy a tape recorder.

31. All the facts about *Concord Electronics Corp.* tape recorders are yours for the asking in a free booklet. Portable, battery operated to four-track, fully transistorized stereos cover every recording need.

32. "Everybody's Tape Recording Handbook" is the title of a booklet that *Sarkes-Tarzian* will send you. It's 24-pages jam-packed with info for the home recording enthusiast. Includes a valuable table of recording times for various tapes.

34. "All the Best from Sony" is an 8-page booklet describing *Sony-Super-scope* products—tape recorders, microphones, tape and accessories. Get a copy today before you buy!

35. If you are a serious tape audiophile, you will be interested in the all new *Viking/Telex* line of quality tape recorders.

## TELEVISION

70. Need a new TV set? Then assemble a *Heath* TV kit. *Heath* has all sizes. B&W and color, portable and fixed. Why not build the next TV you watch?

127. *National Schools* will help you learn all about color TV as you assemble their 25-in. color TV kit. Just one of *National's* many exciting and rewarding courses.

## ELEMENTARY ELECTRONICS

Department 469  
229 Park Avenue South  
New York, N.Y. 10003

Please arrange to have the literature whose numbers I have circled at right sent to me as soon as possible. I am enclosing 25¢ to cover handling. (No stamps, please.)

Indicate total number of booklets requested

1	2	3	4	5	6	7	8	10	11
17	23	26	30	31	32	34	35	42	44
45	46	48	50	54	66	70	74	78	96
99	100	101	102	103	104	106	107	109	111
114	116	118	119	123	126	127	128	129	130
134	135	136	137	140	141	142	143	144	145
146									

NAME \_\_\_\_\_

ADDRESS \_\_\_\_\_

CITY \_\_\_\_\_

STATE \_\_\_\_\_ ZIP \_\_\_\_\_



**Someone  
should develop  
an easy way  
to learn  
electronics at  
home**

**RCA Institutes  
did!**

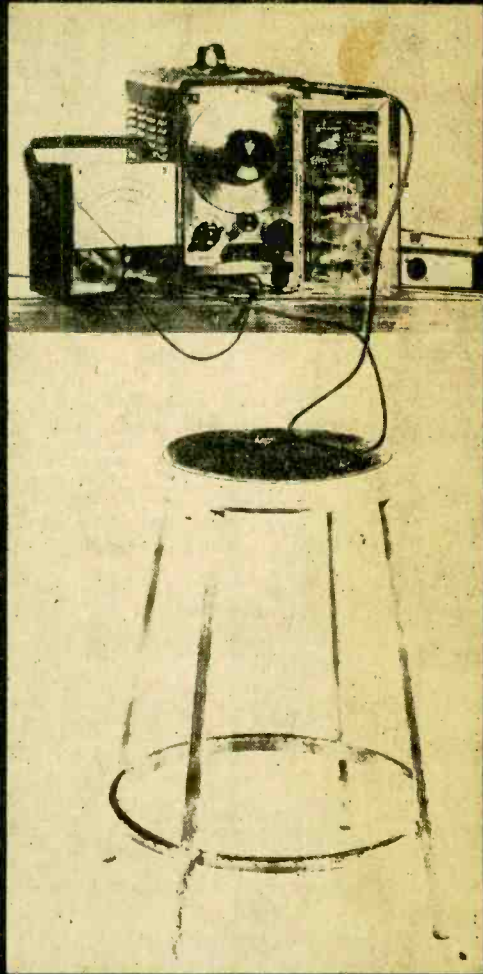

Here is a whole new approach to learning electronics at home! RCA Institutes, one of the nation's largest schools devoted to electronics, has developed a faster, easier way for you to gain the skills and the knowledge you need for the career of your choice. Here for the first time is a student-proved, scientifically designed way to learn. If you have had any doubts in the past about home training in electronics—if you have hesitated because you thought you might not be able to keep up—or that electronics was too complicated to learn—here is your answer! Read how RCA Institutes has revolutionized its home training ideas!



**NEW CAREER PROGRAMS  
BEGIN WITH "AUTOTEXT"  
INSTRUCTION METHOD!**

**Start to learn the field of your  
choice immediately!  
No previous training or  
experience in electronics  
needed!**

With this new revolutionized method of home training you pick the career of your choice—and RCA Institutes trains you for it. RCA's Career Programs assure you that everything you learn will help you go directly to the field that you have chosen! No wasted time learning things you'll never use on the job! The Career Program you choose is especially designed to get you into that career in the fastest, easiest possible way!

And each Career Program starts with the amazing "AUTOTEXT" Programmed Instruction Method—the new, faster way to learn that's almost automatic! "AUTOTEXT" helps even those who have had trouble with conventional home training methods in the past. This is the "Space Age" way to learn everything you need to know with the least amount of time and effort.

**CHOOSE A CAREER PROGRAM NOW**

**Your next stop may be the job of your choice.** Each one of these RCA Institutes Career Programs is a complete unit. It contains the know-how you need to step into a profitable career. Here are the names of the programs and the kinds of jobs they train you for. Which one is for you?

**Television Servicing.** Prepares you for a career as a TV Technician/Serviceman; Master Antenna Systems Technician; TV Laboratory Technician; Educational TV Technician.

**FCC License Preparation.** For those who want to become TV Station Engineers, Communications Laboratory Technicians, or Field Engineers.

**Automation Electronics.** Gets you ready to be an Automation Electronics Technician; Manufacturer's Representative; Industrial Electronics Technician.

**Automatic Controls.** Prepares you to be an Automatic Controls Electronics Technician; Industrial Laboratory

Technician; Maintenance Technician; Field Engineer.

**Digital Techniques.** For a career as a Digital Techniques Electronics Technician; Industrial Electronics Technician; Industrial Laboratory Technician.

**Telecommunications.** For a job as TV Station Engineer, Mobile Communications Technician, Marine Radio Technician.

**Industrial Electronics.** For jobs as Industrial Electronics Technicians; Field Engineers; Maintenance Technicians; Industrial Laboratory Technicians.

**Nuclear Instrumentation.** For those who want careers as Nuclear Instrumentation Electronics Technicians; Industrial Laboratory Technicians; Industrial Electronics Technicians.

**Solid State Electronics.** Become a specialist in the Semiconductor Field.

**Electronics Drafting.** Junior Draftsman, Junior Technical Illustrator; Parts Inspector; Design Draftsman Trainee Chartist.

**SEPARATE COURSES**

In addition, in order to meet specific needs, RCA Institutes offers a wide variety of separate courses which may be taken independently of the Career Programs, on all subjects from Electronics Fundamentals to Computer Programming. Complete information will be sent with your other materials.

**2 CONVENIENT PAYMENT PLANS**

RCA Institutes offers a unique tuition plan that lets you progress at your own pace. You only pay for lessons as you order them. You don't sign a contract obligating you to continue the course. There's no large down-payment to lose if you decide not to continue.

However, if you desire, RCA Institutes also offers a convenient monthly payment plan.

**VALUABLE EQUIPMENT**

You receive valuable equipment to

keep and use on the job—and you never have to take apart one piece to build another.

**New—Programmed Electronics Breadboard.** You now will receive a scientifically programmed electronic breadboard with your study material. This breadboard provides limitless experimentation with basic electrical and electronic circuits involving vacuum tubes and transistors and includes the construction of a working signal generator and superheterodyne AM Receiver.

**Multimeter and Oscilloscope Kits At No Additional Cost.** You will receive with most RCA Institutes Career Programs the instruments and kit material you need to build a Multimeter and Oscilloscope. The inclusion of both these kits is an RCA extra.

**CLASSROOM TRAINING  
ALSO AVAILABLE**

RCA Institutes maintains one of the largest schools of its kind in New York City where classroom and laboratory training is available in day or evening sessions. You may be admitted without any previous technical training; preparatory courses are available if you haven't completed high school. Coeducational classes start four times a year.

**JOB PLACEMENT SERVICE, TOO!**

Companies like IBM, Bell Telephone Labs, GE, RCA, Xerox, Honeywell, Grumman, Westinghouse, and major Radio and TV Networks have regularly employed graduates through RCA Institutes' own placement service.

**SEND ATTACHED POSTAGE PAID CARD FOR COMPLETE INFORMATION, NO OBLIGATION.**

All RCA Institutes courses and programs are approved for veterans under the new G.I. Bill.

Accredited Member  
National Home Study Council

IF REPLY CARD IS DETACHED—SEND THIS COUPON TODAY

RCA INSTITUTES, Inc., Dept. EAQ-39  
320 West 31st Street, N.Y., N.Y. 10001

Please rush me FREE illustrated catalog. I understand that I am under no obligation.

Name \_\_\_\_\_ Age \_\_\_\_\_  
(please print)

Address \_\_\_\_\_

City \_\_\_\_\_

State \_\_\_\_\_ Zip \_\_\_\_\_



# EN PASSANT

(Continued from page 23)

Why did White resign? Because he is in zug-zwang (disagreeable obligation to move) and must be mated, lose his Queen, Rook, or Bishop, or see Black win by queening his Queen Rook Pawn. Here is the analysis—

A. If 35 P-B6, RxB wins.

B. If 35 BxP, R-N7# 36 K-R1, R-B7# 37 K-N1, Q-N7 mate.

C. If 35 R-K1, (all other Rook moves except 35 R-KN1 are likewise insufficient) QxBP 36 BxP, R-N7# wins the Queen.

D. If 35 R-KN1, (relatively best) RxB! 36 QxR, (36 RxB, Q-R8 mate) Q-Q3# 37 R-N3, PxR# 38 QxP, B-K1 (to halt White's KRP and KBP) 39 P-R4, P-N4! (the point of 32 . . . . P-R4!) 41 PxP, P-R5! and Black wins easily by queening first.

E. If 35 Q-B4, (if the Queen leaves the QB1-KR6 diagonal then 35 . . . . RxB wins) Q-N7 mate.

F. If 35 K-N1, Q-R8# 36 K-B2, Q-N7# 37 K-K1, RxB 38 QxQ, RxQ 39 P-B6, R-N1 40 P-B7, R-KB1, followed by the capture of the KBP and QRP, wins for Black.

## Problem 17

By Kenneth S. Howard  
United States

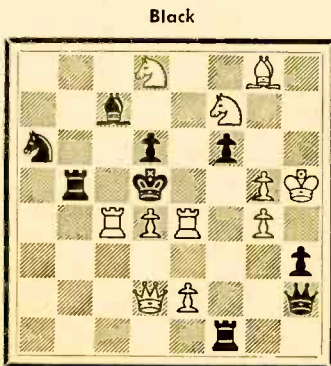

White

White to move and mate in two.  
Solution in next issue.

This cross-check problem, illustrating three discovered checks by White's Queen Pawn, won First Prize in the Informal Tourney sponsored by the Western Morning News and Daily Gazette.

Solution to Problem 16: 1 Q-R1.

Traps. Every opening has its traps and every

Grandmaster and tyro fall into one of them at one time or another. Although one should not base his play on these early pitfalls, it is wise to learn them in order that you may sidestep them yourself today and catch your unwary opponent in one tomorrow. Here is one which occurs frequently in the staid Queen's Gambit Declined—

1 P-Q4	P-Q4	4 B-N5	QN-Q2
2 P-QB4	P-K3	5 PxP	PxP
3 N-QB3	N-KB3	6 NxP??	....

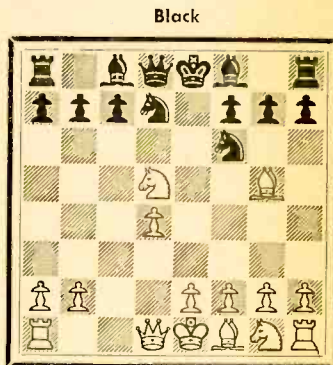

Black

White

Careless, greedy, and believing he is setting a trap to win the Black Queen, White snatches a Pawn.

6 . . . . NxB!

Astonishingly, Black seems to step into the trap!

7 BxQ B-N5#!  
8 Q-Q2 . . . .

Alas, this is what White had not foreseen, he must give back the Queen.

8 . . . . BxQ#  
9 KxB KxB

And Black has won a piece for a Pawn. A case of the trapper trapped!

**News and Views.** U.S. Champion Robert J. Fischer amassed an overwhelming 11½-1½ to win the Seventh Israel International at Natanya. D. Yanofsky and M. Czerniak were next with 8 points.

Boris Spassky defeated Victor Korchnoi, 6½-3½, at Kiev, in the final Challengers Elimination Match. As a result, he will play his compatriot World Champion Tigran Petrosian for the title.

The U.S. Junior Championship ended in a tie for first place between Gregory S. DeFotis and Norman Weinstein.

Marcel Duchamp is dead at 81. Art giant, father of the Dada school, his most famous painting was "Nude Descending a Staircase." He was active in New York State chess circles for many years. ■





# ELEMENTARY ELECTRONICS ETYMOLOGY

By Webb Garrison

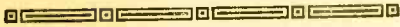

## Silicon

▲ Doggedly searching for new elements, early in the last century Sir Humphrey Davy spent years trying to isolate four metals that he thought constituted an especially interesting group. Though he never found them, he gave names to each of the elusive substances.

One of them, *silicium*, attracted the interest of Scottish chemist Thomas Thomson. He managed to isolate a small quantity of the strange stuff about 1817, analyzed it and correctly concluded it to be non-metallic. In the light of his findings he modified Davy's label to *silicon*. This, he explained, was due to the fact that "the element bears a closer resemblance to boron and carbon than to metallic elements" [many of whose names traditionally ended in *-ium*].

Later investigators discovered that in the earth's crust silicon ranks second only to oxygen in abundance. It is usually found in compounds rather than in the pure state. Except for its key role in the glass industry, silicon was long regarded as having little economic or technological importance.

Then modern research workers found that the tetravalent element is a versatile semiconductor. Davy was wrong in thinking it to be a metal; he was right in theorizing that it might have important electrical properties.

Today the element whose name is taken from Latin for "flint" is the key actor in a global drama. For silicon made possible the development of the monolithic integrated circuit. A Minuteman ICBM missile uses 2144 such circuits whose combined weight is less than 1/10th of an ounce.

Silicon chips, already dominant in military computers and radio, are rapidly penetrating the fields of TV, household appliances, and industrial controls. This means that in an almost occult sense mankind has come full circle. Man's first major tools were made of chipped flint; now our sophisticated computers can't function without the element named for the flint in which it occurs.

## Cell

▲ During the period of the Crusades, the great religious establishments of Europe began setting up branches in remote regions. At first, many an outpost consisted of a one-room building. From Latin *cella* (the store-room or small apartment that named the modern cellar) priests called such a branch a *celle*. In time the French name entered English as *cell*.

Applied to a compartment of a honeycomb and then to a room in a prison, the religious term entered the vocabulary of biology. Here it was used to name the "little house" that is the basic building block of life.

On June 26, 1800, a paper was read to London's Royal Society. It described the work of Alessandro Volta, pioneer physicist who had succeeded in producing a continuous flow of electric current. His apparatus consisted of 30 pairs of zinc and silver discs, connected by brine-soaked cloths. Naturally, the current produced was very weak.

But it was strong enough to spur international interest in development of the "wet" or chemical battery. One early experimenter, William Cruikshank, divided a wooden trough into compartments in his effort to construct a more powerful voltaic pile. Cruikshank borrowed from biology and called each segment of his apparatus a "cell."

Today there are many kinds of electrical cells: nickel-iron, photoelectric, photo-voltaic, cadmium, Daniell, Kerr, Leclanche mercury, and so on. Though they differ widely in structure and method of operation, all cells share with medieval religious outposts the quality of being self-contained and set apart.

## Shunt

▲ Possibly as an emphatic formation based on a much earlier term, *to shun*, an Englishman of the 13th century who went out of his way to avoid a person or place was mocked by comrades who said he was prone *to shunt*.

Once coined, the vigorous term found many uses. It was applied to a swordsman who moved to elude a blow as well as to an embarrassed woman who turned aside in shame. Much later, railroaders borrowed the expression to name the act of moving a train from a main line to a side track.

More than a century ago, electrical workers found that they often needed a way to reduce current passing through a circuit. This problem was solved by adding a secondary circuit. Such an arrangement permits part of the current to by-pass the main circuit. So the hoary expression for turning aside seemed just right to name a secondary circuit. Hence the modern electrical *shunt* perpetuates ancient slang for "going out of the way." ■

# As the Wife sees it

By Jack Schmidt

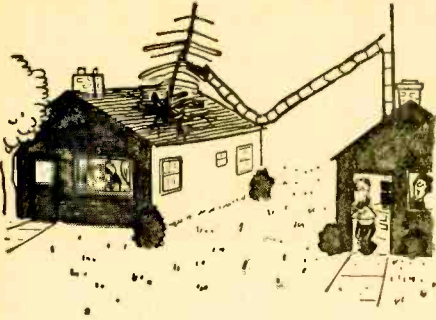

"Don't make a big thing of it—just go over and tell them you want your antenna back!"

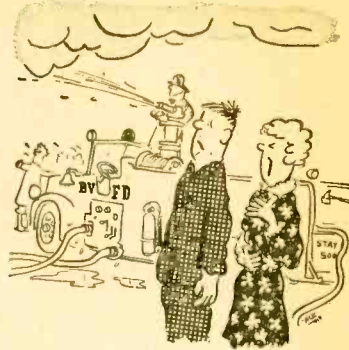

"Well, Marconi, there goes the hard cash you saved by wiring it yourself!"

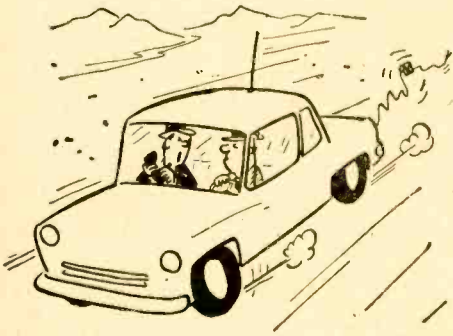

"It's your wife . . . she says you forgot to disconnect the battery charger this morning!"

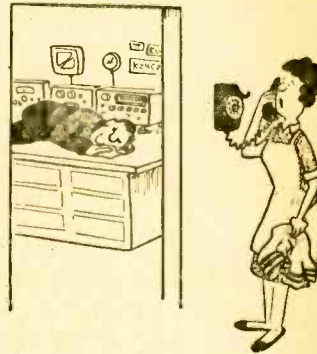

"I hate to disturb him, Albert, he's doing a very important bench test!"



"Special Delivery for a Mr. KMD4313."



"Fred, the man is here to fix the color TV!"



# elementary Electronics

- ✦ The very best receivers
  - ✦ The coolest antenna farm
  - ✦ The world at your fingertips
- ...and a salary to boot!

Not for real, you say? But it is. It's all part of



## The strange world of \$\$ PAID \$\$ short wave listening

By Dick Strippel

It could almost be an SWL's dream! You're seated in front of the best receiver money can buy . . . a Collins, a TMC, a Marconi, maybe a Racal. You're monitoring by ear, but automatic start-stop tape recorders take down every syllable or dah-dit that issues forth.

Your location might be far from civilization, where there's room for huge antennas—though you could be aboard a ship such as U.S.S. *Pueblo*, or flying at 20,000 feet aboard a converted transport plane.

Your employer? Uncle Sam (who else?).

You wouldn't be alone. Estimates have placed the number of radio monitor stations operated by the U.S. Army, Air Force, CIA, and other government agencies in the thousands.

Under the ultimate command of the (Continued overleaf)

National Security Agency—the organization which directs America's super-secret communications intelligence efforts, these intercept posts eavesdrop on the radio and radar transmissions of both friendly and not-so-friendly nations.

**Ever Listening.** While current fiction interest centers around spy and super-spy, more meaningful intelligence data in real life comes

Splitters at the station divide the signals among individual receivers." Typical of these couplers are the CU-168s now showing up on the surplus market.

The sergeant added other details. "At Fort Monmouth, New Jersey, I had been taught to copy Cyrillic (i.e., the Russian) alphabet CW on an electric typewriter—I never learned to send code. We were amazed at how much Soviet traffic was sent by key CW," he revealed. "We'd listen in to tanks on maneuvers talking to each other and their headquarters on 3 to 4 MHz CW!"

## Paid shortwave listeners are where you find them!



Site 23, our secret SWL post somewhere in Turkey, has never been photographed, but secret missile sites (above, left) have been snapped. This site in west Turkey may have some paid SWLs. Francis Gary Powers (above, right) holds model of U-2 aircraft he flew when shot down over USSR; Powers just might have been in contact with Site 23 when knocked out of sky. On other side of world we have a listening post on Clark Field, Philippines (right).



from listening. Reason is that when collected in large enough quantities and properly analyzed, radio transmissions can tell much about a country's strengths and weaknesses.

To gain insight into how a large, dry-land monitor post operates, we spoke to an Army sergeant who had been stationed at one near Asmara, Eritrea.

"The station's antenna farm is located on top of a nearby plateau," he told us. "Head-end amplifiers boost the signals from these antennas and pass them on via trunk feeders.

This dependence on manual Morse has led to doubts about Russia's man-in-space program, since few conventional SWLs have heard Soviet Cosmonauts. But had these listeners turned on the BFOs (and been able to copy Russian CW), they might have heard the 20- and 42-MHz signals of the orbiting brass pounders. For the truth is that Uncle Sam's monitors *have* listened in on every Soviet space shot, including some which literally never got off the ground.

**Site 23.** One of the posts intercepting



Russian space radio traffic is simply called Site 23. Located near the village of Golbasi, south of Ankara, Turkey, the station functions in a manner similar to the Asmara installation just mentioned.

According to descriptions, creature comforts at Site 23 rate high. Both bachelor and family quarters for some 800 persons are available. Entertainment facilities include a pool, clubs, tennis courts, and similar accommodations provided at military posts having more prosaic missions.

While the exact duties of Site 23 are top

lects—but who may not be able to speak the language—translate voice, CW, and teletypewriter radio communications.

Counterintelligence operations also man intercept posts to trap those very few espionage agents who communicate with their headquarters by radio. When contacting its agents, Moscow has favored 6340; 8888; 14,775; and 17,080 kHz, with 8888 more a calling than a working frequency. Other channels employed usually lie near international broadcast bands.

**Burp Transmissions.** Can ordinary SWLs

## Gentlemen do not read each other's mail—hogwash!

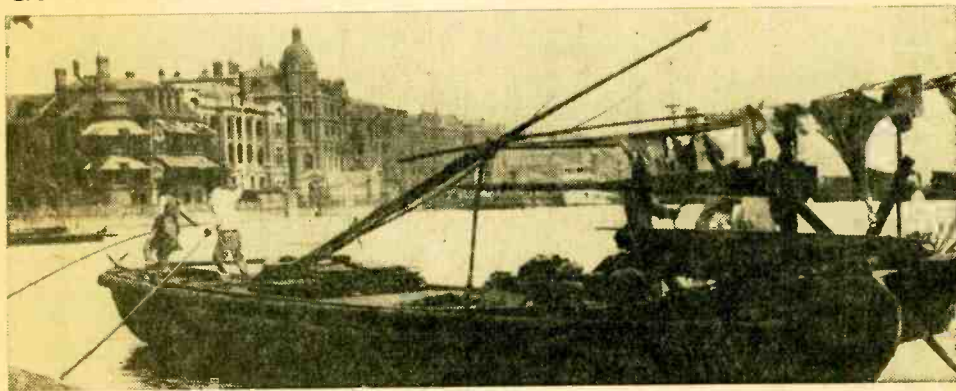

*It all started during World War I, but paid SWLing did not take on serious proportions until 1920s when Herbert O. Yardley (left) cracked secret coded messages monitored by Signal Corps. William F. Friedman (right) cracked famed Japanese Purple Code, a feat that resulted in many American naval victories during World War II. Without listening posts scattered about Pacific, Friedman's efforts would never have been rewarding. Our first listening post in Far East was on fourth floor of U.S. consulate in Shanghai in 1926 (top).*



secret, it's believed the post played a key role in the communications network for U-2 flights operated over the Soviet Union (these were discontinued after Francis Gary Powers was shot down and taken prisoner in 1960). Originally staffed by U.S. personnel, Site 23 is now run by Turks trained in the United States.

On the other side of the world, at a monitor post on Clark Field in the Philippines and at others in arctic Alaska, GI operators who fluently understand one or more Chinese dia-

eavesdrop on these transmissions? It's all but impossible, since messages are sent in 240 wpm CW—each sounds like a burst of static or a burp. Agents using two two-speed tape recorders drop this machine-gun paced code to a reasonable speed, then decipher its five-letter word groups. What some SWLs have reported as secret spy instructions quite probably were nothing more than stock market reports or details of shady business deals.

Ultimately, all messages picked up by government monitors are passed on through

intelligence channels to the headquarters of the National Security Agency at Ft. Meade, Maryland. There, computers break even the toughest codes and ciphers. Traffic-analysis techniques identify military units and attempt to establish their conditions of readiness.

Not all radio monitoring work is so dramatic. One of the missions of the Central Intelligence Agency is listening to foreign broadcast stations. CIA posts all over the

This activity was most recently illustrated when CIA and U.S. State Department monitors were first to learn of the surprise invasion of Czechoslovakia by Warsaw Pact nations. On the evening of August 20, these government SWLs picked up R. Prague's BCB outlets announcing the border crossings. Later that night, many conventional SWLs heard the early close-down of Prague's short-wave outlet following its transmissions to South America. Russian mechanized units rolled into the city as the last strains of the Czech national anthem faded from the 7345-kHz channel.

**How It Began.** Electronic eavesdrop-

## The search for elusive radio waves continues aloft!

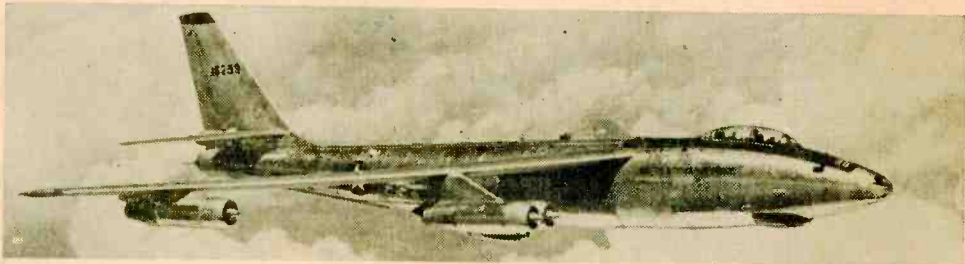
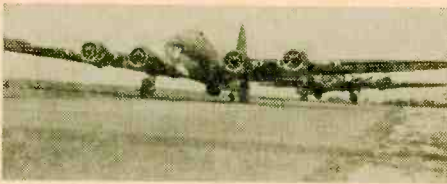

Photos courtesy U.S. Air Force, U.S. Navy, and UPI

Germans snooped on U.S. bombers on English runways during World War II (top, left). Now it's done the other way—Lockheed RC-121D (top, right) snoops on radar sites many hundreds of miles away. Air Force RB-47 (center) was shot down in international waters by a Russian MIG. U-2 (bottom, left), another snooper, was hit by a Red missile. Air Force's new SR-71 (bottom, right) may replace U-2.

world pick up and pass on to Washington details of every major program. Daily, a special staff edits, correlates, prints, and issues this information to the agency's "customers." The subject of a broadcast might be important; so, too, might be what was left unsaid. And, as former CIA chief Allen Dulles admitted, resident CIA agents have occasionally scooped news bulletins.

ping had its origin early in World War I. In 1915, a British Army Intelligence listening post was intercepting German field orders transmitted in plain text from a powerful spark set in Berlin. By the end of the war, accurate radio direction finding had been developed and great progress had been made in codes and ciphers.

During the early 20s, U.S. Army Signal



Corps intercept posts helped genius code-breaker Herbert Yardley crack secret messages from several foreign nations. More than once during international negotiations his efforts gave U.S. representatives valuable insights into the other side's thinking. Yardley's so-called black chamber was closed in 1929 when the then Secretary of State Henry L. Stimson flatly stated, "Gentlemen do not read each other's mail."

The Navy also realized the value of monitoring the airwaves. By 1926 it had, among others, a station on the fourth floor of the American consulate in Shanghai, China. When its regenerative receivers could not

Rico, and on Corregidor in the Philippines. Through an unofficial arrangement sometimes hampered by red tape and snafus, these stations supplied William F. Friedman of the Signal Corps with the hundreds of messages which enabled him to break the Japanese Purple Code. Friedman, using mathematical permutations derived from the intercepts, constructed a Purple machine functionally the same as those used by the Japanese.

In Europe during World War II, the Germans maintained extensive listening networks, backed by direction finding and cryptanalysis facilities to trap spies and saboteurs. They intercepted several Roosevelt-

## Spy ships—they come in all sizes and shapes!

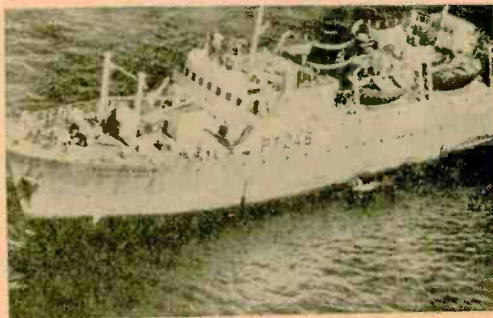
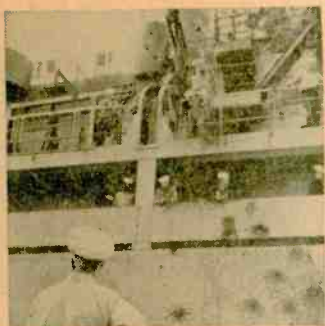

You can be sure that if it floats, it has a radio on board. U.S.S. Liberty (top, left) was racked up by Israelis during 1968 Near East war. Destroyers Turner Joy and Maddox (top, center and right), snooping in Gulf of Tonkin, were shot at. U.S.S. Pueblo (bottom, right) was captured by North Koreans while sailing in international waters. Innocent-looking Russian trawler (bottom, left) is a spy ship?

pick up short-range transmissions from Japanese warships at sea, several sets were installed aboard the destroyer U.S.S. *McCormick*. That autumn, the ship became the first floating monitor post, secretly eavesdropping on Japanese fleet exercises.

During the 1930s, the Army and Navy operated listening posts in the continental U.S., Panama Canal Zone, Hawaii, Puerto

Churchill transatlantic radiotelephone conversations using de-scrambling equipment.

Luftwaffe monitors backed up Reich radar defenses. According to post-war interviews, by listening to "ramp checks" of SCR-274N transmitters aboard Eighth Air Force bombers, the number of aircraft and often the target of upcoming raids could be determined. The Japanese used similar tactics and

maintained a huge intercept station in the southern home islands. From its receivers came information which helped Japan plan its strategic and tactical defense.

**Counterattack!** With extensive use of radar came countermeasures to block its all-seeing eye. Specialized equipment extended the military SWL's frequency coverage to several thousand megahertz. Airborne APR-type UHF receivers and ARA scope read-out analyzers were developed to determine the "signatures" of enemy radars. Similar equipment was built for shipboard use. By determining the distinctive electronic characteristics of a radar set, techniques could be worked out to jam or otherwise thwart enemy equipment.

A Navy training manual describes this activity:

Electronic countermeasures (ECM) prevent the enemy from using his radar and communications equipment effectively, produce false signals on the enemy receivers, and prevent the enemy from using countermeasures on our own radar and communications (counter-countermeasures).

With the end of the hot war and the start of the Cold War, radar and communications monitoring activities increased greatly. Unfortunately, the U.S., new to the ways of deceit and intrigue, got caught several times. Items:

- A Navy "Privateer" aircraft—a single-tail version of the WW II B-24—was shot down by Russians when it "strayed" into East Germany on a mission which combined eavesdropping with "stimulating" air defense systems.

- A USAF B-47 was downed by MiG fighters over the Barents Sea while on an "electromagnetic research" mission.

- Powers' U-2 was hit by anti-aircraft missiles over Russia's heartland.

- More recently, Secretary of Defense Robert S. McNamara revealed in Congressional testimony last year that the 1965 Gulf of Tonkin incident was the result of destroyers U.S.S. *Maddox* and U.S.S. *C. Turner Joy* probing North Vietnamese and Chinese electronic radiations.

That revelation came shortly after a major

communist coup in the shadowy war of electronic wits—the capture of U.S.S. *Pueblo* by North Korea, its crew and its probably-scuttled intercept and processing gear.

**Fishing Ferrets.** The U.S. isn't alone in the radio intercept game. It's no secret that Russia's fleet of trawlers—the world's largest—includes at least 20 ships that carry more monitoring equipment than fishing tackle. And their catch is considerable. These vessels openly hang around U.S. military and space activity and shadow U.S. naval ships at sea. Occasionally they are joined by destroyers and long-range jets.

Currently, the U.S. operates two other "ferrets" of the *Pueblo* class and five similar to U.S.S. *Liberty*. Incidentally, there appears to be evidence, supposedly supported by tape recordings, that *Liberty* overheard Israeli messages starting a "preventive war" and was deliberately attacked during the June 1967 Mideast fighting.

With more and more radio traffic being carried over near line-of-sight VHF channels, naval vessels and large aircraft—such as EC-121-Rs and EC-130s—seem ideally suited for monitor work. Because of their mobility, they can easily move to within range of target transmitters and are relatively safe when in international waters or air space. Filling in any gaps in coverage, spy-in-the-sky satellites whirl around the earth picking up electronic intelligence and snapping impressively detailed pictures.

**The Way It Is.** While some say the future of radio monitoring belongs to the satellites, obsolescent U-2s and EC-121 Constellations still fly from Florida, Formosa, and Thailand. Large, landbased intercept posts will probably never become obsolete because of their high security factor.

And what about the operators in this deadly serious game of electronic eavesdropping? Would they consider their jobs an SWL's dream? Of the five who contributed information for this article, none had been interested in radio before being selected for this work. After separation from government service, only one half-hearted entered ham radio Novice ranks. He let his license expire.

Quite possibly, with the same logic that turns bankers into mechanics, the government believes the best technicians are those whose interest in their jobs won't get in the way of its proper performance—day after day. In short, radio monitor work could be an SWL's nightmare! ■



# MYSTERY BAND CONVERTOR

Our Mystery Band Converter is just the key to open doors to that little-known portion of the radio spectrum which lies smack between the 10- and 6-Meter ham bands. The region from 30 to 50 MHz is a real mystery to most SWLs 'cause there just aren't any receivers around that'll pick up these action-packed signals! Not only will the Mystery Band Converter give you a change of pace from regular listening fare, but it will greatly extend the usefulness

(Continued overleaf)

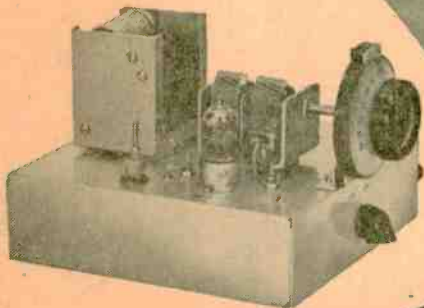

By Charles Green, W6FFQ

Don't just tune to 34 MHz and relax. Build this RF converter that blasts you into the action-packed frequencies above 10 Meters!

# e/e MB CONVERTOR

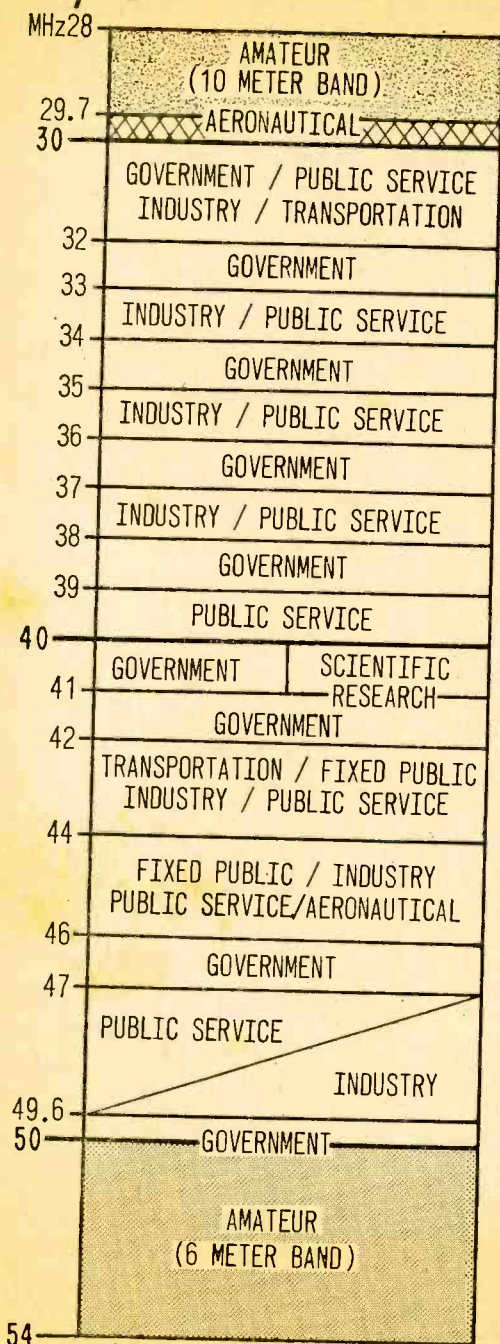

Spectrum chart indicates frequencies allotted by U.S. government to various services. Portion covering 30 to 50 MHz is smack between 10- and 6-Meter ham bands. Ham transmissions should help you get a bearing before you start monitoring tricky broadcasts of utility companies, etc., which are of short duration.

of your present SW receiver. The 30- to 50-MHz band has allocations for government service, industry, land transportation, public service, domestic public, and some scientific research (see spectrum chart), so this "mystery band" is almost as exciting as the vhf frequencies used for police and aircraft communications. Transmissions you'll hear include civil defense, fire, police, utility companies, radio-dispatched emergency vehicles, radio paging, and industrial communications.

While frequency allocations and degree of activity vary across the country, your Mystery Band Converter will provide hours of exciting listening. For the first time you'll have some daytime listening to balance the endless sweep of international broadcasts during evening hours.

**Broadband Circuit.** This one-tube converter tunes from 30 to 50 MHz and provides an RF output of 1550 kHz. You simply turn to 1550 on your AM receiver and then tune in the action with the vernier dial of your converter. Besides the simplified design, there is a plug-in AC power supply that enables you to power other projects as well.

**Plug-in Power.** The 125-V secondary from transformer T1 is connected to half-wave rectifier D1; the rectified DC is then filtered by an RC network consisting of C2A/B and R1. Leads for the B+ supply, 6.3-V filament supply, and 117-VAC primary are connected to P1 as shown on the schematic.

The plug-in power supply goes together in

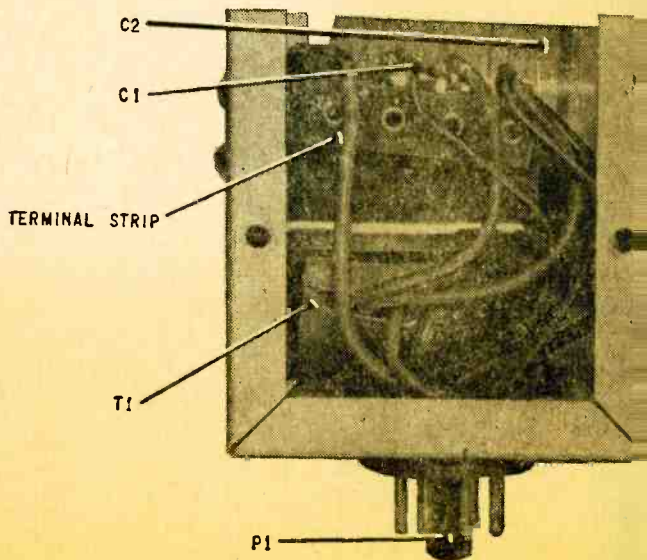

P1



Antenna signals fed through J1 to L1 are tuned by C2A. Tube V1A mixes the received signals with the RF output of the V1B oscillator circuit. This circuit is tuned by L2/C2B over the 30-50 MHz band and its output differs from the incoming signals by 1550 kHz. This frequency difference is converted by V1A into a 1550-kHz RF output and fed through L4 and J2 into your receiver.

**Construction.** The basic unit is built on a 7 x 7 x 2-in. aluminum chassis. Start your work by taping a piece of paper over the chassis to mark the component locations. Before actually laying out component locations, install the vernier dial at the front. We used a section of 1/2-in. aluminum angle-stock to mount the dial assembly, but a section of sheet aluminum bent to form a bracket can also be used.

Position C2A/B temporarily behind the dial and locate the chassis mounting holes. If C2A/B has a flat shaft, either drill and tap a new set screw hole on the dial housing (as we did), or insert a metal section to allow the dial's set screw to grip the shaft. Now locate the remaining holes on the paper.

a jiff. Build it into a 2 3/4 x 2 1/8 x 2 3/4-in. aluminum box and use caution when installing the components as there is very little space.

Cut a hole in the box bottom and install plug P1. Mount power transformer T1 at an angle on one side as shown to allow room for the terminal strip, D1 and C1, as well as electrolytic capacitor C2. Wire in the com-

ponents exactly as shown because parts placement is critical due to the high frequencies involved. Install ground lugs on the mounting screws of V1's socket. Use metal spacers or nuts to keep the frame of C2A/B aligned with the vernier dial and the chassis. Make sure the dial doesn't bind when it is rotated; this indicates misalignment.

Drill 1/4-in. holes directly below the C2A/B stator lugs for the C1 and C13 leads. Power jack J3 can be mounted directly on the chassis or on a section of aluminum below an opening in the chassis to allow flush mounting of the power supply unit.

Coil L4 is mounted in a rubber grommet on the left side along with L1, L2 and V1. When you wire the components keep the leads as short and direct as possible. Use insulation to keep leads from C1 and C13 from shorting against the chassis.

The *gimmick* capacitor is made with two lengths of #22 insulated hookup wire twisted together with three turns. Keep the wire ends as short as possible. To make L1's

ponents according to the schematic. Make sure parts and leads don't short to the box when the cover is installed.

You can use your power supply module to provide the juice for any number of projects. There are outputs for both an unfiltered 125-V B+ and a filtered 120-V B+. Just make sure both chassis are grounded. ■

#### PARTS LIST FOR POWER SUPPLY

- C1—001-uF ceramic disc capacitor  
 C2A, B—Dual-section, 20-30-uF, 150-VDC electrolytic capacitor (Sprague TVA-2421; Lafayette 34T5592 or equiv.)  
 D1—400-PIV, 750-mA silicon rectifier (1N-2070 or equiv.)  
 P1—Chassis mounting octal plug (Amphenol 8Δ-CP8, Allied 47E0020 or equiv.)

- R1—1000-ohm, 1-watt 10% resistor  
 T1—117-VAC pri., 125-V, 15-mA—6.3-V, 0.6-A sec., power transformer (Allied 54C-1410 or equiv.)  
 1—2 3/4 x 2 1/8 x 2 3/4-in. aluminum chassis box (LMB-771 or equiv.)  
 Misc.—4-lug terminal strip, wire, hardware, solder, etc.

*Plug-in power supply is kind of traveling salesman that'll give plenty of gas to circuits operating around 120 V. As photo shows, extra care must be taken to avoid shorts against metal case. Note that power transformer T1 is mounted at angle; this allows more room for components mounted above on terminal strip. If you want, line cord can be added here instead of on power jack.*

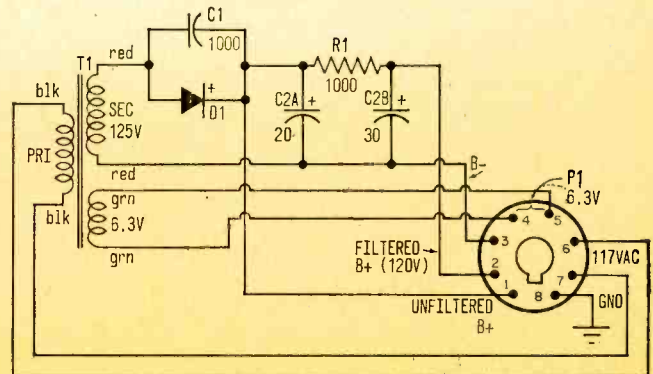

# e/e MB CONVERTOR

primary, wind 2 turns of #22 hookup wire around the L1 winding and connect one wire to a ground lug at the socket of V1 and the other wire to J1.

Coil L2's tickler is made by winding 3 turns of #22 hookup wire around L1 in the same direction as the coil winding. Connect the end of the wire closest to the chassis to a ground lug at the socket of V1 and the other end to pin 8 of V1. Again, keep the leads as short and direct as possible. Finally, for L3, wind 1 turn of #22 bus wire around R1 and solder the leads flush against R1.

**Alignment.** Plug the power supply into its socket. With V1 in its socket, connect J2 to your receiver's antenna and ground terminals, using coaxial cable. If the receiver doesn't have external antenna and ground terminals wind several turns of hookup wire around the antenna loopstick and connect these leads to the coax.

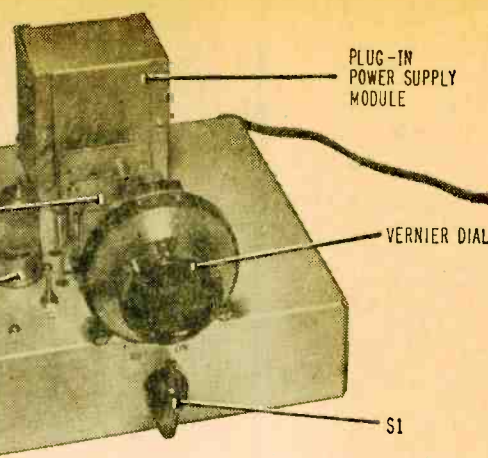
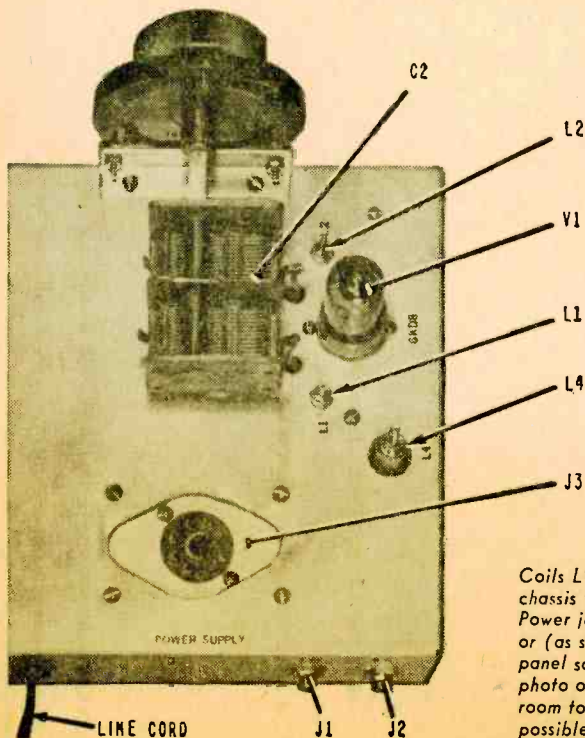

*Large vernier dial allows precision tuning of stations that are somewhat difficult to find. Transmissions are usually brief and to the point. Power supply is behind C2 and isolated from tube V1.*

Be sure there's no connection to the chassis of an AC/DC receiver to prevent possible electrical shock. Plug in the power cord to the AC line, set S1 to *on* and allow the unit to warm up for a few minutes. Set your receiver's tuning dial to a clear frequency near 1550 kHz.

Connect a signal generator to J1 and set the generator controls for a 1550-kHz modulated output. Adjust L4 for a signal of maximum strength. Now set C2A/B to full capacity and adjust trimmer capacitors C3 and C11 for minimum capacity. Set the generator controls for a 30-MHz modulated output and adjust L1 and L2 for maximum signal strength.

Set C2A/B to minimum capacity and adjust the generator controls for a 50-kHz modulated output. Adjust C3 and C11 for maximum signal strength and then repeat the preceding 30- and 50-MHz adjustments.

If you cannot hear the generator's signal in your receiver, the oscillator circuit may not be operating. To check this out, connect a VTVM probe to pin 9 of V1B and the common lead to the chas-

*Coils L1, L2, and L4 are accessible from top of chassis to permit easy alignment of convertor. Power jack J3 can be mounted on top of chassis, or (as shown here) underneath chassis on metal panel so that supply module is flush. At right, photo of guts shows that there's plenty of elbow room to work in. A more compact package is possible, but critical stages should be shielded.*



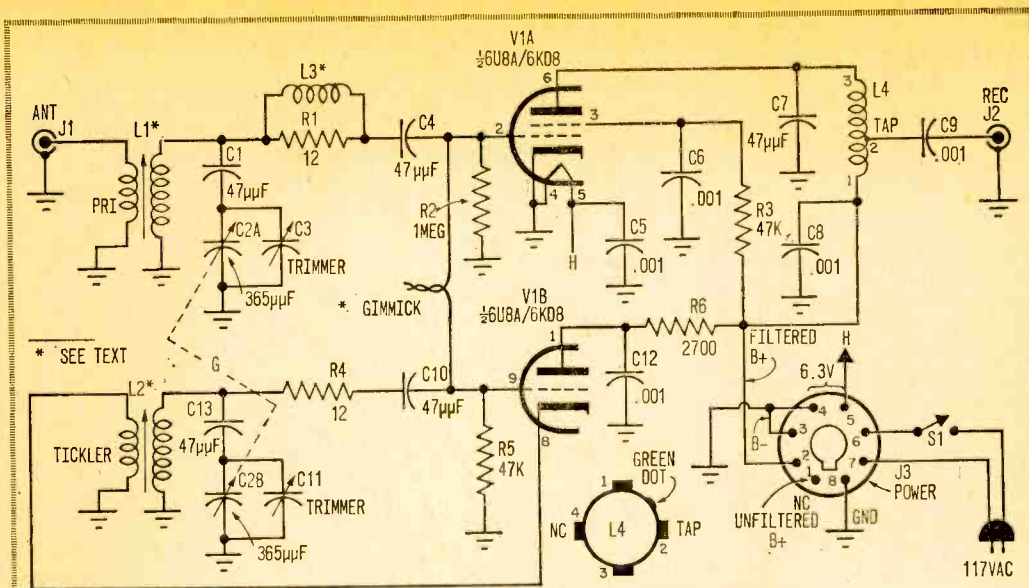

**PARTS LIST FOR MYSTERY BAND CONVERTOR**

- C1, C4, C7, C10, C13—47-pF ceramic disc capacitor
- C2A, B—Dual-section 365-pF variable capacitor (Lafayette 32T1102 or equiv.)
- C3, C11—Trimmer capacitors (part of C2)
- C5, C6, C8, C9, C12—.001- $\mu$ F ceramic disc capacitor
- J1, J2—Phono jacks
- J3—Octal socket (Amphenol 78R58, Allied 47C0008 or equiv.)
- L1, L2—0.68- $\mu$ H RF coil (J.W. Miller 20A687-RB1 or equiv.—see text)
- L3—See text
- L4—Tapped oscillator coil (J.W. Miller A-5496-C or equiv.)
- Note—Coils L1, L2, and L4 are available

- from Custom Components, Box 352, Alden Manor, Elmont, N.Y. 11003, for \$4.95, including postage and handling.
- R1, R4—12-ohm, 1/2-watt 10% resistor
- R2—1,000,000-ohm, 1/2-watt 10% resistor
- R3, R5—47,000-ohm, 1/2-watt 10% resistor
- R6—2700-ohm, 1/2-watt 10% resistor
- S1—Spst, 125-V, 3-A toggle or slide switch
- V1—6U8A/6K08 vacuum tube
- 1—7x7x2-in. aluminum chassis (Bud AC-405, Allied 42C7849 or equiv.)
- Misc.—2 7/8-in. vernier dial (Lafayette 99T-6029 or equiv.), 9-pin tube socket, AC line cord, aluminum brackets (see text), #22 solid hookup wire, 1/4-in. spacers, grommets, hardware, solder, etc.

sis. The VTVM should indicate a minimum of several negative volts. If it doesn't, reverse

the connections to the tickler on coil L2.  
**Operation.** Since signals in this portion of the spectrum have a line-of-sight propagation (similar to TV signals), an outside antenna mounted as high as possible is best for good reception. Most signals will undoubtedly be vertically polarized, so a CB whip or ground-plane antenna should work fine. Use coax to connect the antenna to the converter.

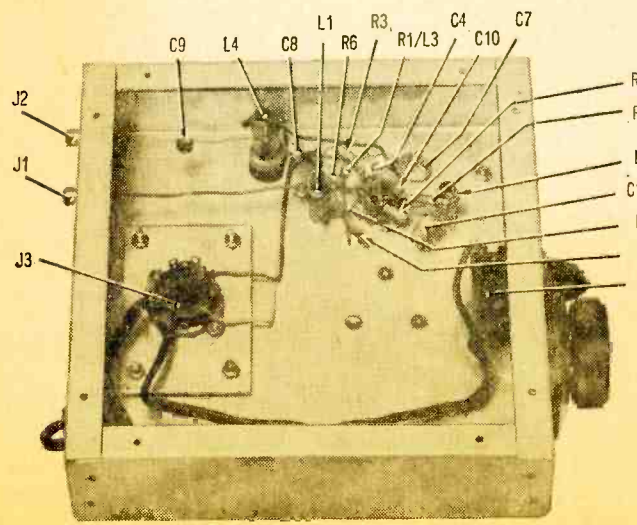

Because of the wide frequency coverage, tuning will be sharp. Tune very slowly and use the receiver's tuning dial as a bandspread or fine tuning control.  
Note that FM transmission can be received by tuning to one side of the signal for slope detection.

# MYSTERY-BAND

Here's a pocket guide for quick and ready listening to police,

Stations in the listing below represent many of the police, fire, and other emergency radio stations operating between 30 and 50 MHz. Actually, there are thousands of additional stations on these frequencies; we have attempted to cover those in the larger cities and towns which are most active on the air and are heard over the longest distances.

In many instances, the cities indicated operate a number of transmitters on the same channel. Due to space limitations, we have generally shown only one of these stations per frequency in each city. Also, bear in mind that it's very common for small towns to congregate on certain frequencies on a statewide basis. Therefore, if you don't find a particular city or town shown for a specific state, there's a good chance that it operates on one of the frequencies listed for that state. Since state police networks are generally extensive (several dozen stations per channel), we have listed these frequencies for your use.

**ALABAMA**  
(SPD nets: 44.62 45.98)  
Birmingham KF2727 45.66 CP

**ARIZONA**  
(SPD nets: 39.18 39.36 44.66)  
Flagstaff KOA348 39.18 CP  
KBB851 46.02 P  
Kingman KOA776 39.18 CP  
KOF554 39.18 CP  
Phoenix KQA775 39.18 CP  
Tucson KOA258 39.18 CP  
KOC497 46.06 VF  
Winslow KOA203 39.18 CP

**ARKANSAS**  
(SPD net: 44.62)  
Fayetteville KKA863 37.10 P  
Hot Springs KKF280 37.10 P  
Texarkana KK0635 33.98 F  
KKC659 37.10 P  
W. Memphis KKC213 37.10 P

**CALIFORNIA**  
(SPD nets: 39.10 42.12 42.34 42.40 42.44 42.54 42.56 45.86)  
Beverly Hills KMF619 33.70 F  
KMA450 37.10 P  
Los Angeles KBQ236 33.48 F  
KBQ236 33.60 F  
KBQ236 33.70 F  
KBQ236 33.82 F  
KBQ236 33.84 F  
KBQ236 33.90 F  
KBQ236 33.94 F  
KDZ328 37.14 P  
KFV978 39.20 CP  
KFV978 39.28 CP  
KMA629 39.32 CP  
KMA629 39.36 CP  
KMA629 39.48 CP  
KMA628 39.52 CP  
KMF964 39.98 CP  
KCU833 45.82 CP  
KCU833 46.02 CP

**San Jose** KMA376 39.92 CP  
**San Rafael** KMA224 39.46 CP  
KMA224 39.70 CP  
KMA224 39.82 CP  
KML958 46.28 CF  
KAR967 46.50 F  
KML958 46.50 CF  
**Santa Barbara** KMH319 45.46 CP  
**Santa Monica** KMA859 45.50 P  
KMA581 33.70 F  
**Vallejo** KMH234 33.82 VF  
KGJ658 37.06 P

**COLORADO**  
(SPD nets: 42.46)  
Denver KAA511 39.06 CP  
KCT512 39.06 CP

**CONNECTICUT**  
(SPD nets: 45.02 45.10)  
Bridgeport KEP640 33.70 VF  
KCF588 33.78 F  
KCF588 33.86 F  
KCA284 39.10 P  
KCA284 39.34 P  
KCF595 33.86 CF  
KCA464 39.42 P  
Darien KDD941 33.62 F  
KCF594 33.86 CF  
KCA971 37.10 P  
KCA971 39.46 P  
KCF592 33.86 CF  
KCA778 39.46 P  
KCA778 39.94 P  
KCC345 46.50 F

**GREENWICH**  
KCF592 33.86 CF  
KCA778 39.46 P  
KCA778 39.94 P  
KCC345 46.50 F

**Oceanside** KMA857 45.54 P  
KDL922 46.08 F  
**Orange** KMA752 45.14 CP  
KMA752 45.22 CP  
KMA752 45.26 CP  
KMA752 45.30 CP  
KMA752 45.34 CP  
KMA752 45.66 CP  
KF0907 46.06 CF  
KMD639 46.10 CF  
KBU636 46.34 F  
**Pasadena** KCL217 45.42 P  
KMF260 46.10 F  
**San Diego** KMJ212 45.70 CP  
KMJ212 45.94 CP  
**San Francisco** KMJ408-17 45.14 P  
KMJ408-17 45.46 P  
KMJ408-17 45.58 P  
KMB488-98 46.18 F  
KMB488-98 46.46 F

**Pasadena** KCL217 45.42 P  
KMF260 46.10 F  
**San Diego** KMJ212 45.70 CP  
KMJ212 45.94 CP  
**San Francisco** KMJ408-17 45.14 P  
KMJ408-17 45.46 P  
KMJ408-17 45.58 P  
KMB488-98 46.18 F  
KMB488-98 46.46 F

**San Jose** KMA376 39.92 CP  
**San Rafael** KMA224 39.46 CP  
KMA224 39.70 CP  
KMA224 39.82 CP  
KML958 46.28 CF  
KAR967 46.50 F  
KML958 46.50 CF  
**Santa Barbara** KMH319 45.46 CP  
**Santa Monica** KMA859 45.50 P  
KMA581 33.70 F  
**Vallejo** KMH234 33.82 VF  
KGJ658 37.06 P

**COLORADO**  
(SPD nets: 42.46)  
Denver KAA511 39.06 CP  
KCT512 39.06 CP

**CONNECTICUT**  
(SPD nets: 45.02 45.10)  
Bridgeport KEP640 33.70 VF  
KCF588 33.78 F  
KCF588 33.86 F  
KCA284 39.10 P  
KCA284 39.34 P  
KCF595 33.86 CF  
KCA464 39.42 P  
Darien KDD941 33.62 F  
KCF594 33.86 CF  
KCA971 37.10 P  
KCA971 39.46 P  
KCF592 33.86 CF  
KCA778 39.46 P  
KCA778 39.94 P  
KCC345 46.50 F

**Danbury** KCF595 33.86 CF  
KCA464 39.42 P  
**Darien** KDD941 33.62 F  
KCF594 33.86 CF  
KCA971 37.10 P  
KCA971 39.46 P  
KCF592 33.86 CF  
KCA778 39.46 P  
KCA778 39.94 P  
KCC345 46.50 F

**Hartford** KCA330 45.86 P  
KCA330 45.90 P  
**New Haven** KCA378 33.82 F  
KCA280 37.10 P  
KJU824 37.32 P  
KGW716 37.40 P  
KCA280 45.86 P  
**New London** KCA276 33.90 F  
KCA276 33.94 F  
KCA554 37.12 P  
KCA554 37.26 P  
**Norwalk** KCE670 33.86 F  
KCB297 39.46 P  
KCB297 39.98 P  
**Stamford** KCF600 33.86 CF  
KCB280 33.98 F  
KCA336 39.02 P  
KCA336 39.46 P  
**Waterbury** KCA741 39.10 P  
KEM748 45.86 P

**DELAWARE**  
(SPD net: 45.02)  
Dover KGC524 33.78 VF  
New Castle KDL809 33.78 CF  
KDG536 33.94 VF  
Wilmington KE0309 33.78 VF  
KGD251 33.78 VF  
KGD394 33.94 VF  
KGF268 39.86 CP

**DISTRICT OF COLUMBIA**  
Washington KQA947 39.02 P  
KQA792-5 39.02 P

**FLORIDA**  
(SPD nets: 45.06 45.10 45.42)  
Bradenton KID220 37.10 CP  
Gainesville KIM203 45.22 CP  
Miami KFG483 37.12 CP  
KIM654 33.72 CF  
Jacksonville KIL436 33.74 CF  
Naples KIJ601 46.02 CP  
St. Augustine KIC244 39.50 CP  
St. Petersburg KJY886 46.12 VF  
Sarasota KDE709 46.06 CF  
Tallahassee KIH616 37.30 CP

**GEORGIA**  
(SPD net: 42.02)  
Albany KGT575 42.02 CP  
Athens KIN766 39.50 P  
Decatur KIB572 46.02 CP  
KIK492 46.18 CF  
KFN721 42.02 CP  
Macon KJY886 46.12 VF  
Savannah KIB851 37.10 P

**HAWAII**  
Hilo KJD906 46.10 CF

**IDAHO**  
(SPD net: 42.54)  
American Falls KJE224 39.82 CP  
Boise KBY477 39.82 P  
KBY477 39.86 P  
KGP703 39.86 CP  
KGP700 47.20 CP  
Mountain Home KOG972 39.82 P  
K01861 39.82 P  
Pocatello KOH209 39.82 P  
Twin Falls KOG982 39.82 P

**ILLINOIS**  
(SPD nets: 39.46 42.50 42.56 42.60)  
Bloomington KSA938 39.46 CP  
KSA938 39.50 CP  
Cairo KGR233 39.50 CP  
KSA515 39.50 P  
Chillicothe KSB568 39.46 P  
Decatur KSA926 39.46 CP  
KSA926 39.50 CP

## ABBREVIATIONS

C—County Agency  
D—Civil Defense  
F—Fire (unless otherwise noted, a city-operated fire department)  
ME—Hospital  
P—Police (unless otherwise noted, a city, boro, or township police department)  
SPD—State Police  
TE—Transit Emergency  
V—Volunteer agency



# STATION GUIDE

fire, hospital, and emergency stations throughout the U. S.A.

**Kankakee** KCL754 33.74 F  
KSB204 39.46 CP  
KSB204 39.50 CP  
**Macomb** KSC343 39.46 CP  
KSC343 39.50 CP  
**Moline** KSE204 39.46 CP  
KSE204 39.50 CP  
**Rockford** KSA380 39.46 CP  
KSA380 39.50 CP  
**Springfield** KSB284 39.46 P  
KSC460 39.46 CP

**INDIANA**  
(SPD net: 42.42)  
**South Bend** KJD321 37.04 P

**IOWA**  
(SPD nets: 42.08 42.58)  
**Ames** KAB216 37.10 P  
**Cedar Rapids** KEU928 37.10 CP  
KEU928 37.20 CP  
KAA756 39.28 P  
**Council Bluffs** KAN839 33.94 F  
KBU685 37.10 CP  
**Davenport** KGT566 37.10 CP  
**Des Moines** KAB540 37.10 CP  
**Dubuque** KAM681 37.10 CP  
**Ottumwa** KCW421 37.10 CP  
**Sioux City** KAA966 37.10 P

**KANSAS**  
(SPD nets: 44.98 45.14)  
**Abilene** KAA494 39.46 CP  
KAA494 39.58 CP  
**Atchison** KAE695 39.46 CP  
KAE695 39.58 CP  
**Kansas City** KJB814 39.46 CP  
**Salina** KAB205 39.46 P  
KAB205 39.58 P  
KDZ390 39.58 CP  
**Topeka** KAA399 39.46 CP  
KFV918 39.46 CP  
KAA399 39.58 CP  
KFV918 39.58 CP  
**Wichita** KAA663 39.46 P  
KAB235 39.46 CP  
KAA663 39.58 P  
KAB235 39.58 CP  
KAX436 39.58 P  
KAX581 46.14 CF

**KENTUCKY**  
(SPD nets: 42.64 44.62)  
**Frankfort** KIC514 45.58 P  
**Lexington** KBG517 33.98 CP  
KIB884 37.16 CP  
KIB873 39.68 F  
**Louisville** KII319 33.86 F  
KOK504 33.86 F  
KIB695 37.06 P  
KIB695 37.14 P

**LOUISIANA**  
(SPD nets: 39.30 39.50 44.70)  
**Baton Rouge** KJY678 39.40 P  
KKG654 39.50 P  
KJY678 39.54 P  
KJY678 44.70 P  
**Lake Charles** KE0244 39.86 CP  
**New Orleans** KGK657 39.22 P  
KKI784 39.50 CP  
KGK657 39.62 P  
**Shreveport** KKA387 39.66 CP  
KKW561 44.70 P

**MAINE**  
(SPD net: 42.14)  
**Bath** KDN929 39.62 P  
**Brunswick** KCA873 39.10 P  
**Falmouth** KKC298 39.54 CP  
**Portland** KJK778 39.54 CP  
KJK778 39.62 CP

**MARYLAND**  
(SPD nets: 39.10 39.26 39.30 39.34)  
44.70 44.74)  
**Annapolis** KGB645 39.58 CP  
KGC845 46.50 VF  
KGD308 46.50 VF

**Baltimore** KGA340 39.42 CP  
KGA340 39.44 CP  
KGA340 39.56 CP  
KGA340 39.62 CP  
KGA340 39.72 CP  
KCB961 46.50 VF  
KGC527 46.50 VF  
**Hagerstown** KGC676 33.86 CF  
**Salisbury** KGA935 39.82 P

**MASSACHUSETTS**  
(SPD nets: 37.14 39.58 44.74)  
**Boston** KJS733- 33.74 F  
5  
KCC768- 39.02 P  
84  
**Brookline** KCF364- 33.78 F  
70  
**Framingham** KCC457 33.98 F  
KCA458 39.52 P  
**Lynn** KCA702 45.46 P  
**Plymouth** KAT541 33.90 F  
KCA708 39.22 P  
KCA281 45.34 P  
KCA226 46.02 P  
**Revere** KCA706 33.86 F  
**Salem** KCA968 45.54 P  
**Worcester**

**MICHIGAN**  
(SPD nets: 42.48 42.56 42.58 42.60)  
42.68 45.38)  
**Ann Arbor** KQH905 37.10 CP  
**Cheboygan** KQG579 39.82 CP  
**Detroit** KDS689 37.06 P  
KQB953 39.06 P  
KQA371 39.10 P  
KQB953 39.28 P  
**Flint** KJR386 39.14 CP  
**Grand Rapids** KQG608 39.14 CP  
KQG608 39.42 CP  
**Jackson** KCI658 33.78 F  
**Muskegon** KQA918 39.82 P  
**St. Joseph** KQB341 39.58 CP  
**Sault St. Marie** KBT457 39.82 CP  
**Ypsilanti** KDX474 37.10 CP

**MINNESOTA**  
(SPD nets: 42.66 42.82)  
**Duluth** KAA939 39.22 P  
KAA939 39.46 P  
**Grand Rapids** KAG351 45.14 P  
**International Falls** KA0244 45.58 CP  
**Minneapolis** KAL399- 33.82 F  
418  
KAA517 39.90 CP  
KAA517 45.66 CP

**MISSISSIPPI**  
(SPD nets: 42.02 42.12)  
**Jackson** KKR841 45.10 CP  
KKL450 46.46 F  
KKE323 45.10 P  
**Natchez** KKD275 45.10 P  
**Vicksburg**

**MONTANA**  
(SPD net: 39.82)  
**Billings** KDT393 39.82 CP  
KOE381 39.82 CP  
KDT393 39.86 CP  
KOH637 39.94 P  
**Bozeman** KOA404 39.82 P  
**Butte** KOA278 39.82 P  
KOG907 39.82 CP  
KOG907 39.94 CP

**Great Falls** KOA216 39.82 CP  
KOA216 39.94 CP  
**Kalispell** KOA999 39.82 CP  
**Missoula** KOA722 39.82 CP  
K01451 39.82 P  
K01451 39.94 P

**NEBRASKA**  
(SPD net: 42.46)  
**Grand Island** KAL656 39.90 CP  
**Lincoln** KAH638 39.90 CP  
**Omaha** KA0216 33.86 F  
KAB320 37.10 CP

**NEVADA**  
(SPD net: 42.94)  
**Carson City** KON350 39.50 P  
**Reno** KDN560 39.22 CP  
KOA303 39.50 P  
KAW739 46.06 F

**NEW HAMPSHIRE**  
(SPD nets: 37.18 44.94)  
**Bristol** KBV721 37.10 P  
**Concord** KCA792 37.10 P  
**Dover** KCA352 37.10 P  
KCA215 33.90 F  
KCA794 37.18 P  
**Laconia** KCA695 33.78 F  
**Manchester** KC1292 45.90 CP  
**Salem** KGW680 45.94 P

**NEW JERSEY**  
(SPD nets: 44.62 44.66 44.94)  
**E. Orange** KEB385 39.54 P  
**Elizabeth** KEC361 45.98 CP  
**Hackensack** KEA334 37.38 CP  
**Irvington** KEA743 45.10 P  
KAZ584-7 46.24 F  
**Morristown** KEB262 39.08 P  
**New Brunswick** KEJ874 33.82 F  
**Newark** KED494 45.22 CP  
**Orange** KEB348 39.62 P  
KDA401 46.12 F  
**Paramus** KFM359 37.38 CP  
KCC209 39.94 P  
**Passaic** KDN419 45.78 P  
**Paterson** KEH997 46.40 F  
KED412 39.86 P  
KED839 45.42 P  
Park  
KAQ236 46.20 F  
KAQ236 46.38 F  
**S. Hackensack** KKB860 37.10 P  
KKB860 37.38 P  
**Trenton** KEB276 37.26 P  
**W. Orange** KED285 45.62 P  
KCZ455 46.08 F

**NEW MEXICO**  
(SPD nets: 39.78 39.90)  
**Albuquerque** KKD428 39.18 P  
**Gallup** KKG315 39.64 P  
**Roswell** KKC644 39.90 P  
**Santa Fe** KKC615 39.50 P  
**Tucumcari** KKK534 39.90 P  
KKQ534 39.98 P  
KKD311 39.90 P

**NEW YORK**  
(SPD nets: 42.04 42.14 42.36 42.52)  
**Albany** KDX411 46.06 VF  
**Amsterdam** KEB441 39.18 P  
**Binghamton** KED580 33.90 VF  
KDG222 33.98 FD  
KED639 39.22 CP  
KED639 39.46 CP  
**Buffalo** KEB501 37.26 CP  
KJU993 46.38 CF  
**Cortland** KEA243 39.42 P  
KDJ455 46.08 CP

(Continued on page 107)

# DXing the Country that Isn't

Nation within a nation,  
Quebec still has dreams  
of going it alone

By C.M. Stanbury II



## ABBREVIATIONS

BCB, BCBer	broadcast band, broadcast-band station
CBC	Canadian Broadcasting Corporation
DX	long distance, distant (contact or country)
EST	Eastern Standard Time
KHz	kilohertz (kilocycles)
MW	medium-wave
O.R.T.F.	Office de Radiodiffusion-Télévision Française
QRM	noise and signals interfering with desired signals
S/O	sign-on
SW	shortwave
SWBC	shortwave broadcasting

**W**ith the obvious exception of Cuba, the Canadian province of Quebec is probably the most controversial area in all North America. Largely isolated by language, often publicized for its separatist minority, genuinely dominated by a surge of at least moderate nationalist ambitions, and definitely in a state of change, Quebec represents a fascinating challenge for the distant radio listener.

The Canadian Broadcasting Corporation's international service maintains its headquarters and studios in the Quebec metropolis of Montreal (transmitters, however, are at Sackville, New Brunswick). During Canada's 1967 centennial celebration and world's fair, the CBC's international service built a multimillion-dollar production center and show place right on the EXPO 67 grounds in Montreal. But despite its extensive Montreal facilities, many Quebec citizens, especially those with separatist leanings, do not feel that the CBC adequately represents the French Quebec culture.

The only shortwave broadcast station actually transmitting from the province is CFCX (6005 kHz) also from Montreal, and relaying the programs of MW BCBER CFCF (600 kHz). CFCX certainly does nothing to represent French culture, since its transmissions are entirely in English. They actually include such items as American commentator Paul Harvey, though this in itself is enough to make the station a unique SW logging.

Station CFCX, owned by Marconi Radio, is in fact one of Canada's oldest SWBC





voices, having first taken the air in the 1930s. The SW portion of Marconi's Montreal operation was silent throughout most of the 50s, then reactivated again at the beginning of this decade. If you live east of the Mississippi, you'll probably be able to pick up CFCX sometime during daylight hours when 49-Meter QRM is at a minimum. Out west, DXers will have to wait for dark and fight it out with the Latin Americans.

**From Abroad.** Despite the political unrest in this province, there are surprisingly few international SWBC transmissions specifically aimed at Quebec. In fact, the only SW broadcast officially designated as for Quebec is from ultra-right Radio Portugal at 2115 EST on 9630 kHz. This is followed by English at 2200 for the rest of Canada.

Contrary to what one might expect from General DeGaulle's public utterances, O.R.T.F.'s French transmissions for North America are officially designated as beamed to Latin America and the West Indies. They are aired at 1400-1430 EST on 17850 and 15120 kHz, then at 1900-1930 EST on 17730, 15245, 11845, and 9755 kHz. Thing

is, DeGaulle and his O.R.T.F. have found an even more spectacular way of getting into the act, as we'll see shortly.

The final outside irritant is R. Havana, Cuba, which has French for this continent at 0500 on 6135 kHz, and at 2200 on 11760 kHz. However, RHC's prime targets are Haiti and DeGaulle's Latin American colonies, rather than Quebec. Undoubtedly, should the Quebec separatist movement deepen, we can expect much more Quebec-oriented SWBC activity that at present.

**Medium Wave.** Best prospects for DX from Quebec are on the Broadcast Band. For novices, easiest BCB station to hear from this province is CBF, the CBC's 50-kW French-language outlet at Montreal on 690 kHz. In eastern and central states, watch for it during evening hours when conditions for northern stations are generally good. There normally will be some QRM from R. Progreso in Havana; out west there will be more severe QRM headaches from CBU Vancouver and XETRA Tijuana, so your best bet may be is CBF's 0600 EST S/On.

Another good DX prospect is the CBC's

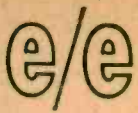

Chateau Frontenac hotel, historic, turreted landmark, rises high above older section of Quebec City.



Quebec Seminary is Old World in appearance, very French in flavor. Note iron gates and grillework.

French-speaking CBJ further north and east at Chicoutimi, with 50 kW on 1580 kHz. Here, there will be interference from both WCLS in Columbus, Georgia (but this will only be a major problem in the southern states) and XEDM at Hermosillo, Mexico. A third CBC outlet worth tuning is Montreal's English-speaking CBM on 940 kHz.

Staying in Montreal but moving up the dial 40 kHz, we find one of the most interesting of those many private BCB stations operating in Quebec—CKGM, famous for one Pat Burns. For the record, Mr. Burns

is telephone talk moderator *par excellence*. He is sharp-tongued, interesting, and very controversial. He previously operated over a Vancouver station where he did wonderful and marvelous things to the local establishment and almost cost that station its license (no credit to the city of Vancouver). North American radio needs more Pat Burnses.

Though Burns would certainly be classed as a progressive on the subject of French-English relations, this still did not prevent a mob from smashing up CKGM's news  
(Continued on page 109)



Gaspé Peninsula, first explored by France's Jacques Cartier in 1534, is still stronghold of French Canadian culture. Fishing remains region's major industry, but highway which encircles peninsula now attracts tourists who delight in charm of picturesque villages as well as hunting and fishing afforded.



# EXPERIMENTER'S ELECTROSCOPE

By Charles Green, W6FFQ

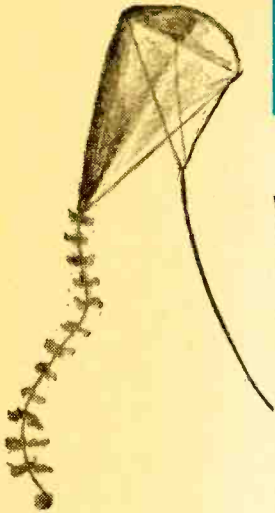

**When Ben Franklin** conducted his famous kite-flying experiment in the midst of a thunderstorm, he wasn't just showing his cool while the lightning flashed. His was a genuine scientific experiment to demonstrate the similarity between lightning and ordinary static electricity. Of course, this was like going into a tiger's cage to see the similarity to a pet pussycat.

Static electricity is normally produced by friction. In cold, dry weather, walking across a rug and then touching a grounded metal object can give you quite a shock. Even sliding out of a car that has a plastic seat cover can end in a jolt.

Static electricity is either an accumulation or deficiency of electrons on an insulating material such as plastic or glass. Even though materials that are electrical insulators cannot freely conduct electricity, electrons can still be dislodged from their atoms by the application of an external force. This force is usually the friction of one electrically insulating material rubbing against another.

When a *glass* rod is rubbed with a cloth, for instance, some of the electrons that are loosely bound to the atoms of the glass are transferred to the cloth. When the cloth is removed from the rod's surface, the glass has a deficiency of electrons and is considered to be positively charged. If a *plastic* rod is rubbed with a cloth, electrons are transferred from the cloth to the plastic rod. This gives the plastic rod a negative charge.

You can experiment with static electricity by assembling an *electroscope*. The electroscope will indicate the presence of a static electric charge by the mutual repulsion of identically charged, metal-foil leaves.

Our electroscope is built into a glass bottle that has an insulated wire suspending two aluminum-foil leaves. When an electrically charged object touches the wire-loop electrode at the top of the electroscope, the static charge will be conducted down the wire to the foil leaves, causing them to separate. The degree of separation depends upon the strength of the electric charge.

**Construction Caper.** We used a 7-oz. Listerine bottle for our electroscope. The bottle is approximately  $5\frac{1}{4}$  in. high and  $2\frac{1}{4}$  in. in diameter.

Build  
this ancient  
device  
and breathe  
in the air  
of discovery  
that  
exhilarated  
ol'  
Ben Franklin



# e/e ELECTROSCOPE

However, most any clear glass bottle can be used, since the exact size is not important. You'll need two more or less identical bottles, though, as we are using two electroscopes in our experiments. Make sure that both bottles are perfectly clean and dry.

Start construction by stripping the outer covering and braided shield from a 6-in. length of RG-59/U coax cable. Cut about  $\frac{3}{4}$  in. of the plastic insulation away from one end of the cable and bend the inner-conductor wire to form a right angle about  $\frac{3}{4}$  in. from the insulation edge. Solder a length of the inner-conductor wire taken from another length of RG-59/U cable to the wire you've already prepared (see our drawing on facing page at right). Bend both wires into a  $\frac{1}{8}$  in. "D" shape and cut off any excess.

Now strip off the insulation of the wire about  $\frac{3}{4}$  in. away from the bent wires. Ream a hole through a cork that fits the bottle and insert the prepared cable as shown. Bend the free wire at the other end into a  $\frac{1}{2}$  in. loop, and either crimp or solder the free end.

Use a single-edge razor blade or a sharp knife to cut out two  $\frac{1}{4} \times \frac{3}{4}$  in. aluminum-foil leaves. You might (as we do) use Reynolds wrap aluminum foil; don't use heavy-gauge or embossed types of foil. Carefully center a small hole as close to the top of the leaf as possible. Install the leaves on

the "D" rings as shown. If necessary, bend the "D" wires out for easier installation and bend them back into shape when the leaves are properly hung. Close the wire ends to prevent the leaves from accidentally falling off.

Carefully insert the assembly into the bottle and make sure that the leaves don't touch the inside walls. Reposition the wire or trim the leaves if necessary.

Now repeat the preceding instructions to make a second electroscope. Try to make both units as identical as possible.

**Building a Charge.** To perform the following experiments you will need glass and plastic rods, as well as some cotton, wool, and nylon (or silk) cloths. We used a 10 in. by  $\frac{1}{4}$  in. dia glass rod that you can obtain at any hobby shop selling chemistry supplies. For the plastic rod, we used a length of plastic insulation from a section of the RG-59/U coax, with both the shield and inner conductor removed. You can also use a toothbrush handle or a plastic alignment tool.

A cool, dry environment is best for these experiments; they may not work in a hot, humid area. The cloths must be perfectly dry. If necessary, you can heat them to drive off any moisture. Change them frequently to avoid any moisture from your hands.

**Experiment No. 1.** Rub the plastic rod with a cotton cloth folded around one end. Use long strokes and moderate pressure. Three or four strokes should be enough to charge the rod, depending on the dryness of your work area. Be sure not to touch the *activated end*.

*Basic setup for electroscope is shown in first photo. Size of glass bottle is optional, but it should be free from moisture. Metal-foil leaves are suspended freely on D rings and should not touch sides.*

*Second photo shows how to apply static charge to electroscope after rod has been rubbed vigorously at one end. By moving this activated end along ring electrode at top, you can gradually increase charge potential. Final photo at right reveals touch method of applying charge from one electroscope to other unit.*

*White paper placed under both bottles should enhance observation of metal-foil leaves when you compare charges existing at each separate electrode.*

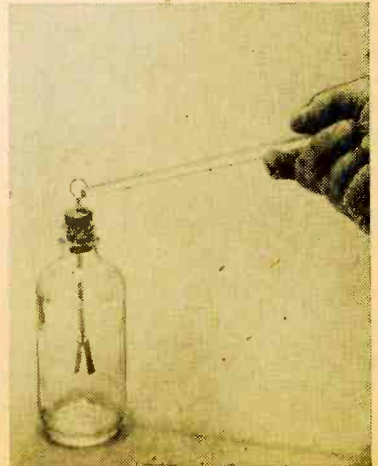
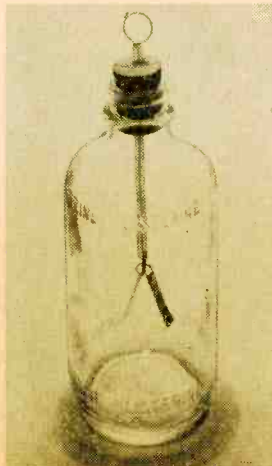



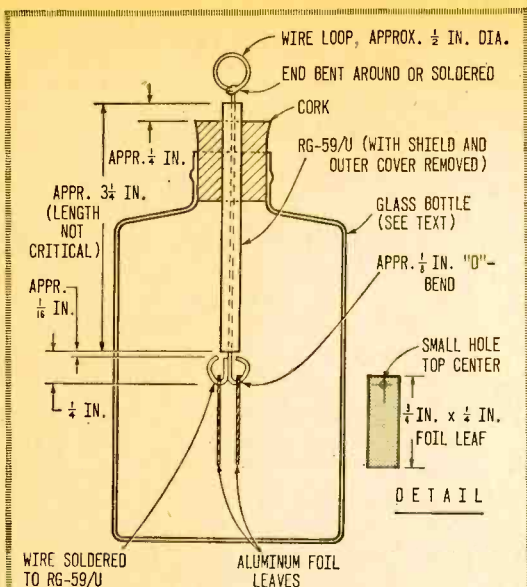

### BILL OF MATERIALS FOR ELECTROSCOPES

- Aluminum foil (Reynolds Wrap or equiv.)
- RG-59/U coaxial cable
- Cloths (wool, cotton, nylon, or silk)
- Glass bottles—see text
- Plastic and glass rods—see text
- Misc.—VTVM, corks, solder, etc.

Place this activated end (the end that was rubbed) against the wire-loop electrode; the foil leaves will move apart. Try running the side of the rod along the loop electrode. This may increase the charge on the electroscopes. The foil leaves will stay apart after you remove the rod from the electrode.

Rub the rod some more and touch the

electrode again. The foil leaves should now extend even further, indicating that the charge has increased. Keep this up until the leaves remain motionless. (Placing the electroscopes on a sheet of white paper will make the leaves easier to see.) Discharge the electroscopes by touching the electrode with your finger. The foil leaves should close together, indicating discharge. And feel safe—there is no shock hazard.

If you have a VTVM with a large input resistance, set it to its lowest negative DC range and connect the common lead (ground) to a foil section placed under the electroscopes. Charge the electroscopes with a plastic rod until the leaves separate and show full charge. Touch the VTVM probe to the electrode and observe that the VTVM momentarily indicates a negative voltage. This shows that the charge from the plastic rod has negative polarity.

Rub a glass rod with a woolen or silk cloth (or nylon), and charge the electroscopes with the activated rod. The glass rod may be harder to activate than the plastic one. Try to rub the rod briskly. Now set the VTVM for the lowest positive DC range and place the probe against the electroscopes electrode. The VTVM will momentarily indicate a positive voltage, showing that the glass rod has a positive charge.

Finally, charge the electroscopes with a plastic rod, and then touch the electrode with a small neon lamp (NE-2 or equiv.). One lead from the neon lamp should be held in your fingers, while the other lead goes to the electroscopes. The lamp will flash and the foil leaves drop. This indicates there was sufficient electrical energy stored up in the electroscopes to activate the neon lamp.

**Experiment No. 2.** Bend a 1/2-in. loop in a 2-in. length of #22 bus wire, and connect the free end to an alligator clip. Attach the clip to the electrode of one of the two electroscopes. Charge up the other electroscopes with a plastic rod.

Carefully move the other electroscopes so that it makes contact against the charged electrode by way of the clipped-on wire loop. Note that the previously uncharged electroscopes now has a charge, and that the charged electroscopes's leaves have moved inward a bit, indicating that its charge has diminished. This experiment shows that one electroscopes can transfer its electrical charge to another, just as a charged capacitor can charge another capacitor.

(Continued on page 108)



Discover the ease  
and excitement of NRI's

# 3 DIMENSIONAL METHOD

## of Electronics, Communications, TV-Radio Training

### 12 HOME STUDY PLANS TO CHOOSE FROM

Practically all vocational and engineering schools require students to conduct carefully planned laboratory demonstrations to prove theory presented in textbooks. So does NRI. Why? Because the only way to really learn at home . . . to recognize and understand circuits . . . is to get your hands on actual equipment, including transistors, printed circuits and today's other solid-state devices. NRI's unique, 3-Dimensional training method puts theory you learn into actual practice. You learn with your hands as well as your head. You learn by unique "discovery" methods the WHY of Electronics, Communications, TV-Radio . . . WHY circuits do the things they do. NRI training starts with carefully, condensed "bite-size," interesting books programmed with ab-

sorbing, revealing experiments using the finest parts money can buy. You get the kind of technical training that gives you experience equal to many, many months of performance on the job.

Whatever your interest, whatever your education, the NRI 3-Dimensional training method can fill your needs. Learning becomes as close to being *fun* as any school can make it. Tens of thousands of men have learned the NRI way. Pick the field of your choice and mail the postage-free card today for your FREE NRI Color Catalog. NATIONAL RADIO INSTITUTE, Electronics Division, Washington, D.C. 20016.

**BEGIN NOW AN ABSORBING  
ADVENTURE—LEARN ELECTRONICS  
THE NRI WAY—MAIL CARD TODAY**

**OVER 50 YEARS OF LEADERSHIP**



**IN ELECTRONICS TRAINING**



# 1 Start Fast with NRI's Educator-Acclaimed Achievement Kit

The day you enroll with NRI this remarkable starter kit is on its way to you—regardless of the course you choose. It is specifically designed for you and your training objective. It has one purpose—to get you started quickly and easily. It is an outstanding way of introducing you to NRI training methods . . . an unparalleled "first dimension" that opens the way to new discoveries, new knowledge, new opportunities. The Achievement Kit is worth many times the small payment required to start your training. Find out more about it. Mail the postage-free card now.



# 2 NRI "Bite-Size" Lesson Texts Program Your Training

Reading is a necessary part of any training program, but it takes a great deal of stamina to wade through a 300-page technical textbook. Every NRI course is condensed into "bite-size" texts that are simple, direct, well-illustrated, averaging an easily-digested 40 pages. These are "programmed" with NRI training equipment you build, experiments you perform, to bring to life the fundamental laws of electronics, the theory, the training of your choice. You are always kept well supplied with these books. NRI does not require you to "pay as you go."

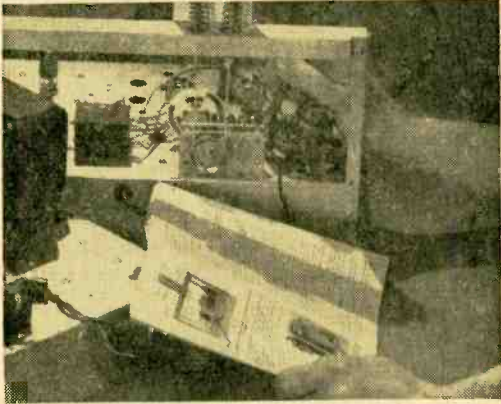

# 3 You Get Practical Experience With Actual Electronic Equipment

NRI does not leave the practical side of Electronics to your imagination. Electronics becomes a clear, understandable force under *your* control as you build, experiment, explore, discover. NRI pioneered the concept of home-lab training equipment to give you 3-Dimensional knowledge and experience. Every kit is designed by NRI to demonstrate principles you must know and understand. Kits contain the most modern parts, including solid state devices. NRI invites comparison with equipment offered by any other school, at any price. Prove to yourself what nearly a million NRI students could tell you . . . that you get more for your money from NRI. Mail postage-free card for your NRI Color Catalog. No obligation. No salesman will call.

**APPROVED UNDER GI BILL** If you served since January 31, 1955, or are in service, check GI line in postage-free card.

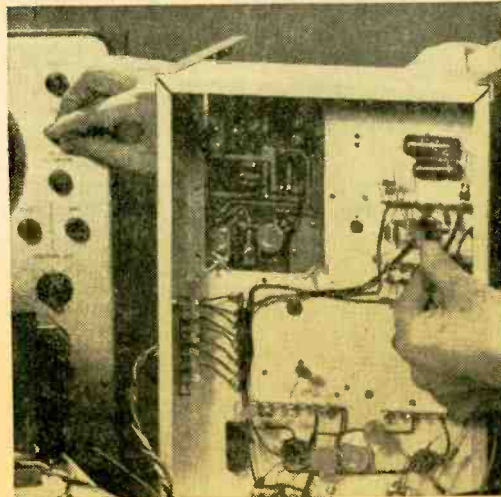



# WATT POWER ON WHEELS

By Marshall Lincoln, W7DQS

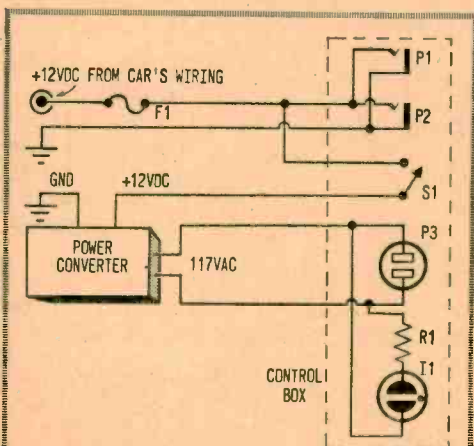

## PARTS LIST FOR WATT POWER ON WHEELS

- F1—20-A fuse (holder not necessary if fuse holder circuit under dashboard is available)
- P1, P2—Phone jack, open-circuit type
- P3—AC socket, chassis mount
- I1—Miniature neon indicator for 117 VAC with jewel and internal resistor, type or color not critical (Tineon 36N2311 or equiv.)
- R1—Part of I1 (see above)
- S1—Spst toggle switch, 125 VAC at 25 amperes
- I—Power converter, kit or wired (Heathkit MP-10 or equiv.)
- 1—Chassis box (see text)
- Misc.—Hardware, wire (automotive grade), solder, etc.

**E**lectrical power in the form of 60-Hz soup from the AC outlets in homes is a convenience taken for granted these days. Catch is, there's still one ingredient making up our daily lives that's as far from the 60-Hz lineup as a polar bear in sandiest Sahara. This is the ever-important family car. True, the Detroit whiz kids give us plenty of chrome and flashing lights. But they completely overlook the many times we would be better off with more electrical convenience as we tool down the road in our shiny bucket of bolts.

Even the availability of the 12 VDC sup-

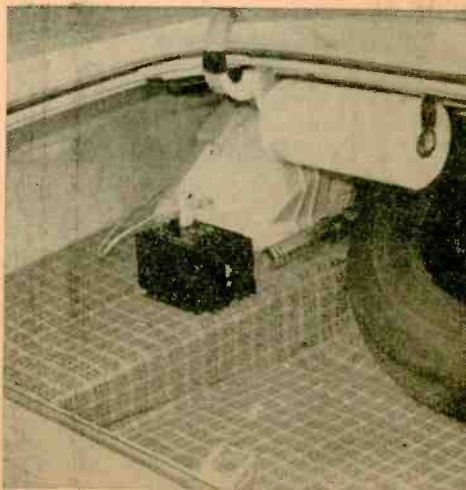

*In author's setup, Heathkit MP-10 power converter in trunk feeds 117 VAC to control box under dash.*



plied by a car's basic electrical system is denied us—unless we sneak it from the cigarette lighter socket or cut into the car's wiring. Good old 117 VAC also is possible in a car, but this practical convenience has again been omitted from our shiny gas buggies.

**Plan Ahead.** In about one Saturday afternoon, anyone with screwdriver and soldering iron can correct this. The simple hookup shown in the schematic diagram makes it easy to have both 12 VDC (without the nuisance of unplugging and misplacing the cigarette lighter to get it) *plus* 117 VAC!

Having 117 VAC in a car raises many eyebrows. This is a convenience which has been available for many years, yet has been used by few persons. The mobile power station hookup shown in our photos is also very handy for powering radio equipment not normally intended for mobile operation.

For example, VHF monitor receivers ordinarily used at home now can be taken along in the car. Transistor radio batteries can get a little rest while the portable radio is powered from the car on a trip. Ni-cad batteries used in a variety of electrical gadgets can be recharged on the road. A traveling salesman can get a fresh shave five minutes before driving up to the front door of an important customer. Hand-held spotlights and trouble lights can be plugged in nice as can be and without disturbing the cigarette lighter.

With the 117-V feature of this power station, you can even operate a 100- or 150-watt light bulb on an extension cord while

camped in the wilderness! Many other uses will occur to you after you have equipped your car with the convenience of a mobile power station. Your uses are limited only by the manufacturer's specs on the power converter.

**The Nuts and Bolts.** All that's required under the dash is a small metal control box in which are mounted connectors, a switch, and pilot light. The one shown in our photos is a 6½- x 2½- x 1½-in. LMB aluminum utility box, but you may select another type

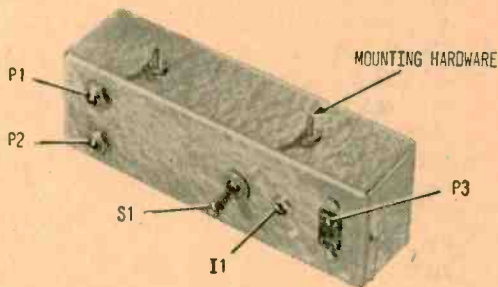

Closeup of aluminum utility box which forms heart of mobile power station. P3 is 117-VAC outlet.

of box depending on your individual requirements and the space available under the dash of your car. This control box becomes the heart of your mobile power supply, for it contains the output connectors for the 12 VDC and 117 VAC power, plus a switch or pair of switches if you wish to control these circuits.

"Getting 12 VDC is simple enough, but where does the 117 VAC come from?" you're wondering. (Continued on page 108)



Completed mobile power station packs plenty of electrical convenience into small space under dash. Both 12 VDC and 117 VAC are available for powering wide variety of electrical accessories and experiments.

# ICs gauge the green in this **PAPER-MONEY CHANGER**

**S**oaring? Roaring? Gay? Fey? What-  
ever handle future historians  
choose to hang on the decade of the  
60s, one thing's for sure. The 60s have  
shown automation to be not only a  
word, but a way of life. Slot machines,  
for example, dispense everything from  
shoe shines to shish kebab. And now  
the word is *go* for machines that ac-  
cept the folding green as well.

The device giving paper-bill ven-  
ding machines their green light is a new  
currency acceptor developed by Trans-  
marine Corporation of Chesterfield,  
Ohio. Dubbed the Ardac Mark 5, the  
acceptor relies on two integrated cir-  
cuits by Texas Instruments to perform  
its paper-money validating function.  
Significantly, the Mark 5 can be set  
up to rule on the authenticity of any



*Adaptability is Ardac Mark 5's biggest  
feature: it can accept any currency made.*

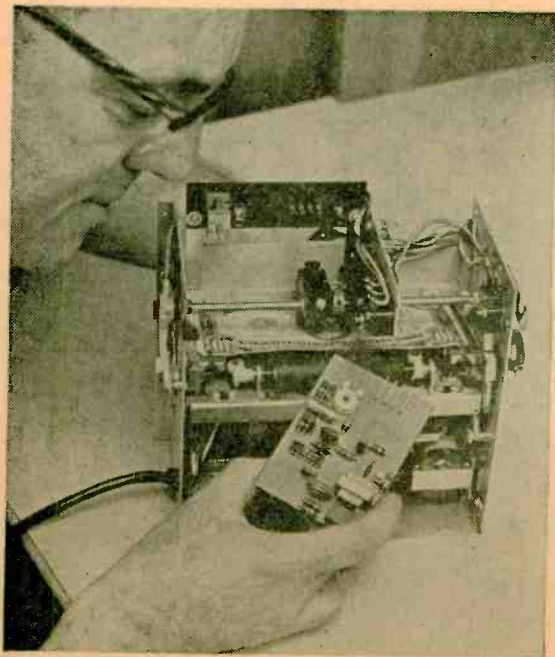

*Already in use in Sweden, Ardac Mark 5 lets drivers buy  
gas with paper money at self-service filling stations.  
Above, company officer inspects Ardac circuitry.*

denomination of any currency in use.

The acceptor determines bill validity  
by analyzing the quality of its intaglio  
printing detail. As a tray containing  
the bill is pushed into the acceptor,  
a sensing switch turns on an infrared  
radiation source. The radiation passes  
through the moving bill at a selected  
point in the bill design, over which  
an exact replica of that selected area  
screens a stationary silicon cell.

Intaglio details on the moving bill  
sequentially superimpose over those  
on the replica screen. With each super-  
imposition, a burst of infrared radia-  
tion passes through both bill and  
screen, generating an electronic pulse  
as it strikes the silicon cell. Thing is,  
only a bona fide bill can generate the  
correct number and size of pulses. As  
a result, the TI integrated circuit  
accurately differentiates between sig-  
nals generated by infrared penetration  
of U.S. Mint ink and paper, and sig-  
nals resulting from the best ink and  
paper available to counterfeiters.

—Ron Mitchell ■



**L**et there be light! Fair enough, except in a darkroom when you're handling photographic materials that can be ruined by excess light. Sooner or later all photo buffs run smack into an unexpected light problem that can cost money in wasted materials.

Surprisingly, the problem is seldom a matter of total darkness situations, say when you load film into a developing tank. Here your eyes will spot even the smallest pinhole

into action. Either a bell rings or (if you wish) the device cuts off electrical power to your enlarger, printbox, or safelight.

As a bonus, when you are off-duty in the darkroom, Photomate (with a simple modification you can wire in advance) will do double duty as a versatile all-purpose alarm for a variety of watchdog applications throughout your home. It can serve as a fire alarm, burglar alarm, pipe-freeze alarm . . . the list is endless. We'll have more to

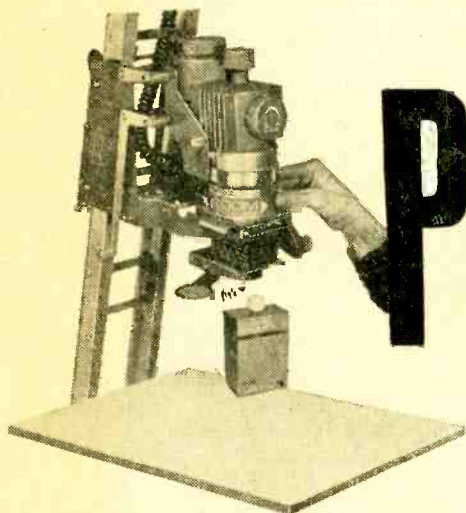

# Photomate

Here's a do all device that will give you the insurance you need for the darkest darkroom in town and the safest shack on the block—with plenty of savings thrown in, too!

By Ron Michaels

that's admitting unwanted light into the darkroom.

But when your safelight is on and your eyes and mind are accustomed to seeing *some* light, then, baby, accidents do happen. You may open your "paper safe" while the enlarger or printing box light is on. Your darkroom door may open just a crack, admitting unsafe, white light. The safelight filter could slip slightly and flood your work area with white light that you don't notice until it's too late.

You get the idea, so let's get to the solution—it's an unusual photoelectric alarm we've dubbed the Photomate. Place it on your work table and it will constantly monitor ambient room light during semi-dark (safelight) periods. The instant candlepower rises to an unsafe level the alarm goes

say about this later; first, let's talk circuitry.

**Working Order.** The circuit is built around a silicon controlled rectifier (SCR) and associated relay circuit that's powered by a simple DC supply consisting of transformer T1, rectifier module Z1, capacitor C1, and bleeder resistor R1. Whenever SCR1 is triggered by feeding a current pulse into its gate lead, direct current is allowed to flow through relay K1, thereby closing its contacts. The relay remains actuated until power switch S1 is opened; doing this automatically resets the SCR circuit.

Relay K1's first set of switch contacts controls a 117-VAC electric bell and pilot light I1; the other set is available for an external AC circuit (i.e., to switch off your enlarger lamp, as we discussed earlier).

The trick to setting off the alarm is to





This is the reason for CONTROL jack J1. It allows you to connect a control switch to the alarm. A good idea would be to install a normally closed switch on your paper safe (or other storage box) so that it opens when the safe is opened. You can wire this switch to the alarm via a dual-circuit audio plug that matches J1. When the switch is closed it shorts out C3 (i.e., voltage is zero) regardless of how much light shines on PC1. As soon as the box is opened, however, the switch opens, allowing C3's voltage to rise to a value controlled by PC1 and R5. If the light level is excessive the alarm will then fire.

Remember, while the Photomate alarm circuit has been made sensitive to light, it isn't very difficult to make it sensitive to other things, too. Simply wire a 100k resistor across PC1's leads, place some black plastic tape across the photocell's surface (so that it has a very high resistance), and set LEVEL control R5 for maximum resistance (i.e., most sensitive position).

Now any kind of switching mechanism connected to J1 via a dual-circuit plug be-

comes the triggering device for the alarm. As long as the switch is closed (shorting out C3), the alarm is off. But the instant the switch opens, C3's voltage will quickly rise above the trigger voltage of D2.

If you desire the multi-purpose alarm capability right from the start, just add function switch S2 to R6 as shown in the schematic. Flipping on the switch connects R6 across PC1 without the necessity of opening the case to solder in a resistor.

You can use your ingenuity to devise different switching mechanisms that'll make the alarm sensitive to different things. For example, a thermostat will make it temperature-sensitive so it becomes a fire alarm. A metal ribbon across a window or a switch on a door transforms it into a burglar alarm. Attaching a switch to a float converts it into an overflow alarm for a swimming pool. A stripe of metallic conducting paint on a glass vial full of water produces a pipe-freeze alarm; when the water freezes it expands, breaking the vial and the circuit.

**Building It.** The complete circuit fits,

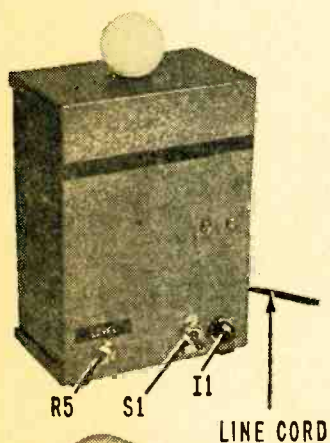

*Controls for this alarm system are well situated on front panel. Should alarm go off during work in darkroom, indicator lamp I1 will come on and illuminate controls so that unit can be switched off quickly. Alarm bell can be located on back panel (as shown) or can be placed in remote location somewhere in house. Ping-pong ball serves as light diffuser so that photocell will be sensitive to ambient light coming from all directions.*

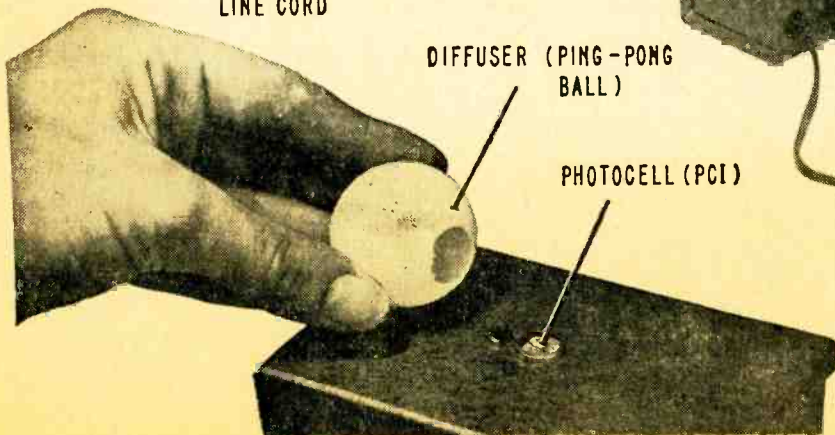
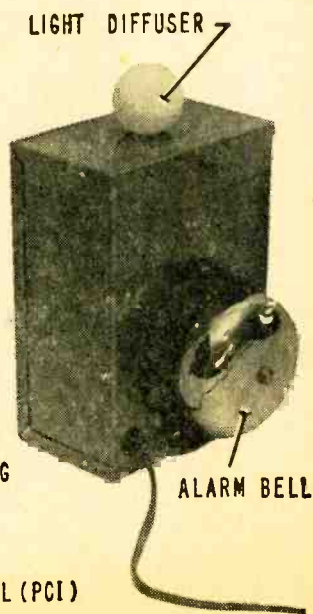

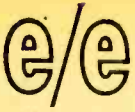

## PHOTOMATE

with room to spare, inside a 7 x 5 x 3-in. aluminum box. Don't use something smaller as there are several *hot* terminals (connected to the AC line) in the circuit—plenty of elbow room makes it easy to avoid short circuits. The bulk of the SCR, relay, and trigger circuits are mounted on a small piece

switch the alarm *off* should you want the darkroom totally dark.)

If you wish, you can eliminate the pilot lamp entirely—its sole practical function is to make it easy to find the power switch in a darkened room when the alarm does go off. After all, you'll want to silence that clanging bell as fast as you can.

Make a light diffuser for the photocell out of a standard ping-pong ball. Just cut a 1/2-in. hole in the ball and cement it to the

*Parts layout for alarm isn't critical, but wiring shown in photo has advantage of keeping AC line connections in one part of chassis. Most of trigger circuitry associated with SCR1 mounts on perf board seen at upper right in chassis; rectifier module Z1 fits across bottom of board. Double check polarity of all critical parts in schematic.*

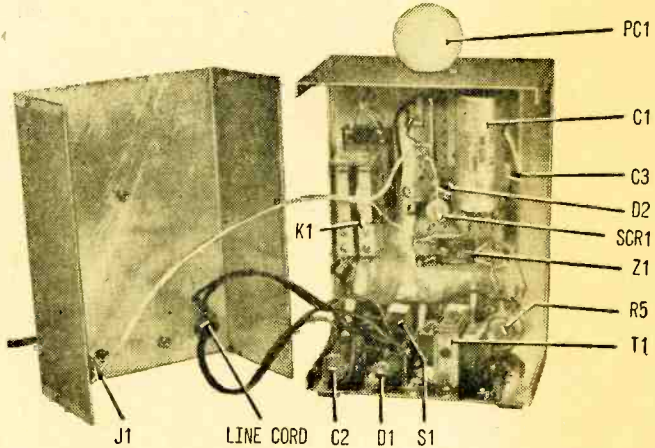

of perf board, using push-in terminals as wiring points.

While the bridge rectifier module Z1 (see Parts List) is a convenient component, you can make your own full-wave bridge by wiring together four silicon rectifiers according to the diagram near the schematic. (Use the silicon rectifier specified for D1.)

Parts placement isn't critical, though the layout we used has the advantage of keeping the line-voltage connection points together in one area. Remember to double-check the polarities of C1 and D1 before you solder them in place. Diode D2 is a bidirectional device, so it can be wired into the circuit in either direction.

Cut a 1/2-in. dia hole in the top of the cabinet for PC1. Then cement its rim to the inside of the box to hold it in place. You can mount the bell at the rear as we did, or at a remote location if you prefer. Pilot-light assembly I1 can be wired to the circuit as shown (it goes on with the alarm), or you can use it as a conventional pilot light by wiring its leads across points A and B. (The one disadvantage of the latter approach is that the glowing lamp may produce too much light of its own; you may have to

box with rubber cement. Its role is to *capture* light rays that strike the alarm at other than a vertical angle. The alarm will work without a diffuser, but it will be less sensitive to ambient light changes coming from the right or left side.

Since a door could be slightly ajar in your darkroom, you'll want to be protected from any incidental light coming at an angle. The diffuser helps to make sure that the alarm will be sensitive to this light.

Calibration is a trial-and-error procedure. Arrange the safelighting in your darkroom for correct ambient light levels, then slowly increase the resistance of R5 until the alarm fires. Switch *off* the power, and back R5 off slightly. Now turn the power back *on*. If the alarm fires again, repeat the procedure; if it doesn't, your alarm is properly set . . . the slightest increase in ambient light level will trigger the circuit.

After the alarm has been in use for a while, check the position of R5 as it may have to be recalibrated. Should the threshold adjustment be decreased too much, the voltage across C3 may be insufficient to trigger the alarm even though ambient light intensities reach the danger point. ■



## THEY FIND FUGITIVES IN 5 SECONDS FLAT!

**C**ruising down the highway, a California state patrolman sees a car that somehow rouses his suspicion.

He just has a feeling that something is amiss, and he has no legal grounds for stopping the driver and questioning him. So the officer takes the newest, giant step to test his hunch. He radios the license number to headquarters in Sacramento. A keyboard operator there relays it to Washington, D.C. In less than a minute, the patrolman—who has been following the suspect car for a mile or so—gets his reply.

An automobile bearing that license was stolen, two days ago in Oregon.

It's not make-believe; it's what's happening. What's more, the patrolman could if he wanted to, go even further right there on the spot. Having halted the car based on the information at hand, he could demand the driver's operating license. By relaying data from it (name, date of birth, etc.) over the same route he could, in less than another minute, obtain

*(Continued overleaf)*

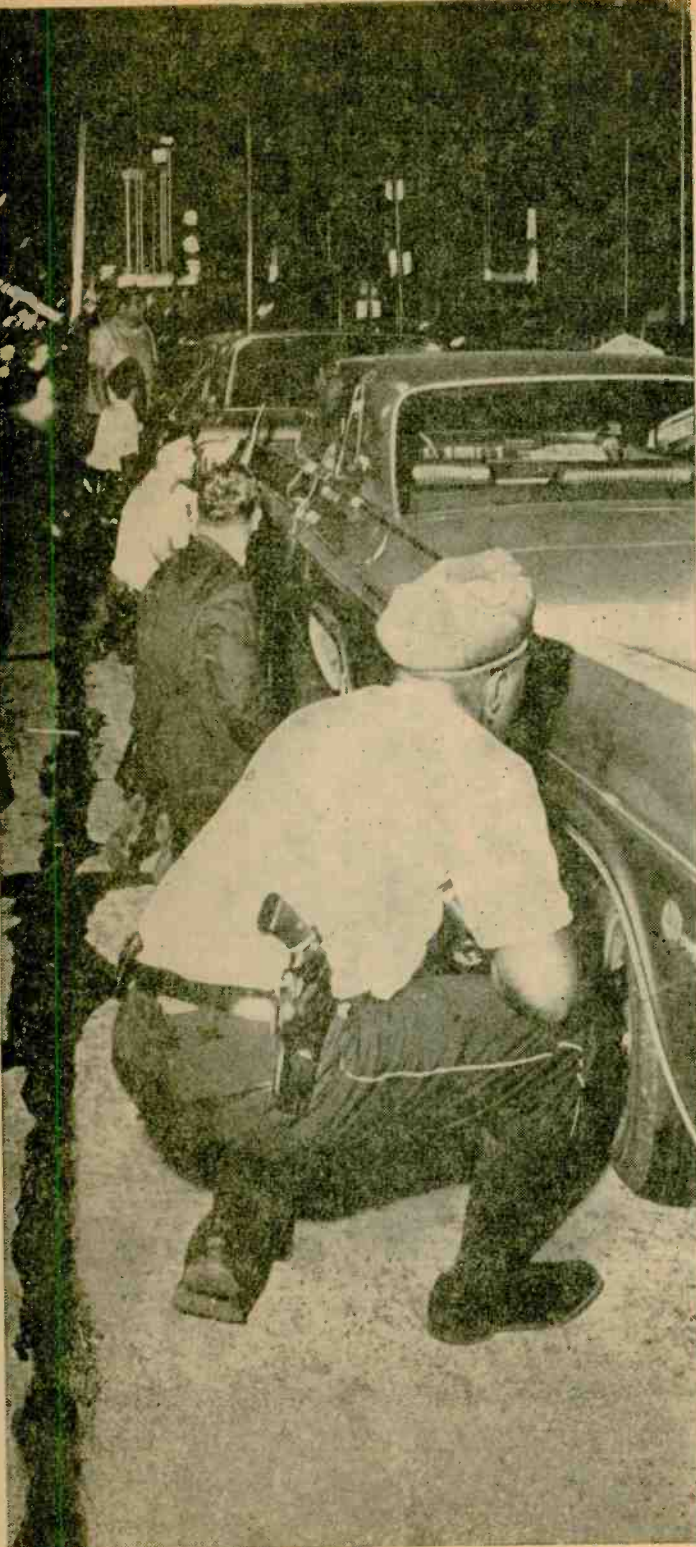

UPI Photo

## e/e FUGITIVE FINDERS

an astonishing amount of information about his man, if he were on the wanted list.

**Call It NCIC.** This is the weird but (to the general public) wonderful world of the National Crime Information Center, which is actually a country-wide records/communications system rather than a single location. Electronic from the word go, NCIC promises after only a year or so of operation (during which far-flung units joined in, one by one) to become one of the prime nemeses of felons.

People in other, peaceful pursuits have been concerned in recent years about how computerization may affect their jobs. By

and state police departments already have access to the remarkable memories of two computers in Washington. In less than five seconds after being asked, either can zip out a complete history of a stolen car, a filched gun, or a fugitive from justice subject to extradition to another state.

**It's A Hit!** Watching the monitoring read-out machine in NCIC control headquarters in Washington is an impressive experience. Inquiries come in steadily from the several "terminal" stations from coast to coast. Then the watcher is almost blinded by the response of the center's computers, three miles away, as they *brrrrrt* out a startling amount of information almost immediately.

True, the computers often come back with the message, "No record." But in a steadily



*Tapes, discs, and punched cards serve as memories in various NCIC-linked computers across the country (photo at right shows setup in St. Louis). Police stations in Los Angeles area are linked by CCTV as well (left).*

and large, the computers haven't proved all that dangerous. But now there's one career they can end quite abruptly: that of a criminal.

Anyone who has committed a serious crime lately, or is thinking of entering the business, is gambling against the odds. And the odds are going to get much longer.

Why? An instant-information system devised by the Federal Bureau of Investigation, supported by law enforcement agencies across the country and being augmented by more and more of them every day, is capable of flashing pertinent information most anywhere, almost instantaneously.

That is no exaggeration. About 350 local

mounting percentage of cases fed to them, the computers are returning details ranging all the way down to a tattoo on the right forearm of the fugitive, or a scar on his left middle finger

When that happens, observers of read-out units at NCIC and at other such widely-spaced places as Atlanta, New Orleans, St. Louis, and Sacramento write a succinct note on the wide computer paper as it comes out of the machine: "Hit." And, if it's really big, they're apt to scrawl more boldly, "HIT!"

The NCIC batting average has been good from the start, and it's getting better all the time. More than 4000 hits were recorded in 1967, and by year's end some 14,000



queries were being fed to the computers each 22-hour working day.

**Many In One.** But the Washington computers (to which more units can be added as more capacity is needed) are just the center of an electronic nervous system that is rapidly spreading across the land.

With crime rates rising practically everywhere in the U.S., and with the populace becoming more and more mobile, law-enforcement agencies recognized some years ago that new and faster methods of identification were direly needed.

The FBI came up with a solution in the fall of 1965, when it proposed that data about crimes and criminals, accumulated all over the country, be stored in a single computer center. Such an installation could make such data available within the period of a

Louis not only is connected by teletype with NCIC, but its own computers are tied in with those in Washington. The city's local bank of information is stored there; that which also fits NCIC specifications is automatically forwarded to the nation's capital.

Many times, however, local records don't apply to a new crime situation. For this reason, St. Louis' computers are programmed so that if a query put to them doesn't produce a positive answer, they themselves query the Washington computers.

That was what happened that first day of operation in August; the St. Louis computers didn't turn up with the answer, so they queried NCIC. And back came the answer.

Now, a score of St. Louis County police agencies, located outside the city, as well as all the city's police districts, are connected



*Sgt. Greg Sullivan acts as programmer for both local and NCIC dispatches at St. Louis computer center (left); Readout monitor at NCIC in Washington (right) is observed by FBI inspector while operators feed computers.*

couple of blinks to all the offices and agencies connected with it.

Eager cooperation was forthcoming, and FBI Director J. Edgar Hoover predicted that the new network "is going to work to help police everywhere intercept lawbreakers before they can strike again."

It was not a shallow boast. Take the case of St. Louis, where the metropolitan police department hooked up with NCIC a year ago last August. Within 25 hours, a license number called in by an alert officer pinpointed a car stolen two weeks earlier in California. Its driver proved to be an escapee from the St. Louis workhouse.

As with several other terminal stations, St.

to the computer and via it to NCIC.

**C For Compatible.** The whole NCIC system is complicated, to say the least. Many of the computers forming interfaces, or plugs, with those in Washington are of different makes and models. The program had to be designed so that all would be compatible. Standard programming and procedures had to be devised—an operation that required months of study and a multitude of decisions. So, too, did the extent of crimes and criminals to be recorded, as well as prospective future additions to the roster.

Working closely with the FBI during this phase were the California Highway Patrol, (Continued overleaf)

# e/e FUGITIVE FINDERS

the first agency to become completely operative with NCIC, and the St. Louis department. Since it went into business in January, 1967, however, NCIC has been joined by dozens of other local agencies. And the number continues to grow.

A very comprehensive system is being planned for Los Angeles, for example. Designed jointly by System Development Corp. and the Los Angeles Police Department, it will eventually cost \$2.2 million. In time it not only will provide a computer link with NCIC, but will be used to analyze the MO (Modus Operandi) of criminals who, since the time of Sherlock Holmes and earlier, have continued to follow general patterns in the crimes they commit.

The system, with its several sub-systems, will serve as what Los Angeles Police Chief Thomas Reddin calls the "instant cop." Not only will it be able to flash back written information in a hurry; graphic subjects such as pictures and fingerprints will be within its capabilities. Chicago and New York state police already are able to transmit such graphics via a form of television, and other municipal centers are following suit.

There may well come a time, in fact, when officers all over the country are able to view the pictures of suspects on small screens on

the dashboards of their cruisers. And still more is in the offing.

**Ready And Willing.** Already, two studies are under way to determine whether it is feasible not just to project a fingerprint, but to use a computer to analyze and define its every line. Prospects of success are excellent, says FBI Inspector J.J. Daunt, who heads up the NCIC control center. While the lines and whorls of a fingerprint are extremely complicated data, he notes, "That's exactly the sort of thing a computer can best solve."

Meanwhile, police computers are kept busy at other tasks as well. Some of them can pinpoint areas of highest crime rates and actually draw and redraw maps showing the current danger areas. They can likewise spot traffic buildups, determine the most efficient posting of police forces, and, of course, make out payrolls and produce checks.

The computer, it is apparent, is able to prevent as well as to detect crime. Here, as elsewhere, its efficiency will depend on the information fed to it, and the way it is fed. But more and more, it will be helping the human factor to cut down the country's rising crime rate.

So if you just happen to be thinking of breaking the law, think twice. Within a matter of minutes, you might be on the spot. From coast to coast, the people who are looking for you will be writing down a single word:

"HIT!"

*There's many a slip between the rig and stick!*

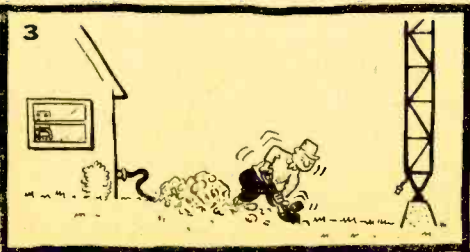
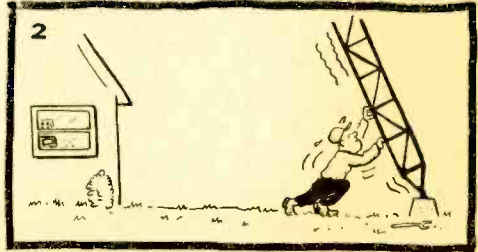
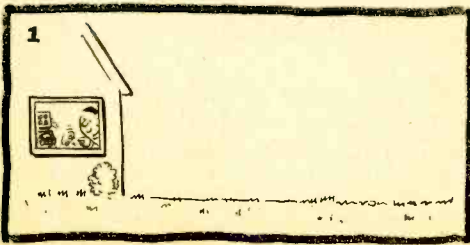





# And now... **PAPER** Batteries



—dry, dunkable, and power-packed!

By Erik Horneman

**O**ne way to make a dry cell thin enough to slip into a billfold is to run over a flashlight battery with a steamroller. If that seems impractical, try making wafer-thin dry cells using home-made energy paper. You'll learn more than most anyone but Einstein about galvanic cells, and you just might come up with a Science Fair winner to boot.

Energy paper is the key component in the new disposable, one-shot cell recently developed by the North American Philips Company. Though these cells are not yet on the market, they are expected to be developed into power packs useful in any number of applications—powering such cordless appliances as electric shavers and toys, even starting car engines suffering from storage-battery malnutrition.

A typical Philips energy cell is less than two inches square, only one millimeter thick, and weighs only two grams. Despite its small size, the cell can operate a one-watt electric shaver for five or more minutes—more than enough for a good facial clean-up.

**Dunkable Sandwich.** The energy cell,

unlike an ordinary so-called dry cell, is *completely* dry. And it remains so until dunked in water to activate galvanic action. The cell consists of a thin sandwich comprised of a zinc or magnesium anode, a sheet of paper impregnated with common salt, the energy paper impregnated with carbon and potassium persulfate ( $K_2 S_2 O_8$ ), and an underlying sheet of conducting foil. In many applications—the electric shaver is one, the magnesium layer is built into the appliance so that the disposable energy cell consists of only three layers.

Surprisingly, the thin cell has a power density at least five times greater than that of a comparable conventional dry cell. This is attributed in part to the thinness of the energy sheet which minimizes internal resistance in the cell, in part to the use of potassium persulfate as a depolarizer. ( $K_2 S_2 O_8$ , for the record, produces soluble reaction products that do not interfere in any way with the electrical conductivity of the carbon particles.)

Every chemical cell that generates elec-

# e/e PAPER BATTERIES

tricity consists of two or more components that can react to induce a flow of electrons. In a conventional dry cell, the zinc can is the electron donor. The electrons travel through an external circuit to the manganese dioxide/carbon paste which acts as the electron acceptor. The zinc and manganese dioxide are separated by an electrolyte solution (ammonium chloride) in which ions carry the current from paste to zinc anode.

In the new energy cell, zinc or magnesium is used as the electron donor, the potassium persulfate/carbon energy paper as the electron acceptor, and common salt as the current-carrying electrolyte.

The voltage delivered by this type of cell depends largely on the metal used for the anode. A terminal voltage between 1.9 and 1.5 V (flat discharge curve) is obtained when magnesium is used as the electron donor.

**Experimental Cell.** Most of the materials you need to make an experimental energy cell can be found around the house. The only uncommon component is potassium persulfate. However, this can be purchased from a chemical supply house or from a photo supply store having a good stock of basic photographic chemicals (the persulfate is used by photographers to eliminate traces of fixer from prints).

If you can't lay hands on the persulfate, try using other depolarizers such as manganese dioxide, potassium dichromate, copper sulfate, or copper oxide. But don't expect comparable results with these substitutes.

The carbon and zinc can be obtained from a used dry cell such as a size D flashlight cell. Cut lengthwise through the outer casing with a hacksaw so that the zinc shell can be peeled off intact. Some leak-proof cells have an outer shell of iron; what you want is the inner zinc can.

Flatten the zinc into a smooth sheet, clean off all adhering chemicals, and polish the metal with sandpaper or steel wool. When trimmed, the can from a D cell will provide an anode plate measuring about  $1\frac{3}{4} \times 3\frac{1}{2}$  in.

Also salvage the carbon rod in the center

*Ordinary flashlight cell provides two materials required for experimental dry battery: carbon and zinc. Once cell is disassembled, carbon rod must be filed to produce powder; mixture of powdered carbon and potassium persulfate is then troweled on both sides of surgical gauze or other fabric.*

of the cell. Rub this on a fine-toothed file to make a fine carbon powder. It might be well to heat the carbon rod in a flame before powdering to drive off any volatile contaminants.

The inventors do not reveal what metal is used for the underlying conducting foil; they imply that it functions only as a conductor and not as an integral reactive part of the cell. However, your experimental cell's voltage will be affected by the choice of metal for the cathode. For example, copper works very well; aluminum, poorly.

**Gauze and Effect.** You would have a tough time impregnating paper with a mixture of carbon and potassium persulfate, so do it the easy way by substituting surgical gauze or other loose-weave fabric (e.g. old curtain material) for the paper. Just make a paste from the carbon and persulfate mixture with a little water, then trowel the paste into the cloth. Work on both sides of the gauze to get thorough impregnation. Powder the persulfate *before* mixing with the carbon, and do not warm the impregnated gauze to

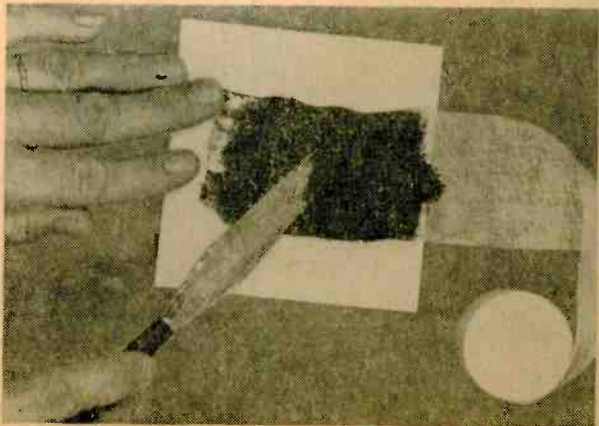



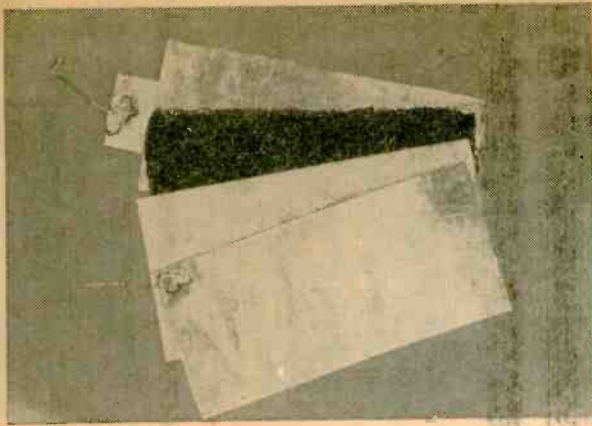

Experimental cell is four-layer sandwich made up of zinc anode (at bottom), salt paper, energy gauze, and copper cathode (at top). Commercial version, pictured on opening page of this article, successfully powers prototype Norelco electric shaver.

speed drying (persulfate is decomposed by heat).

The proportion of carbon to persulfate used in the commercial cell remains a trade secret. You should experiment with different ratios to determine the most effective mixture. The author's very arbitrary mixture consisted of one part persulfate to two parts carbon, though this may be nowhere near the optimum ratio.

The sodium chloride paper is easier to make. Simply dunk a sheet of household paper toweling (or filter paper) into a saturated solution of common salt and hang it up to dry. Cut the carbon gauze and salt paper into sheets of the same size as the zinc anode.

To assemble the energy cell, place a piece of carbon-impregnated gauze on the copper sheet, then add a sheet of salt paper. Wet the papers with water before adding the zinc anode.

Admittedly, this crude approximation of the commercial energy cell won't perform as efficiently as the real McCoy, but it does produce enough juice to create a glow in a 1.5-V flashlight bulb.

A VTVM connected across the zinc and copper electrodes indicates a 1.1-V emf which, surprisingly, is identical to the theoretical voltage obtained by calculating the algebraic difference between the zinc and copper standard electrode potentials shown in our table (see next page):

$$0.76 - (-0.34) = 1.10 \text{ volts}$$

Things don't usually work out that neatly

*Voltage output of home-made cells is function of metal used for cathode. Zinc/aluminum cell delivers low emf of about 0.28 V (top photo); zinc/copper cells delivers emf of 1.1 V (bottom photo). Though somewhat hard to come by, sheef magnesium provides higher cell voltages than other common metals.*

because of various factors that may significantly affect the cell's internal resistance. For example, when a lead electrode is used in place of the copper electrode, the voltage drops below 1 V. When aluminum foil is used in place of copper, the emf plummets to 0.28 V.

Incidentally, the cell will develop a potential of about 0.8 V if the carbon gauze is removed, leaving only the salt paper sandwiched between the zinc and copper electrodes. (This comes as no surprise to those experimenters who have made a classic voltaic pile by separating alternate dimes and pennies in a stack of coins with paper wet with salt solution.) The energy paper (gauze) increases the voltage appreciably; more importantly, the depolarizer in the gauze undoubtedly increases the amount of power that can be obtained from the cell.

**Cheap Research.** Experimentation with

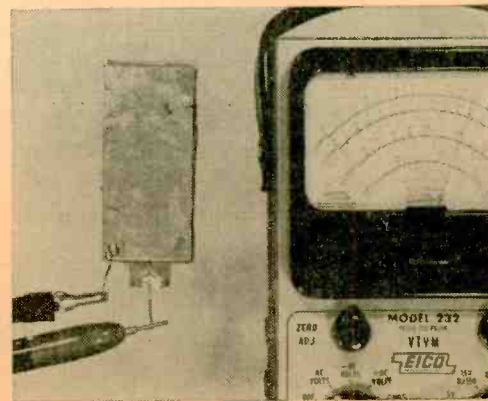
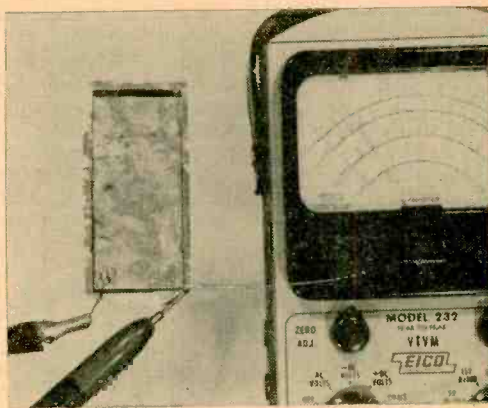

## PAPER BATTERIES

paper cells may be just the ticket for those science students who can't afford a lot of expensive research hardware. Most of the material requirements can be found around the house.

You don't actually need a VTVM to test the cells. The brightness of a 1.5-V flashlight bulb will provide a rough idea of the voltage produced, and the length of time the lamp glows will be a measure of the cell's power density. In a Fair demonstration, these cells can perhaps be used to run small electric motors you can build from scrap materials.

If you want more accurate measurements of the cell voltages, make a simple voltmeter by wiring a 500,000-ohm potentiometer in series with a milliammeter. Turn the control to maximum resistance, then connect four flashlight cells in series with the meter. Adjust the resistor until the milliammeter scale shows a full scale reading. This will be the 6-V setting. Leaving the resistor in the same position, remove one flashlight cell at a time to get meter positions for 4.5, 3.0 and 1.5 V. It will then be easy to mark off intermediate positions on the new voltage scale.

The experimental approach you should

### STANDARD ELECTRODE POTENTIALS

Element	Half reaction	Volts
Magnesium	$\text{Mg} \rightleftharpoons \text{Mg}^{++} + 2e$	2.37
Aluminum	$\text{Al} \rightleftharpoons \text{Al}^{+++} + 3e$	1.66
Manganese	$\text{Mn} \rightleftharpoons \text{Mn}^{++} + 2e$	1.18
Zinc	$\text{Zn} \rightleftharpoons \text{Zn}^{++} + 2e$	0.76
Chromium	$\text{Cr} \rightleftharpoons \text{Cr}^{++} + 2e$	0.56
Iron	$\text{Fe} \rightleftharpoons \text{Fe}^{++} + 2e$	0.44
Nickel	$\text{Ni} \rightleftharpoons \text{Ni}^{++} + 2e$	0.25
Tin	$\text{Sn} \rightleftharpoons \text{Sn}^{++} + 2e$	0.14
Lead	$\text{Pb} \rightleftharpoons \text{Pb}^{++} + 2e$	0.13
Hydrogen		0.00
Copper	$\text{Cu} \rightleftharpoons \text{Cu}^{++} + 2e$	- 0.34
Mercury	$\text{Hg} \rightleftharpoons \text{Hg}^{++} + 2e$	- 0.80

take is fairly obvious. Various proportions of carbon and potassium persulfate should be tested to determine the optimum ratio of these materials. Also test as many different metals as possible for their electrode properties. Remember that the electron donor (anode) should be of a metal higher in the electrochemical series than the cathodic metal.

Sheet magnesium may be hard to find, but it's worth seeking. Reason: it provides higher cell voltages than can be obtained with any of the other common metals. As a case in point, the standard electrode potential of magnesium is 2.37 V as compared to 0.76 V for zinc (see our table above). ■

## PAPER TRANSISTORS, TOO!



**W**estinghouse Electric has developed a process for making transistors which, like paper matches, may someday be torn out, used, then thrown away. Unique among electronic devices, Westinghouse's paper transistors can be bent, twisted, and coiled. According to Dr. T. P. Brody, head of the scientific team that devised the experimental semiconductors, "flexible transistors appear to be useful for almost any device that does not have to operate at high temperatures or be especially rugged, or does not involve high power or very high frequency."

Dr. Brody explains the new manufacturing technique by comparing it with a trick old as the hills in photographic circles. "We wind a roll of paper or foil through a 'printer' one full frame at a time, just about the way a roll of 35-mm film is exposed in a camera," he states. "Currently, each frame is about the size of a postage stamp and has more than 600 transistors on it. Rolls of 13,000 have been made."

When will paper transistors be available to hobbyists? "I would emphasize," says Dr. Brody, "that their development is still in its early stages and a commercial product is still some years away." ■



# PATCH UP YOUR TROUBLES

By Frank Deems

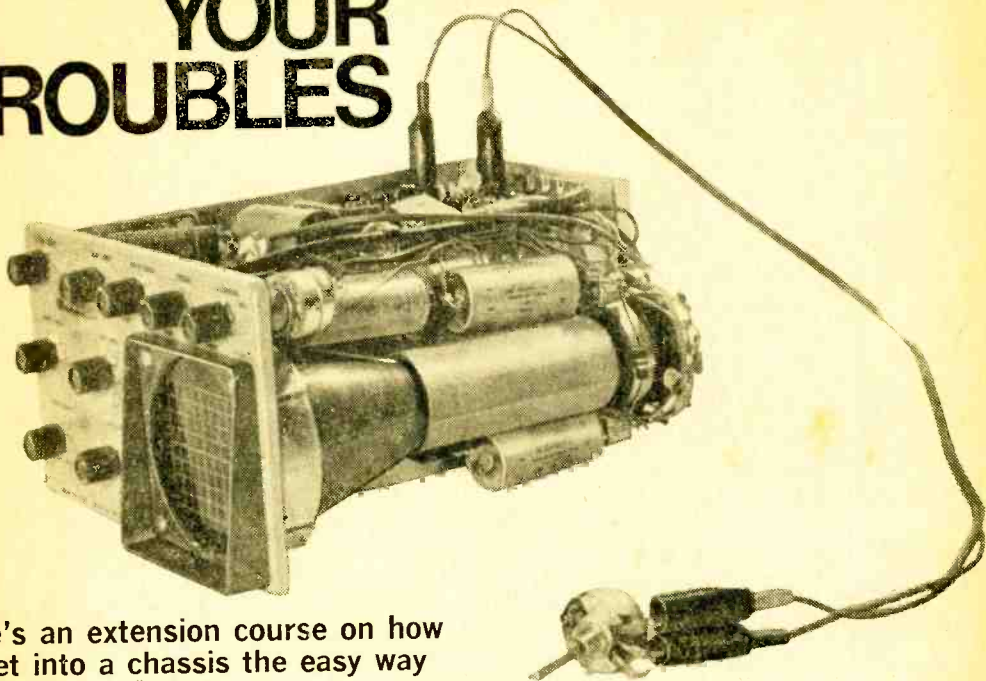

Here's an extension course on how to get into a chassis the easy way

**A** popular song of many years back had a line that went "Pack up your troubles." Even if you can't carry a tune in a bushel basket, you can apply this advice to your electronic experimenting by just changing one word from the song's lead.

Make it *Patch up your troubles*, and you'll have a solution for many of your bench problems. Not with Band-Aids or Scotch tape, mind you, but with some good serviceable patch cords. By equipping yourself with a half-dozen or so of these nifty items—cut to a variety of lengths and fitted with different connectors suited to your needs—you'll be ready for most any situation that comes up.

Essentially, patch cords are just electronic "extension cords." They usually have an alligator clip at either end for temporarily connecting components into a chassis, or for interconnecting two chassis. Patch cords permit you to set up temporary circuits or to tap into existing circuits for test purposes. Properly used, these cables can be just as reliable as neat soldered connections.

**Amps to Bats.** Applications for patch cords are endless. For example, you may have had trouble with an amplifier and questioned whether the load on the B+ supply was too great for the power transformer on the chassis. If you have a larger transformer on the shelf, but hesitate to rip out the old one, all you need do is temporarily install the new one with a couple of patch cords.

Just disconnect the high-voltage leads of the old transformer from the power supply, wrap them with tape, and bend them safely out of the way. Using your patch cords, connect the high-voltage leads of the new transformer to the power supply. With the new transformer on the bench next to the power supply, connect its primary to a 117-VAC outlet with another patch cord having a

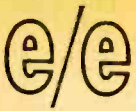

## PATCH UP TROUBLES

standard AC plug at one end. Make sure all other leads are either installed or insulated from each other and the chassis. This setup can be connected in a few minutes and should tell you if the new transformer would be an improvement over the old one.

Want to substitute a different type of battery in a transistor circuit without changing battery clips, etc.? Simple. With the new battery in a clip, or with the patch cord clipped directly to its terminals, just connect it into the circuit in place of the old one.

Patch cords can be used to connect the power supply from one piece of gear into a second unit which has no power supply.

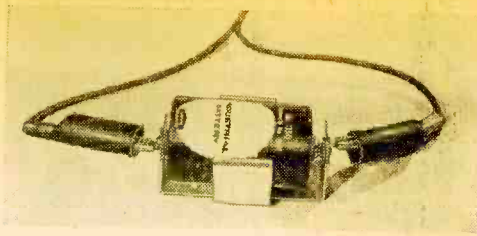

*If you're uncertain about operating voltage of a transistor circuit and want to make a quick check, just attach patch cords to external battery.*

with a different color insulation; the other is to use paint to put colored bands around the wire (or the shank of the clips) at both ends. Obviously, the latter method is best for lamp cord, since both wires will have the same color insulation.

On most of your cable you'll want rubber

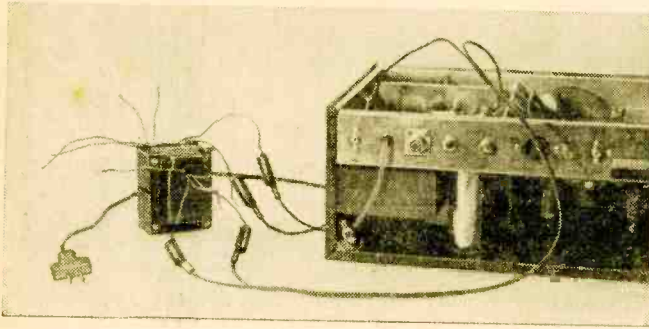

*You can replace power transformer in piece of equipment by simply patching in a spare. Disconnect original high-voltage leads, insulate them, and bend them aside. Now attach leads from spare transformer into circuit, using zip cord arrangement. Watch out for shorts, and be sure to use insulating sleeves over all alligator clips.*

They can free your hands from holding meter probes when you need to make adjustments while watching meter indications. You can even substitute resistors or capacitors in series or parallel to determine the correct value needed for a circuit modification. Better yet, you can connect a potentiometer or rheostat into a circuit to determine the proper fixed resistance value you want for the long haul.

**Hardware Items.** The simplest and most useful patch cords are just insulated wires with alligator clips soldered to each end. Many times it's useful to have such cords in pairs, so ordinary lamp cord, or *zip cord*, is good cable to use. It's heavy enough to carry just about any current you're likely to work with, and it's flexible enough to last for years.

You'll want a couple of cables about 6 or 8 in. long, and maybe a pair about 3 or 4 ft. long; the most practical length for most patch cords is about 2 ft. Color coding is generally very useful, and there're two ways you can accomplish this. One is to use wire

insulating sleeves that slip down over the full length of the alligator clips. This prevents them from touching other connections in the chassis. They should fit loosely so they can be pulled back when necessary to allow you to clip the lead into place. After the connection is made, slide them forward again. ■

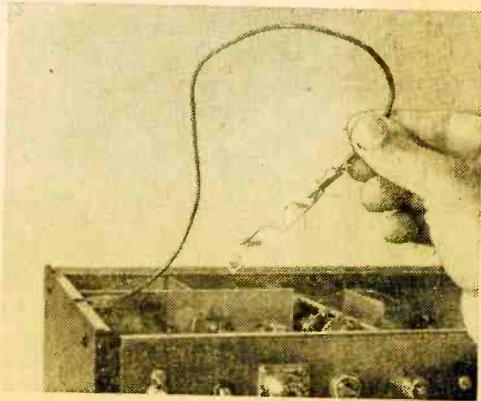

*Hum is sometimes caused by inadequate shielding. To check this out, connect a piece of tinfoil (covered with tape) to chassis ground and trace circuitry.*



# ERECTING A ROOFTOP TOWER

By Homer L. Davidson

Forget about masts, guy  
—a rooftop TV antenna  
require less money,

wires, and dizzying heights  
will take less time,  
and give plenty of zonk!

**D**o you really want to climb Mount Everest to get good TV reception? Are you waiting for the moment when your mast gets the shakes and comes toppling down during a storm that was never supposed to show up?

If you get the wim-wams thinking about all the complications that might come up when erecting a mile-high TV antenna—or if you've already been through the mill—this guide to erecting a roof-

top antenna should give you courage. Actually, it's not as bad as it first seems. If you're willing to sacrifice some height to gain a goof-proof installation, not only will you sleep better at night and feel better in your pocket book, but your neighbors will appreciate a job well done.

We've come up with some groovy photos that show a young fella going about his work. As you can see, he's got a sturdy roof (good shingles and joists), a few tools, and the roof mounting antenna. That's it.

With screwdriver, pliers, and crescent wrench in hand, all you do is select the right tower for your particular receiving area. This depends on the kind of signals you wish to receive (uhf, vhf, FM, etc.), distance from the transmitter, and the obstructions in between. Your local TV shop will probably give you some advice on just what you need.

**Here To Stay.** A rooftop tower has many advantages over a mast. It's easier to install, it has a much better appearance, it's more secure, and you eliminate vibrating guy wires that run endlessly from the



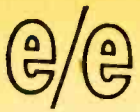

## T-V TOWER

mast to your house. Very few rooftop antennas blow over during severe storms, so they prevent additional damage to your roof. Should the boom or any of the elements be damaged they can be reached with no trouble at all.

Only a few holes are needed to install the tower on your roof. Before you get started, check and make sure that your antenna will be no higher than other installations in your neighborhood. If necessary, check the local city ordinance for TV antenna installations. Some cities have very exact requirements and even a permit fee. Better to be safe now than sorry later.

Small TV towers come in lengths of 18, 30, and 36 in., as well as 5- and 10-ft. lengths. While they are sturdy and cost little, a tower mounted on a 1½- to 2-story home should provide adequate reception even in a fringe area. If you're really out in the cold, a hi-gain Yagi-type antenna will help to put you in the ball park.

**Selecting a Sight.** Once on the roof, select a likely spot for a three-legged tower. We'll help you out by recommending dead center on the roof peak (you get a ground-plane effect this way that will reduce local RF interference somewhat); just count the total number of shingles and divide by two to reach *Ground Zero*. Mounting the antenna to one side of the roof is possible, but less effective.

Make sure you're clear of tree limbs, etc., and in the line of sight of some TV stations. At all cost, keep away from power lines of any description.

In extreme fringe areas you can mount the tower on the highest part of your roof. But if you've got more than 10 ft. of antenna skyward (extending above the tower), it will have to be guyed properly. Under normal circumstances, however, guy wires shouldn't be necessary. A good rule of thumb is: a 5-ft. mast extended out of a 30- to 36-in. tower; a 10-ft. mast extended out of a 5- to 10-ft. tower.

If you're mounting the tower on a flat surface (with no peak), simply center it by using the roof corners as a guide. A friend can hold the boom at the approximate dead center while you take sightings from alternate corners.

**Mounting Boom.** Before securing the

three-legged tower, check that all three legs are located *over* a roof joist (i.e., supporting beam). The towers have adjustable legs so this is possible. You can locate the joist by taking a hammer and tapping lightly over the surface of the roof. The first solid thump indicates you've got a beam where you need it.

Temporarily place the legs of the tower on the corresponding joists. Place the two adjoining legs (i.e., the two that form the base of the triangle) in the direction where winds are excessive. It's usually north winds or northwesterlies that cause most problems, but it pays to make sure for your particular area.

Level the tower before securing (lagging) it to the joists. A carpenter's level will prove to be a worthwhile investment, but should one be lacking, place the boom on the tower anyway and sight it against house outlines and other reference points. When using a level, level the tower in two opposite directions with the boom installed.

Now you can secure the legs to the joists using the supplied screws. Be sure to place at least two screws in the base of each supporting leg. If they don't go directly into the joist you will have to sound out the joist's location again. Probably a shift of ¼ in. is all that will be needed. Make sure that all screws are flush with the roof surface and as tight as possible.

**Antenna Up and Away.** Remove the antenna from the packing carton and prepare it for mounting. Most TV antennas can be unfolded in a second and the antenna rods will lock into position. Simply push or pull the elements into the correct configuration and clip them into place. You'll find it easier to assemble the antenna on the roof, but take care not to damage shingles while you're working. Wherever you work, leave plenty of space for the job.

To connect the 300-ohm lead-in wire to the assembled antenna, use either small eyelet connectors or form an eyelet with the bare wire. Place the lead under a lock washer, tighten the connection, and place some electrical tape over the antenna terminals. This will insulate the antenna connections from erosion due to wind and moisture.

If the antenna has a fairly long boom, two brace supports should be used to support it. Place a standoff on the front support brace while the antenna is still being prepared for mounting.

**Two Types.** In this installation a uhf *bow-tie* antenna will be mounted below the



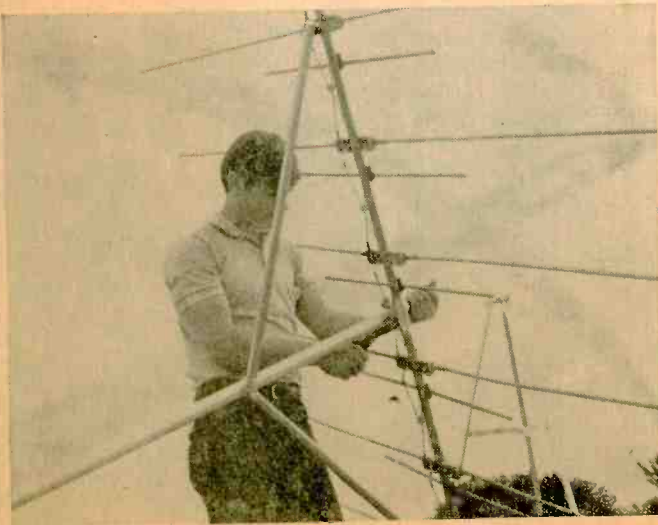
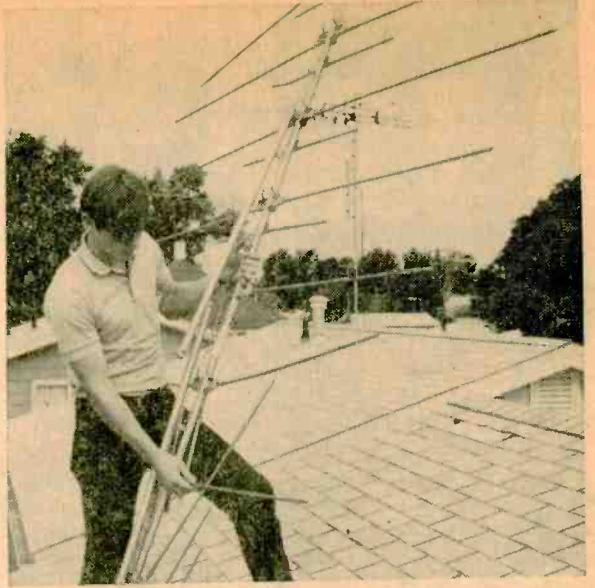

*Before securing tower to roof, place TV mast in position so that tower can be properly leveled (see photo on previous page). Once antenna has been installed, final leveling can be achieved with small set screws on support braces. At least two screws should be used to secure legs to joist. Carefully remove vhf antenna from carton, fold out all elements, check their configuration, and then lock them into place. Hook up lead-in cable to antenna, and with cable in place, mount a standoff on one arm brace to hold it in position. Now that antenna lead-in is installed, mount antenna to 5 or 10 ft. mast. Tighten all bolts and pull up brace supports so that antenna will be level.*

## T-V TOWER

all-channel vhf boom. Since the latter is the basic unit it is mounted first. *Remember*—many antennas combine elements for both uhf and vhf reception, so you'll only need the bow-tie (or equivalent) if you're in a fringe area or the uhf signals are not in the same plane with the vhf signals.

Choose the correct length of mast to install in the tower. This will depend on reception requirements (also, check rule of thumb already mentioned for tower measurements). Most likely it will be either a 5- or 10-ft. piece. Bolt the antenna to the mast, level the bay, and tighten the mounting bolts. Pull up the brace supports so the antenna is in a level line and snug up the "U" bolts on the brace. Try not to flatten out any of the aluminum pipe.

Once you've lowered the mast into the tower, you can raise or lower it to get best reception. Rotate it so that the smallest elements on the boom are pointing toward desired stations; in fringe areas this may simply mean *snow-free* reception.

Some receiving areas require a uhf translator antenna. This is usually a bow-tie having several "V" elements and a reflecting screen. Gain is sometimes as high as 12 dB at distances up to 50 miles. If a translator antenna isn't required (as mentioned before), you can forget about the next steps.

Unfold the uhf antenna's mounting elements and bolt them into place. Connect the polyethylene lead-in cable to the antenna terminals and feed it through standoffs down the front of the antenna (or back through the screen). Now mount the bow-tie on the mast with two clamps just below the vhf boom. Point the bows toward the station you want; reflector remains flush behind them.

**Leading Question.** The lead-in cables for both antennas are fed down the mast and tower by way of standoffs (one for each lead). Bring the cables down one leg of the tower, pull them tight, and rotate the twin lead until you have a spiral that's taut so it won't flap in the wind. Crimp the insulating washers in the standoffs to hold the spiral in place. If you've got coax, however, you can tape it to the mast (see section on rotators).

Check to see at what point your leads will come off the roof and start down to the set. Position two screw standoffs here, fasten

down the two leads, and pull them tight. Keep on making a taut spiral with the twin lead as before.

Going across the roof, place a screw standoff every 4 ft. and keep the two leads taut as they are inserted. This should make for a neat installation.

Once the tower legs, screw standoffs, etc., are in place, use plastic roof cement to cover up all the screws for a weather-proof installation. Smear the stuff over any metal part that penetrates the roof's surface.

The antenna leads should now be brought down the side of the house. Place two screw standoffs just under the roof overhang and two more standoffs at the bottom where the leads will be fed into the house proper (through a window or the siding). Again, the leads should be taut, with more standoffs added wherever necessary. Try to keep the cables away from metal rain spouts, power lines, or other obstructions.

**Rotating the Beam.** If an antenna rotator is added to your installation it should be mounted *before* the vhf boom. Place the mast into the tower brace supports and mount the assembled rotator to this piece of pipe. If you use a 10-ft. tower, place the rotator on the tower mast as opposed to the antenna mast. This way it's easier to lower the vhf boom into the rotator assembly.

Connect the 4-, 5-, or 8-wire cable to the rotator. Make a note of the correct terminals for both ends of the cable. Terminal 1 on a flat 4- or 5-wire cable will be silver so start with it. Connect each wire to the rotator and tape the cable to the mounting bracket. The rotator's cable can be brought down either by taping it to the mast or using more standoffs.

Be sure to leave a 1½- to 2-ft. loop in your antenna leads where they run past the rotator. This permits the antenna to turn a full 360 degrees without binding or pulling the leads out of position. Use a standoff above and below the rotator to hold the loop in position. These standoffs should be in position before you tape the rotator cable to the mast. This way you won't pierce these wires with one of the standoffs; this could ground the rotator's cable.

Check the correct direction for the rotator before leaving the antenna in one position. Rotator mechanisms have either a north or south starting position. When the antenna is in its correct starting position, bolt it into place. See if the antenna loop is free so it will rotate through a full 360 degrees. ■



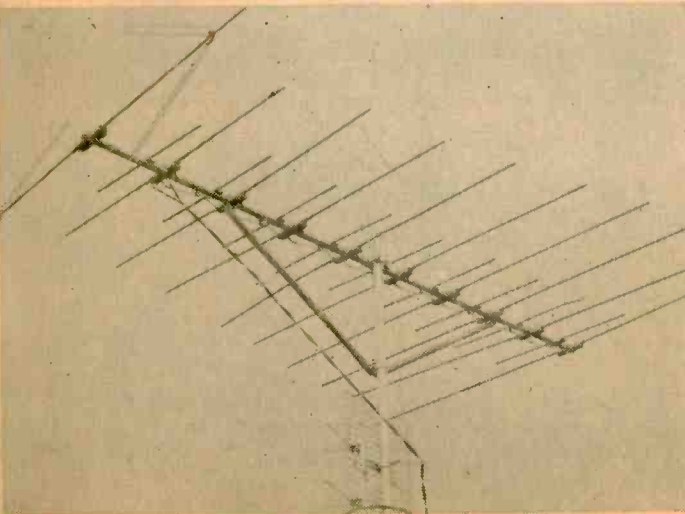
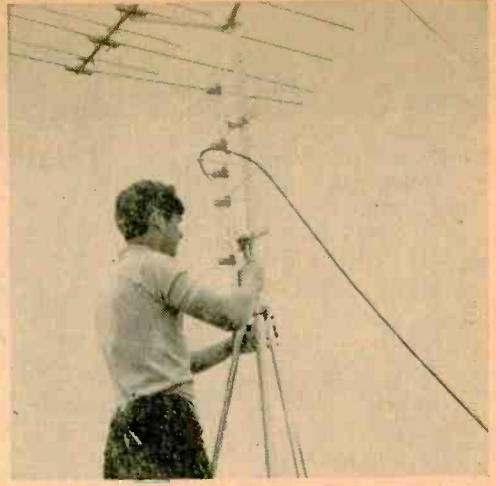

Remove uhf antenna from carton (if needed—see text) and fold out all elements. Remember, if you're going to install a rotator it should be mounted before either the vhf or uhf arrays are bolted to tower's boom. Mount uhf antenna below vhf array and point bow ties towards desired TV stations. Now bring two lead-in cables down mast along one leg of tower. Standoffs should be used to keep leads in position. Loop of  $1\frac{1}{2}$  to 2 ft. is necessary to allow rotator to turn full 360 degrees. If you have no rotator, leads may be taut. Use plastic cement to cover all metal surfaces that penetrate roof's surface. At left, both antenna arrays have been mounted on boom and pointed towards major TV stations in area. Final leveling adjustment can now be made.

# WILLING WORKHORSE

VTRs make  
the scene  
anywhere  
instant replay  
spells  
a winner



Group therapy (left) and garment manufacture (above) are but two of multifarious applications for video tape recorders. Installed at Langley Porter Neuropsychiatric Institute in San Francisco, VTR captures everything group members say and do; tape can be repeatedly replayed later for subsequent study and analysis. In garment factory, Musingwear training director Vernette Scott focuses compact Ampex CC-6007 TV camera on Mrs. Geneva Williams so her performance on sewing machine can be recorded on Ampex VR-7500 VTR. Tape is later shown to evaluating personnel.



Sword-play for replay is standard procedure among students at University of Wisconsin. Reason: students can view their fencing form and style immediately after match, thanks to Ampex VR-7100 Video-trainer system. Videotape's instant replay feature is also used in women's physical education classes and in certain co-educational classes to help students learn athletic skills and poise. VTR's big advantage here is same as in many other installations: it enables participants to see and hear themselves as others do. At Colorado State University (see photo below), VTRs actually provide engineers with on-the-job training. Classroom presentation by Dr. Sanford Thayer is recorded on nine VTRs; master tapes are then sent to nine participating Colorado industries for on-the-job viewing by company engineers. Working engineers are enrolled at university and receive credits toward graduate degrees through television classes. After viewing, tapes are returned to university and reused.

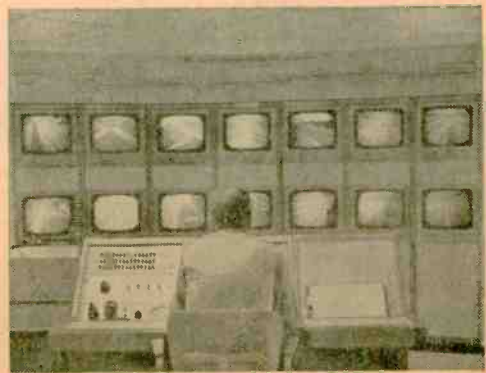
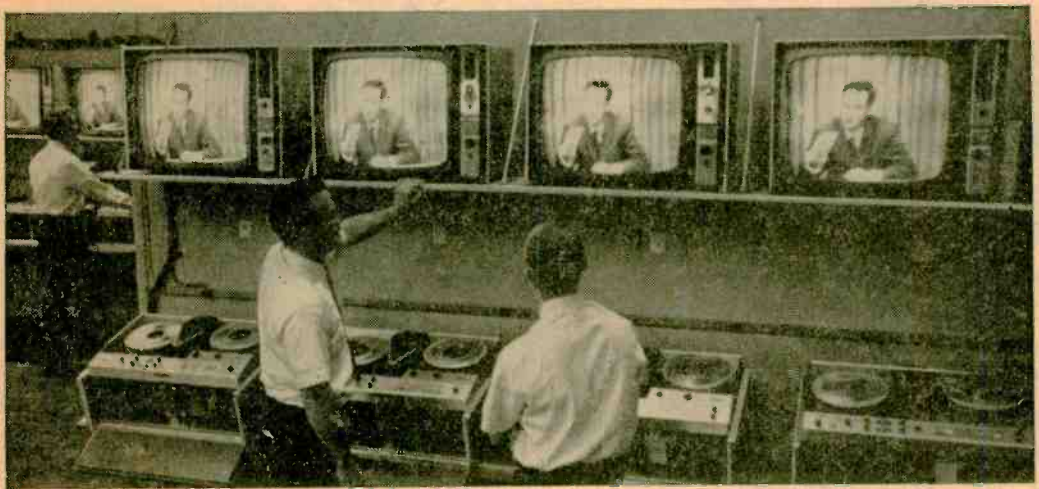
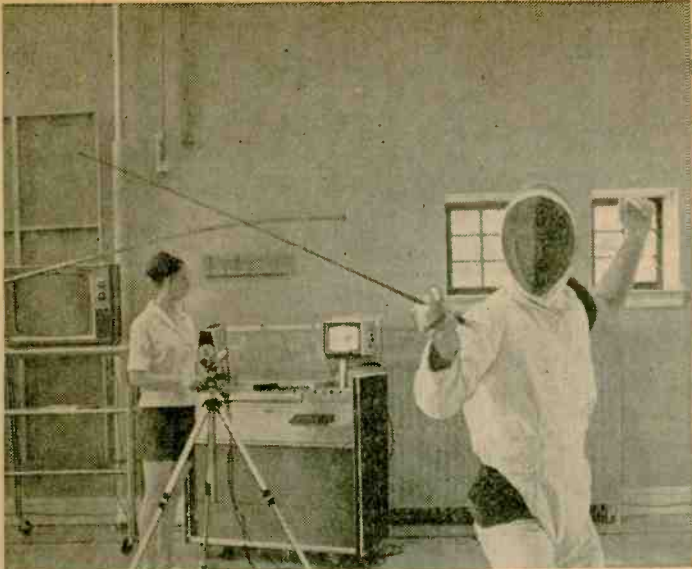

Skiing instruction (left) and traffic flow (above) are other facets of Twentieth Century Life that profit from watchful eye of VTR. Setup at left is at Sun Valley, Idaho; installation above, at Houston, Tex.

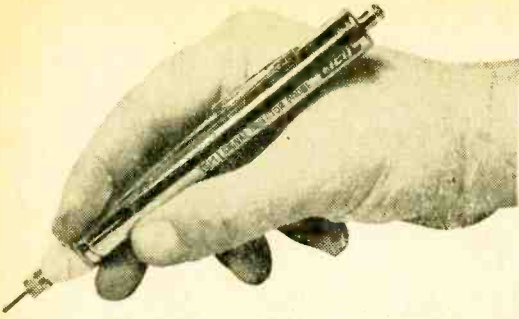

**EICO Model PSI-1  
Square Wave Generating  
Signal Injector Probe**

**A**lmost from the advent of the transistor, the *signal injector* probe (or beeper) has been the first choice of experimenters trying to equip a service shop on a shoestring budget. Reason for the beeper's popularity is that it quickly traces defective circuits by acting as a portable (and inexpensive) signal source.

A signal injector like the EICO model PSI-1 generates a square wave having a fundamental frequency of about 1 kHz. Unlike sine waveforms, which are strictly fundamental and lacking in harmonic content, the square-wave pulse from the signal injector is rich in harmonics and produces multiples of the 1-kHz signal on up through the IF and RF ranges. The more distorted (pulse-shaped) the waveform is, the higher its harmonics.

Since the PSI-1 probe produces such a broad range of frequencies, it can be applied to either the AF, RF, or IF circuits of a receiver, tuner, or amplifier. The signal (a distorted 1-kHz tone) will be heard in the speaker regardless of which stage the probe is applied to. If the probe is applied to a circuit point and no signal is heard, then the defective stage has been isolated. This is the fast, quick-and-dirty method of troubleshooting that has made the signal injector a favorite test instrument among experimenters and hobbyists.

Tests on various amplifiers and shortwave receivers showed that the PSI-1 was able to drive one heck of a signal through audio circuits, very strong signals through IF circuits, and fairly strong signals up to 30 MHz through RF stages. We even obtained a slight output at 50 MHz in an inexpensive 6-Meter transceiver. The probe, however, is rated by EICO for use only up to 30 MHz, and for normal troubleshooting we suggest 30 MHz be the upper limit.

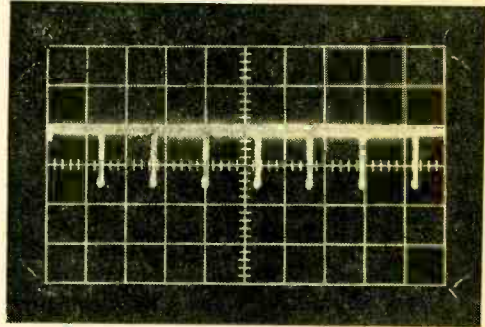

*Scope trace reveals that probe's 1-kHz output has sharp pulses rich in harmonic content. Useful frequencies range from AF to 30 MHz.*

Having only three components, the PSI-1 probe is a very simple *blocking oscillator*—with the same basic circuit as the vertical oscillator in many TV receivers. Of the three components, only the transistor and a specially designed blocking oscillator coil resonant at 1 kHz are functional. The capacitor is used to block DC in the circuit being tested.

You simply connect the transistor directly to the transformer, then connect the DC blocking capacitor and shove the whole assembly into the probe's shell. Press the button on the back and you've got a working beeper. Note that there is no battery holder. The probe loads just like a pocket flashlight  
(Continued on page 110)

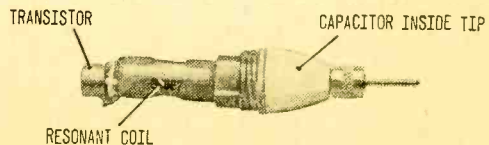

*Signal injector has three components. Transistor plugs into resonant oscillator coil; capacitor in tip blocks DC flowing in test circuit.*



**Dig radio telescopes? Try this one for size!**

**T**HE LARGEST RADIO TELESCOPE now in existence is all of 5000 miles long. One end of the instrument is in California; the other in Sweden! Hard to believe? Then consider this: the radio telescope of the future may be so large that one end of it may have to be put on the moon—perhaps even on Mars!

Let's start with the more modest, 5000-mile job. If it exists, why hasn't anyone seen the monster? Reason is it's more or less invisible. And it's invisible because it is a synthetic, mathematical entity created by a

# The Monster with One Foot on Mars

By Jorma Hyytiä

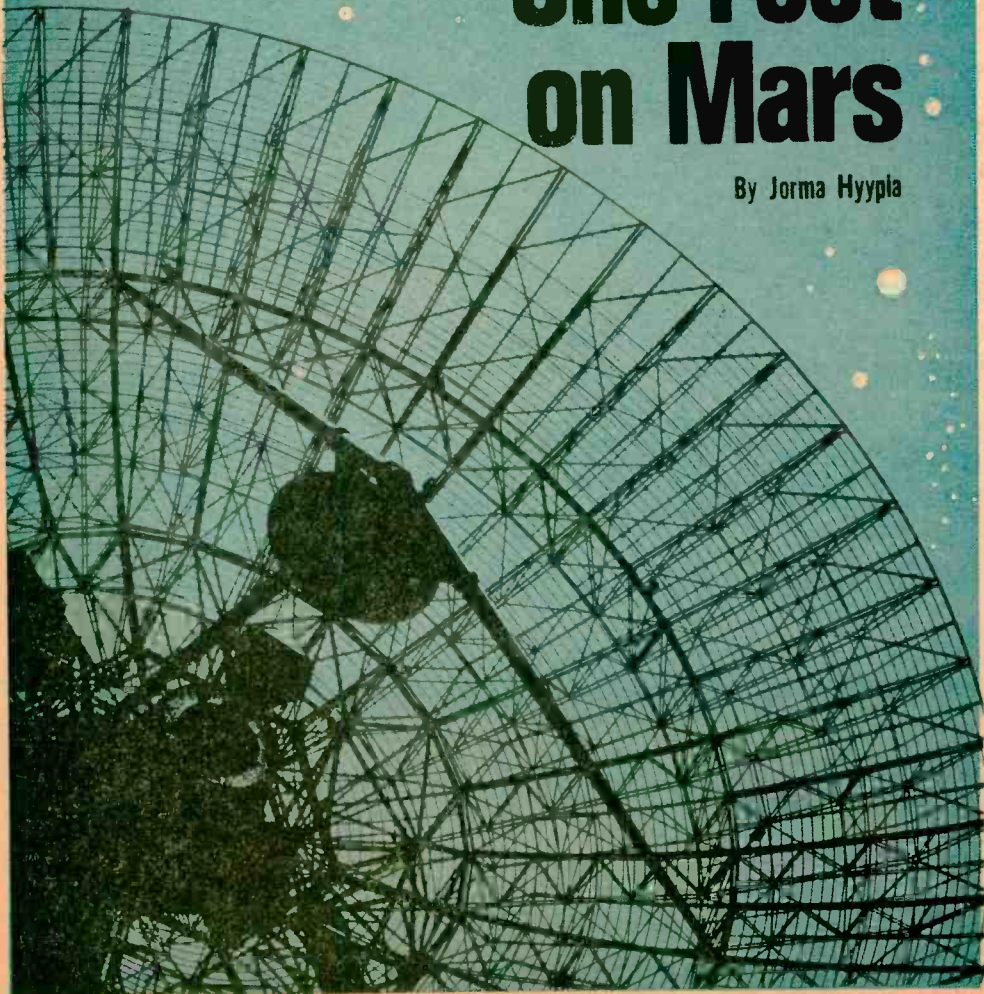

## e/e MONSTER ON MARS

complex assemblage of ordinary radio telescopes, tape recorders, atomic clocks and a computer system. Still not clear? It will be—just stick with us. But first, grab this: the super telescope we are talking about performs *as though* it really *does* have an enormous antenna thousands of miles long.

This huge radio telescope system was constructed with one primary purpose in mind: to more accurately measure the sizes of those objects in outer space that generate radio signals. As we'll see, the accuracy of measurement is related directly to the size of the telescope used.

**The Importance of Resolution.** The principal function of a radio telescope is to collect and concentrate weak electromagnetic energy from outer space to permit detection and measurement. Ideally, a telescope of either kind should collect energy from one direction while rejecting stray waves coming from other directions. This is anything but easy to accomplish.

In optical telescopes, light diffraction creates a blurring effect which distorts images; points of light—those of distant stars, for example—are imaged as tiny discs of light rather than what they really are. If two stars are very close together, their disc images may merge to such degree that two stars appear as a single source of light. The ability of an optical telescope to separate such close objects and reveal them in the form of distinct, separate images is called the *resolving power* of the telescope.

In either an optical or radio telescope, the theoretical limit of resolving or "image-splitting" power is dependent on two basic factors: the size of the collecting element (lens, mirror, or antenna) and the wavelength of the light or radio energy received. The larger the collector, and the shorter the wavelength, the better the resolving power of the instrument.

Radio telescopes are hampered even more by wave diffraction than are optical telescopes because radio wavelengths are from ten thousand to ten million times longer than light waves. Thus, a radio telescope having an antenna 200 in. in diameter cannot possibly exhibit angular resolution comparable to that obtained with an optical telescope having a mirror of the same dimensions.

To take a concrete example, the wavelength of light in the yellow-green (maximum visibility) portion of the spectrum is about 5560 Angstroms or roughly 20 millionths of an inch. The shortest radio wavelength so far used with the super radio telescope is 6 cm, or almost 2.4 in.

Let's see what these large differences in wavelengths mean in terms of resolution, using optical and radio telescopes of equal size. One will have a 200 in. diam. mirror; the other a 200 in. diam. antenna. The ratio of mirror diameter to the wavelength of light is 10,000,000; the ratio of antenna size to radio wavelength is about 83 (200 divided by 2.4). It thus should be clear that the optical system has a theoretical resolving power over 120,000 times greater than that of the radio telescope because of the difference in wavelengths used.

**The Bigger the Better.** One way to im-

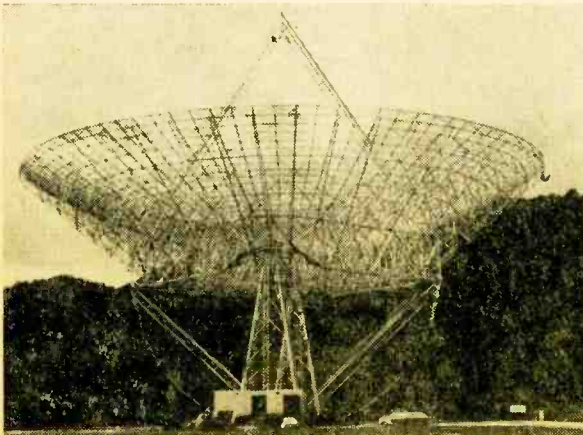

Greenbank, W. Va., home of National Radio Astronomy Observatory claims world's largest movable radio telescope (left), with dish antenna 300 ft in diam. Smaller, 85-ft scope (right) is also part of Greenbank setup.



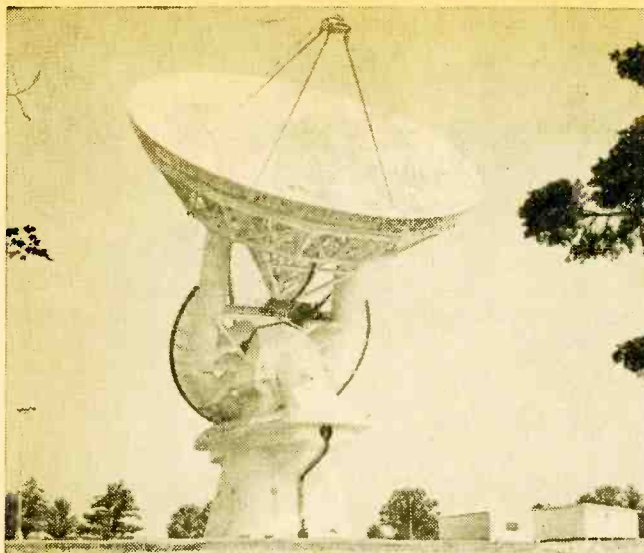

*Third monster at Greenbank, completed in 1965, is 140 ft in diam and some 200 ft above ground. Concrete base supporting scope is itself 60-ft high and contains scope's controls, radio receivers, power transformers, mechanical equipment, and work shops. Total rotating weight of scope, including antenna, polar shaft, spherical bearing, yoke, and ballast, exceeds 2600 tons!*

prove the resolving power of a radio telescope is to use the shortest possible wavelengths. Obviously, there is a limit of how far you can go in this direction. Also, it's not always desirable to reduce the wavelength because very often relatively longer wavelengths are needed to obtain specific types of information from outer space. Thus the only practical solution is to increase the size of the telescope—which means increasing the size of the antenna.

Our table showing the resolving powers of optical telescopes and the super radio telescope reveals what can be accomplished by increasing antenna size. Remember that the smaller the angular resolution, the greater the resolving power.

The 0.0006 arc seconds of resolution achieved with the radio telescope was under conditions wherein a 6-cm. radio wavelength was used with an antenna several thousand miles long (extending from West Virginia to Sweden). This degree of resolution is about 50 times greater than is theoretically possible using the 200-in. Palomar telescope; it's also some 100,000 times greater than that of the average human eye.

(The pupil of the human eye has a diameter of about 3 mm and the minimum angle

of resolution calculates to be about 47 angular seconds. However, because of optical defects and limitations of the retina, the average eye is not able to resolve objects less than 60 angular seconds apart.)

The fantastic resolving power of the big radio telescope can be visualized another way.

This resolution is equivalent to the ability to measure the size of a postage stamp in Sweden as seen from West Virginia, or to measure the size of an automobile on the moon!

**Paired Telescopes.** Single radio telescopes can measure angular distances in the sky with resolutions comparable to that of the human eye. Years ago, radio astronomers learned how to improve the resolution of radio telescopes by linking two or more instruments together by means of cable or radio communications. But such linkages are of limited usefulness because the telescopes must be within a few hundred miles of each other; the high cost of cables and the complexity of radio linkages limit practical application of this method of telescope pairing.

Successes with these earlier cable- and radio-linked telescopes indicated that the resolution of radio telescopes could be improved even more if the VLB (very long baseline) could be extended to international or intercontinental proportions. This new idea was put to practical test only a year ago by the National Radio Astronomy Observatory, working in collaboration with scientists from Arecibo (Puerto Rico), the Massachusetts Institute of Technology, and the University of California. This first successful VLB experiment, involved telescopes in Puerto Rico, California, Massachusetts, Maryland, Canada, among others.

The new international telescope system that evolved from these initial experiments makes use of four widely separated instruments. The largest of these is a 140-ft diam-

**Comparative Resolving Powers**

Optical Instrument	Arc Seconds	Angular Degrees
Super radio telescope	0.0006	0.00000166
200-in. Palomar telescope	0.03	0.000083
40-in. Yerkes telescope	0.14	0.000039
Human eye	60.00	0.0166

# e/e MONSTER ON MARS

eter telescope at the National Radio Astronomy Observatory, Green Bank, W. Va. Three smaller telescopes, each 85 ft in diameter, are at the following locations: Chalmers University of Technology, Onsala, Sweden; Massachusetts Institute of Technology, Cambridge, Mass.; the University of California, Hat Creek, Calif.

**Atomic Clocks.** The trick was to synchronize these telescopes without using cable or radio connections. This was done by feeding the radio signals, captured by each telescope, into individual tape recorders while simultaneously calibrating the recorded observations with the aid of ultra-precise atomic clocks (see our drawing).

Tape recording of radio telescope signals is a standard procedure, used even when telescopes are operated as single units. But now, the integration of accurate atomic clock timing systems into this standard technique makes it possible to compare with great accuracy data obtained by telescopes at several widely separated locations.

The four telescopes in the new system line up roughly in an east-west direction. This orientation is important because it becomes possible to synchronize the scanning of selected sections of sky by utilizing the rotation of the earth as a sweep mechanism. Each individual telescope antenna can also be moved to alter its altitude; it thus becomes possible to scan successive strips of the sky. The time-

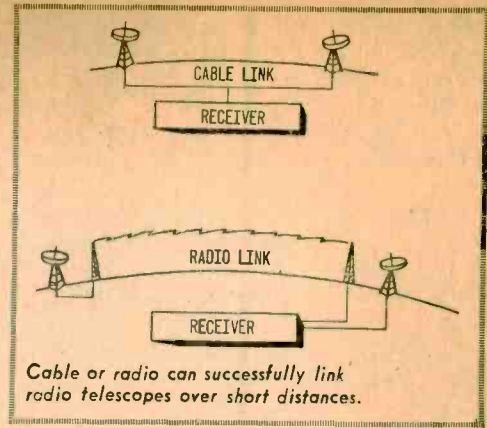

calibrated, tape-recorded scan data are then correlated with the aid of high-speed digital computers to produce a radio-wave "picture" of the sky that is very much like one that would be obtained if an antenna several thousand miles in diameter had been used.

**Moon-Scopes to Come?** The only way to further increase the already phenomenal resolution of the super telescope would be to make the baseline still longer. To a degree, this could be done by using instruments in certain other parts of the world. But the amount of improvement over the present system would not be especially dramatic.

The only alternative would seem to be that of extending the baseline into outer space by placing one of the telescopes on the moon. In light of recent advances in space science, such a feat cannot be ruled out as a very real possibility. Data collected by the moon-scope would be taped, and the information would

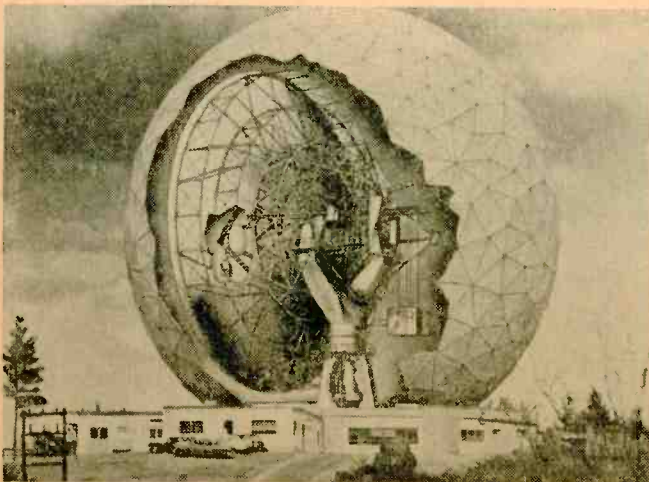

Installation at Haystack Microwave Research Facility (operated by M.I.T.'s Lincoln Laboratory for U.S. Air Force) boasts 120-ft antenna within 150-ft diam radome. Note man within circle in closeup at right.



then be telemetered to receivers on earth.

An earth- and moon-based system would of course require the solving of some knotty problems. So long as the chain of telescopes remains on earth, strip scanning of the sky is relatively simple because the rotation of the earth synchronizes all the telescopes. But a telescope on the moon would obviously have to be synchronized with earth-based instruments in some other way. This would be difficult, but not necessarily impossible.

The mean distance from earth to moon is about 238,000 miles. This would provide a baseline almost 50 times longer than the one now used on earth. The improvement in resolution could be most impressive. And if that isn't enough, the system might be extended even further—to Mars, say, in which case the baseline could be as long as 248 million miles!

Aside from improving resolution by creating a larger synthetic antenna, there may be other advantages in placing part of the telescope system outside of the earth's atmosphere. There isn't much point in building optical telescopes much larger than the 200 in. Palomar instrument. Reason: the advantages of a bigger telescope would be largely negated by image distortion created by atmospheric disturbances; moreover, far smaller telescopes placed into earth-orbiting observatories can do better work than much larger ones on earth.

In like manner, radio telescopes operating on the airless moon may function much better because they would be relatively free of those environmental interferences that plague radio reception on earth.



Monster at University of California's Hat Creek installation near Mount Lassen is also 85 ft in diam.

**Splitting Quasars.** In January 1968 the new telescope was put to use. One of its first jobs was to "split" quasars, those intrinsically bright radio sources that some astronomers believe may be located in the far extremities of the observable universe. If the sizes of the component parts that make up a quasar can be determined accurately, astronomers will have an easier time trying to figure out what mechanisms in these objects generate such stupendous amounts of radio energy.

For quasar splitting, the astronomers used the Swedish and the West Virginia telescopes to pick up 6 cm. radio waves emanating

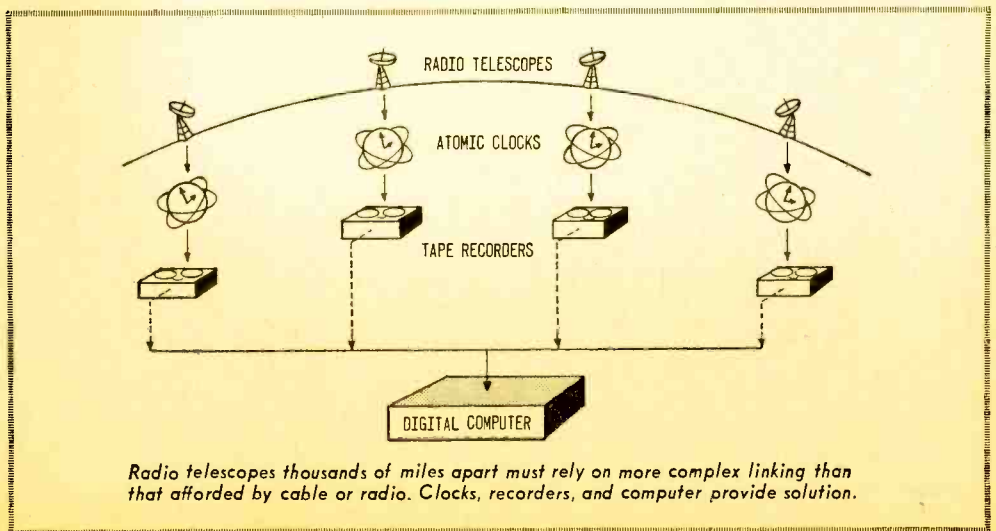

Radio telescopes thousands of miles apart must rely on more complex linking than that afforded by cable or radio. Clocks, recorders, and computer provide solution.

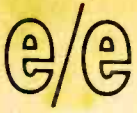

## MONSTER ON MARS

from the brightest known quasar (identified as 3C273). It was already known that this quasar has a complex structure.

But just how complex is it? The new telescope has provided many of the answers in its first attempt at quasar splitting. But it can't provide the full answer. At least one component of the quasar is so small it still defies measurement. From theoretical considerations of the radio spectrum of 3C273, and because the energy source is known to vary in radio intensity, astronomers predict that this remaining component may have a diameter of about one ten-thousandth of a second of arc (that's about 0.00000003 part of an angular degree!).

Elated as the astronomers are with the proven capabilities of the new telescope, they readily admit that bigger ones are needed. Said one: "To measure it (the remaining component of quasar 3C273) accurately, astronomers will have to reduce the wavelength of their observations, or separate the antennas used in the experiment even farther than they now are."

**Radiant Queen.** A large mass of glowing hydrogen gas, about 6000 light years away from earth, is located in the constellation of Cassiopeia—the "Queen" of the skies. This mass of gas, known as W-3, is a source of radio energy. Near the edge of W-3 are other speck-like sources of radiation that intrigue astronomers.

The *width* of the emission lines of these tiny sources of OH (hydroxy molecule) radiation indicate that the radiating gas must be very cold—perhaps only a few degrees above absolute zero ( $-459.72^{\circ}\text{F}$ ). On the other hand, the *amount* of radio energy received from these sources implies that the temperature is well over a million-million degrees!

Contradictory? Yes—unless it can be demonstrated that the radiation is emitted because of some *non-thermal* mechanism such as a giant space maser. To prove or disprove the maser theory, astronomers and physicists must have reliable measurements of the sizes of these radiating objects. The super telescope was designed to do just this.

The first results of the OH experiments (using 18 cm. wavelength) show that one of these tiny specks exhibiting OH emission has a diameter of only four thousands of a sec-

ond of arc (0.000001 degree)! If the object is 6000 light years away from us—and astronomers believe it is—the measured diameter indicates that the "speck" would fit easily inside the orbit of planet Jupiter. Put another way, the object would cover less than one ten-thousandth of the distance from earth to the nearest star. In astronomic terms, this is a very small object indeed, considering the energy it packs. It represents the smallest angular diameter ever measured for a source of stellar radiation.

A short while after these experiments had been concluded, the Green Bank telescope in West Virginia was used to detect a previously unobserved line of microwave radiation (6.3 cm wavelength) in the W-3 radiation region of constellation Cassiopeia.

The astronomers who made the discovery state: "The strength of the new 6.3-cm emission line from the OH molecule confirms that the gas is radiating by a non-thermal emission mechanism. . . . Just how the maser phenomenon is produced in interstellar space remains a mystery, but the new discovery of OH radio emission at 6.3 cm will hopefully help unravel the mystery."

**Endless Opportunities.** When the techniques of VLB radio astronomy have been further refined, many other experiments of great interest to astronomers, physicists, and geophysicists will become possible.

The system can be used to test general relativity involving the bending of light waves near the edge of the sun. Atomic clocks on different continents may be synchronized to an accuracy of one one-hundredth of one-millionth of a second of time (up to 100 times better than currently used techniques permit). Geophysicists will be able to measure intercontinental distances with an accuracy better than a few inches; such precise measurements will lead to better understanding of earth tides and continental drift. And the system may be used to study irregularities in the rotation period of the earth as well as changes in the direction of the earth's rotation axis.

Long ago, Archimedes expounded on the marvels of mechanical leverage, saying: "Give me a place to stand on and I will move the earth." Modern astronomers might well paraphrase Archimedes by saying: "Give us a place to put our instruments and we will measure the universe."

One of these days, the astronauts may take the astronomers to the moon and say: "Prove it!"



# Without NTS training you've only scratched the surface in electronics...

NTS digs deep into electronics. Proof? Look at the close-up at the left. It's the first transistorized digital computer-trainer ever offered by a home study school.

Fascinating to assemble, the NTS Compu-Trainer® introduces you to the exciting world of computer electronics. Its design includes advanced solid-state NOR circuitry, flip-flops, astable multivibrators and reset circuits. Plus two zener and transistorized voltage-regulated power supplies. The NTS Compu-Trainer can perform 50,000 operations per second, and is only one of many ultra-advanced kits we offer to give you incomparable, in-depth career training.

## NTS... THE FIRST HOME STUDY SCHOOL TO OFFER LIVE EXPERIMENTS WITH INTEGRATED CIRCUIT KITS

With NTS Project-Method Home Training, you build a computer sub-system using the new, revolutionary integrated circuits. Each one, smaller than a dime, contains the equivalent of 15 resistors and 27 transistors.

With Project-Method, kits are carefully integrated with lesson material. All our kits are real equipment—not school-designed versions for training only. Project-Method was developed in our giant resident school... and proven effective for thousands of men like yourself. It's the practical-experience approach to learning. Gets you going in a hurry!



### ■ COMMUNICATIONS

This Transceiver is included in Communications courses. It's yours to build... to easily prepare for F.C.C. License exam... To become a fully-trained man in communications.

### ■ 25" COLOR TV

Included in Color TV servicing courses. Building this advanced receiver gets you deep into color circuitry—advances you into this profitable field of servicing—the easy way. Color is the future of television, and your future, too!

### ■ INDUSTRIAL & COMPUTER ELECTRONICS

New ideas, new inventions, are opening whole new fields of opportunity. Electronic control systems, computers, are being applied to great numbers of manufacturing processes every day. We train you for this new field, fast! With advanced control systems devices, a new 5" oscilloscope, and the NTS Compu-Trainer. Modern, quick and easy training prepares you to enter this brand-new world like a pro.



**GET THE FACTS! SEE ALL NEW KITS AND COURSES OFFERED IN THE NEW NTS COLOR CATALOG. SEND THE CARD TODAY!** No obligation. No salesman will call.

**Classroom Training At Los Angeles.** You can take classroom training at Los Angeles. NTS occupies a city block with over a million dollars in facilities devoted exclusively to technical training. Check box on coupon.

## NATIONAL TECHNICAL SCHOOLS

WORLD-WIDE TRAINING SINCE 1905

4000 So. Figueroa Street Los Angeles, Calif. 90037

APPROVED FOR VETERANS



Accredited member:  
National Home Study Council  
National Association of  
Trade and Technical Schools.



**PIEZO Model WX-127**  
**Frequency-Stabilized**  
**FM Wireless Microphone**

**A** mini-size FM wireless microphone, the Piezo WX-127 measures just  $4\frac{3}{4} \times 1 \times 1$ -in. and weighs in at only 3 oz. And that weight, believe it or not, includes the two RM-625 mercury cells in the power supply.

But in spite of its minuscule size and weight, the WX-127 contains considerably more circuitry than is found in the usual low-cost FM mike. Specifically, there's a buffer amplifier between the oscillator and antenna which prevents frequency instability. And as anyone in the know can tell you, that's Problem No. 1 with most any inexpensive FM mike.

Wireless mikes which lack a buffer amplifier feed the antenna directly from the modulated FM band oscillator. Result is that they're prone to frequency instability since anything—even body capacity—which affects the antenna's reactance is reflected back to the oscillator. This detunes the oscillator and changes the operating frequency.

The tuned buffer amplifier in the WX-127, on the other hand, prevent frequency-changing reactance effects from being reflected from the antenna back into the oscillator. In

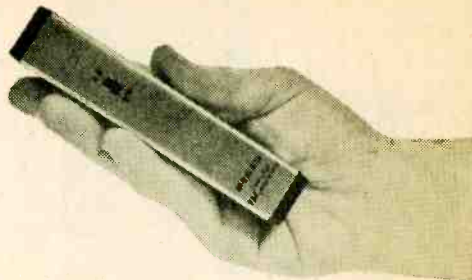

addition, the entire mike is fully shielded by a solid metal case, thereby ensuring that body-capacity effects have minimal effect on the oscillator.

**Three On One.** The entire 3-transistor circuit—an audio amplifier/modulator, an oscillator, and the buffer amplifier—is on a small printed circuit strip inside the case. An access-hole to the oscillator coil slug is provided so the user can easily change the operating frequency.

The plug-in antenna is an extra-flexible black wire which can be tucked into a pocket, pants leg, or shirt pocket. Our tests indicated that the antenna doesn't have to hang straight down. We also found performance to be pretty much the same whether the antenna was in the open or concealed.

A small bulge at the end of the antenna hides a holder for the supplied insulated alignment tool, which is used to set the oscillator to an unused FM channel.

The Piezo WX-127 is powered by two RM-625 mercury cells which fit inside the case in a manner suggestive of the system used on quality cameras. Twisting an over-size capscrew exposes the well which the two mercury cells are dropped into. Firm connection is made when the spring-loaded cap is replaced.

The FCC requires that FM wireless mikes meet certain specifications in regard to suppression of spurious signals. Fortunately, since the tuned buffer amplifier in the WX-127 tends to pass the operating frequency only, it effectively suppresses spurious signals to the FCC requirements.

**Performance.** We tested the WX-127 using a low-cost FM tuner as the receiver. Noise-free reception was obtained to slightly more than 100 ft. at all times. Noise-free  
*(Continued on page 110)*

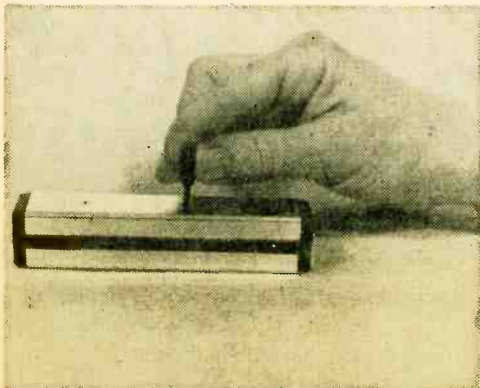

*Small, insulated alignment screwdriver, which stores in end of plug-in antenna, is used to adjust oscillator frequency to unused FM channel via access hole on rear side of WX-127's case.*



# BASIC COURSE IN ELECTRICITY AND ELECTRONICS\*

## PART VII— UNDERSTANDING TRANSISTORS



**W**HAT YOU WILL LEARN! Transistors were invented 21 years ago. Since that time millions have been used in a great variety of electronic devices. In this course you will learn something of what a transistor is and what it can do. You will also be given details about a few interesting transistor circuits that you can build.

### WHAT IS A TRANSISTOR?

The term *transistor* comes from the combination of two words—"transfer resistor." A transistor *transfers* small values of electrical energy into larger values. Weak voltages (such as those representing sound) can be made strong enough by transistor circuits to operate a speaker.

A transistor is actually a variable *resistor*, but not of the ordinary type you have studied. It is unique because its *resistance can be varied electrically*. Small incoming voltages cause small currents to flow through the transistor.

\* This series is based on *Basic Electricity/Electronics*, Vol. 1, published by Howard W. Sams & Co., Inc.

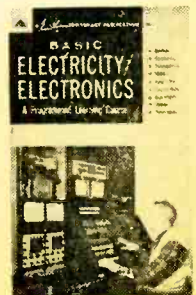

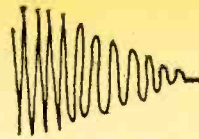
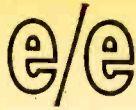
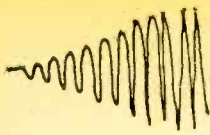

The small currents make corresponding but large changes in the transistor resistance, causing other transistor currents to make equally large changes in value. The output signals are therefore similar to, but stronger than, the input signals.

Transistors are constructed from materials classified as *semiconductors*. Germanium and silicon are examples.

### HOW TRANSISTORS ARE USED

Transistors come in several shapes and sizes. There are now hundreds of varieties, each one having special characteristics that makes it different than the others for specific applications. The three types shown in the diagram are representative of the shape and size of most transistors. An *alpha-numeric* (letter and number) code is assigned to each type of transistor. This designation, with the aid of a handbook, identifies the operating characteristics of each particular transistor.

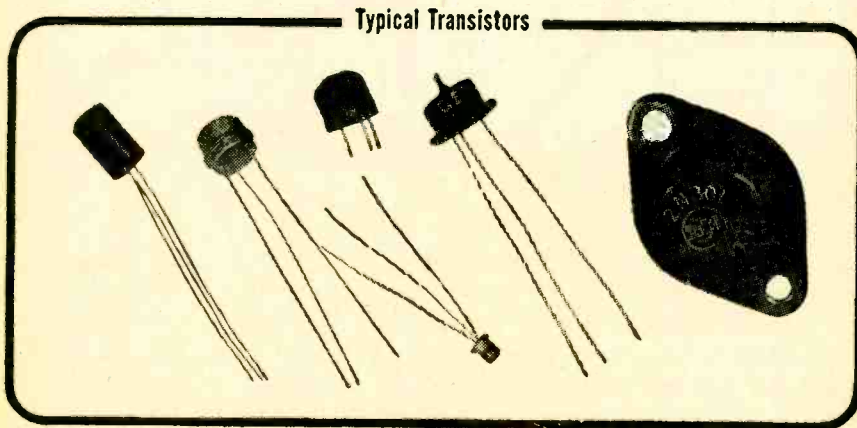

### Amplifiers

Transistors are capable of converting small voltages or currents into larger ones. The process is called *amplification*. Electronic circuits that accomplish this function are known as *amplifiers*. Most of the circuits used in electronic equipment of all types are designed as amplifiers.

Vacuum tubes, for example, were used in amplifier circuits long before transistors were developed. Transistors are replacing the vacuum tube as an amplifying device in many applications for several reasons. These include:

1. Small size and weight, allowing equipment to be made smaller and lighter.
2. Low operating voltages, eliminating the need for heavy and expensive power supplies.





3. Relatively noise free, permitting signals to be amplified without certain types of distortion.

Transistor amplifiers are used in radios, television receivers, tape recorders, phonographs, and a host of military, commercial, and industrial electronic equipment.

### Control Circuits

In control circuits, a transistor acts as an electrically operated switch. Such circuits are built into electronic clocks, testing devices, digital computers, etc.

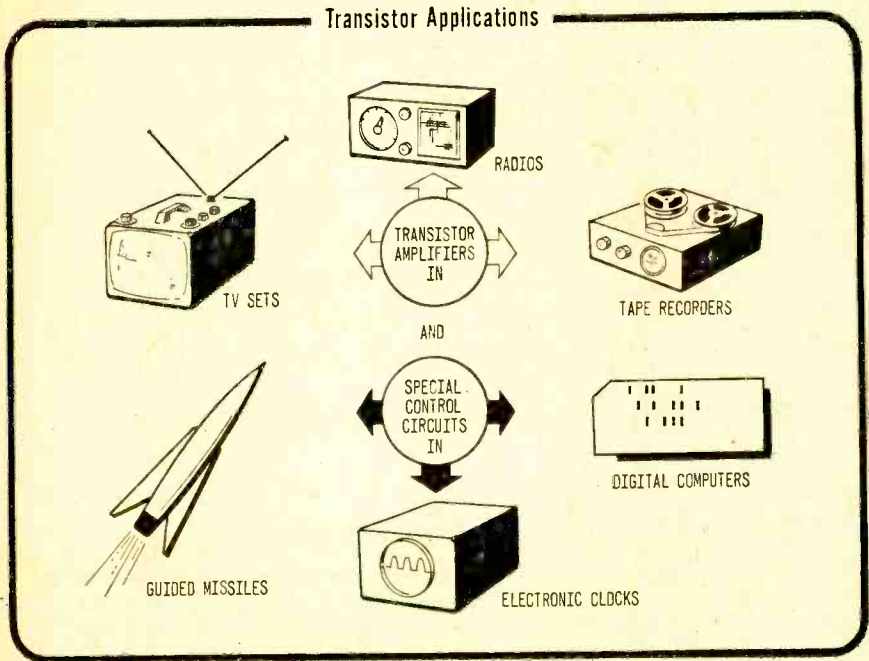

- Q1. A transistor is a device that can convert (small, large) signals into (small, large) signals.
- Q2. This conversion process is called -----.
- Q3. A transistor can amplify because its internal ----- can be electrically varied.
- Q4. A transistor is ----- in size, ----- in weight, and can use --- voltages for operation.

#### Your Answers Should Be:

- A1. A transistor is a device that can convert *small* signals into *large* signals.
- A2. This conversion process is called *amplification*.
- A3. A transistor can amplify because its internal *resistance* can be varied electrically.
- A4. A transistor is *small* in size, *light* in weight, and can use *low* voltages for operation.

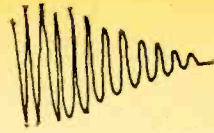
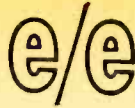
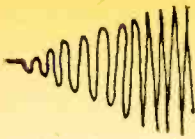

### TYPICAL TRANSISTOR CIRCUITS

One type of transistor circuit will be explained to give you an understanding of transistor operation. The circuit should be constructed as an experiment to reinforce your learning.

#### A Transistor Voltage Divider

A transistor can be used with resistance in series to form a voltage divider. Construction details are shown below.

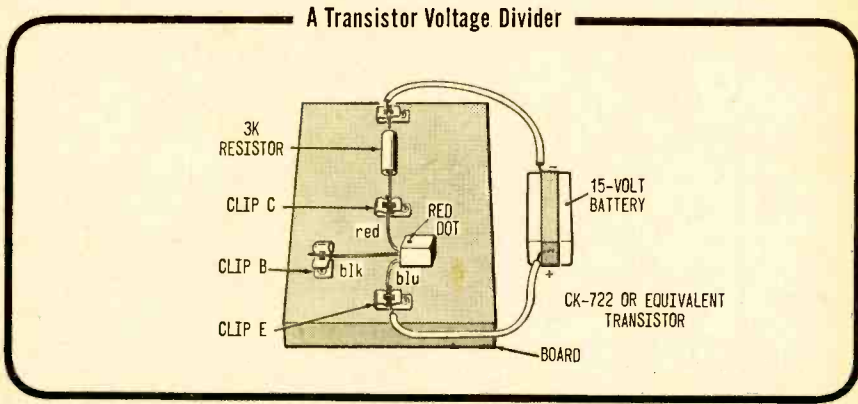

Be careful when handling the transistor because the fragile wires break very easily. Avoid sharp bends and kinks.

Two schematics of the circuit are shown below. One shows an incomplete symbol for the transistor—the correct version will be given and described later. The other schematic shows the transistor as a variable resistance. The slanted arrow indicates the resistance is variable.

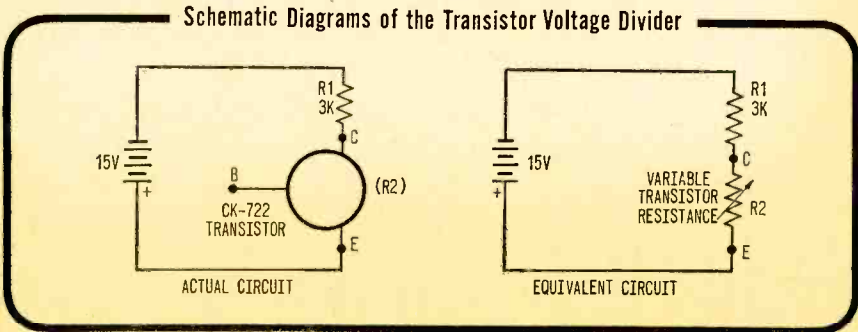

**NOTE:** Until you have more experience, do not connect any ohm-meter directly across the transistor leads. Certain ranges of some



ohmmeters develop enough current to destroy small transistors. The 3000-ohm resistor in the above circuit acts as a current-limiting resistance to prevent the 15-volt battery from doing the same thing.

Based on your knowledge of resistance in series, what value must R2 be in order to obtain a voltage reading of 7.5 volts at terminal C? Yes, it must be the same value as R1 (3000 ohms) to divide the value of source voltage equally between them.

- Q5.** What approximate value must R2 have if nearly all the source voltage is measured across R1?
- Q6.** To have most of the source voltage dropped across R1, R2 must be (more, less) than 10 times the value of R1.

**Your Answers Should Be:**

- A5.** For 15 volts to appear across R1, R2 must be very close to zero ohms. *A very few ohms* would be a good answer. Remember, voltage (IR drop) is distributed among series resistors in accordance with their value in ohms. A resistor which is 10 times as large as another has 10 times as much voltage across it as the other.
- A6.** To have most of the source voltage dropped across R1, R2 must be *more* than 10 times the value of R1.

**The Circuit Operating as a Switch**

If you measure the voltage across the transistor with the circuit connected as shown, you will find that it will be very close to 15 volts. An extremely accurate meter might measure it as 14.96 volts. This leaves 0.04 volt for R1. If the voltage across R2 is 374 (14.96 divided by 0.04) times greater than the voltage across R1, the resistance of R2 must be the same number of times larger. This works out to be a value of over 1,000,000 ohms. The illustration shows how the voltmeter is connected across the transistor.

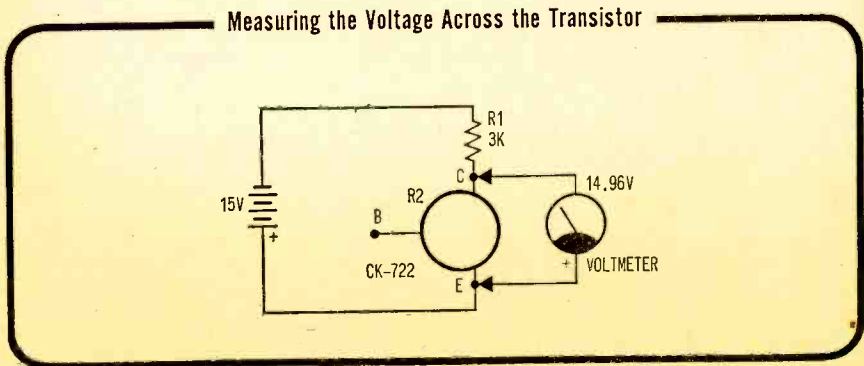

Under these conditions, current in the circuit would be very small, about 15 millionths of an amp. In effect, the high resistance of the transistor is very

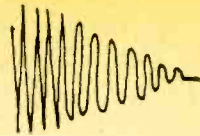

close to being an open circuit—no current flowing.

The structure of the transistor material will cause this resistance to change when current flows from B to E.

By adding a large resistor (56,000 ohms) from the negative side of the battery to the B terminal of the transistor, approximately 250 microamps will flow through the transistor. The meter reading, as shown below, is near 0 volts.

### Voltage Across Transistor with Negative Voltage at B

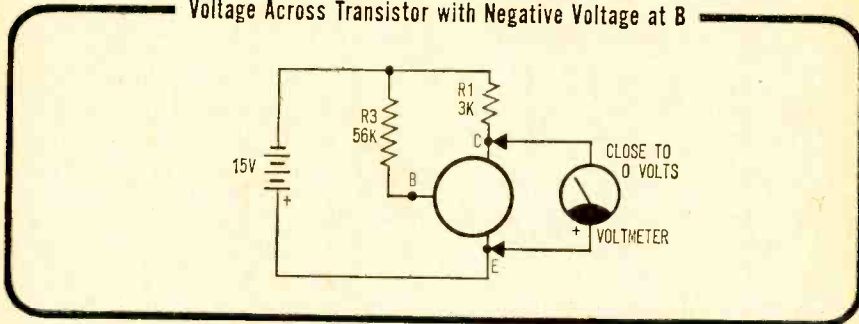

In effect, the path through the transistor from C to E has decreased from a very high resistance to a very low resistance. The transistor is operating as if it were a switch. The pair of diagrams below show the transistor acting as a switch. With no current through B, the transistor acts as an open switch; with current it acts as a closed switch.

### Transistors Can Act Like a Switch

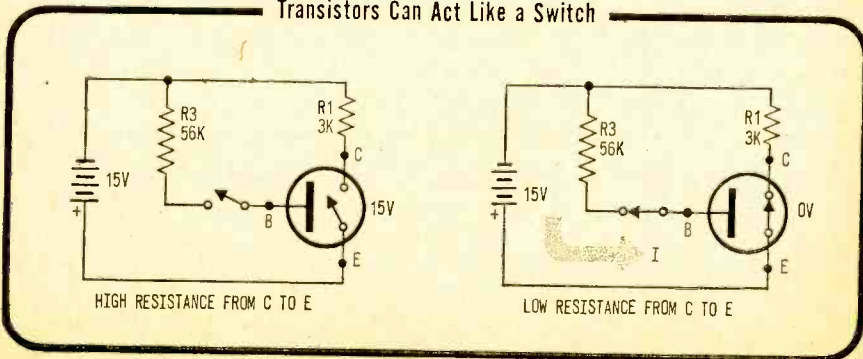

**Q7.** When a small amount of current enters the B terminal, the transistor acts as a(an) ----- switch and almost (all, none) of the source voltage appears across it.

**Q8.** With no current through B, the C to E switch is (open, closed) and almost (all, none) of the source voltage can be measured across the terminals.



**Your Answers Should Be:**

- A7.** When a small amount of current enters the B terminal, the transistor acts as a *closed* switch and almost *none* of the source voltage appears across it.
- A8.** With no current through B, the C to E switch is *open* and almost *all* of the source voltage can be measured across the terminals.

In practice, the transistor switch is opened and closed by electrical signals applied to the B terminal. These will be discussed later in the chapter.

### TRANSISTOR SYMBOLS AND CONNECTIONS

Transistors have their own symbols and methods of being connected within a circuit, the same as other electrical and electronic components.

#### Symbols

There are two types of transistors—*npn* and *pnp*. The difference between the two is the type of materials used in their construction and, as a result, the direction that current flows between terminals.

Symbols for both types are shown below. The CK-722 (used in the experiment) is a *pnp* transistor.

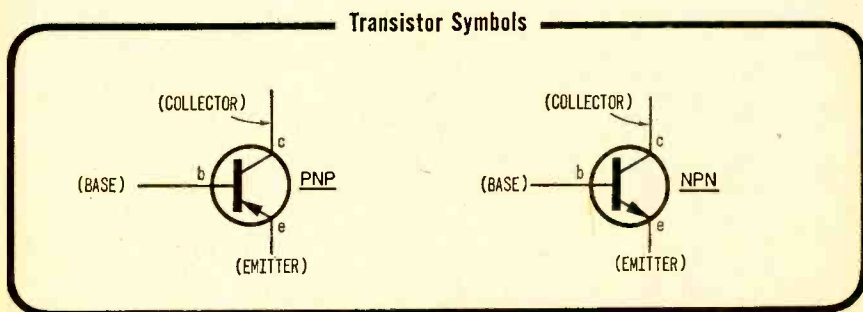

The only difference in the two symbols is the direction of the arrowhead. Be able to recognize either one. Current not only flows through the two types in different directions, but they are connected into a circuit differently.

Also note the names for the B, C, and E terminals. *Base*, *collector*, and *emitter* identify the significant parts of a transistor; b, c, and e are the notations often used in schematic diagrams.

Shown at top of page 98 are the basic circuits for *npn* and *pnp* transistors, and the flow directions for base, collector, and emitter currents. Study them carefully before answering Q9-17.

- Q9.** The symbol  $I_B$  stands for ----- current.
- Q10.** The symbol  $I_C$  stands for ----- current.
- Q11.** The symbol  $I_E$  stands for ----- current.
- Q12.** The symbol  $I_T$  stands for ----- current.

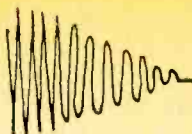
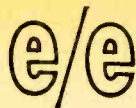
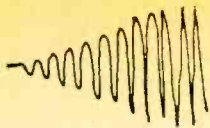

## Basic Transistor Circuits

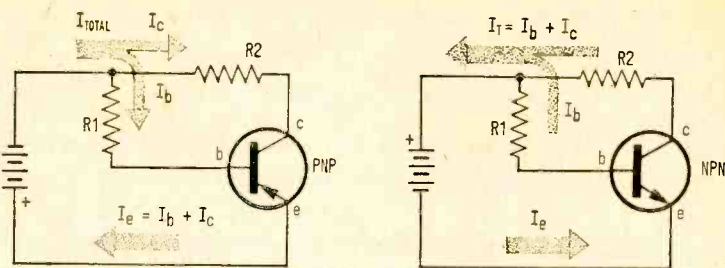

- Q13. In both circuits, emitter current is equal to ----- current plus ----- current.
- Q14. In both circuits, total current is equal to ----- current plus ----- current.
- Q15. In either circuit, ----- current and ----- current are the same value.
- Q16. The terminals of R<sub>1</sub> and R<sub>2</sub> nearest the transistor are negative in the (*nnp*, *pnp*) circuit.
- Q17. Emitter current is (greater, less) than the base current.

## Your Answers Should Be:

- A9. The symbol  $I_B$  stands for *base* current.
- A10. The symbol  $I_C$  stands for *collector* current.
- A11. The symbol  $I_E$  stands for *emitter* current.
- A12. The symbol  $I_T$  stands for *total* current. (Total current refers to the current that flows through the voltage source.)
- A13. In both circuits, emitter current is equal to *base* current plus *collector* current.
- A14. In both circuits, total current is equal to *base* current plus *collector* current.
- A15. In either circuit, *total* current and *emitter* current are the same value.
- A16. The terminals of R<sub>1</sub> and R<sub>2</sub> nearest the transistor are negative in the *nnp* circuit. (The terminal of any resistor through which current enters has negative polarity.)
- A17. Emitter current is *greater* than the base current.

## A SIMPLE CONTROL CIRCUIT

A control circuit can be made from the transistor voltage divider used in the first part of this chapter. The control circuit will be used as a means of apply-



ing the principles you have learned about transistors. Enough details are furnished so you can construct and use the circuit if you desire.

### Circuit Construction

The control circuit is very similar to the other transistor circuits that have been discussed. A schematic diagram (including parts detail) is shown below.

R1 and R2 connect the transistor base to the negative terminal of the 15-volt battery. R1 can be any low resistance material or device. Its purpose is to interrupt the base circuit when the event to be detected takes place.

R3 connects the collector to the negative terminal of the battery. The positive battery terminal is connected to the emitter. A lamp is connected in parallel with the transistor and will light when the event is detected.

The battery is not shown as a symbol in the schematic diagram. Arrowheads, however, point to the proper terminal connections. This technique is used to save space and reduce clutter in the schematic diagram.

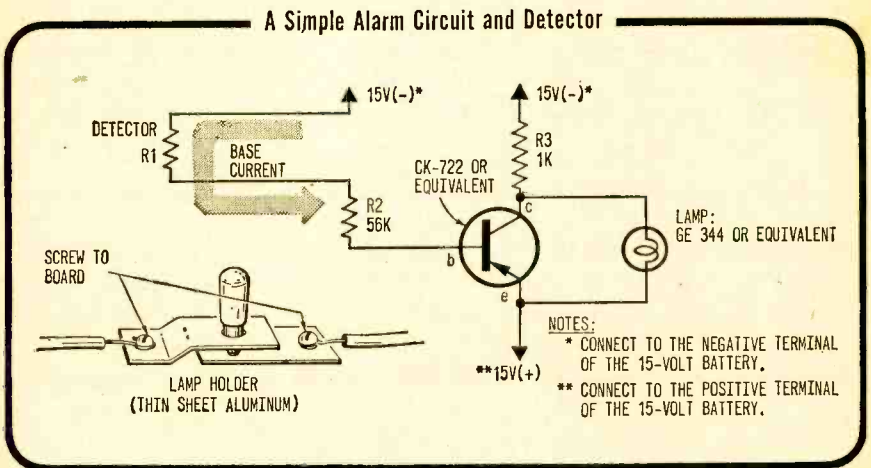

- Q18.** When base current flows through the transistor, a very (high, low) resistance appears between collector and base.
- Q19.** When resistance between c and e is high, (fifteen, zero) volts will be developed between collector and base.

#### Your Answers Should Be:

- A18.** When base current flows through the transistor, a very *low* resistance appears between collector and base.
- A19.** When resistance between c and e is high, *fifteen* volts will be developed between collector and base. (By comparison, R3 will be a very low resistance. Therefore, most of the voltage source will be developed across the transistor.)

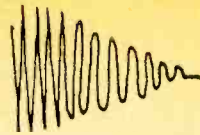
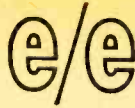
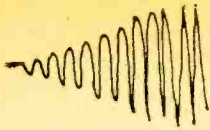

- Q20. The voltage polarity of R3 is negative on the (collector, battery) side.
- Q21. The voltage polarity of R2 is positive on the (base, detector) side.
- Q22. The lamp (will, will not) light as long as base current is flowing.

**Your Answers Should Be:**

- A20. The voltage polarity of R3 is negative on the *battery* side. (Remember that collector current in a *pnp* circuit flows toward the collector. The polarity of R3, then, must be minus to plus, top to bottom.)
- A21. The voltage polarity of R2 is positive on the *base* side.
- A22. The lamp *will not* light as long as base current is flowing. (When base current flows, c-to-e resistance is almost zero. Not enough voltage is developed across the transistor to light the lamp.)

**How the Circuit Operates**

The preceding questions established the fundamental principles of transistor operation. Now these principles will be used to explain how the circuit operates.

Current Flow in Alarm Circuit

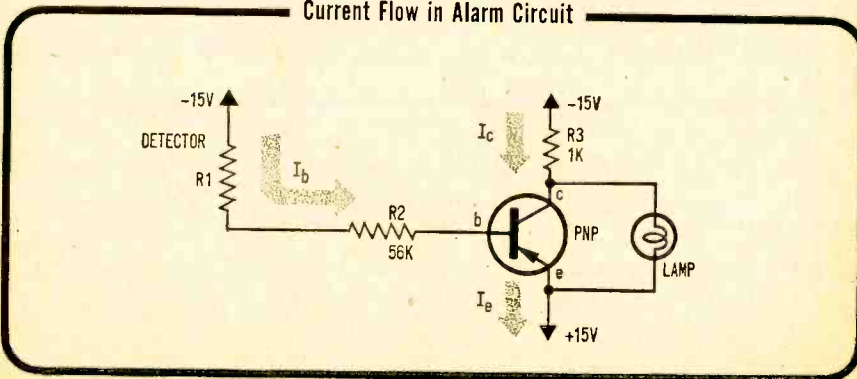

When detector R1 remains unbroken, the following conditions exist:

1. Base current flows through the transistor.
2. The transistor acts as a closed switch.
3. Zero voltage appears between c and e.
4. The lamp does not light.

When the detector is broken (opened):



1. Base current stops flowing.
2. The transistor acts as an open switch (from c to e).
3. Voltage appears between c and e.
4. Voltage is applied across the lamp, causing it to light.

**The Detector**—A simple detector can be made from a strip of aluminum foil. Taped to a door or a window, it will break when either is opened, thus lighting the alarm. Construction details are shown below.

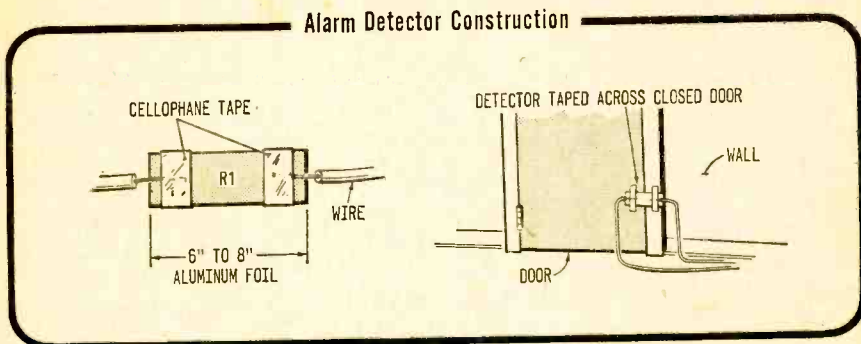

- Q23. The lamp is out when  $---$  current is flowing.
- Q24. The lamp is on when c-to-e resistance is (high, low).
- Q25. When the lamp is lit, there is (zero, maximum) voltage across R3.
- Q26. When the detector breaks, there is (zero, maximum) voltage across R2.
- Q27. The value of base current is equal to  $-----$  current minus  $-----$  current.
- Q28. In a circuit using an *npn* transistor, base current flows (toward, away from) the source, and emitter current flows (toward, away from) the transistor.
- Q29. (Collector, emitter, base) current is equal to the total current flowing through the source.

**Your Answers Should Be:**

- A23. The lamp is out when *base* current is flowing.
- A24. The lamp is on when c-to-e resistance is *high*.
- A25. When the lamp is lit, there is *zero* voltage across R3.
- A26. When the detector breaks, there is *zero* voltage across R2.
- A27. The value of base current is equal to *emitter* current minus collector current.
- A28. In a circuit using an *npn* transistor, base current flows *toward* the source, and emitter current flows *toward* the transistor.
- A29. *Emitter* current is equal to the total current flowing through the source.

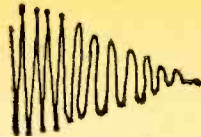
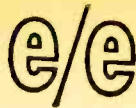
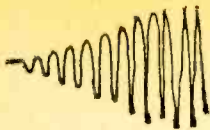

## A TRANSISTOR AMPLIFIER

A transistor can be used to amplify voltages. As you recall, amplify means to increase amplitude or value. In other words, a weak signal (radio wave or audio voltage, for example) can be made stronger by passing it through an amplifying circuit.

### Alternating Current or Voltage

Before you begin thinking about amplifiers you should become more familiar with alternating voltage. You know that an alternating current reverses itself periodically. During one period of time, current flows in one direction. During the next period, current flows in the opposite direction. The flow of current does not make the change instantaneously; it does not move in one direction, then pause before it moves in the other. The changes occur over a period of time, regardless of how short the time may be.

The illustration appearing below shows a graph of how an AC voltage (or current) changes direction. The same picture can be seen on an electronic test instrument, called an *oscilloscope*.

The dimensions of the graph show voltage values vertically and time in seconds horizontally.

You will note that this AC *sine wave* (as it is called) takes 2 seconds to change from zero volts to its maximum of 2 volts. It rises rapidly during the first second (to approximately 0.7 of its maximum value). It then rises less and less rapidly until its full value is finally reached at the end of the remaining second.

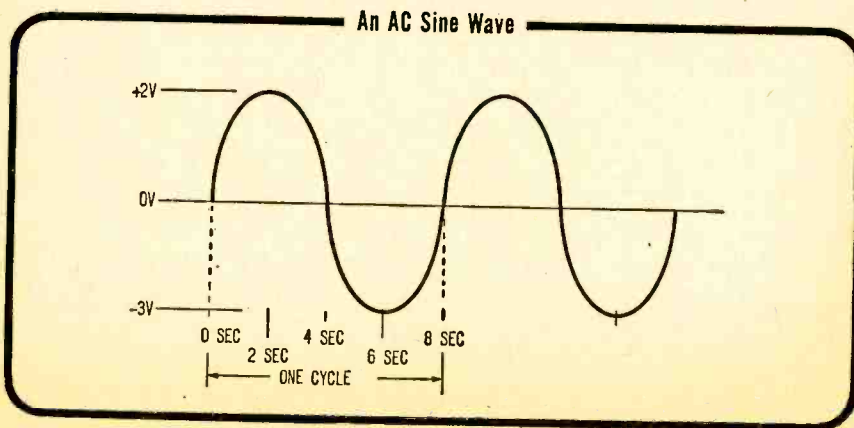

From zero to 2 seconds the voltage is rising in the positive direction. It decreases to zero volts, following the same shape curve, in the next 2 seconds. At this point it has completed one half of its full cycle. This portion of the waveform is called the *positive half cycle*.

During the *negative half cycle*, it repeats the first half, except that now it



moves in the negative (or opposite) direction. From zero volts, it *increases* in value until it reaches the maximum—minus 2 volts. This takes 2 seconds. In the next 2 seconds, the voltage *decreases* from its maximum negative voltage back to zero.

The rise and fall of the positive and negative half cycles are identical. The only difference is the direction—one is from zero to a maximum positive voltage and back to zero, while the other is from zero to a maximum negative voltage and back to zero. AC voltage in your home follows the same pattern. It completes 60 full cycles every second (60 positive half cycles and 60 negative half cycles).

**Q30.** A weak signal can be increased in amplitude by passing it through a(an) ----- circuit.

**Q31.** An AC cycle consists of two half cycles; one is ----- and the other is -----.

**Your Answers Should Be:**

**A30.** A weak signal can be increased in amplitude by passing it through an *amplifying* circuit.

**A31.** An AC cycle consists of two half cycles; one is *negative* and the other is *positive*.

**Gain**

The behavior of an amplifier is described in terms of *gain*. Without going into lengthy detail, amplifiers are designed to operate at some definite voltage level during periods when no signals are applied. In the illustration below, the voltage level of the input side is  $-2$  volts. The output side operates at  $+90$  volts.

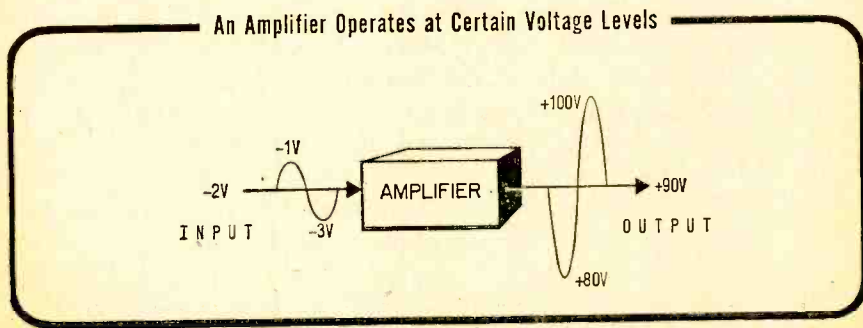

If an AC signal that is changing from  $+1$  volt to  $-1$  volt during a full cycle is applied to the input, the signal voltage will add to the DC voltage already present at the input. For example, when the signal is maximum positive, the  $+1$  volt is added to the  $-2$  volt DC level to produce a  $-1$ -volt input to the amplifier at that time. When the signal swings in the negative direction,  $-1$  volt and  $-2$  volts become  $-3$  volts. In other words, the swing of the input is from  $-1$  to  $-3$  volts, or a *change in voltage* of 2 volts.

Assume that the characteristics of the amplifier are capable of making the

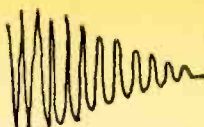
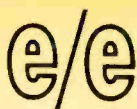
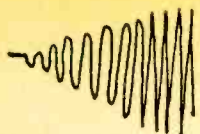

corresponding output voltage changes shown in the diagram with such an input signal. The operating level of the amplifier output is +90 volts. During the first half cycle of the input, the output changes from +90 volts to +80 volts. During the second half cycle, the swing is from +90 volts to +100 volts.

This means that an *input voltage change* of 2 volts caused an *output voltage change* of 20 volts (from +80 to +100). The output change was ten times that of the input, so the *gain* of this amplifier is 10.

How would you express this in arithmetic form? Like this:

$$\text{Gain} = \frac{\text{change in output voltage}}{\text{change in input voltage}}$$

Or, if you want to find the change in output for a given amplifier with a particular input signal:

$$\text{Change in output } E = \text{gain} \times \text{change in input } E$$

Amplifiers can be designated with gains ranging from very small to very large. The amount of gain desired is first determined and then an amplifier is selected that has such a gain.



- Q32.** An alternating voltage appears at the input of an amplifier. It causes the input voltage to vary from -2 volts to -1.2 volts. What is the change in input voltage?
- Q33.** The same change in input voltage produces an output waveform that swings from +12 volts to +42.6 volts. What is the gain of the amplifier?
- Q34.** An amplifier has a gain of 39; the input voltage swings from -5.25 to -5.05 volts. What will be the change in the output voltage?
- Q35.** Would a steady DC voltage applied to the input of an amplifier cause the circuit to amplify?

**Your Answers Should Be:**

- A32.** Change in input voltage is 0.8 volt.
- A33.** The gain of the amplifier is 38.25.
- A34.** Output voltage change would be 7.8 volts.
- A35.** The answer is *no*. (After the initial rise of the DC voltage at the instant it is applied, there would be no further change in the input voltage and consequently no change in the output voltage. Hence, there would be no amplification.)





## A Simple Transistor Amplifier

You may wish to construct the transistor amplifier shown in the schematic diagram below. R2 is shown as 9000 ohms.

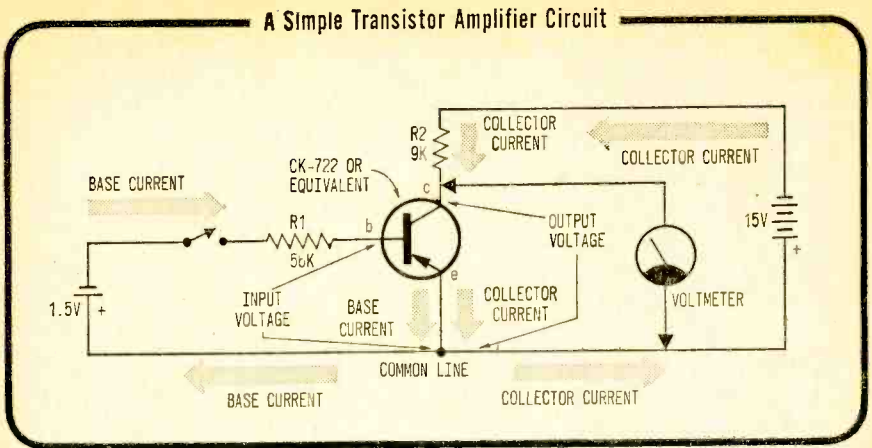

The input to this amplifier is maintained at 1.5 volts by the dry cell shown. An AC signal applied to the base will rise above and below this reference voltage.

The output voltage can be measured from the collector to the common line. Since the common line is connected to the emitter, the output voltage will be that appearing across the transistor from c to e. In all other respects the amplifier circuit is similar to the transistor control circuit.

A change in input voltage will occur if the switch in the line connected to the base is opened and closed. The change can be observed on a voltmeter with its leads connected to the base and the common line. Output voltage changes can also be read with a voltmeter connected as shown.

The graph below shows the voltage changes that will occur.

With the switch open, the input registers 0 volts and the output  $-15$  volts. With the switch closed, the input changes to  $-1.5$  volts and the output to  $-5$  volts. The same readings occur each time the switch is opened and closed.

If the switch were opened and closed at one second intervals, as shown in the graph, the cycles would repeat themselves at a steady rate. The frequency would be one cycle every two seconds as opposed to the household electrical AC

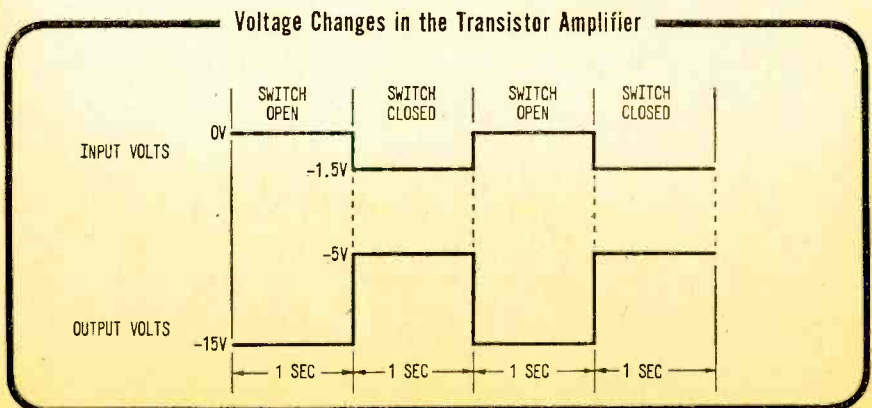

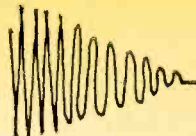
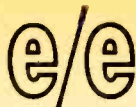
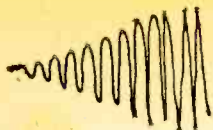

frequency of 60 cycles per second. Because they have straight sides and flat tops, the waveforms in the graph are called *square waves*.

- Q36.** What is the gain of the transistor amplifier circuit just described?
- Q37.** The output waveform rises rapidly, remains at a steady value, and then decreases rapidly to its original level. What type of waveform is it?
- Q38.** What type of voltmeter would you use to measure the output when the switch is closed?

**Your Answers Should Be:**

**A36.** The gain is 6.7 (a change of 10 output volts divided by a change of 1.5 input volts).

**A37.** The waveform is a *square wave*.

**A38.** A *DC voltmeter*. (The same voltmeter would also be used for measurements while the switch is open.)

## WHAT YOU HAVE LEARNED

1. A transistor is a variable resistor that can be controlled electrically.
2. Transistors use small input voltage changes to produce larger output voltage changes.
3. A transistor may be used as a resistor in a voltage divider.
4. A transistor may be used as an electrical switch.
5. There are two types of transistors, NPN and PNP. In an NPN, base and collector currents flow away from the transistor. Emitter current flows toward the transistor. These currents flow in opposite directions in a PNP transistor.
6. AC voltage rises to, and falls from, its maximum voltage periodically. The polarity alternates between positive and negative directions.
7. The gain of an amplifier is determined by dividing the change in input voltage into the corresponding change in output voltage.

### NEXT ISSUE: PART VIII Understanding Radio Transmitters and Receivers

This series is based on material appearing in Vol. 1 of the 5-volume set, BASIC ELECTRICITY/ELECTRONICS, published by Howard W. Sams & Co., Inc. @ \$19.95. For information on the complete set, write the publisher at 4300 West 62nd St., Indianapolis, Ind. 46268.



# MB Station Guide

Continued from page 45

Elmira	KEB389	39.42 P
Ithaca	KBV858	39.22 P
	KEE574	45.88 CF
Jamestown	KEB398	39.18 P
	KEC503	46.10 F
Monticello	KEE238	39.22 CP
	KEE257	39.22 P
	KEE238	39.46 CP
	KEC815	45.88 CF
Mineola	KEB237	37.04 CP
	KEB237	37.14 CP
	KEG254	46.10 CF
New York City	KGL703	30.74 TE
	KGL701	30.82 TE
	KLK551	39.36 P
	KEC531	39.82 P
	KLE915	39.90 P
	KJE868-	47.66 ME
	908	
Newburgh	KEA458	39.90 P
	KED879	46.46 F
Peekskill	KEB564	45.14 P
	KCP575	46.26 F
Poughkeepsie	KJU289-	39.14 CP
	90	
	KED404	45.54 P
	KEJ211	46.28 VF
	KEJ340	46.36 CF
	KEB891	46.44 F
Rochester	KEA898	39.18 P
	KEB243	46.10 F
	KJB995	46.34 F
	KJB995	46.46 F
Schenectady	KEA792	37.10 P
	KEB303	39.46 CP
	KEC457	45.46 P
	KED727	45.88 CF
Syracuse	KEM632	39.60 CP
	KFD561	39.74 P
	KEA207	39.98 P
	KEP693	46.14 CF
White Plains	KEB301	37.06 P
	KEB301	37.10 P
	KED497	46.14 F
	KED497	46.26 F
Yonkers	KEB442	45.50 P
	KCI560	46.50 F
NORTH CAROLINA		
(SPD nets: 42.52 42.56 42.62)		
Asheville	KIB296	39.98 CP
Charlotte	KBT939	33.94 CF
	KIAA888	39.98 CP
Gastonia	KBP903	33.46 VF
	KFR575	33.46 VF
	KIP859	37.10 CP
Greenville	KIC285	39.22 P
	KFV902	39.46 CP
Hendersonville	KIK455	37.10 P
	KJJ413	37.10 P
	KIB891	39.10 P
Hickory	KIC216	45.50 CP
	KIC867	46.10 F
Raleigh	KIC856	45.14 CP
Rocky Mount	KIB892	39.42 P
NORTH DAKOTA		
(SPD net: 42.38)		
Fargo	KAB448	39.90 P
OHIO		
(SPD nets: 42.08 42.42 42.56 45.02 45.06 45.22 45.86)		
Akron	KQA880	33.74 F
	KQA880	33.86 F
	KQB328	39.62 CP
Canton	KDE280	33.82 CF
Cincinnati	KCU761	33.90 VF
	KCU760	39.14 CP
Cleveland	KQA216	33.90 F
	KQA550	37.18 P
	KQA216	45.88 F
	KDC972	46.48 F
Columbus	KQK542	33.86 F
	KQB505	39.46 CP
	KDX462	39.50 P
	KEX216	39.58 P
	KQF882	46.50 F
Dayton	KQE686	33.70 F

Lima	KQA818	39.42 P
	KLH950	39.58 F
	KQD729	39.58 CP
	KDE248	46.10 F
Sandusky	KAR675	39.58 CP
	KQB580	39.58 P
Sylvania	KQB531	33.74 F
	KQG242	37.10 P
Toledo	KQD210	33.74 F
	KQB424	37.10 CP
Zanesville	KBL988	33.98 F
	KLKG600	39.76 CP
OKLAHOMA		
(SPD net: 44.70)		
Bethany	KKJ835	37.10 P
Oklahoma City	KGJ654	37.26 P
	KKC374	37.26 CP
OREGON		
(SPD nets: 42.88 42.94)		
Klamath Falls	KOM815	33.98 F
The Dalles	KAY935	39.82 CP
Umatilla	KON769	39.82 CP
PENNSYLVANIA		
(SPD net: 42.62)		
Allentown	KDK643	33.98 CF
Altoona	KGC760	33.74 F
	KGB363	39.42 P
Erie	KGB900	33.98 F
Gettysburg	KCR236	45.10 CP
Harrisburg	KDY314	33.90 VF
	KCS505	45.42 P
	KFI461	45.42 P
Norristown	KGA243	45.26 CP
	KGA243	45.46 CP
Philadelphia	KGG45-	
	47	47.46 D
	KGG45-	
	47	47.54 D
	47	47.62 D
Pittsburgh	KCD573	33.86 VF
	KDP982	39.02 CP
	KDQ343	39.14 P
	KGA374	39.82 P
	KGB327	39.90 P
York	KGD214	33.90 CF
	KGE326	45.10 CP
PUERTO RICO		
Ponce	KBW545	46.42 CF
San Juan	KCP582	46.42 CF
RHODE ISLAND		
(SPD nets: 42.10 42.62)		
Charlestown	KCV254	45.10 P
Newport	KCC639	46.06 CF
SOUTH CAROLINA		
(SPD net: 42.10)		
Columbia	KIC431	45.54 CP
Leesville	KAQ240	45.10 P
SOUTH DAKOTA		
(SPD nets: 39.10 39.22)		
Brookings	KAB479	39.10 P
Pierre	KBA203	39.02 CP
Rapid City	KAH560	39.02 CP
	KAA587	39.10 P
	KAH560	39.10 CP
	KAA587	39.30 P
Sioux Falls	KFB922	39.22 CP
TENNESSEE		
(SPD nets: 42.42 42.56)		
Chattanooga	KIC375	37.10 P
	KIM973	37.26 P
	KLB941	39.54 CP
Jackson	KII1269	42.42 CP
Kingsport	KIC363	42.56 CP
Knoxville	KIA809	37.10 P
	KIA809	37.14 P
	KIF869	37.26 CP
Memphis	KIC306	39.46 P
	KIX281	42.42 CP
	KIX281	42.56 CP
Nashville	KIK636	33.90 F
	KIA233	37.26 P
	KIA355	39.54 CP
TEXAS		
(SPD nets: 37.22 42.84 42.90)		
Abilene	KKF229	46.02 P
Amarillo	KGR319	37.22 CP

Austin	KGP706	37.18 P
	KKA873	37.18 CP
Corpus Christi	KBN495	33.48 CF
	KKJ794	37.20 CP
	KDT314	37.26 CP
Dallas	KJI365	37.14 CP
	KKF891	37.18 CP
	KKQ551	37.26 CP
	KKF891	37.30 CP
	KKB364	45.50 P
	KKB364	45.66 P
	KKB364	45.70 P
	KKB364	45.74 P
	KKB364	45.78 P
	KKB364	45.82 P
	KAW616	46.34 F
	KAW616	46.50 F
Ft. Worth	KKJ509	37.18 CP
	KKJ509	37.26 CP
	KKJ509	37.36 CP
	KJE236	45.90 P
	KKJ509	45.90 CP
	KFX376	46.06 F
	KKM799-	46.06 CF
	802	
Galveston	KDC898	46.14 F
	KJI541	37.18 CP
	KKB816	37.18 CP
	KKB816	37.26 CP
Houston	KFM377	37.10 P
	KKC381	37.10 CP
	KC1639	37.14 P
Lubbock	KKV899	37.18 CP
Port Arthur	KKA938	37.22 P
Texarkana	KBU296-8	33.98 F
	KKH906	37.10 P
	KKH906	37.26 P
	KKN955	37.26 CP
Waco	KJU379	37.18 CP
	KKD489	39.42 P
	KAY361-6	46.18 F
UTAH		
(SPD nets: 42.88 42.94)		
Salt Lake City	KOG596	45.50 CP
	KOG596	45.54 CP
	KJI459	45.66 CP
VERMONT		
(SPD net: 42.86)		
Burlington	KCB999	33.78 F
	KEP650	39.94 CP
Rutland	KCC988	33.78 F
	KCA468	39.10 P
VIRGINIA		
(SPD nets: 42.86 42.88)		
Alexandria	KEL429	46.08 CF
	KIG374	46.18 VF
Fairfax	KIB950	39.54 CP
	KEL436	46.08 CF
	KIF337	46.18 CF
Falls Church	KEL423	46.08 CF
Leesburg	KIG504	39.50 CP
Petersburg	KBL763	39.50 P
Richmond	KDY416	46.46 CF
Staunton	KIB777	39.50 P
Winchester	KIA408	37.18 CP
WASHINGTON		
(SPD net: 42.54)		
Chehalis	KDL844	39.82 CP
Olympia	KGL589	39.82 CP
Seattle	KOA748	39.50 F
Spokane	KEY815	39.74 P
	KFA485	39.82 P
	KLH992	39.94 P
	KOA534	39.94 CP
Tacoma	KOB452	39.82 CP
Walla Walla	KOB598	39.82 CP
	KOG987	39.82 P
WEST VIRGINIA		
(SPD nets: 42.10 42.12)		
Elkins	KJR252	46.10 F
Huntington	KQH701	39.98 CP
Morgantown	KQB582	37.06 P
WISCONSIN		
(SPD nets: 42.04 42.38 45.86)		
Madison	KAZ666	39.46 CP
	KAZ666	39.52 CP
Milwaukee	KSA536	39.46 P
	KSA536	45.46 P
Racine	KSI822	45.98 P
	KDG900	46.08 CF

## Watt Power On Wheels

*Continued from page 57*

The answer to this lies in another piece of equipment which will mount at a remote location in your car. This vital item is a 117-V power converter. It converts the 12 VDC available from the car battery to 117 VAC. (6-V models are also available.)

A variety of converters are available on the market; some are supplied in kit form. The converter used by the author is a Heath-kit Model MP-10, which is representative of the converters using a transistor oscillator circuit to permit operation of a transformer to produce higher voltage in a car. (Significantly, this particular converter operates from either 6 or 12 VDC.) the output voltage from such a converter is a square wave instead of a sine wave, but it's nevertheless usable with most 117-V devices you may want to operate in your car.

One thing you will wonder about when you measure the output of the power converter with a voltmeter is that you get a reading higher than 117 V. This is because your voltmeter is designed to measure AC having a sine wave form. The output from one of these power converters will not have such a wave shape, so it will "fool" your meter into an incorrect reading.

Don't let this bother you. If you have the converter hooked up according to the instructions that come with it, you should have no problems. If in doubt, connect a 120-V light bulb to the output of the converter. Make sure it has a wattage rating within the specified power rating of the converter you're using. If the light burns at normal brilliance, you're in business.

**Place To Put It.** Probably the handiest place to mount the converter is in the trunk. Run the power leads under the floor mat. This way, the converter will be out of the way. No one will accidentally knock the plugs loose or trip over the wires. The installation usually isn't too hard. And once it's done, it never need be touched until you trade cars.

To avoid bypassing your car's ammeter (if it has one), do *not* connect the lead marked "+12 VDC from car's wiring" directly to the battery. Instead, connect this lead to the accessory terminal on your ignition switch. In this way, no one can turn on the converter or use the 12-V plugs if the ignition is locked.

The wires used to connect up your mobile power station must be large enough to carry a fair amount of current without overheating. The 12-V line going to P1, P2, S1, and to the input of the power converter should be #10 or 12 wire. Smaller wire might do if the load you put on the system is light, but it costs very little more to put in wire heavy enough to be sure you never start an electrical fire in your car.

That's about all there is to putting a power station in your chariot. Plan carefully in advance, and you probably can do the whole job in a single Saturday afternoon. ■

## Experimenter's Electroscopes

*Continued from page 51*

**Experiment No. 3.** Discharge both electroscopes by touching them with your finger, move them apart, and charge them again with a plastic rod. Do this until the foil leaves in both electroscopes are at the same angle (i.e., showing the same potential).

Move the electroscopes together until the electrode on one is touching the clipped-on loop of the other electroscopes. Note that the foil leaves do not move. This means that the electroscopes still have the same initial electrical charge. This experiment shows that no conduction of static electricity takes place when there is no difference in the amount of charge (potential difference). Both of the electroscopes had the same electrical charge, so there was no conduction.

**Experiment No. 4.** After discharging the electroscopes, charge one with a plastic rod (negative charge), and charge the other with a glass rod (positive charge). Make sure that the charges are equal (so the leaves in both electroscopes are at the same angle).

Move the electroscopes together until the electrode on one is touching the wire ring on the other. The foil leaves in both electroscopes will drop, indicating that they are fully discharged. This shows that opposite electric charges will cancel each other out.

Try experimenting with different types of plastic rods and different types of cloth material. You can check charge polarity by first charging the electroscopes with a known polarity (glass rod is positive; plastic rod is negative), then placing the unknown rod against the electroscopes electrode. If it discharges the electroscopes, the unknown charge is of opposite polarity. ■



## DXing Country That Isn't

Continued from page 48

cruiser while it recently covered a strike which had separatist overtones. The cruiser was attacked simply because CKGM is English-speaking. CKGM carries Burns' program during evening hours, and is on all night with pop music.

If you're looking for privately-owned French-language stations, two transmitters at Quebec City (the provincial capital) might be heard. They are CJLR on 1060 kHz and CHRC, which recently boosted its power, on 800 kHz. Also using the latter frequency is Montrealer CJAD. (For a complete list of Quebec BCB stations, see WHITE'S RADIO LOG.)

**Radio Quebec.** Early last year the Quebec government reactivated a law which had been on the province's books since 1943. It creates a state-owned corporation known as R. Quebec.

Under this legislation, R. Quebec can build, buy, or expropriate radio and TV stations, and turn these into a network. Whether it could actually do any of these things without federal permission remains to be seen. R. Quebec will most certainly produce educational TV programs and distribute them to private stations. But even this isn't the area

where Quebec's separatist leanings will show their most pronounced radio face.

As it stands now, the battle will be fought over outer space. R. Quebec wants, and according to this act supposedly has the authority, to *directly* negotiate a program exchange with the DeGaulle government. What's more, Quebec intends to actually take part in the French communications satellite project—Symphonie I, which is scheduled for launch in 1971. Significantly, 1971 is the earliest possible date that Canada could launch its own communications satellite, and Ottawa considers space radio an exclusive territory of the federal government.

Whatever else that can be said about R. Quebec and DeGaulle's O.R.T.F., they have at least decided to make this a battle worthy of the space age. And that battle promises to be one which will command maximum attention. ■

### Waves To and From French Canada

Station, Location	Frequency (kHz)	Schedule (EST)
CFCX, Montreal	6005	0000-2400
R. Havana, Cuba	6135 11760	0500-0530 2200-2230
R. Portugal, Lisbon	9630	2115-2200
O.R.T.F., Paris	9755, 11845, 15245, 17730 15120, 17850	1900-1930 1400-1430



Largest city in Canada, Montreal is highly cosmopolitan and commonly known as the Paris of North America. Quebec countryside, in contrast, is noted for its simplicity and beauty, with unswilled air and aura of innocence. Farmhouse and barn above, typical of those found throughout Quebec, is at Baie Saint-Paul, in Charlevoix county.

## Piezo Wireless Mike

Continued from page 90

reception was obtained to almost 200 ft. when the FM tuner's dipole antenna was oriented broadside to the mike. When the antenna was oriented so the mike was almost off the ends of the antenna, sporadic noise, though of low intensity, was apparent. The amount of noise varied, depending on the specific orientation of the mike to the ends of the antenna.



Extremely small and light, Piezo FM wireless mike is roughly size of two lipstick cases stacked end to end. Its power switch is locking-slide type.

Sound quality was good, providing the mike was held at least 6 in. from the lips when speaking in a loud voice (6 in. can be considered a normal mike working distance). When speaking in a soft voice, the mike

## EICO Signal Injector

Continued from page 80

—which it resembles right down to the pocket clip. A factory-mounted spring inside the shell presses two N-type batteries against the transistor's case.

**Summing Up.** This is just about the easiest kit ever designed, but it's one of the most effective signal injectors we've seen. If your budget can't stand more expensive

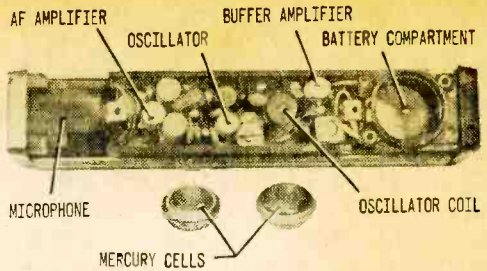

Circuit all but fills case except for mike element and battery compartment. Metal cover shields entire circuit save for area around antenna jack.

could be worked as close as 2 in. Since there is no modulation level control (typical of low-cost FM mikes), close-miking of a loud voice resulted in overmodulation, with resultant distortion at the FM tuner output. Be sure to speak in a normal voice at all times.

Because the mike is small and very light, it can easily be suspended in lavalier fashion around the neck. This pretty much negates chances of overmodulation while simultaneously leaving the hands completely free (there's no problem about holding down the power switch, since it's the locking slide type).

Also worth noting is the fact that the WX-127 is supplied with a shorting antenna plug to prevent accidental or unauthorized use.

**Summing Up.** In the rock-bottom price range, the Piezo WX-127 (it goes for \$17.50) is about the best performing FM mike we've seen so far. Piped through a guitar amplifier or auditorium system, it performs extremely well and is about the least expensive way to free a speaker or a performer from the restrictions of an ugly, long microphone cable.

For additional information on the Piezo WX-127 FM Wireless Microphone, write the Mura Corp., Dept. T, 355 Great Neck Rd., Great Neck, N.Y. 11021. ■

signal generators and tracers at this time, latch onto the PSI-1; it's the fastest and least expensive way to start troubleshooting AF, IF, and RF circuits. Regardless of the strength of the 1-kHz harmonics, you'll be sure to get a useful output at every stage in a receiver.

The EICO PSI-1 Signal Injector Probe kit is priced at \$5.95, including batteries. A wired model is available for \$9.95. For additional information write EICO, Dept. T, 283 Malta St., Brooklyn, N.Y. 11207. ■



# CLASSIFIED Market Place

FOR BIGGER PROFITS! NEW CAREER OPPORTUNITIES!  
READ AND REPLY TO THESE CLASSIFIED ADS

Classified Ads 65¢ per word, each insertion, minimum 10 words, payable in advance. To be included in the next available issue of **ELEMENTARY ELECTRONICS**, copy must be in our New York Office by Mar. 10th. Address orders to C. D. Wilson, Manager, Classified Advertising, **ELEMENTARY ELECTRONICS**, 229 Park Avenue South, New York, N. Y. 10003.

## ADDITIONAL INCOME

**MONEY**—Sparetime Opportunity Panelists At Home Wanted By New York Researcher. Leading research firm seeking people to furnish honest opinions by mail from home. Pays cash for all opinions rendered. Clients' products supplied at no cost. For information write: Research 669, Mineola, N. Y. 11501. Dept. 633-EE.

**FREE!** The World's Leading Money-making Magazine. How and when to earn a Second Income, develop a Spare-time Business, get into Profitable Franchising, become a successful Agent. For your free copy—write Income Opportunities, 229 Park Avenue South, New York, N. Y. 10003.

## BOOKS & PERIODICALS

**TERRIFIC**, New Army Written Book. Basic Theory And Application of Transistors, \$1.40 Postpaid. Devices, Box 136E, Bronx, N. Y. 10463.

**CATALOG** of All Science & Mechanics Craftprints. Send 25¢ to cover postage and handling to Craftprint Div., Science & Mechanics, 229 Park Avenue South, New York 10003.

## BUSINESS OPPORTUNITIES

**I MADE \$40,000.00 Year** by Mailorder! Helped others make money! Start with \$10.00—Free Proof! Torrey, Box 318-T, Ypsilanti, Michigan 48197.

**FREE Book "990 Successful Little-Known Businesses"** Fascinating! Work home! Plymouth 311-T, Brooklyn, N. Y. 11218.

## CAMERAS & PHOTO SUPPLIES

**AMAZING!** Revolutionary! New photo album. Inquiry requested. Dennis, 1718 Sunset Way, Sonoma, Calif. 95476.

## COINS, CURRENCY & TOKENS

**COINS Discounted!** Catalogue 25¢. Buying Catalog 50¢. Sullivans, #3330-FB, St. Paul, Minn. 55101.

## EARTHWORMS

**BIG Money Raising Fishworms and Crickets.** Free literature. Carter Farm-O, Plains, Georgia 31780.

## EDUCATION & INSTRUCTION

**EARN Your Degree In Electronics Engineering.** Highly Effective Home Study Courses In Electronics Engineering Technology And Electronics Engineering Mathematics. Free Literature. Cook's Institute Of Electronics Engineering, P. O. Box 36185, Houston, Texas 77036. (Established 1945.)

## GIFTS THAT PLEASE

**FREE**, Gift Catalog. Selective and Distinctive. True Values SMC, Box 903, Salt Lake City, Utah 84110.

**GIVE** the best reading in the Mechanical Field—give Science & Mechanics! \$4.00 for year's subscription. Science & Mechanics, 229 Park Avenue South, New York, New York 10003.

## INVENTIONS WANTED

**WE** either sell your invention or pay cash bonus. Write for details. Universal Inventions, 298-3, Marlon, Ohio 43302.

## MAGNETS

**MAGNETS.** All types. Specials—20 disc magnets or 2 stick magnets, on 10 small bar magnets, or 8 assorted magnets, \$1.00. Maryland Magnet Company, 5412-R, Gist, Baltimore, Md. 21215.

## MISCELLANEOUS

**ROOT BEER Formulas.** Instructions \$3.00. Tomarch, 1114-41st, Brooklyn, New York 11218.

**QUART** dried hops \$1.00, with 101 recipes—Homebrewing, Winemaking, Hop-breads, Sourdoughs, and supplies catalogue. Nichols Nursery, Northpac, Albany, Oregon 97321.

**SURPRISE Package \$1.00.** Catalog Free. Tom Carson, 208-C-SE, Ardmore, Okla. 73401.

**HIGH voltage shocker module \$5.95.** For fun, pranks, property protection. Effective. Non-lethal. Satisfaction guaranteed. Catalog 20¢. Franks Scientific Co., P. O. Box 158, Martelle, Iowa 52305.

**JUST out!** Confidential spy, clandestine, spacecraft frequencies & schedules. \$1.00. Date-A. P. O. Box 2396, Champaign, Ill. 61820.

## MONEYMAKING OPPORTUNITIES

**INSTANT Money!** Plastics are the wave of the future. Big profits now! At home! Spare time! Materials costing 11¢ bring \$2.58 profits immediately! Free information! Rush name on postcard to: Warner, 1512 Jarvis, Dept. CL-107-A, Chicago, Ill. 60626.

**MAKE Your Classified Ad Pay.** Get "How To Write a Classified Ad That Pulls." Includes certificate worth \$2.00 towards classified ad. Send \$1.25 to C. D. Wilson, Science & Mechanics, 229 Park Avenue South, New York, N. Y. 10003.

## RADIO & TELEVISION

**THOUSANDS** and thousands of types of electronic parts, tubes, transistors, instruments, etc. Send for Free Catalog. Arcurus Electronics Corp., EME, 502-22nd St., Union City, N. J. 07087.

**KITS, Metal Detectors \$5.95.** Audio Telescope \$5.95. Others. Lectronics, Box 42, Madison Heights, Mich. 48071.

**BUILD Distance Crystal Sets.** 10 plans —25¢; 18 different—50¢; 20 different—50¢. Catalog. Laboratories, 12041-G Sheridan, Garden Grove, Calif. 92640.

**POLICE — Fire — Aircraft — Marine — Amateur** calls on your broadcast radio! Free catalog. Salch Company, Woodsboro EE14, Texas 78393.

## SCIENCE & CHEMISTRY

**POWERFUL! Converging!** Stellar Radiation Cause Gravitation. \$1.00. Carnahan, 2007 Easton, Austin, Texas 78723.

## STAMP COLLECTING

**FREE 121 Different Flag Stamps.** W-B Stamp Company, Wilkes-Barre, Penna. 18703.

## TREASURE FINDERS—PROSPECTING EQUIPMENT

**FIND Buried Treasure** with the most popular transistorized metal detector in the country. Treasure Probe available as kit (\$14.88), assembled (\$18.88), with powerful built in speaker (\$24.88). Schematic, parts, list, and step by step instructions \$1.00. Ten day money back guarantee. Free catalog available. Treasure Probe, EGD, P. O. Box 64, Lakewood, New Jersey 08701.

**THERE IS NO CHARGE FOR THE ZIP CODE—PLEASE USE IT IN YOUR CLASSIFIED AD**

**For Greater Classified Profits  
why not try the new combination classified ad medium**

Your classified ad will appear in **SCIENCE & MECHANICS MAGAZINE** as well as in a minimum of four other **SCIENCE & MECHANICS PUBLICATIONS**. Write now for information to C. D. Wilson, Manager, Classified Advertising, **SCIENCE & MECHANICS**, 229 Park Avenue South, New York, N. Y. 10003.

# Join "THE TROUBLESHOOTERS"

They get paid top salaries  
for keeping today's  
electronic world running

Suddenly the whole world is going electronic! And behind the microwave towers, push-button phones, computers, mobile radio, television equipment, guided missiles, etc., stand

**THE TROUBLESHOOTERS**  
—the men needed to inspect, install, and service these modern miracles. They enjoy their work, and get well paid for it. Here's how you can join their privileged ranks—without having to quit your job or go to college in order to get the necessary training.





**J**UST THINK how much in demand you would be if you could prevent a TV station from going off the air by repairing a transmitter...keep a whole assembly line moving by fixing automated production controls...prevent a bank, an airline, or your government from making serious mistakes by servicing a computer.

Today, whole industries depend on Electronics. When breakdowns or emergencies occur, someone has got to move in, take over, and keep things running. That calls for one of a new breed of technicians—The Troubleshooters.

Because they prevent expensive mistakes or delays, they get top pay—and a title to match. At Xerox and Philco, they're called Technical Representatives. At IBM they're Customer Engineers. In radio or TV, they're the Broadcast Engineers.

What do you need to break into the ranks of The Troubleshooters? You might think you need a college degree, but you don't. What you need is know-how—the kind a good TV service technician has—only lots more.

### Think With Your Head, Not Your Hands

As one of The Troubleshooters, you'll have to be ready to tackle a wide variety of electronic problems. You may not be able to dismantle what you're working on—you must be able to take it apart "in your head." You'll have to know enough Electronics to understand the engineering specs, read the wiring diagrams, and calculate how the circuits should test at any given point.

Learning all this can be much simpler than you think. In fact, you can master it without setting foot in a classroom...and without giving up your job!

For over 30 years, the Cleveland Institute of Electronics has specialized in teaching Electronics at home. We've developed special techniques that make learning easy, even if you've had trouble studying before. Our AUTO-PROGRAMMED® lessons build your knowledge as easily and solidly as you'd build a brick wall—one brick at a time. And our instruction is personal. Your teacher not only grades your work, he analyzes it to make sure you are thinking correctly. And he returns it the same day received, while everything is fresh in your mind.

### Always Up-To-Date

To keep up with the latest developments, our courses are constantly being revised. This year CIE students are

## **NEW** COLLEGE-LEVEL COURSE IN **ELECTRONICS ENGINEERING**

for men with prior experience in Electronics. Covers steady-state and transient network theory, solid state physics and circuitry pulse techniques, computer logic and mathematics through calculus. A college-level course for men already working in Electronics.

getting new lessons in Laser Theory and Application, Microminiaturization, Single Sideband Techniques, Pulse Theory and Application, and Boolean Algebra.

In addition, there is complete material on the latest troubleshooting techniques including Tandem System, Localizing through Bracketing, Equal Likelihood and Half-Split Division, and In-circuit Transistor Checking. There are special lessons on servicing two-way mobile radio equipment, a lucrative field in which many of our students have set up their own businesses.

### Your FCC License—or Your Money Back!

Two-way mobile work and many other types of troubleshooting call for a Government FCC License, and our training is designed to get it for you. But even if your work doesn't require a license, it's a good idea to get one. Your FCC License will be accepted anywhere as proof of good electronics training.

And no wonder. The licensing exam is so tough that two out of three non-CIE men who take it fail. But our training is so effective that 9 out of 10 CIE graduates pass. That's why we can offer this famous warranty with confidence: If you complete a license preparation course, you get your FCC License—or your money back.

### Mail Card for 2 Free Books

Want to know more? Send for our 44-page catalog describing our courses and the latest opportunities in Electronics. We'll send a special book on how to get a Government FCC License. Both are free—just mail the bound-in postpaid card. If card is missing, use coupon below.

### ENROLL UNDER NEW G.I. BILL

All CIE courses are available under the new G.I. Bill. If you served on active duty since January 31, 1955, or are in service now, check box on card or coupon for G.I. Bill information.

## **CIE** Cleveland Institute of Electronics

1776 East 17th Street, Cleveland, Ohio 44114

### Cleveland Institute of Electronics

1776 East 17th Street, Cleveland, Ohio 44114

Please send me without cost or obligation:

1. Your 44-page book "How to Succeed in Electronics" describing the job opportunities in Electronics today, and how your courses can prepare me for them.

2. Your book on "How To Get A Commercial FCC License."

I am especially interested in:

Electronics  
Technology

Broadcast  
Engineering

First Class  
FCC License

Electronic  
Communications

Industrial  
Electronics

Electronics  
Engineering

Name \_\_\_\_\_  
(PLEASE PRINT)

Address \_\_\_\_\_

City \_\_\_\_\_ State \_\_\_\_\_ Zip \_\_\_\_\_

Check here for G. I. Bill information.

EL-13

# BUILD YOUR OWN RADIO

Reg. U.S. Pat. Off.

**CIRCUITS AT HOME**  
with the New Improved

**PROGRESSIVE RADIO "EDU-KIT"®**

only \$26.95



Training Electronics Technicians Since 1946

**A Practical Home Radio Course**

- |   |   |
|---|---|
| <p><b>Now Includes</b></p> <ul style="list-style-type: none"> <li>★ 12 RECEIVERS</li> <li>★ 3 TRANSMITTERS</li> <li>★ SQ. WAVE GENERATOR</li> <li>★ SIGNAL TRACER</li> <li>★ AMPLIFIER</li> <li>★ SIGNAL INJECTOR</li> <li>★ CODE OSCILLATOR</li> </ul> | <ul style="list-style-type: none"> <li>★ No Knowledge of Radio Necessary</li> <li>★ No Additional Parts or Tools Needed</li> <li>★ EXCELLENT BACKGROUND FOR TV</li> <li>★ SCHOOL INQUIRIES INVITED</li> <li>★ Sold In 79 Countries</li> </ul> |
|---|---|

**YOU DON'T HAVE TO SPEND HUNDREDS OF DOLLARS FOR A RADIO COURSE**

The "Edu-Kit" offers you an outstanding PRACTICAL HOME RADIO COURSE at a rock-bottom price, and the most modern methods of home training. You will learn radio theory, construction practice and servicing. THIS IS A COMPLETE RADIO COURSE IN EVERY DETAIL. You will learn how to build radios, using regular schematics; how to wire and solder punched metal chassis as well as the latest development of Printed Circuit chassis. You will receive training for the Novice, Technician and General Classes of F.C.C. Radio Amateur Licenses. You will build Receiver, Transmitter, Square Wave Generator, Code Oscillator, Signal Tracer and Signal Injector circuits, and learn how to operate them. You will receive an excellent background in electronics and radio.

Absolutely no previous knowledge of radio or science is required. The "Edu-Kit" is the product of many years of teaching and engineering experience. The "Edu-Kit" will provide you with a basic background in electronics and radio, worth many times the low price you pay. The Signal Tracer alone is worth more than the price of the kit.

**THE KIT FOR EVERYONE**

You do not need the slightest background in radio or science. Whether you are interested in Radio & Electronics because you want an interesting hobby, a well paying business or a job with a future, you will find the "Edu-Kit" a worth-while investment. Many thousands of individuals of all

ages and backgrounds have successfully used the "Edu-Kit" in more than 79 countries of the world. The "Edu-Kit" has been carefully designed, step by step, so that you cannot make a mistake. The "Edu-Kit" allows you to teach yourself at your own rate. No instructor is necessary.

**PROGRESSIVE TEACHING METHOD**

The Progressive Radio "Edu-Kit" is the foremost educational radio kit in the world, and is universally accepted as the standard in the field of electronics training. The "Edu-Kit" uses the modern educational principle of "Learn by Doing." Therefore you construct, learn schematics, study theory, practice trouble shooting—all in a closely integrated program designed to provide an easily-learned, thorough and interesting background in radio. You begin by examining the various radio parts of the "Edu-Kit." You then learn the function, theory and wiring of these parts. Then you build a simple radio. With this first set you will enjoy listening to regular broadcast stations, learn theory, practice testing and trouble-shooting. Then you build a more advanced radio, learn more advanced theory and techniques. Gradually, in a progressive manner, and at your own rate, you will find yourself constructing more advanced multi-tube radio circuits, and doing work like a professional Radio Technician.

Included in the "Edu-Kit" course are Receiver, Transmitter, Code Oscillator, Signal Tracer, Square Wave Generator and Signal Injector Circuits. These are not unprofessional "breadboard" experiments, but genuine radio circuits, constructed by means of professional wiring and soldering on metal chassis, plus the new method of radio construction known as "Printed Circuitry." These circuits operate on your regular AC or DC house current.

**THE "EDU-KIT" IS COMPLETE**

You will receive all parts and instructions necessary to build twenty different radio and electronics circuits, each guaranteed to operate. Our Kits contain tubes, tube sockets, variable hardware, electrolytic, mica, ceramic and paper dielectric condensers, resistors, tie strips, selenium rectifiers, coils, volume controls and switches, etc.

In addition, you receive Printed Circuit materials, including Printed Circuit chassis, special tube sockets, hardware and instructions. You also receive a useful set of tools, a Professional electric soldering iron, and a self-powered Dynamic Radio and Electronics Tester. The "Edu-Kit" also includes Code Instructions and the Progressive Code Oscillator. In addition to F.C.C. Radio Amateur License training. You will also receive lessons for Servicing with a basic Progressive Signal Tracer and the Progressive Signal Injector, a High Fidelity Guide and a Quiz Book. You receive Membership in Radio TV Club, Free Consultation Service, Certificate of Merit and Discount Privileges. You receive all parts, tools, instructions, etc. Everything is yours to keep.

Progressive "Edu-Kits" Inc., 1186 Broadway, Dept. 530DJ, Hewlett, N. Y. 11557

**UNCONDITIONAL MONEY-BACK GUARANTEE**

Please rush my Progressive Radio "Edu-Kit" to me, as indicated below. Check one box to indicate choice of model:

- Regular model \$26.95.
- Deluxe model \$31.95 (same as regular model except with superior parts and tools plus valuable Radio & TV Tube Checker).

Check one box to indicate manner of payment:

- I enclose full payment. Ship "Edu-Kit" post paid.
- Ship "Edu-Kit" C.O.D. I will pay postage.
- Send me FREE additional information describing "Edu-Kit."

Name \_\_\_\_\_  
Address \_\_\_\_\_  
City & State \_\_\_\_\_ Zip \_\_\_\_\_

**PROGRESSIVE "EDU-KITS" INC.**

1186 Broadway, Dept. 530DJ, Hewlett, N. Y. 11557

**FREE EXTRAS**

- SET OF TOOLS
- SOLDERING IRON
- ELECTRONICS TESTER
- PLIERS-CUTTERS
- VALUABLE DISCOUNT CARD
- CERTIFICATE OF MERIT
- TESTER INSTRUCTION MANUAL
- HIGH FIDELITY GUIDE & QUIZZES
- TELEVISION BOOK & RADIO TROUBLE-SHOOTING BOOK
- MEMBERSHIP IN RADIO-TV CLUB
- CONSULTATION SERVICE & FCC AMATEUR LICENSE TRAINING
- PRINTED CIRCUITRY

**SERVICING LESSONS**

You will learn trouble-shooting and servicing in a progressive manner. You will practice repairs on the sets that you construct. You will learn symptoms and causes of trouble in home, portable and car radios. You will learn how to use the Professional Signal Tracer, the unique Signal Injector and the dynamic Radio & Electronics Tester. While you are learning in this practical way, you will be able to do many a repair job for your friends and neighbors, and charge fees which will far exceed the price of the "Edu-Kit." Our Consultation Service will help you with any technical problems you may have.

**FROM OUR MAIL BAG**

J. Stataitis, of 25 Poplar Pl., Waterbury, Conn., writes: "I have repaired several sets for my friends, and made money. The 'Edu-Kit' paid for itself. I was ready to spend \$240 for a Course, but I found your ad and sent for your Kit."

Ben Valerio, P. O. Box 21, Magna, Utah: "The Edu-Kits are wonderful. Here I am sending you the questions and also the answers for them. I have been in radio for the last seven years, but like to work with Radio Kits, and like to build Radio Testing Equipment. I enjoyed every minute. I worked with the different kits; the Signal Tracer works fine. Also like to let you know that I feel proud of becoming a member of your Radio-TV Club."

Robert L. Shuff, 1534 Monroe Ave., Huntington, W. Va.: "Thought I would drop you a few lines to say that I received my Edu-Kit, and was really amazed that such a bargain can be had at such a low price. I have already started repairing radios and phonographs. My friends were really surprised to see me get into the swing of it so quickly. The trouble-shooting Tester that comes with the Kit is really swell, and finds the trouble, if there is any to be found."

**PRINTED CIRCUITRY**

At no increase in price, the "Edu-Kit" now includes Printed Circuitry. You build a Printed Circuit Signal Injector, a unique servicing instrument that can detect many Radio and TV troubles. The revolutionary new technique of radio construction is now becoming popular in commercial radio and TV sets.

A Printed Circuit is a special insulated chassis on which has been deposited a conducting material which takes the place of wiring. The various parts are merely plugged in and soldered to terminals.

Printed Circuitry is the basis of modern Automation Electronics. A knowledge of this subject is a necessity today for anyone interested in Electronics.