

CC

# ELEMENTARY ELECTRONICS

**6** BONUS  
LOW-COST  
BENCH-TESTED  
PROJECTS!

SUMMER 1965

A 75¢ QUARTERLY

**BUILD WINKY-DINK:  
\$3 fun project using  
computer circuitry!**

**How the TV  
Camera Sees  
and Sends!**

**How Signal  
Generators  
Work!**

**How to Use  
a Slide Rule  
for Electronic  
Computations!**

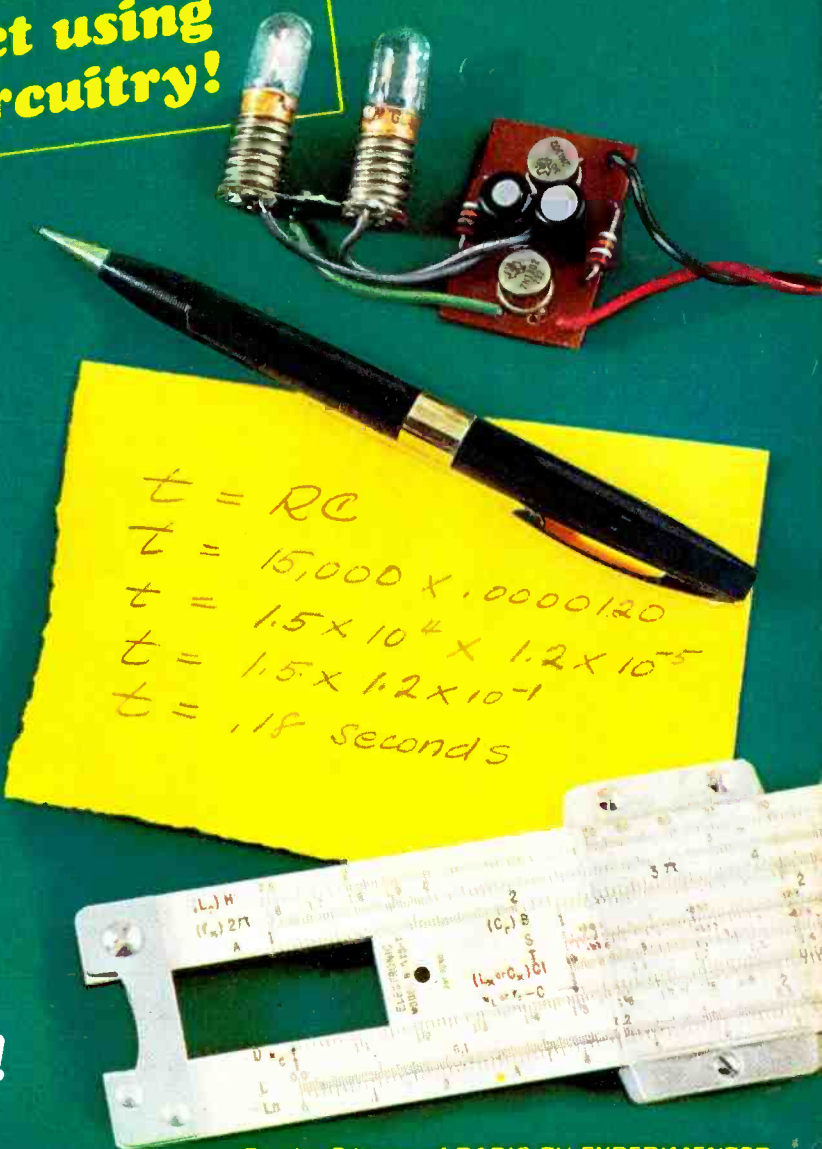

$t = RC$   
 $t = 15,000 \times .0000120$   
 $t = 1.5 \times 10^4 \times 1.2 \times 10^{-5}$   
 $t = 1.5 \times 1.2 \times 10^{-1}$   
 $t = .18 \text{ seconds}$

By the Editors of RADIO-TV EXPERIMENTER

# EICO

# BEST VALUES IN KITS and wired equipment

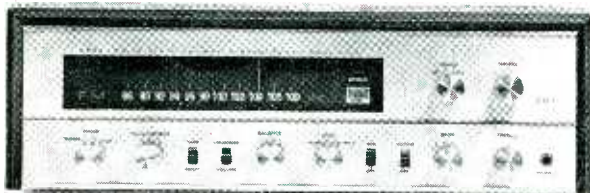

### RP 100 SOLID STATE 4-TRACK STEREO TAPE DECK

Top professional quality—independent record and play—transistor electronics—used by industry in computer and communications systems • 3-motor drive including hysteresis synchronous capstan motor • 3 high-performance heads • **Kit only \$299.95. Wired \$450.**

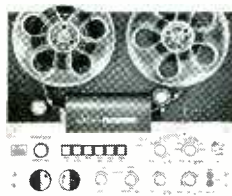

### 3566 SOLID STATE FM MPX AUTOMATIC STEREO TUNER/AMPLIFIER.

Finest all-transistor kit value, equal to \$500-600 class instruments. Kit comes with pre-wired and prealigned RF, IF & MPX circuit boards plus transistor sockets. Outstanding 2 UV IHF sensitivity, automatic FM stereo-mono switching, muting, 40 db FM stereo separation. Total 66 watts IHF music power, **only \$229.95 semi-kit** (recommended to beginners!); optional walnut cabinet \$14.95—also **\$349.95 factory wired** including cabinet.

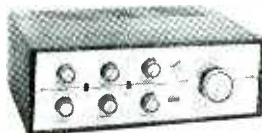

**2536 FM MPX STEREO TUNER/AMPLIFIER.** Superb FM stereo-MPX tuner, plus a 36-watt stereo amplifier. "In tuning ease, general handling, and sound quality... leaves little to be desired." HIRCH-HOUCK LABS in ELECTRONICS WORLD. **Kit only \$154.95. Wired \$209.95.**

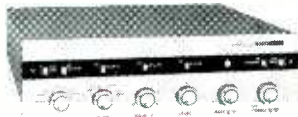

**ST 70-WATT INTEGRATED STEREO AMPLIFIER** Best buy of highest ranked stereo amplifiers according to independent testing. **Kit \$99.95. Wired \$149.95. ST40 40-WATT INTEGRATED STEREO AMPLIFIER.** **Kit \$79.95. Wired \$129.95.**

**HF-90A FM TUNER.** Prewired and aligned FM front end. Most popular FM tuner kit ever made—"Without question an extraordinary value." American Record Guide. **Kit \$44.95. Wired \$69.95.**

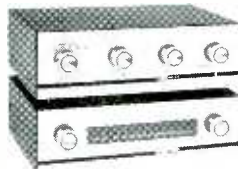

**HF-12A 12-WATT MONO AMPLIFIER.** 18 watts IHF power. "Packs a bigger wallop than is apparent from the specifications." POPULAR ELECTRONICS. **Kit \$39.95. Wired \$59.95.**



### 435 DC WIDEBAND 3" SCOPE

Sensational performance in a compact 15-lb. package. Flat-face 3-inch CRT with V and H trace expansion. Flat from DC to 4.5 Mc/s, useful to above 10 Mc/s. Zener diode calibrator. Equal to scopes costing many times more. **Kit only \$99.95. Wired \$149.95.**

### 324 RF Signal Generator

Covers 150 Kc/s to 435 Mc/± 1.5% frequency accuracy. Internal 0-50% 400-cycle modulation. **Kit \$28.95. Wired \$39.95.**

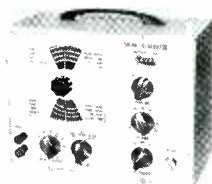

### 232 PEAK-TO-PEAK VTVM

For color and B&W TV servicing, experimenters and laboratories. 7 non-skip ranges on every function. Measures AC peak-to-peak and RMS as well as DC. Response 30 Cn/s to 3 Mc/s with HVP probe. **Kit \$29.95. Wired \$49.95.**



### 369 SWEEP/POST INJECTION MARKER GENERATOR

For the "pro" service engineer, experimenters and laboratories. For aligning TV, FM and communications receivers. Sweeps cover 3-220 Mc/s. Markers cover 2-225 Mc/s. **Kit \$89.95. Wired \$139.95.**



**667 TUBE/TRANSISTOR TESTER** Dynamic conductance tube tester • 14 combinations of 3 plate and 3 screen voltages and 3 ranges of grid voltage • Interelement leakage readings in ohms. Checks all new tube types • Two step transistor test • **Kit \$79.95, wired \$129.95. Model 628 Emission tube tester** • Checks all new tube types • **Kit \$44.95, wired \$59.95. Model CRU**—adapts 667 or 628 for testing B&W & Color TV picture tubes. **Wired \$9.95.**



**EICO** EICO Electronic Instrument Co., Inc.  
131-01 39th Avenue, Flushing, N.Y. 11352

Send new 1965 catalog featuring more than 230 EICO Products

Name \_\_\_\_\_

Address \_\_\_\_\_

City \_\_\_\_\_ Zip \_\_\_\_\_ State \_\_\_\_\_

EE



# American Basic Science Club's Master Lab... a HOME SCIENCE LAB AND COURSE

You get ALL the Following Equipment in 9 Monthly Kits

**ELECTRICAL LAB**  
All the equipment for basic electrical experiments with Wheatstone Bridge (impedance resistor), Magnetizer and De-magnetizer, Thermocouple, Potentiometer, Continuity Tester, Estimation Voltmeter, Solenoid Coin Tossar, Electromagnetic Relay, Neon Lamp, Galvanometer, Induction Coil, Resistors, Chemicals and Electrodes for Plating and Electrolysis.  
**FOR SAFETY** a step-down Isolation Transformer provides required current.  
(Available as a Separate Unit for \$8.95 Postpaid)



**STROBE LIGHT**  
A Neon Lamp that flashes at intervals you can synchronize with the speed of rotation or vibrating objects in order to "freeze" their motion to permit close study and checking frequencies and RPM. Flashes one time per revolution by a high speed Oscillator. Operates on the Master Lab DC Power Supply. (When bought as a separate unit uses a 90 V Battery that is included in unit price.)  
(Available as a Separate Unit for \$7.95 Postpaid)

**PHOTOELECTRIC RELAY**  
Crystal Photocell, Electronic Amplifier, Relay, Large Condensing Lens in Cabinet Mount. Features automatic "on-or-off" or holding circuit operator. Sensitivity Control. Plug-In Outlet for controlled circuit. Use for alarms, counters, etc. Operates on 115V AC. A basic unit for many exciting experiments.  
(Available as a Separate Unit for \$8.95 Postpaid)

**ANALOG COMPUTER**  
Electronic Computer multiplies, divides, calculates powers, roots, logarithms. Set up the problem on the scales of two linear potentiometers and find the answer by listening for the null point on the third potentiometer. More accurate, educational, and practical than similar computers that sell for several times the price. Easy to assemble. Complete with Headphone.  
(Available as a Separate Unit for \$4.95 Postpaid)

**LIGHT AND OPTICS LAB**  
Exciting optical projects for the study of light. Equipment includes: five Precision Lenses, Prism, Polarizing Filters, Diffraction Grating, Mirror, Telescoping Tubing, Lens Mounts, Tube Holders and Brackets. All the parts and instructions to build a Microscope Camera Obscura, Camera Lucida, Polariscope, Photometer, and many other optical devices.  
(Available as a Separate Unit for \$5.95 Postpaid)

**PHOTOGRAPHY LAB**  
A PRECISION 35MM ENLARGER... horizontal type with twin condensing lenses and 3" F/L projection lens. Produces quality enlargements up to 8" x 10". Contact Print Frame takes negatives up to 3 1/2" x 5". 3 Plastic Developing Trays, Neon Safelight, Tray Thermometer, Film Clips, Developing Chemicals, Fixing and Fading Paper and Darkroom Handbook. Make quality enlargements for 6c. Make prints for only 2c.  
(Available as a Separate Unit for \$9.95 Postpaid)

**RADIO LAB AND COURSE**  
SHORTWAVE AND BROADCAST RADIOS. 3-tube regenerative circuit. Uses 115V AC house current. Complete with headset.  
CARBON MICROPHONE and 2-stage AUDIO AMPLIFIER... RADIO TRANSMITTER for code or voice.  
DC POWER SUPPLY (Power transformer, Vacuum Tube Rectifier and 20-20 mfd. capacitor filter circuit) converts home AC to the DC required for electronic experimenting.  
RIPPLE TANK WAVE GENERATOR with variable frequency. Produces standing waves, nodal lines, etc. Invaluable in understanding wave theory.

**A COMPLETE ELECTRONICS COURSE**  
You really learn electronics with this exciting, learn-by-doing course. No Experience Necessary. Basic enough for beginners—rewarding enough for the "pro".

**A VALUABLE ELECTRONICS LAB**  
Containing parts by RCA, MALLORY, PYRAMID, GE, CENTRALAB, STACKPOLE, TRIM, CINCH and other reliable manufacturers. Retail value of these electronic parts is more than 25 DOLLARS!  
(Available as a Separate Unit for \$17.80 Postpaid)

**PHOTOMICROGRAPHY LAB**  
"Projection-Type" Camera takes and prints pictures of subject mounted on microscope slides. Enlarges up to 100 times. Takes the place of microscope, camera and printer. No other equipment needed. Includes: Developing Trays, Chemicals, Paper, Microscope Slides and Safe Light. Uses standard sizes of regular roll film.  
(Available as a Separate Unit for \$6.95 Postpaid)

**SLIDE PROJECTOR**  
Has interchangeable projection assemblies—one for standard 35MM slides, and the other, with greater magnification, for microscope slides. Comes with 140 watt GE Projection Lamp, Large Twin Condensing Lenses for extra brightness, sturdy Steel Housing with inner chimney and baffles for cool operation.  
(Available as a Separate Unit for \$6.95 Postpaid)

**LIGHT TRANSMITTER-RECEIVER**  
The TRANSMITTER consists of a Light Source, a Modulating Reflector Diaphragm and an Optical Projection System. The RECEIVER is a Two-Stage Audio-Amplifier, controlled by a Photo-electronic Cell that catches the projected light beam and causes the original sound waves to be reproduced in the headphone. Talking on a Light Beam.  
(Available as a Separate Unit for \$14.95 Postpaid)

**ATOMIC ENERGY LAB**  
ATOMIC CLOUD CHAMBER WITH PROJECTOR ILLUMINATOR. See the vapor trails of alpha and beta particles, and of cosmic rays.  
SPINMANSCOPE. Shows exploding atoms.  
ELECTROSCOPES—metal housed with Scale and Magnifying Viewer. Measures background radiation and tests sample sources.  
SAFE RADIOACTIVE MATERIALS. Alpha Source in handy container and Uranium Ore.  
Full instructions and explanations open up the fascinating field of nuclear physics.  
(Available as a Separate Unit for \$6.95 Postpaid)

**SPECTROSCOPE**  
Analyze spectra of glowing gases. See and identify the Fraunhofer Lines. A quality instrument featuring an easy-to-read built-in scale and a powerful condensing system for a bright spectrum. Equipment includes Alkaline Burner and a 2 Watt Neon Spectral Lamp. Full instructions cover theory and use.  
(Available as a Separate Unit for \$5.95 Postpaid)

**ULTRAVIOLET LAMP**  
140 watt filter type UV LAMP. Heavy metal cabinet. 6 Foot Cord, Rotary Switch. Produces dazzling color effects with invisible black light. Has many uses in the fields of Mineralogy, Clime Detection and Science. Accessories include Invisible Ink, Tracer Powder, Fluorescent Crayons.  
(Available as a Separate Unit for \$6.95 Postpaid)

**SURVEYOR'S TRANSIT**  
A practical Transit. 6X erect image telescope with Range Finder Reticle for measuring remote distances and heights. Vernier reading for both horizontal and vertical scales. Leveling Head with Thumb Screw Adjustment and Split Level. Clamps under head hold wooden legs of tripod. (Legs not included.) Instructions cover elementary surveying, range-finding.  
(Available as a Separate Unit for \$5.95 Postpaid)

**TELESCOPE AND MOUNT**  
30X erect image. Extends to 30" length. Five ground and polished lenses. Ramsden Eyepiece. Sturdy Equatorial Mount makes it easy to follow the movement of heavenly bodies. Mount has fittings for wooden legs that complete the tripod (legs not included).  
(Available as a Separate Unit for \$4.95 Postpaid)

**WEATHER STATION**  
REMOTE READING ANEMOMETER AND WIND-VANE... Flashing Neon Lights on indoor indicator board show wind speed and direction. Operates on less than 1 cent per month. Safety Power Cord makes all connections safe. 150 lb. of Lead-in Wire. Plus—Air Tank Barometer with 4 in. indicator column. Sling Psychrometer measures relative humidity. Rain Gauge measures rainfall to 1/100 inch. ALSO Cloud Chart, Weather Map and Forecasting Manual—a complete set-up for amateur meteorology.  
(Available as a Separate Unit for \$7.95 Postpaid)

**9 KIT MASTER LAB Includes ALL the Equipment for ALL the Above... only \$37.55**  
SEND \$2.00 WITH ONLY COUPON PAY \$3.95 ONLY CANCEL ANY TIME YOU WISH—MONEY BACK IF NOT DELIGHTED

**MULTI-USE DESIGN—A MASTER LAB FEATURE**  
All the above equipment, as separate units, adds up to over \$13000. How can the 9 kit Master Lab have it all for only \$37.55? Multi-use design is the answer. For example: The Slide Projector quickly and easily converts into the Photo-Enlarger, Spectroscope, Cloud Chamber Illuminator, etc. Similarly, the Transit Head doubles as a Telescope Mount. Such multi-purpose design makes possible an all-science lab at an unheard-of low price. Multi-purpose design is used only where it is advantageous. For example, it is NOT used in such applications as the permanently-mounted weather instruments, where it would not be practical.

**KIT-A-MONTH—OR ALL AT ONCE**  
Get Master Lab an either plan (see coupon). You may start with the Kit-A-Month plan, and at any time get the balance of the 9 kit series in one shipment by sending \$3.95 for each of the unshipped kits.

**SEPARATE UNITS ALL GOOD BUYS**  
You can order any of the individual units and be sure that it is a quality item and the best value in its field. The Master Lab, however, is the "buy of buys" and every science-minded person should try it.

**NO EXPERIENCE NECESSARY—IT'S EASY! IT'S FUN!**  
The easy-to-follow, learn-by-doing instructions enable any interested person to complete all the projects without difficulty. The 9 instruction manuals and 6 auxiliary textbooks are expertly written, clearly illustrated, excitingly different. Over 480 pages. Over 270 illustrations. A real science course for a solid science background.

**ACCLAIMED BY EDUCATORS**  
"You offer a range of experiments usually performed only in the better high school and college laboratories. The number of concepts presented, and the clarity and concreteness of their development is amazing."  
R. M. HELM, Prof. of Physics  
East Carolina College, Greenville, N. C.

**FREE with first kit!**  
**MYSTERY SHOCK BOX**  
Yours to keep even if you return the kit for full refund

**KIT-A-MONTH... THE EASY WAY TO A WONDERFUL LAB!**  
\* You take only as many kits as you wish—no obligation.  
\* You may return any kit and receive full refund.  
These "No Risk" assurances because we know... you'll be amazed and delighted  
The first kit will convince you that you want the Master Lab  
Send \$2 today—get your first kit on its way!

All Orders on 10 Day Approval—Your Satisfaction or Your Money Back  
 Start sending me the MASTER LAB in 9 monthly kits. I enclose \$2.00 and will pay \$3.95 plus COD postage on receipt of each kit. I may cancel unshipped kits at any time.  
 Send me complete MASTER LAB (all 9 kits) in one shipment I enclose \$37.55 Full Payment, Postage Paid.  
 Send me only the \_\_\_\_\_ Unit. I enclose \$\_\_\_\_\_, Full Payment, Postage Paid.

NAME \_\_\_\_\_  
ADDRESS \_\_\_\_\_  
CITY & STATE \_\_\_\_\_  
**AMERICAN BASIC SCIENCE CLUB, INC.**  
501 East Crockett St., San Antonio, Texas 78202

**A SPACE AGE HOBBY... EXCITING—REWARDING!**



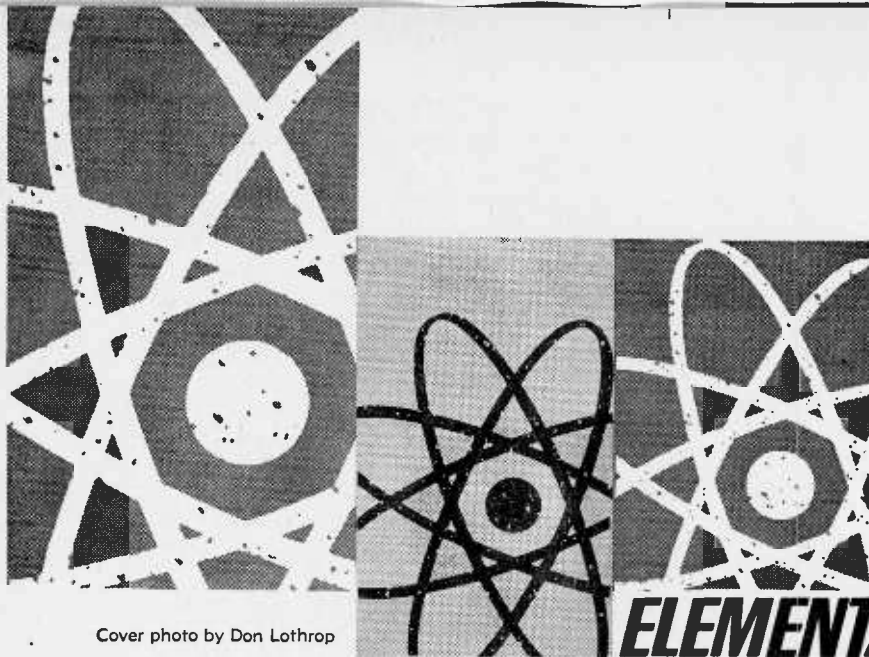

Cover photo by Don Lothrop

# ***ELEMENTARY ELECTRONICS***

## **Theory Articles**

Meet the Schematic Diagram.....	27
How the TV Camera Sees.....	37
Signal Generators .....	41
The Slide Rule.....	47
Effective Radio Grounding.....	53
How FM Receivers Work.....	55
Inside the Oscilloscope.....	65
Measure Your Antenna Resonance.....	71
After Ohm's Law—Maxwell's Cyclic Method..	75

## **Construction Articles**

Midget Extension Light.....	78
Build Winky-Dink .....	79
CB Tuning Meter.....	81
Push-Pull Crystal Receiver.....	83
CdS Power Control Unit.....	87
Discarded Portable Becomes Test Speaker...	89
BFO (Beat Frequency Oscillator).....	90
Plug-in Power Supply.....	92

## **Departments**

Ask Me Another.....	5
Correction .....	13
NewScan .....	14
Classified Ads .....	20
Literature Library .....	22

FACTORIES ARE TURNING OUT MILLIONS OF APPLIANCES DAILY . . . WHO WILL REPAIR THEM?

# START YOUR OWN BUSINESS!



## ELECTRICAL APPLIANCE REPAIRING

There are over 60,000,000 families in the United States. They average 15 or more appliances each, and every marriage means another 15 appliances. Billions of dollars are invested in appliances, yet every year more appliances appear on the market. Eventually they all need adjustment or repair — that is why Electrical Appliance Repairing is such a profitable business today and will go on paying big cash profits for years to come.

### EARN WHILE YOU LEARN

Since 1935 Christy Trades School has been teaching mechanically-inclined men the profitable Electrical Appliance Repair business. You learn by working with your hands — testing and repairing. We send you kits to assemble and keep, including the valuable Christy Electronic Trouble Tracer. We show you how to find trouble in refrigerators, automatic washers, irons and everything electrical, how to fix it quickly. We tell you what to charge, how to solicit business, where to get spare parts wholesale. We also teach you how to build power tools from spare parts, and how to do welding, house wiring, and other profitable businesses.

### MAKE MONEY RIGHT FROM THE START

Many of our students pay for their entire course before they have completed their training! How? Because right from the very beginning they are shown how to make actual repairs! Thousands of Electrical Appliance Technicians can testify that the CTS course is a practical course written in simple, easy-to-understand language, profusely illustrated with hundreds of photographs and detailed drawings.

**PAY-AS-YOU-LEARN PLAN.** Send TODAY for FREE illustrated book and special form for paying from earnings made while learning. See how you can soon own your own money-making business!

**USE YOUR OWN BASEMENT,** garage, or kitchen. You don't need expensive equipment. Work full or spare time, as you wish.

**\$6 to \$7 AN HOUR** are the going rates for making ordinary repairs and doing routine appliance service work. Think of the things you could have if you had your share of this money!

**AGE IS NO BARRIER,** nor is a minor handicap. The work is light and pleasant. Work when you wish — you're the boss!

**RETIRED MAN BUILDS BUSINESS.** Mr. Marion A. Pippin, 1139 E. Lincoln Ave., Decatur, Ill., writes: "I am now in the phone book in 4 places in the yellow pages. My business is getting better all the time." Mr. Pippin, now in his sixties and retired, is building a real business with solid security in his fix-it shop. You can do the same with CTS training.



**ELECTRONIC TESTING KIT FURNISHED**

**SEND COUPON TODAY!**



**SEND FOR FREE BOOK . . .**

**tells you how to do it!**

#### CHRISTY TRADES SCHOOL INC.

Dept. A-3Y, 3214 W. Lawrence Avenue, Chicago, Illinois 60625

Please RUSH FREE book on America's fastest growing industry, Electrical Appliance Repairing, and special form for paying from earnings while learning.

Name

Address

City  State

# LEARN **ELECTRONICS**

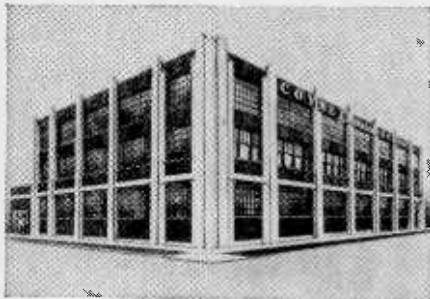

FOUNDED 1899

NOT-FOR-PROFIT

## COYNE ELECTRONICS INSTITUTE

Electronics Engineering Technology	—	Degree (2 Yrs.)
Electrical-Electronics Technician	—	Diploma (40 Wks.)
TV-Radio-Electronics Technician	—	Diploma (40 Wks.)
Combined Electronics Technician	—	Diploma (80 Wks.)
Practical Electrical Maintenance	—	Diploma (32 Wks.)
Practical Refrigeration Air Conditioning and Appliance Repair	—	Diploma (24 Wks.)
Specialized Industrial Electronics	—	Diploma (16 Wks.)
Introduction to Electricity-Electronics	—	Certificate (8 Wks.)
FCC First Class Radiotelephone	—	Certificate (100 Hrs.)

Special finance plans. Part time employment service while in school. Also Free graduate employment service.



Use this coupon to get our FREE BOOK  
"YOUR OPPORTUNITIES IN ELECTRONICS"

COYNE ELECTRONICS INSTITUTE, Dept. of Electronics 45-P  
1501 W. Congress Parkway, Chicago, Illinois 60607

Name \_\_\_\_\_ Age \_\_\_\_\_

Address \_\_\_\_\_ Phone \_\_\_\_\_

City \_\_\_\_\_ Zone \_\_\_\_\_ State \_\_\_\_\_

Unlike most other schools, we do not employ salesmen

## WANT TO LEARN AT HOME?

"How To Succeed Through Home Study" is the only magazine that gives complete details on courses such as electronics, accounting, repairs of all kinds, engineering, broadcasting and many other fields of interest to today's active men.

Increase your knowledge and earning potential by sending for your copy of "How To Succeed Through Home Study"—\$1.

**How To Succeed Through Home Study**  
505 Park Avenue, New York, N. Y. 10022

# ELEMENTARY ELECTRONICS

No. 739

Summer 1965 Edition

*Editor*

**JULIAN M. SIENKIEWICZ**  
WA2CQL, 2W5115

*Associate Editor*

**WILLIAM HARTFORD**  
KKD7432

*Art Director*

**ANTHONY MACCARRONE**

*Cover Art Director*

**FRANK TAGGART**

*Art Editor*

**JOSEPH DAVIS**

*Art Associates*

**ALBERT DE QUERQUIS**  
**LINDA BRUSE**

*Advertising Director*

**ELLIOT S. KRANE**

*Advertising Manager*

**JIM CAPPELLO**

*Production Director*

**LEN PINTO**

*Production Manager*

**CARL BARTEE**

*Production Assistant*

**HELEN GOODSTEIN**

*Promotion Manager*

**RON SMILEY**

*Executive Editor*

**JOE DAFFRON**

*President and Publisher*

**B. G. DAVIS**

*Executive Vice President and Assistant Publisher*

**JOEL DAVIS**

*Vice President and Editorial Director*

**HERB LEAVY**

ELEMENTARY ELECTRONICS (No 739) is published by SCIENCE & MECHANICS PUBLISHING CO., a subsidiary of Davis Publications, Inc. Editorial, business and subscription offices: 505 Park Ave., New York, N.Y. 10022. Advertising offices: New York, 505 Park Ave., PL-2-6200; Chicago: 520 N. Michigan Ave., 527-0330; Los Angeles: 6363 Wilshire Blvd., 653-5037. Atlanta: Pirnie & Brown, 3108 Piedmont Rd., N.E., 404-233-6729; Detroit: Paul Pequinot, 357 Kendry Drive, Bloomfield Hills, Mich., 313-338-1922; Long Island: Len Osten, 9 Garden Street, Great Neck, N.Y., 516-487-3305.

Copyright 1965 by Science & Mechanics Publishing Co.

# ask me another

By Leo G. Sands

*Elementary Electronics* brings the know-how of an electronics expert to its readers. Leo G. Sands, columnist for *Radio-TV Experimenter*, will be happy to answer your question. Just type or print your unsolved problem on the back of a 4¢ postal card and send it to "Ask Me Another," *Elementary Electronics*, 505 Park Avenue, New York, New York 10022. Leo will try to answer all your questions in the available space in upcoming issues of *Elementary Electronics*. Sorry, Leo will be unable to answer your questions by mail.

## Dahdahdah Didahdit

*How can I learn to receive code fast?*

—L. M. S., Flushing, N. Y.

Memorize the code first. You learned the alphabet and the multiplication tables, so you can memorize the code. Sending is easy but receiving may be more difficult. You might try tuning in a code station and leave your receiver on when going to sleep. Your "sub-conscious" mind, as some reports state, listens to code and deciphers it while you sleep. In the morning, you may wake up and find you can copy code. But we won't guarantee it. In the June, 1964 issue of *RADIO-TV EXPERIMENTER* you will find a complete roundup of code training courses on records and tape. If you have trouble learning code, we suggest you go seek the aid of "professional" from a radio amateur.

## Calling CB

*How can I modify a CB set so I can use it for paging?*

—J. C. P., Newark, N. J.

The speaker circuit of a typical CB set is shown in the top drawing of the two schematics. When the transmit-receive relay (or switch) S is in the R (receive) position the speaker is connected. In the T position, the speaker is disconnected and the cathodes of



*Your copy is waiting*

## The do-it-yourselfer's newest catalog

Here's your new catalog of quality electronic kits and assembled equipment . . . your shopping guide for TV set kits, transistor radios, voltmeters, scopes, tube testers, ham gear, PA systems, and a host of other carefully engineered products. Every item in the Conar catalog is backed by a no-loopholes, money-back guarantee. It's not the biggest catalog, but once you shop its pages you'll agree it's among the best. For years of pleasurable performance, for fun and pride in assembly, mail the coupon. Discover why Conar, a division of National Radio Institute, is just about the fastest growing name in the kit and equipment business.

# CONAR

**MAIL NOW!**

CONAR

DV5C

3939 Wisconsin Avenue, Washington, D.C. 20016

Please send me your new catalog.

Name \_\_\_\_\_

Address \_\_\_\_\_

City \_\_\_\_\_ State \_\_\_\_\_ Z-code \_\_\_\_\_

# Olson

\* **FREE**

Fill in coupon for a **FREE** One Year Subscription to **OLSON ELECTRONICS'** Fantastic Value Packed Catalog—Unheard of **LOW, LOW PRICES** on Brand Name Speakers, Changers, Tubes, Tools, Stereo Amps, Tuners, CB, and other Values. Credit plan available.

NAME \_\_\_\_\_  
ADDRESS \_\_\_\_\_  
CITY \_\_\_\_\_ ZONE \_\_\_\_\_ STATE \_\_\_\_\_

If you have a friend interested in electronics send his name and address for a **FREE** subscription also.

**OLSON ELECTRONICS**  
INCORPORATED

364 S. Forge Street Akron, Ohio 44308

Get Your First Class Commercial

## F. C. C. LICENSE

**QUICKLY!**

Career opportunities in *communications electronics* are almost unlimited. Prepare now. Let Grantham train you—by correspondence, or by classroom and laboratory instruction. Get your *first class commercial* F.C.C. license in as little as 3 months, or at a slower pace if you prefer. Then, continue in more-advanced electronics training if you wish. Diploma awarded. Our catalog gives full details.

Learn how our training can prepare you for your F.C.C. license; write or telephone the School at any one of the teaching divisions listed below, and ask for "Catalog E-5."

### Grantham School of Electronics

1505 N. Western Av., Hollywood, Cal. 90027  
(Phone: HO 9-7878)

408 Marion Street, Seattle, Wash. 98104  
(Phone: MA 2-7227)

3123 Gillham Road, Kansas City, Mo. 64109  
(Phone: JE 1-6320)

818 - 18th St., NW, Washington, D.C. 20006  
(Phone: 298-7460)

# ask me another

the transmitter tubes are grounded.

To modify this circuit for paging an s.p.d.t. switch is added and the circuit is rewired as shown in the bottom schematics. Here S1 is the transmit-receive relay (or switch) and S2 is the added switch. When S2 is in the "normal" position, the set operates as before. When set to the PA position, the set's own speaker operates when receiving and the external paging speaker operates when the transmit switch is pressed. But, the transmitter won't go on the air except when S2 is in the "normal" position and the transmit button is pressed.

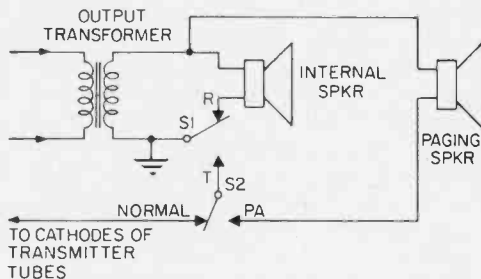
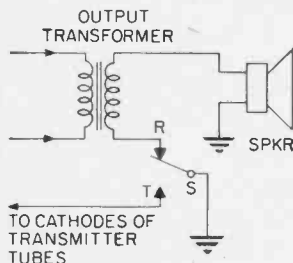

### Land Line

*I have an intercom system from my house to a friend's house interconnected by about 200 feet of cable lying on the ground. When I turn on the intercom, I pick up radio stations. Why?*

—E. J., Richmond Hill, N. Y.

The cable, if not shielded or balanced, acts as an antenna and the first stage of the intercom acts as a detector. Try using two-conductor shielded cable with vinyl plastic jacket (Belden 8737 or equivalent) and try

(Continued on page 10)



# A New Electronic Slide Rule with Instruction Course

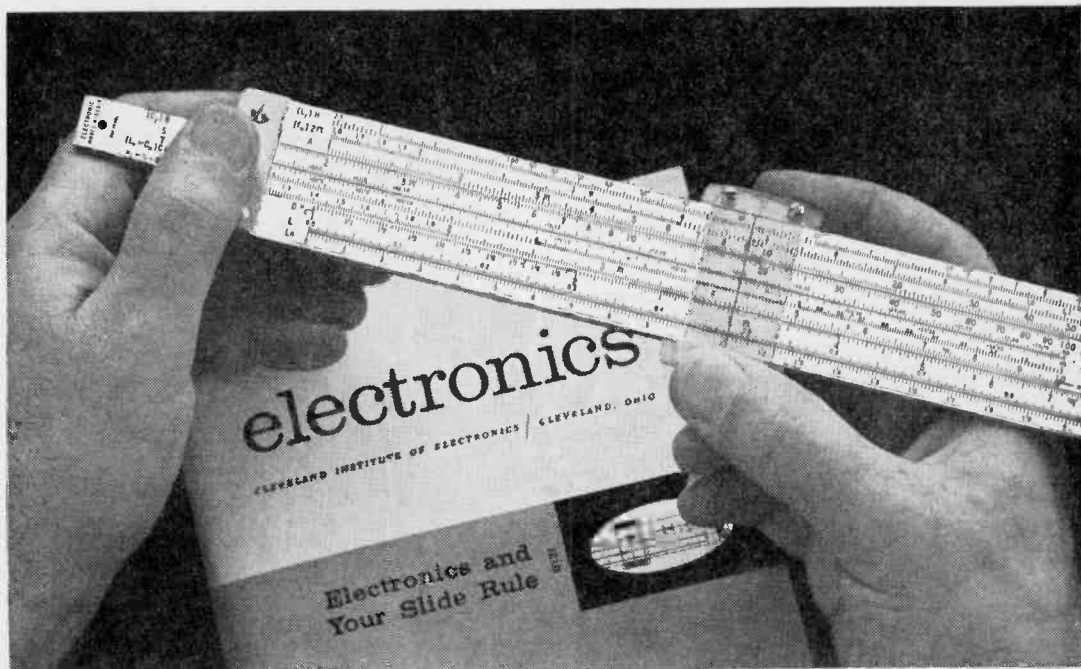

## Why didn't someone think of this before?

Here's a great *new* way to solve electronic problems accurately . . . easily. The Cleveland Institute Electronics Slide Rule\* is the only rule designed specifically for the exacting requirements of electronics computation. It comes complete with an illustrated Instruction Course consisting of four AUTO-PROGRAMMED lessons . . . each with a short quiz you can send in for grading and consultation by CIE's expert instructors. With this personal guidance, you'll soon be solving complex electronics problems in seconds while others still struggle along with pad and pencil.

Here's what Mr. Joseph J. DeFrance, Head of the Electrical Technology Dept., New York City Community College, has to say about it:

"I was very intrigued by the 'quickie' electronics problem solutions. It is an ingenious technique. The special scales should be of decided value to any technician, engineer, or student. The CIE slide rule is a natural."

See for yourself. You will learn how to use special scales to solve problems dealing with reactance, resonance, inductance, AC and DC circuitry, etc. And, as an added bonus, you can use this high-quality rule for conventional computation, too.

This all-metal Slide Rule is a full 10" long and is made to our rigid specifications by Pickett, Inc. Slide Rule, Instruction Course and handsome top-grain leather carrying case . . . all yours for just \$14.95. Cleveland Institute of Electronics, 1776 East 17th St., Department EL-101, Cleveland, Ohio 44114.

### SATISFACTION Warranty

The Electronics Slide Rule with Instruction Course is available only from Cleveland Institute of Electronics, and is covered by CIE's exclusive "Satisfaction Warranty." Order it now . . . use it for ten full days. Then, if you're not completely satisfied, CIE will refund full payment. \*U.S. Patent Number 3,120,342.

### SEND COUPON TODAY

to: **Cleveland Institute of Electronics**

1776 East 17th St., Dept. EL-101 • Cleveland, Ohio 44114

- Please send me your Electronics Slide Rule with Instruction Course and top-grain leather carrying case. I am enclosing \$14.95.
- Please send descriptive brochure only . . . without obligation.

Name \_\_\_\_\_ (Please Print)

Address \_\_\_\_\_ County \_\_\_\_\_

City \_\_\_\_\_ State \_\_\_\_\_ Zip \_\_\_\_\_

A leader in electronics training . . . since 1934.

# BECOME A RADIO

## Build 20 Radio and Electronic Circuits at Home

### ALL GUARANTEED TO WORK!

#### YOU DON'T HAVE TO SPEND HUNDREDS OF DOLLARS FOR A RADIO COURSE

The "Edu-Kit" offers you an outstanding PRACTICAL HOME RADIO COURSE at a rock-bottom price. Our Kit is designed to train Radio & Electronics Technicians, making use of the most modern methods of home training. You will learn radio theory, construction practice and servicing. THIS IS A COMPLETE RADIO COURSE IN EVERY DETAIL. You will learn how to build radios, using regular schematics; how to wire and solder in a professional manner; how to service radios. You will work with the standard type of punched metal chassis as well as the latest development of Printed Circuit chassis. You will learn the basic principles of radio. You will construct, study and work with RF and AF amplifiers and oscillators, detectors, rectifiers, test equipment. You will learn and practice code, using the Progressive Code Oscillator. You will learn and practice trouble-shooting, using the Progressive Signal Tracer, Progressive Signal Injector, Progressive Dynamic Radio & Electronics Tester, Square Wave Generator and the accompanying instructional material. You will receive training for the Novice, Technician and General Classes of F.C.C. Radio Amateur License. You will build Receiver, Transmitter, Square Wave Generator, Code Oscillator, Signal Tracer and Signal Injector circuits, and learn how to operate them. You will receive an excellent background for television, Hi-Fi and Electronics. Absolutely no previous knowledge of radio or science is required. The "Edu-Kit" is the product of many years of teaching and engineering experience. The "Edu-Kit" will provide you with a basic education in Electronics and Radio, worth many times the complete price of \$26.95. The Signal Tracer alone is worth more than the price of the entire Kit.

#### THE KIT FOR EVERYONE

You do not need the slightest background in radio or science. Whether you are interested in Radio & Electronics because you want an interesting hobby, a well paying business or a job with a future, you will find the "Edu-Kit" a worth-while investment. Many thousands of individuals of all

ages and backgrounds have successfully used the "Edu-Kit" in more than 79 countries of the world. The "Edu-Kit" has been carefully designed, step by step, so that you cannot make a mistake. The "Edu-Kit" allows you to teach yourself at your own rate. No instructor is necessary.

#### PROGRESSIVE TEACHING METHOD

The Progressive Radio "Edu-Kit" is the foremost educational radio kit in the world, and is universally accepted as the standard in the field of electronics training. The "Edu-Kit" uses the modern educational principle of "Learn by Doing." Therefore you construct, learn schematics, study theory, practice trouble-shooting—all in a closely integrated program designed to provide an easily-learned, thorough and interesting background in radio. You begin by examining the various radio parts of the "Edu-Kit." You then learn the function, theory and wiring of these parts. Then you build a simple radio. With this first set you will enjoy listening to regular broadcast stations, learn theory, practice testing and trouble-shooting. Then you build a more advanced radio, learn more advanced theory and techniques. Gradually, in a progressive manner, and at your own rate, you will find yourself constructing more advanced multi-tube radio circuits, and doing work like a professional Radio Technician.

Included in the "Edu-Kit" course are Receiver, Transmitter, Code Oscillator, Signal Tracer, Square Wave Generator and Signal Injector circuits. These are not unprofessional "breadboard" experiments, but genuine radio circuits, constructed by means of professional wiring and soldering on metal chassis, plus, the new method of radio construction known as "Printed Circuitry." These circuits operate on your regular AC or DC house current.

#### THE "EDU-KIT" IS COMPLETE

You will receive all parts and instructions necessary to build 20 different radio and electronic circuits, each guaranteed to operate. Our Kits contain tubes, tube sockets, variable, electrolytic, mica, ceramic and paper dielectric condensers, resistors, tie strips, coils, hardware, tubing, punched metal chassis, instruction Manuals, hook-up wire, solder, selenium rectifiers, volume controls and switches, etc.

In addition, you receive Printed Circuit materials, including Printed Circuit chassis, special tube sockets, hardware and instructions. You also receive a useful set of tools, a professional electric soldering iron, and a self-powered Dynamic Radio and Electronics Tester. The "Edu-Kit" also includes Code Instructions and the Progressive Code Oscillator. In addition to F.C.C.-type Questions and Answers for Radio Amateur License training. You will also receive lessons for servicing with the Progressive Signal Tracer and the Progressive Signal Injector, a High Fidelity Guide and a Quiz Book. You receive Membership in Radio-TV Club, Free Consultation Service, Certificate of Merit and Discount Privileges. You receive a chassis, tools, instructions, etc. Everything is yours to keep.

#### SERVICING LESSONS

You will learn trouble-shooting and servicing in a progressive manner. You will practice repairs on the sets that you construct. You will learn symptoms and causes of trouble in home, portable and car radios. You will learn how to use the professional Signal Tracer, the unique Signal Injector and the dynamic Radio & Electronics Tester. While you are learning in this practical way, you will be able to do many a repair job for your friends and neighbors, and charge fees which will far exceed the price of the "Edu-Kit." Our Consultation Service will help you with any technical problems you may have.

J. Statistis, of 25 Poplar Pl., Waterbury, Conn., writes: "I have repaired several sets for my friends, and made money. The "Edu-Kit" paid for itself. I was ready to spend \$240 for a Course, but I found your ad and sent for your Kit."

#### FROM OUR MAIL BAG

Ben Valerio, P. O. Box 21, Magna, Utah: "The Edu-Kits are wonderful. Here I am sending you the questions and also the answers for them. I have been in Radio for the last seven years, but like to work with Radio Kits, and like to build Radio Testing Equipment. I enjoyed every minute I worked with the different kits; the Signal Tracer works fine. Also like to let you know that I feel proud of becoming a member of your Radio-TV Club."

Robert L. Shuff, 1534 Monroe Ave., Huntington, W. Va.: "Thought I would drop you a few lines to say that I received my Edu-Kit, and was really amazed that such a bargain can be had at such a low price. I have already started repairing radios and phonographs. My friends were really surprised to see me get into the swing of it so quickly. The Trouble-shooting Tester that comes with the Kit is really swell, and finds the trouble, if there is any to be found."

#### PRINTED CIRCUITRY

At no increase in price, the "Edu-Kit" now induces Printed Circuitry. You build a Printed Circuit Signal Injector, a unique serving instrument that can detect many Radio and TV troubles. This revolutionary new technique of radio construction is now becoming popular in commercial radio and TV sets.

A Printed Circuit is a special insulated chassis on which has been deposited a conducting material which takes the place of wiring. The various parts are merely plugged in and soldered to terminals.

Printed Circuitry is the basis of modern Automation Electronics. Knowledge of this subject is a necessity today for anyone interested in Electronics.

**NOW! TRAIN AT HOME**

**BUILD 20 RADIO AND ELECTRONIC CIRCUITS AT HOME**

**ORDER DIRECT FROM AD . . . USE COUPON ON NEXT PAGE**

**RECEIVE FREE RADIO & TV PARTS JACKPOT**

# TECHNICIAN for only \$26<sup>95</sup>

THE NEW IMPROVED DELUXE

## Progressive Radio "Edu-Kit"<sup>®</sup>

is now ready



Reg. U.S. Pat. Off.

NOW INCLUDES

- ★ 12 RECEIVERS
- ★ 3 TRANSMITTERS
- ★ SQ. WAVE GENERATOR
- ★ AMPLIFIER
- ★ SIGNAL TRACER
- ★ SIGNAL INJECTOR
- ★ CODE OSCILLATOR

PRACTICAL  
HOME  
RADIO  
COURSE

only  
\$26<sup>95</sup>

SCHOOL INQUIRIES INVITED

### Unconditional Money-Back Guarantee

The Progressive Radio "Edu-Kit" has been sold to many thousands of individuals, schools and organizations, public and private, throughout the world. It is recognized internationally as the ideal radio course.

By popular demand, the Progressive Radio "Edu-Kit" is now available in Spanish as well as English.

It is understood and agreed that should the Progressive Radio "Edu-Kit" be returned to Progressive "Edu-Kits" Inc. for any reason whatever, the purchase price will be refunded in full, without quibble or question, and without delay.

The high recognition which Progressive "Edu-Kits" Inc. has earned through its many years of service to the public is due to its unconditional insistence upon the maintenance of perfect engineering, the highest instructional standards, and 100% adherence to its Unconditional Money-Back Guarantee. As a result, we do not have a single dissatisfied customer throughout the entire world.

TRAINING ELECTRONICS  
TECHNICIANS SINCE 1946

## FREE EXTRAS

- SET OF TOOLS
- SOLDERING IRON
- ELECTRONICS TESTER
- PLIERS-CUTTERS
- VALUABLE DISCOUNT CARD
- CERTIFICATE OF MERIT
- TESTER INSTRUCTION MANUAL
- HIGH FIDELITY GUIDE • QUIZZES
- TELEVISION BOOK • RADIO TROUBLE-SHOOTING BOOK
- MEMBERSHIP IN RADIO-TV CLUB: CONSULTATION SERVICE • FCC AMATEUR LICENSE TRAINING
- PRINTED CIRCUITRY

*You Will Find That The Progressive Radio "Edu-Kit" Is Perfect*

- • • FOR anyone who wishes to learn more about radio construction, theory and servicing.
- • • FOR anyone who is looking for an interesting hobby.
- • • FOR anyone who would like to learn radio but does not have time to attend regular school hours.
- • • FOR anyone who wants to start studying for a high-paying radio job.
- • • FOR anyone who wishes to start in Television.

- Send "Edu-Kit" postpaid. I enclose full payment of \$26.95.
- Send "Edu-Kit" C.O.D. I will pay \$26.95 plus postage.
- Rush me FREE descriptive literature concerning "Edu-Kit."

Name .....

Address .....

**PROGRESSIVE "EDU-KITS" INC.**

(ATT: S. Goodman, M. S. in Ed., Pres.)  
1186 Broadway, Dept. 307DJ, Hewlett, N. Y.

**WORTH \$15.00**

# Coming Next...

## in Elementary Electronics

### • UHF ANTENNA INSTALLATION

Be sure you can receive UHF. If it isn't already in your town, it soon may be. Don't be caught unprepared.

### • NOISE LIMITERS

These fast-acters switch out disturbing noise pulses, leaving normal signals alone.

These and dozens of other useful facts are featured in the next issue of **ELEMENTARY ELECTRONICS**. Be sure and buy your copy, starting July 15. Available at all newsstands for 75¢.

## ask me another

Continued from page 6

grounding the shield at one end (to a cold water pipe) and then the other, or to the chassis of the master unit with the chassis grounded or ungrounded as shown in the diagram. If the intercom is an AC/DC type (no power transformer), install an isolation transformer or the next call you make will be for help.

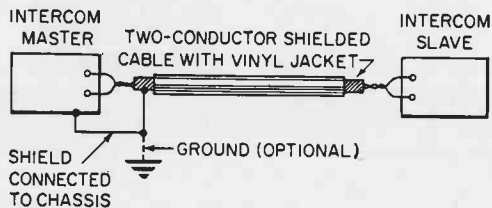

### Battery Boost

*I have a small battery-operated tape recorder which does not have a fast rewind. Can you tell me how I can alter the enclosed circuit to add this feature without damaging the motor?*

—R. L., Hamilton, Ohio

You might try breaking the circuit at "X" in the diagram and connecting an additional 1.5 volt battery at this point so 3 volts will be applied to the motor during rewind. This should make the motor run faster. The way most portables are made today, you may have a lot of trouble squeezing an extra dry cell inside the plastic case.

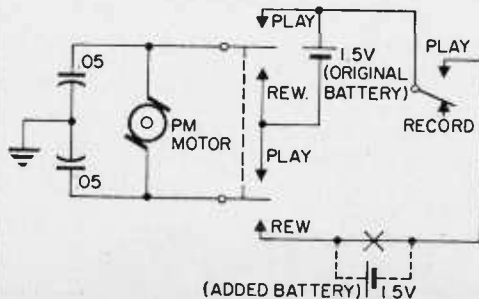

## CB Can Go Amateur

*Can I convert a CB set into a ham rig?*  
—R. H., Hibbing, Minn.

You certainly can. For 10-meter band operation, just take a few turns off the transmitter coils, and the receiver RF, mixer input and oscillator coils, and replace the crystals with ones of appropriate frequency. For 15-meter or 20-meter band operation, add turns to the coils.

Some enterprising manufacturer should bring out a CB-to-ham converter. As shown in the diagram, the transmit frequency is converted upward or downward and amplified. Incoming signals are converted to produce an IF signal at the frequency to which the CB receiver is tuned.

Frankly, if you have a yen for two-way communication, then shake yourself free of the limited CB channels and go amateur. After a short while on 10, 15 or 20 meters, you would never think of going back to CB.

## One-way CB

*Is it lawful to use CB for one-way communication? I want to transmit to friends who have receivers but no transmitters.*

—W. W., Weston, Conn.

Yes it is. But, you must announce your call sign and "address" your message to a specific person or group of persons since broadcasting by CB stations is not permitted. Considering the limited nature of your communications network, keep messages very short or the FCC will be knocking at your door. Also, if there is a land line between you and your friends, give your business to the telephone company.

## Buy It!

*Can you tell me where I can obtain plans for a portable or 12-volt mobile receiver in the 30-50 mc range?*

—R. T., Pittsburgh, Pa.

It is difficult to build a 30-50 mc band receiver with adequate sensitivity and selectivity. You can buy a 12-volt operated mobile tunable receiver (Montioradio M-40) for about \$115 or an AC operated set for \$60 (Lafayette HA-50) to \$100 (Hallcrafters CRX-1) which you can use at home as well as in a car by also using a DC-to-AC inverter costing from \$29.95 (Cornell-Dubilier 12TV12) to \$35 (Teradio 50127).

Now! A clear, simple way  
to teach yourself

# ELECTRONICS

At last there's a simple, surefire way for you to learn basic electronics at home, in your spare time. That way is ELECTRO \* STUDY—a new, step-by-step self-teaching method that brings electronics within the grasp of everyone, regardless of experience or education.

Each ELECTRO \* STUDY unit consists of a simply written, profusely illustrated textbook... and a programmed Study Guide, with hundreds of questions and answers on material in the text. As you read the text, you review important points by referring to the Study Guide, so you remember them better. This frame-by-frame method makes tough points seem easy. You really learn your stuff!

Here are the 16 ELECTRO \* STUDY units, each covering a vital area of basic electronics knowledge:

- E1 Electrons at Work
- E2 Electric Circuits and Ohm's Law
- E3 Magnetism, Electromagnetism—Wiring, Soldering
- E4 Theory of Alternating Currents
- E5 Direct-Current Networks
- E6 Inductance and Capacitance
- E7 Transformers in Radio and Electronics
- E8 Motors and Generators in Electronics
- E9 Resonant Circuits
- E10 Radio Communications Fundamentals
- E11 Vacuum Tube Fundamentals
- E12 Batteries and Electronic Power Supplies
- E13 Audio Frequency Amplifiers
- E14 R-F Circuits
- E15 Transistors and Their Applications
- E16 Superheterodyne Receivers

Order as many of these units as you want—but order now! Take advantage of the special introductory price of just \$4.95 each. Charter subscribers will receive, FREE, a handsome vinyl case for each Study Guide.

**DON'T DELAY. FILL OUT THE COUPON NOW!**



**INTERNATIONAL EDUCATIONAL SERVICES**

Box 824, Scranton, Penna. 18515

- Send me, postpaid, the ELECTRO \* STUDY units circled below, at \$4.95 each. I enclose check (money order) for \_\_\_\_\_ to cover full amount.
- Send me circled units COD. I will pay postage. 15-day money-back guarantee, either way.

E1   E2   E3   E4   E5   E6   E7   E8  
E9   E10   E11   E12   E13   E14   E15   E16

Name \_\_\_\_\_

Address \_\_\_\_\_

City \_\_\_\_\_

State \_\_\_\_\_ Zip Code \_\_\_\_\_



Can You Solve This Equation in One Step?



You can with the Alysnco Slide Rule. Professional 10 Scale Model.

Solve the most complex math problems—cube roots—logarithms quickly, easily. The perfect answer for the electronic hobbyist, designer, engineer. Not a toy but a truly professional tool. Work like the pros with the Alysnco Rule.

Engineering Slide Rule with instructions—ONLY

**\$4.00**

Bonus, offer! Self-teaching illustrated course on slide rule technology regularly \$2.00. With slide rule only \$4.95 ppd. No C.O.D. Send post card for free literature.

**Alysnco EE-65 171 S. Main St., Natick, Mass.**

### See ad on Inside Front Cover

**EICO** Electronic Instrument Co., Inc.  
131-01 39th Avenue, Flushing, N. Y. 11352

Send new 1965 catalog featuring more than 230 EICO Products.

Name \_\_\_\_\_

Address \_\_\_\_\_

City \_\_\_\_\_ Zip \_\_\_\_\_ State \_\_\_\_\_

EE

# MAKE MORE MONEY

Dozens of successful ways to be your own boss or to conduct a small business profitably on a full or part-time basis. Reveals how many franchise and mail order operations work—detailing the pros and cons of these ventures.

## INCOME OPPORTUNITIES

1 year subscription—\$4.50

INCOME OPPORTUNITIES 89 EE4  
505 Park Avenue, New York, N. Y. 10022

Please enter my special 1 year subscription to INCOME OPPORTUNITIES.

I enclose \$4.50  Bill me later

NAME \_\_\_\_\_ (Please print)

ADDRESS \_\_\_\_\_

CITY \_\_\_\_\_ STATE \_\_\_\_\_ ZIP CODE \_\_\_\_\_

# ask me another

## Hot Xtals

*What is a crystal oven?*

—B. B., Barrington, N. H.

A crystal oven is a small enclosure in which one or more frequency determining crystals is enclosed. The temperature inside the oven is kept at a constant, relatively high level by a thermostat-controlled electric heating element. Thus, the temperature inside the oven is steady, and will not rise or fall with the outside temperature. CB crystals are not usually placed in ovens. But, in commercial equipment where frequency tolerance is  $\pm 0.0005\%$  or better, an oven is required.

## Too Much of Something

*A 50,000-watt station about five miles away operating on 1540 kc blankets my radio dial between 1500 and 1580 kc and I can also tune in the station on 540 and 625 kc. How can I limit reception of this station to a 10-kc wide band?*

—D. W., Cooksville, Ont.

Your problem is an unselective receiver or front-end overloading. You might try adding an RF gain control at the RF amplifier cathode, or at the mixer if the set does not have an RF amplifier, as shown in the diagram. The 5000-ohm potentiometer may be connected in series with the cathode bias resistor, if there is one, as shown in A, or directly to the cathode through a limiting resistor as shown in B. The gain of the input stage can be reduced to minimize overloading on strong local signals.

## Xtal Only

*I recently purchased a surplus BC-625 two-meter transceiver with a crystal controlled receiver. How can I modify it to make it tunable?*

—E. B., Hawthorne, N. J.

The unit you have purchased is better known as the SCR-522 which is the "daddy" of present day VHF mobile radios. It is difficult to convert into a tunable set because it employs a single conversion superhet and a complex channel tuning mechanism. It might

be better to get appropriate crystals for receiving and transmitting on popular 2-meter frequencies.

### Listening to Police Calls

*I have been told that local authorities cannot prevent anyone from having a receiver in his car which is capable of receiving police calls. Others have told me that this is not true. What are the facts?*

—T. R., Bronx, N. Y.

The FCC is not concerned with receivers except when they are capable of causing radio interference. But, in many areas local authorities prohibit use in cars of receivers capable of receiving police calls and, in at least 30 states, TV sets whose screen can be seen by the driver. Until recently, it was unlawful for New York City taxicabs to be equipped with auto radios. Local authorities can enforce such local regulations by taking away driver licenses and exacting such other penalties as are prescribed in local laws. The Communications Act prohibits divulging the contents of radio communications (other than broadcast) and even their "existence" must not be disclosed. The law also prohib-

its "use" of intercepted messages except by persons from whom they are intended. The United States is bound by a treaty (International Radio Conference of 1947) to uphold these restrictions on the use of radio communications. ■

### Electronic Filter Power Supply Correction

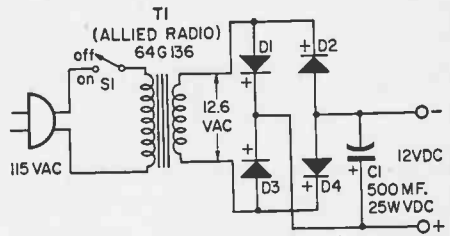

On page 102 in the last issue of *ELEMENTARY ELECTRONICS*, the optional power supply for the Electronic Filter was incorrectly drawn in the schematic diagram. Correct the diagram to look like the one shown above. ■

**COYNE offers**  
**LOW COST**  
**TELEVISION**  
**RADIO - COLOR TV**

**Training in**  
**Spare Time AT HOME**

**—PLUS Two Weeks Personal Training in our Chicago Shop-Labs—FREE of any extra Tuition!**

Coyne—and only Coyne—can make you such a sensational offer. No increase in cost of home training, but as soon as you graduate you are qualified to spend two weeks in Chicago, working on actual projects, getting personal instruction—without one cent of extra tuition. Like getting a post-graduate course free. This offer may be withdrawn at any time, but those who inquire about Coyne's home training now will be guaranteed two weeks of shop training at Coyne's expense for resident tuition. Send name for FREE BOOK.

Now, you can quit *wishing* you had a profitable Radio-TV Service Business of your own. Now, you can quit *dreaming* about a big pay job in Television—and *do something* to make your dreams come true. Start your basic training at home in spare time. We train you to do the work, and show you how to get the work to do—even while you are learning. No costly "put together" kits to pay for. Lowest tuition—low monthly payments. Free employment service to graduates. Send name for all facts. No salesman will call.

**Send Name for FREE BOOK. No salesman will call**



**COYNE ELECTRONICS INSTITUTE**  
**HOMETRAINING DIVISION, Dept. 45-H7**  
**1501 W. Congress, Chicago 60607**

Please mail free book and offer of two weeks personal training in Chicago without extra tuition for home study graduates. Explain low monthly payments.

Name \_\_\_\_\_

Address \_\_\_\_\_

City & State \_\_\_\_\_



Founded 1899

The largest, oldest,  
best equipped resident school  
of its kind.

## COYNE ELECTRONICS INSTITUTE

Chartered as an Educational Institution Not For Profit  
1501 West Congress Parkway, Dept. 45-H7, Chicago 60607

# LIKE ELECTRONICS?

You'll enjoy every issue of

## RADIO-TV EXPERIMENTER

Written by the experts, every issue has articles on:

- up-to-the minute equipment
- unusual projects
- interesting experiments

and it is the *only* source for the well-known, valuable White's Radio Log.

Keep up with your favorite interest by having RADIO-TV EXPERIMENTER sent to your home. It's easy—just mail the coupon. 1 year: \$4.

Radio-TV Experimenter 129  
505 Park Ave., N. Y., N. Y. 10022

Please start my subscription today.

I enclose \$4.     Bill me.

name \_\_\_\_\_

address \_\_\_\_\_

city \_\_\_\_\_

state \_\_\_\_\_ zip code \_\_\_\_\_



### Dummy Gets His Brain For Apollo Flight

Moon bound Apollo astronauts will know pretty much what to expect from acceleration and G forces thanks to *ANDY* the anthropomorphic dummy shown above getting his *brain*. *ANDY*'s skull, fitted out with 13 tiny electronic sensing and transmitting devices, together with the rest of the humanoid, is now undergoing drop tests and other pre manned flight experiments.

These experiments are being conducted by North American's Space and Information Systems Division, Downey, California, for NASA as part of the Apollo program. The electronic

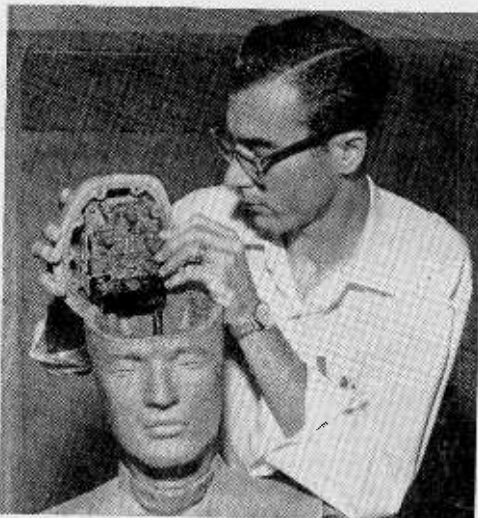

skull package senses the rate changes and G forces on the dummy's head through use of tiny sub-miniature rate gyros and accelerometers for all three axes of movement. Fairchild Controls, a Division of Fairchild Camera and Instrument Corporation, producers of the skull package, say that rate changes of up to 500°

per second and accelerations of  $\pm 50$  G's may be encountered by the dummy during some phases of the flight. Thus, by comparing the dummy's encountered forces with man's known capabilities, flight regimes for Apollo can be established to protect the Moon voyagers during their trip.

## World's Most Advanced TV Mobile Tape Unit

A custom-engineered mobile location unit, designed to be the most versatile video tape system in the world, has been purchased by MGM Telestudios from RCA and is already in use on location for TV commercials and programs. The new unit, which cost \$250,000, was made to MGM Telestudios' specifications from the chassis up, to produce highest quality TV pictures with a maximum of ease. Dubbed "Leo," after the famed MGM lion, it had been in the planning, building and testing stages with the RCA Broadcast and Communications Products Division for over a year.

Among "Leo's" major innovations is an electronically controlled, hydraulically operated camera boom, which provides the ultimate in



photographic mobility. This 22-foot boom, the only one of its kind in the world, is controlled by the cameraman and can move up to 4½ feet per second in any direction while shooting with *velvety ease*.

"Leo" was designed with accessibility as its keynote. All articles needed for location work are stored in exterior custom lockers for immediate use. Cameras are lowered from the truck to the ground on hydraulic platforms. When "Leo" arrives at a site, it can deposit a camera ready for shooting within 60 seconds. All wires and cables are stored on four electrical drums on the truck's sides. At the push of a button, these are reeled back when taping has been completed. With its predecessors, this operation generally results in a mass of tangled "spaghetti" and is a time-killer; with MGM

# COLOR CODED NUTDRIVER SETS

no fumbling..  
you reach for  
the right one  
every time!



No. 17  
HANDY  
BENCH STAND

- 7 Most-used sizes — 3/16" thru 3/8" • High carbon steel, polished and plated • Precision fit case-hardened sockets
- Shockproof plastic handles (UL) • Large, readable size indexes

No. 127  
SPACE SAVING  
WALL RACK  
(Lockable)



### OTHER SETS, TOO:

hollow-shaft or mixed

### PLUS A FULL RANGE OF SEPARATE NUTDRIVERS:

3/32" thru 3/4" — Regular, Stubby, Extra-long, Midget (Pocket clip)

available through leading electronic distributors

# XCELITE®

XCELITE INC. • 80 BANK ST., ORCHARD PARK, N. Y.

Send free literature on nutdriver sets.

name \_\_\_\_\_

address \_\_\_\_\_

city \_\_\_\_\_

state & zone \_\_\_\_\_

# NEWSCAN

Telestudios' tape truck, it can be accomplished in minutes and "Leo" is ready to move on to the next location.



"Leo" is completely self-powered by its own motor generator for its electronics and stage lighting. It is fully air-conditioned and heated and its equipment is transistorized. It contains a mobile phone and a special walkie-talkie system, allowing contact with helicopters, planes and motorboats for running shots.

Another exclusive feature is the "director's caddie." It takes the director's center of operations from the confines of a control room outside to wherever the taped action is to be. The wheeled caddie is fully monitored and contains its own portable communications center for pictures, audio and talkback. It is thus possible for the director to talk with any of the truck's personnel privately by pushing a button on the console. One single cable plugs from "Leo" into the caddie, readying it for instant functioning. There has been nothing like it until now.

"Leo" is the fruition of a five-year dream. It began on paper, in which all 'bugs' were removed from existing versions of mobile tape units, and every possible advantage and efficient innovation was penciled into the blueprint—right down to its electric pencil sharpener.

## Tiny Radio Transmitter For Nose Cones And Parachutes

A tiny radio transmitter which weighs only 10 ounces and sends a signal over 100 miles may help to locate missile nose cones and space capsules as well as downed airmen. According to the National Cash Register Company (NCR), the missile device is a special version of the NCR airman's "rescue beacon" and is about the size of a pack of cigarettes. Currently shock rated at 1000 G's, the tiny transmitter is waterproof and is designed to fit in a missile nose cone. Upon impact the miniature beacon is activated and begins sending signals for homing.

The nose cone beacon is being developed by NCR under a contract with the National Aeronautics and Space Administration (NASA). It is designed to transmit a full-strength radio signal all day and all night before it begins to weaken. Other models in the series of rescue beacons developed by NCR's Military Equipment Department include a version for the

FREE!

**DOUBLE \$25<sup>00</sup>**

**BONUS**

Add 25¢ handling

**\$1**

SURPRISE PAK BONUS #1

PLU S

**CHOOSE ANY \$1 ITEM FREE**

**BOTH FREE with \$10 Orders**

<input type="checkbox"/> 25 CRYSTAL DIODES Germanium and silicon..... \$1  <input type="checkbox"/> 5 2N107 TRANS'TRS G.E., pnp, audio..... \$1  <input type="checkbox"/> 40 DISC CONDENSERS 25mmf to .01mf, to 5KV.... \$1	<input type="checkbox"/> 60 CERAMIC COND'RS Discs, hi-Q too; to .01mf... \$1  <input type="checkbox"/> 60 TERMINAL STRIPS 1 to 8 lugs, wide assortment. \$1  <input type="checkbox"/> 60 INSUL'TD RES'TRS ½, 1, 2W. Carbons, 5% too. \$1	<input type="checkbox"/> 40 PREC'S'N RES'TRS ½, 1, 2W, asst, 1% values.. \$1  <input type="checkbox"/> 75 HALF WATTERS resistors, asst, 5% too..... \$1  <input type="checkbox"/> 10 CK722 TRANS'TRS Raytheon, pnp, audio..... \$1	<input type="checkbox"/> \$25 SURPRISE PAK \$1 Popular asst. radio parts.... \$1  <input type="checkbox"/> 60 TUBULAR COND'RS \$1 nylar, molded, paper, etc... \$1  <input type="checkbox"/> 10 VOLUME CONTROLS \$1 9 types, duals too, to 1 meg. \$1
<b>FREE CATALOG ON:</b> <input type="checkbox"/> TRANSISTORS, <input type="checkbox"/> RECTIFIERS, <input type="checkbox"/> ZENERS, <input type="checkbox"/> SCRS, <input type="checkbox"/> PARTS, <input type="checkbox"/> PAKS			
<input type="checkbox"/> 50 COILS & CHOKES RF, if, ant, osc, etc..... \$1  <input type="checkbox"/> 10 ELECTROLYTICS can & tubulars, to 500mf... \$1  <input type="checkbox"/> 30 HOBBY TRANS'TRS rf, lf, audio, shop use..... \$1	<input type="checkbox"/> 30 POWER RESIST'RS 5 to 50W. to 20Kohms..... \$1  <input type="checkbox"/> 10 ELECTROLYTICS "Tiny"; transtr clr, to 100mf \$1  <input type="checkbox"/> 15 PNP TRANSISTORS CK722, 2N107, asst cases... \$1	<input type="checkbox"/> 15 NPN TRANSISTORS 2N170, 2N35, 2N440, etc... \$1  <input type="checkbox"/> 4 TINY TRANSFORM'S transistor projects..... \$1  <input type="checkbox"/> 25 TRANSTR RECT'RS silicon, 750ma, asst v..... \$1	<input type="checkbox"/> 10 POWER RECTIF'RS 2 amp, stud, 50 to 400V... \$1  <input type="checkbox"/> 30 MOLDED COND'RS \$1 Vit-Q, mylar, black beauty... \$1  <input type="checkbox"/> 10 TINY RECTIFIERS \$1 ¼", ceramic, 1A, 50-400V... \$1
<p><b>PARTS BY THE POUND</b></p> <p>DISCS CERAMICS 488 1 LB. 500-1000 pcs. 4 Ea.</p>	<p><b>HOBBY SPECIAL</b></p> <p>TRANSISTORS 250 RF, IF, Audio</p>	<p><b>POLY PAKS</b> P. O. Box 942N So. Lynnfield, Mass.</p>	
		<p>Orders: include postage, avg. wt. per pak 1 lb.</p>	



U. S. Air Force which a downed airman can use as a personal locator, and a crash position indicator presently under test by the U. S. Army in South Vietnam. NCR has also proposed a model which could automatically separate from an aircraft in a crash or collision. This type could also be dropped by plane to act as a marker buoy or relocater.

Aircraft rescue beacons can provide an immediate alert in the event of a crash, and the ability of the search crews to "home in" on the signals permits the search to continue in bad weather and at night. The various models of rescue beacons developed at NCR can be mounted in an aircraft, on the tail assembly or even on a parachute. The beacons can be insulated against heat, and are shock-resistant and waterproof. Special buoyant models will also float. Described as the smallest, lightest and most powerful units of their kind yet developed, the beacons in tests have exceeded all original design specifications.

### Space Tape

More than enough magnetic recording tape to reach from New York to New Orleans, over 1,300 miles, will be used to record engineering and scientific information, including TV pictures, which will be radioed to earth from the Project Mariner spacecraft bound for Mars. Most of the information will be recorded on Ampex high performance magnetic tape recorders, like the one pictured, located at tracking stations around the globe. Several times the original amount of magnetic tape will be used in analyzing and processing the recorded data in the months following the mission, according to Ampex Corporation. Captured on the tape during the 240-day space voyage will



# CAMPERS!

A subscription to *Camping Journal* brings you a complete guide to everything that's happening in the camping world. *Camping Journal* is a man-sized magazine, written by pros. Read what they say about equipment, food, rigs, first aid—all aspects from wilderness camping to fire-arms to gourmet camp cooking. You'll enjoy every issue, so don't delay: mail the coupon now.

**Camping Journal** 124 E-4  
505 Park Avenue  
New York, N.Y. 10022

I am a camping enthusiast! Please start my subscription to *Camping Journal* TODAY.  Enclosed is \$4.50 (1 year).  Bill me.

NAME \_\_\_\_\_

ADDRESS \_\_\_\_\_

CITY \_\_\_\_\_

STATE \_\_\_\_\_ ZIP CODE \_\_\_\_\_

## NEWSCAN

be a wide range of information, including pictures of Mars, information on the performance of the space vehicle and experimental data on outer space.

### First In War, Last In Peace

The first radioman ever assigned to the USS MASSACHUSETTS was "signed on" for her last cruise. Stirling M. Olberg, a senior engineer in the radiometric systems section at Raytheon Company's Space and Information Systems Division at Bedford, Mass., was aboard



Stirling M. Olberg checks out his SBE-33 amateur radio transceiver for watches he will stand on board former battleship USS Massachusetts on its last trip.

with his own amateur radio equipment to maintain communications during the week-long "dead ship" tow to her retirement berth at Fall River, Mass. and her new role as a civic attraction. When he joined the ship initially, more than 22 years ago, she was still being outfitted at Fore River, Mass. A Radioman Third Class, he was the first man of his rating assigned to the precommissioning detail.

During the long and final voyage home for the USS Massachusetts, Olberg was all alone, operating a compact amateur radio station where 56 radio operators once transmitted coded orders to Allied invaders and striking forces. Instead of the array of electronic gear that once filled the battlewagon's radio rooms, her voice was a single sideband set used by hams in their international conversations. A fellow Raytheon employee and neighbor, Wesley Randall, was among those ashore following the progress of the USS Massachusetts over the airwaves. Randall, who lives at Linda Avenue, Framingham, Mass., transmitted under the call sign W4COW. Others in the Boston area and along the coast also have been alerted by the

*American Radio Relay League* to help speed messages to and from the ship.

Olberg first became interested in amateur radio activities while he was in high school at Petaluma, Calif. He joined the Navy in 1939 to "see the world" as a radioman. After his first ship, USS Maryland, became a casualty at Pearl Harbor, Olberg was transferred to the Fore River shipyard at Quincy, Mass. A plank owner, the sailor's name for a charter member of the crew of a newly commissioned ship, Olberg remained in the USS Massachusetts throughout World War II. He was in the ship when she shelled the Vichy French installations at Casablanca and exchanged 16-inch salvos with the battleship Jean Bart in one of the last engagements between two dreadnaughts. From Africa, the USS Massachusetts sailed for the island-hopping campaigns of the Pacific.

Olberg, whose own call sign is W1SNN, was using the specially-assigned call sign W1USN from August 8 through 14, 1964. His SBE-33 was on 7.305 kc. in the 40-meter band.

### Getting The Dope On Narcotics

North Carolina law enforcement officers are using an unusual weapon in their continuing battle against narcotics traffic. The State Bureau of Investigation here has turned to a complex piece of General Electric x-ray equipment to quickly and accurately analyze for suspected illegal drugs. The x-ray sleuth, known as diffractometer, is normally found in industrial research and development laboratories. Crime lab experts, however, point out that it is equally valuable in the field of criminology since it often enables them to make positive identifica-



Sheriff O. B. Weatherstroom watches while senior chemist William S. Best compares recorded measurements from the GE X-ray diffraction equipment with known measurements in the book distributed by the American Society for Testing Materials.

tion of drug compounds in minutes when other testing methods normally require several hours. This speed has several times permitted state law enforcement officials to book suspects who might otherwise have had to be released for lack of sufficient or timely evidence.

The G-E X-ray equipment can determine the nature of a material present in quantities as small as two thousandths of a grain or less. And, equally important, the X-ray analysis does not destroy the sample or evidence, as often is the case when wet chemistry techniques are used.

The crime lab, which handled 6,000 analyses of materials connected with more than 500 separate cases last year, doesn't limit use of the equipment to narcotics cases. It also analyzes such evidence as paint chips from hit-and-run autos, soil samples taken from suspects' shoes and that found at the scene of a crime, and suspected poisons in food samples.

According to senior chemist William S. Best, in charge of the lab, a material to be analyzed is first broken down to a powder form. It is then placed on a tray and inserted into the diffractometer, where X-radiation is directed at the material while the tray is rotated. X-rays striking the crystalline structure of the material are scattered, or diffracted, in different directions and in varying intensities. This pattern of X-ray beams is scanned and measured by a detector and compared with patterns for known materials and compounds.

On 24-hour call, the lab is staffed by three chemists and takes criminal cases on request from the sheriff's department, local police departments, judges and state officials.

## Electronic Data Processing Keeps MD's Up-To-Date

The National Library of Medicine (NLM) reports its unique information retrieval system called MEDLARS (Medical Literature Analysis and Retrieval System) is now on-line. The system's primary function is to exploit a single information input to produce multiple printed outputs having at least five times as much information as originally entered. MEDLARS, a \$3-million system built around a large-scale Honeywell 800 computer, is said to be the first application of electronic data processing techniques to complex problems of scientific information handling in a library.

The library began developing the MEDLARS concept in 1960 in an all-out effort to control an information explosion that has been threatening to engulf the medical sciences. This year, for example, the library will be indexing more than 16,000 issues of medical journals containing an average of 10 articles each on subjects ranging from abdominal disorders to zymomo-

*(Continued on page 24)*

# WHY NOT RECEIVE EVERY COPY OF ELEMENTARY ELECTRONICS?

*Subscribe to*  
**ELEMENTARY  
ELECTRONICS**  
*today*

Each issue will arrive directly at your home to tell you everything that is going on in the world of basic electronics. And, importantly, it is written by professionals.

**ELEMENTARY ELECTRONICS**  
is chock full of

- Theory Articles
- Features
- Build-It-Yourself Projects

Send us your order now, and join the many satisfied subscribers who look forward to each issue of **ELEMENTARY ELECTRONICS**.

**ELEMENTARY ELECTRONICS,**  
505 Park Ave., N. Y., N. Y. 10022

Please enter my subscription today.  I enclose \$3.  Bill me.

name \_\_\_\_\_

address \_\_\_\_\_

city \_\_\_\_\_

state \_\_\_\_\_ zip code \_\_\_\_\_



**"Pulling Power Is Amazing"**

# Classified MARKET PLACE

For information on Classified ads—to be included in our next **ELEMENTARY ELECTRONICS**—write C. D. Wilson, Mgr., Classified Advertising, 505 Park Ave., New York, N. Y. 10022.

## ADDITIONAL INCOME

**NEW Amazing Portable 49¢ Meal.** Selected by U.S. Olympic Team. Sparetime neighborhood selling and Area Wholesale sellers wanted. Send \$1.00 for three meals. Comidex Corporation, New Canaan, 14, Connecticut.

**MAKE Mail Order pay.** Get "How To Write a Classified Ad That Pulls." Includes certificate worth \$2.00 toward classified ad in S & M. Send \$1.00 to C. D. Wilson, Science & Mechanics, 505 Park Ave., New York, N. Y. 10022.

## AUTHOR'S SERVICE

**PUBLISH your book!** Join our successful authors, publicity advertising promotion, beautiful books. All subjects invited. Send for free manuscript report and detailed booklet. Carlton Press, Dept. SMH, 84 Fifth Avenue, New York 11.

## BATTERIES—GENERATORS

**COMPLETE Rebuilding Manuals!** Batteries \$3.00. Hydraulic Jacks \$3.00. C.O.D. Accepted. Bayer Publications, 938-FB Betty Avenue, Neenah, Wis.

## BOATS, MOTORS & MARINE SUPPLIES

**COMPLETE RDP Manual.** \$3.00 Postpaid. Phoenix, 1165 Citron, Anaheim, California.

**BOAT Kits!** Factory molded fiberglass or pre-assembled plywood, 50 models, 12' to 30'. Free catalog. Luger, Dept. AD-55, 9200 Access Road, Minneapolis 31, Minn.

**BOATCRAFT is the best!** Don't be without this quarterly magazine. Order now. \$3.00 for one year. Boatcraft, 505 Park Ave., New York, N. Y. 10022.

## BOOKS & PERIODICALS

**BOOKS 2000 Subjects.** Catalog 15¢. Myers Book Service, Marquand, Mo.

**CATALOG of all Science and Mechanics Craftprints.** Send 25¢ to cover postage and handling to Craftprint Div., Science & Mechanics, 505 Park Ave., New York 22.

## BUSINESS OPPORTUNITIES

**I MADE \$40,000.00 a Year by Mailorder.** Helped others make money! Start with \$10.00—Free Proof. Torrey, Box 3566-T, Oklahoma City 6, Okla.

**HIGH Weekly Earnings!** Address—mail letters featuring real merchandise. Receive \$10 with every order—keep \$8 profit. Supplies furnished. Free particulars. Modern Merchandising, Box 357, Oceanside, N. Y.

**IMPORT-Export opportunity,** profitable, world-wide, mail-order business from home, without capital; or travel abroad. We ship proven plan for no risk examination. Experience unnecessary. Free details. Mellinger, P-714, Los Angeles 90025.

**\$50.00 per 1000 possible.** Addressing 1000 envelopes. Longhand-typewriter, Home-spare time. Free particulars. General Enterprises, Box 303, Island Park, New York.

**OPERATE Restaurant Or Diner.** Free Booklet reveals profitable plan. Write Restaurant Business School, Dept. RC-45, 1920 Sunnyside, Chicago 40, Ill.

**FREE Book "990 Successful Little-Known Businesses."** Fascinating! Work home! Plymouth-811-A, Brooklyn 4, N. Y.

**REPAIR Hydraulic Jacks easy—profitable.** Write Hydraulic Parts Supply, 3045, El Paso, Texas.

**MAIL Baby Catalogs.** Imprinted with your address to New Mothers for Big Profits! Details. Catalog, 25¢. Volz-SM11, Ypsilanti, Mich.

**AMAZING New Way to own your own business.** Write for free copy of Booklet IO-1. Modern Franchising Magazine, 1085 Walnut Ave., Des Plaines, Ill.

**FREE Vending Machine Catalog.** Rake, Dept. 10, 1214 W. Girard, Philadelphia, Pa.

## BUY IT WHOLESALE

**BARGAINS! Buy Wholesale! Save Money!** Free Catalog! Norris, 273-WA, Merrick, Lynbrook, N. Y.

## CAMPING, FISHING, HUNTING EQUIPMENT, TENTS, ETC.

**FREE! Newest edition famous Corcoran Catalog.** Largest selection hunting, camping, fishing equipment. All items field tested. Books, clothing, fishing tackle, tents, gun cases, sleeping bags. Dozens of specialties. Corcoran, Dept. CH-55-C, Stoughton, Massachusetts.

**STOP Taking Suitcases when you go camping.** There's a better way—Camper's Stack Bureaus. Interlocking sections stack in seconds. Ideal for tents and tent trailers. Kits from \$13.45. Send for free folder. William H. Needham Co., 55-3 Governor Drive, Westfield, Mass.

## CARTOONING, COMMERCIAL ART & SIGN PAINTING

**LEARN Sign Painting.** Profitable. Free Information. Hal Barebo, O'Fallon, Mo.

## COINS, CURRENCY & TOKENS

**UNCIRCULATED 1935 Pony Express Silver Commemorative Medal \$1.00.** Coin Lists Free. Sayers, 1000 Unaka, Johnson City, Tennessee.

**U.S.: Coins: Lists 20¢.** Lund, 200 South Sycamore, No. Platte, Nebraska 69101.

## DETECTIVES

**DETECTIVE Training Home Study Credentials.** Civil Investigative Training, P.O. Box 17423, Lockhart, Florida.

## DO IT YOURSELF

**SCALP Hair Care: Men, Women try European Tonic.** Money Back Guarantee. International Laboratories, Box 4176, Miami Beach, Fla.

**1001 HOW-TO Ideas—Loaded with practical money-saving tips for do-it-yourselfers.** Kinks cover Home Maintenance, automotive, child care, household hints, etc. Send \$1.00 for your copy. S&M Handbooks, 505 Park Avenue, New York, N. Y. 10022.

## EARTHWORMS

**BIG Money Raising Fishworms and Crickets.** Free Literature. Carter Farm-O, Plains, Georgia.

## EDUCATION & INSTRUCTION

**LEARN Auctioneering.** Free Catalog! Missouri Auction School, 1330-144 Linwood, Kansas City, Mo. 64109.

**"MIND-Conditioning":** Progressive lessons in reconstructing conscious thinking. 75¢ postpaid. Ward Publications, Lakemont, Georgia.

## ELECTRICAL EQUIPMENT & SUPPLIES

**BUILD your own supersensitive light meter from complete kit with easy to follow instructions.** Send \$24.95 to Kit Div., Science & Mechanics, 505 Park Ave., New York, N. Y. 10022. Money Back Guarantee.

## FISHING TACKLE, BAIT & LURES

**COLLAPSIBLE Farm-Pond-Fish-Traps;** Animal traps. Postpaid. Free Information, pictures. Shawnee, 3934K Buena Vista, Dallas 4, Texas.

**TRANSISTORIZED Fish Caller.** Calls fish from up to 300 yards to your fishing spot. Send for Free trial offer. Rama Sales, 4700 Crenshaw, Los Angeles, Calif. 90043.

## FLORIDA LAND

**FLORIDA Water Wonderland: Homesites, Cottagesites, Mobilsites.** Established area. \$390.00 full price. \$5.00 month. Swimming, fishing, boating. Write Lake Weir, Box 38-EX, Silver Springs, Florida. AD 6-1070-(F-1)

## FOR INVENTORS

**PATENT Searches—48 hour airmail service.** \$6.00, including nearest patent copies. More than 200 registered patent attorneys have used my service. Free Invention Protection Forms. Write Miss Ann Hastings, Patent Searcher, P. O. Box 176, Washington 4, D. C.

**MODEL Building, Manufacturing, Research.** In the Heart of Technical New England since 1942. William Parker, 32A Westminister, Worcester, Mass. 01605.

## GIFTS THAT PLEASE

**1,000 NAME and Address Labels with zip code postpaid \$1.00.** Request Personalized gift folder. Roy LaParl, 1513 Springwells, Detroit, Mich. 48209.

**FOR the best reading and learning in the Mechanical Field, you want to give as a gift—Science & Mechanics.** The pros tell all about subjects as: Automotive, Science, Electronics, Home Workshop and more. Send \$4.00 for year's subscription to Science & Mechanics, 505 Park Ave., New York, N. Y. 10022.

## HELP WANTED

**USA Overseas Jobs—application forms, job guidebook only \$1.00.** Pilot, 46 West 33 Street, New York City 1.

## HOME MOVIES

**TEACH yourself 8mm instructional four Golf Lessons (Woods, Short Irons, Long Ball, Cure Slice), three Bowling Lessons, 4-step Ladewig or Fazio, 5-step Nagy. \$2.88 each 50'. Any four \$10.50 ppd. Exciting entertainment.** 64 spectacular Indianapolis "500" 8mm color. 187' \$12.95 ppd. Sportlight Films, 20-SM North Wacker Drive, Chicago, Ill. 60606.

## HYPNOTISM

NEW concept teaches you self-hypnosis quickly! Free literature. Smith-McKinley, Box 3038, San Bernardino, Calif.

## INVENTIONS WANTED

**INVENTORS!** We will develop, sell your idea or invention patented or unpatented. Our national manufacturer-clients are urgently seeking new items for highest outright cash sale or royalties. Financial assistance available. 10 years proven performance. For free information, write Dept. 7, Wall Street Invention Brokerage, 79 Wall Street, New York 5, N. Y.

**INVENTOR** Turn your invention into cash, we either sell your invention, or pay you cash bonus, write for details. Universal Inventions, Marion 88, Ohio.

**FEDERAL Trust Company, 4344 East Indian School Road, Phoenix, Ariz. 85018.**

## MAIL ORDER OPPORTUNITIES

**"CAN'T Lose" Mailorder Plan.** Copy Free. Gaylord, 820-S West 30th, Odessa, Texas.

**MAKE Mail Order pay.** Get "How To Write a Classified Ad That Pulls." Includes certificate worth \$2.00 toward classified ad in S & M. Send \$1.00 to C. D. Wilson, Science & Mechanics, 505 Park Ave., New York, N. Y. 10022.

## MISCELLANEOUS

**AMAZING, Amusing, enchanting magazine!** Good Reading, Low Advertising rates. Box 2083, Ventnor, New Jersey 08406.

**FUN Camping and Travel Book.** Keeps Children Busy. Send \$1.00. Jeret, Box 1357, Sarasota, Fla.

## MONEYMAKING OPPORTUNITIES

**EARN Big Commissions Full or Part Time.** Show America's largest line low priced business printing and advertising specialties. Calendars in season. Big Free Sales Kit samples hundred items used daily by business people. Build profitable repeat business. Start right now. National Press, Dept. 13, North Chicago, Ill.

**FOR Money Making Opportunities.** Business Building Offers. Write Toioacar, 2907-A West 39th Place, Chicago, Ill. 60632.

**MEN—WOMEN.** Simplified Export Guidebook. Free Details. Gayle Enterprises, 693-SM East 20th, Merced, Calif.

**LONG Needed Invention.** Call on service stations. Full or part time. Huge profits. Facts free write Cyclo Mfg., 3816 Dahlia, Dept. 115, Denver, Colo.

**THE Small Business Man** no longer has to pay his local printer a premium price for a small order. Now he can get 1,000 vellum business cards custom-printed by mail at a huge discount—as little as \$4.45. Less an extra 5% discount for cash! A giant 350-page catalog displays hundreds of smashing values, but it's available only to direct-selling salespeople, along with free bonus gift catalog. For complete free money-making sales kit, write: Willens-David Lionel Press, Dept. W-14, 1425 11th Street, Waukegan, Ill. 60065.

## OF INTEREST TO WOMEN

**BUY! Sell! Bargain dresses, etc.** Empire, 1916-PC Fifth, Sacramento, California 95814.

**TYPE manuscripts home for authors.** Immediate earnings. Complete instructions \$1.00. Terry Home Services, Box 2027-SC, Downey, Calif.

## PATENT SERVICE

**PATENT Searches, \$6.00!** For free "Invention Record" and "Important Information Inventors Need," write Miss Hayward, 1029-D Vermont, Washington 5, D. C.

## PERSONAL

**QUIT Smoking—Easy Proven Way.** Send \$5.00. Box 10403, Phoenix, Arizona 85016.

## PETS, DOGS, BIRDS, RABBITS, ETC.

**MAKE big money raising rabbits for us.** Information 25¢. Keeney Brothers, New Freedom, Penna.

## PRINTING, MIMEOGRAPHING & MULTIGRAPHING

**50 PERSONALIZED Parcel Post Labels \$1.00.** Free Folder. Roy LaParl, 1513 Springwells, Detroit, Mich. 48209.

## PROFITABLE OCCUPATIONS

**INVESTIGATE Accidents.** Earn \$750.00 to \$1,500.00 monthly. Car furnished. Expenses paid. No selling. No college education necessary. Pick own job location in U. S., Canada or overseas. Investigate full time. Or earn \$8.44 hour spare time. Men urgently needed now. Write for Free information. Absolutely no obligation. Universal, CMH, 6801 Hillcrest, Dallas 5, Texas.

## RADIO & TELEVISION

**RADIO & TV Tubes 33¢—Free List.** Cornell, 4215-17 University, San Diego 5, California.

**\$1.00 DELIVERS Plastic Packets for 60 QSL's.** Tepabco, Boyers Ave., Gallatin, Tennessee.

**FREE Electronics Catalog.** Tremendous bargains. Electrolabs, Department C-508DJ, Hewlett, N.Y. 11557.

**PRACTICAL, One Hand, self-feeding soldering gun.** Precision designed for Radio and TV work. Stamped envelope brings free illustrated details. Wilson Company, 321 Indian Trail, Marietta, Georgia.

**CRAMMED with Electronics Articles** of interest to novices and pros alike. Subscribe now: 6 issues for \$4.00. Order from Radio-TV Experimenter, 505 Park Ave., New York, N. Y. 10022.

## REMAILING SERVICE

**CENTRAL Jersey resort area.** Remails 25¢. Monthly \$3.00. Confidential. Liedbach's, Box 206, Oceanport, N. J. 07757.

**QUEBEC City 4, Canada.** Box 567. 25¢-\$3.00. Send me for literature.

## SALESMEN & DISTRIBUTORS

**EARN Big Commissions Full or Part Time.** Show America's largest line low priced business printing and advertising specialties. Calendars in season. Big Free Sales Kit samples hundred items used daily by business people. Build profitable repeat business. Start right now. National Press, Dept. 12, North Chicago, Ill.

**DOZENS of ways for Salesmen & Distributors** to use successful money-making ideas. Learn about the current money-makers that you can take on part-time. Exclusive stories on businesses and selling secrets that made money for others are available in Income Opportunities. Send \$1.00 for the current copy or start a Bi-Monthly subscription now at \$4.50. Write to Income Opportunities, 505 Park Ave., New York, N. Y. 10022.

**THE Small Business Man** no longer has to pay his local printer a premium price for a small order. Now he can get 1,000 vellum business cards custom-printed by mail at a huge discount—as little as \$4.45. Less an extra 5% discount for cash! A giant 350-page catalog displays hundreds of smashing values, but it's available only to direct-selling salespeople, along with free bonus gift catalog. For complete free money-making sales kit, write: Willens-David Lionel Press, Dept. W-15, 1425 11th Street, Waukegan, Ill. 60065.

## SONGWRITERS

**POEMS Wanted** for musical setting and recording. Send poems. Free Examination. Crown Music, 49-SC West 32, New York 1.

## STAMP COLLECTING

**FREE!** Highly Interesting Literature. No Approvals. Persille, 436 New York Ave., Brooklyn 25, N. Y.

# TIRED OF PAYING HIGH SERVICE COSTS?

**RADIO-TV REPAIRS** illustrates in easy-to-follow steps how to fix, maintain and improve equipment. For only 75¢, you can own this valuable manual, cut down on expensive bills—and increase your radio, television and hi-fi enjoyment. At all newsstands\*

\* If they've sold out,  
**write RADIO-TV REPAIRS**  
505 Park Avenue, New York, N. Y. 10022  
and enclose \$1.

## FISHERMEN! Want Action?

There's plenty of it in FISHERMAN. Every issue brings first-hand stories by pros; where to land the big ones, what waters to fish—and when. All your questions are answered in FISHERMAN.

If you are a fisherman, buy FISHERMAN. A subscription costs only \$3 per year. Start your copies coming TODAY!

### MAIL THE COUPON

Please enter my subscription to FISHERMAN (1 year).  I enclose \$3.  Bill me.

name \_\_\_\_\_

address \_\_\_\_\_

city \_\_\_\_\_

state \_\_\_\_\_

zip code \_\_\_\_\_

**FISHERMAN, 505 Park Ave., New York, N. Y. 10022**



# LITERATURE LIBRARY

Numbers in heavy type indicate advertisers in this issue. Consult their ads for additional information.

## ELECTRONIC PARTS

1. This catalog is so widely used as a reference book, that it's regarded as a standard by people in the electronics industry. Don't you have the latest *Allied Radio* catalog? The surprising thing is that it's free!

2. The new 516-page 1965 edition of *Lafayette Radio's* multi-colored catalog is a perfect buyer's guide for hi-fi's, experimenters, kit builders, CB'ers and hams. Get your free copy, today!

3. *Progressive "Edu-Kits" Inc.* now has available their new 1965 catalog featuring hi-fi, CB, Amateur, test equipment in kit and wired form. Also lists books, parts, tools, etc.

4. We'll exert our influence to get you on the *Olson* mailing list. This catalog comes out regularly with lots of new and surplus items. If you find your name hidden in the pages, you win \$5 in free merchandise!

5. Unusual scientific, optical and mathematical values. That's what *Edmund Scientific* has. War surplus equipment as well as many other hard-to-get items are included in this new 148-page catalog.

6. Bargains galore, that's what's in store! *Poly-Paks Co.* will send you their latest eight-page flyer listing the latest in merchandise available, including a giant \$1 special sale.

7. Whether you buy surplus or new, you will be interested in *Fair Radio Sales Co.'s* latest catalog—chuck full of buys for every experimenter.

8. Want a colorful catalog of goodies? *John Meshna, Jr.* has one that covers everything from assemblies to zener diodes. Listed are government surplus radio, radar, parts, etc. All at unbelievable prices.

9. Are you still paying drugstore prices for tubes? *Nationwide Tube Co.* will send you their special bargain list of tubes. This will make you light up!

10. *Burstein-Applebee* offers a new giant catalog containing 100's of big pages crammed with savings including hundreds of bargains on hi-fi kits, power tools, tubes, and parts.

11. Now available from *EDI (Electronic Distributors, Inc.)* a catalog containing hundreds of electronic items. *EDI* will be happy to place you on their mailing list.

12. VHF listeners will want the latest catalog from *Kuhn Electronics*. All types and forms of complete receivers and converters.

## HI-FI/AUDIO

13. Here's a beautifully presented brochure from *Altec Lansing Corp.* Studio-type mikes, two-way speaker components and other hi-fi products.

14. For the love of mikes! *Astatic Corp.* has lots. Studio types, ham types, recording types, etc. See its catalog sheets for the details.

15. A name well-known in audio circles is *Acoustic Research*. Here's its booklet on the famous *AR* speakers and the new *AR* turntable.

16. *Garrard* has prepared a 32-page booklet on its full line of automatic turntables including the *Lab 80*, the first automatic transcription turntable. Accessories are detailed too.

17. Two brand new full-color booklets are being offered by *Electro-Voice, Inc.* that every audiophile should read. They are: "Guide to Outdoor High Fidelity" and "Guide to Compact Loudspeaker Systems."

18. Speakers and enclosures from *Argos Products Co.* feature a new and novel well-mounting system. To find out more, *Argos* will be happy to send literature.

19. A valuable 8-page brochure from *Empire Scientific Corp.* describes technical features of their record playback equipment. Also included are sections on basic facts and stereo record library.

20. Tape recorder heads wear out. After all, the head of a tape deck is like the stylus of a phonograph, and *Robins Industries* has a booklet showing exact replacements. Lots of good info on how the things are built, too.

21. *Wharfedale*, a leading name in loudspeakers and speaker systems, has a colorful booklet to send to you on its product line. Complete with prices, it is a top-notch buyers guide.

22. A wide variety of loudspeakers and enclosures from *Utah Electronics* lists sizes shapes and prices. All types are covered in this 16-page heavily illustrated brochure.

24. Here's a complete catalog of high-styled speaker enclosures and loudspeaker components. *University* is one of the pioneers in the field that keeps things up to date.

26. When a manufacturer of high-quality high fidelity equipment produces a line of kits, you can just bet that they're going to be of the same high quality! *H. H. Scott, Inc.*, has a catalog showing you the full-color, behind-the-panel story.

27. An assortment of high fidelity components and cabinets are described in the *Sherwood* brochure. The cabinets can almost be designed to your requirements, as they use modules.

28. Very pretty, very efficient, that's the word for the new *Betacom* intercom. It's ideal for stores, offices, or just for use in the home, where it doubles as a baby-sitter.

30. Tone-arms, cartridges, hi-fi, and stereo preamps and replacement tape heads and conversions are listed in a complete *Shure Bros.* catalog.

## TAPE RECORDERS AND TAPE

31. "All the Facts" about *Concord Electronics Corporation* tape recorders are yours for the asking in a free booklet. Portable battery operated to four-track, fully transistorized stereos cover every recording need.

32. "The Care and Feeding of Tape Recorders" is the title of a booklet that *Sarkes-Tarjian* will send you. It's 16-pages jam-packed with info for the home recording enthusiast. Includes a valuable table of recording times for various tapes.

33. Become the first to learn about *Norelco's* complete Carry-Corder 150 portable tape recorder outfit. Four-color booklet describes this new cartridge-tape unit.

34. The 1964 line of *Sony* tape recorders, microphones and accessories is illustrated in a new 16-page full color booklet just released by *Super-scope, Inc.*, exclusive U.S. distributor.

35. If you are a serious tape audiophile, you will be interested in the new *Viking of Minneapolis* line—they carry both reel and cartridge recorders you should know about.

## HI-FI ACCESSORIES

38. An entirely new concept in customizing electron tubes has generated tubes a new replacement line. *Gold Lion* tubes give higher output and lower distortion than ordinary production high-fidelity tubes.

39. A 12-page catalog describing the audio accessories that make hi-fi living a bit easier is yours from *Switchcraft, Inc.* The cables, mike mixers, and junctions are essentials!

## KITS

41. Here's a firm that makes everything from TV kits to a complete line of test equipment. *Conar* would like to send you their latest catalog—just ask for it.

42. Here's a 100-page catalog of a wide assortment of kits. They're high-styled, highly-versatile, and *Heath Co.* will happily add your name to the mailing list.

43. Want to learn about computers the easy way? Brochure from *Digication Electronics* describes its line of transistorized kits.

**AMATEUR RADIO**

45. Catering to hams for 29 years, *World Radio Laboratories* has a new FREE 1965 catalog which includes all products deserving space in any ham shack. Quarterly fliers, chock-full of electronic bargains are also available.

46. A long-time builder of ham equipment, *Hallcrafters, Inc.* will happily send you lots of info on the ham, CB and commercial radio-equipment.

47. Here's a goodly assortment of literature covering the products of the *Dow-Key Co.* They make coaxial relays, switches, and preamps for hams and CB'ers.

**CITIZENS BAND SHORT-WAVE RADIO**

48. *Hy-Gain's* new 16-page CB antenna catalog is packed full of useful information and product data that every CB'er should know about. Get a copy.

49. Want to see the latest in communication receivers? *National Radio Co.* puts out a line of mighty fine ones and their catalog will tell you all about them.

50. Are you getting all you can from your Citizens Band radio equipment? *Cadre Industries* has a booklet that answers lots of the questions you may have.

51. Antennas for CB and ham use as well as for commercial installations is the specialty of *Antenna Specialists Co.* They also have a generator for power in the field.

53. When private citizens group together for the mutual good, something big happens. *Hallcrafters, Inc.* is backing the CB React teams and if you're interested in CB, circle #53.

54. A catalog for CB'ers, hams and experimenters, with outstanding values. Terrific buys on antennas, mikes and accessories. Just circle #54 to get *Grove Electronics* free 1964 Catalog of Values.

55. Interested in CB or business-band radio? Then you will be interested in the catalogs and literature *Mosley Electronics* has to offer.

Also see items 46 and 47.

**SCHOOLS AND EDUCATIONAL**

56. *Bailey Institute of Technology* offers courses in electronics, basic electricity and drafting as well as refrigeration. More information in their informative pamphlet.

57. *National Radio Institute*, a pioneer in home-study technical training, has a new book describing your opportunities in all branches of electronics. Unique training methods make learning as close to being fun as any school can make it.

58. Interested in ETV? *Adler Electronics* has a booklet describing educational television and this goes into a depth study of ETV in all its ramifications. There's a good science fair project here for someone!

59. For a complete rundown on curriculum, lesson outlines, and full details from a leading electronic school, ask for this brochure from the *Indiana Home Study Institute*.

60. Facts on accredited curriculum in E. E. Technology is available from *Central Technical Institute* plus a 64-page catalog on modern practical electronics.

61. *ICS (International Correspondence Schools)* offers 236 courses including many in the fields of radio, TV, and electronics. Send for free booklet "It's Your Future."

**ELECTRONIC PRODUCTS**

63. A complete booklet and price list giving you the inside data on *Schober Organs* are yours for the asking.

64. If you can use 117-volts, 60-cycle power where no power is available, the *Terado Corp.* Trav-Electric 50-160 is for you. Specifications are for the asking.

65. Want power plus for your auto? New Transistorized Ignition adds 20% more MPG. 3 to 5 times more spark plug life. Lower maintenance cost. Free catalog and instruction booklet.

67. Get the most measurement value per dollar." That's what *Electronic Measurements Corp.* says. Looking through the catalogue they send out, they very well might be right!

**TELEVISION**

69. Interested in tackling a TV kit? *Arkay International, Inc.* will send you full literature (including a schematic) of this truly educational kit. It's used in many of the electronic schools.

70. The first entry into the color-TV market in kit form comes from the *Heath Company*. A do-it-yourself money saver that all TV watchers should know about.

71. The smallest television set to date is featured in this beautiful prepared brochure from *SONY Corp.* You'll be amazed at the variety this firm offers.

72. Get your 1964 catalog of *Cisin's* TV, radio, and hi-fi service books. Bonus—TV tube substitution guide and trouble-chaser chart is yours for the asking.

**SLIDE RULE**

74. Get your copy of *CIE's (Cleveland Institute of Electronics)* 2-color data sheet on their electronics slide rule and information on their free "Auto-Programmed" 4-lesson instruction course.

**TOOLS**

78. *Xcelite's* Allen type hex screwdrivers work faster, easier, reach where wrenches won't go. Bulletin N763 illustrates and describes fixed handle screwdrivers, detachable Allen hex blades, pocket roll kits.

**Elementary Electronics, Dept. LL-739**  
505 Park Avenue, New York, N. Y. 10022

Please arrange to have the literature whose numbers I have encircled sent to me as soon as possible. I am enclosing 25¢ (no stamps) to cover handling charges.

I am a subscriber

Indicate total number of booklets requested



1	2	3	4	5	6	7	8	9	10	11	12	13
14	15	16	17	18	19	20	21	22	23	24	25	26
27	28	29	30	31	32	33	34	35	36	37	38	39
40	41	42	43	44	45	46	47	48	49	50	51	52
53	54	55	56	57	58	59	60	61	62	63	64	65
66	67	68	69	70	71	72	73	74	75	76	77	78

NAME (Print clearly) \_\_\_\_\_

ADDRESS \_\_\_\_\_

CITY \_\_\_\_\_ STATE \_\_\_\_\_ ZIP CODE \_\_\_\_\_

Service on this coupon expires October 1, 1965

# NEWSCAN

Continued from page 19

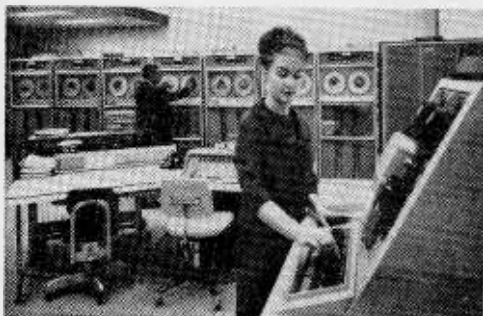

MEDLARS citations containing complete bibliographical information on the contents of medical articles received by NIM as are fed into a Honeywell 800 computer for processing and storage through a 1,000-character-a-second paper tape reader being operated in the foreground by a pressy Miss and NIM information specialist.

nas. By 1970, the library expects to be receiving 25,000 issues a year containing about 250,000 articles.

More than 300 medical journal issues are received each week at NLM for MEDLARS. They are distributed to the indexing staff for selection of articles, translation of foreign article titles, and indexing of each article with appropriate descriptors from controlled list of terms.

Although MEDLARS has a number of tasks to perform, including the answering of demand search requests and preparation of recurring bibliographies on specialized medical subjects, its primary job is preparation of *Index Medicus*.

*Index Medicus* is NLM's massive monthly bibliography of the world's medical literature and contains approximately 12,000 citations in an average 500-page issue. It is "must reading" for MD's trying to keep abreast of latest developments in medical research and practice. Once a month, the Honeywell 800 edits and completely cross-references all unit records stored in it during the previous four weeks. It then stores this information on magnetic tape for input to a unique optical output device called GRACE (Graphic Arts Composing Equipment). GRACE automatically translates the computer's output into high-quality photocopy from which the final printing plates are made, printing complete pages at a rate of 300 characters a second (from a font of 226 characters) on positive photographic film or paper.

GRACE is being used to compose *Index Medicus*, *Cumulated Index Medicus*, and other

recurring bibliographies requiring typographical variations and graphic excellence. Before GRACE was available, these publications were prepared on the Honeywell 800's high-speed printer using 16-pound heat transfer paper with a one-time Mylar ribbon.

MEDLARS, which prepared *Index Medicus* for the first time in January, has helped reduce to less than 10 days the total throughput time needed to produce the volume; a number of days less than it normally would have taken NLM's expert staff to accomplish the same job. Actual computer time amounts to less than three hours.

## Half-Billion Years In The Telephone Business

Every syllable you utter into the mouthpiece of your telephone titillates a few thousand tiny particles of coal from one of the most expensive and pampered coal piles in the world. The little "black diamonds," housed in a capsule in the mouthpiece, become "all shaken up" by your voice and respond by transmitting an electrical copy of your words down the telephone wires to your Aunt Gertrude.

The story begins in the prehistoric past. The giant forests of the then-tropical American



Almost as rare as the young lady's fine diamonds by Cartier is the precious piece of coal held in her hand. The coal supplies the tiny particles of carbon placed in every telephone transmitter to send an electrical "copy" of your voice down the telephone lines.

climate fell and were buried under deep layers of mud. Heat and the pressure of the overlying layers converted the wood to coal and the mud to rock. Generally, the greater the heat and pressure, and the longer the burial, the larger the portion of pure carbon in the coal. Such "pure" coal is called "anthracite." It is chemically equivalent to the diamond in a ring.

The scene now shifts to modern times and to a factory of one of the world's largest manufacturers of telephone equipment, International Telephone and Telegraph Corporation. Engineers at the ITT Kellogg Telecommunications Division, Chicago, wanted to obtain more coal to make carbon to place in telephone mouthpieces. The carbon had to be as pure as possible to avoid loss of speech quality with time. The coal also had to be very hard. Otherwise, the carbon granules would crumble and become dusty with use, the conversation would become weak and the dust would interfere with the clarity of the words.

The telephone engineering department was given the assignment, "Find a good carbon source and stockpile enough for 15 to 20 years further production of the finest transmitters." They knew where to look. Experience has shown that, although carbon can be obtained from many sources and in many forms, the best kind for mouthpiece transmitters is anthracite from the Jeddo Highland Coal Company mine at Jeddo, Pennsylvania, used by the several U.S. transmitter manufacturers.

But the engineers had a problem. The quality of coal can vary greatly, even in different parts of a single mine. They had to obtain only the best. From what part of the Jeddo mine should they order? They asked for samples and tested. Then they asked for some more samples and tested some more. And again. Almost two years passed. Finally, they made the decision. Selecting a specific batch of the finest anthracite, the engineers ordered 35 tons—enough coal to make millions of transmitters.

The mine gave this special coal royal treatment. It was carefully mined and washed. Then it was handpicked to remove imperfect pieces. Bagged in 100-pound sacks, it was delivered to the ITT plant at Corinth, Miss. and placed in a special storeroom where it is watched over like a prize dahlia at a flower show.

Despite the hand sorting at the mine, each batch goes through additional hand sorting before starting through the production line. It is then crushed and ground to the size of the granules used in transmitters. Then, by careful sieving, particles of a uniform size, looking much like finely ground black pepper, are obtained. These are then washed again to eliminate all dust. Impurities in and on the coal granules can affect the voice quality. Therefore, the particles are next roasted at a high

temperature for a long time to drive off impurities. Finally, the precious granules are measured out in amounts about the size of a pencil eraser. These are then sealed in a small chamber in each transmitter capsule in the telephone mouthpiece.

The actual value of the coal is multiplied thousands of times over by all this attention, for the transmitters obtained from a single ton of coal are worth well over a half-million dollars. So, when your phone rings, remember that the next voice you hear may be coming to you courtesy of the world's fanciest coal pile, started a half-billion years ago!

## Automobile Design By Computer

An experimental computer laboratory that may someday help create new automotive designs is now being used by General Motors engineers today. The laboratory for design research is part of the General Motors DAC-I project (Design Augmented by Computers), a system under development during the past several years by GM's Research Laboratories. The prototype man-machine design system has been operating for experimental purposes for eight hours a day since early 1963. In its present form, the DAC-I system consists of a large scale computer, a man-computer communication console and image processing equipment which enables the computer to read and generate drawings. In addition, the GM researchers have developed a large library of computer programs (more than 3/4 million instructions) to enable the designer to use his equipment effectively.

Such a combination makes possible experi-  
(Continued on page 36)

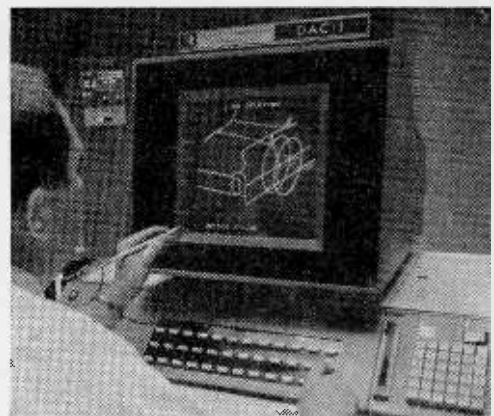

A GM research engineer checks out a computer program that allows him to modify a design drawing. A touch of the "electronic pencil" to the tube face signals the computer, in this case, to delete a line from the viewed drawing.

# FREE!...Send Today

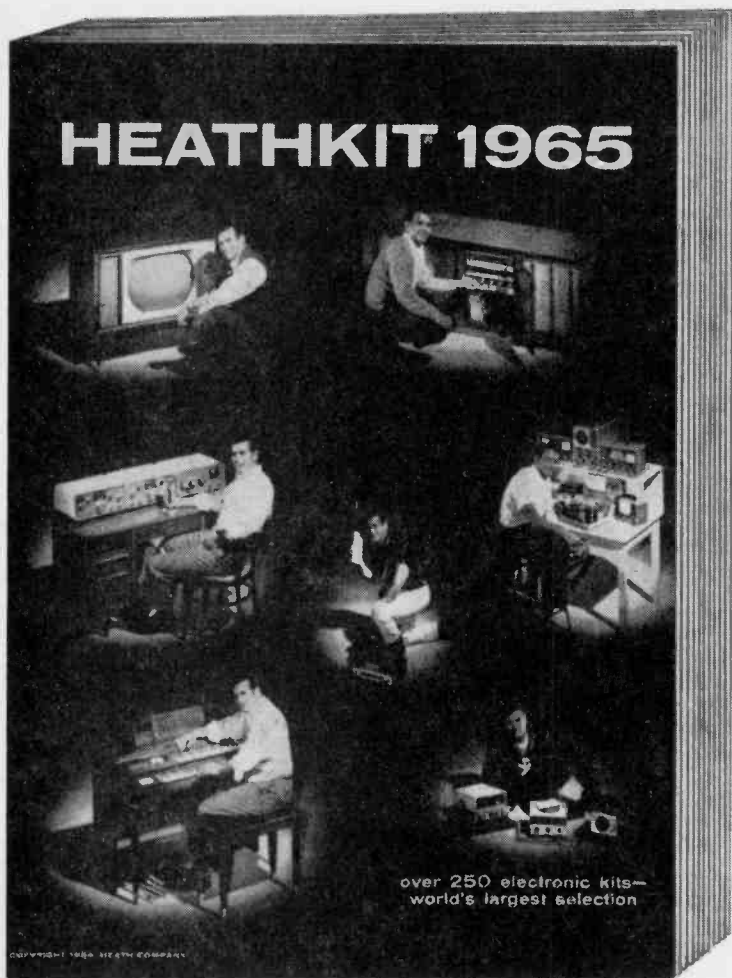

**World's  
Largest  
Electronic  
Kit  
Catalog**

**Save 50% on:  
Electronic Organs  
Color TV  
Stereo/Hi-Fi  
Shortwave  
Automotive  
Amateur Radio  
Citizen's Band  
Education  
Photography  
Lab & Test  
Marine**

## Over 250 Easy-To-Build Kits

Over 250 ways to add better quality and more fun to your hobby or profession . . . and save up to 50%! Convenient time-payment plan. Free help from our technical correspondents. Find out why Heath is the world's largest manufacturer of quality electronic kits. Send for your FREE 1965 Heathkit Catalog now!



**HEATH COMPANY, Dept. 139-4**  
Benton Harbor, Michigan 49023  
In Canada: Daystrom, Ltd., Cooksville, Ontario

Please send Free 1965 Heathkit Catalog.

Name \_\_\_\_\_  
(Please Print)

Address \_\_\_\_\_

City \_\_\_\_\_ State \_\_\_\_\_ Zip \_\_\_\_\_

Prices & specifications subject to change without notice.

CL-202





# e/e SCHEMATIC DIAGRAM

transistors for tubes can be more readily shown by a schematic diagram. For example, a transistor has three elements. This can be seen at a glance by looking at a schematic representation of the transistor such as shown by Q1 or Q2 in Fig. 2. A pictorial diagram will only show the socket connections for the transistor (Fig. 1.); not what's inside.

Schematic diagrams are also much more flexible as they do not limit the circuit arrangement; physical placement of components and wiring, to a simple configuration as do pictorials. Thus, you can adopt the circuit given in a schematic to your own particular desired physical arrangement.

**Schematic Symbols.** Before we go much further, we must become familiar with the various schematic symbols as they form the "building blocks" of any and all schematic diagrams.

Although there are minor variations, elec-

tronic schematic symbols are universal. The schematic diagram of a piece of Russian or German electronics equipment can easily be interpreted even though you may not be able to make out one word of writing which accompanies it.

Fig. 3 illustrates some of the more commonly used electronic schematic symbols

CODE			
COLOR	1st DIGIT	2nd DIGIT	MULTIPLIER
BLACK	0	0	1
BROWN	1	1	10
RED	2	2	100
ORANGE	3	3	1,000
YELLOW	4	4	10,000
GREEN	5	5	100,000
BLUE	6	6	1,000,000
VIOLET	7	7	10,000,000
GRAY	8	8	100,000,000
WHITE	9	9	1,000,000,000
GOLD	-	-	.1
SILVER	-	-	.01

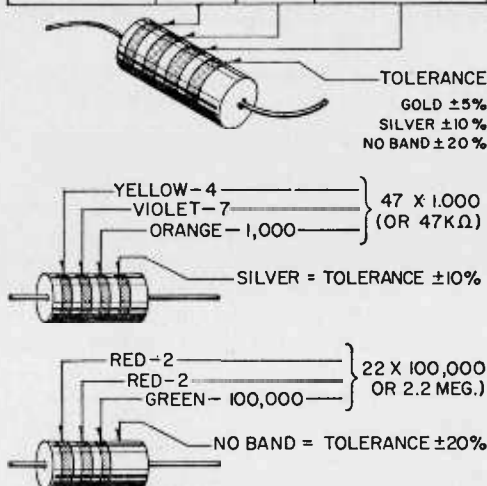

Fig. 4. The colored bands around the body of a color coded resistor represent its value in ohms. These colored bands are grouped toward one end of the resistor body. Starting with this end of the resistor, the first band represents the first digit of the resistance value; the second band represents the second digit; the third band represents the number by which the first two digits are multiplied. A fourth band of gold or silver represents a tolerance of 5% or 10%, respectively, of the true indicated value—plus or minus. The absence of a fourth band indicates a tolerance of 20%. The physical size of a composition resistor is related to its wattage. Size increases progressively as the wattage rating is increased. The diameters of 1/2-watt, 1-watt, and two-watt resistors are approximately 1/8", 1/4" and 5/16", respectively. The color chart and examples which follow provide the information required to identify resistors.

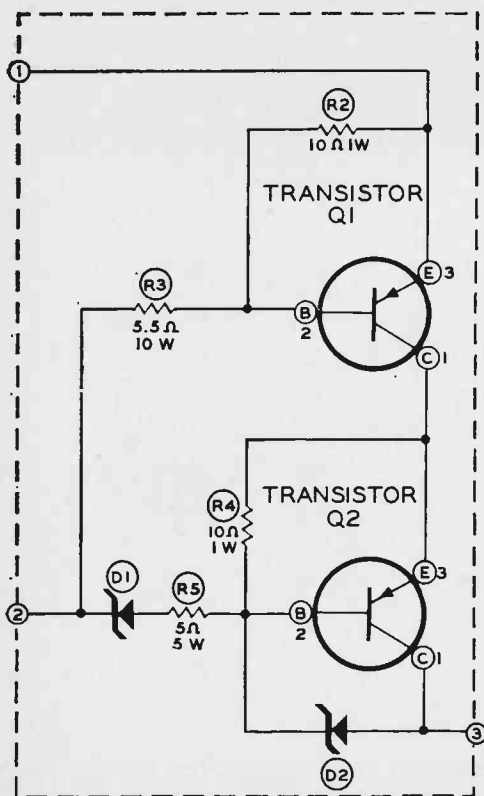

Fig. 2. Schematic diagram for the component shown in Fig. 1's detail pictorial diagram.







<p style="text-align: center;"><b>RESISTOR</b></p> 	<p style="text-align: center;"><b>CAPACITOR</b></p> 
<p style="text-align: center;"><b>POTENTIOMETER (CONTROL)</b></p> 	<p style="text-align: center;"><b>ELECTROLYTIC CAPACITOR</b></p> 
<p style="text-align: center;"><b>TRANSFORMER (IRON CORE)</b></p> 	<p style="text-align: center;"><b>VARIABLE CAPACITOR</b></p> 
<p style="text-align: center;"><b>TRANSFORMER (ADJUSTABLE POWDERED IRON CORE) ARROW INDICATES DIR- ECTION OF CORE MOVEMENT TO INCREASE INDUCTANCE</b></p> 	<p style="text-align: center;"><b>BATTERY</b></p> 
<p style="text-align: center;"><b>TRANSFORMER (ADJUSTABLE CORE)</b></p> 	<p style="text-align: center;"><b>PHONE JACK</b></p> 
<p style="text-align: center;"><b>POWER TRANS- FORMER</b></p> 	<p style="text-align: center;"><b>SPEAKER</b></p> 
<p style="text-align: center;"><b>INDUCTOR (COIL)</b></p> 	<p style="text-align: center;"><b>ILLUMINATING BULB</b></p> 
<p style="text-align: center;"><b>PIEZOELECTRIC CRYSTAL</b></p> 	<p style="text-align: center;"><b>METER</b></p> 

Fig. 3. Chart compares radio parts against their schematic symbols.

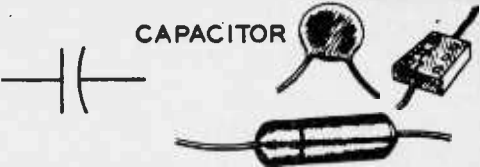
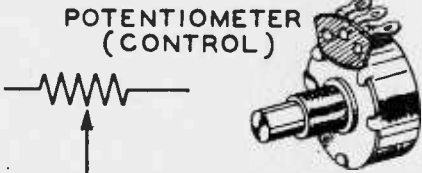
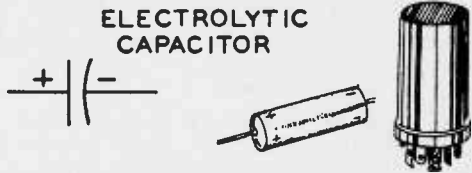
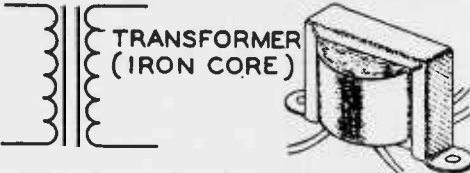
along with their corresponding pictures for easy identification.

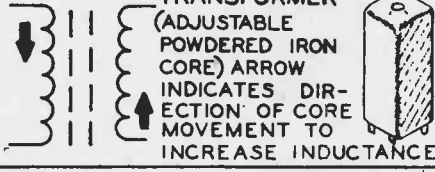
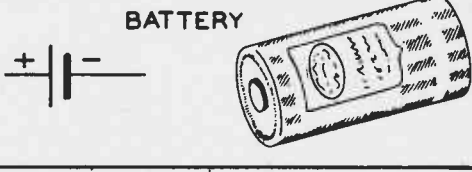
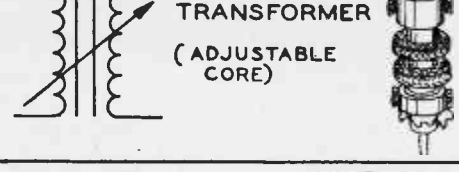
In order to make a great deal of sense from schematics, it's necessary that you also be familiar with the various call-outs and identifications which accompany schematics as well as the symbols in Fig. 3. Table of Abbreviations and Letter Symbols lists the more commonly used identifications. In connection with Table it should be noted that the notation for micro-micro-farad (picofarad—pf.) will often be seen noted as mmf in some of the not so recent schematics.

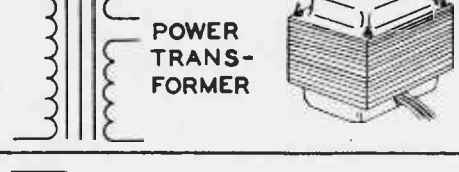
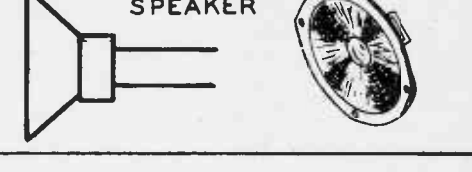
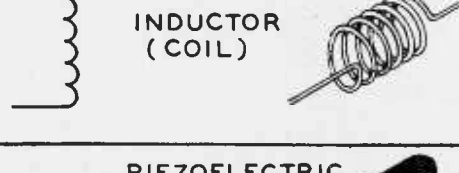
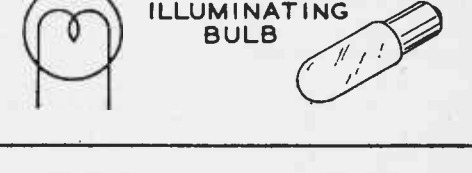
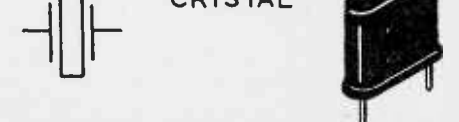
**Color Codes.** In order to identify various components, and component leads, a system

known as "color coding" is used. Fig. 4 lists the color codes for composition resistors; Fig. 5 for mica and tubular ceramic capacitors; while Fig. 6 and Fig. 7 give the color coding for power and audio transformer leads.

In the case of resistors, color coding is provided by a series of colored bands placed around one end of the body of the resistor. As shown in Fig. 4, each color represents a digit. Starting from one end, the first band represents the first digit of the resistance value, the second band represents the second digit, and the third band represents the number by which the first two digits are multiplied. For example, a resistor marked with

Fig. 5. Generally, only mica and tubular ceramic capacitors used in modern equipment are color coded. The color codes differ somewhat among capacitor manufacturers, however the codes shown at left and below apply to practically all of the mica and tubular ceramic capacitors that are in common use today.

CODE				
COLOR	1st DIGIT	2nd DIGIT	MULTIPLIER	TOL. %
BLACK	0	0	1	±20
BROWN	1	1	10	—
RED	2	2	100	±2
ORANGE	3	3	1,000	±3
YELLOW	4	4	10,000	—
GREEN	5	5	—	±5
BLUE	6	6	—	—
VIOLET	7	7	—	—
GRAY	8	8	—	—
WHITE	9	9	—	—
GOLD	—	—	0.1	—
SILVER	—	—	0.1	±10

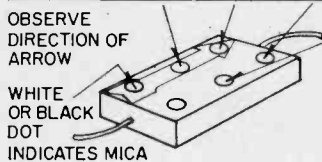
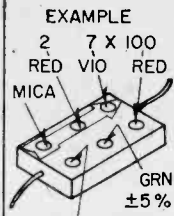

CHARACTERISTIC

2,700 μuf ±5%  
OR .0027 μfd

CODE				
COLOR	1st DIGIT	2nd DIGIT	MULT.	TOLERANCE %
BLACK	0	0	1	±20
BROWN	1	1	10	±0.1
RED	2	2	100	±2
ORANGE	3	3	1,000	±2.5
YELLOW	4	4	10,000	—
GREEN	5	5	—	±0.5
BLUE	6	6	—	—
VIOLET	7	7	—	—
GRAY	8	8	—	±0.25
WHITE	9	9	—	±1.0



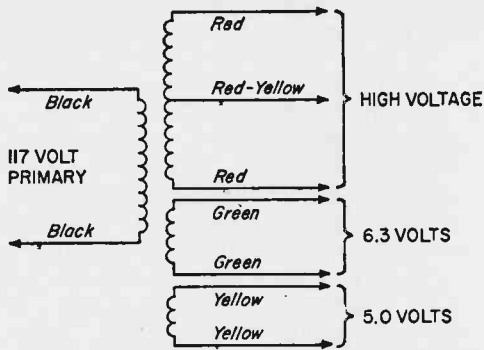

Fig. 6. Color code for a typical three-secondary power transformer. Coding is marked on boxes of replacement transformers.

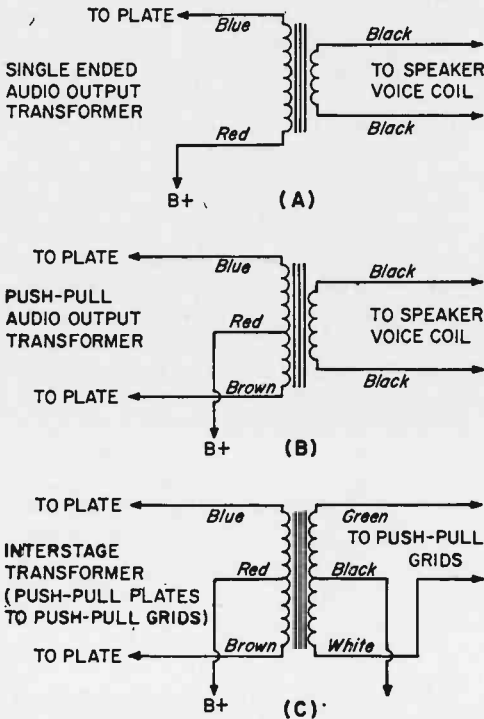

Fig. 7. Audio output transformers (A and B) and audio interstage transformers (C) are color coded for rapid installation, replacement or for in-circuit troubleshooting.

red, blue, and brown bands respectively, would have a resistance value of 270 ohms. Often, a fourth band of either gold or silver is included on the resistor. Known as the "tolerance" band, it indicates the tolerance of the resistor . . . silver for  $\pm 10\%$  and gold for  $\pm 5\%$ . No tolerance band indicates that the resistor has a tolerance of  $\pm 20\%$ .

The color coding of mica and ceramic

### Table of Abbrev. & Letter Symbols

Alternating current	AC
Ampere	amp. or a
Antenna	ant.
Audio frequency	AF
Capacitance	C
Current	I
Cycles per second	cps
Decibel	db
Direct current	DC
Double pole, double throw	d.p.d.t.
Double pole, single throw	d.p.s.t.
Frequency	Freq.
Frequency modulation	FM
Ground	gnd.
Henry	h
Impedance	Z
Inductance	L
Intermediate frequency	IF
Kilocycle	k.c.
Kilovolt	kv
Kilowatt	kw
Megacycle	mc.
Megohm	Meg.
Meter	M
Microammeter	$\mu$ a
Microfarad	$\mu$ f
Microhenry	$\mu$ h
Micromicrofarad	mmf or pf
Milliampere	ma
Millihenry	mh
Millivolt	mv
Milliwatt	mw
Ohm	$\Omega$
Power	P
Radio frequency	RF
Resistance	R
Self inductance	L
Short wave	SW
Tuner radio frequency	TRF
Ultra high frequency	UHF
Vacuum-tube voltmeter	VTVM
Very high frequency	VHF
Volt	V
Volt-ohm-milliammeter	VOM
Watt	w

capacitors is along the same general lines as resistors as indicated in Fig. 5. The first and second dots indicating the capacitance digits in pf; third dot being the multiplier.

The color coding of transformers is completely described in Fig. 6 and Fig. 7. Manufacturers stick very closely to this color code standard and you can rely on it as a useful guide.

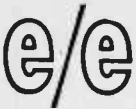

## SCHEMATIC DIAGRAM

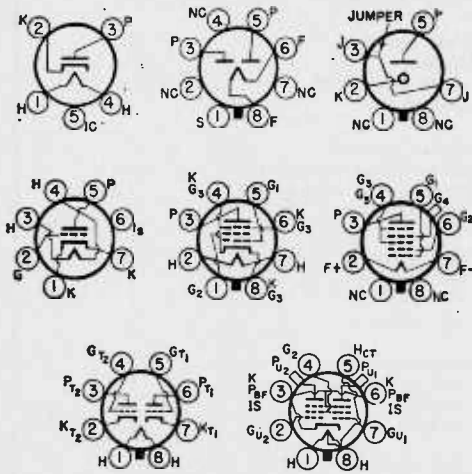

Fig. 8. Diagram of vacuum tubes giving internal connections and socket pin locations.

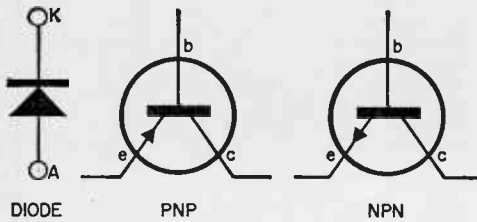
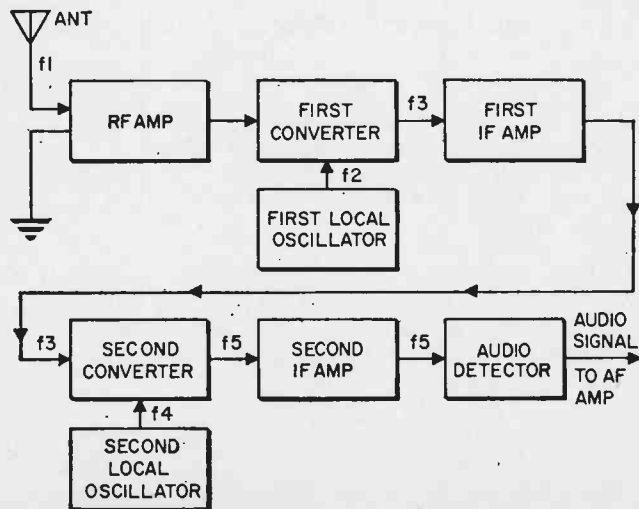

Fig. 9. Semiconductor diodes and transistors have very simple schematic symbols.

Fig. 10. Schematic diagrams for dual-conversion superheterodyne receivers can take up a lot of space and even become confusing. Hence, the block diagram is called upon to divide up the large circuit into several simpler functional circuits. Breaking up circuits into functional groups makes for easier trouble shooting.



## Vacuum Tubes and Semiconductors.

Fig. 8 shows the schematic representation of various commonly used vacuum tubes. Notice the numbers next to each element; these indicate the tube base pin connections to the various elements within the tube when viewing the tube from the bottom. Should a schematic diagram not include these numbers, it's easy to locate them by consulting such sources as the RCA Receiving Tube Manual or the ARRL Handbook. Both of these handbooks provide complete tube base listings.

Fig. 9 pictures the commonly accepted schematic symbols for semiconductor diodes and transistors. Note that a *pnp* transistor has the emitter arrow pointing *toward* the base, while the emitter arrow points *away* from the base in the case of an *npn* transistor.

**The Block Diagram.** While we've been talking primarily about schematic diagrams, a word or two is in order regarding the block diagram, Fig. 10. This type of diagram is useful when it is desired to show only the overall operation of the circuit without giving into any specific circuit details such as components values, etc. The block diagram is particularly useful in tracing the path of a signal through the complete circuit.

Well, there you have the story on schematic diagrams. As you can see, they aren't at all mysterious after all, and once you become familiar with them, you'll be just that much further along the road of electronics. ■



Exclusive with **RCA** ...

# AUTOTEXT

## new, faster, easier way toward a career in electronics

**EXCLUSIVE WITH RCA.** "AUTOTEXT", developed by RCA and introduced by RCA Institutes, Inc. is a system of programmed instruction, a method of learning proved with thousands of students. This beginning course in electronics is accurately planned so that as you read a series of statements, questions, and answers, you learn almost without realizing it. It's fast! It's easy! It's fun!

**BEGIN NOW WITH RCA "AUTOTEXT".** Now you can start your home training the amazing new RCA "AUTOTEXT" way. And, you get a complete set of theory lessons, service practice lessons, experiment lessons, and all the kits you need. Because "AUTOTEXT" has been designed to help you master the fundamentals of electronics more quickly, more easily—almost automatically—you'll be ready to go on to advanced training in electronics sooner than you ever thought possible.

**STUDENT PROVED.** Prove it to yourself as others throughout the country are now doing. An interest or inclination in electronics is all you need. RCA "AUTOTEXT" helps you to do the rest. The future is unlimited. The jobs are available! The important thing is to get started now.

#### CLASSROOM TRAINING ALSO AVAILABLE

RCA Institutes Resident School in New York City offers training that will prepare you to work in rewarding positions in fields such as automation, communications, television, computers, and other industrial and advanced electronic applications. You are eligible even if you haven't completed high school. Check Classroom training and information will be rushed to you.

#### Complete Selection of Home Training Courses.

- Communications Electronics
- FCC License Preparation
- Mobile Communications
- Automation Electronics
- Automatic Controls
- Industrial Applications
- Nuclear Instrumentation
- Digital Techniques
- TV Servicing
- Color TV Servicing
- Transistors
- Electronics Fundamentals
- Electronics Fundamentals (in Spanish)
- Computer Programming
- Drafting

All RCA Institutes Home Training Courses are complete step by step easy-to-understand units. You get prime quality equipment in the kits furnished to you to keep and use on the job. In addition, RCA's liberal tuition plan affords you the most economical possible method of home study training. You pay for lessons only as you order them. If you should wish to interrupt your training for any reason, you do not owe one cent. Licensed by the N.Y. State Department of Education. Approved for Veterans.

**Send postcard for free illustrated book today!  
Specify home training or classroom training!**

**RCA INSTITUTES, INC.,** Dept. EA-45  
350 West 4th St., New York 14, N. Y.



**THE MOST TRUSTED NAME IN ELECTRONICS**

# NEWSCAN

*Continued from page 25*

ments in "conversational communication" between designer and computer. The "conversation" is in engineering graphics—the drawing language used by draftsmen and designers to convert their design ideas into final products.

The General Motors computer researchers explained that the system thus far has achieved three major goals heretofore not attained in a single computer system:

1. The computer can now "read" key lines from engineering drawings and store the information in its memory storage units.

2. The designer and computer now have direct methods of rapidly communicating graphic information back and forth as the man employs the computer to develop or to modify a design.

3. The computer can generate permanent drawings on 35mm film which can, in 30 seconds, be developed and ready to be enlarged into working drawings. For finished engineering drawings, the computer can produce tapes that control drafting machines.

These three goals, they said, were achieved through several major advances in computer technology, involving both new computer hardware and new computer software (i.e., special instructions programmed for the computer).

One of the new hardware units is a graphic display console at which the designer observes the computer's handling of his design problem on a TV-type viewing screen. When needed, he may modify his design or give the computer further instructions using such options as an electric "pencil," a typewriter-like keyboard, a data card reader, or 36 program control keys.

The General Motors computer people reported that one of the key software features of the DAC-I system was a successful "multi-programming" monitor. The monitor allows the computer to spend any available time—down to a thousandth of a second—solving other engineering problems whenever the man at the design console is thinking or putting in new information. This efficient use of costly computer time is one of the essentials to economic application or man-computer design teams.

## Compact Survival Radio For Lifeboats

A small portable radio transmitter/receiver has been designed for use in ships' lifeboats by the International Marine Radio Company Limited, a subsidiary of International Telephone and Telegraph Corporation in London, England. The radio, called a SOLAS 11, is com-

pletely transistorized and weighs less than 30 pounds. It can be operated easily by one man and transmits and receives on three different radio frequencies. During recent tests, signals transmitted off Plymouth, were picked up nearly 1500 miles away, in Malta,

The radio floats. It can be thrown overboard in an emergency and later retrieved from the sea when survival craft have been manned. Built to withstand a 30-ft. drop into the water, it has a 30-ft. nylon heaving line attached. The set is normally strapped to the operator when in use, leaving both hands free to operate the equipment.



Strapped to the operator's body and held down with his toes, the new lifeboat two-way radio set can be cranked with one hand while the other is free to operate the unit.

The SOLAS 11 conforms to the new requirements of the Merchant Shipping (Radio) Rules that will come into force in 1965. Its receiver tunes continuously over the 8-mc. marine band to allow survivors to be given instructions and advice, for example on the treatment of injuries. Survivors' morale will also be given a boost by the knowledge that their distress signals are being picked up. All three transmitting frequencies (500, 2182 and 8364 kc.) can broadcast manual or automatic Morse, a two-tone alarm signal, or speech. Power is normally supplied by a built-in hand generator but a dry battery can be used instead. Because of the all-transistor circuit, only one 16.5-volt battery is needed. An 18-foot whip antenna, headphones and microphones are all stowed in the fibreglass case of the set, which measures only 27 inches by 11½ inches by 9 inches. ■

## Here's how light is converted to electrical impulses at the TV studio

**O**ne of the first television cameras was built in 1884. That early "camera" used a perforated disc to scan a picture. Called a *Nipkow disc*, it was a circular card punctured by 30 holes in a spiral arrangement.

**Mechanical Scanning.** The disc was rotated in front of the scene to be televised. First, one hole passed over the picture. As it left the picture area, the next hole began its pass across the picture. Each successive hole, because of the spiral arrangement, was a little nearer to the center of the disc. By the time the disc had made a complete rotation, the scene had been crossed by all 30 holes, each passing over its own strip of the scene.

The light coming through each hole was focused onto a photo cell. The different light values from each of the holes caused a cor-

responding change in electric current flowing through the photocell. This varying current was sent by wire to the "receiver," another perforated Nipkow disc, and projected onto a screen. The two discs rotated at the same speed. Thus, a picture composed of thirty lines of varying light values was built up to reproduce the original picture.

**Electronic Scanning.** Other mechanical "cameras" and "receivers" were invented and built; however, each had inherent defects that made the system inefficient and not totally practicable. It was almost 50 years later, in 1933, that V. K. Zworykin demonstrated an electronic technique for scanning a television scene. The camera used a special kind of cathode ray tube in which an electron beam was deflected vertically and horizontally to produce a diagonal scanning pattern across a photosensitive

# HOW THE TV CAMERA SEES AND SENDS

By Leon A. Wortman

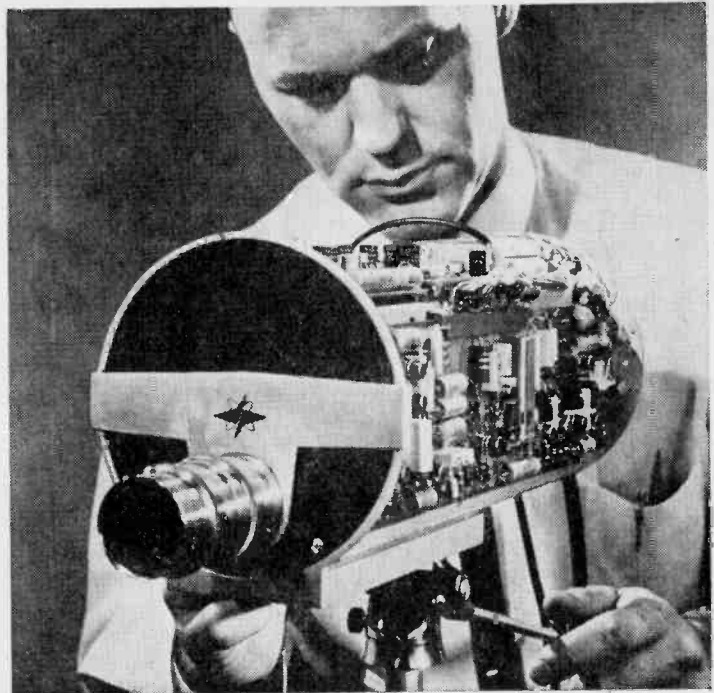

# e/e TV CAMERA

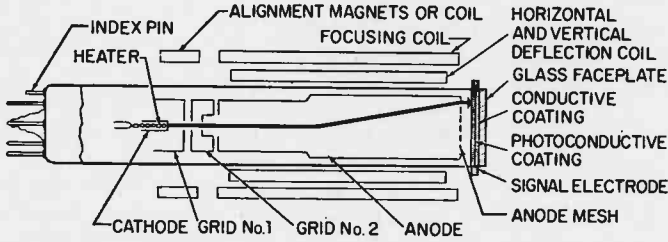

Cut away view of a typical vidicon camera tube with its associated magnetic components showing electron scanning path.

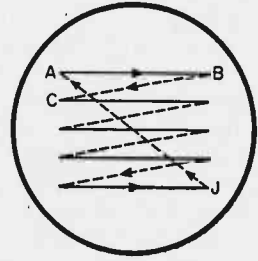

Beam scans from left to right and top to bottom.

panel. Since the time of that initial use of electronic "eyes" for TV, many refinements and variations have been invented and put to use. But the basic principles remain the same.

**The Camera and the Human Eye.** A television camera does not "see" the scene all at once in a single complete picture. It views the scene as a series of tiny dots and depends upon persistence of human vision to observe a continuous image rather than a broken or interrupted group of units. Movie cameras recreate motion on the basis of persistence of vision. A shutter device exposes areas of a film at the rate of 24 frames-per-second in commercial cameras. When projected as a series of sequential and individual still photographs, the eye's persistence of vision produces the continuity, eliminating the blank period while the shutter closes the projector's lens as the film is advanced to the next frame in the sequence. The persistence or retention of the image on the retina lasts for about 1/10th second. Another demonstration of persistence of vision is the illusion of a solid arc of light made by the lighted end of a cigarette butt tossed through the air at night. Of course, the actual object is a dot of light but, while it is in flight, persistence of vision makes it look like an arc of light.

**The Camera Tube.** The eye of a TV camera is the pickup tube. Two types are in most frequent use today, the image orthicon and the vidicon. The image orthicon is considerably more sensitive to low light levels, and is larger and more costly than the vidicon. The former is used primarily in high quality commercial television broadcast work, whereas the latter is used especially in closed circuit non-commercial television circuits. Both use the same basic principles

with respect to converting pictures to electronic signals.

The face of the camera's pickup tube, image orthicon or vidicon, is flat. As shown in the diagram of a vidicon, the inside surface of the tube is coated with a photosensitive material. Its resistance varies inversely with the amount of light striking its surface. A system of optical lenses is placed in front of the target area, just as a film-camera has its lenses placed in front of and focused on a sheet of film. This puts a field of varying light intensities on the target that is a reduced-size reproduction of the scene to be televised. A voltage is applied to the target through a circular ring which is in direct contact with the coating. This voltage is polarized positive with respect to the cathode.

**Scanning the Target.** A fine beam of electrons from the electron gun at the base of the tube is aimed at the target area and, because of the polarization, a current flows in the target circuit. The beam's direction—vertical, horizontal, (and, therefore, diagonal)—can be controlled by a magnetic field. In practice it is controlled by signals fed to an electromagnetic yoke assembly in the tube's envelope or by sets of deflection plates within the camera tube. The objective is to move the beam horizontally across the photosensitive target area a line at a time until the entire target area has been covered by the scanning beam of electrons. Where the areas of the target are brightened by the optic image of the scene to be televised, the electron beam increases in intensity; and decreases in the areas of relative darkness. This is translated into changes in current in the target's electrical circuit and in a *load*, usually a resistor. The resulting voltage drop corresponds to the light and



New look in TV cameras is the Du Mont pint-size TC-175. Fully transistorized, except for 1-inch vidicon, it is used mostly in closed circuit TV. Unlike regular TV's 525-line system, it uses 700 lines for very sharp pictures.

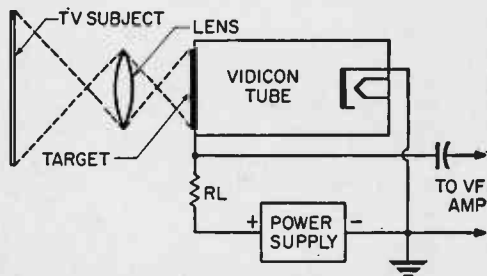

Diagram shows how light is focused on vidicon and circuit to pick up signal.

dark areas of the scene and changes between the limits of minimum and maximum within the capabilities of the tube, its optics and the dynamic illumination of the scene.

Suppose, by means of illustration, the TV camera is focused on a checkerboard containing three different light values: white, intermediate gray, and black. The camera tube's beam starts scanning, moving horizontally across the screen from left to right, returning and moving downward to the left by a distance a little more than the width of the electron beam. Then, the beam scans that line, repeating the sequence of action until the entire face of the target has been scanned. When the beam reaches the bottom left of its field of travel, it returns to the top left to begin the process all over again.

**Blanking the Scan.** Obviously, it takes a certain amount of time to move back from the end of one line to the beginning of the next. Such movement is of no real use in scanning the picture itself. Therefore, the beam must be moved back to the left as quickly as possible. The horizontal trace time takes 56 microseconds and the horizontal retrace time takes only 7 microseconds! This backward movement of the beam could cause some confusion in the picture by introducing an unnecessary pattern of diagonal lines between the horizontal scanning lines. So, circuitry in the camera automatically shuts off or blanks the electron beam during the retrace interval. The overall effect is that of a series of still photographs

being taken as in a motion picture film camera; each TV *still* is composed of a series of dots arranged in horizontal lines with persistence of vision supplying the continuity that produces the visual effects of motion, as in the televised scene at the receiving end.

**Camera Output Signal.** The changes in target current that correspond to the light and dark values of the original scene provide us, then, with the signal information needed for transmission of TV images. These signals are called VF or Video Frequency signals. Before they can be used to operate a TV set several things must be done. The VF signals measured in the camera tube target circuit are relatively small and must be amplified to maintain a high signal-to-noise ratio throughout the TV system. The amplifier circuits must have wide-range frequency response. To give some idea of the range involved, the bandwidth of an amplifier capable of reproducing the frequency range of human hearing must be approximately 15 kc. The bandwidth of a TV-broadcast signal is 4,500 kc.

After the VF signals are amplified to a useful level, synchronizing signals must be added to them before they are fed to the transmitter or TV monitors. These are timing pulses that coincide with the signals that deflect and blank the TV camera's electron beam. The VF and synchronizing information together are called the *composite signal*. This composite signal, the total output of the camera chain is fed into a distribution system whose terminal might be a group of TV monitors in a closed circuit television system or the amplitude modulator stages of a commercial TV transmitter.

**Receiving the Picture.** At the receiving

# e/e TV CAMERA

Simplified diagram of a TV camera. Weak video signal from camera tube is amplified by video amplifier. Sync and blanking generator control blanking circuits and add sync pulses to the output signal.

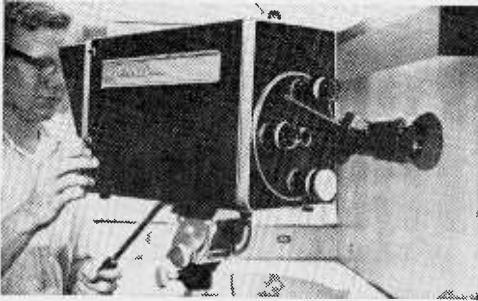
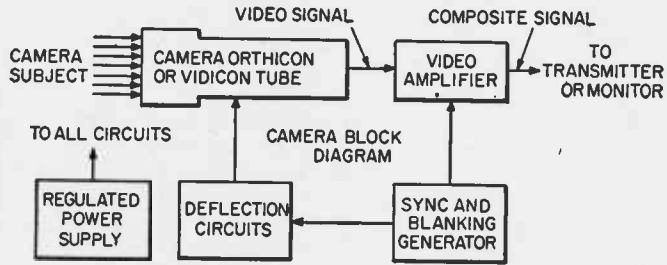

Easy to operate, high school student shoots program for use as educational TV lesson.



Leo has hit the road for MGM. No, not the lion but MGM's new mobile remote TV taping studio. An unusual crane attachment zooms the camera operator high into the air and about for dramatic TV shots. Complete with its own portable power supply, Leo can go on location wherever its wheel can take it.

location, the composite information is accepted by the input circuitry of the monitors or TV sets. There it is amplified, detected and demodulated. The resulting output voltage of the video detector circuit in the TV receiver is a reproduction of the voltage relationships among the whites, intermediate grays, and blacks appearing at the TV camera target circuit. The output voltage of the video detector is amplified to either the cathode or the control grid of the picture tube, depending on the type of circuit. This voltage, varying in amplitude, changes the intensity of the electron beam that "shoots" out from the electron gun at the base of the picture tube. As with the TV camera's photosensitive pickup tube, the beam is a fine pencil point of electrons. The beam is attracted to the picture tube face which is charged by a positive high voltage.

The synchronizing pulses transmitted along with the VF signals are separated from the VF signals in the TV receiver. These are used to trigger the circuitry in the TV receiver that deflects the picture tube's electron beam, enabling the beam of the picture tube to keep in step with the scanning path of the camera pickup tube. Wherever the electron beam strikes the inside surface of the face of the picture tube which has been coated with electroluminescent phosphors, a glow is seen. The glow varies in brilliance with the intensity of the electron beam from its own gun. Thus, a picture or a series of pictures are *painted* on the screen of the receiver's picture tube, resulting in a reproduction of the scene optically focused onto the target of the TV camera tube. ■

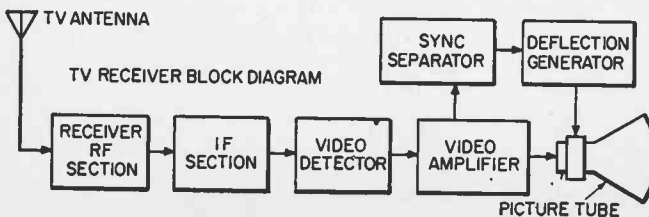

Except for the RF receiving section, the TV receiver is a mirror image of a TV camera. Here the electrical signal is converted back to an image.



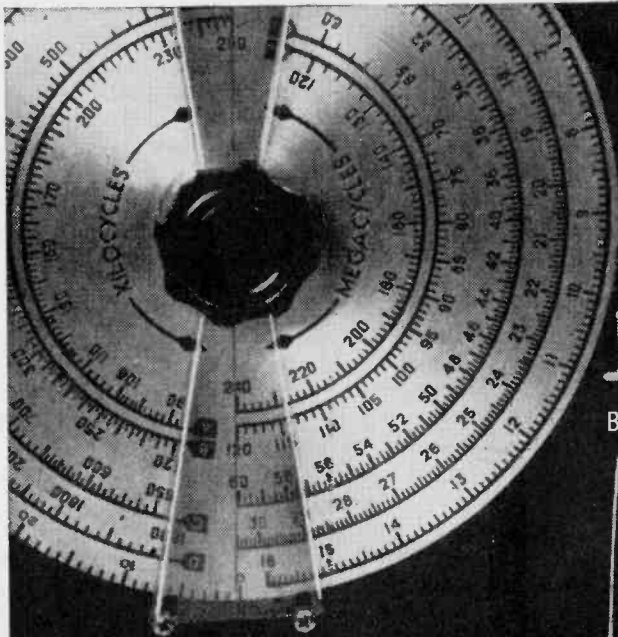

By Len Buckwalter, K10DH

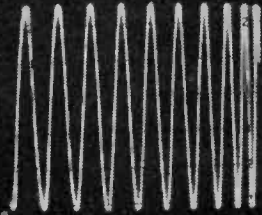

## SIGNAL GENERATORS

Discover how a simple test bench instrument can replace countless broadcast stations and audio signal sources

**J**ust as you're adjusting TV picture controls so people's heads don't come to a point, the scene changes. Or try to track down fuzzy sound in a car or table radio; now you hear it, now you don't. This confounding experience—attempting to use the shifting signals of a radio program or the up-and-down sounds in an audio amplifier—explains why signal generators exist. They supply, on demand, just about any signal needed for test and troubleshooting. That signal can be varied in countless ways; injected into a circuit to pinpoint a suspicious trouble spot or used to check equipment performance. Unlike the radio broadcast or phonograph record, the signal generator produces constant, unchanging signals needed for troubleshooting. You write the signal program schedule.

**The Building Block.** Signal generators fit into several categories; audio, radio, sweep, and *others*. Yet hidden beneath the outer coating of specialization is a basic building block. It's the oscillator. As a fundamental circuit, it drives currents back and forth at any desired rate. It can artificially create the signal or, say, a distant AM radio station. The station transmits a carrier signal somewhere in the 550 to 1600-kilocycle broadcast band at a power that could range up to 50,000 watts. That radio carrier is easily duplicated by a simple oscillator and quickly tuned to any frequency on the dial. Since the generator is on the workbench, signal power can run mere fractions of a watt or milliwatt.

Add a second, low-frequency oscillator to the first and sound can also be transmitted,

# e/e SIGNAL GENERATORS

much as voice and music are sent out by the radio station. The second oscillator produces frequencies within the audio range. By combining radio and audio signals, the generator becomes a miniature broadcast station. This ability to produce one or more controlled frequencies is the inner core of most signal generators. The refinements come later.

**Audio Generator.** Let's fabricate a simple signal generator of the audio type, beginning with its oscillator stage, then expand outward to the special features. The audio generator is widely used to check amplifier circuits which handle signals within the range of human hearing; from about 15 cps to 15,000 cps. Actually, most generators go beyond these limits. Many hi-fi amplifiers need test signals above the audible range. The generator should also be able to check certain devices which work with ultrasonic signals; a depth finder, for example.

Let's consider a popular circuit for generating a broad range of audio tone frequencies. It is the Wien bridge oscillator, heart of many audio signal generators. Its job is to draw upon a large reservoir of steady current in instrument's power supply and vary it according to the desired fre-

quency. Note in Fig. 1 that two tubes are used. During operation, these tubes operate in see-saw fashion; each switching the other on and off in turn. This back-and-forth movement of current flow is made to occur at the desired audio frequency.

The action is based on the principle that a signal introduced to the control grid of a tube will cause a larger current flow in the tube's plate circuit. This is basic amplification. But there's one peculiarity in the amplified flow: it travels in the reverse direction as compared with the grid signal. This is something like walking due North, then turning around and heading due South. According to a compass, you've reversed direction by 180 degrees. The signal, too, undergoes a 180-degree change. Only here the turnaround is from positive to negative. This can be seen in Fig. 1(a). Note that the starting point at Tube 1 grid is marked plus. This positive charge occurs when the oscillator is first turned on, causing the initial surge of current. The signal is amplified and appears at the plate. And, as mentioned above, it is now minus due to the reversal.

There's a good reason for processing the signal in this manner. As we'll see, it can keep the oscillator operating by returning signal energy back to the first tube. Note how the arrows leading to the second tube reveal that a similar process occurs; a negative signal on the grid emerges as a positive signal at the plate. The circuit is completed by returning the positive signal back to the starting point through the feedback path.

This circuit is now ready to oscillate. It has fulfilled an important requirement of all oscillators; positive feedback. The original positive pulse is now strengthened by returning feedback energy. Tube 1 quickly increases its current flow, as Tube 2 (due to its increasingly negative grid) is rapidly turned off. All that remains is switching the

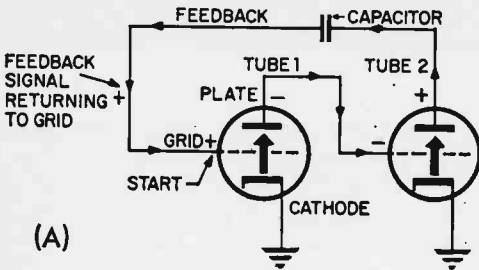

(A)

Fig. 1. Oscillators are basically amplifiers that feed back a portion of their amplified signal to the input circuit in the correct phase to boost the input signal and sustain oscillation. In (A) above, the output signal from the plate of the second stage is fed back to the input control grid of the first stage. In (B), the Wien circuit picks the desired RF frequency and rejects all others.

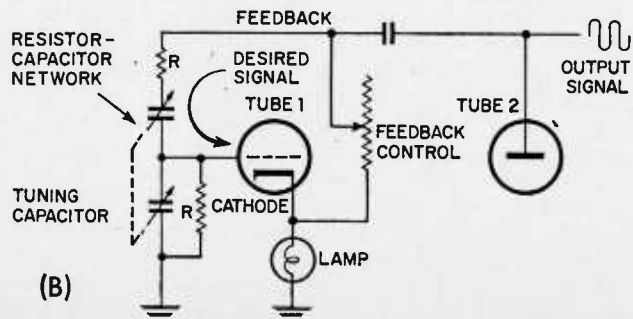

(B)

tubes on and off at an audio rate. This is done by the capacitor shown in the feedback path. Within a small fraction of a second. Tube 1 reaches a state of *saturation*. Although its grid is growing more positive, the tube simply cannot amplify beyond a certain point. This causes its plate signal (negative) to level off to direct current. And this kills the feedback path; a capacitor cannot pass d.c. The capacitor now discharges its stored current in a direction that drives the grid of Tube 1 negative. Thus, the whole process now repeats itself in the opposite direction. The net effect is a continuing ebb and flow of current through the tubes.

The circuit is now made practical by adding some method of varying the frequency. This is the resistor-capacitor network shown in Fig. 1 (b). These components can be considered as a type of filter. According to their values, they permit only one frequency to pass from the feedback path onto the grid of Tube 1. All undesired frequencies are short-circuited in the network. Another way of viewing it is to recall that *positive* feedback gets the circuit oscillating. What the network provides is *negative* feedback—on all but the desired signal frequency. Undesired signals are effectively cancelled out.

**Peeping Inside.** To permit the frequency of the oscillator to vary, the capacitor sections of the network are made variable (Fig. 2). The operator simply dials the signal frequency by rotating a front-panel knob which drives the capacitor plates. He can vary frequency from, say, 20 cps to 200 cps. (The capacitors are limited to fairly small changes in value.) Increasing frequency

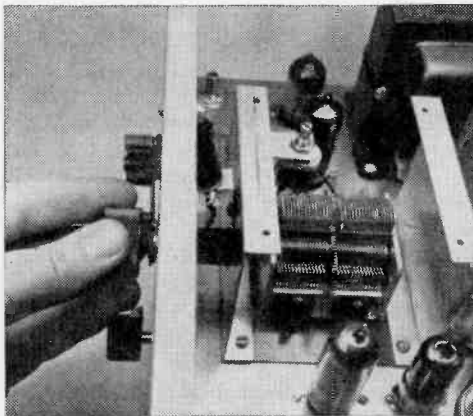

Fig. 2. As audio generator is tuned knob drives dual capacitor in the Wien Bridge.

range, however, is easily done by turning a multiplier switch on the panel to "X10." (See Fig 3) The generator multiplies everything by ten: (Fig 3 photo) the capacitor now can dial frequencies from 200 cps to 2,000 cps. This range increase is achieved by switching in different resistors in the network, as pictured in Fig. 4. In similar fashion, other ranges can be selected; up to 200,000 cps or even 1 mc in some models.

There's a circuit refinement shown in Fig. 1(b) to keep signal energy at a constant level, an important feature in using the generator. It's the lamp placed in the cathode of Tube 1. It acts as a continuous regulator in this fashion: If, for some reason, the signal

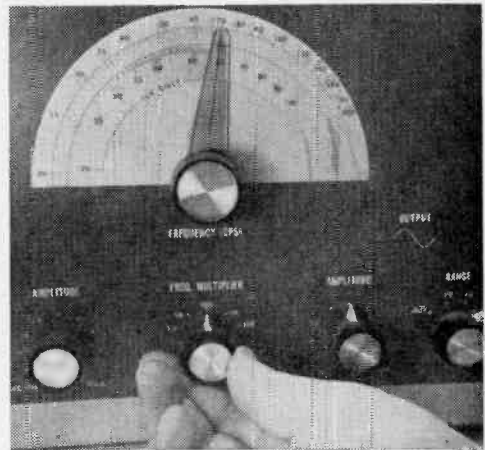

Fig. 3. Frequency multiplier switch on front panel multiplies the dialed frequency on this Heathkit audio signal generator.

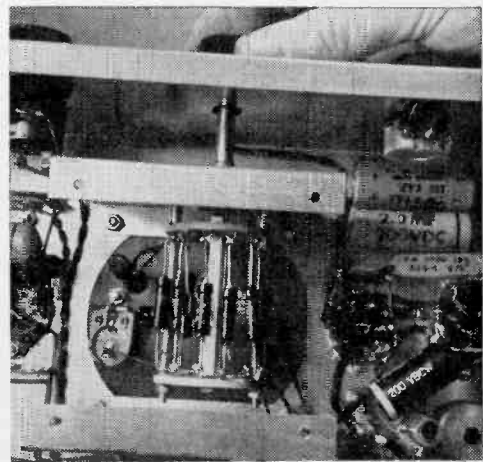

Fig. 4. By switching resistor pairs in Wien bridge circuit frequency can be multiplied.

current through the bulb. It is characteristic of such bulbs that their internal resistance increases with heat. More current, therefore, automatically inserts more resistance in the circuit. Amplification in the tube is lowered and the signal is levelled down to its correct value.

**Output.** To complete the audio generator, a third stage is added; the cathode follower shown in Fig. 5. This tube prevents any

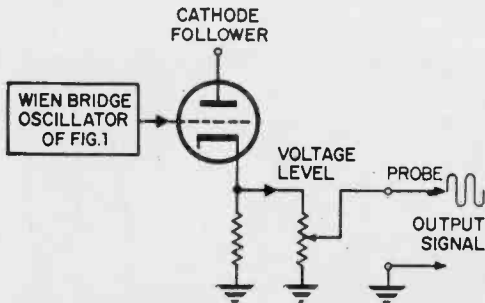

Fig. 5. Cathode follower output in audio generator provides low impedance output.

grows stronger, there will be an increase in interference with the oscillator circuit by the equipment being tested. The cathode follower isolates the oscillator section from such disturbances as excessive loading or other variations which could alter its frequency, or possibly kill oscillation completely. The signal is tapped from the cathode of this stage and applied to a voltage level control. By rotating the control, the operator selects the desired signal voltage, usually between 0-10 volts. From there, the signal is fed to the probes for application to the circuit being tested. (See fig 6.)

A picture of the output signal from an audio generator is shown in Fig. 7. (The photo was taken by applying the signal to an oscilloscope.) The shape is the most basic waveform used in electronics; the sine wave. It rises and falls according to the number of cycles per second. Fed to an audio amplifier, it would be heard in the speaker as a pure tone. At 440 cps, for example, it has the same frequency as note "A" near the center of the piano keyboard.

**Squares.** In addition to sine waves, many audio generators also produce square waves. This waveform is extremely valuable in

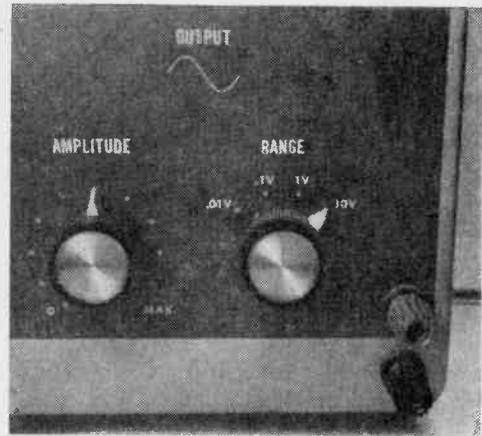

Fig. 6. User may adjust audio signal generator output with range switch (right) and amplitude potentiometer control (left).

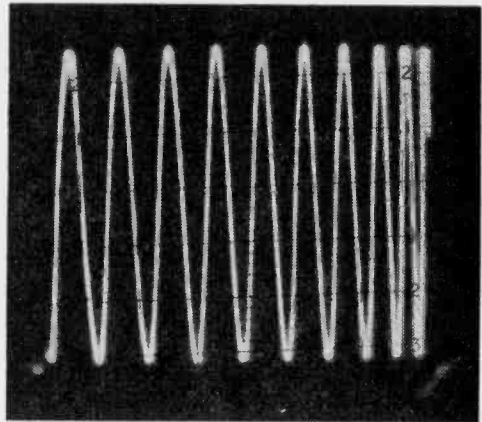

Fig. 7. Sine wave signal from signal generator as seen on an oscilloscope. Signal is a pure tone at 1,000 cycles per second.

checking the frequency response of a hi-fi amplifier. The advantage of the square wave is that it simultaneously contains a huge range of audio frequencies. If fed to an amplifier, then observed to an oscilloscope, it reveals deficiencies in amplifier frequency response. The original square wave becomes distorted or tilted if the amplifier is not reproducing all frequencies equally. A typical square wave is pictured in Fig. 8.

**Making It Square.** The audio generator can create square waves by utilizing the basic sine wave, then feeding it to a "Schmitt trigger" circuit shown greatly simplified in Fig. 9

The circuit is a type of electronic switch

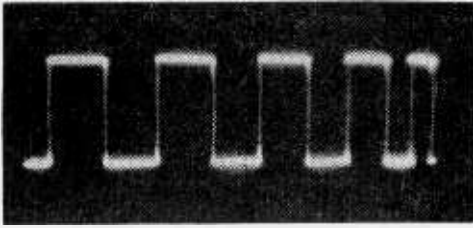

Fig. 8. Square wave signal occurring here at about 1,000 cycles per second, is another important output from an audio generator. Each pulse actually contains many audio frequencies. Applied to a defective amplifier they would lose their square shape and indicate systematic troubles.

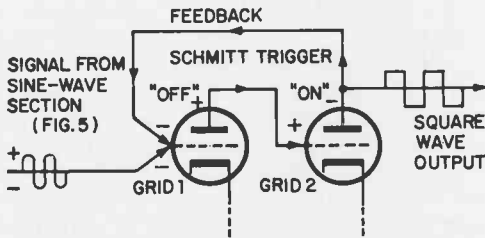

Fig. 9. Square wave section of an audio generator which uses a Schmitt trigger.

triggered by the sine-wave signal. Operation of the two-tube stage shown is quite similar in some respects to the oscillator which produced the sine wave. As in that earlier circuit, two tubes are connected together so their current flows effect each other. Notice that a negative signal occurs at grid 1. (Unlike the oscillator described earlier, where a random signal starts off the circuit, the "trigger" grid is wired so it always begins with a negative charge.) A negative charge on grid 1 cuts off all current flow. The tube is now switched "off." The second tube, however, is forced "on." This, again, is due to the fact that a signal reversal occurs through a tube; the negative charge on grid 1 indirectly creates a positive signal on grid 2.

The two tubes would stay indefinitely in this condition until disturbed. No resistors or capacitors are placed in the feedback path to cause the continuing oscillation of the earlier Wien bridge. The disturbance arrives in the form of the sine-wave signal. As it goes positive, it drives the first grid positive. This unlocks grid 1 and the tube begins to conduct current, therefore switching from off to on. The second tube, tied to the first, is consequently switched off. As

this happens, a positive signal is fed back to the first grid, causing that tube to quickly reach saturation. The two tubes remain switched until the sine-wave at grid 1 changes direction. As it alternates to negative, all the original conditions are restored and the Schmitt trigger goes on *flop*—back to *flip*.

The significant part of this operation is that switching action is extremely fast. This is needed to produce the steep sides of the square waves. Also, both tubes are driven to full saturation to neatly square off the wave. And the action is completely under the control of the trigger action by the sine wave.

**RF Generator.** The radio-frequency generator, like the one in Fig. 10, is used for checking and aligning radio and TV equipment. Its coverage commences where the audio generator leaves off. (It is economically impractical to construct a single instrument to include the large frequency swing from a few cycles per second to hundreds

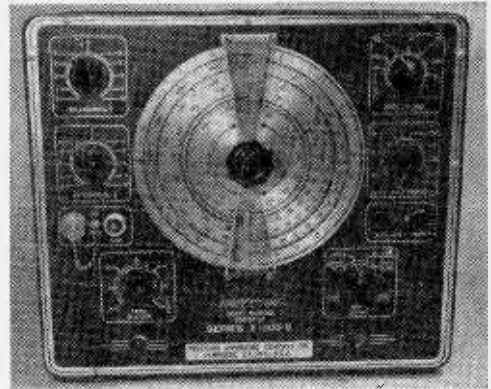

Fig. 10. Front panel of the Precision signal-marking generator showing control knobs.

of megacycles. Nevertheless, there are similarities in the circuits. Again, the heart of the instrument is an oscillator. Instead of the resistor-capacitor network used before, there appears a coil-capacitor arrangement. (Resistors do not lend themselves to frequency-determining components much above 30 kc; they'd have to be too small.) A common oscillator circuit is illustrated in Fig. 11. It is the Colpitts type. The circuit generates a continuous sine wave at the desired radio frequency; from about 100 kc up to 30 mc. This range is greatly extended by harmonics; frequencies which occur at two

# e/e SIGNAL GENERATORS

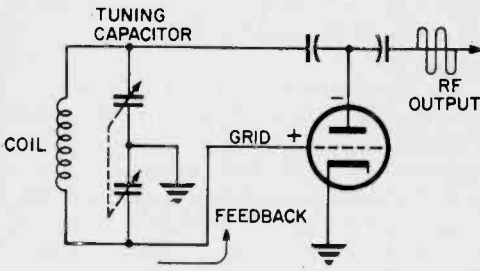
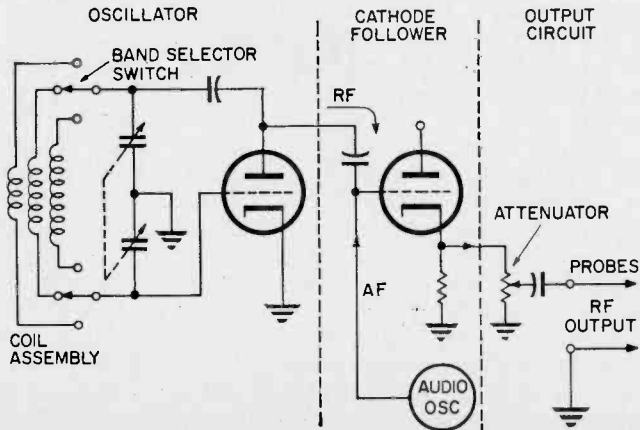

Fig. 11. Schematic diagram of a basic Colpitts oscillator shown greatly simplified.

or more times the oscillator's fundamental frequencies. If the generator is set to produce 30 mc, the operator can also use its third harmonic—90 mc—for test purposes.

The operating principle of the Colpitts oscillator in Fig. 11 is based on a coil and tuning capacitor which form a tuned circuit. When power is first applied to the tube, a pulse of current reaches the tuned circuit and begins to flow between coil and capacitor. Since each of these components has the ability to store current for a certain length of time, the current circulates at a particular (resonant) frequency. The give-and-take exchange between coil and capacitor causes the current to continuously change direction. Thus, there is a constant change of polarity, from minus to plus, at the top and bottom of the tuned circuit. Current soon dies out unless lost energy is restored. This is the function of the tube's ability to amplify. The oscillator is equipped with a feedback

Fig. 12. Simplified diagram of a basic RF signal generator. Oscillator section uses a Colpitts oscillator with band-switched coils for different frequency ranges. Audio oscillator can modulate RF signal, if desired, at input of the cathode follower stage. Attenuator allows user to adjust RF signal supplied to probes.



path to sustain this action. In the Colpitts circuit it's done by splitting the tuning capacitor into two sections, as shown. By grounding the center point, the capacitors form a voltage divider. If the first pulse causes the grid to go positive, for example, current flows to the tube plate. The plate goes negative (due to the reversal). The bottom of the tuned circuit, however, now appears relatively positive. Since the grid picks up the feedback signal at this point, it is driven further in the positive direction. The switch back to negative occurs as the circulating currents in the coil and capacitor swing negative and reverse the process.

**Peeping Inside Again.** A practical, though simplified, schematic of the RF generator is shown in Fig. 12. Several features have been added. Note that a band selector switch appears in the oscillator circuit. This enables the operator to select among various coils, and thus attain several different frequency ranges. The output of the Colpitts oscillator is next applied to a cathode follower stage. As in the case of the audio generator, the oscillator must be protected against external influences to remain stable and accurate. Another function of the cathode follower is to serve as an impedance transformer. A standard output for the signal generator for all round good performance is standardized at 50 ohms. The tube converts the high-impedance output of the oscillator down to this lower value.

RF energy is next applied to an Attenuator, termed the voltage level in the audio version. It performs the same job; permitting the operator to adjust signal voltage to suit his particular test conditions. Some

*(Continued on page 98)*





A capsulated course  
on how to use  
a slide rule to solve  
basic problems

By Herbert Friedman, W2ZLF

**T**o paraphrase a famous poet: "Breathes there an electronics hobbyist with soul so dead that never to himself has said, 'I could be a hell of a technician if I knew how to use a slide rule.'" And of course, in a way this thought is justified, for even the most basic electronic formula—Ohm's law—can require some complex calculations which are not only tedious to work but are beyond the mathematical capabilities of the experimenter. For example: it is simple matter to use Ohm's law to calculate how much current flows in a 10 ohm resistor if the applied voltage is 10 volts. Ohm's law says (in equation form) that  $I = E/R$ , so  $I = 10/10$  which is 1 ampere. Obviously this problem doesn't require a slide rule.

But suppose we have an 8-ohm resistor which is dissipating 15 watts and we want to find the applied voltage. Now we have to use

# THE SLIDE RULE

The  
One-Armed  
Bandit  
of Calculators

a variation of the basic formula, namely:

$$E = \sqrt{W \times R.}$$

This works out to

$$E = \sqrt{15 \times 8.}$$

which is

$$E = \sqrt{120.}$$

For the average experimenter, finding the square root of 120 is not the easiest of

calculations unless you happen to remember those high school algebra lessons you slept through. But pick up a slide rule and move the gadget called the indicator over the number 120 and *voila*, under the indicator you find the answer: 10.95 volts.

Or take another typical experimenter type problem. You are working on an amplifier and find a capacitor is needed for a tone control network that has an impedance of 100 ohms at 15,000 cps. For this problem we'd use the formula:

### HOLD YOUR SLIDE RULE RIGHT!

Slide rules stick and move by jumps unless properly held when setting. In A, the left hand squeezes the rule, binding the slide. Also, it leaves the setting of the slide entirely to the right hand.

Support the body of the rule between your left palm, and the thumb and second finger of the right hand (B). Note: no fingers around the rule! Move the slide with the left thumb and right forefinger. The two-way push prevents excess slide movement.

When the slide is far out of the body, support the body of the rule with the left hand and the second finger of the right hand (C). Do not wrap your fingers around the body. Adjust the slide with the right thumb and forefinger, and the thumb of the left hand.

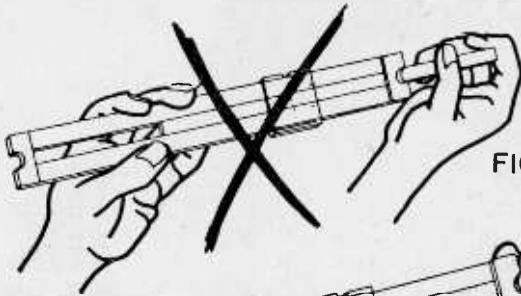

FIG. A WRONG WAY

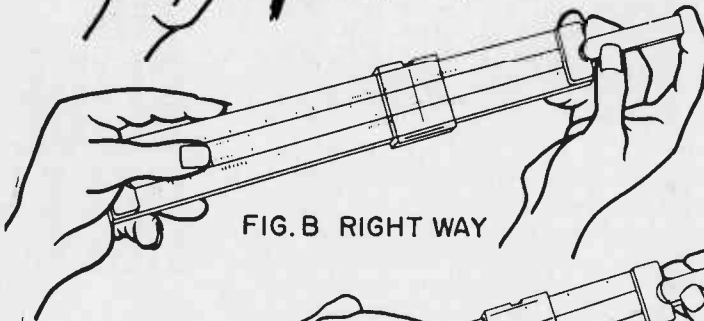

FIG. B RIGHT WAY

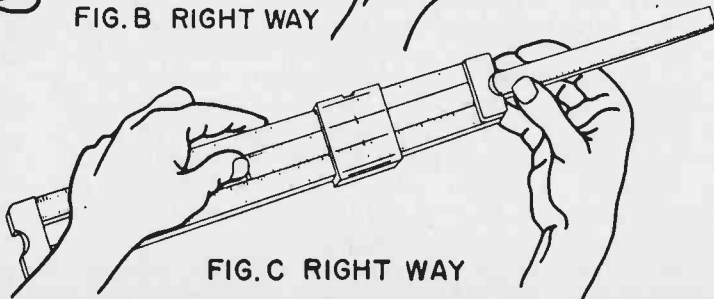

FIG. C RIGHT WAY

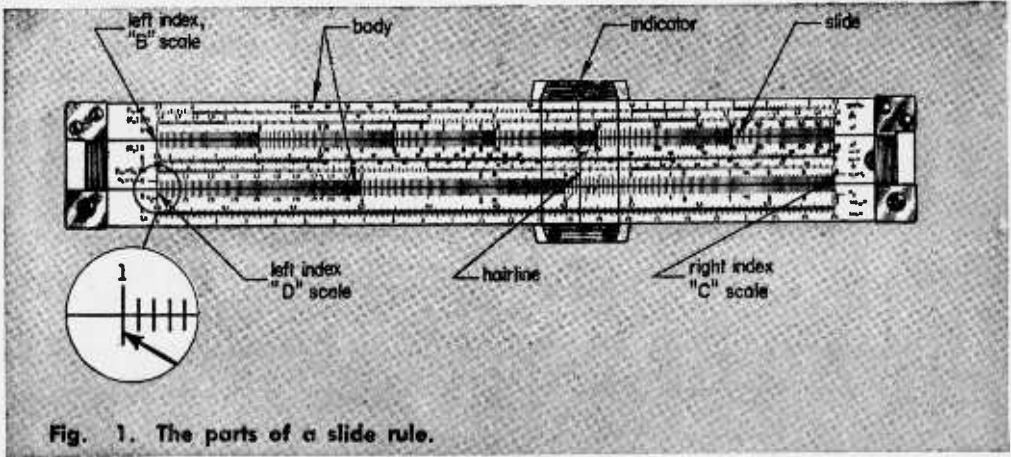

Fig. 1. The parts of a slide rule.

$$X_c = \frac{1}{2\pi F C}$$

where  $X_c$  is the reactance or impedance,  $F$  is the frequency in cycles, and  $C$  the capacitance in farads. First, since we know the reactance needed, we must interpolate the formula for capacitance, and it becomes:

$$C = \frac{1}{2\pi F X_c}$$

And when we put all the numbers in we come up with:

$$C = \frac{1}{2 \times 3.14 \times 15,000 \times 100}$$

And if we work hard enough and don't make any errors in the multiplication and division we come up with

$$C = .11 \text{ mfd. approx.}$$

If you tried to work this problem with pencil and paper (give it a try) considerable time was spent not only in the calculations but in the rechecking. But had you used a slide rule you would have made three simple mechanical motions taking a total of ten seconds and would have come out with the same answer.

So you see, a slide rule is really a mathematical shorthand; and the nice part about it is that for typical electronic formulas you don't have to know much math to use it. It's strictly a mechanical process.

**Looking at the slide rule.** The first thing when you first look at a slide rule is a profusion of scales. (See Fig. 1.) Actually,

slide rules in common use range from four to over ten scales—the exact arrangement determined by the specialized functions for which it is designed. The model shown in this article is what is known as an "electronic slide rule"—that is, the scales are specifically chosen to simplify calculating standard electronic formulas such as

$$E = IR, XI = 2\pi FC, \text{ etc.}$$

Regardless of the number of scales the slide rule is made as shown, with a *body*, *slide* (the one-arm on the bandit) and *indicator*. Problems are solved in one of two ways. Either the indicator can be placed over one scale located on the body with the answer read under the indicator hairline, or several scales can be used switching from body to slide scales and possibly back again. Regardless of the number of motions needed the calculations are done by the process of addition and subtraction.

That's right, the slide rule works on the basis of addition and subtraction, not multiplication and division as might be expected. The trick lies in the fact that the scales can be calibrated in such a manner that addition and subtraction *express* multiplication and division. (Scales for straight addition and subtraction are not placed on commonly used slide rules because you can use pencil and paper faster than you can a slide rule—you don't need a shorthand system.)

**How to make one.** To get a clearer picture of the idea we'll make a slide rule. Make a

tracing (or copy) the two scales shown in Fig. 2 and then cut the scales apart on the "X" marks. Note that these are linear scales, the space between the digits being equal. We will call the "O" the *index*. Now let's try to add  $1 + 3$ . Place the L1 index opposite the 1 on scale L2 as shown in Fig. 3. Now run

and read the answer under the L1 index—the answer is 1. Note that we can use Fig. 2 for illustration because, as we said, subtraction is just the reverse of addition.

Now you might ask: "what has all this got to do with multiplication and division?" Well, remember we said the scales could be

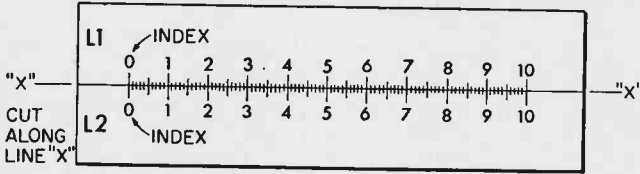

Fig. 2. You can make your own slide rule that can add. Just trace the illustration at left and cut along line "X". If you make your own, expand length to increase accuracy.

your eyes out to the number 3 on scale L1. Note that opposite the number 3, the answer, 4, appears on scale L2; so our home-brew slide rule has been used to determine that  $1 + 3 = 4$ . Try a few more numbers

calibrated to *express* multiplication and division; that's just what is done. Look at the scales shown in Fig. 4. Note that they aren't linear, the distance between 0 and 1 is greater than that between 1 and 2. Similarly, the distance between 1 and 2 is greater than that of 2 and 3. If you cut out these scales and try to do addition and subtraction you'll get erroneous answers. Using our basic problem  $1 + 3 = ?$ , you'll now find that if the L1 index is placed opposite the 1 on scale L2, the number opposite the 3 on scale L1 isn't 4, it's 3. Try other numbers, say  $2 + 3 = ?$ ; note the answer comes out 6, not 5. But if you stop and think you'll realize that the answer to the  $1 + 3$  problem

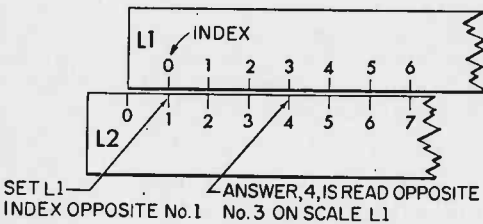

Fig. 3. To add  $1 + 3$  set L1 index over 1 on L2. Read answer, 4, below 3 on L2.

just to get the hang of it. And try some decimal numbers like 1.5 and 3.2. Each major division—like 1 to 2—is divided into ten equal parts; so for 1.5 the index is set opposite the fifth line after the number 1. Similarly, the answer is read opposite the second line after the number 3. By the same reasoning, if the decimal is ignored you can add high numbers like 15 and 32. Just imagine an "O" next to each number so that 1 becomes 10, 2 becomes 20, etc. The number 15 would be the same location as 1.5—the fifth line after the number 1. Similarly, 32 would be the same position as 3.2. And now, instead of the answer being read 4.7 it is read as 47.

Subtraction is just the reverse procedure of addition, and again we'll use Fig. 3 for illustration. Assume the problem is  $4 - 3 = ?$ . Set the 3 on scale L1 opposite the 4 on L2

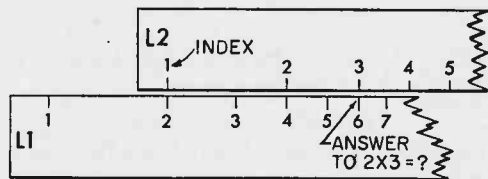

Fig. 4. When modified scales are used, multiplication and division are possible.

is the answer for  $1 \times 3$ ; and the answer for  $2 + 3$  is, again, the answer for  $2 \times 3$ . So using the same principle of addition, by modifying the scales we can multiply. Similarly, if the procedure is reversed the new scales divide instead of subtract.

**More Power To You.** How do we get these "special" scales? If you remember your algebra, you'll recall that numbers with the same base can be multiplied together by adding the exponents. Thus,

$2^2 \times 2^3 = 2^{2+3} = 2^5 = 32$ . If you work it out the hard way you'll get  $2^2 = 2 \times 2 = 4$ ; and  $2^3 = 2 \times 2 \times 2 = 8$ . Then,  $4 \times 8 = 32$ . Same answer but with lots more work, it's much easier just to add exponents. But remember the base, in this instance the number 2, must be the same. You cannot add exponents if the base is different, such as  $2^2 + 3^2$ .

**Powers of 10.** Try another example:  $10^2 \times 10^3$ . That's right, the answer is  $10^5$  or 100,000. In this example the base number is 10; and advanced math shows that any number can be written as 10 with the proper exponent; for example:

$$\begin{aligned} 100 &= 10^2 \\ 200 &= 10^{2.301} \\ 300 &= 10^{2.477} \\ 550 &= 10^{2.740} \end{aligned}$$

Or the small numbers:

$$\begin{aligned} 2 &= 10^{0.301} \\ 3 &= 10^{0.477} \\ 5.5 &= 10^{0.740} \end{aligned}$$

We call the exponents in the preceding examples *logarithms*. Thus, in the expression  $550 = 10^{2.740}$ , 2.740 is said to be the *logarithm* of 550.

We have said, that as long as the base is the same numbers can be multiplied by adding their exponents. Since we can express any number in terms of the number 10, we can multiply any numbers or group of numbers by simply adding the logarithms of each number and then determining what number corresponds to the logarithm total. Let's try a problem with some of the numbers listed above; let's multiply  $2 \times 100$  using logarithms. The log (short for logarithm) of 2 is 0.301; adding this to the log of 100 which is 2.000 we get a total of 2.301. Going back to our samples we find that the number whose log is 2.301 is 200, therefore,  $2 \times 100 = 200$ . Of course, this is a ridiculously simple example and you could do it in a split second without logarithms, but it's an easily understood illustration. Try doing  $97500 \times 729000$  in your head—impossible for most of us, difficult even with pencil and paper. But if you had a log table, a special chart listing the logs of all numbers, you could work this problem in about 15 seconds simply by adding the logs which represent the numbers.

Granted, the average hobbyist and many technicians find it difficult to use logarithms, and it would be inconvenient to have to thumb through a book of log tables for each number in a problem. But by calibrating the slide rule *with numbers to which the logarithms correspond*, the necessity for referring, or even knowing about logarithms is eliminated. As far as the slide rule user is concerned he works directly with numbers. If he is multiplying  $2 \times 3$  he sets up the slide rule using the numbers 2 and 3. The slide rule automatically converts to logs, does the addition, and converts the final answer in logs back to numbers.

We won't go into the mechanics of actual slide rule operation because their instruction manuals are more detailed than we can be with our limited space. But we would like to discuss one bug-a-boo that seems to throw many hobbyists who try to use the slide rule.

**The Shifty Decimal.** Remember back when we made our own slide rule the decimal did not effect how we set up the scales: the index was positioned over the same number whether we set up for 1.5 or 15. Actually the same indexing is used whether the number is 1.5, 15, 150, 1500, 15000, etc., etc. When working the slide rule the decimal is ignored until the answer is obtained; and it is the positioning of the decimal that seems to give the hobbyist the most trouble with the slide rule. Let's look at a practical example of how the decimal is *easily* inserted into the answer.

In a typical reactance problem where we're dealing, say, with 20 megacycles and 3 millihenry, the equation for reactance would be

$$\begin{aligned} Xl &= 2\pi FL \\ Xl &= 2 \times 3.14 \times 20,000,000 \times .003. \end{aligned}$$

Now you can see that it will take as much pencil pushing to calculate the decimal's position as it would be to work the problem. But we can simplify the numbers by reducing them to unit numbers multiplied by a power of 10. The frequency of 20,000,000 cps can be simplified to  $2 \times 10^7$ . Similarly, .003 henries can be written  $3 \times 10^{-3}$ . (The exponent of 10 is the number of digits to the left or right of the decimal.) Keep in mind, from our discussion of logs, that we have the same base, in this instance 10, we



## THE SLIDE RULE

multiply by simply adding exponents. So simplifying our problem we get:

$$X1 = 2 \times 3.14 \times 2 \times 10^7 \times 3 \times 10^{-9}$$

$$X1 = 6.28 \times 2 \times 3 \times 10^4$$

$$X1 = 37.7 \times 10^4,$$

$$X1 = 377,000 \text{ ohms.}$$

Actually, when using the slide rule the answer reads 377 with no indication of the decimal. However, since the problem has been simplified by using powers of 10, the decimal is easily pin pointed. First we have 6.28 which is essentially 6; so we multiply  $6 \times 2 \times 3$  and get 36. Since the slide rule reads 377 the decimal is obviously after the second digit, or  $37.7 \times 10^4$ .

**Cutting Big Numbers Down.** Any large number can be simplified by breaking it

down into units multiplied by a power of 10; and it's when you get the hang of simplification to the point where you work it out in your head that using the slide rule becomes as easy as using *long nose pliers*. Let's tackle what looks like a tough problem:  $156 \times 98900 \times .00456$ . What is the approximate answer (take a break and work it out)? If your approximation falls between 40,000 and 80,000 you're a natural for the slide rule. For those of you who missed, let's check how its done:  $156 = 1.56 \times 10^2$ ;  $98900 = 9.89 \times 10^4$ ;  $.00456 = 4.56 \times 10^{-8}$ . Adding the powers of 10 together, the problem becomes  $1.56 \times 9.89 \times 4.56 \times 10^8$ . The approximate numbers are  $1 \times 10 \times 5 \times 10^8$  or  $2 \times 10 \times 4 \times 10^8$  (we deliberately picked

*(Continued on page 94)*

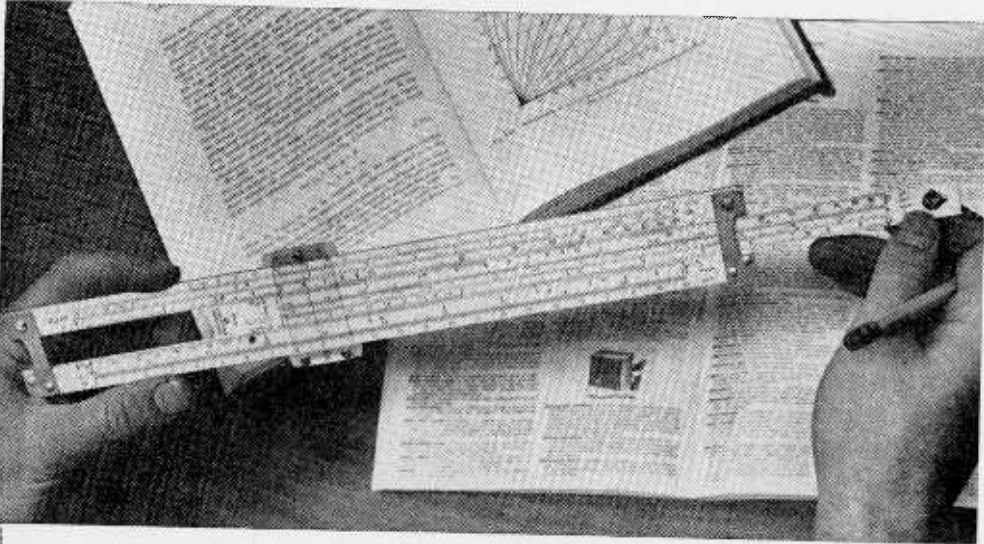

Want to know what combination of coil and capacitor tune a particular frequency? Or find the voltage and resistance that produce a certain current flow? These and other electronic problems can be solved in seconds with a new self-training course and special slide rule offered by Cleveland Institute of Electronics. One side of the rule is marked with electronic scales; Ohm's Law formulas, AC circuits, transformers, resonance and others. The reverse side of the rule can be used for standard computation. The slide rule comes with a self-training course designed for the beginner. Divided into four booklets, the course starts by identifying parts of the slide rule and ends with an explanation of how to solve complex problems. Included is a series of quizzes which the student takes, then sends to a CIE instructor for grading and comments. The complete course, 10" slide rule and leather carrying case cost \$14.95. For details write to: Cleveland Institute of Electronics, Dept. E1 100, 1776 East 17th St., Cleveland, Ohio 44114.



# EFFECTIVE RADIO GROUNDING

Lightning protection and high antenna efficiency begin with a good ground system.

By Howard S. Pyle, W7OE

**P**robably the most neglected item in the installation of amateur radio transmitters and receivers is provision for an adequate earth ground. Too often is the commonly accepted practice of using a connection to a cold water pipe, responsible for many mediocre results. The resistivity of iron pipe itself is relatively high; added resistance is often introduced through rusty or corroded couplings, tee's, and elbows, enhanced by the various joint compounds used to insure against liquid leakage. Add to this the often long pipe runs interposed between the radio equipment and the actual entry of the pipe into the earth itself, and you have a rather ineffective ground system. Some amateurs attempt to overcome this to some extent by burying a number of wires of good conductivity but this introduces the need for providing shallow trenches, each of some length, in a radial pattern. Often such trenching is undesirable in lawn and garden areas. Furthermore, ground resistance in a radial wire system is subject to great variation due to the non-uniform moisture content of the surface soil in various seasons of the years.

The driven type of ground electrode has practically replaced all other methods of assuring a good connection with the earth. It is economical to install and may usually be conveniently placed for making short electrical con-

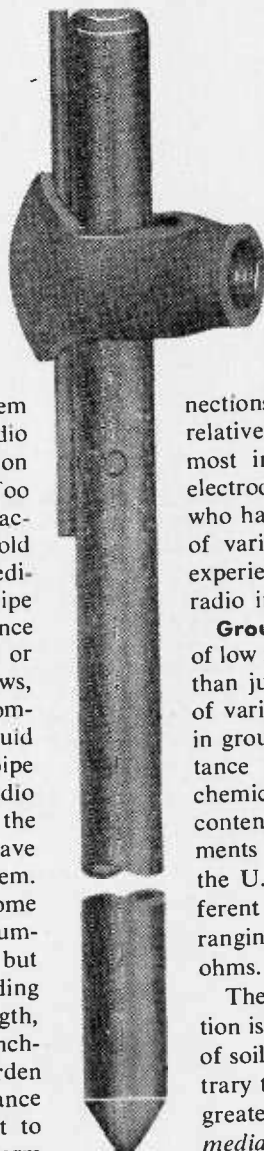

nections; it can be driven to penetrate relatively uniform moisture levels. Almost invariably this type of ground electrode is used by utility companies who have made rather exhaustive tests of various grounding methods. Their experience can well be used in amateur radio installations.

**Ground Resistance.** To be assured of low resistance grounds, it takes more than just good rods. The conductance of various soils is an important factor in ground resistance and such conductance is largely determined by the chemical ingredients and moisture content of the soil. A series of measurements of ground resistance made by the U. S. Bureau of Standards in different types of soil showed values ranging from 2 ohms to around 3000 ohms.

The resistance of a ground connection is mainly dependent upon the type of soil surrounding the electrode. Contrary to commonly accepted belief, the greatest resistance is in the area *immediately* surrounding the electrode and which has the smallest cross-section of soil at right angles to the flow of current through it. This resistance varies inversely as the cross-section and, within a few feet from the electrode where the conducting path is small, the resistivity of the soil is an important factor.

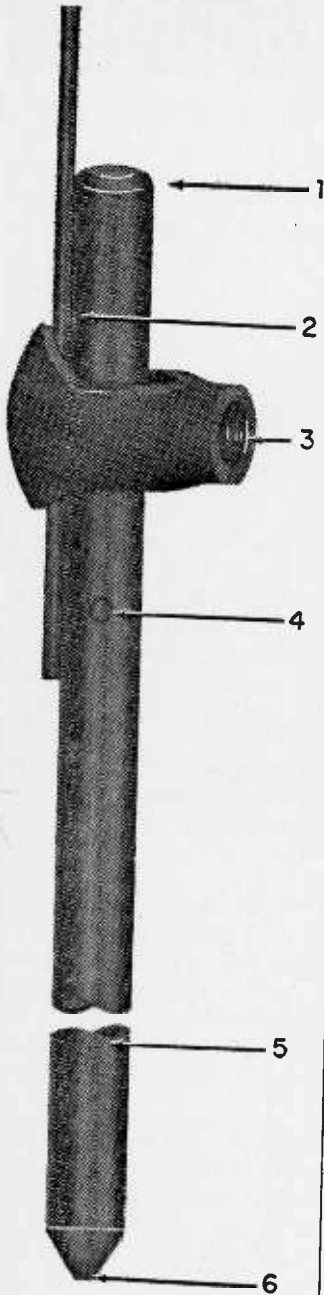

High quality rod has (1) chamfered top to prevent "mush-rooming," (2) copper-to-copper connection, (3) hex-head locking screw in clamp, (4) rod length stamped in metal, (5) welded copper over steel, and (6) strong, cold-pointed end.

**Effect of Moisture in Soil.** The moisture content of the soil is of great importance. A variation of a few percent will make a marked difference in the effectiveness of a ground condition. This is especially true for moisture contents below about 20 per cent. For values over this percentage, the resistivity is not affected too much but below 20 per cent, the resistivity increases rapidly with a decrease in the moisture content. The normal moisture content varies for different localities but on the average it is about 10 per cent in dry seasons and around 35 per cent in wet seasons with an approximate average of 16 to 18 per cent.

**Effect of Temperature.** Temperature is also an important factor in localities where  
(Continued on page 96)

Four rods at base of antenna mast assure good ground system in very dry regions. Other technique (see below) uses chemicals in trench around one rod to reduce ground resistance where soil is dry. This idea needs little space, uses cheap rock salt.

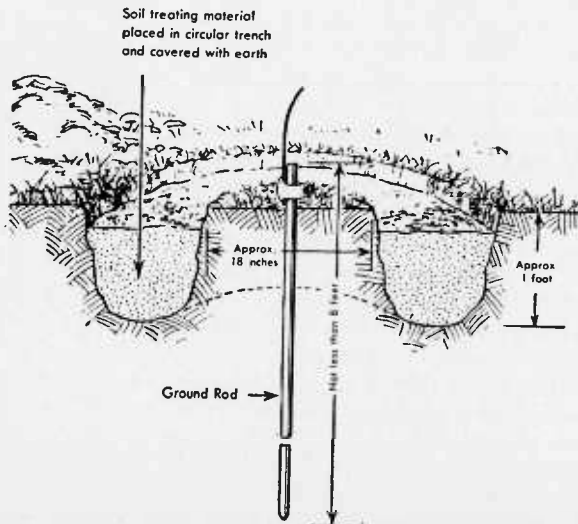
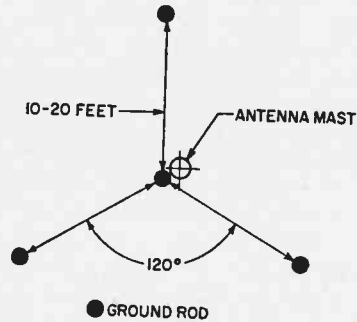

# HOW FM RECEIVERS WORK

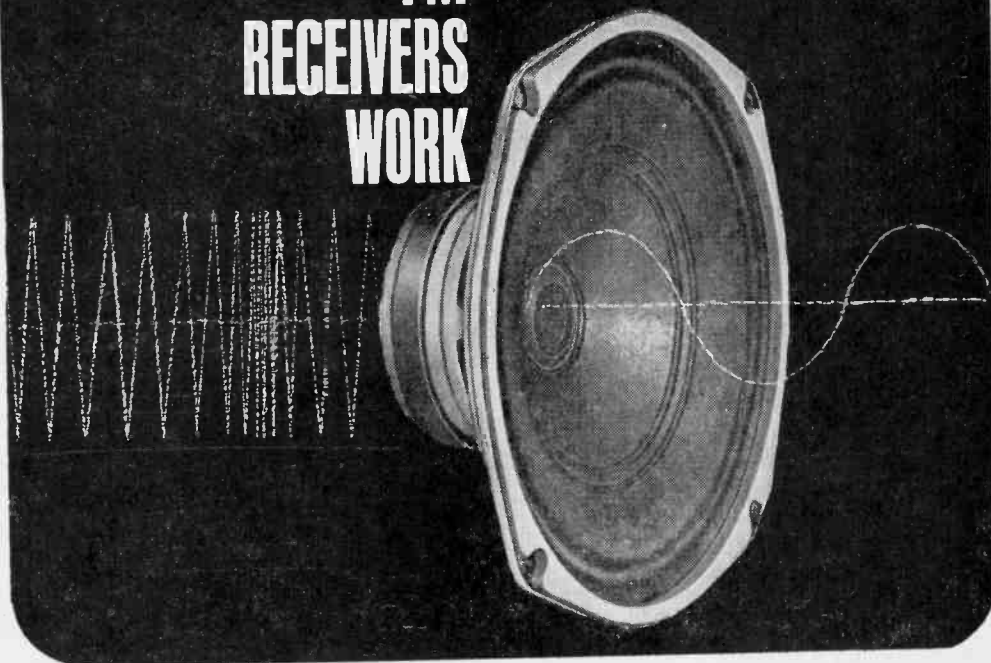

The inside story of radio's most static- and noise-free method of broadcasting and a look at the dynamic man who made it possible.

By Leo G. Sands

**F**requency modulation (FM) radio has been with us for many years, but it was only recently that it reached a stage of great popularity. Its inventor, the late Major Edwin Howard Armstrong, first demonstrated the system as long ago as 1933. But, unlike two other of his discoveries—heterodyne receiver and the superregenerative detector—it took the world years to fully appreciate FM and all it had to offer.

In most applications, it is the noise-suppression characteristics of FM that are important, not its ability to handle broadband modulation. In fact, AM, rather than FM, is used for television picture broadcasting which requires handling a modulated signal several megacycles wide. But this doesn't mean that FM can't be used for TV picture transmission since it is widely employed in TV microwave links. Ordinarily, however,

the picture transmitter in TV broadcasting employs vestigial single-sideband AM and the sound transmitter employs FM to minimize interaction between the two.

In AM, the amplitude of the radio signal is varied in order to transmit intelligence. By way of comparison, this technique is like varying the brilliance of a lamp to communicate in the dark. In FM, the amplitude of the radio signal remains constant and its frequency is varied in order to transmit intelligence. This technique, in contrast, is more like communicating by varying the color of a light while maintaining its intensity constant.

With AM the loudness of the modulating signal at the receiver depends on how much the *amplitude* of the radio signal is varied. In FM, the loudness of the recovered audio depends upon how much the *frequency* of

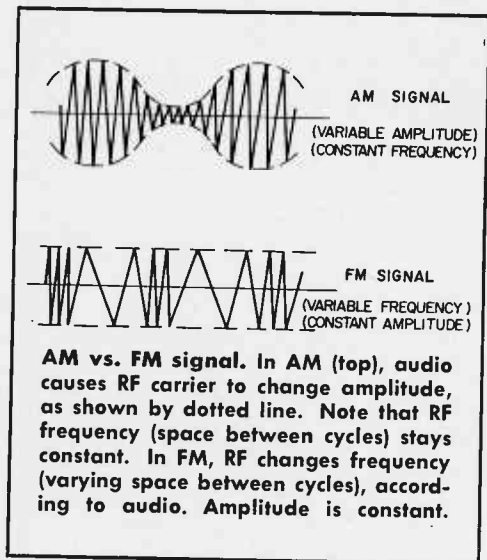

the radio signal is varied. Amplitude variations make no difference in FM as long as the FM signal is strong enough to saturate the receiver.

**Snap, Pop, Crackle.** Most noise consists of bursts of signal which are of short duration and widely varying in amplitude. For this reason, a noise impulse always looks like an AM signal to an FM receiver.

Noise is virtually eliminated in an FM receiver in the presence of a strong signal. This usually is because of the action of the "limiters," which iron out amplitude variations. Sometimes, too, the FM detector itself, is designed to be insensitive to amplitude variations.

**Generating FM Signals.** An FM signal may be produced by varying the frequency of the transmitter oscillator (direct FM) or

by introducing phase shift in one of the stages in the transmitter after the oscillator (indirect FM).

The frequency of the oscillator can be varied by connecting a capacitor-type transducer (condenser microphone or phono pick-up) across the oscillator's tuned circuit. But in practice, the oscillator frequency is varied electronically. A varactor diode, which is like a voltage-sensitive capacitor, can be connected into the oscillator tuning circuit. The audio modulating signal varies the bias on the varactor diode, causing its capacity to change. This simple way of obtaining direct FM is used in microwave transmitters and some commercial FM mobile radio equipment.

A tube is often used to vary the oscillator frequency, as shown in Fig. 1. Here, the oscillator tube, V1, is shown connected in a Hartley circuit. The reactance modulator tube, (V2) is essentially across the oscillator tank circuit. The audio signal fed to the grid of V2 through transformer T1 causes the transconductance of V2 to vary.

As a result, the reactance of V2 varies and acts like a variable capacitor across the oscillator tank circuit, causing the oscillator frequency to vary at the same rate as the audio modulating signal. The amount the frequency varies is determined by the amplitude of the modulating signal.

In FM broadcast transmitters employing a reactance modulator, elaborate means are required for keeping the oscillator frequency within prescribed FCC tolerances. The frequency of a transmitter employing a crystal-controlled oscillator can be varied by introducing phase modulation, without affecting the oscillator frequency. Fig. 2 is a schematic of a balanced phase modulator employing the

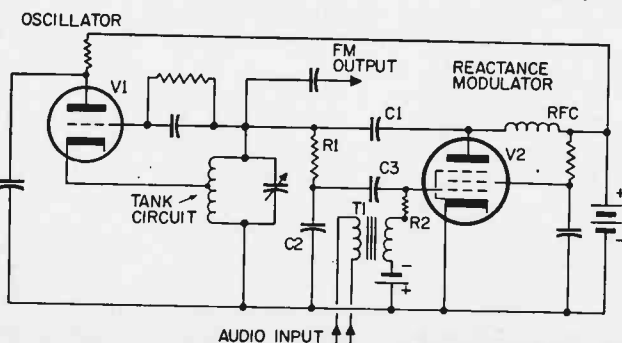

**Fig. 1.** In reactance modulator circuit, audio signal varies current through V2, the reactance tube. This causes V2 to act as a variable capacitor across V1, the oscillator. Thus V1 changes frequency in step with audio.

Fig. 2. In the phase modulator, RF from V1 is split across the modulator tubes (see V2 and V3). As audio changes current in the modulators, RF changes phase—frequency modulation.

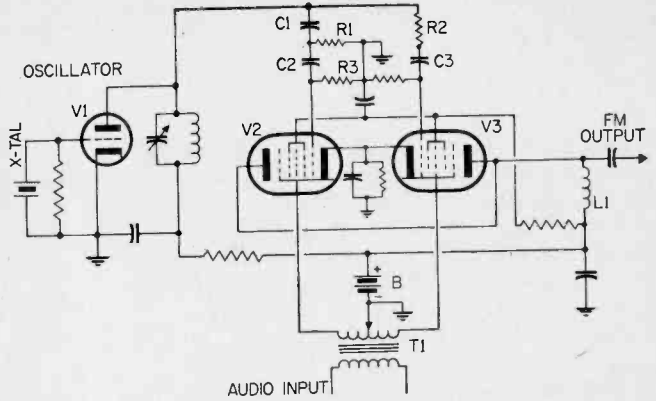

principles developed by Major Armstrong.

In Fig. 2, the unmodulated oscillator signal from V1 is fed through a phase-shift network (C1-R1) to the grid of V2. It then passes through another phase-shift network (R2-C3) to the grid of V3 to produce a 90° phase difference between the RF signals fed to the two modulator tubes.

Simultaneously, the audio signal is fed through transformer T1 to the injection grids of the two modulator tubes. As V2 plate current is increased by a positive-going audio signal, V3 current is reduced, and vice versa.

The relationship of the plate current of V2 and the plate current of V3 changes with modulation. As a result, the output signal developed across L1 and fed to the next stage of the transmitter has the characteristics of an FM signal. Any amplitude variations are erased by the succeeding frequency-multiplier stages which are operated as Class-C amplifiers.

The oscillator operates at a very low frequency compared to the ultimate transmitted signal. The amount the frequency is deviated by the modulator is also very small. But, by employing several frequency-multiplier stages, the carrier frequency and the frequency deviation are both multiplied.

For instance, if the oscillator operates at 100 kc and the RF signal is deviated plus and minus 75 cycles, the output signal would be at 100 mc. if the signal were multiplied 1000 times. The deviation in this case would then be plus and minus 75 kc.

The simplified block diagram of Fig. 3

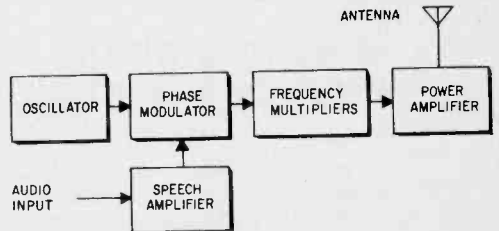

Fig. 3. Major stages in an FM transmitter.

shows the basic circuit employed in many FM transmitters. There generally are several frequency-multiplier stages, although only one box is shown in the diagram.

A multiplier stage may employ a varactor diode or a tube operated as a Class-C amplifier as shown in Fig. 4. When operated Class C, plate current flows only during part of each positive signal cycle at the grid. The output waveform would be very distorted if

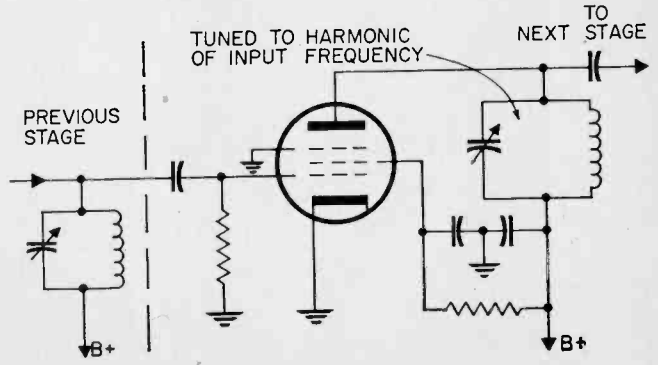
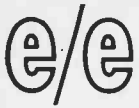

Fig. 4. An FM multiplier stage raises low oscillator frequency to high transmit frequency. This permits oscillator to operate at a very low and stable value.



## HOW FM RECEIVERS WORK

it were not for the plate tank circuit which is tuned to a harmonic (multiple) of the input RF signal. The plate tank circuit can be tuned to the same frequency as the input signal to form a straight-through amplifier or to a harmonic to form a frequency multiplier.

**Characteristics of FM Signals.** For 100 percent modulation, the carrier frequency of an FM broadcasting transmitter is deviated plus and minus 75 kc. The signal requires a minimum of 150 kc. of bandspace. However, the FCC allows each station a slot 200-kc. wide. Furthermore, even though the FM channels are 200 kc. apart, stations in the same area are usually spaced a minimum of 800 kc. apart. See fig. 5.

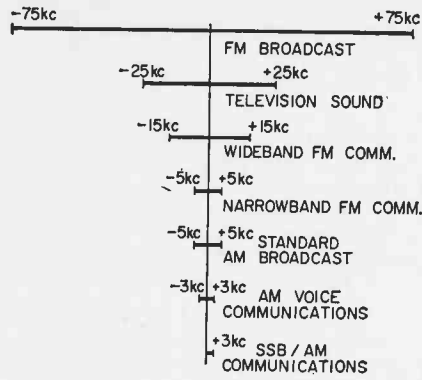

Fig. 5. Bandspace taken by different services.

The FM sound transmitter of a TV broadcast station is allowed to deviate a maximum of plus and minus 25 kc. The bandspace occupancy is therefore a minimum of 50 kc. Marine radiotelephones and coast stations

## SCENES FROM THE LIFE OF MAJ. EDWIN H. ARMSTRONG

□ Very few people know the genius of one man, Major E. H. Armstrong (below), invented the regenerative, superheterodyne receiving, and super-regenerative receiving circuits as well as FM (frequency modulation) radio. Not satisfied with just doing laboratory work, photo at right shows Major Armstrong sitting in a bosun's chair 1,200 feet above New York's Hudson River adjusting the first FM antenna.



Photos courtesy Columbia University

operating in the VHF marine band are allowed to employ plus and minus 15 kc. frequency deviation, as are commercial mobile and Class A and B citizens radio stations in the 450-470 mc. UHF band. In the 25-50 mc. (low) band and the 150-174 mc. (high) band, commercial FM mobile transmitters are allowed to deviate only plus and minus 5 kc.

By narrowing the deviation, more stations can use the band. However, narrowing the frequency deviation detracts from the FM noise improvement and the level of the audio recovered at the receiver.

A standard AM broadcast station is allowed 10 kc. of bandspace, thus limiting the highest modulating frequency to 5000 cps

(5 kc.). When modulated at 5 kc., upper and lower 5-kc. wide sidebands are produced. By contrast, an FM broadcast signal occupies 150 kc. of space, 15 times as much as an AM station.

**Demodulating FM Signals.** The simplest

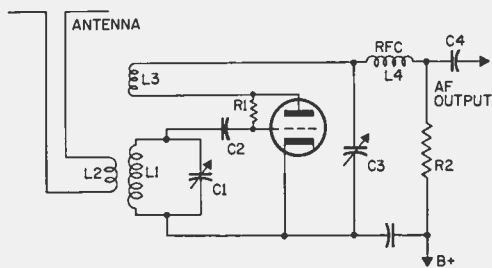
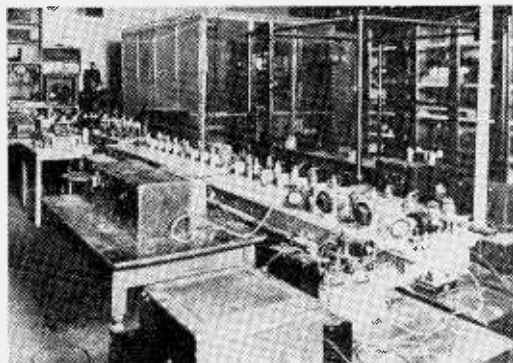

Fig. 6. Simple superregenerative receiver.



The intricate circuitry which first made FM radio possible was built by Major (Professor) Armstrong in the laboratories in the basement of Philosophy Hall on Columbia University's Morningside Heights campus. (See photo left.) In the twilight of his career Major Armstrong (below) returned to his childhood attic room. It was here that Armstrong, "bitten by the wireless bug," tinkered with wireless telegraphy as a boy. The room had remained locked and virtually untouched for over 25 years. Note fallen ceiling.



When the radio industry considered Armstrong's static-free FM radio too revolutionary, he built his own transmitter and antenna tower at Alpine, New Jersey from \$300,000 of his own funds. From this tower pioneer FM station W2XMN went on the air for the first time.





FM receiver employs a superregenerative detector. The circuit shown in Fig. 6 looks like the circuit of an ordinary regenerative detector except for the manner in which the grid leak (R1) is connected. The signal is picked up by the dipole antenna and is fed to antenna coil L2 which is inductively coupled to the tuned circuit C1-L1. Positive feedback is introduced by tickler coil L3, and the amount of regeneration or feedback is controlled by variable capacitor C3.

When C3 is correctly adjusted, the circuit "squegs" and a rushing background noise is heard. When a radio signal is tuned in, the noise diminishes or ceases entirely and the signal is demodulated. The audio output level is almost the same for all stations because of the inherent "limiting" action of the detector. The importance of limiting will be discussed later.

This circuit should not be used except with

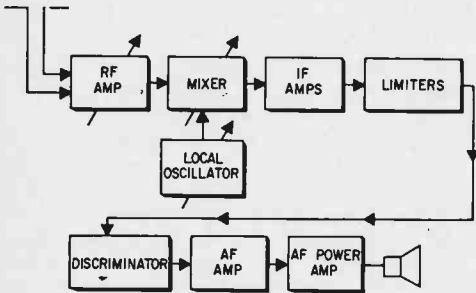

Fig. 7. Block diagram; superhet receiver.

an RF amplifier stage ahead of the detector. Otherwise, it will radiate a signal which might cause interference to other nearby receivers.

All commercially available FM receivers employ a superheterodyne circuit. Fig. 7 is a block diagram of a typical FM broadcast

receiver. The RF amplifier, mixer and local oscillator are tunable through the 88 - 108-mc FM band. The oscillator operates at a frequency 10.7 mc higher or lower than the frequency of the incoming signal in order to produce a 10.7-mc IF signal.

In most FM sets there are two or more IF stages. Unlike the IF amplifier in an AM receiver, the IF amplifier of an FM receiver must be able to pass a signal at least 150-kc. wide. Generally, the IF handpass is even wider in order to prevent distortion when the front end of the receiver is not tuned precisely to the carrier of the incoming signal.

**Limiters.** After the heterodyned (IF) signal has been amplified by the IF amplifiers, it is usually fed to one or more limiter stages. A limiter may employ diodes and thus produce no gain. But, in most receivers, the limiter stages employ tubes which amplify weak signals and limit strong signals. The limiters prevent the IF signal level from rising beyond a certain point and feed a variable frequency, constant amplitude signal to the FM detector.

The circuit of a two-stage limiter employing pentode tubes is shown in Fig. 8. Both stages employ grid-leak bias. When the signal at the grid of V1 swings positive, plate current rises, but only to a certain extent since the amplifier saturates easily. A negative signal at the grid causes plate current to drop, but only to a limited extent because of the bias developed in the grid-leak circuit.

When the signal is above a certain amplitude, the output signal fed to the primary of IF transformer T2 will not increase even if the input signal level increases. Furthermore, because of the 180° inversion of the signal through V1, V2 cleans up the other half of the signal. Consequently, both positive and negative signal excursions at the grid of V1 result in an output signal at T3 which is

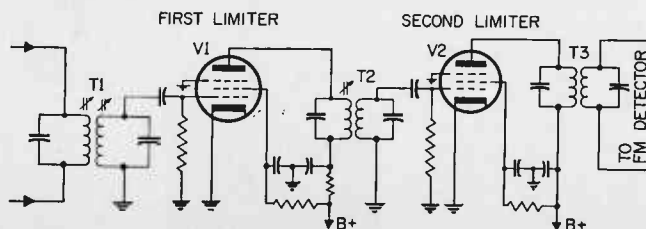
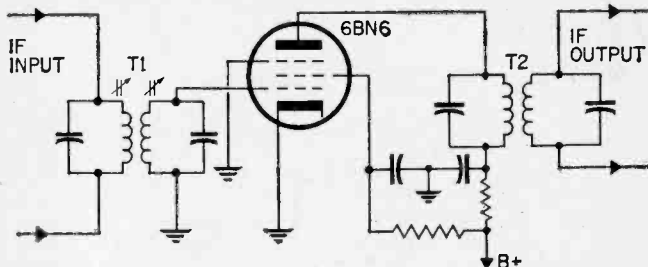

Fig. 8. Typical limiter stages in FM receiver. Tubes smooth out FM signal, eliminating the AM noise. Limiters can't change FM frequency so desired signal is unaffected by the circuit.

**Fig. 9.** The gated-beam tube is a more recent FM detector, found in FM and TV. Tune-up is fast, simple.



constant in amplitude and characterized by almost equal positive and negative excursions.

The gated-beam limiter is considered by many to be far superior to other types of limiters. As shown in Fig. 9, a 6BN6 or other gated-beam tube is used. This type of tube has unique characteristics. A small positive signal at its grid causes plate current to rise to maximum. However, a further positive increase in grid voltage will cause no further increase in plate current.

Similarly, a small negative voltage at the grid causes plate current cut-off. However,

C1-L1 remains excited at its normal frequency (carrier frequency) because of its relatively high Q. Thus the phase difference between the signals at the control and quadrature grids changes in accordance with the frequency of the incoming signal.

Both the control grid and the quadrature grid have a great effect on plate current. When both are slightly positive, maximum plate current flows. But when either is negative beyond a certain point, no plate current flows. Thus, variations in the frequency of the incoming signal produce differences in the voltage levels and polarity at these two

**Fig. 10.** Gated-beam tube is shown operating in FM detector circuit. Tube is both limiter and detector for the FM signal.

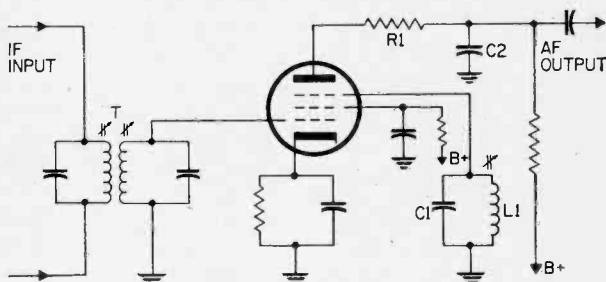

an increase in negative grid voltage will have no effect once plate current becomes zero. Hence, a relatively small sine wave signal at the grid will cause an essentially square wave output signal.

The big advantage of the gated-beam limiter is its fast response. There are no capacitors in the grid circuit to charge. The tube senses and erases noise pulses of very short duration.

**FM Detectors.** The gated-beam tube also makes an excellent FM discriminator (detector). As shown in Fig. 10, the IF signal is fed to its control grid. The tube provides limiting action as in the previous circuit. Through space-charge effect, the signal is also developed across tuned circuit C1-L1 which is connected to the quadrature grid of the tube.

When the input signal varies in frequency,

grids as well as their relationship with respect to time.

The resulting plate current consists of a train of pulses of varying width but relatively constant amplitude. Average plate current depends on the width of the pulses (time maximum plate current flows) and reproduces the audio modulating signal's characteristics. The audio signal is smoothed out by the linearizing circuit R1-C2.

Gated-beam discriminators are widely used in FM mobile receivers and television sets. They are easy to tune without instruments. The core of L1 is simply tuned for maximum audio recovery.

The Bradley FM detector circuit shown in Fig. 11 was developed at Philco. Although it outperformed conventional FM detectors, it wasn't popular with service personnel because an FM signal generator and an oscillo-

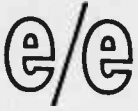

# HOW FM RECEIVERS WORK

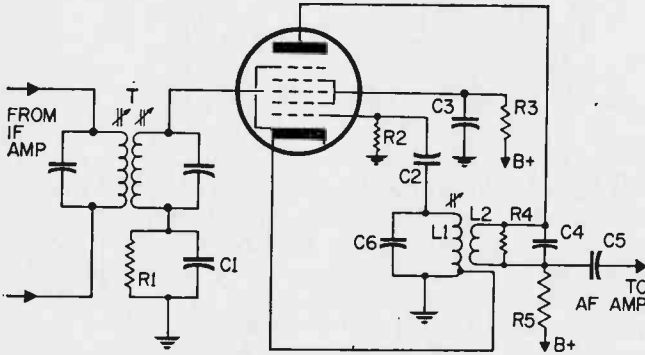

Fig. 11. In the Bradley FM detector, L1-C1 form oscillator circuit with tube. Incoming signal mixes with oscillator energy to recreate the audio signal.

scope were required to tune it properly.

A pentagrid converter type tube is used in this circuit. The incoming IF signal is fed to the injection grid. This signal is modulated by an oscillator, which employs the control grid, cathode and the screen grid (as a plate). This oscillator looks in with the incoming signal which is fed into the oscillator inductively by coil L2 in the plate circuit.

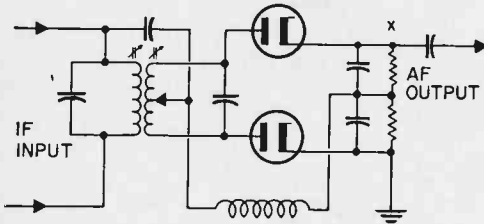

Fig. 12. The Foster-Seeley discriminator.

The circuit of L2 is broadly tuned because of the presence of R4 across it.

The FM signal is demodulated because the oscillator tends to lock in on the carrier frequency. However, as the incoming signal varies in frequency, the phase relationship between the signals at the control grid and injection grid changes. This causes plate current to reproduce the modulating (audio) signal.

The most well known FM detector is the Foster-Seeley discriminator, the circuit of which is shown in Fig. 12. When properly tuned, there is no signal at point "X" when the incoming signal is not modulated. When the signal changes upward and downward in frequency, the voltage at "X" becomes alternately positive and negative at the audio

rate. The amplitude of the voltage at "X" increases with the amount of frequency deviation. For good results, it is necessary that the incoming IF signal be free of amplitude variations, since this circuit will also respond to such changes.

The popular "ratio detector" is similar except that it has a built-in amplitude leveler. As shown in Fig. 13, diodes V1 and V2 are connected in series-aiding as far as capacitor C1 is concerned.

During the times that the incoming signal is positive at the plate of V1 and negative at the cathode of V2, the diodes conduct and charge C1. When the signal polarity reverses, the diodes do not allow current to flow through C1. However, C1 stores the voltage until the polarity again changes. After C1 has become charged, the circuit becomes insensitive to signal amplitude variations. The voltages across C2 and C3 must always equal the voltage across C1 since they are series connected across C1.

When the frequency of the incoming sig-

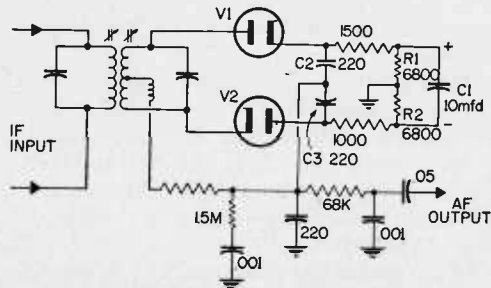

Fig. 13. Ratio detector is now most common.

nal changes, the voltage across C2 decreases and the voltage across C3 increases alternately. This is because the sum of the voltages across each of these capacitors must equal the voltage across C1. The voltage between the junction of C2-C3 and the junction of R1-R2 (ground) is the recovered audio signal.

The capacity of C3 (several microfarads) is so great that noise impulses are ironed out. If the incoming signal level fades slowly, the voltage across C3 will also vary slowly. For this reason, many receivers employing ratio detectors also employ limiter stages ahead of the detector to keep the volume level constant.

The circuits shown here are typical, although manufacturers employ many variations. Some even use slope detectors. A slope detector is simply an AM detector that is tuned so that the input voltage applied to the detector itself varies with frequency. In the circuit shown in Fig. 14, for example, L1 is tuned to one side of the center frequency and L3 to the other side. The unmodulated FM carrier causes the grid voltage to be at some point other than maximum or minimum. When the incoming signal changes in frequency, the grid voltage will rise when the frequency approaches the frequency to which T2 is tuned. Similarly, it will fall when the frequency moves toward the fre-

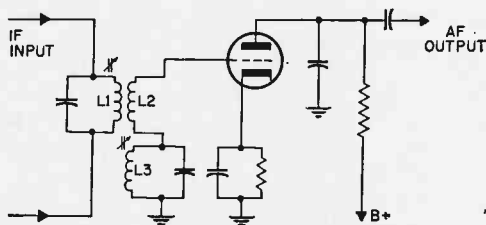

Fig. 14. Slope detector (now rarely used).

quency to which L3 is tuned.

Slope detection takes place when an AM short-wave receiver is tuned to an FM signal within its range (usually 25-30 mc). The FM signal can be demodulated by tuning the receiver slightly off the carrier frequency of the incoming FM signal. The same technique is used when the Hartman VHF converter is used with an auto radio, as shown in Fig. 15,

This converter employs a crystal-controlled oscillator and a mixer which produces an IF signal within the tuning range of the AM auto radio. The crystal is ground to a specified frequency for receiving a certain VHF mobile signal. However, other stations can be tuned in with the auto radio tuning dial. When using such a converter, the converter and the auto radio form a double-conversion superheterodyne receiver, the first IF of which is tunable over a range of approximately 1000 kc.

It should be noted that the slope detector is not as good as other types of FM detectors since it offers no noise improvement unless limiter stages precede it. Nevertheless, it affords an inexpensive way to demodulate FM signals.

An ordinary AM receiver equipped with a converter normally will not produce satisfactory results when tuning in FM stations. This is because of the narrow bandpass of the AM receiver's IF amplifier and the wide frequency deviation of the FM signal. However, acceptable results can be obtained when tuning in narrow hand ( $\pm 5$ -kc.) FM signals, such as those transmitted by U.S. Weather Bureau stations on 162.55 mc in New York, Chicago, St. Louis, Kansas City and Los Angeles.

**Capture Effect.** An FM signal equipped with limiters will favor the stronger of two signals on the same frequency. In fact, it will

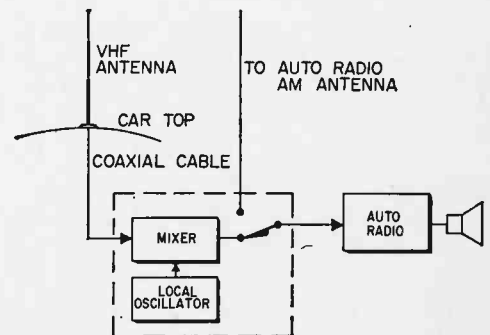
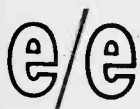

Fig. 15. Converter lowers FM to AM band.

reject the weaker one, provided the stronger one is at least 6 db (twice the field strength) stronger than the weaker signal. When tuned into an FM communications station, for ex-



ample, the desired signal can be wiped out and an undesired stronger signal will be heard. This is called the FM "capture effect."

**FM Reception Problems.** FM broadcast reception fidelity can be impaired by multipath propagation. If the signal reaches the receiving antenna directly and via one or more reflected paths, there will be two or more signals being fed to the receiver. In this case, the signals may not arrive at the same time as the others because of longer paths. When this happens, some signals may oppose each other or combine unfavorably to produce distortion.

When located near a strong FM station, some receivers overload and in some cases one station may tend to blanket the entire dial. Except when virtually on top of the strong station, this is a receiver design fault. Receiver front-end overloading has been overcome in many FM receivers through proper design. While great gain is desirable for long-range reception, it can compound overloading problems.

Many FM receivers have an AFC (automatic frequency control) circuit. The purpose of this circuit is to automatically tune the receiver's local oscillator to the desired station even though the tuning dial is slightly off frequency, AFC also compensates for local oscillator drift which may occur to a considerable extent when the receiver is first turned on.

**Commercially Available Equipment.** There is a wide selection of receivers capable of FM reception. FM tuners are com-

plete receivers except for an audio amplifier capable of driving a speaker. They are intended for use with separate audio power amplifier. Recently, several manufacturers have introduced so-called high-fidelity FM receivers or "tuner-amplifier" combinations, some capable of delivering up to 112 watts of audio to external speakers.

FM-multiplex stereo receivers and tuners are extremely popular in areas where FM-stereo programs are broadcast. From the antenna to the detector, they are essentially the same as other FM receivers. To enable stereo reception from a single station, these receivers are equipped with a multiplex circuit that separates the two audio channels. The same program may be heard with a conventional FM receiver but without the stereo effect. FM-multiplex stereo is a complete subject in itself and will be covered in a future article.

Communications-type FM receivers are similar to FM broadcast receivers except that IF bandwidth is much narrower in order to provide the required selectivity. There are tunable FM receivers for the 30-50 mc and 150-174 mc mobile radio bands. However, receivers used in actual operations nearly always employ crystal-controlled local oscillators to enable reception on one channel only without requiring manual tuning.

There has been a great deal of controversy over whether AM or FM is better for communications purposes. Both have merit, and SSB (single sideband) may prove to be even better. But, for broadcast reception, FM is superior to any other present technique. ■

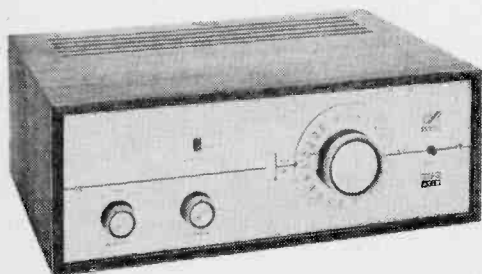

FM receivers come in many sizes and shapes. Above, walnut cased EICO Model 2718 high fidelity home receiver and at right General Electric modular unit from two-way radio.

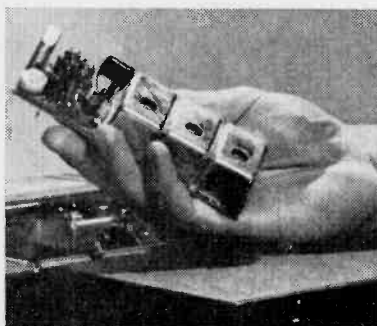

# INSIDE THE OSCILLOSCOPE

An electron stream wiggling across a phosphorescent screen will shed some green light on your waveform measurements—By Leo G. Sands

□ The oscilloscope is unquestionably the most versatile and useful electronic testing instrument you can have on your workbench—whether it be for hobby purposes or servicing. It is a voltmeter which measures voltage with respect to time and presents its measurements in graph form. But first, let's look into how it works.

The oscilloscope heart is a cathode ray tube (CRT) which is similar to a television picture tube except that its beam is moved by applying *voltage* to its deflection plates. In a TV picture tube the beam is moved by applying *current* to its deflection coils. Almost all CRT's employ electro-static deflection whereas almost all modern TV picture tubes employ electro-magnetic deflection.

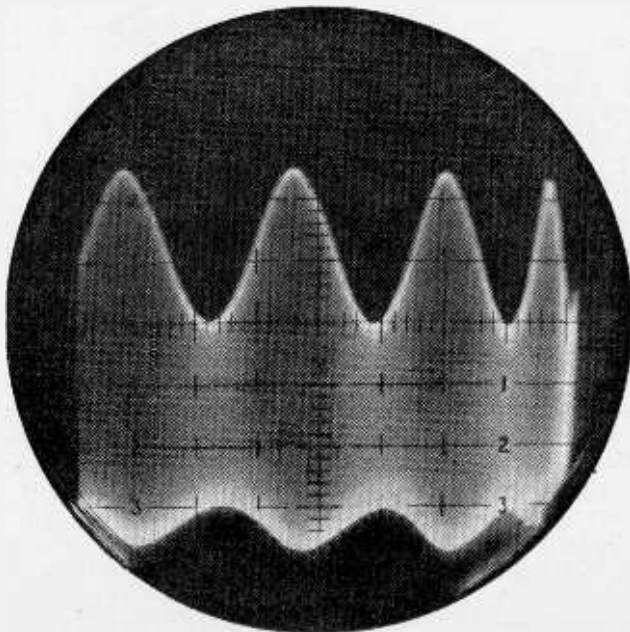

**Inside the CRT.** Electrons are emitted from a cathode and are hurled through various grids toward a phosphorescent screen as shown in Fig. 1. When the electrons strike the screen, the screen glows at the point of impact with the electrons. The electron stream passes through a space which has four plates that are used for deflecting the electron stream. Fig. 2 shows a dot which is the electron beam, the two plates marked "V" are the vertical deflection plates and those marked "H" are the horizontal deflection plates.

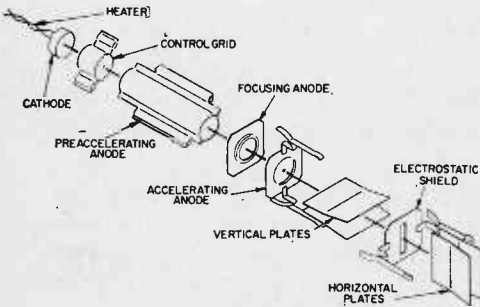

**Fig. 1. Detail diagram of an electronic gun found in cathode ray tubes. Electrons travel from cathode, through deflection plates to screen.**

If we apply a DC voltage to the horizontal deflection plates, as shown in Fig. 3, the dot (electron stream) moves toward the plate at the right which is positively polarized. If we reverse the polarity of the voltage, the dot will move to the left.

By applying a DC voltage to the vertical deflection plates, as in Fig. 4, the dot is moved upward—reversing the polarity of the voltage—moves the dot downward. And, if we apply DC voltages to both sets of plates as in Fig. 5, the dot can move in an oblique direction.

Now, if we use two potentiometers to make it possible to adjust the voltages and their relationship as well as their polarity, as shown in Fig. 6, the dot can be moved to any point on the screen. By turning R1, we can make the top vertical deflection plate positive or negative—R2 lets us do the same to the horizontal deflection plates.

**Voltmeter.** We can measure DC voltage,

using the circuit shown in either Fig. 3 or 4, if we know the sensitivity of the CRT, by noting how far the dot moves from its normal position on the screen.

It is possible to measure AC voltage by applying it to the vertical deflection plates, as shown in Fig. 7. As the AC voltage rises,

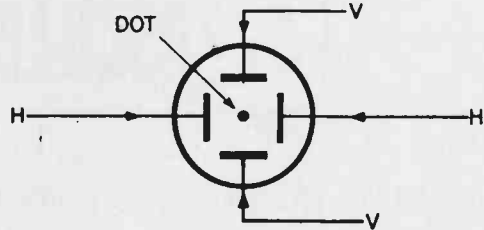

**Fig. 2. Undeflected dot (electron stream).**

falls and reverses in polarity, the dot is moved up and down with each AC cycle. A vertical line is painted on the screen and remains there until the AC voltage is removed. The position of the vertical line can be moved to the left or right by adjusting potentiometer

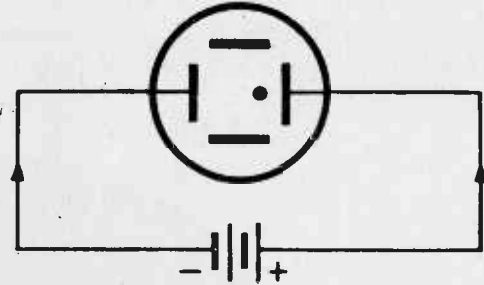

**Fig. 3. Dot moves right to positive plate.**

R. The length of the vertical line is determined by the level of the AC voltage.

**Measuring Time.** By applying a sawtooth voltage to the horizontal deflection plates, as shown in Fig. 8(A), the dot moves at even speed from the left side of the screen to the right. The sawtooth voltage rises evenly from zero to its maximum value and then drops abruptly to zero, and keeps repeating itself, as shown in Fig. 8(B).

If it requires one second for the sawtooth voltage to rise from zero to its maximum value, the dot moves from the left to the right in one second. When the voltage drops abruptly to zero, the dot moves back to the left



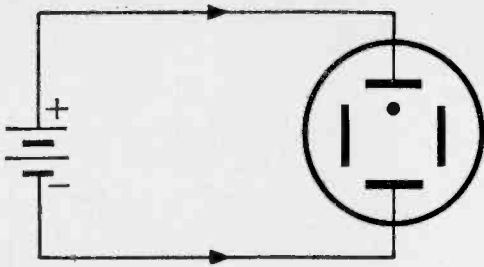

Fig. 4. Dot moves up to positive plate.

at such high speed that it can't be seen. But during its left to right excursions, the dot can be seen traversing in a straight horizontal direction. Thus, we can measure *time*. If we apply a DC voltage across the vertical plates, the horizontal trace will be moved either up or down, depending upon the polarity of the DC voltage. But, it will remain horizontal as

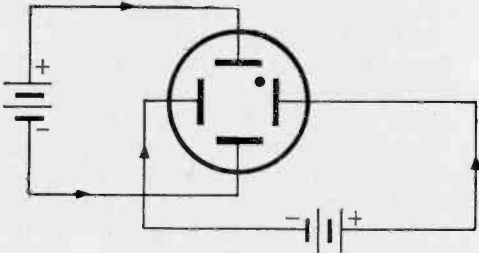

Fig. 5. Dot moves right and up to corner of the two positive plates.

long as the DC voltage is steady.

Now, if we set the sawtooth oscillator to generate one sawtooth wave once every  $\frac{1}{60}$ th of a second, the horizontal trace will appear as a solid line because it retraces itself so fast that the eye thinks it sees it all the time.

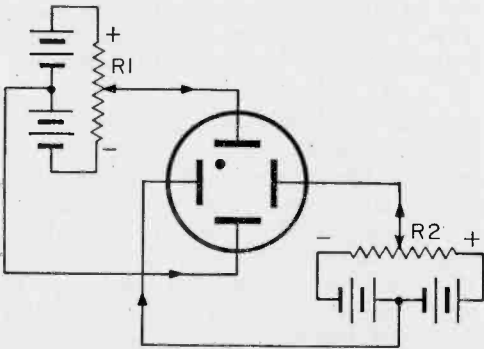

Fig. 6. Position of dot can be varied by adjusting potentiometers R1 and R2.

When we apply a 60-cycle AC voltage to the vertical deflection plates, and a 60-cycle sawtooth voltage to the horizontal deflection plates, as shown in Fig. 9, the AC voltage waveform will appear on the screen. Fig. 10 shows the waveform for one and two sawtooth cycles. If the sensitivity of the CRT is known, we can determine the peak-to-peak voltage of the AC signal by measuring the distance between its positive and negative waveform peaks.

**At the Beginning.** The forerunner of the oscilloscope was the *oscillograph*. In a very simple oscillograph, a paper tape moves at a steady speed and a pen writes on it as its arm is moved by a meter movement, as shown in Fig. 11. The swing of the pen, as indicated by the trace it writes, is determined by the level of the voltage being measured; time is measured by the speed of the paper tape travel. Obviously, such an instrument cannot be used to examine high frequency signals because of the slow tape speed and the inertia of the pen mechanism.

An *oscilloscope*, on the other hand, is an electronic device capable of high speed operation. A typical oscilloscope is shown in Fig. 12. While we have shown direct connections to the deflection plates in Figs. 2 through 9, an oscilloscope employs amplifiers as shown in Fig. 13, and fairly complex sweep circuits.

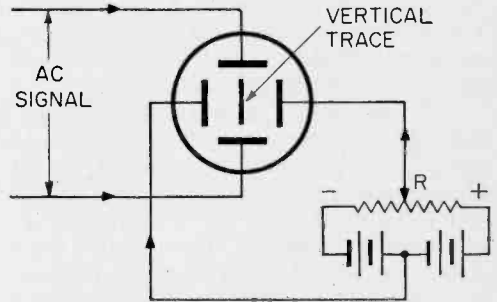

Fig. 7. A rapidly moving AC signal will cause a vertical line trace.

**What's up front.** The scope (abbreviation for oscilloscope) shown in Fig. 12 has several front panel adjustments. The focus (sharpness of dot) is adjusted with the upper left hand knob, and the brightness of the dot with the upper right hand knob. The vertical position of the dot may be adjusted with the knob at the left near the bottom of the screen, and its horizontal position with the knob on the opposite side.

The center knobs (one over the other) are used for selecting the sweep rate (sawtooth frequency). The gain of the vertical amplifier is adjusted by the dual knob at the lower left (vertical sensitivity) and the horizontal gain by the dual knob at lower right.

Connections to the vertical and horizontal inputs are made at the binding posts at the bottom of the front panel. The slide switch at the lower left hand corner is usually set to AC except when a DC voltage or an AC

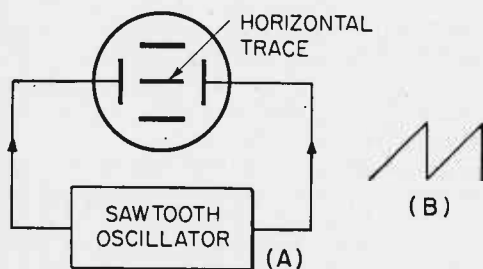

Fig. 8. A horizontal line trace occurs when AC signal is on horizontal plates.

signal with DC imposed is to be observed. The sawtooth signal generated within the scope is available for external use at the pin jack in the lower right hand corner.

With the vertical gain set to maximum, and the horizontal gain set to zero, a vertical line will appear on the screen which will be one centimeter in length for each 18 millivolts (0.018 volts) of input signal applied to the vertical input. By turning up the horizontal gain and adjusting the sweep frequency, the waveform of the signal applied to the vertical input will be seen on the screen. The higher the voltage applied to the vertical input terminals, the lower the vertical gain control setting.

**Using a Scope.** There are countless uses for a scope. In Fig. 14, a set-up is shown for observing a 60-cycle AC signal. Transformer T is a 6.3-volt filament transformer and R is a potentiometer of any convenient value and functions as a variable voltage divider. The adjustable AC voltage is applied to the vertical input terminal and the "G" terminal which is grounded and is common to both the vertical and horizontal inputs. By ad-

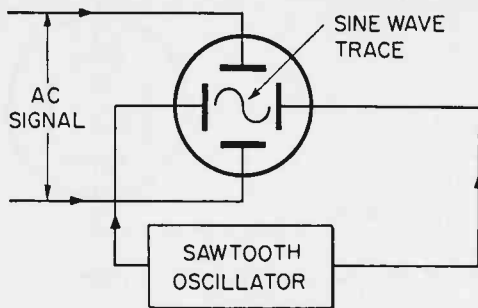

Fig. 9. An AC sinusoidal wave can be seen when a sawtooth signal is applied to the horizontal plates.

justing the vertical and horizontal gain controls, and the sweep frequency, we can observe a single cycle or several cycles (by increasing sweep frequency to a multiple of 60 cycles) of the 60-cycle signal. By adjusting R, changes in the amplitude of the applied AC signal can be seen.

Higher frequency signal waveforms are observed by connecting the output of a signal generator to the scope's vertical input as shown in Fig. 15. If the signal generator is a sine wave audio frequency (AF) oscillator, we can look at its output waveform and note what readjustment of the scope is necessary as we change the frequency.

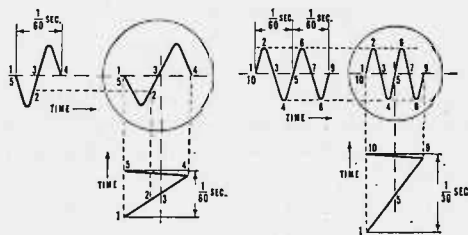

Fig. 10. The numbered points on the two waveforms occur at the same time. This way you can see how trace is developed.

If the signal generator is a combination sine wave/square wave type, it can be set to generate square waves and observe their waveform on the scope screen. By connecting a capacitor, C, in series with the generator output lead and a potentiometer (connected as rheostat) across the vertical input, as shown in Fig. 16, we can observe the effect of this R-C network on sine wave and square wave signals at various frequencies. When R is a one-megohm potentiometer and C has a value of 0.005 mfd, low frequency square

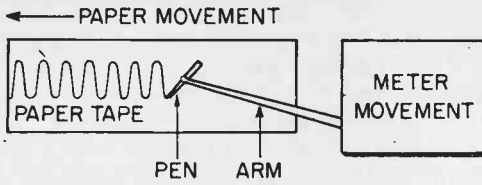

Fig. 11. The oscillograph is an electro-mechanical device that places an inked trace on a moving strip of paper.

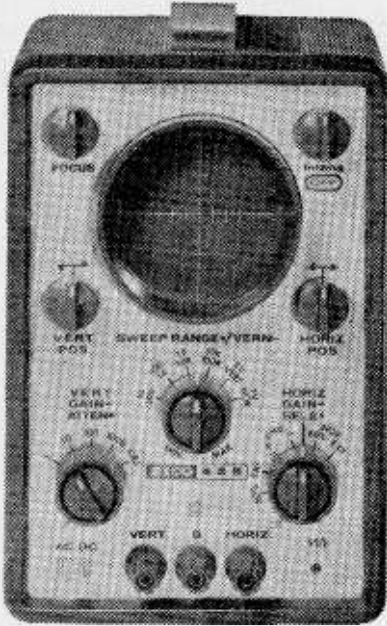

Fig. 12. The EICO 435 oscilloscope, made from a kit, is typical of many models available at moderate prices.

waves can be converted into pulses whose width can be varied by adjusting  $R$ . Also, when using a sine wave signal, we can observe how  $C$  and  $R$  affect frequency response, particularly at low audio frequencies. This demonstrates how the frequency of an audio

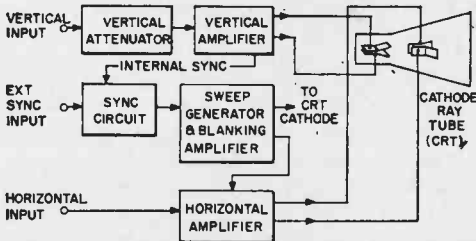

Fig. 13. Block diagram of a typical oscilloscope designed for workbench use.

amplifier is affected by the values of inter-stage coupling capacitors and associated grid resistors.

By putting  $R$  in series with the signal generator output lead and  $C$  across the scope's vertical input, we see other effects on wave shape and amplitude with respect to frequency.

**Looking at RF.** If the signal generator is an RF oscillator and is connected to the scope as shown in Fig. 15, we can observe RF waveforms when the signal generator is set to produce an unmodulated signal. The highest frequency to which the signal generator can

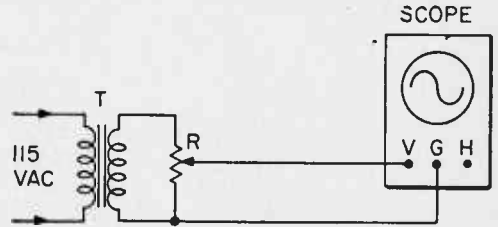

Fig. 14. Set-up for observing 60-cycle AC.

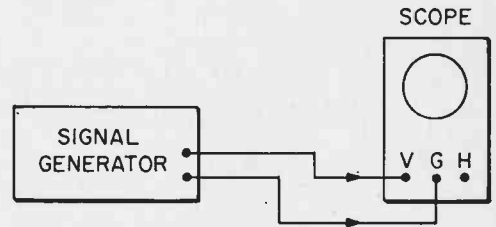

Fig. 15. Signal generator connect to oscilloscope's horizontal input terminals.

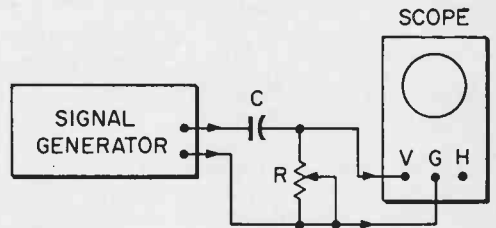

Fig. 16. By connecting a signal diode across resistor  $R$  you can discover how radio AM signals are detected.

be set and still be able to discern the waveform depends upon the frequency response characteristics of the scope. Using the scope shown in Fig. 12, it was possible to observe and lock in signals up to 12 mc. Although this scope has a rated frequency response of

DC to 4.5 mc, it is useful at higher frequencies, but the vertical size of the waveform becomes smaller at frequencies above 5 mc or so.

Turning up the RF signal generator's modulator *on* (amplitude modulation—AM), we can see what an AM radio signal looks like (see Fig. 17). Now, by using the hook-up shown in Fig. 16 and adding a crystal diode across R, we can see how a detector works.

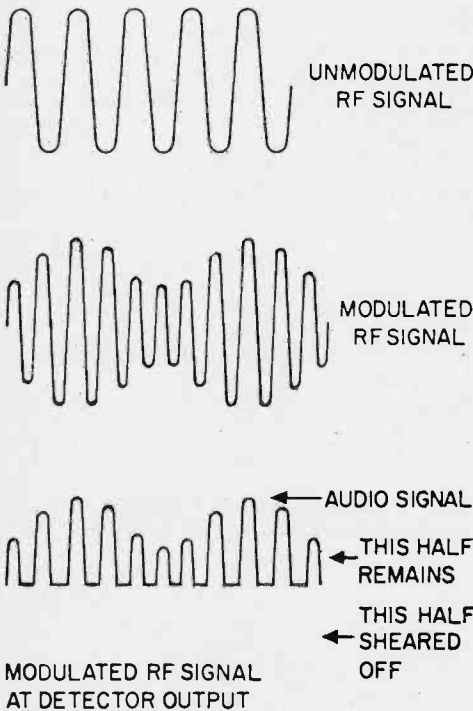

Fig. 17. Most signal generators have modulated and unmodulated outputs. These and detected signal (bottom) can be viewed.

It cuts off part of the waveform and allows us to take a look at the audio modulating signal.

**Trouble-shooting.** Now that we have learned the basics of using a scope, we can use it as a signal tracer. We need a low-capacity probe which can usually be purchased at most radio parts stores. The schematic of a low frequency probe is shown in Fig. 18. The lead to the vertical input ter-

minal of the scope is the inner conductor of a shielded cable. The ground terminal is connected to the shield of the cable.

The pin of the probe is touched to the circuit being checked and the ground clip is fastened to the chassis of the device being checked. The signal passes through R and C which are connected in parallel. Resistor R usually has a high value around 33 megohms and C usually has a value of a few

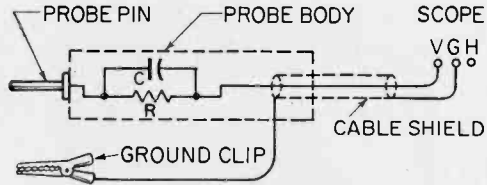

Fig. 18. Probes reduce circuit loading.

picofarads (micro-microfarads). This R-C network reduces the level of the signal reaching the scope and C makes the probe favor higher frequencies, and at the same time reduces the loading effect on the circuit being checked.

By touching the probe pin to the grid and then the plate of every stage of a radio receiver or audio amplifier, when a signal is present, it is possible to view the waveform of the signal at these points. When checking

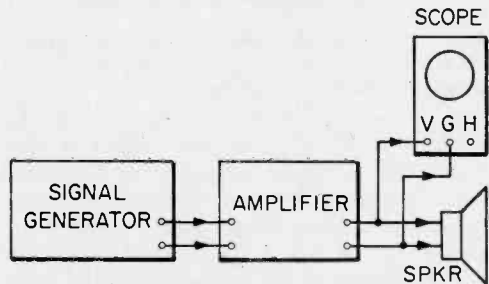
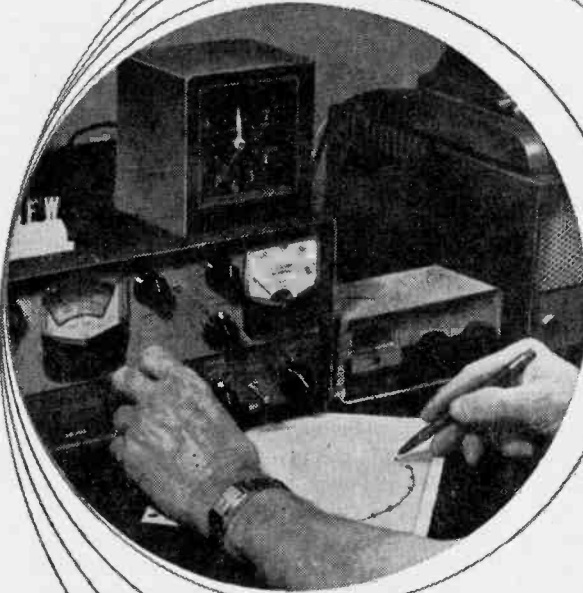

Fig. 19. Audio output from an amplifier can be best rated by observing on 'scope.

RF and IF circuits, the waveform will look something like that shown in Fig. 15. When checking audio circuits, the waveforms of the music or speech will be seen.

**Audio.** The characteristics of an audio amplifier, or the audio section of a radio receiver, may be observed by feeding the output of an audio signal generator into the audio amplifier input as shown in Fig. 19.

(Continued on page 97)



now's the time to

# MEASURE YOUR ANTENNA RESONANCE

BY L. M. DEZETTEL, W9SFW

Hams! CB'ers! Don't throw away precious RF power with a mis-tuned antenna

**T**here's no point in investing time, effort and hard cash in a hot rig and a high antenna, and then not insure that they work together as well as possible. Many a rig is wasting power trying to buck standing waves on the transmission line and trying to drive adequate energy out of a mistuned antenna. It's a safe bet that there is an awful lot of rigs on the air, both CB and Ham, that could stand some checking into how accurately their antenna is *resonated* at the frequencies they are trying to work. It's easy to do and it can save you a lot of RF soup.

**What is this resonance business?** Basi-

cally, it has to do with tuned circuits. Connect a coil in parallel with a capacitor and you have a tuned circuit. The combination "resonates" at a specific frequency, depending on the amount of inductance in the coil and the capacitance in the capacitor. And although it usually has no coils or capacitors visible as such, an antenna also has inductance and capacitance. It is the job of the antenna to broadcast the RF energy of a transmitter with maximum efficiency and this it usually does best when resonant to the RF frequency being transmitted. The length of an antenna determines its inductance (L)

# e/e ANTENNA RESONANCE

DISTRIBUTED CAPACITIES

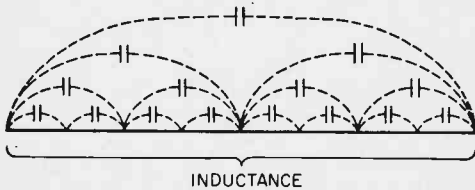

Fig. 1. Like any resonant circuit an antenna has an inductance and capacity giving rise to equal value inductive and capacitive reactances at the resonant frequency.

and is equivalent to the coil in a coil-capacitor combination. Capacitance (C) appears between each element or length of wire to every other element or length of wire in the antenna. (See Fig. 1). This is known as distributed capacitance. This capacitance varies somewhat depending on how high off the ground the antenna is. Thus, any stretched out piece of wire (an antenna) has both inductance and capacitance and will resonate at a specific radio frequency.

**Cut to Size.** Antennas are usually made to resonate at a desired frequency by cutting them to a certain length, therefore all formulas are based on length. The formulas automatically take into account the combination of inductance and capacitance.

If you put up a simple wire antenna (called a half-wave dipole) it will be close to resonance if you cut it to the following length:

$$\frac{468}{\text{freq. in mc.}} = \text{length in ft.}$$

This formula is good for wire antennas up to about 30 mc. For frequencies above that, and for antennas made of metal tubing rather than wire where special tables should be consulted. Vertical antennas which are comparatively close to the ground, also have a slightly different formula. You don't have to bother about it though because most vertical antennas are commercially available already cut to length for resonance. As an example, CB antennas for mobile use, are nearly all 96" long. Most amateur verticals have one or more traps (coil and capacitor assemblies) along their length that are pre-tuned to provide a physically shorter antenna and one that will operate on more than one amateur band. A low cost approach to ver-

tical-antenna design is the frequently seen 18-foot length of aluminum tubing with a coil at the bottom end such as the Hy-Gain 18-V and equivalents. A tap must be properly set on the coil and resonating in the chosen band.

**Measuring L-C.** The grid-dip oscillator (GDO) is an instrument for measuring the resonant frequency of a coil-capacitor combination. Essentially, the GDO is a tunable RF oscillator with a meter added to measure the oscillator tube's grid current. When the coil of the GDO is brought close to a tuned circuit, and the two circuits are resonant to the same frequency, energy is absorbed from the oscillator. This affects the grid current and the change shows on the meter. That's how the instrument got its name—the grid current would "dip" when the oscillator is coupled and tuned to a resonant circuit.

Antenna resonance is most accurately measured when the GCO is coupled to its center. But this is physically impossible when the antenna is a horizontal half-wave dipole strung high in the air. Resonance can be checked at the base of a vertical antenna however, since the base is the electrical center. This comes about because the vertical section is cut for one-quarter wave in length and the earth-ground or the body of the car, in the case of a mobile antenna, provides the other quarter-wave.

**Z Bridge.** Another method of measuring antenna resonance indirectly is to use a SWR (Standing Wave Ratio) bridge or a "Z" (impedance) bridge. These methods are physically far more convenient since the measurements are made at the input end of the feed line connected to the antenna.

To understand how a bridge makes measurements on antennas it is necessary to know that antennas have another characteristic in addition to its L and C that is important to its function. The exact electrical center of an antenna exhibits a pure resistance characteristic at resonance. The center of a horizontal-wire dipole, for example, has an impedance of 72 ohms. It is called "impedance" because you can't measure it with an ohmmeter, like a resistor). The bottom center of most vertical antennas has an impedance of about 36 ohms. The center of the driven element of a three-element beam has an even lower impedance.

**Matching Z.** The transmission lines or "feeders" carrying the RF energy from the transmitter are connected to the electrical center of the antenna. Transmission lines

also have a "characteristic impedance" based on their physical construction. When the impedance of the antenna (at the point of connection) is the same as the impedance of the transmission line there is the most efficient transfer of power. A 76-ohm twin-line is preferably used for horizontal dipole antennas as it provides an excellent match. Verticals and other antennas are fed with coaxial cable having an impedance of around 52 ohms. Any mismatch between the coaxial cable and the antenna is corrected by various impedance-adjusting methods, and is really important only when feeding a beam antenna. Any slight mismatch in feeding a vertical antenna is usually ignored. In the case of a mobile installation, the length of the feeder is usually so short that any losses in it resulting from mismatch is of little consequence.

**SWR.** When a 52-ohm coaxial cable is connected to an antenna and it "sees" an impedance other than 52 ohms, some of the energy sent to the antenna is reflected back and adds to and subtracts from the outgoing wave. This results in "standing waves" on the feed line. A standing wave ratio (SWR) bridge measures the ratio of the maximum current to the minimum current. When the match is perfect with no standing waves on the line and the match is said to have a ratio of one-to-one (1:1).

A higher than 1:1 SWR can result from mismatch between transmission line and antenna, an off-resonance antenna, or a combination of both. We shall use the off-resonance effect to determine resonance of the antenna. And we shall do this by plotting a curve of SWR versus frequency.

As mentioned before, two types of bridges may be used for the measurement of antenna resonance. The more common of the two is the SWR bridge.

Most units are designed to take any amount of power coming from ham shacks and may be left in the line permanently. It can handle the output power of a 5-watt CB transceiver or a 1-kilowatt amateur transmitter. While it is most commonly used to determine the mismatch between transmission line and antenna, and to aid in making adjustments to improve the match, we shall plot a curve of SWR at different frequencies to measure the resonance of the antenna. To do this you must have a transmitter with a built-in VFO (such as the amateur transceiver shown in the photo) or enough crystal positions in a CB transceiver to give you

several points on a curve.

**How It's Done.** Install the SWR bridge as shown in the block diagram in Fig. 2. Set the VFO dial to the lowest even 50-kc

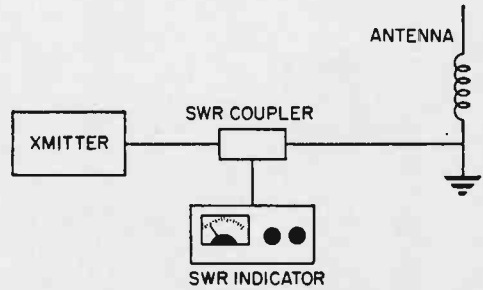

**Fig. 2. Block diagram for interconnecting test gear to measure the SWR of an antenna. VFO in transmitter supplies the RF signal.**

dial reading. Turn on the carrier and, with SWR bridge switch in the "forward" position, set the variable control on the SWR for full scale. Switch to "reflected" and note the SWR ratio reading. Write this down. Tune the VFO 50-kc higher up the frequency band and record the reading. Depending on the band in which the measurement is being made it may be necessary to retune the transmitter drive and output controls to resonance as you move across the band. When you have recorded the SWR reading for each 50-kc point on the dial, transfer this information to a sheet of graph paper. You will end up with a curve as in Fig. 3. The point in the curve of lowest SWR reading is antenna resonance. A graph is obviously not a necessity to finding the point of resonance except where resonance occurs at one end or the other of the band. Then the graph helps establish a general shape that can be pro-

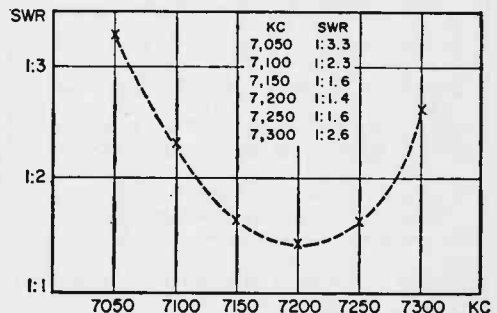

**Fig. 3. Graph made of SWR plots for every 50 kilocycles on a typical dipole antenna tuned to the amateur 40-meter band. If VFO is not available, use several crystals.**



# e/e ANTENNA RESONANCE

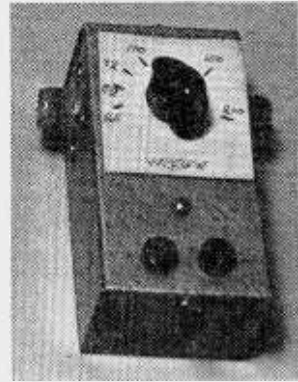
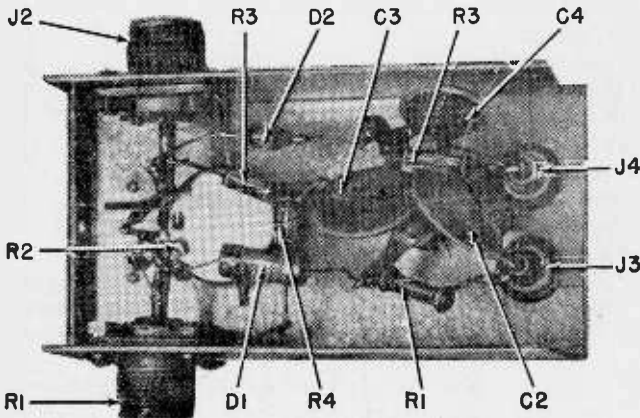

After building the impedance bridge, the next big task is to calibrate the pointer-dial.

Fig. 4. Schematic diagram for an impedance bridge that can be assembled from purchased parts. Potentiometer R2 should be a linear-taper unit. Keep leads very short and shield unit inside aluminum chassis.

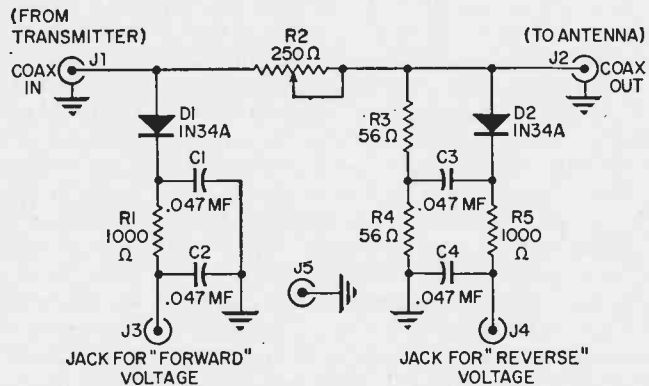

## PARTS LIST

- C1, C2, C3, C4—.047 mf, 600 volts, ceramic disc capacitor
- D1, D2—Germanium diodes, IN34A or equiv.
- J1, J2—Chassis-mounting coax connector (to match connectors on transmitter)
- J3, J4, J5—Insulated tip jack
- R1, R5—1,000 ohm, 1/4 or 1/2-watt resistor, 10%
- R2—250-ohm carbon potentiometer, linear taper
- R3, R4—56 ohm, 1/4 or 1/2-watt resistor, 10%
- 1—Bud Minibox, No. CU-2102-A, 4" x 2 1/8" x 1 5/8"
- 1—Pointer knob, short length of coax cable with plugs to connect Z-bridge to transmitter

jected to a probable resonance point outside the band edges.

For a CB transceiver record the readings in the same way except for each of the crystal positions you have. Make the figures in frequency rather than in channel numbers. Transfer the readings to graph paper and

establish a resonance point as described.

The shortcoming of a SWR bridge is that they are usually designed for use only with 52-ohm coax lines, although they can be used with other impedance cables by changing the value of some internal resistors.

**Using the Z Bridge.** The second of the two bridges is the Z bridge. The one shown in the photograph and Fig. 4 is a homemade device and differs from the SWR bridge in two respects. It has a control (RZ) that permits it to be used with different transmission line impedances. The control is marked off on the face plate in actual DC resistance, and dial readings will then be in transmission line impedance. Its limited power handling capacity (it will take only about 1/2 watt) is its biggest drawback since it requires either that the output power of the transmitter be reduced during tests, or that a signal generator be used. The drawback isn't too severe

(Continued on page 95)

# After Ohm's Law MAXWELL'S CYCLIC METHOD

BY JAY COPELAND

**F**ar too many electronic experimenters and technicians go around in *loops* trying to solve simple network problems using Ohm's law only. This is all to the good provided they are using *Maxwell's cyclic method* along with Ohm's law.

Ohm's law applies to a single element in a circuit or many elements that can be combined into one resistive element for computational purposes. However, there exist circuits where the resistive elements cannot be grouped into a single convenient element. Also, there may be more than one voltage source to further the difficulty in applying Ohm's law. These circuits cannot be dealt with without other basic laws, rules, or mathematical methods.

In the last issue of *ELEMENTARY ELECTRONICS*, (Spring, 1965), Kirchhoff's laws

were discussed in detail. These laws can be used to solve the problems given in this article, however, in most cases you will soon agree that Maxwell's cyclic method is easier to work with as a mathematical tool once you know how to use it.

**Maxwell's Cyclic Method.** Fig. 1 shows

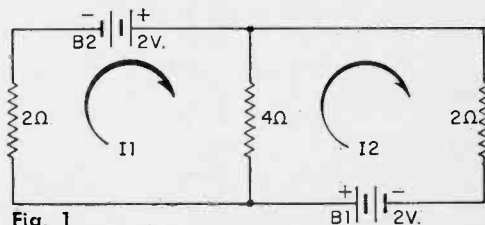
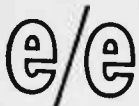

Fig. 1

a simple network similar to that which yielded to solution by Kirchhoff's laws in our last issue. Now, applying Maxwell's cyclic



method we will display a new technique for determining *currents* in and *voltages* across resistors in the network. In Fig. 1 two possible current loops for assumed currents  $I_1$  and  $I_2$  are shown.  $I_1$  is an upward current through the 2-ohm resistor at the left in Fig. 1.  $I_2$  is the downward current in the 2-ohm resistor at the right.  $I_2 - I_1$  is the upward current and  $I_1 - I_2$  is the downward current in the 4-ohm resistor.

Now, let's write the equations for the voltage rises and drops, first clockwise around the left loop and then clockwise around the right loop for currents  $I_1$  and  $I_2$ , respectively. If you recall, these equations are based on *Kirchhoff's voltage law* which states that *the sum of all the source voltages in a closed path of a circuit are equal to the sum of all the voltage drops in the closed path*. The equation for the left loop in Fig. 1 is

$$2 = 4(I_1 - I_2) + 2I_1 \quad (1)$$

and for the right loop

$$2 = 4(I_2 - I_1) + 2I_2 \quad (2)$$

In equation (1), the term two (2) on the left side of the equation equal sign is for the 2-volt battery B1 voltage source. The voltage drop across the 4-ohm resistor is the product of the downward current ( $I_1 - I_2$ ) and the 4-ohms resistance which gives us the term  $4(I_1 - I_2)$  on the right side of equation (1). Nothing mysterious was done here. *Ohm's law* says that  $E = IR$ . The remaining term is the voltage drop caused by  $I_1$  through the 2-ohm resistor. Again, *Ohm's law* to the rescue. The same logic holds true for equation (2) except the current through the 4-ohm resistor is now an upward current, or ( $I_2 - I_1$ ).

Now to solve the two equations, we first group the terms as follows:

$$2 = 4(I_1 - I_2) + 2I_1 \quad (1)$$

$$2 = 4I_1 - 4I_2 + 2I_1$$

or

$$2 = 6I_1 - 4I_2$$

reducing to

$$1 = 3I_1 - 2I_2 \quad (3)$$

and

$$2 = 4(I_2 - I_1) + 2I_2 \quad (1)$$

$$2 = 4I_2 - 4I_1 + 2I_2$$

or

$$2 = 6I_2 - 4I_1$$

reducing to

$$1 = 3I_2 - 2I_1 \quad (4)$$

Now, in equations (3) and (4) we have two equations in two unknowns which can be solved by multiplying both sides of equation (3) by the number three (3) and equation (4) by the number two (2) giving rise to equations (5) and (6), respectively.

$$3 = 9I_1 - 6I_2 \quad (5)$$

$$2 = -4I_1 + 6I_2 \quad (6)$$

Adding equations (5) and (6) together (note that the  $I_2$  terms cancel out) we get

$$5 = 5I_1$$

$$I_1 = 1 \text{ ampere.}$$

or

Substituting the value for  $I_1$  in equation (5) (or in any equation from (1) to (6)) we get

$$3 = 9 - 6I_2 \quad (5)$$

or

$$6I_2 = 6$$

$$I_2 = 1 \text{ ampere.}$$

As a check, substitute the values for  $I_1$  and  $I_2$  into equations (1) and (2).

$$2 = 4(1 - 1) + 2 = 2 \quad (1)$$

and

$$2 = 4(1 - 1) + 2 = 2. \quad (2)$$

Both sides of the equal sign for each equation are numerically equal indicating that correct values for  $I_1$  and  $I_2$  were substituted. Note that the terms ( $I_1 - I_2$ ) and ( $I_2 - I_1$ ) equal zero. This means that the voltage drop across the 4-ohm resistor is zero, *too!* ( $E = IR$ , and zero times any resistance value is always zero.) Mathematically, we have proved this to be so, however, *seeing is believing*.

**A Simple Experiment.** To prove a point, construct the circuit in Fig. 2 using 5%

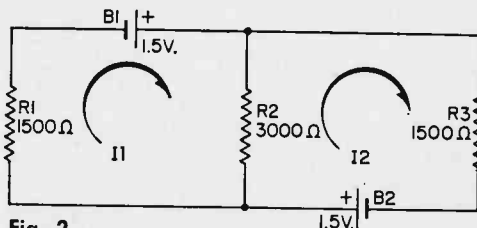

Fig. 2

resistors and D-size, or larger, fresh dry cells (1.5 volts). The circuit in Fig. 2 will have zero current flowing through resistor R2. This can be checked with a voltmeter across R2 (it will read zero) or an ammeter in

series with R2 (it will read zero).

Now connect a vacuum-tube voltmeter (VTVM) across R1 and another VTVM across R3. One VTVM will be enough if you cannot borrow a second unit. Connection details are given in Fig. 3. Note that the VTVM's will read 1.5-volt DC.

Now solve for the current loops in Fig. 3

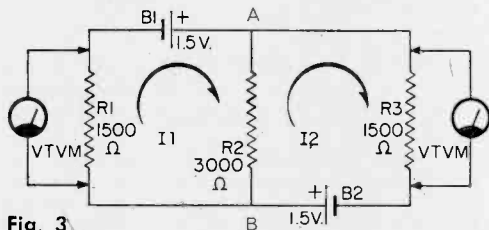

Fig. 3

ignoring both voltmeters. The VTVM's have a high internal resistance of 11-million ohms. For all practical purposes, they do not exist in the circuit because we cannot see or measure their loading effect. Follow the step-by-step procedure used previously and you will find  $I_1$  and  $I_2$  to be .001 ampere or one milliampere. But don't take our word, *solve the problem yourself*. Again, you will find the current through R2 to be zero. Carefully note the readings on the VTVM's then remove R2 from the circuit (Fig. 3). Observe that the VTVM readings remain *unchanged*. Now place a short circuit (heavy wire) across points A and B, and note that the VTVM readings remain *unchanged*. The third and last thing to do is replace the original R2 with any value resistor you happen to have. Again, as twice before, the VTVM readings remain *unchanged*.

As an exercise in applying *Maxwell's cyclic method*, solve for the current loops in Fig. 3 when resistor R2 is infinitely large, R2 is zero ohms, and R2 is any value that comes to your mind. You will discover that the values for  $I_1$  and  $I_2$  do not vary for this *particular* circuit. Also, when the voltage across any two points (A and B in Fig. 3) is zero, no matter what you connect across these points or disconnect from them, there will be no effect on the remainder of the circuit.

**Other Problems.** Lest you begin to believe that all values for  $(I_1 - I_2)$  equal zero, the following problems are presented to give you practice in using *Maxwell's cyclic*

*method*. The problems are not difficult, but have been selected because they have slight variances.

Using *Maxwell's cyclic method*, solve for currents  $I_1$  and  $I_2$  in Fig. 4. The first two equations will be

$$6 = 2I_1 + 3(I_1 - I_2) \quad (1)$$

$$4 = 3(I_2 - I_1) + 4I_2 \quad (2)$$

Now complete the problem by finding the values for  $I_1$  and  $I_2$ , and the voltage drop

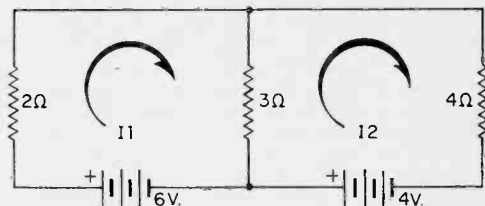
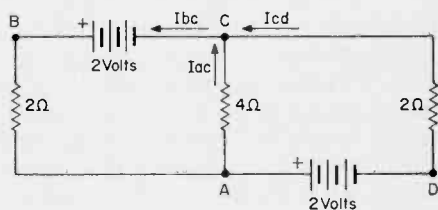

Fig. 4

#### SOLUTION TO LAST ISSUE'S PROBLEM

The reader was asked to solve for the currents given in the diagram below using only *Kirchhoff's* and *Ohm's laws*.



$$I_{bc} = I_{cd} + I_{ac} \quad (1)$$

$$2 = 2I_{bc} + 4I_{ac} \quad (2)$$

$$2 = 4I_{ac} - 2I_{cd} \quad (3)$$

Combine equations (1) and (2)

$$2 = 2I_{cd} + 6I_{ac} \quad (4)$$

$$2 = 2I_{cd} + 4I_{ac} \quad (3)$$

Add equations (4) and (3)

$$4 = 10I_{ac}$$

$$I_{ac} = \frac{2}{5} \text{ ampere}$$

Substitute value for  $I_{ac}$  in equation (3)

$$2 = \frac{8}{5} - 2I_{cd}$$

$$2I_{cd} = -\frac{2}{5}$$

$$I_{cd} = -\frac{1}{5} \text{ ampere}$$

Substitute values for  $I_{ac}$  and  $I_{cd}$  in equation (1)

$$I_{bc} = \frac{2}{5} - \frac{1}{5}$$

$$I_{bc} = \frac{1}{5} \text{ ampere}$$

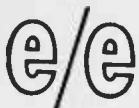

across the 3-ohm resistor ( $E = (I_1 - I_2)R$ ). Be sure to indicate correctly on Fig. 4 which terminal of the 3-ohm resistor is positive with respect to the other. The answers are given immediately below. Do not look at them until you have completely solved the problem.

ANSWERS TO THE ABOVE PROBLEM:  $I_1$  is  $2\frac{1}{13}$  amperes.  $I_2$  is  $1\frac{10}{13}$  amperes. The voltage drop across the 3-ohm resistor is  $1\frac{11}{13}$  volts with the positive voltage terminal at the top of the 3-ohm resistor. Current is assumed to be flowing from (+) to (-) potential, hence  $(I_1 - I_2)$  (a positive value) flows downward through the 3-ohm resistor. Result—top of resistor is more positive than bottom. If you prefer to think in terms of electron flow, your answer will still agree with ours.

**Getting Tougher.** Now solve for currents  $I_1$  and  $I_2$  and the voltage drop and polarity across the 3-ohm resistor in Fig. 5. Note that Fig. 5 is very much like Fig. 4 except that that connections for the 4-volt battery have been reversed. This will greatly alter the final solution. First, write the equations:

$$\begin{aligned} 6 &= 2I_1 + 3(I_1 - I_2) & (1) \\ -4 &= 3(I_2 - I_1) + 4I_2 & (2) \end{aligned}$$

Note the  $-4$  term on the left side of equation (2). This is so because the arrow-head on  $I_2$  enters the 4-volt battery voltage source at the positive terminal and exists at a negative potential. This is a voltage drop, the same thing would happen on a resistor. Don't let it trouble you—all this indicates is

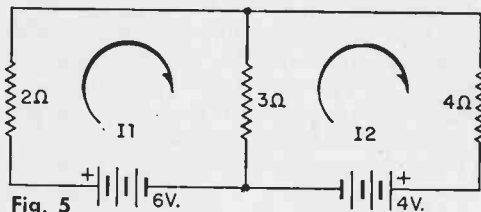

Fig. 5

$I_2$  may be a negative value or the 4-volt battery is taking on a charge. The answers to the problem are given immediately below.

ANSWERS TO THE ABOVE PROBLEM:  $I_1 = 1\frac{2}{13}$  amperes.  $I_2 = -\frac{1}{13}$  ampere.  $(I_1 - I_2) = 1\frac{3}{13}$  amperes. The voltage drop across the 3-ohm resistor is  $3\frac{9}{13}$  volts with the upper terminal at point A positive.

**Parting Problem.** Fig. 6 shows the schematic diagram for a relatively simple net-

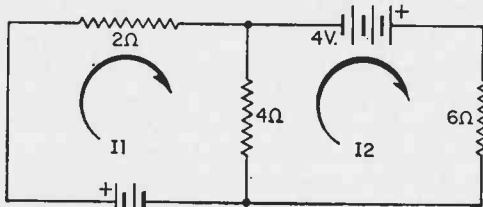
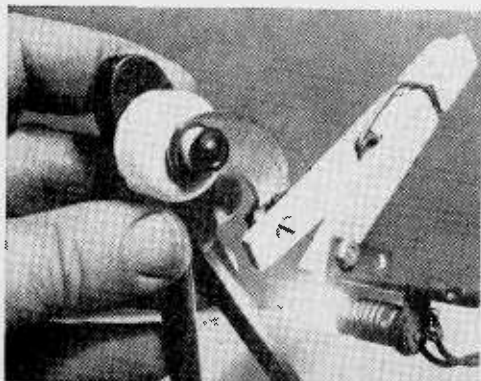

Fig. 6

work. Determine the current flow and direction (up or down) through the 6-ohm resistor. The solution to this problem will be given in the next issue of **ELEMENTARY ELECTRONICS**. ■

## Midget Extension Light



Almost daily there is a need for a tiny extension light for seeing in close quarters. Such a light can be easily made that will be self-supporting in two ways if this is desirable. Fasten a miniature lamp socket to one side of a spring-type clothespin. To the other side of the clothespin attach the magnet element from an automatic can opener. The light is complete for connecting to a battery power source. Connect alligator clips to the long lamp leads so they may connect to battery or 6.3-volt AC filament transformer. Magnet clings to iron and steel tools for extra reach.

—Glen F. Stillwell

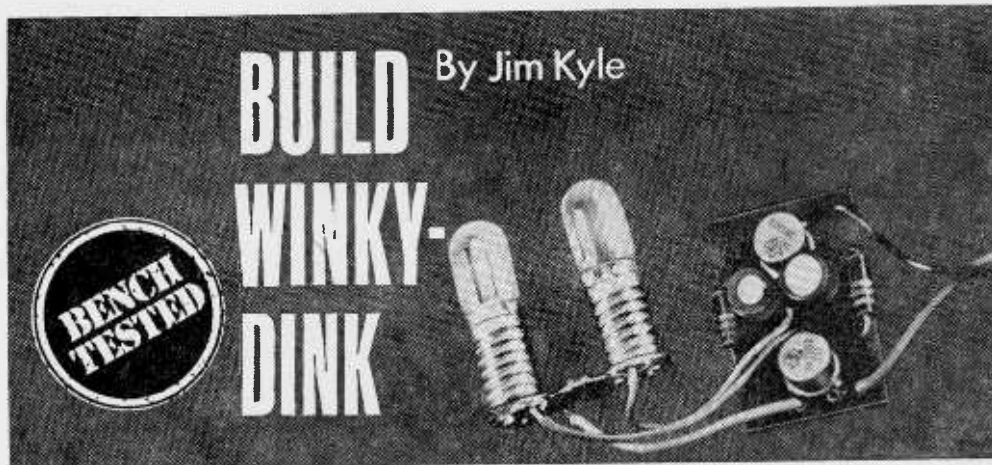

If you're looking for a useful construction project, which can help you test salvaged parts or log rarer DX, the Winky-Dink isn't for you. But if, like most of us, you enjoy a *strictly fun* gadget from time to time, then Winky-Dink is what you have been looking for.

Winky-Dink is a one-hour project leaving the remainder of the evening free to experiment with different blink rates. Only eight components are employed, and total cost should be under \$3.00 (less if you're lucky and have some of the parts in your junkbox).

The completed Winky-Dink does nothing more than sit on the table and wink its two light-bulb eyes back and forth continually, but it's a conversation-stopper to non-electronic-minded visitors. In a home lab crammed with exotic (and expensive) equipment, Winky-Dink easily steals the show when anyone drops in.

If you *must* be practical, it makes a fine toy for a young child. To use it for this, perform simple surgery on a stuffed animal. Remove the sewn-on eyes and replace them with Winky-Dink's bulbs; then provide a zippered compartment for batteries and pack the tiny circuit board into the animal's interior.

**Construction.** Arrange the two transistors, the capacitors, and the resistors on the circuit board and solder the leads to a home-made printed circuit board. See Detail Drawing. Use a small, hot iron and work rapidly; the transistors are rated to withstand soldering-iron heat for no more than 15 seconds at a distance of  $\frac{1}{16}$ -inch from the case.

Rather than using the etched board, you may prefer to lay out the components in similar arrangement on perforated hard-

board. Stiff cardboard is also an excellent "chassis" material; necessary holes can be punched with the point of a drawing compass or with an ice-pick.

Leads to the bulbs can be connected either by soldering them directly to the bulb bases, or by using sockets. Since either #48 or #49

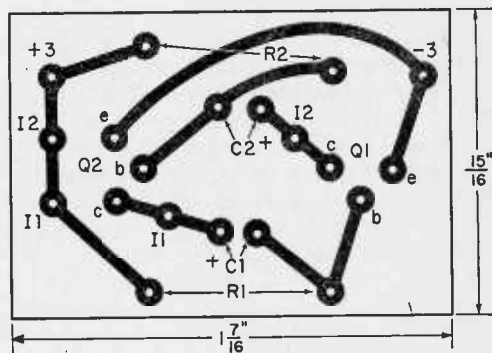

Detailed diagram of underside of printed circuit board—be sure to copy to scale.

pilot lamps can be used (electrically they are identical), you can use either screw or bayonet-type lamp sockets—whichever you have in the junk box.

Battery connections are best made by using a battery holder, although with care you can solder directly to the two cells. The holder is recommended as Winky-Dink draws approximately 60 milliamperes from a fresh pair of D cells, which will require battery replacement from time to time. If the large ignition-type cells are used for power, they should last their shelf life.

**Thumbnail Theory.** Winky-Dink is an astable collector-coupled multivibrator, sim-

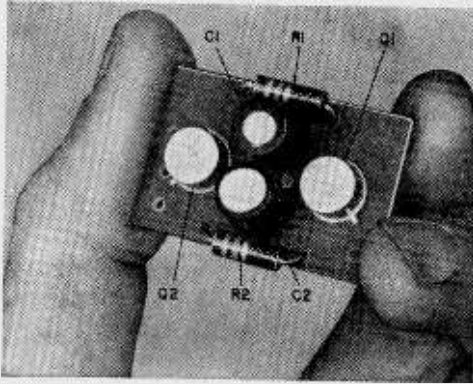

**Winky-Dink circuit board all wired and ready for lamp and battery connections. Be careful not to overheat transistor leads.**

plified to the most extreme degree possible. The transistors function as switches to turn the bulbs on and off, and the capacitors make one transistor stay "off" whenever the other is "on."

For instance, if transistor Q1 happens to be "on," its collector voltage will be nearly zero. This places the positive end of C2 at ground level. However, if Q2 is "off" at the same time, its collector voltage will be the same as that of the battery—3 volts. Thus C1 is charged to 3 volts, through bulb I2.

While C1 is charging, the current flowing to charge it passes through the base-emitter junction of Q1, keeping Q1 "turned on." When C1 reaches full charge, however, this current flow ceases, and Q1 tends to "turn off."

This raises the collector voltage of Q1 positive to ground, then the change in Q1's collector voltage is transferred through C2 to the base of Q2, tending to turn Q2 "on."

This action, in turn, causes the collector voltage of Q2 to drop. The change in collec-

tor voltage of Q2 is transmitted through C1 back to the base of Q1, further tending to turn Q1 "off." In addition, the 3-volt charge on C1 adds to the change, so that the base voltage of Q1 is 3 volts more negative than the collector voltage of Q2. This action is cumulative, and rapidly switches Q1 "off" and Q2 "on."

So long as the 3-volt charge remains on C1, Q1 will be held in cutoff and cannot conduct. C1 "reverse charges" through R1, until the base of Q1 becomes sufficiently posi-

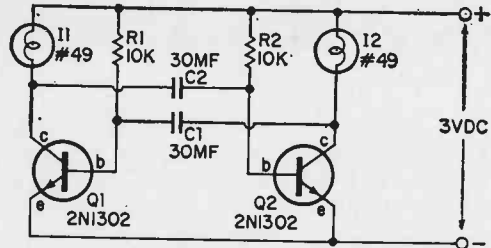

**Be sure to connect positive leads of electrolytic capacitors to Q1 and Q2 collectors.**

tive to allow conduction to begin. Then Q1 begins to turn "on" again, turning Q2 "off" as just described. The process continues indefinitely—as long as the battery lasts.

**Parts Substitutions.** Almost any of the parts may be changed to fit your own availability situation. *Npn* transistors were used because they were on hand. *PNP's* can be used by reversing polarity of the battery and the capacitors. Resistor values for R1 and R2 can be anything between 4700 ohms and 33,000 ohms; the larger values will produce a slower wink rate. The capacitors can be larger but appreciably smaller ones are not recommended; the wink rate becomes so rapid the effect is lost. However, do not substitute the more common No. 47 pilot bulbs; they require 250 milliamperes for proper operation, which results in abnormally short battery life.

Should Winky-Dink fail to wink for you, the trouble should not be hard to find. If both lamps light dimly, you probably have a defective or disconnected capacitor. If one bulb lights brightly while the other is out, the capacitor connected to the same collector as the dark bulb is probably shorted. If both lamps light brightly, either both capacitors are shorted or your transistors are defective (either event is rare). If the bulbs wink, but dimly, you probably have weak batteries. ■

### PARTS LIST

C1, C2—30-mfd., 6-v electrolytic capacitor, subminiature type for printed circuit boards (Lafayette 99G6076 or equiv.)

I1, I2—#49 (screw type) or #49 (bayonet type) pilot lamp

Q1, Q2—2N1302 transistor (RCA) (npn, average beta—100)

R1, R2—10,000-ohm, 1/2-watt resistor

Misc.—Printed circuit board (optional), sockets for pilot lamps (optional), wire, solder, etc.

Estimated cost: \$3.00

Estimated construction time: 1 hour without printed circuit board



By Herbert Friedman, W2ZLF/KB19457

Keep your power and modulation  
up to snuff with this . . .

# CB TUNING MONITOR

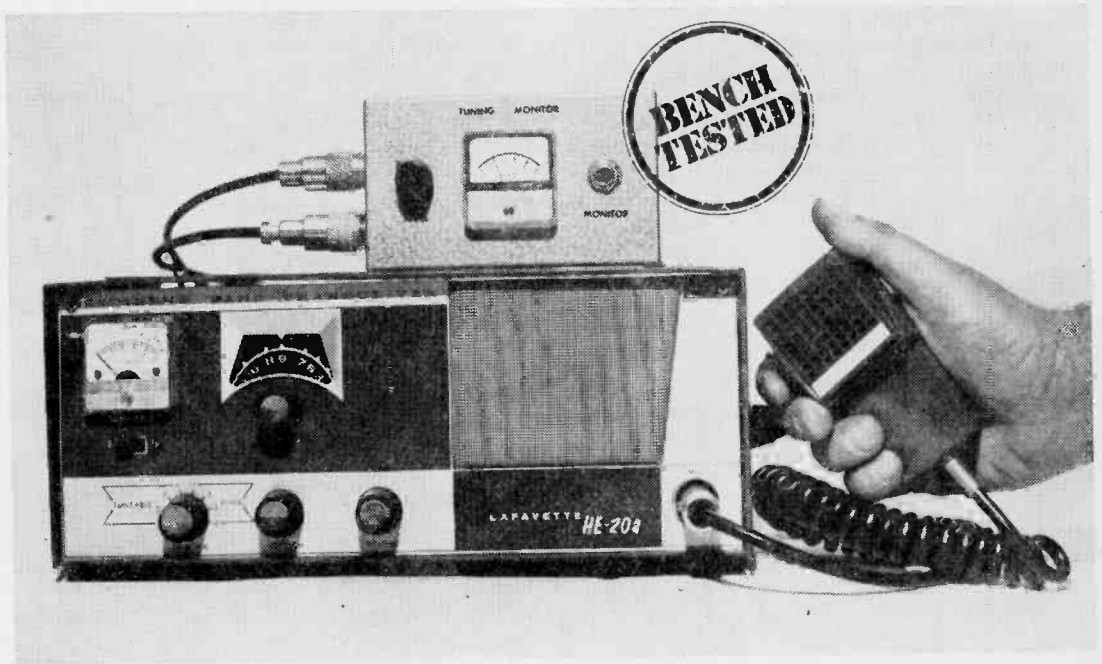

**A**S you well know, modulation quality and RF power output contribute most to a CB rig's get-out ability. Regardless of the quality of the antenna system, if you don't feed RF into the antenna you're not going to get RF out of it. And even if you squeeze every "skoomph" of RF into the antenna, no one's going to hear you if your signal's a mess of squeaks, hash, and hum.

One of the easiest ways you can be sure of maximum RF output and good modulation is to use a tuning monitor; a device permanently connected to the transmission line which indicates the tuning condition and allows you to monitor the modulation.

**Simply a Signal Sampler.** This tuning monitor is tailor made for the CB'er. While it's simple and rock-bottom in cost, it does the job of instruments many times more complex and costly. Resistor network R1-R2 takes a small sample of RF from the transmission line; D1 rectifies the RF and the resultant DC is fed to meter M1. Since the

DC is representative of the RF voltage (and current) on the transmission line (which is representative of the RF power output) M1's reading indicates the transmitter tuning—when M1 peaks the transmitter is tuned. No need for SWR meters, field strength meters, etc.

Component values are chosen so a rig with maximum output—about 3.5 watts—will indicate almost full scale; while a 1 watt output (from old rigs in need of service) will indicate about one-third scale.

Once the transmitter is tuned the meter reading can be adjusted to a convenient value by rotating R3 (say half-scale); then, a change in the power output such as caused by a defective tube or a change in the antenna loading will be immediately apparent as a change in meter reading. By using an easy to remember reference—such as half scale—there'll be no question about a change in the reading.

J1 permits the signal to be monitored

## PARTS LIST

- C1, C2—.001 mf ceramic disc capacitor  
 D1—1N34A miniature germanium diode  
 J1, J2—RF coax receptacle (Amphenol 83-1R)  
 J3—Phone jack, two-circuit normal-through (Littel 12A)  
 M1—Miniature illuminated "S" meter (Lafayette Radio TM-11)  
 R1, R2—4700-ohm, 1/2-watt fixed resistor  
 R3—50-000-ohm Q control, logarithmic taper (IRC Q13-123 or equiv.)  
 1—5 1/4" x 3" x 2 1/8" aluminum chassis box (Premier PMC-1006 or equiv.)  
 2—RF plug connectors (Amphenol 83-1SP)  
 Misc.—Terminal strip, buss-bar, hookup wire, solder, nuts, bolts, etc.

Estimated cost: \$7.00

Estimated construction time: 3 hours

Schematic diagram for CB Tuning Monitor.  
 Jump J1 and J2 with heavy-copper bus wire.

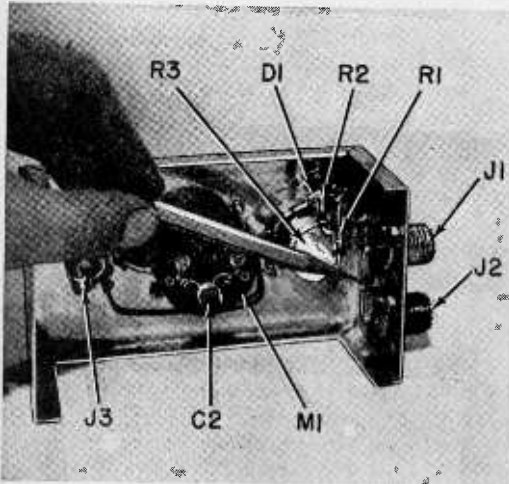
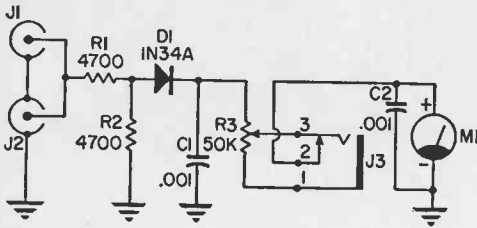

Wide-open layout and few components make the CB Tuning Monitor easy-to-build. Pencil points out R1's wrap-around connection to the coaxial jacks J1 and J2 jumper. Capacitor C3 is connected across the meter's terminals to protect the meter against possible damage to any stray RF currents.

with a headset, or the modulation can be fed to a tape recorder so it can be analyzed critically. (It is often difficult to hear defects if you are monitoring while talking. By listening to a tape playback you're more likely to notice power-line hum, RF hash, etc.)

**Construction.** The unit is built on the main section of a 5 1/4 x 3 x 2 1/8 inch Mini-box. J1 and J2 are standard PL-259 type coaxial jacks. If your equipment uses phono or automobile radio type plugs just substitute matching jacks. While any O-1 ma. meter can be used for M1, the one specified here, an "S" meter, is recommended because it's the most inexpensive.

The J1-J2 jumper should be heavy bus-bar of at least #18 gauge. If you don't have a scrap of bus-bar around, twist together four or five lengths of solid hook-up wire and apply solder until you have one solid, heavy, wire.

Diode D1 is easily damaged by heat, so use a heat sink, such as an alligator clip on each lead when soldering.

Notice carefully the wiring to J3. J3 is a two circuit phone jack—not a shorting type. The normal-thru connection (lug 2) is *not* connected to the grounded jack frame when the phone plug is removed. Use of a shorting type jack will result in the meter being inoperative.

**Using the tuning monitor.** Normally, the most powerful transceiver will drive the meter almost to full scale. However, a high standing wave ratio (SWR) on the feedline can result in a high RF voltage at the point where the monitor is connected to the transmission line. Under these circumstances the meter might well be driven off-scale. If this occurs, simply reduce sensitivity with R3 until you make the necessary repairs.

For best modulation monitoring, the headphones should be of good quality—with an impedance of 2000 ohms or higher. Earphone volume is determined by R3.

When tape recording, adjust the recorder's gain control to approximately its usual setting. Then, adjust R3 for the proper recording level. Don't run R3 wide-open and try to adjust the recording level at the recorder. On most recorders the volume control is after the microphone preamp and a wide-open level from the monitor will overload the preamp. If your recorder has sufficient gain, feed the monitor's output into the recorder's high level input—you'll get a better recording. ■

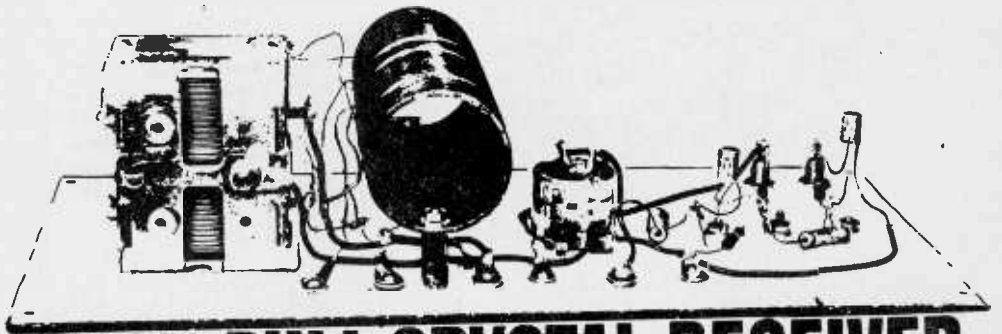

# PUSH-PULL CRYSTAL RECEIVER

Supersensitive circuit pulls in distant AM stations. Has a double-tuned detector and two transistors to raise signal to speaker level.

**T**he crystal receiver has long been the first project of electronics enthusiasts for many reasons. The primary one is that the crystal radio utilizes the many principles of electronics that are first gleaned from textbooks, but can be demonstrated and experimented with when you build this simple radio. The theory of antennas, detection and demodulation of information-carrying electromagnetic energy, and energy transfer in a set of earphones, all that had previously been only theoretical discussion, suddenly becomes a reality. And real not in the sense of laboratory meter deflections and readings, but in the reception of actual radio broadcasts where tuning across the band becomes a much more exciting way to witness that theory in action than watching a meter

needle. One other *big* reason for the popularity of the crystal radio is cost—the *price* is *right*.

**Extra Crystal and Two Transistors.** This crystal receiver uses two crystal diodes in a push-pull detector circuit that improves sensitivity. The detector circuit is very much like a full-wave rectifier which utilizes the positive and negative sweeps of the incoming signal. And, in addition, two transistors amplify the audio output from the detector. A two-stage amplifier following a push-pull detector stage gives results that will be more than you would have expected. Several optional circuits and the inclusion of a few signal taps in the circuit can further improve reception and increase the receiver's versatility.



By Art Trauffer

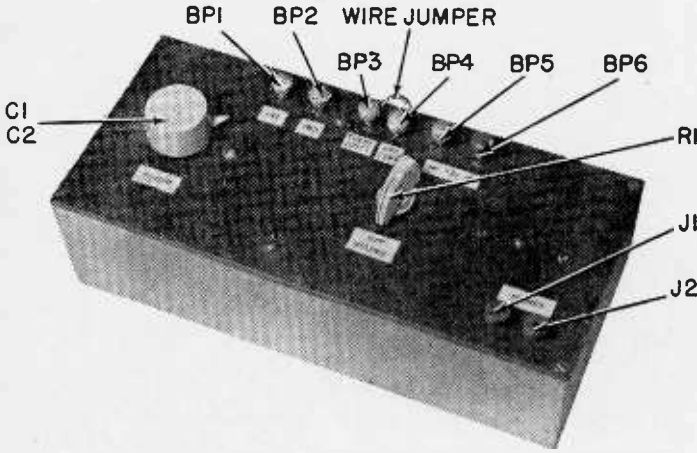

Front-panel view shows tuning and volume knobs. Binding posts along top edge are for connecting battery, antenna and jumper. Use a red post for BP6, black one for BP5. Other posts are white. Output is obtained at jacks J1 and J2.

Fig. 1. Schematic. Separate tuning circuits (L1-C1 and L3-C2) provide push-pull action to capture more signal than in regular detector. Signals from diodes D1, D2 are fed to volume control R1. Two-stage transistor amplifier increases audio for earphone monitoring. Loudspeaker hookup (see Fig. 3) may be used.

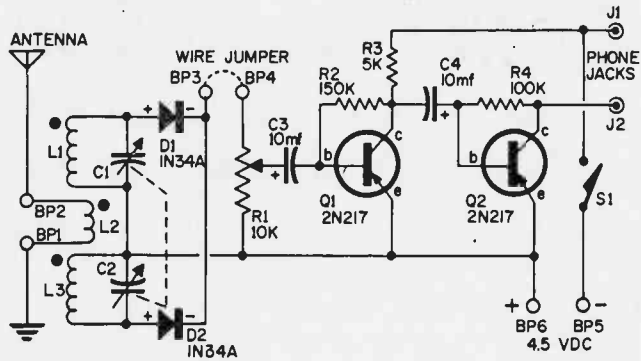

**Tuning the Antenna Coil.** As shown in the schematic diagram, Fig. 1, a split secondary coil, with antenna coil between, is tuned by a two-section variable capacitor. If a single-section variable capacitor is added in the antenna circuit, Fig. 2, the antenna coil can be tuned to obtain both improved sensitivity and selectivity. Using a long outdoor antenna and a good water pipe ground takes further advantage of the added circuit. For frequencies below 850 kc, close the s.p.s.t switch to connect the .001 mfd. fixed capacitor across the variable capacitor. This combination is necessary to cover the entire broadcast band.

**Speaker Listening.** Adding an audio output transformer to the crystal receiver enables you to connect a speaker for room lis-

tening to local stations. As shown in Fig. 3, the 2000-ohm primary of transformer T1 is connected across the headphone jacks J1 and J2. A small 4-ohm speaker can then be connected to the secondary. If you choose to add the speaker listening option to the crystal receiver, you can mount the transformer and speaker in a small commercial enclosure or build a compact speaker box.

**Headphone Connections.** Binding posts BP1 through BP6 actually tap the receiver circuit in significant places: BP1 and BP2 are the ground and antenna connecting points, respectively; BP3 and BP4 split the circuit between the detector stage and the two-transistor amplifier; BP5 and BP6 are the negative and positive input points for the 4½-volt battery power supply. Jacks J1 and

## PARTS LIST

- B1—4½-volt battery (Burgess F3 or equiv.)  
 BP1 through BP6—Six binding posts, 4 white, 1 red, 1 black  
 C1, C2—Two-section variable condenser, each section 365 mmf. (Allied Radio 13L521 or equiv.)  
 C3, C4—10 mfd., 15-volt miniature electrolytic capacitors  
 C5\*—365 mmf., single-section variable condenser (Allied 13L524 or equiv.)  
 C6\*—0.001 mfd. ceramic capacitor  
 D1, D2—1N34A germanium diodes  
 J1, J2—Phone tip jacks  
 L1, L2, L3—Antenna and input tank coils; No. 32 enameled copper wire wound on 1½-in. coil form, 95-30-95 turns, respectively (See text for winding instructions)  
 Q1, Q2—2N217 PNP transistors  
 R1—10,000-ohm potentiometer, logarithmic taper with s.p.s.t. attachable switch (Allied 30M307 and 30M358, respectively)  
 R2—150,000-ohm, ½-watt resistor  
 R3—5,000-ohm, ½-watt resistor  
 R4—100,000-ohm, ½-watt resistor  
 S1—S.p.s.t. attachable switch (see R1 above)  
 S2\*—S.p.s.t. toggle switch  
 T1\*—Audio output transformer; Primary: 2000 ohms, secondary: 4 ohms (Allied 61G401 or equiv.)  
 1—¼-pound spool enameled magnet wire No. 32 (Lafayette Radio 32G3074 or equiv.)  
 1—Coil form, 1½-inch diameter x 3 inches long  
 Misc.—Tuning and pointer knobs, Fahnestock clips, phone plug, composition board, hardwood stock, machine screws, 4-ohm speaker\*, lock washers, hex nuts, wood screws, solder lugs, insulated copper hookup wire, spaghetti, varnish, wood glue, solder, etc.

Estimated cost for basic receiver: \$8.00

Estimated construction time: 6 hours

\*Optional components

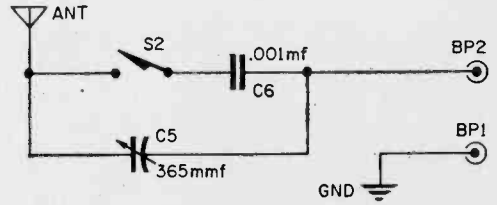

Fig. 2. Optional hookup improves antenna.

your push-pull crystal detector at BP3 and BP6 and feed it to your hi-fi amplifier. To make the connection use a phono cable with one end terminated in two pin plugs for the receiver binding posts.

If you can use the detector stage of the crystal receiver alone, you can do the same with the amplifier stage and use it as a utility amplifier. Connect the 4½-volt battery across binding posts BP5 and BP6 and connect the high impedance headset or transformer and speaker to jacks J1 and J2. Then connect the output from either microphone or turntable (either crystal or ceramic car-

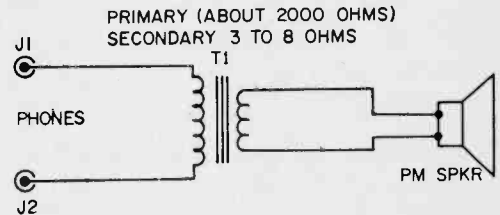

Fig. 3. How to add loudspeaker operation.

J2 are the audio output points where earphones are connected for listening with two stages of amplification. When receiving a powerful signal that can be easily heard from the detector without any amplification, you can connect the earphones right across binding posts BP3 and BP6, without using the battery at all! Remember the wire jumper across BP3 and BP4. Disconnect it when you don't want the detector output fed to the amplifier.

**AM Tuner For Hi-fi System.** Perhaps you have a hi-fi rig that, like many others, doesn't have an AM tuner. And now you find that you miss some of the program fare that a few of those AM-only broadcasters have to offer. All you have to do to receive AM on your rig is pick off the signal from

tridge pickup) to binding posts BP4 and BP6.

**Putting It Together.** The crystal receiver shown in the illustration was built as an experimental project with the possibility of the parts being used again elsewhere. But if you plan to use the receiver regularly, you can plan the construction, layout, and wood finish for a more professional appearance. Here, the parts were placed for reasonably short leads, but some were purposely left long so the parts could be removed and used for other projects. Placement of parts is not critical so you can use your own ideas in locating and mounting the parts. Doing so will develop originality and exercise your ingenuity for more advanced *home brew* projects.

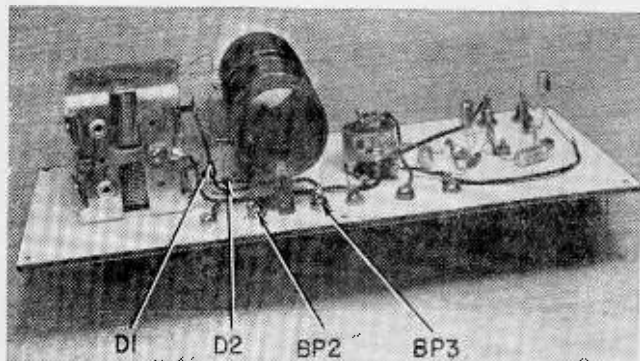

Coil is mounted above surface of panel with spacers or piece of wood dowel. Note the tuning capacitor at left; a solder lug is screwed in one threaded hole on frame. Lug receives wire from control R1 and BP6.

Parts placement, underside of panel. Use wood or fiber board for panel, not metal. Scrape enamel off ends of coil leads before soldering. Battery, not shown, is external. It may be mounted in cabinet if desired.

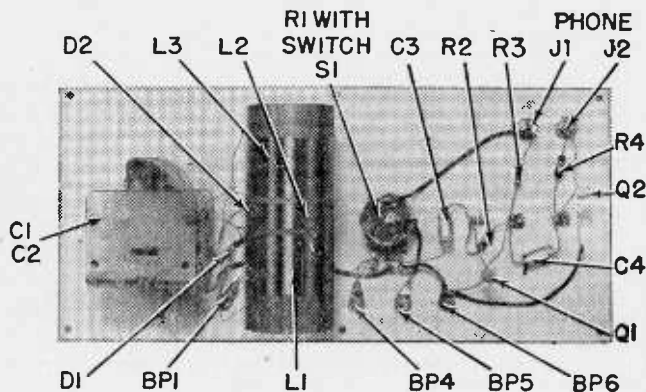

The receiver wiring is simple, but be sure to observe correct polarity on the crystal diodes and electrolytic capacitors. The other major precaution is keeping the amplifier output leads away from the input leads. The mounting board photographs show how the parts are mounted on a 10 in. x 4½ in. panel of ½ in. thick composition board. The two-section variable capacitor (C1-C2) is mounted with two or three short machine screws, and the coil form with two 6-32 one-inch machine screws covered with stand-off sleeves about ¾ in. long. If you use a 1½-inch diameter wood dowel as a coil form, mount it with wood screws.

**Winding the Coils.** The three coils, L1, L2, and L3, are wound on a 1½-inch diameter bakelite or plastic tube coil form about 3 inches long. If you use a wood dowel or cardboard tubing as a coil form, give it a coat of shellac to moisture-proof it; let it dry thoroughly before winding the coils. The two secondary coils, L1 and L3, are each

95 close-spaced turns of No. 32 enameled copper wire. The primary coil, L2, is 30 close-spaced turns of No. 32 enameled copper wire, wound between L1 and L3 leaving a space of ⅛ inch on either side. All three coils are wound in the same direction.

The two 2N217 PNP transistors are mounted by their own leads. Use long-nose pliers to function as a heat sink when soldering the transistors and diodes in the circuit. To prevent shorts, use spaghetti tubing over bare leads where necessary.

**Finishing Touches.** The 10"x 4½"x 2¾" cabinet was made of ¾" hardwood, and put together with small nails and wood glue. Moisture-proof the inside of the cabinet with shellac, and finish the outside according to your own taste and requirements. Mount the front panel with six flat-head, ½-inch wood screws. The front panel dial knobs, binding posts, and phone jacks can be labeled with typewritten strips or decals. Now, all that remains is to slip on your headphones! ■



# CdS POWER CONTROL

Now you can have variable low-power control for HO trains, thermal devices, transformers

**A**ny electrical engineer can tell you that after power is generated, the big problem is how to control it. To a lesser degree, the home experimenter has the same problem. Of course, he doesn't have to *generate* power, it's there for the taking at the nearest 115-volt AC wall outlet. The experimenter's problem is how to get operating power at his test bench or for his gadgets at the voltages and the currents that he needs.

One of the latest power-controlling devices suitable for the experimenter, oddly

enough, is based on a semiconductor that responds to light. Known as the cadmium-sulfide (CdS) cell, this interesting photo device has the property to change its resistance in proportion to the intensity of the light falling on it. For this reason, the CdS cell is also referred to as a light-dependent resistor.

Until fairly recently, the CdS cell was limited to low-power applications like light meters (the SCIENCE & MECHANICS A-3 Supersensitive Darkroom Meter uses a CdS cell) and electric-eye relays. Recently how-

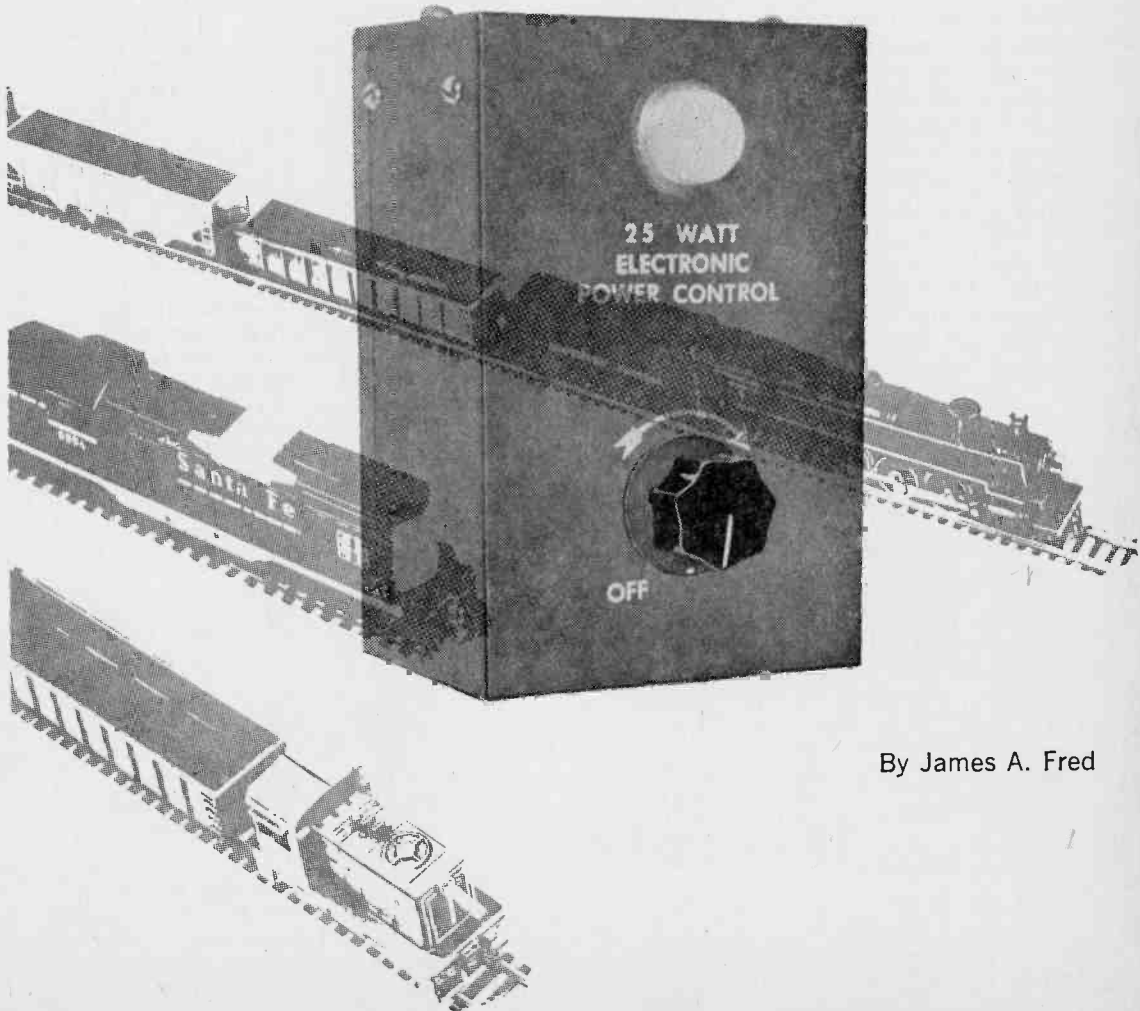

By James A. Fred



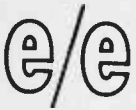

## CdS POWER CONTROL

ever, Delco Radio introduced the LDR-25, an hermetically-sealed CdS cell that will handle up to 25 watts of power when properly heat sunk. In total darkness, the LDR-25 has a resistance of about 500,000 ohms. Under a strong light, the resistance can fall as low as 15 ohms.

**Theory of Operation.** The voltage to the 3-watt lamp I2 is controlled by wire-wound potentiometer (R1). The varying light output of I2 in turn varies the resistance of R2, the CdS cell. Since the cell is connected in series with the AC line and load receptacle, X1, its resistance determines the amount of power fed to anything plugged into X1. This means you have a handy speed control for small AC or DC motors drawing not more than 25 watts. Or you have a heat control for a pencil-type soldering iron that does not draw more than 25 watts. And, of course, it will also vary the brightness of a 25-watt or smaller light bulb. An excellent application for this control box is as a speed control for an HO-gauge model train. As is shown graphically on page 87, an inexpensive HO-power supply is plugged into the CdS control box which is then used to control the speed of the train.

**Construction.** Layout of the control unit is not critical, but certain precautions should be taken during construction. Make sure that

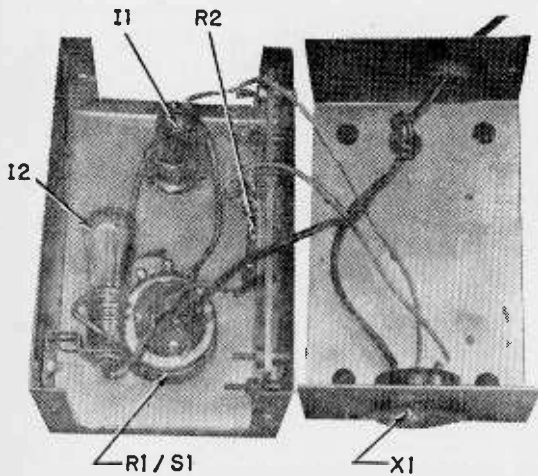

Construction is quite simple as photo shows. Position I2 and R2 apart to avoid overheating.

### PARTS LISTS

- F1—3/16-ampere fuse (type 3AG) and fuse holder
- I1—Neon pilot-light assembly with built-in resistor
- I2—3-watt, 115-volt lamp (type 3S6) and socket (Dialco 605)
- R1/S1—5,000-ohm, 3-watts or larger, wire-wound potentiometer with switch. Separate switch can be used if available.
- R2—CdS cell (Delco LDR-25. \$1.50 each from Graham Electronics Co., 1222 So. Senate Ave., Indianapolis, Ind.)
- X1—Panel-mounting AC receptacle
- 1—4 1/2" x 3" x 2" aluminum box, exact size not critical
- 1—Heat sink made from aluminum sheet scrap, approx. 3 3/4" x 1 1/2"
- Misc.—Line cord, knob, rubber grommets, nuts and bolts, wire, etc.

Estimated cost: \$7.00

Estimated construction time: 3 hours

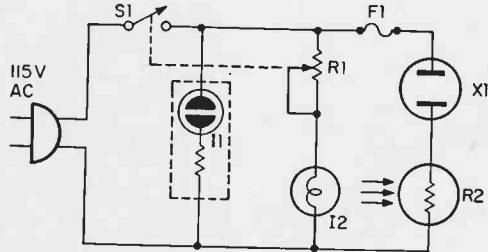

Schematic diagram shows electrical connections between parts but fails to show control I2 has over R2. Light from I2 must fall on window of R2 in order to decrease resistance.

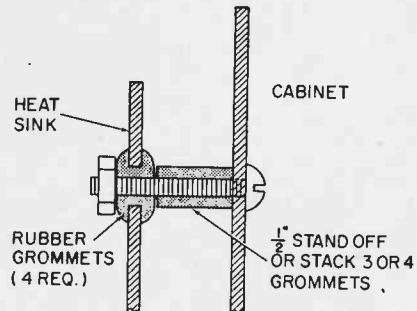

The heat sink for the CdS cell can be made from aluminum sheet stock. Cut to largest size possible without shorting to case. Rubber grommets insulate heat sink from hardware.

25-watt bulb is used to check unit out. If case gets too hot, punch a few vent holes.

bulb I1 is mounted so that its light impinges on the CdS cell R2. R2's heavy aluminum heat sink that is fastened to one side of the cabinet must be insulated from the cabinet since one side of the AC line connects directly to CdS cell R2.

A word of caution is necessary in regard to mounting CdS cell R2. If available, apply some silicone grease to the back of R2 where it contacts the heat sink. This will allow a more efficient transfer of heat. Also the CdS cell is made of a thin, fragile, ceramic disc which must be mounted carefully. Be sure that the metal where the cell is mounted is flat and free of burrs. Also be careful not to overheat the LDR when soldering the lead wires.

After you have used the CdS power-control box for a while, many more uses for it will occur to you. Remember though before using the power-control box, always check the load drawn by the device you wish to control. Fuse F1 will prevent damage to the cell and as long as you don't exceed its wattage rating and operating temperature it should have practically unlimited life. ■

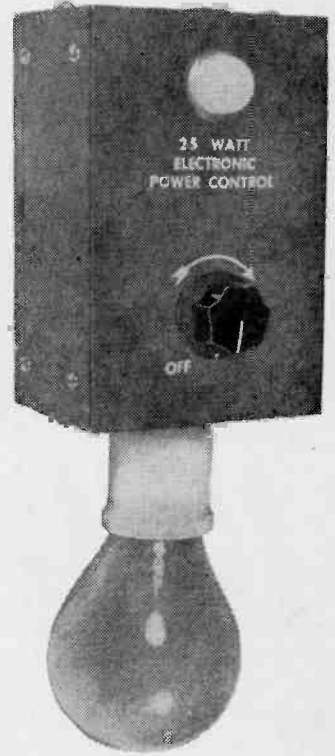

## Discarded Portable Becomes Test Speaker

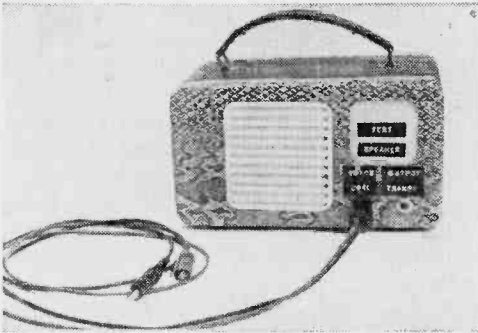

A patch cable consisting of two flexible leads, insulated alligator clips, and phone plug lets you tie into AC/DC radio and TV hot chassis without any danger of shock.

If you own an old tube-type radio portable that's ready for the garbage can, you're in for a windfall by simply converting it to a portable test speaker. Scrap all of the set's guts except the PM speaker and output transformer. Now scrounge up open-circuit and closed circuit phone jacks (see schematic diagram), phone plug, wire, and two alligator clips with rubber sleeve insulators. Wire up the portable case as shown in the schematic diagram and label the cabinet's front panel so you will know which jack is which. Now wire up a patch cord using 3 feet of rubber test lead lengths to the phone jack and install the alligator clips to the wire's free ends. Now you can connect the test set to speaker terminals or into audio plate circuits. ■

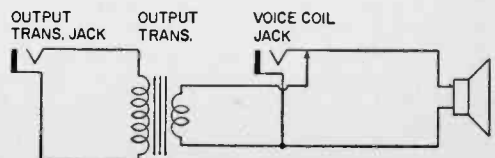

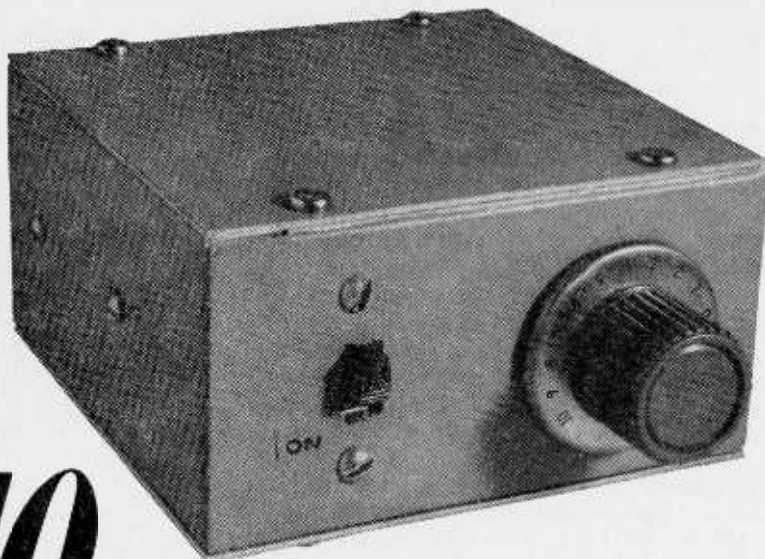

# BFO

BY STEVEN SUMMER

Many hams and short-wave listeners are still equipped with an old receiver that merely "tunes the short wave bands." Such receivers, along with many inexpensive, modern receivers cannot receive code or sideband signals because they have no BFO—beat frequency oscillator. Yet adding an external BFO need not be difficult or expensive. The BFO described in this article is easy to build and will cost less than \$7. It can be added to any superhet radio, AC-DC or transformer operated, whose IF frequency is in the 455 kc range.

The remote BFO makes an ideal *external* accessory because it may be placed a few feet away from the receiver. A single penlite cell furnishes power to a transistorized Hartley oscillator. To avoid coil winding, a miniature transistor IF transformer is used as the tank circuit—supplying all necessary taps and windings. The pitch of the beat note is adjusted by C1, a 17-picofarad variable capacitor. A 2N508 audio transistor is used because it gives a high output.

**Construction.** In order to simplify construction, a phenolic board sub-chassis was used. All parts, except the battery and switch were mounted on the 1½" x 2½" perforated phenolic board. The parts layout is shown in the photographs. There is a small bracket on the bottom of C1, to which the phenolic board is attached with a (6-32 x ¼") ma-

chine screw. Because the bushing on C1 connects the subassembly to ground, only two wires need to be connected to the board to complete the circuit. One wire goes to the output jack, J1, the other to the on-off switch. In order to make removal of the subassembly from the aluminum box easy, these two wires are connected with "Flea Clips."

An aluminum utility box was chosen to house the BFO because its removable top and bottom offer a maximum ease of access. Although the builder may desire four mounting feet, it was found that three mounting feet in a triangular arrangement prevented wobbling. In no case should the builder omit the rubber feet because the screws holding the bottom plate will scratch the operating table or the top of the receiver. On the right hand side of the case a quarter inch hole was drilled so that the slug in the IF transformer could be adjusted with the case sealed up. No drilling location is given in the mechanical layout, since location depends on placement of the IF transformer on the phenolic board. The builder will have to determine the exact location for himself. The output jack, J1, is a phono jack of the single-hole mounting variety. Actually, other connectors would serve equally well, but the phono jack was chosen because of its availability and low cost. A smaller or larger IF transformer can be used if it is electrically similar.

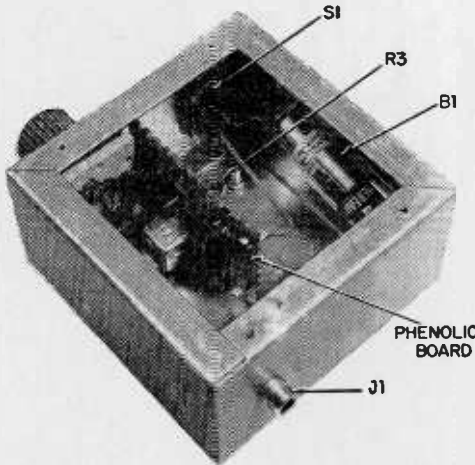
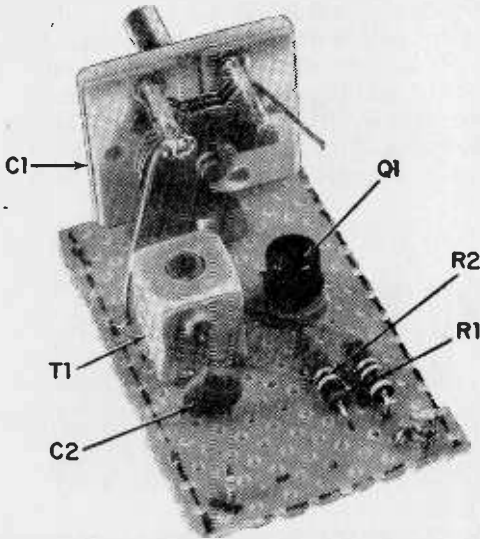

Board mounts vertically in case, held in by the tuning capacitor. BFO signal is at J1.

**Using It.** The BFO is easily connected to the receiver. In fact, no actual physical connection is needed. A one foot piece of insulated hook-up wire, acting as a gimmick capacitor, injects a sufficient signal when wrapped around an IF transformer or the IF amplifier tube. If this arrangement couples in *too much* BFO signal, try wrapping the hookup wire around the power cord or the detector tube. It is important to feed into the receiver a signal of sufficient volume, and not higher. Too much BFO signal will cause the AVC to operate, making the receiver less sensitive. A good test for proper volume is to use the BFO on a sideband signal. With the proper amount of BFO injection even a

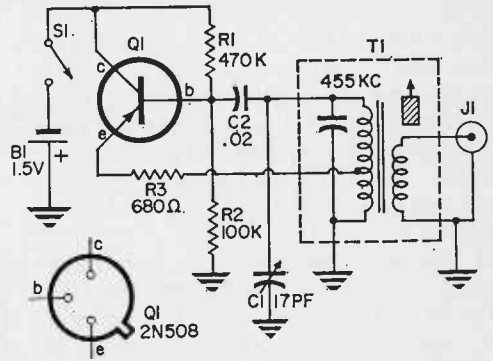

Be sure to follow Q1 connections, as shown in schematic above. Q1 mounts in transistor socket seen in left photo. Wire complete board before inserting in metal case.

#### PARTS LIST

- B1—Penlite cell (Burgess type Z or equiv.)
- C1—17-picofarad (17-mm.f.) variable capacitor (Hammarlund HF-15 or equiv.)
- C2—.02-mf., 100-volt, ceramic disc capacitor
- J1—Phono jack (Switchcraft 3501FP or equiv.)
- Q1—2N508 (GE)
- R1—470,000-ohm, ½-watt resistor
- R2—100,000-ohm, ½-watt resistor
- R3—680-ohm, ½-watt resistor
- S1—S.p.s.t. slide switch (Continental-Wirt G723 or equiv.)
- T1—Miniature transistor IF transformer for 455 kc: primary-25,000 ohms; Secondary-600 ohms, tapped pri. (Miller 2041, Lafayette M5-168A, Argonne AR60 or equiv.)
- 1—Aluminum utility case, 4" x 4" x 2" (Premier AC-442 or equiv.)
- 1—Battery holder for one penlite cell
- Misc. Phenolic board, hardware, flea clips, knob, wire, solder, etc.

Estimated Cost: \$7.00

Estimated construction time: 3 hours

strong signal can be easily demodulated. If the BFO is heard on other nearby receivers, use microphone cable (the center lead only). Don't ground BFO case to AC-DC set.

Being transistorized and battery operated, the BFO has no warm up drift and is not affected by line voltage variations. The battery drain is only ½ milliamperes—hence, long battery life can be expected. It is electrically stable, and drifts only slightly with changes in ambient temperature and mechanical shock. This BFO is a valuable addition to any receiver that lacks one. Because of its electrical and mechanical simplicity, it can be constructed in a few hours, even by an inexperienced builder. ■

It is often desirable to have a source of 120 volts AC available for experimental work. Many times the busy experimenter will hay-wire a few components together for a temporary setup. After doing this a few times myself I decided to design the smallest, most compact, easy to use, power supply that was possible. The one described here plugs directly into the wall outlet and meets the above qualifications.

**A Miniature Package.** One essential requirement was the use of an insulating material for the box or container. Using a metal box close to the 115-volt line seemed to be too hazardous. A plastic relay case, which is readily available in the mail order parts catalogs, was chosen to house the necessary parts.

An Amphenol AC plug, PI, was installed on the open end, and two 5-way binding posts, BP1 and BP2, were installed on the opposite closed plastic end. The size of the filter capacitor's C1 and C2, presented a problem until some really small ones were found in a Mal-lory catalog. Since 12 mfd. was the maximum capacity available there may be just a little

# PLUG- IN



# POWER SUPPLY

BY JAMES A. FRED

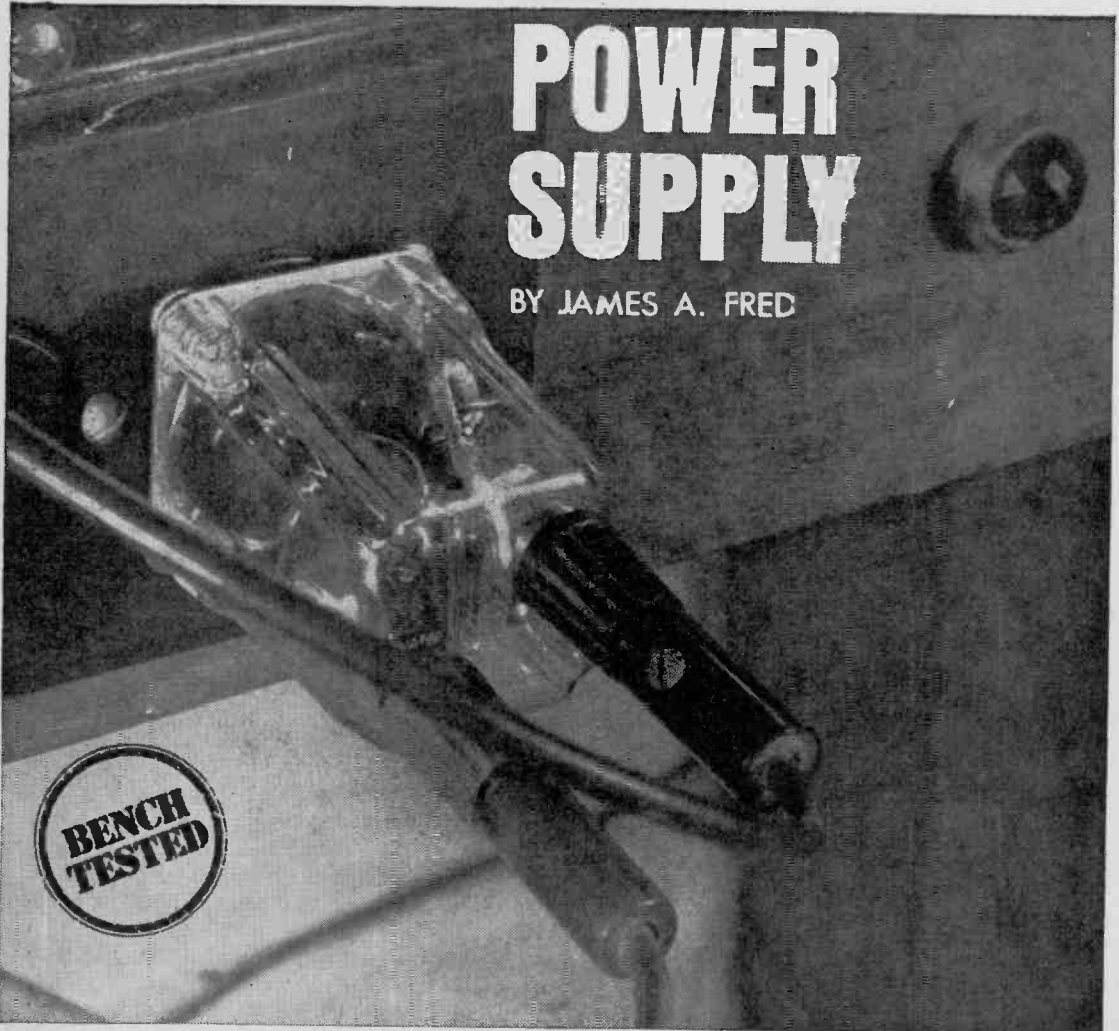

more ripple in the output than is normal. An additional capacitor and also, a fuse can be added rated at ¼ amp resistor could be crowded in if necessary.

The photographs show the overall size as compared to a "C" size flashlight battery. The parts layout is only a guide and each constructor will have to exercise his own judgment when inserting the wired up components into the plastic case. Use a heat sink when soldering silicon diode, D1, into place. The assembly is wired outside the case and the two DC leads are left long enough for soldering to the binding posts. The voltage can be checked before soldering these leads, and screwing the bottom to the case.

**Basic Half-Wave Circuit.** The circuit is unique only in the method used to obtain

voltage regulation. In a power supply of this type the no-load voltage will be approximately 150 volts DC while a 30 ma. load may cut it to 70 volts. This is very poor regulation and can only lead to trouble. Something better than this was desired so I1 and I2, two neon bulbs, NE-83, were connected in series between the DC output binding posts. Under these conditions the power supply will produce 120 volts at no load and 110 volts with a 30 ma. load. When the load exceeds 40 ma., the voltage drops below the maintaining voltage for neon bulbs I1 and I2 and they go out. This gives a built in indication of when the voltage has dropped below 105 volts. Neon bulbs, I1 and I2 serve, in addition, as pilot lights to show when the supply is on. ■

### PARTS LIST

BP1, BP2—Five-way binding posts; one red, one black (Lafayette Radio 99G6233, package of 5 red, 5 black)

C1, C2—12-mfd miniature tubular electrolytic capacitors, 150WVDC (Mallory TT150X12 or equiv.)

D1—1N2094 diode rectifier, 400PIV

I1, I2—NE-83 Neon indicator lamps

P1—AC Plug (Amphenol 61M or equiv.)

R1—10-ohm, ½-watt carbon resistor

R2—1000-ohm, ½-watt carbon resistor

1—Relay case (Allied 75P558 or equiv.)

Misc.—Scrap metal for relay case cover, screws, wire, solder, etc.

Estimated cost: \$5.00

Estimated construction time: 2 hours

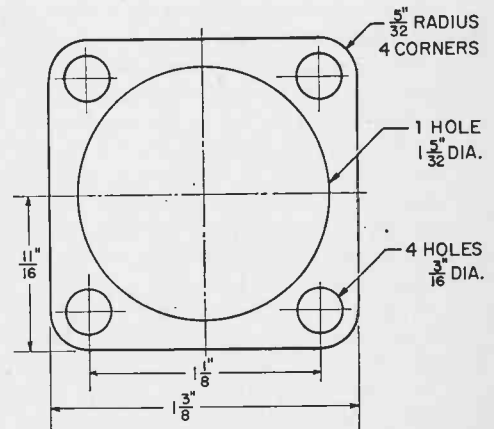

Bottom plate of relay case comes with octal plug—replace with Amphenol AC plug P1.

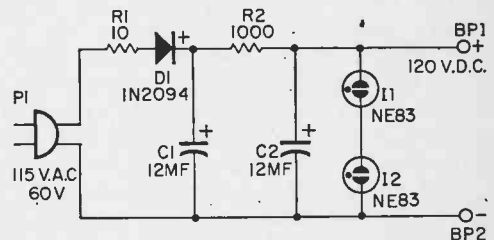
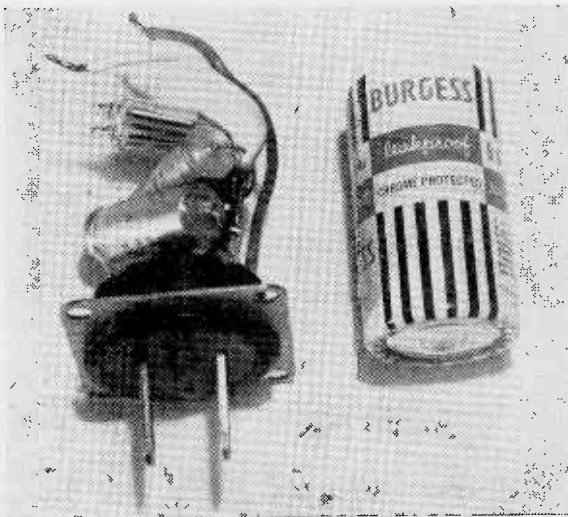

Although a fuse is not required, a ½-amp pig-tail fuse may be added in series with the 10-ohm resistor and the AC plug, P1.

The plug-in power supply all wired and set to be installed in its relay plastic case. As unit was assembled, plastic case was slipped on several times to insure that each added part allowed sufficient clearance.

## The Slide Rule

Continued from page 52

numbers which would produce a range). Whenever you have *two terms* which are about 50% higher than the unit (like 1.56), approximate *one* term to the next higher number. We had 1.56 and 4.56, so we approximate 1.56 as 2, and 4.56 as 4. Similarly, we could have approximated 1.56 as 1, and 4.56 as 5.

**Cubes, Squares and Trig.** There are many other tricks to handling power of 10 and they're usually given in the slide rule manual; we just wanted to show it's a lot easier than it appears to be. The slide rule isn't meant only for the advanced technician and engineer.

Slide rules aren't meant only for straight multiplication and division; the number and types of scales determines the number of functions which can be performed *easily*. A slide rule also works squares and cubes "automatically"; like "what is 3 cubed ( $3^3$ )?" Three cubed is  $3 \times 3 \times 3 = 27$ . Simple? So what's  $265^3$ ? A time consuming problem, you bet. But a slide rule can read-off the answer to  $265^3$  directly. And it can work backwards and give you the cube root.

Cube root of 764 too difficult to figure? Okay, what's the square root of 764? That will still take lots of pencil pushing. But the slide rule will read-off the square or cube root of 764 in about 5 seconds.

Depending on the scales you can do trigonometry, automatic inversion (a fancy name for 1 divided by a number, as  $\frac{1}{8}$ ) and direct multiplication of that favorite electronic expression,  $\pi$  (pi).

**Picking Out a Slide Rule.** The easy use of the slide rule is limited only by the type and number of scales, and it's here that the experimenter often makes a fatal mistake: he selects a rule with so many scales (who's use requires an advanced knowledge of math) that it makes the slide rule more difficult to use than pencil and paper.

The dealer's display case is always filled with slide rules, each with more scales than the next. (Among hobbyists, it's sort of a status symbol to have as many scales as possible.) But keep in mind that the extra scales usually are geared for specific fields, such as civil engineering, aeronautical engineering, and electrical engineering. The average hobbyist has about as much use

for these scales as he has for *shorted capacitors*. But by the same token, the very basic slide rules, the type usually inflicted on high school students, haven't sufficient scales for the electronics experimenter, and every calculation takes a few extra steps—they won't give you the full advantage of "shorthand."

There are two types of slide rules we can recommend to the electronics experimenter. The first is an ideal rule for the beginner and costs less than \$3.00. (That's right, less than three dollars. And gives the same answers as a \$27 slide rule.) The beginner's slide rule is any model with the following scales: C, D, and CI (for multiplication and division); A and B (for squaring); L (logarithms); and possibly K (for cubes). These scales are the very minimum for experimenter use. Next step up the line is a slide rule with S and T scales for trigonometric equations and alternating current calculations where phase angles are involved.

If you've a solid foundation in math you might want to look into a slide rule with scales such as CF and DF which give automatic multiples of  $\pi$ —the scales start at 3.14.

Our second type of slide rule is the one distributed by the Cleveland Institute of Electronics. (See page 52.) This model is jam packed with many scales, but with one exception they are all designed for the experimenter, and they don't require a knowledge of math to use them. In addition to the standard scales, C, D, A, B, etc., there are scales for automatically converting from and to frequency, inductance, resonance, capacitance, reactance, etc. These extra scales are clearly marked with electronic symbols so one doesn't have to refer to the instruction manual when using them. The back of the slide rule is even more unique. It has a special decimal locator that locates the decimal point automatically for all F, C, L,  $X_c$ , and  $X_L$  calculations. Also, all standard formulas commonly used by the electronics hobbyist and technician are printed on the back; the slide rule is almost a handbook in itself.

Obviously, we have skipped over many facets of the slide rule and sugar coated much of what we've discussed. Our purpose is only to show you that the slide rule is not a magical device used only by the advanced technician and engineer; it can be a useful easy-to-use tool even for the part-time hobbyist. ■



## Antenna Resonance

Continued from page 74

however, since most amateur transmitters have some means for reducing power. In the case of the SSB transceiver in the photo, the carrier balance control was turned slightly off balance. For use with a CB transceiver it will be necessary to build a power reducing three-resistor voltage divider, as diagramed in Fig. 5. A sensitive VOM is also required for use with the Z bridge.

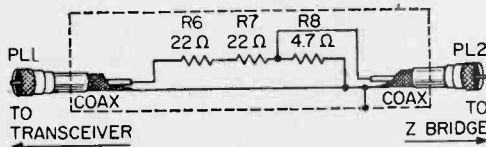

Fig. 5. Power reducer schematic diagram for use with CB 5-watt transmitters. Use 2-watt carbon or composition resistors.

Set up the Z bridge as shown in the block diagram of Fig. 6. Readings will be taken as before, but of frequency versus minimum output voltage readings. Follow these instructions, note that this Z bridge has two pin jacks (J3 and J4) instead of a switch for taking "forward" and "reflected" wave readings. The metal case of the Z bridge is common ground and the negative lead of the meter connects to the case via pin jack J5. To take the "forward" and "reflected" reading simply transfer the positive meter probe from one jack to the other. Here's the step-by-step procedure:

1. Disconnect the transmitter's antenna and connect the Z bridge in its place.
2. Set Z bridge control (RZ) to the transmission line impedance.
3. Set the VOM to its lowest DC voltage range and plug its positive probe into "reflected" wave jack J4. Plug the negative probe into J5.
4. Adjust the transmitter or signal generator for full-scale meter deflection of the VOM.
5. Transfer the VOM positive probe to "forward" wave jack J3. Switch the VOM to the next higher scale and note the voltage reading.
6. Connect the antenna to J2 and increase the output of the transmitter or signal generator to the same voltmeter reading obtained in step 5.

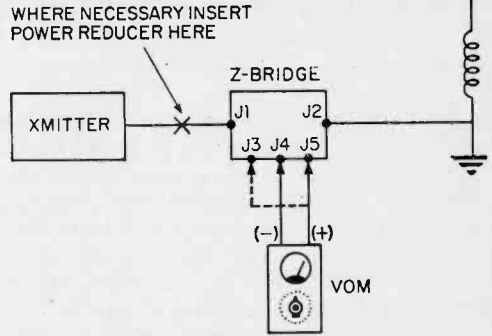

Fig. 6. Block diagram for an impedance bridge connection using a VOM indicator.

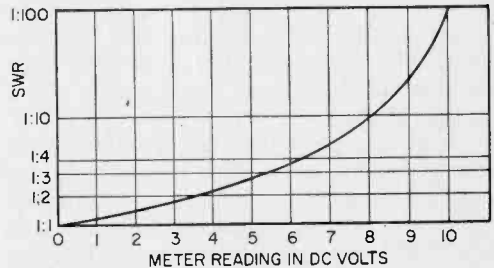

Fig. 7. Use this chart to convert impedance bridge meter readings to SW ratios.

7. Transfer the meter probe to the "reflected" wave jack J4. Switch the VOM back to its lowest DC voltage scale. Write down the figure obtained.

(Note: With CB transceivers you will not be able to readjust the output to the level called for in step 6. It will be sufficient to plot a curve for minimum voltmeter readings without this readjustment.)

Plot a curve based on the above for each 50-kc across the amateur band for which the antenna was cut, or the crystal positions of a CB transceiver. Again, the lowest point on the curve will be the resonant frequency of the antenna.

The Z-bridge voltage readings may be converted to SWR figures by the use of the chart in Fig. 7. For this you must be able to make the output adjustments called for in step 6 above.

The most important requirement for maximum performance is that the antenna be resonant. If the antenna is not resonant to your preferred operating frequency or portion of a band it should be altered so that it is. Shorten the antenna if the resonant frequency is too low and lengthen it if resonance is too high. ■

## Effective Radio Grounding

*Continued from page 54*

the winter seasons are very severe and the earth freezes to a considerable depth below the surface. Below 32 degrees Fahrenheit, the water in the soil freezes and this causes a tremendous increase in the *temperature coefficient of resistivity* for the soil. This coefficient is negative and, as the temperature goes *down*, the resistivity *rises* and the resistance of the ground connection is increased. Grounding electrodes which are not driven below the frost line in such localities will show a great variation in resistance throughout the seasons of the year. Even when driven below the frost line, there is some variation since the upper soil, when frozen, has the effect of shortening the active length of the rod.

It follows then that the depth to which the grounding electrode is driven is an important factor in electrical performance. Driven electrodes should be long enough to reach the permanent moisture level of the soil. Failure to reach moisture may result not only in high resistance but may also cause large variations of resistance during change of seasons. Usually the first few feet near the surface have relatively high resistance and are subject to alternate wetting and drying out due to variations in rainfall. The deeper soil is more stable and less liable to such fluctuation.

The most popular driven electrodes for radio applications are of copper-coated steel and are from five to ten feet in length which is ordinarily adequate to reach permanent moisture. Such electrodes are available from electrical and electronic supply houses; they may also be found in some electronic mail order catalogs. (See page 439 in Allied's Catalog 240B or page 415 in Lafayette's Catalog 650.)

**Methods of Improving Resistance.** The best method for decreasing the resistance of ground connections is not the same for every application. Soil conditions vary widely, not only for different localities but also within a given area and is seldom of uniform resistivity throughout different depths. A method that is best for improving the ground at one location might not be applicable for the ground in another. Various methods are available however to accomplish the desired results.

**Deep Driven Grounds.** This is a method frequently adopted by utility companies for securing better ground connections. They provide a means for reaching the strata of better conducting soils which often lie at a considerable depth below the surface. This type of ground is particularly applicable in areas where it is difficult to secure low-resistance ground connections by means of single five to ten foot rods. As the average location of amateur radio equipment is generally where moist soil can be penetrated with these shorter electrodes, the deep-driven rods to which the utility companies must some times resort, using sectional electrodes to make up as much as 100 feet in length, are seldom practical for amateur radio use. One wise ham installed his ground rod at the bottom of a ditch which was soon to become the basement in his new home. He had a real good ground because his basement leaks.

**Multiple Electrodes.** Another and more practical method for improving the resistance characteristics of grounds for amateur radio applications, is by use of multiple ground rods. When two or more rods are well spaced from each other, they provide parallel paths to earth; they tend to follow the law of metallic resistances in parallel. For example, two rods in multiple theoretically have one half the resistance of a single rod; three rods, one third the resistance of one, etc.

This direct reciprocal relation however, is not quite reached in practice because the spacing of the rods is necessarily limited. For example, two rods spaced 100 feet apart would have a resistance of 50 per cent of that of one rod. Spacings of this order however, are obviously impractical in small back yards. Also, the resistance and reactance of long connecting leads would decrease the effectiveness of rods in parallel.

For the usual convenient spacings of from five to twenty feet apart, whether arranged in a straight line, circular or rectangular pattern, two rods would have an average of approximately 60 per cent of the resistance of one rod, three rods 40 per cent and four rods about 33 per cent. Multiple rods are very effective for improving existing installations and, for practical amateur radio applications, need seldom exceed more than four. In one installation made by WA2CQL, three ground rods were driven into a flower garden—a site kept watered during dry spells.

**Chemical Treatment of Grounds.** Chemical treatment of the soil surrounding a driven rod is useful for lowering the resistance of a ground where deep driven rods or multiple electrodes are not feasible. The treatment decreases the resistivity of the soil adjacent to the rod, providing a fairly good conducting path out to areas of greater soil conductivity. Chemical treatment of the soil is also beneficial in reducing the seasonal variations in the resistance of the ground due to periodic wetting and drying out of the soil. Tests made on untreated ground showed a wide variation the resistance being much greater during the dry summer months. Treated ground in the same vicinity showed a slight increase in resistance during the dry season but this was not nearly as pronounced as for the untreated ground.

Magnesium sulphate, copper sulphate and ordinary rock salt are all applicable as treating materials. Magnesium sulphate is particularly desirable as it is the least corrosive. However, rock salt is the most economical and is quite satisfactory if applied by the trench method. A suitable trench approximately a foot deep, should surround the rod

but not actually contact it. This gives the best distribution of the treating material with the least corrosive effect on the electrode. Soil treatment while not permanent because the chemicals are gradually carried away by natural rainfall and drainage through the soil, will seldom require renewal for periods of several years, depending on the porosity of the soil and the rain fall.

A study of the foregoing information should prove of great assistance to the radio amateur who has been faced with difficulty in providing an adequate ground for his equipment. It will be apparent that provision of an adequate ground system can only result in increased efficiency of radio transmitting and receiving equipment. Where metal masts or towers are used for antenna supports, these should also be firmly connected to the ground system to provide a measure of protection from lightning damage. ■

---

*Much of the material in the preceding paragraphs has been based on research and tests conducted by the COPPERWELD STEEL COMPANY of Glassford, Pa., to whom the author is indebted for the data and some illustrations presented in this article.*

---

## Oscilloscope

*Continued from page 70*

The scope is connected across the amplifier output to observe the output signal. The waveform at the various stages can be observed by using a probe as suggested earlier.

The frequency response of the amplifier can be determined by varying the frequency of the signal generator and noting the change in amplitude of the waveform on the scope screen. The dynamic characteristics of the amplifier can be noted by varying the signal generator output level. When the signal reaches a certain level, the amplifier output may not increase and distortion of the waveform, resulting from overloading, can be noted on the scope screen.

By feeding a square wave signal into the amplifier, you can note whether the output signal is square or distorted because of phase shift and poor high frequency response in the amplifier.

Only a few of the uses of a scope can be covered here. There are excellent books on the subject. A scope can be used for measuring frequency, modulation level and sym-

metry and many, many other tests. Here, we haven't even touched on the use of the horizontal input of a scope. This will be discussed in future articles.

Other scope adjustments, not explained here, such as sync, and the use of 60-cycle and external sync signals are covered in instruction books furnished with scopes.

**Picking a Scope.** There are dozens of scopes on the market ranging in price from around \$70 for a kit to more than \$1000 for a lab-type instrument. The lowest cost scopes will usually satisfy the needs of beginner experimenters. Engineers and color TV servicemen usually insist on a more sophisticated scope with a frequency response extending from DC to 4 mc or higher. Most scopes are not designed to work with DC, but for some purposes the ability to pass DC is essential.

Scopes are available in several brands at radio parts stores and mail order houses. Used and obsolete military scopes are also available from surplus dealers but in many cases you are much better off sticking to equipment designed for you. Regardless of whether you buy a new or used scope, or get a kit and build it yourself, you will find it the most useful device in your shop for learning about electronics. ■

## Signal Generators

*Continued from page 46*

higher-priced generators include an output meter. Hooked across the output, it provides a visual indication of signal level.

This instrument is also called an AM generator. The reason is that, like most units of this type, it contains a provision for amplitude modulation of the signal. (An AM signal duplicates the transmission of the regular broadcast station.) Modulation is achieved by the audio oscillator stage, shown feeding the cathode follower in Fig. 12. In applying an audio signal to the control grid of the cathode follower, the RF signal can be varied in strength, or amplitude modulated. The audio tone is generally 400 cps. Some generators provide terminals so the operator may introduce external audio signals onto the RF carrier. The output of a phonograph, for example, could be used to modulate the generator. Picked by a nearby radio, the signal sounds like a musical program broadcast by an AM station. This can provide one clue to the radio's performance.

**Sweep Generator.** In the earlier discussion of the audio generator, it was mentioned that square waves provide many frequencies at once. There is a counterpart of this in RF generators. Most troubleshooting utilizes just a single frequency at a time, but some circuit checking and alignment requires a rapidly varying RF signal. A common example is in the TV receiver. There are certain circuits centered on approximately 41 mc. But for good picture reproduction, those circuits should be capable of passing frequencies from about 39-43—a span of 4 mc. It is tedious and impractical to apply a series of single signals to check such broad circuits. The sweep generator overcomes this problem by automatically varying any selected signal over a range of about 10 mc. An oscilloscope connected to the TV receiver could then display an overall curve of how the circuits were responding.

A technique for sweeping the RF generator frequency is the controlled inductor method, shown in Fig. 13. The device is positioned in the coil section of the RF oscillator stage. By changing the signal coil's inductance, the frequency of oscillation will similarly change. Note that the signal coil is coupled to a second coil known as the control winding. Applied to this winding is

a source of 60-cycle AC, simply a sampling of house current. It is adjusted to the desired level by the sweep width control. As AC enters the control winding, which is wound around an iron core, the core begins to saturate. This condition reduces the core's ability to conduct a magnetic field.

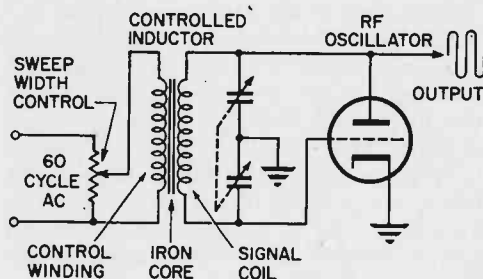

Fig. 13. Control inductor can vary sweep of RF signal at a sweep rate of 60 cps.

We see, too, that the signal coil is also wound around the same iron core. Since the core now presents a poorer path for the magnetic energy of the signal coil, there will be a change in oscillator frequency. The condition of core has caused a lowering of the coil's inductance. (This is similar to unscrewing the slug of a coil.) Decreased inductance in the signal coil has the effect of raising oscillator frequency. As the AC source varies, the oscillator sweeps above and below the center frequency. This all-electronic system updates early sweep techniques which used mechanically rotating capacitors or coils mounted on vibrating assemblies to control an RF oscillator.

**Other Generators.** These three instruments—Audio, RF and sweep—represents the most important generator types in use. Other instruments, though identified by different names, are mostly specialized variations on these basic forms. There are FM generators, for example. Circuit theory is the same as described, but they afford added convenience when much FM service is done. The Color generator produces its special frequencies to flash on the color TV screen the references needed for proper color adjustment.

But under the apparent complexity of these instruments, you're apt to find oscillators, cathode followers and other basic circuits tailored to meet a specific application. Wherever signals occur in a piece of electronic equipment, there's sure to be a signal generator that can duplicate them. ■

# BUILD, EXPERIMENT, EXPLORE, DISCOVER WITH NRI CUSTOM-DESIGNED TRAINING KITS



## BUILD YOUR OWN PHONE/CODE TRANSMITTER

This is just one of seven training kits programmed into NRI's Complete Communications course. You get actual practice in building your own crystal-controlled, phone/code transmitter and putting it on the air. You experiment with modulation, "clamping" circuits, key filters, other aspects of commercial transmitter operation. Can be put on the air simply by attaching an antenna and complies with FCC regulations. As with all NRI training kits, you get the most modern features and parts.

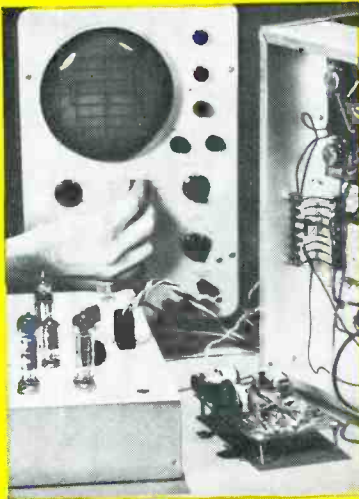

## BUILD ACTUAL ANALOG COMPUTER CIRCUITS

Industry, business offices, the government and military all need trained Electronics Technicians. NRI's Industrial Electronics course prepares you. You progress through 10 carefully designed training kits, topping off your practical experience phase of training by experimenting with feedback control systems, analog computers and digital computer elements. You actually solve problems on this analog computer you build yourself. This is the practical, fast way to a good paying, career position.

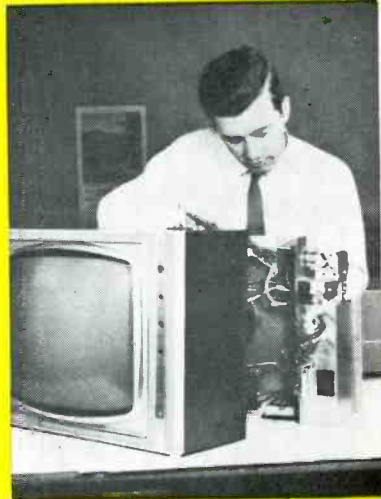

## BUILD A CUSTOM-ENGINEERED TELEVISION RECEIVER

Want to earn \$3 to \$5 an hour in spare time? Want your own part-time or full-time business? In Radio-TV Servicing you learn to install, maintain, service radios, TV sets, hi-fi and stereo, other home Electronics equipment. In your training are eight training kits, including this complete, modern, slim-line TV receiver. You build it yourself, become familiar with components and circuits, learn servicing procedures . . . and earn extra money as you train. National Radio Institute, Washington, D.C.

**SEE OTHER SIDE** ▶

### Join the Thousands Who Gained Success with NRI



"I am Frequency Coordinator for the 11th Naval District. The course was priceless." J. J. JENKINS, San Diego, Calif.



"Many thanks to NRI. I hold FCC License, am master control engineer with KXIB-TV." R.L. WOOD, Fargo, N.D.



"I am a Senior Engineering Aide. Without NRI I would still be working in a factory at a lower standard of living." D. F. CONRAD, Reseda, Calif.



FIRST CLASS  
PERMIT  
NO. 20-R  
Washington, D.C.

**BUSINESS REPLY MAIL**  
NO POSTAGE STAMP NECESSARY IF MAILED IN THE UNITED STATES

POSTAGE WILL BE PAID BY  
**NATIONAL RADIO INSTITUTE**  
3939 Wisconsin Avenue  
Washington, D.C. 20016

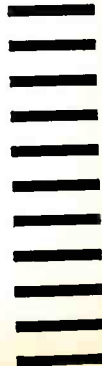



4-12

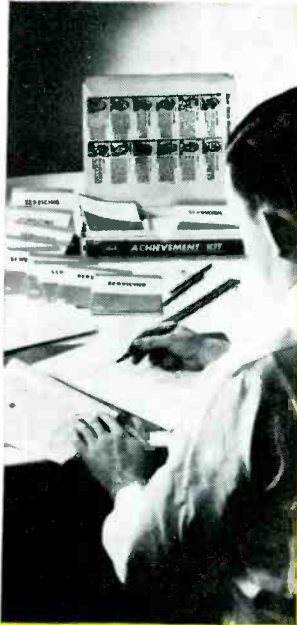

### GET FAST START WITH NEW ACHIEVEMENT KIT

Delivered to your door—everything you need to make a significant start in the Electronics field of your choice. An outstanding, logical way to introduce you to home-study training. It includes your first set of lesson texts and all the "classroom tools" you need. No other school has anything like the new NRI Achievement Kit.



### ELECTRONICS COMES ALIVE WITH NRI TRAINING KITS

Nothing is as effective as learning by doing . . . and NRI pioneered the "home lab" technique of training. NRI invites comparison with training equipment offered by any other school. Begin NOW this exciting program of practical learning. Make the skills of the finest Electronic Technicians your own. Mail card below.



### "BITE SIZE" TEXTS PROGRAM YOUR TRAINING

Certainly, lesson texts are necessary. NRI's programmed texts are as simple, direct and well illustrated as 50 years of teaching experience can make them. They are carefully programmed with NRI training kits to make the things you read about come alive. You experience all the excitement of original discovery.



### HOBBY? CAREER? MAIL CARD NOW TO NRI

Whatever your need . . . whatever your education . . . there's an NRI training plan to fit your requirements. Choose from three major courses or select one of seven special courses in particular Electronics subjects. Check the postage-free card below, fill in and mail. National Radio Institute, Washington, D.C.

# DISCOVER THE EASE AND EXCITEMENT OF LEARNING ELECTRONICS THE NRI WAY

## SEE OTHER SIDE

National Radio Institute, Electronics Div.  
Washington, D.C. 20016

6-045

Please send me your catalog. I have checked the field(s) of most interest to me. (No salesman will call.)

- |  |   |
|--|---|
| <input type="checkbox"/> TV-Radio Servicing      | <input type="checkbox"/> Basic Electronics          |
| <input type="checkbox"/> Industrial Electronics  | <input type="checkbox"/> Electronics for Automation |
| <input type="checkbox"/> Complete Communications | <input type="checkbox"/> Aviation Communications    |
| <input type="checkbox"/> FCC License             | <input type="checkbox"/> Marine Communications      |
| <input type="checkbox"/> Math for Electronics    | <input type="checkbox"/> Mobile Communications      |

Name \_\_\_\_\_ Age \_\_\_\_\_

Address \_\_\_\_\_

City \_\_\_\_\_ State \_\_\_\_\_ Zip Code \_\_\_\_\_

Accredited Member National Home Study Council



**PICK THE TRAINING PLAN OF YOUR CHOICE AND MAIL CARD FOR FREE CATALOG**



**OUR 50TH YEAR OF LEADERSHIP IN ELECTRONICS TRAINING**