

SEE 1969's CB TRANSCEIVERS ON PARADE

**elementary**  
**Electronics**

JANUARY-FEBRUARY 75¢

Facts, figures, photos, prices for 5-watt rig after 5-watt rig! Parade starts on page 65

**SEEING IS BELIEVING!**

Pair our varactor-controlled

**DIO-TRACE GENERATOR**

with any scope and sweep in the cleanest IFs ever!

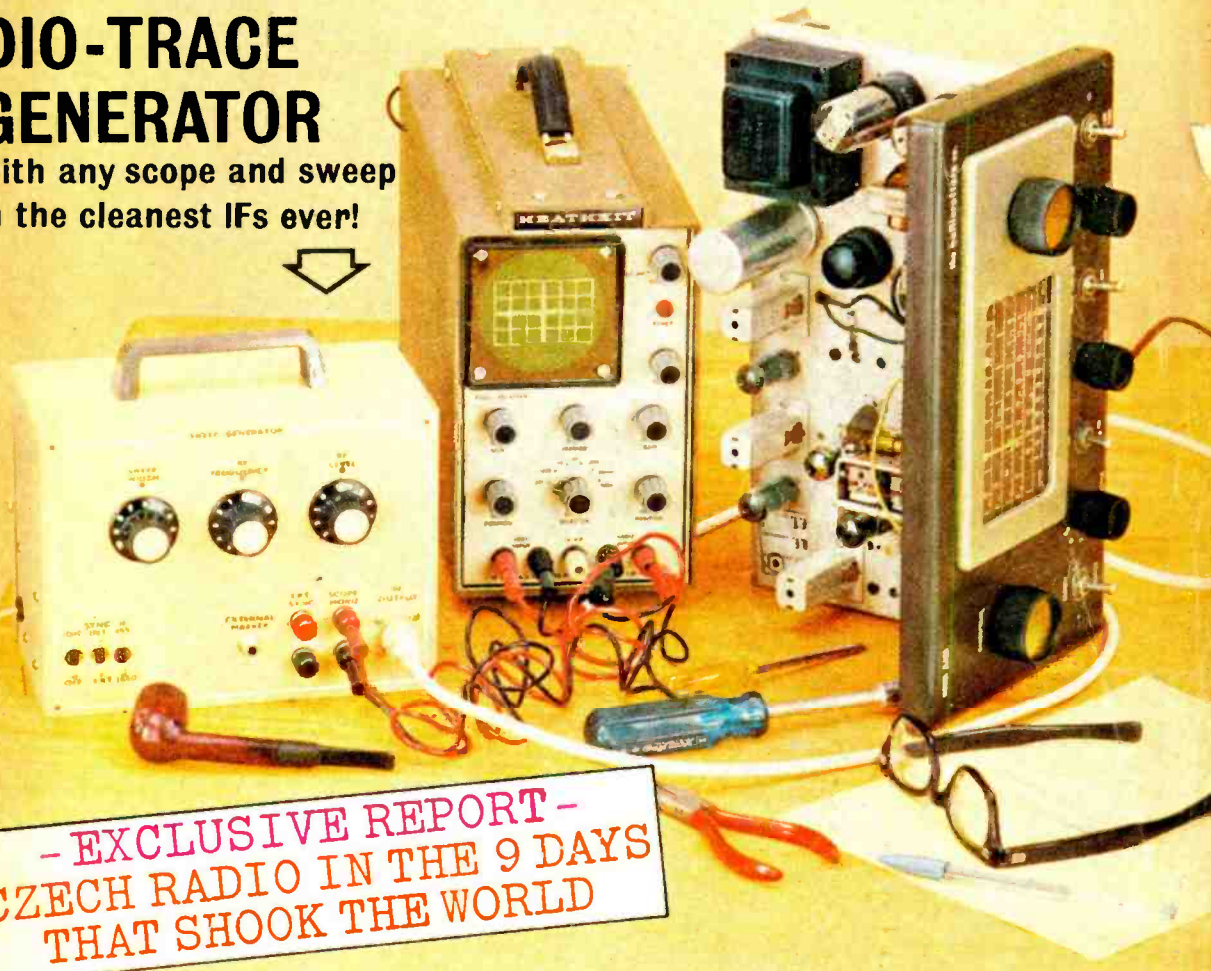

**- EXCLUSIVE REPORT -**  
**CZECH RADIO IN THE 9 DAYS**  
**THAT SHOOK THE WORLD**

- **ELECTRONIC LIGHTMASTER FOR YOUR CAR**—it's automatic!
- **SELF-PROGRAMMING COMPUTER GLITCH BOX**—amaze your friends!
- **LIQUID ELECTROLYTIC SEMICONDUCTOR**—for junior scientists!

# EICO Makes It Possible

Uncompromising engineering—for value does it!  
You save up to 50% with Eico Kits and Wired Equipment.



## Cortina Stereo

THE VERDICT IS IN. High fidelity authorities agree:

Cortina's engineering excellence, 100% capability, and compact dramatic esthetics all add up to Total Stereo Performance at lowest cost.

A Silicon Solid-State 70-Watt Stereo Amplifier for \$99.95 kit, \$139.95 wired, including cabinet. Cortina 3070

A Solid-State FM Stereo Tuner for \$99.95 kit, \$139.95 wired, including cabinet. Cortina 3200.

A 70-Watt Solid-State FM Stereo Receiver for \$169.95 kit, \$259.95 wired, including cabinet. Cortina 3570.

NEW Silicon Solid State 150-watt Stereo Amplifier designed for audio perfectionists. Less than 0.1% harmonic distortion, IM distortion. Less than 0.6% at full output. Controls and inputs for every music source. \$149.95 kit, \$225.00 wired including cabinet. Cortina 3150.

NEW 70-Watt Solid State AM/FM Stereo Receiver for \$189.95 kit, \$279.95 wired including cabinet. Cortina 3770.

NEW

NEW

## Eicocraft

The newest excitement in kits.  
100% solid-state and professional.

Fun to build and use. Expandable, interconnectable. Great as "jiffy" projects and as introductions to electronics. No technical experience needed. Finest parts, pre-drilled etched printed circuit boards, step-by-step instructions.

EC-100 Electronic Siren \$4.95. EC-101 Electronic Burglar Alarm \$6.95.  
EC-102 Electronic Fire Alarm \$6.95. EC-200 Electronic Intercom \$5.95  
EC-300 Audio Power Amplifier \$5.95. EC-400 Electronic Metronome \$3.95.  
EC-500 Tremolo \$9.95. EC-600 Electronic Light Flasher \$3.95.  
EC-700 Electronic "Mystifier" \$4.95. EC-800 Photo Cell Nite Lite \$4.95.  
EC-900 Power Supply \$8.95. EC-1000 Code Oscillator \$2.50.  
EC-1100 FM Wireless Mike \$9.95. EC-1200 AM Wireless Mike \$9.95.  
EC-1300 Electronic VOX \$8.95. EC-1400 Solid State FM Radio \$9.95.  
EC-1500 Solid State AM Radio \$8.95. EC-1600 Electronic Bongos \$7.95

EICOCRAFT



### 6 EXCITING NEW PROJECTS

EC-1700 Ham/CB Vox \$8.95.  
EC-1800 Electronic "TOX" \$8.95.  
EC-1900 "Treasure Finder" \$9.95.  
EC-2000 Electronic Organ \$9.95.  
EC-2100 Electronic "Eye" \$9.95.  
EC-2200 Electronic "Magic" Switch \$9.95

## Color n' Sound



Add a new dimension to your music system. Introducing the first inexpensive solid-state electronic system which provides true synchronization of color with sound. Watch the music you love spring to life as a vibrant, ever shifting interplay of colors.

Simply connect to speaker leads of your Hi-Fi system (or radio). Kit can be assembled in several hours — no technical knowledge or experience necessary. Kit \$49.95, Wired \$79.95.

## Automotive

EICO 888—Car/Boat Engine Analyzer.

For all 6V/12V systems; 4, 6, 8-cyl. engines.

Now you can keep your car or boat engine in tip-top shape with this solid-state, portable, self-powered universal engine analyzer. Completely tests your total ignition/electrical system.

Complete with a Tune-up & Trouble-shooting Manual. Model 888; \$49.95 kit, \$69.95 wired.

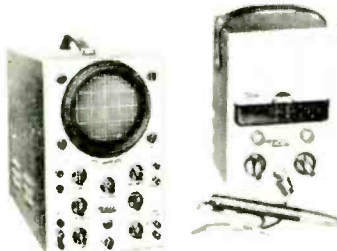

## Test Equipment EICO®

100 best buys to choose from.

"The Professionals"  
—laboratory precision at lowest cost.

Model 460 Wideband Direct-Coupled 5" Oscilloscope. DC-4.5mc for color and B&W TV service and lab use. Push-pull DC vertical amp., bal. or unbal. input. Automatic sync limiter and amp. \$99.95 kit, \$149.95 wired.

Model 232 Peak-to-Peak VTVM. A must for color or B&W TV and industrial use. 7 non-skip ranges on all 4 functions. With exclusive Uni-Probe. \$34.95 kit, \$49.95 wired.

FREE 1969 CATALOG

EE 1-2

EICO Electronic Instrument Co., Inc.  
283 Malta Street, Brooklyn, N.Y. 11207

Send me FREE catalog, describing the full EICO line of 200 best buys, and name of nearest dealer.

Name: \_\_\_\_\_

Address: \_\_\_\_\_

City: \_\_\_\_\_

State: \_\_\_\_\_ Zip: \_\_\_\_\_



----- Mail This Card Today ----->

LAFAYETTE 1969 CATALOG 690 our 48th Year

# FREE!

**BETTER THAN EVER**  
Your Complete Buying Guide to  
Everything in Electronics



OVER  
**500**  
PAGES!

Featuring Everything in Electronics for  
• HOME • INDUSTRY • LABORATORY  
from the "World's Hi-Fi & Electronics Center"

Use LAFAYETTE'S Easy-Pay  
Budget Plan NO MONEY DOWN ...  
Up to 24 Months to Pay

Satisfaction guaranteed  
or Money Refunded

----- Mail This Card Today for Your Friend ----->

**STORE LOCATIONS**

<b>NEW YORK</b> Brooklyn Jamaica Lynbrook	<b>MANHATTAN</b> Scarsdale Syosset	<b>NEW JERSEY</b> Newark Paramus Plainfield	<b>MASSACHUSETTS</b> Boston Natick Seaugus
<b>PENNSYLVANIA</b> King of Prussia Monroeville Philadelphia Pittsburgh	<b>CONNECTICUT</b> Hamden W. Hartford	<b>WASHINGTON, D.C. (Area)</b> Falls Church, Va. Mt. Rainier, Md.	

Mail the Coupon Today for Your  
**FREE 1969 Lafayette Catalog 690**

LAFAYETTE Radio ELECTRONICS  
Dept. 26118 P.O. Box 10  
Syosset, L.I., N.Y. 11791  
Please send the FREE 1969 LAFAYETTE Catalog 690

Name \_\_\_\_\_  
Address \_\_\_\_\_  
City \_\_\_\_\_ State \_\_\_\_\_ Zip \_\_\_\_\_  
(Please Give Your Zip Code No.)



Mail This  
Card Today  
For Your

# FREE!

## 1969 Lafayette Catalog 690

Dept. 25118

Name \_\_\_\_\_  
Address \_\_\_\_\_  
City \_\_\_\_\_  
State \_\_\_\_\_  
Zip \_\_\_\_\_  
(Please Give Your Zip Code No.)

Dept. 25118

Name \_\_\_\_\_  
Address \_\_\_\_\_  
City \_\_\_\_\_  
State \_\_\_\_\_  
Zip \_\_\_\_\_  
(Please Give Your Zip Code No.)

# FREE!

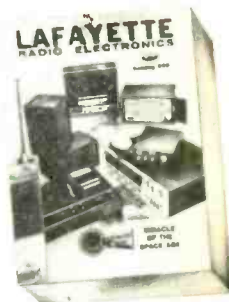

Mail The Card  
Today for Your

# FREE!

## 1969 Lafayette Catalog 690

Mail This Card Today For Your

**FREE!**

1969 LAFAYETTE  
CATALOG 690



Over  
**500**  
Pages

Shop At the "World's Hi-Fi  
& Electronics Center"  
For Widest Selection, Low Prices

Stereo Hi-Fi • Citizens Band • Ham Gear • Tape  
Recorders • Test Equipment • TV and Radio  
• Phonographs, Accessories • Intercoms and PA  
• Closed Circuit TV • Tubes and Parts • Cameras  
• Auto Accessories • Musical Instruments • Tools  
• Books

Featuring Everything in Electronics for  
• HOME • INDUSTRY • LABORATORY  
from the "World's Hi-Fi & Electronics Center"

REVOLUTIONARY NEW



Electronic Miracle  
of the Space Age



Award winning LR-1500T  
IC solid state Receiver



New! Revolutionary "IC"  
2-Way Radios  
"IC" (Integrated Circuit)



New!  
Dyna Com  
Series  
Super  
Walkie-Talkies



New! Musical  
Instruments and  
Accessories

Do A Friend A Favor . . .

Have a friend interested in hi-fi or electron-  
ics? Send us his name and address and we  
will send him his own personal copy of the  
1969 Lafayette Catalog 690.

**FREE!** MAIL THE CARD TODAY!

**LAFAYETTE**  
RADIO ELECTRONICS

P.O. BOX 10  
SYOSSET, L.I., N.Y. 11791

PLACE  
STAMP  
HERE

**LAFAYETTE**  
RADIO ELECTRONICS

P.O. BOX 10  
SYOSSET, L.I., N.Y. 11791

PLACE  
STAMP  
HERE





**YOUR MUSIC IN DAZZLING ACTION with**



**Dramatic New Breakthrough  
In Audio-Visual Enjoyment**

Now you can have a thrilling psychedelic "see-in" right in your own home, club, school or business—in fact—anywhere you want to add sensational "mod" effects. Colored light beams dance and prance, whirl and swirl in perfect time with the music—each individual note creating its own unique, twisting, radiating shape. Adds a spectacularly wild, new dimension to the world of music and entertainment. Combines electronics, science and art with dramatic results. Attaches in seconds to your radio, tape recorder, hi-fi, or stereo with two alligator clips. Can be used on small screens, large walls, stages and whole auditoriums. Build your own MusicVision\* with low-cost Do-It-Yourself Kit. Loads of fun! Fast! Easy! All you need is a light source. If you don't

have one, the versatile Edmund 35mm 500 Watt Projector is a terrific bargain. All kinds of other uses too—set up to accept motorized accessories. Also available in 15"x18"x27" Walnut Cabinet Model, Tube Unit, or 8" and 12" Sets which include encased 8" or 12" Motlondizer, Color Wheel and set of apertures for use with your own 35mm projector. Large 12" set provides fabulous effects for commercial applications. Order by stock number listed below. Money-back guarantee. Complete information in new catalog. If you want additional details now, send 25¢ in coin for fully illustrated, 16-page Booklet No. 9096EK. "Introduction to MusicVision."

\* Patent pending.

**8" DO-IT-YOURSELF KIT**—Stock No. 71.009EK ..... \$22.50 Postpaid  
**8" SET** (Motlondizer, color wheel, apertures) Stock No. 71.030EK \$45.00 Postpaid  
**12" SET** (Same as above w/larger Motlondizer) Stock No. 71.032EK \$57.50 Postpaid  
**WALNUT VENEERED CABINET MODEL**: Stock No. 85.181EK ..... \$99.50 F.D.B.  
**EDMUND 500 Watt 35mm PROJECTOR**—Stock No. 71.057EK ..... \$24.50 Postpaid



**TOP-QUALITY LOW-COST STROBE**

Create spectacular psychedelic lighting effects with this genuine electronic strobe. Terrific for parties, special occasions, experiments . . . perfect for combos, night clubs, dances, exhibitions. Adjusts from 1 to 10 short duration flashes per second on a make-shift mechanical device. Amaze friends with old-time movie effects. Beat party ice-breaker ever—"freeze" the action and "un-freeze" your guests. Practical too—check action of moderate-speed machinery. Xenon lamp gives one million flashes. 9 3/4" diam. reflector. Uses reg. 110-120 volt A.C. current. Handsome solid walnut cabinet. 9 1/2" x 9 3/4" by 4". Send for Bulletin #75—describes other new unique lighting effects. Stock No. 70.989EK . . . . \$79.95 Ppd.



**NEW! LOW-COST COLOR ORGAN**

Accompany music with colored lighting that changes in hue and intensity. Create tremendous variety of unusual and beautiful effects. Simply plug in 3 diff. sets of colored lights and place near audio source. Notes picked up by interior "mike" determine which colored lights go on—loudness determines intensity. Surprising number of commercial, display and home uses—control lighting in pools and fountains, window and holiday decorations, great for parties. Tough, compact unit with light intensity control. 4-7/16" x 2 1/2" x 4 1/4". 1 lb. 6 oz.  
**Stock No. 1900EK . . . . . \$39.95 Ppd.**  
**4 CHANNEL DE LUXE 2,000 WATT**  
**Stock No. 71.103EK. \$195.00 Ppd.**

**KEEP PACE WITH  
THE SPACE AGE!**

**AMAZING  
BARGAINS**

for Fun • Study • Profit  
from  
**EDMUND SCIENTIFIC CO.**  
300 Edscorp Building  
Barrington, N. J. 08007



**LOW-COST OVERHEAD PROJECTOR**

If you've always wanted one but couldn't afford to pay \$150 here's your opportunity to get a 5"x5" model ideal for school, home and small audience use. Comes without light source—use your own 35mm projector for (ray ours). Ideal for transparencies, lantern slides, negatives, drawings, unusual lighting effects. 3 1/2 lbs. 9 1/4" x 8 1/2" x 5-9/16". Top-and-bottom mirrors. F3.5. 16mm F.L. lens, double Fresnel condenser. Easy friction-foocusing, Keystone adjustment. Easily portable.  
**Stock No. 71.011EK . . . . . \$29.50 Ppd.**  
**EDMUND 500 Watt 35mm PROJECTOR**  
**Stock No. 71.057EK . . . . . \$24.50 Ppd.**

**MAGIC JUMPING DISCS**

Put one of these quarter-sized crazy buttons down and stand back. In a matter of seconds it'll jump almost 6 feet high. Just like magic . . . but it's really scientific. Actually, the warmth of your hand holding these metal discs makes the trick. After palming a disc, place it on any cool surface and in moments it'll take-off. Loads of fun for kids of all ages. Terrific conversation piece. Package of twelve only \$2.  
**Stock No. P-41.150EK . . . . . \$2.00 Ppd.**  
**Stock No. P-41.180EK (set of 100) \$12.00 Ppd.**

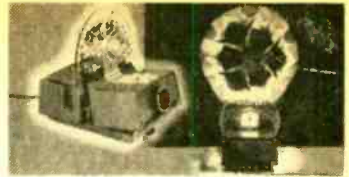
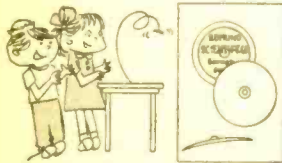

**NEW! PROJECTION KALEIDOSCOPE**

At last—a low-cost unit complete with 9" diam. liquid wheel. Projects infinite variety of brilliant color patterns which do not repeat. Specially designed wheel. 3" projection lens and Edmund Visual Special Effects Projector make it all possible. Easily operated. Large screen image at short projection distance perfect for photo backgrounds. Light shows, parties, dances, etc. Front or rear projection. Incl.: 1 RPM 115V Motor, motor bracket, instructions.  
**Stock No. 71.121EK . . . \$94.50 Postpaid**  
**SOLID Multi-Colored Glass Accessory Wheel (9" Diam.)**  
**Stock No. 71.122EK . . . . . \$15.00 Ppd.**



**NEW LOW-COST ULTRASONIC CLEANER**

Top-quality 1/2rd pint unit for only \$39.95. Cleans dirt, grime completely, quickly, safely. Small delicate parts, precision electronic items, lab instruments, jewelry, coins, even dentures sparkle like new. American-made—operates on regular house current. Solid state generator w/automatic turn-off. Power regulating knob. No shocks. No radio interference. 6"x4"x4" stainless steel.  
**Stock No. 71.003EK . . . . . \$39.95 Ppd.**  
**LARGE INDUSTRIAL 1 1/2-GAL. SIZE**  
**Stock No. 85.128EK. (wt. 37 lbs.)**  
**. . . . . \$249.95 FOB**



**NEW MODEL DIGITAL COMPUTER**

Solve problems, tell fortunes, play games with miniature version of giant electronic brains! Adds, subtracts, multiplies, shifts, complements, carries, memorizes. Colored plastic parts easily assembled. 12"x3 1/2" x 4 3/4". Incl. step-by-step assembly diagrams, 32-p instruction book covering operation, computer language (binary system) programming problems and 15 experiments.  
**Stock No. 70.693EK . . . . . \$9.98 Ppd.**  
**BIG NEW DIGICOMP II (Intro. price)**  
**Stock No. 70.946EK . . . . . \$16.00 Ppd.**

**MONEY-BACK GUARANTEE**

Order by Stock No.—Send Check or M.O.

**GIANT FREE CATALOG**

148 Pages! More than 4,000

**UNUSUAL BARGAINS!**  
 Completely new 1969 edition. New items, categories, illustrations, 148 easy-to-read pages, packed with nearly 4000 unusual bargains. Dozens of electrical and electromechanical parts, accessories. Enormous selection of Astronomical Telescopes.  
**EDMUND SCIENTIFIC CO., 300 Edscorp Building, Barrington, N. J. 08007.**  
 Mail coupon for FREE Catalog.

Name \_\_\_\_\_  
 Address \_\_\_\_\_  
 City \_\_\_\_\_ State \_\_\_\_\_ Zip \_\_\_\_\_



# elementary Electronics

Dedicated to America's Electronics Hobbyists

- ☆ 31 **CZECH RADIO—THE UNTOLD STORY!**  
*Czech-Mate!—how they all but outfoxed the Russian Bear*
- ☆ 35 **SPECIAL CONSTRUCTION PROJECT**  
*Dio-Tracer—an AM sweeper for ANY superhet*
- ☆ 65 **THE CB SCENE FOR 1969**  
*Complete Directory of 5-Watt Base and Mobile CB Transceivers*
- ☆ 46 **PROJECTS FOR CAR, HOME, AND SHACK**  
*Electronic Lightmaster—see your way home safely*
- ☆☆ 53 *Computomatic—the nothing box with that something touch*
- ☆☆ 57 *Let's Build a Liquid Semiconductor*
- ☆☆ 75 *Beginner's \$7.95 Shortwave Receiver*
- 20 **SWL AND DX FEATURES**  
44 *DX Central Reporting*  
44 *Operation 803—hands between Nebraska and Haiti*  
49 *DX Mexico—great find, great listening, great DX*
- 21 **HAPPENINGS FAR & NEAR**  
40 *John Napoli's Awesome Arm*  
56 *The Iceman Cometh—cartoon page*  
78 *For Bulls and Bears*  
79 *You and Those Radar Speed Traps*  
90 *The Big CB Putt-On—CB tees off*
- 22 **AS OUR LAB SEES IT**  
42 *Acoustic Research Solid-State Amplifier*  
64 *Hartmann Marine RDF-101 Radio Direction Finder*
- 23 **THE REGULARS**  
8 *Random Noise—editorial chit-chat*  
10 *Hey Look Me Over!—new products*  
13 *NewScan*  
22 *En Passant—chess column*  
24 *Literature Library—info you can use*  
30 *e/e Etymology*  
91 *A Basic Course in Electricity and Electronics, Part VI—Understanding Basic Circuit Actions*

Cover Photo by Leonard Heicklen

### AUTHORS IN THIS ISSUE:

Bill Britton, John W. Collins, Herb Friedman—W2ZLF/  
KB19457, Webb Garrison, Charles Green—W6FFQ, Joe  
Gronk, Don Jensen, Tom Kneitel—K2AES/KDQ4552, Mar-  
shall Lincoln—W7DQS, Ron Michaels, Jack Schmidt, C. M.  
Stanbury II, and the ELEMENTARY ELECTRONICS' Edi-  
torial Staff.



☆  
Cover  
Highlights



# Success in Electronics Comes as Naturally as 1-2-3 through Education

1

**Grantham School of Electronics** EE 1-69  
1505 N. Western Ave., Hollywood, Calif. 90027

Please mail me your free catalog, which explains how Grantham training can prepare me for my FCC License and Associate Degree, in electronics. I understand no salesman will call.

Name \_\_\_\_\_ Age \_\_\_\_\_  
Address \_\_\_\_\_  
City \_\_\_\_\_ State \_\_\_\_\_ Zip \_\_\_\_\_

There they are — three big steps — three deliberate steps which lead directly to success in electronics. Your future is shaped by the moves *you* make — by the steps *you* take. Begin now with Step #1.

**STEP #1** is a simple request for full information on the Grantham Associate Degree Program in Electronics. You take this step by filling out and mailing the coupon. We mail our catalog to you; we do not send a salesman.

**STEP #2** is earning your FCC first class radiotelephone LICENSE and radar endorsement. You complete this step in the first two semesters of the Grantham educational program (by correspondence or in residence). Train with the school which gives associate-degree credits for your license training, offering you the opportunity to advance beyond the FCC license level to a college degree in electronics.

**STEP #3** is earning your ASEE DEGREE. This degree is conferred when you have earned credit for all six semesters of the Grantham curriculum.

The Grantham Associate Degree Program offers in-depth technical education, and prepares you for employment as an *engineering technician*—a big step above an ordinary technician. (Most of our students are already technicians when they begin the course.) Engineering technicians usually work directly with scientists and engineers, analyzing and solving engineering problems. *You can make more money as an engineering technician!*

## Accreditation, and G.I. Bill Approval

Grantham School of Electronics is *accredited* by the Accrediting Commission of the National Home Study Council, and is *approved* for both correspondence and resident training under the G.I. Bill. Just mail the coupon, or write or telephone us for full information without obligation.

## Grantham School of Electronics

1505 N. Western Ave. 818 18th Street, N.W.  
Hollywood, Calif. 90027 or Washington, D.C. 20006

Telephone:  
(213) 469-7878

Telephone:  
(202) 298-7460

2

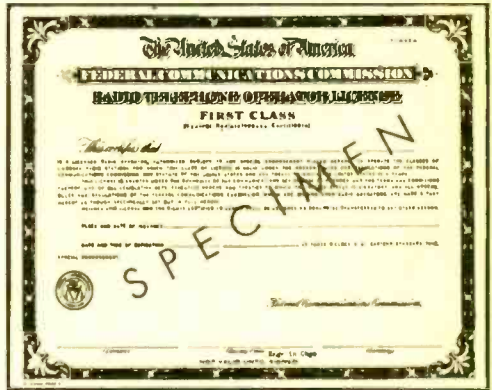

3

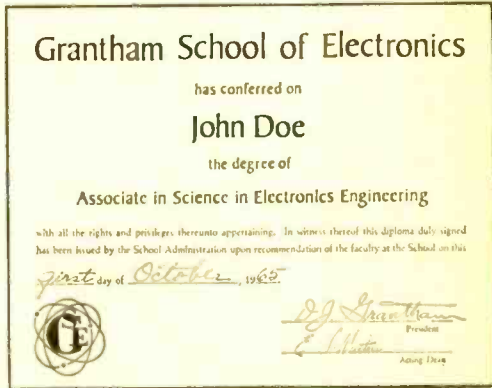

# now there are 3 time & tool-saving double duty sets

New PS88 all-screwdriver set rounds out Xcelite's popular, compact convertible tool set line. Handy midgets do double duty when slipped into remarkable hollow "piggyback" torque amplifier handle which provides the grip, reach and power of standard drivers. Each set in a slim, trim, see-thru plastic pocket case, also usable as bench stand.

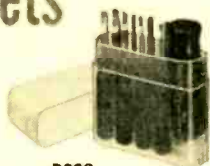

**PS88**  
5 slot tip,  
3 Phillips  
screwdrivers

**PS7**  
2 slot tip,  
2 Phillips  
screwdrivers,  
2 nutdrivers



**PS120**  
10 color  
coded nutdrivers



**XCELITE INC. • 80 BANK ST., ORCHARD PARK, N. Y.**  
Please send free literature N563.

name \_\_\_\_\_  
address \_\_\_\_\_  
city \_\_\_\_\_ state & zone \_\_\_\_\_

# elementary Electronics

Jan./Feb. 1969

Vol. 7/No. 3

Dedicated to America's Electronics Hobbyists

*Editor-in-Chief*

**JULIAN M. SIENKIEWICZ**  
WA2CQL, KMD4313

*Managing Editor*

**RICHARD A. FLANAGAN**  
KQD2566

*Technical Editor*

**CLIFFORD L. FORBES**  
KBQ8535

*Art Editor*

**JIM MEDLER**

*News Editor*

**HELEN PARKER**  
KQD7967

*Art Director*

**ANTHONY MACCARRONE**

*Cover Art Director*

**IRVING BERNSTEIN**

*Associate Art Director*

**JOHN YUSKO**

*Art Associate*

**JACK GOLDEN**

*Advertising Director*

**JIM CAPPELLO**

*Production Manager*

**CARL BARTEE**

*Assistant Production Manager*

**PAULA S. HELFANT**

*Instruments Division Manager*

**WILFRED M. BROWN**

*President and Publisher*

**B. G. DAVIS**

*Executive Vice-President and Assistant Publisher*

**JOEL DAVIS**

*Vice-President and Editorial Director*

**HERB LEAVY, KMD4529**

*Vice-President and Production Director*

**LEONARD F. PINTO**

*Vice-President and Treasurer*

**VICTOR C. STABILE, KBP0681**

ELEMENTARY ELECTRONICS is published bi-monthly by Science & Mechanics Publishing Co., a subsidiary of Davis Publications, Inc. Editorial, Business and Subscription offices: 229 Park Avenue South, New York, N.Y. 10003. One-year subscription (six issues)—\$4.00; two-year subscription (12 issues)—\$7.00; and three-year subscription (18 issues)—\$10.00. Add \$1.00 per year for postage outside the U.S.A. and Canada. Advertising offices: New York, 229 Park Avenue South, 212-OR 3-1300; Chicago: 520 N. Michigan Ave., 312-527-0330; Los Angeles: J. E. Publishers' Rep. Co., 8380 Melrose Ave., 213-653-6841; Atlanta: Pirnie & Brown, 3108 Piedmont Rd., N.E.; 403-233-6729; Long Island: Len Osten, 9 Garden Street, Great Neck, N.Y., 516-487-3305; Southwestern advertising representative: Jim Wright, 4 N. 8th. St., St. Louis, 314-CH-1-1965.

EDITORIAL CONTRIBUTIONS must be accompanied by return postage and will be handled with reasonable care; however, publisher assumes no responsibility for return or safety of manuscripts, art work, or photography. All contributions should be addressed to the Editor, ELEMENTARY ELECTRONICS, 229 Park Avenue South, New York, N.Y. 10003.

Second-class postage paid at New York, New York and at additional mailing office. Copyright 1968 Science and Mechanics Publishing Co.



# Like a better job, more money, a better future? Put yourself in this picture!



In a matter of months, this new ICS course can have you doing advanced troubleshooting on color sets!

**Lowest priced TV Servicing and Repair Course available!** Costs less than \$100. After just two lessons you'll be able to repair 70 percent of all TV troubles!

**Build yourself a business in your spare time!** Start with repairing your own TV set, then your neighbors'—and you're off and running. At end of course, you should be able to handle multiple TV troubles of all kinds, including color!

**Complete, practical, makes learning easy and fun!** 6 texts, 936 pages of concise, easy-to-follow

instruction. 329 illustrations show you how to recognize and identify TV troubles right from the screen. Texts tell you how to remedy each trouble, and why that remedy is best! Self-examinations enable you to check what you learn as you go along. Coveted ICS diploma upon completion.

**Approved by National Electronic Associations.** Used as part of their Apprenticeship program to train Service Technicians—an important step toward NEA certification. Called the best TV Repair and Servicing Course for the money!

**Big opportunity to get into big, money-making field!** Learn in your spare time, the famous ICS way. Get specially prepared dictionary of TV terms at no extra charge. Schematics of most popular TV's also available—a bargain in itself. Use the coupon to get all details.

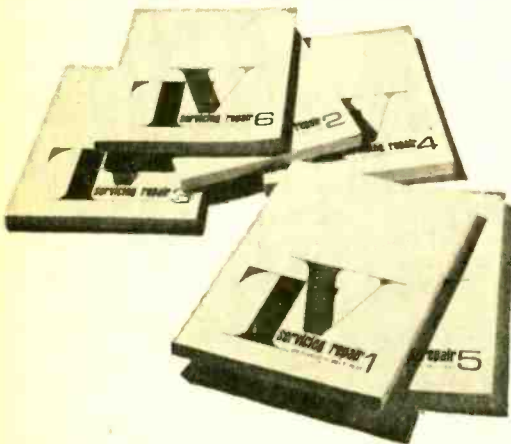

**ICS**

ICS, Dept. F9334L, Scranton, Penna. 18515

Yes, I'm interested in your new TV Servicing/Repair Course. Send me complete information. I understand there's no obligation.

Name

Street

City

State  Zip

# Olson



\* **FREE**

\*  
Fill in coupon for a **FREE** One Year Subscription to **OLSON ELECTRONICS' Fantastic Value Packed Catalog—Unheard of LOW, LOW PRICES on Brand Name Speakers, Changers, Tubes, Tools, Stereo Amps, Tuners, CB, and other Values. Credit plan available.**

NAME \_\_\_\_\_  
ADDRESS \_\_\_\_\_  
CITY \_\_\_\_\_ STATE \_\_\_\_\_  
GIVE ZIP CODE \_\_\_\_\_

If you have a friend interested in electronics send his name and address for a **FREE** subscription also.

## OLSON ELECTRONICS

304 S. Forge Street Akron, Ohio 44308

## Audio-Color

Lets you see your music



**ASSEMBLED**  
**\$54.95**

**KIT FORM**  
**\$44.95**

**\$5 DOWN — \$5 MONTH**

Walnut finished cabinet included / Shipped REA Collect

Easy to build, easy to install. All transistor **AUDIO-COLOR** adds a visual dimension to musical enjoyment. A brilliantly moving panorama of color casts dancing images on a soft frosted screen, reflecting rising and falling volume with each beat of the music. Here's a truly unique and exciting new musical experience. Make check or money order to **CONAR**.

**SEND FOR FREE CONAR CATALOG**

## CONAR

Division of National Radio Institute,  
Dept. AV9C, 3939 Wisconsin Ave.,  
Washington, D.C. 20016

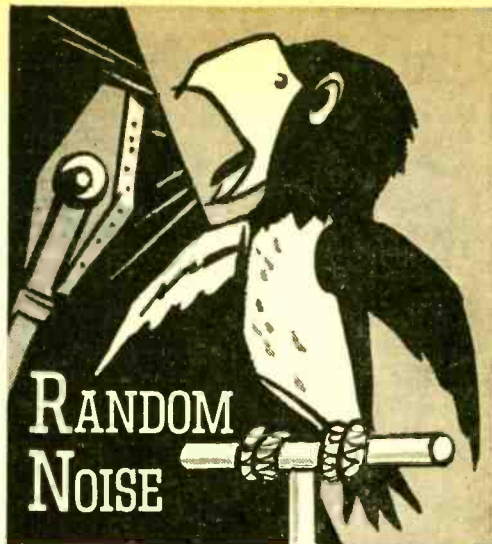

By **JULIAN M. SIENKIEWICZ**, Editor

**The Apollo 7 flight** proved an interesting point. Simply stated, it goes this way: the most sophisticated electronic device man can orbit in space is only as good as the fancy of the astronaut who cares—or cares not—to use it.

The full story may never be known. But at this writing it is known that astronaut Walter Schirra disliked the idea of taking a TV camera on board—presumably because he disliked the idea of flight controllers looking over his shoulder in space.

The TV system designed for the Apollo 7 is not representative of the best America is capable of today. The camera consumes 6.5 watts of power, uses a 500-kHz bandwidth, has 325 scan lines (your home TV has 525 scan lines—European has more), and displays a mere 10 frames per second. In short, the specs for the TV camera suggest anything but broadcast standards.

Thing is, when design was first begun back in 1962 with the then-existing state of the art, the space-borne camera system was the best that could be made with the burdensome specifications of outer-space engineering. Millions of dollars have been poured into the Apollo 7 camera project. Surely, the project should not have been begrudged an honest test as initially programmed in the flight plans.

**Everyone's Getting into the Act.** There was a time when you could tell who was a publisher and who wasn't. The name of the company usually was the tip-off. For example, *Davis Publications, Inc.* is a publishing company because that's what the name tells you, and if you check page 6 in this magazine you will see that it's the company that publishes **ELEMENTARY ELECTRONICS**. Now let's try two other names like *Radio Corporation of America* and *Amphenol Distributor Division of the Bunker-Ramo*





Here's a tired tigress resting after an afternoon's outing with RCA's home-brew metal locator.

Corporation—hell, they couldn't be publishers. But they are!

Want proof? RCA has just introduced a new, 224-page Solid-State Hobby Circuits Manual. Inside this project-builder's delight are detailed instructions on solid-state circuits for use in the home, automobile, photo-lab, ham shack, and by musicians, audio buffs, and experimenters. Priced at \$1.75, the manual—to this Editor at least—is a must for the home builder and experimenter. Get a copy today at your local electronics parts distributor.

As for the Amphenol people, they've come up with a "How-To Handbook" on connector assembly information for termination to popular RG-58A/U coax, plus poop on how to solder, how to interpret schematic symbols, how to read resistor color codes, etc. It's a great workbench reference, and the price is unbeatable—*free!* All you have to do to get a copy is send them a stamped, self-addressed envelope to How-To Handbook, Amphenol Distributor Div., Bunker-Ramo Corp., 2875 S. 25th Ave., Broadview, Ill. 60153. By the way, tell 'em we sent you.

**Dry Walls, Anyone?** The other day I hung some bookshelf speakers on a plasterboard wall—the job was quick, required minimum tools, and created *no mess* whatever. I owe it all to a new product that's about as electronic as a hammer. It's the new Molly drive fastener for dry walls. (A dry wall is that sheet rock or plaster wallboard that's become popular in construction lately.)

After marking the sites on the wall where I wanted the hidden speaker hangers to be located, I drove the Molly drive fasteners in place with a zap of the hammer—no drilling at all. Once the fasteners are in place, a screwdriver does the remainder of the work. Find out for yourself. Pick up a blister pack of Molly drive fasteners for dry walls at a hardware store or shopping center—you get four for 49¢. ■

## LEARN ELECTRONIC THEORY

### BY BUILDING THESE STEP-BY-STEP KITS

Embark now on an exciting step-by-step journey toward the assembly of a highly professional eight-transistor or five-tube radio. Enjoy the personal pride and accomplishment of assembling your own radio . . . and learning a great deal about basic electronics and radio theory. Graymark, leader in kits for instructional classroom use, here offers two of these radio kits to the public. Each comes complete with all parts and fully illustrated/easy-to-follow instruction manual. All parts are fully warranted. Send coupon below for fully illustrated color brochure.



COMACHO

**"COMACHO" EIGHT-TRANSISTOR RADIO.** Kit provides basics of superheterodyne transistor theory operation. Builds into an attractive printed circuit-board radio, mounted in plastic case. Compares favorably with more expensive units. Earphone included. \$19.95 each.

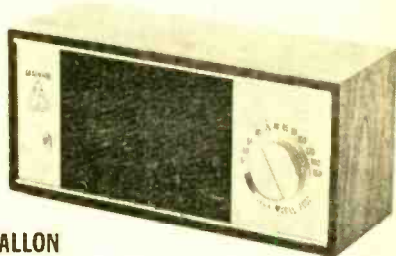

SCALLON

**"SCALLON" FIVE-TUBE RADIO.** Easy-to-understand kit approach to superheterodyne circuitry. Assembles into a distinctive table-type radio. Tubes, contemporary walnut cabinet included. \$21.95 each.

Send order today to:

**Graymark**

ENTERPRISES, INC.

P.O. Box 54343 • Ter. Annex, • Dept. 105

Los Angeles • Calif. 90054

Send Kits Checked

COMACHO (\$19.95 ea.)  SCALLON (\$21.95 ea.)

Send Postpaid. Enclosed find check/money order for full amount. (Calif. Res. add 5% total purchase)

Send C.O.D. I will pay full amount, plus postage.

Send illustrated color brochure.

Name \_\_\_\_\_

Address \_\_\_\_\_

City & State \_\_\_\_\_ Zip \_\_\_\_\_



Hey,  
look me  
over...

New Products  
that caught  
the Editor's eye

### Take a Card!

An absolute must for the budding radio-TV repairman is a good-looking, legible business card. And two colors gives it that much more zotz. The Relief Printing Corp. will custom-design your card with your choice of colors, trademark, and lettering, at only \$8.50 for 500 cards. All cards are completed on two-ply pasted Bristol stock and are packaged in individual Draw-Pul Card Savers. Write for specifics to the Relief Printing Corp., 63 Summer St., Boston, Mass. 02110.



Relief Printing Company Sample Business Card

### Synchronous-Speed Turntable

Garrard's Synchro-Lab Series stars the SL95 automatic transcription turntable. Introduced last year, it has a sleek new look and engineering refinements. The Synchro-Lab motor is actually two motors in one. It contains an induction section, which imparts an instant start and high driving torque to the turntable, and a synchronous section, which automatically locks into the unvarying 60-Hz electric current to maintain absolutely constant speed. The synchronous motor has made it possible to incorporate a light-weight turntable, which has the advantage of relieving wear on the center bearings. Its tone



arm rests on gyroscopically gimballed pivots for minimal friction. The auto-rise safety record platform raises at the push of a button for stacking records to be played automatically, and lowers into the unit floor when the turntable is



Garrard's Synchro-Lab SL95 turntable

used manually. The manual-cueing-pause system in the SL95 is operated with one control. A single lever starts the turntable, activates cueing, lifts the arm, and lowers it gently to the record. Other features: built-in calibrated stylus pressure gauge; adjustable sliding counterweight isolated in rubber; anti-skating control; snap-in cartridge clip which eliminates the need for a plug-in shell. The SL95 sells for \$129.50. If you care for more specs, write the Garrard Div. of British Industries, Westbury, N.Y. 11591.

### Exploring the Shortwaves

Imaginatively dubbed the Magellan, Admiral's YK377 is a 6-band FM/AM radio with short-wave, longwave, and marine coverage. It has 18



Admiral's YK377 6-Band AM/FM Radio



transistors, 6 diodes, automatic frequency control, slide-rule vernier tuning, dial light, tone control, separate regular and fine tuning controls, and a powerful 6 x 4-in. Alnico V speaker. Other features are two ferrite rod antennas, tuning meter and battery condition indicator, 44-in. telescopic antenna, and a built-in AC charger converter which permits the radio to be played on household current and also charges the batteries. In a walnut grained finish with aluminum grille and diecast handle, the Magellan retails for \$99.95, complete with batteries and earphone. At your local store, or write to Admiral Corp., 3800 Cortland St., Chicago, Ill. 60647.

## Cut Up with Safety

New diagonal cutting safety pliers introduced by the Milbar Corp. have been designed to eliminate two hazards—flying pieces normally encountered when cutting electrical wire, and snipped pieces dropping onto circuit boards and

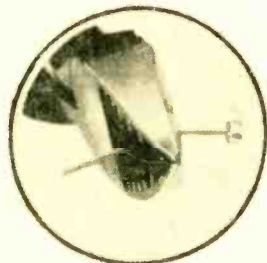

Milbar Corp.  
Diagonal-Cutting  
Safety Pliers



causing possible damage to electronic assembly operations. Adjacent to the cutting edges is a rubber-plastic compound forming adhesive surfaces to firmly hold cut pieces. The tool is claimed to be self-cleaning. Available in 4½- and 7½-in. lengths, the two sizes are priced at \$4.95 and \$5.95. For complete information on these pliers, write to Milbar Corp., 2800 E. 116th St., Cleveland, Ohio 44120.

## Swell News for Hams

And for all you hams, there's a new Allied receiver, model A-2515, a 5-band AM/CW/SSB unit, which features solid-state circuitry, tunes all amateur bands from 80 to 10 meters, international shortwave, aircraft, marine, other shortwave broadcasts, and the standard AM broadcast band. Bands covered are 150-400 kHz, 550-1600 kHz, 1.6-4.8 MHz, 4.8-14.5 MHz, and 10.5-30 MHz. The A-2515 has two FETs in the RF stage, four mechanical filters, noise limiter, and automatic volume control. Built-in variable

Scott's new LR-88  
receiver takes the



out of kit building

Ladies and children needn't leave the room when you build Scott's new LR-88 AM/FM stereo receiver kit. Full-color, full-size assembly drawings guide you through every stage . . . wires are color-coded, pre-cut, pre-stripped . . . and critical sections are completely wired and tested at the factory.

In about 30 goof-proof hours, you'll have completed one great receiver. The LR-88 includes FET front end, Integrated Circuit IF strip, and all the goodies that would cost you over a hundred dollars more if Scott did all the assembling.

Performance? Just check the specs below . . . and write to Scott for your copy of the detailed LR-88 story.

**LR-88 Control Features:** Dual Bass and Treble; Loudness; Balance; Volume compensation; Tape monitor; Mono/stereo control; Noise filter; Interstation muting; Dual speaker switches; Stereo microphone inputs; Front panel headphone output; Input selector; Signal strength meter; Zero-center meter; Stereo threshold control; Remote speaker mono/stereo control; Tuning control; Stereo indicator light. **LR-88 Specifications:** Music-Power rating (IHF), 100 Watts @ 4 Ohms; Usable sensitivity, 2.0  $\mu$ V; Harmonic distortion, 0.6%; Frequency response, 15-25,000 Hz  $\pm$  1.5 dB; Cross modulation rejection, 80 dB; Selectivity, 45 dB; Capture ratio, 2.5 dB; Signal/noise ratio, 65 dB; Price, \$334.95 (Recommended Audiophile Net)

## You'll swear by it



# SCOTT®

H. H. Scott, Inc., Dept. 211 01, Maynard, Mass. 01754  
Walnut case optional

© 1968, H. H. Scott, Inc.





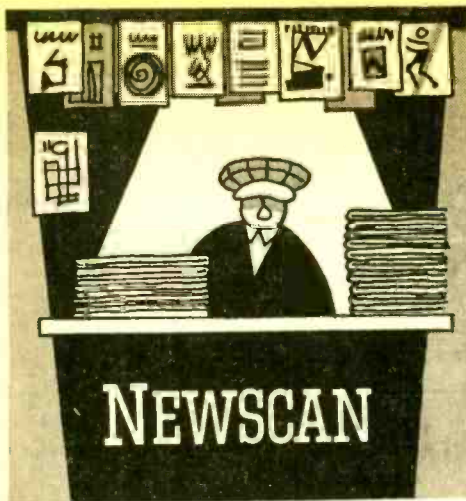

## The Voice from Space

A space communications link was established into downtown Philadelphia using an Applications Technology Satellite "parked" in orbit 22,500 miles above the east coast of Brazil. The space communications "first" was demonstrated by the General Electric Space Systems Organization personnel during an international communications conference.

The experiment, which represents the state-of-the-art in space communications technology, was designed to illustrate to convention visitors the potential use of satellites for mass dissemination of information via telephone. (Turn page)

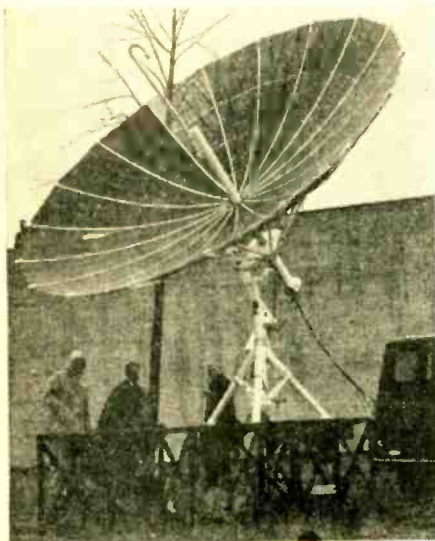

A new type, high-gain 15-foot GE communications antenna installed at the ice skating rink at Penn Center in downtown Philadelphia (photo) and a large terminal antenna of NASA's satellite tracking station in Rosman, North Carolina were an integral part of a successful space communications linkup for public demonstration.

**These 3 BIG DRAFTING KITS GIVEN TO YOU!**  
... when you train at home with NASD for a **HIGH PAY JOB IN DRAFTING!**

Take your pick of 1000s big salary jobs open to Draftsmen. U. S. Labor Dept. reports "42% more Draftsmen needed in next 10 years—not enough applicants to fill jobs available now." Easy home-study plan has helped 100s beginners toward \$5555, security, prestige as Draftsmen—many with only grade school training. Others report good earnings drafting part time while still learning. Why not you?

**RUSH COUPON FOR FREE KIT!**  
Mail coupon for FREE "DRAFTING CAREER KIT," Sample Lesson, Drafting Aptitude Test including new 5-Way Drafting Instrument & 20 Page Book, "Your Future In Drafting"—ALL FREE. No salesman will call. G.I. approved. Write today

NORTH AMERICAN SCHOOL OF DRAFTING, Dept. 1351  
4500 Campus Drive, Newport, California 92660

Rush "Drafting Career Kit," including Book, Sample Lesson, Aptitude Test & Drafting Instrument—All Free!

NAME \_\_\_\_\_ AGE \_\_\_\_\_  
ADDRESS \_\_\_\_\_  
CITY \_\_\_\_\_ STATE \_\_\_\_\_ ZIP \_\_\_\_\_

SPARE TIME OPPORTUNITY  
**MONEY**  
PANELISTS AT HOME WANTED BY NEW YORK RESEARCHER  
Leading research firm seeking people to furnish honest opinions by mail from home, pays cash for all opinions rendered. Clients' products supplied at no cost. For information write Research 669, Mineola, N. Y. 11501, Dept. 662

WRITE NOW FOR **McGEE'S CATALOG**  
1969 SENT FREE  
**1001 BARGAINS IN**  
SPEAKERS—PARTS—TUBES—HIGH FIDELITY COMPONENTS—RECORD CHANGERS—  
Tape Recorders—Kits—Everything in Electronics  
1901 McGee Street, Kansas City, Missouri 64108

**ON SALE NOW!**  
If you enjoy making furniture you'll find a special treat waiting for you at most of the newsstands. That's the **WOOD PROJECTS 1969** edition now on sale.  
**WOOD PROJECTS 1969** will cost only 75¢ at newsstands or \$1 per copy, postpaid, from Science & Mechanics Publishing Co., 229 Park Avenue South, New York, N. Y. 10003. Send for **YOUR copy NOW.**



The telephone link spanned more than 45,000 miles. Originating in the Sheraton at a dial telephone in the GE exhibit booth, conversations traveled over land line to the NASA satellite ground tracking station in Rosman, North Carolina and then transmitted on to the satellite fixed in orbit over the south Atlantic Ocean. Through the use of a high-gain 15-foot parabolic-type antenna erected at the ice skating rink at Penn Center, conference delegates conversed via satellite loop with other visitors in the Sheraton exhibit booth.

Another pair of dial telephones mounted on the side of the antenna radome on the ice rink offered the general public the opportunity to talk by communications satellite.

The ATS-111 is the latest in the series of NASA orbited satellites and is an initial step toward demonstrating the technical feasibility in the 1970's of bringing the widest possible programming spectrum into homes equipped with a low cost converter and antenna system for television receivers. At high mass production levels, the equipment cost could be as little as \$50 per home.

This concept applied in underdeveloped countries, for example, would mean programming produced by any major broadcast center could be beamed via satellite to another continent with strategically placed communications terminals. The technique would rapidly facilitate a progressive education program for large segments of the world's population.

The advent of direct broadcast satellites early in the 1970's will provide high resolution video reproduction capable of "blackboard" detail in a classroom situation emanating from a television studio thousands of miles away.

Satellites of the future will become invaluable to geologists, hydrologists and others for real-time resources data provided by sensory pay-

loads on satellites orbiting the earth. Important strides are expected in agricultural land management from earth resources satellites being proposed by industry. Scientists, too, will benefit from high-speed data links via satellites which will be capable of real-time transmission of information from central computer banks operating at data rates as high as 100 million bits a second.

Ever changing weather patterns for long range forecasting, and oceanographic information relative to shipping and fishing will be recorded in a comprehensive way by still other satellites. Low cost communications terminals made available to interested nations will permit the widespread utilization of this data as never before.

### One Gun and Color

A multi-color display system, which will enable air traffic controllers to analyze instantly various flight corridors or runways through four-color information portrayals, has been developed by Sylvania. The system, employing a new technique in a color, video cathode ray tube display, presents information in red, green, yellow, and orange. Words, numerals, or graphic material can be displayed on the tube with greater clarity, detail, and color registration than is possible with present systems.

Data of all kinds could be displayed on the new multi-color tubes, which can be made in sizes ranging from 1 to 27 inches. The display system shown in the photo is driven by computer. A keyboard is employed to initiate data appearing on the display. The system can be adapted for any application in which rapid visual distinction of information is required. In air traffic control systems the various colors could indicate runways, air lanes, holding patterns, or aircraft travelling at different altitudes.

### The Electronic Coffee Market....





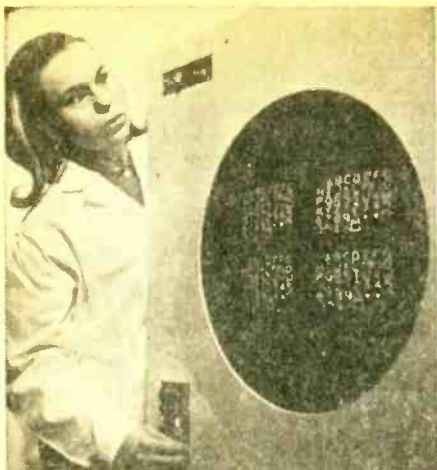

The new Sylvania multi-color information system displays data in four separate colors—red, green, yellow, and orange. The heart of the computer-driven system (above) is a 19-inch one-gun tube.

In military applications, the new display system could be used to quickly distinguish hostile and friendly forces, or for satellite tracking. For commercial uses in computer displays, the multicolor system could be used to indicate changing stock market conditions. Instrumentation readings, including waveforms, also could be separated visually by color through the new display system.

The electron tube used in the display system features a green phosphor, Sylvania's "rare earth" europium red phosphor, and a single electron gun. When activated by the gun's beam, the phosphors gave off colored light, thereby creating the display.

A special barrier separates each layer of phosphor on the face of the display. A low voltage electron beam activates the red phosphor

....it could happen!



5

6

CORK

Buy 10 PAKS & CHOOSE 1 FREE

- \$25 SURPRISE PAK: transistors, rect. diodes, etc. ... \$1
- 5 ONE AMP 800 PIV RECTIFIERS, silicon top hat ..... \$1
- 10 KODAK LENSES, convex, piano, etc. Hobby must \$1
- 50 GERMANIUM GLASS DIODES, 1N34, 1N48 no test \$1
- 40 TOP HAT SILICON RECTIFIERS, no test/asst values \$1
- 25 EPOXY RECTIFIERS, silicon asst, no test ..... \$1
- 40 PRECISION RESISTORS, 1/4-2W, 1% asst values .. \$1
- 30 TRANSISTORS, rf, if, audio, osc, no test ..... \$1
- 60 TUBULAR CONDENSERS, to .5mf to 1KV, asst .... \$1
- 50 DISC CONDENSERS, to .05mf npo, temp coef, asst \$1
- 60 TUBE SOCKETS, receptacles, plugs, audio, etc. ... \$1
- 30 POWER RESISTORS, to 25 watts, to 24K ohms .... \$1
- 3 2N3568 NPN TRANSISTORS, 200mc, 200V, 200hfe, \$1
- 3 2N3563 TRANSISTORS, npn, 600mc, 100hfe, epoxy \$1
- 10 VOLUME CONTROLS, to 1 meg, switch too! ..... \$1
- 10 ELECTROLYTICS, to 100mf, tubulars too, asst .... \$1
- 50 RADIO & TV KNOBS, asstd colors & styles ..... \$1
- 10 TRANS'OR ELECTROLYTICS to 100mf, asst values \$1
- 50 COILS AND CHOKES, if, rf, ant, osc, peaking, etc \$1
- 65 HALF WATTERS, to 1 meg, 5% popular values too \$1
- 60 HI-QUALITY RESISTORS, 1/4, 1, 2W asst values .... \$1
- 10 RCA PHONO PLUGS & JACK SETS, tuners, etc. .... \$1
- 4 INTEGRATED CIRCUITS, gates, etc. no test ..... \$1
- 2-PC INFRA-RED DETECTOR & FILTER SET science proj \$1
- 2 FIELD EFFECT TRANSISTORS, n channel, hobby C. \$1
- 50 TERMINAL STRIPS, 1 to 8 lug types ..... \$1
- 3 PHOTO ELECTRIC CELLS, hi. imp., schematic ..... \$1
- 3 TRANS'OR AMPLIFIER, WIRED, 3x2x3/4" schematic \$1
- 10 PRINTED CIRCUIT BOARDS, copper clad, 100 uses \$1
- 10 TRANSISTOR SOCKETS, for pnp & npn types..... \$1
- 10 PANEL SWITCHES, toggle, slide, micro, rotary .. \$1
- 5 "SUN" BATTERIES, for 100's of lite sens proj's \$1
- 5 RAYTHEON CK-722 TRANSISTORS, pnp, most pop \$1
- 5 G.E. 2N107 TRANSISTORS, pnp, audio ekts ..... \$1
- 6 "IBM" COMPUTER BOARDS, many trans, diodes. \$1
- 40 "MICRO" CONDENSERS, for transistor circuitry \$1
- 3 14W. EPOXY TRANSISTORS, npn, silicon, B-5000. \$1
- 15 3 to 12 AMP STUD RECTIFIERS, up to 600 PIV .... \$1

ADD POSTAGE, avg. wt: 1/2 lb.  CATALOG 10c

POLY PAKS

P.O. BOX 942L  
LYNNFIELD, MASS.  
01940

The Latest  
Hi-Fi  
Buyers' Guide  
"is great!"



This is a magazine with a difference, designed to help you, the buyer, pick the hi-fi components that are right for you. It's packed with test reports on stereo equipment of all kinds, reports that tell you exactly how each and every piece of equipment chalked up when put through its paces in our lab.

You'll find the Fall/Winter 1968 Hi-Fi BUYERS' GUIDE on your newsstand. Or if he's sold out send \$1.25 plus 25¢ postage to:

Hi-Fi BUYERS' GUIDE

229 Park Avenue South / New York, N.Y. 10003







Pretty Philco-Ford Corporation secretary Kay Falabella demonstrates new electronic central dispatch for the Editor. At the flick of a switch, the electronic dispatcher can instantaneously show individual locations for a fleet of tractors and trailers or the complete status for a fleet's terminals.

Fast Freighter updates all relevant records. As a result, terminal managers can maintain a continuous check on shipments either inbound or outbound from their terminals—avoiding cumbersome use of wall maps and the high cost of long-distance telephoning.

With instantaneous communications and con-



"Wow, that was a real whopper!"



**EQUIPMENT**

★ WIDEST SELECTION ★  
 ★ LOWEST PRICES ★  
 ★ FASTEST SERVICE ★

ALL MERCHANDISE SHIPPED  
 IN FACTORY SEALED CARTONS

"10-8"

Write us for  instant reply!

**CB Shack Unlimited**

P. O. BOX 62246  
 VIRGINIA BEACH, VA.  
 23462

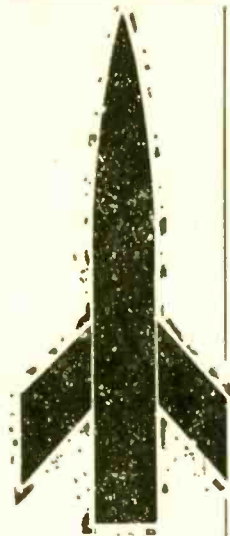

Keep up to date with **SCIENCE & MECHANICS**

Science & Mechanics—the only magazine that keeps you right up to date on developments in space technology, weapons, automobiles, medicine, boats, planes, tools, new products, and exciting world events.

Keep up to date. Make sure of your home delivered copy by returning the coupon today.

<b>SCIENCE &amp; MECHANICS</b>	EE-1/2
229 Park Ave. S., N. Y., N. Y. 10003	
12 issues \$4; 24 issues \$8; 36 issues \$12. (Foreign: Add \$1 a year.)	
Please enter my _____ year(s) subscription.	
<input type="checkbox"/> I enclose \$ _____	<input type="checkbox"/> Bill me.
Name _____	
(Please Print)	
Address _____	
City _____	State & Zip _____

tinually updated central information records, motor freight managers have through Fast Freighter a continually fresh and up-to-the-minute picture of their operations and resources.

### Gravity's Got a Lot of Pull

An Applications Technology Satellite launched from Cape Kennedy combined a delicate balancing system with a weather eye camera that can zero in on storms over the North and South American continents. Launched into a 22,300 statute-mile high orbit by an Atlas/Centaur booster, the 864-pound satellite hovers over the equator, about 400 miles west of Quito, Ecuador in the Pacific Ocean.

The ATS series of seven satellites, of which ATS-D is the fourth, is designed to provide "in-orbit laboratories" for improving spacecraft systems. General Electric Company's Space

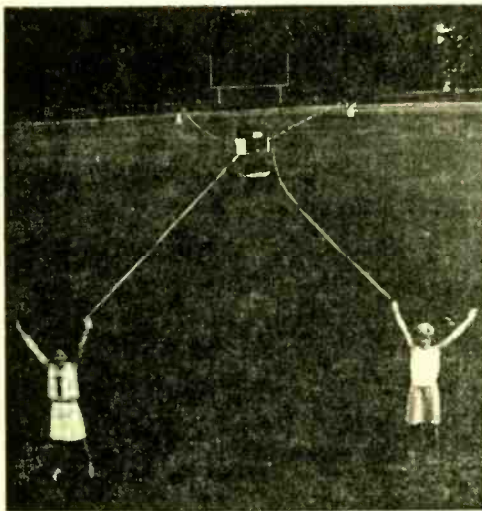

*Most young girls get starry-eyed over football players, but here is a group that's starry-eyed over an experiment-loaded satellite the size of a football field. The white tape the lasses hold represents four 123-foot long paper-thin metal booms that provide satellite stability when in orbit.*

Systems Organization has the primary mission of demonstrating at an altitude of 22,300 miles the feasibility of a satellite stabilization technique that depends on the gravitational pull of the Earth.

Because of the long slender shape of the football field size satellite (251 feet from tip to tip) one end of ATS-D will be closer to Earth than the other, and thus will be affected more by gravity. Although these gravity forces are very small, about a hundred-thousandth of a pound, they prove to be sufficient to cause a satellite to look toward Earth.

The delicate gravity gradient balancing experiment in space is aided by deploying four 123-foot long primary booms and two 45-foot long damper booms. However, this action is not taken for approximately seven days into the flight, or until the spacecraft's rate of spin is reduced to near zero.

In the 1970's, weather, communications and navigation satellites, for example, will depend on a steady platform to keep cameras and sensors continually pointing toward Earth. Application of gravity gradient stabilization for long-life satellites is most advantageous because the passive system provides a high degree of reliability and a life expectancy of more than five years.

ATS-D will be the first flight for the day/night television camera (885 lines) which will take photos of developing weather systems. Infrared photos of the Earth have been previously taken by weather satellites, but nighttime pictures in the visible spectrum (that part of the spectrum which man can see) have not been possible.

Each picture will cover an area on Earth 1,150 statute miles square (1.3 million square miles), with a resolution of less than 1.5 statute miles at picture center. The steerable optics in this image orthicon camera permits cloud cover pictures to be taken 4,000 miles in any direction on the face of the Earth (from the tip of South America to the Hudson Bay). Sixty-four pictures and three hours will be required to photograph the entire Earth's disk.

Capabilities of this camera system at nighttime will be evaluated under various degrees of moonlight ranging from quarter moon to full moon. Now lovers will have to share the full moon with a peeping satellite.

### The Tweet That's Sweet

A compact electronic screening instrument, approximately the size of a flashlight, that can detect a baby's hearing difficulties within hours of birth, has been developed by Zenith. Tabled the Neo-meter, it was developed in response to the recognized need by audiologists and otologists for a precision-built, portable instrument to screen children's hearing at the earliest possible age. Too often in the past, a child's hearing difficulty was not detected until he was enrolled at school. The neo-meter makes it possible for children to be screened for hearing problems while they are still in the hospital nursery.

The development of a child's speech depends on his ability to hear. If the Neo-meter screening indicates there is a hearing difficulty, parents and pediatricians can be alerted immediately. Remedial action can be taken so the speech of the hard-of-hearing child can progress at a rate comparable to that of a child with normal hearing.





*New Neo-meter developed by Zenith allows nurse or trained volunteer to screen hearing of new-born infants within hours of birth. Early detection of possible hearing loss—within first 6 months of life—allows parents and doctors to take steps so child's speech in his early years may develop at rate comparable to that of child with normal hearing.*

The Neo-meter is a small solid-state instrument that weighs only 10½ ounces with batteries. It is easily held in one hand. Ease of operation facilitates use in pediatricians' offices as well as hospitals. Volunteers can be trained to use the unit quickly and efficiently, easing the work load of nurses and doctors, the company stated.

Four pushbuttons, each marked for a precisely calibrated level of sound, control the signals which resemble the tweet of a bird. When held 12 inches from the baby's ear, his  
*(Continued on page 105)*

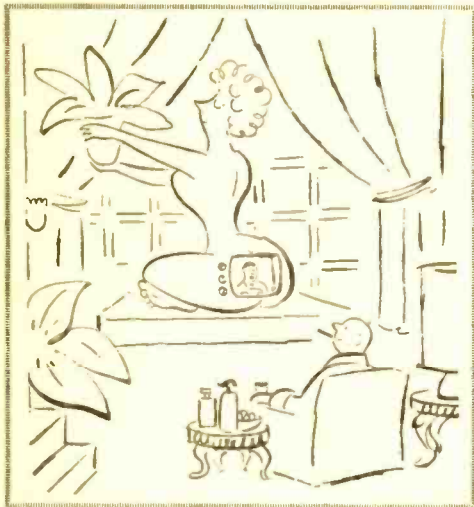

# Can't find the key to electronics?

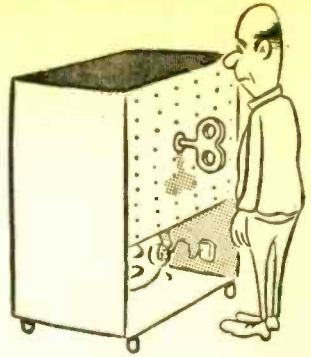

—then get your electronics cool with this introductory offer to the two leading electronics magazines! Use coupon:

DAVIS PUBLICATIONS, INC. EE-1/2  
 229 Park Ave. S./New York, N.Y. 10003

Yes! I want to find the key to electronics.

Begin my subscription to both RADIO-TV EXPERIMENTER and ELEMENTARY ELECTRONICS at your special low-subscription rate of \$7.00

Bill me later.  Check enclosed.

Name .....

Address .....

City ..... State ..... Zip .....

(Outside U.S.A. & Canada add \$1.50 pstge. & hndlg.)

—Now, both of these fine magazines will be delivered to you at the special subscription rate of just \$7.00 . . . save \$2 from newsstand price.



## ELEMENTARY ELECTRONICS

The magazine that serves up electronics theory in pleasant spoonfuls and reinforces the knowledge you gain with exciting and useful projects.

## RADIO-TV EXPERIMENTER

The magazine dedicated to the hobbyist—the man who wants to obtain a fuller and broader knowledge of electronics through the applications of his hobby.



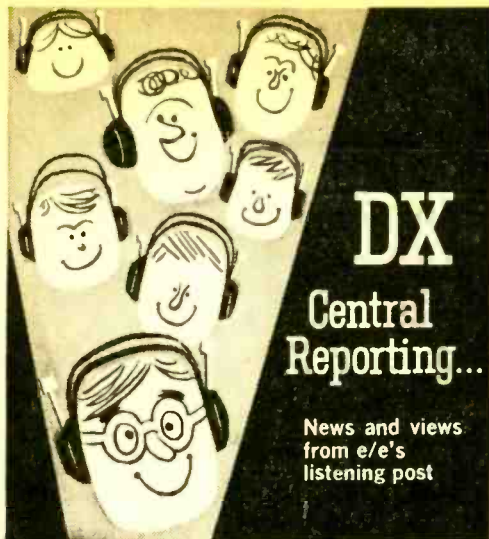

## Keeping It Clean

Most everyone has heard about clandestine radio's part in international power politics. But there are at least a few would-be broadcasters who desperately do *not* want to be pawns in games played by the major powers. For them the only solution is to broadcast from what can be loosely classified as a "neutralist" nation.

The best heard example of this phenomenon is *A Voz de Libertad*, operated by Portuguese refugees and using transmitters belonging to Radiodiffusion-Television Algerienne. Algeria, of course, is at the far left end of the neutralist camp. Nevertheless, it is not under direct control of Moscow or Peking as are such countries as Czechoslovakia, Albania, and Cuba.

*A Voz de Libertad* is currently reported in the United States evenings at 1900-2000 EST on 11835 kHz. Other frequencies probably include 6175 and 9685 kHz. RTA makes no attempt to disguise the fact that its transmitters are used by *A Voz de Libertad*. And for the past couple years RTA has been engaged in a vest-pocket radio war with another "neutral" station, the Swiss Broadcasting Corporation. The issue: who owns 529 kHz?

For some reason, logging this controversy has become an *in* game with DXers, possibly because that frequency is located in such an off-beat part of the dial—just below the U.S. broadcast band. Since SBC's home-service transmitter at Beromunster was on 529 first, SBC claims squatters' rights. The claim has been supported by the European Broadcasting Union. And, until recently at least, RTA couldn't have cared less.

Switzerland differs radically from what we usually think of today as a neutral power. Switzerland isn't really non-aligned because it's

an integral part of the Western economic structure. Nor is it a newly independent, emerging nation attempting to progress (or just stay alive) by playing the major powers against each other. Switzerland is merely neutral in the sense that it does everything possible to stay out of international disputes (except as a peace maker). Shortwave listeners can confirm this for themselves by tuning in on SBC's English language transmissions beamed to North America at 2015 EST on 9535 kHz.

Under these circumstances it can be safely stated that the 529-kHz radio war was an unique experience for the Swiss, one which the Algerians may have thoroughly enjoyed. And though at last report RTA had finally decided to stop tormenting SBC, don't be too surprised if that high-powered Algerian transmitter should suddenly reappear on 529 kHz.



Unusual QSL from Radiodiffusion-Television Algerienne outlet on disputed 529 kHz highlights virtually lost art of weaving.

Despite the high sunspot count, DXers east of the Mississippi still have a chance for transatlantic reception on 529—though it will certainly require much effort and patience. If RTA returns to this frequency, it will be best around 1700-1800 EST (SBC comes on around 0030 EST). North American QRM can be expected primarily from beacons, most notably station NB at North Bay, Ont. There is also supposed to be a Costa Rican broadcast station on 530 kHz—R. Rumbos at Cartago.

## On the Borderline

Speaking of beacons, if a strange voice suddenly appears on 530 kHz with minute landing



instructions for an aircraft, it won't be some sinister new twist in the Algerian-Swiss radio war. Instead, it'll be a beacon (like NB at North Bay, Ont., just mentioned, or OX at Comox, B.C. on 527 kHz) suddenly turned aeradio and guiding a blind-flying pilot into (hopefully) a safe landing.

Most Canadian beacons operating just below the BCB are equipped for such action. And while the band is used for this purpose only as a back-up to vhf systems, such transmissions are obviously well worth waiting for. Reason: they provide listening excitement seldom matched by orthodox BCB stations. Most of these off-band transmitters are good verifiers and can be QSLed even if you don't hear a voice transmission. All you need do is time their identification patterns to the second.

Other Canadian stations recently reported by DXers include BN 512 at Camp Borden, Ont.; UP 516 at Ottawa, Ont.; and FZ 524 at St. Hubert, Que. A number of U.S. beacons have been reported in the past, but most apparently operate from quasi-classified locations. One whose location is known, however, would be station BE at Bedford, Mass., operated by the Federal Aviation Agency on 512 kHz.

Chances are your AM receiver already reaches down to 529, and any competent serviceman can alter the rig so that it will tune down to 512. The hard part will come when you try to get your QSLs accepted. While most of organized BCBdom will, grudgingly, accept RTA 529 as a legitimate catch, they won't recognize NB—even though the North Bay outlet is a whole kiloHertz closer to the orthodox BCB. Sounds a little like some hush-hush CIA scheme to discourage BCBers from hunting for those quasi-clandestine U.S. beacons. ■

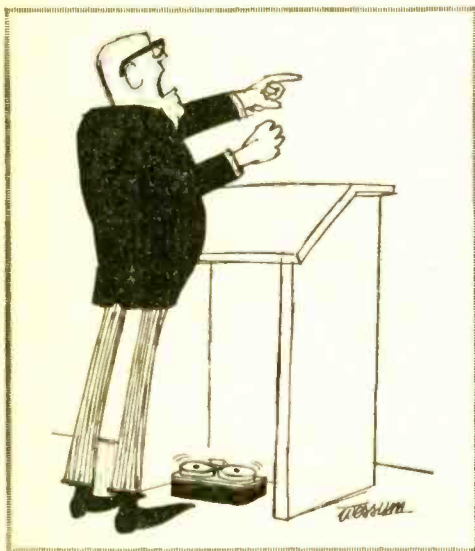

## NOW, BETTER THAN EVER the new and improved S&M supersensitive photo meter

Here is a precision instrument that meets the highest standards of any meter available. It offers consistently accurate readings at very low light levels, which, if required, can be converted to ft.-candles from a graph supplied. Researchers, scientists, educators and hobbyists have confirmed that this meter can read light levels as low as 0.000245 ft.-candles.

The S&M Supersensitive Photo Meter uses the newest Clairex Corp. CL-505L Cadmium Sulfide Light Cell to measure light levels from twilight to bright sunlight at ASA speeds of 3 to 25,000. A new 5/8" high easel type probe and also a miniature probe are now available as accessories. The Computer included gives F stops from .7 to 90; lists exposure time from 1/15,000 sec. to 8 hrs.; 4 range selection; EV-EVS-LV settings; weighs only 10 ounces.

Used extensively in Photo Labs, Physics and Research Labs, Hospitals, High Schools, Universities and numerous industries. Also used with movie or still cameras, microscopes and telescopes and IS A MUST FOR PHOTOMICROGRAPHY.

FREE BOOKLET included on Photomicrography

SCIENCE & MECHANICS—INSTRUMENTS DIV. EE-1/2  
229 Park Ave., S., New York, N.Y. 10003

Enclosed is \$\_\_\_\_\_. Please send me the new S&M Supersensitive Photo Meter. If I am not satisfied, I may return the meter within 10 days for a complete refund.

(Prices subject to change without notice)

### Model 102 Photo Meter

- |  |   |
|--|---|
| <input type="checkbox"/> \$36.95 with standard probe + carrying case | <input type="checkbox"/> Add'l. Standard Probe \$7.50 |
| <input type="checkbox"/> Microscope Adapter \$5.00                   | <input type="checkbox"/> \$2.00 carrying case         |
| <input type="checkbox"/> Add'l. Computer \$2.00                      | <input type="checkbox"/> 3/8" mini Probe \$7.50       |
|  | <input type="checkbox"/> Easel Probe \$7.50           |

Add 10% for Canadian and foreign order. New York City residents add 5% sales tax. (No Stamps)

Name \_\_\_\_\_ (please print)

Address \_\_\_\_\_

City \_\_\_\_\_ State \_\_\_\_\_ Zip \_\_\_\_\_

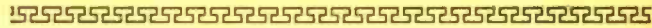

**Second, Rook vs. Bishop.** This is generally a draw. Exceptions are when the Kings are in opposition and when the defending King is in the wrong corner of the board. When these exceptions are not in effect, as in this case, the player with the Rook cannot force a win.

 Our study of the end games continues with a look at three which do not occur frequently. However, they prove something of a headache for beginner and master alike when they do.

**First, Queen vs. Rook.** This is a win for the player with the Queen, though not an easy one. The basic winning idea is to force the opposing King to the edge of the board, bring up your own King, create a zugzwang which compels the Rook to move away from its protective King, and then to pick off the stray with a series of checks. This case by Prof. J. Berger is a good example.

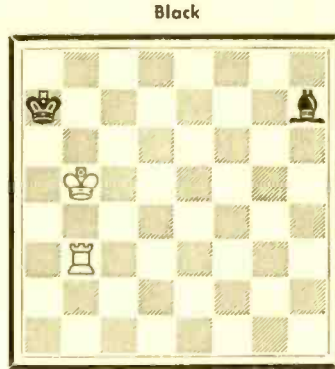

Black

White

- |         |       |         |       |
|---------|-------|---------|-------|
| 1 R-K3! | B-N3! | 3 K-Q7  | K-N2  |
| 2 K-B6  | K-N1  | 4 R-N3# | K-R3! |

And, as White cannot mate or win the Bishop, the position is drawn.

**Finally, Rook vs. Knight.** This is usually a draw too. But Black must keep his King in the center and his Knight must not stray afield. Thus—

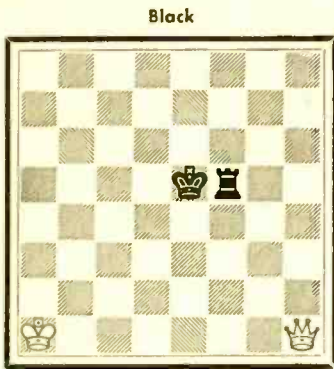

Black

White

- |           |       |           |       |
|-----------|-------|-----------|-------|
| 1 K-N2    | R-B5  | 13 Q-N8#  | K-K2  |
| 2 K-B3    | R-K5  | 14 Q-QB8! | R-Q8  |
| 3 K-Q3    | R-Q5# | 15 Q-B5#  | K-Q2  |
| 4 K-K3    | R-Q4  | 16 Q-N5#  | K-Q1  |
| 5 Q-R2#   | K-B4  | 17 Q-R5#  | K-B1  |
| 6 Q-B4#   | K-K3  | 18 Q-B3#  | K-Q2  |
| 7 K-K4    | R-Q3  | 19 Q-N4   | K-B2  |
| 8 Q-B5#   | K-K2  | 20 Q-B4#  | K-Q1  |
| 9 K-K5    | R-Q2  | 21 K-K6   | R-K8# |
| 10 Q-B6#  | K-K1  | 22 K-Q6   | R-Q8# |
| 11 Q-R8#! | K-B2! | 23 K-B6   | R-Q7  |
| 12 Q-R7#  | K-K1  | 24 Q-B5   | ....  |

And White mates (25 Q-B8 mate) or wins the Rook (25 Q-N5#).

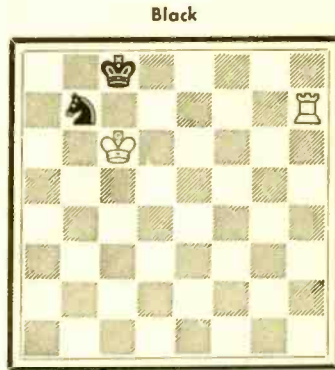

Black

White

- |        |       |        |       |
|--------|-------|--------|-------|
| 1 .... | N-Q1# | 3 K-Q5 | N-Q1  |
| 2 K-Q6 | N-N2# | 4 R-R8 | K-Q2! |

And, as in the preceding example, the game is a draw because White cannot mate or win material.

**Game of the Issue.** Larry Evans of New York and Las Vegas, youthful veteran at 38, is the new U.S. Champion. Larry first won the title when he was only 19. Later he won it again and also became U.S. Open and Canadian Open



Champion, a fixture on U.S. Olympiad Teams, a winner of many international tournaments, and the author of several books.

In winning the title this time, during July-August at the Empire Hotel, in New York, Evans compiled six wins and five draws. His style was classical and cool. With an edge, he pressed it, at a disadvantage, he found ways to recover. A characteristic game is the one against Grandmaster Nicolas Rossolimo. Black, an English Opening, which he wins by obtaining an opening edge, slowly converting it into a favorable ending, and winning a piece.

1 P-QB4	N-KB3	16 KPxP	PxP
2 N-QB3	P-K3	17 B-K3!	Q-R3
3 N-B3	B-N5	18 KR-B1	PxP
4 Q-B2	P-B4	19 QxP	QxQ
5 P-QR3	B-R4	20 RxQ	N-Q4
6 P-KN3	N-B3	21 B-B5	KR-Q1
7 B-N2	O-O	22 QR-QB1	P-B4?
8 O-O	P-Q3	23 R-Q4	K-B2
9 P-K3	B-Q2	24 QR-Q11	K-K3
10 P-Q4	BxN	25 P-QR4!	R-Q2
11 QxB	PxP	26 B-B1	P-QN3
12 NxP	NxN	27 B-QR3	QR-Q1
13 QxN	B-B3	28 R-B1	R-QB1
14 P-K4!	Q-N3	29 B-N5	R/2-QB2
15 Q-Q3!	P-Q4	30 R-K1 #!	Resigns

Position after 30R-K1#

Black

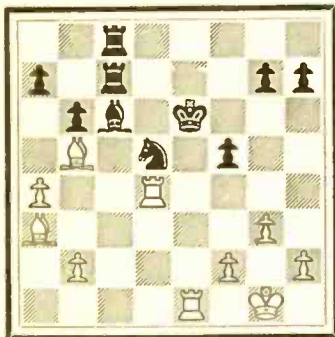

White

Why did Black resign? Because he must lose a piece—which, of course, means the game. Here is the analysis—

- If 30 ... N-K6 31 RxN# wins.
- If 30 ... K-B3 31 BxB, RxB 32 RxN wins.
- If 30 ... K-B2 31 BxB, N-B3 (31 ... RxB 32 RxN wins) 32 B-N5 wins.
- If 30 ... K-Q2 31 RxN mate!

**News and Views.** United States Championship results: L. Evans, 8½-2½. R. Byrne, 8-3. S. Reshevsky, 7-4. P. Benko, 6½-4½, and A. Bisguier, 6-5. A. Horowitz, Rev. W. Lombardy,

Dr. A. Saily, H. Seidman, N. Rossolimo, T. Weinberger, and B. Zukerman also participated.

Bent Larsen, the Great Dane, flew over and captured the 69th U.S. Open at Snowmass, Aspen, Colorado. He won 10 games and drew two. P. Benko (who usually wins this event) and W. Browne (a young comer) tied for 2nd and third with 9½-2½.

Oft-time champion of the Manhattan Club Arthur Bisguier regained his title by scoring 10-2 in the Championship. Rev. W. Lombardy, 9½-2½, J. Sherwin and Dr. K. Burger, 7-5, each, were next in line.

**Problem 16**  
By N. Sikdar  
India

Black

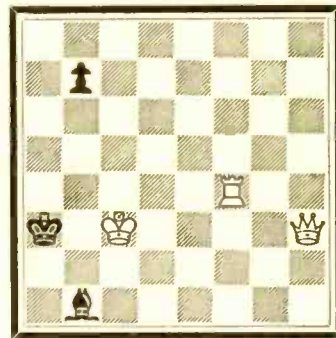

White

White to move and mate in two.  
Solution in next issue.

A not-so-simple miniature (seven or fewer pieces) by a famous composer from Delhi.

*Solution to Problem 15: 1 Q-N2.*



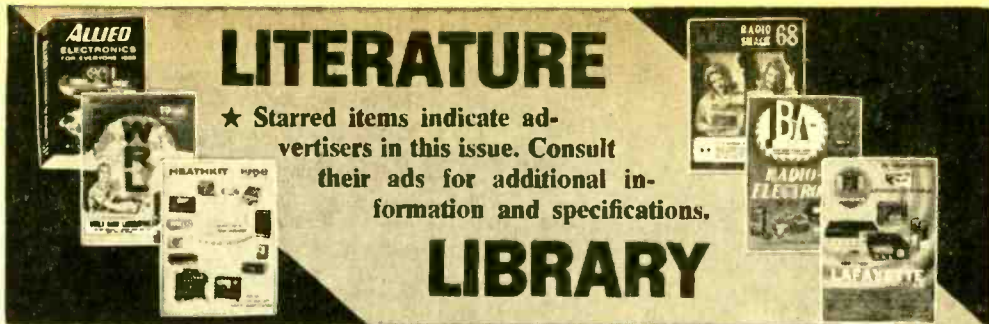

# LITERATURE

★ Starred items indicate advertisers in this issue. Consult their ads for additional information and specifications.

# LIBRARY

## CB—AMATEUR RADIO— SHORTWAVE RADIO

100. You can get increased CB range and clarity using the "Cobra-23" transceiver with speech compressor—receiver sensitivity is excellent. Catalog sheet will be mailed by B&K Division of Dynascan Corporation.

141. Newly-designed CB antenna catalog by *Antenna Specialists* has been sectionalized to facilitate the picking of an antenna or accessory from a handy index system. Man, *Antenna Specialists* makes the picking easy.

102. No never mind what brand your CB set is, *Sentry* has the crystal you need. Same goes for ham rigs. Seeing is believing, so get *Sentry's* catalog today. Circle 102.

130. Bone up on the CB with the latest *Sams* books. Titles range from "ABC's of CB Radio" to "99 Ways to Improve your CB Radio." So Circle 130 and get the facts from *Sams*.

107. Want a deluxe CB base station? Then get the specs on *Tram's* all new Titan II—it's the SSB/AM rig you've been waiting for!

101. If it's a CB product, chances are *International Crystal* has it listed in their colorful catalog. Whether kit or wired, accessory or test gear, this CB-oriented company can be relied on to fill the bill.

96. Get your copy of *E. F. Johnson's* new booklet, "Can *Johnson 2-Way Radio* Help Me?". Aimed for business use, the booklet is useful to everyone.

129. Boy, oh boy—if you want to read about a flock of CB winners, get your hands on *Lafayette's* new 1969 catalog. *Lafayette* has CB sets for all pocketbooks.

103. *Squires-Sanders* would like you to know about their CB transceivers, the "23'er" and the new "55S." Also, CB accessories that add versatility to their 5-wattlers.

46. Pick up *Hallcrafters'* new four-page illustrated brochure describing *Hallcrafters'* line of monitor receivers—police, fire, ambulance, emergency, weather, business radio, all yours at the flip of a dial.

116. Pep-up your CB rig's performance with *Turner's* M+2 mobile microphone. Get complete spec sheets and data on other *Turner* mikes.

48. *Hy-Gain's* new CB antenna catalog is packed full of useful information and product data that every CBER should know. Get a copy.

111. Get the scoop on *Versa-Tronics'* Versa-Tenna with instant magnetic mounting. Antenna models available for CBers, hams and mobile units from 27 MHz to 1000 MHz.

45. CBers—get your copy of *World Radio Labs* 1969 CB Catalog No. 2. You've got to see to believe *WLR's* special CB bonus offers. This is the catalog for big CB buyers.

50. Get your copy of *Amphenol's* "User's Guide to CB Radio"—18 pages packed with CB know-how and chit-chat. Also, *Amphenol* will let you know what's new on their product line.

54. A catalog for CBers, hams and experimenters, with outstanding values. Terrific buys on *Grove Electronics'* antennas, mikes and accessories.

## ELECTRONIC PRODUCTS

143. Bring new life to your hobby. Exciting plans for new projects—let *Electronics Hobby House* give you the dope. Circle 143, now.

★42. Here's colorful 116 page catalog containing a wide assortment of electronic kits. You'll find something for any interest, any budget. And *Heath Co.* will happily sent you a copy.

★44. Kit builder? Like wired products? *EICO's* 1969 catalog takes care of both breeds of buyers. 32 pages full of hi-fi, test, CB, ham, SWL, automotive and hobby kits and products—do you have a copy?

128. If you can hammer a nail and miss your thumb, you can assemble a *Schober* organ. To prove the point, *Schober* will send you their catalog and a 7-in. disc recording.

126. *Delta Products* new capacitive discharge ignition system In kit form will pep up your car. Designed to cut gas costs and reduce point and plug wear. Get *Delta's* details in full-color literature.

66. Try instant lettering to mark control panels and component parts. *Datark's* booklets and sample show this easy dry transfer method.

109. *Seco* offers a line of specialized and standard test equipment that's ideal for the home experimenter and pro. Get specs and prices today.

## ELECTRONIC PARTS

★135. Get with ICs! *RCA's* new integrated Circuit Experimenter's Kit KD2112 is the first of its kind and should be a part of your next project. Get all the facts direct from *RCA*. Circle 135.

140. How cheap is cheap? Well, take a gander at *Cornell Electronics'* latest catalog. It's packed with bargains like 6W4, 12AX7, 5U4, etc., tubes for only 33¢. You've got to see this one to believe it!

★2. Now, get the all-new 512-page, fully illustrated *Lafayette Radio* 1969 catalog. Discover the latest in CB gear, test equipment, ham gear, tools, books, hi-fi components and gifts. Do it now!

144. Hear today the organ with the "Sound-of-Tomorrow," the *Melotronic* by *Whippany Electronics*. It's portable—take it anywhere. Send for pics and descriptive literature.

1. *Allied's* catalog is so widely used as a reference book, that it's regarded as a standard by people in the electronics industry. Don't you have the 1969 *Allied Radio* catalog? The surprising thing is that it's free!

8. Get it now! *John Meshna, Jr.'s* new 46-page catalog is jam packed with surplus buys—surplus radios, new parts, computer parts, etc.

23. No electronics bargain hunter should be caught without the 1969 copy of *Radio Shack's* catalog. Some equipment and kit offers are so low, they look like misprints. Buying is believing.

★5. *Edmund Scientific's* new catalog contains over 4000 products that embrace many interests and fields. It's a 148-page buyers' guide for *Science Fair* fans.

106. With 70 million TV and 240 million radios somebody somewhere will need a vacuum tube replacement at the rate of one a second! Get *Universal Tube Co.'s* Troubleshooting Chart and facts on their \$1.50 flat rate per tube.

★4. *Olson's* catalog is a multi-colored newspaper that's packed with more bargains than a phone book has names. Don't believe us? Get a copy.

7. Before you build from scratch check the *Fair Radio Sales* latest catalog for electronic gear that can be modified to your needs. *Fair* way to save cash

6. Bargains galore, that's what's in store! *Poly-Paks Co.* will send you their latest eight-page flyer listing the latest in available merchandise, including a giant \$1 special sale.

10. *Burstein-Applebee* offers a new giant catalog containing 100s of big pages crammed with savings including hundreds of bargains on hi-fi kits, power tools, tubes, and parts.

11. Now available from *EDI (Electronic Distributors, Inc.)*: a catalog containing hundreds of electronic items. *EDI* will be happy to place you on their mailing list.

120. *Tab's* new electronics parts catalog is now off the press and you're welcome to have a copy. Some of *Tab's* bargains and odd-ball items are unbelievable offers.



**TOOLS**

- ★78. Do more jobs with fewer tools. Double duty sets contain midget nut and screwdrivers plus special piggy-back handle that gives midgets the power and reach of standard drivers. *Xcelite's* the name—get their catalog 166.
- 118. Secure coax cables, speaker wires, phone wires, etc., with *Arrow* staple gun tackers. 3 models for wires and cables from 3/16" to 1/2" dia. Get fact-full *Arrow* literature.

**TELEVISION**

- 70. Need a new TV set? Then assemble a *Heath* TV kit. *Heath* has all sizes. B&W and color, portable and fixed. Why not build the next TV you watch?
- 127. *National Schools* will help you learn all about color TV as you assemble their 25-in. color TV kit. Just one of *National's* many exciting and rewarding courses.

**SCHOOLS AND EDUCATIONAL**

- 142. *Radio-Television Training of America* prepares you for a career—not a job. 16 big kits help you learn as you build. 120 lessons. Get all the facts today!
- ★74. Get two free books—"How to Get a Commercial FCC License" and "How to Succeed in Electronics"—from *Cleveland Institute of Electronics*. Begin your future today!
- ★136. "Power Engineering," a new 32-page, illustrated brochure by *ICS (International Correspondence Schools)* describes seven *ICS* Power Engineering courses that may open a new career for you. Get a copy today!
- 114. Prepare for tomorrow by studying at home with *Technical Training International*. Get the facts today on how you can step up in your present job.
- ★137. For success in communications, broadcasting and electronics get your First Class FCC license and *Grantham School of Electronics* will show you how. Interesting booklets are yours for the asking.

- 138. For a complete rundown on curriculum, lesson outlines, and full details from a leading electronic school, ask for this brochure from the *Indiana Home Study Institute*.
- 105. Get the low-down on the latest in educational electronic kits from *Trans-Tek*. Build light dimmers, amplifiers, metronomes, and many more. *Trans-Tek* helps you to learn while building.
- ★3. Get all the facts on Progressive *Edu-Kits Home Radio Course*. Build 20 radios and electronic circuits; parts, tools and instructions come with course.

**HI-FI/AUDIO**

- 134. Discover *PlayTape*—America's newest tape cartridge and tape players. Units priced at under \$17 with cartridges at 45-disc prices. *PlayTape* has one of America's largest recorded libraries.
- 139. *Altec Lansing* covers both ends of the audio market—microphones and loudspeaker systems. *Altec* supplies the facts—you do the asking. Circle 139 now!
- 19. *Empire's* new 16-page, full-color catalog features speaker systems in odd shapes for beautiful room decor. Also, rediscover *Empire's* quality turntable line and cartridges.
- ★26. Always a leader, *H. H. Scott* introduces a new concept in stereo console catalogs. The information-packed 1969 Stereo Guide and catalog are required reading for audio fans.
- 85. Write the specs for an ideal preamp and amp, and you've spelled out *Dynaco's* stereo 120 amp and PAS-3X preamp. So why not get all the facts from *Dynaco*!
- 119. *Kenwood* puts it right on the line. The all-new *Kenwood* FM-stereo receivers are described in a colorful 16-page booklet complete with easy-to-read-and-compare spec data. Get your copy today!
- 131. Let *Elpa* send you "The Record Omnibook." It's a great buy and *Elpa* wants you to have it free. Your records will thank you when the mail-man delivers it.

- 17. Mikes, speakers, amps, receivers—you name it, *Electro-Voice* makes it and makes it good. Get the straight poop from *E-V* today.
- 27. 12 pages of *Sherwood* receivers, tuners, amplifiers, speaker systems, and cabinetry make up a colorful booklet every hi-fi bug should see.
- 99. Get the inside info on why *Koss/Acoustech's* solid-state amplifiers are the rage of the experts. Colorful brochure answers all your questions.

**TAPE RECORDERS AND TAPE**

- 123. Yours for the asking—*Elpa's* new "The Tape Recording Omnibook." 16 jam-packed pages on facts and tips you should know about before you buy a tape recorder.
- 31. All the facts about *Concord Electronics Corp.* tape recorders are yours for the asking in a free booklet. Portable, battery operated to four-track, fully transistorized stereos cover every recording need.
- 32. "Everybody's Tape Recording Handbook" is the title of a booklet that *Sarkes-Tarzian* will send you. It's 24-pages jam-packed with info for the home recording enthusiast. Includes a valuable table of recording times for various tapes.
- 34. "All the Best from *Sony*" is an 8-page booklet describing *Sony-Super-scope* products—tape recorders, microphones, tape and accessories. Get a copy before you buy!
- 35. If you are a serious tape audiophile, you will be interested in the all new *Viking/Telex* line of quality tape recorders.

**HI-FI ACCESSORIES**

- 112. *Telex* would like you to know about their improved *Serenata* Headset—and their entire line of quality stereo headsets.
- 104. You can't hear FM stereo unless your FM antenna can pull 'em in. Learn more and discover what's available from *Finco's* 6-pages "Third Dimensional Sound."

**ELEMENTARY ELECTRONICS**

Dept. 269  
229 Park Avenue South  
New York, N.Y. 10003

Please arrange to have the literature whose numbers I have circled sent to me as soon as possible. I am enclosing 25¢ 1 to 10 items; 50¢ for 11 to 20 items to cover handling. (No stamps, please.)

Indicate total number of booklets requested

	1	2	3	4	5	6	7	8	10	11
17	19	23	26	27	31	32	34	35	42	
44	45	46	48	50	54	66	70	74	78	
85	96	99	100	101	102	103	104	105	106	
107	109	111	112	114	116	118	119	120	123	
126	127	128	129	130	131	134	135	136	137	
138	139	140	141	142	143	144				

NAME \_\_\_\_\_

ADDRESS \_\_\_\_\_

CITY \_\_\_\_\_

STATE \_\_\_\_\_ ZIP \_\_\_\_\_



# You get more for your money from NRI—

## America's oldest and largest Electronic, Radio-Television home-study school

Compare. You'll find—as have so many thousands of others—NRI training can't be beat. From the delivery of your first lessons in the remarkable, new Achievement Kit, to "bite size," easily-read texts and carefully designed training equipment . . . NRI gives you more value.

Shown below is a dramatic, pictorial example of training materials in *just one* NRI Course. Everything you see below is included in low-cost NRI training. Other major NRI courses are equally complete. Text for text, kit for kit, dollar for dollar—your best home-study buy is NRI.

### Available under NEW GI BILL

If you served since  
January 31, 1955, or  
are in the service,  
check GI line in  
postage-free card.





## **GET A FASTER START WITH NRI'S NEW EXCLUSIVE ACHIEVEMENT KIT**

The day your enrollment is received your Achievement Kit will be on its way to you. It contains everything you need to make an easy, fast start in the Electronics training of your choice. This attractive, new starter kit is an outstanding, logical way to introduce you to home-study the way NRI teaches it . . . backed by a dedicated staff and the personal attention you should expect of a home-study school. It is your first special training aid . . . designed to make your adventure into Electronics absorbing, meaningful. Your Achievement Kit contains your first group of lesson texts; rich vinyl desk folder to hold study material; the industry's most complete Radio-TV Electronics Dictionary; valuable reference texts; lesson answer sheets; envelopes; pencils, pen; engineer's ruler—even postage. No other school has anything like it.

OVER 50 YEARS OF LEADERSHIP



IN ELECTRONICS TRAINING

## **LEARNING BECOMES AN ABSORBING ADVENTURE WITH NRI TRAINING KITS**

What better way to learn than by doing? NRI pioneered and perfected the "home lab" technique of learning at home in your spare time. You get your hands on actual parts and use them to build, experiment, explore, discover. Electronics come alive! NRI invites comparison with training equipment offered by any other school. Begin NOW this exciting, practical program. It's the best way to understand the skills of the finest technicians—and make their techniques your own. Whatever your reason for wanting to increase your knowledge of Electronics . . . whatever your field of interest . . . whatever your education . . . there's an NRI instruction plan for you, at low tuition rates to fit your budget. Get all the facts about NRI training plans, NRI training equipment. Fill in and mail the attached postage-free card today.

NATIONAL RADIO INSTITUTE, Washington, D.C. 20016.

This is an example of material included in just one NRI course. Other courses are equally complete. But NRI training is more than kits and "bite-size" texts. It's also personal services which have made NRI a 50 year leader in home-study. Mail postage-free card today.

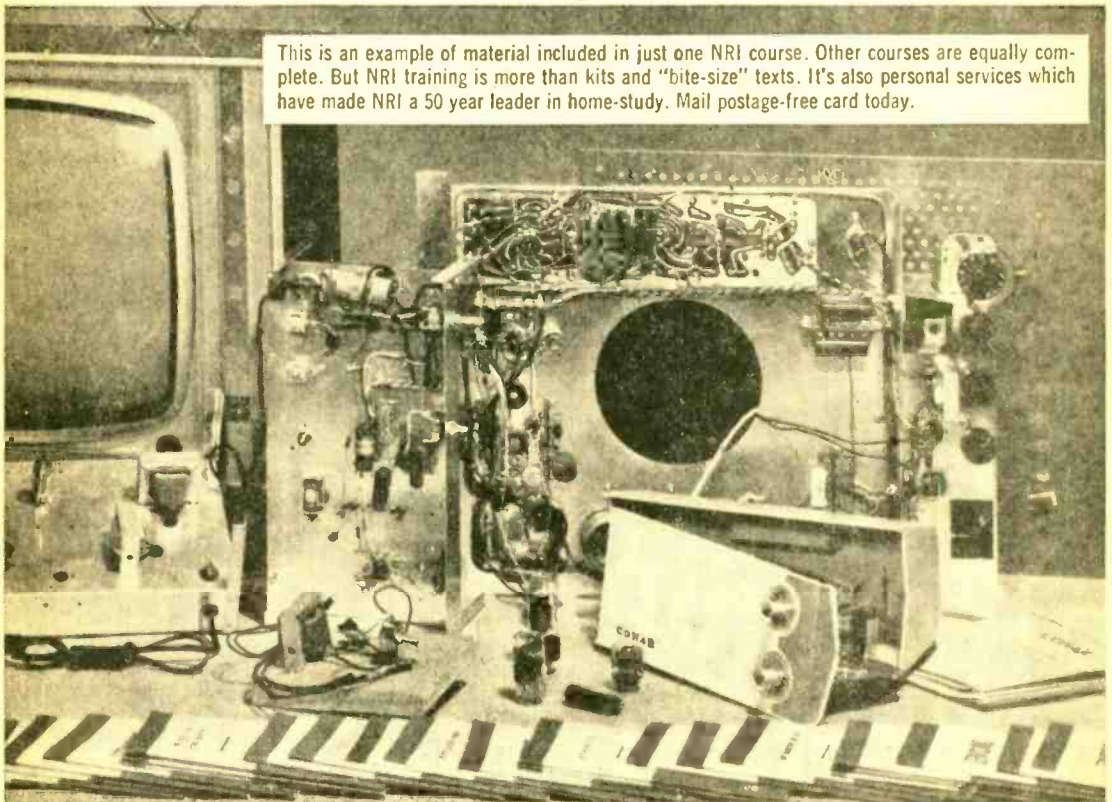



# ELEMENTARY ELECTRONICS ETYMOLOGY

By Webb Garrison



## Bulb

▲ One of the first plants to be cultivated was a hardy biennial that we now know as the onion. It flourished throughout the orient very early, was cultivated in Britain before the beginning of written history, and for a time was accorded divine honors in Egypt.

Passing through Latin from Greek, with spelling only slightly modified, the name of the pungent vegetable entered 16th-century English as *bulb*. Once the word became part of the common vocabulary its meaning expanded. So by 1650 it was applied to any onion-shaped root; fifty years later it was used to name a roundish dilation of any cylindrical structure in an animal body.

Late in the 18th century, glass blowers learned how to dilate the ends of tubes. It was inevitable that such artifacts, bearing an obvious resemblance to onions, should be called "bulbs."

Glass bulbs were put to many uses, none of which greatly affected the course of history. Then Thomas Edison discovered how to place a filament inside a bulb and the incandescent lamp was born. Precise usage would require that the ancient label be reserved for the onion-shaped glass that encloses a filament. But in ordinary speech, "bulb" has come to indicate a complete lamp or electron tube—regardless of its size or shape. □

## Memory Core

▲ *Memor*, Latin for "mindful," was often used in the special sense of being mindful of the dead. Hence it helped to shape our verb *to mourn*. Traces of its influence can also be seen in *memoir* and *memorandum*. So it is natural that the process of recollection—or faculty by which a person remembers—should be called *memory*.

Memoirs and memoranda were long stored on paper by means of symbolic shapes that we call written words. But until recent times only living creatures actually possessed memory.

This situation changed when researchers

found that an electric signal can be stored by means of a focused electron beam which forms a charge pattern on an insulating target. The same or another beam can later scan the target and recover the signal.

Early electronic storage tubes took such forms as the graphecon, radechon, and metrechon. Growing familiarity with ways to store and recover information, plus increasing sophistication of equipment, demanded a change in terminology. Since it could do things previously done only by the brain, the electronic storage tube came to be known as "the memory tube."

With the rise of miniaturization, an additional change took place. Minute bits of magnetic material shaped like doughnuts function as the "brains" of most modern digital computers. Such units do not resemble earlier tubes. They are more like the horny seed-capsules—or cores—of apples. Blending two ancient terms and giving each a new connotation, electronic engineers coined *memory core* to name the seed-like descendant of the storage tube which makes computers "mindful." □

## Crystal

▲ It's often difficult to know whether to take words of ancient writers in literal or figurative senses. That's the case with the Greek term *krustallos*. Related to words meaning "freeze" and "frost," it is sometimes considered to show that credulous countrymen of Homer thought ice turned into stone when stored long enough.

This point of view was put forward in one of the earliest English references to ice-like minerals. "Crystall," wrote a scholar in 1398, "is a bright stone and clere wyth watry colour. Men trow [are confident] that snowe or yse is made hard in space of many yerres; therefore the Grekys gave this name thereto."

Long applied chiefly to quartz—whose resemblance to ice is obvious—*crystal* came to name transparent glass as well as geometrical forms occurring in nature. Study of the latter showed that the shape of a given crystal is specific for the particular mineral involved.

Piezoelectric effects of many crystals were recognized comparatively recently. Then it was found that many others are semiconductors.

Lacking the special nature and properties of crystals (especially quartz and rochelle salts), radio couldn't have developed as it did. A typical early unit had a crystal in the detector stage of the receiver for demodulation of RF signals.

Ground down to the right dimension, a crystal will vibrate at its natural frequency. Such vibration is so precise that crystals are used to regulate frequency in receivers, transmitters, and other common devices. Development of the ruby laser grew out of special properties exhibited by this form of "ice turned into stone." □



# CZECH-MATE!

Message: death for the Russian Bear

By Don Jensen

For nine days in August they told it like it was. And in doing so, some 200 dauntless Czechoslovak broadcasters won a lasting place in



## CZECH-MATE!

the history of both radio and the world.

For those nine days, August 21-29 of 1968, they held together a makeshift network of 18 clandestine stations despite the efforts of 650,000 Soviet-bloc troops to silence them. When finally they ceased to be the free voice of their nation, censorship was self-imposed, with the reluctant realization that it was the only way for Czechoslovakia to retain even a vestige of its newfound liberty.

For 200 consecutive hours, this group of announcers and technicians somehow made their network function, enabling Czech leaders to transmit instructions to party functionaries, advising the people about what was happening. On and on they talked. And, during the wee hours before dawn, when hard news dwindled to a trickle, the speakers rambled on about anything and everything—even kitchen recipes—just to give their eager audience something reassuring to listen to.

How did they do it? Here is the real story of the secret stations and their staffs who,

with courage, ingenuity and a little luck, managed to Czech-mate the Kremlin's masters.

**It actually began** some weeks before the lightning thrust by the five Warsaw Pact countries. Masterminding plans for the clandestine network were two men, Jiri Pelikan, the 42-year-old director of the national television chain, and Zdenek Hejzler, head of Czechoslovak Radio.

Since January, when the Stalinist regime of Antonin Novotny was toppled by the liberal leader, Alexander Dubcek, Czech broadcasters enjoyed an unprecedented degree of freedom. But early in the summer, when the Red Bear's growls grew louder, radio and TV staffers began glancing nervously over their shoulders toward Moscow. That the Soviets would really invade was unthinkable. Still, a contingency plan was devised—just in case.

But the unthinkable did happen. Ten minutes before two on the morning of August 21, the home service of Radio Prague broke the news.

*"Last night, August 20, about 11 p.m., the armies of the Soviet Union, the Polish People's Republic, the German Democratic Republic, the Hungarian People's Republic, and the Bulgarian People's Republic crossed the national*



*Tank is Russian, but swastika added by Czech patriots indicates Czechs liken Soviet rape of their nation to German invasion prior to World War II. This is one of tanks that spearheaded attack on Radio Prague.*





*Rumbling through Bratislavo, Soviet tanks are bombarded with rocks by defiant Czechs. Underground radio called for general strike to paralyze entire nation unless Russian-led forces withdrew within 24 hours.*

*frontiers of Czechoslovakia without the knowledge of the President of the Republic, the National Assembly, the government, the First Secretary of the Communist party, or any of their bodies."*

When the news was bulletined on American TV, U.S. DXers hurried to their short-wave sets to tune the North American service of R. Prague. But the English language program, taped some nine hours earlier, was strictly Dullsville. Czech announcers talked of metallurgical developments and the visit of former curly-headed cinemoppet, Shirley Temple Black.

Clanking tank treads heralded the arrival of the enemy to Prague, but militant Czechoslovak students were one jump ahead of the Russians. Realizing R. Prague was a prime target for the invaders, before dawn youths began building barricades of vehicles outside the studios on Vinohradska Street.

When Soviet and Bulgarian tanks bulled their way through the overturned trucks and trolley cars, student defenders set several of the armored units ablaze. Machine-gun fire cut down more than a score of young people and the R. Prague building was pockmarked by bullets.

Inside, a woman announcer tersely reported, "This is the end!" The Prague frequency went dead at 7:21 a.m.

**But the Russians** had not expected resistance. Puzzled, they hesitated and checked their orders. Though tanks and troops ringed

the studio building, the surprised staff, given an unexpected breather, returned the station to the air. At 11 a.m., time ran out. An infantry captain, with fresh instructions, moved his soldiers into the building and shut down the transmission.

If the military command, headquartered in the Russian Embassy in the plush Bubenec district, thought the station's fall signaled the end of active resistance, this illusion was soon shattered. The transmitter tubes were barely cool when a mysterious new radio voice—the Free Legal Transmitter of the Czechoslovak Broadcasting — was heard.

Located somewhere in Prague, it was the first station of an amazingly effective clandestine



*Wordless placard cites obvious parallel between Hitler's successful seizure of portions of Czechoslovakia in 1938 and Russian-led invasion of nation in 1968.*

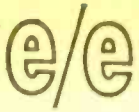

network that soon included transmitters in Pilsen, Budejovice, Hradec Králové, Brno, Ostrava, Bratislava, Gottwaldov, Pardubice, Kosice, Banska Bystrica, and other Czechoslovak cities. Weeks of planning by Pelikan, Hejzler, and their staffs had paid off. Virtually the entire broadcasting organization had gone underground.

Stations began broadcasting from small apartments, shop cellars, warehouses, and barns. Mobile transmitters in cars and trucks moved from place to place to avoid detection. To their chagrin, secret police agents learned that many of the free stations were using portable transmitters of a civil defense net which the Soviets, themselves, had urged the Czechs to establish.

The clandestines used whatever equipment was handy. Stations were heard on the medium and short waves, on VHF FM channels, and on three TV bands. DXers closely followed a pair of shortwave frequencies audible in this country.

On that first frantic day, Czech-speaking George Schnabel, a Rochester, N.Y., listener, came across the mysterious Prague outlet on 7345 kHz.

*"To arms! We call to arms. We repeat, we are calling to arms!"*

Two voices, a man's and a woman's, urgently repeated this message through the heavy jamming. The weak, poorly modulated signal wavered and left the air, only to return a few minutes later when the apparently mobile station had changed location.

*"We will keep you constantly informed of all information."*

*Hastily erected barricades of burnt-out buses and wrecked cars slowed Soviet advance on Radio Prague, but were only token resistance. Reds managed to silence R. Prague within 9 hours after first crossing border.*

Wide World Photos pages 31, 32, and 33 (bottom); United Press International photos, pages 33 (top) and 34

In Vienna and London, monitors heard other underground freedom radios reporting heavy fighting against the occupation armies. They called on all Czechs to rally to their reform leaders, held captive by the Russians.

By the third day of the crisis, the network was operating under a full head of steam. Smoothly switching, sometimes in mid-sentence, from one station to another, it was growing stronger in radiated power and in importance. It also grew bolder; sometimes too bold. R. Banska Bystrica was hunted down and captured. Free R. Brno's staff was arrested by Soviet troops. Undaunted, a new crew took over almost immediately at an emergency transmitter site.

In the beer capital of Pilsen the story was different. There, hundreds of young people simply pressed around the locked doors of Free R. Pilsen. The station, unlike the other underground broadcasters, never left its pre-invasion studios. For six days, the youths protected their station with their unarmed bodies.

Three tanks rumbled up to the building and leveled their cannons. But the Red soldiers, intimidated, or perhaps impressed, by the demonstration of raw courage, made no attempt to break through the human barrier.

European shortwave listeners heard the stations on several frequencies: 5930; 6065; 6190; 9505 and 21,450 kHz. In New York State, Schnabel again tuned the 41-Meter Free Czechoslovak Transmitter.

*"Here is a communique. Help the legal government by joining in the general strike called to protest against the occupying forces."*

Skipping the formal niceties, the agitated announcer slipped into street slang to de-

*(Continued on page 108)*





## COVER STORY

Varactor  
diodes  
electronically  
tune  
one of the  
handiest  
sweep  
generators  
you've  
ever  
seen

By Charles Green,

W6FFQ

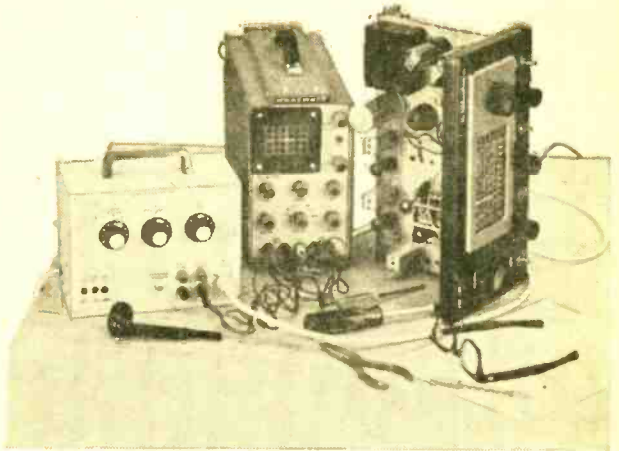

# DIO-TRACER

In this world of super performance and super prices, we all expect our receivers to operate with plenty of zip. Whether it's a simple AM portable or a double-conversion communications receiver, we want all we can get—with no waiting in line down at the local repair shop.

Everybody tests their own tubes. But troubleshooting a receiver often comes down to the grubby fact that the IF stages in your superhet are coming apart at the seams. Getting a good signal is impossible if your tuned transformers are out of alignment. And if your receiver is designed to pull in a number of frequency bands, these adjustments will be especially critical.

**Maximum Response.** Our Dio-Tracer is a sweep generator for superhet AM receivers ranging from rock-bottom to super-pro models. It provides the basic IF frequencies of 455 or 1650 kHz (the latter is usually found in double-conversion circuits). Easy to operate, the Dio-Tracer will prove handy as a pocket VOM.

Most sweep generators are complex and expensive; they provide wide-range sweep deviations for the broad-band circuits of FM and TV receivers. Often as not, the lowly AM region is completely ignored. Signal generators having only a fixed output are the more usual fare for AM troubleshooting. *(Continued overleaf)*



# DIO-TRACER

Schematic indicates where shielded cable should be used to wire critical points. Note that drain and source leads of Q1 (FET) are interchangeable.

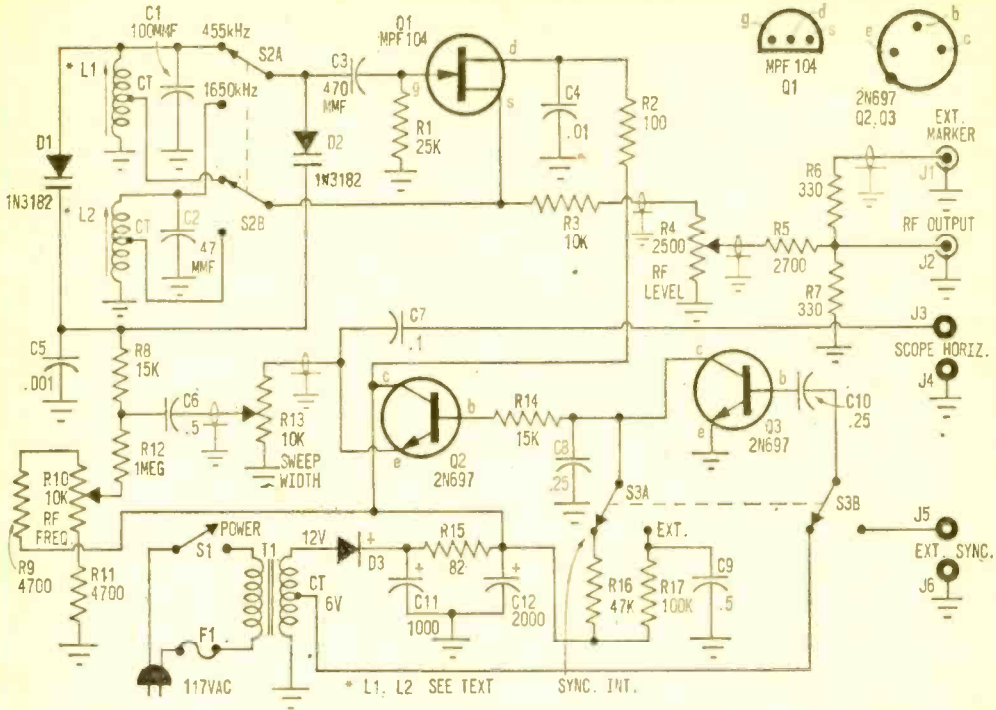

But the Dio-Tracer allows you to observe response curves of superhet IF amplifiers right on your oscilloscope. Even though it is a narrow-band generator, its sweep width is wide enough so you can *actually* see your receiver's response in the area around the IF frequency where sensitivity is maximum.

If you use a fixed signal generator, receiver response at frequencies selected at random must be plotted on a graph. Our Dio-Tracer, however, turns your oscilloscope into an instant graph! You align the IF stages while you watch the trace appearing on the CRT.

**How It Works.** This sweep generator has a built-in AC power supply and a circuit that's as up-to-date as Twiggy. A field-effect transistor (FET) is matched with two varactor diodes in the RF sweep circuit, while two silicon transistors supply a synchronized sawtooth output. This output goes to the external horizontal input of your scope and acts as a time base to properly display the IF response curve on the CRT. The return trace provides a horizontal line to show the bottom of the curve.

Field-effect transistor Q1 is connected via S2 and L1/C1 or L2/C2 into a Hartley oscillator circuit resonating at either 455 or 1650 kHz. Varactor diodes D1 and D2 are biased by the RF frequency control R10 and act as tuning capacitors in the tank circuit of Q1. Diode D2 tunes the 1650-kHz tuned circuit of L2/C2; D1 is connected in parallel with D2 to provide the additional capacity required for the 455-kHz circuit of L1/C1.

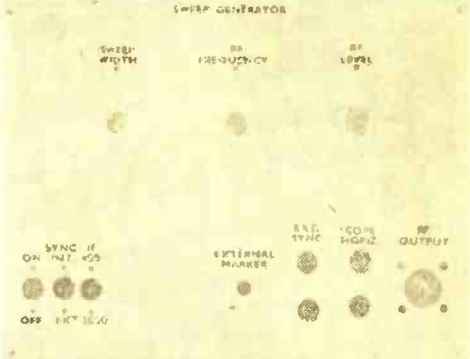

Clean layout of controls and jacks on front panel is shown before parts are mounted. Either decal or Datak lettering can be used to indicate controls.



## PARTS LIST FOR DIO-TRACER

- C1—100-pF ceramic disc capacitor  
 C2—47-pF ceramic disc capacitor  
 C3—470-pF ceramic disc capacitor  
 C4—.01-uF ceramic capacitor  
 C5—.001-uF ceramic disc capacitor  
 C6, C9—.5-uF tubular capacitor  
 C7—.1-uF ceramic capacitor  
 C8, C10—.25-uF tubular capacitor  
 C11—1000-uF, 25-VDC electrolytic capacitor  
 C12—2000-uF, 15-VDC electrolytic capacitor  
 D1, D2—1N3182 varactor diode (Amperex Varicap)  
 D3—100-PIV, 500-mA silicon rectifier (Texas Instruments 1N4364 or equiv.)  
 F1— $\frac{1}{2}$ -A pigtail fuse  
 J1—Phono jack  
 J2—Panel mounting coaxial RF connector (Amphenol SO-239, Newark 39F1052 or equiv.)  
 J3, J5—Red, insulated binding post (H.H. Smith 206, Newark 39F860 or equiv.)  
 J4, J6—Black, insulated binding post (H.H. Smith 206, Newark 39F861 or equiv.)  
 L1—Tapped oscillator coil (J.W. Miller X-5496-C, Lafayette 34H8709 or equiv.)  
 L2—Tapped oscillator coil (J.W. Miller A-5496-C, Lafayette 34H8713 or equiv.)  
 Q1—Field-effect transistor (Motorola MPF-104)  
 Q2, Q3—2N697 npn transistor  
 R1—25,000-ohm,  $\frac{1}{2}$ -watt resistor  
 R2—100-ohm,  $\frac{1}{2}$ -watt resistor  
 R3—10,000-ohm,  $\frac{1}{2}$ -watt resistor  
 R4—2500-ohm, linear taper potentiometer  
 R5—2700-ohm,  $\frac{1}{2}$ -watt resistor  
 R6, R7—330-ohm,  $\frac{1}{2}$ -watt resistor  
 R8, R14—15,000-ohm,  $\frac{1}{2}$ -watt resistor  
 R9, R11—4700-ohm,  $\frac{1}{2}$ -watt resistor  
 R10, R13—10,000-ohm, linear taper potentiometer  
 R12—1,000,000-ohm,  $\frac{1}{2}$ -watt resistor  
 R15—82-ohm, 1-watt resistor  
 R16—47,000-ohm,  $\frac{1}{2}$ -watt resistor  
 R17—100,000-ohm,  $\frac{1}{2}$ -watt resistor  
 S1—5pst slide switch  
 S2, S3—Dpdt slide switch  
 T1—117-VAC pri., 12.6-V (CT), 1.2-A sec., filament transformer (Radio Shack 273-1505; Allied 54B4136 or equiv.)
- Misc.—8 x 6 x 4  $\frac{1}{2}$ -in. aluminum chassis box (LMB 146, Newark 91F1125 or equiv.), 4  $\frac{1}{4}$  x 7  $\frac{7}{8}$ -in. perf board, push-in terminals, 3-lug terminal strip,  $\frac{1}{2}$ -in. angle aluminum stock (see text), RG-58/U coaxial cable, test leads, line cord, solder lugs, knobs, grommet, wire, solder, hardware, etc.
- Note—The Amperex varactor diode is available from Newark Electronics Corp., 500 N. Pulaszki Rd., Chicago, Ill. 60624 for 68¢. Minimum mail order is \$2.50, so additional components should be ordered.

The sawtooth generator circuit of Q3 is synchronized via S3B to the 60-Hz AC output at the center tap of T1's secondary. When S3 is switched to EXT SYNC, the sawtooth circuit is synchronized by an external audio generator connected to J5 and J6.

The sawtooth signal is fed through the emitter-follower circuit of Q2 to SWEEP WIDTH control R13 and to varactor diodes D1 and D2. As the sawtooth voltage increases or decreases, the capacitance of the varactor diodes also changes, thereby periodically changing the frequency of Q1's

oscillator circuit. Potentiometer R13 controls the sawtooth voltage going to the varactor diodes and hence, the amount of frequency deviation (sweep). The sawtooth signal is also fed to J3 and J4 for connection to the horizontal amplifier of an oscilloscope used to view the detected sweep waveform.

The varying RF output from Q1 is fed through R3 to RF LEVEL control R4 and to the RF OUTPUT coax receptacle J2. An external marker generator can be connected to EXT MARKER jack J1. The DC power for this unit is supplied by filament transformer T1 and D3, and is filtered by C11, C12, and R15.

**Building It.** The Dio-Tracer operates at low RF frequencies, but wiring and layout should still be neat, with all connections as short as possible. For best results, follow the layout shown in our photos.

The unit is housed in a compact 8 x 6 x 4  $\frac{1}{2}$ -in. aluminum box. Best way to start is to cut a 4  $\frac{1}{4}$  x 7  $\frac{7}{8}$ -in. section of perf board and install it approximately 2  $\frac{1}{2}$  in. up from the bottom of the box. We used two 4  $\frac{3}{8}$ -in. lengths of  $\frac{1}{2}$ -in. angle aluminum to mount the perf board, but small angle brackets can also be used.

Install the controls and jacks as shown in the photos. You should position the termi-

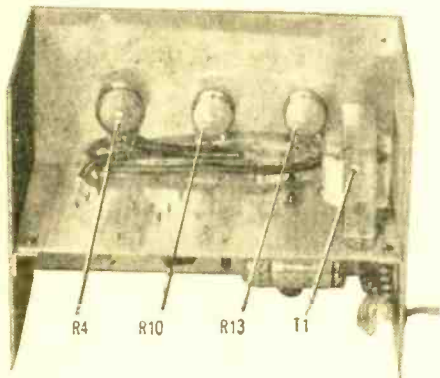

Coaxial cable is used to wire controls and RF output jacks. Shielded leads are designated in schematic.

# e/e DIO-TRACER

nals of R10, R13, and R4 toward the perf board to get short leads to the board. Use serrated washers on the controls to prevent movement. Transformer T1 should be mounted close to the side of the box as shown. Follow the perf-board layout illustrated in the photo.

Most of the components are fastened to the perf board with push-in terminals. Keep component leads short for maximum rigidity and wire them as shown in the schematic. Leads to L1 and L2 should be short and high above the board.

Since coax cable is used to prevent RF losses, make sure that the coax leads are grounded at both ends. Also check that diodes D1, D2, and D3 are connected in their proper polarity. You should use a length of special insulated tubing over F1 to prevent shorts. Make sure that all the ground bus leads and ground terminals on the board are tied together and grounded to the box.

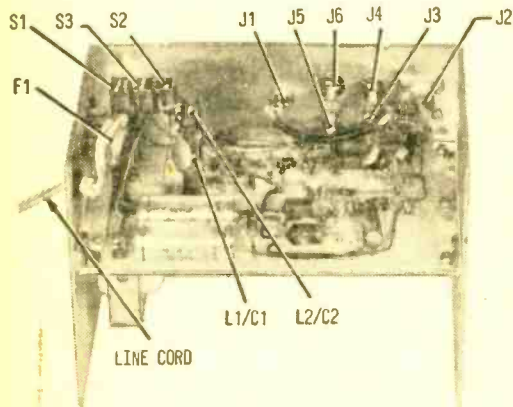

Perf board mounts 2 1/2 in. up from bottom. Jacks and switches are wired directly to board with short leads. Coax cables are grounded at both ends.

**Adjustment.** First set the controls as follows: R13 (SWEEP WIDTH) to full counter-clockwise position; R10 (RF FREQUENCY) to mid-range position; R4 (RF LEVEL) to full clockwise position; S1 on, S3 to SYNC INT, and S2 to an IF of 455 kHz. Connect the RF OUTPUT to the vertical amplifier of an oscilloscope and connect the SCOPE HORIZ

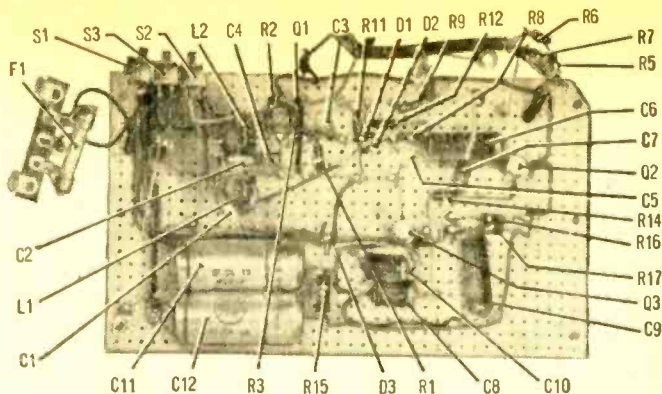

Parts layout on perf board isn't critical since RF frequencies are relatively low; but neat job of wiring will do much to enhance performance. Leads to L1 and L2 should be elevated.

jacks to the scope's horizontal amplifier. Connect EXT MARKER jack J1 to an RF signal generator.

Now set the oscilloscope controls for external sweep (internal time base off) so that the Dio-Tracer's sawtooth output provides a horizontal line on the CRT. Adjust the horizontal gain control for a convenient length. Then set your signal generator's controls for a 455-kHz unmodulated RF output.

The Dio-Tracer (using the RF LEVEL control) has a maximum output of about 45 millivolts. Should the vertical amplifier of your oscilloscope be insensitive to such a weak signal, you will either have to devise an RF preamp (broadband booster) for your scope's vertical input, or use the RF stage of an AM receiver to achieve proper gain. For purposes of adjustment, tapping the output at R4 (ahead of R5!) may be sufficient.

Adjust L1 until you see zero beat on the oscilloscope. Since the 455-kHz marker

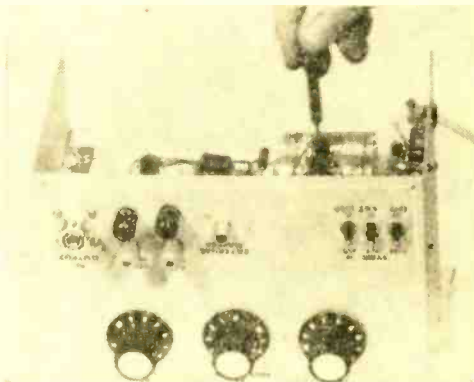

Alignment procedure takes but a minute. Since coils actually used only have single slug, they are adjusted from top side of board rather than bottom.



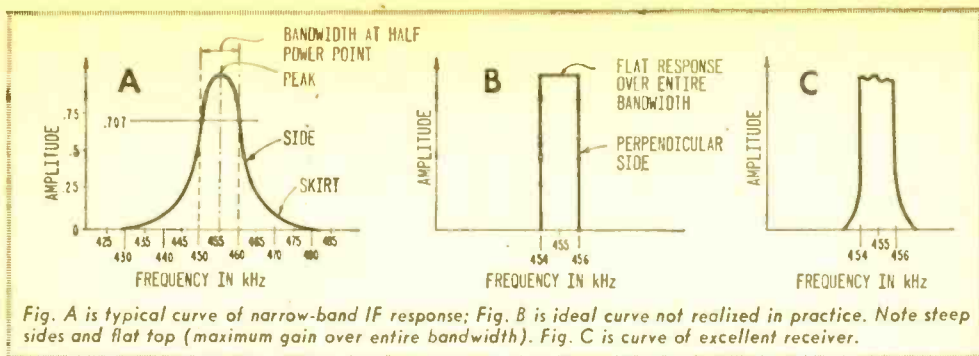

Fig. A is typical curve of narrow-band IF response; Fig. B is ideal curve not realized in practice. Note steep sides and flat top (maximum gain over entire bandwidth). Fig. C is curve of excellent receiver.

beats with the internal sawtooth sweep, the carrier will have modulated sidebands. Zero beat occurs when the modulation disappears from the carrier. A germanium or silicon diode may have to be inserted between the RF output and the scope's vertical input if your oscilloscope's vertical amplifier has limited frequency response. Adjust the marker generator output for best zero-beat indication.

Then switch S2 to 1650 kHz and set the signal generator to the same frequency. Adjust L2 until you see the zero beat on the oscilloscope. (The 1650-kHz output is somewhat lower than at 455 kHz.)

Set SWEEP WIDTH control R13 to maximum clockwise position, and adjust the RF FREQUENCY control so that the zero beat moves along the sweep pattern. The zero beat should move either to the left or right depending on the direction of rotation of the RF FREQUENCY control. This test indicates that the sweep and marker circuits are functioning.

To test EXTERNAL SYNC operation, connect an audio generator set to 10 Hz to J5 and J6 and set S3 to EXT. Adjust the generator's output for a convenient sweep length on the oscilloscope; the sweep pattern should be similar to the 60-Hz trace except that it has flicker due to the lower sweep rate.

**Getting the Trace.** The IF amplifiers of receivers are generally one or more stages of fixed-tuned, transformer-coupled amplifiers. For proper selectivity and sensitivity, they should be aligned to give an overall flat top and steep sides to the response curve.

There are many books available that describe the use of sweep generators in alignment procedures (see box). For best results consult these books for detailed descriptions on just how to get the sweep traces you need. What follows is a brief outline of the connections to and operation of your sweep

generator when aligning a typical receiver.

First, connect the generator's RF output to the grid of the receiver's mixer tube with coaxial cable. Either short the AVC line, or bias it with a battery (the voltage will depend on receiver characteristics). Connect the SCOPE HORIZ output to an oscilloscope's horizontal input. The internal time base of the scope should be off. Use coaxial cable to connect the oscilloscope's vertical-amplifier input to the detector output of the receiver.

Set the sweep generator for either a 455- or 1650-kHz output (as required) and adjust the RF output and oscilloscope amplifier controls for an IF response curve of convenient size. Adjust RF FREQUENCY to center the display and adjust SWEEP WIDTH to control the width of the response curve. The curve should normally show the base line on either side of the IF response.

Note that the sweep generator is normally operated with internal sync; but for better definition of narrow IFs, an external audio

(Continued on page 109)

#### Suggested Book Titles

- How to Use Signal Generators in Radio/TV/Hi-Fi Servicing, by John D. Lenk. *John F. Rider, Inc.*
  - Sweep and Marker Generators for Television and Radio, by Robert G. Middleton. *Gernsback Library, Tab Books.*
  - Troubleshooting with the Oscilloscope, by Robert G. Middleton. *Howard W. Sams & Co.*
  - Understanding Electronic Test Equipment, by Joseph A. Risse. *Howard W. Sams & Co.*
  - Obtaining and Interpreting Test Scope Traces, by John F. Rider. *John F. Rider, Inc.*
  - The Oscilloscope, by George Zwick. *Gernsback Library, Tab Books.*
- The books above are available from Lafayette Radio, Allied Radio, your local bookstore, or from the publishers.

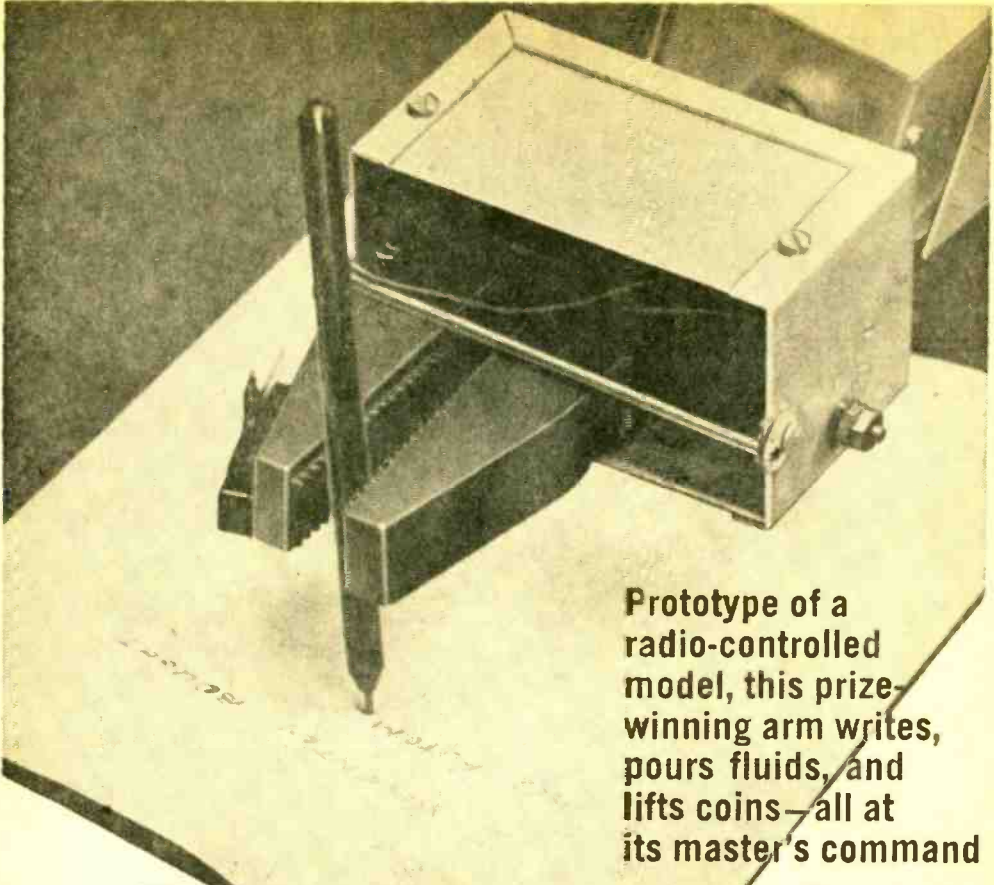

Prototype of a radio-controlled model, this prize-winning arm writes, pours fluids, and lifts coins—all at its master's command

# John Napoli's *Awesome Arm*

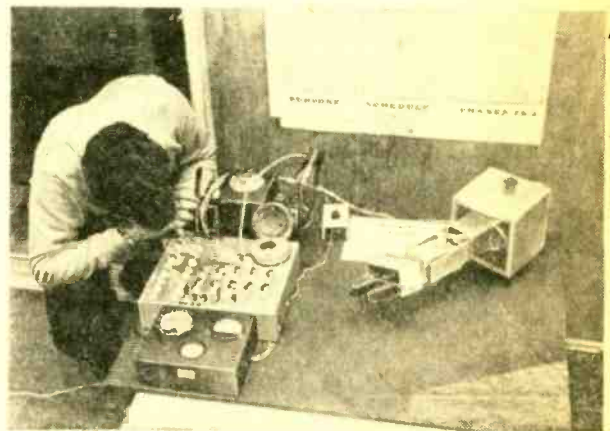



Pen clutched tightly in its vise-like jaws (far left), John Napoli's awesome Arm quietly performs one of its many feats: writing. Also capable of pouring fluids or writing on blackboards (see below), John's Arm responds to its master's beckon and call from master control panel (right).

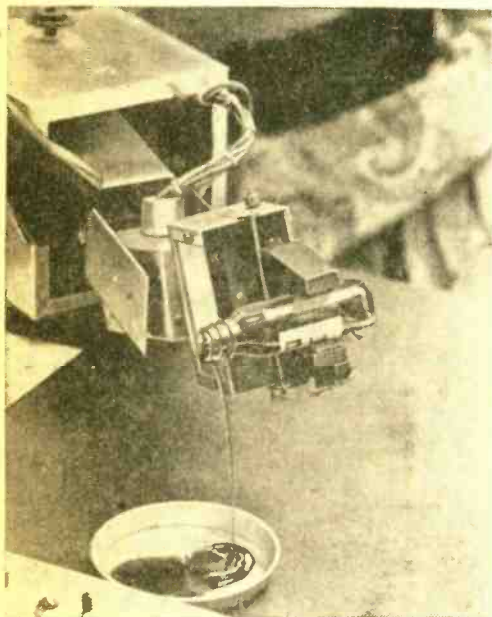

**A**n 11th-grade student at Brooklyn Technical High School, John Napoll recently received first prize at the American Institute's 30th School Science Fair for his "Automated Arm For Precision Engineering." John, who hopes to attend the Massachusetts Institute of Technology (M.I.T.) after graduating from high school, designed and constructed the Arm in his room at his Brooklyn, N.Y. home.

Responsible for all phases of the project, John created the control box as well as the mechanics of the unit. And in the near future, John intends to come up with a radio-controlled model. As for the present device, it's already capable of performing a variety of remarkable feats: it can write on paper and blackboards, pour fluids into a basin, even lift coins from John's worktable.

Like many talented teenagers with a creative bent, John boasts varied interests. An expert guitarist, he is also a competent photographer and occasionally takes time out for some deep-sea fishing.

—Joe Gronk ■

John checks out wiring and relays in control panel (far left) before putting Arm in operation. With present setup, Arm must be connected to control panel via cable link in order to function, but John has plans to change all that. In the works: a radio-controlled model that will operate completely on its own.

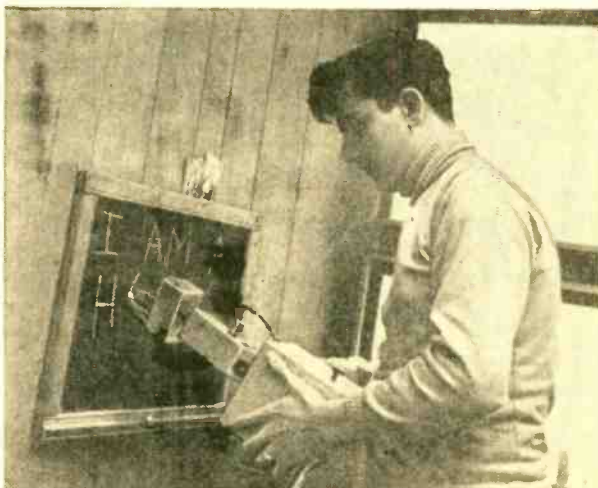

# @/e

# HIGH-FIDELITY

## ACOUSTIC RESEARCH

### All Solid-State

### Integrated Stereo Amplifier



To warrant equipment in terms of performance is virtually unknown. For many manufacturers even have trouble meeting their advertising claims on a production run. So you get an accurate preview of what to expect from the AR (Acoustic Research) amplifier when you note that the unit is warranted for both reliability and performance for a period of two years. Further, all charges are at the manufacturer's expense (AR even reimburses the owner for shipping!).

The AR amplifier, an all solid-state unit with a list price of \$225.00, is a no-frill preamp/amp. It provides only the circuitry necessary for highest quality sound reproduction and comes without reverse mode switches, phone jack, multi-speaker outlets, and the like. What it comes with is extensive instructions and full color-coding of all connections.

The unit provides inputs for a magnetic phone, tuner, and tape playback; there is also a set of jacks for feeding a tape recorder. One set of very wide-spaced speaker terminals is provided for each channel, as well as a switched 100-watt AC convenience outlet and an unswitched 300-watt outlet.

Front-panel controls include the input selector, friction-clutched concentric bass

and concentric treble, volume, and an unusual mode switch concentric with the balance control. The mode switch provides for mono, stereo, or null—the last being a special setting that allows two identical speakers to be set for absolute electrical balance.

**Nulling the Input.** When the mode switch is set to null, the polarity of one channel is reversed so that the signal to the two speakers is exactly 180° out of phase. Therefore, when the balance control is set so that the outputs from the speakers virtually cancel one another, the system is in exact electrical balance between the left and right channels. The entire operation is conducted with a mono input signal, either from a mono record or a mono FM signal.

The only other front panel item is the tape monitor switch. In use, this allows you to record on a three-head recorder via the amplifier's preamp (say from a phono or tuner) while simultaneously playing back through the power amplifier.

Of special interest is extensive color-coding of the input and output jacks. Every connection made by the user has its own individual colors; the phono input jack colors specifically match the color coding on the output leads of the AR turntable, thereby ensuring correct right/left orientation.

**Performance.** As shown in Fig. 1, response at full power (see next page)—50 watts into 8 ohms—is essentially ruler flat from 15 to 20,000 Hz, being down only 2 dB at 40 kHz. Of particular note is the exceedingly low distortion of 0.1% maximum at 50 watts from 20 to 20,000 Hz (the limits of the test equipment). Allowing for residual instrument distortion, the AR's actual distortion ranges between 0.02 and 0.08%. In short, the AR measures effectively distortion free. Even at a full 60 watts into 4 ohms the distortion never exceeds 0.15%.

Maximum tone-control action at the 1-watt level is shown in Fig. 2.

In comparing our specifications against those found in some hi-fi publications, you

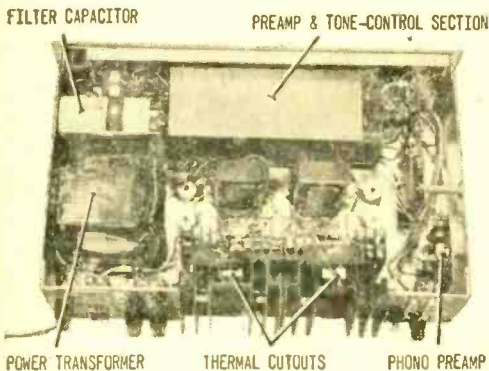

View of AR amplifier with cover removed. Thermal cutouts are mounted within large heatsinks at rear of chassis; power supply is located at extreme left.



may note a disparity between our test limit of 50 watts into 8 ohms and the more-than-50-watt rating used elsewhere. Explanation lies in the speaker fusing provided for each channel. In addition to a line fuse (which protects the amplifier) and thermal overloads on the output transistors (which turn off the AC supply if the transistors overheat), the AR is also equipped with a 3-A fast-acting fuse in each speaker lead. Intent here is to protect the speakers in the event an output capacitor fails.

In practice, this 3-A fuse, an 8AG type, will blow almost instantaneously if overloaded, and within seconds if pushed to 90% of its rating. Using Ohm's Law, you find that the fuse limits the total available continuous power output (not instantaneous

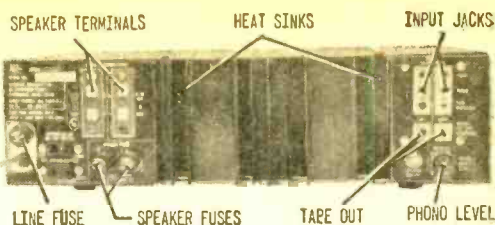

Rear view of AR amplifier. Line and both speakers are fused for maximum protection; phono level control permits matching unit to almost any cartridge.

trical null were 0.25 mV rms for the tape and tuner inputs, and 1.8 to 6 mV rms for the phono input. Both channels of the phono input have individual level controls on the rear apron, so the phono input level can easily be made to match the tuner or tape

Fig. 1. Frequency response of AR amplifier at sustained 50 watts into 8 ohms. Total harmonic distortion (THD) was less than 0.1% between 20 and 20,000 Hz.

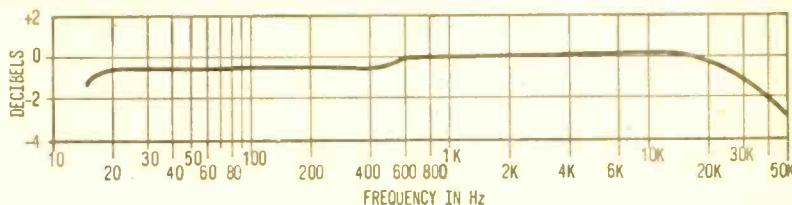
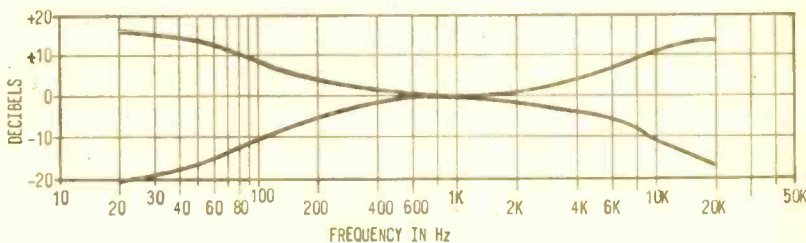

Fig. 2. Maximum tone-control action at 1-watt output, referenced to 1000 Hz. Knobs on tone controls are clearly identified as to channel and are friction-clutch type.



peaks) to 36 watts into 4 ohms. Yet the amplifier is rated—and will deliver—50 watts rms into 4 ohms if there is no fuse. We can only assume the higher power outputs reported by other publications were obtained by jumping the fuses.

With the fuses jumped out, the AR delivered its rated power of 60 watts rms into 4 ohms, 50 watts rms into 8 ohms, and 30 watts rms into 16 ohms. And it did so with substantially less than the rated 0.5% THD from 20 to 20,000 Hz. Since power peaks of program material aren't sustained, the fuses will pass the full power rating during average use; they limit the maximum power only when using continuous sine-waveform during test procedures.

**In and Out.** Input sensitivities for 50 watts into 8 ohms with the volume control fully open and the balance control set to elec-

levels. Normally, the phono level controls are set to provide the desired speaker level with the volume control set to the 2 o'clock position—the optimum signal-to-noise and distortion settings.

With the volume control wide open, and 50 watts into 8 ohms as the reference level, the tuner and tape input noise levels were better than -75 dB, the phono noise level better than -62 dB.

**Listening and Looking.** Since most solid-state amplifiers are capable of flat, low-distortion measurements, the truly critical test is listening. Here, the outstanding performance of the AR amplifier was readily apparent. The AR proved remarkably quiet, with no apparent hiss or hum, even at the loudest tolerable listening level. Overall sound quality was superb, with no discernible

(Continued on page 110)

# O PERATION

Jeremie le 29 Aout 1967  
M. Barry Deal

Cher Monsieur Deal,  
Cette semaine j'ai eu la grande joie de recevoir à la Douane de Jeremie les 2 tubes 803 que vous m'avez expédié pour me permettre d'augmenter la puissance de la station.

Je vous remercie beaucoup pour ce grand cadeau. Dieu de votre générosité à l'endroit de la Voix de la Grand Anse. En Septembre prochain j'espère que nous pourrions capter très bien la Voix de la Grand Anse sur 60m. 5090kHz

Merci  
Alix Felix



Alix Felix at console of his home-brew station, La Voix de la Grand Anse. Facsimile of thank-you letter from Alix to his friend Barry Deal is reproduced above; see text for translation.

**M**ore than 2000 miles separate Jeremie, a backwater Haitian town, and the tiny Nebraska farming community of Ord. The physical contrasts between the midwestern town and the little port, tucked between Haiti's wooded Massif de la Hotte and the sea, could not be greater. In human terms, however, the gulf has been narrowed, thanks to a young Nebraska DXer and "Operation 803."

The moving force behind "Operation 803," a project designed to keep Jeremie's only radio station on the air, was 18-year-old Barry Deal. It all began over a year ago when the station, 4VAF, "La Voix de la Grand Anse" hit a snag. An 803 transmitting tube, vital to the station's operation,



# 803

*For the want of a nail, a shoe  
was lost; for the want of an 803,  
a station was (nearly) lost*

By Don Jensen



*Shortwave listening  
became a living  
hobby when  
SWL Barry Deal  
of Ord, Nebraska  
pulled in "La Voix  
de la Grand Anse"  
on his Lafayette  
HA-230 receiver.  
This was the  
beginning of  
"Operation 803."*

was faltering and a replacement could not be had in Haiti. When the tube dimmed and died, the little 250-watt station left the air, for good it seemed.

**Small, but Good.** "La Voix de la Grand Anse" (The Voice of the Big Handle), which got its name from the great, handle-like peninsula jutting into the sea on Hispanola's western tip, was a one-man operation, built and operated by 31-year-old Alix Felix. Alix, Jeremie's only radio technician, had only the simplest of equipment. He built his own six-tube transmitter, with the 803 in the "final." "La Voix de la Grand Anse" had no glass-enclosed studio, no elaborate broadcasting facilities. It was shoe-horned into a single corner of a stuccoed

room, an open concrete grillwork across its large window.

Alix, his own announcer, has a simple turntable, desk microphone, and control equipment on a plain wooden table. Nearby, on a low bench, sits an inexpensive, home-type tape recorder. Programming only a few hours during the evenings in the French patois of the area, Alix broadcast popular music to the 12,000 inhabitants of Jeremie . . . and the occasional shortwave listener overseas who caught his feeble signal.

**Troubles.** Equipment problems prevented 4VAF from broadcasting every night. The crisis came when the 803 failed and Felix was unable to locate a replacement. Then

*(Continued on page 110)*

By Ron Michaels



# ELECTRONIC

Don't let switched-on headlights take your car's

**W**hat can you say on a bleak morning when you discover that you accidentally left your car's headlights turned on the night before, and your battery is now stone cold dead?

Because this minor tragedy has happened to me once too often, I decided to end this headache by designing an automatic headlight circuit—the Electronic Lightmaster. It waits patiently every time I switch off my car's ignition, looking to see whether or not I've also switched off the headlights. If I haven't, after a reasonable length of time (about 20 seconds), it simply switches them off for me . . . no ifs, ands, or buts.

Electronic Lightmaster is an apt name, because at the flip of a switch I can convert the circuit into a time-delay relay that purposely keeps my headlights turned on for about 2½ minutes after I leave my car. This feature transforms my car's lights into *mobile* street lights that can illuminate dark driveways or paths during the short time it takes me to walk from my car to a doorway or some other entrance.

**In the Works.** The circuit is built around a Darlington amplifier. This is a two-transistor design that has the very high input resistance needed to build a time-delay relay. Essentially, the amplifier looks at the voltage stored in capacitor C1 and applies almost the same voltage to the coil of relay K1.

To achieve the lighting effects we want, the circuit is connected to your car's electrical system in an unusual fashion. To begin with, one of K1's pair of contacts is wired in series with the headlight power line. Your lights will only work if K1 is activated, keeping the contact closed.

With switch S1 in its NORMAL position, the amplifier circuit is powered by the headlight power line. Thus, when you flip your car's light switch *on*, power is applied to the circuit. However, the relay will close only if capacitor C1 is charged to +12 VDC. Note that C1 is charged by a wire connected to your car's ignition switch. This means that if you flip your light switch *on* and also

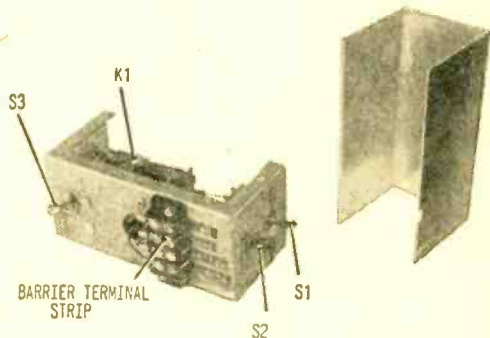

Lightmaster circuit fits into compact case, unless you choose to install it under dashboard of your car.



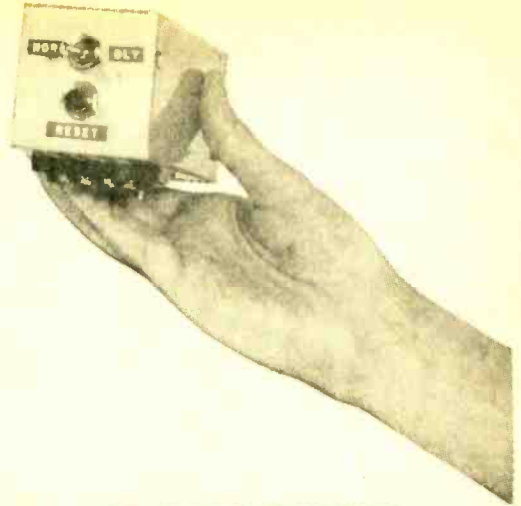

# LIGHTMASTER

battery for a lethal ride—switch 'em off automatically!

have turned *on* the ignition, then your headlights will light up.

If for any reason you should turn *off* the ignition, capacitor C1 is no longer connected to a source of voltage. It will begin to discharge through resistor R2. As a result, its stored voltage drops, bringing along with it the voltage applied to relay K1. After 20 seconds, the voltage at the relay's coil is too low to keep the relay activated and it drops out, thereby switching off the headlights.

When you move S2 to its DELAY position, the Electronic Lightmaster is modified slightly. Now R2 is removed from the circuit, so that the only resistance which can discharge C1 is the very large input resistance

of the amplifier itself. Practically speaking, this means that it now takes 2½ minutes for the relay voltage to fall low enough to deactivate the contacts. Also, K1's pair of contacts is placed across your car's headlight switch. This means that you can turn *off* the switch as usual when you leave the car without disrupting the Lightmaster circuit.

Pushbutton switch S2 brings capacitor C1's voltage up to its full value when it is pressed. Therefore, it functions as a RESET button. You need to use it only on those occasions when you have already used up a good part of the time delay before you've left your car. For instance, say you take some time retrieving a lost item under your seat after you've switched the ignition off. Pushing S2 for a full second restores the time delay period.

Switch S3 is the system's power switch—I've labeled it BYPASS. One pair of its contacts is wired in series with the relay coil, the other across the relay contacts that control the headlights. If you flip S3 to BYPASS, the circuit is effectively removed from the headlight wiring.

**Building It.** As with any automotive project, it's difficult to design a single device that will fit into every car. So you may choose to use your ingenuity when you build the device and assemble it in a different kind of box. If you wish, you can even

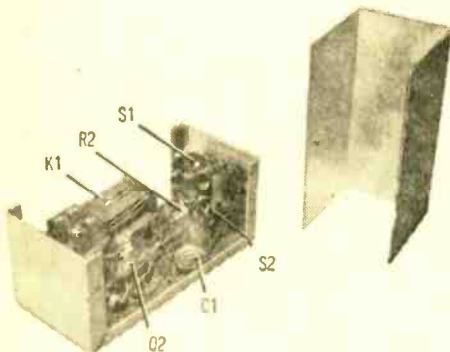

Relay K1 mounts on spacers to bottom half of case; leads to car wiring are fed to barrier terminal strip.

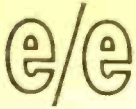

## LIGHT-MASTER

mount the guts underneath the hood and the three control switches on the instrument panel.

I wired the circuit into a 2½ x 2½ x 5-in. aluminum chassis box and hung it below the dash. My aim was to put the controls within easy reach. Parts placement isn't critical. But since anything installed in a car will be shaken up a bit, be sure that all connections are mechanically and electrically sound.

To make the most of the limited space, I mounted the relay above the bottom of the case by placing spacers on its mounting screws. All wiring is done in point-to-point fashion, using terminal strips as soldering and mounting points. To guard against short circuits, you should place sleeving on all leads that might conceivably brush against other wires or metal objects. This is important because the case is grounded and part of the electrical circuit.

Double check the polarity of C1 when you install it. The circuit won't work if its leads are reversed.

Transistor Q2 is a newly-developed, plastic-encapsulated power transistor. Cut off the *unused* collector lead (the lead next to the beveled edge), and make all collector connections to the metal tab. This tab acts like a small heat sink and must be positioned clear of other components.

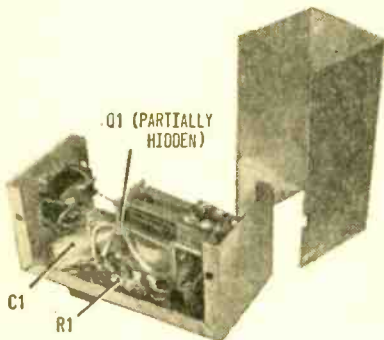

For rough ride, components should be secure in case.

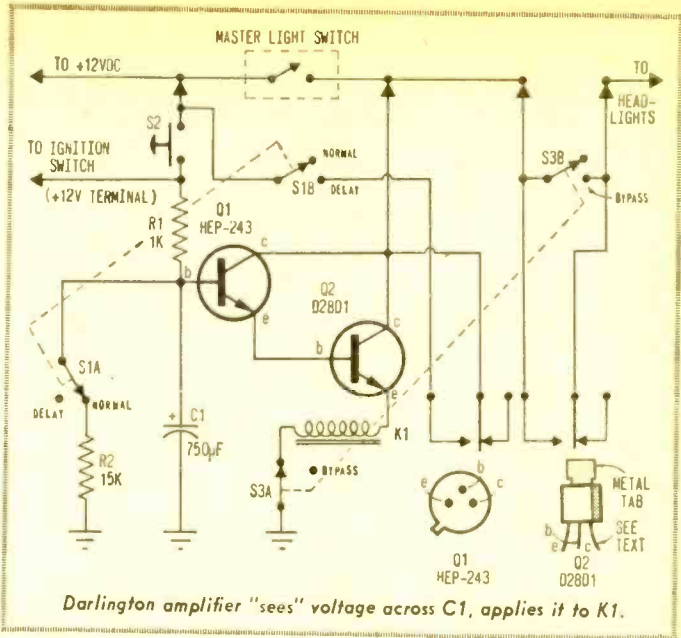

Bring the four leads that connect to your car's wiring out to the four-terminal barrier strip. Use heavy duty wiring for these connections.

**Installation.** All required connections to your car's wiring are outlined in our diagram. The only tricky area is the headlight power line (it may take a while to find the correct lead). A wiring diagram for your car will be helpful, so try and get a copy (your public library may have a copy of the shop manual). The lead you want is between the master light switch and the hi/low beam switch. This single wire carries the power to light your headlights.

However you install this watchdog device, you'll save yourself a lot of anguish. ☐

### PARTS LIST FOR LIGHTMASTER

- C1—750-µF, 15-VDC electrolytic capacitor
- K1—Relay assembly, 12-VDC coil and 10-A, dpdt contact switch (Guardian 200-12D and 200-M2, Allied 41E5714 and 41E5719)
- Q1—Npn silicon transistor (Motorola HEP-243, Allied 22C3886)
- Q2—Npn silicon power transistor (GE D2801, Allied 49C3 D28D1 GE)
- R1—1000-ohm, ½-watt resistor
- R2—15,000-ohm, ½-watt resistor
- S1, S3—Dpdt toggle switch
- S2—Spst pushbutton switch (normally open)
- Misc.—2½ x 2½ x 5-in. aluminum chassis box (see text), 3-lug terminal strip, 4-lug terminal strip, 4-terminal barrier strip (Cinch-Jones 4-140, Allied 47E1803 or equiv.), spade lugs, ¼-in. spacers, sleeving, grommet, decals, solder, wire, hardware, etc.



Nation of Toltecs, Aztecs,  
Mayas, and Spaniards,  
Mexico numbers  
among the world's  
most colorful  
countries. Want  
to partake of  
her spirit?  
Then turn on,  
tune in, and



Mexican National Tourist Council photo

# DX MEXICO

By C.M. STANBURY II

**P**ossibly the most varied, and therefore the most interesting challenges for DXing lay South of the border, down Mexico way. Mexican stations range from powerful English voices along the U.S. border to SWBC operations of all sizes, to local BCB outlets (which best represent the real Mexico and are very tough to log), to NASA's space-age installation at Guaymas on the Gulf of California. In short, Mexico offers an endless

MEXICAN BORDER STATIONS

kHz	Call	Transmitter Location	Mailing Address
690	XETRA	Tijuana	Los Angeles, Calif.
800	XELO	Ciudad Juarez	El Paso, Texas
860	XEMO	Tijuana	San Diego, Calif.
1050	XEG	Monterrey	Fort Worth, Texas
1090	XERB	Rosarito Beach	San Diego, Calif.
1570	XERF	Ciudad Acuna	Del Rio, Texas

Reception reports may be addressed either to the U. S. mailing address or to the transmitter location, except for XEG, where reception reports should be addressed to Monterrey, Nuevo Leon.

series of truly exciting DX possibilities.

Amongst DXers, Mexico is probably best known for its border stations, which range in power from 5 to 250 kW and are strung from Monterrey westward to Tijuana. These stations are often written up in SWL bulletins largely because of their programming, which includes such items as faith healers, hate peddlers, underground music, and commercials for *genuine, simulated* diamond rings. All but XEG at Monterrey are located within a few miles of the American frontier. Because these border stations have been written up so often, we'll let you tune in for yourself and see which station programs what. Most are excellent verifiers.

**Shortwave.** The three most widely heard Mexican SWBC stations are La Voz de la

America Latina (XEWW on 9515 and 6165 kHz), Radiofusoras Comerciales (XERR on 15110 kHz and XEHH, 11880 kHz), both in Mexico City, and XEQM (6105 kHz) at Merida, Yucatan. Station XEWW is not only a typical Latin American big-city operation, which, except for the language, is not unlike 50 kWers in New York, Chicago, or Los Angeles, but it is the key station for Mexico's major network. This means that XEWW's programming includes such things as radio plays (virtually a lost art form on this side of the Rio Grande), special news features, and live variety shows. Station XEQM, by contrast, operates on a much more modest scale and somewhat resembles the local rural BCB stations which we'll describe later on. Both XEWW and XEQM are excellent verifiers while XERR/XEHH tends to be erratic.

Once the SWL has QSLed Mexico by one of the above, he's ready for rarer sport. Out in the western badlands of Sonora is the city of Hermosillo. It has two SWBC representatives. When XEBR (11820 kHz) is on, it is widely heard. Unfortunately, XEBR's appearances on the shortwave scene are quite irregular. Meanwhile, the University of Sonora operates XEUDS on 6115 kHz where it is sometimes heard during evening hours.

So far, all of the stations mentioned, except XEQM Merida, transmit from areas where the people are of Aztec and Spanish descent. But the far eastern end of Mexico is part of the former Mayan empire and his-

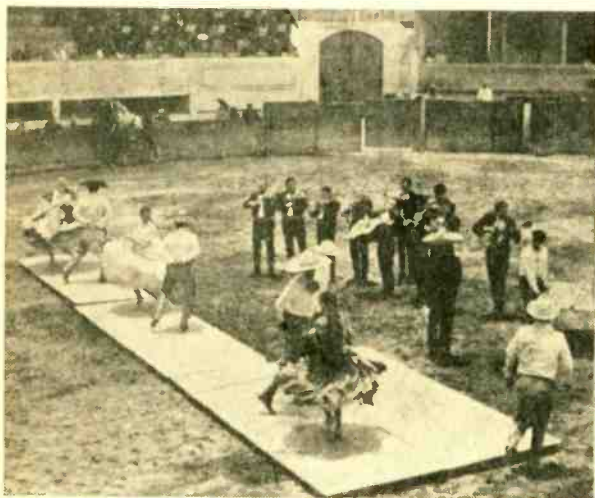

Land of flowers, bulls, and exciting native dance, Mexico comes alive via shortwave radio like no other nation. Mariachi music, though foreign to many U.S. ears, soon proves thoroughly captivating for its spontaneity and rhythm; every town in Mexico, no matter how small, has its strolling mariachi band to entertain at weddings, private parties, and



torically minded SWLs will want to work both these ancient nations. In addition to XEQM, Mayan Mexico boasts XETS, R. Tapachula (6120 kHz), located only a few miles from the Guatemalan border.

**Back to the BCB.** Not all the potent, multi-kilowatt stations are of the "border" variety. The list of multi-kilowatt Spanish-speaking outlets includes XEWA (540 kHz), San Luis Potosi, and XEW (900 kHz), Mexico City—both operated by La Voz de la America Latina, XERH (1500 kHz) Radio fusoras Comerciales. XEX (730 kHz), XEQ (940 kHz), and XEB (1220 kHz), all Mexico City. What might be described as a Spanish-speaking border station is XEDM (1580 kHz), 'way out there in Hermosillo. This one aims transmissions mostly at Americans of Mexican origin and announces a Nogales, Ariz. mailing address.

There are many others, but what the truly fanatic DXer really wants to hear are those low-powered rural voices mentioned earlier—like XEBB. There are so many of these that we simply don't have space here for any kind of comprehensive listing. Despite the presence of American tourists in many parts of rural Mexico (such as the Acapulco area), all broadcasts are in Spanish. Programming consists mainly of the staples—commercials (a list of these is most useful in proving your reception), and traditional *ranchero* style Mexican music, which could be compared to our Country & Western. After listening to some of the SWBC stations mentioned earlier, you should now be able

#### ABBREVIATIONS

BCB	broadcast band
DX	long distance, distant (contact or country)
DXer	hobbyist who seeks DX contacts
DXing	the act of receiving distant stations
ID	identification
kHz	kilohertz (kilocycles)
kW	kilowatt
NASA	National Aeronautics and Space Administration
QRM	noise and signals interfering with desired signals
QSL	decorated postal card or letter from station acknowledging reception report
QSLed	sent or received a QSL
SWBC	shortwave broadcast
SWL	shortwave listener
XE	prefix to Mexican station call letters

to readily distinguish *ranchero* from other forms of Latin American music. Mexican stations usually ID by slogan but often mention their call letters and locations.

Mexican BCB reception will of course be best during ionospheric disturbances when much U.S. and Canadian QRM is wiped out. Which XE voices you log is largely a matter of luck and your particular location, but normally the best time to hunt is between 0000 and 0300 EST.

**Guaymas.** In sharp contrast to the ancient Aztec and Mayan empires, the *ranchero* music, and the border hate peddlers, is NASA's space facility on the Gulf of California, a couple hundred miles southeast of Hermosillo. When that first manned Apollo space flight blasts off, one of the stations communicating with the Astronauts, track-

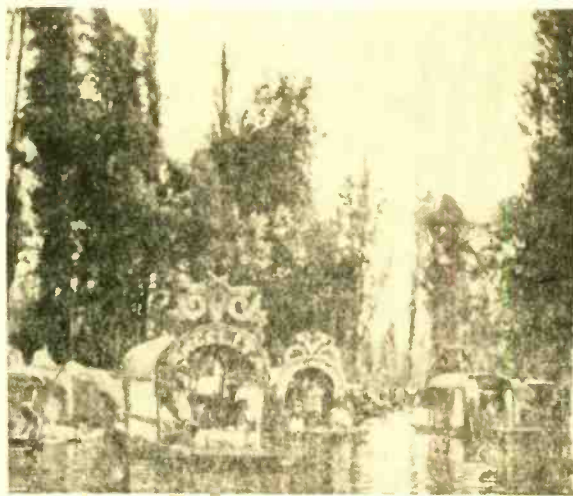

in the public plaza on a Sunday afternoon (see photo at left). In fact, fiesta and celebration are the spice of Mexico's way of life. In center photo, Mexicans lead garlanded oxen to cathedral for traditional ceremonies of blessing of work animals. And at right, flowers are everywhere in famed floating gardens of Xochimilco.

Air France photos

ing their ship, and recording those vital telemetry readings, will be Guaymas.

Most of us read much about the space age and yet there is very little tangible evidence that this planet has really entered it. In fact, much of our globe is grossly backward. The location of the Guaymas facility certainly highlights the current weird state of man's civilization, possibly better than any other radio station. The next time Americans go into orbit, you will be able to hear it from

Space-Age Mexico on 15016 kHz.

**States Again.** Not known to a good many U.S. DXers is the fact that the U.S. isn't the only group of *united states* on the North American continent. Mexico's official name, in Spanish, is *Estados Unidos Mexicanos*, which, when translated, becomes Mexican United States. All told, there are 29 states in the Republic, plus two territories whose governors are appointed by the President. The country's capital, Mexico City, lies in a federal district (*Distrito Federal*), which is similar in nature to our own District of Columbia.

As we've said, Mexico can literally come alive through the medium of shortwave radio. Good listening! ■



*This magnificent pile of baroquerie is a must for any visit to Mexico City. The cathedral is named for the patron saint of Mexico, Our Lady of Guadeloupe.*



*Convenient to Mexico City is the lovely and mile-high silver-mining city of Taxco, whose silver industry was rescued and revived by an American.*



*In Mexico City's vast Chapultepec Park, near the ultra-modern University City, stands this impressively beautiful monument to the Cadets of Chapultepec, who gave their lives defending the site.*



*One of four superlative ruins of the Toltec civilization, the Pyramid of the Sun rises 216 feet above Teotihuacan, 30 miles northeast of Mexico City. Pyramid is dedicated to Toltec Sun God.*

Air France photos



# COMPUTOMATIC

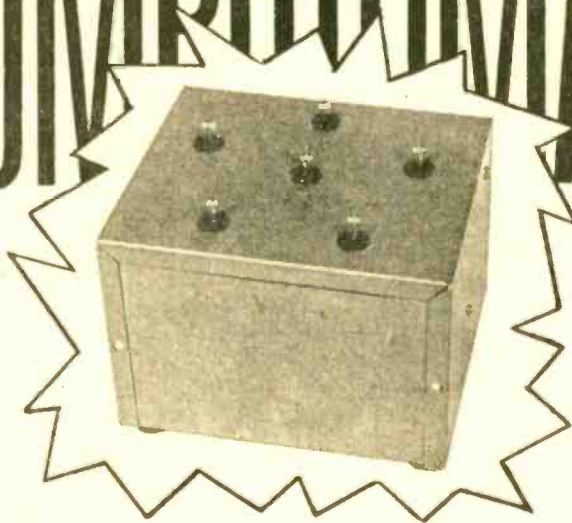

Here's a Black Box that sees, hears, and does nothing—except wow your friends and give your shack that sharp UNIVAC look

By Herb Friedman, W2ZLF/KBI9457

**I**t sits on your desk with its lights blinking, and the sounds of the computer world come from inside. In fact, it looks for all the world like it might really be a computer! But in spite of all the *eep* and *eep-oop* sounds and the blinking lights, the Computomatic does absolutely nothing; it just sits there and appears to be calculating the National Debt.

The Computomatic is basically a nothing box—but with one big difference. Instead of having mere lights that blink on and off at a random rate, this gadget has an internal vari-tone oscillator that is actually triggered by the lights. As each light turns on, a soft *eep*, *eep-oop*, or glide tone is generated.

Just as the random light pattern slowly changes, so does the sound pattern. And soon the listener finds that exactly at the moment he thinks he has discovered the rhythm of the sound pattern, the light pat-

tern makes a slight change and the sounds follow with a similar change in sequence. At one moment you may hear a clock inside the box (accompanied by a glide tone), while the next moment your clock shifts into a sweep that mystifies.

The Computomatic has a nothing-box circuit and a two-stage multi-tone generator. Both circuits are battery-powered; current drain is so low the batteries should deliver several months of service—possibly even more, depending on how often the device is used.

**Assembly.** The Computomatic is built into a 4 x 5 x 6-in. aluminum chassis box. The circuitry is mounted on a perf board positioned on one side panel. Push-in terminals are used for tie points. The miniature speaker goes on the opposite side.

Capacitors for the lighting circuits—C1 through C9—take up quite a bit of space

# e/e COMPUTOMATIC

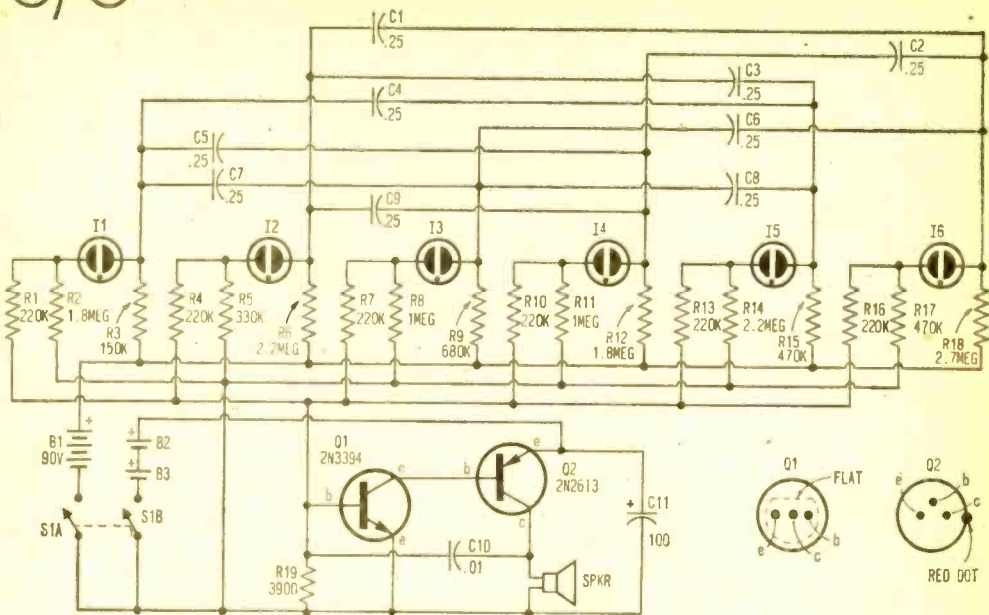

## PARTS LIST FOR COMPUTOMATIC

B1—90-V battery (RCA VS090 or equiv.)  
 B2, B3—1.5-V AA battery (Burgess Z or equiv.)  
 C1 thru C9—.25- $\mu$ F, 100-VDC capacitor  
 C10—.01- $\mu$ F, 25-VDC (minimum) capacitor (see text)  
 C11—100- $\mu$ F, 15-VDC (minimum) capacitor  
 I1 thru I6—NE-2 or NE-2E neon lamp  
 Q1—2N3394 npn silicon transistor (IGE)  
 Q2—2N2613 pnp germanium transistor (RCA)  
 R1, R4, R7, R10, R13, R16—220,000-ohm,  $\frac{1}{2}$ -watt 10% resistor  
 R2—1,800,000-ohm,  $\frac{1}{2}$ -watt 10% resistor  
 R3—150,000-ohm,  $\frac{1}{2}$ -watt 10% resistor  
 R5—330,000-ohm,  $\frac{1}{2}$ -watt 10% resistor  
 R6, R14—2,200,000-ohm,  $\frac{1}{2}$ -watt 10% resistor  
 R8, R11—1,000,000-ohm,  $\frac{1}{2}$ -watt 10% resistor

R9—680,000-ohm,  $\frac{1}{2}$ -watt 10% resistor  
 R12—1,800,000-ohm,  $\frac{1}{2}$ -watt 10% resistor  
 R15, R17—470,000-ohm,  $\frac{1}{2}$ -watt 10% resistor  
 R18—2,700,000-ohm,  $\frac{1}{2}$ -watt 10% resistor  
 R19—3900-ohm,  $\frac{1}{2}$ -watt 10% resistor (see text)

S1—Dpst toggle switch

Misc.—4 x 5 x 6-in. aluminum chassis box, 4  $\frac{1}{2}$  x 3  $\frac{1}{2}$ -in. perf board, miniature 8-ohm speaker (approx. 2  $\frac{1}{4}$  x 2  $\frac{1}{4}$  in.), push-in terminals, battery connector for B1 (Allied 18B5309 or equiv.), AA battery holder (Keystone 140, Allied 18B5902 or equiv.),  $\frac{1}{4}$ -in. spacers, rubber feet, grommets, spaghetti, wire, solder, hardware, etc.

Note—Values of R1 thru R18 may vary  $\pm$  20%. If you have these values in your junk box, use them.

so use at least half of the perf board to wire them. Your board should be cut so it takes up the entire side of one panel, with only enough clearance at the sides so that the cabinet cover can be installed.

Since capacitors C1 through C9 take up a lot more space than appearance would dictate, position the terminals they are connected to in a line running through the center of the board. While it may appear that half the board is overdoing it, you'll have just enough space when they're finally installed. Make certain none of these leads

are shorting. If necessary, use spaghetti when in doubt about your wiring.

Capacitors C1 through C9 should be rated for a working voltage of at least 100 VDC (see Parts List). Capacitor C10 can be a 25-V model or the same as C1-C9. Make certain C11 is installed in the polarity shown, with the positive lead connected to Q2's emitter. You will have to use the transistors specified in the Parts List; don't try to substitute for them.

**Blinking 'n Pulsing.** After the perf-board assembly is completed, set it aside until you



All components except neon lamps and miniature speaker are mounted on perf-board sub-assembly. Capacitors at left take considerable amount of space, so their connecting terminals should be positioned in center of board to allow maximum space on left side. Three bus leads are used to simplify wiring resistors to neon lamps. Schematic conforms to wiring pattern, but order is reversed looking from left to right on diagram. Double-check all leads.

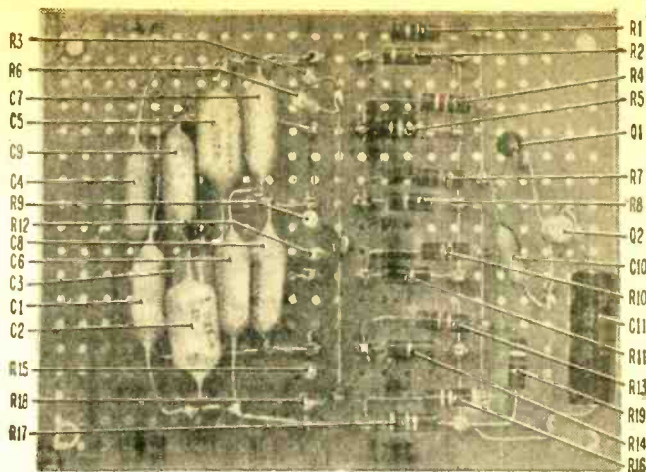

have installed the speaker and six neon lamps. The neon lamps I1 through I6 are types NE-2 or NE-2E. Don't substitute one with higher brightness (like the NE-2H) as the resistors specified are only for the NE-2 or NE-2E.

Mount the lamps on top of the cabinet's main section. Each lamp is mounted in a 3/8-in. rubber grommet and cemented in place with a silicon rubber adhesive. Since I1 pulses rather than blinks, it should be installed in the center so that the blinking lights are on the outside. (This pulsing is required to trip the glide tone. Don't attempt to get the bulb to blink.)

Use any 8-ohm miniature speaker that will fit in the box. It should be mounted on a side panel with no holes for a grille. If you drill holes in the panel the sound will be excessively loud, but without holes the sound will be soft and appear to come from deep inside the Computomatic.

Now install the perf-board assembly. To prevent the push-in terminals which protrude through the board from shorting to the cabinet, install 1/4-in. spacers between the

board and cabinet. To avoid a wiring error, install I1's connections first. The remaining lamps can be wired in any order. Be sure to insulate both leads from the lamps. Slip a piece of spaghetti (sleeving) over the hookup wire, tack-solder the lamp's leads to the wire, and then slide the sleeving forward so it covers the leads flush with the glass.

The batteries mount in the bottom portion of the cabinet. Battery B1 is a type used in older portable radios. If you can obtain a smaller or less expensive model, by all means make the substitution. It is held in place with a loop of wire stretched between two cable clamps—one at either end of the battery.

If you use a standard battery connector, check the connecting wires from the terminals. Electric (black is positive) rather than electronic (black is negative) color coding may be used. Batteries B2 and B3 are standard AA cells mounted in a double-AA battery holder. Wire the batteries through a dpst switch, but don't tie the negative leads from B1 and B3 together through an spst switch.

Because of individual variations in transistors, the tone generator may not trigger with the lamps. If this should happen, try different values for R19—either higher or lower, in 20% steps—until the generator fires in step with the lamps. If you obtain only a constant tone, trim R19's value until you obtain the glide.

If you've done a good job, your Computomatic will take over from here. Just turn it on and watch your bench light up and sound off like any good UNIVAC should. After all, what's wrong with having the first programmed shack on the block? ■

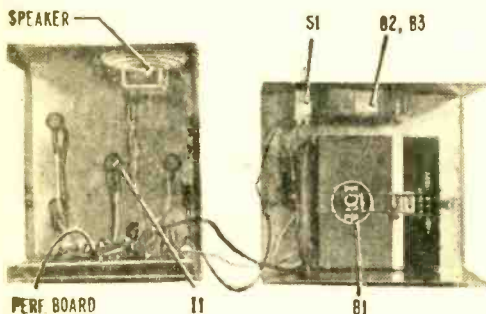

Battery B1 is held in place by hookup wire which passes through two cable clamps; twist ends together.

# The Iceman Cometh



"Remember now, be gentle with that changer!"

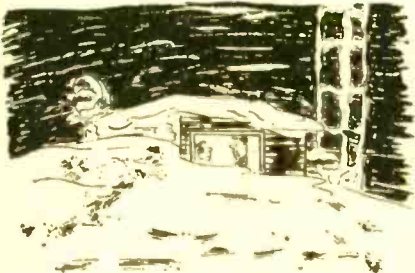

"Give 'em a call on guard... ask for two scotch, one rye and one bourbon!"

((((( ))) ))))

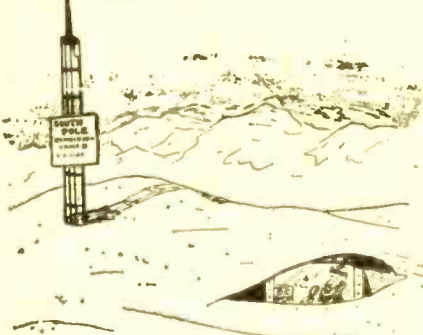

"...summer has finally come to our station!"

by Jack Schmidt



"Now think hard, WA2CQL, didn't I warn you about the weight the day you put it up?"

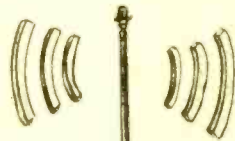

"You know, Harry, the boys downstairs are not going to believe us when we tell them how cold it is up here."



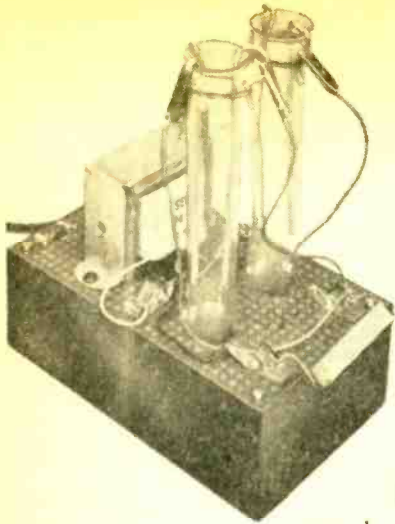

# LET'S BUILD A LIQUID SEMICONDUCTOR

See through this wet  
and wild semiconductor rectifier  
and go back to the good ol' days when  
radio was just turning on

By Charles Green, W6FFQ

**B**efore the steamship there was the clipper ship, and before the solid-state rectifier there was the liquid semiconductor rectifier. Back in the Roaring Twenties, the liquid semiconductor rectifier (or electrolytic rectifier) was in use when the home radio receiver was still a curiosity. It was used as a cheap and easy method of charging a receiver's storage batteries from the AC line.

The liquid semiconductor rectifier was made from lead and aluminum electrodes placed in a borax solution. (Other metals and chemicals were also used.) The electrolyte and electrodes were contained in a glass jar which had a vented lid to allow the escape of gases formed during its operation. The rectifier was durable and immune to electrical overloads.

**Today's Model.** The liquid semiconductor rectifier will operate over a range from just a few volts to 117-VAC line voltage. When power is applied to the rectifier, current flow to the aluminum electrode creates a semiconductor layer on the surface of the aluminum. This semiconductor layer has a low resistance to current flowing to the aluminum and a high resistance to current flowing away from it.

If 117 VAC is applied to the lead electrode, a pulsating, positive voltage will appear at the aluminum electrode. The semi-

conductor action takes place between the electrolytic solution and the aluminum, while the lead electrode simply makes electrical contact with the electrolyte.

You can experiment with a liquid semiconductor rectifier by building our special module. It's a handy, compact unit having an AC power supply and two test tubes.

**Construction.** The experimental module is built on the perfboard cover of a 3 $\frac{3}{4}$  x 6 x 2-in. Bakelite box (see Bill of Materials). A power transformer and two test tubes are mounted as shown in the photo. We used 7-in. test tubes approximately 1 in. in diameter, but any convenient size will do.

Power switch S1 and the fuse holder are mounted on the board behind power transformer T1. The primary leads from T1 are fed through holes in the perf board for connection to S1 and F1. The secondary leads go to terminals J3 and J4.

The AC line cord is run through an existing hole in the Bakelite box. Mount J1 and J2 in front of the test tube holes. Connect J2 to J4 as shown in Fig. 1, and connect a short lead with a clip at one end to J1. Also prepare some other short clip leads for connection to the test tube electrodes.

Insert a 4-in. length of #8 solid aluminum wire into a test tube. Carefully bend over one end of the wire to fit the tube rim

# e/e LIQUID SEMICONDUCTOR

and cut off any excess. Make sure the wire runs straight and close to the inside wall of the tube.

Now cut and fit a 4-in. length of #16 60/40 solder (rosin or solid core) to the opposite wall of the test tube, and shape it just like the aluminum electrode. Fit a rubber band around the electrodes, and if necessary, insert a small section of thin plastic under the electrode rims to hold the electrodes in place.

Fit the test tube into one of the holes in the top (its diameter will depend on the tube) and designate it TT-1. Small sections of thin plastic inserted into the hole alongside the test tube should hold it firmly in place.

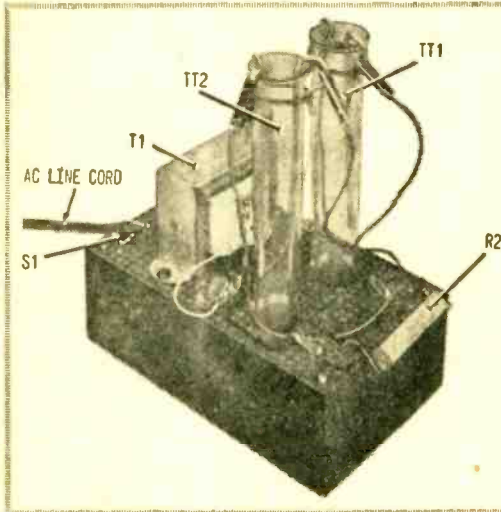

Now insert two 4-in. lengths of aluminum wire and one 4-in. length of solder into the other test tube. Form and cut them to size just as you did for TT-1. Again, use rubber bands and plastic sections to hold the electrodes and secure the test tube. Designate this test tube TT-2 and one of the aluminum electrodes as A1, the other A2. Space the electrodes in both test tubes from each other so that they do not touch.

Dissolve one level tablespoon of household borax in 8 oz. of lukewarm water. Then fill both test tubes with the borax solution to approximately 1/2 in. from the top.

**The Semiconductor Film.** Connect the circuit shown in Fig. 2. Use short clip leads to the test tube electrodes, taking care that

the electrodes don't short. Connect the positive lead of a DC voltmeter to J1 and the negative lead to J2. Set the voltmeter range so that it will read 6 volts.

Plug the module's AC cord into a 117-VAC outlet. Turn S1 on. Note that your voltmeter indicates little more than zero. Allow the module to operate for approximately 5 minutes and observe that the voltage reading gradually increases and finally levels off to a constant value (our meter

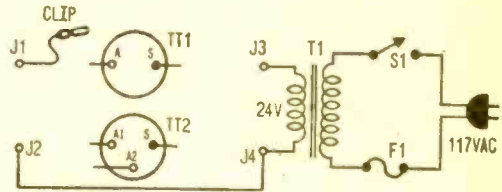

Fig. 1. Basic circuit of module. Hook up components in this manner before going on to other experiments.

## BILL OF MATERIALS

- C1—10- $\mu$ F, 50-VDC electrolytic capacitor
- F1—1-A fuse, with panel-mounting holder
- J1, J2, J3, J4—Fahnestock clips or binding posts
- R1—250-ohm, 10-watt 10% resistor
- R2—20,000-ohm, 10-watt 10% resistor
- S1—Spst slide switch
- T1—117-VAC pri., 24-V, 1.2-A sec., power transformer (Radio Shack 273-1480 or equiv.)
- TT-1, TT-2—7-in. x 1-in. dia test tubes

Misc.—3 3/4 x 6 x 2-in. Bakelite box with perf board top (Radio Shack 270-097 or equiv.), #8 solid aluminum wire, #16 60/40 solder, AC line cord, clip leads, solder lugs, plastic sections, solder, wire, hardware, etc.

Ready-to-go utility box with perfboard top holds components and has hole for line cord.

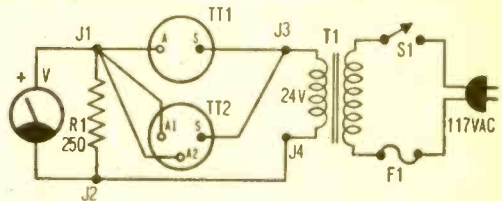

Fig. 2. Semiconductor film is formed by allowing current to flow until DC voltmeter indicates 6 V.

indicated 6 V). The exact voltage isn't critical and will vary with particular experiments. Note, however, that bubbles form around the electrodes, thereby indicating electrochemical activity.

When your voltage indication has leveled



off, turn S1 off. The semiconductor film has been formed. (Remember that the test tube electrodes are connected in parallel.)

**Half-Wave Rectifier.** To get rectification, hook up the circuit in Fig. 3. Note that R2 is now substituted for R1. This is required because the semiconductor film is formed by using a larger current flow (a smaller resistance load) than under normal circumstances (a larger resistance load).

Set the voltmeter to a range that will indi-

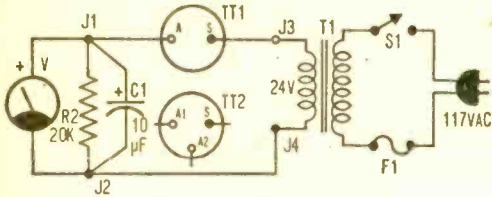

Fig. 3. Rectifier circuit.

cate approximately 25 V. Turn S1 on and observe that the meter does show about 25 V, indicating that the liquid rectifier is working as a half-wave rectifier. If there has been a considerable delay in hooking up the circuit of Fig. 3, there may be some delay while the semiconductor film reforms. This would cause a time lag before the meter indicates the correct voltage. Note that most of your bubble activity takes place at the aluminum electrode.

Unhook one lead of C1 from the circuit and observe that the meter indication drops to a much lower value. This shows that a considerable amount of AC ripple (see below) is left in the circuit. This unsteady DC is filtered to get an efficient output.

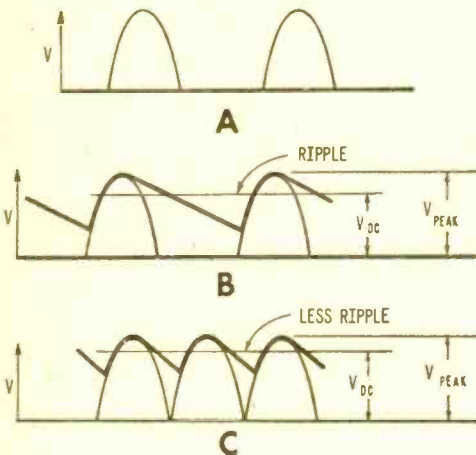

Fig. A is output of half-wave rectifier; Figs. B and C illustrate effect of RC filter network on both half-wave and full-wave outputs. Amount of ripple (pulsating DC) depends on values of R and C.

Now turn S1 off and quickly disconnect the leads from TT-1. Measure the resistance across the electrodes with an ohmmeter, then reverse the leads to your meter and measure again. Note that the resistance is very high in one direction and low in the other direction. This is equivalent to the front-to-back resistance of a semiconductor.

**Electrolytic Capacitor.** The liquid semiconductor layer can also act like the dielectric in a capacitor. Since the semiconductor layer is very thin, a large amount of capacity can be achieved in a very small surface area. The thickness of this semiconducting layer is dependent on the applied voltage. The higher the voltage, the thicker the layer, and the less capacity in a given area. This

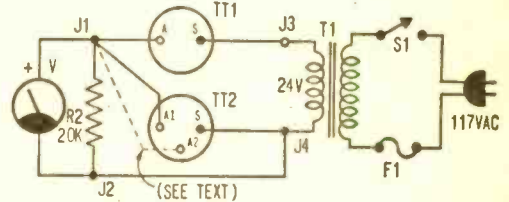

Fig. 4. Since film on aluminum electrode acts like dielectric, applied voltage will control capacitance.

experiment will use only TT-2 connected as an electrolytic capacitor.

Follow the module circuit in Fig. 4, but don't connect the A2 electrode of TT-2 now. Turn S1 on and note that the voltmeter indication gradually increases to a stable reading (our meter indicated 17 V). Connect the A2 electrode to J1 and note that the voltmeter indication has now increased (about 21 V is right). The voltage has increased because of the additional dielectric area (semiconductor area) added to the circuit. This increases the filtering action, thereby passing a higher voltage.

If you have a capacitor bridge, turn S1 off and disconnect the leads to TT-2 (taking care not to disturb the electrodes!). Connect the A1 electrode to the positive lead of the capacitor bridge and connect the S electrode to the negative lead from the bridge. Measure the capacity. (Our unit measured 2.5  $\mu$ F.) Finally, connect A2 to A1 and measure the capacity again—you should get about 4.5  $\mu$ F.

This experiment has simulated the operation of a wet electrolytic capacitor that was once used extensively in electronic equipment, but has now been replaced by the dry electrolytic capacitor that we're all familiar with. ■

**Someone  
should develop  
an easy way  
to learn  
electronics at  
home**

**RCA Institutes  
did!**

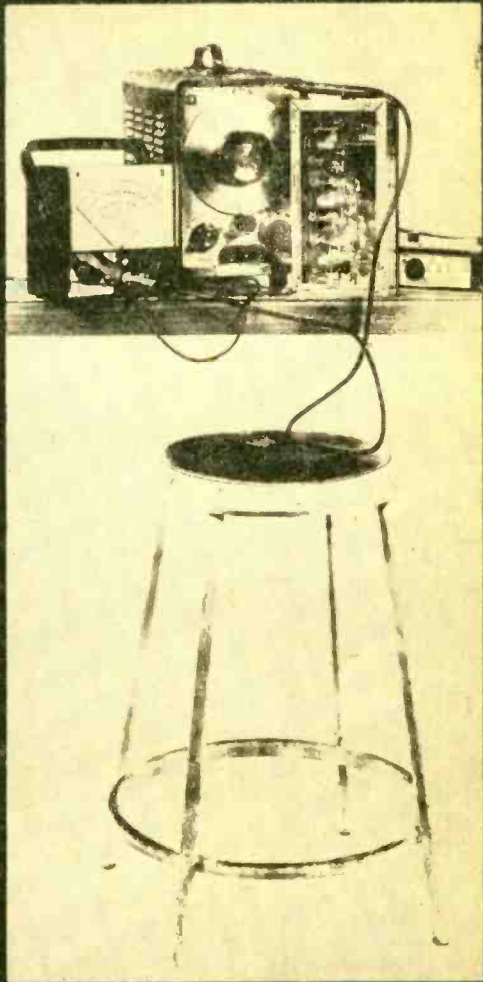

Here is a whole new approach to learning electronics at home! RCA Institutes, one of the nation's largest schools devoted to electronics, has developed a faster, easier way for you to gain the skills and the knowledge you need for the career of your choice. Here for the first time is a student-proved, scientifically designed way to learn. If you have had any doubts in the past about home training in electronics—if you have hesitated because you thought you might not be able to keep up—or that electronics was too complicated to learn—here is your answer! Read how RCA Institutes has revolutionized its home training ideas!



**NEW CAREER PROGRAMS  
BEGIN WITH "AUTOTEXT"  
INSTRUCTION METHOD!**

**Start to learn the field of your  
choice immediately!  
No previous training or  
experience in electronics  
needed!**

With this new revolutionized method of home training you pick the career of your choice—and RCA Institutes trains you for it. RCA's Career Programs assure you that everything you learn will help you go directly to the field that you have chosen! No wasted time learning things you'll never use on the job! The Career Program you choose is especially designed to get you into that career in the fastest, easiest possible way!

And each Career Program starts with the amazing "AUTOTEXT" Programmed Instruction Method—the new, faster way to learn that's almost automatic! "AUTOTEXT" helps even those who have had trouble with conventional home training methods in the past. This is the "Space Age" way to learn everything you need to know with the least amount of time and effort.

**CHOOSE A CAREER PROGRAM NOW**  
Your next stop may be the job of your choice. Each one of these RCA Institutes Career Programs is a complete unit. It contains the know-how you need to step into a profitable career. Here are the names of the programs and the kinds of jobs they train you for. Which one is for you?

**Television Servicing.** Prepares you for a career as a TV Technician/Serviceman; Master Antenna Systems Technician; TV Laboratory Technician; Educational TV Technician.

**FCC License Preparation.** For those who want to become TV Station Engineers, Communications Laboratory Technicians, or Field Engineers.

**Automation Electronics.** Gets you ready to be an Automation Electronics Technician; Manufacturer's Representative; Industrial Electronics Technician.

**Automatic Controls.** Prepares you to be an Automatic Controls Electronics Technician; Industrial Laboratory

Technician; Maintenance Technician; Field Engineer.

**Digital Techniques.** For a career as a Digital Techniques Electronics Technician; Industrial Electronics Technician; Industrial Laboratory Technician.

**Telecommunications.** For a job as TV Station Engineer, Mobile Communications Technician, Marine Radio Technician.

**Industrial Electronics.** For jobs as Industrial Electronics Technicians; Field Engineers; Maintenance Technicians; Industrial Laboratory Technicians.

**Nuclear Instrumentation.** For those who want careers as Nuclear Instrumentation Electronics Technicians; Industrial Laboratory Technicians; Industrial Electronics Technicians.

**Solid State Electronics.** Become a specialist in the Semiconductor Field.

**Electronics Drafting.** Junior Draftsman, Junior Technical Illustrator; Parts Inspector; Design Draftsman Trainee Chartist.

**SEPARATE COURSES**

In addition, in order to meet specific needs, RCA Institutes offers a wide variety of separate courses which may be taken independently of the Career Programs, on all subjects from Electronics Fundamentals to Computer Programming. Complete information will be sent with your other materials.

**2 CONVENIENT PAYMENT PLANS**

RCA Institutes offers a unique tuition plan that lets you progress at your own pace. You only pay for lessons as you order them. You don't sign a contract obligating you to continue the course. There's no large down-payment to lose if you decide not to continue.

However, if you desire, RCA Institutes also offers a convenient monthly payment plan.

**VALUABLE EQUIPMENT**

You receive valuable equipment to

keep and use on the job—and you never have to take apart one piece to build another.

**New—Programmed Electronics Breadboard.** You now will receive a scientifically programmed electronic breadboard with your study material. This breadboard provides limitless experimentation with basic electrical and electronic circuits involving vacuum tubes and transistors and includes the construction of a working signal generator and superheterodyne AM Receiver.

**Multimeter and Oscilloscope Kits At No Additional Cost.** You will receive with most RCA Institutes Career Programs the instruments and kit material you need to build a Multimeter and Oscilloscope. The inclusion of both these kits is an RCA extra.

**CLASSROOM TRAINING  
ALSO AVAILABLE**

RCA Institutes maintains one of the largest schools of its kind in New York City where classroom and laboratory training is available in day or evening sessions. You may be admitted without any previous technical training; preparatory courses are available if you haven't completed high school. Coeducational classes start four times a year.

**JOB PLACEMENT SERVICE, TOO!**

Companies like IBM, Bell Telephone Labs, GE, RCA, Xerox, Honeywell, Grumman, Westinghouse, and major Radio and TV Networks have regularly employed graduates through RCA Institutes' own placement service.

**SEND ATTACHED POSTAGE PAID CARD  
FOR COMPLETE INFORMATION, NO OB-  
LIGATION.**

All RCA Institutes courses and programs are approved for veterans under the new G.I. Bill.

Accredited Member  
National Home Study Council

IF REPLY CARD IS DETACHED—SEND THIS COUPON TODAY

RCA INSTITUTES, Inc., Dept. EAQ-19  
320 West 31st Street, N.Y., N.Y. 10001

Please rush me FREE Illustrated catalog. I understand that I am under no obligation.

Name \_\_\_\_\_ Age \_\_\_\_\_  
(please print)  
Address \_\_\_\_\_  
City \_\_\_\_\_  
State \_\_\_\_\_ Zip \_\_\_\_\_



## Hartman Marine RDF-101 Compensated, Solid-State Radio Direction Finder

No one likes to play it cheap with his life, and that's one good reason why marine lifesaving equipment, such as a radio direction finder (RDF), command premium prices. But, as proved by the Hartman Marine RDF-101, a radio direction finder for use on land or sea need not be priced at \$200 or \$300; in fact, the Hartman RDF goes for well under this price range—\$59.95 to be exact.

The RDF-101 is basically a sensitive transistor radio mounted in a small plastic case with a revolving radio compass and a magnetic compass. It is supplied with a detachable gimbal bracket and strap which permits the RDF to be secured to a bulkhead, and/or carried on the shoulder. The RDF is also supplied with the "Hartman Broadcast Station Locator"—a booklet listing the longitude and latitude of all 50 states plus Puerto Rico and Virgin Island stations.

**Getting A Fix.** It takes less than a minute to obtain two BCB station's bearings for a reasonably accurate fix; perhaps two minutes to get a three- or four-station bearing. However, speed is not necessary in obtaining a fix unless you're on the Niagara River headed for a fall.

Here's how to get a fix. The transistor radio is mounted in a rotating "compass" assembly. Scribed on the panel is a lubber line which passes through the radio compass and points to the magnetic compass. In the lower right hand corner is a signal strength meter.

First step is to rotate the entire RDF case until the lubber line points to the N (north) on the magnetic compass. Next, a standard broadcast station is tuned in, and the large azimuth dial is rotated until the tuning meter indicates *minimum signal strength*, called a "null." When the station is nulled, you simply read off the magnetic bearing from the azimuth dial; this is the magnetic bearing of the radio station in relation to your position. Actually, the radio compass can null at two points exactly 180° apart,



say 83° and 263°. You then locate the radio station's position (using the supplied Broadcast Station Locator) and draw a line through the radio station's position on the *magnetic bearing*.

You then do the same with a second radio station; the point where the two magnetic bearing lines cross on the map is your location. For greater accuracy, you can take three station coordinates; and your position would be within the triangle formed by the three intersecting lines.

**Poles Apart.** Now you'll note we've talked about *magnetic bearing*, not *true bearing*. That's because the magnetic north pole and true north pole are not at the same site. All marine maps give both magnetic and true norths. However, if your map does not  
(Continued on page 107)

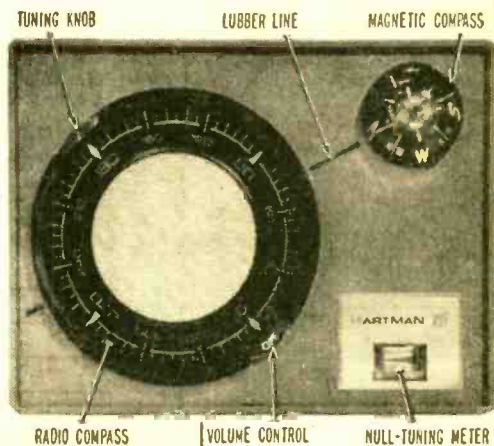

Simply rotate unit until lubber line points to N on magnetic compass. Azimuth dial gives bearing.



ATTEN-SHUN! HERE COMES THE PARADE OF

1969

BASE AND MOBILE

# CB TRANSCEIVERS

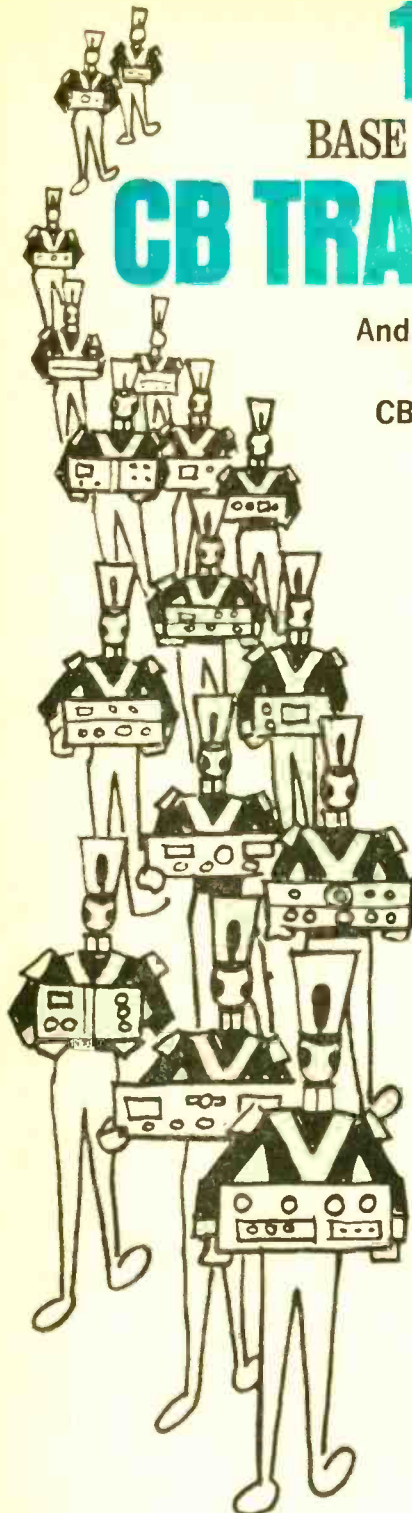

And there they go, passing in review—  
5-watt rig after 5-watt rig in the  
CB Directory you've been waiting for!

**O**n the following pages you'll see a preview of the 1969 CB transceivers—the sets that'll soon be appearing on dealers' shelves and in the 1969 catalogs. These are all full-power, 5-watt units designed for base station use at home or mounted in a car for mobile operation. Many can be utilized either way.

The trend for 1969 is decidedly solid-state, with plenty of new gadgetry and—here's an item we can all appreciate—*lower* prices! Many of the old-line sets have been drastically slashed pricewise this year, some by as much as \$40.00 and more. New sets, like a 6-channel unit bowing in at only \$79.95, are establishing the long-awaited downward cost picture the CB industry has been shooting toward for years.

With increasing technical sophistication and mass production, the 1969 CB outlook is clearly split between 1) the low-priced, jampacked mobile sets, and 2) the top-of-the-line base stations, some exceeding \$400.00 in price. The middle-of-the-road equipment, however, is still worth investigating if you feel you must have full 23-channel capability.

*(Turn page)*

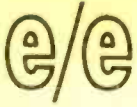

This middle category, diminishing somewhat in emphasis due to severe competition, has left manufacturers in a quandary for '69. An inspection, for example, of various brands offering identical set performance (and circuitry) reveals a range that's hard to rationalize. You can go, for example, from \$129.00 for a frequency synthesizing set to exactly twice that figure for identical functions. You figure it out.

Amid all this competition, however, the one who really comes out ahead is *you*, the prospective CB set buyer. For the first time in years, you've got a choice that is matched only by the 1969 buyer of a B&W TV set. Got the picture?

One shortcoming, however. Another trend this year is to 12-VDC power source standardization. With few exceptions, *all* new sets are being manufactured without universal (12 VDC and 117 VAC) supplies. This means you'll have to invest in an optional AC adaptor. These units, since they're offered by nearly every manufacturer, have not been included in this listing. Bear in mind, however, that with one lone exception all these adaptors are compatible *only* with equipment produced by the same manufacturer.

Next, look into channel availability. Do you really need full 23-channel operation? While prices are indeed tumbling this year,

you're still paying your biggest premium for this bag. Also, if you have decided this is what you want, make certain that's what you get.

There's nothing more frustrating than laying out \$199.95 for a 23-channel rig only to learn that it's minus 22 channels. And since most rigs require both a transmit and receive crystal for every channel you desire, you end up requiring 44 more crystals. This can easily run to \$160.00! Also check distribution offered by manufacturer you are interested in. Will you have to order your crystals by mail and possibly wait four weeks for them, or can you buy them at the friendly corner CB shop?

Prices shown here are subject to variation. To be honest, these are list. Which means, fellow horsethieves, that you can usually talk your hungry salesman down a few hard-earned bucks before closing the deal. Even the very newest low-priced sets can frequently be had for more than 10 percent off. In fact, you'd be amazed what deals you can work out if you shop around. But note that this technique doesn't apply to mail-order stores or catalog buys.

Now, before you do anything more, use this listing to narrow down your selection and *write the manufacturer!* You'll need full details before you buy. Many rigs that appear identical here may actually be in different ballparks from a size and weight standpoint, for instance. A complete directory of manufacturers and their addresses is included elsewhere in this issue (see page 104) for your convenience. ■

## 1969 CB BASE AND MOBILE TRANSCIVER DIRECTORY

### ● ALLIED RADIO CORP. ALLIED & KNIGHT-KIT

**A-2530.** This new communications set, dubbed the A-2530, has 10-channel capability and can be used both in the car and at the base station—due to its built-in universal power supply. With full 5-watt input rating, this handsome CB set retails for \$109.95.

**Safari III.** A 23-channel rig for \$89.95? You bet. So small you can hold it in one hand, the solid-state Safari III can be had with any number of optional accessories. In kit form.

**Safari II.** Still one of CB's easiest kits to put together, Allied's Safari II is particularly great for the CB



Knight-kit Safari II

newcomer who'd like to try his hand at homebrewing. But best of all—and you'll note we saved it for last—is the pricetag. A mere \$69.95.

### ● AMPHENOL CORPORATION

**PEE-WEE CB.** Otherwise known as the Amphenol 750, this amazingly tiny, full-power transceiver has been the talk of the 1968-69 season. Perfect for the beginner and oldster alike, this rig—which

weighs in at less than 3 lb—features 6-channel operation, super-heterodyne receiver (which, incidentally, has the Editors buzzing), 13 transistors, and 4 diodes. With a long coil cable, the microphone/speaker allows you to step outside of the car yet still continue your conversation. Complete with crystal for channel 9, the popular Pee-Wee CB sells for \$79.95. They just can't get much cheaper . . . or smaller.

**Model 777.** A perfect base mate for the Pee-Wee is the new Amphenol 777 23-channel frequency-synthesizing transceiver. With a high-output dynamic push-to-talk microphone, dual-conversion receiver (somewhat unusual in this price range), the circuit contains 19 transistors and 10



diodes. Priced to move at \$169.95, she's a low-profile job designed for 12 VDC operation.

**Model 675.** All new electronic circuitry is free from "power robbing mechanical devices." 5 watts, 12 VDC. Channels: 10 available, channel 11 installed. With dual-conversion receiver, this solid-state unit contains 17 transistors and 5 diodes. Priced at \$159.95.

**Model 725.** Simplicity is the keyword of this compact. Another 12 VDC model (Amphenol builds them all this way), she's an 8-channel job with superheterodyne receiver and 14 transistors and 3 diodes. Priced to move at \$99.95.

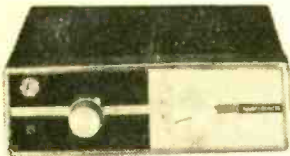

Amphenol 725

**Power Pedestal.** While this section should confine itself only to Class D 5-watt transceivers, Amphenol's late-breaking entry should be noted. Why? Because their all-new solid-state 790 power converter (which transforms 117 VAC into pure 12 VDC—actually 13.5 volts) can be used with any CB transceiver, not just Amphenol's. Secret of success here is their special magnetic-strip mounting arrangement on the top of the 790 Pedestal. She'll hold just about any mobile rig you throw at



Amphenol 777 & 790

her. Better yet, it's been designed with a sound deflection system to counteract the normal "tinny" effect that occurs when a CB set with a base-mounted speaker is set atop conventional AC adaptors. The new Amphenol Model 790 Power Pedestal projects this sound out the front of the unit, actually improving its tonal quality. Price: \$29.95 with 2N544 capacitive multiplier, zener diode voltage regulator.

Rumor. Though we couldn't confirm at press time, it appears that Amphenol has even more exciting things scheduled to break early this year. Among them: a teeny, tiny mobile rig with pricetag to match, a really unusual "first of a kind" base station, and something we can't talk about yet in way of a handheld unit. Keep watching the ads, gang.

#### ● APELCO CO.

**565.** Apelco, long a leader in the marine communications arena, continues this year with its popular model 565—an all solid-state, 5-channel rig designed for mounting aboard ship. With built-in 12 VDC power supply, gimbal mounting hardware, and crystals for channel 11, she bows in at \$129.95.

**AR-15.** Here's an Apelco rig designed for use strictly as the base station, complete with self-contained 117 VAC power supply. With 9-channel capability and a speaker that doubles as a mike (reverse of the Amphenol 750 trick), there's no dangling cord to contend with. Recommended for use at yacht clubs, gas docks, or marinas. Price? \$99.95.



Apelco AR-15

**AR-16.** Pushbutton CB, a real rarity these days, can be had in this 10-channel rig from Apelco. But the real feature is its power source flexibility, far outdistancing the competition with 12 VDC basic plus optional 32 VDC or 117 VAC supply plug-ins. Cost: \$159.95.

#### ● AUTOMATIC RADIO MFG. CO.

**TRE-6500.** Many manufacturers tout their products to farmers, but here's a company that really goes after them in a big way. The Automatic Radio TRE-6500, otherwise known as the "tractor CB," is a full-power (5-watt) 2-channel CB transceiver plus conventional AM radio. Contains all desired CB features plus a rare 10 watts of audio output from either receiver. Though it comes

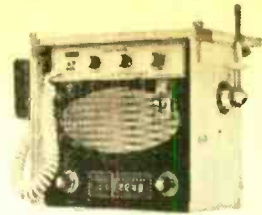

Automatic Radio TRE-6500

with built-in 12 VDC power supply, an optional 117 VAC supply is also available. Price is available from dealers, who base cost in part upon installation requirements, tractor type, mounting hardware required, etc.

#### ● AUTRONICS CORP.

**Buddy.** Autronics, though not particularly well known to new CBers, is a manufacturer of tube-type CB equipment. An example of this is the Buddy, a unit containing 17 tubes and providing full 23-channel CB capability. With S-meter and all the rest, the Buddy is designed for base-station use—complete with built-in 117 VAC power supply. Price should be checked with your dealer.

**TX-11B.** Another tube rig is Autronics 23-channel TX-11B (you figure out what the "11" stands for). It has 7 tubes, can be adapted for field or mobile use (by means of a power inverter), and sells for approximately \$124.95.

**RC-11B.** Known as Autronics "top-of-the-line" CB rig, the RC-11B is a 6-channel set with all the trimmings. Designed solely for use as a base station (built-in 117 VAC power supply), the unit is known for its high degree of circuit sophistication. With "everything," \$179.95.

**Spartan.** Breaking its unwritten constitution a bit, Autronics has elected to combine semiconductors and tubes in this set, providing the Spartan with 4 CB channels on transmit and receive and a price tag of \$149.95. Before you run off, however, you might investigate its versatility: she comes with both 12 VDC and 117 VAC power supplies.

**Deluxe.** Here's a mixture of Spartan semiconductor/tube design technology and added Buddy advantages—a rig that offers 10-channel flexibility, plus the versatility of self-con-

tained 12 VDC and 117 VAC power supplies. Price: \$169.95.

● **B&K MFG. CO.**

**Cobra 23.** B&K's big '68 set continues to be a major item into 1969. The "more power, more punch, more range" Cobra 23 is an all solid-state rig featuring full 23-channel operation with no crystals to buy. The 23 also applies in part to its semiconductor content: 9 diodes and 23 transistors. With built-in 12 VDC supply, it sells for \$169.95.



B&K Cobra 23

**Cobra V.** A scaled-down version of the Cobra 23 big brother, the Cobra V checks in with 5 channels, self-contained 12 VDC supply, and full semiconductor content at \$99.95.

**CAM-88.** B&K's real top-of-the-line rig, the CAM-88 is a "proven 23-channel performer" that will appeal to the true dyed-in-the-wool Citizens Radio enthusiasts. With S-meter, noise elimination circuit, and other assorted gadgetry, the CAM-88 bows in at \$214.95. Oh, yes! It also includes 12 VDC and 117 VAC supplies for full versatility at home or in the mobile.



B&K CAM-88

● **BROWNING LABORATORIES, INC.**

**Eaglette.** Something of a spinoff from Browning's "The Eagle" (see listing that follows), the all-new Eaglette promises to be a big item for 1969. What makes it different is that the Eaglette is a mobile rig, Browning's first. With local and long-distance switch, illuminated S-meter, self-contained crystals for all 23 channels, the new Browning



Browning Eaglette

entry promises to be quite a contender in the running for Mr. Mobile 1969. Price not available at press time.

**Golden Eagle.** For flair, sophistication, and jet-set design you can't beat the Golden Eagle. Here's where a manufacturer took a super CB station and stepped it up in quality and features. The Golden Eagle supersedes the Eagle (see listing below) with many of the former features retained and many desirable new features added. A Collins mechanical filter, for example, brings over 80 dB adjacent-channel rejection to the receiver. Unit has facilities for paging and remote speakers with separate volume controls. Price, complete with base-station microphone: \$395.00.



Browning Golden Eagle

The Eagle. Touted as "the ultimate CB rig," this hefty two-part professional CB base station is designed for the discriminating operator. The Browning Eagle offers just about every feature you can think of. A few: dual oscillator converter for selectivity and a host of "specials" too numerous to go into at length here. Your best bet is to see your dealer for complete run-down. Price? A mere \$359.00.

● **BURSTEIN-APPLEBEE**

**BA-23X.** A real sleeper that few CBers know about is this bargain from Burstein-Applebee. Fact: full 23-channel performance—with all crystals included—yet not frequency



Burstein-Applebee BA-23X

synthesizing. Fact: both mobile (12 VDC) and base (117 VAC) supplies built into the unit. Price: \$119.95 complete. A spotting switch lets you calibrate the receiver.

**BA-8.** This 8-channel rig has a tunable receiver and front-panel socket for quick change of transmit crystals. Can be used both at home and in the car. Price? \$79.95.

● **COURIER COMMUNICATIONS, INC.**

**Courier Traveller.** In a battle with Amphenol for title of "world's smallest CB rig" is Courier's all-new Traveller, a set that comes complete with crystals for all 23 CB channels. Measuring 5 3/4" x 6 1/4" x 1 7/8" in. H, the tiny Traveller is completely solid-state. It includes lighted S-meter, modulation indicator, illuminated channel selector. With 10-year factory guarantee, \$149.00.

**Courier 23.** Still more improvements this year on the famous e.c.i. rig, the "23." Features include crystals for all 23 channels, dual conversion receiver, exclusive "modulation Sampler," illuminated S-meter, adjustable noise limiter, built-in 12 VDC and 117 VAC power supply. Price: \$189.00.

**Courier Royale.** A CB rig fit for a king—or maybe you? Well, that's what the White Plains, N.Y. firm is saying about its custom-built tube set, the Royale. With a Collins mechanical filter and many, many extras, the Royale can run either off car or house current. 1969 price: \$279.00.



Courier Royale

**Courier 23-Plus.** A 1968 entry that holds big promise for '69 is the Courier 23-Plus, another tube transmitter similar in design to the popular "23." This one, however,



contains a souped-up receiver "guaranteed to hear anything that's on the band" at the moment—no matter how far off. Price? \$199.00.

**Courier Classic.** The new 10-year Courier guarantee applies in full to this solid-state entry. This transistorized compact unit is designed for long-term mobile use and can put you on all 23 CB channels in a jiffy. Priced at \$199.00.

**Courier TR-23S.** Playing the "23" theme for all its worth, Courier's got a base station this time that's 23-channel delight. Neatly styled with many extras, she bows in at \$169.00.

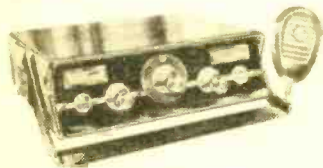

Courier TR-23S

**Courier TR-5.** Perfect for the young enthusiast who wants to go CB and really doesn't have need to talk on all 23 channels at once, the tiny TR-5 is worth investigating. Completely solid-state and with built-in 117 VAC supply, she'll only set you back \$99.00.

● **CRAIG PANORAMA, INC.**

Craig 4301. Craig, though not yet a major CB influence, is taking on 1969 for all its worth with its new Model 4301 mobile CB rig. Providing 5-channel operation, this all solid-state unit is designed to retail for \$99.95.

● **DEMCO ELECTRONICS, INC.**

**Super Satellite.** For 1969, Demco's improved still more on its popular "Satellite." Result, the "Super Satellite." Truly a custom-tailored CB rig, the set is available in a wide variety of versions depending upon the features you select (many accessories also available). This deluxe version retails for \$430.00. Includes 23-channel flexibility, built-in power modulator.

**Ravelle 23.** A mobile unit, this Demco '68/'69 entry is a deluxe job with many extra features, including dual-conversion receive circuit and



Demco Ravelle 23

built-in AC/DC power supplies. With full 23-channel capability, she sells for \$224.50.

**Ravelle.** Here's a Demco that you can use just about anywhere. With universal power supply, she blasts her 5 watts onto whatever 6 CB channels you select. Price: \$134.50.

**Chalet.** Another mobile rig available with any number of optional Demco accessories, the Chalet comes equipped for operation on any 6 CB channels you select. Completely solid-state, it sells for \$129.50.



Demco Chalet

● **EICO ELECTRONICS INSTRUMENT CO., INC.**

**Sentinel 12.** A peek at EICO's tube line reveals the Sentinel 12, long a best seller for this New York-based concern. Basically, the "12" is a



EICO Sentinel 12

versatile 12-channel 5-watt that retails for only \$99.95. Though EICO's well-known for its electronic kit projects, these sets are all pre-wired and ready to go.

**Sentinel Pro.** Essentially an expanded version of the "12"—with full 23-channel capability, the Eico Sentinel Pro remains a big one among CBers. With literally all the extras, she sells for \$169.95, complete.

**Nova-23.** Introduced in 1968 and slated for big-time acceptance in '69 is the new Nova-23 CB transceiver. With heavy design concentration upon the receiver section, full transistorization, full 23-channel versatility, the Nova-23 retails for \$189.95. With the works.



EICO Nova-23

● **GENERAL RADIOTELEPHONE CO.**

**MC-11.** Not much in the way of details available at press time, but the manufacturer is touting this one as, simply, "the best CB unit ever made." With full 24-channel capability, this all-new General Radiotelephone unit with S-meter, PA function, etc. retails at \$229.50. She comes with crystals for 1 channel.

**Super MC-9.** The tried-and-true "General" (old-time CBers will recall this one) has been revamped and fully updated for 1969 in the form of the Super MC-9. With improved circuitry, increased receiver selectivity, a new fine tuning control, and lots more, she retails at \$189.50. Complete.

**VS-6.** Bringing up the low-priced end of the General Radiotelephone line is the VS-6, a ruggedized 5-channel whoopersnooper that comes complete with built-in universal power supply. A modest \$89.50 will make it yours.

● **HAMMARLUND MFG. CO.**

**CB-205.** Okay. We all know Hammarlund is not a major CB transceiver manufacturer. But did you know that they are the world leader in "combine" receiver/CB configurations? Take this new CB-205 that's got everyone wondering what's next, for example. Basically a combination shortwave receiver (540 kHz through

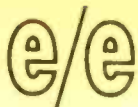

## CB DIRECTORY

30 Mhz) and CB transmitter with full 5-watt capability, the CB-205 offers 6-channel transmit and full-band tunable receive. With built-in Q-multiplier (what's a Q-multiplier? Go ask your mother), she sells for \$259.95.



Hammarlund CB-205

### ● HEATH COMPANY

**GW-14A.** All-new for 1969 is Heath Company's factory-assembled Heathkit GW-14A. Features? Try these: 14-transistor construction, provisions for 23-channel operation, improved modulator circuit, tuning meter, automatic noise limiter, etc. But the really big news is this: it's fully FCC Type Accepted! Price: \$124.95. For the mobile.

**GW-14.** Okay, so you want a kit? Here's a version of the above which you can assemble yourself and perhaps save a bundle of dough. How much? You figure it out. Price is \$76.95 with all the features of the GW-14A.



Heathkit GW-14

**GW-22A.** Basically a carryover from earlier years in the CB field, this unit continues to be a big one for the crew at Benton Harbor, Mich. A tube set you can put together yourself, the 5-channel rig can be purchased as a mobile unit for—and get this, you teenagers—for only \$49.95. Want it as a base station? Okay. It's yours for only \$47.95.

**GW-12A.** A complete 5-watt CB transceiver for only \$34.95? You bet, with this Heathkit mover. She comes with crystals for any single channel you'd like to operate and with her own built-in 117 VAC power supply. Want mobile and base versatility? It's yours for only \$39.95.

### ● INTERNATIONAL CRYSTAL MFG. CO.

**Model MO-23.** Remote-control CB is something that still is hard to come by in the Citizens Radio industry. Yet International Crystal Manufacturing Company is at it again with their ever-popular MO-23 combination tube/transistor mobile transceiver. Specially designed to be trunk-mounted with only the control head and microphone under the dash, the neat 12 VDC set will put you on all 23 channels. Seen those taxicab FM communications sets? Well, here's one for you, priced at only \$210.00.

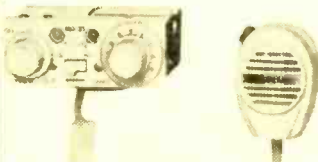

International Crystal MO-23

**Model 660.** Here's an all-channel CB transceiver that can be used both at home and in the car. With a universal power supply built into the unit and all crystals supplied, it represents a bet worth looking into. An illuminated channel selector has 12 positions; a HI/LO switch selects either channels 1 through 12 or 13 through 23. Complete with everything, she sells for \$205.00.

### ● E. F. JOHNSON CO.

**Messenger 320.** All new for 1969 is Johnson's Messenger 320, a 23-transistor unit with 15 diodes that provides—and get this—a double-conversion superheterodyne receiver. Designed primarily for mobile use (built-in 12 VDC power supply), Johnson's new entry features combination S-meter/RF power output meter, squelch, 3-watt PA system, etc. FCC Type Accepted. Price: \$199.50. All 23 channels.

**Messenger 350.** Want to go SSB (single sideband)? It's a cinch with this unusual CB rig. With 2-channel send/receive capability, she is com-



E.F. Johnson Messenger 350

pletely transistorized and designed expressly for mobile communications. Complete price: \$299.95.

**Messenger 323.** Perhaps one of Johnson's most versatile rigs, the Messenger 323 will put you on all 23 channels and is just the ticket for the sophisticated mobile user who doesn't mind paying a bit more for better mobile performance. Solid-state throughout, she sells for \$229.95.

**Messenger 300.** Featuring double the channel-working capability of the Johnson Messenger 100 (see below), this ever-popular model provides the full 5-watt input power of the entire company line and is transistorized throughout. Receiver features a souped-up section with greatly improved selectivity. With built-in 12 VDC supply, she retails at \$189.95.



E.F. Johnson Messenger 300

**Messenger 110.** With a 14-transistor circuit, plenty of transmit/receiver pizzazz, and complete with speech compression, the all-new Messenger 110 is one of the latest transceivers rolling off Johnson's production lines. With 5-channel construction, she's priced to move at \$99.95. Complete with built-in 12 VDC mobile supply.

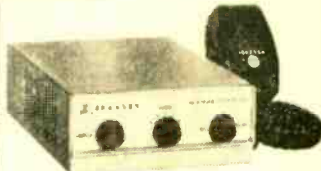

E.F. Johnson Messenger 110

**Messenger 100.** Designed primarily for mobile use, the Johnson Messenger 100 is completely solid-state. With 6-channel operational capability, she sells for \$129.95.



**Messenger III.** Want a 12-channel mobile rig? This may be it. A popular Johnson product for several years now, this all-transistor unit is priced at \$159.95, with built-in 12 VDC power supply.

**Messenger II.** Known in many circles as a souped-up version of its predecessor, the Messenger II will put you on any 10 of the 23 available CB channels for a mere \$159.95. Special feature: universal power supply (12 VDC plus 117 VAC).

**Messenger I.** The famous 5-channel tube-type Messenger I is still being manufactured for 1969, complete with all the well-known Johnson Messenger features — including a built-in universal power supply (see above). Price: \$114.95.

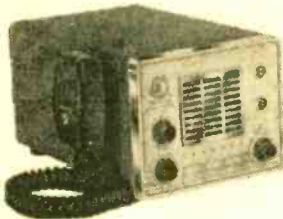

E.F. Johnson Messenger I

● **KAAR ELECTRONICS CORP.** Skyhawk Mark II. With everything going up these days, it's nice to know someone out there is thinking about your pocketbook. Kaar, for example, is reversing the CB trend by slashing \$40 off the price of its pace-setting Skyhawk Mark II. New price: \$229.95. Designed for 12 VDC mobile operation, the Kaar unit has full 23-channel transmit/receive capability (yes, all crystals are included) and is so small that it can be held in one hand. With 2-year guarantee and your choice of seven color panels (even includes wood grain for your den or library), the exciting 1969 Mark II can also be had with optional 117 VAC power supply.



Kaar Skyhawk Mark II

**Skylark I.** Little brother to the unit described above, the Kaar Skylark I

also enables you to choose front panel colors at no extra charge. Ruggedly constructed and solid-state throughout, she provides 11-channel transmit/receive capability at the full 5-watt input rating. Price: \$179.95.

● **LAFAYETTE RADIO ELECTRONICS CORP.**

**HE-20T.** A new one for 1969, this Lafayette unit features 12-channel crystal-controlled transmit and 23-channel tunable receive. A 13-transistor, 10-diode entry, the HE-20T also includes a spotting switch, 455-kHz mechanical filter, TVI trap, PA versatility, universal power supply. Priced to move at \$89.95.



Lafayette HE-20T

**HB-625.** This exciting '68 unit has even more pizzazz for 1969. Featuring three integrated circuits, 18 transistors, and what Lafayette calls "40-transistor performance," the unit comes with built-in 12 VDC power supply, mechanical selectivity filter, dual-conversion receiver circuit, and full 23-channel capability. With all crystals supplied, she retails for \$189.95.



Lafayette HB-625

**HB-525C.** Another unit featuring integrated circuits (ICs), the Lafayette HB-525C offers its owner a 23-transistor circuit, dual-conversion receiver, mechanical (455 kHz) selectivity filter, variable squelch control, plus PA capability. With all 23 crystals supplied, this unit comes with 12 VDC supply for \$149.95.

**HB-23.** This compact solid-state rig also boasts an IC—an integrated circuit of pinhead size—to boost performance. You'll also find a mechanical filter to sharpen reception and a 23-channel selector. Supplied with crystals for channels 9, 13, and



Lafayette HB-23

19, the HB-23 goes for \$99.95. Also there's an all-channel version you can have for \$124.95. With built-in 12 VDC power supply.

**HB-600.** A set referred to by many as the "ultimate CB rig," the HB-600 boasts a selective receiver and powerful transmitter section as well as universal (12 VDC and 117 VAC) power supply. With full 23-channel opportunities—all crystals are supplied with the rig—she bows in at \$219.95.



Lafayette HB-600

**Comstat 25A.** Known as the "top-of-the-Comstat-line," the 25A was recently redesigned with all new features for the new generation of CB enthusiasts. With 23-channel transmit/receive capability and equipped with a universal power supply (12 VDC and 117 VAC), the attractive transceiver can be had for a mere \$139.95.

**Comstat 23 Mark V.** A set that works on 117 VAC (or 12 VDC with an optional adapter), the Comstat 23 Mark V features tube-type construction throughout with all 23 crystals supplied. Receiver section has dual-conversion circuitry for sharp reception and an output jack for tape-recording received signals. Cost? \$114.95.

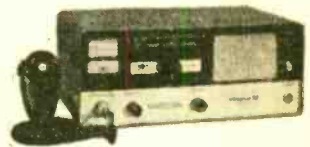

Lafayette Comstat 23 Mark V

**Comstat 19.** Sort of mid-range in the Comstat line is this 9-channel entry, the Comstat 19. A set that comes ready to operate on the band with a built-in 117 VAC power supply, this transceiver can be yours

for the unusually low price of only \$59.95.

**Telstat-23.** All-channel operation is possible now with this Telstat unit. And it's also possible to go either 117 VAC or 12 VDC mobile. Inside are 17 transistors—plus an integrated circuit—bringing the total to 22. Complete with mike, crystals, etc. for \$159.95.

● **MARK PRODUCTS CO.**

**Mark Invader 23.** A new solid-state unit featuring 23-channel operational capability, the Mark Invader 23 also provides: S-meter/RF output meter, PA facility, and 12 VDC supply for mobile use. With 29 semiconductor devices in the circuit and equipped with all the crystals you'll need, the new Mark Invader 23 can be yours for \$169.95.

● **CHAS. A MESSENGER CORP.**

**Fieldmaster Model TR-18.** Just what the name implies, this all-new design is an 18-transistor, 24-channel CB set that is truly among the world's smallest. With built-in PA facility, 12 VDC supply, etc. she sells for \$149.95. Yes, you get all

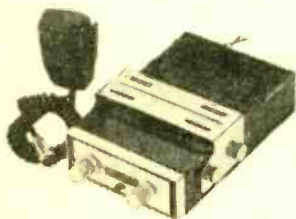

Messenger Fieldmaster Model TR-18

the channels—without purchasing a single additional crystal. Also of interest, this quote from the Messenger Corp.: "4-stage transmitter, min. 3.6-watts output."

● **MIDLAND INTERNATIONAL CORP.**

**Model 13-870.** Midland doesn't sell direct to CBers through the normal routes, but many distributors and dealers do carry their ever-increasing line. With no real advertising and promotional backup directed to the CB press, however, it is possible



Midland Model 13-870

that we may have missed a few new entries. The Model 13-870 is completely transistorized with 23-channel transmit/receive capability and sells for \$149.95 with built-in 12 VDC power supply.

**Model 13-860.** Another mobiler's delight is this model, a scaled-down version of the rig described above. With 12-channel capability, she clocks in at \$99.95.

**Model 13-150.** Here's another Midland import, a completely solid-state 8-channel CB transceiver. With built-in 12 VDC power supply, she sells for \$84.95, complete.

● **MOBILEPHONE**

**Model 27.** A tube-type set that isn't much to look at but which offers full 23-channel transmit/receive capability is Mobilephone's Model 27 CB transceiver. With universal power supply, she can be used both in the VW and at home. For price, check your Mobilephone dealer.

● **MULTI-ELMAC CO.**

**Citi-Fone II.** Here's the rig that got everyone talking last year and that continues to be a big item at Multi-Elmac. The Citi-Fone II is not a transceiver, but rather a transmitter/converter. It converts your AM car radio into a CB receiver and contains its own 5-watt CB transmitter, set for operation on any one of two CB channels. Press a switch and your AM auto radio converts over. Press another switch and you're on the air. Solid-state throughout, with built-in 12 VDC power supply. Price: \$49.95.

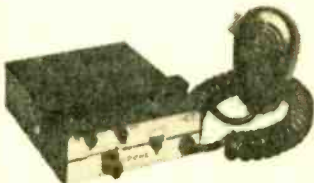

Multi-Elmac Citi-Fone II

**Citi-Fone 99.** While everyone else is phasing out the old and bringing in the new 1969 models, Multi-Elmac just keeps their tried-and-tested sets going. Their Citi-Fone 99 is an 8-channel 5-watt rig that comes complete with universal (117 VAC and 12 VDC) power supply for use both at home or in the family buggy. Price: \$99.95.

**Citi-Fone SS.** Essentially a souped-up version of the "99," this rig has everything Multi-Elmac can offer in the way of CB equipment—including full 23-channel operation. With built-in universal power supply, she's yours for \$169.95.



Multi-Elmac Citi-Fone SS

● **OLSON ELECTRONICS, INC.**

**Olson 8.** Here's a solid-state, 8-channel CB rig that weighs 5 lb., comes with "3¼ watt output" and—believe it or not—a price tag of \$59.99! A mobile rig with built-in 12 VDC power supply, automatic noise limiter, and low-profile design, this set last year cost \$80.00. Comes with crystals for channel 11.

**Olson 12.** With squelch and PA facilities, this set is designed primarily for 12 VDC operation. It provides 12-channel operation and all features of the Olson 8 above, including solid-state construction. Price: \$99.95.



Olson 12

● **PACE COMMUNICATIONS CORP.**

**Pace 2300.** Though this set was introduced last year, it still ranks among the company's main 1969 entries. A set that comes complete with all 23 transmit/receive crystals.



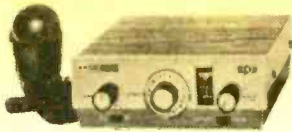

Pace 2300

tals, PA facility, squelch, plus a host of other features, the Pace 2300 bows in at \$219.95. All solid-state, natch.

The Pace Plus-23. Another Pace-setter with all 23 channels (crystals supplied), this item contains all of features listed above plus a unique local/DX receiving configuration. Solid-state construction throughout, the Pace Plus-23 retails for \$199.95.

Pace 200. Here's a cute rig with 12-channel transmit/receive capability, PA feature, S-meter, etc. that's also completely solid-state. With everything and equipped for 12 VDC power, she sells for \$159.00. Neat.

Pace 100. Next is Pace's 6-channel entry, the Pace 100. Equipped with transmit/receive facilities on Channel 11, this rig also features complete solid-state construction. Price: \$129.95.

The Auto-Mate. Here's a rig that pretty much stands on its own—with the possible exception of the Multi-Elmac Citi-Fone II. With a function of converting your car radio into a full-scale CB receiver at the flick of a switch, the Auto-Mate also provides push-to-talk 5-watt Class D transmit. Designed to mount entirely under the dash, she costs a mere \$69.95.



Pace Auto-Mate

### ● PEARCE-SIMPSON, INC.

Sentry II. A solid-state touted as "the world's first 5-channel CB radio with a Class B push-pull audio amplifier, super-sensitive receiver, and full-powered transmitter that comes with either palm microphone or telephone handset at no extra cost," P/S's Sentry II makes an impressive

appearance. Other features include one-year warranty, "4.0 watt power output," and an effective noise limiting circuit. Price: \$99.90.



Pearce-Simpson Sentry II

Director 23. Here's a rig boasting a final transistor "that won't blow—even if you key up and forget to connect the antenna." Other items: she's a 23-channel transceiver with all crystals included, "4.0 watts output" assured by manufacturer, "HetroSync" frequency synthesizing techniques, etc. With 12 VDC power supply built in, this solid-state unit sells for \$269.90.

Guardian 23B. Another set with the exact same price tag as the Director 23, this one employs nuvistors for a super-sharp, double-conversion receiver. With universal power supply, this set comes complete with all crystals.



Pearce-Simpson Guardian 23B

Companion II. This mid-range (price-wise) CB set comes with a telephone-type handset instead of conventional push-to-talk mike for an extra \$5.00, or with conventional carbon hand mike if you'd rather go the regular route. Features include: tunable receive, 5 fixed transmit/receive channels, output power "3.5 watts." With universal (12 VDC and 117 VAC power supply) voltage capability, she bows in at \$159.90.

Companion IV. With a telephone handset furnished at no extra charge, the P/S Companion IV is a 10-channel, solid-state transceiver with many additional features. This is basically a mobile rig which the manufacturer says "will operate even when the battery is too low to start the car." (Should come in handy if you need a tow). Price: \$139.90.



Pearce-Simpson Companion IV

### ● J.C. PENNEY

Penney Pinto 23. Yes, believe it or not, the J.C. Penney Company is now in the 1969 CB business—and not just retailing someone else's equipment! The Penney Pinto 23, on sale at all Penney Auto Centers, features full 23-channel transmit/receive, S-meter, squelch control, PA system, and external speaker jack. An illuminated color-coded dial shows the proper channels for transmitting. Compact wood grain cabinet tops off this unusual entry. With all crystals, she's yours for a more \$129.00.

### ● POLYTRONICS COMMUNICATIONS

PC-23C. Ranking among those teeny tiny '69 rigs, the Polytronics PC-23C is a compact mobile rig featuring full 23-channel performance (yes, all crystals are included). Completely transistorized, the set provides double-conversion superheterodyne receive, full 5-watt input and "3.5 watts output," signal-strength meter, illuminated channel selector, and a choice of custom-colored trim (green, red, blue, beige) at no extra charge. With everything, \$199.50.

PC-23. Known as the big brother of the Polytronics set line, the PC-23 is available in a series of models priced from \$299.50 through \$379.95, depending upon the custom features you desire. Basic set is a tube-type design (including nuvistors), 23-channel construction, including also "exclusive spectral-tuning." With universal power supply and PA facility.

Poly-Pup. Transistorized throughout, the tiny Polytronics Poly-Pup has been revamped for the new 1969 market and is a basically attractive model to boot. Comes with 7-channel versatility and mobile supply. Price: \$149.50.

Poly-Otter. With an unlikely name like that, you'd expect an equally

unlikely application—and you'd be right. Billed as the first CB rig for motorcycles, this one is sealed against the elements and bolts to the bike's rear rack or replaces one saddle bag. She's remotely controlled from the handlebars and features 7-channel operation. Price: \$199.50.

**Utility 5.** Perfect for heavy-duty industrial field work, the Polytronics Utility 5 has been ruggedized in an aluminum case and has been completely weatherproofed. With special rechargeable batteries, this work-horse prices out at \$259.95. A similar model for ranch or farm, the Poly-Communicator, is priced at \$243.95.

● **RADIO SHACK CORP. (REALISTIC)**

**TRC-24.** Well worth investigating is Radio Shack's 23-channel TRC-24, a set with all crystals supplied. Featuring 18 transistors, 4 diodes, and 1 thermistor, the transceiver uses frequency synthesis to achieve this



Realistic TRC-24

versatility without commanding an unrealistic (no pun intended) price. With an illuminated channel selector, S-meter, and dual-conversion receiver, the TRC-24 retails at only \$139.95. Complete with built-in 12 VDC power supply.

**TRC-18.** Another set receiving a lot of press these days is Radio Shack's TRC-18. She features 12-channel performance, illuminated channel selector, S-meter and all the rest, the TRC-18 has an unusual "extra"—that of being capable of receiving and transmitting on one crystal per channel! Equipped with Channel 11, the company has recently been offering a free 5-crystal pack (you specify channels) to new buyers. Price: \$99.95. With 12-volt mobile supply.

● **RAYTHEON COMPANY (RAY-TEL)**

**TWR-11.** Though Raytheon has been quiet lately about its CB line, the truth is that their established products—such as the TWR-11—will continue on quite big in 1969. The "11," a glistening "super-star transceiver" (pictured in ads at Tiffany & Co. jewelers with a girl in leopard-skin jacket), features 10-channel operation, 12 VDC supply, host of options. The set is solid-state throughout and sells for \$159.95, complete with pushbutton tuning.



Ray-Tel TWR-11

**TWR-9.** The TWR-9 is a 6-channel radio with base station application capability, thanks to its universal (117 VAC and 12 VDC) power supply. Smartly styled, she sells for \$99.95.

● **REGENCY ELECTRONICS, INC.**

**Imperial.** An unusual entry for '68 that will be continued into 1969 is Regency's Imperial, subject of many lavish 4-color ads. Why is it unusual? Because it's one of very few SSB (single sideband) transceivers on the market. Actually transmitting double sideband (DSB), it can receive either one, hence a total effect of providing 46 usable CB channels! Otherwise, it's very much like the Range-Gain II. Price: \$299.00.



Regency Imperial

**Range-Gain II.** A neat 23-channel DSB (double sideband) transceiver, the Range-Gain II comes with universal power supply (12 VDC plus 117 VAC) so you can go either base or mobile. Priced at \$235.00.

**Charger.** Here's a delight of a CB rig designed expressly for the CBer



Regency Charger

on the go. A 12-channel transceiver with built-in 12 VDC power supply, the Charger is solid-state throughout. Priced at \$110.00.

**Pacer II.** An 11-channel base or mobile CB rig (universal power supply), the Pacer II was previously part of the "Metrotek" line of medium-priced CB equipment. Price: \$110.00.

**Bronco.** The most inexpensive of the Regency CB entries, the Bronco is a solid-state 8-channel rig with all the extras you'd want for the price . . . including built-in 12 VDC power supply. Priced to move at \$89.95.



Regency Bronco

● **ROBYN COMPANY**

**Bronco 7 Plus 4.** No relation to Regency's Bronco product, this Robyn entry is an all-transistor CB rig with 11-channel transmit/receive. Designed for use in the family auto, it has an interesting feature of using the microphone as a private listening speaker when the user so desires. Priced at \$139.50.

**Robyn 24 Range Gainer.** Top-of-the-line entry from Robyn is their "24" Range Gainer, a neat rig with full 23-channel capability. With a unividing 12 VDC and 117 VAC operation, it's been priced at \$189.50. versal power supply built in (pro-

● **SONAR RADIO CORP.**

**Model H.** This 7-channel CB rig provides an external socket for additional crystals — something quite unusual these days — and works from 12 VDC in the car or 117 VAC at the base. Price, \$159.95.

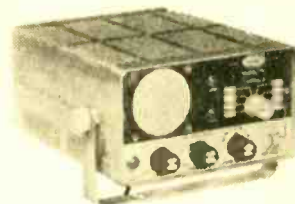

Sonar Model H

(Continued on page 104)



\$7<sup>95</sup> buys this

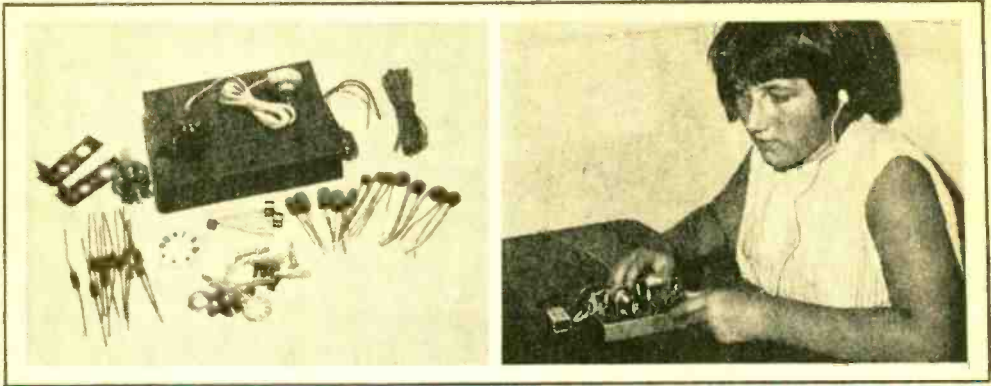

## BEGINNER'S SHORTWAVE RECEIVER

This handy rig rides SW like crazy and really socks it to ya!

By Bill Britton

**A**ll too often the so-called beginner's kit is either too difficult to assemble, requires additional components (which you discover only after the project is almost completed), or gives performance worth about a tenth of the selling price. So let's say you're a novice at construction and would like to tackle something that is worthwhile, something that's really designed with *you* in mind.

What to do? Simple! Latch onto the Radio Shack Science Fair 3-transistor shortwave radio kit. It costs but \$7.95, and gives you more than your money's worth in performance. Add a simple handsread and volume control, as we'll show later, and you'll have an SW radio as good as Pop used to use way back when.

The Science Fair SW radio kit employs one transistor as regenerative detector, a hook-up famed for phenomenally high sensitivity, and a minimum of circuitry. (It's also known for poor selectivity—the ability to reject signals near the desired one, but then you can't have everything for \$7.95.) In addition, two stages of AF am-

plification pump plenty of volume from the crystal earphone supplied with the kit.

As supplied, the receiver will tune from 3 to 40 MHz, depending on the coil in use. But like most regen circuits of this type, it is really "hot" only to about 20 MHz.

**A New Idea.** The Radio Shack SW kit utilizes a new type of "beginner's assembly technique" that's amazing only in the sense that no one has thought of it before. The box the kit is packaged in is made of heat-resistant plastic and has a keyed perf board on one side; the holes are labeled from 1 to 16 across the top and from A to M along the side. The builder simply installs the components on the perf board exactly as shown in the almost full-scale pictorial.

Spring-type push terminals are used for external connecting points, such as the antenna, battery, and headphones. The regeneration and tuning controls mount on pre-drilled brackets supplied with the kit. Unlike most other kits in this price range, tie-point terminals are not used. Instead, the com-

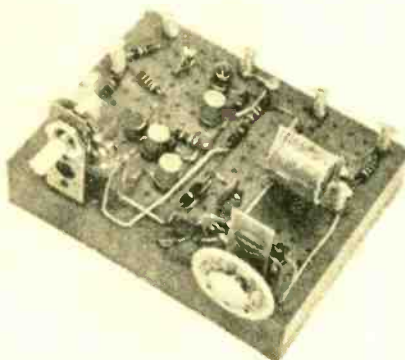

Completed beginner's receiver without modifications. Coils pop right into springs.

# e/e SW RECEIVER

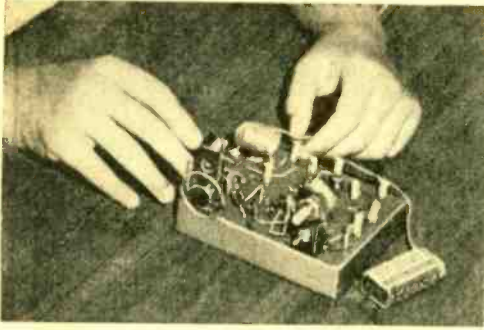

Series of plug-in coils are easily wound using an AA battery as coil form. Performance should be checked before securing coil with Scotch tape, etc.

ponent leads are pushed through the holes on the perf board, twisted together, then soldered. The soldered connections prove stiff enough to support the components.

Anyone who follows instructions should have the kit completed in, at most, two evenings. Then come the coils.

**Simplified Coils.** First, a warning. The kit instructions don't tell you that there is only enough wire supplied for winding the coils. Therefore, use some spare #22 or #24 solid, insulated wire for the coils (you'll need it).

The coils are wound as described (15 turns, 8 turns, etc.), using a standard AA cell (penlight battery) as the coil form. Don't worry about neatness, since anything that looks even remotely like a coil will likely work. If the coil has a tendency to spring open (and the larger, low-frequency coils will), simply hold the coil together with a few turns of Scotch tape.

In the event you run short of wire before winding all the coils, you can use #24 solid, plastic insulated wire for frequencies below 15 MHz and #22 solid insulated or uninsulated wire for

*Detailed view of circuit layout on plastic perf board, which is actually part of box. All mounting holes are identified for simple point-to-point wiring. Radio comes complete, except for 9 V battery.*

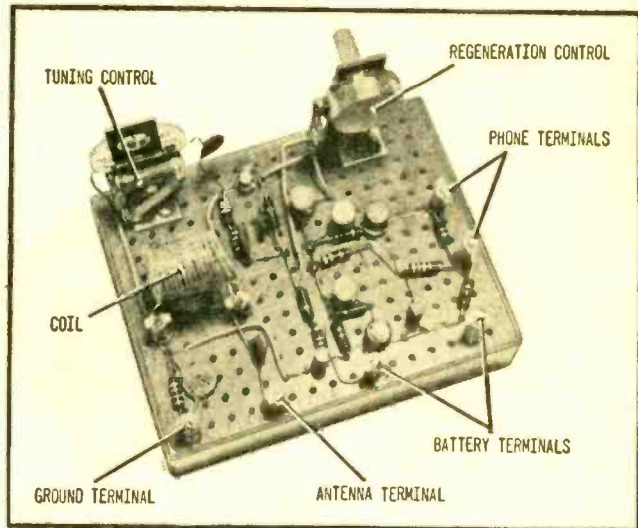

frequencies above 10 MHz. (The frequencies overlap because of the coil winding data supplied. For less than 9 turns, #22 wire can be used.)

Should you find that you would like a particular coil to cover a slightly lower or higher frequency, that's easy, too. Simply compress the coil to lower the frequency slightly, or stretch the coil to raise the frequency. If you intend to wind *all* the coils for full frequency coverage from 3.0 to 40 MHz, we suggest you purchase a roll of Radio Shack's #278-003 wire with the kit.

When the kit is completed it's only necessary to connect an antenna, a battery, and the crystal earphone supplied. Since there's no power switch, you simply connect the leads from the supplied battery terminals to the appropriate spring-loaded binding posts.

Use the longest possible antenna, and if possible, utilize a ground (to a cold water pipe or equivalent).

**Unmodified Performance.** Reception involves tuning the variable capacitor and adjusting the regeneration control for maximum signal strength. This will occur just before the receiver breaks into oscillation (a continuous whistle).

Don't expect the performance of a \$100 receiver. But do expect the unit to do a good job of receiving moderate to strong signals up to about 20 MHz, very strong signals to about 28 MHz, and some extremely strong stations above 28 MHz, too.

**Adding Bandsread . . .** A few simple, inexpensive modifications can sharply improve performance and convenience. Since the tuning capacitor supplied with the kit



covers a relatively large tuning range, separating two very close stations tends to be difficult. But by adding a small trimmer capacitor of 25 to 50 pF across the main tuning capacitor, it's possible to separate closely spaced stations.

A typical installation using a Hammarlund type MAPC capacitor is shown in our photo. The capacitor is mounted on a Vector control bracket of the type supplied with the Vector experimenter chassis kits. The holes in the bracket will fit exactly the spacing of the kit's perf board if it's mounted at holes I16 and K16. (If necessary, clip the corner of the bracket at K16 to ensure clearance of the kit's tuning capacitor bracket.) Mount the capacitor as low as possible in the bracket, and cut off all excess (so you don't cut your fingers when tuning).

Connect the trimmer capacitor's *stator* terminal to the tuning capacitor terminal

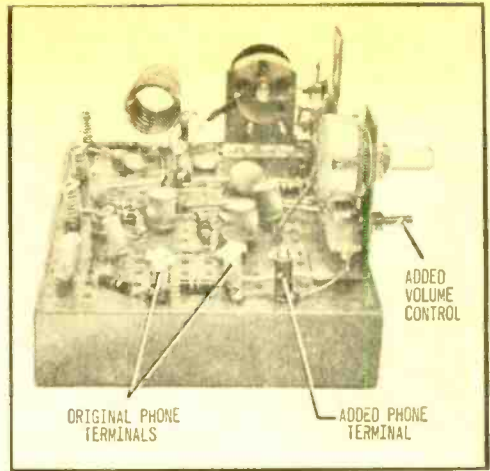

*Small, miniature volume control goes directly below regen control, making use of pre-drilled hole in bracket. Additional spring terminal is for headphone.*

#### BILL OF MATERIALS FOR BEGINNER'S SW RECEIVER

- 1—Shortwave radio kit (Radio Shack 28-110)
- 1—9-V battery (Radio Shack 23-464)
- 1—25- to 50-pF trimmer capacitor (Hammarlund MAPC or equiv.) (optional—see text)
- 1—500,000-ohm miniature potentiometer (Lafayette 32 T 7361 or equiv.) (optional—see text)

Misc.—Wire, ground clamp, etc.

which is connected to capacitor C4 (on the left of the tuning capacitor). Next, connect the trimmer's *rotor* terminal to the coil spring post at F16. Put a knob on the shaft, and the bandspread modification is completed.

... **And Volume Control.** The crystal earphone supplied with the kit produces a sound level approaching the threshold of pain. While the level can be reduced by cranking down the regeneration control, the receiver's sensitivity is also reduced and you

might skip over a desired station while tuning. For better control of volume, we suggest adding a miniature 0.5 megohm potentiometer (Lafayette 32 T 7361 or equiv.) in series with the crystal headphone.

To do so, install the potentiometer in the bracket hole directly below the regeneration control (on the left side of the receiver). It will be a very tight fit, but if you loosen the regeneration control's mounting nut you'll be able to slip the headphone control into the hole. (A standard size control definitely will *not* fit.) Position the headphone control so the terminals point to the left. Then, place a Vector type spring terminal, or any other terminal, at hole J1.

The crystal earphone supplied normally connects to the spring terminals at holes E1 and H1. When the modification is completed the earphone will connect between E1 and the new terminal at J1. To effect this change, connect a wire from the spring terminal at H1 to the bottom headphone control terminal. This done, connect the center headphone control terminal to the new spring terminal at J1. And that's it! The receiver now has both bandspread and a volume control, and you're ready for some good SWL-ing! ■

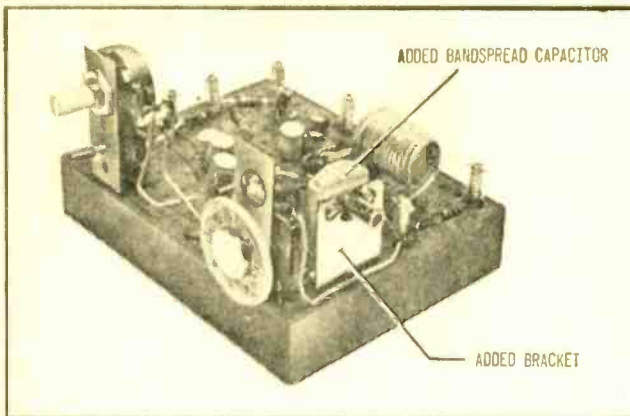

*Bandspread capacitor can be installed on small Vector control bracket located between variable capacitor and coil. Space should be adequate, but make sure connections from capacitor are short.*



# FOR BULLS AND BEARS

**T**he Ultronic Systems subsidiary of Sylvania Electric Products Inc. has developed a desk-top brokerage unit that can retrieve extensive, detailed financial market information at the touch of a finger and display it instantly on its own video screen. The new unit, called Ultronic *Videomaster*, can summon and simultaneously display 17 specific up-to-the-second details about any of the more than 8000 securities, regardless of the pace of market trading. It can simultaneously monitor any 18 selected securities and report on their performance. It can alert its operator to special stock situations within price limits he sets. In addition, the unit provides optional capabilities for displaying market summaries, financial news service, and economic background data from both internal and external computer sources.

Basic information for the unit is derived from the Ultronic Systems market data network, the most extensive of its kind in the world. The network ranges from Hong Kong to Switzerland to Lebanon to New York, covering most of North America and Free Europe. In conjunction with Reuters, Ltd., the worldwide news agency, the company also provides the nation's newest financial news service.

The Ultronic *Videomaster* unit consists of two major components—a keyboard and a video unit that has a picture screen measuring 12 inches diagonally. The keyboard consists of 26 keys lettered A to Z. Keys A to J also include the numbers one to 10, respectively. The keyboard also includes other keys labeled with abbreviations commonly used in the financial community, such as PR for “preferred,” representing a class of equity security; WI for “when issued,” representing a security traded, but not yet

available in the form of a certificate signifying ownership.

The keyboard is detachable, allowing greater flexibility in the arrangement of desk and office space to meet customer requirements. For example, the keyboard can be associated with a large-screen video monitor displaying the information.

Ultronic *Videomaster* employs three basic operating modes to provide specific market information and service most demanded by brokers. Each mode displays a separate set of data. The operator of the unit can switch back and forth between the modes without having to re-program his selections.

*(Continued on page 106)*



Here's Sylvania's new desk-top brokerage unit that can retrieve a wide range of financial market information at the touch of a finger. Named Ultronic *Videomaster*, the unit features a keyboard which can summon specific information about any one of more than 8000 securities, as well as general market data. The information is displayed on the 12-in. video screen in concise, easy-to-read form.



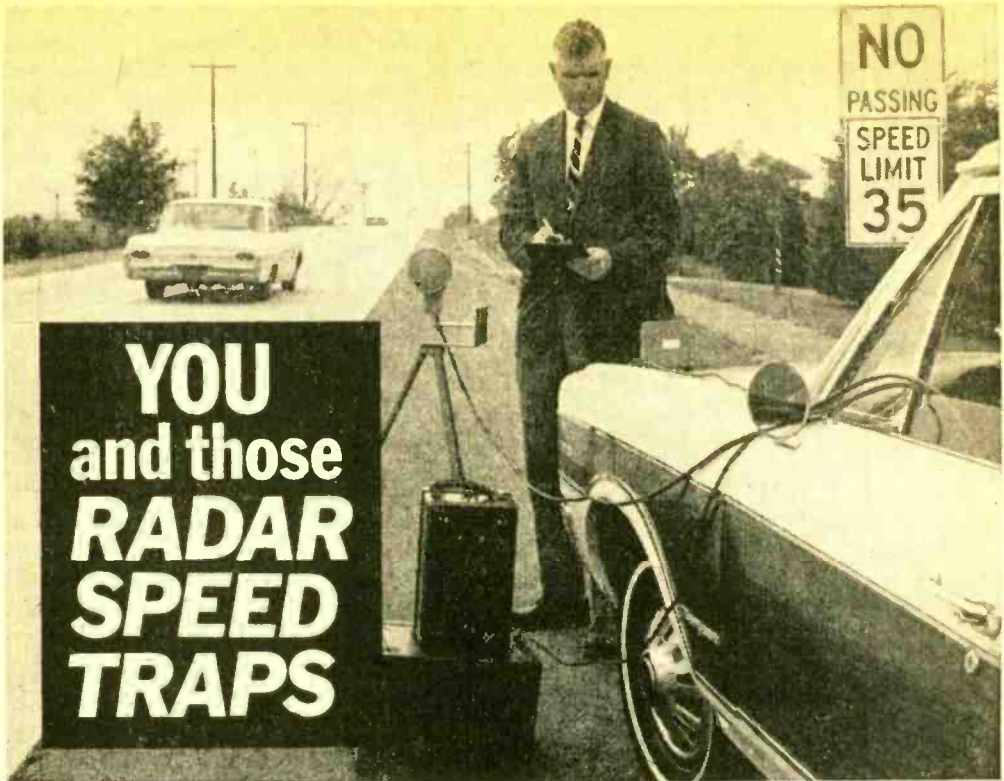

# YOU and those RADAR SPEED TRAPS

Could it be the letter, not the spirit, of the law they get you on?

By Thomas S. Kneitel, K2AES, KQD4552

**P**olice radar traps (they call them "speed meters" in polite company) are taking over the American highways! Really! Fact is, it's almost impossible to drive along any major highway without passing through secret radar beams set up solely to monitor your driving. Right this minute there are almost 10,000 speed traps in operation in the 50 states!

It shouldn't come as any surprise to you to learn that there are 15 in Chicago, or 22 in Los Angeles. But does it grab you a bit when you find out that Biggs, California (population: 831) has a trap? And would you also believe Hayden Village, Idaho, hometown to 39 hearty souls, has a radar trap as well?

In truth, speed meters have become a farce and a disgrace to law enforcement, a shabby tool used by even the most miniscule jerkwader as a way of bringing money into the local treasury from unsuspecting out-of-area motorists. Radar, once the proud wonder-child of a technological society, has (in the case of radar traps) been turned into a gnarled, ugly, many-handed monster.

Paul C. Petrillo, a professional traffic engineer in charge of the Traffic Engineering and Safety Service of the AAA-affiliated Automobile Club of New York, says, "Most motorists can't help becoming unintentional violators when traveling on highways that have speed limits that do not match road conditions." Arguing that radar traps have little effect on highway safety, Petrillo says that motorists are the best judge of the most safe speed for a given stretch of road.

You're shook up now. You've just been told that there should be no protection against motorists being swallowed up by lunatics in 500-horsepower locomotives doing the Indianapolis bit. Not so!

You'll first have to prove to me that a marked patrol car staffed by a single officer cruising up and down a stretch of road is less effective (and more economical) for road safety than The Man hiding in the bushes like a sneak with a few thousand dollars of complicated electronic gear, radioing ahead to *another* officer with instructions on who to pull over for a ticket.

Whatever became of the motorcycle cop

## RADAR SPEED TRAPS

of old, hiding behind the billboard? He's been replaced by Big Brother, skulking around in the shrubbery with his magical black box!

**What It Is.** The radar used by police is a type known as "Doppler Radar." This radar operates on the principle of relative motion between a source of the radar waves and a reflective surface causing a frequency shift in the reflected wave. The effect is similar to the case of an automobile going past a pedestrian. If the driver blows the horn, the pitch seems higher when the car is approaching than when it is going away.

In the case of speed meters, continuous radiation at a specific frequency is beamed towards oncoming traffic and some is reflected back to the officer operating the gadget. The reflected signal is compared with a sample of the transmitted wave, and the resulting shift in frequency, proportional to the speed of the moving car, is called the *Doppler shift*. At a speed of 100 mph, the Doppler shift is 73 Hz.

Radar speed meters are usually employed in either of several popular ways. The most familiar method is to have the antenna mounted on a tripod by the side of the

road and connected to the radar unit (hidden from the motorist's view) by cable. Sometimes the car is parked on the shoulder of the road with the antenna in the trunk or mounted by the driver's window like a spotlight. The speed indicator is in view of the officer who checks out all oncoming traffic. When a speeder is picked up, the officer can then radio ahead to another car. Sometimes, too, the radar car itself takes off after the errant motorist for the presentation of the driving award, returning to the stake-out spot when the fun is over.

When properly calibrated, radar speed meters are accurate to within 1%. Their weakness is heavy traffic, which causes confused meter readings. Of course, deliberate RF jamming would also do this, but anybody wishing to try that little trick is asking for some additional kicks from the FCC.

**The Evidence.** When you get pulled into court after having been picked up by radar, you have only a slim chance of talking yourself off the hook. Usually, the officers have an inked tape record of your sprint to show to the judge. And even though it's just a squiggly line which doesn't offer any proof that it represents a record of *your* car, a conviction ordinarily follows shortly thereafter.

In Nassau County, N.Y., police recently added a new twist to eliminate any such



*Comfortably seated in radar-trap vehicle, this officer has only to radio ahead to pickup car and ZAPI— instant speeding ticket. Unit immediately above dash is Stephenson Radar Speedanalyzer, which, if we are to believe the luzz, tells the nice man all he needs to know about your speed, remotely.*



Having been warned by road sign that speed is radar-controlled, driver at right keeps ear peeled to radar deflector. Unit in car and in photo at right below is Radatron's Radar Sentry; unit in photo at left below is produced by Solar Electronics.

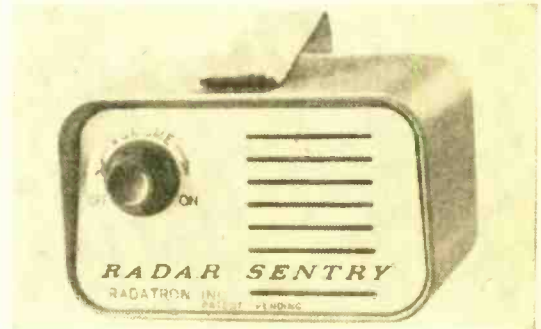

doubts. A Volkswagen bus parked by the side of the road snaps a combination photo of your car along with a meter reading of your speed. Just try laughing your way out of that one!

**Can They Be Jammed?** There is only one legal way of jamming a radar speed meter, but it isn't particularly practical. It requires that you mount a 16-in. speaker on the front of your car, stretch a piece of plastic kitchen wrap tightly across the speaker's face, and glue strips of aluminum foil to the plastic. When a 2000- to 3000-Hz tone is pumped into the speaker it will cause havoc with the meter readings. Assuming you drive a large truck, you might just have room for a setup of this sort. But then large trucks (at least the ones I've driven behind) never seem to get up the moxie to do much better than 30 mph, even with a good tail

wind helping them along.

Other rumored tricks (like placing ball bearings in the hub caps, dragging lengths of chain beneath the car, and placing bundles of tinfoil beneath the grille) are totally useless for jamming.

Of course, the *best* protection against getting radared is not to speed in the first place. But speeding is a very peculiar word without any hard definition. Nobody will argue that roaring through a 30-mile zone at 75 mph isn't speeding—but did you ever notice that you sometimes gain a little extra speed while driving down an incline?

You don't have to make any effort to do this; even if you take your foot off the gas it happens and you end up exceeding the speed limit. Short of riding with your foot on the brake or dropping down into a lower gear you'll pick up 5 to 10 mph within the

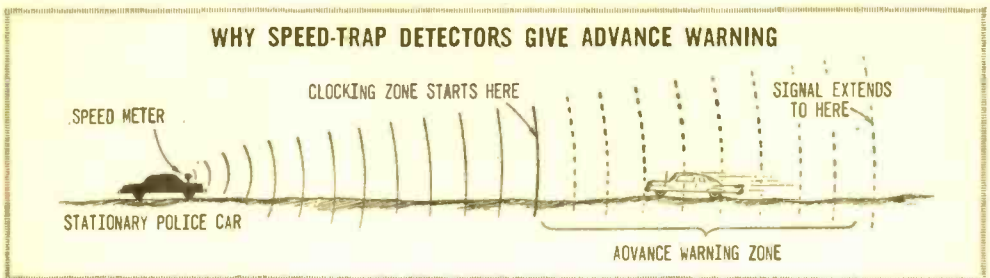

## e/e RADAR SPEED TRAPS

first few hundred feet of even a gentle slope and not even notice the difference. Is that speeding?

As you've probably guessed, such sites are among the more favored locations for radar traps. So, too, are other spots where unsuspecting motorists (especially ones not familiar with the roads) can be expected to accidentally and temporarily speed because of road conditions.

Such favorite places also include spots where the speed limit abruptly drops without adequate notice to drivers; long and gently sloping inclines on a parkway (especially if they terminate in a right-hand curve); and long, relatively straight, stretches of suburban highway where the speed limit seems to be strangely low.

Speed traps are almost always set up in the same spots with little variation. The police know the most effective places to

catch the unwary and there's little point in arguing with success; besides, if they change spots they might face the horror of nabbing a local resident. For instance, a radar stake-out is in place almost daily a mile or two south of Exit 10 in the southbound lane of the New Jersey Turnpike; it seems a total success. In Florida, you can count on one going eastbound from Bithlo and Cocoa on state road 520. Anyone who drives a lot soon learns to spot the most likely road conditions for trap growing.

You also get to know that the mere fact that a community has posted a vast array of radar warning signs does not necessarily assure you that radar is actually in use there. Similarly, the absence of signs doesn't mean that there is no radar in use.

Just as there are roads where radar traps bloom like posies in June, there are times and conditions which will seldom face you with one. Nighttime (except on major Florida highways) generally means radar-free motoring; snow or ice on the roads and heavy snowbanks alongside also spell radar-



Three devices used by police in radar-trap setups: above, radar speed meter installed in glove compartment with automatic chart recorder at right (entire installation would be unnoticed by passing motorist); right, portable radar unit; below, radar antenna on window.

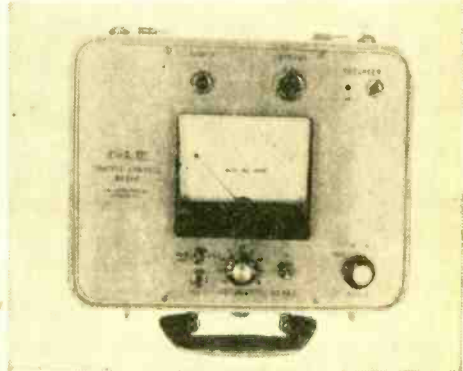



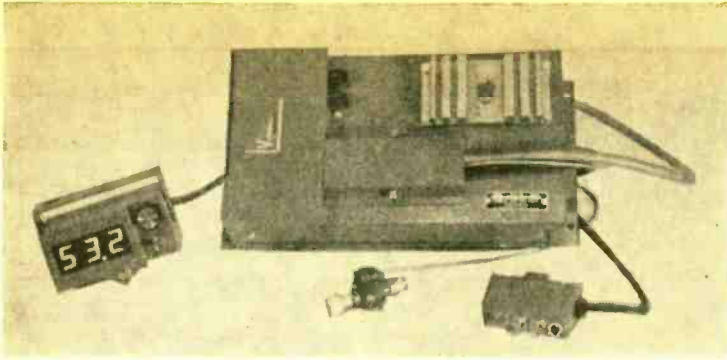

Latest unit to be added to police arsenal of speed-trap devices is the Vascar (Visual Average Speed Computer And Recorder for those who don't dig abbreviations). Already reported in Maine, Indiana, and North Carolina, unit permits fairly accurate speed checks even though both police car and suspect car are in motion.

less driving. Even a heavy rainstorm sends them all back whence they came. Highways without shoulders (like elevated roadways) and crowded city streets with traffic lights at each corner are almost devoid of them.

Don't forget, however, that there are a number of non-radar speed-catching devices which can be used in different applications and instances. These involve black cables stretched across the roadway at 22 feet apart or white stripes painted across the roadway several hundred feet apart. A new gadget known as Vascar enables the police to check your speed while *their* car is in motion (with radar they must be parked) and moving towards or away from you.

**Is There Protection?** The best protection, if you figure that you're a candidate for the microwave beams, is to go Greyhound and leave the driving to them. If you're a zooming maniac who hasn't had a nodding acquaintance with a speed limit in 10 years, you deserve to be removed from the scene, even by something as shady as radar. If you're like most motorists—easy prey to underhanded and rigged setups coldly calculated to catch you off guard under extenuating road conditions—there is *some* hope for defending yourself.

To begin, study the cars parked along any roads in areas of the kind we've been talking about. If they look like typical un-

marked cars (solid white, black, and maroon are popular), be on your guard. Secondly, you can purchase either of two radar detecting devices to warn you of radar traps before they start putting you on the squiggly line.

For the record, there are two different radar frequency bands in use today. The old *S-band* is on 2455 MHz, and the newer *X-Band* is at 10,525 MHz. There are only about 650 units still on the S-band.

The detecting devices are small (about the size of a pack of smokes) and contain batteries, circuitry, and a speaker. You clip them onto your car's sunvisor and aim their antennas down the road ahead of the car. When the set detects a radar signal from a speed trap, the device makes a high-pitched whine which continues until you are out of the radar "zone of influence."

You get an advance warning before you actually hit this clocking zone because the radar signals extend down the road for at least twice as far as they are being used by the trap. If the trap is measuring at 500 feet out, you will get a signal at least 1000 feet out—sufficient time for you to safely slow down the 5 or 10 mph necessary to save you a ticket. Of course, if you're really burning the old rubber, you'll never be able to bring your car safely under control because some X-band traps start clocking at only 150 feet out. To drop 60 to 30 or 40 mph in 150 feet on sudden notice is impossible for most motorists and cars.

**The Units.** Of the two detecting devices now being marketed, the one most often seen is the *Radar Sentry* (sometimes marketed under the name *Driver Alert*), manufactured by Radatron, Inc., 232 Zimmerman St., N. Tonawanda, N.Y. 14120. The unit stands guard on both the S- and X-bands simultaneously; when there are no incoming

*(Continued on page 105)*

**Clocking Ranges  
of Typical Radar Speed Traps**

Band Used	Can Measure (feet)	Can Be Detected At (feet)
S	175	300-500
X	150	300
X	300	600
X	500-600	1000 or more

# There's A Heathkit Gift



NEW kit GT-18  
\$189.95  
(loss ski)



NEW kit GR-58  
\$47.95



NEW kit TA-38  
\$225.00



kit SB-310  
\$249.00

## The HEATHKIT "Boonie-Bike" . . . The All-Season Trail Bike

Introducing the new Heathkit GT-18 Trail Bike . . . it lets you go places other people can't . . . remote backwoods and forest areas . . . rugged mountain regions . . . isolated lakes & streams . . . rough country roads and long forgotten paths . . . even in the snow . . . places inaccessible by usual means. With the GT-18 you no longer have to depend on paved or dirt roads, or even trails. The GT-18 is only 24½" wide — if there's room to walk, you can ride with this one. But don't let the small size give you the wrong impression. The GT-18 is full of surprises. It's larger and huskier than a mini-bike, smaller, lighter and substantially more powerful than a motorcycle-type trail bike . . . and it has the agility, stability, traction and sheer guts of a mountain goat. Here's why: Pre-mounted on the welded ¾" tubular steel frame is the easy-starting Briggs & Stratton 5 horsepower, 4 cycle engine, and it gives the 116 pound GT-18 extraordinary power. Performance? You can't touch it for any price. The tubeless front tire is big by trail bike standards (5.30 x 4.50"), but the tubeless rear tire is nothing short of huge — 18 x 8.50!! And that's what's behind the amazing all-surface performance . . . that 8½" tread coupled with the two speed shift and 5 horse engine will power you thru mud, sand, snow, gravel, tall weeds and rough underbrush . . . up steep hills & rocky paths that would put other bikes totally out of it. And when the going gets snowy, just snap on the optional ski accessory (GTA-18-1 at \$16.95). Heath's unique "grip-lock" mounting eliminates any need for tools too!

And stopping is easy and safe with the big hand-operated Bendix drum type rear brake. Loaded with other features too . . . welded steel skid pan, spring shock front suspension . . . big, comfortable seat . . . safety spring-loaded throttle . . . 400 pound load capacity and much more. The Heathkit All Season Trail Bike is so much fun you'll be looking for reasons to ride it. It's the only way to go when the going gets rough. Order yours today. 125 lbs.

## HEATHKIT GR-58 Solid-State AM/FM Clock Radio

The easy way to get up in the morning. Choose the morning news & weather on AM or the bright sound of FM music. AFC makes FM tuning easy. The "Auto" position on the Telechron® clock turns only the radio on, or use the "Alarm" setting for both the radio and the alarm. You can even enjoy fresh coffee when you awake in the morning, thanks to the clock-controlled accessory AC socket on the back of the new GR-58. The handy "snooze" alarm feature lets you wake up gradually for ten minutes to the sound of the radio, then the alarm goes on . . . push the "snooze" button to silence the alarm for ten minutes more of music or news — the alarm sounds automatically every ten minutes and the "snooze" button turns it off, cycling continuously until the selector switch is moved to another position. Fast, easy circuit board construction, smart blue hi-impact plastic cabinet and top reliability make this GR-58 the clock radio for you. 8 lbs.

## HEATHKIT TA-38 Solid-State Bass Amplifier

The new Heathkit TA-38 is the hottest performing bass amp on the market, for quite a few reasons. First, there's all solid-state circuitry for reliability. Then there's the tremendous power — the TA-38 puts out 120 watts of EIA music power, 240 watts peak, or 100 watts continuous. Extremely low harmonic & IM distortion too. Many amps suffer from "blow-out" problems, but not the new TA-38 — *YOU CAN'T BLOW IT* . . . it boasts two 12" heavy duty special design speakers with giant 3 pound 6 ounce magnet assemblies mounted in a completely sealed, heavily damped ¾" pressed wood cabinet — those speakers will take every watt the amp will put out, and still not blow. Sound? The TA-38 is tailored to reproduce the full range of bass frequencies delivered by bass guitars and its sound with combo organs and other instruments is remarkable. Easy 15 hour assembly to the wildest bass amp on the market. Order one now and surprise the guys with the high-priced gear. 130 lbs.

## HEATHKIT SB-310 Professional SW Receiver

The finest shortwave receiver you can buy. Covers six shortwave broadcast bands (49, 41, 31, 25, 19 & 16 meters), 80, 40 & 20 meter amateur bands and 11 meter CB. And the new optional SBA-310-3 kit converts the 11 meter band to 15 meters for additional amateur coverage. Has many of the same features that have made Heathkit amateur gear the world's best selling . . . pre-built & pre-aligned Linear Master Oscillator . . . crystal-controlled "front end" for same-rate tuning on all bands . . . linear tuning with 1 kHz dial calibrations . . . separate RF and AF gain controls . . . 5 kHz crystal filter included for clear AM, CW & SSB reception . . . switch-selected upper and lower sideband coverage . . . built-in 100 kHz calibrator . . . headphone jack . . . calibrated "S" meter . . . famous Heathkit SB-Series styling and much more. For the finest shortwave listening, order your SB-310 today. 24 lbs. SBA-310-3, 15 Meter Conversion Kit, 1 lb., \$9.95.



# Idea For Every Budget

## HEATHKIT AD-27 FM Stereo Compact

The new Heathkit "27" Component Compact was designed to change your mind about stereo compact performance. How? By sounding as if it were made of top quality stereo components . . . which in fact it is. Heath engineers took their highly rated AR-14 solid-state Stereo Receiver, modified it physically to fit the cabinet, and matched it with the precision BSR McDonald 500A Automatic Turntable. Performance? Here's the AD-27 in detail. The amplifier delivers 30 watts music power . . . 15 honest watts per channel — enough to drive any reasonably efficient speaker system. Response is virtually flat from 12 Hz to 60 kHz, and Harmonic & IM distortion are both less than 1% at full output. Tandem Volume, Balance, Bass & Treble controls give you full range command of all the sound. Select the FM stereo mode with a flick of the rocker-type switch and tune smoothly across the dial, thanks to inertia flywheel tuning. You'll hear stations you didn't know existed in your area, and the clarity and separation of the sound will amaze you. The adjustable phasing control insures best stereo separation at all times. And the automatic stereo indicator light tells you if the program is in stereo. AFC puts an end to drift too. The BSR Automatic Turntable has features normally found only in very expensive units, like cueing and pause control, variable anti-skating device, stylus pressure adjustment and automatic system power too. Comes complete with a famous Shure diamond stylus magnetic cartridge. The handsome walnut cabinet with sliding tambour door will look sharp in any surroundings, and the AD-27 performs as well as it looks. For the finest stereo compact you can buy, order your "27" Component Compact now. 41 lbs.



NEW  
kit AD-27  
\$169<sup>95</sup>



NEW  
kit AD-17  
\$109<sup>95</sup>

## HEATHKIT AD-17 Stereo Compact

Using the component approach of the AD-27, Heath engineers took the solid-state stereo amplifier section of the AD-27, matched it with the high quality BSR-400 Automatic Turntable and put both of these fine components in a handsomely styled walnut finish cabinet. The result is the "17" — featuring 30 watts music power, 12 Hz to 60 kHz response, auxiliary & tuner inputs, less than 1% Harmonic & IM distortion, adjustable stylus pressure & anti-skate control and much more. Order your "17" now. 27 lbs.

## HEATHKIT AS-18 Miniature Speaker System

Miniature in size, but not in performance. This new Heathkit acoustic suspension system features two Electro-Voice® speakers . . . a 6" woofer and a 2 1/4" tweeter for 60 Hz to 20 kHz response. Handles 25 watts of program material. Adjustable high frequency balance control lets you adjust the sound to what you like. The 8 1/4" H x 15 1/4" W x 6 1/4" D walnut cabinet is protected by clear vinyl for lasting good looks. Pick a pair of these performers for stereo compacts. 16 lbs.



NEW kit AS-18  
\$32<sup>95</sup>



NEW kit GR-17  
\$43<sup>95</sup>

## HEATHKIT MI-18 Solid-State Tachometer

The new Heathkit MI-18 has advanced performance features like unique inductive pickup for connection to any spark-type engine and any ignition system, 0-6000 & 0-9000 RPM ranges, temperature compensated ±4% accuracy, stainless steel hardware, splashproof black & chrome case. Pick the MI-18-1 for panel mounting, or the MI-18-2 with case and hardware. Send for yours now. 4 lbs.

NEW kit MI-18  
\$29<sup>95</sup>  
(panel mount)

\$32<sup>95</sup>  
(case mount)

## HEATHKIT GR-17 Solid-State AM-FM Portable

Everything you want in an AM/FM portable: The all solid-state circuit delivers clear, stable AM from distances the mini-portables can't match, and the FM section, with its 34' whip antenna, three IF stages and 5 uV sensitivity performs like a high priced table model receiver. AFC for drift-free listening and easy tuning too. All critical circuits preassembled and pre-aligned, and the circuit board assembly makes construction even easier. For the greatest sound around, get your GR-17 today. 5 lbs.



## HEATHKIT GD-325C Low Cost Solid-State Organ

Put the sound of live music in your home now with this low cost, all solid-state Heathkit/Thomas Organ. It features all genuine Thomas factory-fabricated parts and 5-year warranty on the plug-in tone generators. Ten true organ voices . . . variable repeat percussion . . . 13 note heel and toe bass pedals for C1 to C2 range . . . two overhanging 37-note keyboards, range C2 thru C5 each . . . Color-Glo keylights . . . 75 watt peak music power amplifier . . . 12" speaker . . . vibrato . . . manual balance control. Thousands of people have already experienced the thrill and unique personal satisfaction of building this sophisticated, beautiful sounding musical instrument, and you can too. It takes no special skills or knowledge — the famous Heathkit manual with its easy to follow instructions and giant fold-out pictorials make the 50 hour assembly enjoyably simple. Comes with finished walnut cabinet and bench plus 40-lesson self-teacher course. Put the sound of music in your home this Christmas with the GD-325C from Heathkit. 172 lbs.

kit GD-325C  
\$439<sup>95</sup>



# Heathkit® Christmas Gifts

Now There Are 4 Heathkit Color TV's...  
All With 2-Year Picture Tube Warranty

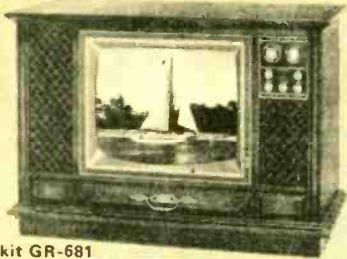

kit GR-681



kit GR-295



kit GR-227



kit GR-180

New Wireless  
TV Remote Control  
For GR-295, GR-227  
& GR-180

**\$69<sup>95</sup>**

New Wireless  
TV Remote Control  
For GR-681

**\$59<sup>95</sup>**



Wish Your Family Merry Christmas This Year  
With A New Heathkit Color TV... A Better  
Buy Than Ever With New Lower Prices

New GR-681 Deluxe Color TV <sup>kit GR-681</sup>  
With Automatic Fine Tuning **\$499<sup>95</sup>**  
(less cabinet)

The new Heathkit GR-681 is the most advanced color TV on the market. A strong claim, but easy to prove. Compare the "681" against every other TV — there isn't one available for any price that has all these features. Automatic Fine Tuning on all 83 channels... just push a button and the best color picture in the industry. Push another front-panel button and the VHF channel selector rotates until you reach the desired station, automatically. Built-in cable-type remote control that allows you to turn the "681" on and off and change VHF channels without moving from your chair. Or add the optional GRA-681-6 Wireless Remote Control described below. A bridge-type low voltage power supply for superior regulation; high & low AC taps are provided to insure that the picture transmitted exactly fits the "681" screen. Automatic degaussing. 2-speed transistor UHF tuner. hi-fi sound output, two VHF antenna inputs... plus the built-in self-servicing aids that are standard on all Heathkit color TV's but can't be bought on any other set for any price... plus all the features of the famous "295" below. Compare the "681" against the others.

GRA-295-4, Mediterranean cabinet shown... **\$119.50**  
Other cabinets from \$62.95

now only

Deluxe "295" Color TV... Model GR-295 **\$449<sup>95</sup>**  
(less cabinet)

Big, Bold, Beautiful... and packed with features. Top quality American brand color tube with 295 sq. in. viewing area... new improved phosphors and low voltage supply with boosted B+ for brighter, livelier color... automatic degaussing... exclusive Heath Magna-Shield... Automatic Color Control & Automatic Gain Control for color purity, and flutter-free pictures under all conditions... preassembled IF strip with 3 stages instead of the usual two... deluxe VHF tuner with "memory" fine tuning... three-way installation — wall, custom or any of the beautiful Heath factory assembled cabinets. Add to that the unique Heathkit self-servicing features like the built-in dot generator and full color photos in the comprehensive manual that let you set-up, converge and maintain the best color picture at all times, and can save you up to \$200 over life of set in service calls.

GRA-295-1, Walnut cabinet shown... **\$62.95**  
Other cabinets from \$99.95

now only

Deluxe "227" Color TV... Model GR-227 **\$399<sup>95</sup>**  
(less cabinet)

Has same high performance features and built-in servicing facilities as the GR-295, except for 227 sq. inch viewing area. The vertical swing-out chassis makes for fast, easy servicing and installation. The dynamic convergence control board can be placed so that it is easily accessible anytime you wish to "touch-up" the picture.

GRA-227-1, Walnut cabinet shown... **\$59.95**  
Mediterranean style also available at \$99.50

now only

Deluxe "180" Color TV... Model GR-180 **\$349<sup>95</sup>**  
(less cabinet)

Same high performance features and exclusive self-servicing facilities as the GR-295 except for 180 sq. inch viewing area. Feature for feature the Heathkit "180" is your best buy in deluxe color TV viewing... tubes alone list for over \$245. For extra savings, extra beauty and convenience, add the table model cabinet and mobile cart.

GRS-180-5, table model cabinet and cart... **\$39.95**  
Other cabinets from \$24.95

now only

Now, Wireless Remote Control For Heathkit Color TV's

Control your Heathkit Color TV from your easy chair, turn it on and off, change VHF channels, volume, color and tint, all by sonic remote control. No cables cluttering the room... the handheld transmitter is all electronic, powered by a small 9 v. battery, housed in a small, smartly styled beige plastic case. The receiver contains an integrated circuit and a meter for adjustment ease. Installation is easy even in older Heathkit color TV's thanks to circuit board-wiring harness construction. For greater TV enjoyment, order yours now.

kit GRA-681-6, 7 lbs., for Heathkit GR-681 Color TV's... **\$59.95**  
kit GRA-295-6, 9 lbs., for Heathkit GR-295 and GR-25 Color TV's **\$69.59**  
kit GRA-227-6, 9 lbs., for Heathkit GR-227 and GR-180 Color TV's **\$69.95**



# Keep On Giving

## HEATHKIT AR-15 Deluxe Solid-State Receiver

The Heathkit AR-15 has been highly praised by every leading audio and electronics magazine, every major testing organization and thousands of owners as THE stereo receiver. Here's why. The powerful solid-state circuit delivers 150 watts of music power, 75 watts per channel, at  $\pm 1$  dB, 8 Hz to 40 kHz response. Harmonic & IM distortion are both less than 0.5% at full rated output. The world's most sensitive FM tuner includes these advanced design features . . . Cascade 2-stage FET RF amplifier and an FET mixer for high overload capability, excellent cross modulation and image rejection . . . Sensitivity of 1.8  $\mu$ V or better . . . Harmonic & IM distortion both less than 0.5% . . . Crystal Filters in the IF section give a selectivity of 70 dB under the most adverse conditions. Adjustable Phase Control for maximum separation . . . elaborate noise operated squelch . . . stereo only switch . . . stereo indicator light . . . two front panel stereo headphone jacks . . . front panel input level controls, and much more. Easy circuit board construction. For the finest stereo receiver you can buy anywhere, order your AR-15 now. 34 lbs. Optional walnut cabinet, AE-16. 10 lbs. . . \$24.95

## HEATHKIT AJ-15 Deluxe Stereo FM Tuner

The remarkable solid-state FM stereo tuner section from the famous Heathkit AR-15. If you already own a fine stereo amplifier, the AJ-15 is the stereo FM tuner for you. It has the exclusive design Heathkit FET FM tuner with two FET RF amplifiers and an FET mixer for 1.8  $\mu$ V sensitivity and excellent cross modulation. The tuner section is completely factory assembled and aligned for easier construction too. Other features include the exclusive Heathkit Crystal filters in the IF section for perfect bandpass shape, noise-operated squelch, stereo threshold control, "Black Magic" panel lights and more. Put the world's best FM stereo tuner in your system now . . . the AJ-15. 18 lbs. Optional walnut cabinet AE-18, 8 lbs. . . \$19.95

## HEATHKIT AA-15 Deluxe Stereo Amplifier

The powerful solid-state amplifier section from the famous Heathkit AR-15. If you already have a fine stereo tuner, the AA-15 is the perfect mate for it. It features 150 watts of music power — 75 watts per channel . . . virtually flat response from 8 Hz to 40 kHz . . . less than 0.5% Harmonic & IM distortion at full output . . . individual input level controls . . . two front panel stereo headphone jacks . . . a tone-flat switch that bypasses the wide-range tone controls . . . loudness switch . . . positive circuit protection that makes the power amplifier circuits virtually short-circuit proof and "Black Magic" panel lighting. Put the world's best stereo amplifier in your system now . . . the AA-15. 28 lbs. Optional walnut cabinet, AE-18, 8 lbs. . . \$19.95

## HEATHKIT AS-48 High Efficiency System

Our Finest Heathkit System . . . the new AS-48 with famous JBL<sup>®</sup> speakers. The specially constructed 14" woofer employs a 4" voice coil, 11 1/2 pounds of magnet assembly and an inert, self-damping material to deliver clear, full-bodied bass down to 40 Hz. Crisp, open highs, up to 20 kHz come from the 2" direct radiator. LC-type crossover. The three position HF level control gives balance as you like it. All components are front mounted in the beautiful one-piece assembled pecan finish cabinet for easy construction. For very high performance stereo, order two of these amazing bookshelf systems today. 43 lbs.

## HEATHKIT AS-38 Bookshelf System

The New Heathkit AS-38 is a medium priced system featuring JBL<sup>®</sup> speakers that's small enough to be used in apartments, yet delivers sound that qualifies it for use with the best of components. The 12" woofer and 2" tweeter produce clean, natural response from 45 Hz to 20 kHz and the variable high frequency level control lets you adjust the sound to your liking. For easier assembly and a more solid sound, all components mount from the front of the assembled walnut cabinet. Build in an evening, enjoy rich, complete sound for years. Order two for stereo. 38 lbs.



kit AR-15  
\$339.95  
(less cabinet)

Wired ARW-15  
\$525.00  
(less cabinet)

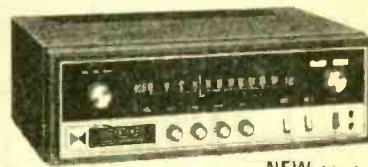

NEW kit AJ-15  
\$189.95  
(less cabinet)



NEW kit AA-15  
\$169.95  
(less cabinet)



NEW kit AS-48  
\$169.95

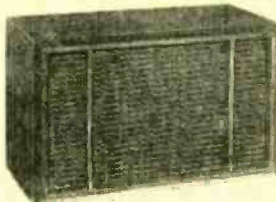

NEW kit AS-38  
\$144.95



**NEW**  
**FREE 1969 CATALOG!**  
Now with more kits, more color. Fully describes these along with over 300 kits for stereo/hi-fi, color TV, electronic organs, electric guitar & amplifier, amateur radio, marine, educational, CB, home & hobby. Mail coupon or write Heath Company, Benton Harbor, Michigan 49022.

HEATH COMPANY, Dept. 139-1  
Benton Harbor, Michigan 49022  
In Canada, Daystrom Ltd.

Enclosed is \$ \_\_\_\_\_, plus shipping.

Please send model (s)

Please send FREE Heathkit Catalog.

Please send Credit Application.

Name \_\_\_\_\_

Address \_\_\_\_\_

City \_\_\_\_\_

State \_\_\_\_\_

Zip \_\_\_\_\_

Prices & specifications subject to change without notice.

CL-346

# THE BIG CB PUTT-ON

**W**alter Hagen, golf titan of the 20s, was first to admit that everything about tournament golf has changed since the days when he caddied at Oak Hill Country Club in Rochester, N.Y. (Hagen, for the record, is one of 37 members of the Professional Golfers' Association, an honor even the most snobby would be reluctant to snivel at.)

Everyone expected new faces among the top finishers at this great tournament course, where gifted young Lee Trevino of Texas defeated defending champion Jack Nicklaus. But the method used by the Rochester Holst Club to control crowds at the Oak Hill Country Club was *not* expected.

Archie C. Clarke, Chairman of the Communications Committee, was the Rochester member assigned responsibility for providing communications for gallery management and security control. Through cooperation of the E. F. Johnson Co. of Waseca, Minn., he was able to set up a complete two-way radio network among the 18 marshals controlling the crowds at each green. Each was equipped with a Johnson Messenger 100 portable CB transceiver; the Club House sported a Messenger III base station.

Thanks to this unusual use of CB, play was speeded up and crowd control maintained throughout the four days.—*Joe Gronk* ■



*Unseen by participants and fans, 18 marshals quietly and efficiently maintained crowd control during recent '68 U.S. Open Golf Championship held at Oak Hill Country Club in Rochester, N.Y.*



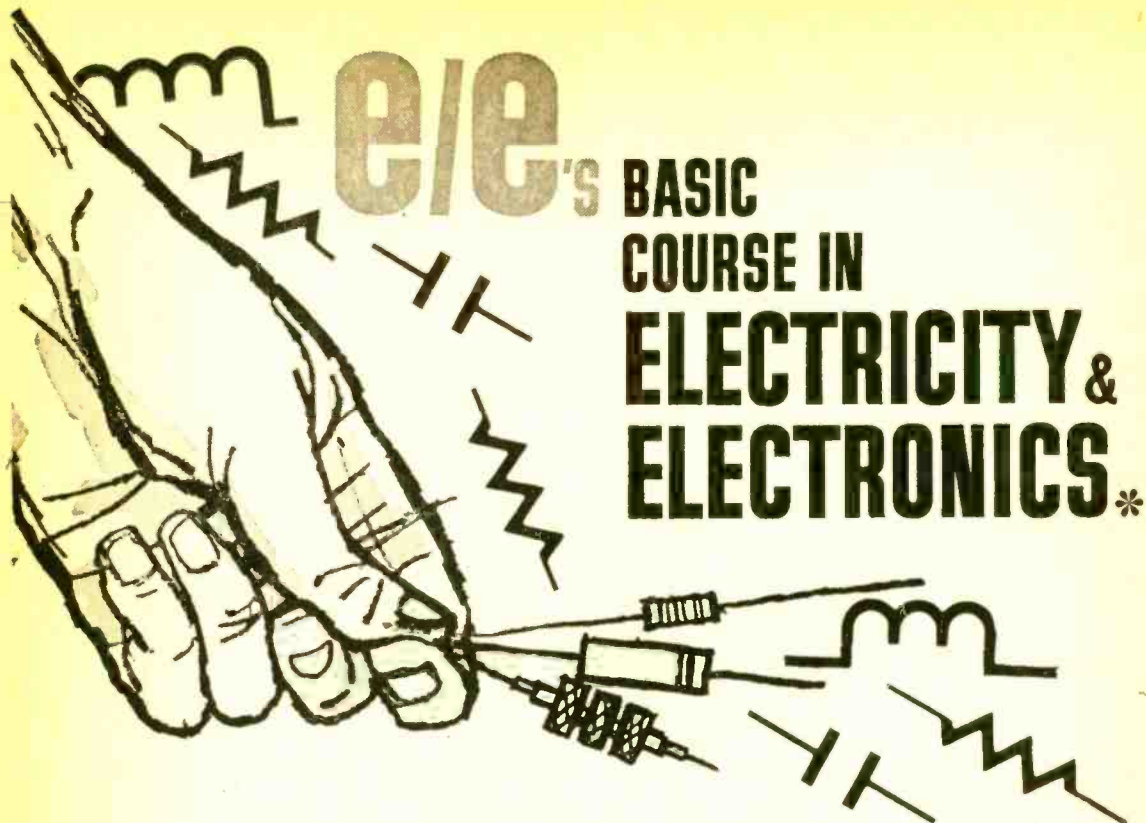

## PART VI—UNDERSTANDING BASIC CIRCUIT ACTIONS

**W**HAT YOU WILL LEARN. It is important that you learn what an electrical or electronic circuit is. You will now learn to recognize the basic elements every circuit must have. When you complete this chapter you will be able to examine a circuit and determine how it works. In addition, you will learn the simple fundamentals used to determine how any electric and electronic circuit works.

### ELECTRICITY AND ELECTRONICS

You will read or hear many definitions for electricity and electronics which will seem to establish a difference between the two terms. Are they really different? The truth is, electricity and electronics are far more similar than they are different.

#### Electrical Circuits

In an electrical circuit, current from a voltage source flows through conductors to an electrical device. *(turn page)*

\* This series is based on *Basic Electricity/Electronics*, Vol. 1, published by Howard W. Sams & Co., Inc.

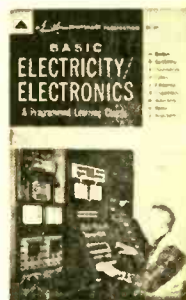

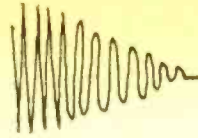
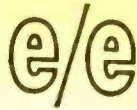
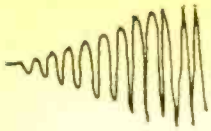

In passing through the device, current causes it to operate—a lamp lights, a motor rotates, a doorbell rings, an oven heats, etc. The electrical device, whatever it may be, must be part of a circuit connected to a voltage source. Compare this to an electronic circuit.

### Electronic Circuits

In an electronic circuit, current from a voltage source flows through conductors and electronic components to perform a desired electronic function. For example, radio and television receivers contain many electronic circuits. In a radio, the functions of each circuit are such that the set reproduces a sound transmitted by a broadcast station many miles away. Circuits in a television set function in a similar manner and make it possible for you to see as well as hear a broadcast.

### Basic Fundamentals

A radio or television set is plugged into the same voltage source as a lamp, motor, refrigerator, or any other electrical device. Current and voltage make no distinction between an electrical or electronic circuit. They react the same in either. The components that have been built into the circuit(s) determine how current and voltage will be used to make the electrical or electronic device operate.

The following diagram expresses this concept by showing the relationship of the three elements contained in any circuit. If you accept the concept this illustration reveals and always remember it, you will have no difficulty in learning the electrical or electronic theory required to become a good technician.

What does the illustration say? It states that any circuit contains only three factors—voltage, current, and circuit parts—which influence the circuit's operation.

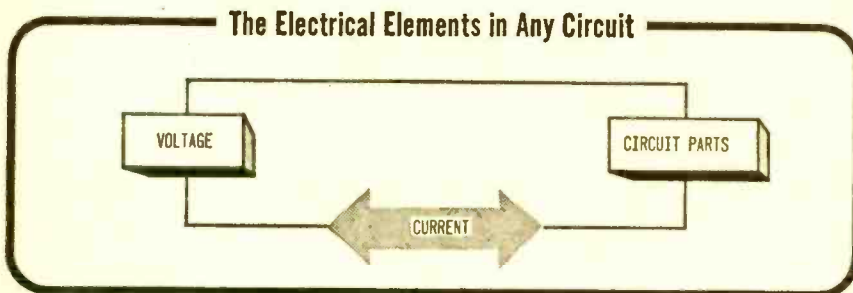

Voltage, as you know, is an electrical pressure that causes current to flow under proper conditions. Current flows if there is a closed loop (complete path) from one side of the voltage source through the circuit components to the other side. The amount and type of voltage to be applied and how much current



will flow is dependent on the type and value of components used in the circuit. As an example, you have seen circuits similar to those shown in the schematic diagrams below.

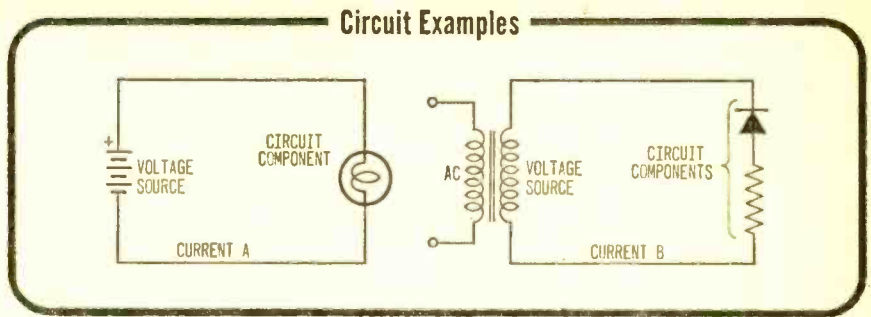

- Q1. What is the voltage source in part A above? In part B?
- Q2. What is the circuit component in part A? What are they in part B?
- Q3. Which way will current flow (clockwise or counterclockwise) in parts A and B?
- Q4. Which part (A or B) contains a circuit that is a closed loop?

**Your Answers Should Be:**

- A1. The voltage source in part A is a *battery* and in part B it is a *transformer*. (You may have stated AC or electrical outlet for part B. However, you must get into the habit of looking at the voltage that is applied across a specific circuit shown in a diagram. The left side of the transformer may be plugged into a 117-VAC outlet, but it is in another circuit consisting of the primary winding and the outlet. The circuit shown contains the voltage source and the circuit component. Remember to look for the specific voltage that is applied to an individual circuit.)
- A2. The component in part A is a *lamp*. In part B the components are a *diode* (upper) and *resistor* (lower).
- A3. Current will flow *counterclockwise* in part A and *clockwise* in part B.

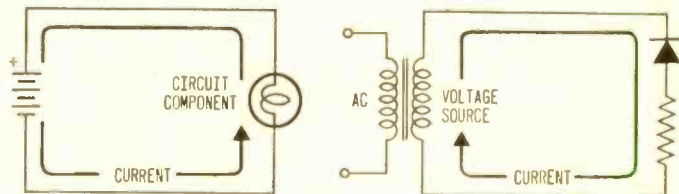

- A4. *Both circuits are closed loops.*

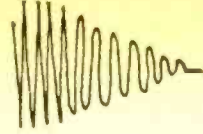
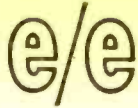
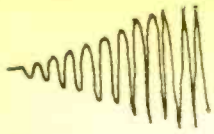

You were not expected to give as long an answer as those shown above. If you arrived at the specific answers correctly, you have shown that you remember and can apply the information studied in other chapters of this course.

The questions and explanations were included to underline a significant point—whatever happens in any circuit depends on the effect circuit components have on its voltage and current. This may sound like a very simple, easily understood statement. but those who do not study circuits with this simplicity in mind will find them difficult. Those who approach every circuit and resolve its complexities in terms of this simple, always reliable statement will have no trouble whatsoever.

### ANALYZING ELECTRONIC CIRCUITS

Using the approach stated in the preceding paragraph, see if you can follow the analysis of a basic amplifier circuit. The circuit is similar to one of those used in preceding chapters.

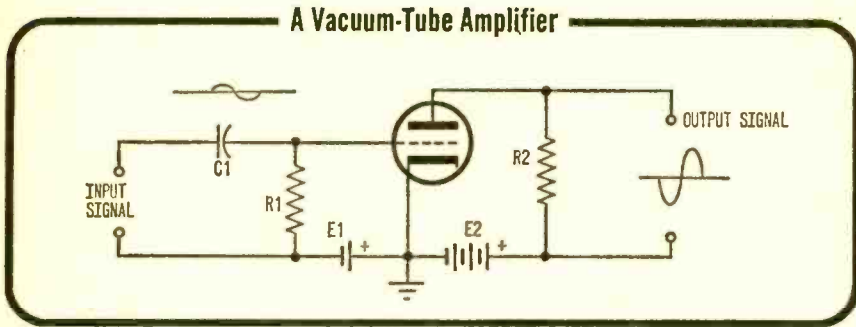

#### Circuit Function

This circuit uses a vacuum tube. The function of the circuit is to amplify (increase) the voltage of the input signal, as shown in the difference between the input and output waveforms. Disregarding the input and output signals for a moment, you can find two voltage sources in this circuit—there are two battery symbols. The actual circuit will probably not have batteries; the symbols merely show that there is a DC voltage source across the points indicated.

- Q5. The three basic factors of any circuit are \_\_\_\_\_, \_\_\_\_\_, and \_\_\_\_\_.
- Q6. The best method to use in analyzing any circuit is to determine the effect that circuit components have upon applied \_\_\_\_\_ and \_\_\_\_\_.
- Q7. Redraw the vacuum-tube amplifier circuit and show the



path and direction of current through the closed loop that includes E2.

- Q8. The three active elements in the vacuum tube above are -----, -----, and -----.
- Q9. The purpose of the circuit is to ----- the input signal.
- Q10. The two battery symbols are used to indicate -- ----- is being applied.

**Your Answers Should Be:**

- A5. The three basic elements of any circuit are *voltage*, *current*, and *components*.
- A6. The best method to use in analyzing any circuit is to determine the effect that circuit components have upon applied *voltage* and *current*.
- A7.

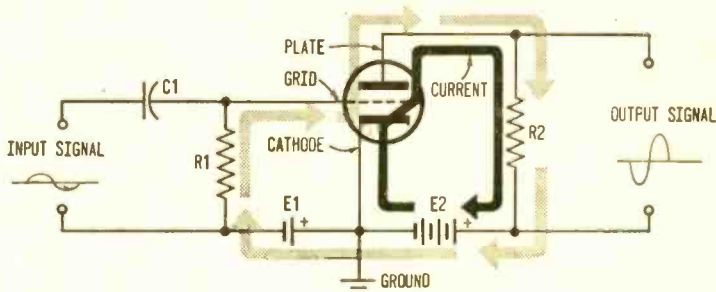

You had two choices for the current path. They are represented as solid and shaded lines above. Although the solid line is correct, do not feel bad if you chose the other.

- A8. The three active elements in the vacuum tube are *control grid*, *cathode*, and *plate*.
- A9. The purpose of the circuit is to *amplify* the input signal.
- A10. The two battery symbols are used to indicate *DC voltage* is being applied.

**Control by the Grid**

Current (the solid line in the preceding diagram) flows through the vacuum tube (a triode) if its plate is positive with respect to its cathode. This is the purpose of E2. The amount of current that flows can be controlled by the voltage on the control grid with respect to the cathode. In fact, a small change in grid-to-cathode voltage causes a large change in plate current.

The grid-to-cathode voltage is negative and, if sufficiently high, will stop current flow altogether. As this voltage is made less negative, more and more current will flow.

The input to the triode amplifier circuit has the same shape as an AC-voltage waveform. It appears on the grid as a voltage also. Capacitor C1 and resistor R1 play a part in placing this signal voltage on the grid. The line through

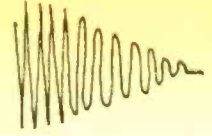
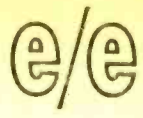
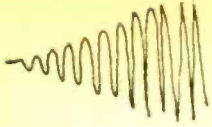

the center of the input waveform is called a *reference line*. (Voltage must always be thought of as being with reference to, or with respect to, some other point in the circuit.) In this case the reference line refers to the DC grid voltage (bias). The part of the waveform that is above the line is positive voltage, and the part below the line is negative. Since it is AC, the voltage of the signal is regularly changing from positive to negative.

The purpose of E1 is to establish a uniform negative voltage between the grid and cathode. This makes the grid negative with respect to the cathode. In this circuit, current will not flow from the grid to the cathode. The changing voltage of the AC waveform is also on the grid, subtracting from or adding to the voltage of E1. When the signal voltage is going positive, it subtracts from the voltage of E1. For example if E1 were -1.5 volts (negative from grid to cathode) and the signal were +0.5 volt at a given instant, voltage on the grid would be reduced to -1 volt (the grid still negative with respect to the cathode).

- Q11. The control grid is (negative, positive) with respect to the cathode.
- Q12. What will be the voltage on the grid when the signal voltage is -0.5 volt?
- Q13. E2 makes the plate ----- with respect to the cathode.
- Q14. The amount of plate current that flows is controlled by the ----- on the -----.
- Q15. In a triode amplifier, a small change in grid voltage causes a (small, large) change in plate current.
- Q16. The purpose of E1 is to make the ---- negative with respect to the -----.

**Your Answers Should Be:**

- A11. The control grid is *negative* with respect to the cathode.
- A12. *2 volts*.
- A13. E2 makes the plate *positive* with respect to the cathode.
- A14. The amount of plate current that flows is controlled by the *voltage on the control grid*.
- A15. In a triode amplifier, a small change in grid voltage causes a *large* change in plate current.
- A16. The purpose of E1 is to make the *grid (control grid) negative* with respect to the *cathode*.

**Change in Plate Voltage**

As you can see, the voltage on the grid changes in accordance with the



## Amplifying a Signal

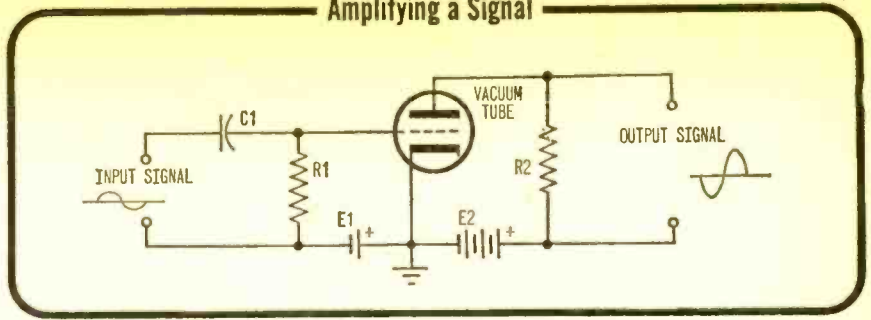

changing voltage of the signal. Current through the tube changes in a like manner—it increases when the signal rises in the positive direction. This is because the negative repelling voltage of the grid is being decreased. When the signal increases in the negative direction, it adds to the negative voltage on the grid, causing plate current to decrease.

The changing current of the tube passes through R2 on its return to voltage source E2, causing the voltage across R2 to change in the same manner as the changes of the signal voltage. Since a small change in grid voltage causes a large change in tube current, the changes in output voltage across R2 are greater than the corresponding input changes on the grid. Thus, the signal has been *amplified*.

### Circuit Analysis Summary

The entire explanation or understanding of this vacuum-tube amplifier circuit is based on the effect the circuit components have on current and/or voltage. This is true of any circuit. You should have had very little difficulty in following the explanation even with limited knowledge of electricity. The reason, of course, is that everything was explained in terms of changes in voltage or current with respect to the components of the circuit. The effect that vacuum tubes, resistors, capacitors, and even voltage sources have on a signal moving through a circuit requires a great deal of careful explanation. If you will remember to always relate the detailed descriptions to the effect they have on voltage and current changes, you will have no trouble.

- Q17.** In a triode amplifier, the (negative, positive) terminal of a DC voltage source is applied to the control grid.
- Q18.** The (input, output) signal causes grid voltage to vary.
- Q19.** Grid voltage regulates the amount of plate current by (attracting, repelling) electrons in the tube.
- Q20.** The circuit which is shown above is called a(an) \_\_\_\_\_ because it increases the voltage of the input signal.
- Q21.** The plate of the tube is kept at a (higher, lower) (negative, positive) voltage than the cathode.
- Q22.** The circuit amplifies the input signal because (small, large) changes in grid voltage cause (small, large) changes in plate current.

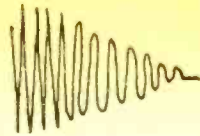
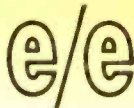
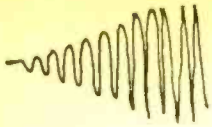

Q23. The changes in plate current cause (small, large) changes in plate voltage.

**Your Answers Should Be:**

- A17. In a triode amplifier, the *negative* terminal of a DC voltage source is applied to the control grid.
- A18. The *input* signal causes grid voltage to vary.
- A19. Grid voltage regulates the amount of plate current by *repelling* electrons in the tube.
- A20. The circuit is called an *amplifier* because it increases the voltage of the input signal.
- A21. The plate of the tube is kept at a *higher positive* voltage than the cathode.
- A22. The circuit amplifies the input signal because *small* changes in grid voltage cause *large* changes in plate current.
- A23. The changes in plate current cause *large* changes in plate voltage.

### CIRCUIT COMPONENTS

How many different circuit components are there? If this question is worrying you, you are worrying needlessly. There are only three major components (parts).

#### The Major Parts of Any Circuit



#### Resistors, Capacitors, and Coils

All circuits, regardless of their complexity, contain at the most only three different kinds of parts—*resistors*, *capacitors*, and *coils* (often called *inductors*).

The effect that a resistor has on current or voltage is measured in terms of its *resistance*, a term with which you are already familiar. The effect of a capacitor is measured in *capacitance*. The effect of a coil is called *inductance*. The effect each has on voltage or current depends on whether it is DC or AC, and, if AC, how rapidly the voltage or current is changing. But each effect—resistance, capacitance, or inductance—is based on a few easily learned principles.



## Circuit Applications

The illustration below shows that an input signal is converted to that shown at the output because of the effect of circuit resistance, capacitance, and inductance on the signal as it passes through the circuit. By this manner, the operation of any circuit can be explained. The *ground* symbol shown in the illustration is normally used as a reference point for zero voltage.

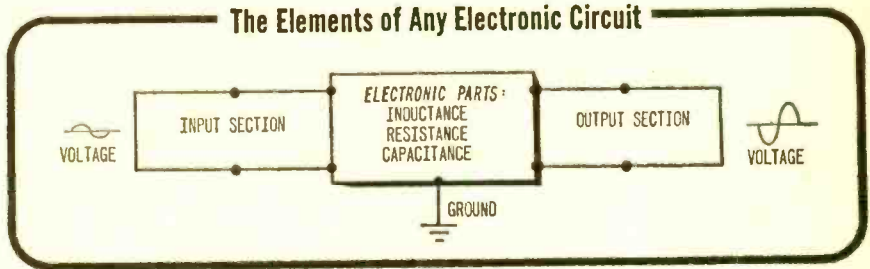

You might think that the symbol for a vacuum tube or transistor does not look like an inductance, capacitance, or resistance. You are correct. However, the way a vacuum tube or a transistor operates can be explained by how it reacts in terms of resistance, inductance, or capacitance when current is passing through it or when voltage is applied to it.

- Q24. The three different electrical factors in a circuit are \_\_\_\_\_, \_\_\_\_\_, and circuit components.
- Q25. The three different types of circuit components are \_\_\_\_\_, \_\_\_\_\_, and coils.
- Q26. Operation of a vacuum tube can be explained in terms of \_\_\_\_\_, \_\_\_\_\_, and \_\_\_\_\_.

### Your Answers Should Be:

- A24. The three different electrical elements in a circuit are *voltage*, *current*, and *circuit components*.
- A25. The three different types of circuit components are *resistors*, *capacitors*, and coils.
- A26. Operation of a vacuum tube can be explained in terms of *resistance*, *capacitance*, and *inductance*.

## CHANGING VOLTAGE AND CURRENT

Circuits in electronic equipment are designed to obtain the performance desired of the equipment. A signal entering the first circuit is converted into an output signal that becomes the input to the next circuit where it is converted again. The input-conversion-output sequence continues through all the circuits

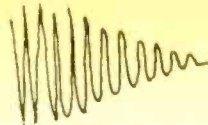
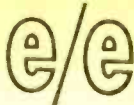
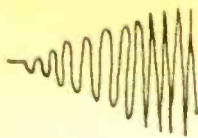

until a waveform is obtained that will cause proper operation of the output device.

### Voltage and Current Waveforms

Since the exchange between circuits is accomplished by voltage and/or current, a means of describing a waveform (signal) becomes very important. Like any other object, a waveform has dimensions. A sheet of paper, for example, is so many inches wide by so many inches long. A waveform has height and width dimensions also, but different units are used to describe them.

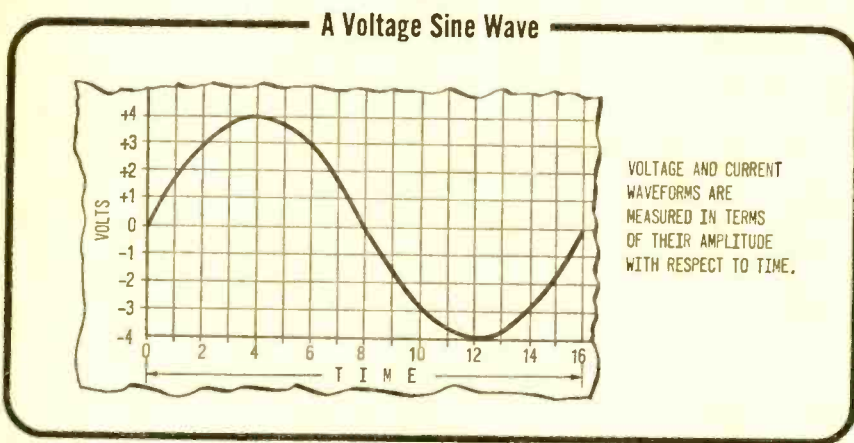

The illustration shows a single cycle of a voltage waveform. The AC *sine wave*, as this particular waveform is called, is continually changing at the rate indicated by its curvature.

### Circuit Applications

Normal presentation in equipment diagrams indicates the amplitude of a waveform in terms of its maximum values. See diagram on next page.

Part A (page 101) shows the same sine wave as on the preceding diagram. The dimensions are 8 volts from its positive peak to its negative peak. The time duration of one cycle is 20  $\mu\text{sec}$  (microseconds). A microsecond is one-millionth of a second. Part B shows the same waveform after it has been rectified (using a diode circuit, for example). The single peak remaining is 4 volts from zero to maximum positive. The time duration of the cycle is still the same 20  $\mu\text{sec}$ .

Understanding the dimensions of a waveform is very important. Waveform representations of signals are used constantly in electronics, since a vast amount of information about a signal can be put into this picture form. Amplitude and time values allow you to describe specifically what the voltage or current will do in a circuit.

## Waveform Representations

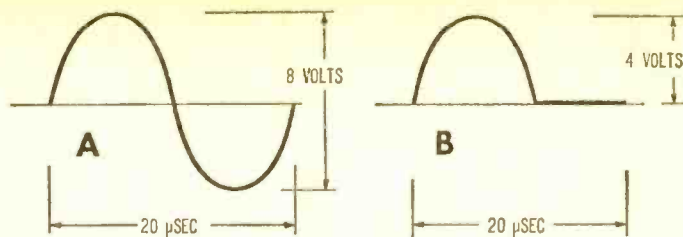

- Q27. In an equipment, the output signal of one circuit becomes the ----- for the next circuit.
- Q28. The exchange of signals between circuits is accomplished by ----- or ----- waveforms.
- Q29. The dimensions of a waveform are ----- and -----.
- Q30. A sine wave is a continuously (steady, changing) voltage or current.
- Q31. In the diagram on the opposite page, what is the amplitude of voltage at time increment 4?
- Q32. What is its value at time increment 8?
- Q33. What is the amplitude at time increment 12?

### Your Answers Should Be:

- A27. In an equipment, the output signal of one circuit becomes the *input signal* for the next circuit.
- A28. The exchange of signals between circuits is accomplished by *voltage* or *current* waveforms.
- A29. The dimensions of a waveform are *amplitude* and *time*.
- A30. A sine wave is a continuously *changing* voltage or current.
- A31. At time increment 4, voltage has risen to *+4 volts*.
- A32. At time 8, it is *zero volts*.
- A33. At time 12, voltage has decreased to *-4 volts*.

### Amplitude and Frequency

As you have learned, waveforms can be described by their time and amplitude dimensions. How is this done?

**Time Dimension**—Time is the horizontal dimension of a waveform. It is usually represented in terms of seconds, milliseconds (1/1,000 of a second), or microseconds (1/1,000,000 of a second).

The time line for a waveform usually represents the duration of one cycle. In part A above, it is 20 μsec and in part B it is 10 μsec. From this, the duration of a portion of a cycle can be determined. In part A, a half wave (half of a full cycle) is 10 μsec. A quarter wave in part A is 5 μsec.



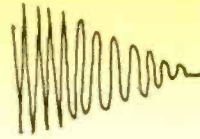
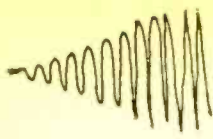

### Time Duration of a Cycle

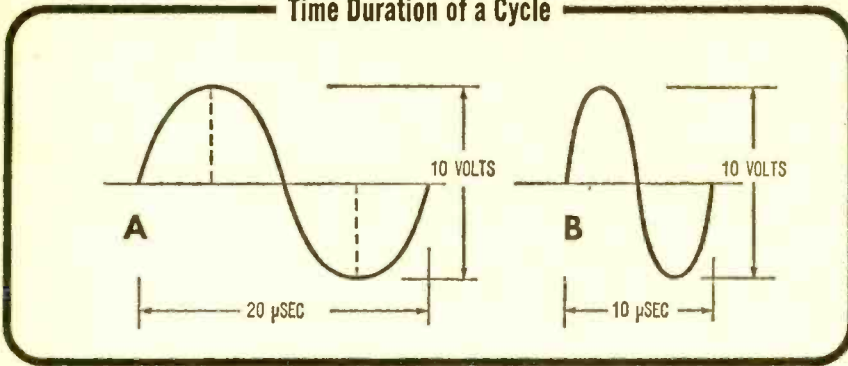

**Frequency**—Since a waveform cycle repeats itself continuously, its frequency can be determined. The frequency of a signal is the number of times that it repeats itself in a certain period of time, usually one second. If the time duration for one cycle is one second, the signal repeats itself once each second. Its frequency, then, would be one cycle per second. If one cycle is 1/10 of a second in duration, it repeats itself 10 times in one second, resulting in a frequency of 10 cycles per second. As you have already determined, the arithmetic expression to find frequency is:

$$\text{Frequency} = \frac{\text{one second}}{\text{time duration of one cycle}}$$

If the time duration is expressed in milliseconds or microseconds, the top and bottom values of the right side of the expression must be expressed in the same units of time. In other words, both top and bottom values must be either in seconds, milliseconds, or microseconds. Failure to have these values in the same units of time is a common source of error when solving this type of problem.

### Determining Frequency

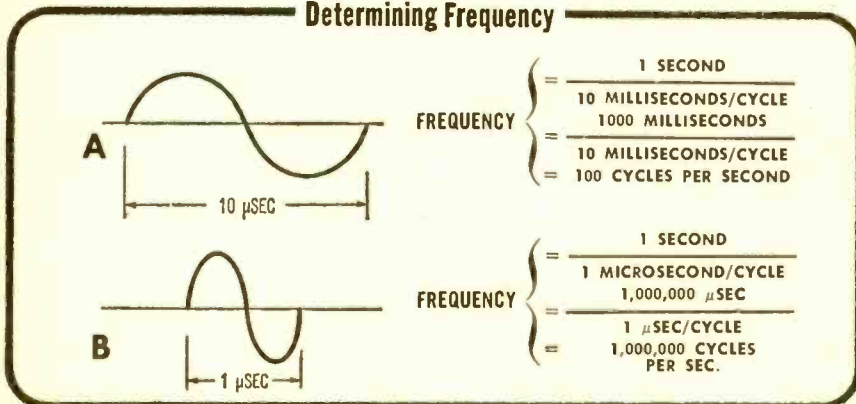

- Q34. The time dimension of a waveform is measured from (left to right, bottom to top).
- Q35. There are ----- microseconds in a second.
- Q36. There are ---- microseconds in a millisecond.
- Q37. A full cycle is 60 milliseconds. What is the duration of a quarter cycle?
- Q38. What is the frequency of a 100-millisecond cycle?
- Q39. What is the frequency of a 0.001-second cycle?

**Your Answers Should Be:**

- A34. The time dimension of a waveform is measured from *left to right*.
- A35. There are *1,000,000* microseconds in a second.
- A36. There are *1000* microseconds in a millisecond.
- A37. A full cycle is 60 milliseconds. A quarter cycle would be *15 milliseconds*.
- A38. A 100-millisecond cycle has a frequency of *10 cycles per second*.
- A39. A 0.001-second cycle has a frequency of *1000 cycles per second*.

**WHAT YOU HAVE LEARNED**

1. There is little difference between electrical and electronic circuits. Both are based on identical principles. There is a difference, however, in the manner in which the circuits are applied.
2. Whether it be an application of electricity or one of electronics, circuits operate in a manner that is determined by the effect the components of the circuit have on current that is passing through the circuit or on the voltage that is applied to the circuit.
3. All electronic components, regardless of their name or description, are either resistors, capacitors, inductors, or a combination of these. The effect they have on voltage or current is called resistance, capacitance, and inductance. Since these are the only elements that constitute any circuit, learning their principles well and then applying their effect on current and voltage makes analysis of how a circuit works relatively easy.
4. Many students do poorly in learning electronics because they get lost in descriptive detail. To prevent this from happening to you, fit the function of each component into its place in the mental image you have retained of the entire circuit and what it is designed to do.

**NEXT ISSUE: PART VII—Understanding Transistors**

This series is based on material appearing in Vol. 1 of the 5-volume set, BASIC ELECTRICITY/ELECTRONICS, published by Howard W. Sams & Co., Inc. @ \$19.95. For information on the complete set, write the publisher at 4300 West 62nd St., Indianapolis, Ind. 46268.

## CB Directory

Continued from page 74

**FS-23.** Frequency synthesis is employed in this 23-channel tube configuration to obtain 1-control switching. Selective control can be added later if you'd like this feature. Cost: \$299.95.



Sonar FS-23

**J-23.** A tiny transistorized CB transceiver, the J-23 comes complete with all crystals you'll ever need, has PA feature, a long list of extras, plus built-in 12 VDC mobile power supply. A top-of-the-crop item, the J-23 sells for \$230.95.

### ● SQUIRES-SANDERS, INC.

**The Admiral.** Topping the list of new S/S entries for 1969 is the Admiral, an all solid-state 23-channel CB base station. Features include: pulse eliminator, 5-watt transmitter, speech compression, desk mike, "dual antenna," Hi/Lo sensitivity switch, PA facility, on-the-air light, digital clock, etc. With 117 VAC supply, she sells for \$329.95.

**The Commodore.** Another 1969 23-channel model, the Commodore features solid-state construction, double-conversion receiver, crystal filter, 7-kHz selectivity, adjustable squelch, pulse eliminator, etc. A mobile rig, she sells at \$199.95.

## CB MANUFACTURERS

Allied Radio Corp., 100 N. Western Ave., Chicago, Ill. 60680  
Amphenol Corp., 2875 S. 25th Ave., Broadview, Ill. 60153  
Apelco Co. (Raytheon), 213 E. Grand Ave., S. San Francisco, Calif. 94080  
Automatic Radio, 2 Main St., Melrose, Mass. 02176  
Autronics Corp., 180 N. Vinedo, Pasadena, Calif. 91107  
B&K Mfg. Co., 1801 W. Belle Plaine, Chicago, Ill. 60613



Squires-Sanders Commodore

**The Skipper.** Another 1969 entry is S/S's 23-channel Skipper. This rig features dual-conversion receive, solid-state construction including—get this—an integrated circuit plus field effect transistor, illuminated S-meter, solid-state T/R switching, speech clipping, PA facility, etc. With built-in 12 VDC supply, it sells for \$159.95.

### ● SSBCO

**Model ASB-11.** With one of the shortest manufacturer's names going, SSBCO has been producing an interesting line of combine AM/SSB transceivers for quite some time. The Model ASB-11, for example, is an attractive set with 5-channel operational capability featuring a Collins mechanical filter. Equipped for 12 VDC operation, she sells for \$277.50.

**Model ASB-11A.** A deluxe version of the Model ASB-11 described above, this one has a built-in noise blanker circuit. Price: \$322.50.

**Model SSB-27.** Similar to Model ASB-11 without the AM feature. Only \$249.95.

**Model SSB-27A.** A deluxe version of the Model SSB-27. Has built-in noise blanker. Priced at \$299.50.

### ● TRAM ELECTRONICS, INC.

**Titan II.** Where else can you pay almost \$500 for a single CB set? Certainly a Cadillac in the Citizens Radio field, the new Titan II wraps two CB rigs into one. The rig—much



Tram Titan II

the same as the SSBCO ASB-11—features both sideband and AM, only this time it's double sideband. Completely compatible with all single sideband, double sideband, and standard AM CB stations, the Tram Titan II comes with multi-function S-meter, power meter, Collins mechanical filter, multi-stage RF gain control, plus many, many extras. Price: \$482.00.

**The Titan.** One of the very few CB rigs in this price category (above \$400), the Tram Titan goes virtually unchallenged as one of the finest base station transceivers on the market today. With a 117 VAC power supply and full 23-channel capability, it's regarded highly in CB circles. A perfect base set for the mobileer with an XL-100, she sells for \$434.00.

**The XL-100.** The XL-100 lights up flashing the channel you're operating on a large dial. Additionally, it comes with a wide variety of special features and is designed expressly for mobile work. Extremely small, the unit is equipped for all 23 channels. Selling price: \$318.00.

### ● WORLD RADIO LABORATORIES

**Rustler II.** A set with tunable receive—and spotting switch plus squelch control plus noise limiter—and 11-channel transmit, the WRL Rustler II also puts a crystal socket on the front panel for added versatility. With power supply (117 VAC and 12 VDC), she sells for \$79.95.

Browning Laboratories, Inc., 100 Union Ave., Laconia, N.H. 03246  
Burstein-Applebee, 3199 Mercier St., Kansas City, Mo. 64111  
Courier Communications, Inc., 56 Hamilton Ave., White Plains, N.Y. 10601  
Craig Panorama, Inc., 2302 E. 15th, Los Angeles, Calif. 90021  
Demco Electronics, Inc., Rte. 1, Bristol, Ind. 46507  
Eico Electronic Instrument Co., Inc., 283 Malta St., Brooklyn, N.Y. 11207

General Radiotelephone Co., 3501 W. Burbank Blvd., Burbank, Calif. 91505  
Hammarlund Mfg. Co., 73-88 Hammarlund Or., Mars Hill, N.C. 28754  
The Heath Co., Benton Harbor, Mich. 49022  
International Crystal Mfg. Co., 18 N. Lee Ave., Oklahoma City, Okla. 73102  
E.F. Johnson Co., 6552 10th Ave. S.W., Waseca, Minn. 56093



## CB MANUFACTURERS

Kaar Electronics Corp., 2250  
Charleston Rd., Mountain View,  
Calif. 94141  
Lafayette Radio Electronics Corp.,  
111 Jericho Tpke., Syosett, N.Y.  
11791  
Mark Products Co., 5439 W. Fargo  
Ave., Skokie, Ill. 60076  
Chas. A Messenger Corp., 1405 N.  
Avon, Burbank, Calif. 91505  
Midland International Corp.,  
1519-21 Atlantic St., N. Kansas  
City, Mo. 64116  
Mobilefone, Box 32, Anderson, Ind.  
46015  
Multi-Elmac Co., 21470 Coolidge  
Hwy., Oak Park, Mich. 48237

Olsn Electronics, Inc., 386 S.  
Forge St., Akron, Ohio 44308  
Pace Communications Corp.,  
24049 Frampton Ave., Harbor  
City, Calif. 90710  
Pearce-Simpson, Inc., 4710 N.W.  
77th Ave., Miami, Fla. 33100  
J.C. Penney Co., 11800 W. Burleigh  
St., Wauwatosa, Wis. 53213  
Polytronics Communications,  
Box 536, Baltimore, Md. 21203  
Radio Shack Corp. (Realistic),  
730 Commonwealth Ave.,  
Boston, Mass. 02215  
Raytheon Co. (Ray-Tel), 213 E.  
Grand Ave., S. San Francisco,  
Calif. 94084

Regency Electronics, Inc., 7900  
Pendleton Pike, Indianapolis, Ind.  
46226  
Robyn Co., 4303 Kroes Rd.,  
Rockford, Mich. 49341  
Sonar Radio Corp., 73 Wortman St.,  
Brooklyn, N.Y. 11207  
Squires-Sanders, Inc., Martinsville  
Rd., Liberty Corner, N.J. 07938  
SSBCO, Box 101, Chicago, Ill.  
60645  
Tram Electronics, Inc., Box 189,  
Winnisquam, N.H. 03289  
World Radio Laboratories, 3415 W.  
Broadway, Council Bluffs, Iowa  
51503

### Radar Speed Traps

*Continued from page 83*

signals it produces a low hissing noise reminiscent of a broadcast receiver not on a station. As you pass airports or near large harbors, you may hear the set gurgle or bleep a few times whenever the airport or ship radar scans past your antenna; these signals do not sound anything at all like the steady whine of a radar trap.

A second unit, the *Radar Detector*, is produced by Solar Electronics, Box 15371, Denver, Colo. 80215. This unit tunes *only* the X-band and does not pick up S-band, ship, or aircraft radars. In fact, until you actually enter an X-band trap, the set makes absolutely no noise or sound at all because of a built-in squelch circuit. A test button on the front panel enables you to set off the set's warning signal in order to check out the battery condition and to familiarize you with the warning.

**Are They Legal?** According to the manufacturers of these devices, they are legal in 48 states though a few communities have laws against their use. The two forbidden states are Massachusetts and Virginia.

As for the morality of using the devices, there is obviously both a pro and a con. One manufacturer of detectors reasons that the units actually help to promote road safety, his argument: with a detector in his car, a motorist is more likely to keep his eye on the speedometer and drive at posted speeds.

Could be, though you might also argue that this man has an ax to grind. Whatever the case, the fact remains that the electronic age has brought forth upon our highways 10,000 eyes to monitor your driving habits. ■

### Newsan

*Continued from page 19*

response to any of the four signals may be a jerk or a sudden movement of bands, arms, or legs, or a more subtle response such as the blinking of an eye. Priced at \$285.00, the unit is inexpensive considering it can be used to test 12,000 babies before batteries need replacement.

### What Has Edison Wroth

The greatest single advance in lighting economy since the introduction of the light bulb has been announced by Westinghouse engineers. They have developed a new fluorescent lamp with a life rating of 18,000 hours based on three hours burning per start. On rapid start circuits this represents an increase in lamp life of 50 per cent over the ordinary 40-watt fluorescent lamp now on the market. This rated life of 18,000 hours compares to an average rated life of 750 to 1,000 hours for an ordinary household incandescent light bulb.

A key feature of the new Extended Service lamps is the fact that they operate on all standard 40 watt ballasts and in all 40 watt fixtures. This was accomplished by Westinghouse engineers through the use of a new diameter T-10 glass tube, improved control of phosphors, a change in internal lamp pressure and gases, and an advanced electrode design.

The new lamp will mean substantial savings for industrial and commercial fluorescent lamp users. The longer designed life of the Extended Service lamps will mean fewer lamp replacements thus substantially reducing the total maintenance costs over that of ordinary lamps. Also, group relamping can now be done at much longer intervals. When ordinary 40-watt installations are experiencing about 10 per cent failures, those using the new Extended Service lamps will just start to experience the first normal failures. ■

## For Bulls and Bears

*Continued from page 78*

The "Quote" mode simultaneously displays 17 items of information pertaining to a particular security. The information is updated continuously as market transactions affect the issue. The video screen display includes this current market data: the most recent sale price and time; an arrow indicating if the price is higher or lower than the previous transaction; bid and asked prices; high and low prices; opening and closing prices; volume.

Presented at the same time is this key background data: the latest 12-month earnings per share of the company whose security has been selected; the annual dividend; the price-earnings ratio, and the yield.

The display also includes an alerting signal to indicate a current news report that may affect the security and when the issue trades ex-dividend.

The "Marketminder" mode allows the Ultronic *Videomaster* user to simultaneously select and monitor the market price performance of up to 18 separate stocks. What's more, the unit is equipped so that the user can quickly and easily change any or all of the 18 securities.

The mode allows the broker to keep in direct touch with a personally selected list of securities that might be of interest to traders or other customers who are following the trend of certain securities.

In addition to monitoring the latest prices of 18 selected securities, the "Marketmind-

er" mode also indicates by a flashing plus or minus sign beside the issue when the price of a selected security breaks out of a trading range which was previously assigned by the *Videomaster's* user.

The trading range limit is assigned by use of the third basic mode, called "Limitminder."

When the Ultronic *Videomaster* is switched to the "Limitminder" mode the operator of the unit may, in effect, ask the unit to notify him electronically either through the "Marketminder" or the "Limitminder" mode when a specific security has advanced or declined in price to pre-determined limits.

When either limit is reached, a light on the Ultronic *Videomaster* keyboard switches on. In addition, a plus or minus sign flashes beside the selected security. The plus or minus signs also appear on the "Marketminder" mode. The indicators continue to signal until such time as the operator decides either to alter or even completely eliminate the limits.

In addition to the three basic operating modes, Ultronic *Videomaster* also has an exceptionally broad capability for employment of optional modes.

Among the optional features is a "Market Summary" mode. By switching to this mode, the operator will be able to display instantly a wide range of general market information, including the volume of trading on the New York and American stock exchanges; the number of stocks up in price, lower, or unchanged; the major stock index averages; stocks leading in trading volume, and significant market sub-indices. ■

## Hey, Look Me Over!

*Continued from page 12*

zles, including a blank that can be customized by the user. The glue is non-toxic, non-irritating, and non-flammable. Model 250 is available at hardware stores for \$22.95, complete with 3/32-in. orifice nozzle and 60 sticks of glue. For literature, write to Consumer Products Center, United Shoe Machinery Corp., 221 Oley St., Reading, Pa. 19601.

### How to Drown out the Instruments

For all you vocalists who're tired of having your sonic time beaten by amplified guitars,

drums, organs, sitars, and all like that, Atlas Sound has produced the Banshee. It's a cobra-flare horn, and it will spray out the vocals with 125 watts of peak power. Frequency response of the Banshee is 100 to 12,000 Hz, and the sound intensity is claimed to be 131 dB! Man, that should drive your ear drums to the center of your head. Impedance is 16 ohms. Banshee has a built-in pre-wired phone jack; you just insert a speaker cable with a two-conductor phone plug and everybody can really dig those crazy lyrics. Atlas recommends a speaker stand to elevate the sound above the crowd. It's best to keep the audience below the sonic boom. Atlas has two models, the SS-4 for \$25, the SS-2 for \$48. The Banshee is \$121.00, and for more poop, write Atlas Sound, Parsippany, N. J. 07054.



## Hartman Direction Finder

Continued from page 64

have this information (you may be using a road map to chart your way through a national park), Hartman tells you the difference between magnetic and true north for land mass and waters in and around the United States. It's so simple to use that any Boy Scout can show you how.

**Does \$59.95 Buy Accuracy?** Though the rotating radio compass is calibrated in 5° divisions, 1° can be estimated with reasonable accuracy, and a few test plots estab-

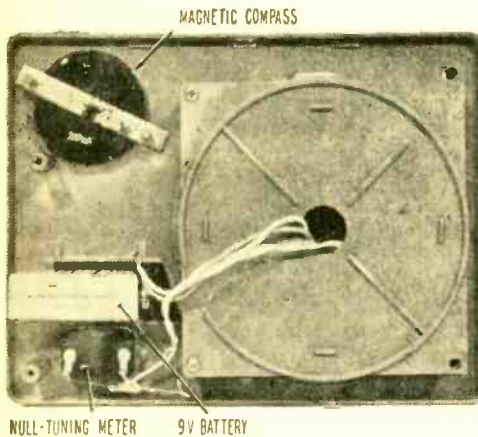

Transistor radio is mounted under frame that secures azimuth dial. Battery compartment allows easy access.

lished that the navigator can expect an overall accuracy of 1°—comparing favorably with RDFs priced several hundred dollars more than the RDF-101.

Note that in our example of using the RDF-101 no mention was made of “boxing the compass” to compensate for a boat's magnetic effect. This is because the RDF-101 magnetic compass is pre-compensated to reduce the effects of nearby magnetic objects. Because of “bending” of radio waves caused by mountains, etc., the RDF-101 delivers maximum accuracy using radio stations located up to 25 miles, though you can put yourself “in the ball park” with stations located a greater distance.

**Paraphernalia, Bah!** Throw away the instruction book! One of the features we found particularly appealing is the anodized aluminum plotting directions on the back of the RDF. The plotting instructions are illustrated, and the user can easily determine his

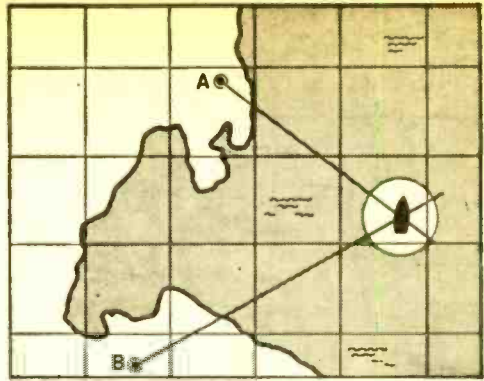

Navigator is at point where bearings from two or three BCB stations cross. Station Locator is included.

position even if the instruction book is lost.

**How It's Made.** The RDF consists of a transistor BC radio mounted in a rotating frame—the azimuth dial. The 9-V Burgess 2U6 (or equiv.) battery is a standard transistor radio battery available in most stores, and is changed through a cover on the back panel. A plastic cover protects the radio from water spray.

**Summing Up.** Though priced at a rock-bottom \$59.95, the Hartman Marine RDF-101 provides the accuracy and dependability of direction finders priced many times higher. By using standard broadcast stations for direction finding, it eliminates dependency on beacon stations requiring “homing” navigation systems, and also does away with tidal charts and wind calculations. And, of course, you get the advantage of an RDF system and a portable radio all in one case. For additional information write to Hartman Marine Inc., Dept. TG, 65 7th Ave., Newark, N. J. 07104. ■

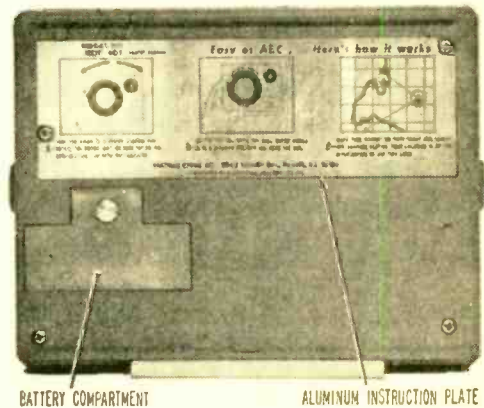

Permanent instructions are provided on back of RDF. When lubber line points to N, rotate azimuth dial for minimum reading (null) on meter; this gives bearing.



## Czech-Mate

Continued from page 34

scribe the national disaster. It was like a Czech Chet Huntley saying, "David, we're in one hellava mess!"

A midwest SWL, Gerry Dexter heard another Prague-based underground radio on 11,990 kHz during an eight-minute English newscast. "Operating from occupied Czechoslovakia," it aired programs continuously in English, French, German, Italian, even Arabic.

To escape detection and provide communications within the occupied territory, a number of the stations shared the 21-Meter channel. Schnabel logged the following exchange.

*"Free Legal Transmitter Eastern Bohemia, base four . . . Come in Northern Moravia . . . Crocodile is calling . . . Southern Moravia, please report in . . . Goodbye, we'll be seeing you . . . Transmitter Brno, came in . . . Friends in Brno, we thank you . . . This is Northern Moravia."*

But there were more personal messages, too.

*"Simon Picha from Cáslav. Your family is fine. Grandma and the children are fine. You are to call 25-217 in Hradec Králové."*

**The U.S.S.R., smarting** from the strong world reaction to the takeover, fought back. For the first time since 1961, the Russian language programs of the Voice of America and the BBC were jammed. Even neutral R. Sweden and DeGaulle's Radiodiffusion Television Francaise had their programs blocked. To do this, the electronic buzzsaws and squealers temporarily were shifted from R. Peking channels to the western frequencies.

Non-communist nations were accused of aiding the "subversive elements" in Prague. A West German film crew was arrested and charged with harboring an illegal shortwave station in their van. R. Moscow reported the alleged discovery of an underground radio on the grounds of an unidentified western embassy. Maybe it was true. Clandestine voices originated from even more improbable locations, including—would you believe—dreary old Pankrac Prison, headquarters of the secret police.

To counter the broadcasts, the invaders set up their own clandestine, R. Vltava (Mol-

dau), somewhere in East Germany. But hardly anyone listened to the bland explanations by foreign-sounding speakers that the "liberation" soldiers had entered the country to protect against counterrevolutionary plots. Czech ham radio operators added to R. Vltava's miseries by gleefully jamming the signals with their own transmitters.

Strangely enough, the biggest threat to the free stations was posed by a railroad train. Packed with direction finding equipment for ferreting out the hidden transmitters, it crawled slowly across Czechoslovakia from the border.

At Ceska Trebova, a rail junction 80 miles east of Prague, Czech State Railway workers rebelled. They would take the train no further, they vowed. For hours the cars stayed on a siding. Then the 25-Meter station sent out this urgent message:

*"All railroaders alert! All railroad personnel in Hradec Králové! The occupiers have taken the locomotive and have forced the train crew to continue. The disabled train is again on the move, its goal unknown. Railroaders, the liberty of our legal broadcasts is endangered. We alert you that more remains to be done. This train must be stopped!"*

By the time the long overdue train limped into the capital and its electronic gear was unloaded, it was too late to do the Russians much good.

In a crematorium chapel, an honor guard of uniformed railway employees wept as the coffin of Jindrich Krahulec was carried past. A 20-year-old locomotive engineer, Krahulec had been shot to death by Red soldiers.

The end came on August 29. The broadcasters had argued for continued resistance, but once their national leaders had been forced to submit to Soviet demands, the stations could not hold out long. Grudgingly, their staff members agreed to a return of censorship as an indispensable means of achieving the withdrawal of foreign troops from the cities.

All programs of the phantom network were routed through the Prague studio, where they were carefully censored. Several days later, these programs were replaced by the official, but no longer free, radio and television services.

*And what of the familiar voices? It's not known what, if any, part the English-speaking announcers played in the underground operations. Since the resumption of the regular R. Prague programming, the voices of Milan Brod and Jean Novakova have again*

been heard. Still unaccounted for at this writing are Cecille Krizova, Vladimir Novy, and the Slavikova sisters, Paula and Jana.

As for those who fought and lost, Pelikan and Hejzler suddenly found themselves on "extended vacations." For others, who were able to leave the country, it was self-imposed exile. Still others, apparently, were able to return to their old jobs, though their subsequent fate is unknown.

"We have lost because we wanted everything," said one.

But in their gallant loss they won the lasting respect of their countrymen and the world. ■

#### STATEMENT OF OWNERSHIP, MANAGEMENT AND CIRCULATION

Date of Filing: Oct. 1, 1968  
TITLE OF PUBLICATION: ELEMENTARY ELECTRONICS  
Frequency of Issue: Bi-Monthly

Location of Known Office of Publication: 229 Park Ave. South, New York, N. Y. 10003

Location of the Headquarters or General Business Offices of the Publishers: 229 Park Ave. South, New York, N. Y. 10003

Names and Addresses of Publisher, Editor, and Managing Editor:

Publisher—B. G. Davis, 229 Park Ave. South, New York, N. Y. 10003

Editor—J. M. Sienkiewicz, 229 Park Ave. South, New York, N. Y. 10003

Managing Editor—R. A. Flanagan, 229 Park Ave. South, New York, N. Y. 10003

#### Owners:

Science & Mechanics Publ. Co.  
229 Park Ave. South, New York, N. Y. 10003

Davis Publications, Inc.  
229 Park Ave. South, New York, N. Y. 10003

B. G. Davis  
229 Park Ave. South, New York, N. Y. 10003

Joel Davis  
229 Park Ave. South, New York, N. Y. 10003

Known Bondholders, Mortgagees, and Other Security Holders Owning or Holding 1 Percent or More of Total Amount of Bonds, Mortgages or Other Securities: None

Extent and Nature of Circulation	Average No. Copies Each Issue During Preceding 12 Months	Actual Number of Copies of Single Issue Published Nearest to Filing Date
A. Total No. Copies Printed (Net Press Run)	139,261	164,460
B. Paid Circulation		
1. Sales Through Dealers and Carriers, Street Vendors and Counter Sales	44,417	45,000
2. Mail Subscriptions	22,008	47,000
C. Total Paid Circulation	66,425	92,000
D. Free Distribution (including samples) by Mail, Carrier or Other Means	1,362	723
E. Total Distribution (Sum of C and D)	67,787	92,723
F. Office Use, Left-Over, Unaccounted, Spoiled After Printing	71,474	71,737
G. Total (Sum of E & F—should equal net press run shown in A)	139,261	164,460

I certify that the statements made by me above are correct and complete.

V. C. Stabile, Business Mgr.

## Dio-Tracer

Continued from page 39

generator set to 10 Hz can be connected to the EXTERNAL SYNC jacks, with S3 set to EXT. Make sure that the RF output isn't too high; it may overload the receiver and distort the IF response curve.

Many checks of IF response can be made without markers by simply examining the overall shape of the response curve. A marker generator, however, can be connected to the EXT MARKER jack.

A large paper capacitor (about 0.1  $\mu$ F) should be connected across the oscilloscope's vertical input to narrow the frequency response and sharpen the marker on the response curve trace. Keep the marker generator's amplitude as low as possible to prevent overloading the receiver and distorting the response curve. You should adjust the marker frequency to check IF response curve limits.

The IF transformers can now be tuned for the correct response. You can also check the performance of Q multipliers or IF filters by watching the peak or dip in the response curve as they are operated.

With a couple of good books on hand, you and your Dio-Tracer will easily master most any alignment problem that comes up. And the few inches of space that this generator takes up on your workbench should prove to be extremely valuable property. ■

#### ADVERTISING INDEX

Advertiser	Page
CB Shack Unlimited	17
Classified Advertising	111
Cleveland Institute of Electronics	112-113-114-3rd Cover
Conar Div.	8
National Radio Institute	26-27-28-29
Edmund Scientific Co.	3
EICO Electronic	2nd Cover
Grantham School of Electronics	5
Graymark Enterprises, Inc.	9
Heath Co.	84-85-86-87-88-89
International Correspondence Schools	7
Lafayette Radio	1-2
McGee Radio Co.	13
National Systems Corp.	13
Olson Electronics, Inc.	8
Poly Paks	15
Progressive "Edu-Kits" Inc.	4th Cover
RCA Institutes, Inc.	60-61-62-63
Scott, Inc., H.H.	11
World Field Research	13
Xcelite, Inc.	6

## Operation 803

*Continued from page 45*

the Ord, Nebraska shortwave listener entered the picture. Reading of Alix's plight in a radio club bulletin, Barry Deal decided to help. "Operation 803" was born.

Barry's plan was to buy several of the vital 803s in the U.S. and ship them to the Haitian station. Barry's request for donations in an SWL bulletin brought a response from a number of shortwave listeners. Soon the necessary funds were collected. A temporary hitch developed when the teenager was unable to locate the transmitting tubes in his home town. A Voice of America official then suggested a mail-order source and the young listener placed an order for two of the tubes.

**Jeremie Thank-You.** By late summer, the 803s were on their way to Haiti.

## AR Amplifier

*Continued from page 43*

distortion or coloration on thundering chords or brass crescendos.

As for workmanship, the AR amplifier is one of the finest examples of quality construction we have seen in consumer equipment. Chassis components are mounted as though the amplifier were destined to be blasted to the moon and back. Wiring is oversized, with insulation we haven't seen outside of military equipment. Transistor leads on the PC boards are left full-length, reducing the possibility of soldering heat damage during assembly. Wiring, even where not usually done, is clamped or taped down. And a PC board, which is nowhere near the metal cover, is covered with "fish paper" to further reduce the possibility of a short (which couldn't happen anyway). It is really no wonder that AR is able to offer a truly unconditional guarantee in terms of reliability and performance.

The AR amplifier is supplied with a perforated cover and a slightly oversized front panel. A customizing wood escutcheon is also supplied as a separate item. The amplifier can be used "as is," as a component, or it can be placed in a panel cut-out with the oversized panel concealing the cut. For a

Some time later, Barry received a letter in French, bearing the Jeremie postmark.

"This week I had the great joy of receiving at Jeremie Customs the two 803 tubes that you shipped," Alix wrote. "I thank you very much for this big gift!" The station owner promised Barry that "La Voix de la Grand Anse" would return to the air as soon as possible. That promise has been kept. Recently, listeners have reported hearing 4VAF broadcasting popular music and infrequent French announcements. "La Voix de la Grand Anse" has been heard on its old frequency of 5090 kHz, signing off at 0055 GMT. Other reports state it has been heard until after 0115 GMT, indicating apparently that its schedule is still a bit irregular.

Radioteletype interference on the 60-Meter frequency often makes reception very difficult, but because of "Operation 803" Jeremie's residents still have their station and DXers still have a chance to tune one of the rarer stations in the hemisphere. ■

professional installation the entire front panel can be removed to allow installation of the wood escutcheon.

**Summing Up.** The AR amplifier will provide even the most critical hi-fi enthusiast with all the clean power, optimum response, and low distortion he will ever need or could possibly use. As an extra bonus he will get some of the finest construction to be found in consumer equipment.

For additional information, write Acoustic Research, Inc., Dept. D, 24 Thorndike St., Cambridge, Mass. 02141. ■

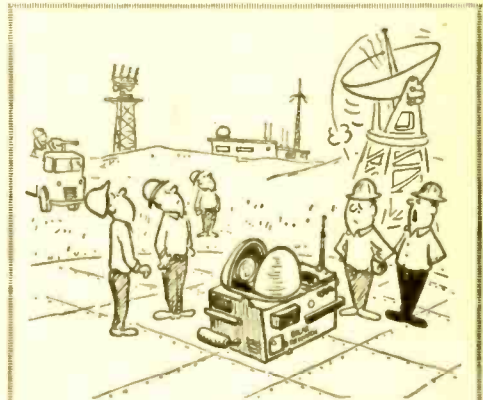

"I suppose you realize, Hargood, that you just launched our \$1.2-million super-solar research balloon without our \$2.3-million super-solar research unit!"



# CLASSIFIED Market Place

FOR BIGGER PROFITS! NEW CAREER OPPORTUNITIES!  
READ AND REPLY TO THESE CLASSIFIED ADS

Classified Ads 65¢ per word, each insertion, minimum 10 words, payable in advance. To be included in the next available issue of ELEMENTARY ELECTRONICS, copy must be in our New York Office by Jan. 10th. Address orders to C. D. Wilson, Manager, Classified Advertising, ELEMENTARY ELECTRONICS, 229 Park Avenue South, New York, N. Y. 10003.

## ADDITIONAL INCOME

**MONEY**—Sparetime Opportunity Panelists At Home Wanted By New York Researcher. Leading research firm seeking people to furnish honest opinions by mail from home. Pays cash for all opinions rendered. Clients' products supplied at no cost. For information write: Research 669, Mineola, N. Y. 11501. Dept. 633-EE.

**FREE!** The World's Leading Money-making Magazine. How and when to earn a Second Income, develop a Spare-time Business, get into Profitable Franchising, become a successful Agent. For your free copy—write Income Opportunities, 229 Park Avenue South, New York, N. Y. 10003.

## BOOKS & PERIODICALS

**TERRIFIC**, New Army Written Book. Basic Theory And Application of Transistors, \$1.40 Postpaid. Devices, Box 136E, Bronx, N. Y. 10463.

**CATALOG** of all Science & Mechanics Craftprints. Send 25¢ to cover postage and handling to Craftprint Div., Science & Mechanics, 229 Park Avenue South, New York 10003.

## BUSINESS OPPORTUNITIES

**I MADE \$40,000.00** Year by Mailorder! Helped others make money! Start with \$10.00—Free Proof! Torrey, Box 318-T, Ypsilanti, Michigan 48197.

**FREE** Book "990 Successful Little-Known Businesses." Fascinating! Work home! Plymouth 211-P, Brooklyn, N. Y. 11218.

## EARTHWORMS

**BIG** Money Raising Fishworms and Crickets. Free literature. Carter Farm-O, Plains, Georgia 31780.

## EDUCATION & INSTRUCTION

**EARN** Your Degree In Electronics Engineering. Highly Effective Home Study Courses In Electronics Engineering Technology And Electronics Engineering Mathematics. Free Literature. Cook's Institute Of Electronics Engineering, P. O. Box 36185, Houston, Texas 77036. (Established 1945.)

## ELECTRICAL EQUIPMENT & SUPPLIES

**PRINTED** Circuit Board Kits. Materials. Free Catalog. Seneca Electronics, P.O. Box 2022D, Kokomo, Indiana 46901.

## ELECTRONIC COMPONENTS

**FREE** catalog of unusual electronic items for the experimenter. Franks Scientific Co., P.O. Box 156, Martelle, Iowa 52305.

## FOR SALE—MISCELLANEOUS

**SEND** your favorite photo with \$3.95. I'll return Giant 24x36 Poster, Pat James (EE11), 260 Conklin, Brooklyn, N. Y. 11236.

**THE** First Known Three Dimensional Charts Cubic—Multiplier, Area—Triangle. Percent—Interest, Board—Feet. All for \$3.00. Abacoos, Box 1401, Gray, Penn. 15544.

## GIFTS THAT PLEASE

**3-D-CHESS** Rules \$2.00. 3-D-Chess Boards \$18.00. Box 6531-R, Hampton, Va. 23668.

**UNUSUAL** gifts for the family! Free catalog! Williams, Dept. SMC-1, 1651 Shaw Place, Claremont, Calif. 91711.

**MOUNTED** Texas Longhorns \$35.00, Hunter's Horn \$12.50. Fred Hackett, Ettrick, Wis. 54627.

**GIVE** the best reading in the Mechanical Field—give Science & Mechanics! \$4.00 for year's subscription. Science & Mechanics, 229 Park Avenue South, New York, New York 10003.

## HYPNOTISM

**ADULTS** Only! Hypnotize Successfully! "Instantaneous"—"One Word"—"Against Will." Methods Exposed! Complete illustrated course—including Self-Hypnosis—10" Hypnodisk—"Secret Nerve Pressure Technique." (They never know!) \$2.00 Results Absolutely Guaranteed! Fowler, Box 4390, Woodbury, N. J. 08096.

## INVENTIONS WANTED

**WE** either sell your invention or pay cash bonus. Write for details. Universal Inventions, 298-3, Marion, Ohio 43302.

## MAGNETS

**MAGNETS**. All types. Specials—20 disc magnets or 2 stick magnets, on 10 small bar magnets, or 8 assorted magnets. \$1.00. Maryland Magnet Company, 5412-R, Gist, Baltimore, Md. 21215.

## MISCELLANEOUS

**ROOT BEER** Formulas. Instructions \$3.00. Tomarch, 1114-41st, Brooklyn, New York 11218.

**QUART** dried hops \$1.00, with 101 recipes—Homebrewing, Winemaking, Hop-breads, Sourdoughs, and supplies catalogue. Nichols Nursery, Northpac, Albany, Oregon 97321.

**THERE** is no charge for the Zip Code. Please use it in your Classified Ad.

## MONEYMAKING OPPORTUNITIES

**1000% PROFIT** Bronzing Baby Shoes. Free Literature, Box 11069, Kansas City, Missouri 64119.

**MAKE** Your Classified Ad Pay. Get "How To Write a Classified Ad That Pays." Includes certificate worth \$2.00 towards classified ad in S & M. Send \$1.25 (includes postage) to C. D. Wilson, Science & Mechanics, 229 Park Avenue South, New York, N. Y. 10003.

## PETS—DOGS, BIRDS, RABBITS, ETC.

**BUY** Direct—Save! Monkeys, Ocelots, Birds, Reptiles. Pet Books. List 10¢. Exotic Animal Importers Inc., Box 3069-1, Hialeah, Fla. 33013.

## PROFITABLE OCCUPATIONS

**NOW**—Learn Public Relations At Home! Prepare for an exciting career—or study public relations to enhance your own business. Taught by skilled professionals by mail, 72 lessons, about \$5.00 each. Write Dept. EE, American Institute of Public Relations, 141 W. Jackson Blvd., Chicago, Illinois 60604.

## RADIO & TELEVISION

**THOUSANDS** and thousands of types of electronic parts, tubes, transistors, instruments, etc. Send for Free Catalog. Argutus Electronics Corp., EME, 502-32nd St., Union City, N. J. 07087.

**CONTROL** panels. Modernize your electronic equipment with a professional aluminum name plate made from your specifications. Free sample. Prerepco, Postbox 95, South Willington, Conn. 06266.

**BUILD** Distance Crystal Sets. 10 plans—25¢; 18 different—50¢; 20 different—50¢. Catalog. Laboratories. 12041-G Sheridan, Garden Grove, Calif. 92640.

## REMAILING SERVICE

**SOUTHERN** California Confidential Remalls 25¢. Able, Box 444, Rosemead, Calif. 91770.

## SALESMEN—DISTRIBUTORS

**SPINNING** Satellite—amazing outer space toy. Fantastic potential. Sample, details one dollar. Box 547, Altadena, California 91003.

## START YOUR OWN BUSINESS

**NOW!** Start your own wholesale or retail business, amazing profits, no stocking, we furnish catalogues, samples, promotional list. Free literature write today. Bro-Mel Co., 508 Oak, Quincy, Ill. 62301.

**YOU'LL MAKE  
MONEY**

**SAVE MONEY TOO—  
BY READING and ANSWERING  
THESE CLASSIFIED ADS**

# You can earn more money if you get an FCC License

...and here's our famous CIE warranty that you will get your license if you study with us at home

**N**OT SATISFIED with your present income? The most practical thing you can do about it is "bone up" on your electronics, pass the FCC exam, and get your Government license.

The demand for licensed men is enormous. Ten years ago there were about 100,000 licensed communications stations, including those for police and fire departments, airlines, the merchant marine, pipelines, telephone companies, taxicabs, railroads, trucking firms, delivery services, and so on.

Today there are over a million such stations on the air, and the number is growing constantly. And according to Federal law, no one is permitted to operate or service such equipment without a Commercial FCC License or without being under the direct supervision of a licensed operator.

This has resulted in a gold mine of new business for licensed service technicians. A typical mobile radio service contract pays an average of about \$100 a month. It's possible for one trained technician to maintain eight to ten such mobile systems. Some men cover as many as fifteen systems, each with perhaps a dozen units.

## Coming Impact of UHF

This demand for licensed operators and service technicians will be boosted again in the next 5 years by the mushrooming of UHF television. To the 500 or so VHF television stations now in operation, several times that many UHF stations may be added by the licensing of UHF channels and the sale of 10 million all-channel sets per year.

## Opportunities in Plants

And there are other exciting opportunities in aerospace industries, electronics manufacturers, telephone companies, and plants operated by electronic automation. Inside industrial plants like these, it's the licensed technician who is always considered first for promotion and in-plant training programs. The reason is simple. Passing the Federal government's FCC exam and getting your license is widely accepted proof that you know the fundamentals of electronics.

So why doesn't everybody who "tinkers" with electronic components get an FCC License and start cleaning up?

The answer: it's not that simple. The government's licensing exam is tough. In fact, an average of two out of every three men who take the FCC exam fail.

There is one way, however, of being pretty certain that you will pass the FCC exam. And that is to take one of the FCC home study courses offered by the Cleveland Institute of Electronics.

CIE courses are so effective that better than 9 out of every 10 CIE-trained graduates who take the exam pass it. That's why we can afford to back our courses with the iron-clad Warranty shown on the facing page: you get your FCC License or your money back.

There's a reason for this remarkable record. From the beginning, CIE has specialized in electronics courses designed for home study. We have developed techniques that make learning at home easy, even if you've had trouble studying before.

## In a Class by Yourself

Your CIE instructor gives his undivided personal attention to the lessons and questions you send in. It's like being the only student in his "class." He not only grades your work, he analyzes it. Even your correct answers can reveal misunderstandings he will help you clear up. And he mails back his corrections and comments the same day he receives your assignment, so you can read his notations while everything is still fresh in your mind.

## It Really Works

Our files are crammed with success stories of men whose CIE training has gained them their FCC "tickets" and admission to a higher income bracket.

Mark Newland of Santa Maria, Calif., boosted his earnings by \$120 a month after getting his FCC License. He says: "Of 11 different correspondence courses I've taken, CIE's was the best prepared, most interesting, and easiest to understand."

Once he could show his FCC License, CIE graduate Calvin Smith of Salinas, California, landed the mobile phone job he'd been after for over a year.

## Mail Card for Two Free Books

Want to know more? The postpaid reply card bound-in here will bring you free copies of our school catalog describing opportunities in electronics, our teaching methods, and our courses, together with our special booklet, "How to Get a Commercial FCC License." If card has been removed, just mail the coupon at right.

**THESE CIE MEN PASSED THE FCC LICENSE EXAM... NOW THEY HAVE GOOD JOBS**

**Matt Stuczynski,  
Senior Transmitter  
Operator, Radio  
Station WBOE**



"I give Cleveland Institute credit for my First Class Commercial FCC License. Even though I had only six weeks of high school algebra, CIE's AUTO-PROGRAMMED® lessons make electronics theory and fundamentals easy. I now have a good job in studio operation, transmitting, proof of performance, equipment servicing. Believe me, CIE lives up to its promises."

**Chuck Hawkins,  
Chief Radio  
Technician, Division  
12, Ohio Dept.  
of Highways**



"My CIE Course enabled me to pass both the 2nd and 1st Class License Exams on my first attempt... I had no prior electronics training either. I'm now in charge of Division Communications. We service 119 mobile units and six base stations. It's an interesting, challenging and rewarding job. And incidentally, I got it through CIE's Job Placement Service."

**ENROLL UNDER NEW G.I. BILL:** All CIE courses are available under the new G.I. Bill. If you served on active duty since January 31, 1955, OR are in service now, check box on reply card for G.I. Bill information.

**Cleveland Institute of Electronics**  
1776 E. 17th St., Cleveland, O. 44114

Please send me without cost or obligation:

Your 40-page book "How to Succeed in Electronics" describing the job opportunities in Electronics today, and how your courses can prepare me for them.

Your book on "How to Get a Commercial FCC License."

I am especially interested in:

- |  |  |
|--|--|
| <input type="checkbox"/> Electronics Technology  | <input type="checkbox"/> Electronic Communications |
| <input type="checkbox"/> Broadcast Engineering   | <input type="checkbox"/> Industrial Electronics    |
| <input type="checkbox"/> First Class FCC License | <input type="checkbox"/> Electronics Engineering   |

Name \_\_\_\_\_ (PLEASE PRINT)

Address \_\_\_\_\_

City \_\_\_\_\_

State \_\_\_\_\_ Zip \_\_\_\_\_ Age \_\_\_\_\_

Check here for G.I. Bill information

EL-12

## 2 NEW CIE CAREER COURSES

**1. BROADCAST (Radio and TV) ENGINEERING**...now includes Video Systems, Monitors, FM Stereo Multiplex, Color Transmitter Operation and CATV.

**2. ELECTRONICS ENGINEERING**...covers steady-state and transient network theory, solid state physics and circuitry, pulse techniques, computer logic and mathematics through calculus. A college-level course for men already working in Electronics.

**CIE** Cleveland Institute of Electronics  
1776 East 17th Street, Cleveland, Ohio 44114



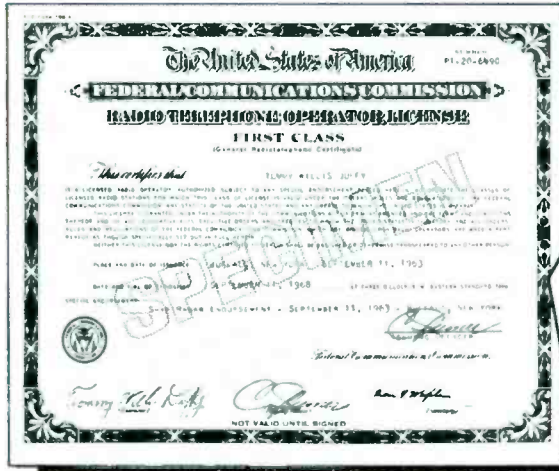

Cleveland Institute of Electronics

# WARRANTY

of success in obtaining a  
 Government FCC License

The Cleveland Institute of Electronics hereby warrants that upon completion of the Electronics Technology, Broadcast Engineering, or First-Class FCC License course, you will be able to pass the FCC examination for a First Class Commercial Radio Telephone License (with Radar Endorsement) ;

OR upon completion of the Electronic Communications course you will be able to pass the FCC examination for a Second Class Commercial Radio Telephone License;

AND in the event that you are unable to pass the FCC test for the course you select, on the very first try, you will receive a FULL REFUND of all tuition payments.

This warranty is valid for the entire period of the completion time allowed for the course selected.

*G. O. Allen*  
 Dr. G. O. Allen  
 President



