

©

ELEMENTARY ELECTRONICS

HOW TO
DX SPACE SHOTS

MARCH-APRIL 75¢

JAN 27 1975

PROJECTS FOR A RAINY DAY
\$925 Line Failure Alarm
\$699 Project Power Pack
\$349 Electronic Foot Stomper



Add
TALK
POWER
to CB and
Ham rigs
↓

design notes
for a
HAM
CONTROL
CENTER



THE INSIDE
STORY ON
DETECTORS: AM/FM/VIDEO

FLIP-FLOPS—
THE TWO-CYLINDER ENGINES OF ELECTRONICS

By the Editors of RADIO-TV EXPERIMENTER



Introducing EICO's New "Cortina Series"!

Today's electro-technology makes possible near-perfect stereo at moderate manufacturing cost: that's the design concept behind the new EICO "Cortina" all solid-state stereo components. All are 100% professional, conveniently compact (3 1/8"H, 12"W, 8"D), in an esthetically striking "low silhouette." Yes, you can pay more for high quality stereo. But now there's no need to. The refinements will be marginal and probably inaudible. Each is \$89.95 kit, \$119.95 wired.

Model 3070 All-Silicon Solid-State 70-Watt Stereo

Amplifier: Distortionless, natural sound with unrestricted bass and perfect transient response (no inter-stage or output transformers); complete input, filter and control facilities; failure-proof rugged all-silicon transistor circuitry.

Model 3200 Solid-State FM/MPX Automatic Stereo Tuner: Driftless, noiseless performance; 2.4μV for 30db quieting; RF, IF, MX are pre-wired and pre-tuned on printed circuit boards — you wire only non-critical power supply.

7 New Ways to make Electronics more Fun!

Save up to 50% with EICO Kits and Wired Equipment.



You hear all the action-packed capitals of the world with the NEW EICO 711 "Space Ranger" 4-Band Short Wave Communications Receiver — Plus ham operators, ship-to-shore, aircraft, Coast Guard, and the full AM band. 550KC to 30MC in four bands. Selective, sensitive superhet, modern printed circuit board construction. Easy, fast pinpoint tuning; illuminated slide-rule dials, logging scale; "S" meter, electrical bandspread tuning, variable BFO for CW and SSB reception, automatic noise limiter. 4" speaker. Headphone jack. Kit \$49.95. wired \$69.95.



More "ham" for your dollar than ever — with the one and only SSB/AM/CW 3-Band Transceiver Kit, new Model 753 — "the best ham transceiver buy for 1966" — Radio TV Experimenter Magazine. 200 watts PEP on 80, 40 and 20 meters. Receiver offset tuning, built-in VOX, high level dynamic ALC, silicon solid-state VFO. Unequaled performance, features and appearance. Sensationally priced at \$189.95 kit, \$299.95 wired.

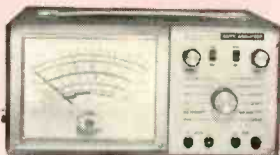

NEW EICO 888 Solid-State Engine Analyzer

Now you can tune-up, trouble-shoot and test your own car or boat.

Keep your car or boat engine in tip-top shape with this completely portable, self-contained, self-powered universal engine analyzer. Completely tests your total ignition/electrical system. The first time you use it — just to tune for peak performance — it'll have paid for itself. (No tune-up charges, better gas consumption, longer wear) 7 instruments in one, the EICO 888 does all these for 6V and 12V systems; 4, 6 & 8 cylinder engines.

The EICO 888 comes complete with a comprehensive Tune-up and Trouble-shooting Manual including RPM and Dwell angle for over 40 models of American and Foreign cars. The Model 888 is an outstanding value at \$44.95 kit, \$59.95 wired.



New EICOCRAFTS easy-to-build solid-state electronic TruKits: \$ great for beginners and sophisticates alike. As professional as the standard EICO line — only the complexity is reduced to make kit-building faster, easier, lower cost. Features: pre-drilled copper-plated etched printed

circuit boards; finest parts; step-by-step instructions; no technical experience needed — just soldering Iron and pliers. Choose from: Fire Alarm; Intercom; Burglar Alarm; Light Flasher; "Mystifier"; Siren; Code Oscillator; Metronome; Tremolo; Audio Power Amplifier; AC Power Supply. From \$2.50 per kit.



There's more PUNCH in the new EICO "Sentinel-Pro" 23-channel Dual Conversion 5-watt CB Transceiver. New advanced Big-Reach "Range Plus" circuitry lengthens "talk-power" reach. Automatic noise limiter super-sensitizes for weak signals. "Finger Tip" antenna loading and transmitter tuning controls. 23 crystal-controlled transmit and receive channels — all crystals supplied. Rear-illuminated S/R/F meter. Transistorized 12VDC and 117VAC dual power supply. Wired only, \$169.95. Positive-Negative Ground/Mobile Marine Modification kit (optional \$5.95).



Model 460 Wideband Direct-Coupled 5" Oscilloscope, DC-4.5mc for color and B&W TV service and lab use. Push-pull DC vertical amp., bal. or unbal. input. Automatic sync limiter and amp. \$109.95 kit, \$149.95 wired.

FREE 1967 CATALOG

EICO Electronic Instrument Co., Inc. EE-3
131-01 39th Ave., Flushing, N. Y. 11352

Send me FREE catalog describing the full EICO line of 200 best buys, and name of nearest dealer. I'm interested in:

- test equipment ham radio
 stereo/hi-fi Citizens Band radio
 automotive electronics

Name _____

Address _____

City _____

State _____

Zip _____



Model 232 Peak-to-Peak VTVM. A must for color or B&W TV and industrial use. 7 non-skip ranges on all 4 functions. With exclusive Uni-Probe. \$29.95 kit, \$48.95 wired.

Let I.C.S. equip you for success in radio-TV-electronics—

with professional equipment!



Brand-new "Electronic Laboratory," now being offered for the first time, can help you land in this big money-making field—FAST!

Here's an opportunity for you to turn spare time into cold cash, or begin a whole new career—in a field where the rewards have never been greater. And you *don't* need previous experience to do it!

International Correspondence Schools has just developed a new I.C.S. Electronic Laboratory you can construct in your own home. Includes series of training kits, plus the new I.C.S. VTVM—the professional quality vacuum tube voltmeter shown here. With it comes complete course instruction combining all the fundamentals with practical knowledge you can apply at once. And best of all, you build your own professional test instrument!

I.C.S. instruction gets you going with equipment you can really use!

A famous manufacturer of nationally known electronic testing equipment worked closely with I.C.S. to develop the Electronic Laboratory and the VTVM itself. Everything you get is geared to increase your skill and knowledge step by step. Until finally, you've completed a precision testing

unit you can use for practically any kind of experimentation, design or servicing work.

Here's how I.C.S. instruction works. You begin with basic study lessons. Texts are clearly worded and easy to follow. At the same time, you "act out" what you learn with simple experiments. Then, in 3 easy stages, you assemble your own precision testing unit. Throughout, your instructor gives you expert, professional help. You learn at home, in spare time, as fast as ability permits.

Coupon brings full details on your future in this fast-growing field!

Make up your mind right now to find out how I.C.S. training in Radio-TV-Electronics can pay off for *you*. See how it can help you cash in on the tremendous demand for men skilled in installation, maintenance and servicing of radios, TV sets, hi-fis, computers, automation systems and a host of other space-age devices. Clip and mail the coupon below. You'll receive 3 valuable *free* booklets—including sample lesson. They'll show how you can land in this big-money field *fast!*

Coupon brings 3 valuable FREE booklets. MAIL IT TODAY!

INTERNATIONAL CORRESPONDENCE SCHOOLS I C S

Dept. 34974A, Scranton, Penna. 18515

(In Hawaii: P.O. Box 418, Honolulu. In Canada: I.C.S. Canadian, Ltd. In other countries: I.C.S. World, Ltd.)

Please rush me your new 64-page booklet "ElectronICS" which answers the most often-asked questions about preparing for an electronics career. Also send me "How to Succeed," and a sample I.C.S. lesson. I have indicated my field of interest below.

- | | | | | |
|---|---|---|---|---|
| <input type="checkbox"/> Electronic Fundamentals | <input type="checkbox"/> Hi-Fi/Stereo & Sound Systems | <input type="checkbox"/> Electronic Principles for Automation | <input type="checkbox"/> Industrial Electronics Engineering | <input type="checkbox"/> Industrial Electronics Telephony |
| <input type="checkbox"/> Electronic Instrumentation | <input type="checkbox"/> General Electronics | <input type="checkbox"/> Semiconductor-Transistor Circuits | <input type="checkbox"/> FCC Radiotelephone Licenses | <input type="checkbox"/> Other (please specify) _____ |
| <input type="checkbox"/> Computer Fundamentals | <input type="checkbox"/> Radio-TV Servicing | <input type="checkbox"/> Electronics Technician | | |

Name _____ Age _____

Address _____

City _____ State _____ Zip Code _____

Occupation _____ Employed by _____

Working Hours _____ A.M. to _____ P.M. Convenient payment plan _____ Training Programs for Industry _____

I am a member of U.S. Armed Forces. Send me facts about special low rates.

ELEMENTARY ELECTRONICS

MARCH/APRIL, 1967

THEORY

- ☆ 29 Flip-Flops—The Two-cylinder Engines of Electronics
- 37 Those Electronic Diagrams
- 55 SSB Is In!
- ☆ 81 The Inside Story on Detectors
- 97 Power in Watts

CONSTRUCTION

- ☆ 43 Ham Shack with a Heart
- ☆ 49 Transmitter Speech Processor
- ☆ 61 Power Pack: Experimenter's Six or Niner
- 66 50¢ Transistor Tester
- ☆ 71 Line Failure Alarm
- ☆ 93 Electronic Foot Stomper
- 95 Tenna Blitz

FEATURES

- 16 Tips from a Technician's Notebook
- 28 Wide World of Electronics
- 46 Great Day for QSL
- 47 Lafayette RK-840 Stereo Tape Recorder
- 64 Space-age Showcase
- ☆ 68 Space Shots: Countdown for DX
- 79 Low Down on Way Down QSL
- 80 Arecibo Listening

DEPARTMENTS

- 6 Newscan—Electronics in the News
- 18 Ask Me Another
- 24 e/e Etymology
- 25 En Passant—Chess Column
- 67 Imagineering
- 74 Home-Study Bluebook
- 75 FCC Q & A
- 108 Literature Library

- ☆ Cover Highlights

AUTHORS IN THIS ISSUE:

Len Buckwalter—K1ODH/KBA4480, John W. Collins, James A. Fred, Herb Friedman—W2ZLF/KBI9457, Webb Garrison, Carl L. Henry, Steve Karlson, Tom Kneitel—K2AES/KBG4303, Walter R. Levins, A.A. Mangieri, Francois Markett, Howard S. Pyle—W7OE, Leo G. Sands—W7PH/KBG7906, E. Norbert Smith—W5MQL, and the ELEMENTARY ELECTRONICS' Editorial Staff.

Cover Photo by Leonard Hecklen



NOW THERE ARE 138 RADIO SHACKS COAST TO COAST!

- ARIZONA — Phoenix
- ARKANSAS — Little Rock
- CALIFORNIA — Anaheim, Bakersfield, Downey, Garden Grove, La Habra, Long Beach, Los Angeles, Mission Hills, Mountain View, Oakland, Rededa, Sacramento, San Bruno, San Diego, San Francisco, Santa Ana, Santa Monica, Torrance, West Covina
- COLORADO — Denver
- CONNECTICUT — Hamden, Manchester, New Britain, New Haven, New London, Orange, Stamford, West Hartford
- FLORIDA — Orlando
- GEORGIA — Atlanta
- ILLINOIS — Chicago
- KANSAS — Wichita
- LOUISIANA — New Orleans
- MAINE — Portland
- MARYLAND — Langley Park
- MASSACHUSETTS — Boston, Braintree, Brockton, Brookline, Cambridge, Dedham, Framingham, Lowell, Medford, Natick, Quincy, Saugus, Springfield, Waltham, West Springfield, Worcester
- MICHIGAN — Detroit
- MINNESOTA — Minneapolis, St. Paul
- MISSOURI — Kansas City, St. Joseph, St. Louis
- NEBRASKA — Omaha
- NEW HAMPSHIRE — Manchester
- NEW JERSEY — Pennsauken
- NEW MEXICO — Albuquerque
- NEW YORK — Albany, Binghamton, Buffalo, New York, Schenectady, Syracuse
- OHIO — Cincinnati, Cleveland
- OKLAHOMA — Oklahoma City, Tulsa
- OREGON — Portland
- PENNSYLVANIA — Philadelphia, Pittsburgh
- RHODE ISLAND — Providence, East Providence
- TENNESSEE — Chattanooga, Memphis, Nashville
- TEXAS — Abilene, Arlington, Austin, Brownsville, Corpus Christi, Dallas, Fort Worth, Houston, Lubbock, Midland, San Antonio, Sherman, Waco
- UTAH — Salt Lake City
- VIRGINIA — Arlington, Virginia Beach
- WASHINGTON — Everett, Seattle

RADIO SHACK

SPECIAL GET-ACQUAINTED OFFER FROM THE COUNTRY'S LEADING ELECTRONIC PARTS DISTRIBUTOR!

1,000 OHMS/VOLT POCKET AC/DC VOM

Thousands Sold at Our Regular Low Price:

~~5.95~~
YOU SAVE \$2.00

- Measures a Mere 3 1/2" x 2 1/8" x 1"
- Thumb-Set Zero Adjustment
- With Test Leads and Battery

Lowest price ever! 2-color scale; 5 ranges. AC/DC volts: 0-1000 in 3 ranges; 0-150 ma DC; 0-100 KΩ. 22-4027.

ONLY 3.95



HOBBYIST'S ONE TUBE RADIO KIT



- Tunes AM Band from 540-1600 KC
- Hi-Q Coil for Top Sensitivity

28-001

3.49

Fun to use; easy enough for anyone to build.

2-TRANSISTOR AM RADIO KIT



- With Crystal Earphone
- Solid State Circuitry
- Ideal for Beginners or Do-It-Yourselfers

28-002

3.98

Fine reception across the entire broadcast band!

WIRELESS MIKE/TRANSMITTER KIT



- Broadcasts into Any AM Radio at Ranges up to 20 Feet!

28-003

2.98

Use as room-to-room intercom or "baby-sitter"!

ELECTRONIC ORGAN KIT



- Better than 1 Octave Range! Easy to Play!
- A Family Favorite!

28-004

5.95

Play songs on an organ you built yourself!

SAVE \$1.00



Your Choice of Either \$2 Book at Half Price!

50 easy-to-build solid state projects... from a simple radio to a 2-way intercom system. Each book entirely different: Book 1, 62-1050; Book 2, slightly more advanced, 62-2025

FILL OUT COUPON AND MAIL TODAY TO:

RADIO SHACK

East: 730 Commonwealth Ave., Boston, Mass. 02215
West: 1515 So. University Dr., Ft. Worth, Tex. 76107

Please rush me the item I've checked below.

I enclose \$ _____, plus 50¢ for postage and handling:

VOM, 22-4027

Organ, 28-004

1-Tube Radio, 28-001

Book #1, 62-1050

2-Trans. Radio, 28-002

Book #2, 62-2025

Wireless Mike, 28-003

Please send me a FREE 1967 Radio Shack Catalog

Name (print) _____

Street _____

City _____

State _____ Zip _____

EE-367

Now there's a full line of

Weller®

Soldering Tools

for all soldering needs

Each model outperforms any other soldering tool of comparable size and price. All have replaceable tips of solid copper, instant heat, long reach, and rugged construction that means long-life, dependable performance.



Weller Dual Heat Guns

Feature trigger-controlled dual heat, efficient double-barrel design, long-life tip, and work spotlight. Available in three wattage ratings, and in handy soldering gun kits. Priced from \$6.95 list.

Weller MARKSMAN Irons

Best for intricate soldering or continuous-duty operation. Five sizes—all lightweights—with replaceable, premium-plated $\frac{1}{8}$ " to $\frac{3}{16}$ " tips. From \$2.98 list. Also in complete kit form with a soldering aid, solder and 2 extra soldering tips.



Try them all . . . at your electronic parts distributor!

WELLER ELECTRIC CORP., Easton, Pa.
WORLD LEADER IN SOLDERING TECHNOLOGY

ELEMENTARY ELECTRONICS

MARCH/APRIL 1967

Vol. 4 No. 1

Dedicated to America's Electronics Experimenters

JULIAN M. SIENKIEWICZ WA2CQL/KMD4313	<i>Editor</i>
RICHARD A. FLANAGAN	<i>Managing Editor</i>
ELMER C. CARLSON KOD1752	<i>Technical Editor</i>
JIM MEDLER	<i>Art Editor</i>
HELEN PARKER	<i>Editorial Assistant</i>
ANTHONY MACCARRONE	<i>Art Director</i>
EUGENE F. LANDINO	<i>Associate Art Director</i>
IRVING BERNSTEIN	<i>Cover Art Director</i>
BARBARA GABRIEL	<i>Art Associate</i>
JIM CAPPELLO	<i>Advertising Manager</i>
LEONARD F. PINTO	<i>Production Director</i>
CARL BARTEE	<i>Production Manager</i>
HELEN GOODSTEIN	<i>Assistant Production Manager</i>
DAVID COHN	<i>Promotion Director</i>
WILFRED M. BROWN	<i>Kit Division Manager</i>
JOSEPH DAFFRON	<i>Group Executive Editor</i>

President and Publisher
B. G. DAVIS

Executive Vice President and Assistant Publisher
JOEL DAVIS

Vice President and Editorial Director
HERB LEAVY, KMD4529



ELEMENTARY ELECTRONICS, Vol. 4, No. 1 is published bi-monthly by SCIENCE & MECHANICS PUBLISHING CO., a subsidiary of Davis Publications, Inc. Editorial, business and subscription offices: 505 Park Ave., New York, N. Y. 10022. One-year subscription (six issues)—\$4.00; two-year subscription (12 issues)—\$7.00; and three-year subscription (18 issues)—\$10.00. Add \$1.00 per year for postage outside the U.S.A. and Canada. Advertising offices: New York, 505 Park Ave., 212-PL-2-6200; Chicago: 520 N. Michigan Ave., 312-527-0330; Los Angeles: 6253 Hollywood Blvd., 213-463-5143; Atlanta: Pirnie & Brown, 3108 Piedmont Rd., N.E., 404-233-6729; Long Island: Len Osten, 9 Garden Street, Great Neck, N. Y., 516-487-3305; Southwestern advertising representative: Jim Wright, 4 N. Eight St., St. Louis, CH-1-1965.

EDITORIAL CONTRIBUTIONS must be accompanied by return postage and will be handled with reasonable care; however, publisher assumes no responsibility for return or safety of manuscripts, art work, or photographs. All contributions should be addressed to the Editor, ELEMENTARY ELECTRONICS, 505 Park Avenue, New York, N. Y. 10022.

Second-class postage paid at New York, New York and at additional mailing office. Copyright 1966 by Science and Mechanics Publishing Co.

Want a high-pay career in Electronics?

This free book may change your life

It tells how to go about getting the key
to job success in the growing electronics
boom—a Government FCC License

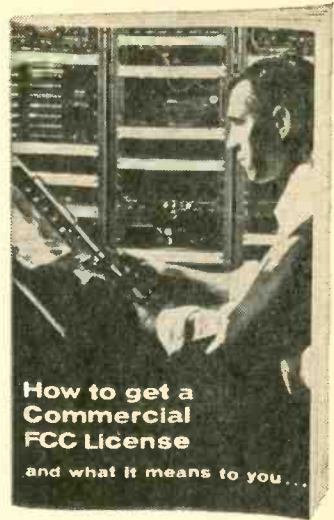

THERE'S A BIG BOOM IN ELECTRONICS. And YOU can be part of it. You don't need a college education or any previous experience in electronics. The free book shown here tells you how.

In the last 15 years, the electronics manufacturing industry alone has grown from \$2.7 billion to \$17 billion, and is expected to hit \$24 billion by 1970.

Thousands of trained men are urgently needed to help design, manufacture, inspect, test, install, operate, and service electronics marvels that are making headlines. If you qualify, it means a secure, steady high-pay job with a real future to it.

Maybe you'd like to become a broadcast engineer . . . put famous radio disc jockeys and television entertainers "on the air." Or be your own boss servicing some of the more than a million two-way mobile radio systems in taxis, trucks, trains, etc. Or work alongside famous scientists developing and testing such electronics miracles as picture-frame TV, desk-top computers, pea-sized hearing aids, rocket guidance and control systems.

Regardless of which you choose, the secret of "getting your foot in the door" is getting a Government FCC (Federal Communications Commission) License. It's government-certified *proof*, respected by employers everywhere, that you have passed a standard Federal exam on the fundamentals of electronics—that you're not just an electronics handyman, but a real "pro." Many jobs legally require it.

Now, because of the importance of getting your FCC License, Cleveland Institute of Electronics has prepared a valuable 24-page book telling you how to go about it.

ENROLL UNDER NEW G.I. BILL

All CIE courses are available under the new G.I. Bill. If you served on active duty since January 31, 1955, OR are in service now, check box in coupon for G.I. Bill information.

You will find out why the Commercial FCC License is often called the "passport to success." You'll see how and why the Government issues these licenses. You'll learn how you can get your license . . . and qualify for top opportunities in Electronics.

With this book, you will receive a second free book, "How To Succeed In Electronics." It's the catalog of the Cleveland Institute of Electronics . . . first organization to offer an FCC License Warranty. (CIE will refund all of your tuition if you don't pass the FCC exam . . . on your first try . . . after completing the course designed to prepare you for it.) You will learn why better than 9 out of 10 men with CIE training get their FCC Licenses, even though 2 out of 3 without this training fail.

To receive both books without cost or obligation, just mail the coupon below. If coupon has been removed, write to: Cleveland Institute of Electronics, 1776 East 17th Street, Dept. EL-1, Cleveland, Ohio 44114. Do it now—it may change your whole life.

MAIL COUPON FOR 2 FREE BOOKS

CIE Cleveland Institute of Electronics
1776 East 17th Street, Cleveland, Ohio 44114

Please send me, without cost or obligation, your 24-page book, "How To Get A Commercial FCC License," together with your school catalog, "How To Succeed In Electronics," of license-preparation courses.

Name _____ (please print)

Address _____

City _____ State _____ Zip _____

Occupation _____ Age _____

Check here for G.I. Bill information.

Accredited Member National Home Study Council
A Leader in Electronics Training . . . Since 1934

EL-1

SHOPPING MART

GIANT SURPLUS BALLOONS



Edmund Scientific Co., Barrington, New Jersey 08007.

"Balls of fun" for the kids, traffic stoppers for stores, terrific for amateur meteorologists. Create a neighborhood sensation. Great backyard fun. Exciting beach attraction. Amateur meteorologists use to measure cloud heights, wind speed and temp. Made of heavy black rubber. Inflate with vacuum cleaner or auto air hose; or locally available helium for high rise. 8' diam. \$2.00 Ppd. Order Stock No. 60,568EK.

HI-VOLTAGE ELECTROSTATIC GENERATOR



\$43.50 Ppd. Order #70,264EK. Edmund Scientific Co., Barrington, New Jersey 08007.

Van De Graaf low-amp type. 200,000 volt potential, yet completely safe. Demonstrates lightning. St. Elmo's fire, repulsion of charges, electrostatic dust collection, many other electrical wonders. Motor, 110V, 60-cycle, AC. Humidity range, 0-90%. Current, 1.5 to 2.5 microamps. Aluminum base, frame and charge collector. Unbreakable plastic insulating column. Ht. 17", dia. 6 3/4". Full instructions.

EXPERIMENTAL FUN WITH TESLA COIL



6". \$44.00 Ppd. Order #70,301EK. Edmund Scientific Co., Barrington, New Jersey 08007.

Now perform spectacular experiments without wires as Nicola Tesla did 50 yrs. ago. Generator with coil, etc., transmits extremely high frequency electromagnetic radiation (millions of cycles per second)—through space. Lights fluorescent tube 2 ft. away, ionizes gases, performs total of 21 fascinating experiments. Incl. Neon Lamp, discharge electrode, 2 radiation antenna plates. Generates 5,000 V for 110 V 60-C AC. Mens. 6" x 6" x 6".

DUPONT PLASTIC LIGHT GUIDE KIT



stock #70,683EK AD. Edmund Scientific Co., Barrington, N. J.

Experiment with amazing new plastic fiber optic light guides. 1001 uses for mfrs., experimenters, hobbyists. Use for exciting new projects and products. Guides transmit light same as wire conducts electricity. Use to illuminate remote areas, multiple locations from single source, confine light to small areas, conduct sensing and control systems. Inc. 2 guides, source, lens, dyes, connectors. \$10 Ppd. Order #70,855EK. Edmund Scientific Co., Barrington, New Jersey 08007.

NEW MODEL DIGITAL COMPUTER



stock #70,683EK AD. Edmund Scientific Co., Barrington, N. J.

Solve problems, tell fortunes, play games with miniature version of giant electronic brains! Adds, subtracts, multiplies, shifts, complements, carries, memorizes. Colored plastic parts easily assembled. 12" x 3 1/2" x 4 3/4". Incl. step-by-step assembly diagrams, 32-p. instruction book covering operation, computer language (binary system) programming, problems & 15 experiments. \$5.98 Ppd. Order #70,571EK. Edmund Scientific Co., Barrington, N. J. 08007.

"FISH" WITH A MAGNET



Go treasure hunting on the bottom! Fascinating fun & sometimes profitable! Tie a line to our 5-lb. Magnet—drop it overboard in bay, river, lake or ocean. Trol it along bottom—your "treasure" haul can be outboard motors, anchors, other metal valuables. 5-lb. Magnet is war surplus—Ainco V Type—Gov't. cost \$50. Lifts over 150 lbs. on land—much greater weight under water. \$12.50 Ppd. Order Stock #70,571EK. Edmund Scientific Co., Barrington, N. J. 08007.

GIANT FREE CATALOG



Completely new 1967 edition—148 pages. Bargains galore! New categories, items, illustrations. 1,000's of buys for industry. Optics, Science, Math. On-the-job helps, quality control aids. Optics for research labs, design engineers, experimenters. Instruments for checking, measuring... to speed work, improve quality, cut costs. Hard-to-get war surplus bargains. Write for Catalog EK. Edmund Scientific Co., Barrington, New Jersey 08007.



NEWSCAN

Laser TV

Scientists have developed an experimental TV picture system using a laser beam scanned by ultrasonic waves. The system produces large-size pictures for projection with sharpness and detail approaching that of a conventional TV picture. Designed by Zenith scientists, the system is one of a number of approaches to TV picture displays of the future being investigated in Zenith laboratories. The experimental laser system demonstrates the feasibility of an all-electronic approach to a TV picture display using a laser light source. Their achievement represents a step toward developing the technology necessary for new methods of TV picture display not dependent on the cathode-ray tube.

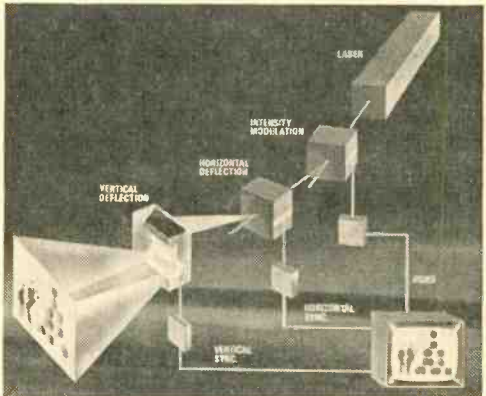

Block diagram of Zenith's experimental laser TV system shows four major components in processing of picture and stages where TV signals from parts of TV chassis are processed and fed into system. Complete chassis is not necessary to system, but is used to provide necessary electronic signals and for monitoring.

Zenith's experimental laser display system uses: a 50 milliwatt, helium-neon laser light source; a first ultrasonic diffraction cell for in-

(Continued on page 10)

Regardless Of What You Pay For A Color TV...

It Can't Perform As Well As This New Heathkit® "180" For Only \$379⁹⁵*



Here's Why!

Exclusive Features That Can't Be Bought In Ready-Made Sets At Any Price! All color TV sets require periodic convergence and color purity adjustments. This new Heathkit GR-180 has *exclusive* built-in servicing aids so you can perform these adjustments anytime . . . *without* any special skills or knowledge. Simple-to-follow instructions and detailed color photos in the GR-180 manual show you exactly what to look for, what to do and how to do it. Results? Beautifully clean and sharp color pictures day in and day out . . . and up to \$200 savings in service calls during the life of your set!

Exclusive Heath Magna-Shield . . . surrounds the entire tube to keep out stray magnetic fields and improve color purity. In addition, *Automatic Degaussing* demagnetizes and "cleans" the picture everytime you turn the set on from a "cold" start.

Choice Of Installation . . . Another Exclusive! The GR-180 is designed for mounting in a wall or your own custom cabinet. Or you can install it in either optional Heath factory-built Contemporary or Early American styled cabinets.

From Parts To Programs In Just 25 Hours. All critical circuits are preassembled, aligned and tested at the factory. The GR-180 manual guides you the

rest of the way with simple, non-technical instructions and giant pictorials. You can't miss!

Plus A Host Of Advanced Features . . . like the hi-fi 180 sq. inch rectangular tube with "rare earth phosphors", smaller dot size and 24,000 volt picture power for brighter, livelier colors and sharper definition . . . *Automatic Color Control* and gated *Automatic Gain Control* to reduce color fading and insure jitter-free pictures at all times . . . deluxe *VHF Turret Tuner* with "memory" fine tuning . . . *2-Speed Transistor UHF Tuner* . . . *Two Hi-Fi Sound Outputs* for play through your hi-fi system or connection to the GR-180's 4" x 6" speaker . . . *Two VHF Antenna Inputs* — a 300 ohm balanced and a 75 ohm coax . . . *1-Year Warranty* on the picture tube, 90 days on other parts. For full details mail coupon on the following page. Better yet, use it to order the best 19" Color TV buy . . . it's available now in limited quantities.

***Kit GR-180**, everything except cabinet,
102 lbs. \$379.95
GRA-180-1, walnut cabinet (shown above),
30 lbs. . . 18 1/4" D x 28 1/4" W x 29" H . . . \$49.95
GRA-180-2, Early American cabinet,
37 lbs. . . 18 1/4" D x 28 1/4" W x 31 3/4" H . . .
Available February \$75.00

NEW 12" Transistor Portable TV — First Kit With Integrated Circuit

Unusually sensitive performance. Plays anywhere . . . runs on household 117 v. AC, any 12 v. battery, or optional rechargeable battery pack (\$39.95); receives all channels; new integrated sound circuit replaces 39 components; preassembled, prealigned tuners; high gain IF strip; Gated AGC for steady, jitter-free pictures; front-panel mounted speaker; assembles in only 10 hours. Rugged high impact plastic cabinet measures a compact 11 1/2" H x 15 3/4" W x 9 9/16" D. 27 lbs.

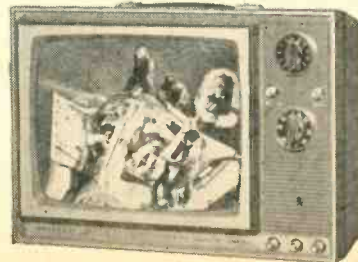

Kit GR-104
\$119⁹⁵

Turn Page For More New Kits From HEATH

How To Have Fun While You Save . . .

Harmony-by-Heathkit® Electric Guitars & Heathkit Guitar Amplifier



A \$129⁹⁵
Kit TA-16

A NEW Heathkit Transistor Guitar Amplifier

60 watts peak power; two channels — one for accompaniment, accordion, organ, or mike, — the other for special effects . . . with both variable reverb and tremolo; 2 inputs each channel; two foot switches for reverb & tremolo; two 12" heavy-duty speakers; line bypass reversing switch for hum reduction; one easy-to-build circuit board with 13 transistors, 6 diodes; 28" W. x 9" D. x 19" H. leather-textured black vinyl cabinet of 3/4" stock; 120 v. or 240 v. AC operation; extruded aluminum front panel. 52 lbs.

American Made Harmony-By-Heathkit Guitars

All wood parts factory assembled, finished and polished . . . you just mount the trim, pickups and controls in predrilled holes and install the strings . . . finish in one evening.

These Valuable Accessories
Included With
Every Guitar Kit

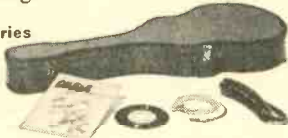

Each guitar includes vinylized chipboard carrying case, cushioned red leather neck strap, connecting cord, Vu-Tuner® visual tuning aid, tuning record, instruction book and pick . . . worth \$19.50 to \$31.50 depending on model.

B Deluxe Guitar . . . 3 Pickups . . . Hollow Body

Double-cutaway for easy fingering of 16 frets; ultra-slim fingerboard — 24 1/4" scale; ultra-slim "uniform feel" neck with adjustable Torque-Lok

B
Kit TG-46
\$219⁹⁵
(save \$111.55)



C
Kit TG-26
\$99⁹⁵
(save \$47)



D
Kit TG-36
\$119⁹⁵
(save \$40.55)



reinforcing rod; 3 pickups with individually adjustable pole-pieces under each string for emphasis and balance; 3 silent switches select 7 pickup combinations; 6 controls for pickup tone and volume; professional Bigsby vibrato tail-piece; curly maple arched body — 2" rim — shaded cherry red. 17 lbs.

C Silhouette Solid-Body Guitar . . . 2 Pickups

Modified double cutaway leaves 15 frets clear of body; ultra-slim fingerboard — 24 1/4" scale; ultra-slim neck for "uniform feel"; Torque-Lok adjustable reinforcing rod; 2 pickups with individually adjustable pole-pieces under each string; 4 controls for tone and volume; Harmony type 'W' vibrato tail-piece; hardwood solid body, 1 1/2" rim, shaded cherry red. 13 lbs.

D "Rocket" Guitar . . . 2 Pickups . . . Hollow Body

Single cutaway style; ultra-slim fingerboard; ultra-slim neck, steel rod reinforced; 2 pickups with individually adjustable pole-pieces for each string; silent switch selects 3 combinations of pickups; 4 controls for tone and volume; Harmony type 'W' vibrato tailpiece; laminated maple arched body, 2" rim; shaded cherry red. 17 lbs.

NEW! Deluxe Solid-State FM /FM Stereo Table Radio

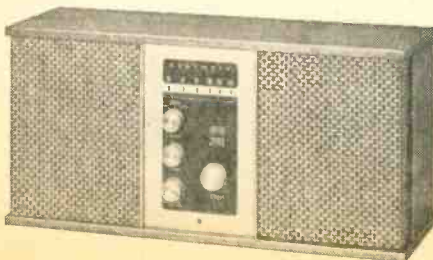

Kit GR-36
\$69⁹⁵

Tuner and IF section same as used in deluxe Heathkit transistor stereo components. Other features include automatic switching to stereo; fixed AFC; adjustable phase for best stereo; two 5/4" PM speakers; clutched volume control for individual channel adjustment; compact 19" W x 6 1/2" D x 9 1/4" H size; preassembled, prealigned "front-end"; walnut cabinet; simple 10-hour assembly. 17 lbs.

Build Your Own Heathkit® Electronics

NEW Heathkit® /Magnecord® 1020 4-Track Stereo Recorder Kit



Kit AD-16
\$399⁵⁰
 (less cabinet)

Save \$170 by doing the easy assembly yourself. Features solid-state circuitry; 4-track stereo or mono playback and record at 7½ & 3¼ ips; sound-on-sound, sound-with-sound and echo capabilities; 3 separate motors; solenoid operation; die-cast top-plate, flywheel and capstan shaft housing; all push-button controls; automatic shut-off; plus a host of other professional features. 45 lbs. Optional walnut base \$19.95, adapter ring \$4.75.

New! SB-101 80-10 Meter SSB Transceiver —

Now With Improved CW Transceive Capability



Kit SB-101
\$360⁰⁰
 (less speaker)

Now features capability for front panel switch selection of either the USB/LSB standard 2.1 kHz SSB filter or the optional SBA-301-2 400 Hz CW filter . . . plus simplified assembly at no increase in price over the already famous Heathkit SB-100. Also boasts 180-watt P.E.P. input, 170 watts input CW, PTT & VOX, CW sidetone, Heath LMO for truly linear tuning and 1 kHz dial calibrations. 23 lbs. SBA-301-2, 400 Hz CW filter . . . \$20.95. Kit HP-13, mobile power supply . . . \$59.95. Kit HP-23, fixed station supply . . . \$39.95

2-Watt Walkie-Talkie



Assembled
 GRS-65A
\$99⁹⁵

New . . . Factory Assembled. Up to 6 mile range; rechargeable battery; 9 silicon transistors, 2 diodes; superhet receiver; squelch; ANL; aluminum case. 3 lbs. 117 v. AC battery charger & cigarette lighter charging cord \$9.95. Crystals \$1.99 ea.

NEW Portable Phonograph Kit

Kit GD-16
\$39⁹⁵



All Transistor. Assembles in 1 to 2 hours. Preassembled 4-speed automatic mono changer; 4" x 6" speaker; dual Sapphire styli; 45 rpm adaptor; olive & beige preassembled cabinet; 117 v. AC. 23 lbs.



FREE

World's Largest
 Electronic Kit
 Catalog!

108 pages ... many in full color ... describe these and over 250 easy-to-build Heathkits for color TV, stereo/hi-fi, CB, ham, marine, shortwave, test, educational, home and hobby items. Mail coupon for your free copy.

HEATH COMPANY, Dept. 139-3
 Benton Harbor, Michigan 49022

Enclosed is \$ _____, plus shipping.

Please send model (s) _____

Please send FREE 1967 Heathkit Catalog.

Name _____

Address _____

City _____

State _____

Zip _____

Prices & specifications subject to change without notice.

CL-269

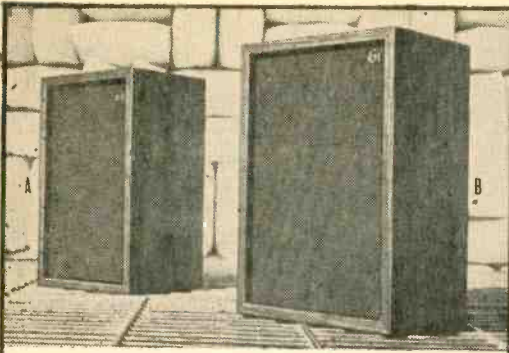

When a Pioneer Speaks ...it's time to listen!

That's when you'll hear the optimum in tonal quality . . . sound reproduction at its faithful best.

You can always count on Pioneer speakers and speaker systems to deliver a quality performance. Every time. All the time.

Made by the world's largest manufacturer of speakers, this premium audio equipment is available at popular prices.

And you can select from many fine models—from the unique, handsome metal-grilled CS-24 Auxiliary Wall Speaker to the efficient, compact CS-20, CS-52 and the Ultimate 5-speaker CS-61 Bookshelf System. All carried only by franchised dealers.

A word from you and we'll send literature and the name of your nearest dealer.

(A) CS-62 Bookshelf 3-way speaker system (3 speakers). Oiled walnut enclosure. Meas. 25 $\frac{5}{8}$ " x 15 $\frac{5}{8}$ " x 11 $\frac{1}{8}$ ", retail price: \$142.00.

(B) CS-61 Bookshelf 3-way speaker system (5 speakers). Oiled walnut enclosure. Meas. 24 $\frac{1}{4}$ " x 16 $\frac{1}{8}$ " x 13 $\frac{1}{4}$ ", retail price: \$175.00.

(C) CS-20 Compact 2-way speaker system. Oiled walnut enclosure. Meas. 13 $\frac{1}{4}$ " x 8" x 8 $\frac{1}{2}$ ", retail price: \$35.00.

(D) CS-24 Ultra-thin wall or bookshelf speaker system. Unique metal-grilled oiled walnut enclosure. Meas. 16 $\frac{1}{8}$ " x 10 $\frac{5}{8}$ " x 4 $\frac{3}{4}$ ", retail price: \$27.75.

(E) CS-52 Compact 2-way speaker system. Oiled walnut enclosure with gold metal trim. Meas. 13 $\frac{1}{2}$ " x 8 $\frac{1}{4}$ " x 8 $\frac{1}{2}$ ", retail price: \$59.95.



**PIONEER ELECTRONICS U.S.A.
CORPORATION**

140 SMITH AVENUE, FARMINGDALE, LONG ISLAND, N.Y. 11735
(516) 694-7720

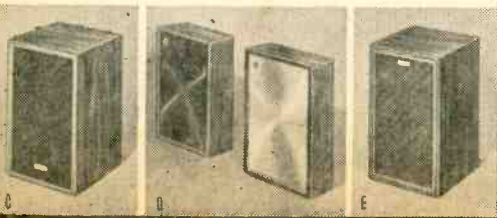

NEWSCAN

tensity modulation; a second diffraction cell that acts as a horizontal deflector which provides a high degree of resolution; and a vertical deflector. They perform essentially the same functions as parts of a conventional picture tube and deflection yoke. In addition there are a number of optical components to shape and focus the beam on a screen. Because a helium-neon laser emits a red light beam, the picture on the screen is black and red.

The principle of using ultrasonic waves to interact with a light beam is one that has been known for some 30 years. Previously it was thought that ultrasound could only be applied to intensity modulation or control of brightness. TV signals for display by the system are provided by portions of a regular TV chassis and are processed before being fed into the intensity modulation (video), horizontal deflection and vertical deflection stages of the system.

Honest Weight

A new portable electronic platform scale developed by *Revere Corporation of America* determines the load imposed by the wheels of a "front loader" with precise accuracies of 99.95% (better than Ivory soap). Battery-powered and designed specifically for use in



A big job by a small bit of electronics is performed by Revere's portable electronic scale.

remote areas, the unit's platforms and ramps weigh only 800 lbs. A technician is shown reading the instrument which indicates the load put on each of the two platforms by the 70,000-lb. frontloader. Rear wheels can be measured simply by driving the frontloader forward a few feet. The combined load of the platforms, each with a capacity of 100,000 lbs., is transmitted through *Revere* electronic load cells in
(Continued on page 12)

Build this famous *knight-kit*[®] Star Roamer[®] 5-Band Shortwave Receiver Kit



and have the whole wide world at your fingertips!

Think of it!—even if you know nothing at all about electronics—in a few fun-filled evenings you can assemble the Knight-Kit Star Roamer that lets you listen to the four corners of the world!

You visit the famous cities of Europe, Asia, Africa ... get continuous 24-hour-a-day aviation weathercasts ... zero-in on Coast Guard LORAN signals ... get the exact time from station WWV in Washington, D. C. ... listen in on the interesting conversations of Hams, Citizens Banders and Radio Telephoners—AND listen to your favorite programs on the standard AM band, too.

Thousands of folks of all ages have assembled the Star Roamer and have been amazed at how easy it is. All you do is follow crystal-clear, non-technical instructions and extra-large illustrations that show where every part fits ... and almost

before you know it you're listening to exciting broadcasts from all over the world!

The Star Roamer covers 200 to 400 kc and 550 kc to 30 mc in 5 bandswitched ranges, and features a reliable superhet circuit ... plus Automatic Volume Control to prevent fading and blasting, illuminated "S" meter for fine tuning, and many other features found only in shortwave receivers that cost many times more.

Complete with all parts, handsome 5½ x 12¼ x 8" charcoal gray and aluminum case, and easy-to-follow assembly instructions for only.....

\$39⁹⁵

Read the unique money-back guarantee ... exclusive in the industry ... then rush coupon for full details and Special Introductory Offer.

KNIGHT-KIT GUARANTEE

Build a Knight-Kit in accordance with our easy-to-follow instructions. When you have completely assembled the kit, you must be satisfied or we will return your money, less transportation charges, under the Allied guarantee of satisfaction.

ALLIED RADIO

ALLIED RADIO, Knight-Kit., Dept. 51CC
P. O. Box 4398, Chicago, Ill. 60680

Please rush full details and Special Introductory Offer on the Knight-Kit Star Roamer 5-Band Shortwave Receiver.

Name _____ PLEASE PRINT _____

Address _____

City _____ State _____ Zip _____

Olson



*** FREE**

Fill in coupon for a **FREE One Year Subscription** to **OLSON ELECTRONICS' Fantastic Value Packed Catalog—Unheard of LOW, LOW PRICES on Brand Name Speakers, Changers, Tubes, Tools, Stereo Amps, Tuners, CB, and other Values. Credit plan available.**

NAME _____

ADDRESS _____

CITY _____ STATE _____ ZIP _____

If you have a friend interested in electronics send his name and address for a **FREE** subscription also.

**OLSON ELECTRONICS
INCORPORATED**

577 S. Forge Street Akron, Ohio 44308

Get Your **F.C.C. LICENSE** and **A.S.E.E. DEGREE**

We offer the following courses — all approved under the *new G.I. Bill*. Select the course you are interested in, and write or phone for free details.

- Electronics Engineering Technology* (resident course, which leads to the A.S.E.E. degree);
- Basic Electronics Engineering Technology* (correspondence course, which covers the first 1/3 of the EET course listed above, and credit for which can be applied toward the A.S.E.E. degree);
- Communications Electronics* (resident course, which leads to the FCC first class license and trains you to be a communications technician);
- F.C.C. License Course* (correspondence course, which prepares you for your FCC first class radiotelephone license — after completing this course, if you should fail to pass the FCC exam for this license *all your tuition payments will be refunded*).

For free brochure, write:
Desk 6-R

Grantham School of Electronics

1505 N. Western Ave., Hollywood, Cal. 90027
Phone: (213) 469-7878

818-18th St., NW, Washington, D.C. 20006
Phone: (202) 298-7460

NEWSCAN

the ramps to the readout instrument, where the signal is amplified and translated into a meter reading giving the actual load. Device can be set up alongside highways in minutes to check axle loads on trucks. State police checking axle loads of trucks will now be able to set up check points almost anywhere.

Mini-Tools

The world, truly, is getting smaller. Machined parts that were thought to be tiny only a few years ago are, by today's standards, big. Pictured below on the small stand of a microscope are dozens of different parts machined of



You can tell how small small is by comparing machined parts to centimeter scale on microscope stage platform.

stainless steel for the computer, electronics, telephone, missile and communications industries. These machined parts of stainless steel are made by *Jaymax Precision Products, Inc.*, Subsidiary of *Vernitron Corporation* where plus or minus .0002" is standard measurement. The firm is using stainless steel in some top secret jobs that will find their way to outer and inner space.

Viet Tape

Television's familiar instant replay brought three soldiers in Vietnam together with their families in Chicago recently in the first test of a proposed system of "video tape letters" home. Videotape recordings of the three men were made at the USO in Saigon and flown to Chicago for the test. The parents of the soldiers in the test tape were invited to the Chicago USO to view the recordings and record return audio and video messages to their sons. Lt. Thomas C. Coll, Sp/4 Edward A. Bailey and
(Continued on page 14)

LAFAYETTE HB-525 Solid State Mobile 2-Way Radio

All Crystals Supplied!

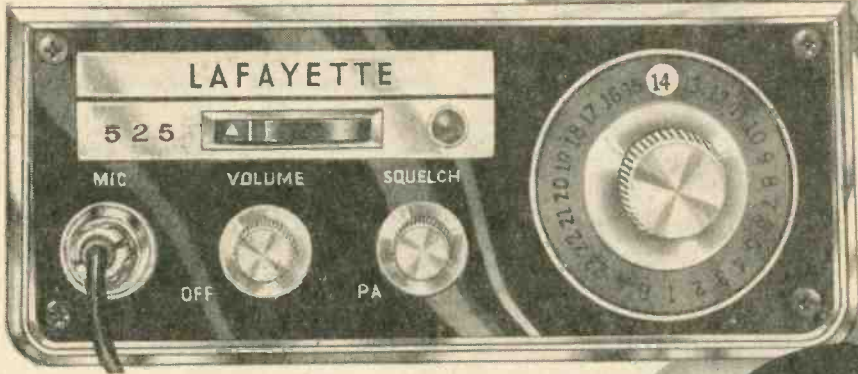

• Size: 2³/₈" by 6¹/₄" 99-3076WX*

All **23** CB Channels
Crystal Controlled

Plus 2 Reserve Channels

149⁹⁵
NO MONEY DOWN

- 19 Transistors, 7 Diodes, Thermistor
- Dual Conversion Receiver for Extra Selectivity and Sensitivity
- Full 5-Watt Input
- Range Boost™ Circuitry for Added Power
- 3-Position Delta Tune—Provides Accurate Fine Tuning
- Mechanical 455KC Filter for Superior Selectivity
- Push-to-Talk Dynamic Microphone
- Variable Squelch plus Series Gate Automatic Noise Limiting
- Public Address System (with external speaker)
- 12-Volt DC Operation (pos. or neg. ground) 6-Volt DC (with optional DC Power Supply)
- Pi-Network for Optimum RF Output
- 117 Volt AC Operation with Optional Power Supply

*Imported

FREE

Over 500 Pages

1967 CATALOG NO. 670

Featuring Everything in Electronics for

• HOME • INDUSTRY • LABORATORY

from the "World's Hi-Fi & Electronics Center"



LAFAYETTE Radio ELECTRONICS
Dept. DEEC-7 P.O. Box 10
Syosset, L. I., N. Y. 11791

DEEC-7

Send me the FREE 1967 LAFAYETTE Catalog 670

Name _____

Address _____

City _____ State _____ Zip _____

WRITE
NOW FOR
1967
SENT FREE

McGEE'S CATALOG

1001 BARGAINS IN
SPEAKERS—PARTS—TUBES—HIGH FIDELITY
COMPONENTS—RECORD CHANGERS—
TAPE RECORDERS—KITS—
EVERYTHING IN ELECTRONICS

McGEE RADIO CO.,
1907 McGee St.
Kansas City 8, Missouri
 SEND 1967 McGEE CATALOG

NAME.....

ADDRESS.....

CITY.....

ZONE.....

STATE.....

Tape this ad to the back of your TV or Radio Set

ALL TV-RADIO RECEIVING TUBES



• ALL BRAND-NEW, First Quality. All Types Available. • Orders Shipped First Class Same Day Rec'd. • Unconditionally Guaranteed. • 24 Month Warranty. Send \$1 for ea. tube + 50c. postage & handling of entire order. FREE: Write for "do-it-yourself" TV Test Chart and Tube List to Dept. EE-347.

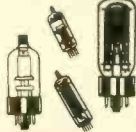

UNIVERSAL TUBE CO. Ozone Park, N. Y. 11417



Learn how to become a GAME WARDEN

GOV'T HUNTER, FORESTER, WILDLIFE MANAGER

Exciting job openings now for qualified men who love outdoor work. Protect forests and wildlife—arrest violators! Good pay, security, prestige and authority for respected career Conservation Officers. Easy home-study plan! Send for FREE FACT BOOK, aptitude QUIZ, SUBSCRIPTION to Conservation magazine. State age. NORTH AMERICAN SCHOOL OF CONSERVATION
Campus Drive, Dept. 1353, Newport, Calif. 92660

ALL BAND BATTERY SHORT WAVE RADIO KIT \$12.95



Listen around the world—Thousands of miles away! Ships—Aircraft—Voice of America—Russia—London—Australia—Amateurs—Police. Also USA Broadcast—5 Wave Bands 1 1/2 to 4 3/4 MC. Calibrated tuning dial. Wt. only 3 lbs. World wide reception.
Send only \$3.00 (cash Ck Mo) and pay postman \$9.95 COD pstg or send \$12.95 for PP del in USA. Basic Kit as shown includes plastic case and BC coil FREE. Long Distance antenna, if you order NOW. Available only from Midway Co., Dept. BE-3, Kearney, Nebr.

Learn of the many money making ideas and low cost/high profit businesses you can start in.

INCOME OPPORTUNITIES—75¢

on sale now

Take the guessing out of home buying. Complete plans and specifications from leading architects.

SMALL HOME PLANS—\$1.25

on sale now or write Davis Publications, Inc./505 Park Ave./New York, N. Y. 10022. Add 25¢ each for postage & handling.

NEWSCAN

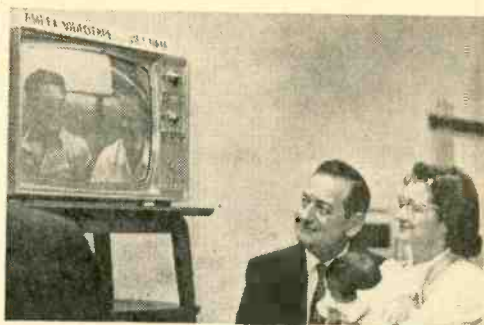

Ampex brings the boys home from Viet Nam for a taped video chat with loved ones in the Chicago area.

Pfc. Donald P. Kunzer, all from the Chicago area, were the three servicemen who participated in the test.

Recorders used for the Vietnam USO test are Ampex models costing substantially less than recorders used by the broadcasting stations and were available for the first time this year. They are primarily designed for closed circuit use in education, industrial training, medicine and government applications.

Indigestible Goodies

There is nothing edible in these boxes unless, of course, you're a goat! The "oranges and plums," actually made of hard maple, and the assorted ceramic triangles, and carpet tacks,



What can an editor write here other than, "Look and enjoy."

carborundum nuggets and roofing nails are used at the Scintilla Division plant of The Bendix Corporation, Sidney, N. Y., to remove "flashing" or rough edges from threads in electrical connector parts for space and defense applications. The connectors are tumbled in huge barrels containing any number of the materials shown in front of the pretty Miss. The tumbling "clean-up" insures that the threads will make a tight seal.

(Continued on page 17)

BUILD YOUR OWN RADIO

CIRCUITS AT HOME with the New Improved PROGRESSIVE RADIO "EDU-KIT"®

only
\$26.95

A Practical Home Radio Course

Now Includes

- ★ 12 RECEIVERS
- ★ 3 TRANSMITTERS
- ★ 50. WAVE GENERATOR
- ★ SIGNAL TRACER
- ★ AMPLIFIER
- ★ SIGNAL INJECTOR
- ★ CODE OSCILLATOR

- ★ No Knowledge of Radio Necessary
- ★ No Additional Parts or Tools Needed
- ★ EXCELLENT BACKGROUND FOR TV
- ★ SCHOOL INQUIRIES INVITED
- ★ Sold In 79 Countries



Reg. U. S. Pat. Off.

Training Electronics Technicians Since 1946

YOU DON'T HAVE TO SPEND HUNDREDS OF DOLLARS FOR A RADIO COURSE

The "Edu-Kit" offers you an outstanding PRACTICAL HOME RADIO COURSE at a rock-bottom price. Our Kit is designed to train Radio & Electronics Technicians, making use of the most modern methods of home training. You will learn radio theory, construction practice and servicing. THIS IS A COMPLETE RADIO COURSE IN EVERY DETAIL.

You will learn how to build radios, using regular schematics; how to wire and solder punched metal chassis, as well as the latest development of Printed Circuit chassis.

You will learn the basic principles of radio. You will construct, study and work with RF and AF amplifiers and oscillators, detectors, rectifiers, test equipment. You will learn and practice trouble-shooting, using the Progressive Signal Tracer, Progressive Signal Injector, Progressive Dynamic Radio & Electronics Tester, Square Wave Generator and the accompanying instruction material.

You will receive training for the Novice, Technician and General Classes of F.C.C. Radio Amateur Licenses. You will build Receiver, Transmitter, Square Wave Generator, Code Oscillator, Signal Tracer and Signal Injector Circuits, and learn how to operate them. You will receive an excellent background for television, Hi-Fi and Electronics.

Absolutely no previous knowledge of radio or engineering experience. The "Edu-Kit" will provide you with a basic education in Electronics and Radio, worth many times the low price you pay. The Signal Tracer alone is worth more than the price of the kit.

THE KIT FOR EVERYONE

You do not need the slightest background in radio or science. Whether you are interested in Radio & Electronics because you want an interesting hobby, a well paying business or a job with a future, you will find the "Edu-Kit" a worth-while investment. Many thousands of individuals of all

ages and backgrounds have successfully used the "Edu-Kit" in more than 79 countries of the world. The "Edu-Kit" has been carefully designed, step by step, so that you cannot make a mistake. The "Edu-Kit" allows you to teach yourself at your own rate. No instructor is necessary.

PROGRESSIVE TEACHING METHOD

The Progressive Radio "Edu-Kit" is the foremost educational radio kit in the world, and is universally accepted as the standard in the field of electronics training. The "Edu-Kit" uses the modern educational principle of "learn by doing." Therefore you construct, learn schematics, study theory, practice trouble shooting—all in a closely integrated program designed to provide an easily-learned, thorough and interesting background in radio.

You begin by examining the various radio parts of the "Edu-Kit." You then learn the function, theory and wiring of these parts. Then you build a simple radio. With this first set you will enjoy listening to regular broadcast stations, learn theory, practice testing and trouble-shooting. Then you build a more advanced radio, learn more advanced theory and techniques. Gradually, in a progressive manner, and at your own rate, you will find yourself constructing more advanced multi-tube radio circuits, and doing work like a

professional Radio Technician. The "Edu-Kit" course are Receiver, Transmitter, Code Oscillator, Signal Tracer, Square Wave Generator and Signal Injector Circuits. These are not unprofessional "breadboard" experiments, but genuine circuits, constructed by means of professional wiring and soldering on metal chassis, plus the new method of radio construction known as "Printed Circuitry." These circuits operate on your regular AC or DC house current.

THE "EDU-KIT" IS COMPLETE

You will receive all parts and instructions necessary to build twenty different radio and electronics circuits, each guaranteed to operate. Our Kits contain tubes, tube sockets, variable, electrolytic, mica, ceramic and paper dielectric condensers, resistors, tie strips, hardware, tubing, punched metal chassis, Instruction Manuals, hook-up wire, solder, selenium rectifiers, coils, volume controls and switches, etc.

In addition, you receive Printed Circuit materials, including Printed Circuit chassis, special tube sockets, hardware and instructions. You also receive a useful set of tools, a professional electric soldering iron, and a self-powered Dynamic Radio and Electronics Tester. The "Edu-Kit" also includes Code Instructions and the Progressive Code Oscillator, Tester. In addition to F.C.C. Radio Amateur License training. You will also receive lessons for servicing with the Progressive Signal Tracer and the Progressive Signal Injector, a High Fidelity Guide and a Quiz Book. You receive Membership in Radio-TV Club, Free Consultation Service, Certificate of Merit and Discount Privileges. You receive all parts, tools, instructions, etc. Everything is yours to keep.

PRINTED CIRCUITRY

At no increase in price, the "Edu-Kit" now includes Printed Circuitry. You build a Printed Circuit Signal Injector, a unique servicing instrument that can detect many Radio and TV troubles. This revolutionary new technique of radio construction is now becoming popular in commercial radio and TV sets.

A Printed Circuit is a special insulated chassis on which has been deposited a conducting material which takes the place of wiring. The various parts are merely plugged in and soldered to terminals.

Printed Circuitry is the basis of modern Automation Electronics. A knowledge of this subject is a necessity today for anyone interested in Electronics.

FREE EXTRAS

• SET OF TOOLS

- SOLDERING IRON
- ELECTRONICS TESTER
- PLIERS-CUTTERS
- VALUABLE DISCOUNT CARD
- CERTIFICATE OF MERIT
- TESTER INSTRUCTION MANUAL
- HIGH FIDELITY GUIDE • QUIZZES
- TELEVISION BOOK • RADIO TROUBLE-SHOOTING BOOK
- MEMBERSHIP IN RADIO-TV CLUB: CONSULTATION SERVICE • FCC AMATEUR LICENSE TRAINING
- PRINTED CIRCUITRY

SERVICING LESSONS

You will learn trouble-shooting and servicing in a progressive manner. You will practice repairs on the sets that you construct. You will learn symptoms and causes of trouble in home, portable and car radios. You will learn how to use the professional Signal Tracer, the unique Signal Injector and the dynamic Radio & Electronics Tester. While you are learning in this practical way, you will be able to do many a repair job for your friends and neighbors, and charge fees which will far exceed the price of the "Edu-Kit." Our Consultation Service will help you with any technical problems you may have.

FROM OUR MAIL BAG

J. Statatils, of 25 Poplar Pl., Waterbury, Conn., writes: "I have repaired several sets for my friends, and made money. The "Edu-Kit" paid for itself. I was ready to spend \$240 for a Course, but I found your ad and sent for your Kit."

Ben Valerio, P. O. Box 21, Magna, Utah: "The Edu-Kit are wonderful. Here I am sending you the questions and also the answers for them. I have been in Radio for the last seven years and like to work with Radio Kits, and like to build Radio Testing Equipment. I enjoyed every minute I worked with the different kits; the Signal Tracer works fine. Also like to let you know that I feel proud of becoming a member of your Radio-TV Club."

Robert L. Shuff, 1534 Monroe Ave., Huntington, W. Va.: "Thought I would drop you a few lines to say that I received my Edu-Kit, and was really amazed that such a bargain can be had at such a low price. I have already started repairing radios and phonographs. My friends were really surprised to see me get into the swing of it so quickly. The Trouble-shooting Tester that comes with the Kit is really new and finds the trouble. If there is any to be found."

UNCONDITIONAL MONEY-BACK GUARANTEE

Please rush my Progressive Radio "Edu-Kit" to me, as indicated below:

Check one box to indicate choice of model

- Regular model \$26.95.
- Deluxe model \$31.95 (same as regular model, except with superior parts and tools plus Radio & TV Parts Jackpot worth \$15.)

Check one box to indicate manner of payment

- I enclose full payment. Ship "Edu-Kit" post paid.
- Ship "Edu-Kit" C.O.D. I will pay postage.
- Send me FREE additional information describing "Edu-Kit."

Name

Address

PROGRESSIVE "EDU-KITS" INC.

1186 Broadway, Dept. 517DJ, Hewlett, N. Y. 11557

Tips from a Technician's Notebook

Shortcuts—developed, and used, by our readers—to make your servicing and troubleshooting easier and more professional.

MIDGET EXTENSION LIGHT

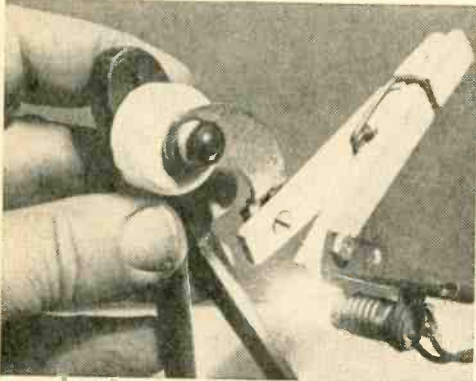

■ Almost daily there is a need for a tiny extension light for seeing in close quarters. Such a light can be easily made that will be self-supporting in two ways if this is desirable. Fasten a miniature lamp socket to one side of a spring-type clothespin. To the other side of the clothespin attach the magnet element from an automatic can opener. The light is complete for connecting to a battery power source. Connect alligator clips to the long lamp leads so they may connect to battery or 6.3-volt AC filament transformer. The magnet will cling to iron tools for extra reach.

EMERGENCY COUPLER HAS ZERO BACKLASH

■ A one-inch length of automobile windshield wiper hose can be used as a quick, inexpensive $\frac{1}{4}$ "-to- $\frac{1}{4}$ " shaft coupler for radio and other electronic gadgets. While not intended to replace conventional couplers which employ set screws, the hose does grip the shafts with surprising tenacity, making it handy in an emergency or in experimental

breadboards. A 3- to 4-inch length of hose makes a good flexible coupler for connecting the shaft of a variable component to a knob shaft when the two shafts are out of line up to 45 degrees from each other—backlash is practically nil.

Other uses for the hose include couplers for small electric motors, Veeder-Root counters—in fact, anywhere $\frac{1}{4}$ -inch shafts are used, and the load requirements are moderate.

DISCARDED PORTABLE BECOMES TEST SPEAKER

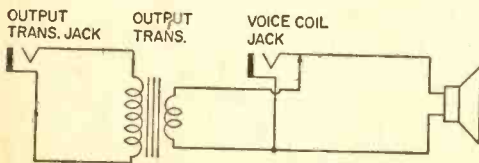

■ If you own an old tube-type radio portable that's ready for the garbage can, you're in for a windfall by simply converting it to a portable test speaker. Scrap all of the set's guts except the PM speaker and output trans-

former. Now scrounge up open-circuit and closed circuit phone jacks (see schematic diagram), phone plug, wire, and two alligator clips with rubber sleeve insulators. Wire up the portable case as shown in the schematic diagram and label the cabinet's front panel so you will know which jack is which. Now wire up a patch cord using 3 feet of rubber test lead lengths to the phone jack and install the alligator clips to the wire's free ends. Now you can connect the test set to speaker terminals or into audio plate circuits. ■

NEWSCAN

First Neon Sign

The glass tube shown in the photo below is believed to be the world's first neon sign. In 1904 Dr. Perley G. Nutting, a pioneer electrical scientist at the *National Bureau of Standards*, devised illuminating glass tubes which were



Most people will say, "So what!" But take a good look. That bent tube of glass and gas was one of the first neon signs ever to go on display.

filled with gas and lighted by passing an electrical discharge through them. The signs were used in an *NBS* exhibit in the Louisiana Purchase Exposition in St. Louis in 1904. Commercial application followed some 26 years later. The first neon sign said, appropriately enough, "neon."

This tube and several others from Nutting's laboratory are on display at the museum of the U. S. Department of Commerce's National Bureau of Standards in Gaithersburg, Maryland. Come on down next vacation time.

Rolling Switchboard

Here's a switchboard with an ocean going roll aboard a luxury cruise ship. When completed it will supply the passengers with 400 lines, 6 trunk circuits, and direct connections with any telephone in the world through the vessel's

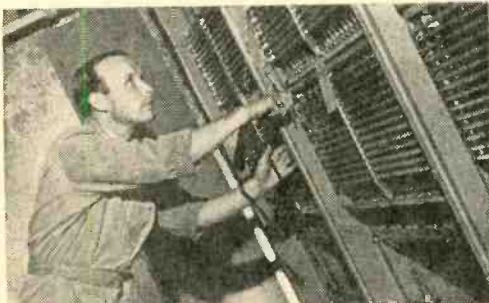

Sea-going switchboard contacts the world by telephone.

radio room. Installer Arne Brenden, of the Norwegian subsidiary of *ITT*, installs the modern "Pentaconta" crossbar telephone equipment on the high seas. The automatic exchange is being installed while the vessel is enroute and will be completed about the time the boat docks in Scandinavia at the end of cruise. ■

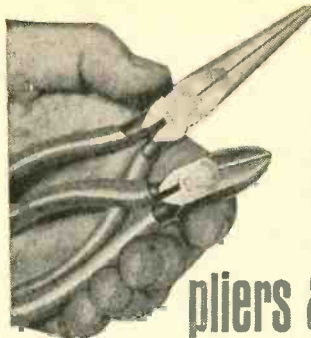

LONG NOSE AND
DIAGONAL PLIERS

look to
Xcelite for
the best in
pliers & snips, too

CHAIN NOSE ELECTRICIAN'S
PLIERS



RADIO AND TV PLIERS



COMBINATION
SLIP JOINT PLIERS



SIDE CUTTING PLIERS



TRANSVERSE
CUTTING PLIERS



UTILITY PLIERS

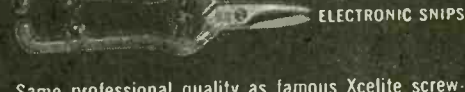

ELECTRONIC SNIPS

Same professional quality as famous Xcelite screwdrivers and nutdrivers. Forged alloy steel construction. Precision machined. Scientifically proportioned. Variety of sizes. All available with permanent, plastic coated Cushion Grip handles for extra working comfort (except slip joint models).

XCELITE®

XCELITE INC. • 80 BANK ST., ORCHARD PARK, N. Y.
Send Catalog Sheet N664 on pliers and snips.

name _____
address _____
city _____ state & zone _____



ASK ME ANOTHER

Elementary Electronics brings the know-how of an electronics expert to its readers. *Leo G. Sands*, columnist for *Radio-TV Experimenter*, will be happy to answer your question. Just type or print your unsolved problem on the back of a 4¢ postal card and send it to "Ask Me Another," *Elementary Electronics*, 505 Park Avenue, New York, New York 10022. Leo will try to answer all your questions in the available space in upcoming issues of *Elementary Electronics*. Sorry, Leo will be unable to answer your questions by mail.

Can't Have One

Why is a dry cell tested for life in volts instead of amps when it's amperage that counts? Cells I have tested whose voltage is normal, but amperage is low, don't light a lamp as well as one whose amperage is higher.

—D. H., Peterborough, Ontario

The old-fashioned way to test dry cells was with an ammeter. The current way is to measure the voltage of the cell while under load, as shown in the diagram. Checking voltage with no load can lead to erroneous conclusions. Each size of dry cell has its own load to meet manufacturers specifications—best test is to use the regular operating load when measuring voltage.

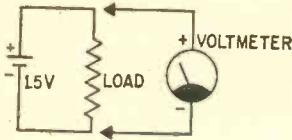

Needs a Map

I bought a used telephone-answering recorder, Carroll Electronics Model RC1. I am having trouble getting a suitable interconnecting plug. Can you give me a schematic? I can't seem to find Carroll Electronics. What is their address?

—R. J., Palos Park, Illinois

Don't have a schematic available. But, you probably can get one from the manufacturer whose address is listed as 1205 West Roscoe Street in Chicago.

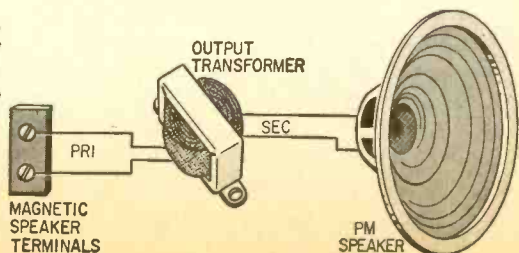

How About That!

Where can I get a schematic of a Tonefunk Model W 6056W AM, FM and SW radio and record player? Eleven servicemen in Winston-Salem say that nothing can be done without a diagram. The German manufacturer no longer makes radios. Sams and Supreme don't have the diagram.

—J. E. M., Rural Hall, North Carolina

An expert should be able to fix any radio with or without a diagram. The schematic just makes it easier. Perhaps a reader has a diagram. If so, please contact J. E. M. at P.O. Box 94, Rural Hall, North Carolina.

Change to PM Speakers

How can I modernize old radios? I would like to replace electromagnetic speakers with PM types.

—W. W., (Address not given)

Hope you aren't confusing electromagnetic with electrodynamic speakers—they're quite different. Magnetic speakers weren't much more than glorified earphones—a high-impedance (2,000 to 5,000 ohms) coil that vibrated a paper cone. No output transformer was used.

Electrodynamic speakers are quite modern by comparison—a low-impedance coil moving in a field generated by an electromagnet. Electrodynamic units have at least four leads to the speaker proper—two for the voice coil; two for the field coil.

For magnetic speaker replacement use a universal output transformer. Connect the primary to the speaker terminals and the speaker across the transformer secondary taps that give maximum volume and best sound quality.

Field coils for the electrodynamic speakers are of two types—high resistance (5000 to 15,000 ohms) and low resistance (under 2000 ohms). The high resistance field coils are connected across the DC supply and are used as a bleeder resistance and if you leave it out of the circuit it won't matter usually—if it is part of a resistance network you can replace it with a high-wattage resistor. The low-resistance field coils are used as filter chokes and either must be left in the circuit, replaced with a choke or with a resistor. (Better install new filter capacitors too—ones with 40 to 60 mf rating for better DC filtering since the hum-buck circuitry will not be in the PM circuitry.)

Mike Low-Down

I have a low-impedance mike and several high-impedance amplifiers and I would like to connect the mike to the amplifiers without re-wiring them. How can I do it?

—D. B., Eldorado, Texas

Use a matching transformer as shown in the diagram and adjust the primary transformer taps to match your mike.

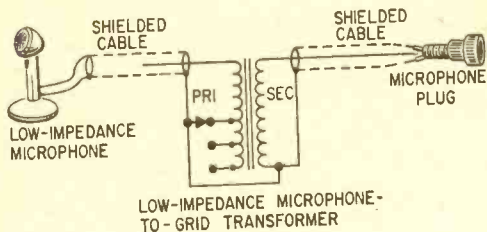

400 Hz Supply

I would like to get a power supply delivering 115-volt, 400-cycle AC for a radar set. Can you tell me where I can buy one or how to build one?

—R. B., Swedesboro, New Jersey

Bogue Electric, 100 California Avenue, Paterson, New Jersey, makes 400-cycle power supplies, but they aren't cheap. Don't forget that you can't operate a radar lawfully unless you have a station license to cover it.

Color-TV Service Info

What is the correct procedure for adjusting the color in my Zenith TV set? It has gain controls for red, blue and green but I am at a loss to know what to do with them.

—N. P. P., East Tawas, Michigan

Get a Sams Photofacts kit for your set at a radio parts distributor. It should contain the information you need. Don't overlook the service manual published by the manufacturer—send model and serial number for exact information.

Off Calibration

I have a communications receiver which contains a 100-kc crystal calibrator. The dial markings are away out of line. Using the calibrate re-set control, I can't get them into line. I have tried connecting a trimmer capacitor across the calibrate re-set capacitor but this put it off more. Can you suggest anything?

—J. W. G., Oakville, Ontario

First, check the dial calibration—tune in known-frequency stations like WWV and any others that you might be able to find that are listed in White's Radio Log. Check all bands—if calibrations are "off" by the same amount it would seem most likely that your tuning dial is not positioned properly on the tuning-capacitor shaft. If calibrations are "off" only on some bands (or more on some than others) it would seem that realignment and recalibration are

It's FUN It's NEW It's EDUCATIONAL DO-IT-YOURSELF ELECTRONICS KIT



Build your own AM radio, voice operated lamp, rain detector, fire alarm.
Now Only

\$15.95

Work with capacitors, resistor, inductors. BUILD YOUR OWN POWER TRANSISTOR and the circuits to test it! Learn electronic symbols, how to read schematics . . . simply explained in the easy-to-follow instruction manual. All parts included.

Fill out coupon below and mail to:

Idea Corporation of America • P. O. Box 417 • Tempe, Ariz.

Please rush delivery of the Do-it-yourself Electronics Kit to:

NAME

ADDRESS

CITY STATE

I am enclosing full payment of \$15.95. Send Electronics Kit postpaid or I have enclosed \$2.00 extra for my C.O.D.

NOW...BUILD YOUR OWN CCTV CAMERA



NEW IMPROVED MODEL

- Vidicon
- 25mm. fl.9 Lens
- Cable
- Instructions

\$20950

ASSEMBLED \$259.50 **\$20 DOWN**
\$10 MONTH

The affordable answer to an easy-to-use, top performing surveillance camera. Hundreds of uses in home, store, plant, office, hospital, school. Connects instantly to any TV set. Gives excellent picture with light under normal room lighting. Operates up to six sets. Complete—nothing else to buy. Optional lenses and tripod available.

All parts guaranteed one year. Vidicon guaranteed 90 days. Make check or money order to CONAR. Shipped REA collect.

SEND FOR FREE CONAR CATALOG

CONAR Division of National Radio Institute, Dept. CV7C
3939 Wisconsin Ave., Washington, D.C. 20016

ASK ME ANOTHER

needed. Once the dial is calibrated properly tune to WWV on 2.5, 5, 10 or 15 MHz (mc) and adjust to 100-kHz (kc) crystal calibrator to zero-beat with the WWV carrier.

Adding Bandsread

I have an ancient Emerson Model 524 receiver and I would like to know if I can bandsread the ham bands over a longer portion of the shortwave bands. I am planning to use it as a novice receiver and would like, if possible to spread the 40 and 80 meter bands.

—N. G., Flemingsburg, Kentucky

Add an auxiliary local-oscillator-tuning capacitor as shown in the diagram. Mount it close to the present tuning capacitor gang—use a shaft extender, if necessary, to couple the bandsread capacitor to its own tuning dial. Maximum capacitance of the bandsread capacitor probably won't be as high as 50 *uuf* and may be as low as 25 *uuf* if you want to keep the oscillator within the bandpass of the RF circuits. The relatively-broad tuning of the IF circuits. The relatively-broad tuning of the IF amplifier may not give you the selectivity you will probably need for clear reception.

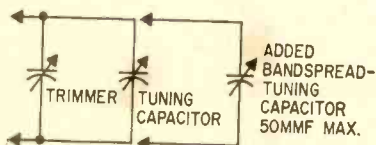

Simple But Expensive

Is there a simple way of varying the speed of a phonograph motor by electronic means?

—M. M. L., Port Jefferson, N. Y.

It depends upon the type of motor. If it is frequency sensitive, you could use the set-up shown in the diagram. But, why vary the motor speed? While doing so, it might speed up or slow down the music, it would also vary its pitch.

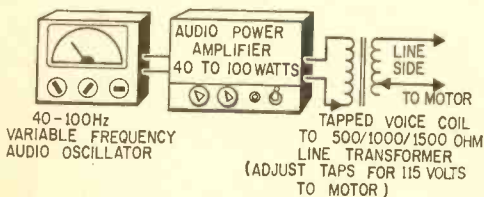

Trapping TV Signals

Is it possible to block out the signals of a station in our local area broadcasting on TV Channel 6 so I can pick up a station 162 miles away. If so, how?

—D. W., Jamestown, N. Y.

Not if the station you want is also on Channel 6. Even a good antenna will pick up some signal for the rear if the station you want should be in the opposite direction. To reduce effects of an adjacent-channel TV station you can make a simple wave trap with a small capacitor and a short length of twin lead. If a small-value fixed capacitor is used the twin lead will have to be adjusted in length for maximum effect. If a compression-type trimmer is used it is adjusted for maximum effect.

The twin-lead trap is just taped loosely to the lead-in—there is no direct connection. Certain spots on the lead-in will give more effect than others.

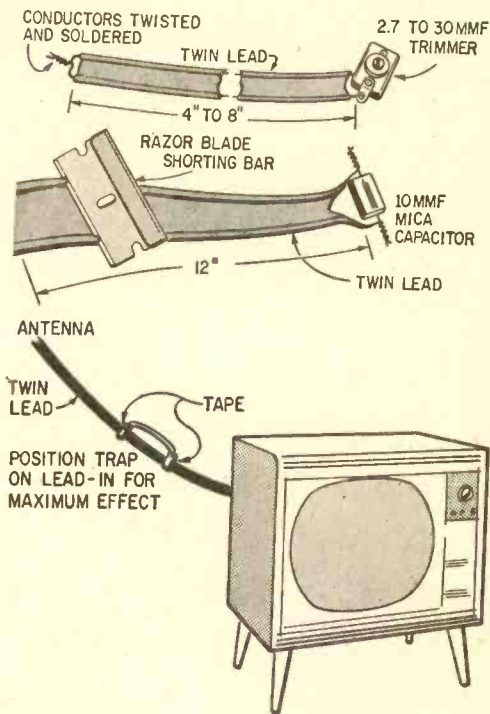

A Little Light

I have an old Powell repeater flash and a rechargeable power supply, Model W.C. 20, both of which after nearly 20 years, are now giving me trouble. As Powell has gone out of business, I am hoping that you might know where I could get schematic diagrams of both units.

—W. J. M., Pocatello, Idaho

Never heard of either. If any reader has the schematics, send them in, please.

Information vs. EDP

I have been told there is a big future in "information" systems. What are they and where can I get basic information?

—D. R., Hollywood, California

That's just another definition of computer systems and EDP (electronic data processing). Get a copy of the September 1966 issue of Scientific

American. For 60 cents you can get around 30 huge magazine pages of the latest information about "information" and computers. If your newsstand can't get you a copy order one from the publisher at 415 Madison Avenue in New York City. If you want to dig more deeply, get a copy of "Computer Dictionary and Handbook" by Charles J. Sippl, published by Sams. It costs \$12.95. Your local book store or radio parts distributor should be able to get you a copy.

Are You for Real?

Where can I get a catalog listing schematics of radio and TV sets which I repair.

—T. F. B., Springfield, Massachusetts

Write to Howard W. Sams & Co., Inc., 4300 West 62nd Street, Indianapolis, Indiana, and ask for a Photofacts catalog.

Missed Aerobander

Can you give me a circuit for a transistor converter covering from 108 to 132 mc (MHz) for use with a BCB transistor radio?

—B. R., Hunlock Creek, Pennsylvania

See the December 1965-January 1966 issue of RADIO-TV EXPERIMENTER. On page 45 you will find a construction article—the Aerobander. Send us 75¢ and we'll send you a copy of that issue if you don't have it—include 25¢ for postage and handling.

New Speaker Is Problem

Where can I get a field coil speaker for a small table radio? Or, can I use a 4-ohm PM speaker? The black speaker lead runs to pin 6 of 12SK7, the green one to the output transformer and the yellow lead to pin 8 of a 35Z5.

—A. E. F., Phoenix, Arizona

Connect a PM speaker as shown in the diagram, adding a filter choke to take the place of the field coil.

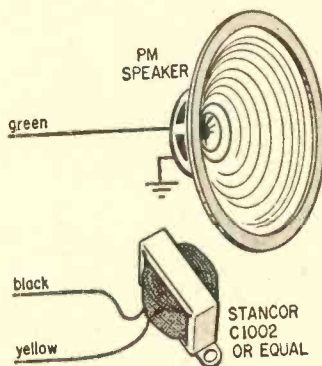

Parts Problem!

In one of your construction articles an NE-77 neon lamp and a cadmium-sulphide photocell are listed. I can't find such a neon lamp and

Your Own Business Now Provides For Their Future

What better way to learn how to conduct a low investment business profitably than thru the pages of INCOME OPPORTUNITIES. Whether you're interested in full or part-time, the Mar/Apr issue provides "55 Businesses for Under \$500" . . . tells how they work and reveals their pros and cons. Read INCOME OPPORTUNITIES for up-to-the-minute details on franchises with investments as low as \$1,000 and also valuable guides on mail order and personal business.

Special Introductory Offer . . .

Now you can prepare for the future with INCOME OPPORTUNITIES for only \$3.00 per year.

INCOME OPPORTUNITIES EE-367
505 Park Avenue, New York, N.Y. 10022

Begin my subscription to INCOME OPPORTUNITIES with the next issue. Enclosed is \$3.00 for 1 year (cash or money-order). Bill me. (Foreign: add 75¢ a year)

Name _____
please print

Address _____

City _____

State _____ Zip _____





Now, better than ever, the new and improved S&M supersensitive photo meter

Here is a precision instrument that meets the highest standards of any meter available. It offers consistently accurate readings at very low light levels, which, if required, can be converted to ft.-candles from a graph supplied. Researchers, scientists, educators and hobbyists have confirmed that this meter can read light levels as low as 0.000245 ft.-candles.

The S&M Supersensitive Photo Meter uses the newest Clairex Corp. CL-505L Cadmium Sulfide Light Cell to measure light levels from twilight to bright sunlight at ASA speeds of 3 to 25,000. A new $\frac{5}{8}$ " high easel type probe and also a miniature probe are now available as accessories. The Computer gives F stops from .7 to 90; lists exposure time from 1/15,000 sec. to 8 hrs.; 4 range selection; EV-EVS-LV settings; weighs only 10 ounces.

Used extensively in Photo Labs, Physics and Research Labs, Hospitals, High Schools, Universities and numerous industries. Also used with movie or still cameras, microscopes and telescopes and IS A MUST FOR PHOTO-MICROGRAPHY.

SCIENCE & MECHANICS—KIT DIVISION EE-367 505 Park Avenue/New York, N.Y. 10022

Enclosed is \$_____ Please send me the new S&M Supersensitive Photo Meter. I understand that if I am not completely satisfied, I may return the meter within 10 days for a complete refund.

- | | |
|---|--|
| <input type="checkbox"/> No. 101—in kit form | <input type="checkbox"/> No. 103 |
| <input type="checkbox"/> \$29.95 with carrying case | <input type="checkbox"/> \$2.00 carrying case only |
| <input type="checkbox"/> No. 102—fully assembled | <input type="checkbox"/> Additional Computer |
| <input type="checkbox"/> \$34.95 with carrying case | <input type="checkbox"/> \$1.00 |
| <input type="checkbox"/> Easel Probe \$6.50 | <input type="checkbox"/> $\frac{5}{8}$ inch Probe \$6.50 |

Add 10% for Canadian and foreign order. New York City residents add 5% for N.Y.C. sales tax.

Name _____ (PLEASE PRINT)

Address _____

City _____ State _____ Zip Code _____

ASK ME ANOTHER

don't know which type of photocell to use. Can you tell me?

—L. B., Macon, Georgia

The NE-77 is a one-watt lamp with wire terminals, priced at \$0.55 net. Newark Electronics Corp. in Chicago lists it in its catalog. Try a Clairex CL5M2 photocell priced at \$1.75. This cell will handle two watts.

Phones Replace Old Speaker

My old radio has four speaker wires. How can I disconnect the speaker and permanently install headphones?

—J. A., Des Moines, Iowa

Leave the speaker connected because the speaker field coil is usually the power supply filter choke. To mute the speaker and use headphones, short circuit the voice coil terminals at the speaker and connect the earphones through a terminal strip in series with one of the voice coil leads as shown in the diagram. If you use high impedance earphones, connect a 10-ohm resistor across them as shown. If you use 8-ohm headphones (Superex, etc.), you can omit the resistor. High-impedance headphones may also be connected in place of the primary of the driver transformer or the primary of the output transformer unless you have push-pull output.

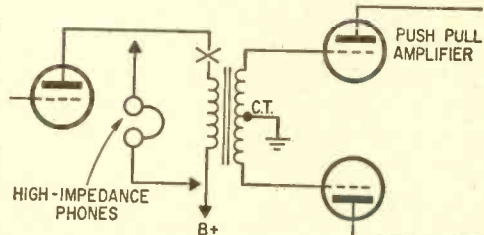
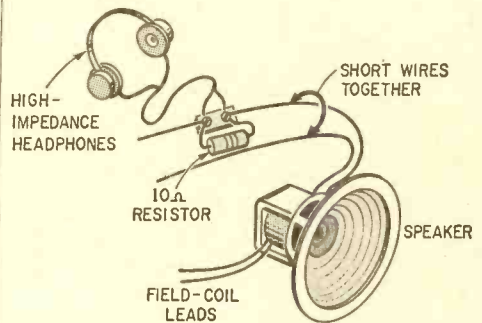

Aid From Oldtimer

Your answer to the question about the circuit of an old Atwater Kent radio was correct as far as your knowledge goes. But, did you ever stop to think that someone might have these circuits? I have the circuit of the Atwater Kent plus a thousand others including American Mohawk, Acme, Amrad, Browning Drake, Gilfillan, Kol-

ster, Ozark, Silver Marshall, Wells Gardner, etc. In the future I suggest you ask through your pages if someone else may have what you are looking for. Maybe we old radio men could help.

—S. E. S., Chatham, Ontario

So we're asking you. Those names are still familiar and bring fond memories. How about Fada, Sparton, Stewart Warner, Remler and Bremer Tully? Readers, S. E. S. is Syd Sutton whose address is 325 St. Clair Street in Chatham. Syd, we'll keep you in mind and are delighted to know someone had sense enough to save those old schematics.

Add An S-Meter

How can I hook up an "S" meter to my short-wave receiver?

—S. H., Stillwater, Minn.

Easy. Simply add two potentiometers and connect a 0-1 DC milliammeter between the cathode of an IF amplifier which is controlled by AVC and the cathode of the AF power amplifier as shown in heavy lines in the diagram. Replace the AF power amplifier cathode resistor with a 2-watt potentiometer (R1) having approximately the same resistance as the original resistor. Adjust this pot for meter zero with no signal received and pot R2 to meter full-scale when receiving the strongest signals.

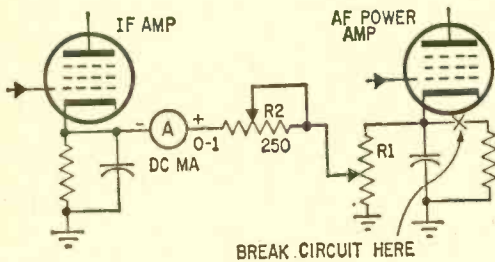

10-Code for CBing

I am planning to have some CB QSL cards printed and want to list the 10-code (10-4, etc.). I have seen several 10-code charts but some numbers are not listed. Where do I get the whole list from 10-1 to 10-100?

—S. D. G., Fort Stockton, Texas

All of the possible numbers are not used. The official police and fire 10-code has been enriched by CBers and new numbers are not necessarily used by everyone. Why not settle for the numbers you have? If you embellish it, recipients may not know what you are trying to say.

Seeking Schematic

Where can I get a schematic of a Lear RM-402C receiver?

—B. C., Tullahoma, Tennessee

Try writing to Lear Jet Corp., 13131 Lyndon Avenue, Detroit, Michigan or Motorola, Inc., 4501 West Augusta Blvd., Chicago, Illinois, which bought up Lear's avionics business.

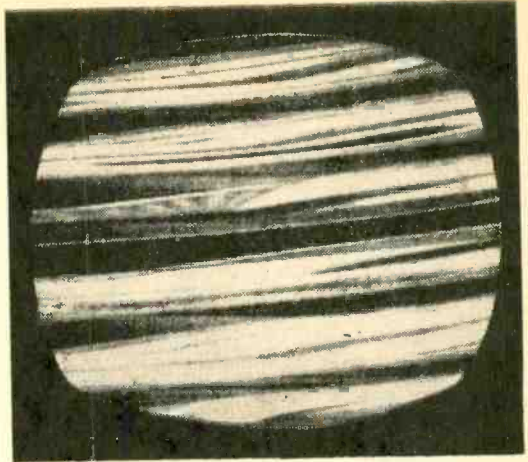

Color TV "Acting-up"?

Learn How To Adjust Your New Color TV Set!

Save money too!

Avoid the expense of calling a repairman each time your TV set "acts-up". In easy-to-understand language, complete with illustrations, learn just how to adjust your color TV; the right way to replace your picture tube; how to fix your own tape recorder, kiddie phono, fm tune, stereo system and ac/dc radio. These and many more dollar-saving tips in the new edition of TV REPAIR.



Now on sale at your newsstand!

TV REPAIR EE-367
505 Park Avenue
New York, N. Y. 10022
Please send me my personal copy of TV REPAIR. Enclosed is \$1.00, which includes postage and handling.

Name _____
(please print)
Address _____
City _____ State _____ Zip _____



ELEMENTARY ELECTRONICS ETYMOLOGY

By Webb Garrison



Magnet

▲ *Magnesia ad Maeandrum*—or *Magnesia* on the Maeander—was built near the mouth of a famous river in Asia Minor. Until its destruction by the Cimmericians about 700 B.C. the city was an important center of commerce and art.

But it was best known as the source of a queer type of heavy mineral that ancients found to be endowed with special power. Known to the Greeks as *Magnetis*, from the city of its origin, the potent stuff could draw iron to itself.

There was no practical use for it until, centuries later, someone discovered that the nature of a needle was changed when it was rubbed with stone from *Magnesia*. Arranged so that it could swing freely, such a needle always pointed to the north.

Makers and users of the compass found that *magnete*, as they called the power-conferring mineral, occurred not only in Turkey but also in many other regions. It was long taken for granted by seamen that a huge mass of the stuff formed an "Ilande of *Magnete*" located under or near the north pole and responsible for the tug on a compass needle. In one of his bursts of fancy Milton wrote of an imaginary white city surmounted by a castle built of magnet.

Natural magnets varied greatly in power and quality, so had few applications other than in making crude navigational instruments. But with the development of the electromagnet science and industry found a versatile and reliable tool. Today magnets are made in shops and plants all over the world—but none come from the site of ancient *Magnesia*.

Geiger Counter

▲ After a brilliant career as a student Hans Geiger became an assistant to the great Sir Ernest Rutherford. Together the men made early experiments with alpha particles. Rutherford developed the theory of the atom and won a Nobel prize; Geiger concentrated on perfecting a radiation counter.

By 1908 he was successful with alpha particles. He then turned to study of beta-ray

activity. This work was done in close collaboration with W. Müller. Together the scientists succeeded in making a gas-filled tube with cylindrical cathode and axial wire anode. Ionized particles that penetrated the envelope of the device set up momentary current pulsations in its gas. This Geiger-Müller tube found numerous important uses. Linked with other components it proved capable of measuring radiation intensity with great accuracy.

Though Müller spent years on the project and made vital contributions to it, the combination of two German names was too much. A few authorities still prefer abbreviation and speak of the GM counter, but in living speech such tribute to the scientific partnership has vanished. Specialists and beginners ignore Müller's role and speak of the *Geiger counter*.

Battery

▲ In the language of medieval France *battre* was used as a verb of action to name the process of beating repeatedly with hard blows. Military leaders were positively ecstatic when the development of cannon gave them a new and powerful means of beating down the walls of an enemy city or fortress. So from the old term for such action they called an artillery unit a *batterie*.

Many a *batterie* played a decisive role in battle. Since such a unit included from 2 to 6 guns, fired in sequence, its name attached to various kinds of coordinated groups of things and persons. Among these was a favorite toy of early electrical experimenters: panes of sash glass armed with thin lead plates and arranged in precise order. Properly wired and activated by acid, such a device would yield a steady flow of electricity.

He probably borrowed the name from other amateurs who used it earlier, but Benjamin Franklin was one of the first to write about work with an electric *battery*. His crude one actually preserved the pattern of ordered sequence that marked an artillery unit. But many of today's batteries have little if anything in common with a row of cannon trained on a target and set to fire in order. ■

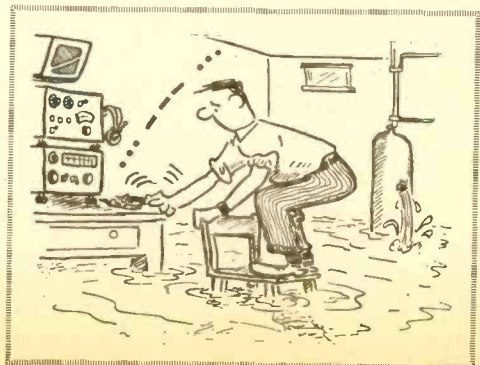

EN PASSANT

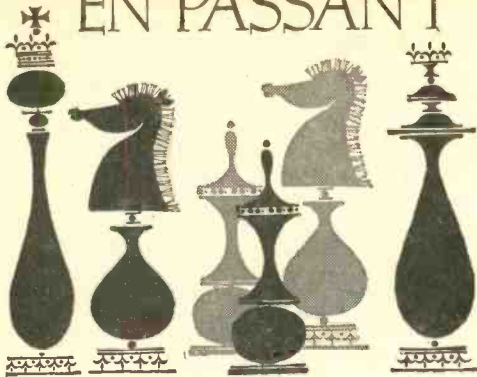

BY JOHN W. COLLINS



□ Chess, like ancient Gaul, is divided into three parts—the opening, the middle game and the ending. And the proper method of studying it is to consider each of these parts separately. James Mason, author of “The Art of Chess,” wrote in 1898 that “For want of method—right method—even much study may prove vain.” He observed that chronologically the opening comes first, but logically, in study, it must come last and he posed the question: “If you do not know what to do with three pieces, what about thirty-two?” So it is that most modern books which cover the three parts, as well as those devoted exclusively with the ending, begin with a discussion of the ending and the elementary mates.

A Royal Pair. The most common and the easiest of the elementary mates is that of King and Queen against King. The stronger side can always force checkmate, from any position, in ten moves at most. From the diagram position below White wraps it up with—

Black

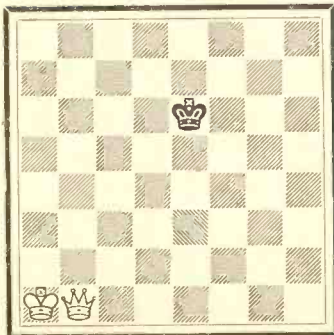

White

- | | | | |
|----------|------|---------|------|
| 1. K-N2 | K-Q4 | 4. K-Q4 | K-B6 |
| 2. K-B3 | K-K4 | 5. Q-N5 | K-B7 |
| 3. Q-KN6 | K-B5 | 6. Q-N4 | K-K8 |



How Bad Is Highway Hi-Fi?

Car cartridge tape players are rapidly becoming the hottest item to hit Detroit since the compact car. Yet, how effective can they actually be? For a surprising and informative answer read the Feb/Mar issue of RADIO-TV EXPERIMENTER.

EASY TO LEARN ELECTRONICS

If you're at all interested in electronics—whether you take it seriously or not—RADIO-TV EXPERIMENTER is bound to make this fascinating subject a lot easier to understand.



SPECIAL HALF-PRICE OFFER

For a limited time, you can receive 12 issues for only \$4.00 . . . an amazing 50% savings!

**NOW ON SALE
AT YOUR NEWSSTAND!
SUBSCRIBE TODAY!**

RADIO-TV EXPERIMENTER EE-367
505 Park Avenue/New York, N.Y./10022

Begin my subscription to RADIO-TV EXPERIMENTER with the next issue.

I am enclosing \$4.00 for 2 years. Payment enclosed (check or money order) Bill me. (Outside U.S.A. & Canada add \$1.50 for postage.)

Name _____ (please print)

Address _____

City _____ State _____ Zip _____

Please include your ZIP CODE

EN PASSANT

- 7. K-K3 K-B8
- 8. Q-N7 K-K8
- 9. Q-N1 Mate

Usually it is accomplished in fewer moves. White's only problem is to avoid stalemates (draws).

One More. The next easiest of the elementary mates is that of King and Rook against King. And the mating process is similar and as follows:

Black

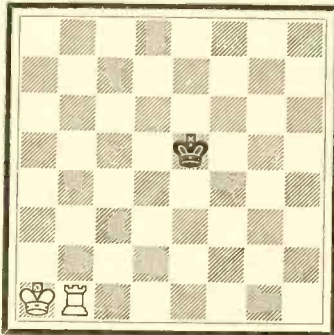

White

- | | | | |
|----------|-------|---------------|-------|
| 1. K-N2 | K-Q5 | 8. R-N5# | K-R5 |
| 2. K-B2 | K-K5 | 9. K-B4 | K-R6 |
| 3. R-N5! | K-Q5 | 10. K-B3! | K-R7! |
| 4. K-N3 | K-K5 | 11. R-N8 | K-R8! |
| 5. K-B3 | K-B5 | 12. K-B2 | K-R7 |
| 6. K-Q3 | K-N5 | 13. R-R8 Mate | |
| 7. K-K3 | K-N6! | | |

In both these endings the dominant idea is to gradually force the helpless King to the edge of the board.

French Defense. In my previous column I presented four miniature games and mentioned "The 1,000 Best Short Games of Chess" by Irving Chernev. On page 396 of that book is a short short I won. I played Black and my opponent was Frutsaert of Belgium. It occurred in the 1948 World Correspondence Chess Championship and the opening was a French Defense.

- | | | | |
|------------|-------|-----------|---------|
| 1. P-K4 | P-K3 | 14. R-QB1 | P-B4! |
| 2. P-Q4 | P-Q4 | 15. NxN | BxN |
| 3. N-Q2 | N-QB3 | 16. RxP? | Q-KN3! |
| 4. KN-B3 | N-B3 | 17. K-B1 | RxN! |
| 5. P-K5 | N-Q2 | 18. PxR | B-R6# |
| 6. P-B4 | P-B3 | 19. K-K2 | R-K1# |
| 7. BPxP | KPxP | 20. K-Q1 | B-N7! |
| 8. B-N5 | PxP | | Resigns |
| 9. NxP | Q-B3 | | |
| 10. N/2-B3 | B-N5# | | |
| 11. B-Q2 | BxB# | | |
| 12. QxB | O-O | | |
| 13. BxN | PxB | | |

Position after 20 . . . B-N7!

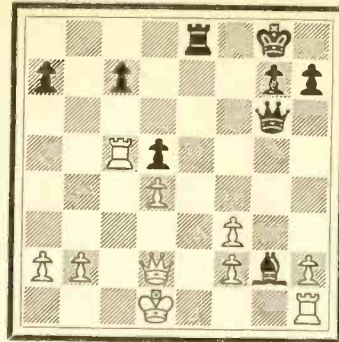

Why did White resign? Because he cannot defend against Black's mating attack, combination to win the Queen and threats to the King Rook and King Bishop Pawn. Here is the analysis—

A. If 21 R-N1 (the King Rook cannot be abandoned) BxP# 22 K-B1, QxR# 23 K-B2, R-K7 wins the Queen.

B. If 21 R-K1, Q-N8# 22 R-B1, BxP# 23 R-K2, Q-K5! 24 R-B2, BxR# 25 QxB (or 25 K-B1, Q-R8# 26 Q-K1, QxQ mate) Q-R8# 26 K-Q2, RxQ# 27 KxR, Q-K5# 28 K-Q2, QxP# and wins with a Queen and Pawn against a Rook.

C. If 21 R-K1, Q-N8#! 22 Q-B1, Q-Q6# 23 Q-Q2, RxR# 24 KxR, Q-B8 mate.

With no time-clock ticking away at your elbow, as it does in over-the-board tournament chess, one has plenty of time to work out every last detail in this branch of the game.

This one fitted my "Why did White resign?" format. And every once in a while a writer feels justified in publishing one of his own games—if for no other reason than to let the reader see he can play as well as edit.

Problem. The problem this month is an original one, never published before. It is composed by Master Sidney Bernstein of Brooklyn, N. Y.,

Problem 5.

By S. N. Bernstein

Black

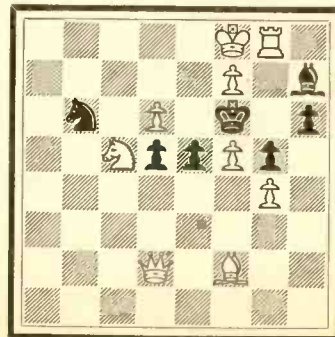

White

White to move and mate in two.
Solution in next issue.

former champion of the Manhattan and Marshall Chess Clubs. He quips it is his "sole and immortal masterpiece." It has an astonishing key move and a rich variety of mating variations.

Solution to Problem 4: 1 Q-Q8.

More Answers. The Solution to End Game Study #2 is 1 P-N5! Now if 1 BPxP 2 P-R5! PxRP 3 P-B5, P-R5 4 P-B6 and wins. If 1 BPxP 2 P-R5! PxBP 3 PxP, P-B6 4 P-N7 and wins. And if 1 P-N5! RPxP 2 P-B5! PxBP 3 P-R5 and wins. In each case White queens first and then liquidates all the Black Pawns with the new Queen.

Tips for Readers. A brief explanation of chess notation and symbols may be in order.

The pieces are denoted by capital letters, thus K = King, Q = Queen, R = Rook, N = Knight (more modern and economical than the older Kt), B = Bishop, and P = Pawn.

And # = check or double check (often given as ch), ! = good move, ? = weak move, !? = speculative move and double or triple exclamation and question marks = exceptionally good or weak moves.

There are several methods of recording moves, the English Notation, which we use, and the Algebraic Notation, used in Europe, being the most prominent. In the English Notation each square on the board has two names, one used by White and one used by Black, derived from the original placement of the pieces. Thus the original square on which the White King is placed is called K1, the square immediately in front of it K2, the one in front of that K3, and so on to K8. Conversely, White's K8 is Black's K1, the one in front of that K2 (White's K7) and so on. Reading from left to right, therefore, the squares on White's first rank are called QR1 (Queen Rook One), QN1, QB1, Q1, K1, KB1, KN1 and KR1. 1 P-K4, the first move in my game with Frutsaert, if written out in full would read Pawn to King Four and the last move B-N7 would read Bishop to Knight Seventh. Strange and seemingly difficult at first, one catches on very quickly to these notations and symbols.

News and Views. Grandmaster Boris Spassky of the U.S.S.R. scored 11½-6½ in taking the Piatigorsky Cup Tournament in Santa Monica during July-August. Robert J. Fischer, U.S. Champion, off to a poor start, made a sensational stretch run and barely missed catching Spassky with 11-7. Bengt Larsen of Denmark finished third with 10-8.

Grandmasters Pal Benko and Robert Byrne each compiled scores of 11-2 to emerge as co-winners of the U. S. Open at Seattle in August. Duncan Suttles of Vancouver was a clear third with 10-3.

Grandmaster Larry Evans of New York, reviser of "Modern Chess Openings," 10th Edition, won the Canadian Open at Kingston, Ont., August-September, with 9-1. ■

NEW 1967 ELECTRONICS HOBBYIST ANNUAL

NOW AT YOUR NEWSSTAND!



Hours of
"How To" Enjoyment
for Pro & Novice
\$1.00 For A Limited
Time Only

You can purchase the newest, most exciting magazine for those whose interest in electronics is on the hobby level. THE ELECTRONICS HOBBYIST contains easy to learn tested and proven construction projects of every description. Literature Library and New Products sections as well as such new departments as CB News and Views, Hi Fi Trends and Communications for the Ham/SWL.

SOME CONSTRUCTION PROJECTS INCLUDE:

AUDIO COMPRESSOR/OHMS-RANGE EXPANDER/
DIAL-AN-OHM/6-METER SOLID-STATE/
WALKIE-TALKIE/TRANSI-MATCH/
A GO-GO STEREO COMPACT/
100-KHZ CALIBRATOR/BUILD THE AERO-BANDER/
SCR SLAVE PHOTOFLASH/

Plus many more projects, gadgets, and construction ideas—enough to provide every experimenter with weekend fun for six months or more.

FOOLPROOF DESIGN! • EASY CONSTRUCTION!

Your favorite construction project has been carefully researched and tested by experts. Each article is complete with theory, construction tips, parts lists, diagrams, and photos to make construction easy and foolproof.

ACT NOW!

**FOR IMMEDIATE HOME DELIVERY
RETURN THIS COUPON TODAY! !**

THE ELECTRONICS HOBBYIST		EE-367
505 Park Avenue/New York, N. Y./10022		
Enclosed is \$1.00. Please send my copy of the 1967 Edition.		
Name _____		
Address _____		
City _____	State _____	Zip _____

Wide World of ELECTRONICS

By Jack Schmidt



"Where's the burnt tube?"



"Wait till you see the cute ashtray Harold made from those small plastic chips!"



"... and have somebody fake a look at my garage door opener!"

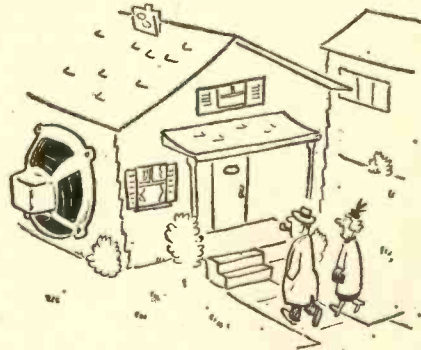

"Whatever you do, don't ask him about his hi-fi!"

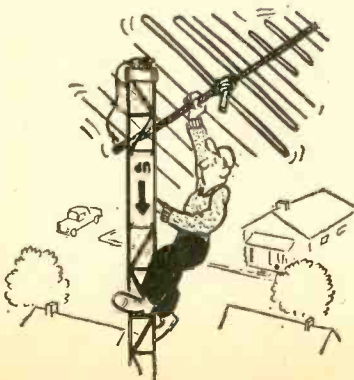

"Did you leave one of your 'bugs' in the den, Honey?"

FLIP-FLOPS

FLIP-FLOPS

THE 2-CYLINDER ENGINES OF ELECTRONICS

By Len Buckwalter, K1ODH/KBA4480

Click-click, push-pull go zillions of flip-flops every day—that is, if you could hear these silent electronic double-throw switches. They utter no sound as they tip-toe through computers, see-saw in sonar, or skim through counting circuits. They're not only quiet, but perform the switching job without moving parts, friction or wear. And they're fast. That's why in numberless applications, the flip-flop has given the heave-ho to the mechanical toggle switch and relay.

The flip-flop is filed under several names because of the different jobs it does and the way it does them. Some are called a *multi-vibrator*, others *relaxation oscillator*, or maybe something special like a *Schmitt Trigger*. Whatever the name, the flip-flop has these distinguishing features. First, it's a two-stage combination of tubes or transistors with a feedback connection between them. Whenever one stage is *on* (conducting current) the other is *off*. But a stupendous feature of the flip-flop is that it abhors any in-between condition. Like pushing a flower pot off a window ledge, once the action starts it is self-completing. Snappy switchover is important—when flipping to flop, in a computer for example, a gradual transition for a counting operation might print your tax-refund check as \$10,000 instead of 10 cents. As we'll see, the circuit's feedback assures that the *on* stage always tries to force the other one *off*. That's a persistent theme despite numerous variations.

Another peculiarity is that the circuit produces signals which don't resemble the familiar, flowing sine wave generated by regular oscillators. The wave form is often

square, clipped or sawtooth in shape. That's because the circuit switches quickly as stages are driven between *on* and *off*. This is important for generating pulses in radar equipment which needs squared-off signals of fast rise and decay time. Another quality of the flip-flop is that it can trigger itself or feed on external signals. To penetrate the heart of a flip-flop, we can start with the method for developing the switching action.

Putting Phase in Reverse. Let's feed a simple amplifier tube with an input signal and cause it to conduct current. The input is shown as a positive-going pulse (1) applied to the tube grid in Fig. 1. As in any conventional amplifier, a positive-going grid voltage produces an increase in plate-current flow through the tube (from cathode to plate). It also produces another effect: voltage at the plate (2) will drop to a lower value. Reason for the drop is that more current flows through the plate-load resistor and that component drops more B+ supply voltage than previously. The plate of the tube receives less supply voltage, since current flow has increased, and the tube appears (to the power supply) as a lower value resistance.

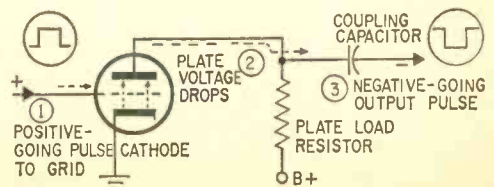

Fig. 1. Basic triode amplifier shows effects of a square-wave signal passing through the circuit. The numbers relate to specific actions covered in text.

e/e FLIP-FLOPS

For example, if plate voltage is originally 250 volts B-plus, a positive-going signal on the grid might drop it to 150 volts—the remaining 100 volts appearing as a voltage drop across the plate-load resistor.

The drop in plate voltage—to a less-positive level—is applied to the coupling capacitor. The direction of current flow is such that electrons flow onto the plate of the capacitor connected to the plate-load and this charge repels electrons away from the other right-hand plate. The net result is a *negative-going* signal (3) at the output side of the amplifier. This action, actually a 180-degree phase reversal, is crucial to operating the flip-flop circuit. The tube has caused the input signal to do an about-face. Consider, next, how the same phase reversal occurs in a transistor. With the trend toward solid state, the semiconductor is becoming the standard device in constructing flip-flop circuits.

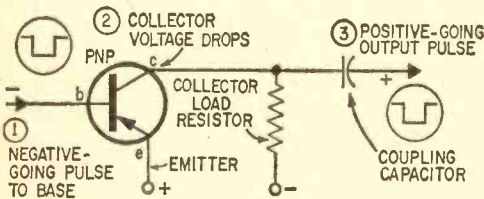

Fig. 2. Basic transistor amplifier should be compared with basic vacuum-tube amplifier (Fig. 1). Both *pnp* and *npn* transistors can be used in this circuit.

In Fig. 2 is a transistor amplifier. Its phase-reversing action is nearly identical to that of the tube. Only difference is the polarity of the input signal; to start the stage conducting, it is a negative-going pulse. (This is true for a *pnp* transistor; an *npn* type would require a positive-going input pulse for the same effect.) As the base is driven

more negative (1), collector current rises. Unlike the tube plate in our earlier example, collector voltage (2) drops to a less negative (or more positive) value. Applied to the coupling capacitor, this change appears at the output as a positive-going signal (3). Again, the output signal is opposite in polarity when compared to the input, due to a phase reversal. Now couple *two* identical phase-reversing stages together, and you have the beginning of a basic flip-flop circuit.

Hitching Flip to Flop. We can fire the opening gun to commence flip-flop action, as traced in Fig. 3. When the circuit is first turned *on*, one tube will always conduct more than the other even though all circuit values are the same. It could be due to slight tube unbalance, a fluctuation in the power supply, or some other transient disturbance. We'll assume that tube V1 is first to conduct. What follows is a four-step sequence shown by the numbers in Fig. 3. Plate current (1) commences to flow through tube V1, which lowers V1 plate voltage because of the IR drop across R1. This is the phase-reversal effect described earlier and the resulting signal rapidly charges the coupling capacitor (2) with a negative-going signal. We've assigned this charge a value of -75 volts and it's applied to the grid of the second stage, V2. High negative voltage at the grid puts V2 into cutoff and V2 plate current flow stops. If you consider what's happened, you'll note, that as the first tube (V1) went on, it quickly drives the second stage into cutoff with a strong negative signal. But the circuit doesn't remain in this condition very long.

The charged coupling capacitor between stages sees a path to ground through the grid resistor. Thus the capacitor begins to discharge current to ground. But that outflow of current is not sudden since electrons encounter opposition from the grid resistor. The coupling capacitor (C1) and grid resistor form an RC (time-constant) circuit that slows the discharge. And it's possible to select a resistor-capacitor combination to

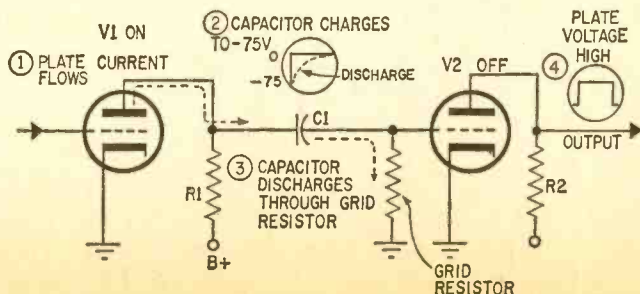

Fig. 3. Two-stage amplifier shows current flow, coupling-capacitor discharge path, discharge waveform and output signal. Numbered points are covered in text. Circuit action occurs too rapidly to be shown on normal measuring instruments but can easily be seen with a good scope.

control capacitor discharge from seconds to microseconds.

Next see what occurs at the plate of V2—the *off* tube—during the discharge time of the capacitor. We can see at the output side (4) that plate voltage has risen to a high positive value, caused by a negative charge on V2 grid. What's more, the plate will display a steady high-voltage plateau as the capacitor discharges. It might seem that V2 plate voltage would slowly rise as the capacitor loses its negative charge. This doesn't happen, however—the tube can be completely cut

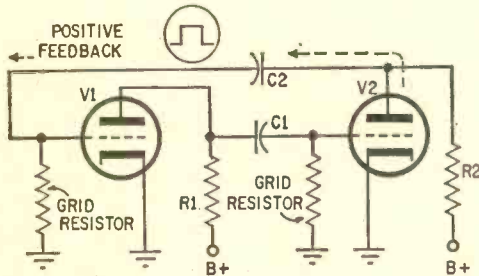

Fig. 4. Basic flip-flop circuit includes feedback path—added to two-stage amplifier in Fig. 3. A capacitive-coupled flip-flop works reliably only at moderate to high frequencies or repetition rates.

off with a small negative grid voltage (less than about 10 volts). It takes the capacitor nearly its full discharge time to go from a high of -75 volts to below -10 volts. Thus V2 remains cutoff during most of the discharge time. It results in a squared-off, positive-going output pulse.

From Flop to Flip. Now we can complete the flip-flop circuit as shown in Fig. 4. What's been added is a second coupling capacitor, C2, from the plate of V2 back to the grid of V1. Purpose of this component is to create a positive feedback path. As you may recall, when the plate of V2 was switched *off* it developed a positive-going voltage pulse. With the addition of the second coupling capacitor (C2), the pulse is now applied back to the grid of V1. The result is to rapidly force V1 to conduct more current. Soon the tube is fully *on* (completely saturated) and it can pass no additional increasing current.

These events reveal how the flip-flop relies on positive feedback to obtain its important characteristic: that an *on* tube produces a signal which is subsequently returned from the *off* stage. Feedback is always in a direction that reinforces the *on* condition. Up to this point, the circuit has produced one-half cycle. Next to be examined is how the tubes may continuously switch back and forth.

Recall that in Fig. 3, the coupling capacitor charged quickly, but discharged at a fairly slow rate through the grid resistor. When the discharge time is nearly complete, V2 goes from the *off* to an *on* condition since the capacitor no longer delivers a negative-going cut-off voltage to the grid of V2. As V2's grid voltage approaches zero, current will commence flowing through V2. At this moment the circuit goes from flop to flip—all the conditions described earlier are reversed. The sequence occurs this way as V2 now goes *on* and V1 is switched *off*: rising current flow through V2 drops that tube's plate voltage; this feeds back a negative-going signal to the grid of V1; tube V1 is then cutoff and remains that way until its grid capacitor (C2) loses its charge.

From Eccles to Jordan. The flip-flop circuit described so far is termed *free running*. It repeatedly see-saws at a frequency which depends on values selected for the coupling capacitors and grid resistors. The circuit produces square-wave output since the stages are either fully *on* (saturated) or fully *off* (grids driven into the cutoff region). And since the feedback signal is initiated quickly (during capacitor charge), the instant of switchover is very fast. And the *on* or *off* periods may be sustained by choosing larger capacitor and resistor values. These features make the flip-flop an admirable device for computer logic circuits since the electronic components—tubes, resistors, etc.—may change value through age, but the circuit continues to generate a distinct *binary* action. When a serious component defect does occur, it generally puts the circuit completely out of action. This is far more reliable than a circuit which produces some in-between or analog signal. Another descriptive term for the free-running flip-flop is the *astable* multivibrator. If you want to be historical about it, call the circuit an *Eccles-Jordan* multivibrator. Now to modify it for another important function.

One Shot. The circuit in Fig. 5 is variously called the *one-shot* multivibrator, or the *univibrator*. It displays the useful characteristic of responding with a single, uniform output pulse when triggered by pulses of varying lengths from an external source. This enables it to perform as a counter of input pulses.

If we examine Fig. 5, it is seen that the one-shot circuit differs from its free-running cousin. The principal operating feature is that one tube—V1 always prefers to remain

e/e FLIP-FLOPS

off, while V1 attempts to maintain a conducting, or on, condition. An external pulse applied to V1, however, instantly switches that tube on and V2 off. Then the circuit will automatically reset to its normal condition, awaiting the next input signal.

Note in Fig. 5 there is no complete, or closed, feedback loop; that is, no coupling capacitor returns the signal from V2 back to V1. There is another type of coupling between stages. It is the common cathode connection. If plate current flows in either tube, a voltage drop appears across cathode resistor R2. Further, an increase in that voltage drop across R2 always tends to reduce current flow in both tubes. (This is a standard cathode biasing technique, where an increase in positive voltage at the cathode is the same as making the tube grid more negative.)

Fig. 5. Cathode-coupled one-shot flip-flop will always return to its starting condition—V1 is always driven to cutoff because of the grid bias across R2 and applied only to V1 through R1. No bias is on grid of V2 since grid is returned (through R3) directly to cathode.

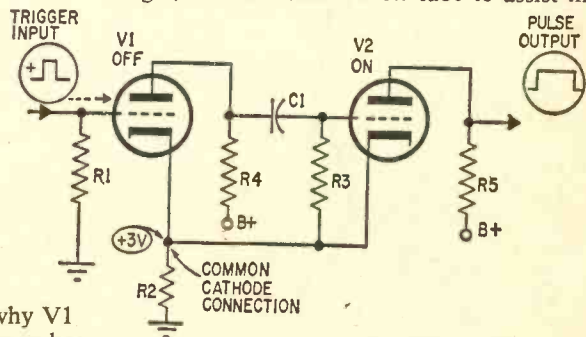

Before the action begins, let's see why V1 is normally off, while V2 is on. This can be traced to the grid connection for each tube. V1 is returned to ground through resistor R1 and no grid bias develops from this source. But the tube cathode, operating at +3 volts does bias the grid. The grid of V1 is now at cutoff value since a +3-volt cathode voltage means that the grid is 3 volts negative in relation to the cathode. Thus V1 doesn't conduct current (through its plate circuit) at this time. Now to trace the source of the +3 volts on the cathode.

If tube V2 is examined, it is seen that its cathode also connects to the common cathode resistor. The grid of V2, however, doesn't return directly to ground. It connects directly to the cathode (through R3). This eliminates the effect of cathode bias (+3 volts) and V2 is permitted to conduct a large amount of current. This imbalance between tubes represents the normally on and off condition of

the two stages. But this on and off relationship changes when a triggering pulse is applied to the circuit. The pulse, which is positive going, overcomes the negative bias on the grid of V1. (Recall that the +3-volt cathode has the effect of biasing the grid to -3 volts). Plate current now flows through R4 and V1 and plate voltage drops. This sends a negative-going pulse through coupling capacitor C1. The negative-going pulse causes tube V2, normally on, to sharply decrease its current flow and plate voltage increases. It is this plate voltage increase at V2 which produces the signal output of the one-shot multivibrator.

As in earlier circuits, pulse length is controlled by discharge time of the coupling capacitor (C1) through the grid resistor. That time is uniform, and independent of the length of the trigger input.

There is still another feature of the circuit—one that keeps the changeover action brisk. Without it, the tubes wouldn't switch quickly enough to form a clean, square-wave output. It's the common cathode connection for both stages, which causes the on tube to assist in

switching the other tube off as quickly as possible. When plate current of V2 falls, less current flows through the common cathode resistor—a less positive voltage appears at the top of the R2. Since V1 is also connected to this point, the grid bias on this tube (V1) becomes less negative. The total effect of this circuit feature is that the tube which goes on (V1) helps turn off the other tube.

The cycle ends as V1 reaches saturation and can no longer pass a signal through the coupling capacitor. This causes V2 to switch back to its normally on condition, and V1 to off. The circuit is now ready to receive the next triggering signal. Since the one-shot multivibrator automatically returns to its original state after it goes through its cycle, it is sometimes called a monostable multivibrator. (Continued on page 36)

SEND CARD FOR RCA'S NEW 1967 HOME STUDY CAREER BOOK TODAY

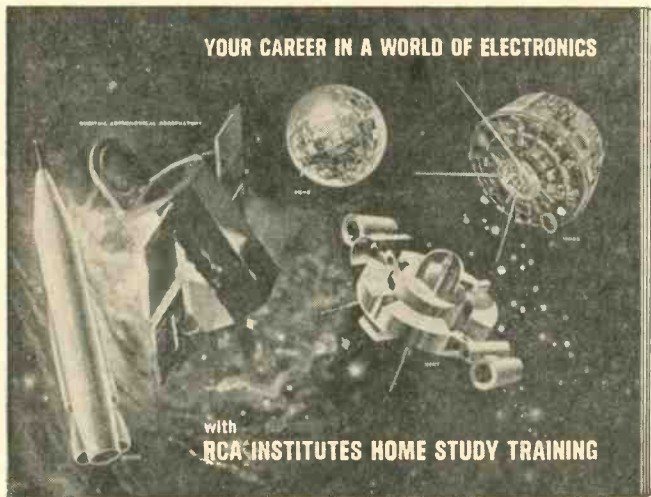

CUT THE TIME BETWEEN NOW AND SUCCESS

- Find out about RCA Institutes Career Programs.
- Learn about the amazing "Autotext" programmed instruction method—the easier way to learn.
- Get the facts about the prime quality kits you get at no extra cost.
- Read about RCA Institutes' Liberal Tuition Plan—the most economical way for you to learn electronics now.
- Discover how RCA Institutes Home Training has helped its students enter profitable electronic careers.

Lots more helpful and interesting facts too! Send postage-paid card for your FREE copy now. No obligation. No salesman will call.

RCA INSTITUTES, Inc. Dep't. EA-37
350 West 4th Street, New York, N. Y. 10014

RCA Institutes also offers
Classroom Training.
Catalog free on request.
(Courses also available in Spanish)



The Most Trusted Name in Electronics

Continued from page 32

Fig. 6. Variable-frequency multivibrator can be used as a code practice oscillator if you replace s.p.s.t. switch with a morse-code key. While output is not a sine wave it is suitable for this use. Output can also be used as generator for signal-tracing tests.

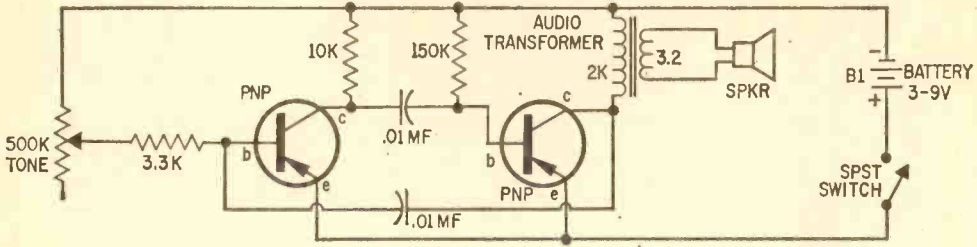

A Practical Application. As we have seen, the input pulse merely serves to trigger the cycle, which then takes off and completes itself. The output signal is always the

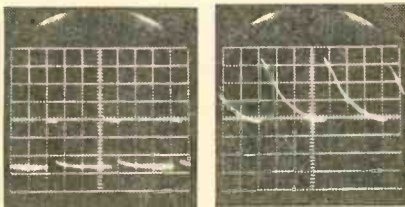
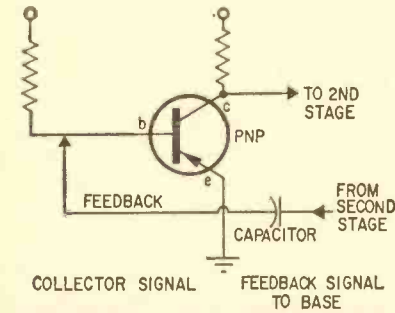

Fig. 7. Partial circuit and waveforms of Fig. 6.

same length, since it is timed by the coupling capacitor and resistor. This feature might be useful for, one example, in a transistorized automobile tachometer. Triggering signals obtained from the ignition system distributor

points tend to vary in length, according to engine speed. But applied to the one-shot multivibrator, all input pulses are cleaned up before proceeding further into the tach's circuits. Output will contain only the number of pulses per second—not their varying length. Another application is in computer counting. Let's assume that a given one-shot multivibrator always produces an output pulse which is one second long. Now trigger that circuit with a continuous stream of short input pulses, each one-tenth second long. The result will be one output pulse for every ten input pulses. (After the first input pulse, the circuit takes off and can't respond until it resets, just as the eleventh pulse comes along). This function can perform addition by ticking off every ten pulses. A third important application of the one-shot multivibrator is in expensive oscilloscopes where it becomes the *Schmitt Trigger*. When the scope is examining a complex input signal, the triggered sweep can be adjusted to lock on to any desired portion of the signal. This synchronizes the scope to produce stable images. (Less sophisticated scopes try to lock on or synchronize with the strongest portion of the input signal).

Construct Your Own. The circuit given in Fig. 6 is that of a practical flip-flop you (Continued on page 110)

Fig. 8. Multivibrator drives direct-coupled amplifier to flash 12-volt, 1-amp lamp used in high-intensity lights. Power transistor is needed to carry such a high current. If you decide to build flasher use heavy-duty battery—D-cells won't last.

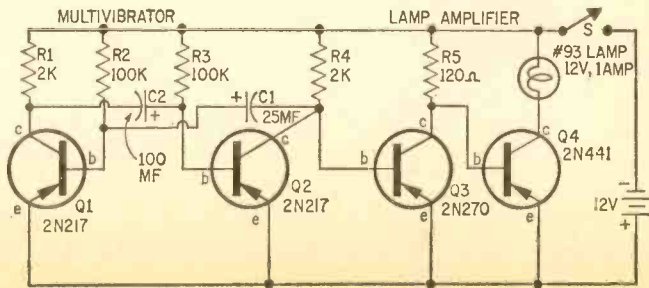

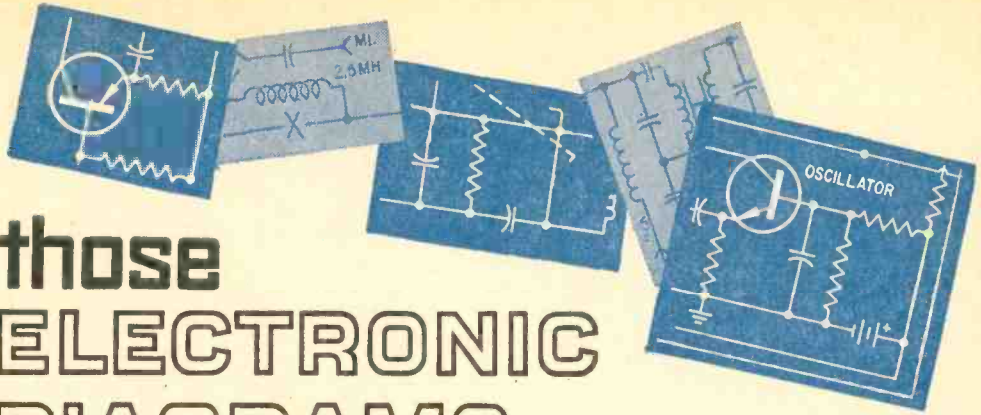

those ELECTRONIC DIAGRAMS

BY
E. NORBERT SMITH

Diagrams are the maps of electronics. If you don't understand them it's a good bet you won't get anywhere. Here are the most frequently used types.

Electronics is one of the largest and fastest growing industries today. It varies in complexity from inexpensive audio amplifiers to complex systems that make possible a successful soft lunar landing. As with any specialty, various abbreviations and symbols are used to such an extent that the outsider is left bewildered, if not frightened.

The diversity of electronics may be seen in the variety of electronic diagrams used. They range from the simple block diagram, familiar to the most casual electronics reader, to highly complex logic diagrams used in computer work. A better understanding of the various electronic diagrams used may prove useful as well as interesting.

Block Diagrams. The block diagram is the simplest of all the electronic diagrams and is perhaps the most widely used. It consists of named boxes connected by a series of lines. The rules for the block diagram

are few and flexible. The named boxes or blocks may be a single transistor or an entire radar system. The lines generally show signal flow but can just as easily identify primary power distribution or direction for a laser beam.

Flexibility is what makes the block diagram so useful. No matter how complex a circuit or system may be, a simplified block diagram can be drawn to bridge the gap in understanding. The signal flow in something as complex as a dual-conversion receiver can easily be illustrated with a simplified block diagram. Once you have mastered the simplified block diagram a more complex block diagram could be explained.

Primarily then, the block diagram is an introduction; a training aid—useful for describing an electronic circuit or system to someone for the first time. It provides an uncluttered, functional view of a circuit.

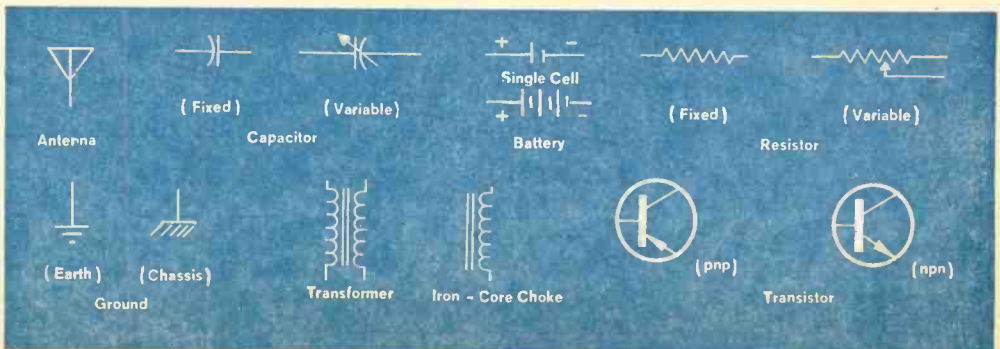

Some of the many symbols used in schematic diagrams.

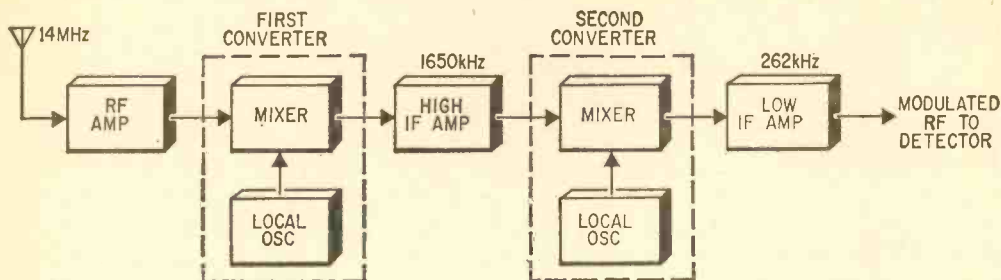

Block diagrams are helpful in tracing signal flow but they are seldom included in manufacturers' manuals. They are used extensively in advanced texts covering the more complex units like TV and communications receivers.

The block diagram is by no means limited to the classroom. It has found wide application in the advertising medium. For example, it is often used to acquaint prospective customers with the operation of an electronic product without giving away the actual circuit. As a troubleshooting aid the block diagram can help to isolate a trouble to one area or stage by showing signal flow.

The block diagram, however, doesn't show enough detail to understand how any given circuit performs its function. All it does is indicate the individual stages. To indicate the actual electronic components that make up a circuit the schematic diagram is used.

Schematic Diagrams. The schematic diagram could be called an electron's eye view of the circuit. It consists of lines representing wires and symbols designating every electronic component as shown in its proper electrical relation to the remaining circuit. This electrical relation (rather than physical relation) may be somewhat difficult to grasp at first. The majority of the blueprints and drawings (whether it is a house plan or design for a machine) are carefully drawn to maintain proper physical relation, but any physical resemblance a schematic diagram may have to the layout of resistors and capacitors in the working circuit is purely accidental. The schematic diagram's purpose is to show exactly what is connected (electrically) to what—not where the components will be physically positioned.

The abbreviated table of schematic symbols, on the preceding page, would need several pages to present completely—with all the variations and combinations.

Some of the more common electronic symbols, as used in the industry today, are

pictured in the table. They may seem rather arbitrary at first, but a little thought will show their descriptive nature. How could a capacitor be described more clearly than two plates separated by a gap, or an inductor by a looping line. These symbols have found such universal acceptance that, for example, an American electronics engineer, technician or experimenter will find only a little difficulty "reading" a German or Japanese schematic diagram.

Schematic diagrams are the written language of electronic circuits. They are used from the conception of an idea through development and testing and finally they are an invaluable road map in troubleshooting.

Many electronic circuits start as a schematic diagram scribbled on a scrap of paper by an electronics design engineer. This rough schematic may then be modified, added to, and redrawn dozens of times before the circuit is built and tested. To the design engineer, the schematic diagram is a tool with which to make calculations; try new circuit configurations and make preliminary cost estimates.

Schematic diagrams, along with block diagrams, are used extensively in electronics training at all levels. They make it possible to understand how even the most complex system functions. At first glance the schematic diagram of a TV or even a radio seems quite complicated but after becoming familiar with the symbols it will become apparent that many of the circuits seem duplicated, at least in part.

All components grouped around one transistor, or tube, are often referred to as a stage. In a radio there may be two or three identical, or at least very similar, IF ampli-

fier stages. Most RF stages have certain similarities, as do audio or IF stages. After the few basic circuits are understood a complex electronic circuit can be reduced to many simple stages which, when taken one at a time, are easy to understand.

In addition to having each component, its value and electrical position, a troubleshooting schematic may have such helpful guides as waveforms, voltages, resistance to ground, etc., marked at various points in the circuit. These guides are used in troubleshooting when an instrument indication is found that differs from the value printed on the schematic. The defective component can then be found more quickly.

Although the experienced engineer, technician or experimenter can usually build a working circuit from only a schematic diagram, more information is needed by the beginning experimenter. In working with high-gain and high-frequency circuits, lead dress becomes just as important as using the

proper components. Signal leads must be kept short, special grounding methods may be required and care must be observed to avoid unwanted hum pick-up. To assure the circuit works as it was designed to, the original layout must be used. This requires the use of the pictorial diagram.

Pictorial Diagram. The pictorial diagram is the most lifelike of all the electronics diagrams. Often actual retouched photographs are used for a pictorial diagram. It is common, however, to have draftsmen or technical illustrators draw the pictorial diagram. In order to illustrate a crowded area an exploded view or exaggerated drawing is used.

The purpose of the pictorial diagram is to show how and where (physically) each component is mounted. All tie points, sockets and mounting hardware are shown. Generally, the components are shown simply by an outline drawing with their circuit designation and possibly their value written on them. *(Turn page)*

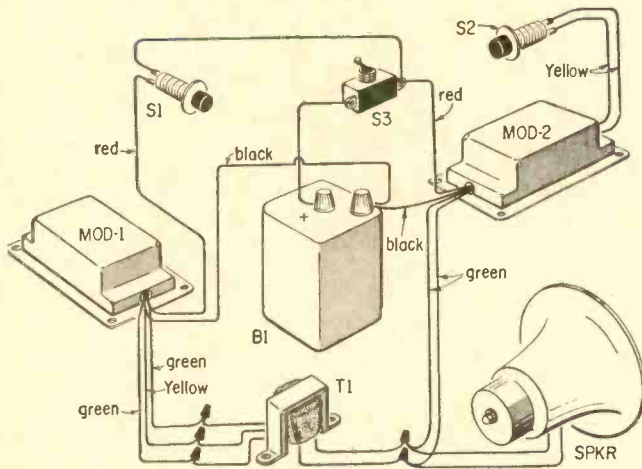

Artist's concept of the electronic circuit is the pictorial diagram. The one at the left shows the same circuit as that in the photograph below. In the pictorial diagram all connections are shown as they would be made to the component—only the chassis is not shown here. Tubular objects are solderless connectors.

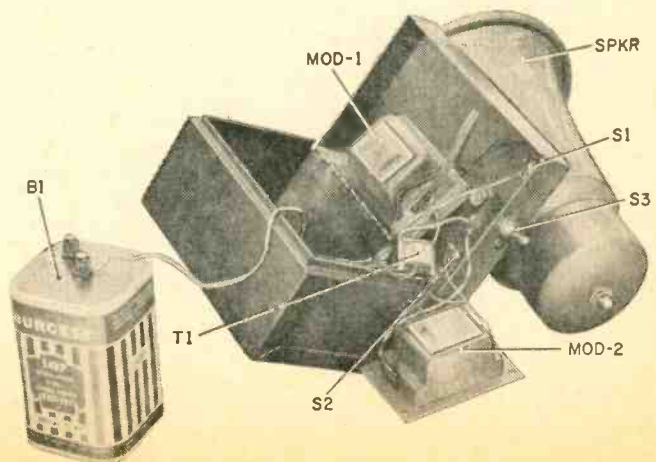

Photograph (right) shows actual construction of the unit. Some of the connections are obscured and others are a confused jumble. It's a good assembly illustration as all parts are shown in their exact positions—mounted in cabinet.

Pictorial diagrams enable the inexperienced builder to duplicate the layout and lead dress of the professional. They enable production-line workers to assemble complex electronic equipment without knowing any electronic theory. These detailed drawings are what made electronics kit building a reality.

By using the pictorial diagram a beginner can build an electronic circuit and by carefully rechecking his work for errors a circuit can usually be made to work (at least in modest construction projects) but the pictorial diagram is meant to be used as a layout guide with the checking done using the schematic. Even though all the components, hardware, and so on is shown in the pictorial diagram, it becomes difficult, especially in larger construction projects, to determine where to drill holes in a chassis or panel. A drill diagram is needed.

Chassis Layout Or Drill Diagram. The chassis layout or drill diagram is for the metal worker. It is a sketch that shows the location and size of each hole to be drilled in the chassis or panel. Dimensions are usually referenced from one corner or edge. In industry, drill diagrams are an absolute necessity because the metal work is done in a different area (or even subcontracted) than electronic assembly. Each panel and chassis must look like every other panel and chassis for that certain piece of electronic equipment.

The chassis layout or drill diagram is generally the work of a specialist called an electronics packaging engineer or designer. He works with the circuit design engineer to package the electronics in a box that meets all the circuit requirements, is pleasing to the eye and mechanically feasible to fabricate. The packaging engineer must know the exact dimensions of all components, which ones produce RF noise or heat, which controls are used the most, etc. He then may go as far as building a mock-up to find the layout that is most suitable. From this final layout the drill diagram is sketched from a prototype unit and finally drawn by draftsmen.

The hobbyist that uses a drill diagram will find it a great help in producing a neat, clean, finished project. Unless a considerable amount of time is spent measuring components and planning their exact location a rather haphazard layout can result. In electronic circuit construction all the mounting holes should be drilled first to avoid getting metal chips in the partly built circuit. Also if all the holes are drilled at one time, the panel or chassis may be painted, or otherwise finished as desired before the components are mounted—without scratching the finish by drilling some holes later.

Printed Circuit Layout. Due to reduced size, ease of assembly and increased reliability more and more electronic circuits are being produced on printed-circuit boards. It's not uncommon to find printed-circuit boards in home-built projects. In its simplest form the printed-circuit board is an insulator base (such as phenolic or fiberglass)

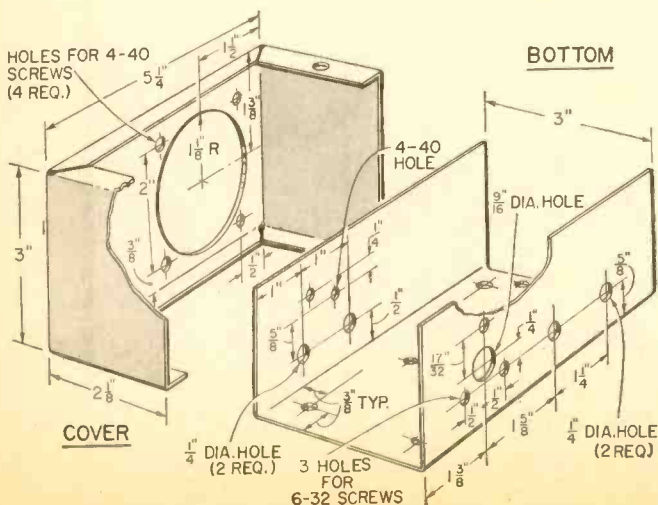

Chassis layout diagram style shown here is suitable for most construction projects. Commercial drill diagrams would show a flat surface for each side that is to be drilled, punched or cut out. Generally a box such as one shown here would be drilled, punched and cut before it was bent into shape unless it was a commercial box.

covered by a thin sheet (foil) of copper, on one side or both sides. Most of the copper is etched off leaving a pattern of copper on the board. This pattern of copper is used in place of the interconnecting wires for the components that are mounted on the circuit board.

Mass produced printed-circuit boards are usually made by a photographic process. This requires a positive transparency through which areas of a photo-sensitive coating

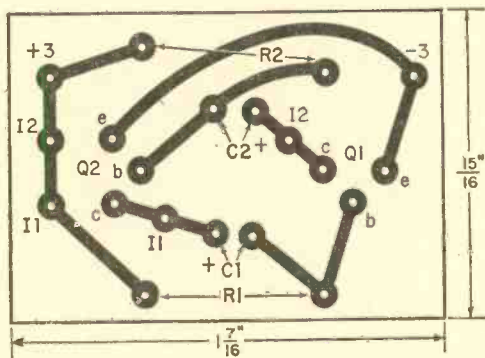

Printed-circuit layout is almost twice the finished size. Doughnut-shaped pads surround holes for pig-tail leads of resistors, capacitors and transistors.

(previously applied to the copper foil) are exposed—much like photographic prints are exposed. This positive is the printed circuit layout.

For some simple, not-too-small applications the layout is produced 1 to 1 (actual size) but usually the printed-circuit artwork is several times larger than the finished board—then reduced, photographically, to exact size. It is easier and more accurate to lay out a circuit several times larger than the actual circuit board—then reduce it to actual size—than it would be to try to lay out a miniature printed-circuit board actual size.

To understand how reducing the size improves the accuracy, assume for a moment that a draftsman can work by using a grid pattern to a tolerance of $\pm 1/32$ inch. Also assume that a transistor is to be mounted and the holes for the leads allow only $\pm 1/32$ inch ($\pm .03$ inch) tolerance. The draftsman must be very careful or the transistor leads will not fit the hole. On the other hand, if the draftsman is working on a layout that is to be reduced by a ratio of 4 to 1 he can make an error of 4 times $1/32$ or $1/8$ inch and the transistor leads will still fit. Or looking at it another way, a $\pm 1/32$ -inch error on the large layout reduces to only $\pm 1/128$ inch. All

layout artwork must be done on a dimensionally stable material (such as Mylar) which will not shrink or stretch from heat or humidity.

The printed-circuit layout diagram is a very specialized diagram—for only one specific application; that of producing a printed circuit. Shear and trim lines are usually included as well as a reduction guide. A reduction guide is a line with a reduced length specification. When photographically reducing the printed circuit to the right size, this reduction guide is used to know exactly how much to reduce it.

Logic Diagrams. The logic diagram is used for designing computers. It is sort of a cross between the schematic and block diagram but it is mostly a block diagram. A computer is a highly electronic machine containing tens of thousands of transistors. It is relatively simple in spite of its complexity. Computers are constructed by using a few basic circuits many times, over and over. In the logic diagram each of these circuits or logic functions is represented by a symbol with the interconnecting lines representing logic or signal flow. Each of the logic symbols represent an electronic circuit, such as an *and* gate, *bistable flip-flop*, etc., which performs some logic function.

The use of a symbol to represent one complete logic function greatly simplifies the logic diagram by omitting such repetitive

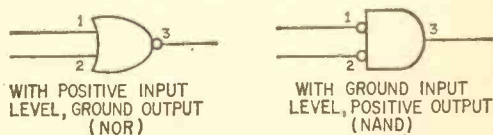

Logic diagram symbols are many and varied. These are from MIL-STD (Military Standard) 806B. Industrial designs by different manufacturers often use somewhat different forms as logic blocks in the logic diagrams.

nonessentials as supply lines, bias networks, etc. This electronic shorthand still illustrates exactly each logic function and the signal distribution. Computers are designed from a logic approach with the designer hardly knowing how, electronically, each function is performed. In fact even at the maintenance level the logic diagrams are used to aid in locating the defective plug-in board which is replaced—all without the aid of a schematic diagram. Only if the board is to be repaired must a schematic diagram be used.

Logic diagrams are not limited to calcu-

lating applications. Complex industrial production machines, also computers, are often presented by a logic diagram. The logic diagram is not only an aid to understanding how a machine operates but is valuable in troubleshooting as well.

Ladder Diagram. The ladder diagram, so named because the circuits are laid out horizontally between two vertical wires like a ladder, is widely used in industry, but is not as well known as some of the other diagrams. The ladder diagram is similar to the schematic diagram in that all electrical components are shown, but the ladder diagram is laid out from top to bottom usually in the order in which it works. Some of the symbols used are similar to those used in schematics but some seem quite different. The ladder diagram was developed as a troubleshooting aid for industrial production-line machines. Wherever there is mass production, there is automation and with it electrical or, if you prefer, electronic control circuits. Just trying to find out what circuits a given relay controls on a many-page schematic diagram becomes quite a task. The ladder diagram greatly simplifies the job by showing all the circuits a relay controls on the same line as the relay. At right is an example of a ladder diagram; a circuit to provide a temperature controlled environment—heating and cooling—using a modified refrigerator is given in part.

To illustrate how the ladder diagram works consider for a moment what is required to energize RLY4 on line 6. One terminal of the coil of RLY4 is connected to one side of the 117 VAC line. If S1, the AC power switch, is closed, the other terminal of the relay coil is connected to the other side of the line through the contacts of RLY 3, S4, the overtemperature light (with a series 100k resistor) and the overtemperature thermostat contacts (that are paralleled with a 100k resistor). The relay coil cannot be energized by the small current that flows through either of the 100k resistors. But even the current through both resistors is enough to light the neon lamp. Now if S4 is pressed the overtemperature light will go out—it will also go out if the contacts of RLY3 are closed. As long as the overtemperature light is on, RLY4 is not energized. Only when

RLY3 contacts are closed (or if S4 is pressed) and the overtemperature thermostat contacts are closed will the coil of RLY4 be energized. The coil of RLY3 is not shown in this portion of a very long diagram.

The ladder diagram makes a convenient tool with which to design and troubleshoot automatic and production machines. You may find one pasted on the back of your automatic washing machine or refrigerator.

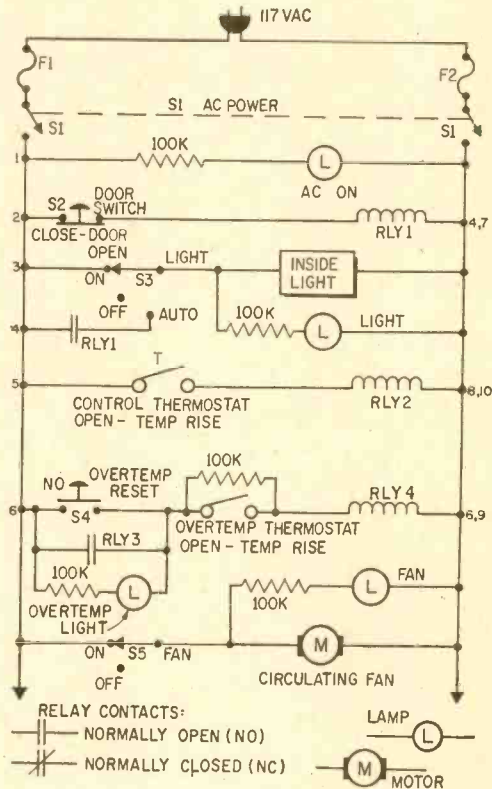

Ladder diagram simplifies circuitry by separating relay coils from relay contacts. This eliminates the many lines, representing wires, that crisscross most schematic diagrams. Ladder diagram is limited to control circuits in appliances and in automation.

The ladder diagram given here is much abbreviated—it would run most of the way down the page. It is only an illustration of a typical ladder diagram—just to be compared with the previously given types. Diagrams used here were taken, partly or completely, from actual devices.

There are many other kinds of electronic diagrams in use today but they are beyond the scope of this article. Only the more common and useful types have been discussed. ■

DESIGN NOTES FOR A HAM CONTROL CENTER

HAM SHACK



WITH A HEART

BY HOWARD S. PYLE
W7OE

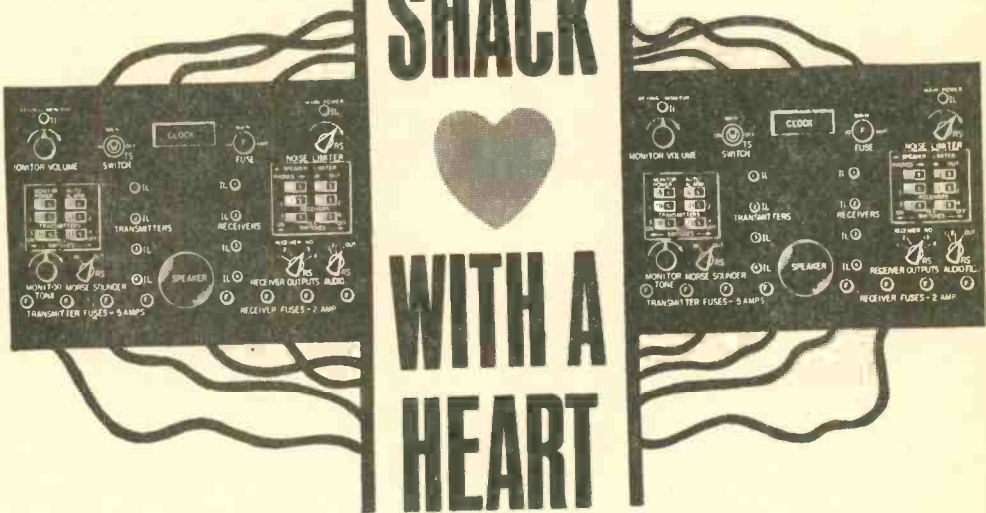

“And what may you mean by that?” you may well ask! Well, just what is the *heart* of a ham shack? Obviously it is the center from which control of all the equipment is effected. If you don’t have such centralized control, you’re antiquated. That’s right! If going on the air means you have to independently switch on every piece of gear you’ll be using—transmitter, receiver, keyer, antenna rotators and miscellaneous accessory equipment by flipping a myriad of switches scattered on their individual panels—you’re doing it the *hard* way!

Centralized control can be as simple or as complex as the multiplicity of your gear or your own personal ideas of operating convenience dictate. For a simple novice set-up, for example, comprising only a transmitter, receiver and possibly an electric clock, a *control center* may seem to be a bit on the ridiculous side—but *is* it? Take a quick break-down; obviously the clock must run continuously—24 hours a day—to be of any value. Often it occupies a spot on top of the receiver or transmitter or it may be hung on the wall in a spot not always convenient to read quickly when logging. The receiver has a toggle switch on the panel for AC power on-off control perhaps; the transmitter no doubt is likewise fitted. Both have, or should have, independent fuses.

Too often these are buried deep within the chassis, far from a convenient spot for a quick change should you happen to blow one. Why not group all of these controls, fuses and, yes, even the clock and indicator lights in one neat little package together with a main switch and fuse, right in front of you?

A Start. Take a look at the little unit in the photo group on the next page. This is the *heart* of a simple novice station. In addition to the clock, a main-power toggle switch and fuse, together with an indicating

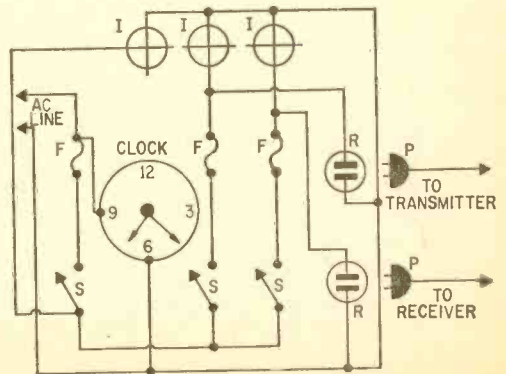

Simplest control center has main switch (left) and two switched outlets or receptacles (R) for power plugs of transmitter and receiver. Clock is not turned off by either main switch or by main fuse.

e/e HAM SHACK HEART

light are provided (in the vertical row to the left of the clock). If the main switch is turned to *off* no power can reach any of the other switches and all equipment *except* the clock is effectively turned off. The same condition occurs should the main switch fuse blow. However, assuming the fuse is good and the main switch is *on*, the bank of switches, fuses and lights to the right of the clock provide independent control of each piece of equipment as well as a visual indication that it is *on*. (In the unit shown in the photo, one switch, fuse and indicator light could be deleted as this unit was built in the days when a Conelrad receiver for the Ham shack was a legal requirement; the control could however remain and be used for some other piece of equipment.)

With a little magic box like this, it is obvious that the transmitter and receiver can be separately switched *on* or *off*, if the power switches on their individual panels are left in the *on* position. If either piece of gear blows a fuse it is right in front of the operator in an insert type fuse-holder; changed in a jiffy—without removing umpteen screws to dig into a chassis! Remember though to either by-pass the chassis fuse with a wire or use one of higher-than-normal rating with the normal size placed in the control unit. This little box then constitutes just about as simple a control center as could be devised for a minimum amount of equipment yet it is just as effective and conveni-

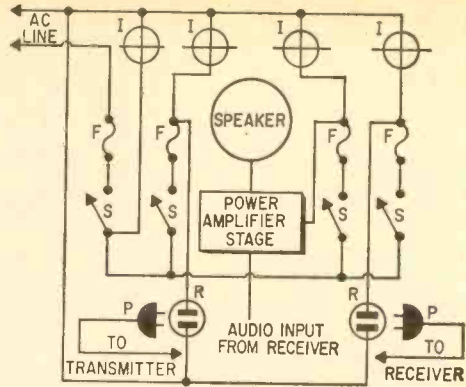

Four pilot lamps (I) across top of diagram indicate (from left to right) main power, transmitter power, power amplifier on-off, and receiver power. Fuses (F) protect house wiring from fuse-blowing defect.

ent a centralizing point for the station equipment AC power as its more elaborate big brothers.

Audio Too! Now take a look at the little unit in the upper right of the group photo. This lad chose to include his speaker in the control-center cabinet. In fact he also included a power amplifier stage for the speaker as well! His clock was wall mounted within easy visual range—no need to move it to the control cabinet. His switch, light and fuse combinations included a main AC-power control, a similar combination for the transmitter and again, a duplicate group for the receiver. The third fuse-switch-light string controls the power amplifier stage for the built-in speaker.

A control center is not necessarily limited to power circuit controls—far from it. Almost any station accessories can be included

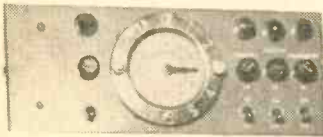

For a simple installation (top left) all you need is a couple of switches and an equal number of pilot-light and fuse-holder assemblies. If you must start small it is best to leave lots of room for expansion—for equipment never dreamed of now.

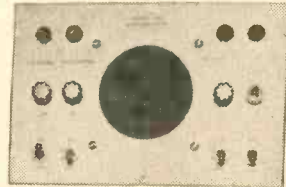

as well. Take a look at the unit at the lower right of the picture. Note that both a clock and a speaker are mounted in the panel of this control center. In addition, an RF-keying monitor is mounted in the upper left hand corner of the panel and a noise limiter (with rectangular dial plate) on the right. Switches, fuses and indicator lights for a transmitter, receiver and the RF-monitor power supply are provided as well as fuse, switch and indicator light for the incoming AC power. A fuse is also provided for the clock circuit; perhaps a superfluous refinement although adequate fusing of all circuits is never wrong.

The Grand Daddy. Now have a look at the lower left hand unit . . . the "grand-daddy" of all control centers. This one leaves little to be desired. A jump type clock with a ten-minute call-ident alarm buzzer occupies the upper center of the panel.

One of the twelve slide switches on the panel permit silencing or activating the alarm circuit. A built-in RF keying monitor is provided and the two knobs (in a vertical plane on the left of the panel) control the volume and tone of the monitor. The monitor is AC powered—with a slide switch and AC fuse in its supply line together with an indicator light. The other four slide switches on the left hand sub-panel control not one but four transmitter AC power supply sources. A duplicate sub-panel, on the right (which also has six slide switches), controls the AC supply to four receivers. The left hand upper slide switch on this panel selects either the built-in speaker or headphone jack on the rear panel. Next to the RF-monitor tone control on the lower left of the main panel is a two-position rotary switch which connects the output of any of four receivers

(Continued on page 112)

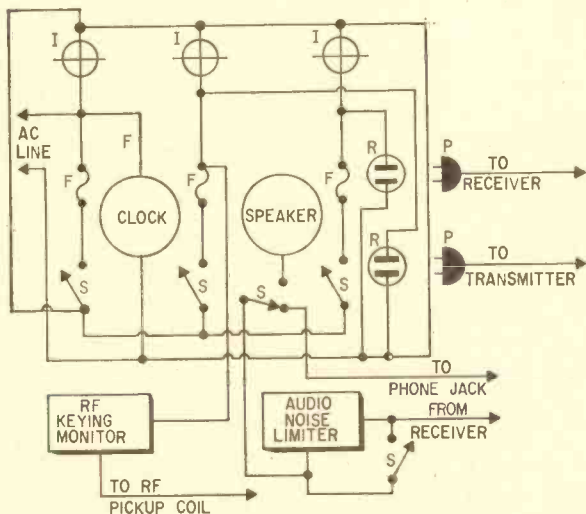

Additional switches added to this control unit are not only for the power circuits—audio circuits are controlled as well. This shows the design of a control center is suitable to all types of controlling—audio as well as power—in high-fidelity systems. Control center can be designed to switch speakers, select tuner, turntable or tape player outputs and make connections for tape recorder to any of the components in the system—even for stereo.

Grand Daddy of them all controls most functions needed by the active amateur radio operator. In fact this control center, with a few exceptions, would do for commercial installation of an efficient, 2-way communications setup. You may not need all these controls to start—just leave panel space to add the new controls as you add new items of equipment.

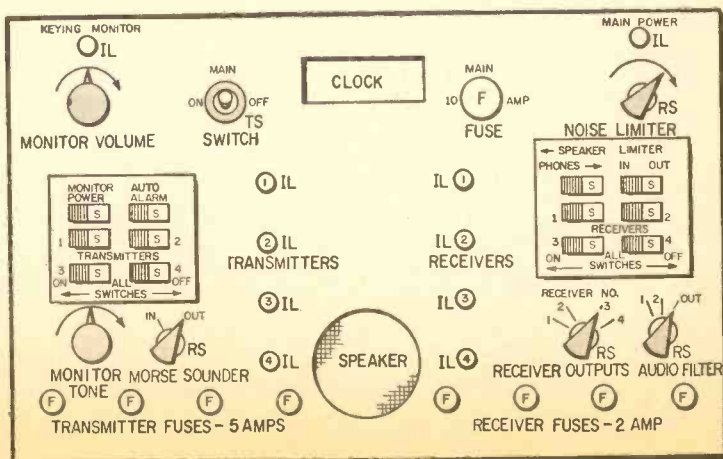

A veri that's on for 24 hours only has all the makings of a once-in-a-lifetime deal!

Great Day for QSL



December 1, 1966, may have been just another day in the lives of most people, but it was a very special one for the staff of the National Bureau of Standards' station WWV. It was also a special day for countless Hams and SWLs around the world, and in a most unusual way. What made the day for the WWV people was inauguration of transmissions from that station's new home in Fort Collins, Colo. And for DXers of every ilk, the day offered a rare opportunity to snag what had all the markings of a rare QSL.

When you come right down to it, of course, securing a QSL card from WWV is no great shakes, since the station mails out hundreds every year. But this was a card with a difference, for it was intended to furnish the WWV staff with valuable information on how the station was being re-



Above, WWV's First-Day QSL (shown greatly reduced in size). At left, part of antenna array at new Colorado site.

ceived from its new location. Just as importantly, it was also designed to honor those Hams and SWLs who succeeded in logging the station's new transmitter during its first day on the air. Since WWV is a cinch to tune on one of its many frequencies (which, by the way, are the same 2.5, 5, 10, 15, 20, and 25 MHz as always), applicants were required to correctly quote a new voice announcement made during the first day of operation from the new site. Further, all reports had to be postmarked before midnight of December 2, local time.

Most of WWV's equipment is brand-spanking new, and the present site is more centrally located than the old one at Greenbelt, Md. And while final tabulations weren't available at time of writing, NBS officials expect WWV will be received throughout most of the continental U.S. better than ever before. All of this means that a WWV QSL ordinarily belongs anywhere but in the rare category, although that First-Day QSL is another matter. For first days and First-Day QSLs just don't come along that often.

—RON MITCHELL ■

e/e**HIGH-FIDELITY****LAFAYETTE Model RK-840****4-Track Solid-State
Stereo Tape Recorder**

Though just about the size and weight of the new breed of battery operated tape recorders, Lafayette's new RK-840 is a full-feature, AC-powered, family-style recorder that packs into one case decent performance from several points of view; from Pop's hi-fi flat frequency response to junior's experiments with cavernous, echo sound effects.

Features. The RK-840 has switch selected speeds of $7\frac{1}{2}$ and $3\frac{3}{4}$ ips. The $1\frac{1}{8}$ ips speed is available by removing a sleeve on the capstan shaft. Each channel is independently push-button controlled; either track or both may be selected for recording. With the exception of the record button interlocks, all functions (*FF*, *stop*, *play*, *pause* and *FR*) are determined by a single mode switch. A special push-button switch selects the proper equalization for a phono pickup, allowing direct recording without the use of an intermediate amplifier.

Both microphone and high level inputs are provided for the *L* and *R* channels, each channel controlled by an independent volume control. The tone control, which is effectively the speed equalizer, is ganged; a single setting determines the equalization for both channels. Line level outputs as well as a stereo headset jack are provided.

Both the left and right power amplifiers and their associated speakers are built-in. For those who prefer "big speaker" sound, external speaker jacks are provided that automatically disable the internal speakers. One other big plus, the unit can operate with the cover closed.

Two calibrated VU meters, one for each channel, indicate both the record and playback levels. The meter switching is automatic. When the recorder is in the *record* mode, the meters indicate the record level; when the recorder or track is set for *play*, the meters indicate playback volume levels.

How It Tested. All functions delivered, at the least, decent sound quality and/or convenience. In any mode, the recorder's mechanical operation is typical of the simplicity of family models. The electrical performance in terms of frequency response is shown in the graph. Note that at $7\frac{1}{2}$ ips both tracks are within 2 db of each other; they can be made closer yet by juggling the setting of the level controls. The indicated response was obtained with the tone control in the 10 o'clock position. Unfortunately, the tone control is not calibrated for the "flat" position at any speed—it must be determined by the user. But who cares? Just set it for best *sound*.

At $3\frac{3}{4}$ ips the tracking is again good to about 8 kHz, diverging to the upper limit of 10 kHz; but this is still good when one considers that the RK-840 is in the budget price range.

We did not check out the $1\frac{1}{8}$ ips speed with instruments as it is obviously intended only for speech reproduction. A dictation

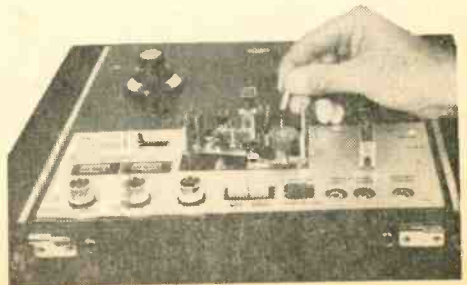

Push-pull switch selects recorder's two basic speeds of $7\frac{1}{2}$ and $3\frac{3}{4}$ ips, but a third speed— $1\frac{1}{8}$ ips—can be obtained simply by removing sleeve from capstan.

e/e Lafayette RK-840

test at this speed rated the RK-840 as excellent.

With a record level of "0" VU at 1 kHz, and the level control wide open for playback, the maximum distortion checked out at 2.8% through the line level output jacks. Though the internal power amplifiers are rated for 3 watts each, with the recommended "0" VU recording level the maximum power output was 2.2 watts into 16 ohms—the recommended internal and external speaker impedance. At typical room volume power level of 1.0 watt, the total overall distortion was less than 1.5%. Using the line output and your own hi-fi amplifier, the distortion at the recommended recording level should measure less than 1%—typical of even much more expensive recorders.

Inputs. The various input sensitivities are about typical for portable recorders; for the indicated "0" VU recording level the line inputs require 0.1v., the microphone inputs 0.2 mv., the phono input 0.6 mv.

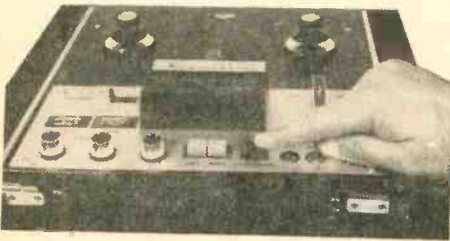

Unusual—and valuable—feature of the RK-840 is its built-in equalization for dubbing any LP record. Magnetic-phono pickup can be fed directly into recorder.

Overall record/play response of RK-840 at 3 3/4 ips was flat within ± 2 db over major portion of audio spectrum. Note relatively small divergence between two channels.

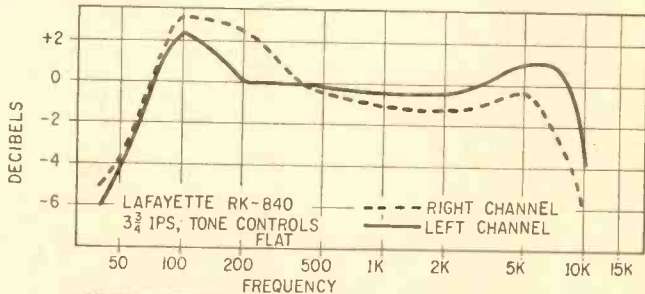

Two channels fell within 2 db of each other at 7 1/2-ips setting. Useful response was maintained to 15 kHz, indicating recorder is capable of full-fidelity performance.

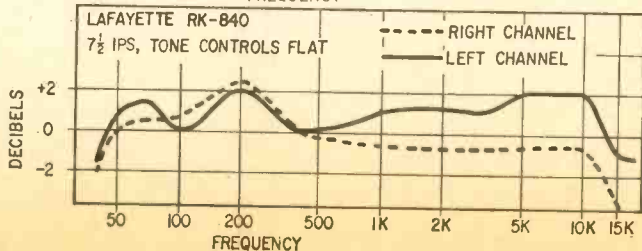

The microphone input impedance can create some problems for the recordist prone to experiment with different microphones. While the auxiliary (line) input impedance is 500,000 ohms, and the phono input is 50,000 ohms, the microphone load is 10,000 ohms—designed for the two microphones supplied with the recorder. Do not connect microphones intended for load impedances in the megohms, such as a hi-Z crystal or ceramic model. Severe bass attenuation will be the end result.

The Sound Counts. Perhaps the most important aspect of any of the miniature portable recorders is the sound quality through its own playback, for it is one thing to feed a tape deck through a hi-fi amplifier (even the cheapest of recorders can do that well) but it is quite something else to get decent sound out of very small speakers.

The integral sound quality of the RK-840 is best described as "mellow." The sound is balanced slightly towards the bassy side, with a generally ear-pleasing tone associated with wood speaker enclosures (the cabinet is wood), rather than the brittle, slightly edgy tone that results when small speakers are combined with plastic or metal enclosures.

Considering the budget price of \$169.95, Lafayette has managed to combine the characteristics of a tape deck suitable for a budget priced Hi-Fi system with the advantages and conveniences of a portable family type recorder in the RK-840.

For more information write to Lafayette Radio Electronics Corp., Dept. CP, 111 Jericho Tpke., Syosset, N. Y. 11791

**COVER
STORY**

TRANSMITTER SPEECH PROCESSOR



**You don't need Hi-Fi to
make your needs known on CB.
So it pays to weed out
power-wasting frequencies.**

by E. Norbert Smith

Once you build this *Speech Processor* and hook it to your rig it will be a popular topic of conversation when you get together on the air with the gang. CB'ers and Hams alike have much interest in getting the most out of their low-power rigs.

There are a number of well known ways to squeeze the last milliwatt out of the transmitter without actually increasing the final amplifier's input power. Probably everyone realizes the importance of a good, properly matched antenna, a low-resistance ground system and a low-loss antenna feeder. But given the crowded conditions on many amateur bands and the inherently-low power capabilities of CB equipment, more talk power is always needed.

The *Speech Processor* greatly increases the effectiveness of any AM transmitter—

and it is perfectly legal to build, install and adjust without the appropriate license (for CB transmitter repair). By combining three methods, which are commonly used and have proved highly effective, into one small unit the benefits of all three can be utilized for maximum modulation.

Compressing the Frequency Band. Most of the intelligibility in speech frequencies is centered between 500 and 2500 Hz (cycles). However, a large percentage of speech power is normally below 500 Hz. If the frequencies below 500 Hz are reduced or eliminated the frequencies actually needed for communication can be increased in amplitude without exceeding 100% modulation. Two additional bonuses that frequency compression contributes are: reduced hum (because the low-frequency response is cut); decreased

e/e SPEECH PROCESSOR

Block diagram of Speech Processor makes circuit (below) easier to understand—if you want to dig into the technical side of the unit. You don't have to know how it works to build it or use it—but it might make it a bit easier to set controls.

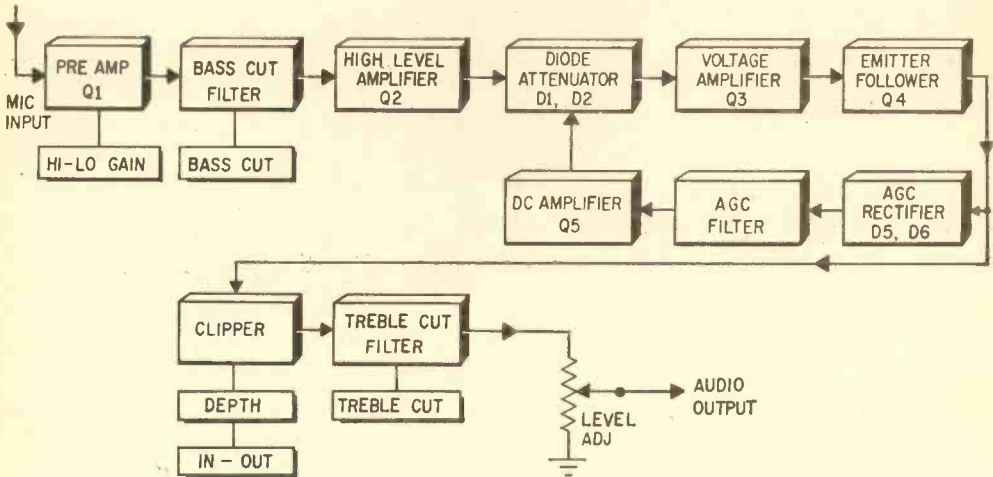

RF bandwidth because the high-frequency generated sidebands are attenuated or missing altogether.

Volume Compression or Audio AGC.

If a modulator is properly adjusted to give 100% modulation on voice peaks, it will fall far below 100% modulation under a major portion of normal operating conditions due partly to changing voice intensity (as with expression and mood), and partly to changing lip-to-microphone distance with changing positions, etc. Vast differences also occur when the microphone is passed from one individual to another.

Obviously it is desirable to modulate the transmitter as fully as possible at all times and the most dependable method is with audio AGC (*Automatic Gain Control*). A

sampling of the output of the speech amplifier is rectified, filtered and used to control the gain of an earlier stage. The output then will have constant *average* amplitude, enabling the transmitter to be fully modulated regardless of differing voice levels and different lip to microphone distances (within limits of course).

Speech Clipping. Speech waveforms contain considerably less average power than a sine wave of equal peak amplitude because of many high-amplitude, low-energy, short-duration peaks in speech. Since the percentage of modulation is based on peak values a transmitter modulated 100% by a sine wave will contain many times the sideband or talk power of a transmitter modulated 100% by speech waveforms of the same

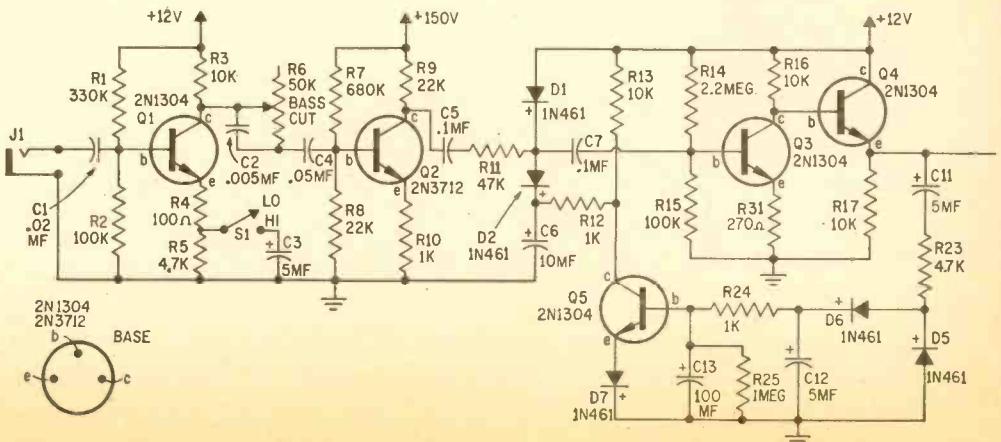

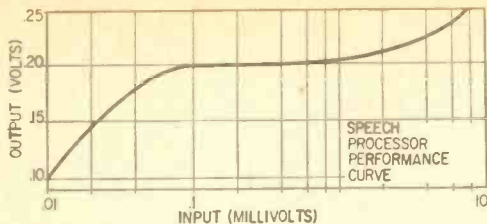

Graph shows Speech Processor output voltage in relation to input (microphone) voltage. Input varies over 1,000-to-1 range—output 2.5-to-1.

peak value. If the low-energy peaks are clipped off, the remaining waveform will contain a much higher ratio of average power to peak power.

This is quite the opposite of hi-fi audio and this purposeful clipping does distort the speech so that it doesn't sound exactly like the original. However, it is possible to secure a worthwhile increase in modulation power without sacrificing intelligibility. As much as 20 db of clipping can be used without loss of intelligibility, although some naturalness is lost. A clipping level of 20 db simply means a 10-volt peak speech waveform is clipped to 1 volt.

Speech clipping introduces the same high-order harmonics as does overmodulation and therefore some form of filtering must be used *after* clipping and *before* modulation, otherwise, look out for the FCC.

The *Speech Processor* combines each of these methods of improving talk power in one easy to build package. The processor is simply connected between the microphone and the microphone-input jack of the present CB or amateur rig. Almost 40 db of speech AGC is available to insure full modulation from lip to arm length. And from no-clipping to 20 db of clipping is available with the turn of a knob. Both high-frequency and

Schematic diagram loses much of its complexity if you compare it to the block diagram at the top of opposite page. Power supply is on the next page.

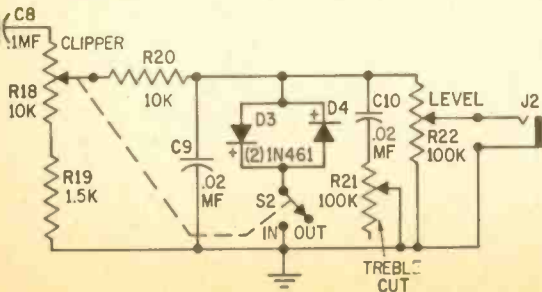

Alternate circuit for AGC rectifier and filter adds three controls to Speech Processor. Added controls match circuit operation to your voice frequencies.

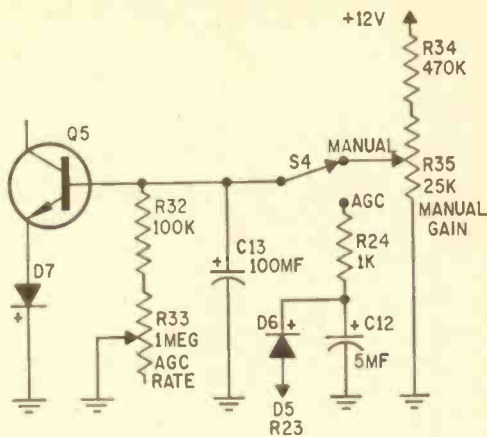

low-frequency response can be adjusted to suit personal preference.

Circuit Action. Referring to the block diagram, we find the output of a crystal or dynamic microphone is amplified by the preamp. The gain of the preamp (Q1) can be *hi* or *lo* depending on whether part of its emitter resistance is bypassed or not through S1. (See schematic.) The output of the preamp goes to the *bass-cut* control (R6) where the lower-frequency response can be narrowed from 120 Hz to 500 Hz (cps). The signal proceeds to the high-level amplifier which uses a television video-output transistor (Q2) to provide 150-volt peak-to-peak capability. At first glance this seems like an uncommonly large voltage swing but it must be remembered the *Speech Processor* is capable of 40-db audio AGC. This means the input signal can change in amplitude by 1000 times with hardly any change in the output. So, stated another way, to have 40-db audio AGC means 40-db extra gain to throw away with large signal conditions.

Diode Attenuator. The device that throws away that 40-db gain when not required is the next stage, a diode attenuator. In the simplified partial schematic the signal passes through a high-value resistor to the junction of two diodes. If the diodes are hardly conducting (R_e large) little attenuation occurs because the effective "impedance" of the diodes is large. But as diode current *increases* this effective impedance *decreases* and the signal is attenuated more as more and more current flows. In the *Speech Processor* R_e is replaced with a tran-

e/e SPEECH PROCESSOR

sistor (Q5—the DC amplifier in the block diagram) which amplifies the rectified and filtered output of the emitter-follower (Q4). More on this later.

After the signal has been reduced to the required level it goes to another voltage amplifier (Q3) followed by an emitter-follower (common-collector) stage. (Q4) used to provide low output impedance. Here a small part of the signal is used as an AGC voltage—it is rectified by two more diodes, (D5, D6) and filtered so the AGC stage responds to average (not instantaneous) voice levels. Following the filter is the DC ampli-

fier which controls the current flow through the diode attenuator—thus controlling the signal attenuation.

With a very weak audio signal, very little signal voltage is present to be rectified and passed to Q5 (the DC amplifier) so it is almost cut off and very little current flows through the diodes. This increases their effective resistance so the weak signal into the diode attenuator passes through with very little attenuation.

On the other hand when a large signal is present more voltage is rectified and the DC amplifier (Q5) conducts and much more current flows through the diodes greatly lowering their effective impedance. Now this large signal entering the diode attenuator is greatly reduced in level. So the average output level of the *Speech Processor* going on

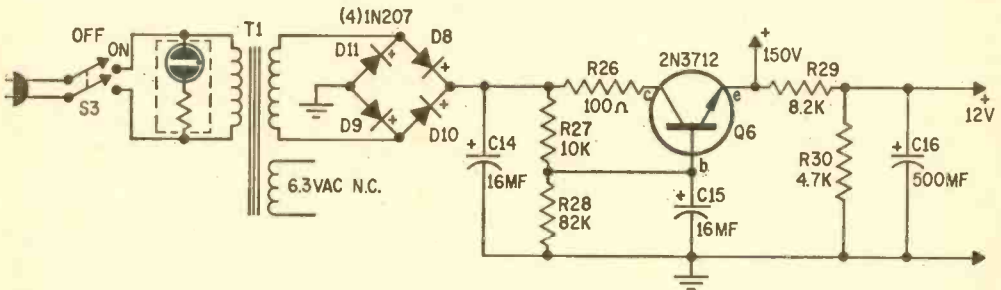

Power supply circuit diagram can fool you. It looks like a normal transistor power supply but voltage from collector of Q6 is 150 volts. Unit can be hooked to mobile rig if you can get 150 volts somewhere.

SPEECH PROCESSOR PARTS LIST

C1, C9, C10—.02-mf, 150-volt disc capacitor
 C2—.005-mf, 150-volt disc capacitor
 C3, C11, C12—5-mf, 25-volt electrolytic capacitor
 C4—.05-mf, 150-volt disc capacitor
 C5—.1-mf, 150-volt disc capacitor
 C6—10-mf, 25-volt electrolytic capacitor
 C7, C8—.1-mf, 75-volt disc capacitor
 C13—100-mf, 3-volt electrolytic capacitor
 C14, C15—16-mf, 150-volt electrolytic
 C16—500-mf, 50-volt electrolytic capacitor
 D1, D2, D3, D4, D5, D6, D7—1N461 silicon diode
 D8, D9, D10, D11—Silicon diode, 1N207, 1N1694 or equiv.
 J1, J2—Jack, 2-conductor shielded (to suit builder)
 Q1, Q3, Q4, Q5—npn transistor, 2N1304, GE-5, SK3011, or equiv.
 Q2, Q6—npn transistor, 2N3712, or equiv.
 R1—330,000-ohm, 1/2-watt resistor
 R2, R15—100,000-ohm, 1/2-watt resistor
 R3, R13, R16, R17, R20, R27—10,000-ohm, 1/2-watt resistor
 R4, R26—100-ohm, 1/2-watt resistor
 R5, R23, R30—4,700-ohm, 1/2-watt resistor
 R6—50,000-ohm, 2-watt potentiometer
 R7—680,000-ohm, 1/2-watt resistor

R8, R9—22,000-ohm, 1/2-watt resistor
 R10, R12, R24—1,000-ohm, 1/2-watt resistor
 R11—47,000-ohm, 1/2-watt resistor
 R14—2,200,000-ohm, 1/2-watt resistor
 R18—10,000-ohm, 2-watt potentiometer with s.p.s.t. switch (S2)
 R19—1,500-ohm, 1/2-watt resistor
 R21—100,000-ohm, 2-watt potentiometer
 R22—100,000-ohm, 2-watt potentiometer
 R25—1,000,000-ohm, 1/2-watt resistor
 R28—82,000-ohm, 1/2-watt resistor
 R29—8,200-ohm, 1-watt resistor
 R31—270-ohm, 1/2-watt resistor
 S1—S.p.s.t. slide switch
 S2—S.p.s.t. switch (part of R18)
 S3—D.p.s.t. slide switch
 T1—125-volt, 15-ma secondary, power transformer (Stancor 8415, Knight 61Z410 or equiv.)
 1—3 x 4 x 5-in. utility cabinet—see text (Bud AU1028 or equiv.)
 Misc.—Pilot light assembly (optional) perforated phenolic board, machine screws, nuts, knobs, line cord and AC plug, wire, solder, etc.

Estimated cost: \$22.00

Construction time: 6 hours

to the transmitter remains almost constant regardless of input variations.

From the emitter follower the remainder of the signal goes to the speech clipper (D3, D4) which, with S2 closed, clips off the undesirable, low-energy speech peaks. From here the signal goes to the *treble cut* control (R21) which removes the speech-frequency harmonics produced in the clipper and controls the high-frequency response from 5 kHz down to about 2 kHz. The signal then continues to the *level* or modulation control (R22) which sets the correct level or amplitude to suit the particular speech amplifier and modulator used.

Construction. The *Speech Processor* can be built quite easily on two pieces of perforated-phenolic circuit board, the power

supply on one and the audio circuits on the other. Due to the high gain, the input and output leads and all signal leads going to controls should be shielded with the shield grounded on one end. The input stage should be well separated from the output stage and all signal leads must be as short as possible. To avoid overcrowding, place components on both sides of the board. After completion of both boards "hay wire" in required controls and check for proper operation. First check both power supply voltages. Be sure of power supply, electrolytic capacitor and diode polarities. The voltage measured at each transistor collector (except emitter follower and DC amp) should be approximately half that measured between ground and supply-voltage point. If any stage is com-

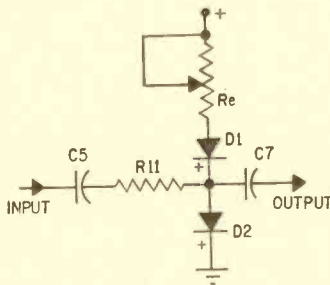

This simplified partial schematic of diode attenuator uses same part callouts as in main schematic diagram. Voltage across diodes is controlled by Re.

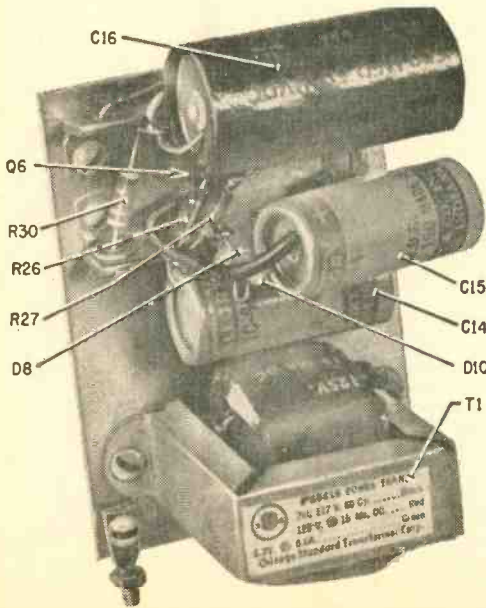

Bottom view of the power supply shows location of most of the components. If more expensive, smaller filter capacitors are used there will be more room.

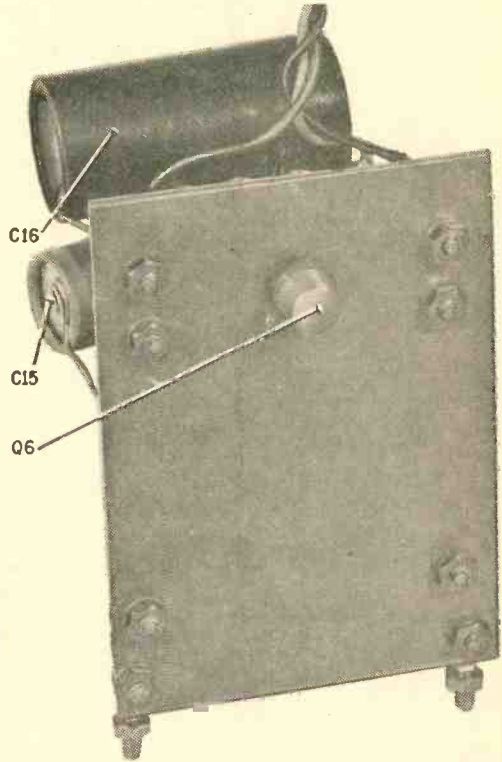

Reverse side of power supply shows single transistor, Q6. Transistor socket is not really needed; Q6 could be soldered right into circuit by leads.

pletely on (collector at ground), or off, (collector at supply voltage), recheck wiring and capacitor polarities. If all DC potentials seem normal connect a microphone or audio-signal generator to the input (J1) and follow the AC voltage through each stage. It should reach its highest peak-to-peak level in the second or high-level amplifier stage, and finally the output level at J2 should be slightly

e/e SPEECH PROCESSOR

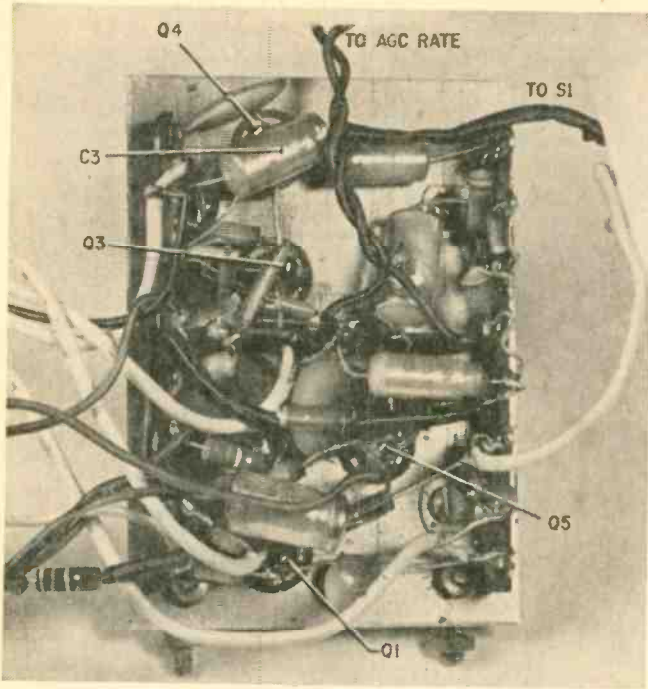

Packaging can be a problem if you use standard-sized parts to wire the Speech Processor. Use miniature components wherever possible. Since current is no problem use AWG-22 or AWG-24 wire—use stranded wire for all connections between subchassis and panel mounted controls, etc. Miniature components will boost the price considerably unless you shop carefully. All five of the transistors on the other side of this subchassis can be wired directly into the circuit. The main reason for the sockets was to make substitution easier—to test many transistors in circuit.

larger than the audio input level at J1.

Change the level at the input (by shouting into the microphone or upping the signal-generator output voltage). The output should increase momentarily then fall quickly to the original value. If not, check closely the circuits associated with the DC amp and rectifying diodes.

When all seems well, mount the two circuit

boards in a suitable metal box. Builder's skill and amount of money spent for electrolytic capacitors will determine the final size (small capacitors are more expensive). The author's was installed in a 3 x 4 x 5-inch cabinet, however, a somewhat larger box, such as a 5 x 7 x 3-inch would have less crowding and a bit easier final construction.

(Continued on page 114)

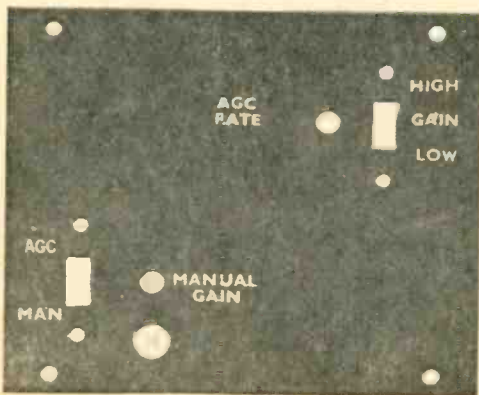

Rear panel of Speech Processor (left) shows location of the least used circuit adjustments. Use miniature switches and controls wherever possible. Actually all controls, including those on front panel (right) could be screwdriver adjustments or locking-type potentiometers since none of the controls are varied constantly—once set they need not be changed again.

SSB is in!



By
Len Buckwalter
K1ODH/KBA4480

By eliminating the nonessential, power-wasting components in the AM signal, range is increased—making efficiency much higher.

Ask a CBer what he wants most. "More range," might be the reply. Or query a Ham on his secret wish. "Bigger band, less QRM," could be the answer. And you might ask a communications engineer, "What's your innermost craving?" His possible answer, "More efficient radio-frequency power." Put together those wishes for slim, but booming signals and they'd all be answered by SSB . . . single sideband.

This single-sideband system of radio transmission does all those things and then some. Surprisingly, it wasn't ushered in by the space age, solid-state or some last-minute breakthrough. SSB is nearly as old as high-button shoes and, until recent years, considered too mysterious for all but commercial communications. Today, single sideband has been snapped up by the military, is embraced by Ham radio and soon may invade the Citizens Band.

Single sideband is to AM, or amplitude modulation, what the car is to the horse and buggy. Both get you there but one is quaint, the other cool and efficient. As we'll see, single sideband is actually a sophisticated form of AM, but one that squeezes each watt for all it's worth. Sideband can whip a conventional AM signal of 100 watts into sounding like 800.

Conditioning by Carrier. As far back as 1914 it was suspected that a radio wave, when modulated by voice, was not *one* but *three* distinct signals. The regular AM signal had been shown as a single signal; a radio carrier whose strength changes with audio information. That conventional "envelope" pattern is in Fig. 1. An audio signal from the

microphone is strengthened in the audio amplifier, then is applied to the RF amplifier (in the transmitter) where it meets the steady carrier.

At this common meeting point, the modulator, audio voltages aid or oppose the carrier during modulation with the result shown. It's a convenient picture that provides a reassuring explanation of what happens during amplitude modulation. If the audio signal is 1 kHz (kc) (a high-pitched tone) then carrier strength varies 1000 times per second.

But a patent issued in 1923 destroyed the one-signal concept. As the first practical SSB system, it contended that an AM signal should really be considered in three parts. And the claim was backed up by the first successful SSB transmission between the United States and England—about 22 years after Marconi made the first transatlantic hop between the same countries. Here's what the new image of AM looked like.

In Fig. 2 is the triple signal, based on a radio carrier of 600 kHz modulated by an audio tone of 1 kHz. (This would be roughly equal to conditions existing at the moment

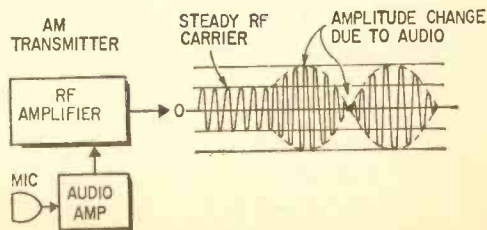

Fig. 1. Conventional picture of AM signal shows modulated RF output as varying envelope pattern. But output from transmitter is actually in three parts.

e/e SSB IS IN!

you're hearing a time signal sounded by a station in the standard broadcast band.) Most shattering feature in the waveforms of Fig. 2 is how the carrier in the middle appears. It bears not the least trace of modulation! The carrier is as smooth as a bag of mortar left out in the rain. It never changes amplitude by one whit. The audio signal can be found in two *sidebands* which lie just above and below the carrier frequency. These



Typical SSB rig (this is an EICO Ham transmitter) incorporates Mode switch to enable operator to select CW, AM, or SSB operation at will. Finger points to knob labeled "Carrier Bal" which serves as fine-tuning adjustment of modulator stage to eliminate RF carrier.

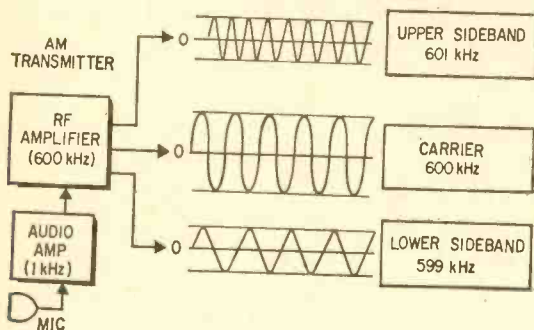

Fig. 2. Correct depiction of AM signal reveals three distinct components: the original 600 kHz carrier in addition to carrier-plus-audio and carrier-minus-audio sidebands. Since carrier contains no information, its transmission serves no useful purpose.

sidebands deserve close inspection.

When the audio tone (1 kHz) combined with the carrier (600 kHz) in the transmitter, a mixing process occurred in the RF amplifier. As audio and radio frequencies beat against each other, they formed carrier-plus-audio and carrier-minus-audio frequencies. That creates the two sidebands, an upper one at 601 kHz, a lower sideband on 599 kHz. This may also be recognized as the heterodyne process, where mixing signals add and subtract. Thus sidebands are always spaced from the carrier by a frequency a number of Hz or kHz determined by the audio signal. Modulate with voice or music and sidebands spring further from the carrier as tones grow higher in frequency—or move in close to the carrier for low-pitch sounds. Again, it's due to the frequency-mixing process.

Another View. The 3-piece signal can also be viewed as a collection of frequencies strung out along a receiver dial, as shown in Fig. 3. Let's say the dial pointer is at 600 kHz, tuned to the carrier. Since a receiver has bandwidth—it accepts a group of close-spaced frequencies—we pick up sidebands just above and below 600. Each of those sidebands represents the whole band of modulating frequencies that might occur during a voice transmission.

If an audio tone reaches up to 3 kHz it generates an upper sideband on 603 kHz (3+600). Too, there's a mirror-image appearing at 597 kHz, the lower sideband. The intermediate lines in Fig. 3 indicate the product of other audio tones. One precaution when interpreting the image is this: sidebands are not in themselves audio tones. They are RF signals whose frequencies are determined by the original audio. RF remains the medium which carries signals, via the antenna, out "over the air."

If upper and lower sidebands repeat the same intelligence, why transmit both? There is one good reason. On arriving at the receiv-

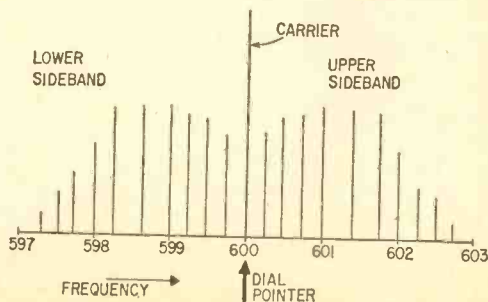

Fig. 3. Some idea of conventional AM's spectrum-wasting properties is evident in this diagram. Note that a 3 kHz signal fills an area fully 6 kHz wide.

er, power from sidebands add, so two are better than one. But there's a strong argument against transmitting duplicates. It's available room on the bands—which now groan under heavy communications traffic. Wouldn't it be better to recover the power in one sideband and inject it into the other? This would effectively halve the signal band width—and almost double available space in the radio spectrum. As we'll see, this is one significant advantage of single sideband. There's a second one—just as important—and it's given in Fig. 4.

Power Down the Drain. Now you can see how a conventional carrier wastes energy.

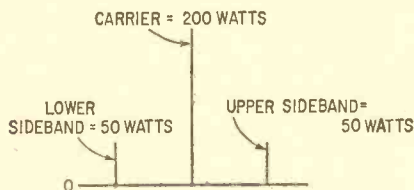

Fig. 4. A conventional AM transmitter also is extremely inefficient with the power at its disposal, as this diagram suggests. In the case of a 300-watt rig, roughly 66⅔% of the total power is poured into the carrier, which, as already noted, carries no information whatever. Balance of power—a mere 100 watts—is split between upper and lower sidebands.

Fig. 4 illustrates how a regular 300-watt AM transmitter divides its power: the carrier contains 200 watts, while each sideband has 50. That's a colossal waste since carriers, as we've noted, contain no modulation. Total useful power—in two sidebands—is a mere 100 watts, or one-third the carrier level.

If a carrier spills two-thirds of the transmitter power down the drain, why is it produced in the first place? The reason is that an RF signal is a necessary ingredient in the recipe for cooking up sidebands. Audio must mix with RF, and during the conventional modulating process watts divide into that uneven, 3-way split. This underlies the first step toward the single sideband transmitter. The SSB rig generates a carrier but a negligible

one—at most a few watts. Once sidebands are produced, the carrier will be rejected before it gulps RF watts further along in high-level stages. First part of the process is done in the *balanced modulator*.

Before plunging into the circuit, consider the push-pull amplifier shown in Fig. 5. In a normal amplifier of this type, an input signal is applied in push-pull (the top tube grid is driven positive as the lower goes negative). But the input signal in Fig. 5 is being applied *equally* to both grids, or in a parallel connection. Both amplifier tubes commence to conduct. Since the output transformer is split by a centertap, two magnetic fields are created.

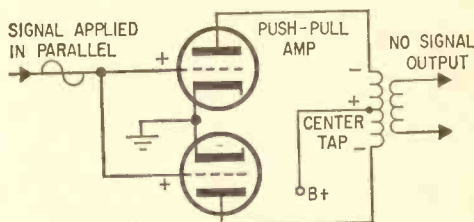
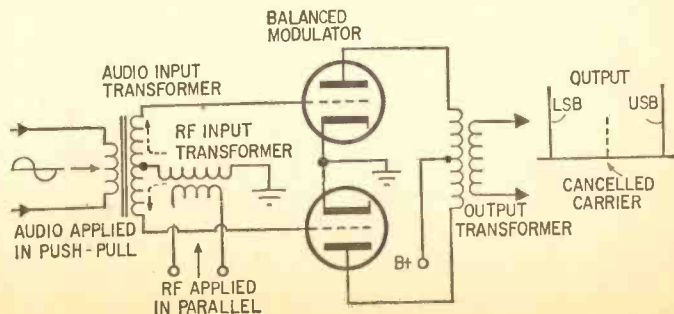

Fig. 5. Properly balanced push-pull amplifier cancels in-phase (or parallel) signals, which explains need for phase inversion in push-pull circuits. SSB rigs utilize this property to cancel out carrier.

The interacting fields, however, are opposite and cancel each other. The upshot is this: whenever you feed in *parallel*, but extract in *push-pull*, there'll be no output signal since it's phased out. But feed and extract in push-pull (as done in a hi-fi output stage) and full amplification occurs. Both parallel and push-pull can be used in the balanced modulator to produce a sideband signal.

Begin with an audio signal and apply it to the input side, as in Fig. 6. This signal will enter in push-pull since it rides through an input transformer whose secondary winding is center-tapped. Since the output side is similarly arranged for push-pull operation, it can be assumed that audio input will not cancel. (Turn page)

Fig. 6. One type of SSB rig delivers two sidebands but no carrier in what is known as a double-sideband suppressed-carrier hookup. As explained in text, output signal consists solely of a lower sideband (LSB) and an upper sideband (USB), since carrier cancels out in modulator.



Meanwhile, a steady carrier signal is also applied to the tube grids. But since the RF input transformer has no centertap, an equal (parallel) signal drives the tube grids. *Steady* RF, therefore, always cancels on the output side. Now start talking into the microphone. As the audio signal drives the top grid positive, it drives the lower grid negative. During this moment, the RF signal doesn't encounter the same conditions (tubes balanced), as when no audio was present. Audio voltage has unbalanced the tubes and RF can flow during this time with no cancellation at the output. A similar condition also exists when audio reverses and drives the lower grid negative.

Thus the audio signal continuously varies bias and upsets tube balance. The net result is an RF signal at the output side which varies at an audio rate—the familiar modulation envelope pattern. And since there has been a mixing process between RF and audio, the RF output signal consists of upper and lower sidebands.

Note in Fig. 6 that the carrier (steady RF) doesn't appear at the output. The output signal, consisting of upper and lower sidebands, is known as *double sideband suppressed carrier*.

Eliminate One Sideband. A system for slicing off a sideband utilizes the *crystal filter* (see Fig. 7). The crystal forms an extremely selective tuned circuit just a few

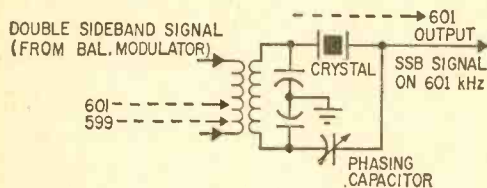

Fig. 7. Crystal filter affords one method of dumping one sideband, passing the other. Here, crystal passes signal on 601 kHz, rejects signal on 599 kHz. Once adjusted, crystal performs function indefinitely.

kHz wide. Placed in the path of the double-sideband signal, it acts as a sharp, series-resonant circuit with little opposition to one of the sidebands. The unwanted signal is attenuated.

Another popular method uses the *mechanical filter*. It is a series of mechanically resonant metal disks, as shown in Fig. 8.

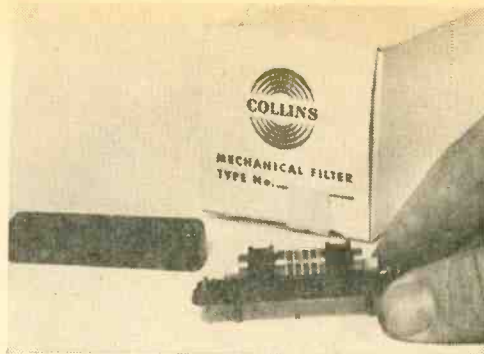

Fig. 8. Mechanical filter also is found in many SSB rigs, since its ability to pass only one of two sidebands can be as good as (if not better than) that of quartz crystal. Principle is that of tuning fork.

Both sidebands are applied to the mechanical filter and their voltages converted to mechanical movement (via an electromagnetic coil and rod). This spurs the disks into action. Since resonant motion can occur only over an extremely narrow range of frequencies, the undesired sideband signal cannot slither through. At the output end of the mechanical filter is a second coil-and-rod assembly to convert the mechanical signal back into electrical energy. Both crystal and mechanical filters are not only far sharper than coil-capacitor (L-C) combinations, but are smaller, very stable and require virtually no adjustment.

Phasing. There are other sideband techniques. We've been describing the *filter* system but there's the *phasing* system, too. Since it is somewhat more critical to set up and keep in adjustment, the phasing approach seems to be less popular than the filter in much of the presently used circuitry. The phasing technique takes audio and RF signals then splits each into two parts in suitable phasing networks. The four signals are then recombined in two balanced modulators where they add and subtract. All undesired mixed signals cancel; the wanted sideband emerges.

Another variation is the type of balanced modulator circuitry selected by the single-sideband transmitter designer. As we've described it, a double-sideband signal is produced by a type of push-pull amplifier. There's also a "bridge" balanced modulator, seen in Fig. 9. Again, there are two inputs—one for the RF carrier and one for audio. The carrier, however, is suppressed when no audio signal is present since it produces equal RF voltage across bridge points A and B. (For current to flow there must be a voltage

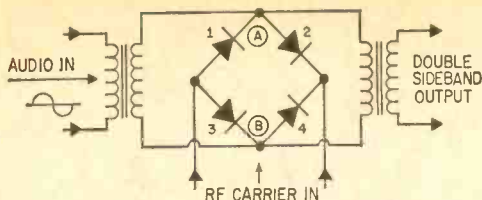

Fig. 9. Still another technique for suppressing a carrier relies on a bridge balanced modulator. Both AF and RF are fed into bridge, but circuit cancels carrier, allowing only two sidebands to emerge.

difference between "hot" and ground sides of the circuit.) At this time the bridge is in balance.

When audio is applied across top and bottom, the bridge becomes unbalanced. For example: when the audio cycle is positive, diodes 2 and 3 are biased to conduct, while diodes 1 and 4 are reverse biased (no current flows). This upset in the bridge enables RF voltage to develop at the output—at an audio rate. Thus the double sideband signal results.

Still another technique is the balanced modulator which produces signal mixing in the multigrid structure of a tube. Here audio and RF combine within the tube's electron stream, but the underlying concepts are the same.

Consider the status of the single sideband generated by the balanced modulator and filter. It is superior to the conventional AM signal since it occupies half normal bandwidth; it's about 3 kHz wide instead of 6 kHz. And if the SSB signal is now applied to an RF amplifier, only pure intelligence—not useless carrier—is boosted to desired output wattage. But there are further steps before that efficient signal can ride off an antenna.

The SSB signal is developed at low power levels in the transmitter, not more than a few watts. In fact, it is usually handled in tubes commonly found in receivers. But there's another low-level feature in sideband generation. It's frequency. For a sideband filter—crystal or mechanical—to operate with high sharpness and selectivity, operating frequency must be low. Usually filtering process occurs at less than about 6 MHz. Thus a sideband signal must undergo a shift to the desired final frequency. In a Ham rig, for example, single sideband output may be needed on one of the popular bands in the 3.5, 7, 14, or 28-MHz range.

Conventional transmitters increase frequency with multiplier stages. An RF amplifier tube is strongly driven by an input signal until it produces distortion in the form of harmonics, or frequency multiples. That approach works well in regular AM transmitters since only the RF carrier signal is distorted. This doesn't matter since it bears no intelligence during the frequency-multiplying step. The audio modulation is tacked on at the final RF amplifier and thus escapes distortion. Multipliers, however, would destroy a sideband signal. To preserve its audio envelope, the sideband signal must be heterodyned up or down to the final operating frequency. The mixing step will appear as we trace the simplified diagram of a complete SSB transmitter.

The Transmitter. In Fig. 10 there is a block diagram of a transmitter which includes operating features like selectable sidebands and continuous tuning. Tracing the signal paths begins at the left, where the carrier is initially generated. It's simply an

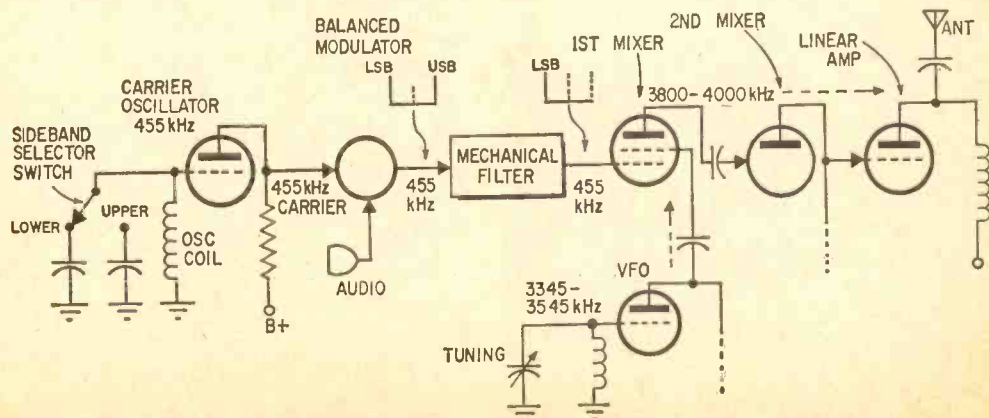

Fig. 10. Block diagram of a basic SSB transmitter. Unlike conventional AM transmitters where audio is injected at the final, SSB rigs insert audio comparatively early. Mixers therefore replace multipliers in circuit.

e/e SSB IS IN!

oscillator which generates a low-level RF signal at 455 kHz—a popular frequency since it can use the IF transformers manufactured for standard AM receivers. Found in this stage is the sideband switch. By selecting either of two capacitors, oscillator frequency can be changed a small amount. Further along the circuit, this shift will determine which sideband is picked up by the mechanical filter.

Next major stage is the balanced modulator which receives carrier and audio signals. As already described (Fig. 6), its output is a double-sideband signal with the carrier suppressed. The single-sideband signal appears after the next stage—the mechanical filter. Although the filter is nominally rated for 455 kHz, the important figure is its bandwidth. In this case, the filter's "opening" is stated as 3.1 kHz by the manufacturer, equivalent to the span of frequencies contained in one sideband. Back in the carrier oscillator, the sideband selector shifts the carrier just enough so the desired sideband lines up in the passband of the filter. Thus the operator may choose upper or lower sideband. Output of the mechanical filter is a lower sideband signal nominally on 455 kHz.

Next is the mixing process. We'll trace how the 455-kHz sideband is heterodyned up to the 75-meter amateur phone band (3.8-4 MHz). The mixer receives the 455 kHz sideband signal at its control grid, and a mixing (RF) signal on its screen. That second RF signal arrives from the VFO (variable fre-

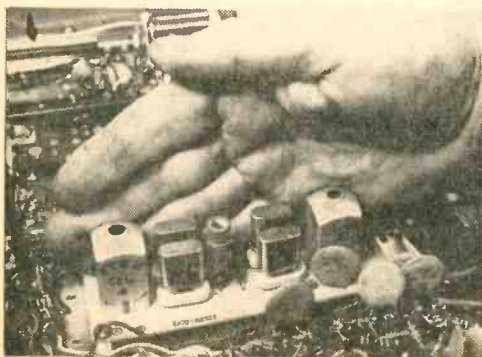

Practical example of crystal filter is seen on subassembly in SSB rig. Four crystals (in center) insure sharp response at desired bandwidth, two IF-type transformers (one at either end of board) serve to match filter to associated circuitry.

quency oscillator) stage. The two signals add in the mixer and output is on the desired operating frequency, as shown. Note that the operator can change output frequency by tuning the VFO. Shown, too, in Fig. 10 is a second mixer stage. By subjecting the signal to further mixing, output on other bands is obtainable.

To beef up the single-sideband signal, it is fed to a final RF amplifier. Here again circuitry differs from that of a conventional AM rig. Regular CW and AM transmitters utilize a Class-C output amplifier, the type that's most efficient, but one that creates greatest distortion. Distortion is no problem in regular AM



Many sideband rigs employ fixed crystal oscillator for heterodyning signal to desired frequency (rod points to crystal associated with mixer in this unit).

since modulating audio is applied only at the plate of the output stage, and doesn't ride from grid to plate. But in SSB, a final amplifier must preserve the envelope pattern since the grid signal contains audio intelligence. For that reason, the final stage for single sideband is a linear amplifier. By reducing grid bias on an RF amplifier it operates at somewhat less efficiency (Class B) but imparts little distortion to the modulated signal.

When you first see specs on a linear amplifier for Ham or CB radio, you may be in for a surprise. It's often rated at *twice* the legal wattage (2000 for Ham, 10 for CB). That's because linear amplifiers are not measured in the same fashion as their conventional Class C cousins. In the regular AM rig, wattage is determined by measuring steady carrier power. Since the sideband signal has no carrier—signals are always rising and falling in step with modulation—ratings are given as *PEP*, or (Peak Envelope Power). This describes power developed when a steady tone drives the amplifier to its maximum rated output. Since this only happens during modulation

(Continued on page 116)

EXPERIMENTER'S



Simple regulated power supply can be wired for either 6- or 9-volt output that's more stable than common transistor batteries.

In this solid-state age, most moderate- to high-current experimenter projects use 6 or 9 volts as the power source. Projects running above 9 volts usually are low-current devices and a battery will last months and months. Down on the other end, the very-low-current *itsy-bitsy* projects, so favored by elementary and junior high science teachers, operate for what seems like months and months on a flashlight or Number 2 dry cell.

It's six and nine volts that break the experimenter's back. A 20 ma device will get by on a Z4 battery, but you can't squeeze out 1 ampere into a 3-watt amplifier—it takes but minutes to kill a buck-and-a-quarter battery.

Regulation. If you're an experimenter, why not avoid the whole battery problem with the *Six-or-Niner* regulated power supply? This inexpensive job (see schematic diagram and parts list) will supply about 9.4 volts (the voltage of a fresh battery) at currents from 0 to 100 ma. with a regulation of 0.2 volt. This means that whether your project draws 1 microampere or 100 milliamperes, the maximum variation of the *Six-or-Niner's* output voltage will be 0.2 volt. Maximum output is 500 ma (0.5 ampere), and the regulation from 0 to 500 ma is, at worst, 0.4 volt. That's better regulation than you can get from transistor batteries rated at 6 or 9 volts.

Six-volt output can be obtained by simply changing two components, R2 and D1, though you may also make this a dual voltage supply by *switching* between the 6- and 9-volt R2-D1 components.

Ripple. If you're working with a high-level audio amplifier most of the power-supply filtering you'll need is built into the *Six-or-Niner*. Maximum AC ripple—the AC component of the output DC—is 4 millivolts. About 100 mf connected across the supply's output or built into the project will give you no-hum, practically *pure DC*—but generally you won't need the extra filtering as 4 millivolts ripple is quite low.

Since the *Six-or-Niner* is intended for experimenters—and things do go wrong with experimental projects—there is full protection against short circuits. Resistor R1 acts both as a fuse (protecting against long-term overload) and as a voltage limiter against shorts. The normal output of the supply is intended for up to 500 ma. Current in excess of 500 ma will cause the resistor to *burn up*, thereby protecting the transistor, diode D1 and T1. In addition, in the event of a short circuit somewhere in the project connected to this DC supply, the entire output voltage will be dropped across R1, thereby protecting the experimental project in addition to the power supply.

How It Works. Transistor Q1, which is in

series with the power source, functions as a variable resistor whose value is determined by the base bias—in relation to the collector and emitter voltages. The base bias is clamped at about 9.1 volts by Zener diode D1. If the voltage at the emitter of Q1 attempts to fall (go more positive), which may be caused by a sudden surge in the load on the power supply, the base-to-emitter voltage becomes more negative and the collector current increases. An increase in collector current through Q2 is caused by the reduction in collector-to-emitter "resistance." When emitter-to-collector resistance is reduced, the voltage drop across Q1 is also reduced and the emitter voltage rises to the rated value of the Zener diode (D1) in the



Bracket to mount Q1 is also a heat sink to keep down case temperature at the power transistor. Actually no heat sink is needed since maximum current is only 500 milliamperes—a voltage drop of 6 volts, maximum.

PARTS LIST

- C1—500-mf, 25-volt electrolytic capacitor
- C2—100-mf, 12-volt electrolytic capacitor. See text.
- D1—Zener diode, 6.2-volt (Motorola HEP103 or equiv.).
- 9.1-volt (Motorola HEP104 or equiv.). See text.
- Q1—Power transistor, pnp (Motorola HEP230 or equiv.). See text.
- R1—4.7-ohm, 1-watt resistor, 10 %
- R2—Select value to match D1. 1200 ohms for 6.2 Zener diode or 560 ohms for 9.1 volt Zener diode. See text.
- T1—Filament transformer, 12.6-volt (Knight 54A-1420 or equiv.)
- Z1—Bridge rectifier, encapsulated (Motorola HEP175). See text.
- Misc.—Perforated phenolic board, push-in terminals, machine screws and nuts, wire, solder, aluminum for heat sink/mounting bracket, etc.

Estimated cost: \$6.99
Construction time: 2 hours

base circuit. The same effect takes place when the collector voltage falls below that across the Zener diode.

If the emitter or collector voltages attempt to increase, the effective base bias appears more positive (less negative) and the effective resistance of Q1 increases until the voltage drop from emitter-to-collector has restored the output voltage to the rated value of the Zener diode.

Construction. The model shown in the photos is assembled on a section of perforated circuit board approximately 3¾ x 4¾ inches; use the closest size you can cut from a stock size perforated phenolic board. Push-in terminals or flea clips are used for tie points. Assemble the power supply in the order it's laid out on the board, starting with diode D1. Resistor R1 is installed under C1, so it must be mounted before C1 is soldered into place.

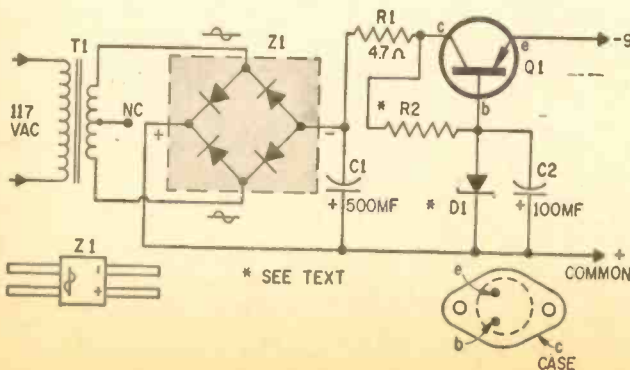

Just about any regulated output voltage can be had by changing D1 and R2. Increase R2 for lower-voltage Zener diodes—decrease it for higher-voltage diodes.

Transistor Q1 is mounted on a heat sink fashioned from a piece of scrap aluminum or a tin can. Actually no heat sink is needed for normal service and the bracket simply provides a mounting. Only when relatively high current is used does Q1 get even slightly warm. Do not insulate Q1 from the heat sink as the collector connection for Q1 will be made through a solder lug at one of the heat sink mounting screws. You get better heat sink operation when the mica washer is not used—it's not needed. The connections to base and emitter leads of Q1 are soldered directly to the transistor leads, so don't use excessive heat. Hit the joint with a wet cloth or damp tissue as the joint cools to remove heat quickly.

For a 9-volt output, R2 is 560 ohms (10%) and D2 is the 9.1-volt Zener diode. Try the Motorola HEP104 Zener diode. For a 6-volt output R2 is 1200 ohms (10%) and D2 is a 6.2-volt Zener diode—Motorola HEP104. If Motorola HEP diodes cannot be obtained locally they are readily available, as standard stock, from Allied Radio. For 9-volt operation C1 must be rated, at the least, 25 VDC and C2 is rated, at the least, 12 VDC. For 6-volt output C2 may be reduced to a 6-volt rating.

Parts Substitution. Except for the Zener diode, and possibly bridge rectifier Z1, all components are strictly junk-box salvage. The exact specified Zener diodes must be used to obtain the exact voltage. Box-type bridge rectifier Z1 is actually four diodes in



Encapsulated bridge rectifier is easily supported by its ribbon-like leads—connections are marked.

a miniature case and can be replaced with four diodes with a 50-PIV 1-amp rating (or higher). The two connections from T1 are made to the two Z1 tab terminals opposite the ~ mark; the (+) and (-) DC-output tab terminals are similarly marked. Transformer T1 is a 12-volt filament type—rated at least 1 ampere. The center tap is not used. The filament transformer (T1) specified in the parts list is about the lowest priced unit we could locate. "Scrounge" if you want a lower price. Transistor Q1 can be any medium or high-power transistor—use the lowest priced type you can obtain or whatever's in the junk box. The *Six-or-Niner* uses the Motorola HEP230—use any equivalent.

Other than observing correct polarities there are no special wiring precautions. Just make certain that the positive leads of C1 and C2 and cathode of D1—the end marked with a white band—are connected to the common (positive) power supply buss.

Only the basic power supply has been shown, but you can enclose the unit in any cabinet you choose, adding an output meter for current and a power on-off switch if desired. We suggest that if a metal cabinet is used both the positive and negative output terminals be insulated from the cabinet to prevent possible short circuits to the experimental equipment. ■

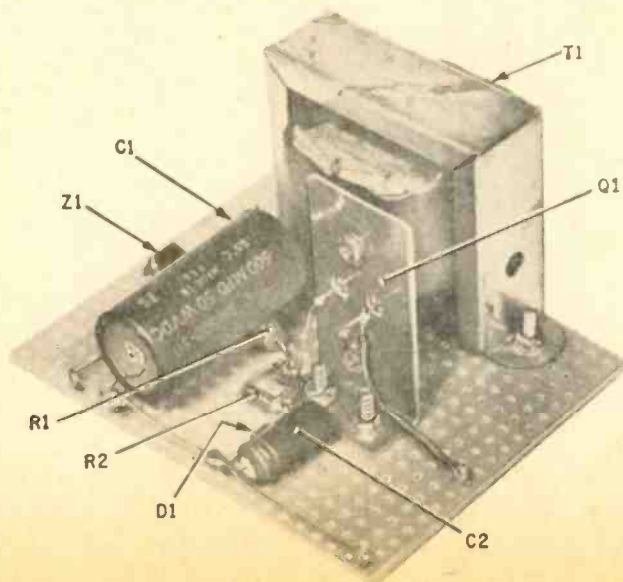

Completed unit shown here is about half actual size. Reposition parts for more compact layout and you can fit power supply into any corner of project chassis.

SPACE-AGE SHOWCASE

By Ron Mitchell

The New York World's Fair is only a memory now, but one of its very best exhibits is still playing host to hundreds of visitors each week. It is the Hall of Science Museum, acclaimed from the very first days of the Fair for its exciting appearance and outstanding exhibits. Having escaped the wreckers, the museum has since reopened, with an even greater wealth of exhibits.

Admission is free, and, as our photos show, the museum is especially thronged on school days. The reason isn't hard to find, for many a teacher views the museum as a veritable space-age showcase, opening window after window on the world of today—and tomorrow. ■

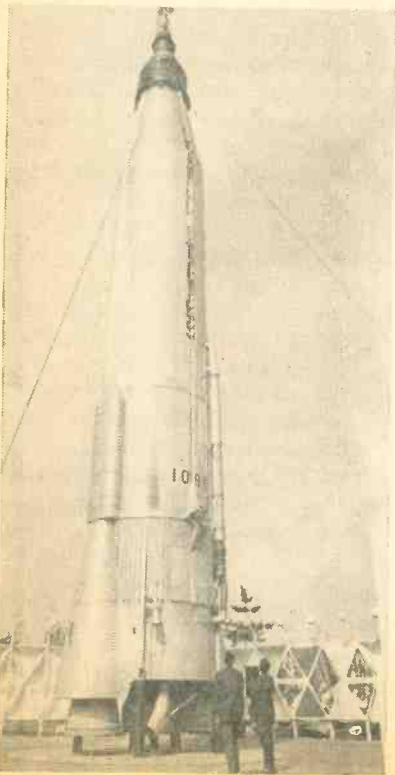

Even astronauts' spacesuits are available for close scrutiny in this museum that touches on the whole of modern technology. There's also a diagram to explain what each element is for.



With lunch in hand and eagerness in their faces, school children throng Hall of Science Museum. Below, science enthusiasts gaze at towering rocket.

The many laws which govern our solar system are colorfully and interestingly exhibited in still another section of the museum. Given proper preparation and orientation, science-minded youngsters can hardly fail to profit from their hours at the museum.

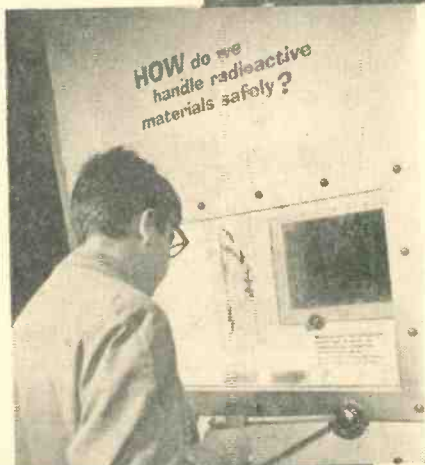
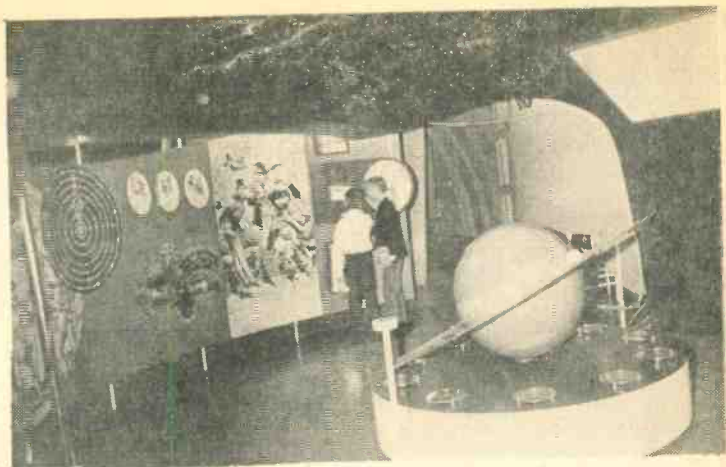

Materials in enclosure are harmless, but youngster can still manipulate mechanical hands of same type used in atomic-energy labs.

Lunch break finds boys full of talk about the many scientific wonders they've already observed and of others that are still to come.

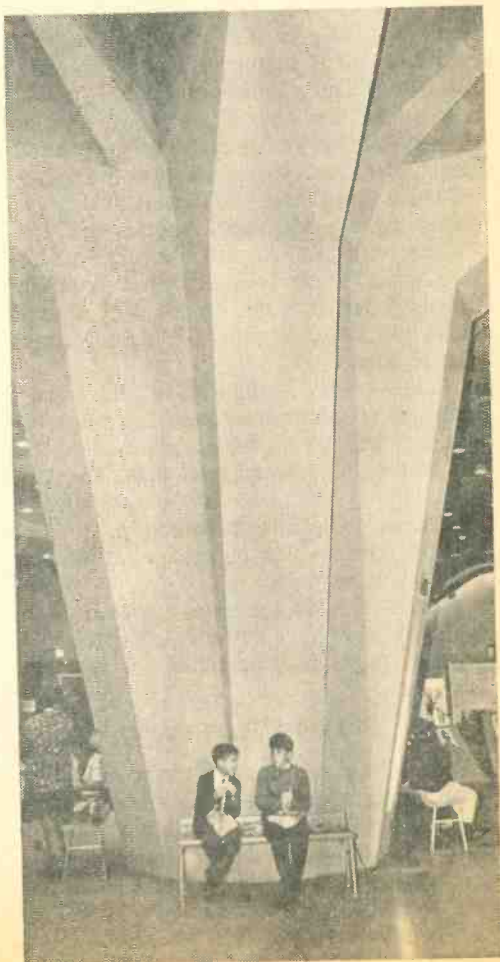

Shorts, open junctions, collector-to-base leakage, even amplification can be charted for almost any transistor using little more than a reliable VTVM and a little something you might call "know-how."

50 CENT TRANSISTOR TESTER

By A. A. Mangieri

While it's nice to have a fancy transistor checker to indicate gain and leakage, you don't have to pass over a pile of dollars to just find out if that transistor is usable or dead. Much information on the condition of a transistor can be had using nothing more than a VTVM and a resistor. One simple amplification test shows whether the transistor can amplify, and also reveals shorted and open transistor junctions. Another collector-to-base leakage test spots leaky and drifting transistors. These tests are used when the transistor tester is not on hand or when a quick test bench check of transistor condition is needed.

Those Tests. Amplification and leakage tests use an ohms range—giving resistance readings well up on the scale to insure that the test voltage is not too low. To avoid calculations, resistance readings are used as guidelines to transistor condition although leakage currents can be calculated from an Ohm's law formula.

Current flow in the ohms test lead of the typical VTVM (for any indicated resistance on any range) may be calculated using the formula

$$I = Vb / (Rx + Rc)$$

where Vb is the ohmmeter-circuit battery voltage, Rx is the measured or indicated resistance, and Rc is the center-scale resistance reading of the selected ohms range.

Voltage across the ohms test leads, which is also across the transistor under test, varies from Vb (usually 1.5 volts with the test leads

open) down to zero with the test leads shorted. This voltage varies uniformly with meter-pointer position, not indicated resistance. It is exactly $Vb/2$ (half of Vb), or .75 volt, when the meter pointer is at mid-scale.

Amplification. For the amplification test, connect the circuit as shown, but less S1 (or the clip lead). Set the ohms-range selector on the VTVM to $R \times 10$ ohms. This range passes up to 15 milliamperes current with test leads shorted. The indicated resistance

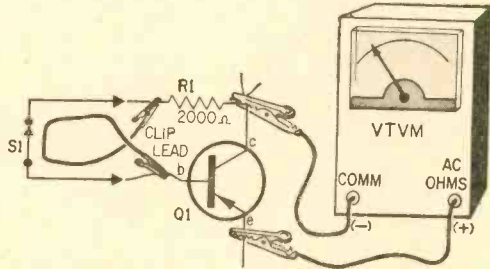

Just two components—a 2.2k resistor (shown here as 2000 ohms) and a s.p.s.t. switch (shown here as a clip lead)—suffice for transistor amplification tests.

should be above 5000 ohms—near full-scale. A very much lower reading indicates a leaky or shorted transistor. Connect the clip lead or switch S1 to connect R1 to the base of Q1. This supplies base current to the transistor. The indicated resistance should then drop to a value much lower than 2000 ohms (the value of R1). Usual values are 30 ohms or so for high-gain transistors to 200 ohms or so for low-gain transistors. If little
(Continued on page 113)

electronics IMAGINEERING

Look what happens when *imagin-ation* and *engin-eering* get together!

Read Battery Drain Quickly

- To measure battery drain in radios and experimental circuits, use this special test lead. Cement a thin brass or aluminum strip to each side of a piece of plastic.

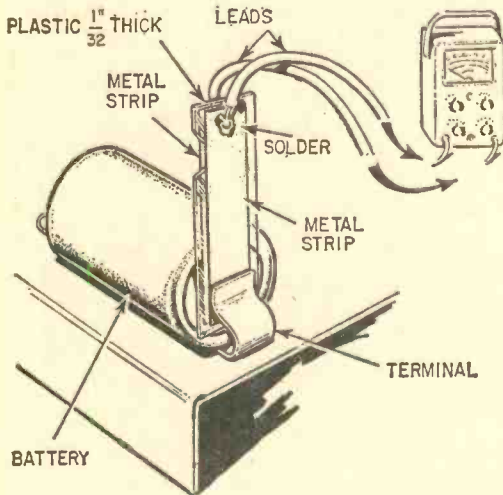

Then solder leads to each metal strip and connect them to a VOM. Insert the lead between the batteries and terminals to make quick current-draw readings.

Rubber-Mount Treble Speaker

- Rubber suction cups are ideal shock-mounts for treble loudspeakers. They make good mechanical mounts and acoustically isolate the speaker frame from cabinet panels which tend to accentuate the bass frequencies. Attach the cups to the speaker frame with screws (get the kind of cups having threaded inserts or screws) and to the cabinet panel with rubber or service cement.

Salvaging Worn Radio-TV Control

- When a volume, tone, or other radio-TV variable resistance control becomes worn and gives spotty operation that can't be eliminated with control cleaner, try reversing the two outer wire connections. This may put the operating range of the control on the least-used portion that is still serviceable.

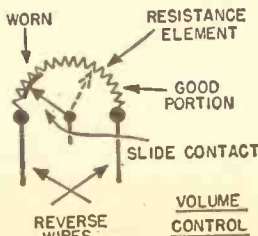

Color-Coding Wires

- When you need some color-coded wires for a circuit and only plain-colored wires are on hand, color-code your own. To do this, wrap lengths of the wire around a mailing tube, broom handle or other suitable form, and paint diagonal lines across the coil with different-colored paints. Apply the paint sparingly with cotton swab or piece of cotton on the end of a match. Tape holds coil in place.

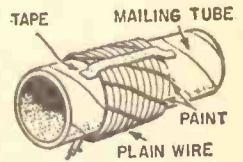

Solder Silences Noisy Tube

- When a tube in a radio, TV, amplifier or other device becomes microphonic and produces an undesirable howl or ringing sound from the speaker, don't throw the tube away. Wrap the glass envelope with several turns of solder or heavy uninsulated copper wire. The added weight and support will often damp out vibrations that cause oscillations.

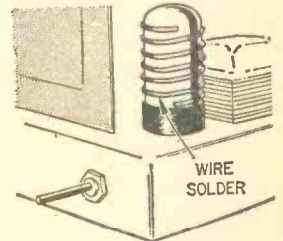

Extending Component Leads

- After the same components have been soldered into several different experimental circuits which then have been dismantled, the length of the leads gradually becomes shorter until the parts are no longer usable. You can extend such leads for further use by splicing on a 2-in. length of bare wire about the same diameter as the component lead. Wrap several turns of #22 or smaller bare wire tightly around the larger wire, near one end, to form a connecting sleeve. Scrape both wires clean or remove any enamel coating with solvent. Then push it up until it extends partly beyond the end of the wire. Insert the short component lead into the end of the sleeve and sweat-solder it, using resin sparingly.

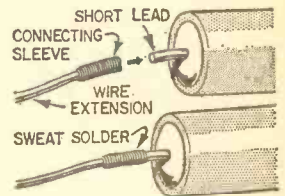

COUNTDOWN FOR DX



Why should any sophisticated DXer wait for network radio reports of what's what with our astronauts when he can tune in on the action direct?

By Tom Kneitel
K2AES/KBG4303

Being something of a busybody, always concerned with what's going on behind the scenes, I decided that while network TV/radio coverage of our space shots was okay for the general public, it was falling far short of the mark where I was concerned. What about all of those long pauses? What did Jules Bergman mean when he said, "They appear to be having some kind of problem in the capsule?"

Having a trusty Hertz inhaler sitting on the shelf, I decided to try and locate the original source of the network's information—the network's remote transmitter located aboard the rescue vessels. A little tuning and there it was, loud and clear and furnishing considerably more "closed circuit" information on the progress of the space shot than was filtering through to John Q. Public's transistor portable. Not only was I able to dig out the network's stations, I accidentally stumbled upon the entire NASA communications network, rescue ships, Cape Ken-

nedy, helicopters, and all. I was able to listen to the music being sent from Cape Kennedy to the capsule and even to President Johnson wishing the astronauts a happy landing, all direct and as it was happening (the network coverage frequently ran these communications, but with *mucho* delay).

The Big List. One problem I had arose when I found that most of the NASA stations weren't using callsigns or announcing their locations, using instead "tactical" identifier names. After listening in on a few of the launchings and taking notes, comparing my own observations with those listed in DX club bulletins (such as ASWLC, CIDXC, and NNRC), I was able to piece together a handy roster of the stations and their most often heard 'fone (mostly SSB) frequencies.

Every time I spoke to a fellow DX hound about my little list I was buttonholed for a copy and hounded until I came through with an exact duplicate of the fruits of my moni-

(Continued on page 70)

Elementary Electronics' Guide to Space Shot DX

POSSIBLE APOLLO LAUNCH STATIONS

17655 kHz	20186
-----------	-------

SEARCH & RECOVERY NETWORKS

3023.5 kHz.	9027
3090	9830
4690	11205
4739	11248 (Circuit 1K)
5718 (Circuit 1B)	11256.5
6393	11421
6694.5 (Circuit 1D)	13227
6698	13237
6709.5	13320 (Circuit 1M)
6993	15022
8880	15028.5
8975.5	15051
8982.5	15088 (Pacific)
8985	15968
9005 (Circuit 1H)	17610
	20007 (emergency)

RADAR TRACKING STATIONS

- Ships: Ship Sierra, Ship Whiskey, Ship Yankee, RKV, Alumni, Auto 1, Number 1, etc.

6787 kHz	8176	11514	18635
7898	10648	14896	18660
7919	10780	17643	19960
			22857

- Antigua Tracking, Antigua Is.

7919 kHz	AFE86	10780	AFE86
----------	-------	-------	-------

- Ascension Tracking, Ascension Is.

6752 kHz	AFE83	11634	AFE83
7919	AFE83	12140	AFE83
10780	AFE83	20286	AFE83
11407	AFE83	20454	AFE83
		20700	AFE83

- Canary Tracking, Canary Is.

8119.5 kHz	EAU65	13527.5	
13423		20450	EDT63
13447.5	EDT42		

- Canton I. Tracking, Phoenix Is.

10987.5 kHz	KCCA	16440	KCC97
-------------	------	-------	-------

- Cape Kennedy, Fla.

5775 kHz	AFE70	14585	AFE70
7675	AFE70	14896	AFE70
7833	AFE70	17390	AFE70
7919	AFE70	18330	AFE70
8260	AFE70	19960	AFE70
10780	AFE70	20390	AFE70
11634	AFE70	20454	AFE70
12140	AFE70	20475	AFE70
13170	AFE70	20700	AFE70
13878	AFE70		

- Honolulu Tracking, Hawaii

9212 kHz		12212	
10410	KUH50	13175.5	

- Kano Tracking, Nigeria

9440 kHz	50V8	18335	50V7
13905	50V23	21845	50V4
15870	50V3		

- London Tracking, England

6970 kHz	GAD26	13620	GDJ33
7480	GCI27	13595	GBB33
8005	GLK28	14890	GCI34
9157.5	GAN29	18130.5	GCB38
10792.5		18580	GMJ38
10795	GBL30		
13555	GIC33		

- Panama Tracking, Panama

9132.5 kHz	HPI	17682.5	HOD72
10242.5	HPD2	20727.5	HOD24
15925	HPE		

- Perth Tracking, Australia

9200 kHz		13580	
10950	VKK4	14939	

- Sydney, Australia (link to Honolulu)

10165 kHz		13500	19465
-----------	--	-------	-------

- Tanarive Tracking, Malagasay Rep.

7690 kHz		11430	
9863	5RX98	12275	5RY23
10270		20990	5RZ9

BROADCAST OPERATIONS

- Aboard rescue vessels

6956 kHz	9460	KH9344 & KJ3197
9337.5	13915	KJ3498

- IT&T Control, Brentwood, N.Y.

7622 kHz	WFH87	14635	WFK44
11035	WFL51		

- RCA Control, Rocky Point, N.Y.

4555 kHz	WEO44	13915	WES43
7407.5	WEP57	15460	WES65
9095	WEP69	15982.5	WES25
9460	WEO59	15987.5	WES75
10620	WES50	18960	WES58

MUSIC TO CAPSULE

15016 kHz

CAPSULE FREQUENCIES

225.7 mHz	telemetering
259.7	telemetering
296.8	voice

GODDARD SPACE CENTER

7580 kHz
7878
10615

SOME STATIONS IN SEARCH & RESCUE NETWORKS

Ageless Sierra	Kwajalein Relay
Atlantic Chief Radio	(Marshall Is.)
Atlantic Public Affairs	Lake Champlain (ship)
Atlantic Recovery	Lant Leader
Atlantic Surgeon	Lively Net Radio
Atlantic Tribe	Mayport Control
Atlas	(Jacksonville, Fla.)
Boxer (NASA ship)	McKinley Leader

(Continued on page 70)

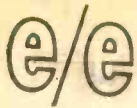

COUNTDOWN FOR DX

Continued from page 68

toring. Apparently there are very few listeners who realize how easy it is to eavesdrop on these communications. I thought that you might like to have a copy, so I'm making it immortal in these hallowed pages.

As clarification to the listings, I'd like to point out that most of the frequencies are approximate, and some of the locations are stated as the users of tactical callsigns are educated guesses. Some fellows have, I understand, gone on to bigger and better things by even obtaining QSL's from stations engaged in these launches—notably the stations at Cape Kennedy and aboard the U.S.S. Guadalcanal.

It seems that most of the communications from Cape Kennedy are actually transmitted from the Cape via remote control from the Manned Space Flight Center at Houston.

With each space shot the picture changes slightly. For instance, the President has been heard talking to the capsule on 6709.5 kHz during one shot and on 9005 kHz in a subsequent launch. Sometimes the press stations are shifted around from one vessel to another (KJ3498 has been aboard the U.S.S. Wasp and the U.S.S. Guam during different shots). In any event, the frequencies seem to remain fairly constant over the various shots and the same tactical callsigns are heard regularly. The busiest channels are 6709.5, 9005, and 15088 kHz.

How Good Is the Data? All of the information in this article is based on listening reports made during the Mercury and Gemini shoots. However, you can bet your bottom buck that 95% of the network will remain intact and on frequency for the Apollo space shots. With the space communications networks around the globe tried and proven, Apollo communications needs will be serviced by the existing network with new frequencies added only where old channels get too crowded.

I think that by listening to these stations you'll greatly add to your appreciation of the gigantic task it is to successfully launch, keep track of, and land a manned capsule. It's quite an involved deal, and you can be part of the "in" group digging the sounds while your neighbors sit and wonder what's happening. ■



DX'ing a Russian in space is difficult because of the language barrier and the Reds' reluctance to announce space shots in advance. The author even has trouble identifying Volga River boat captains.

Space Shot DX List Continued from page 69

Camera Bug (aircraft)	Naha Rescue
Cape Recovery	(Ruykyu Is.)
Chisel Bolt (ship)	Norris (ship)
Dauntless	Northlant 3 (ship)
Eastlant Leader (ship)	Pacific Chief
Eniwetok Rescue	Pary
(Marshall Is.)	Pine Tree
Fisher	Pistol Pete
Gemini Quad	Rescue 1 (helicopter)
Goodrich (ship)	Roamer
Guadalcanal Sick Bay	Rony
(ship)	Samoa Rescue
Guam Rescue	Sea Roar
(Mariannas Is.)	Singapore Relay
Gulf Stream	Southlant (ship)
Gun Train	Star Buster
Hickory	Strike 1
Houston Public Affairs	Top Hand
Houston Recovery	(Annapolis, Md.)
Houston Surgeon	War Chief
Ivanhoe (Norfolk, Va.)	Wasp Radio (ship)
	Westlant Leader (ship)



*Who will be the first U. S. astronaut you DX?
The coming Apollo program promises many firsts.*

LINE FAILURE ALARM



BY
JAMES A. FRED

Now when your pet experiment is deprived of AC power it will complain loudly about it.

How many times has your electricity gone off at night and you never knew it—until you woke up late for work? There are also many more-serious situations that need instant attention, such as in laboratories where a complicated experiment might be a complete failure because you never knew that the line voltage had failed sometime during the experiment.

At home there is the refrigerator and freezer to worry about as well as the electric alarm clock. Of course a power line failure due to a thunderstorm will usually awaken some member of the family. However many power line failures originate many miles from your home. A careless motorist may knock over a utility pole, a line fuse may blow, or some other remote type of failure may occur without warning.

In the past it has been necessary to use a relay energized by the line voltage, when the line voltage failed the relay dropped out and a battery and buzzer connected in series produced a warning sound. Here is a solid-state circuit that has no moving parts and should be very trouble free. The heart of the circuit is a *Sonalert*. The *Sonalert* delivers an audible signal generated by a tran-

sistor oscillator driving a ceramic transducer. It operates on 6- to 28-volts DC and only draws 3 ma. to produce 68 db of sound. At 28 volts DC it will produce up to 80 db of sound.

How it Works. You should find the circuit quite interesting. The schematic diagram shows the line voltage is rectified by a full-wave bridge Z1. It is filtered and used to maintain a trickle charge on a 9-volt battery, through diode D1. Current limiting resistors R1 and R2 are used to adjust the DC voltage across R3, which is the load resistor. It also serves as the return path from the *Sonalert* to the negative terminal of the battery. The capacitor removes some of the ripple from the DC voltage. When line voltage is present the 10 volts developed by the current flow (from Z1) through the 1000-ohm resistor (R3) is shunted across the *Sonalert* by diode D1. This is because the diode has a much lower forward resistance than the *Sonalert*. When the line voltage fails the battery cannot discharge back through the diode so the current flows through the *Sonalert* and back through the 1000-ohm resistor to battery minus. When this happens the *Sonalert* sounds off with a 2800-cycle tone alerting

e/e LINE FAILURE ALARM

anyone in the listening area. The Sonalert will continue to sound until the line voltage is restored or until switch S2 is turned off. The push-to-test switch is there to test the alarm circuit. Since the battery is on a permanent trickle charge and the Sonalert draws only a little over 3 ma. the battery should last well over three years.

To build the *Line-Voltage Failure Alarm* you will need the parts listed. Most of the parts are standard and all should be available at your parts distributor. Substitutions may be made for manufacturers listed but be

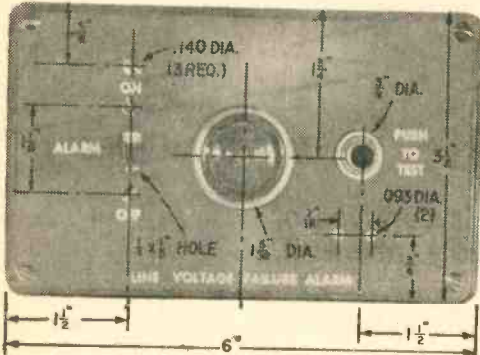

Front panel shows dimensions of layout and size of holes to drill to duplicate the Line Failure Alarm. This noisemaker can be included in another project.

very sure to use the values listed. The two switches, Sonalert and battery are attached to the back of the front panel. The balance of the parts are mounted on a phenolic board using turret terminals. If you prefer you may use perforated phenolic board and push-in terminals or flea clips. The board is then mounted on the panel by a standoff which raises it above the slide switch. Switch S2 is necessary because whenever the line cord is unplugged the Sonalert will sound off.

Construction. The first step in building

this device is to lay out the holes in the front panel and drill them out. After all the holes are drilled in the black phenolic panel carefully wipe it clean and spray it with several light coats of model maker's dull spray. This spray is available in hobby shops and most drug stores. Apply decals or press-on letters to designate the intended use of the switches. Spray on a final coat of dull spray as a protection for the lettering.

While the front panel is drying you can work on the phenolic circuit board. The large photograph of the board will help you in the layout and placement of the parts. The phenolic box must have a hole drilled in the left end for the line cord. All the wiring is straightforward and the only necessary precaution is to use a heat sink when soldering the leads of the diode and rectifier.

After the wiring and assembly is finished double check the hookup before plugging in the line cord. After plugging the cord into an outlet slide switch S2 to on. The *Sonalert* may sound off depending whether or not the DC voltage across C1, R3 is higher or lower than the battery voltage. If it does sound off, ignore it and proceed as follows: connect a DC voltmeter across the filter capacitor

PARTS LIST

- B1—9-volt mercury battery (Mallory TR146X or equiv.—see text)
- C1—50-mf., 25-volt electrolytic capacitor
- D1—Diode, 1N34 (or equiv.)
- R1—8,200-ohm, 1-watt resistor
- R2—2,000-ohm potentiometer (Mallory MTC-23L4 or equiv.)
- R3—1,000-ohm, 1/2-watt resistor
- S1—5-p.s.t. pushbutton switch
- S2—5-p.s.t. slide switch
- Z1—Full-wave bridge rectifier (Mallory FW50 or equiv.)
- Z2—Sonalert (Mallory 5C628 or equiv.)
- Misc.—Phenolic box, box cover, solder terminals, wire, solder, battery holder, battery connector, line cord, machine screws, nuts, spacers, panel decals, etc.

Estimated cost: \$9.25

Construction time: 2 hours

Schematic diagram of Line Failure Alarm shows few parts are required to wire the device. Diode D1 shunts current from bridge rectifier Z1 past Sonalert. Reversed current, from battery, powers Sonalert.

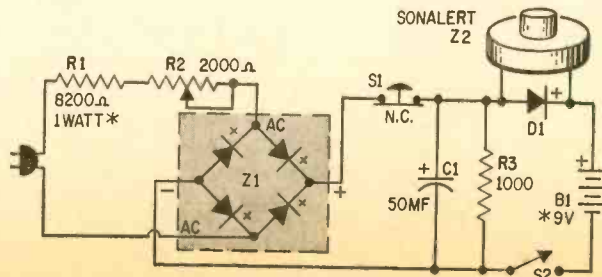

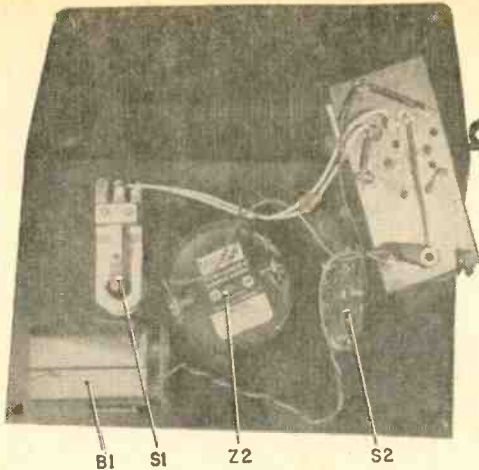

All of the electronic components are mounted on the cover of the box. The circuit board (top right) is mounted on the standoff seen protruding from near the bottom left-hand corner of the circuit board. One machine screw, through hole above S2, secures board.

(C1) and adjust R2 until the *Sonalert* is silent—the meter should now read about 10 volts. Now press the pushbutton (S1) and the *Sonalert* should sound once more. While holding the button in, slide switch S2 to its *off* position—this should quiet the *Sonalert*.

Make it Louder. To make the *Sonalert* louder it is necessary to increase the voltage applied to it. Since it is the battery that powers it when the line voltage fails it is necessary to use a higher-voltage battery.

You can use a RM411 which is rated at 14 volts. Mount it in the same battery holder as before, but it will be necessary to solder the battery leads directly to the battery terminals. The proper battery holder is a Keystone number 166. Of course this also means that a higher DC voltage is necessary from the rectifier. You will have to substitute a

5500-ohm, 2-watt resistor for the 8200-ohm, 1-watt resistor. A convenient way to do this is to use two 11,000-ohm, 1-watt resistors in parallel. Now potentiometer R2 is adjusted for 15 volts or if you don't have a voltmeter adjust R2 with the slide switch *on* until the *Sonalert* is off. Pulling the line plug should start the sound again. This modification will make the sound a good deal louder.

If you want the alarm to wake you up plug it into an outlet near your bed and set the alarm on your bedside table. There will be no trouble recognizing the distinctive 2800-Hz tone—you will never confuse it with an alarm clock, telephone, or door bell.

For use as a laboratory alarm plug the alarm into the same outlet with your equip-

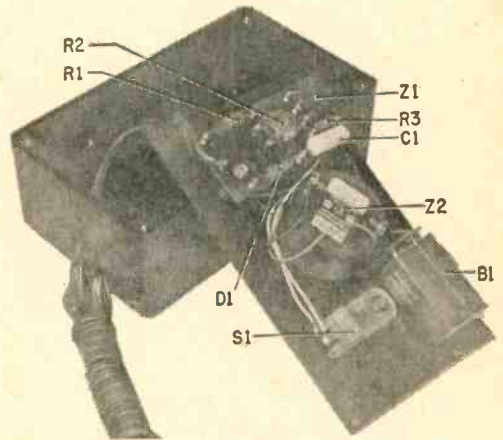

Completed Line Failure Alarm shows adjustment potentiometer R2 in center of component side of circuit board. Adjustment must be made with the unit opened.

ment for your experiment. If by chance you want the alarm quite a distance away from your laboratory area then a long extension cord may be used. Don't forget to slide the switch to *off* when moving the alarm from place to place. ■

HOME STUDY BLUEBOOK COUPON

(Turn page for details)

Age _____ Are you a Veteran? _____ Employed in Electronics? _____

Occupation _____ Male _____ Female _____ Single _____ Married _____

Are you a student? Full-time _____ Part-time _____ Home Study _____

Check the last school you attended: Circle schools you graduated:

Grade School _____ High School _____ College _____ Graduate School _____

Have you ever taken a Home-Study course? _____ Completed? _____

What school(s)? _____

What is your yearly income to the nearest thousand? \$ _____

(If your income is \$6745, write in \$7000)

HOME STUDY BLUEBOOK

e/e's Guide to selected
Home-Study Courses
now being offered by
Electronics Schools



☞ **One of the E's in Electronics** is for *Education*—wherever you can get it. Fortunately, many of our readers are located near resident schools offering electronics courses suited to their educational needs. A far greater number, however, are less privileged on one or both of two counts: resident schools are either located so far away that attendance would be impractical or personal educational needs have become so esoteric and specialized that resident schools simply can't provide appropriate instruction. And this is where home-study courses from non-

resident schools can prove indispensable. For such schools not only fill normal educational needs, they actually forge ahead by offering courses and personalized educational services resident schools can never hope to provide.

☞ Listed below are a few courses from several home study schools. For more information, circle those course numbers that interest you on the coupon below, and fill out both sides of the coupon. **ELEMENTARY ELECTRONICS** will forward your request to the schools and ask that additional data be sent to you directly.

1. 2-Way Radio. *National Radio Institute's* Complete Communications Course gets you to pass the FCC First Class Radiotelephone license exam or returns your money. This "beginner-oriented" course covers mobile, marine, aircraft, and railroad communications, plus radio-TV transmission, microwave relay, and teletype. Course contains 70 lessons with texts, 13 reference texts, 7 training kits. Tuition: \$309 with time payment optional; average completion time, two years. GI Bill approved.

2. 2-Way Radio. *Grantham School of Electronics'* FCC License Course (Course FL). No previous training required; enrollment at any time; up to one full year allowed for completion. Prepares student for First Class FCC Radiotelephone license; if he fails, *all* tuition payments are refunded. Course of 88 lessons in basic mathematics, basic electricity, basic electronics, and communications electronics. \$130 cash in advance; or \$25 down, 6 monthly \$20 payments. GI Bill approved.

3. Radio Construction and Repair. *Progressive Edu-Kits* train you to become a Radio Technician (no education or experience necessary). For \$26.95, you receive all parts and instructions for building 20 different radio and electronic circuits, guaranteed to operate. Kits contain 12 receivers, 3 transmitters, signal tracer, amplifier, signal injector, code oscillator, square-wave generator. You also receive printed circuit materials, a multiple tool set, electric soldering iron, books and other valuable items.

4. Computer in a Case. *Cleveland Institute of Electronics* offers four Auto-Programmed slide rule lessons along with their already-famous electronics slide rule, which features nine conventional scales plus an "H" scale to solve resonant frequency problems and the "2 pi" scale for inductive or capacitive reactance problems. Lessons and slide rule (complete with case) are only \$24.95.

CUT HERE

ELEMENTARY ELECTRONICS, Dept. HS-1
505 Park Avenue, New York, N. Y. 10022

☞ Yes! I would like to know more about the electronics home study courses described above. I am interested in only the course numbers circled below.

1 2 3 4

Name _____ Age _____

Address _____ Vet? _____

City _____ State _____ Zip _____

(Fill in facts on reverse side)

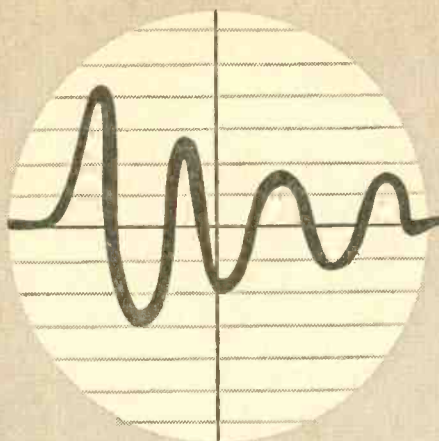

FCC

Q&A

By Carl L. Henry

The prospective radio operator licensee must be proficient in the state-of-the-art, whether it be tubes or semiconductors. Prepare yourself—learn the basic circuits.

Those of us who passed the FCC radio operator's test years ago would be unpleasantly surprised if we had to take it today. Since 1950, the tests have been expanded to cover UHF radio, radar, FM radio, television, and the use of semiconductors in communications. Each of these new fields has added questions to the operator's tests. The most recent addition to the tests, semiconductors, has added many new questions.

Questions on semiconductors will be easier for the *novice* than for the *old-timer*. Once tube operation is mastered, it is hard to relearn amplifier theory on a *current* basis rather than on a *voltage* basis. In 1950 there were no transistors, and no tunnel diodes. At the rate that semiconductors are being incorporated into electronic equipment, by 1970 there may be no tubes.

One thing we can be sure of is that the radio operator licensee must be proficient in the *state-of-the-art*, whether it be tubes or semiconductors, and the Federal Communications Commission operator's test questions will reflect this requirement. So this month I will cover some of the test questions about semiconductors, many of which are included in the new supplement to the *Study Guide to Radio Operator's Examinations*, just published by the U.S. Government Printing Office.

Q Describe the physical structure of two types of transistors and explain how they operate as an amplifier.

A Generally, there two basic types of transistors. These are the seldom-encountered point-contact and popular junction types. The point-contact transistor is constructed of a single pellet of *n*-type germanium with two *catwhisker*-like contacts. These *catwhiskers* are the *emitter* and *collector*, while the *base* lead makes an area contact with the body of the pellet. This pellet is very small, being in most cases no larger than the head of a pin. *p*-type areas are formed around the *catwhisker* connections.

The junction transistor is constructed as a multiple wafer sandwich. A *pn*p transistor consists of an *n*-type germanium wafer with a *p*-type wafer on either side. Connections are made to the wafers with wires, the center wafer being the base.

Amplifier action is as follows: barriers are formed at the wafer junctions. These barrier resistances are affected by the applied external currents. Forward biasing the base-emitter junction increases the supply of holes in the base-collector region, which is reverse-biased. This allows a comparatively small current (supplied to the base-emitter junction) to control a larger current through the base-collector junction, thus giving a power gain. A voltage gain is available and is maximum in the common-emitter circuit configuration due to the high ratio of input to output impedances.

Q Draw a schematic diagram of a two stage audio amplifier using transistors.

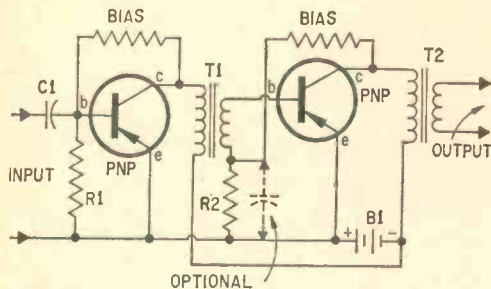

Fig. 1. This typical transformer-coupled two-stage transistor amplifier can be used for preamplifier or output (to speaker or as modulator) stages—the basic circuit is the same. Only the actual part values will change as power or signal levels reach maximum.

A See Fig. 1.

Q What affect does biasing have on the performance of a PNP transistor?

A A transistor circuit will generally not operate at all without some forward bias on the base emitter circuit. Too much forward bias on the base circuit will damage the transistor. Proper biasing is therefore necessary for the transistor to operate.

Q Name some common types of transistors and draw their schematic symbols.

A There are two general classes of transistors, by physical construction: point-contact and junction; by wafer arrangement: *pn*p and *np*n. The schematic symbols for transistors are shown in Fig. 2.

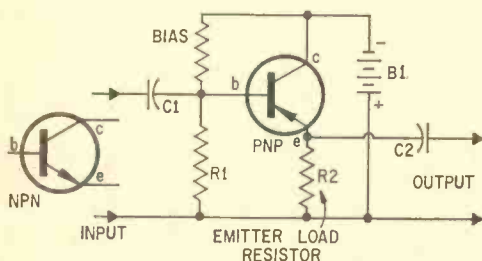

Fig. 2. Either NPN or PNP transistors may be used in a circuit—just reverse supply voltage polarity. Emitter-follower or common collector circuit is the semiconductor equivalent of the vacuum-tube cathode-follower circuit—both have a gain of less than one.

Q Draw a transistor amplifier circuit which would be analogous to that of a vacuum-tube cathode-follower amplifier.

A See Fig. 2.

Q Draw a simple schematic of a Hartley type transistor oscillator.

A See Fig. 3.

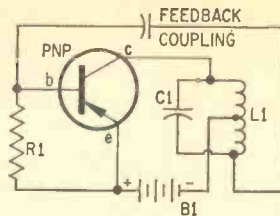

Fig. 3. Oscillator circuits will be a major part of the examination. This basic Hartley oscillator circuit will be important to remember. Basic Colpitts oscillator circuit is given in Fig. 6. Make sure you can tell the difference between the two types.

Q Describe the difference between positive (*p*-type) and negative (*n*-type) semiconductors with respect to: (a) the direction of current flow when an external emf is applied; (b) the internal resistance when a external emf is applied.

A (a) When an external emf is applied to a *p-n* or *n-p* junction, the current flow tends to be high when the polarity is negative toward the *n*-type side, and positive toward the *p*-type. A *pn*p transistor in a common emitter circuit is therefore forward biased (that is, has largest current flow) when the emf polarity is negative in the base circuit, with reference to the emitter; and when the second emf is positive in the collector circuit, with reference to the emitter. The internal resistance is smallest in this forward bias direction. Therefore, for maximum internal resistance, the polarity described is reversed. An *npn* transistor is exactly opposite to the *pn*p type.

Q What is the difference between forward and reverse biasing of transistors?

A Forward bias is that condition of maximum current flow and reverse bias is the condition of minimum current flow. A *pn* junction is considered forward biased, the condition of maximum current flow, when an emf is applied positive to the *p*-type side and negative to the *n*-type. A common-emitter *pn*p transistor has an *n*-type base, a *p*-type emitter, and a *p*-type collector. For proper operation, the base-emitter circuit is forward biased; the collector-emitter circuit is reverse biased. The emf supplies therefore connect: negative to base, positive to emitter; negative to collector, positive to emitter. An *npn* transistor would have opposite polarities to maintain the same biasing.

Q Show connections of external batteries, resistance load and signal source as would

appear in a properly (fixed) biased common-emitter transistor amplifier.

A See Fig. 4.

Q Draw a circuit diagram of a method of obtaining self-bias, with one battery, without current feedback, in a common-emitter am-

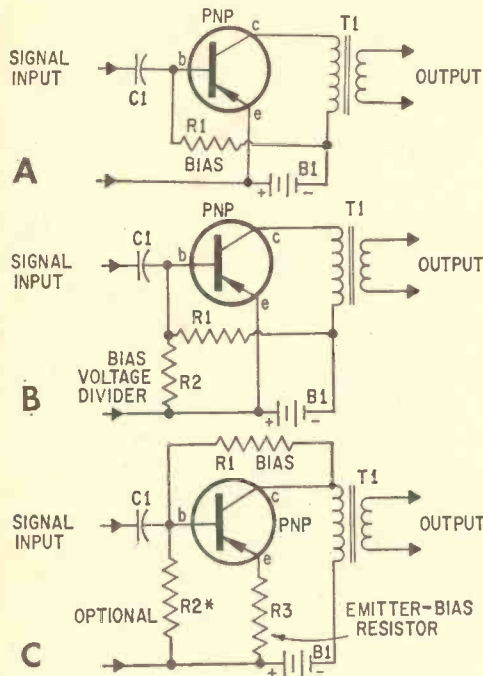

Fig. 4. Simple resistor bias (R_1 in A) is unstable. Adding R_2 (in B) maintains constant voltage at base. Connecting R_1 to collector (in C) introduces negative feedback and reduces temperature runaway. Voltage drop across primary of T_1 (from increased current flow in collector) lowers forward bias to base input.

plifier. Explain the voltage drops in the resistors.

A See Fig. 4.

There are three basic common-emitter biasing circuits, each of which is shown in Fig. 4. Fig. 4A is comparable to a fixed-bias vacuum-tube circuit. Here the base is forward biased by battery B_1 , through resistor R_1 which acts to limit the current in the base circuit, since in a forward bias condition the base-emitter circuit has a low resistance. The collector-emitter circuit is biased by B_2 , through the load T_1 . There is no degeneration in this circuit.

The bias for both base and collector are supplied by a single battery in Fig. 4B. The base-emitter bias is supplied by a voltage divider consisting of R_1 and R_2 . This circuit has one basic flaw. The base-emitter circuit has, as mentioned before, a low resistance when forward biased. The value of R_2 is

chosen to be between 5 and 10 times the base-emitter resistance to partially stabilize this resistance. It cannot be too low, and since R_1 is generally considerably higher, the current through the base-emitter circuit is not stable with variations in temperature.

A method of biasing the transistor that is better, from the standpoint of stability, is shown in Fig. 4C. The bias is supplied here by R_1 from the collector circuit. This supplies degeneration and also acts to stabilize the bias by its self-correcting action. Emitter-bias resistor R_3 is unbypassed, further signal degeneration is introduced here that also helps to stabilize the circuit. Too, this resistance acts to raise the base-emitter resistance.

Q Explain the significance of each item listed: (A) Collector-to-Base Voltage (Emitter open)—40 MAX. VOLTS (B) Collector-to-Emitter Voltage (Base to Emitter Volts—0.5v)—40 MAX. VOLTS (C) Emitter-to-Base Voltage —5 VOLTS MAX. (D) Collector Current 10 MAX. MA. (E) Transistor Dissipation at Ambient Temperature of 25°C for operation in free air 120 MAX. MW. (F) At case Temperature of 25°C for operation with heat sink 140 MAX. MW. (G) Ambient-Temperature Range: Operating and Storage —65 to 100°C.

A The rating given in transistor handbooks fall into two categories: absolute Maximum ratings and working ratings. The ratings shown here are absolute maximum ratings. With the emitter open, if the collector-to-base voltage exceeds 40 volts, the transistor will be damaged.

The second specification is the reverse breakdown voltage on the collector-emitter circuit with the base reverse-biased. This is also specified frequently in terms of a micro-ampere leakage current called I_{co} .

The third specification is the reverse breakdown voltage across the base-emitter circuit. From this we can judge that the input to the stage should not exceed —5 volts when summed with the forward bias. Since the forward bias is usually small, from a voltage standpoint (a constant-current source), the input must be restricted to a 10-volt swing at peak value on a sinusoidal signal.

The collector current is listed as 10-MA. maximum. Under no conditions should the base bias be such as to allow a greater current flow in the collector circuit.

Transistors are self-destroying when their maximum ratings are exceeded, because a

destruct cycle is started which reinforces itself. For example, if an excessive current flows in the collector circuit, the transistor junction overheats. This heat causes the resistance of the junction to decrease, which causes the current to increase further, which in turn, heats the junction more, etc.

Maximum dissipation is stated to be 120 MW. This is the real limiting factor in transistor operation. Although the collector-emitter voltage is stated to be 40 volts, and the collector current stated to be 10 MA, the transistor cannot handle both maximum values at the same time. This would be a dissipation of 400 MW. Either the voltage or current can be the stated maximum value, and the other must be limited to the value that will not cause the maximum dissipation to be exceeded. For instance, if the voltage is -40 volts, the maximum current can only be $0.120/40$ or 3 milliamperes. Notice too that this dissipation is specified at room temperature in free air—this means that in normal operation if the room temperature of the air at the transistor exceeds 25°C , the maximum dissipation must derate accordingly. If a heat source such as a power resistor were located near the transistor and no ventilation provided, the transistor might be derated from 120 milliwatts to possibly as little as 1 milliwatt.

The seventh specification limits both the storage, that is, inactive; and operating temperature to -65°C to 100°C . The transistor will cease to function even in a derated condition beyond these temperature extremes.

Q Draw a circuit diagram of a common-emitter amplifier with emitter bias. Explain its operation.

A See Fig. 4C. The resistor in the emitter circuit, R3, is used to develop emitter bias voltage. However, contrary to vacuum-tube operation, transistors must be biased *on*, not *off*. The resistor used here bucks the forward bias of the base circuit. Without a bypass capacitor, its effect is to raise the input resistance of the transistor by a rule-of-thumb factor of approximately $R \times \beta$ (gain of the amplifier.) A 1000-ohm resistor would raise the input resistance (if the amplifier gain was, say, 100) to 100×1000 or 100,000 ohms. The actual input resistance cannot be raised this much, but lower resistance values give a good approximation. A further effect is to stabilize the stage gain. The degeneration introduced in this manner is very effective in stabilizing stage gain and preventing thermal run-away.

Q The value of the alpha cutoff frequency of a transistor is primarily dependent upon what one factor? Does the value of alpha cutoff frequency normally have any relationship to the collector-to-base voltage?

A The alpha cutoff frequency of a transistor is primarily dependent on the width of the base region of its junction and the following formula is fairly accurate: alpha cutoff (in megacycles) is equal to C/W^2 , where C is equal to 5-6 for germanium npn, 1-9 for germanium pnp. W is equal to the width of the base region in mils. The alpha cutoff frequency increases with increasing collector bias because widening of the space-charge layer decreases the effective base region width.

Q Why is stabilization of a transistor amplifier usually necessary? How would a thermistor be used in this respect?

A Stabilization of a transistor amplifier is necessary because of variations in the transistor characteristics with varying temperatures. A thermistor can be used in the bias-
(Continued on page 111)

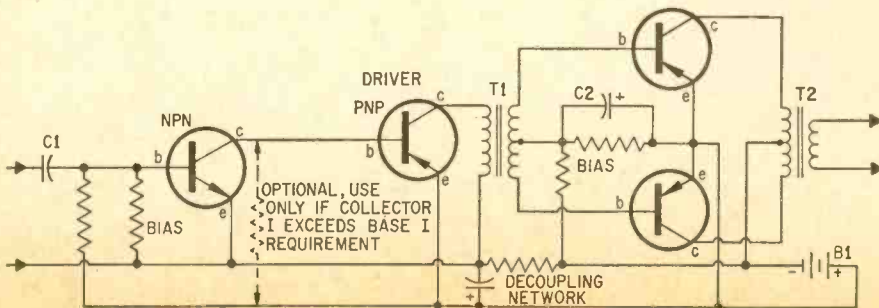

Fig. 5. Typical transistor amplifier transformer-couples low-signal stages to drive push-pull output stages.

Low Down on Way-Down SWL

Paradys, S. Africa
Sarawak, Maylaysia
Lusaka, Zambia
Suva, Fiji
Tananarive, Malagasy
Gwelo, Rhodesia
Pyongyang, Korea
Wewak, Papua
Taipei, Taiwan
Conakry, Guinea
Kabul, Afraganistan
Bagdad, Iraq
Kabul, Afghanistan

Paradys, S. Africa
Sarawak, Maylaysia
Lusaka, Zambia
Suva, Fiji
Tananarive, Malagasy
Gwelo, Rhodesia
Pyongyang, Korea
Wewak, Papua
Taipei, Taiwan
Conakry, Guinea
Kabul, Afraganistan
Bagdad, Iraq
Kabul, Afghanistan

By Walter R. Levins

Tired of the ordinary SW DX? Looking for a new frontier to conquer? Well, here's something new and difficult for even the old-time Shortwave Listener (SWL) to add to his list of rare DX loggings.

For the average SWL, 90 meters is an unknown part of the SWBC (ShortWave BroadCast) spectrum—a part he never tunes in. However, here on 90 meters lurks that rare DX on a relatively low frequency. Low frequencies coupled with low power present a challenge you can't afford to miss. But in return, that rare QSL comes and makes the undertaking well worthwhile. With winter here, the 90-meter SWBC band should be at its maximum.

The band extends from approximately 3250 kHz (kc) to about 3995 kHz (which actually is 75.09 meters). On these frequencies some of the rarest DX can be found. Most 90-meter stations broadcast primarily for listeners in regional areas and very few for international purposes. Hence, there are mostly low-power stations on 90 meters. Now let's have a look at these stations by continent.

Africa. This continent is hard to log for some SWLs. Not many stations have high power. But on this band, Africans constitute a large part of the DX. Countries like Rhodesia and South Africa, with their policies of apartheid, bear some attention. Both of these countries can be logged on the 90-meter band. Sierra Leone has its only

SW outlet on this band. A high-powered station (100 kw) operated by Radio Clube de Mozambique offers the only high-powered transmissions from Africa on this band. Mozambique is one of the last colonies in Africa, thus making it a controversial country to verify.

Frequency (kHz)	Power (kw)	Station & Country
3250	20	Paradys, S. Africa
3255	10	Liberian Bc. Corp., Liberia
3259	20	R. Malaysia, Sarawak
3260	100	R. Clube de Mozambique
3270	10	Lusaka, Zambia
3284	10	Suva, Fiji Isl.
3288	30	Tananarive, Malagasy Rep.
3290	25	R. Nacional, Colombia
3295	100	Delhi & Bombay, India
3306	10	Gwelo, Rhodesia
3320	50	Pyongyang, Korea
3335	10	R. Wewak, Papua
3335	10	Taipei, Taiwan
3375	10	R. Angola
3376	50	Conakry, Guinea
3780	100	R. Iran
3925	50	Tokyo, Japan
3985	50	R. Kabul, Afghanistan
3990	50	Baghdad, Iraq

Asia. This is a continent which many SWLs lack in terms of logged countries—especially those SWLs on the East Coast. The Far East has many offerings; such as Sarawak, Indonesia, Fiji Islands and Taiwan. Most Asian transmitters are of the low-power variety, save India (100 kw), Japan (50 kw), Pakistan (50 kw) and Afghanistan (50 kw). Middle East stations in Iran

(Continued on page 113)

ARECIBO LISTENING

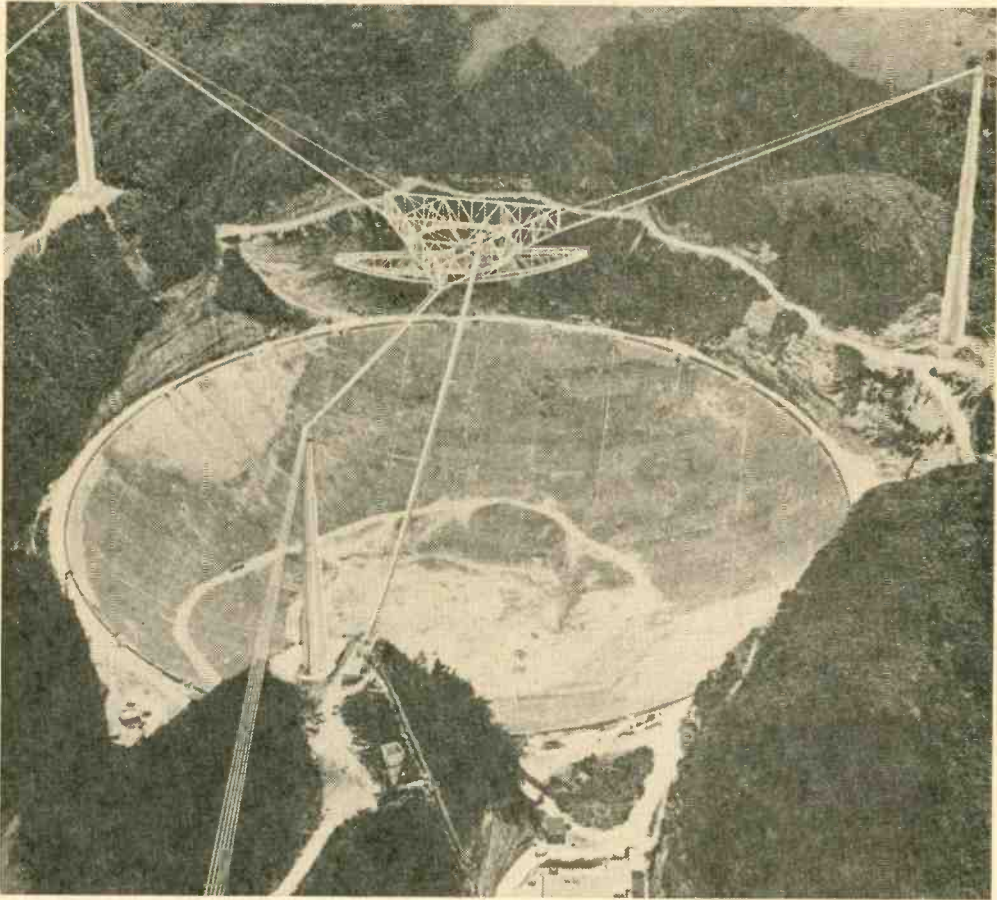

Commonwealth of Puerto Rico

■ Mercury, that speedy little planet nearest the sun, *probably* rotates on its axis once every 88 days, it says here (here being a nationally known and respected encyclopedia bearing a 1964 copyright). But the *real* period of Mercury's rotation is a mere 59 days. Says who? Says the most authoritative voice now exploring the heavens, a unique radio-radar telescope that fills an entire valley near the little Puerto Rican port of Arecibo.

Operated by Cornell University and sponsored by the U.S. Advanced Research Projects Agency, the Arecibo telescope easily qualifies as the world's biggest ear. The entire installation covers an area larger than 56 city blocks, and the antenna alone—

supported by a complex network of towers, cables, and guys (see photo above)—weighs an unbelievable 450 tons!

Happily, the Big Ear has already come forth with scientific findings worth its weight and more. The planet Venus, for example, shrouded in a cloak of clouds and therefore immune to most probing, has always been assumed to rotate counterclockwise like any normal planet. But Arecibo has found that Venus revolves clockwise (though the why of the matter remains a problem for another day).

Still, Arecibo may someday offer the answer to this and countless other riddles. For the Big Ear has only begun to listen.

—Ron Mitchell

the inside story ON DETECTORS

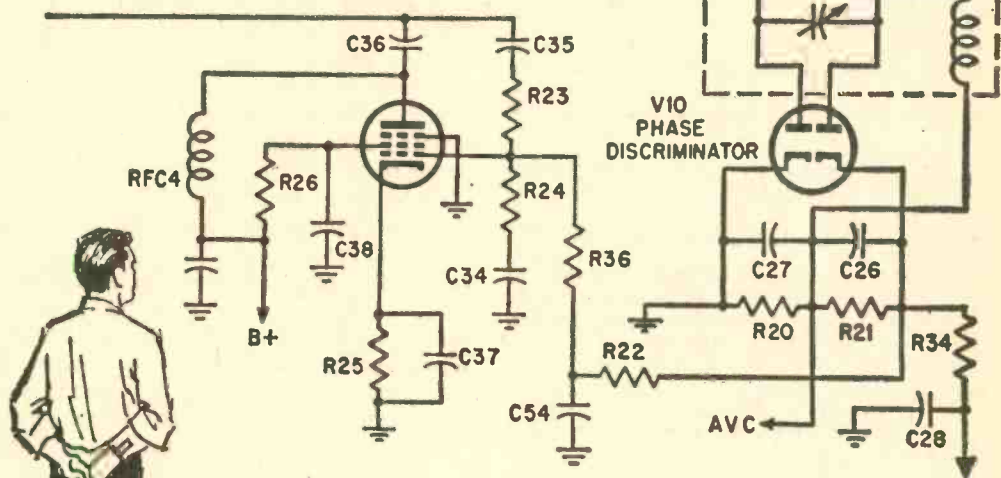

Much has happened since the days of the simple crystal detector. Now we have FM and SSB to add to that old standby—the AM diode demodulator.

By Leo G. Sands, W7PH/KBG 7906

The next important function of a short-wave or home receiver after receiving and amplifying the RF signal is to extract the intelligence. This is the job of the *detector*. However, some prefer to call it a *demodulator* when it picks out the amplitude-modulated carrier. For FM signals this important detector stage usually is one of several types—the most common ones are the *discriminator* and the *ratio detector*. Whatever name you give to a detector stage, the circuit really doesn't care. It does its job by snipping out the intelligence from the RF in the form we would like to hear it—code, voice and even music.

An AM detector may be either a diode rectifier or a non-linear amplifier. When a steady AC voltage (such as an unmodulated RF signal) is applied to a rectifier, either the positive or negative half of the signal is

sheared off as illustrated in Fig. 1. When applied to a non-linear amplifier, either the positive or negative half cycles are amplified more than the other as illustrated in Fig. 2. The output waveform, therefore, is not a replica of the input waveform.

An AM radio signal is simply AC (RF carrier) modulated by lower frequency AC, be it voice, music or an audio tone. Modulation causes the amplitude of the carrier to vary. If we examine a radio carrier with an oscilloscope, it will look as shown in Fig. 3, except the sine waves may be narrower and closer together—depending on the time-base (horizontal) rate. When modulation is applied to the carrier it will compress and expand the RF carrier as shown in Fig. 4. This is known as an AM radio-signal envelope—the peaks of the RF sine waves representing the modulating signal. Since the positive and

e/e DETECTORS

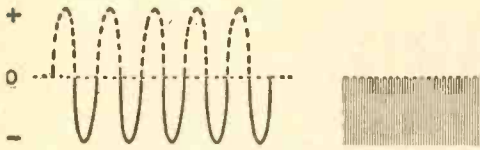

Fig. 1. Perfect diode strips away part of carrier. Output voltage is determined by diode connections so it can be either positive or negative. Connections do not matter in simple circuits as in Figs. 5 and 6.



Fig. 2. Non-linear amplifier results in signal-stripping waveform shown. Average voltage below line must be subtracted from average voltage above zero line. The resulting signal distortion is indicated in Fig. 9.

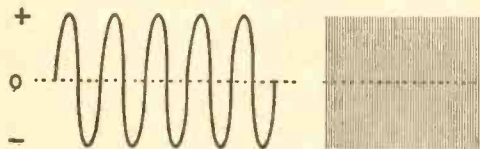

Fig. 3. When viewed on an oscilloscope the RF signal would appear as above—depending on the sweep frequency. High repetition rate at left; low at right.

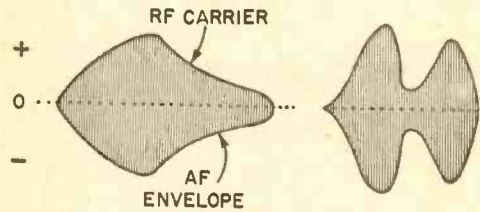

Fig. 4. Gap occurs in RF carrier only when modulation exceeds 100%. Such operation distorts audio information and generates harmonics and other interference.

negative peaks are almost mirror images of each other, and equal in amplitude but of opposing polarity, one of them must be eliminated or attenuated in order to extract the modulating intelligence.

Diode Detector. As we said before, an AM radio signal can be demodulated by feeding it into a rectifier or a non-linear amplifier. If fed into a diode detector using the series-rectifier circuit shown in Fig. 5 or the shunt-rectifier circuit, Fig. 6, the positive half of the AM envelope will be sheared off (as in Figs. 1 and 2), leaving the negative half upon which the modulating signal rides,

as shown in Fig. 7. The negative-going portion of RF component (carrier) remaining in the detector output is filtered (bypassed) by capacitor C which has an extremely-low impedance at the carrier frequency (RF) and a comparatively-high impedance at the audio (AF) modulating frequencies. Therefore, the voltage applied to the headphones is an audio signal.

Recognize the circuits in Fig. 5 and 6? They're what used to be known as crystal sets—which employed a galena or other metallic crystal as a rectifier (diode). Today the adjustable crystal diode has been replaced by a miniature device—a germanium or silicon (semiconductor) diode.

Non-Linear Amplifier. When an AM signal is applied to a non-linear amplifier (using the basic circuit shown in Fig. 8) the positive half of the signal has a much greater effect on plate current than the negative half. The tube is biased almost to cut-off. When a positive-going signal is applied to its grid, plate current rises sharply. A negative-going signal causes a reduction in plate cur-
(Continued on page 85)

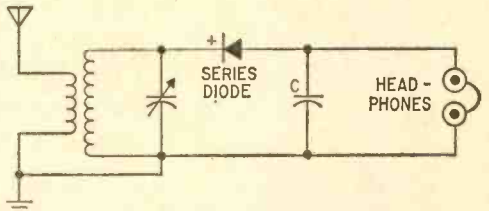

Fig. 5. Series-diode detector allows one half of modulated-carrier signal to flow through headphones while presenting high impedance to other half.

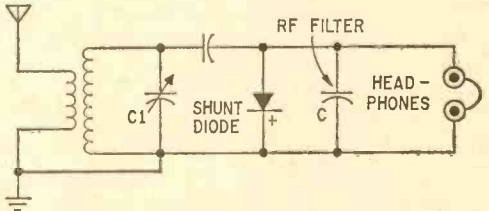

Fig. 6. Shunt-diode detector shorts one half of the carrier signal across headphones; other half flows in headphone circuit with C separating RF from audio.

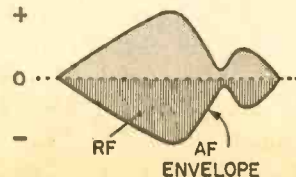
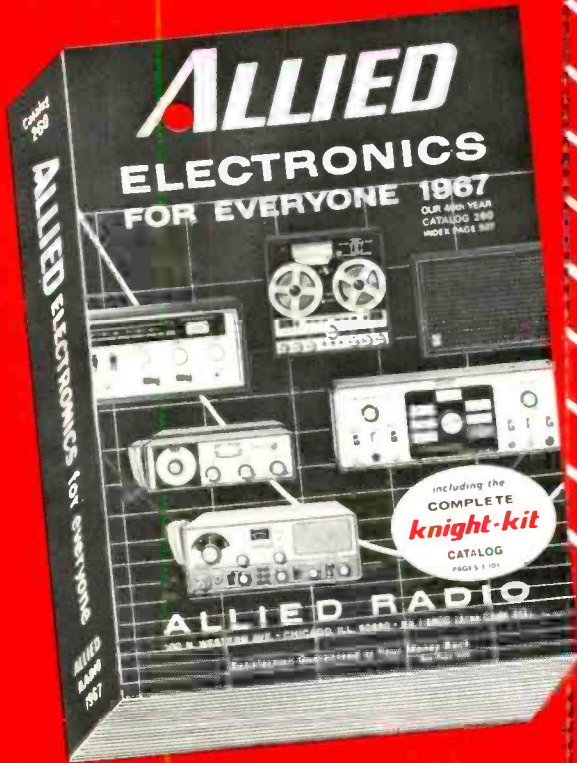

Fig. 7. With positive half of carrier (top half) stripped away RF follows low-impedance path through C in Figs. 5 and 6. Audio flows through headphones.

FREE

ALLIED 1967 CATALOG



NEW 514-PAGE

ALLIED CATALOG

TOP SAVINGS ON THE BEST IN ELECTRONICS FOR EVERYONE . .

- Famous Knight-Kits • Stereo Hi-Fi • Tape Recorders & Tape • CB 2-Way Gear • Walkie-talkies • FM-AM & AM Radios • Short Wave Radios • Portable TV • Intercoms & P.A. Phonographs, Accessories • Amateur Gear Automotive Electronics • Test Instruments TV Antennas & Tubes • Power Tools • Parts Hardware • Transistors • Batteries • Books

NO MONEY DOWN—24 MONTHS TO PAY!
Low Monthly Payments to fit your budget.

NAME—PLEASE PRINT

ADDRESS

CITY

STATE

51C

ZIP

**FREE
ALLIED
1967
CATALOG**

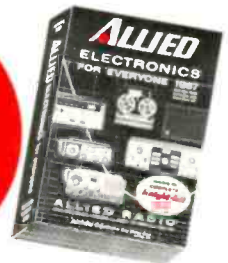

CHOOSE FROM THE WORLD'S LARGEST SELECTION IN ELECTRONICS . . . AND SAVE!

Buy from the world's largest electronics supplier. Use the Allied Credit Fund Plan to enjoy what you want NOW — no money down, 24 months to pay.

RUSH THIS CARD NOW!



TO:

ALLIED RADIO

P. O. BOX 4398

CHICAGO, ILLINOIS 60680

PLACE
STAMP
HERE

PLACE
STAMP
HERE

TO: **ALLIED RADIO**
P. O. BOX 4398
CHICAGO, ILLINOIS 60680



NAME—PLEASE PRINT

ADDRESS

CITY

STATE

51C

ZIP

**FREE
ALLIED
1967
CATALOG**



CHOOSE FROM THE WORLD'S LARGEST SELECTION IN ELECTRONICS . . . AND SAVE!

Buy from the world's largest electronics supplier. Use the Allied Credit Fund Plan to enjoy what you want NOW — no money down, 24 months to pay.

RUSH THIS CARD NOW!

**RUSH
THIS CARD
TODAY**

FREE

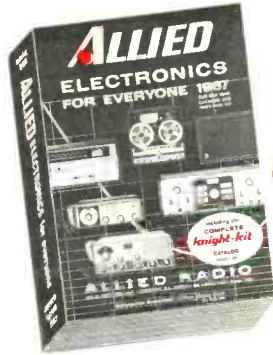

NEW 1967
**ALLIED
CATALOG**

514 pages! See everything new in electronics... featured first at Allied, the world's largest electronics headquarters!

New! for the audiophile



Knight-Kit® Deluxe Stereo FM-AM Tuner. Easy-to-build solid-state design.

New! for the ham operator



Knight-Kit® 6-Meter Amateur Transceiver with universal solid-state power supply.

New! for the CB user



KNIGHT® 2-Way Radio. Compact solid-state design at amazingly low cost!

New! for the serviceman



Knight-Kit® Portable Solid-State Color/Bar Pattern Generator. A top value!

New! for everyone



Ampex 6200 HVR Home Videotape Recorder. Make videotapes at home!

New! for TV and FM owners

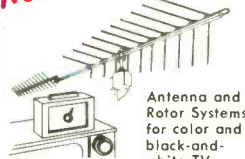

Antenna and Rotor Systems for color and black-and-white TV . . . FM, too!

Plus hundreds more new and exclusive items, and scores of special Allied values!

NO MONEY DOWN!

Enjoy the things you want now, while you take 24 months to pay for them on the Allied easy-on-the-budget Credit Fund Plan.

ALLIED RADIO

P.O. BOX 4398
CHICAGO, ILLINOIS 60680

DO A FRIEND A FAVOR —give him this card to send for his **FREE ALLIED CATALOG**

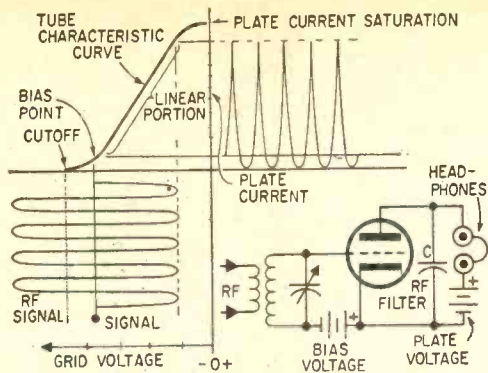

Fig. 8. Plate current/grid-bias voltage characteristic curve is for the typical operation of most tubes.

rent—which is already low and which can't be reduced to less than zero regardless of the amplitude of the negative-going signal. Therefore, the output signal, shown in Fig. 9, is not a replica of the input signal (Fig. 4) and is inverted (positive signal at grid increases plate current and decreases plate voltage). Again, a capacitor (C) across the output filters out the remaining RF component. The average plate current through the headphones, therefore, follows the modulating signal.

Practical Diode Detectors. In most tube-type AM radios, the detector circuit uses one diode section of a duo-diode-triode tube, as shown in Fig. 10. The detector follows the last IF amplifier. The amplitude modulated IF signal (RF after conversion to a lower frequency) is fed to the plate of the diode. But, it is not a shunt detector (as in Fig. 6) even if its cathode is grounded. The detector is in series with the secondary winding of the IF transformer, R1 and R2. Capacitors C1 and C2 in conjunction with R1 form a low-pass filter which passes the AF signal

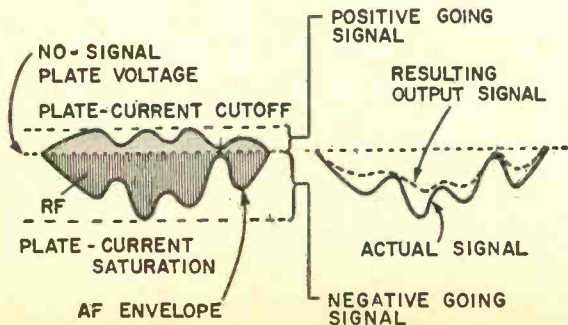

Fig. 9. Because tube does not cutoff sharply at the bias point some distortion is introduced in signal that rides between the bias point and current cutoff.

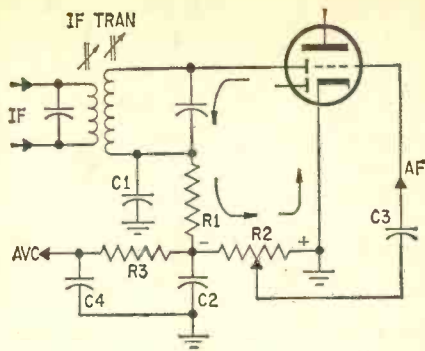

Fig. 10. Duplex-diode-triode detector and the first audio stages appears in almost all AM receivers. Circuit has changed little in 30-odd years of use.

but removes the remaining RF in the signal.

The AF signal voltage is developed across R2 and is fed through C3 to the grid of the AF amplifier (triode section of the tube). At the same time, a DC voltage is also developed across R1 and R2, resulting from rectification of the IF signal. (Arrows indicate electron path). The level of the DC voltage varies at the AF rate. However, by adding R3 and C4, a steady DC voltage is developed across C4 which becomes charged and prevents the voltage from varying with the audio. The level of the DC voltage across C4, therefore, is proportional to the level of the IF carrier signal, not of the derived AF signal. This voltage (AVC) is used for controlling the gain of the receiver by applying it to the grids of RF, IF and mixer stages.

Instead of a tube, a semiconductor diode (D1 in Fig. 11) may be used in the detector circuit. In many transistor-radio circuits, the diode polarity is reversed, as shown in the circuit in Fig. 12. Here, the diode (D1) provides AGC voltage to transistor IF ampli-

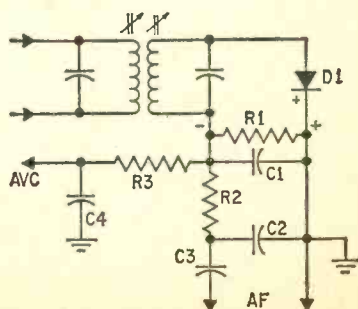

Fig. 11. Circuit of semiconductor-diode detector is just about identical with that of vacuum-tube circuit. C3 isolates transistor base bias from detector DC.

Ⓔ/Ⓔ DETECTORS

fier stages. A small negative voltage is applied to the cathode of the diode and, at the same time, to the base circuits of the gain-controlled transistors. This negative voltage forward biases the transistors and the diode. Current flows through the diode even when no signal is being received.

When a signal is received, current flow through the diode is increased by positive signal swings and reduced or cut off by negative signal swings. A positive DC voltage is also developed across C1 which opposes the negative forward bias applied to the transistor bases, causing the receiver gain to drop. Hence, the receiver gain is controlled by signal level.

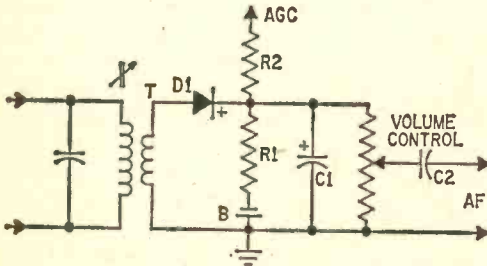

Fig. 12. Cell B applied forward bias to diode D1 to overcome junction potential—increasing sensitivity of detector and AGC controlled RF and IF transistors.

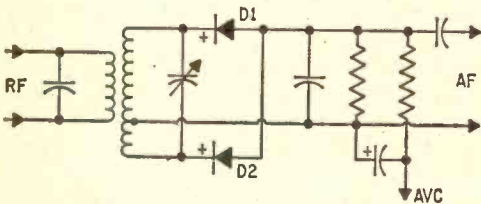

Fig. 13. Full-wave detector circuit increases average voltage available for AVC (AGC). AF output. It is seldom used because it requires special (tapped) coil.

Dual-Diode Detectors. A pair of diodes can be used to form a full-wave detector circuit, as shown in Fig. 13. Or, two diodes can be used in a voltage-doubler circuit as shown in Fig. 14 to provide 6 db of gain in the detector stage. When the IF signal swings negatively, diode D1 conducts and charges C1. When the signal swings positive, D2 conducts and charges C2. The resulting DC voltage across R1 is equal to the sum of the voltage charges across C1 and C2, each of which charges to the peak value of the IF signal. The AF signal is also developed

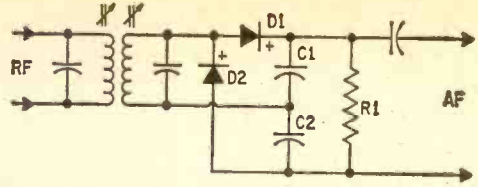

Fig. 14. Full-wave voltage doubler circuit raises signal level to audio amplifier input but not enough to eliminate an audio stage; actual cost is increased.

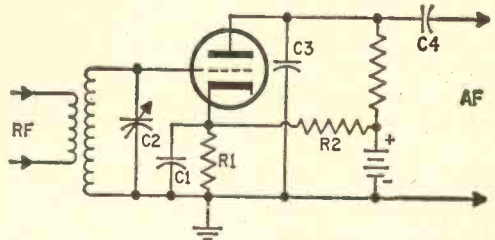

Fig. 15. Plate-detector circuit is similar to that in Fig. 8. Bias voltage is developed across R1 and is filtered by C1. Bleeder R2 increases cathode bias.

across R1, if C1 and C2 are not so large as to bypass audio frequencies.

Plate Detectors. The circuit in Fig. 8 is of a theoretical or basic plate detector. A practical circuit is given in Fig. 15. Bias is provided by cathode resistor R1, augmented by current through R2 which makes the cathode more positive with respect to the grid (grid more negative). Since the grid is always negative, and never draws current, the input impedance is extremely high.

Grid-Leak Detector. The input impedance of a grid-leak detector is not as high as that of the plate detector since some grid current flows, loading down the resonant input circuit and lowering its Q. The signal is fed to the grid through a capacitor (C1), as shown in Fig. 16. The grid and cathode function as a diode (with the grid as the anode), forming a shunt rectifier circuit (as in Fig. 6). When the RF signal is positive going, grid current flows since the grid-cathode path looks like a partial short circuit, causing plate current to rise and C1 to charge—with polarity as indicated in the diagram.

When the input signal is negative going grid current flow cannot occur and the signal voltage is added in series-aiding with the charge on C1, reducing plate current. Excessive build up of voltage in C1, resulting in possible blocking of the tube, is prevented by grid leak R1 which is the load for the grid-to-cathode shunt rectifier. Bias volt-

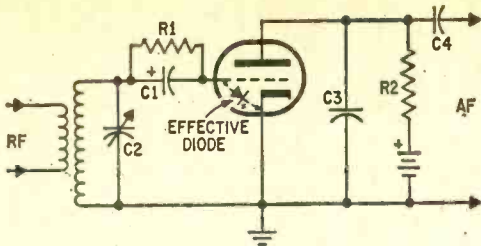

Fig. 16. Grid-cathode circuit of triode acts as a diode— R_1 is load. Voltage across C_1 varies along with audio modulation impressed on received carrier.

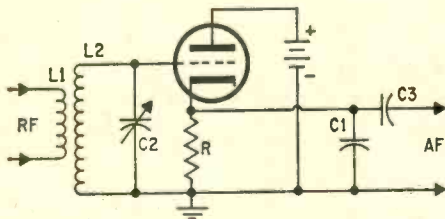

Fig. 17. Load for grid-cathode diode is R . Voltage across R_1 biases triode to cutoff. Filter C_1 passes RF while recovered audio (AF) passes on through C_3 .

age developed by the intercepted signal is determined by the values of C_1 and R_1 , as well as the signal level and frequency.

So, how does it detect? When no signal is being received, plate current is maximum since there is no bias. When a signal is received a negative grid-bias voltage develops across R_1 (grid to cathode) and plate current is reduced. Modulation on the carrier causes plate current to drop more than rise. Hence, the output signal is not a replica of the input signal, and average plate current represents the modulating signal.

Actually, a grid-leak detector is a combination of a diode detector and an AF amplifier as Fig. 16 suggests. The grid sees and amplifies the output of the shunt-diode detector found inside the tube by the cathode-to-grid electron glow.

Infinite-Impedance Detector. The circuit in Fig. 17 could be that of a cathode follower amplifier. It can be a detector or a power amplifier, depending upon the ohmic value of a cathode resistor R (which determines the bias voltage and the values of components in the grid circuit). When R has a relatively high value, the grid is biased so that the tube operates in the non-linear portion of its characteristic curve (see Fig. 8). Then it is a detector which functions like a plate detector. Positive input signals cause a sharp rise in cathode current and negative signals cause a small reduction.

This is known as an *infinite impedance*

detector, used mainly in the hi-fi AM tuners—it provides no voltage gain.

Pentode Detectors. Pentodes are also used as grid-leak and plate detectors. Their output impedance is much higher than for triodes and resistance-capacitance coupling to the AF amplifier is generally employed.

The biggest advantage of using a sharp cut-off pentode as a detector is gain. The grid-leak detector circuit shown in Fig. 18 delivers a much higher signal voltage to the AF amplifier than one using a triode. The same is true of the pentode plate detector circuit shown in Fig. 19. The screen voltage can be critical. When using either circuit it is necessary to try various screen voltages to obtain maximum output with minimum distortion.

Regenerative Detectors. About 55 years ago, Dr. Lee DeForest and his associates

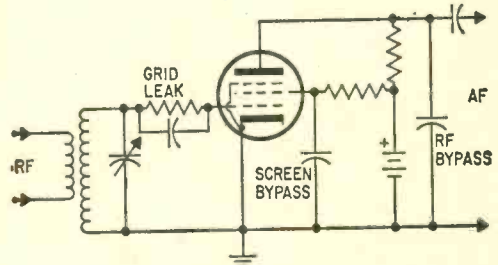

Fig. 18. Pentode circuit is essentially the same as that for a triode. Screen gives added gain to stage as well as other advantages of using a pentode tube.

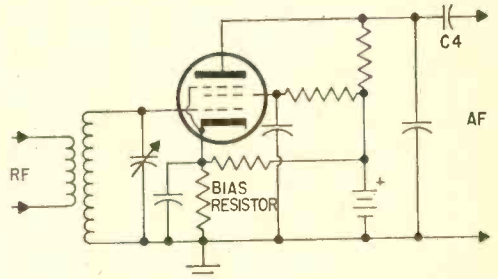

Fig. 19. Plate detector using pentode should be compared to that of triode in Fig. 15. Voltage developed across bias resistor operates tube near cutoff region.

were developing an AF amplifier, in Palo Alto, California, utilizing DeForest's audion (triode) tube. Accidentally, the output transformer and the input transformer got too close together and oscillation took place. About the same time, Major Edwin H. Armstrong deliberately designed an electronic oscillator around the DeForest tube. The courts were busy for a long time trying to determine which came first, the chicken or the egg.

(Turn page)

e/e DETECTORS

The barristers argued about the *regeneration* technique for drastically increasing the gain of a detector and for producing RF energy. If we take the grid-leak detector circuit of Fig. 16 and add a tickler coil (L3 in Fig. 20), we have a regenerative detector. Before filtering the RF out of the plate circuit (with C2), if we feed the plate current through coil L3, energy will be fed back from the plate to the grid. We use the tube to amplify the intercepted signal. Then, after amplification, we send it back through the tube to be amplified again. As a result the gain of several tubes is obtained from the use of only one.

However, most regenerative detectors are unstable and can cause interference to someone else's reception. That's why they have almost disappeared in spite of their high gain.

To receive CW (code signals), the detector should oscillate. When receiving AM signals, the detector should *not* oscillate. Maximum gain (sensitivity) and selectivity are obtained just below the threshold of oscillation. Therefore, receivers with regenerative detectors are equipped with a regeneration control—there are many types. In Fig. 20, variable capacitor C3 is the regeneration control. The lower its capacitance, the greater the feedback. A potentiometer (R2)

is used in Fig. 21 to control regeneration by varying the plate voltage. And, in Fig. 22 in which a pentode vacuum tube is used, regeneration by varying the screen voltage with R1.

Superregenerative Detectors. The same man, Armstrong, who invented FM and the superheterodyne, also invented the *superregenerative* detector. It's like a regenerative detector except that it is alternately swung in and out of oscillation at an ultrasonic rate. It provides extremely high gain, but it lacks the selectivity of a plain regenerative detector.

The regenerative detector (V1) shown in Fig. 23 is made superregenerative by the quench oscillator (V2). When the quench oscillator's signal swings positive, it reduces the bias on V1, allowing it to oscillate. When it swings negative, it quenches the oscillation. The quench oscillator frequency can be quite low as long as it's above the frequency of audibility.

Most superregenerative detectors are self-quenched—a separate quench oscillator is not used. Instead, the detector's grid leak and capacitor have values which cause the tube to function as a blocking oscillator and a regenerative detector simultaneously. The grid leak (R) resistance is increased to a high value (several megohms) and is sometimes connected between the grid and plate (B+) as shown in Fig. 24.

A superregenerative detector will detect both AM and FM signals. It often provides as much sensitivity with one tube or transis-

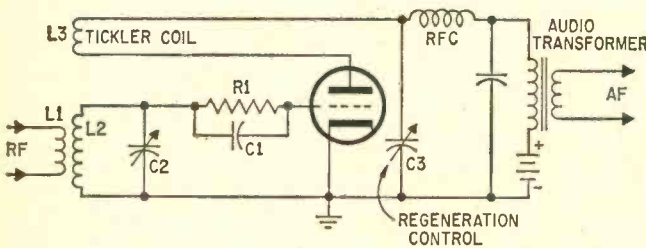

Fig. 20. Regenerative detector uses separate feedback winding (L3). Feedback is controlled (L3) by varying capacitance of C3—changing circuit impedance for RF through L3, C3 and triode. Grid leak R1-C1 develop grid bias as in a grid-leak detector circuit.

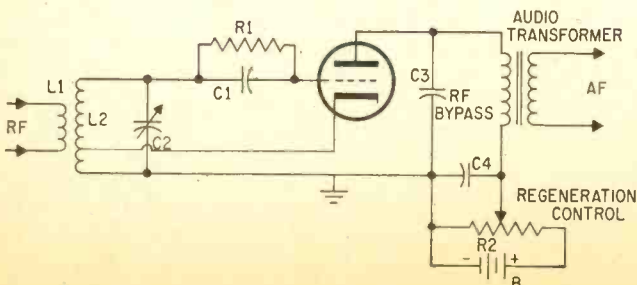

Fig. 21. Autotransformer L2 provides feedback signal to grid circuit. Feedback is controlled (L2) by increasing or decreasing plate voltage with R2 (a voltage divider across B).

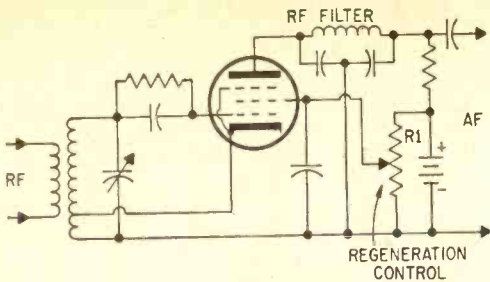
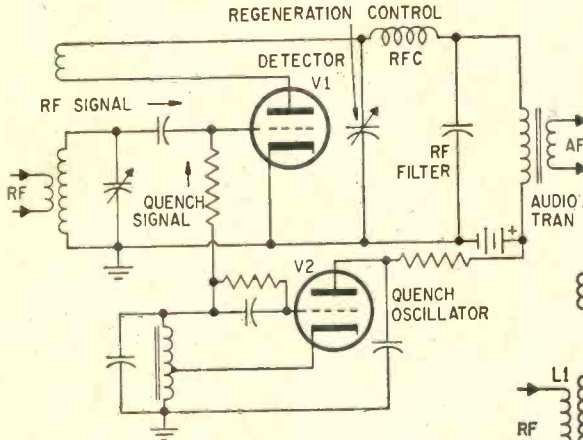

Fig. 22. Screen-voltage regeneration control has smoother control over regeneration. Rapid changes in supply voltages seriously affect regeneration. Batteries or well-regulated power supply are a must.



tor as a superhet employing several. It also provides limiting action. Its response to weak and strong signals is about the same. But, it has poor selectivity and has a background hash (noise) when no signal is being received. This detector will also cause interference unless preceded by an RF amplifier.

FM Slope Detectors. The job of an FM detector is to sense a change in the frequency of a radio signal. It should not sense changes in signal amplitude. This can be avoided by employing limiters ahead of the detector. A limiter saturates when it is fed a signal above a certain level and delivers a signal of constant amplitude to the detector. Thus, if fed an AM signal, the AM (variation in amplitude) is erased. But, changes in frequency are not affected.

The simplest way to demodulate an FM signal is to use an AM detector tuned slightly off frequency. In a superheterodyne receiver with a 455kHz IF, for example, if the receiver is detuned so that the IF produced by an unmodulated carrier is at 450kHz instead of 455kHz, the output of the detector will vary as the frequency of the signal is deviated. When the signal fre-

quency deviates $+5\text{kHz}$, detector output will be maximum. When it deviates -5kHz , detector output will be much lower. As the carrier frequency deviates, the detector output will vary and the FM signal will be demodulated. This is known as *slope* detection. The results leave much to be desired, as far as fidelity is concerned.

A superior slope detector employs a more elaborate circuit, as Fig. 25 indicates. Here, L2 is tuned to a frequency above the mean IF and L3 below the mean IF. When the incoming signal is deviated upward, a larger voltage is developed across L2 than L3, and

Fig. 23. With the exception of added quench oscillator and grid resistor connection, circuit of superregenerative detector is identical to the circuit given in Fig. 20.

Fig. 24. Self-quenching circuit is preferred for high-frequency receivers. The regeneration control bypasses RF through variable capacitance shunting from L3.

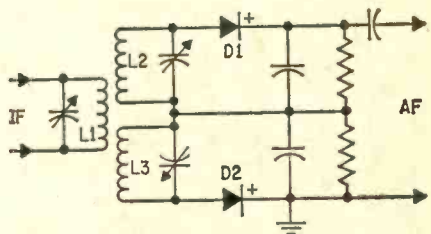
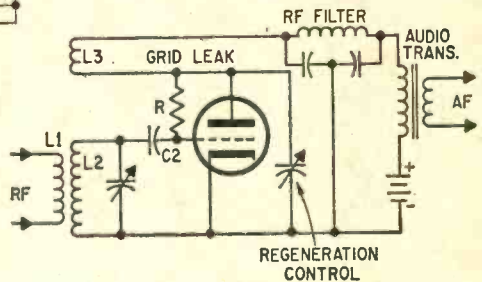

Fig. 25. Slope detector is difficult to align and requires sharply-tuned circuits. Critical circuitry is never popular since it requires frequent retuning.

vice versa. While each of the detectors (D1 and D2) detect changes in amplitude, they will jointly demodulate an FM signal since the signal amplitude seen by each depends upon frequency.

Discriminator. The Foster-Seeley circuit is a much more sophisticated FM detector. As Fig. 26 shows, the signal from the preceding IF stage (limiter) is fed inductively into the secondary of T and through a capacitor (C) to the center tap of the second-

DETECTORS

ary. When T is tuned to the carrier frequency and the incoming signal is at that frequency, equal and opposite voltages are fed to the two diodes. The DC voltage at X is zero. When the frequency of the signal deviates up and down, each diode alternately conducts more heavily than the other. Therefore, the voltage at X becomes alternately positive and negative, obtaining AF from an FM signal.

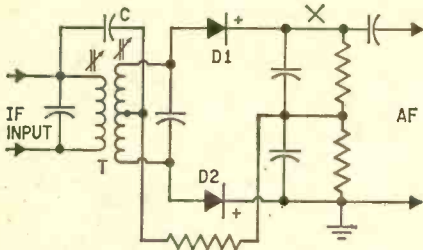

Fig. 26. Foster-Seeley discriminator was very popular in the early days of TV. Now it is seldom used—only a very few hi-fi FM tuners use this circuit at all.

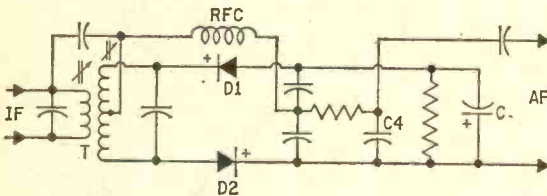

Fig. 27. Ratio detector has built-in limiting that eliminates need for the special stages that contribute little or no gain. This circuit is a favorite for cutting those production costs.

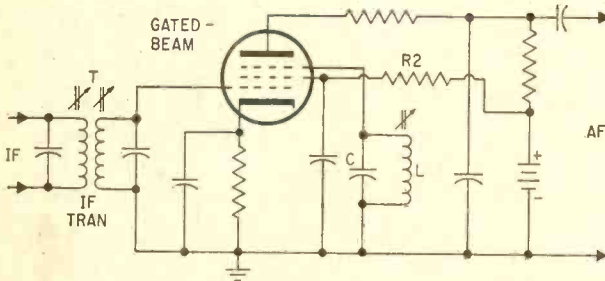

Fig. 28. Gated-beam detector uses a quadrature coil (tuned circuit L-C) to form a reference signal that converts FM signal into audio (AF) voltages. Phase difference between IF signal and quadrature signal is the secret.

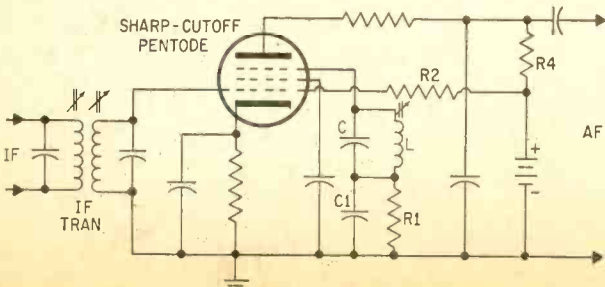

Fig. 29. Using a sharp-cutoff pentode requires added bias for the suppressor grid. This suppressor bias is developed across R1-C1 and increases the effectiveness of the control the suppressor grid has on plate-current flow.

Ratio Detector. While this circuit is used widely in FM communications receivers, the *ratio* detector (shown in Fig. 27) is commonly used in FM broadcast tuners and receivers and TV sets. It combines some of the features of a limiter and a discriminator. Capacitor C charges to a level determined by the level of the incoming signal. The effects of rapid changes in signal level are negated.

Gated-Beam Tube. One of the most effective FM detectors employs what is known as a gated-beam tube (6BN6, etc.) which is used in a circuit such as the one shown in Fig. 28. The symbol for a gated-beam tube is the same as for a common pentode, but the tube is actually quite different.

The suppressor grid (No. 3) voltage of a pentode has but little effect on plate current. But, the voltage on the quadrature grid (also No. 3) of a gated-beam tube has a great effect. If even slightly negative, plate current is cut off and the control grid (No. 1) loses control. If slightly positive, plate current is controlled solely by the signal on the control grid.

In the gated-beam detector circuit shown in Fig. 28 the quadrature circuit (L and C) is tuned to the center frequency of the IF

Fig. 30. Bradley detector was never popular in entertainment receivers. Again, a hard-to-align circuit — increases production cost and loses popularity or, in many cases, never gets a chance in mass-produced circuitry.

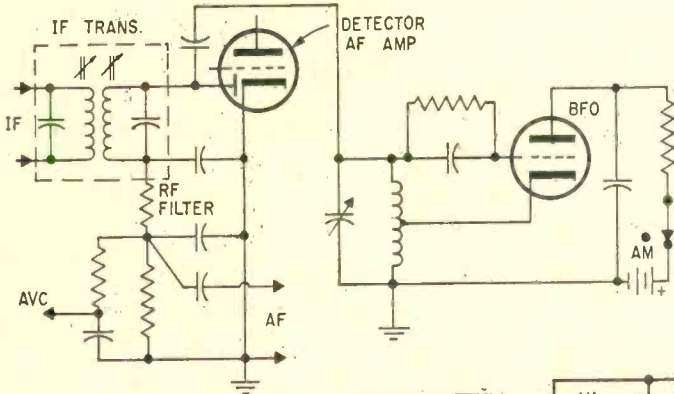
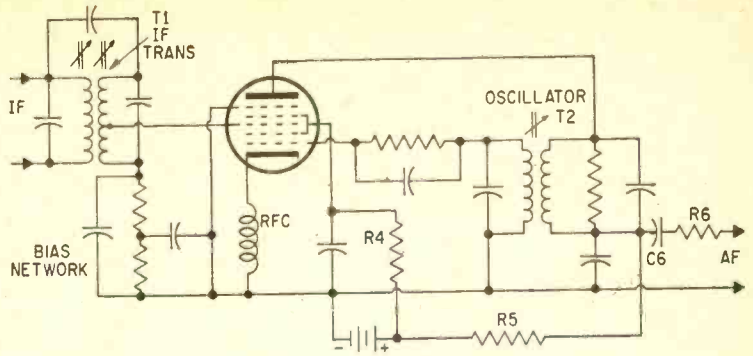
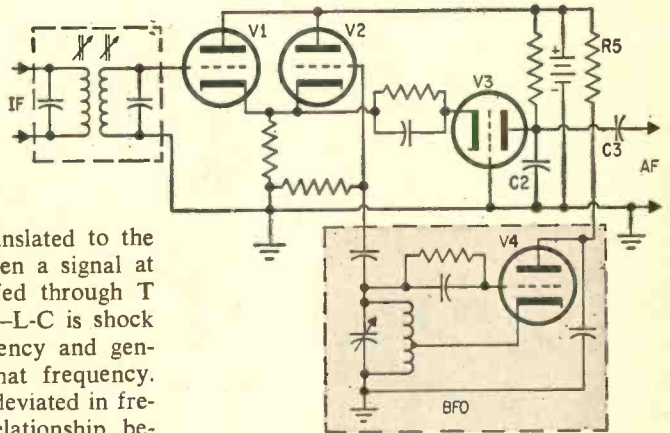

Fig. 31. Single Sideband detector requires BFO (Beat Frequency Oscillator) to reinsert carrier signal. The rest of the detector circuit is the same as that for the diode detector in Fig. 10.

Fig. 32. Product detector is also used for SSB (Single Side Band) audio recovery. Complex circuit gives better stability and isolation for the BFO circuit.



(the carrier frequency as translated to the IF within the receiver). When a signal at the IF center frequency is fed through T to the control grid (No. 1)—L-C is shock excited at its resonant frequency and generates a signal voltage at that frequency. When the incoming signal is deviated in frequency (FM) the phase relationship between grids 1 and 3 varies, causing them to be alternately positive and negative, but not in phase. The plate current, therefore, varies with the change in frequency of the incoming signal.

The circuit shown in Fig. 29 is similar, but a sharp-cutoff pentode is used instead of a gated-beam tube. It functions in a similar manner except that bias for grid 3 is developed across R1 and C1 by the signal. Both types of FM detectors are popularly used in TV sets, but the gated-beam type is preferred in FM communications receivers.

Still another type of FM detector is the Bradley detector, whose circuit is shown in

Fig. 30, which was developed at Philco. Here, an oscillator is employed, operating at the translated carrier frequency (IF). As the signal deviates in frequency, the local oscillator signal and the incoming signal are out of phase and extract a signal (audio) which is equal to the rate at which the signal frequency is being deviated.

SSB Detectors. An SSB (Single Side-Band) signal is a form of AM signal. Ordinarily, an AM signal has two sidebands, one above and one below the carrier. The same intelligence is contained in each. Only one is required for reception. And, in fact,

e/e DETECTORS

even the carrier is superfluous as far as the actual transmitting is concerned. Therefore, most SSB transmitters radiate only one sideband and no carrier. For example, an SSB transmitter operating on 27,125-kHz and modulated by voice within the 300-3000-Hz (cps) range would radiate a signal extending from 27,125.3-kHz to 27,128-kHz, but no carrier on 27,125-kHz.

In order to demodulate an SSB signal it is necessary to re-insert the carrier at the receiver. The re-inserted carrier can be at the IF. For example, if the above signal is intercepted with a receiver having a 453-kHz

ceivers. One of these is the typical product detector circuit shown in Fig. 32. Tubes V1 and V2 form an electronic mixer. The incoming SSB signal is fed to the grid of V1 and the BFO signal is fed to the grid of V2. The output of the mixer, containing both signals is fed to the cathode of V3, a grounded grid detector. Its output feeds audio to the AF amplifier.

The product detector shown in Fig. 33 employs one less tube. Tube V1 is a cathode follower whose output is fed to the cathode of V2 which functions as a detector. The BFO signal is fed to the grid of V2 where the signals are mixed. An RF filter (C1, C2, L) removes any remaining BFO and sideband signals, leaving only the recovered audio.

Transistor Detectors. So far, we have

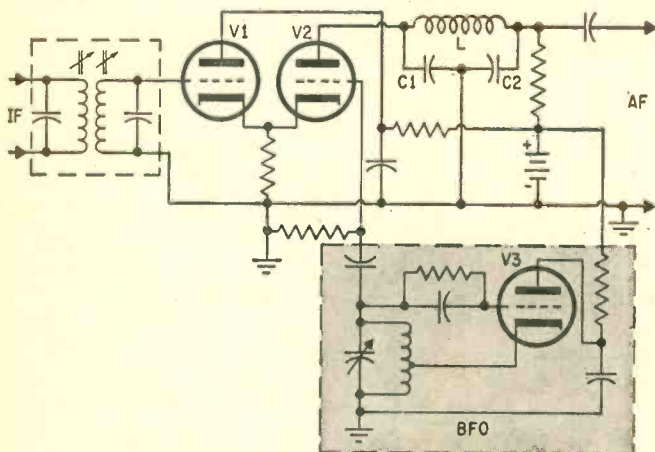

Fig. 33. Circuit is similar to that of product detector in Fig. 32 —modified circuit requires one less triode. A great saving in space as well as parts.

Fig. 34. Transistor circuit has base tapped down on the coil of the tuned circuit. Using tap reduces loading on tuned circuit—increasing selectivity.

IF (27,125-kHz translated to 455-kHz), a locally generated 455-kHz signal is required.

An ordinary AM detector of any type can be used along with a 455-kHz BFO (Beat Frequency Oscillator) as shown in Fig. 31. The 27,125.3-27,128-kHz signal will have been translated in the receiver to 455.3-458 kHz. When this sideband is heterodyned with a 455-kHz CW signal, the resulting beat frequencies will extend from 300-3000 Hz ($455.3-455 = 0.3$ kHz and $458-455 = 3$ kHz). If the frequency of the BFO varies, the pitch of the recovered voice signals will be changed. This will also happen as the transmitter or receiver local oscillator frequency varies. Therefore, the BFO is usually made variable in order to offset these frequency changes.

Product Detectors. More sophisticated SSB detectors are used in professional and amateur communications receivers and trans-

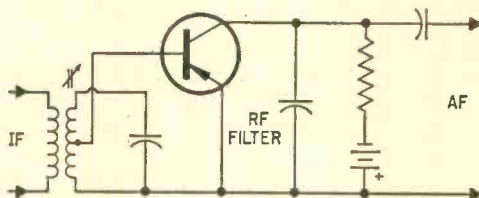

only looked at tube and semiconductor diode detectors. Transistors can be used in similar circuits except in the case of a gated beam FM detector which has no solid state counterpart.

The most common transistor detector for AM employs a circuit similar to the one shown in Fig. 34. Here, fixed forward bias is not provided. Instead, the signal provides forward bias. When no signal is present, collector current is zero except for minute leakage current. Negative signal excursions
(Continued on page 116)

Electronic Foot Stomper

By
Herb Friedman
W2ZLF/KBI9457

*Why not beat time
the Space-Age way—
use electronics to
save your achin' feet.*



Because they cost next-to-nothing (use junk-box components), and can be assembled by a five-year-old, electronic metronomes have always been a favorite *one-night project* with experimenters. They *always* work, and are great for elementary school Science Fairs, primarily because while other science fair projects just sit and stare at the parents, a metronome at least will *tic-tic-tic*.

But an *electronic tic-tic* can be more than a child's toy. Dress it up in a fancy box, select component values that get the *tics* to vary continuously through the 40 to 208 beat-per-minute range, and you've got a nice, and thoughtful, gift for a musical friend. And *your* cost (less the box, speaker and battery) comes to less than \$3.50.

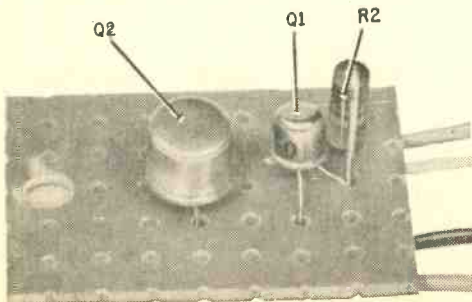

Whole circuit is contained on a scrap of perforated phenolic circuit board. Only other component on the board is C1—that's on the other side. If you like C1 can be mounted on this side of board alongside Q1 and Q2. Control R1 is mounted on side of cabinet.

Electronic Is Better. What's the advantage in an electronic metronome? Well there's tone quality and long-term convenience, to name just two. The ordinary arm-buster used by musical students requires winding, and it's five-to-one the spring will run out long before the last note of the Hungarian Rhapsody. And the usual *tack-tack* of the spring-wound arm buster is often more annoying than the clown who interrupts every fifth note to comment on the musician's abilities. On the other hand, the metronome shown in the schematic diagram produces a soft *thock-thock* sound, similar in characteristics to a muted tom-tom drum, a very pleasant beat to play along with.

The basic metronome circuit shown could cost you under \$3.50—providing you use only the components listed in the Parts List and shop carefully. Do not attempt to improve performance by using industrial grade components as a tantalum capacitor is not going to improve anything over the lowest-priced C1 specified. Same thing with transistors Q1 and Q2. With the specified transistors the output sound is a soft *thock-thock*; using better or less expensive transistors will result in the usually annoying electronic metronome *tic-tic* sound—like someone driving a nail into your ear. However, if you like *tic-tic* substitute the *least expensive* audio-grade transistors you can get (like 20 for a dollar); and while you can

e/e FOOT STOMPER

substitute for the specified R1, R2 and C1 values, keep in mind that the timing will not correspond to a standard metronome.

Circuit Board. Assemble the electronics on a section of perforated phenolic-board about 1 inch x 1 inch. If you don't have a scrap of perf-board lying about use any piece of stiff fibre board or plastic and drill your own holes with a #52 or 1/16-inch drill. (Don't be fussy about the hole size, as long as the component doesn't fall through, the hole is the right size.)

Solder terminals are not needed. As

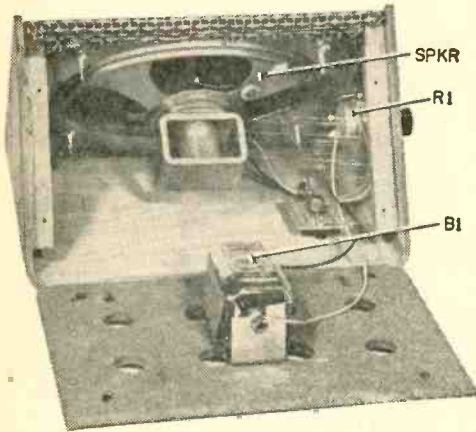

Inside view of Foot Stomper shows speaker, battery, location of R1 and perforated circuit board. The battery is mounted on the bottom cover of the speaker cabinet—use flathead screws to prevent scratches.

shown in the photographs, just pass the leads through the holes, twist once, and solder.

The completed metronome consists of the phenolic board assembly, the external R1, the battery and the speaker. The speaker can be anything you've got lying around with a 3.2-, 4- or 8-ohm voice coil. Any six-volt battery will do—the smaller the better. So little current is drawn the battery should last almost as long as its shelf-life.

Box It. For a little ritzy styling, you can use the inexpensive wood grain speaker enclosure shown. The cabinet is purchased complete with speaker, volume control and wire. Remove the existing speaker-level control and install R1 in its mounting hole. Using a single screw, with a 1/4 inch spacer or stack of washers between the board and the cabinet, install the metronome circuit

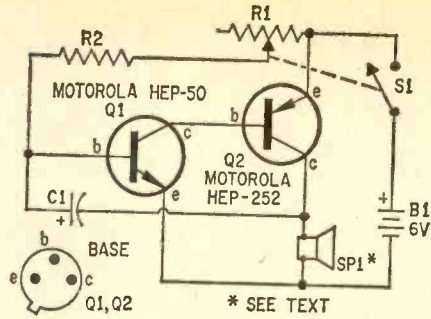

Direct-coupled transistor circuit has few components and requires only a scrap of phenolic board to mount them on. Speaker SP1 is the largest item and S1-R1 mounts on the side of the speaker enclosure. Either 6-volt battery or 4 cells in series will power unit.

PARTS LIST

- B1—6-volts (Burgess Z4 or equiv.)
 - C1—2-mf., 6-volt electrolytic capacitor (Lafayette 99C6003 or equiv.)
 - Q1—Transistor, npn (Motorola HEP-50 or equiv.)
 - Q2—Transistor, pnp (Motorola HEP-252 or equiv.)
 - R1—1,000,000-ohm potentiometer with switch S1 (Lafayette 32C7287)
 - R2—100,000-ohm, 1/2-watt resistor
 - S1—S.p.s.t. switch (part of R1)
 - SPKR—Speaker (see text)
 - Misc.—Perforated phenolic board, battery holder, mounting hardware, wire, solder, etc.
- Estimated cost: \$3.49
Construction time: 1 hour

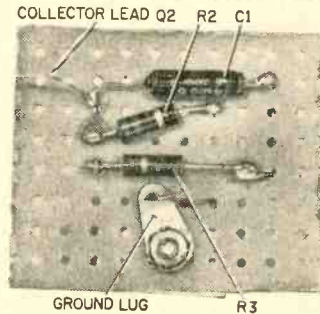

Bottom view of perforated circuit board shows lone component C1 and connections to speaker and B1.

board in the cabinet close to R1.

Mount the battery holder (if one is used) on the speaker cabinet's removable base. Finish the wiring and your "Oh, how thoughtful" gift is ready for presentation.

If desired, you can install a calibrated dial under R1's knob to indicate the actual beat. Slip a piece of stiff cardboard under R1's mounting nut and then compare the electronic beats against a standard metronome—indicate the correct timing on the cardboard. ■

TENNA-BLITZ

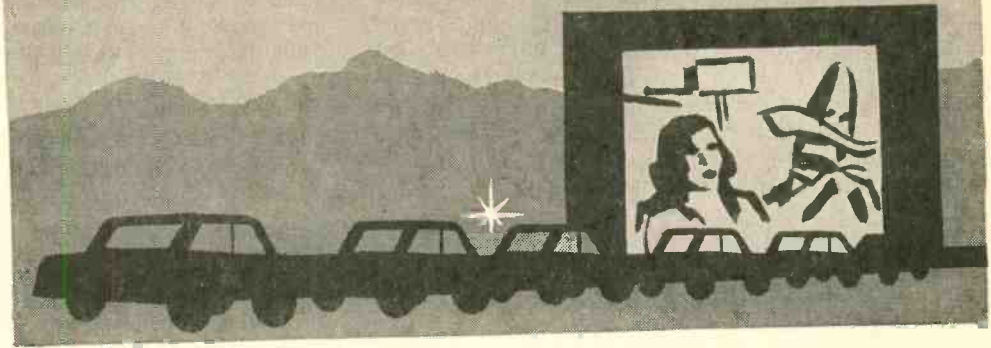

You'll be outstanding in a parking lot whether you mount the flashing light on the tip of your antenna or place the box-mounted lamp on the dashboard.

by Steve Karlson

Just as the blinker on top of an antenna tower is a beacon for ships of the sky, the *Tenna-Blitz* is your beacon as you go through the American futility dance—trying to find your car in the movie parking lot when it's 12 midnight.

Or if you're the type of churl who sends his date out for refreshments at the drive-in, you can use the *Tenna-Blitz* to guide her back before the iced drinks turn to warm sugar-water.

What is the *Tenna-Blitz*? If you've got a good imagination it's a miniature radio tower with a blinker on top. Otherwise, it's a small metal cabinet with a lamp on top that flashes every three seconds (see, isn't it more fun to have imagination?). Of course, the *Tenna-Blitz* isn't limited to finding your car. Need some attraction for the window notices of the local drama group?; then throw the circuit together on the perf-board, discard the cabinet to keep costs down, and we'll guarantee a blinking light will attract almost as much attention as last month's *Playboy* centerfold. If you think hard you'll come up with even more ridiculous uses for the *Tenna-Blitz* than we've dreamed up.

What it is. The *Tenna-Blitz* circuit shown in the schematic diagram is a simplified blocking oscillator. When power is first applied, collector-to-emitter impedance of Q1 is high, keeping Q2 almost at cutoff. As C1 charges, the end connected to the base of Q1 (through R1) goes more positive, till finally it reaches a potential high enough to "break-

over" the diode formed by the base-emitter circuit of Q1; Q1 conducts, causing Q2 to conduct, and the current flowing through Q2's emitter-collector causes lamp I1 to light. At the instant of conduction, C1 discharges

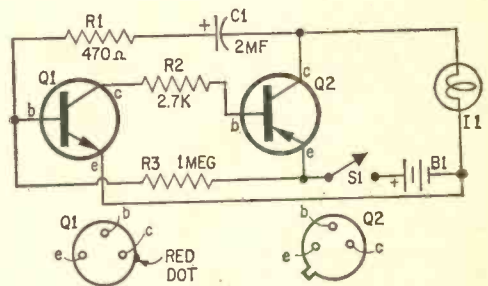

Schematic diagram for the *Tenna-Blitz* reveals what is known as a blocking oscillator. Resistor R1 (in conjunction with capacitor C1) controls length of flash.

PARTS LIST

- B1—6-volt Z4 battery (RCA VS068 or equiv.)
 - C1—2-mf, 6-volt electrolytic capacitor (see text)
 - I1—2-volt, 60-ma panel lamp (Type 48 or 49)
 - Q1—2N647 npn transistor, or equiv.
 - Q2—2N404 pnp transistor, or equiv.
 - R1—470-ohm, (maximum) 1/2-watt resistor (see text)
 - R2—2,700-ohm, 1/2-watt resistor (see text)
 - R3—1,000,000-ohm, 1/2-watt resistor (see text)
 - S1—S.p.s.t. toggle or slide switch
 - Misc.—Perforated phenolic board, chassis box, grommet, battery holder, wire, solder, machine screws and nuts, scrap aluminum, etc.
- Estimated cost: \$2.00
Construction time: 1 hour

e/e TENNA-BLITZ

through the base-to-emitter circuit of Q1, Q2's collector-to-emitter circuit, and R1. When the charge on C1 falls below Q1's base-to-emitter breakover voltage, Q1 is driven to cut off, cutting off collector current to Q2, and lamp I1 is extinguished. Then the procedure starts all over with the charge on C1 building up until Q1 conducts.

The lamp flashes approximately every

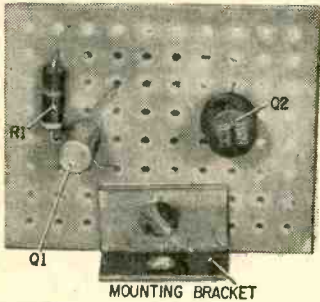

All components are mounted directly on a section of perf-board without need for tie-points or terminals. L-bracket attached to bottom holds board in place.

three seconds. The length of the flash—from a rapid blink to a full second—depends on R1's value. R3 (in combination with Q1's leakage) provides a slight forward bias to increase the blink time of lamp I1.

Average battery current is next-to-nothing and a fresh Z4 battery can last for several months. If you turn it on when you go into the movie it will still be blinking six hours later, and tomorrow, and tomorrow and tomorrow.

Completed unit fits neatly into suggested chassis box, although switch S1 should ideally be of the miniature variety to avoid any possibility of crowding. Note holder for B1.

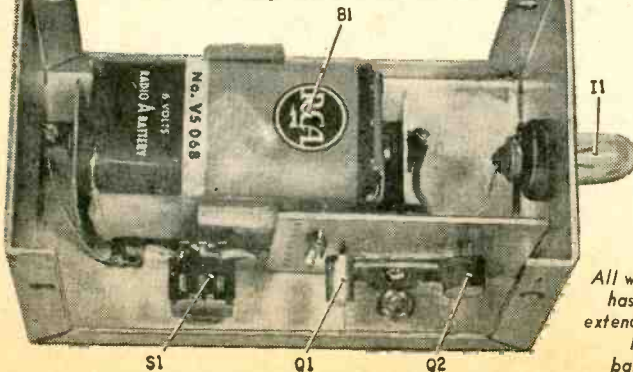

All wired up and ready to go, completed unit has but one control—switch S1, whose shaft extends from lower left of front panel. Flasher lamp I1 appears at top of chassis box; its base is pressed into 1/2-in. rubber grommet.

Construction. Both the cabinet, (a 2 1/4 x 2 1/4 x 4-inch aluminum chassis box) as well as the battery holder are optional.

While we are certain that the *Tenna-Blitz* will work with the transistors specified for Q1 and Q2, any npn and pnp transistors you've got in the junk box might work just as well.

In the unit shown the electronic circuit is assembled on a 1 1/2 x 2-inch section of perf-board
(Continued on page 114)



Only three components appear on bottom of perf-board: capacitor C1 and resistors R2 and R3. Collector lead from Q2 (see call-out) runs to one side of lamp I1; screw holding ground lug in place also supports perf-board mounting bracket (see photo at left),



POWER IN WATTS

LEO G. SANDS

Accurate power measurements demand the right tools— instruments that can cover AC line, audio, and RF frequencies

Do you know what's what with watts? Power in watts, kilowatts and megawatts makes the industrial giant move—it toasts your bread, dries your clothes, heats your house, brightens that dark corner with light and is right there when you want recreation. It's time you learned more about this ever-faithful servant.

Electric power consumption is expressed in *watts*. One watt is consumed by a one-ohm load to which one volt is applied, causing one ampere of current to flow. Power in watts is equal to

$$W = EI = E^2/R = I^2 R$$

E representing volts, *I* representing current in amperes, and *R* representing load resistance in ohms.

The power consumed by a load in a DC circuit can be determined by measuring the voltage and current with a DC voltmeter and and DC ammeter as shown in Fig. 1, and then multiplying the meter readings to watts.

$$W = EI$$

When the load resistance is known, power consumption can be determined by measuring either the voltage across the load or the current through it as shown in Figs. 2 and 3, and computing

$W = E^2/R$ or $W = I^2 R$, respectively. If the load resistance is not known, it can first be determined by measuring it with an ohmmeter or bridge.

Resistance Load. When the load in an AC circuit is resistive (lamp, heating element, tube filament, etc.), the same technique may be used—using AC meters, of course—as shown in Fig. 4.

Volt-Amperes. In an AC circuit, when the load is inductive (transformer, motor, etc.), the voltage and current are not in phase. The products of the measured voltage and current is equal to *volt-amperes*, not watts, as before. To measure *true power*, a wattmeter is required. Its indication will differ from the calculated volt-amperes (*apparent power*) by an amount determined by the *power factor* of the load. The power factor of an inductive load is less than unity.

An electro-dynamometer is similar in construction to a voltmeter or ammeter except that it employs an electromagnet (field coils) instead of a permanent magnet, as illustrated in Fig. 5. The rotating coil, to which the indicating pointer is attached, is the voltage coil and is connected across the line through a series resistor. The field coils are the cur-

e/e POWER IN WATTS

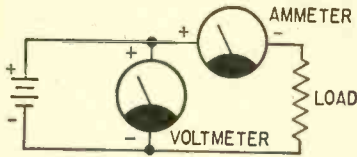
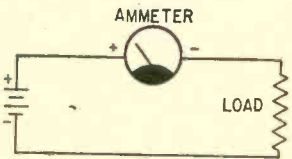

Fig. 1. Voltmeter can be across source or load since IR drop across ammeter is low; as is voltmeter current.



Figs. 2, 3. With constant-resistance load you need only measure voltage (top). When voltage is known, current measurement can be used to calculate wattage.

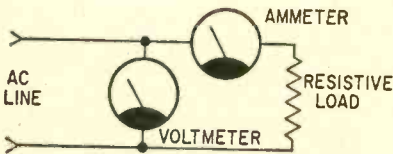

Fig. 4. This connection for AC wattage measurement is accurate only when the load is a pure resistance.



Multimeter-sized instrument that measures wattage, current and voltage is made by Simpson—Model 390.

rent coils through which load current flows. (In some types the rotor is the current coil and the field coils are the voltage coils.) The meter will indicate zero when there is no load current through the current coils. When there is load current, the meter indicates the true power consumption of the load, even if power factor is not 100%.

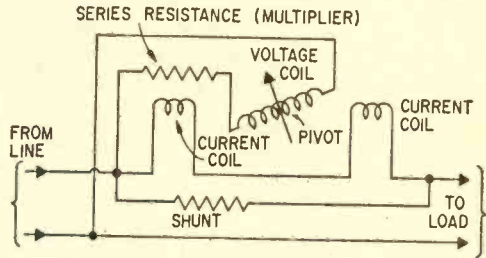

Fig. 5. Electro-dynamometer-type wattmeter connects to both sides of line and to load—computes $E \times I$.

Watt-hour Meter. The utility company keeps track of the power you consume with a watt-hour meter, which is essentially an induction motor whose speed is proportional to power consumption. It is installed where the AC line enters the house. Like a wattmeter, it has a voltage coil and two series-connected current coils plus a compensating coil, as shown in Fig. 6. The coils are wound

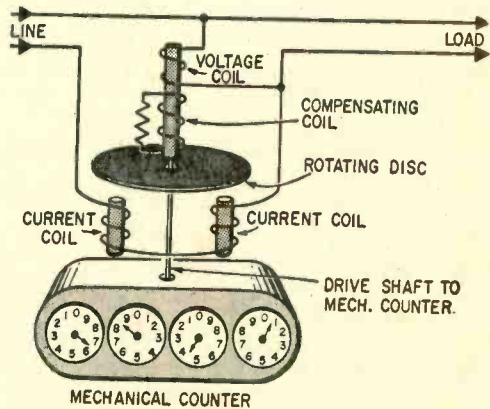

Fig. 6. Watt-hour meter is variable-speed motor and a revolution counter—computes wattage against time.

on iron cores and are stationary. The moving element is a metallic disc which rotates when power is consumed.

Current flowing through the coils induces current flow in the disc. Since the voltage coil has many turns, it is highly inductive and the magnetic flux at its ends will lag about 90 degrees behind the applied voltage. The fluxes at the ends of the current coils,

which have very few turns, are in phase with the current. Hence, torque is produced.

Sound. The threshold of human hearing is zero decibel (db) equal to one tenth of a billionth of a watt of sonic power per square centimeter. The dynamic range of the human ear is 120 db, a ratio of a trillion to one.

Sound levels can be measured with a microphone, audio amplifier and AF output meter. However, a professional instrument such as the General Radio 759-13 sound-level meter is more complex. Frequency weighting networks are provided, as shown in Fig. 7,

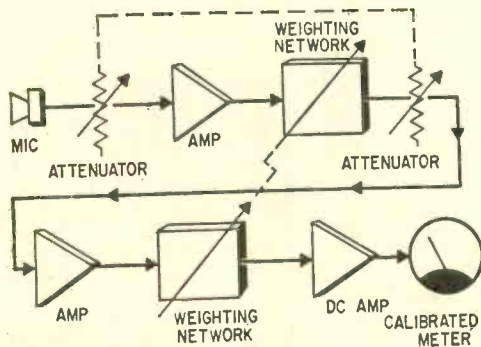

Fig. 7. Block diagram of the General Radio 759-13 sound-level meter shows the instrument is quite a complicated device—required to do precise tests.

to permit adjustment of frequency response. The range of the instrument is from 24 to 140 db above the standard reference level.

Audio. Audio power level may be expressed in watts, dbm or dbw. The standard reference levels are 0 dbm, representing one milliwatt (0.001 watt), and 0 dbw, representing one watt. Hence, 10 watts could be 40 dbm or 10 dbw since a 10 db rise in power level is ten fold in terms of watts.

An electrodynamic wattmeter could be used for measuring relatively high audio power levels but only at the frequency for which the meter was designed (usually 60 Hz—cycles per second).

Ordinarily, audio power is measured with an AC voltmeter, VTVM or calibrated scope connected across the load, as shown in Fig. 8. If the load resistance is known, power can be computed by dividing the resistance into the square of the voltage

$$W = E^2/R.$$

For example, if there is 4 volts across a 16-ohm load, the power consumed by the load would be one watt since 4×4 divided by 16 equals one.

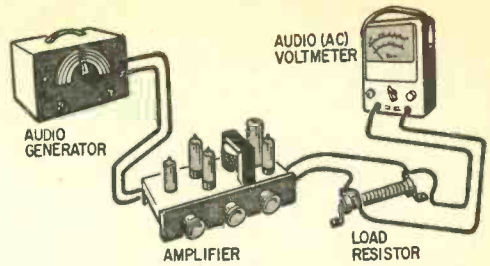

Fig. 8. Typical setup to measure audio-power output of public-address or high-fidelity power amplifiers.

When an oscilloscope is used for measuring voltage across the load, it must be calibrated in terms of RMS voltage.

Another way is to use an audio (AC) ammeter in series with the load as shown in Fig. 9. If the meter indicates one ampere

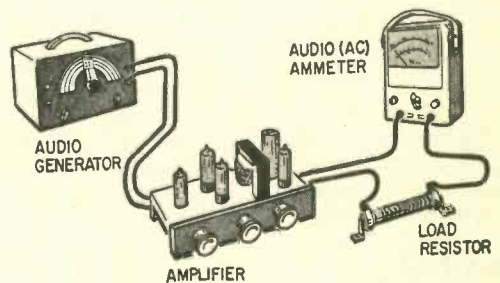

Fig. 9. This setup is seldom used—that in Fig. 8 is preferred since audio-frequency voltmeters are a lot more popular than audio-frequency milliammeters.

flowing through a 16-ohm load, the power consumed by the load is equal to 16 watts since

$$W = I^2R = 1 \times 1 \times 16 = 16.$$

The disadvantage of this technique is that it is accurate only at the frequency for which the meter was designed (usually 60 Hz).

To measure the true output capability of an audio amplifier, use a sine wave input signal (from an audio oscillator, etc., as shown in Fig. 8). Turn up the amplifier gain control and advance the signal generator output for maximum voltage across the load. Then compute power consumed by the load dividing the load resistance into the square of the indicated voltage

$$W = E^2/R.$$

However, the output may be distorted. So, look at the signal across the load with a scope. It should be a sine wave (Fig. 10). If not, lower the input signal level until the output signal is a sine wave and then recompute the *undistorted* (relatively) output power—RMS power.

e/e POWER IN WATTS

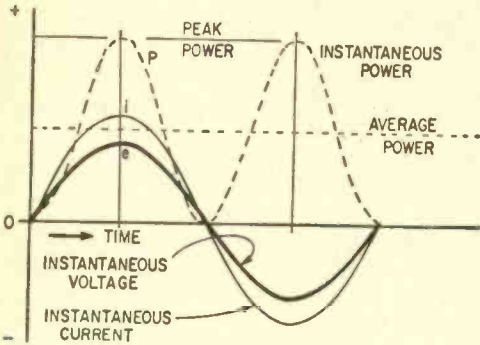

Fig. 10. Sine wave has voltage, current and power indicated—wattage can never be a negative value.

RMS or Music Power. Now RMS power is quite different from *music power*. A sine wave test signal works the amplifier hard whereas music is a complex signal with lots of hills and momentary peaks in it. Therefore, in terms of music power, the output rating of an amplifier may be much greater than its RMS power capability.

When measuring the output of a transistor amplifier, DC may be present at the output terminals. To avoid the possible effects of the DC, connect a large paper dielectric capacitor (2 mf) in series with the AC voltmeter, or if you are using a VOM, connect the test leads to the *common* and *output* jacks. With a VOM low-frequency power response of the amplifier will not be read accurately.

Professional audio power-output meters, such as the General Radio, 583-A, contain an impedance matching network, a calibrated attenuator and output meter as shown in Fig. 11. The variable ratio transformer permits selection of 40 different impedances from 2.5 to 20,000 ohms. The instrument measures power from 100 microwatts to 5 watts (in four ranges) at frequencies from 20 Hz to 10 kHz. The meter is calibrated

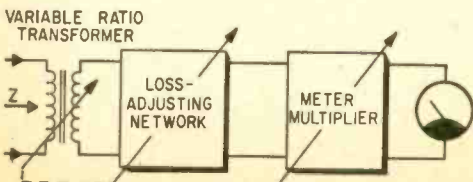

Fig. 11. Variable ratio transformer is input of block diagram of General Radio 583-A power meter.



Plug-in Add-A-Tester (Model 654) converts popular Simpson 260 VOM to audio wattmeter almost instantly.

from 0-50 milliwatts and from 0-17 db above one milliwatt. With the meter multiplier, the total range is from -17 db to +37 db—with reference to one milliwatt.

A later model, the General Radio 1840-A, measures from 100 microwatts to 20 watts and its frequency response extends from 20 Hz to 20 kHz. The impedance can be set to 48 different values from 0.6 ohm to 30,000 ohms.

RF Transmission. Scientists have long tried to transmit electric power through space without wires. It is being done, but



Relative measurements of RF power can be made with Olson's low-cost CB-67 SWR and Field Strength Meter.

with extreme inefficiency. It's called *radio*. When you tune in a station radiating 50 kilowatts of energy, some of it is consumed by your receiver—perhaps a fraction of a billionth of a watt. But, it is power.

When beam transmission is used, much more of the radiated power is captured by the receiver. For example, when using a 10-db gain Yagi antenna with a CB set delivering 3 watts into the antenna, the ERP (Effective Radiated Power) is 30 watts. At

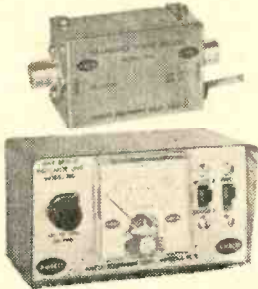

Two-unit instrument consists of Standing Wave Bridge (Model SWB), Bridge Indicator Unit (Model BIU). These Ameco units indicate up to 1,000 watts at frequencies between 1.8-225 MHz without added loss.

a distant receiver, the signal will be 10 db stronger. If a similar gain antenna is used at the distant receiver, the signal level will be boosted another 10 db, making the signal as effective as one from a 300-watt transmitter.

Thus, a total of 20 db of power gain (100 times) is obtained without increasing the electric power consumption of either CB set. A gain antenna provides increased power free, except for the initial cost of the antenna.

There actually isn't more power. The available power is simply concentrated into a beam instead of being dispersed in all directions.

Input Power. A transmitter consumes power from a battery or a power line and converts it into RF energy. A typical CB set consumes about 50 watts of primary power and delivers about 3 watts of RF, making it about 6% efficient. Primary (AC) input power can be measured in volt-amperes with an AC voltmeter and ammeter as shown in Fig. 4 or by reading the meters built into an AC power supply, such as the one shown in Fig. 12. Or, watts can be measured with a wattmeter.

But *input* power, as far as the FCC is concerned, is the power consumed by the final RF stage of the transmitter (not including

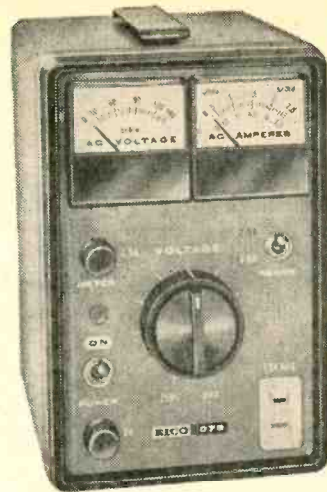

Fig. 12. AC power input can be controlled easily with this EICO Model 1078-K Variable Bench Supply. Fuses protect instrument—meters indicate output.

filament power). In the case of a CB set, input power is limited to 5 watts. If the transmitter delivers 3 watts of RF, its RF power amplifier efficiency is said to be 60%.

Input power to a pentode tube can be determined by measuring plate voltage and plate current, plate and screen current or cathode current. The voltage is measured with a DC voltmeter, connected as shown in Fig. 13, with the transmitter operating but not being modulated. Combined plate-screen current can be measured with a milliammeter, as shown by breaking the circuit at X1. To measure plate current only, break the circuit at X2 and insert the milliammeter there. Cathode current can be measured by breaking the cathode circuit at X3 and inserting a milliammeter series with it, as shown also in the diagram.

If the final RF stage uses a transistor, input power is determined by measuring the collector-emitter voltage and collector cur-



Measure relative transmitter power of Ham, marine, commercial or CB rigs with this small Heathkit PM-2.

e/e POWER IN WATTS

rent, as shown in Fig. 14, and then multiplying the indicated voltage and current.

Input power, whether to a tube or transistor, is equal to the voltage times the current in amperes. For example, if the plate voltage is 200 and the plate current is 25 milliamperes, input power is 5 watts since $200 \times 0.025 = 5$.

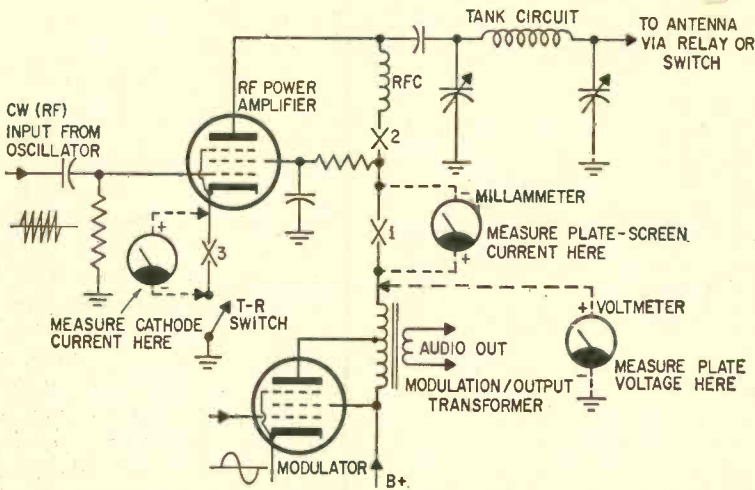

Fig. 13. Transmitter input-power measurement method varies with the circuit used in the individual transmitter. Usually meter is at some distance from plate or cathode circuit—shunt is in actual current path.

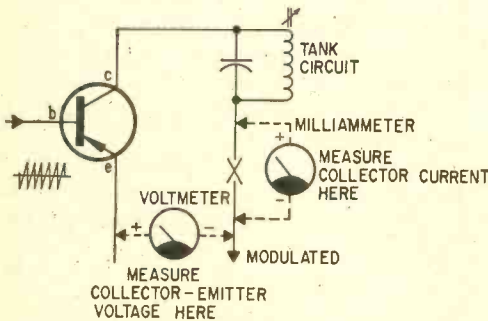

Fig. 14. Transmitter using transistor in output has power measured similar to method in Fig. 13.

RF Output Power. The relative RF output power of a transmitter can be determined by using a filament-type (incandescent) lamp as a dummy load or phantom antenna, connected directly across the transmitter output. In the case of a CB set, a No. 47 pilot lamp is often used. The lamp has a

resistance of approximately 50 ohms and will light brightly when consuming about two watts. The more brightly it glows, the higher the RF output. A factory-made power indicator dummy load employing three lamps in parallel is illustrated in Fig. 15.

A lamp can also be used to determine absolute RF power output by measuring its brilliance with a photoresistive cell and a meter, as shown in Fig. 16. The lamp and photocell should be placed inside a light-tight enclosure to keep out external light.

This simple instrument is calibrated with the circuit in Fig. 17. Simply plot a graph (or make a table) for translating the meter



Fig. 15. Dummy load for low-power transmitter uses three pilot lamps. Current flow changes resistance.

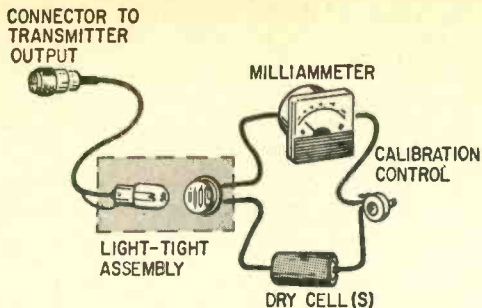

Fig. 16. Increased RF power brightens lamp, changing resistance of photocell which varies meter current.

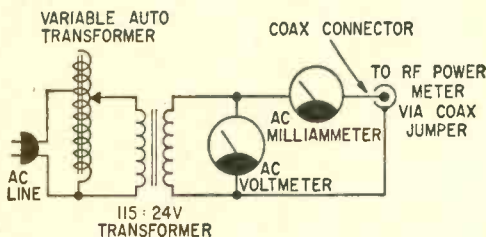

Fig. 17. Simple circuit measures power used to calibrate RF-power meter shown in Fig. 16 above.

indications into watts—multiplying volts by amperes to arrive at watts.

The simplest way to measure the RF power output of a relatively low-power transmitter at frequencies up to 30 MHz (mc), is to use an RF ammeter (thermocouple type) in series with a dummy load, as shown in Fig. 18. Since the load resistance is known, power is determined by noting the ammeter reading and computing I^2R . For example, if the meter indicates 0.5 amperes, and the load resistance is 50 ohms, the power is about 12.5 watts since $0.5 \times 0.5 \times 50 = 12.5$.

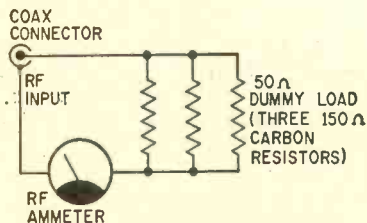

Fig. 18. Dummy load with series RF ammeter measures current through constant load or resistance (Fig. 3).

How Much Heat. RF power can also be measured by converting RF energy into heat by feeding it into a resistive dummy load and noting the resulting rise in temperature. A resistive dummy load, connected to the transmitter output, is sometimes immersed

in water and the increase in water temperature is measured. Or, the sensing element of a thermometer (Fig. 19) can be strapped to a dummy load and the increase in temperature noted.

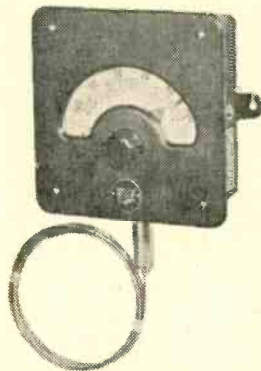

Fig. 19. Industrial thermometer measures heat rise in dummy load—a practical way since heat is power.

The RF energy from a transmitter can be fed into a thermistor connected in a bridge circuit, as shown in Fig. 20. The RF causes an increase in the temperature of the thermistor whose resistance drops, unbalancing the bridge. Power is then determined by rebalancing the bridge or translating the amount of indicated unbalance into watts.

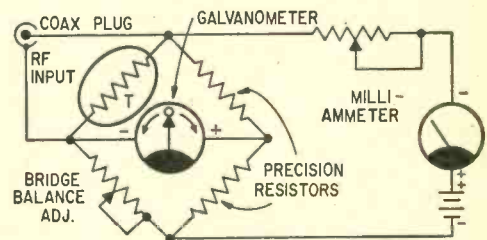

Fig. 20. Simplified circuit of bridge-type power meter. Milliammeter, potentiometer not always used.

A thermocouple can be used to sense the rise in temperature of a dummy antenna load (R), as shown in Fig. 21. The higher the load temperature, the greater the output voltage of the thermocouple. The millivoltmeter can be calibrated directly in watts.

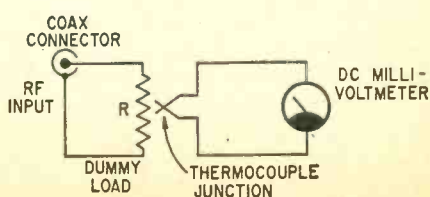

Fig. 21. Heat in dummy load generates voltage in a thermocouple junction—indicating wattage on meter.

e/e POWER IN WATTS

Another way to use a thermocouple is shown in Fig. 22. Here the thermocouple is in series with the dummy load (R). Current flowing through the thermocouple causes self heating and generates a DC voltage which is developed across R and measured

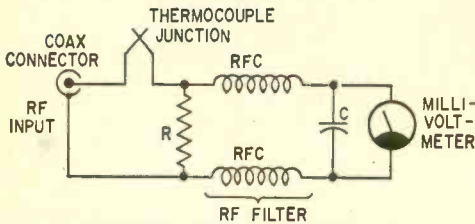

Fig. 22. Two RFCs and C form RF filter that is used in many instruments to isolate RF; pass DC to meter.

by the millivoltmeter. The two RF chokes and C keep the RF out of the meter. The transmitter must have a DC path across the antenna connector to allow the DC to flow around the circuit.

Still another way to measure RF output power is to use the filament of a tube as the dummy load, as shown in Fig. 23. The combined resistance of the tube filament and the resistors should be approximately the same as the transmitter output impedance. As the RF heats the tube filament, plate current flows in proportion to RF watts. The tube

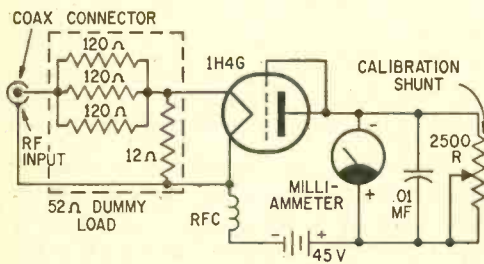

Fig. 23. Heating of filament varies current passed through diode-connected-triode to indicate RF power.

can be a filament-type diode or a triode connected, as shown, as a diode. The meter is a DC milliammeter whose range depends on the type of tube used, and which can be adjusted with shunt potentiometer R.

CBers, hams and mobile radio service technicians use less complicated means to measure RF power. The most popular device for this purpose is the SWR (Standing

Wave Ratio) meter. Ordinarily, it is used in series with a radiating antenna, as shown in Fig. 24, to measure forward and reflected power for determining the efficiency of an antenna system. When set to measure forward power, it indicates transmitter power output. When set to measure reflected power, it indicates how much of the power is being reflected back from the antenna and is being wasted.

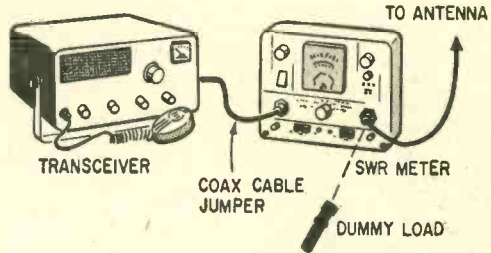

Fig. 24. Connected between transmitter and antenna, tester indicates power output and reflected power.

The same instrument can be used on the bench for extended periods of troubleshooting and testing—measuring transmitter output power—by plugging a 50-ohm dummy load into its antenna terminal. Dummy loads of this type are available from Lafayette (catalog No. 42C 0902, \$0.98) and other parts stores as well as from Sierra Electronics (Ford-Philco), Menlo Park, California. By setting the SWR meter to measure forward power, it will indicate transmitter output in watts.

More accurate RF wattmeters are available from Bird and Sierra (Fig. 25) which contain an internal 50-ohm dummy load.

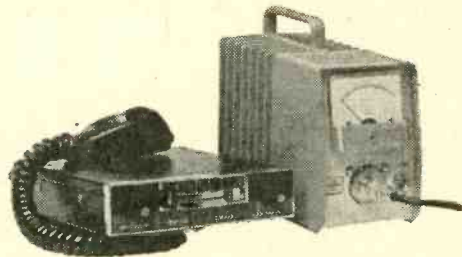

Fig. 25. Accurate RF wattmeter is suitable for much higher power transmitters—fins at rear radiate heat.

Devices of this type employ circuits similar to those shown in Fig. 26 and 27. They simply rectify the RF voltage and measure the resulting DC.

An electronic wattmeter can be used for measuring RF power. In Fig. 28, two triode tubes are used in a bridge circuit employing a galvanometer (zero-center meter such as

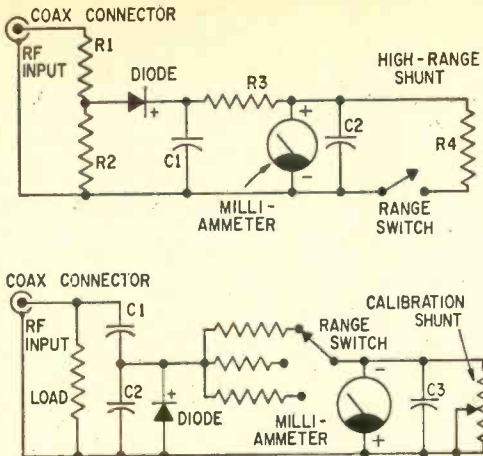

Fig. 26, 27. At top, R4 is shunted across milliammeter for high-power range. RF voltage divider (R1, R2), range switch multipliers measure voltage.

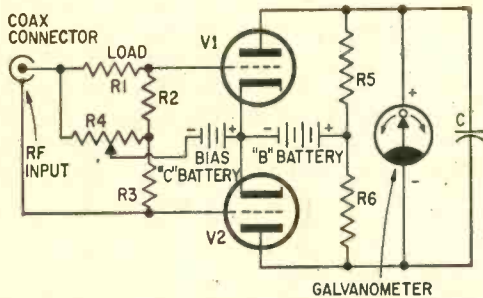

Fig. 28. Vacuum-tube circuit is similar to that in a VTVM. Only RF input circuitry is quite different.

a 50-0-50 DC microammeter.) With no RF power input applied, the bridge is balanced with R4. With RF power applied, the bridge is rebalanced and the power is read from the calibrated scale used with R4.

P.E.P. Measurement. So far, we have been discussing RF-carrier power as produced by a CW, AM or FM transmitter. The power output of an SSB (Single-Sideband) transmitter is expressed in terms of PEP (Peak Envelope Power.) This is usually

measured with an oscilloscope when modulating the transmitter with two audio tones simultaneously (frequently 1000 Hz and 1800 Hz), as shown in Fig. 29. The power output is determined by the height of the scope pattern. The scope must be a wide-band type capable of working at the RF-signal frequency. A conventional scope can be used, as shown in Fig. 30, by connecting directly to the vertical deflection plates of the CRT. The deflection voltage is obtained by tuning L and C to the transmitter frequency.

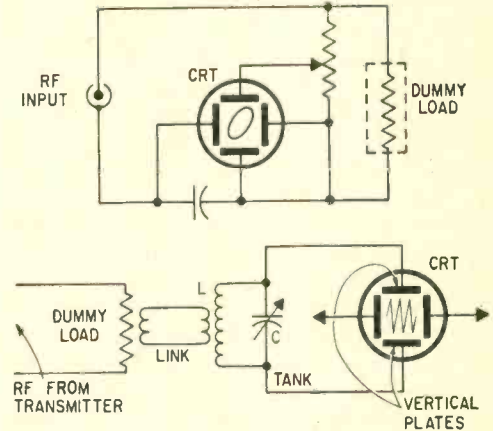

Fig. 30. Phase-shifting circuit, top, doesn't need time-base sweep as in lower method using oscilloscope.

Talk Power. While carrier power is important (except in an SSB transmitter where it is absent) it contains no intelligence unless keyed or modulated.

Maximum useful transmitter range is achieved under 100% modulation. The RF power output of an AM transmitter rises 50% above its unmodulated carrier level when modulated 100% by a sine wave audio signal. When modulated by voice or music, the average power output does not increase as much, but power output peaks can hit as high as 400% of the unmodulated carrier level.

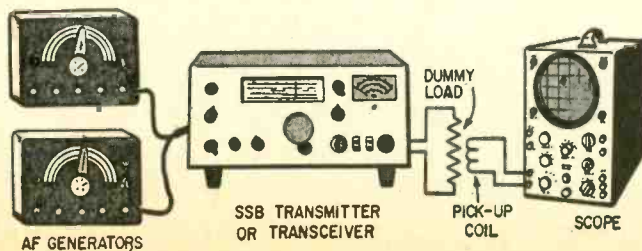

Fig. 29. Two AF generators feed signals into modulator of rig. Dummy load is a necessity for all extended periods of transmitter testing—particularly with high-powered rigs that can easily span the nation.

e/e POWER IN WATTS

To achieve 100% modulation when using plate modulation, the power output of the modulator must be approximately the same as the transmitter's RF output. In the case of a 3-watt RF output CB set, the modulator usually delivers around 3 watts of audio.

The increase in power output of an AM transmitter due to modulation can be measured with an RF output meter. When 100% modulated by a sine wave test tone, the power output reading should rise 50%. If an RF ammeter is used, as shown in Fig. 18, the current should rise 22.5%. For voice modulation, the indicated power-output increase will be less.

The RF-power output of an FM transmitter, on the other hand, does not increase under modulation. Instead, the carrier frequency varies with modulation. The more the frequency is deviated, the greater the effective talk power. The RF power output of an FM transmitter is measured with an RF wattmeter which indicates carrier power. Modulation level is measured with a deviation meter which indicates frequency deviation, not power.

RF-Power-Meter Connections. In all of RF power measuring devices, coaxial connectors are shown. Ordinarily, transmitters are designed to work into a 50-ohm antenna system and coaxial connector—most accept a PL-259 plug. Many measuring instruments are also equipped with SO-239 receptacles (some use an N or UHF type connector). Connections to the transmitter output are made easier with a coaxial jumper,

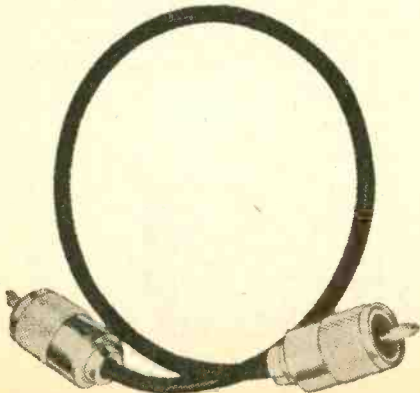

Fig. 31. Length of co-axial cable with connectors makes it easier to connect to transmitter, antenna.



Threaded connectors, along left edge of panel, mate with those on ends of co-ax in Fig. 31. The Olson CB-24 uses solid state circuitry to make seven important tests on all types of Citizen's Band transceivers.

such as the one shown in Fig. 31. In this case the jumper is a length of RG-58/U (50-ohm) coaxial cable with a PL-259 plug at each end. Some transmitters, (such as medium frequency marine and some ham types) have binding posts and their output impedance may be other than 50 ohms.

Types of Power. Ordinarily, when dealing with AC, AF and RF, we are concerned with RMS (Root Mean Square) power. Like an AC voltage, power has a *peak* value which, in the case of a sine wave, is 1.414 times the RMS value or 1.57 times the *average* value. It is the RMS value which is the effective value, and which is normally given in AC voltage specifications as *120-volts AC*.

Power consumption may also be related to time. If a load consumes one watt intermittently for 10% of the time, the average power is only one tenth of a watt. The peak power of a radar pulse for example could be 30 kilowatts. If each pulse is one microsecond in duration and is repeated 500 times per second, the average power would be only 15 watts since power is present only $\frac{1}{20000}$ th of the time.

A small capacitor can be charged slowly, consuming a very small amount of power over a period of time. When short circuited it can release a tremendous amount of power, but only momentarily—for an extremely short period of time.

Music contains peaks of considerable power, often much higher than the rated output of an amplifier. Yet, they can be handled by a well designed amplifier since

they occur only during a short period of the total time. At normal room level, the average power may be less than 100 milliwatts but occasional sound peaks might feed several watts into the speaker system.

RMS power is measured using the techniques described previously. Peak power can be determined by measuring the peak voltage drop across the load with an oscilloscope—noting the height (deflection) of the trace and computing the power level. With a scope you can observe short-duration peaks which are missed by a meter.

The power consumption of some loads may vary considerably when power is first applied. A filament-type (incandescent) lamp may consume many times its rated wattage when first turned on since the resistance of its filament is very low when cold—increasing considerably with increasing temperature. A motor needs several times its rated power until it reaches normal running speed.

You pay for electric power on the basis of watts consumed over a period of time. If you consume 6000 watts for 15 minutes and 1000 watts for 45 minutes, you will have to pay for 2.25 kilowatt-hours since the average power consumption during the hour was 2,250 watts.

A battery is rated in terms of ampere-hours. For example, if a battery is rated 100-ampere hours and 10 amperes are drawn for 10 hours, the battery will pre-



Sensitive Field Strength Meter (Jerrold Model 704B) reads down to 5 microvolts for TV and FM intensity surveys. Lafayette CB Transceiver Tester (below) measures RF power, field strength, modulation, etc.

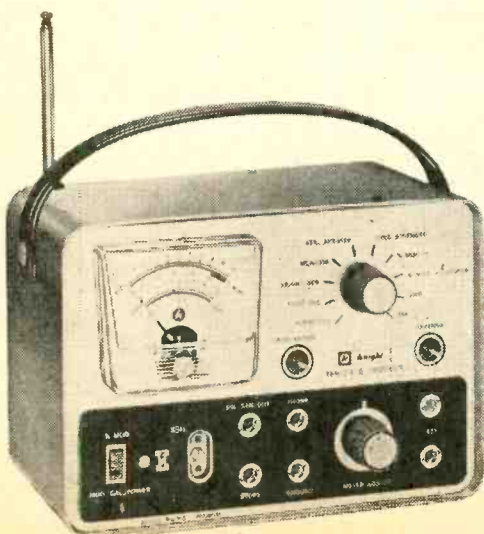

Portable Knight (Model Ten-2) CB tester performs ten test functions on transmitter and receiver circuits.

sumably be exhausted. If it is a 12-volt battery, it will have delivered 1.2 kilowatt-hours of power (120 watts for 10 hours).

The efficiency of electronic equipment is rising, thanks to transistors. The power consumption of a 20-watt all-transistor amplifier can be as low as 30 watts whereas a tube type might consume 100 watts or more. Where does this wasted energy go? Most of it is converted into unwanted heat—and that's what's watt. ■



LITERATURE

★ Starred items indicate advertisers in this issue. Consult their ads for additional information and specifications.

LIBRARY



CB—BUSINESS RADIO SHORTWAVE RADIO

115. Get the fully story on *Polytronics Laboratories* latest CB entry—Carry-Comm. Full 5-watts, great for mobile, base or portable use. Works on 12 VDC or 115 AC.

★93. *Heath Co.* has a new 23-channel all-transistor 5-watt CB rig at the lowest cost on the market, plus a full line of CB gear. See their new 10-band AM/FM/Shortwave portable and line of shortwave radios.

101. If it's a CB product, chances are *International Crystal* has it listed in their colorful catalog. Whether kit or wired, accessory or test gear, this CB oriented company can be relied on to fill the bill.

48. *Hy-Gain's* new CB antenna catalog is packed full of useful information and product data that every CB'er should know. Get a copy.

107. Get with the mobile set with *Tram's* XL'100. The new Titan CB base station, another *Tram* great, is worth knowing about.

111. Get the scoop on *Versa-Tronics' Versa-Tenna* with instant magnetic mounting. Antenna models available for CB'ers, hams and mobile units from 27 MHz to 1000 MHz.

45. Catering to 2-way radio buffs for 30 years, *World Radio Laboratories* has a new free catalog which includes the latest CB transceivers, etc. Quarterly fliers check-full of bargains are also available.

50. Make your connection with *Amphenol*—tune in to the latest on CB product news with specs and pics on new gear. Keep informed on Amphenol's new products.

100. You can get increased CB range and clarity using the "Cobra" transceiver with speech compressor—receiver sensitivity is excellent. Catalog sheet will be mailed by *B&K Division of Dynascan Corporation*.

54. A catalog for CB'ers, hams and experimenters, with outstanding values. Terrific buys on *Grove Electronics' antennas, mikes and accessories*.

96. If a rugged low cost business/industrial two-way radio is what you've been looking for, be sure to send for the brochure on *E. F. Johnson Co.'s* brand new Messenger "202."

102. *Sentry Mfg. Co.* has some interesting poop sheets on speech clippers, converters, talk power kits and the like for interested CB'ers, hams and SWL'ers, too.

103. *Squires-Sanders* would like you to know about their CB transceivers, the "23'er" and the new "55S." Also, CB accessories that add versatility to their 5-watters.

KITS

★42. Here's a colorful 108-page catalog containing a wide assortment of electronic kits. You'll find something for any interest, any budget. And *Heath Co.* will happily send you a copy.

★44. *EICO's* new 48-page 2-color pocket-size short form catalog is just off the press. Over 250 products: Ham radio, CB, hi-fi—in kit and wired form—are illustrated. Also, discover *EICO's* new experimenter kit line.

ELECTRONIC PRODUCTS

66. Try instant lettering to mark control panels and component parts. *Datak's* booklets and sample show this easy dry transfer method.

108. Get the facts on *Mercury's* line of test equipment kits—designed to make troubleshooting easier, faster and more profitable.

67. "Get the most measurement value per dollar," says *Electronics Measurements Corp.* Send for their catalog and find out how!

92. How about installing a transistorized electronic ignition system in your current car? *AEC Laboratories* will mail their brochure giving you specifications, schematics.

109. *Seco* offers a line of specialized and standard test equipment that's ideal for the home experimenter and pro. Get specs and prices today.

HI-FI/AUDIO

26. Always a leader, *H. H. Scott* introduces a new concept in stereo console, catalogs. "At Home With Stereo," offers decorating ideas, a complete explanation of the more technical aspects of stereo consoles.

85. Need a tuner? Preamp? Amp? Tape deck? Then inspect *Dyna* for kits or wired units. It's worthwhile looking at test reports *Dyna* sends your way.

110. Get the latest facts on sound columns. *American Geloso Electronics Inc.* offers a ten-page booklet giving the hows and whys plus method of installation and arrangement of sound columns.

15. A name well-known in audio circles is *Acoustic Research*. Here's its booklet on the famous AR speakers and the new AR turntable.

16. Discover how Cueing Control, anti-scating and other *Garrard* features in the Lab 80 offer tops in audio listening. 32-page *Garrard* Comparator Guide will make you a wiser buyer—get it.

17. Build your own bass reflex enclosures from fool-proof plans offered by *Electro-Voice*. At the same time get the specs on *EV's* solid-state hi-fi line—a new pace setter for the audio industry.

19. *Empire Scientific's* new 8-page, full color catalog is now available to our readers. Don't miss the sparkling decorating-with-sound ideas.

24. Need a hi-fi or PA mike? *University Sound* has an interesting microphone booklet audio fans should read before making a purchase.

27. An assortment of high fidelity components and cabinets are described in the *Sherwood* brochure. The cabinets can almost be designed to your requirements, as they use modules.

95. Confused about stereo? Want to beat the high cost of hi-fi without compromising on the results? Then you need the new 24-page catalog by *Jensen Manufacturing*.

99. Get the inside info on why *Acoustech's* solid-state amplifiers are the rage of the experts. Colorful brochure answers all your questions.

34. You can't pick the tape recorder you need without a program—and *Sony Superscope* has one. Full color 16-page booklet is as good as your dealer's showcase. Includes accessories.

TAPE RECORDERS AND TAPE

113. *Scotch* is the product and it's made by *Minnesota Mining and Mfg. Co. (3M)*. Get a packet full of facts and tape data from *3M* and learn all about your tape recorder and the tape it needs.

31. All the facts about *Concord Electronics Corp.* tape recorders are yours for the asking in a free booklet. Portable, battery operated to four-track, fully transistorized stereos cover every recording need.

32. "Everybody's Tape Recording Handbook" is the title of a booklet that *Sarkes-Tarjan* will send you. It's 24-pages jam-packed with info for the home recording enthusiast. Includes a valuable table of recording times for various tapes.

33. Become the first to learn about *Norelco's* complete Carry-Corder 150 portable tape recorder outfit. Four-color booklet describes this new cartridge-tape unit.

35. If you are a serious tape audiophile, you will be interested in the new *Viking* of *Minneapolis* line—they carry both reel and cartridge recorders you should know about.

91. Sound begins and ends with a *Uher* tape recorder. Write for this new 20 page catalog showing the entire line of *Uher* recorders and accessories. How to synchronize your slide projector, execute sound on sound, and many other exclusive features.

HI-FI ACCESSORIES

112. *Telex* would like you to know about their improved *Serenata Headset*—and their entire line of quality stereo headsets.

39. A 12-page catalog describing the audio accessories that make hi-fi living a bit easier is yours from *Switchcraft, Inc.* The cables, mike mixers, and junctions are essentials!

98. Swinging to hi-fi stereo headsets? Then get your copy of *Superex Electronics'* 16-page catalog featuring a large selection of quality headsets.

104. You can't hear FM stereo unless your FM antenna can pull 'em in. Learn more and discover what's available from *Finco's* 6-pager "Third Dimensional Sound."

AMATEUR RADIO

46. A long-time builder of ham equipment, *Hallcrafters* will send you lots of info on the ham, CB and commercial radio-equipment.

SCHOOLS AND EDUCATIONAL

114. Prepare for tomorrow by studying at home with *Technical Training International.* Get the facts today on how you can step up in your present job.

59. For a complete rundown on curriculum, lesson outlines, and full details from a leading electronic school, ask for this brochure from the *Indiana Home Study Institute.*

★61. *ICS (International Correspondence Schools)* offers 236 courses including many in the fields of radio, TV, and electronics. Send for free booklet "It's Your Future."

★74. How to get an F.C.C. license, plus a description of the complete electronic courses offered by *Cleveland Institute of Electronics* are in their free catalog.

105. Get the low-down on the latest in educational electronic kits from *Trans-Tek.* Build light dimmers, amplifiers, metronomes, and many more. *Trans-Tek* helps you to learn while building.

TOOLS

★78. Learn about *Xcelite's* line of pliers and snips, specialized for radio, TV and electronic work. *Xcelite's* hand tools offer many advantages worth looking into. Bulletin N464 and N664.

TELEVISION

★70. *The Heath Co.* now has a 19" color TV to complement their 21" and 25" models. A new B&W portable model will be a hot seller for the mobile set. Get the facts today!

72. Get your 1967 catalog of *Cistin's* TV, radio, and hi-fi service books. Bonus—TV tube substitution guide and trouble-chaser chart is yours for the asking.

29. Install your own TV or FM antenna! *Jefferson-King's* exclusive free booklet reveals secrets of installation, orientation; how to get TV-FM transmission data.

97. Interesting, helpful brochures describing the TV antenna discovery of the decade—the log periodic antenna for UHF and UHF-TV, and FM stereo. From *JFD Electronics Corporation.*

ELECTRONIC PARTS

★1. *Allied's* catalog is so widely used as a reference book, that it's regarded as a standard by people in the electronics industry. Don't you have the latest *Allied Radio* catalog? The surprising thing is that it's free!

★2. The new 1967 Edition of *Lafayette's* catalog features sections on stereo hi-fi, CB, ham gear, test equipment, cameras, optics, tools and much more. Get your copy today.

★3. Bargains galore! Parts, tools, test equipment, radios and many more specials at ultra-low prices. *Progressive Edu-Kits* will send latest catalog.

★4. *Olson's* catalog is a multi-colored newspaper that's packed with more bargains than a phone book has names. Don't believe us? Get a copy.

★23. No electronics bargain hunter should be caught without the 1967 copy of *Radio Shack's* catalog. Some equipment and kit offers are so low, they look like misprints. Buying is believing.

★5. *Edmund Scientific's* new catalog contains over 4000 products that embrace many interests and fields. It's an 148-page buyers' guide for Science Fair fans.

★106. With 70 million TV's and 240 million radios somebody somewhere will need a vacuum tube replacement at the rate of one a second! Get *Universal Tube Co.'s* Troubleshooting Chart and facts on their \$1 flat rate per tube.

7. Whether you buy surplus or new, you will be interested in *Fair Radio Sales Co.'s* latest catalog—chuck full of surplus buys for every experimenter.

8. Want a colorful catalog of goodies? *John Meshna, Jr.* has one that covers everything from assemblies to zener diodes. Listed are government surplus radio, radar, parts, etc. All at unbelievable prices.

6. Bargains galore, that's what's in store! *Poly-Paks Co.* will send you their latest eight-page flyer listing the latest in merchandise available, including a giant \$1 special sale.

10. *Burstein-Applebee* offers a new giant catalog containing 100's of big pages crammed with savings including hundreds of bargains on hi-fi kits, power tools, tubes, and parts.

11. Now available from *EDI (Electronic Distributors, Inc.)* a catalog containing hundreds of electronic items. *EDI* will be happy to place you on their mailing list.

12. VHF listeners will want the latest catalog from *Kuhn Electronics.* All types and forms of complete receivers and converters.

ELEMENTARY ELECTRONICS, Dept. 367
505 Park Avenue, New York, N. Y. 10022

Please have literature whose numbers I have encircled sent to me as soon as possible. I am enclosing 25¢ (no stamps) to cover handling charges.



	1	2	3	4	5	6	7	8	10	11	12	15	16	17
	19	23	24	26	27	29	31	32	33	34	35	39	42	44
	45	46	48	50	54	57	59	61	66	67	70	72	74	78
	85	91	92	93	95	96	97	98	99	100	101	102	103	104
	105	106	107	108	109	110	111	112	113	114				

I am a subscriber

Indicate total number of booklets requested

NAME (Print clearly) _____

ADDRESS _____

CITY _____ STATE _____ ZIP CODE _____

Flip-Flops

Continued from page 36

can easily build for demonstration purposes. It is a free-running multivibrator whose values were selected to generate a continuous tone in the audio range. The tone, heard in the speaker, is variable from about 100 Hz (cycles) to several thousand Hz, as controlled by the 500K potentiometer. The transistors may be any general-purpose audio *pnp* types (GE-1, 2N107, etc.). The circuit can oscillate with battery voltage from about 3 to 9 volts, but output is louder on the higher voltage. A circuit of this type produces a tone which is slightly different in quality from that generated by a conventional sine-wave oscillator. Rather than sounding colorless, like a pure tone, it is fuller and musical. It's due to the squared-off wave produced by flip-flop action. It is rich in harmonics, or multiples, of the fundamental pulse frequency. The output transformer which feeds the speaker is a 2K to 3.2-ohm type commonly found in AC-DC table radios.

Viewing the Flip-Flop Signal. We constructed the practical circuit of Fig. 6 and threw a scope across key circuit points to obtain pictures of two signals; feedback and output pulses in one stage. Both photos are seen in the schematic of Fig. 7. One is the sawtooth shape, representing the charge-discharge action of the coupling capacitor, the other is a square output wave which shows the *on* and *off* conditions of the transistor. Before tracing it in detail, recall the basic action of a *pnp* transistor. A *positive-going* signal applied to its base *reduces* current through the collector circuit, a condition which drive the transistor into cutoff. Output voltage will be high (maximum negative).

Examine first the feedback signal (lower left) applied to the base or input side. That signal is being fed back from the second stage. The wave begins with a sharp, upward thrust in the positive direction, which represents charging of the capacitor in a few millionths of a second. Applied to the base, it causes rapid cutoff of collector current. This is seen in the top scope trace which monitors the collector; voltage is rapidly increasing in the negative-going (downward) direction. In comparing input and output signals, you will see that a phase reversal has occurred since positive input has produced negative output.

Next, the input signal at the base com-

mences to taper away, representing the relatively slow discharge of the capacitor. Collector voltage, however, is still maintained at full cut-off condition. Only when the capacitor reaches nearly full discharge will it release the transistor from the cutoff condition. In the interests of simplicity we've shown only signals for one stage during a half cycle. The identical sequence follows in the second stage to complete a full cycle of flip-flop action.

Electronic Switching. We've seen the flip-flop in counting and oscillator circuits. Our final application illustrates electronic switching. The circuit in Fig. 8, a practical device described in RCA semiconductor literature, eliminates thermal switches or other mechanical contacts. The circuit might be used to operate a flashing lamp for emergency use on the highway.

The two transistors at the left form a free-running multivibrator which produces a square wave approximately 69 times per minute. This signal is used to *gate* the third transistor (2N270) *on* and *off*. Output of the transistor then controls the base of the final transistor, a 2N441, which can handle the heavy lamp current. Since all switching functions occur within the semi-conductor material, there are no contacts to get dirty, oxidize or wear out. Life of the switch can be considered indefinite.

Now that you have the theory of flip-flops under your belt and have mastered a few simple, but practical, circuits, you are on your own for dreaming up any number of zany applications for flip-flops. ■



FCC Q & A

Continued from page 78

determining voltage divider so that as the temperature increases the forward base bias is reduced. Alternately, a germanium diode or transistor junction can be used as part of a voltage divider in this application.

Q Draw simple schematic diagrams of the following transistor circuits and explain their

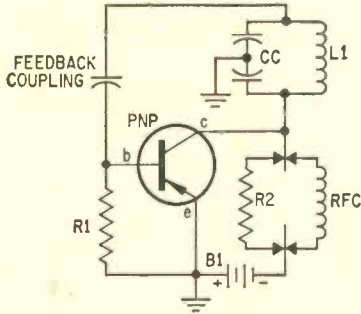

Fig. 6. Basic Colpitts oscillator circuit uses two capacitors in tuned circuit. Either R2 or RFC is needed as collector load of DC current—RF goes through tuned circuit (L1 and split capacitor CC).

principle of operation. Use only one voltage source: (a) Colpitts-type oscillator, (b) Class-B push-pull amplifier, (c) A pnp transistor direct coupled to a npn type.

- A** (a) See Fig. 6.
 (b) See Fig. 5.
 (c) See Fig. 5.



Get an early start in electronics with **ELEMENTARY ELECTRONICS**

The magazine that serves up electronic theory in pleasant spoonfuls and reinforces the knowledge you gain with exciting and useful projects.

Special Introductory Offer
 12 issues for only \$4.00. SAVE 50%

ELEMENTARY ELECTRONICS EE-367
 505 Park Avenue/New York, N.Y./10022

Begin my subscription to **ELEMENTARY ELECTRONICS** with the next issue. I am enclosing \$4.00 for 2 yrs.; Bill me.

Name _____ (please print)

Address _____

City _____ State _____ Zip _____

Elementary Electronics Magazine Rack For the Outdoor Enthusiast

- **Boating Journal 75¢**—Editorially directed to fill the needs of America's huge group of small boat owners of outboard engines, inboard/outboard and outboard power units. Suggests cruises, boat tests, racing, designs, maintenance and handling techniques plus coverage on new products.
- **Camping Journal 75¢**—Edited for the camper, fisherman, hunter, boatman, hiker and others who vacation in the out-of-doors. Features all facets of mobile camping and wilderness treks by foot, pack horse and canoe. Complete with where-to-go and how-to-do-it topics.
- **Mobile Life 50¢**—For present owners and prospective buyers of travel trailers, pickup campers and mobile homes.

These magazines can be found on sale at all newsstands. Or write for your copy using the coupon.

DAVIS PUBLICATIONS EE-367
 505 Park Avenue/New York, N.Y./10022

Please send me the latest copy of the magazine(s) I have indicated. I am adding 25¢ to the price indicated to cover postage & handling charges.

- Boating Journal 75¢
 Camping Journal 75¢
 Mobile Life 50¢

Name _____ (please print)

Address _____

City _____ State _____ Zip _____

Ham Shack Heart

Continued from page 45

to either the normal speaker-headphone arrangement or to a telegraph converter. This latter is a vacuum-tube device employing a sensitive polar relay which accepts the receiver output, amplifies it and transfers it to a conventional telegraph sounder. The owner of *this* control center is a member of a charmed circle who often work each other in the Continental *Morse* telegraph code rather than International, hence the sounder arrangement! Now to the right of the main panel, there are two rotary switches just below the slide-switch sub-panel. The left hand rotary switch connects the output of any of the four receivers to the speaker, headphones or telegraph sounder as selected. The other rotary switch provides two values of audio-tone filtering as well as a position to cut the filter out of the circuit.

Above the right hand slide-switch sub-panel is a potentiometer to control the audio noise limiter—a slide switch directly below it switches it in or out of the circuit. In a horizontal row along the bottom of the panel, eight fuses protect the four transmitters and four receivers. The main fuse (to the right of the clock) and the main switch (to the left of the clock) remove all power from the entire control unit—turning off all equipment connected to it by merely flipping one switch. The clock, of course, has a separate, fused circuit which remains “hot” at all times. Fusing for the clock, RF-monitor power supply and the telegraph converter are on the back panel. While conveniently reached for possible replacement, these fuses were not deemed sufficiently important to warrant front-panel space as they are not pertinent to actual communication operation.

The indicator lights (one for each receiver and transmitter and one for the main incoming power as well as one for the keying monitor supply) are of novel design. They are small neon lamps with a built-in resistor for 115-volt operation and are press-fitted into appropriate panel holes. Amber jewels are used for the receivers and keying monitor and red for transmitters and main power. All external wiring from the control center to the equipment is terminated in a series of plugs and sockets on the rear panel—eliminating all screw or solder type terminals.

The complete control center can be unplugged from all equipment and removed in less than a minute. With the exception of the transmitter and receiver AC-supply plugs, no two plug-and-socket assemblies are alike, preventing any misconnection. Should the two AC power plugs (both of the octal type) be reversed in connecting, no harm is done. The transmitter switches would then simply activate the receivers and vice-versa which would immediately make the transposition obvious. As a further safeguard however, one plug and socket assembly is painted bright red, the other brilliant green. While hardly in a class with Gemini Control, this versatile control center apparently overlooks nothing which could be considered as a station operating convenience and most certainly provides finger-tip control of everything, directly from the operating position.

Design Your Own. From the foregoing description and the accompanying illustrations it should appear rather evident that wide leeway in the design of a control center is possible. From the simplest little transmitter-receiver AC control box to the “granddaddy” unit, these control centers offer a broad range for exercise of ingenuity and initiative to produce a control center to suit your equipment. Individual ideas of the “homebrew” designer and builder can run rampant. Regardless of the end result, grouping controls at one central point is about the handiest and most convenient station layout imaginable. The block diagrams offer some ideas for various control groupings; almost any item of station equipment can be deleted or added and the arrangements shown are sufficiently flexible to provide for wide leeway in modifications to suit the builders’ fancy. ■

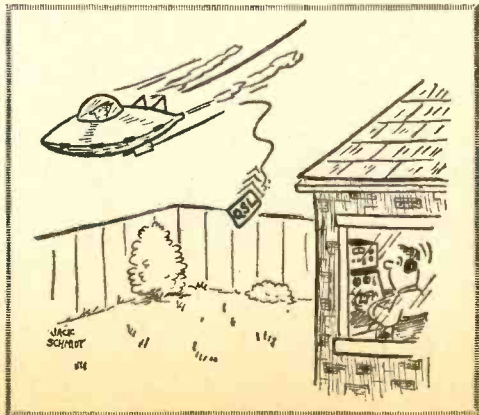

50¢ Transistor Tester

Continued from page 66

or no resistance change is noted upon applying base current, the transistor can be assumed to be defective.

Base Leakage. The next test checks I_{cbo} , the collector-to-base leakage current with emitter open, in terms of resistance or current if desired. Excessive I_{cbo} leakage biases or shifts the transistor operating points upwards to higher collector currents—leading to excess heating, large-signal distortion and other effects. A transistor with higher-than-normal I_{cbo} leakage may or may not operate properly depending on the particular circuit and other factors.

Switch the VTVM to the $R \times 10K$ -ohm range. Maximum test current on this range is 15 microamperes with leads shorted. Open S1 and connect the positive-voltage ohms lead to the base. The indicated resistance should fall in the upper third of the scale corresponding to a test-lead current of five microamperes or less. Most transistors will read higher than one megohm on this ohms range—the lower the resistance, the higher the leakage current.

A high-leakage transistor will indicate near zero ohms on the $R \times 10K$ -ohms range. An appreciable downward drift of the meter pointer indicates unstable leakage current leading to transistor drift. No sharp division line exists, but resistance readings well below 200K at these test voltages indicate higher-than-normal leakages for low-power transistors. Silicon transistors, which have extremely-low I_{cbo} leakages, will read near infinity on the $R \times 10K$ range.

These tests and resistance guidelines were established by checking a number of low-power germanium junction transistors including not only good but also defective transistors to insure their rejection. Although infrequently, a transistor passing these tests may fail to operate properly in the circuit (at normal voltages) if the transistor has an abnormally-rising I_{cbo} leakage current with an increase in collector voltage.

When running these tests, do not inadvertently set the ohms range to $R \times 1$ ohm. This range supplies about 150 milliamperes of test current—which could damage some converter-mixer type transistors. And just reverse all polarities shown and mentioned when checking *npn* transistors. ■

Way-Down SWL'ing

Continued from page 79

and Iraq are also members of the high power society. Relay stations of the BBC and the VOA make Malaysia and the Ryukyu Islands voices of the Far East. Australian territories of Papua and New Guinea operate regional stations of 10 kw each.

Europe. Very few European transmitters broadcast on 90 meters, mainly because regional broadcasting can be done on the standard broadcast and FM bands (without the high levels of static, usual in tropical areas, on these bands). All of the European stations broadcasting on 90 meters are high powered—such as the BBC in London, Radio Budapest in Hungary, and Radio Free Europe in Germany.

South America. With South America being mostly tropical, many stations operate on this band. These stations, however, are predominantly low powered. Radio TV Dominicana, Santo Domingo, is one of the few South Americans running over 5 kw in this band. Since this country has just been through a rebellion, logging it is fun.

Sky Wires. Antennas for the 90-meter band present no problem. A longwire antenna is sufficient. Generally speaking, logging Africa is easier on the east coast, and Asia easier on the west coast. QSLing these stations require a better than average report because of their regional broadcasting.

Listening on 90 meters offers you a chance at logging many rare stations. Just keep those ears ready for anything and take a slow twirl on that dial! ■

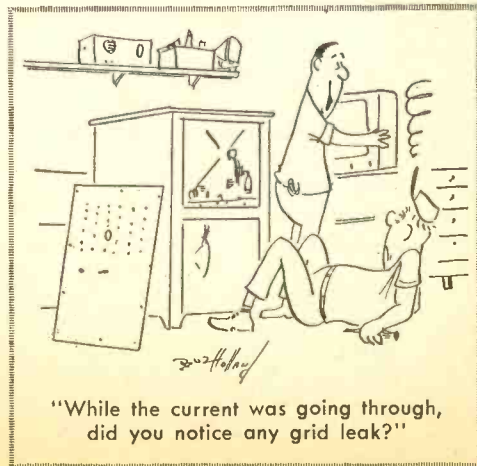

Tenna-Blitz

Continued from page 96

board. To make connections, simply push the component leads through the holes in the board, twist them together, and solder. There's no need for terminals.

If you're building the unit as shown, form a bracket for mounting the perf-board from scrap aluminum (as shown in the photographs). The bracket provides the ground connection for the circuit via a solder lug which is held in place by the bracket mounting screw.

Wide variation is permitted in component values. R1, which controls the length of the flash, may be eliminated and replaced with a jumper for a "quick burst" of light. The higher you make the value of R1 the longer the flash will be. But do not exceed 470 ohms. If the flash is too long (caused by more than 470 ohms) Q2 will overheat and literally burn up.

Protection resistor R2 (2700 ohms) allows experimentation with different transistors. If you use the transistors specified in the parts list R2 may be eliminated and replaced with a jumper. R3 provides a slight bias for Q1 and its value may range from 470K to 2.2 megohms.

The value of capacitor C1 should be between 2 and 4 microfarads. Too small, the lamp won't blink; and too large, the period between flashes will be excessive.

Lamp I1 must be a type 48 or 49 or an equivalent 2-volt, 60 milliamper lamp. It is press-fit into a 1/2-inch rubber grommet (no need for the expense of a lamp holder). Just make certain you solder the wires to I1 very quickly—use flux if necessary to insure a fast flow joint.

A Touch Of Schmaltz. If you use the *Tenna-Blitz* as a car beacon it is normally placed on the rear deck or the dashboard. But you can attach a small clip to I1 and mount it on the tip of the antenna running the wires back to the control unit inside the car. Of course, while the local hoodlums will pass-by the blinker on the dash—thinking it's a child's toy, you can almost bet a tower light on the antenna will attract them from every nook and gutter (don't say we didn't warn you).

Can you power the *Tenna-Blitz* from your 12 v. car battery? No! The excess current will destroy Q2 and I1. ■

Speech Processor

Continued from page 54

Using the Speech Processor. To use the speech processor simply unplug the microphone from your rig and plug the microphone into the *Speech Processor* and plug the *Speech Processor* into the microphone input of your rig. Turn on the AC. Wait a few seconds for voltages to stabilize and with the level control set to about mid-range make a call. Unless a low-output dynamic microphone is used the HI-LO gain switch (S1) can be left in the low-gain position. With a scope (or the help of a friend) adjust the level control (R22) for just a little less than 100% modulation.

Now move the microphone to arm's length and talk in a normal level voice. Modulation should stay about the same. The bass and treble controls are adjusted to suit individual preferences and band conditions; with both controls fully advanced the voice should sound more penetrating and less natural.

The clipper will probably be used only when conditions are bad as there is some loss of naturalness. However, this is a small price to pay for the difference of making and losing a contact. ■

STATEMENT OF OWNERSHIP, MANAGEMENT AND CIRCULATION		Publication Title and issue number of this form with issue published	
Date of filing: October 1, 1966		Issue of publication: Elementary Electronics	
Frequency of issue: Bi-Monthly			
1. Name and address of publisher: B. G. Davis, 505 Park Ave., New York, N. Y. 10022			
2. Name and address of editor: Joseph Daffron, 505 Park Ave., New York, N. Y. 10022			
3. Name and address of business manager: Joseph Daffron, 505 Park Ave., New York, N. Y. 10022			
4. Name and address of circulation manager: Joseph Daffron, 505 Park Ave., New York, N. Y. 10022			
5. Name and address of printer: Science & Mechanics Pub. Co., 505 Park Ave., New York, N. Y. 10022			
6. Name and address of distributor: Science & Mechanics Pub. Co., 505 Park Ave., New York, N. Y. 10022			
7. Name and address of advertiser: Joseph Daffron, 505 Park Ave., New York, N. Y. 10022			
8. Name and address of circulation manager: Joseph Daffron, 505 Park Ave., New York, N. Y. 10022			
9. Name and address of circulation manager: Joseph Daffron, 505 Park Ave., New York, N. Y. 10022			
10. Name and address of circulation manager: Joseph Daffron, 505 Park Ave., New York, N. Y. 10022			
11. Name and address of circulation manager: Joseph Daffron, 505 Park Ave., New York, N. Y. 10022			
12. Name and address of circulation manager: Joseph Daffron, 505 Park Ave., New York, N. Y. 10022			
13. Name and address of circulation manager: Joseph Daffron, 505 Park Ave., New York, N. Y. 10022			
14. Name and address of circulation manager: Joseph Daffron, 505 Park Ave., New York, N. Y. 10022			
15. Name and address of circulation manager: Joseph Daffron, 505 Park Ave., New York, N. Y. 10022			
16. Name and address of circulation manager: Joseph Daffron, 505 Park Ave., New York, N. Y. 10022			
17. Name and address of circulation manager: Joseph Daffron, 505 Park Ave., New York, N. Y. 10022			
18. Name and address of circulation manager: Joseph Daffron, 505 Park Ave., New York, N. Y. 10022			
19. Name and address of circulation manager: Joseph Daffron, 505 Park Ave., New York, N. Y. 10022			
20. Name and address of circulation manager: Joseph Daffron, 505 Park Ave., New York, N. Y. 10022			
21. Name and address of circulation manager: Joseph Daffron, 505 Park Ave., New York, N. Y. 10022			
22. Name and address of circulation manager: Joseph Daffron, 505 Park Ave., New York, N. Y. 10022			
23. Name and address of circulation manager: Joseph Daffron, 505 Park Ave., New York, N. Y. 10022			
24. Name and address of circulation manager: Joseph Daffron, 505 Park Ave., New York, N. Y. 10022			
25. Name and address of circulation manager: Joseph Daffron, 505 Park Ave., New York, N. Y. 10022			
26. Name and address of circulation manager: Joseph Daffron, 505 Park Ave., New York, N. Y. 10022			
27. Name and address of circulation manager: Joseph Daffron, 505 Park Ave., New York, N. Y. 10022			
28. Name and address of circulation manager: Joseph Daffron, 505 Park Ave., New York, N. Y. 10022			
29. Name and address of circulation manager: Joseph Daffron, 505 Park Ave., New York, N. Y. 10022			
30. Name and address of circulation manager: Joseph Daffron, 505 Park Ave., New York, N. Y. 10022			
31. Name and address of circulation manager: Joseph Daffron, 505 Park Ave., New York, N. Y. 10022			
32. Name and address of circulation manager: Joseph Daffron, 505 Park Ave., New York, N. Y. 10022			
33. Name and address of circulation manager: Joseph Daffron, 505 Park Ave., New York, N. Y. 10022			
34. Name and address of circulation manager: Joseph Daffron, 505 Park Ave., New York, N. Y. 10022			
35. Name and address of circulation manager: Joseph Daffron, 505 Park Ave., New York, N. Y. 10022			
36. Name and address of circulation manager: Joseph Daffron, 505 Park Ave., New York, N. Y. 10022			
37. Name and address of circulation manager: Joseph Daffron, 505 Park Ave., New York, N. Y. 10022			
38. Name and address of circulation manager: Joseph Daffron, 505 Park Ave., New York, N. Y. 10022			
39. Name and address of circulation manager: Joseph Daffron, 505 Park Ave., New York, N. Y. 10022			
40. Name and address of circulation manager: Joseph Daffron, 505 Park Ave., New York, N. Y. 10022			
41. Name and address of circulation manager: Joseph Daffron, 505 Park Ave., New York, N. Y. 10022			
42. Name and address of circulation manager: Joseph Daffron, 505 Park Ave., New York, N. Y. 10022			
43. Name and address of circulation manager: Joseph Daffron, 505 Park Ave., New York, N. Y. 10022			
44. Name and address of circulation manager: Joseph Daffron, 505 Park Ave., New York, N. Y. 10022			
45. Name and address of circulation manager: Joseph Daffron, 505 Park Ave., New York, N. Y. 10022			
46. Name and address of circulation manager: Joseph Daffron, 505 Park Ave., New York, N. Y. 10022			
47. Name and address of circulation manager: Joseph Daffron, 505 Park Ave., New York, N. Y. 10022			
48. Name and address of circulation manager: Joseph Daffron, 505 Park Ave., New York, N. Y. 10022			
49. Name and address of circulation manager: Joseph Daffron, 505 Park Ave., New York, N. Y. 10022			
50. Name and address of circulation manager: Joseph Daffron, 505 Park Ave., New York, N. Y. 10022			
51. Name and address of circulation manager: Joseph Daffron, 505 Park Ave., New York, N. Y. 10022			
52. Name and address of circulation manager: Joseph Daffron, 505 Park Ave., New York, N. Y. 10022			
53. Name and address of circulation manager: Joseph Daffron, 505 Park Ave., New York, N. Y. 10022			
54. Name and address of circulation manager: Joseph Daffron, 505 Park Ave., New York, N. Y. 10022			
55. Name and address of circulation manager: Joseph Daffron, 505 Park Ave., New York, N. Y. 10022			
56. Name and address of circulation manager: Joseph Daffron, 505 Park Ave., New York, N. Y. 10022			
57. Name and address of circulation manager: Joseph Daffron, 505 Park Ave., New York, N. Y. 10022			
58. Name and address of circulation manager: Joseph Daffron, 505 Park Ave., New York, N. Y. 10022			
59. Name and address of circulation manager: Joseph Daffron, 505 Park Ave., New York, N. Y. 10022			
60. Name and address of circulation manager: Joseph Daffron, 505 Park Ave., New York, N. Y. 10022			
61. Name and address of circulation manager: Joseph Daffron, 505 Park Ave., New York, N. Y. 10022			
62. Name and address of circulation manager: Joseph Daffron, 505 Park Ave., New York, N. Y. 10022			
63. Name and address of circulation manager: Joseph Daffron, 505 Park Ave., New York, N. Y. 10022			
64. Name and address of circulation manager: Joseph Daffron, 505 Park Ave., New York, N. Y. 10022			
65. Name and address of circulation manager: Joseph Daffron, 505 Park Ave., New York, N. Y. 10022			
66. Name and address of circulation manager: Joseph Daffron, 505 Park Ave., New York, N. Y. 10022			
67. Name and address of circulation manager: Joseph Daffron, 505 Park Ave., New York, N. Y. 10022			
68. Name and address of circulation manager: Joseph Daffron, 505 Park Ave., New York, N. Y. 10022			
69. Name and address of circulation manager: Joseph Daffron, 505 Park Ave., New York, N. Y. 10022			
70. Name and address of circulation manager: Joseph Daffron, 505 Park Ave., New York, N. Y. 10022			
71. Name and address of circulation manager: Joseph Daffron, 505 Park Ave., New York, N. Y. 10022			
72. Name and address of circulation manager: Joseph Daffron, 505 Park Ave., New York, N. Y. 10022			
73. Name and address of circulation manager: Joseph Daffron, 505 Park Ave., New York, N. Y. 10022			
74. Name and address of circulation manager: Joseph Daffron, 505 Park Ave., New York, N. Y. 10022			
75. Name and address of circulation manager: Joseph Daffron, 505 Park Ave., New York, N. Y. 10022			
76. Name and address of circulation manager: Joseph Daffron, 505 Park Ave., New York, N. Y. 10022			
77. Name and address of circulation manager: Joseph Daffron, 505 Park Ave., New York, N. Y. 10022			
78. Name and address of circulation manager: Joseph Daffron, 505 Park Ave., New York, N. Y. 10022			
79. Name and address of circulation manager: Joseph Daffron, 505 Park Ave., New York, N. Y. 10022			
80. Name and address of circulation manager: Joseph Daffron, 505 Park Ave., New York, N. Y. 10022			
81. Name and address of circulation manager: Joseph Daffron, 505 Park Ave., New York, N. Y. 10022			
82. Name and address of circulation manager: Joseph Daffron, 505 Park Ave., New York, N. Y. 10022			
83. Name and address of circulation manager: Joseph Daffron, 505 Park Ave., New York, N. Y. 10022			
84. Name and address of circulation manager: Joseph Daffron, 505 Park Ave., New York, N. Y. 10022			
85. Name and address of circulation manager: Joseph Daffron, 505 Park Ave., New York, N. Y. 10022			
86. Name and address of circulation manager: Joseph Daffron, 505 Park Ave., New York, N. Y. 10022			
87. Name and address of circulation manager: Joseph Daffron, 505 Park Ave., New York, N. Y. 10022			
88. Name and address of circulation manager: Joseph Daffron, 505 Park Ave., New York, N. Y. 10022			
89. Name and address of circulation manager: Joseph Daffron, 505 Park Ave., New York, N. Y. 10022			
90. Name and address of circulation manager: Joseph Daffron, 505 Park Ave., New York, N. Y. 10022			
91. Name and address of circulation manager: Joseph Daffron, 505 Park Ave., New York, N. Y. 10022			
92. Name and address of circulation manager: Joseph Daffron, 505 Park Ave., New York, N. Y. 10022			
93. Name and address of circulation manager: Joseph Daffron, 505 Park Ave., New York, N. Y. 10022			
94. Name and address of circulation manager: Joseph Daffron, 505 Park Ave., New York, N. Y. 10022			
95. Name and address of circulation manager: Joseph Daffron, 505 Park Ave., New York, N. Y. 10022			
96. Name and address of circulation manager: Joseph Daffron, 505 Park Ave., New York, N. Y. 10022			
97. Name and address of circulation manager: Joseph Daffron, 505 Park Ave., New York, N. Y. 10022			
98. Name and address of circulation manager: Joseph Daffron, 505 Park Ave., New York, N. Y. 10022			
99. Name and address of circulation manager: Joseph Daffron, 505 Park Ave., New York, N. Y. 10022			
100. Name and address of circulation manager: Joseph Daffron, 505 Park Ave., New York, N. Y. 10022			
1. Total number of copies (net press run):		140,547	131,453
2. Paid circulation:		49,921	45,000
3. Total distribution (sum of 2 and 3):		60,578	48,500
4. Total paid circulation:		55,718	3,500
5. Total distribution (sum of 4 and 5):		1,026	730
6. Total paid circulation (sum of 4 and 5):		51,604	49,210
7. Total distribution (sum of 6 and 7):		89,243	82,243
8. Total paid circulation (sum of 6 and 7):		140,547	131,453
I certify that the statements made by me above are correct and complete.			
Signature of owner, publisher, business manager or owner: V. C. Stabile, Business Manager			

CLASSIFIED Market Place

FOR BIGGER PROFITS! NEW CAREER OPPORTUNITIES!
READ AND REPLY TO THESE CLASSIFIED ADS

Classified Ads 55¢ per word, each insertion, minimum 10 words, payable in advance. To be included in the next available issue of **ELEMENTARY ELECTRONICS**, copy must be in our New York Office by March 10th. Address orders to C. D. Wilson, Manager, Classified Advertising, **ELEMENTARY ELECTRONICS**, 505 Park Ave., New York, N. Y. 10022.

ADDITIONAL INCOME

MAKE Your Classified Ad Pay. Get "How To Write a Classified Ad That Pulls." Includes certificate worth \$2.00 towards classified ad in S & M. Send \$1.00 to C. D. Wilson, Science & Mechanics, 505 Park Ave., New York, N. Y. 10022.

AUTO PARTS & ACCESSORIES

CAR REPAIR: Dedicated to mechanically minded readers. Send \$1.00 (includes postage & handling) to Car Repair, 505 Park Ave., New York, New York 10022.

BOATS, MOTORS & MARINE SUPPLIES

Full size, cut-to-shape boat patterns, blueprints. Send 60¢ for big New illustrated "Build a Boat" catalog includes Fishing Boats, Garvies, Cruisers, Catamarans, Houseboats—Outboards, Inboards, Sailboats—7½ to 38'. "How to Build a Boat" booklet \$2.50. Cleveland Boat Blueprint Co., Box 18250, Cleveland, Ohio.

BOAT Kits. Save money—assemble yourself. Factory molded fiberglass or pre-assembled plywood. 12' to 32' Cruisers, Runabouts, Houseboats, Sail Boats. Big Line accessories, motors, trailers. Easy terms. Free catalog. Luger, Dept. UC-67, 9200 Bloomington Freeway, Bloomington, Minn. 55435.

BOOKS & PERIODICALS

1000 **ELECTRONIC** Books Available By Mail. Free Catalog. Books, Box 796-C, Montreal, Canada.

FREE LIST. Inspirational and Self-Help Books. Write: Aubrey, Box 221, Cranford, New Jersey 07016.

CATALOG of all Science & Mechanics Craftprints. Send 25¢ to cover postage and handling to Craftprint Div., Science & Mechanics, 505 Park Ave., New York, New York 10022.

BUSINESS OPPORTUNITIES

I MADE \$40,000.00 a year by Mailorder! Helped others make money! Start with \$10.00—Free Proof! Torrey, Box 318-T, Ypsilanti, Michigan, 48197.

FREE Book "990 Successful Little-Known Businesses." Fascinating! Work home! Plymouth 911-T, Brooklyn, N. Y. 11216.

MONEYMAKING Mail-Order Opportunities. \$200.00 weekly possible. Litton, 33MC, Randallstown, Maryland.

For Business Opportunities—read Science & Mechanics. 12 issues \$4.00. Write Science & Mechanics, 505 Park Ave., New York, N. Y. 10022.

EARTHWORMS

BIG Money Raising Fishworms and Crickets. Free literature. Carter Farm-O, Plains, Georgia 31780.

EDUCATION & INSTRUCTION

BUILD Your Own Test Equipment and a Stereo AM-FM Radio. Practical Home Study Courses in Electronics in Theory, Practice and Servicing with complete kits and tools included in price. Write for free booklet with no obligation to: Inesco, Intercontinental Electronics School, Dept. 16B, 9100 St. Lawrence Blvd., Montreal 11, Quebec, Canada.

CORRESPONDENCE Courses — B.Sc., Engineering, Electronics. Catalog \$1.00. Canadian Institute of Science & Technology, 263J Adelaide St. W., Toronto.

ENGINES, MOTORS, DYNAMOS

STEAM Boat & Steam Automobile Brochure. Send Only Two Dollars. Shaw, Box 21204, Concord, Calif. 94521.

FOR INVENTORS

PATENT Searches—48 hour airmail service, \$6.00, including nearest patent copies. More than 200 registered patent attorneys have used my service. Free invention protection forms. Write Miss Ann Hastings, Patent Searcher, P. O. Box 176, Washington, D. C. 20004.

HYPNOTISM

NEW concept teaches you self-hypnosis quickly! Free literature. Smith-McKinley, Box 3038, San Bernardino, Calif.

FREE!! Gigantic Hypnotism Catalog! Azadiah, 5786 So, Elm, Fresno, Calif. 93760.

INVENTIONS WANTED

WE either sell your invention or pay cash bonus. Write for details. Universal Inventions, 298-3, Marlon, Ohio.

LEATHERCRAFT

FREE "Do-it-yourself" Leathercraft Manual. Tandy Leather Company, 1001 Pch. N58, Fort Worth, Texas.

MODELS & MODEL SUPPLIES

SHIP Models. New Catalog 15¢. Scientific, Inc. 113N Monroe, Newark, New Jersey 07105.

MONEYMAKING OPPORTUNITIES

HOW To Make a Home Operated Mail Business Pay! Details—Carpenter, 2907-J West 39th Place, Chicago, Ill. 60632.

START Profitable Business in spare time. Investigate many money-making agency and franchise opportunities. Send 10¢ for sample copy of Income Opportunities Magazine. 505 Park Avenue, New York, 10022. Dept. S.

PATENT SERVICE

PATENT Searches—48 hour airmail service, \$6.00, including nearest patent copies. More than 200 registered patent attorneys have used my service. Free invention protection forms. Write Miss Ann Hastings, Patent Searcher, P. O. Box 176, Washington 4, D. C.

PERSONAL

BILL Problems? Poor credit no trouble. Not a loan company. Send for free application. Automatic Acceptance, 318DC Broadway Blvd., Reno, Nevada or 307DC Pccasset Ave., Providence, R. I.

PETS—DOGS, BIRDS, RABBITS, HAMSTERS, ETC.

MAKE big money raising rabbits for us. Information 25¢. Keeney Brothers, New Freedom, Penna.

RADIO & TELEVISION

McGEE Radio Company. Big 1966-1967 Catalog Sent Free. America's Best Values. Hi-Fi, Amplifiers, Speakers, Electronic Parts. Send Name, Address and Zip Code Number to McGee Radio Company, 1901 McGe Street, Dept. EE, Kansas City, Missouri 64108.

FREE Catalog. Electronics parts, tubes. Wholesale. Thousands of items. Unbeatable prices. Arcturus Electronics-RT, 502 22nd St., Union City, N. J. 07087.

CANADIANS—Giant Electronics Catalogs. Hi-Fi, Shortwave, Ham, CB. Rush \$1.00. ETCO, Dept. EZ, Box 741, Montreal, Canada.

SEND \$5.00 for giant size Experimenters' Parts Assortment. J. C. Electronics, 14221 Sommermeyer, Houston, Texas 77040.

SCIENCE EXPERIMENTS

SCIENCE Experimenter—the magazine dedicated to the youth who is interested in experimentation, construction and Science Fair entries. Send \$1.00, includes Postage, to Science Experimenter, 505 Park Ave., New York, N. Y. 10022.

SONGWriters

POEMS Wanted for musical setting and recording. Send poems. Free examination. Crown Music, 49-SC West 32, New York 1.

TREASURE FINDERS—PROSPECTING EQUIPMENT

"NEW" Scientific Instrument detects buried gold, silver, coins, treasures. \$19.95 up. Free catalog. Relco-A30, Box 10563, Houston, Texas 77018.

DIAMONDS, Gold. Find Them. Pamphlet Free. 18788 Cajon, San Bernardino, California 92407.

THERE IS NO CHARGE FOR THE ZIP CODE—PLEASE USE IT IN YOUR CLASSIFIED AD

SSB Is In!

Continued from page 60

peaks, it is accepted within legal limits prescribed by the FCC.

Receiving Sideband. Sideband transmitting systems may seem complex at first glance but it was probably the receiver that held back single sideband acceptance for many years. And this despite the fact that no special circuits are needed to receive single sideband on a communications receiver that contains a BFO for making code signals audible. The problem was mostly a matter of receiver selectivity, stability, or freedom from drift.

Picking up single-sideband is mainly a matter of *reinserting the carrier*. In any receiving system, the detector must reverse the process that began back at the transmitter. As you may recall, a carrier was required to create sidebands. It's also necessary to recreate original audio. It's the mixing process all over again. When the conventional AM

transmitter sends carrier and sidebands to the receiver, the detector heterodynes them to produce audio. Using our earliest example: a 600-kHz carrier mixes with a 601-kHz sideband to produce a 1 kHz difference . . . which is the original audio. (The lower sideband contributes to the identical result). But an incoming single sideband signal is carrierless. This is easily corrected by turning on the receiver's BFO.

Tuning a single-sideband signal on a receiver is done slowly and with care. The reason is that the BFO must inject a signal which corresponds exactly to the frequency of the original carrier—if it had been transmitted. As the BFO dial is adjusted, an incoming speech transmission first sounds like a signal of tremendous distortion. Then it assumes a characteristic "Donald Duck" quality. But when tuning is on the nose, the sideband signal can be crystal clear and intelligible, even during difficult band conditions. So effective is single sideband that the new definition for conventional AM. When that day comes, AM may very well mean "Ancient Modulation." ■

Detectors

Continued from page 92

provide forward bias causing collector current to flow in proportion to signal strength. Positive signal excursions provide reverse bias and have no effect. Hence, we have the solid-state version of the plate detector.

Other Detectors. There are also other kinds of detectors. Some, such as level detectors, sense changes but not necessarily intelligence. A superheterodyne radio, for example, has two detectors, but only one is called a detector these days. Long ago, the mixer (frequency converter) was called the "first" detector and the AM demodulator

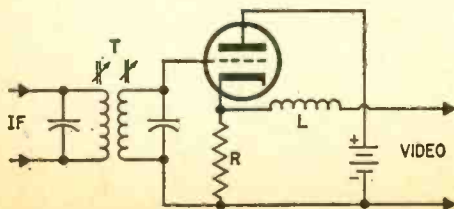

Fig. 35. Video detector using triode in cathode-follower hookup. Coil labeled "L" serves as RF choke.

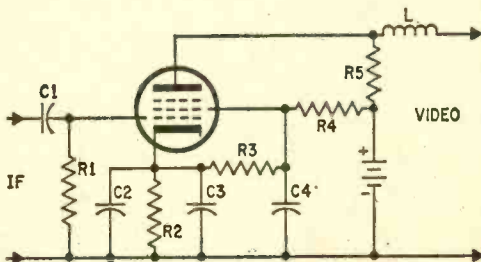

Fig. 36. Video detector using pentode. Both this circuit and the one appearing in Fig. 35 are AM types.

was called the "second" detector. The frequency converting mixer is a detector since it may be a rectifier or a non-linear amplifier.

Television sets have at least three detectors, a frequency converting mixer, an audio detector (FM) and a video detector (AM). The latter can be a diode or employ a triode, as in Fig. 35, or a pentode, as in Fig. 36. The former is an infinite impedance type (cathode follower) whereas the latter is a plate detector. In both circuits, coil L is an RF filter.

It is not possible to cover all type of detectors here. Basically, AM detectors are rectifiers or non-linear amplifiers, and FM detectors are essentially sensors of phase or frequency. ■

NOW 12 EASY, EXCITING WAYS TO LEARN ELECTRONICS, TV-RADIO WITH NRI

NRI has a training plan to fit your interest, your need, your education . . . from Color TV Servicing to Electronics for Printers. Pick the field of your choice and mail postage-free card now.



TELEVISION-RADIO SERVICING

Learn to fix home entertainment equipment like radio, hi-fi and stereo sets, all kinds of TV sets. Training kits include choice of black-and-white or color TV set you build. A profitable field full or part-time.



INDUSTRIAL-MILITARY ELECTRONICS

From basic principles to computers. Comprehensive training teaches fundamentals, then takes you into such modern-day miracles as servos, telemetry, multi-plexing, phase circuitry, others.



COMPLETE COMMUNICATIONS*

Teaches and provides actual practice in operation, service, maintenance of AM, FM, and TV broadcasting stations. Also covers marine, aviation, mobile radio, facsimile, microwave, radar.



FCC LICENSE*

Prepares you for First Class FCC Radiotelephone License exams. You begin with fundamentals, advance to required subjects covering equipment, procedures.



MATH FOR ELECTRONICS

A brief course for engineers and technicians who need a quick review of essential math used in industry, communications, government. Basic arithmetic review, short-cut formulas, modern digital number systems, much more.



BASIC ELECTRONICS

A concise course in Electronic terminology and components. A wealth of useful information to help you better understand the field. For anyone who wants a basic understanding of Radio-TV Electronics.



ELECTRONICS FOR AUTOMATION

Not for beginners, but for men with some knowledge of Electronics who want an understanding of process control, ultrasonics, telemetering and remote control, electromechanical measurements, other subjects.



AVIATION COMMUNICATIONS*

Prepares you to install, maintain, service direction finders, ranges, markers, Loran, Shoran, Radar, landing systems. Earn your FCC License with Radar Endorsement.



MARINE COMMUNICATIONS*

Covers transmitters, direction finders, depth indicators. Radar, Sonar, other equipment on commercial ships, pleasure boats. Prepares for FCC License with Radar Endorsement.



MOBILE COMMUNICATIONS*

Learn to install and maintain mobile transmitters and receivers used by police and fire departments, public utilities, construction firms, taxis, etc. Prepares for FCC License.



ELECTRICAL APPLIANCE REPAIR

Prepares you quickly to repair all types of appliances, including air conditioning, refrigeration, small gasoline engines. An easy, practical course leading to profitable part-time or full-time business of your own.



ELECTRONICS FOR PRINTERS

Designed to teach operation and maintenance of Electronic equipment which controls the latest devices developed for the graphic arts industry. From basic principles to computer circuits. Approved by major manufacturers.

* NOTE: You must pass your FCC License exam (any Communications course) or NRI refunds in full the tuition you have paid.

SEE
OTHER
SIDE

EARN YOUR FCC
LICENSE OR YOUR
MONEY BACK

FILL OUT
AND MAIL
POSTAGE-FREE
CARD



TRAIN UNDER NEW GI BILL.
If you served since Jan. 31, 1955,
or are in service now, check GI
line in postage-free card.

BUSINESS REPLY MAIL
NO POSTAGE STAMP NECESSARY IF MAILED IN THE UNITED STATES

POSTAGE WILL BE PAID BY
NATIONAL RADIO INSTITUTE
3939 Wisconsin Avenue
Washington, D.C. 20016

FIRST CLASS
PERMIT
NO. 20-R
Washington, D.C.





ONLY NRI GIVES YOU YOUR OWN COLOR KIT

Discover the Ease and Excitement of Learning TV-Radio, Electronics at Home with NRI

Begin now an exciting adventure. NRI—the home-study school that pioneered learn-by-doing training kits is now first to bring you COLOR TV training equipment. Learn Color TV Servicing by building your own high-quality Color set. You get “on-the-job” experience as you train. Your family enjoys the thrills of vibrant color shows for years to come. And, thanks to NRI training, you can do your own servicing—no costly service contract.

Earn \$4 to \$6 an Hour Extra Spare Time

Color TV is booming. Set sales exceed 5,000,000 a year now. 10-million-color-set years are predicted soon. And 60% of color set owners also own black-and-white sets. TV Technicians are in demand now to serve this giant, money-making, growing market. NRI shows you how to cash in on Color TV: how

to earn \$4 to \$6 an hour extra in spare time while learning; how to be your own boss in a full-time Radio-TV Servicing business, or qualify quickly for jobs in the fascinating fields of broadcasting/communications, industrial electronics, automation and space projects.

Act Now to Move Ahead

NRI offers you a choice of 12 different training plans, designed for people with all kinds of interests, all levels of education. Courses are described briefly on the other side of this page. To find out how you can be a part of the Electronics Age, mail postage-free card for free NRI color catalog. Don't delay. Electronics and Color TV need you now. NATIONAL RADIO INSTITUTE, Electronics Div., Washington, D.C. 20016. No salesman will call.

◀ SEE OTHER SIDE

NATIONAL RADIO INSTITUTE, ELECTRONICS DIVISION
WASHINGTON, D.C. 20016

6-037

Please send me your new color Catalog. I have checked the field(s) of most interest to me. (No obligation. No salesman will call.)



- | | |
|---|--|
| <input type="checkbox"/> Television-Radio Servicing | <input type="checkbox"/> Electronics for Automation |
| <input type="checkbox"/> Industrial Electronics | <input type="checkbox"/> Aviation Communications |
| <input type="checkbox"/> Complete Communications | <input type="checkbox"/> Marine Communications |
| <input type="checkbox"/> FCC License | <input type="checkbox"/> Mobile Communications |
| <input type="checkbox"/> Math for Electronics | <input type="checkbox"/> Electrical Appliance Repair |
| <input type="checkbox"/> Basic Electronics | <input type="checkbox"/> Electronics for Printers |

Check for facts on New GI Bill

Name..... Age.....

Address.....

City..... State..... Zip Code.....

**PICK YOUR
FIELD** and
mail postage-free
card for free
color catalog



OVER 50 YEARS
OF LEADERSHIP
IN ELECTRONICS TRAINING