

HOW LINEAR IC DESIGNERS ARE BUILDING DENSER CHIPS/67
EXECUTIVE OUTLOOK: NO SLOWDOWN IN TECHNOLOGY/86

A MCGRAW-HILL PUBLICATION

SIX DOLLARS

DECEMBER 18, 1986

Electronics[®]

SMART CARD

**WILL IT CREATE
A BILLION DOLLAR
IC BUSINESS?**

PAGE 55

**CATALYST IS BETTING ON IT WITH
ITS MICROCONTROLLER CHIP**

PAGE 59

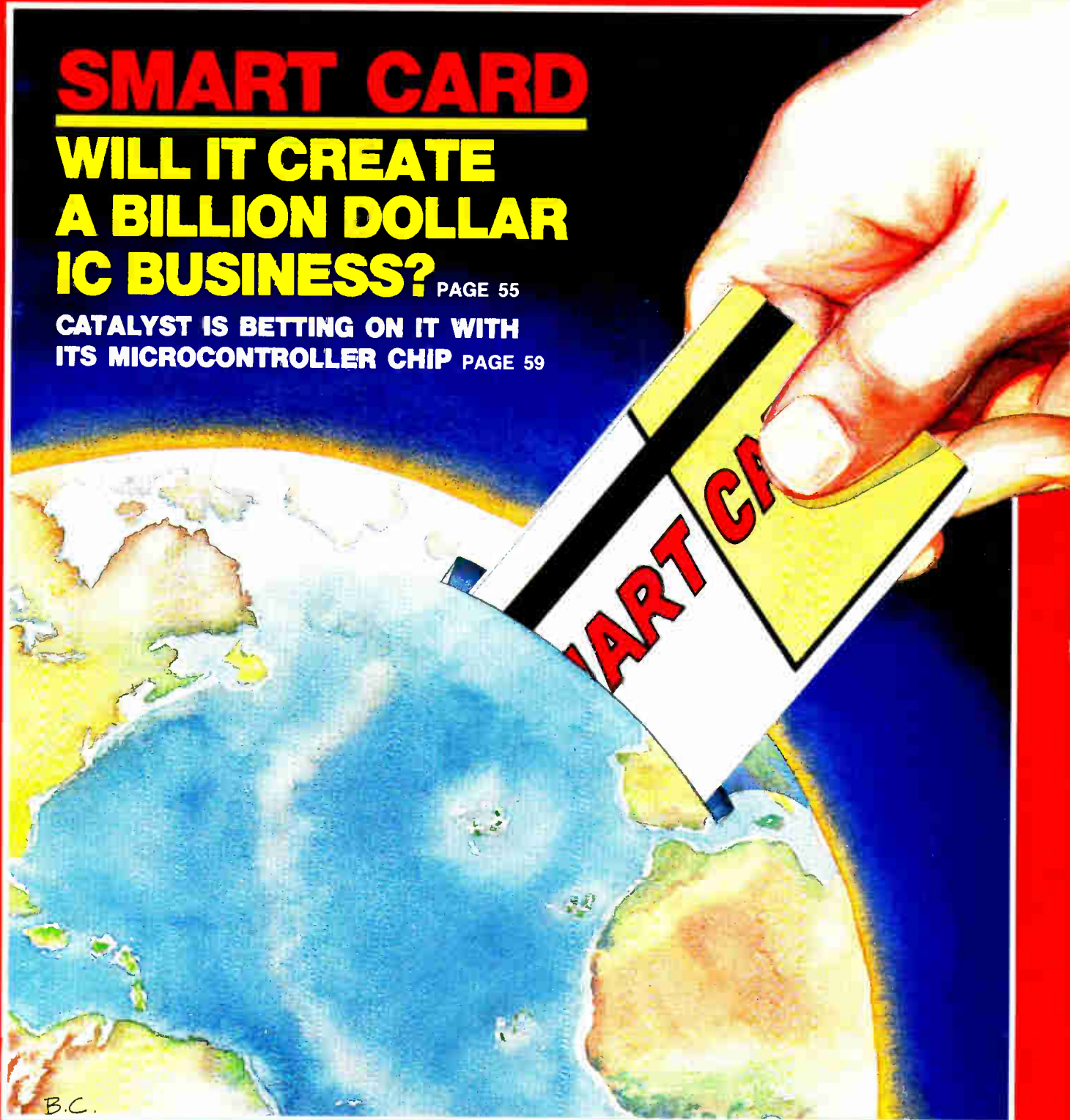

B.C.

Help Wanted

- Dependable worker.
- Minimum wages.
- High compatibility a must!
- Works unsupervised after hours.
- Able to travel.

MITEL CMOS MODEM ICs FIT THE JOB!

Today's modems must be more durable, smaller and, of course, more cost-effective than before. Mitel fills these requirements with 300 or 1200 bps CMOS modems that meet Bell 103/113 and 212A standards for North American products and also CCITT V.21 and V.22 standards for international markets.

The MT3530 Monolithic 300 bps Modem

The MT3530 is an ISO²-CMOS™ single-chip, full duplex, asynchronous, FSK modem. For complete applications flexibility, this IC operates in many modes:

- Auto-Answer/Originate modes for smart modem applications.
- Manual mode for stand-alone RS-232C modem applications.
- Pass-through mode for protocol independence.
- Test mode for analog and digital loopback.

This IC has on-chip transmit and receive filters, a 4.8 KHz UART clock output, and is TTL compatible.

The MT35213/212A 1200 bps Modem Set
The MT35213 is a single-chip, full duplex 1200 bps, PSK modem with a 300 bps FSK fallback mode for operating in adverse signal conditions. This IC has a 48 dB dynamic range and has loopback capability in both analog and digital.

The MT35212A Modem Filter uses switched capacitor techniques to implement both the filtering and equalization requirements of Bell 212A and CCITT V.22 modems. For CCITT V.22 applications, this device supplies a notch filter that provides selectable 1800 or 550 Hz rejection. This IC offers on-chip answer/originate mode selection and includes half-channel compromise amplitude and group delay equalizers; two uncommitted op amps can be used for anti-alias filtering.

These parts are available in plastic or ceramic dual-in-line packages. Contact your local Mitel sales office for further information.

Circle 900 on reader service card



MITEL SEMICONDUCTOR

UNITED STATES - San Diego, California. Telephone: (619) 276-3421. San Jose, California. Telephone: (408) 249-2111. Oakbrook, Illinois. Telephone: (312) 655-3930. Boca Raton, Florida. Telephone: (305) 994-8500. **CANADA** - Kanata, Ontario. Telephone: (613) 592-5630. **UNITED KINGDOM** - Portskewett, Newport, Gwent, South Wales NP6 4YR. Telephone: +44 291-423355. **ASIA** - Tsuen Wan, Hong Kong. Telephone: +852 0-463641. **EUROPE** - Denmark. Telephone: +45 1-612566. Milan, Italy. Telephone: +39 2-8245222/8245177. West Germany. Telephone: +49 711-7701522.

TM, • - Trademark of Mitel Corporation
© Copyright 1986 Mitel Corporation

The answer to your motion control problem is right here.



Pick what you need from growing families of digital potentiometers, general-purpose motion-control ICs, snap-in encoder modules, 2 & 3 channel encoders, quadrature decoder counters, and code wheels.

HP gives you a complete family of motion control products — all of them accurate, easy to install, compact, and low in price. In fact, our latest brochure describes more options for controlling and measuring motion than any one has ever offered you before.

This broad range of adaptable sensors and controls frees you from the distraction of having to design your own. It also gives you the bonus of HP's leading-edge, digital

optoelectronic technology and decades of commitment to products that deliver as expected. And more.

Plus, you get the convenience of HP field service and application support wherever you are located in the U.S. or around the world.

For a closer look, mail the coupon now for a free descriptive brochure. For pricing and delivery, contact your authorized Hewlett-Packard components distributor. In the U.S.: Almac Electronics, Hall-Mark, Hamilton/Avnet, or Schweber. In Canada: Hamilton/Avnet or Zentronics, Ltd.

Hewlett-Packard, Components Division, P.O. Box 10301, Palo Alto, CA 94303-0890. **Yes.** Please send me a free brochure describing HP's full line of motion control products.

Name _____

Title _____

Company _____

Address _____

City/State/Zip _____

EL 12/18/86

We'd like
to address the
misconception that
our products
cost more.

Most people think the cost of a connector is represented by its unit price.

Not necessarily so.

At ITT Cannon, cost involves a number of important factors. Take durability. Cannon prides itself on making quality connectors that last longer, saving you the cost of frequent replacement. And availability. Cannon's extensive distribution network gets you your order when and where you want it, saving you lead time and money. Also, reliability. By designing a superior connector, Cannon assures performance, which ultimately makes your end product more cost effective.

The bottom line? With high quality standards prerequisite, Cannon products actually have lower total installed costs than other connector manufacturers.

True, there are other connector brands that initially cost less. But you could pay the price in the long run.

Consider it the difference between a product you can buy and a product you can trust.

*Worldwide Headquarters
10550 Talbert Ave.
Fountain Valley, CA 92708
Or call (714) 964-7400*

ITT CANNON
*We're making progress.
Not excuses.*

Circle 2 on reader service card

EDITOR-IN-CHIEF

Robert W. Henkel

EXECUTIVE EDITORS

Samuel Weber (technical), Arthur Erikson (news)

MANAGING EDITORS GROUP

Bernard C. Cole, Tom Manuel,
Benjamin A. Mason, Jonah McLeod,
Howard Wolf, Jeremy Young

ART DIRECTOR

Fred Sklenar

DEPARTMENT EDITORS

Communications: Robert Rosenberg
Computers & Peripherals: Tom Manuel
Government & Military: Jerry Lyman
Industrial & Consumer: Wesley R. Iversen
(Chicago)
Packaging & Production: Jerry Lyman
Semiconductors: Bernard C. Cole (San Mateo)
Software & Microsystems: Alexander Wolfe
Special Projects: George Sideris (San Mateo)
Test & Measurement: Jonah McLeod
(San Mateo)

NEWS DEPARTMENT

Front of the Book: Jeremy Young
Probing the News: Howard Wolf
New Products: Jack Shandle
Assistant News Editor: Rick Elliot

EDITORIAL PRODUCTION & COPY DESK

Benjamin A. Mason (Director)

Production

Charles D. Ciatio (Mgr.), Kathy O'Neill

Copy Editors

Larry King (Chief), George Ellis,
Nancy J. Erickson

ART

Sachiko Soskin (Associate Director)

NEWS BUREAUS

Boston: Craig D. Rose (Mgr.), Paul Angiolillo
Chicago: Wesley R. Iversen (Mgr.)
Dallas: J. Robert Lineback (Mgr.)
Los Angeles: Larry Waller (Mgr.), Ellie Aguilar
New York: Tobias Naegele (Mgr.)
San Mateo: Clifford Barney (Mgr.)
Frankfurt: John Gosch (Mgr.)
London: Steve Rogerson
Paris
Tokyo: Charles L. Cohen (Mgr.),
Ayako Hayasnihara
Michael Berger (World News Chief), Amy Borrus

EDITORIAL ADMINISTRATION

Laura Aspery (Administrative Assistant),
Lisa Costenbader, Ina Gruber

PUBLISHER

Laurence Altman

Director of Operations: Thomas E. Vachon

Director of Circulation: Daniel McLaughlin

Production Director: Thomas Egan

Manager of Sales Administration:
Evelyn Schmidt

Research Associate: Diane Breder

For the January 3, 1972, issue, *Electronics* editors decided to ask industry leaders to list their business concerns for the coming year. The idea was to give our readers what we called an Executive Outlook, a preview of the rough spots and the bright spots just down the road.

The idea was a good one, and the result has been an outstanding series that can serve as a prototype of the kind of innovative and authoritative coverage that is our hallmark. The 15th Executive Outlook starts on p. 86, and there are several major contrasts between it and the first edition. For one, the story that appeared on Jan. 3, 1972, was five pages long; the one in this issue spans 10 pages. Also, the first Executive Outlook concerned U.S. companies only; now this roundup encompasses business around the world.

"But perhaps the most significant difference this year is the organization of the story," says assistant managing editor Jeremy Young, who directed the coverage. "We have divided it into two parts: one for the executives and the other for the research and engineering managers. With that format, we have been able to get more specific with our questions. For example, one of the chief concerns for the executives is the new tax law and how it affects their companies. On the other hand, the technolo-



YOUNG. The leader of the team that took the industry's pulse.

gists are more concerned about bottlenecks in the lab-to-market process."

The one thing that hasn't changed is that it takes many people to produce the story. All the editors in our domestic and overseas bureaus interviewed the leaders whose views we present. In New York, those interviews were compiled by Young along with New York bureau manager Tobias Naegele and chief copy editor Larry King. "We quote

about 60 people in the story," says Young. "Keeping all the names and reporting straight is a complicated business."

Some universal worries have persisted over the years. In 1972 the article said, "Three major problems emerged: an inability to compete with Japan on an equal footing, loss of momentum of the country's technological leadership; and doubt about the Nixon administration's game plan.

"On the plus side, conditions seem ripe for recovery—perhaps slow at first, but building to a substantial pace by the second half." One executive is quoted as saying, "By the second half we'll be running to catch up, which is a pleasant predicament compared to the last two years." That's a predicament that would be doubly welcome in 1987.

Overall, the mood of the executives was described as "cautiously optimistic." Sound familiar?

December 18, 1986 Volume 59, Number 37
142,786 copies of this issue printed

Electronics (ISSN 0883-4989). Published biweekly by McGraw-Hill Inc. Founder: James H. McGraw 1860-1948. Publication office: 1221 Avenue of the Americas, N.Y., N.Y. 10020; second class postage paid at New York, New York and additional mailing offices. Postage paid at Montreal, P. O. Registration Number 9034.

Executive, editorial, circulation, and advertising addresses: *Electronics*, McGraw-Hill Building, 1221 Avenue of the Americas, New York, N.Y. 10020. Telephone (212) 512-2000. Teletype 12-7960 TWX 710-581-4879. Cable address: MCGRAW HILL NEW YORK.

Subscriptions limited to professional persons with active responsibility in electronics technology. No subscriptions accepted without complete identification of subscriber name, title or job function, company or organization, and product manufactured or services performed. Based on information supplied, the publisher reserves the right to reject nonqualified requests. Subscription rates: the United States and possessions \$32 one year, \$55 two years, \$76 three years; company addresses and company libraries \$40 one year, \$67 two years, \$93 three years; Canada and Mexico \$34 one year, \$57 two years, \$78 three years; Europe \$50 one year, \$65 two years, \$125 three years; Japan, Israel, and Brazil \$85 one year, \$140 two years, \$200 three years; Australia and New Zealand \$95 one year, \$170 two years, \$240 three years, including air freight; all other countries \$50 one year, \$85 two years, \$125 three years. Limited quota of subscriptions available at higher-than-basic rate for persons allowed to field served. Check with publisher for these rates. Single copies: \$6.00. Please allow four to eight weeks for shipment.

Officers of McGraw-Hill Information Systems Company: President: Richard B. Miller; Executive Vice Presidents: Frederick P. Jannot, Construction Information Group, Russell C. White, Computers and Communications Information Group; J. Thomas Ryan, Marketing and International. Senior Vice President: Francis A. Shinal, Controller. Senior Vice Presidents: Laurence Altman, *Electronics*; Harry L. Brown, BYTE; David J. McGrath, Engineering News-Record. Group Vice President: Peter B.

McCuen, Communications

Vice Presidents: Fred O. Jensen, Planning and Development; Michael J. Koeller, Human Resources; Talit M. Sadig, Systems Planning and Technology. Vice President-Publisher: Paul B. Beatty, Architectural Record and Building Economics.

Officers of McGraw-Hill Inc.: Harold W. McGraw Jr., Chairman; Joseph L. Dionne, President and Chief Executive Officer; Robert N. Landes, Executive Vice President and Secretary; Walter D. Serwatka, Executive Vice President and Chief Financial Officer; Shel F. Asen, Senior Vice President, Manufacturing; Robert J. Bahash, Senior Vice President, Finance and Manufacturing; Ralph R. Schulz, Senior Vice President, Editorial; George R. Eisinger, Vice President, Circulation; Ralph J. Webb, Vice President and Treasurer.

Title registered in U.S. Patent Office; Copyright 1986 by McGraw-Hill Inc. All rights reserved. The contents of this publication may not be reproduced in whole or in part without the consent of copyright owner.

Where necessary, permission is granted by the copyright owner for libraries and others registered with the Copyright Clearance Center (CCC), 21 Congress Street, Salem, Mass. 01970, to photocopy any article herein for the base fee of \$0.50 per copy of the article plus \$0.25 per page. Payment should be sent directly to the CCC. Copying done for other than personal or internal reference use without the express permission of McGraw-Hill is prohibited. Requests for special permission or bulk orders should be addressed to the publisher. ISSN 0883-4989/86 \$0.50 + .25.

Subscribers: The publisher, upon written request to our New York office from any subscriber agrees to refund that part of the subscription price applying to copies not yet mailed. Please send change-of-address notices or complaints to Fulfillment Manager, subscription orders to Circulation Manager, *Electronics*, at address below. Change-of-address notices should provide old as well as new address, including zip codes. Attach address label from recent issue. Allow one month for change to become effective. Subscriber Service: call (201) 981-1064, 9 a.m. to 4 p.m. EST. Postmaster: Please send address changes to *Electronics*, att. Fulfillment Manager CN 808, Marlinton, N.J. 08836.

Editorial department phones: Administration (212) 512-2645, News and New Products (212) 512-2685, Technology (212) 512-2666. Bureaus: Boston (617) 262-1160, Chicago (312) 751-3811, Dallas (214) 458-2400, Los Angeles (213) 480-5234, New York (212) 512-3322, San Francisco/San Mateo (415) 349-4100, Washington (202) 463-1650, Frankfurt 72-5566, London 493-1451, Paris 42-89-03-80, Tokyo 581-9816.
Business departments: (212) 512-6435 (Business departments follow the Advertisers' Index).

Electronics

YEAR-END DOUBLE ISSUE

NEWS	INSIDE TECHNOLOGY
<p>Newsletters</p> <p>Electronics, 21</p> <ul style="list-style-type: none"> • Honeywell drops product efforts in commercial digital GaAs • IBM steps up its commitment to supercomputers • U. S. to probe Japan's supercomputer barriers <p>International, 50</p> <ul style="list-style-type: none"> • The British say they have a way to sharpen large LCD arrays • Japan sets up copyright protection for software 	<p>COVER: Will smart cards create a billion dollar IC business? 55</p> <p>Wallet-sized cards with embedded microprocessor and memory circuitry are beginning to emerge as a chip market that many are calling the next semiconductor bonanza. They envision a horde of applications that could spur sales of many millions of smart-card chips</p> <p>Catalyst is betting on it with its microcontroller chip, 59</p> <p>The company thinks that its new chip, which can hold 2-K bytes of EEPROM, could finally open up the market</p> <p>SPECIAL REPORT: How designers are building denser linear ICs, 67</p> <p>Complex linear ICs are difficult to achieve because the devices don't scale down well. But demand from systems designers is high, and circuit developers are responding with a variety of innovations</p>
<p>Semiconductors, 31</p> <p>Hughes breaks the speed record for digital gallium arsenide</p> <p>IC processing, 32</p> <ul style="list-style-type: none"> • Silicon-on-insulator technology is getting easier • Progress comes, too, in conventional SOI <p>Companies, 32</p> <p>Is GM's high-tech future cloudy with Perot gone?</p> <p>Trade, 33</p> <ul style="list-style-type: none"> • Motorola and Toshiba: they've only just begun • Asian-Pacific boom entices U. S. chip houses <p>Packaging, 38</p> <p>Fairchild slashes the reject rate for military chips housed in DIPs</p> <p>Components, 38</p> <p>Single IC packed with track-and-hold circuitry promises simpler data-acquisition front ends</p>	<p>TI process boosts linear CMOS ICs to LSI densities, 71</p> <p>An example of the new approaches in linear technology is Texas Instrument's Advanced LinCMOS process. It yields densities needed for high-performance data converters and other complex chips combining analog and digital circuitry</p> <p>Layout tool streamlines full-custom IC design, 80</p> <p>Caeco's R-Cells system provides reusable macros, a relative coordinate system that automatically realigns the layout when the size of a transistor changes, and a facility to switch processes</p> <p>Combining the best of step and dc motors, 83</p> <p>Seiberco has married a sensor, driver, and controller to a two-phase motor, and the result is a controllable drive that fills the gap between a stepper and a brushless dc motor</p> <p>Capacitive coupling simplifies isolation, 84</p> <p>Thin-film spiral coupling capacitors are Burr-Brown's radical new way of isolating signals in circuits operating in harsh environments</p> <p>EXECUTIVE OUTLOOK: No technology slowdown, 86</p> <p>In <i>Electronics'</i> annual worldwide survey, executives and technologists look for rapidly changing technologies, which should continue to create new markets. Among the 1987 headlines: BiMOS technology, practical GaAs products, real-world AI, optical disks, and networking</p>
<p>Displays, 42</p> <p>Philips will take on Japan in LCDs</p> <p>Industrial, 45</p> <p>Diagnostic box catches control faults faster</p>	<p>PROBING THE NEWS</p> <p>The competition explodes in power MOS FETs, 97</p> <p>Power circuitry is a fast-growing market segment in a sluggish semiconductor industry. Behind it all is better MOS FET technology</p> <p>The door is opening for chip-on-board assembly, 101</p> <p>Still a niche market, it is solving its technical problems. And the smart card could make the technology one of the leaders in the U. S.</p>

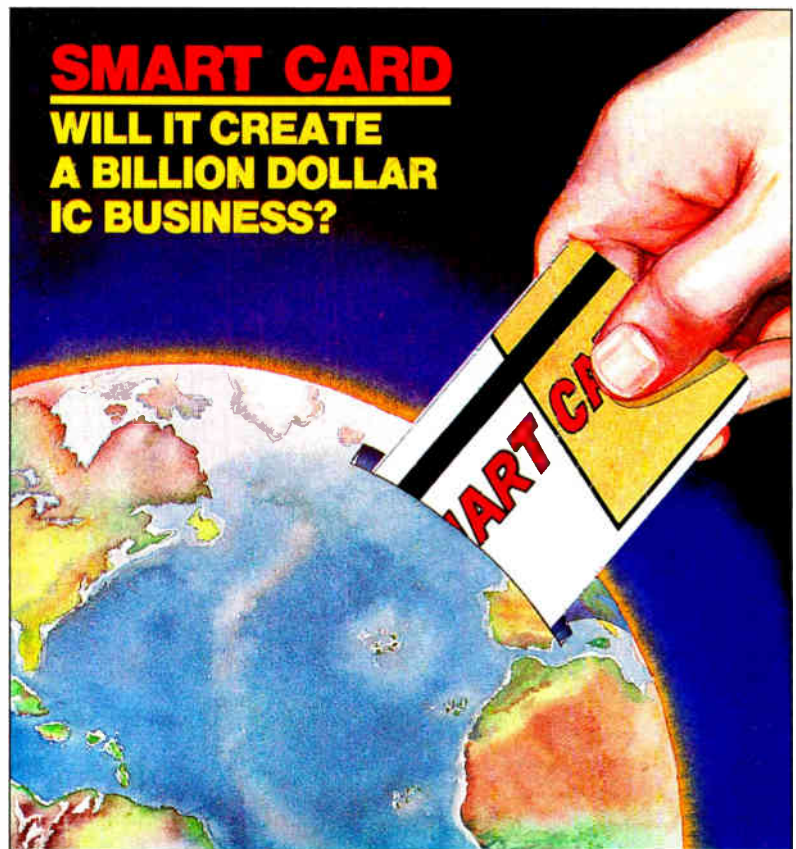
**NEW PRODUCTS****Newsletter, 25**

- LCD-controller chip from Hitachi could cut the cost and size of laptop computers
- Daisy CAD tool will tackle mixed analog-digital simulation
- IBM mainframes to get Boole & Babbage AI-based performance management

Design & Test, 129

- HP's mixed-signal IC tester runs at 128 MHz and can be fitted with as many as 182 test channels
- Enertec's universal counter comes with a built-in CRT display
- An in-circuit ROM and EPROM emulator from Beck-Tech costs only \$595
- A bench instrument from MWB Messwandler-BAU tests ICs for susceptibility to electrostatic discharge

Semiconductors, 135

- RCA's bipolar quad-gated driver limits temperature and current independently on each output
- Implosion-diode rectifier family from Philips is suited for surface mounting
- AT&T's 24-MHz 32-bit chip set targets high-performance, multitasking Unix applications

Components, 142

- Dupont's 1-Mb memory cards blend surface-mount and chip-on-board technologies in three compact packages
- A programmable light source from Lightgate monitors itself to maintain output level to within 1% of desired value
- Motorola's VMEbus-compatible board computer combines fast 32-bit processing with 1 megabyte of memory

DEPARTMENTS**Publisher's letter, 3**

There's a new dimension to Executive Outlook, now that we're surveying technologists as well as line executives

FYI, 8

One good reason why we're the only magazine doing our own market forecast: It's hard to do. Next month will mark 30 years of running this authoritative feature

Letters, 12**People, 16**

How the laser disk is refreshing one career

Meetings, 150**Electronics Week, 158**

- Honeywell leaves the computer field . . .
- . . . and forecasts its first yearly loss
- Panasonic will sell power MOS FETs and memory and logic products in the U. S.



MORRISON

STANFORD

YEARS FROM NOW, WILL YOUR MILITARY SUPPLIER BE JUST A BAD MEMORY?

It's no secret—there's a lot of uncertainty in the marketplace. You never know if the company you're dealing with today will still be around to service you tomorrow. And that's a chance you can't take—especially in the military market.

With INMOS, you're not taking any chances. We have a seven-year history of supporting all major military defense programs with static and dynamic RAMs. Our fabrication facilities are fully compliant with MIL-STD-883C; with military burn-in, performance testing and quality assurance conducted in Colorado Springs.

We have your future in mind with our new CMOS military SRAMs (with performance to 35ns over the full military temperature range) and military low power battery backup CMOS SRAM products. We're the only company in the world to produce 64K and 256K DRAMs with RAS access times down to 80ns, and we're going to keep on producing and servicing innovative military products year after year.

For military products you can depend on, count on INMOS—the beginning of a very good memory.

16K SRAMs		
Device	Process	Access Times
IMS1400M (x1)	NMOS	45, 55, 70ns
IMS1420M (x4)	NMOS	45, 55, 70ns
IMS1403M (x1)*	CMOS	35, 45, 55ns
IMS1423M (x4)	CMOS	35, 45, 55ns

64K CMOS SRAMs	
Device	Access Times
IMS1600M (x1)*	45, 55, 70ns
IMS1620M (x4)*	45, 55, 70ns
IMS1624M (OE, x4)*	45, 55, 70ns
IMS1630M (x8)*	45, 55, 70ns

MILITARY DRAMs		
Device	Process	RAS Access Times
IMS2600M (64Kx1)	NMOS	100, 120, 150ns
IMS2800M (256Kx1)	CMOS	80, 100, 120, 150ns
IMS2801M (256Kx1)	CMOS	80, 100, 120, 150ns

* Also available as Low Power Battery Backup CMOS SRAMs with Idr of 10µA (typical Icc at 2V at 25° centigrade)

inmos and IMS are trademarks of the INMOS Group of Companies.

MIL-STD-883C RAMs



INMOS, Colorado Springs, Colorado, Tel. (303) 630-4000;
Bristol, England, Tel. (0454) 616616;
Paris, France, Tel. (1) 46.87.22.01;
Munich, Germany, Tel. (089) 319 10 28;
Tokyo, Japan, Tel. 03-505-2840.

Circle 7 on reader service card

FYI



Quality Price Availability

Venus Scientific offers over 400 power supply systems; from 5 to 30,000 volts, up to 2,500 watts. Venus has the power supply solution for:

- Lasers
- Military
- Communications
- Aerospace
- Electronic Displays
- Research Labs

399 SMITH STREET
FARMINGDALE, N. Y.
11735
(516) 293-4100
TWX 510 224 6492

One good reason why we're the only magazine doing our own market forecast: It's hard to do. Next month will mark 30 years of running this authoritative feature



Here's a question: What is it that industry managers criticize or make sport of, yet can never get enough of when they're on the hook to develop a budget or product plan? Hint: Only one magazine is smart (dumb?) enough to tackle this impossible job for the electronics industry.

If you still can't guess the answer, grab the next issue of *Electronics*, which will hit the streets on Jan. 8, 1987. You'll see the latest installment of an innovation by this magazine that has become an unequaled classic: our annual market report. Our first 1987 issue will feature 24 jam-packed pages of data on U. S. markets, which as nearly as we can figure out will mark 30 years of running this authoritative feature.

There's a mighty good reason why we're the only magazine turning out our own forecast: It's darn hard to do. The data this year came from more than 500 companies as well as from several market researchers. We came up with the forecasts with the help of a computerized data-analysis system linked to our own electronic publishing system.

But we still have problems. Two of the biggest are getting little or no market data on a product category and the wide disparity in some estimates that companies give us. Major cause for these wide swings are misconceptions of what a category covers, says Art Erikson, executive news editor. Art, who spent November reporting in Europe for our Jan. 22 overseas market report, says: "I was once asked by a market statistician of a major British trade association whether we listed phonograph records as hardware or software." Needless to say, his association's data came in for extra scrutiny.

There always seems to be too many figures in one area and not enough in another, laments Howard Wolff, associate managing editor. Judging from the questionnaires, everyone in Japan has an insight into the pot and trimmer market, but not too many are willing or able to estimate the 1987 sales of satellite earth stations. Also, unfortunately for us, for every respondent like the Japanese marketer who completed his five-page questionnaire with every line on every page filled in, there are another half dozen others who toss our questionnaire in the round file. But we are quick to press on when we realize that our calculations are going to be read and probably used by more than a half million people.

ROBERT W. HENKEL



Cramped for space?

Ultra-miniature
snap action switch.
Fits where other switches won't
...or can't.

So small, a lot of them
will fit into your
densely packed PC board.

CHERRY 

SWITCHES

3600 Sunset Avenue, Waukegan, IL 60087
(312) 360-3500



ACTUAL SIZE
Series DH for low energy applications

Circle 9 on reader service card

NEC NEWSCOPE



NEW 32-BIT CMOS MICROPROCESSORS.

The two new members of NEC's CMOS microprocessor V-Series bring unprecedented density and performance in the 32-bit realm. The V60 and V70 supermicros are the first to integrate a Memory Management Unit and basic floating-point processing functions on a single chip.

The V60 has a 16-bit external data bus for an easy, affordable path into

32-bit products while the V70 is a full 32-bit engine designed to power leading-edge systems.

The super-fast V60 and V70 offer a clock speed of 16MHz, and execute 3.5 MIPS and 6 MIPS respectively. A six-stage pipelined CPU enables concurrent execution of up to 4 instructions. With 32 on-board 32-bit general-purpose registers, there is no need to access slow off-chip

memory.

The V60/V70 feature an on-chip memory management unit with 4 gigabytes of demand-paged virtual memory space, and 4 levels of memory protection for multi-tasking and multi-user environments.

The V60/V70 instruction set is ideal for high-level languages and OS support (UNIX™ V and proprietary realtime OS). There are 21 addressing modes, 273 instructions, and an emulation mode for 16-bit V20/V30 software.

NUMBER 136

COMING SOON: 1.3/1.55 μ DFB LASER DIODES.

Dispersion has always been a major obstacle in long-distance, high-speed light-wave communications. With conventional laser diodes emitting multiple spectrums, pulses deteriorate by dispersion after long travel through the fiber. This in turn limits repeater span to 20–30km and capacity to 400–560Mbps for the prevalent 1.3 μ fiber optic systems.

NEC has overcome this obstacle with newly-developed distributed feedback (DFB) laser diodes for 1.3 μ and 1.55 μ fiber optic transmission systems. They feature a stable single longitudinal mode operation, high efficiency and high output power. The new DFB laser diodes are expected to expand repeater span to 80–100km for 1.3 μ system or 100–200km for 1.55 μ system.

NEC's new DFB laser diodes inherit the renowned double channel planar-buried heterostructure (DC-PBH) and have a diffraction grating in the optical guide region to produce a single wavelength. Output powers are rated 8mw for the 1.3 μ NDL5600 and 5mw for the 1.55 μ NDL5650. They come in the TO-5 package with an integral monitor photo diode or chip-on-carrier configurations.

As matching light-receiving devices, NEC has planar type InGaAs avalanche photo diodes. They have a selective guard ring construction to achieve high sensitivity and excellent reliability.

NEW INTELLIGENT BUILDING COMPLEX AT VANCOUVER.

The intelligent building is an idea whose time has come. As the perfect nestling for office workers in the Information Age, it centers on an advanced information management system which provides simultaneous voice, data and image services to tenants at less cost while it controls the entire building environment efficiently.

The World Trade Centre/Pan-Pacific Vancouver Hotel recently opened is just such an installation. NEC's NEAX 2400 Information Management System (IMS) allows tenants to utilize enhanced telephone/facsimile services including least-cost routing, message center and voice mail services, and computer terminal connection via a multifunction



digital telephone set. The NEAX 2400 IMS also offers sophisticated services to hotel guests.

NEC's Intelligent Building Systems, based on our unique C&C (integrated computer and communications) technology, are the most advanced and comprehensive available today. As the core of this system, the modular NEAX 2400 IMS can expand to 255 tenant partitions. It supports more than a hundred advanced features including a protocol converter to allow communication with most popular

most computers. NEC also supplies comprehensive component equipment including multifunction digital telephones, information display pagers, high-speed facsimiles, business and personal computers, teleconferencing and CATV equipment and local distribution microwave links.

NEC's comprehensive systems breathe new life into the smart building concept, bringing costly services like teleconferencing within the reach of every business.

NEW HIGH-CAPACITY 64QAM DMR SERIES.

NEC's newest 800 Series high-capacity digital microwave radio (DMR) systems transmit two or three DS3 signals per RF carrier, utilizing 64-state quadrature amplitude modulation (64QAM) for effective use of radio spectrum.

Three systems meeting FCC standards are available: a 4GHz 90M-bit system providing 1,344 voice channels, and 6GHz and 11GHz 135M-bit

systems for 2,016 voice channels.

The new systems incorporate the latest LSIs, hybrid and microwave ICs throughout to achieve compact design, lower power consumption and improved system reliability. Housed in a standard 19-inch rack, they require minimal cabling work for installation.

The advanced 800 Series is fully compatible with Bell's facility maintenance and administration system.

NEC

Linear Voltage Regulators In Copper Packages

- No Oscillation
- No Soft Solder
- No Monolithic IC's
- Radiation Resistant
- Meets MIL-Std-883
- -55° to +125°C Operation

The unique design of Solitron's hi-rel Linear Voltage Regulators eliminates electrical, mechanical and environmental problems. Packaged in copper TO-3 cases, typical specifications include:

Solitron Part Numbers		V _{OUT}		V _{IN} Max.	I knee	I short ckt	
I _{OUT} = 3A	I _{OUT} = 5A	Value	Tol.	Tc = +25C	Typ. (Amps)		Max. \angle^{12}
		(Volts)	(± %)	(Volts)	I _{OUT} = 3A	I _{OUT} = 5A	(Amps)
CJSE 039	CJSE 074	+24	3	40	4.5	8.0	0.5
CJSE 048	CJSE 077	-24	3	40	4.5	8.0	0.5
CJSE 009	CJSE 080	+20	3	36	4.5	8.0	0.5
CJSE 010	CJSE 083	-20	3	36	4.5	8.0	0.5
CJSE 001	CJSE 086	+15	3	31	4.5	8.0	0.5
CJSE 002	CJSE 089	-15	3	31	4.5	8.0	0.5
CJSE 036	CJSE 092	+12	3	28	4.5	8.0	0.5
CJSE 045	CJSE 095	-12	3	28	4.5	8.0	0.5
CJSE 017	CJSE 800	+6	3	22	4.5	8.0	0.5
CJSE 018	CJSE 803	-6	3	22	4.5	8.0	0.5
CJSE 033	CJSE 806	+5	3	21	4.5	8.0	0.5
CJSE 042	CJSE 809	-5	3	21	4.5	8.0	0.5

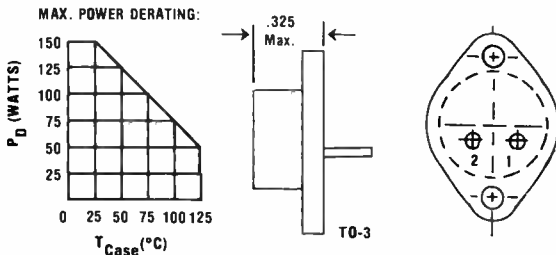

FUNC.	Configuration	
	A	B
V _{IN}	CASE	CASE
V _{OUT}	1	2
RTN	2	1

NOTES:

1. Conditions listed apply from -55°C to +125°C.
2. Tolerances indicated reflect the sum of all changes in V_{OUT} due to line, load and temperature.
3. V_{OUT} tolerances of ±1% and ±2% available upon request.
4. V_{OUT} tolerance at +25°C = ±1%.
5. Ripple rejection = 55 db min.
6. I (quiescent) = 50 Ma max.
7. θ_{JC} = 1°C/W typical.
8. Ordering information: Part numbers listed in table are for configuration A; for configuration B add suffix R to part number listed in the table (i.e. CJSE 039R).
9. For space savings, multiple regulators can be supplied in a common copper flatpack.
10. Output voltages from ±2V to ±50V available upon request.
11. Higher currents up to 50A available in copper flatpacks.
12. Higher short circuit current values available upon request.

Solitron

DEVICES, INC.

1177 Blue Heron Boulevard
Riviera Beach, FL 33404, U.S.A.
Tel: (305) 848-4311 • WATS: (800) 327-8462
TWX: (510) 952-7610 • Telex: 51-3435

LETTERS

Age discrimination?

To the Editor: The comment that Wayne Ponik "declines to state his age" in "Ostertag gets his kicks dealing with picoseconds" [*Electronics*, Nov. 13, 1986, p.74] makes Wayne come off a bit heavy, when in fact his age is no more relevant than his hat size or his religion. It is suprising, especially in light of recent heightened sensitivity to age, sex, and race discrimination, that *Electronics* still finds it necessary to pin an age on everybody, or to call attention to him when he refuses to give it.

Frederick Van Veen
Vice President
Teradyne Inc.
Boston, Mass.

Just in time for a bargain

To the editor: The recent article on a very accurate \$20,000 West German clock [*Electronics*, Oct. 30, 1986, p.38] was interesting and informative. Your readers might be interested in an American-made clock with similar accuracy, more utility, and a \$450 price tag. Precision Standard Time's OEM-10 radio-controlled clock provides accurate, reliable, and National Bureau of Standards-traceable time by receiving and decoding the transmissions from the NBS radio stations WWV in Colorado and WWVH in Hawaii. The clock can be controlled by a computer system over an RS-232-C port and hooked up to an optional digital display.

Rex A. Brown
Vice President, Marketing
Precision Standard Time Inc.
Santa Clara, Calif.

Ottawa was our Waterloo

To the Editor: As a faithful reader of *Electronics* since my years at the University of Waterloo, I was shocked to find in "How Jacob got into analog simulation" [*Electronics*, Oct. 30, 1986, p.82] that the University of Waterloo is in Ottawa! I reckon I was a bit angered because I am a Waterloo graduate. For your information, the University of Waterloo is in Waterloo, Ontario.

Calvin Chang
Computing Facilities Associate
Facilities Provisioning
Toronto, Ont.

That's Schottky!

Correction: The detector portion of the Honeywell Inc. GaAs optoelectronic receiver chip discussed in "GaAs Opto IC gets up to 200 gates" [*Electronics*, Nov. 13, p.31] was built by fabricating interdigitated Schottky contacts—not by using ion implantation, as was reported. The MES FETs on the device were built using ion implantation.

VME, Multibus and Multibus II: Package Your System to Win World-Wide Approval

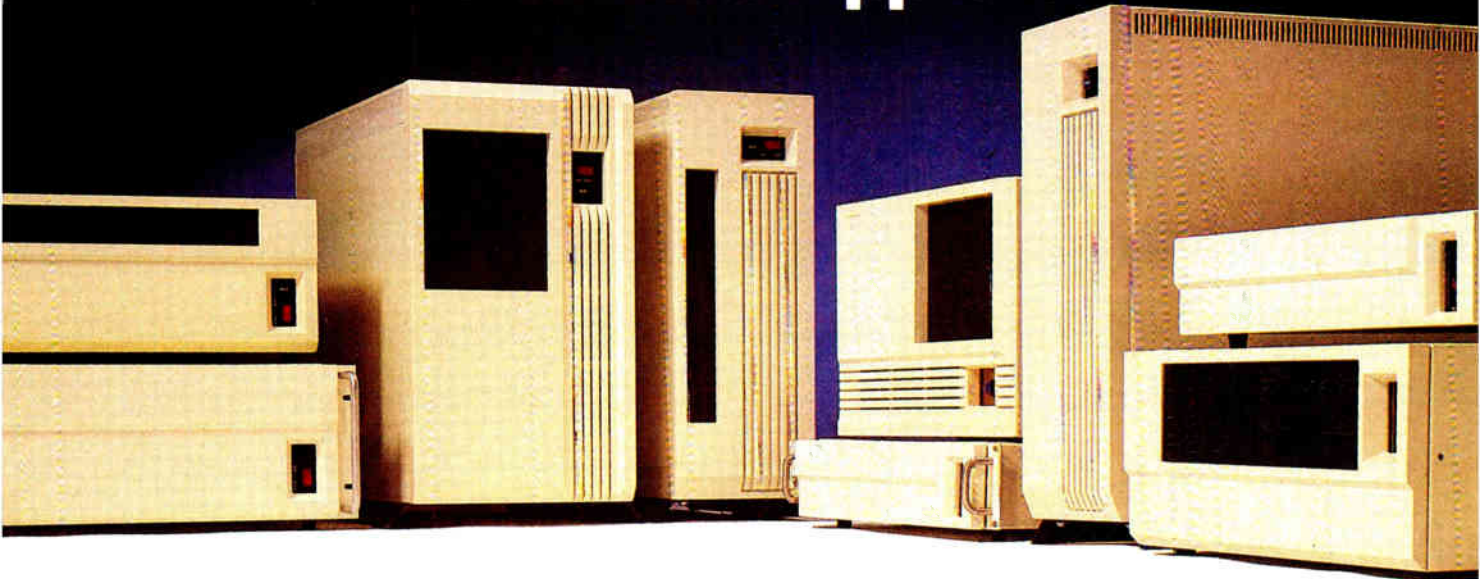

If you sell systems anywhere, you face an increasing number of safety and performance standards. Tough design specs that cost plenty to meet and cost plenty to prove you meet them.

So package your system in an Electronic Solutions enclosure. One that has already met these standards:



Canadian Standards Association

International Electrotechnical Commission

— including FCC Part 15 Class A EMI/RFI compliance that most VME or Multibus II card racks miss by a wide margin.

All you need to add are the cards.

Choose from a huge selection of attractive tabletop, rack-mount and floor-standing DeskMate™ enclosures with 3,4,5,7,10,11,12,13 or 15 card slots. In sizes from only 3½" high. Choose from many options: front, rear, or top card loading; mounting of up to eight half-height 5¼" peripherals; P1 and P2 backplane configurations; and power supply capacity up to 500 Watts.

So to help build your reputation take a little of ours. Our reputation for strength, ruggedness, reliability—and, of course, appearance.

To find an enclosure that meets your approval, call us today for complete catalogs on VME, Multibus and Multibus II System Packaging.

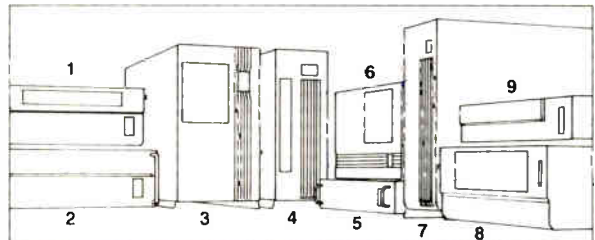

1. Series 7 with 2 half-height peripherals
5 slots VME, Multibus II; 7 slots Multibus I
2. Series 7 (shown with rack mounting)
7 slots VME, Multibus II; 10 slots Multibus I
3. Series 10 DeskMate with 4 full-/8 half-height peripherals
12 slots VME; 10 slots Multibus II; 15 slots Multibus I
4. Series 7 DeskMate
5 slots VME, Multibus II; 7 slots Multibus I
5. Series 3 (shown with rack mounting)
3 slots VME, Multibus II; 4 slots Multibus I
6. Series 10 with 4 full-/8 half-height peripherals
12 slots VME; 10 slots Multibus II; 15 slots Multibus I
7. Series 7 DeskMate
7 slots VME, Multibus II; 10 slots Multibus I
8. Series 7 with 2 full-/4 half-height peripherals
7 slots VME, Multibus II; 10 slots Multibus I
9. Series 3
3 slots VME, Multibus II; 4 slots Multibus I



Electronic Solutions
UNIT OF ZERO CORPORATION

9255 Chesapeake Drive, San Diego, CA 92123 • (619) 292-0242 Telex II (TWX): 910-335-1169

Call Toll Free: (800) 854-7086 In Calif: (800) 772-7086

H I G H P E R F O R M A

3000 miles



With little more than a westerly wind, a small group of adventurers pushed performance to the very edge.

In that same spirit, we at AMCC are committed to helping you get the maximum efficiency from your high performance semicustom designs.

We offer the broadest line of high performance semicustom products—because high performance semicustom is all we do. In fact, we've been successfully delivering efficient high performance arrays to America's top electronics companies for years. Take a look at our specs and you'll discover just how successful our way of thinking has become.

Discover New World Capabilities.

Our bipolar products offer speed/power programmability at the logic-gate level—to optimize performance and minimize overall power dissipation. In fact, you can get gate delays ranging from 225 to 600 picoseconds, depending upon the level of macro performance desired. With densities of up to 5000 equivalent gates. You can even specify a QM1600S with 1280 bits of static RAM and 1600 logic gates together on one chip.

In addition, our high-density CMOS arrays (up to 10,000 gates) also offer extraordinary performance and efficiency. Typically 1.1ns (while dissipating less than 20 μ W per gate per MHz). And, if required for your application, all our devices, both bipolar and CMOS, can be processed to MIL-STD-883C Methods.

Something Unexpected On The Horizon.

When you bring us your design ideas, you'll also discover a combination you may not expect. Because in addition to high performance bipolar and CMOS products, we've also brought

N C E E F F I C I E N C Y

per galleon.

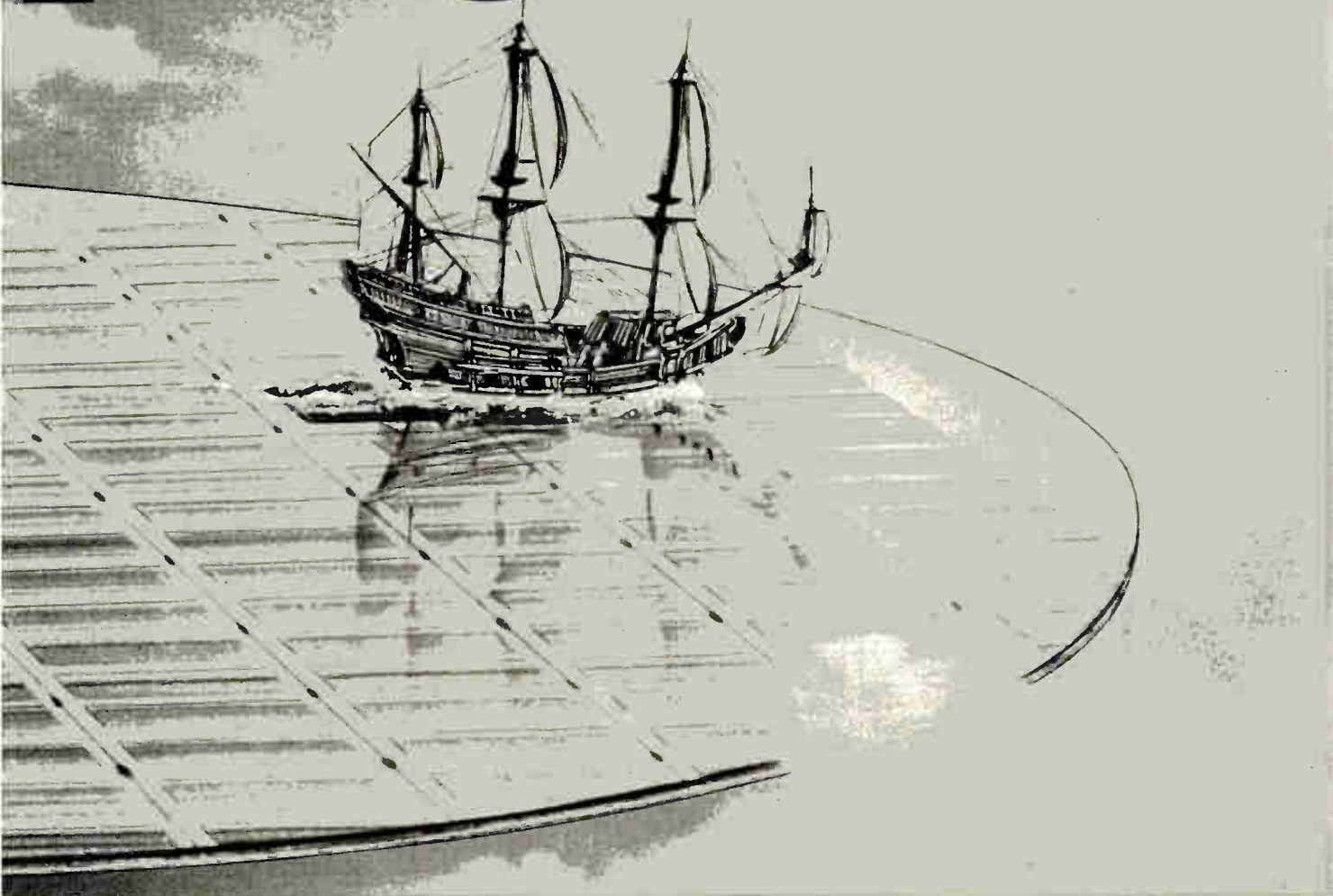

high performance service into view. With our MacroMatrix™ software kit, we can implement your designs, whether they've been generated on your CAD system, by you at our design center or specifically by us for you. MacroMatrix is supported on Daisy™, Mentor Graphics™, Tektronix/CAE™, Valid™ and Tegas™.

Chart A Course For Your Own New World.

That's exactly the kind of performance capabilities you'd expect from the company that was first to offer a flexible design interface and first to deliver mixed ECL/TTL arrays.

Arrays that substantially reduce overall parts count and system power requirements, and simplify component interface.

So when you're ready for the full story on the only independent, high performance semicustom supplier that works side-by-side with you—to

ensure that your designs work right the first time—simply call (619) 450-9333, write us at 5502 Oberlin Drive, San Diego, CA 92121 or circle the reader service number below. In Europe, call AMCC (U.K.) at (44) 256-468186.

AMCC. Dedicated to discovering high performance semicustom solutions...and delivering them.

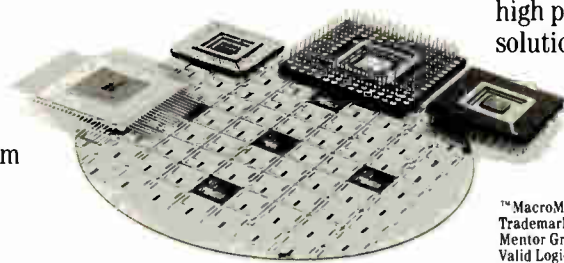

™ MacroMatrix is a trademark of Applied Micro Circuits Corp. Trademarks: Daisy—Daisy System® Corp.; Mentor Graphics—Mentor Graphics Corp.; Tektronix/CAE—Tektronix; Valid—Valid Logic Systems, Inc.; Tegas—Calma, a division of General Electric Co.

Circle 15 on reader service card

AVAILABLE!

1986-'87 Electronics Buyers' Guide

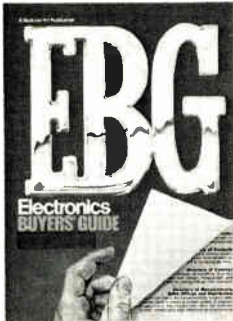

Order your copy today for the industry's most often-used directory:

- It's three directories in one
- Includes more than 4,000 product listings. (approx. 700 pages)
- Contains over 5,000 company listings (approx. 400 pages) including:
 - Company name, address and phone number.
 - Name and title of contact for sales information.
 - Number of engineers at plant and number of employees.
 - Annual dollar sales volume.
 - Local sales offices and manufacturers representatives.
 - Local distributors.
 - Instant referral to company's advertisements.
- Offers FREE current catalog retrieval service (approx. 1300 catalogs)

Price: \$40 USA & Canada
\$50 elsewhere
(add \$30 for airmail)

Send order with payment to:
Regina Hera

Electronics Buyers' Guide
1221 Avenue of the Americas
New York, NY 10020



PEOPLE

HOW THE LASER DISK IS RESHAPING ONE CAREER

As the producer, writer, and host of 65 half-hour television shows on consumer health for Westinghouse Broadcasting, and a communications consultant for Twentieth Century Fox and Viacom, Jim Mason seemed destined for a career in television. But with a degree in public health from the Yale School of Medicine and teaching experience at Boston University Medical School, Mason also had the qualifications for a future in academia.

So he went into electronics.

It started three years ago, says the 38-year-old Boston native, when he be-

came interested in interactive laser-disk technology and was struck by its potential, especially with its promise as a cost-effective educational tool. After spending a year of what he calls "tracking the technology," Mason believed he had found a way to improve what he saw as a longstanding problem—the inability of industry to effectively communicate health-care information, especially in training employees about hazards on the job.

The result: Interactive Medical Communications, a company Mason founded in 1984 to meet the training needs of American industry. Earlier this year, the Boston-based company completed a contract with General Motors Corp. to train more than 400,000 employees in 147 locations across the country.

The medium will be interactive laser-disk systems, or ILDS, which are fast becoming a hot educational item. Comparing the ILDS with the much-heralded but ill-fated computer-aided instruction, Mason sees interactive laser disks as a revolutionary advance, because the systems are like television sets rather than computers.

"CAI provides a rather impersonal approach to learning—it's you and your computer. [With ILDS] we use live-action footage and create a highly engaging and entertaining TV program. We're drawing upon the emotional and visual power of TV and marrying it to the speed and power of the computer."

In the General Motors program, workers are trained to understand the hazards in the workplace by using a touchscreen to answer questions as they watch slickly produced training videos.

The system keeps track of each worker's progress, recording the information that gives an employee trouble and generating a review program. Since employees are trained individually, they work at their own pace and are not intimidated when they don't understand course material.

Such versatility has not been lost on IBM Corp. This fall it threw its hat into the ILDS ring, introducing a system designed to help reduce adult illiteracy and claiming very positive test results.

Mason maintains that ILDS effectively trains employees in an average of one

third less time than the conventional training methods, such as classroom audio-visual presentations. "Interactive laser-disk training has become the only practical way to make sure employees understand and retain vital information, which in turn they can apply in the workplace."

A system from Interactive Medical Communications consists of a color touchscreen monitor, a microcomputer with 640-K



MASON: Marrying TV's qualities and the computer's power.

random-access memory and a 20-Mb hard disk, and a laser-disk player. Branching software is used to create programs that adapt to an individual's progress. In a typical 30-minute disk, a worker will make 40 to 80 decisions that can result in a tremendous number of paths—there are on the order of 10^6 .

Producing an effective laser-disk program is a team effort, says Mason. In addition to content and software expertise, good production values are essential to the program's credibility. "People aren't going to believe a visual image that is not similar to TV," says Mason. A single disk for the General Motors training program took eight months to develop.

Although working with health-oriented material is his company's strong point, Mason says IMC has now developed proprietary tools that will enable it to branch out in areas such as engineering management and other industry-specific applications. Eventually, Mason sees ILDS as reaching even the home market. Claims Mason: "Because it is responsive and identifies the unique needs of each learner, ILDS can be used for virtually any kind of instructional program."
—Rick Elliot

From the Electronics Engineers & Designers Book Service: The books that keep you on the cutting edge of technology

Engineers at the forefront of technology count on the EE&D Book Service for the professional books that help them stay there. EE&D is your direct access to those newly published but hard to find technical books from all the leading publishers.

The newest and best books PLUS:

- **PRE-SCREENING BY TECHNICAL ADVISORS.** Our Advisory Panel of engineers guarantees that each selection is the most current and complete treatment of the topic.
- **TREMENDOUS SAVINGS.** You save up to \$47.25 on the introductory book, and keep saving 20-35% on every book thereafter.
- **SUPERIOR QUALITY.** All books are publishers' original editions.

• YOUR PROFESSIONAL BOOKSTORE BY MAIL.

Every 3-4 weeks, you'll receive the EE&D Bulletin describing the Main Selection and Alternates. If you want the Main Selection, do nothing and it will come automatically. For an alternate selection (or none at all), mark your preference on the reply card and return it by the date specified. You'll always have at least 10 days to decide.

As an EE&D member, you are only obligated to purchase 3 books (in addition to the \$2.75 selection) during the next year, and may cancel any time after that.

Choose
the one you want
first for just
\$2.75
save up to \$47.25!

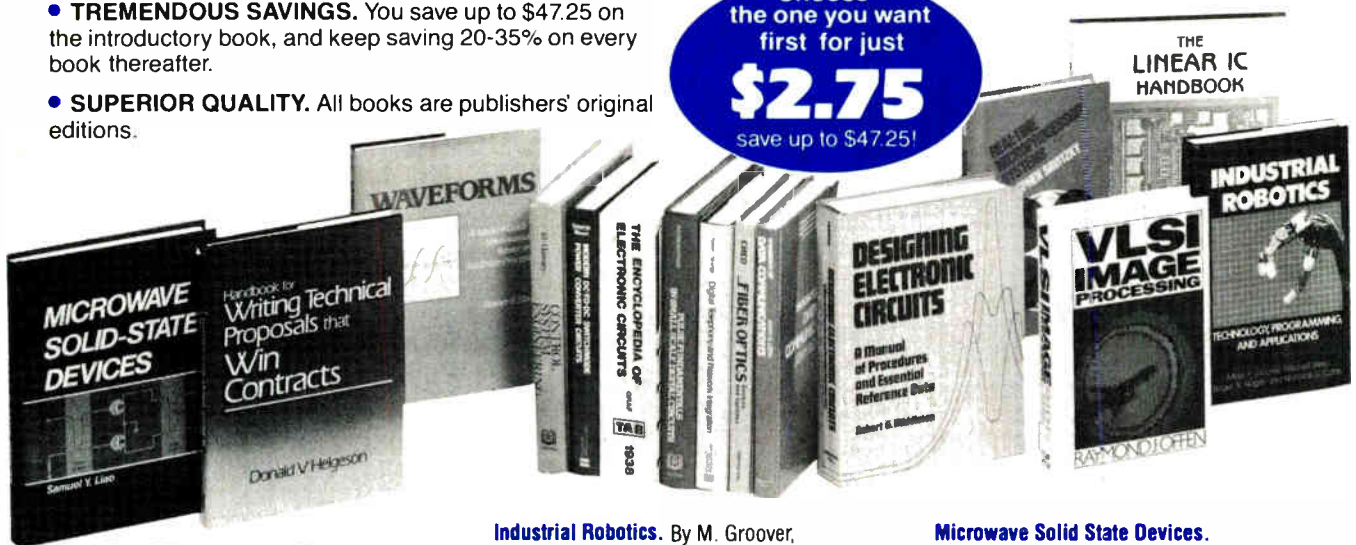

Real-Time Microprocessor Systems.

By S. Savitsky
767111 Pub. pr. \$47.50

Modern DC-to-DC Switchmode Power Converter Circuits.

By R. Severns & G. Bloom
591040 Pub. pr. \$44.95

Digital Telephony & Network Integration.

By B. Keiser
212597 Pub. pr. \$44.50

Encyclopedia of Electronic Circuits.

By R. Graf
069914 Pub. pr. \$50.00

The Linear IC Handbook.

By M. Morley
537308 Pub. pr. \$49.50

Industrial Robotics.

By M. Groover,
M. Weiss, R. Nagel & N. Odrey
463224 Pub. pr. \$43.95

Designing Electronic Circuits.

By D. Middleton
200659 Pub. pr. \$36.95

Handbook for Writing Technical Proposals That Win Contracts.

By D. Helgeson
379685 Pub. pr. \$24.95

Waveforms: A Modern Guide to Nonsinusoidal Waves & Nonlinear Processes.

By J. Tilton
946095 Pub. pr. \$33.95

VLSI Signal Processing.

By R. Offen
942722 Pub. pr. \$36.95

Microwave Solid State Devices.

By S. Liao
580571 Pub. pr. \$44.95

Pulse Fundamentals in Small Scale Digital Circuits.

By W. Baumgartner
R57571 Pub. pr. \$34.95

Control Systems Engineering.

By M. El-Hawary
R10158 Pub. pr. \$39.95

Handbook of Data Communications.

By J. Lenk
377317 Pub. pr. \$31.75

Fiber Optics: Devices and Systems.

By P. Cheo
314203 Pub. pr. \$36.95

Card missing? Write to:

Electronics Engineers & Designers
Book Service
A Prentice-Hall Book Club
P.O. Box 442
West Nyack, NY 10995

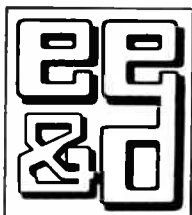

Electronics Engineers & Designers Book Service

A Prentice-Hall Book Club

P.O. Box 442 West Nyack, NY 10995

SEND NO MONEY!

YES, I want the benefits of EE&D membership. Please rush me the book indicated for 10 day free trial. If not 100% satisfied, I'll return it and owe nothing. Otherwise, I'll pay just \$2.75 (plus shipping, handling and applicable sales tax, which are added to all shipments) and agree to purchase 3 additional books at members' discounts during the year, according to the terms of this offer. (Not valid without signature.)

Book #

Signature _____

Name _____

Address/Apt. _____

City/State/Zip _____

For new members only, in the Continental USA and Canada. Enrollment subject to acceptance by EE&D.

Electronics 52-1 EE102-AA(5)

Digital has it now.



The graphics workstations with the largest library of CAE/CAD software in the industry.

Our new VAXstation™ graphics workstations have outstanding hardware performance. Even more important is the amount of electronic design software they run. They offer a huge library from both Digital and Digital's Cooperative Marketing Program Suppliers – all with full service and support. In addition, VAXstation workstations run all the VAX™ software. So every phase of your project, from design to documentation, can be integrated right at your desk and throughout your department. And that's performance no other workstation can give you.

For more information and our expanding list of Cooperative Marketing Program Suppliers, write: Digital Equipment Corporation, 200 Baker Avenue, West Concord, MA 01742. Or call your local sales office.

digital™

ELECTRONICS NEWSLETTER

HONEYWELL DROPS PRODUCT EFFORTS IN COMMERCIAL DIGITAL GaAs

Honeywell Inc. is phasing out commercial-product efforts in the slowly developing market for digital gallium arsenide ICs. The GaAs-IC product line fell victim to corporate cost-cutting measures announced by Honeywell in September—in fact, company officials confirm that they are reviewing efforts in the merchant silicon market as well. With the GaAs move, Honeywell's new GaAs production facility in Richardson, Texas, will be converted to support an expanding thrust into silicon solid-state sensors, after existing contracts for Honeywell's GaAs gate arrays and custom ICs are completed. Honeywell officials add that GaAs research and government work will be consolidated at the company's Physical Sciences Center in Bloomington, Minn. □

IBM STEPS UP ITS COMMITMENT TO SUPERCOMPUTERS

IBM Corp. appears to be punching up its drive to develop supercomputers. That's how industry watchers interpret the creation last week of a new post in IBM's Data Systems Division—the White Plains, N. Y., division that manufactures IBM's 3090 series of large processors. The job, which carries the title of vice president for engineering and scientific computing, will be filled by Irving Wladawsky-Berger, now the division's vice president of development; he earlier served as vice president of systems and director of computer sciences in IBM's Research Division. He will have worldwide responsibility for the strategy, development, and technical support of IBM's supercomputer. Another indication of the stronger commitment to supercomputers is a realignment of operations in what IBM calls "numerically intensive computing" and everyone else calls "supercomputing." As part of the realignment, the Information Systems Group, which is the marketing and service arm of the company, will establish new centers at IBM's facility in Kingston, N. Y., and at its Palo Alto, Calif., Scientific Center to explore advanced technology, develop applications, offer customer support, and sponsor research at colleges. □

U. S. TO PROBE JAPAN'S SUPERCOMPUTER BARRIERS

Determined not to lose America's leadership position in supercomputer technology, the federal government is launching a three-month investigation into Japanese trade practices that have excluded U. S. makers from the Japanese market. "If Japan is targeting the supercomputer industry for dominance—as it has other industries—we have to study how that will affect the U. S. economy and national security," says a spokesman from the U. S. Trade Representative's office, which will conduct the investigation. The U. S. dominates the worldwide market, with 86% of the 168 supercomputers in operation. But in Japan, only 6 of 26 supercomputers are U. S.-made. □

GE TECHNIQUE FOR VERTICAL VIA HOLES PROMISES DENSER VLSI

An enhanced chemical-vapor-deposition technique for metallizing vias promises denser very large-scale integrated circuits. The selective CVD tungsten technique developed by General Electric Co. permits the use of vertical via holes, which require two to five times less real estate than the tapered vias used in conventional circuitry. GE has licensed Genus Inc., Mountain View, Calif., to build equipment for the double-layer-metal process. The GE Research and Development Center in Schenectady, N. Y., already has prototypes of the CVD machine and has used them in tests for a new family of 1.2- μ m gate arrays. GE says yields are better than 95%—high enough to make the company consider adapting its current 1.2- μ m VLSI technology to the new approach. If it does, production chips would emerge in late 1987. □

ELECTRONICS NEWSLETTER

THE PENTAGON PUSHES AN INDUSTRY TECHNOLOGY CONSORTIUM...

The Defense Department, worried about being cut off from leading-edge memory technology, has taken the initiative from industry with a plan to improve commercial semiconductor-manufacturing technology through a federally supported consortium. A Defense Science Board task force is finishing a report, to be submitted next month, that is said to recommend \$1.25 billion in funding, which will be spent over a five-year period, for an industry consortium to develop the technology and the equipment to build advanced dynamic random-access memories. The proposed consortium is considered a good bet for Pentagon approval, and could begin operation next year if the Defense Department can find the funds. □

... AND THE SIA SEEKS TO FORM A MANUFACTURING CO-OP

Apparently lagging behind the Pentagon task force is a Semiconductor Industry Association steering committee that's exploring ways to get federal money for a manufacturing cooperative. Nicknamed Sematech, the co-op would develop dynamic random-access memories as a manufacturing and technology driver. The SIA panel will not report until March. Fears that the DOD plan would swallow up the Sematech effort were discounted by Charles E. Sporck, president of National Semiconductor Corp. and head of the Sematech committee. "Sematech is still under development, and is not linked to the Defense Department." Adds Larry Sumney, president of the industry cooperative, Semiconductor Research Corp., "Everyone feels that something significant will have to be done, on a cooperative basis; I don't think everyone agrees on what that something should be." He says the science board's plan and Sematech were conceptually similar, "but details on each side will be different because the different interests involved aren't identified yet." □

INTEL AND AT&T SIGN A DEAL TO COOPERATE ON ISDN

Intel Corp. and AT&T Co. have signed a cooperative agreement to verify the interoperability of their integrated services digital network (ISDN) chip sets, beginning with the companies' 4-wire transceivers. AT&T is embracing an open-systems strategy for ISDN in an attempt to speed ISDN to commercial reality, and the company is betting that signing with the Santa Clara, Calif., chip maker will help cement it in a leadership role. For its part, Intel hopes the deal can strengthen its position as an ISDN chip supplier. The accord holds great promise for future developments between the two companies—the two are discussing more such deals—and AT&T says it has not ruled out similar agreements with other companies. □

SIA CHANGES SAMPLE TO GET MORE ACCURATE BOOK/BILL FIGURES

The Semiconductor Industry Association is revising the sample from which it calculates the preliminary book/bill figures released at about the middle of each month because its findings were revised upward eight times during 1986. CMOS and semicustom sales, which have accounted for a greater share of market and have caused swings of as much as 5% in estimated and actual bookings, were added to the sample, the SIA says. Using the new sample, which is supposed to include at least 40% of the U. S. market, the SIA estimates three-month average bookings for November at \$720.1 million and average billings at \$723.8 million, for a book/bill ratio of 0.99. It is the second month in a row that the closely watched index has risen. SIA statistician Douglas Andrey attributes the increase to continued slow growth in end-user markets and the long-awaited withering of inflated inventories at original-equipment manufacturers. □



MOTOROLA

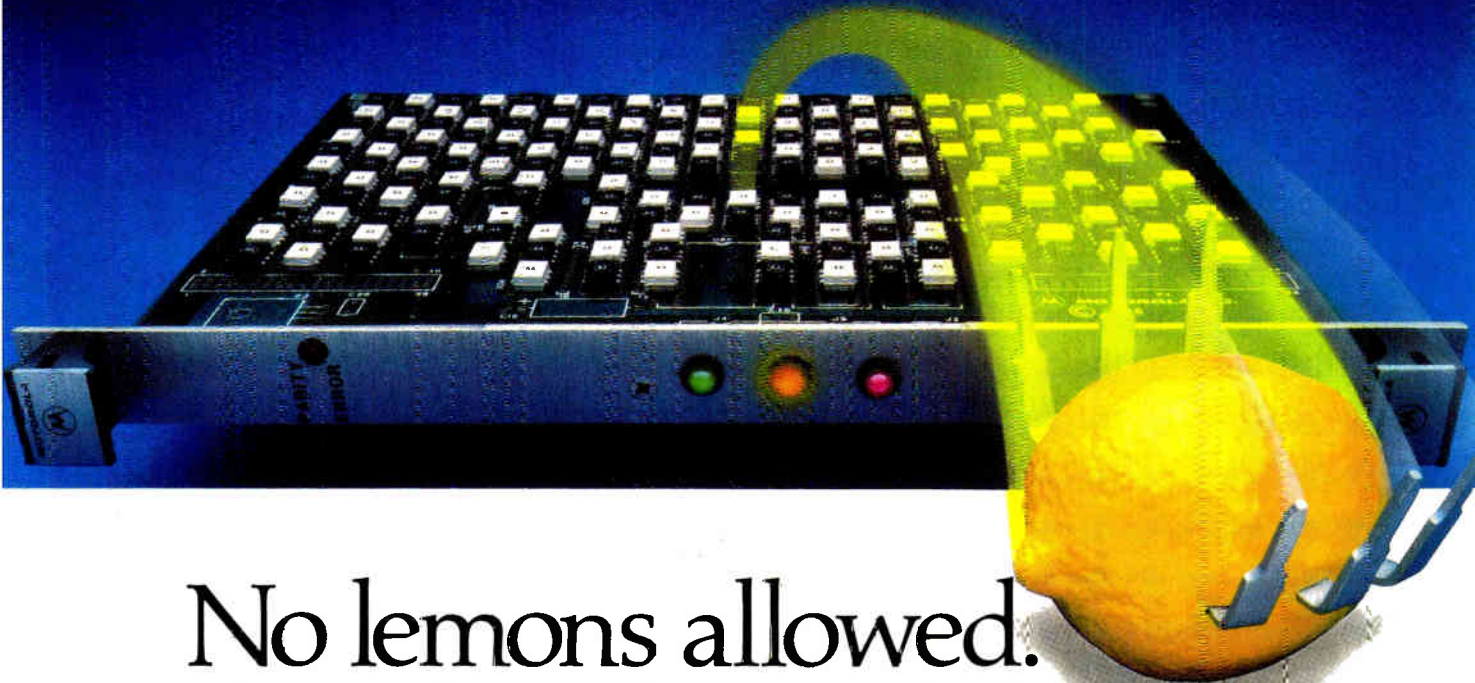

No lemons allowed.

Lots of optoisolator quality or we take the lot back. Free.

No questions asked.

If you find just one of our optoisolators out of spec, out of order or out of tune with your expectations and requirements for quality and reliability, return the lot and we'll replace it at no charge.

That's how much confidence we've got in our entire line-up of high-quality, high-reliability optoisolators.

The same confidence you can feel when you design them in.

Motorola optoisolator AOQ. Guaranteed 50 PPM.

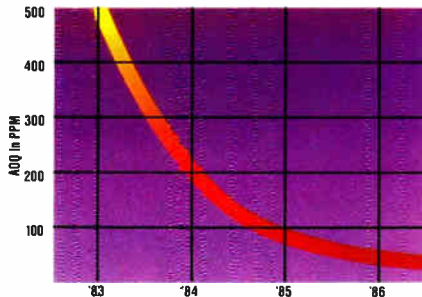

Look at the best in class.

It'll be us.

We tested* our 6-pin DIP optoisolators against a wide variety of other types and found no device exceeded the quality, performance and package integrity of ours.

* 1,000-hour intermittent life, high-temperature storage, LED burn-in, temperature cycle/shock with 0 failures.

In fact, our optoisolator package has continually been improved and upgraded to where our newest version—the white, domed-packaged unit with 20% fewer piece parts/assembly steps—received immediate, unqualified acceptance by VDE and UL—the most demanding regulatory agencies in the world for human safety and equipment protection.

Top integrity in a wide selection.

First, and still the only, to offer 7,500 V peak isolation protection between input and output, across the board, Motorola offers both black- and white-packaged optoisolators with the security for big AC applications—easily interfacing sensitive, expensive control logic to line voltage.

And our entire, volume-produced line of 150 4N-, MOC- and industry-standard devices meets this rugged requirement: transistor, Darlington, SCR, Triac driver or logic output type.

One-on-one design-in help.

1-800-521-6274

Get an engineer-to-engineer update on the latest Motorola optoisolator technology. Call toll-free any weekday, 8:00 a.m. to 4:30 p.m., M.S.T. Or we'll have an applications engineer drop by. For a free 4N35 domed package kit, send the coupon to Motorola Semiconductor Products, Inc., P.O. Box 20912, Phoenix, AZ 85036.

We're
on your
design-in
team.



MOTOROLA

To: Motorola Semiconductor Products, Inc.
P.O. Box 20912, Phoenix, AZ 85036
Please send me a Free 4N35 Motorola Optoisolator kit.

311E1EX12CB86

Name _____

Title _____

Company _____

Address _____

City _____ State _____ Zip _____

Call me (_____) _____

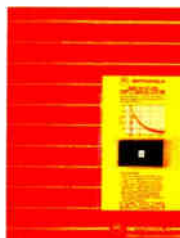

**“Who else could squeeze 512 analog input channels on 2 MULTIBUS™ boards?
Or even 128 channels on one? We’ve done both.”**

Try this on for size.

Data Translation’s new DT712 has 128 analog input channels. More than any other A/D board on the market. Add the DT713 to get 512 inputs.

Engineers faced with a lot of analog sensor inputs no longer have to add on a ton of extra boards for industrial process control applications.

Now all they need is one. Ours.

The DT712 is also extremely economical. With more channels, the cost per channel is at least a third less than anything the competition can offer.

Besides greater cost efficiency, the DT712 also

includes multiple triggering and scanning schemes, and an on-board programmable clock. Plus, a unique screw terminal panel lets you enjoy easy installation of analog signals, and a very clean, noise-free cabling connection.

And the DT712 is compatible with the latest MULTIBUS interface... including 24-bit addressing and 16-bit data transfers.

So before you get into a tight spot, call Data Translation.

We’ve loosened up the problem 512 ways.
Call (617) 481-3700.

The DT712 provides for up to 128 A/D channels on a single MULTIBUS board.



Fred Molinari, President

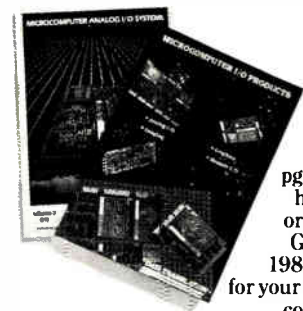
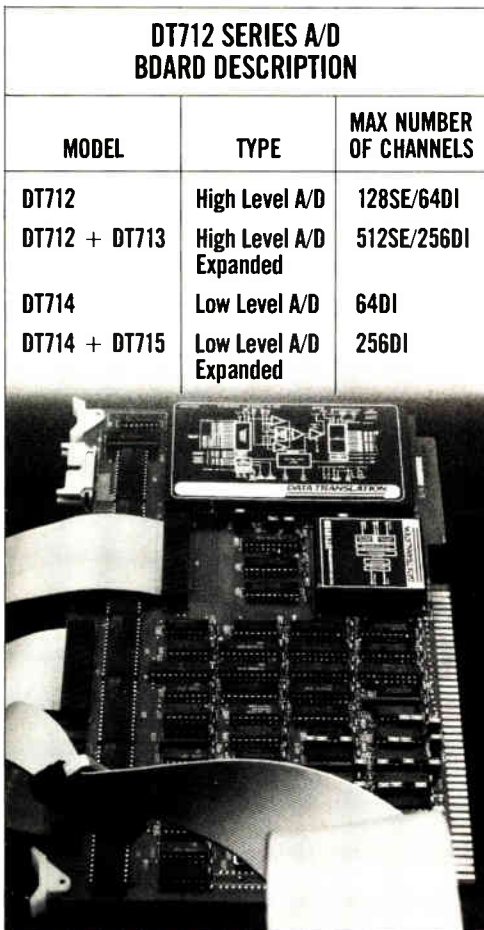

See our new 646 pg. catalog/handbook or see us in Gold Book 1986. Or call for your personal copy today.

DATA TRANSLATION

World Headquarters: Data Translation, Inc., 100 Locke Dr., Marlboro, MA 01752 (617) 481-3700 Tlx 951 646
 European Headquarters: Data Translation, Ltd., 13 The Business Centre, Molly Millars Lane, Wokingham Berks, RG112QZ England Tlx 851849862 (#D)
 International Sales Offices: Australia (61) 2-6635289; Belgium (32) 2-7352135; Canada (416) 625-1907; Chile (2) 2-253689; China (408) 727-8222; (86) 87214317; Denmark (02) 187188; England (44) 0734-793838; Finland (358) 0-372-144; France (33) 146306839; Greece (30) 031-527039; (30) 13-614300; (30) 95-14944; Hong Kong (852) 3-324563; India (91) 2-231040; Israel (972) 3-324298; Italy (39) 2349751; Japan (81) 3-502-5550; (81) 3-348-8301; (81) 3-355-1111; Korea (82) 753-3101; Malaysia (60) 3-36299; Morocco (21) 3-30-6949; Netherlands (31) 70996360; New Zealand (61) 2-663-5289; Norway (47) (02) 559050; Peru (51) (14) 31-8060; Philippines 818-0103; Portugal (351) 1545313; Singapore (65) 271-3163; South Africa (27) 12469221; Spain (34) 14558112; Sweden (46) 87617820; Switzerland (41) 17231410; (41) 22360830; Taiwan (86) 2-721-7864; (86) 2-531-2434; West Germany (49) 89809020.

Circle 24 on reader service card

World Radio History

MULTIBUS is a registered trademark of Intel Corp.

PRODUCTS NEWSLETTER

LCD-CONTROLLER CHIP COULD CUT COST AND SIZE OF LAPTOP COMPUTERS

Portable and laptop computer manufacturers looking to cut costs and the size of their products will want to take a look at Hitachi America Ltd.'s new liquid-crystal-display controller chip. The company says that its new CMOS chip, which replaces 30 separate n-MOS devices, will reduce controller-board space by 40% to 50% and costs by 40%. The monolithic device will enhance system reliability and reduce controller power requirements, the San Jose, Calif., company says. Compatible with industry-standard software, it can control screen sizes up to 1,024 by 2,048 dots—high resolution for laptops. The HD63645 is for Motorola Corp. microprocessors; the HD64645 version interfaces Intel Corp. products. Samples will be available early in January, and production will start later in the first quarter of 1987. In 10,000-piece quantities, the chips will cost \$7.10 each. □

DAISY CAD TOOL TACKLES MIXED ANALOG-DIGITAL SIMULATION

Daisy Systems Corp. is tackling a nagging shortcoming of computer-aided design: simulating the behavior of combination analog-digital circuits. The Mountain View, Calif., company's A-D Lab tool combines Daisy's D-Spice analog simulator and DLS digital simulator through a common interface and data base. Users interactively simulate combination circuits by driving the simulation of each stage with the previous stage. The tool takes into account component technologies, loading, and drives to achieve an exact translation between analog and digital signals. The software will be available later this month on the company's Logician work station and in February on the IBM Personal Computer AT and compatible work stations. The software for the Logician sells for \$5,000. □

IBM MAINFRAMES TO GET AI-BASED PERFORMANCE MANAGEMENT

DASD Advisor, the first in a series of artificial-intelligence products that will help manage the performance of IBM Corp. mainframes, is due next spring from Boole & Babbage Inc. of Sunnyvale, Calif. DASD Advisor interprets data from B&B's DASD (for Direct-Access Storage-Device) Response Manager, a set of programs for gathering and monitoring data on storage-device workloads, and then makes suggestions for load balancing to optimize the use of large systems. Based on AI tools developed at the Aion Corp., Palo Alto, Calif., the Advisor series will consist of extensions to B&B's current products and will be implemented across the entire product line. The DASD Advisor came first because IBM studies show that input/output operations on large disk-drive systems account for 70% of response-time problems and 50% of system costs. Prices for the packages are expected to range between \$10,000 and \$30,000. □

MOTOROLA CUTS PRICES OF ITS FAST CMOS SRAMs BY UP TO 39%

Motorola Inc. is slashing prices on its fast, 1.5- μ m double-metal, double-polysilicon CMOS static random-access memories by as much as 39%. According to Motorola memory executives in Austin, Texas, intense competition among makers of fast SRAMs [*Electronics*, Aug. 7, 1986, p. 121] was a factor, but the higher yields the company is getting keep the line profitable at the lower prices. The deepest percentage cut is in the price of the 25-ns, 4-K-by-4-bit MCM6268P25 SRAM, which now sells for \$8.40 each in plastic DIPs—down from \$13.65—in 500-piece quantities. Prices for a half dozen types of 64-K SRAMs with access speeds of 25 and 35 ns are being trimmed by 10% to 17%. For instance, the 64-K-by-1-bit MCM6287L25 in a ceramic package is now \$42.90 each, down from \$50.70. □

PRODUCTS NEWSLETTER

ETA SYSTEMS' FIRST SUPERCOMPUTER RUNS AT 3.5 GIGAFLOPS

ETA Systems Inc. will start shipping its first product, the E-Series ETA¹⁰ supercomputer, this month or in January. The multiprocessor system will run 20% to 25% below expectations, at 0.8 billion to 3.5 billion floating-point operations/s, but that still tops the fastest Cray supercomputer, which runs at 1.2 gigaflops. Moreover, later in 1987, the St. Paul, Minn., company plans to field another series it says will perform up to expectations. The E Series comes with from one to four central processing units, each equipped with 32 megabytes of local memory and from 256 megabytes to 2 gigabytes of shared memory. Prices range from about \$6 million to \$12 million. Higher performance will arrive late next year with the G Series, incorporating faster versions of the 20,000-gate CMOS arrays that are the heart of both systems. The G Series will cost about \$25 million for an eight-processor system that should hit the 10-gigaflops peak speed for which the ETA¹⁰ was named. ETA split the project into two series when it encountered problems with the gate arrays [*Electronics*, July 24, 1986, p. 21]. □

DATA TRANSLATION'S BOARD BOOSTS A-D THROUGHPUT ON PCs

Data Translation Inc.'s latest data-acquisition board doubles the analog-to-digital conversion rate of its industry-leading boards for the Compaq 386 PC and offers similar improved performance for many other personal computers. The Marlboro, Mass., company claims its DT 2821-G will support throughput at 250 KHz on the Compaq and rates in the 180-to-235-KHz range for the IBM Personal Computer AT and compatibles, depending on clock speed. The single-board system has 12-bit resolution for 16 single-ended or 8 differential analog inputs. It uses a proprietary direct-memory-access technique for uninterrupted data acquisition. On-board hardware includes two 12-bit analog-to-digital converters and a channel-gain inventory list stored in RAM for a-d sampling control. Targeted for use in high-speed data-acquisition and analytical applications, the 2821-G is available now for \$2,995. □

APPLITEK SIMPLIFIES LAN FOR SPERRY OR BURROUGHS COMPUTERS

Aplitek Corp. is making Burroughs and Sperry local-area networks from Unisys Corp. more flexible. One version of its NI10/G gateway allows Burroughs host computers to communicate with asynchronous terminals such as Digital Equipment Corp. VT100s as well as with Burroughs MT983 terminals. A similar gateway will link Sperry hosts using Univac VTS20 terminals and asynchronous terminals. The Wakefield, Mass., company's LAN gateways, priced at \$11,700, allow hundreds of terminals to communicate at distances of up to 20 miles. The gateways accommodate baseband, broadband, or fiber-optic cable. □

QRONOS SOFTWARE TAKES BIG STEP TOWARD OPEN ARCHITECTURE FOR CIM

A big step toward an open architecture for computer-integrated manufacturing is coming from Qronos Technology Inc. Developed with IBM Corp., Production Master runs on the IBM System/88 computer but lets other CIM systems access its decision-support programs. The Cupertino, Calif., company's software also is truly generic, because it works for any industry using batch and continuous-process manufacturing techniques. Production Master's programs include those for inventory, engineering data, and resource management. The product also handles security and on-line help, and it has a structure system for defining physical plant, operations, and other production-oriented variables. Prices will start at \$300,000 when the software becomes available in March. □

ROCKWELL SEMICONDUCTOR TECHNOLOGY DELIVERS HIGH-SPEED DUAL ACIA IN A SINGLE CHIP.

Transmit and receive data simultaneously at different rates with one device.

Introducing Rockwell International's R65C52—the newest member of our high-speed, low-power CMOS family.

Operating at only 10 mW per MHz, the R65C52 Dual Asynchronous Communication Interface Adapter (DACIA) features an internal baud rate generator. It eliminates the need for multiple component support circuits and requires only a single crystal.

The transmitter and receiver baud rate can be selected for 15 different rates under program control from 50 to 38,400 baud or 1/16 times the external clock rate. And, Rockwell's DACIA is programmable for word lengths of 5, 6, 7 or 8 bits; even, odd, or no parity; and 1 or 2 stop bits. In addition, the device has all the controls needed for data set modem operation.

More transmission per time period cuts costs.

By delivering data faster through dual asynchronous communication, line costs are reduced. Additional savings in components are realized by Rockwell's single-chip DACIA that requires less board space, provides higher reliability and affords greater design flexibility.

For more information on the R65C52 call your Rockwell distributor or sales representative today.

Semiconductor Products Division

Rockwell International, P.O. Box C, M.S. 501-300,
Newport Beach, CA 92658-8902 (800) 854-8099
In California (800) 422-4230.



**Rockwell
International**

...where science gets down to business

Aerospace / Electronics / Automotive
General Industries / A-B Industrial Automation

Circle 27 on reader service card

For workstations that thrive in a multivendor

HP's powerful family of technical workstations fits right in with your present computing resources, as well as those added in the future. With industry standard networking, operating systems, and languages. *Plus* hundreds of advanced application packages, and performance extras to give you the competitive edge in all of your engineering and technical activities.

Our solutions are implemented on one of the industry's largest technical computer and workstation families. It consists of the HP Technical Vectra PC, the HP 9000 series 200/300/500, and the new model 840 Precision Architecture Computer.

Full UNIX System V compatibility.

HP's technical workstations use AT&T's System V UNIX operating system with Berkeley 4.2 enhancements and HP improvements. The result is a standard tuned to the workstation environment with windowing, real-time I/O extensions, graphics, six languages and other extras.

The networking you need.

HP offers the networking to unify design, test, manufacturing, and technical office automation in your company. You'll have ARPA and Berkeley services and TCP/IP on Ethernet** and IEEE 802.3 to provide connectivity with IBM, DEC, and other vendors' products.

AI power without special AI machines.

You get everything you expect in a multipurpose workstation, plus the ability to run Artificial Intelligence on the same machine. Based on Common Lisp, it lets you harness AI power for accelerated software development. You can also get premier expert system tools from companies such as Intellicorp and Teknowledge.

Wide range of graphics solutions.

The choice is yours...from low-cost monochrome to high-resolution color monitors...from simple report



run UNIX* systems and environment, talk to HP.



graphics to 3D solids modeling. There are industry standards like GKS and ANSI Computer Graphics Virtual Device Interface (CG-VDI), to protect your investment by making your existing software portable. HP's accelerated graphics solutions are highly modular, so you can upgrade whenever you choose.

Hundreds of application packages.

Specialized technical applications? No problem. HP's application packages include logic and analog CAE, PCB CAD, microprocessor software development, 2D design and drafting, 3D solids modeling and finite element analysis, documentation and report generation, and database management. New software packages are constantly being added for an even larger selection.

HP—protecting your investment.

Buying HP's solutions is not only a smart decision initially, but it provides the added benefit of lower cost of ownership that reflects our commitment to quality and service. For more information, call your local HP sales office listed in the telephone directory white pages.

Tap HP's DATA-LINE for complete facts...instantly!

For on-line information 24 hours a day, use your computer, modem, and HP's DATA-LINE. Dial 1-800-367-7646 (300 or 1200 baud, 7 bits even parity, 1 stop bit). In Colorado call 1-800-523-1724.

*UNIX is a trademark of AT&T.

**Ethernet is a trademark of Xerox Corporation.



**HEWLETT
PACKARD**

DS15603B

Circle 29 on reader service card

To know the environment of your power source is the first step to noise countermeasures



Model
NDR-544
POWER LINE
DISTURBANCE DETECTOR

NDR-544 has broadened the power line monitoring range.

Only by connecting the unit to a power line (single phase or 3-phase, AC/DC line), you can obtain accurate data on the power line such as voltage fluctuation, frequency fluctuation and superimposed impulse noise. In addition, the unit catches an abnormal value beyond the threshold and prints data on such an abnormal state... "When the abnormal value occurred", "How long it continued" and "Fluctuation value". The NDR-544 is the latest model with upgraded measuring functions designed to extensively monitor various power line disturbances. You can im-

Circle 30 on reader service card

mediately check and monitor the environmental conditions of electronic devices before installing them and can also clear up the cause of troubles.

Features

- AC voltage fluctuations of single phase and 3-phase can be monitored.
- ON-OFF at 4 places other than power line can be monitored. (Event function)
- Time at which abnormal state occurs and recovers is printed at a unit of 1/100 second or more.
- Editing function enables user to obtain the whole day's accumulated data.
- Clock, threshold and measurement data are backed up by battery.

Main specifications

- Voltage fluctuation measuring range : 600 V AC max.
Two ranges; 0~±10V DC, 0~±100V DC
- Frequency fluctuation measuring range : 45.0~65.0 Hz
- Impulse voltage measuring range : ±2500 V (Simultaneous monitoring of positive and negative)



NOISE
NOISE LABORATORY CO., LTD.

The harmony of reliability

2662-1, NOBORITO, TAMA-KU, KAWASAKI CITY, KANAGAWA
PREF. 214 JAPAN Tel: (044)933-4311
TeleX 3842777 NOISEL FACSIMILE (044) 932-4511

Electronics

HUGHES BREAKS SPEED RECORD FOR DIGITAL GALLIUM ARSENIDE

CHIP ACHIEVES 18-GHz CLOCK RATE WITHOUT BEING COOLED

LOS ANGELES

Researchers working with gallium arsenide have a new clock-speed record to aim at: slightly more than 18 GHz for digital GaAs integrated circuits. Scientists at GMHE/Hughes Aircraft Co. reported last week that they have demonstrated a divide-by-two frequency-counter chip that runs in the laboratory at a clock rate of 18.05 GHz—without being cryogenically cooled.

The fastest clock rate previously reported for an experimental digital GaAs device was 13 GHz, according to the team at Hughes's Research Laboratories in Malibu, Calif. That chip, built at AT&T Bell Laboratories in 1984, was also a divider circuit. D-type flip-flops operating as binary frequency dividers are normally used to demonstrate the speed-power characteristics of new digital IC technology, the researchers say.

The Hughes GaAs chip gets its high speed by combining a number of advances in both logic design and fabrication techniques. But the most significant aspect of the achievement, the company says, is that Hughes built the high-speed chip using a conventional structure, the metal-semiconductor field-effect transistor. "The MES FET allows operation at room temperature, not the 77 K [-200°C] required for high-electron-mobility transistors [to run at top speed]," says Joseph F. Jensen, staff scientist at the labs. Much high-speed GaAs development work, including the Bell Labs chip, involves the use of HEMTs, which are regarded as having the best performance specifications. But equipping systems with cryogenic cooling causes complications not faced with MES FETs—cryogenic systems are bulky, heavy, and expensive.

Hughes disclosed details about the new circuit last week at the International Electron Devices Meeting in Los Angeles, so manufacturers of GaAs ICs have just begun to mull over its mean-

ing. Even so, one of them is already calling it a potential advance.

"What it shows is how much further MES FET technology can go," says Ira Deyhimi, vice president of engineering for the IC Division of Vitesse Electronics Corp., Camarillo, Calif. "It's proof of the potential of an intrinsically simple structure." His company uses MES FETs for its commercial GaAs circuits, so he welcomes experimental advances that extend the approach's perceived promise. At 18.05 GHz, the new Hughes device runs about five times faster than the fastest commercially available GaAs ICs—and about 10 times faster than silicon parts.

Hughes uses two different types of

not buffered, achieves nearly a fivefold reduction in power dissipation, to 150 mW. CEL, also known as capacitor-diode logic, uses diode level shifting to establish the dc operating points of the circuit, which minimizes operating current and helps attain low power dissipation, according to the Hughes team. Even lower dissipation is attained at lower frequencies—98 mW at 14.5 GHz, for example.

The basic difference between the two logic types is buffering, Deyhimi says. By demonstrating both on the same chip, Hughes is smoothing the way for integrated designs that select logic types for functions where the advantages of the chosen type suit the objective, in Deyhimi's opinion. The two families "are compatible and could be mixed," Jensen confirms.

Direct-write electron-beam lithography gives the chip minimum dimensions of 0.2 μm . Geometries this small demand scaling channel thickness in the device's active regions down to less than 700 Å. This requirement is met by forming the semiconductor layers by molecular-beam epitaxy.

Since molecular-beam epitaxy itself is still young, its use is another noteworthy part of the Hughes project, says process and market

consultant William I. Strauss of Forward Concepts Inc., Tempe, Ariz. Molecular-beam epitaxy "is clearly the way to go when literally laying on a few molecules at a time. It gives much more precise control," he says. The epitaxy technique, which Hughes is developing at Malibu under a U. S. Navy contract, has not yet seen any commercial applications.

Work on the Hughes GaAs chip is continuing, to reduce the 2-V logic swing and further lower the power dissipation. The work is supported in part by a contract from the U. S. Air Force Wright Aeronautical Laboratories, Dayton, Ohio.

—Larry Waller

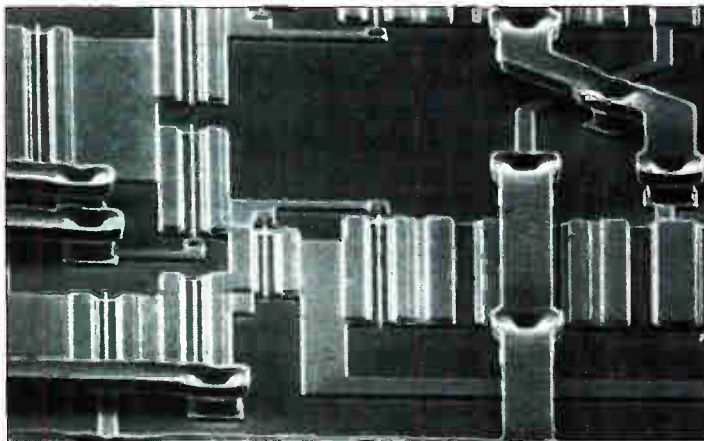

RAPID. Experimental Hughes GaAs chip proves that MES FET structures can run about five times faster than commercially available digital ICs.

logic, both based on depletion-mode technologies, to build the ultrafast circuit, fabricating them side by side on the chip for demonstration purposes. Buffered-FET logic provides the fastest gates—it was clocked at 18.05 GHz—and high fan-out, meaning its output can drive a relatively high number of other gates. Its drawback, however, is the need for level-shifting circuitry, which contributes to excessively high power dissipation—657 mW total for the divider circuit at the top clock rate.

By contrast, capacitively enhanced logic, whose top speed is a slightly slower 17.8 GHz and whose fan-out performance is lower because the output is

SILICON-ON-INSULATOR GETS EASIER

LOS ANGELES

A silicon-on-insulator technique that could change industry thinking about how SOI circuits are fabricated is under development at Matsushita Electric Industrial Co. Matsushita's technique uses standard CMOS processing, avoiding the use of largely unproven chip-fabrication technology required by other SOI approaches, so it may prove far more practical for near-term commercial exploitation.

Experimental devices built with the technique developed by the Kadoma, Japan, company perform about as well as devices built on bulk silicon, according to a paper delivered by the company last week at the International Electronic Devices Meeting in Los Angeles. SOI experts at the meeting were impressed with the work, but noted that Matsushita's SOI technology can build only relatively small isolated islands of bulk silicon. They pointed out that several earlier SOI techniques are more mature.

As silicon fabrication technology approaches submicron geometries, where a plethora of second-order effects disrupts the operation of circuits, interest is growing in SOI because of its higher packing density, improved speed, lower dynamic power consumption, reduction in the number of fabrication steps, and freedom from latchup. Until now, these benefits have required techniques still largely unproven in the production environment, such as using recrystallized silicon and zone melting with lasers and electron beams.

NITRIDE'S THE KEY. Matsushita's alternative requires none of these. It uses conventional bulk CMOS processing to fabricate the insulating layer and to form tightly packed isolated islands onto which active transistors are placed. The key to the process lies in the use of several silicon nitride steps.

With a double layer of Si_3N_4 acting as a mask, trenches are formed to define silicon islands. Another layer of Si_3N_4 is deposited and etched using reactive-ion techniques to cover the sides of the silicon islands, and the silicon substrate underlying the islands is etched away. This is followed by selective oxidation using the two Si_3N_4 layers as masks until the silicon islands are electrically isolated from the substrate. The trenches are filled with polysilicon and SiO_2 .

Matsushita has built islands 1.1 to 1.7 μm wide with a minimum separation of 1.5 μm . The company has fabricated both 25-stage ring oscillators and frequency-halving circuits with delay times of about 360 ps per stage.

Matsushita's technique represents a workable alternative to the more firmly entrenched SOI techniques, according to David Spratt, engineering manager of special product development at Texas Instruments Inc., Dallas. "However, the latter processes have much more momentum going for them," he says.

For example, silicon-implanted oxide techniques have been used to build 4-K static random-access memories, says Susan Partridge, an SOI researcher from GEC Research Ltd., Middlesex, UK. Silicon-on-sapphire is used in a variety of commercial products, she adds.

The major limitation of the Matsu-

shita process, says TI's Spratt, is the size of the islands, about 1 to 2 μm wide and 10 μm long, versus at least 10 by 50 μm for one method used by TI. "It looks as if the applicability of [Matsushita's] process is limited to very high-density applications," he says.

Matsushita's work may, however, help manufacturers to squeeze the last ounce of density and speed out of bulk silicon. "It [also] appears to be a good way of combining bulk-silicon and SOI-type transistors on the same substrate, a difficult proposition for current SOI techniques," Spratt says.

—Bernard C. Cole

PROGRESS COMES, TOO, IN CONVENTIONAL SOI

Not to be upstaged by Matsushita's silicon-on-insulator development, researchers from Texas Instruments Inc. and Sharp Corp. described at IEDM last week advances in SOI technology that build on established techniques.

Starting with a common SOI technique called full isolation by oxidized porous silicon, or FIPOS, researchers from TI have attempted to surmount the process's inherent limitations. The result is a technique the Dallas company calls Islands, for isolation by self-limiting electrolytic anodization of an n^+ epitaxially defined sublayer.

Previous FIPOS efforts, based on electromechanical anodization and oxidation of p-type silicon or p^+ silicon on a p-type substrate, met with limited success because of the difficulty in isolating sufficiently wide islands without forming excessively thick porous oxide layers. There were also problems with slice warpage and stress-related defects caused by the formation of anodization "tails" at the silicon/oxide interfaces.

In the Islands process, epitaxial-quali-

ty silicon is dielectrically isolated using specially formed anodizable structures of n , n^+ , and n^- silicon; computer-controlled processing to decouple vertical and horizontal anodization; and trench etching. The result is the ability to isolate layers of any desired thickness and to anodize either from a top surface or from the side walls of a trench. TI researchers were able to fabricate transistors on 0.5- μm -wide islands isolated by 1.2 μm of porous oxide.

From Sharp in Osaka, Japan, comes a recrystallization technique that allows the first layers in a three-dimensional, layered circuit to be formed as conventional ICs are. An isolating silicon dioxide layer is deposited atop the first layer, then etched to form depressions, where polysilicon film is deposited. The polysilicon/oxide layers are recrystallized by a scanning laser or electron beam. Sharp has fabricated image sensors in which one layer contains the select logic, a second holds the digitizing logic, and a third contains the photodetectors.

—B. C. C.

COMPANIES

IS GM'S HIGH-TECH FUTURE CLOUDY WITH PEROT GONE?

DETROIT

General Motors Corp. may have rid itself of a nettlesome in-house critic, but the automaker still faces rough seas ahead after this month's messy breakup with the charismatic and outspoken H. Ross Perot, former GM director and chairman and chief executive officer of GM's Electronic Data Systems unit. Perot's departure, coupled with the indiffer-

ent success of GM's highly publicized automation efforts, leave the future cloudy for high tech at GM.

A GM management realignment gives overall EDS responsibility to Donald G. Atwood, the executive vice president in charge of the GM/Hughes Electronics Corp. subsidiary, which includes Delco Electronics Corp. The EDS president and newly elected chief executive offi-

cer, Lester M. Alberthal Jr., will now head the data services company, reporting to Atwood.

By combining all its high-technology businesses, including EDS, under one executive, GM says it will promote "even greater synergy" among the operations. But both Atwood and Alberthal are quick to point out that EDS will remain a distinct and autonomous organization within GM. "My responsibility is to work with Les on overall strategy but not to get into day-to-day operations," Atwood says.

Atwood is a well-regarded manager, but some industry watchers doubt that the \$742.8 million buyout pact with Perot will soon lead to improvements at GM, which reported a \$338 million operating loss in this year's third quarter. And it may make things worse. "I know GM created more problems for itself with this than it solved," says Maryann Keller, an automotive analyst at Furman Selz Mager Dietz & Birney Inc. in New York.

If Keller is right, the new problems will be piled on top of old ones. Despite the \$2.5 billion EDS acquisition in 1984 and a \$5.1 billion buyout of aerospace and defense electronics contractor Hughes Aircraft Co. last year, GM's highly vaunted efforts to inject high technology into the company's operations have so far fallen short of the mark. GM manufacturing costs, in fact, are now higher than its domestic competitors', critics point out, and it has been forced to slow down its automation spending programs.

'IT WILL PASS.' However, Perot's departure might have little effect on GM, some observers say, although they agree the automaker faces serious problems in its core business and in its efforts to integrate high technology into the operation. "GM's major challenge is to maintain competitiveness in the automotive industry. I doubt if this will be much distraction. These kinds of things pass within a couple of months," says Edward H. Bowman, a professor of management at the University of Pennsylvania's Wharton School.

Much of the controversy centers on GM Chairman Roger B. Smith's decision, with board approval, to pay nearly double the market price to buy out 11.3 million shares of GM's Class E common stock controlled by Perot. The value of the Class E stock held by Perot and some 200 EDS executives is tied to the performance of EDS, not GM as a whole. Perot became GM's largest indi-



IN CHARGE. GM's Atwood has taken EDS under his wing.

vidual shareholder when the automaker acquired EDS, and in recent months the Texas entrepreneur had become increasingly strident in his criticism of GM's management style and its slow pace of change.

Some observers predict that GM's willingness to spend so much in an apparent effort to silence a critic—as a part of the deal, Perot agreed to stop criticizing GM—will lead to tougher 1987 labor negotiations for the automaker. Union officials are already snarling over GM plans to close all or part of 11 plants over the next three years. And with Perot's departure, EDS employees have lost a champion at the top, GM watchers say. Some fear that lingering concerns over GM's plans for the computer-services unit could take its toll

on EDS employee morale. But in the aftermath of the Perot deal, Atwood says that GM's first order of business must be to deal with the effect on EDS employees.

The Perot affair also created a furor on Wall Street and among some large GM investors, who regarded the EDS chief as a positive force within GM and are concerned over the cost of the buyout. At least two shareholder lawsuits have already been filed aimed at blocking the deal.

Whatever else happens, EDS now must solicit more business outside GM, Alberthal and Atwood agree. EDS revenues have grown from about \$950 million at the time of the GM acquisition to a projected \$4 billion this year. But most of that growth came from new GM business; EDS has fallen behind its historical 20%-plus compounded annual growth rate in noncaptive outside revenues. "This year we'll be in the 15% to 16% range," says Alberthal. "We're shooting to bring it back to the 20% level next year."
—Wesley R. Iversen

TRADE

MOTOROLA AND TOSHIBA: THEY'VE ONLY JUST BEGUN

TOKYO

The sweeping semiconductor accord between Motorola Corp. and Toshiba Corp.—a trailblazing deal linking two of the world's top chip manufacturers—could eventually grow to include a joint Motorola-Toshiba presence in the U.S. market, Toshiba officials say. Industry observers think it could also be the first in a series of major alliances struck by other Japanese and U.S. companies.

The agreement signed late last month improves Motorola's access to the Japanese market, a provision that includes a new plant to be jointly owned by the two companies. It also sets technology-exchange agreements between them and gives Toshiba rights to Motorola's microprocessor line.

Toshiba executives in Tokyo say a similar agreement covering the U.S. market is likely—the two companies are not likely to stand pat with what they have now. "The probability is high for a similar joint venture in the U.S.," says Toru Shima, senior manager of the Semiconductor Group's Business Planning Office. But he cautions that "there is no schedule and no program at present." In fact, some details of the current agreement are still being negotiated, Shima says, even though discussions started about 18 months ago.

For Motorola, the key to cracking the Japanese market will be the new plant,

which will start producing advanced memories and microprocessors in early 1988. For its part, Toshiba will run the plant and will "actively support" Motorola's Japanese marketing effort and its worldwide activities in dynamic and static random-access-memory products.

The plant will be at Izumi City near Sendai, Japan. Building and equipping the first section will cost about \$216 million; a second fabrication module will cost another \$185 million. The name of the enterprise and its president are not yet settled, but the companies have agreed that, besides the microprocessors and DRAMs, the plant will also turn out 64-K and 256-K SRAMs.

MORE TO COME. The Motorola-Toshiba agreement could be a harbinger of other deals between U.S. and Japanese companies. "The semiconductor business can be roughly divided into architecture-design technology and wafer-processing and device-structure" know-how, says Hajime Sasaki, vice president of the Electron Device group at NEC Corp. "The U.S. strengths lie in the architecture, while Japanese strengths are in wafer design and processing."

Equally important, Japanese semiconductor firms are known to believe that an alliance with a U.S. counterpart may be the best way to ensure access to the U.S. market. Such alliances could help shield them against U.S. protectionist

legislation that could be passed in coming years. Similarly, U. S. companies will continue to seek a door to the Japanese market.

Such factors almost certainly played a part in the Motorola-Toshiba deal, according to semiconductor-industry analysts, who note that Toshiba's longer-range objective is an enhanced U. S. presence. "It's part of the political equation," says Adam Cuhney, a San Francisco-based analyst for Kidder, Peabody & Co. "A solid relationship with Motorola could eventually be the best avenue for Toshiba into the U. S. market."

In general, industry sources believe the pact will work out, mostly because, as one consultant puts it, "each firm

gets something it doesn't have now." The payoff will probably come more quickly for Motorola, they say, because the infusion of Toshiba's mass memory expertise, particularly in process and manufacturing technology, can be used to improve many of its product lines immediately. Motorola already buys 256-K RAMs from Toshiba, then does its own assembly. It will expand this operation to include larger RAMs when they come on stream.

For Toshiba, the major payoff is farther off. The plum provision in the initial agreement gives Toshiba the license to produce Motorola's 32-bit 68020 family. The 68020 is the world's best-selling 32-bit microprocessor, and its design has

been sought after by Hitachi Corp. and others, but previously licensed to no one. "This shows the value Motorola placed on Toshiba's process, production, and memory technology," says Hideo Ito, manager of international planning and operations in Toshiba's Semiconductor Group and its chief negotiator for the agreement.

Shima says the Motorola-Toshiba pact is significant "because there were no similar arrangements in the past." Other deals were different, since they often involved one strong and one weak partner. "This time the strengths of both Motorola and Toshiba will be combined. It heralds a new era."

-Larry Waller and Charles Cohen

ASIAN BOOM ENTICES U. S. CHIP HOUSES

DALLAS

A sudden, dramatic boom in semiconductor sales across the Asian-Pacific basin is sending two leading U. S. chip makers in very different directions as they try to stake out regional market shares. As the strong yen cuts into the profit margins of Japanese companies, the Americans see a golden opportunity to pick up business elsewhere in Asia.

Motorola Inc. aims to boost its Asian sales by teaming up with Toshiba of Japan (see p. 33). But its American arch-rival Texas Instruments Inc. is searching for strength within, shuffling executives to form a new, high-level semiconductor post partly aimed at making the most of TI's installed production base in Japan and southeast Asia.

"Japanese chip sales were up 40% this past year in dollar volumes, but the strong yen has given them profitless prosperity," notes electronics analyst Michael A. Gumpert of Drexel Burnham Lambert Inc., in New York. "The Japanese cannot currently afford to be too aggressive" in neighboring Asian countries.

Enter the Americans, says William McClean, semiconductor industry analyst at Integrated Circuit Engineering Corp., a Scottsdale, Ariz., market-research concern. McClean says that U. S. companies are rushing to capitalize on the 1986 Asian boom, which has rocketed sales to nearly double their 1985 level.

In 1985, semiconductor sales in Asian countries—outside of Japan—were running along at about \$300 million per quarter. Sales during the third and fourth quarters were \$296 million and \$313 million, for example, according to ICE figures. Then sales jumped to \$396 million in the first quarter of 1986 and \$509 million in the second quarter. The research company believes that fourth-

quarter sales will hit \$600 million. N-MOS memories alone jumped from \$7 million in January to \$29 million in September after the U. S. imposed "foreign market value" pricing protections in a trade accord with the Japanese.

McClean says the sales explosion is a combined result of U. S. systems-assembly operations migrating to Asia, the growth of new businesses in the region, and increased chip purchases aimed at skirting the U. S. pricing regulations on Japanese ICs. "Some of these chips are getting back to the U. S. on the gray market," he says.

OPEN WINDOW. Regardless of the reasons, Dallas-based TI believes that for the coming year it has a wide-open market window to exploit. William N. Sick, leaving his post as president of TI's Semiconductor Group, has been named to a new position in charge of realizing the company's full potential in the Asian-Pacific region. TI has been manufacturing semiconductors in Japan for 15 years and now operates three wafer plants in there. In addition, it runs four

other chip plants elsewhere in Asia.

Sick says the growth rate in the Asian-Pacific region, excluding Japan, has reached twice that of U. S. markets. To capture a significant portion of the new growth, TI believes, top management must get directly involved in pursuing sales.

But the president of TI's large Semiconductor Group does not have enough time while running the day-to-day operations, explains Sick. As a consequence, TI has named executive vice president William P. (Pat) Weber president of the group and has spun off the top-level efforts in Asia to Sick, who remains an executive vice president with new duties aimed at creating worldwide business alliances with chip customers and other IC makers. Partnerships with other chip companies in Japan are not initially part of TI's new Asian thrust, Sick maintains, rebutting industry speculation.

But while executives in Dallas were attempting to distinguish between Sick's Asian marketing thrust and new efforts to create business alliances in the West,

word leaked from Japan of an inventory-swapping pact between Mitsubishi and TI. TI's Japan subsidiary has agreed to exchange its advanced low-power Schottky bipolar logic parts for Mitsubishi high-speed CMOS logic.

A corporate spokesman for TI in Dallas maintains the Mitsubishi pact is aimed at filling spot shortages in the Japanese market and does not represent a major business alliance. A company source in Japan indicates that TI, which has made similar deals in the past, is using inventory-swapping agreements to avoid bringing up additional fab capacity during uncertain times in the chip market.

-J. Robert Lineback



LOOKING EAST. TI's Sick says sales growth in the Asian-Pacific region is now twice that of the U. S.

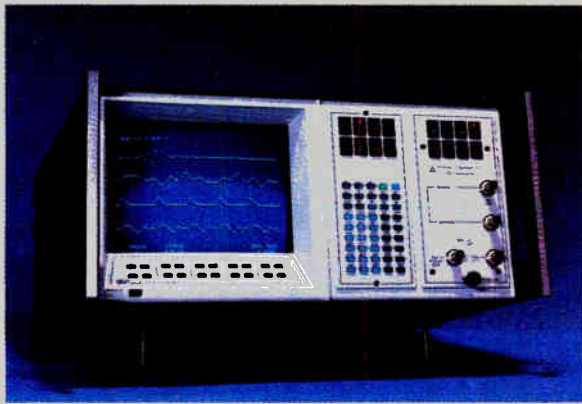

DATA 6000 Waveform Analyzer



DATA 2020 Waveform Generator

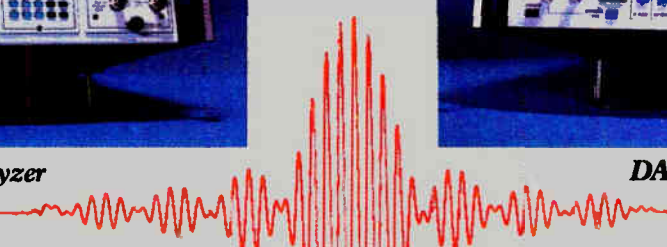

Rule the Waves

Coming...

The DATA 6000 Universal Waveform Analyzer offers the ultimate in signal acquisition and on-board waveform analysis in one unit—without programming. Front panel commands are available for complex waveform operations, such as FFT and Correlation as well as scalar parameters such as Max., Min., Width, Rise, or PK-PK, using the display cursor and crosshair. For specialized measurements, the 6000 can also store analytical routines internally.

- Digitizing Plug-Ins from millihertz to 100MHz sample rates.
- An ultra-high dynamic range digitizing plug-in: 1MHz at 16 bits.
- Simultaneous multi-channel sampling with pre- and post-trigger transient capture.
- FFT (Magnitude and Phase), Convolution, Correlation, Waveform Average, Amplitude Histogram, etc.
- Direct plotter drive for HP-GL compatible plotters.
- Companion Model 681 Flexible Disk Drive for waveform and program storage.
- Full Programmability for ATE via IEEE-488 or RS-232 interface.

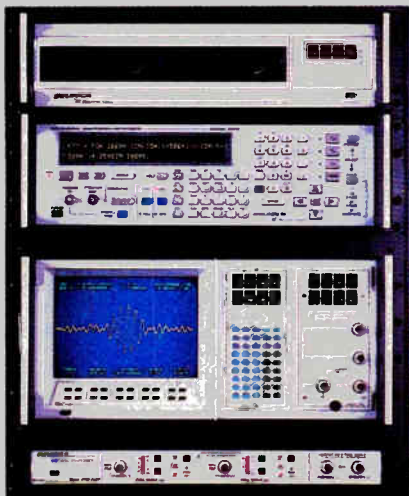

Combining the DATA 2020 and DATA 6000 yields an unbeatable system for signal acquisition, analysis and regeneration. Capture actual signals with the DATA 6000. They can then be modified or combined with other waveforms and down-loaded into the 2020 for regeneration. What was transient can become repetitive, available on call. Shown above, from top to bottom, are the 681 Flexible Disk, the DATA 2020, DATA 6000 and D-1000 Pre-Amplifier: products which give you the power to rule the waves both coming and going.

or Going.

The DATA 2020 Polynomial Waveform Synthesizer* provides an unprecedented ability to emulate real world signals, creating desired waveforms from mathematical definitions. Modify the ideal waveforms to add distortion, noise or glitches. Simulate degraded rise times, phase shifts . . . test the limits. Your systems and products must live in the real world. Emulate it with the 2020.

- Direct front panel or remote entry of mathematical equations of the form $Y = f(t)$.
- High-speed waveform generation—up to 25 megapoints per second at 12 bits (100 megapoints at 12 bits, optional).
- Large waveform output memory—up to 512K points, combined with non-volatile storage of hundreds of waveform equations.
- Standard Functions—sine, square, triangle with variable symmetry, plus white noise which can be summed with any signal.
- Arbitrary Mode including point entry, scope draw, and downloading of the waveform memory.
- Full Programmability for ATE via IEEE-488 or RS-232 interface.

* Patents pending

ANALOGIC®

DATA PRECISION®

HEADQUARTERS: DATA PRECISION, Division of Analogic Corporation, Electronics Avenue, Danvers, MA 01923. Tel: 617-246-1600. Telex: 6817144.

ANALOGIC Ltd., The Center, Weybridge, Surrey, England KT138BN. Tel: 0932-56011. Telex: 928030 ANALOG G.

ANALOGIC GmbH, Daimlerring 2, 6200 Wiesbaden-Nordenstadt, W. Germany. Tel: 06122-4071. Telex: 4182587 ANA D.

Circle 34 For Demonstration
World Radio History

Circle 35 For Additional Information

**At last, the ordinary
microprocessor
can take its rightful
place in history.**



It had to happen—the conventional microprocessor has had its day. Relegated to the ranks of yesterday's devices by the new transputer family from INMOS. It's history in the making.

The IMS T414 transputer is a fast, easy-to-use VLSI component, integrating a 32-bit processor, four inter-transputer communication links, 2K bytes Static RAM, 32-bit memory interface and DRAM controller. All on a single CMOS chip—offering execution rates up to 10 MIPs.

While transputers excel in single-processor systems, their real power can be unleashed by connecting any number of transputers together via the high-speed serial links. Multi-transputer systems can deliver the performance you need today, and can be easily expanded in the future as your processing requirements increase.

And there's more. Programming multiprocessor systems has never been easier. The Transputer Development System (TDS) supports C, Fortran, Pascal and OCCAM, providing a complete software development environment, and is available for a number of popular hosts. Software developed on the TDS can be executed on one or more transputers, enabling cost-performance tradeoffs to be made.

INMOS transputers are available now and have already found their way into companies who are evaluating, prototyping and manufacturing transputer-based systems. Applications include supercomputers, DSP, graphics, robotics, AI, distributed control systems, PC's, engineering workstations and many others.

Write or phone for more information on the transputer family and start making history yourself.

TRANSPUTER PRODUCTS	
IMS T414	32 bit Transputer—2Kbyte —4 links
IMS T212	16 bit Transputer—2Kbyte —4 links
IMS M212	16 bit Disc Processor—1Kbyte—2 links
DEVELOPMENT TOOLS	
IMS D701-2	IBM PC—Transputer Development System.
IMS D600	VAX/VMS—Transputer Development System.
EVALUATION BOARDS	
IMS B002-2	Double Eurocard + IMS T414 + 2Mbyte DRAM + 2 x RS232
IMS B003-1	Double Eurocard + 4 x IMS T414 + 4 x 256Kbyte DRAM.
IMS B004-2	IBM PC Format + IMS T414 + 2Mbyte DRAM.
IMS B006-2	Double Eurocard + 9 x IMS T212 + 128Kbyte SRAM.
IMS B007-1	Double Eurocard + IMS T414 + 0.5Mbyte DRAM + 0.5Mbyte Video RAM.
HIGH PERFORMANCE VLSI MEMORIES	
16K CMOS SRAM, 25-45ns, 64K CMOS SRAM, 35-70ns	
256K CMOS DRAM, 60-100ns	

THE TRANSPUTER

PARALLEL PROCESSING. UNPARALLELED POTENTIAL.



INMOS, P.O. Box 16000, Colorado Springs, CO 80935, Tel. (303) 630-4000;
Bristol, England, Tel. 454-616616; Paris, France, Tel. (14) 687-2201;
Munich, Germany, Tel. (089) 319-1028; Tokyo, Japan, Tel. 03-505-2840.

FAIRCHILD SLASHES DIP BURN-IN REJECTS

PORTLAND, MAINE

A nasty rejection rate in solderability tests for the leads of military chips housed in dual in-line packages has been cut from 25% or 30% to zero at Fairchild Semiconductor Corp., thanks to a new approach to finishing the leads. The technique solves problems with device-lead coatings that result from the burn-in process.

The new approach involves doing burn-in with tin-plated leads and a new wave-soldering technique that is applied after burn-in. It replaces older wave-soldering techniques, which are tricky to adjust and control, with a simpler and cleaner process, and results in a solder coat that exceeds the requirements of military standards.

WAY OF LIFE. Burn-in—operation at 125°C for 160 hours or at 150°C for 80 hours—is a way of life for manufacturers of military integrated circuits. The object of the mandated burn-in is to ensure higher reliability of the chip, but the process causes a major problem for ICs in ceramic DIPs with solder-coated leads—which are required by the Joint Army-Navy specifications.

During burn-in, solder-plated leads are subject to the formation of intermetallic compounds and surface oxides. These degraded leads then often fail the MIL-STD-883 method 2002 solderability test after the burn-in, leading either to expensive rework or to scrap. Such was the case at Fairchild's Digital Aerospace and Defense Division in Portland before the new method was developed.

In 1984, Fairchild started an engineering effort to address the solderability problem and to reduce lead-finishing costs, says Rich Wood, the senior process engineer at Fairchild who developed the concept of the new wave-soldering machine. What it came up with is a method that begins by using tin plating on the leads to absorb the rigors of burn-in. Then, just prior to shipping, the tin plate is replaced with solder in a fluxless process that is both clean and simple. The clean lead substrate beneath the tin plate together with a redesigned solder wave allows the flux to be eliminated from the soldering operation.

NO WASH. Eliminating the flux also eliminates the need to wash and dry the devices after soldering. The removal of this cycle shortens the process; it also means there is no need for a drain, allowing the equipment to be installed anywhere in a manufacturing facility. In addition, the elimination of flammable and corrosive flux makes the operation safer.

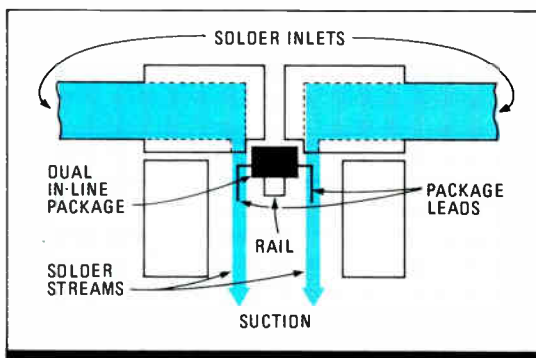

SOLDER COLUMNS. A Fairchild process for coating DIP leads with solder has eliminated solderability-test failures.

The first step in the Fairchild process consists of cleaning the Alloy 42 leads with acid. Then the leads are tin-plated, and the IC is burned-in.

Ordinarily, the next step would be to go to a conventional wave-soldering machine. But for this application, the machines have several drawbacks. Wave heights fluctuate, for example; environmental changes can cause solder "icicles," and there is a tendency for solder to go places it's not wanted.

Fairchild's wave solderer isolates the solder that goes to the leads. The wave consists of two vertically flowing solder columns through which the DIP travels, sliding along a supporting rail (see figure). The two solder columns, one on each side of the DIP, flow down over the leads as the package travels horizontally. The tin plate is dissolved in the molten solder, allowing solder to adhere to the clean substrate that was beneath it. As the package leaves the solder, it

enters a stream of hot nitrogen gas, which prevents the formation of icicles on the ends of the leads.

The resulting solder finish is smooth and uniform, and the part has no difficulty passing the MIL-STD-883 test. The Fairchild process produces a solder layer with a thickness that exceeds military requirements. The average thickness achieved by the process is 750 μm ; the standard specifies a minimum solder thickness of 200 μm . —Jerry Lyman

COMPONENTS

A SIMPLER FRONT END FOR DATA-ACQUISITION SYSTEMS

AUSTIN, TEXAS

Setting up data-acquisition systems to handle multiple high-speed analog signals is a burden that systems designers have had to bear for many years. Discrete-circuit solutions have been plagued by poorly understood error sources and low temperature ceilings, and bipolar-based hybrids are power-hungry and carry high price tags. But by drawing on recent advances in digital CMOS logic, Crystal Semiconductor Corp. is aiming to unburden the systems designer with a single-chip solution containing four simultaneously operating amplifiers.

The Austin, Texas, company has built a CMOS track-and-hold analog integrated circuit—a single chip that, besides the four amplifiers, contains its own microcontroller, signal-storage capacitors, output multiplexer, and output buffers. Crystal says the 18-pin IC could streamline data-acquisition architectures and greatly boost performance.

The cool-running 3- μm design has the digital power to calibrate itself with control logic, and it will maintain steady 12-

bit accuracy even if the operating temperature climbs above the Mil-Spec range, says Crystal.

The track-and-hold market is a small one, worth about \$46 million last year, says Edward D'Entremont, vice president of marketing at Hybrid Systems Corp., an established supplier of track-and-hold and other data-acquisition products in Billerica, Mass. But he adds that the market is growing by about 20% to 25% per year, and Crystal's John Croteau, product manager for data-conversion ICs, believes it could grow even faster with the emergence of low-cost monolithic parts. Track-and-hold devices are generally used in combination with analog-to-digital converters to slow down high-speed signals long enough for the highly accurate (but often slow) ADCs to do their job.

Twelve-bit converters today are relatively slow, able to deal with only 2-Hz signals when unaided by a track-and-hold circuit. D'Entremont says track-and-hold devices enable 12-bit converters to reach about 28 kHz, opening up military radar and avionics applications.



STAR TRACKER (IPS/SPACELAB)

The secret of finding...



SATELLITE NAVIGATION RECEIVER (KNORR/TITANIC)

At 11:40 p.m. on April 14th 1912, the *RMS Titanic* struck an iceberg some 400 miles off the coast of Newfoundland. In less than three hours, the 'unsinkable' luxury liner had sunk to the sea bottom in one of the worst maritime disasters of the century. Finding her became a commitment by oceanologists and technologists alike.

Several tried. All failed. For the problems, like the tragedy, were on a grand scale. The North Atlantic is not known for its hospitality. And the freezing waters are nearly 2.5 miles deep. To add to these difficulties, not only was *Titanic's* last radio position known to be inaccurate, but fierce currents had also swept her away in a south-easterly direction.

Last year, however, after the French ship *le Suroît* had covered 80% of the target zone, the French-American expedition team embarked on the high-technology research ship *Knorr*.

This high-technology included a pair of MAGNAVOX® satellite navigation receivers - one providing highly accurate position information by tracking satellites of the new global positioning system, the other providing periodic position updates from transit satellites. With these two receivers onboard, the *Knorr* was equipped with the most precise and sophisticated marine navigation system available.

The MAGNAVOX receivers were used to criss-cross the remaining 20% of the search area, working to a position accuracy of just 35 meters. Even in heavy seas. Then, starting from the most likely spot, the underwater search vehicle *Argo* was lowered to begin close-up investigation.

At 1:05 a.m. on September 1st, 1985, her video cameras recorded the eerie outline of one of *Titanic's* mighty boilers. The seventy-three year search was over.

Little wonder that our satellite navigators are used aboard thousands of offshore platforms, rigs and ships - including *Queen Elizabeth II* - and that our global positioning system receivers are leading the way in precise navigation, on land, at sea and in the air.

Because no matter where you look, you won't find anything better.

...is knowing where



DOC-ESA/NASA

World Radio History



© WOODS HOLE OCEANOGRAPHIC INSTITUTION

to look... Philips.

From the depths of the ocean to the depths of space. One of the most demanding endeavours is the scientific exploration of the sun - a research programme conducted by NASA in collaboration with the European Space Agency, ESA.

Key to this research is SPACELAB 2; fifteen tons of advanced space technology launched in August 1985. The problem was how to ensure that, once in orbit, SPACELAB 2's platform, with the powerful telescope, could be manoeuvred under remote control without any sensitivity to the shuttle motions.

The solution was provided by three SODERN** SED 04 star trackers integrated by Dornier in the Instrument Pointing System responsible for positioning the platform. Each of these electronic sensors operates to an accuracy of 0.75 seconds of arc - which is roughly equivalent to a golf ball seen from 10,000 meters. Distance, however, is no problem, for the platform responds perfectly to every command from mission control some 300 km below. Which is hardly surprising, for similar SED trackers have been operating on EXOSAT for over 3 years.

In fact, SODERN, as world leader in attitude measurement and star tracking, has been involved in major European and U.S. space programmes, providing over 90 opto-electronic systems with more than 200 years of operation without a single failure.

A convincing record of technology at the highest possible level.

Philips. The sure sign of expertise worldwide.

* MAGNAVON - a high tech North American Philips research company. The operations of Magnavox Government and Industrial Electronics Company (MAGIEC) and its subsidiaries are conducted on a substantially autonomous basis. The stock of MAGIEC has been placed in a voting trust to facilitate MAGIEC's industrial security clearance with the U.S. Department of Defence.

** SODERN - a high tech French Philips research company specializing in e.g. attitude sensors for satellites and spacecraft; positioning and alignment of inertial platforms; rendezvous and docking; remote sensing of Earth resources, etc.



PHILIPS

COPY CAD.

In fact, copy anything. Faster. With higher quality. And more flexibility. For a lot less money.

That's what you get with the CH-5300 Color Hardcopier. And you get it with next to no effort at all.

Because we've already qualified over one hundred video sources. Which means no software drivers are required. And there's no host down-time during installation.

Plus, you can turn your hardcopier into a shared resource with our Multiplexor. Up to four different sources can be connected so the cost per user becomes astonishingly low.

In the

end, you get beautifully sharp color copies of everything on your screen. And you get them fast. Data is downloaded into the hardcopier instantly (there's no processing to slow things down). A-size copies and presentation quality transparencies are produced in under 40 seconds. And B-size copies are delivered in moments.

So copy our phone number. Then call. We'll show you how to save money, save time and save your image with the Seiko CH-5300 Color Hardcopier.

Call Martin Nelson at
(408) 943-9100 today.

SEIKO
INSTRUMENTS

© 1986 Seiko Instruments USA, Inc.



QUALIFIED VIDEO SOURCES FOR THE SEIKO COLOR HARDCOPIER.

Over one hundred models from more than fifty manufacturers. It's a long list and it's growing every day. Give us a call to make sure your hardware is a qualified source.

Qualified Manufacturers

Advanced Electronics Design
 Applicon
 Apollo
 Aries
 AT&T
 Autotrol
 Aydin
 CalComp
 Computer Aided Engineering
 Calma
 Chromatics
 CGX
 Computervision
 Computer Sciences Corp.
 Conographics
 Control Systems
 Data General
 EDS (General Motors)
 Genisico
 Harris
 Hughes
 Hewlett-Packard
 IBM
 Ironics
 Lexidata
 Masscomp
 Matrox
 Megatek
 Metheus
 Moore Products
 Number Nine
 Omnicomp
 Ramtek
 Raster Technology
 Raytheon
 Scion
 Seiko
 Silicon Graphics
 Sun Micro Systems
 Symbolics
 Tektronix
 Vectrix
 Vermont Micro
 Verticom
 VG Systems
 Wang



© 1986 Seiko Instrument U.S.A., Inc.

fringe-effect displays. SBE displays achieve higher contrast and are easier to read than conventional twisted-nematic models. With twisted-nematic displays, contrast is critically dependent on the viewing angle, but SBE displays, in which the molecules of the liquid crystal are twisted by 270°, maintain high contrast even at small voltage variations. SBE displays can achieve four to five times higher contrast than their twisted-nematic cousins. Moreover, dependence on the viewing angle is reduced by a factor of 10 in the vertical and 4 in the horizontal direction.

Besides the opening of the Heerlen center, another significant component in Philips's LCD strategy is an assist from Sharp Corp., Osaka. Under an 18-month-old cooperative agreement, Sharp is sharing its technical know-how on LCD fabrication and also furnishing production equipment. Also, the partners have granted each other licenses to some of their LCD patents, and they are logical

candidates to become second sources for each other's products.

The Japanese ally could be a key factor for Philips—its fiercest competition in the LCD market will come from Sharp, Hitachi, and other Japanese companies that are already entrenched there. Philips thinks that taking on the Japanese will be worth the effort. Conrads says the company is convinced that LCDs—now found mostly in low-cost products such as watches, clocks, and pocket calculators—are going to be used more and more in complex applications, ranging from consumer electronics to automobiles, and telecommunications. "We regard LCDs as key components for future information and communication concepts," he says. Not only will LCDs affect system design—in such areas as personal computers—but they will also find new applications, such as pocket personal computers, and information and navigation systems for automobiles.

—John Gosch

INDUSTRIAL

DIAGNOSTIC BOX CATCHES CONTROL FAULTS FAST

BURLINGTON, MASS.

By going against the grain of current design practice, a new on-line diagnostic unit for process-control systems used in manufacturing achieves dramatically higher input-scanning speed at a lower cost. The diagnostic unit proper is distinguished by the absence of microprocessors and software, at a time when the instinctive reaction to many engineering problems is to reach for a microprocessor. Relying instead on firmware and custom logic, the unit promises to simplify diagnostics and provide scan times that are far faster than other approaches.

Called the Detective, the unit will be field-tested by Ford Motor Co. this month. It is essentially a state machine that requires processes to be modeled in stages, using a flow chart. Developed by Transimatics Inc., Burlington, the system stores, in an electrically programmable read-only memory, data that defines the progression of process-control stages and the inputs required to proceed with a control sequence.

The Detective is based on an approach that Transimatics calls firmware transitional logic. It monitors processes by high-speed detection of input

transitions. Its users see current process-control stages or preset alarm stages identified on the screen of a personal computer. The approach cuts the time needed to detect a transition associated with a malfunction to about 32 μ s. The unit can interface with any programmable logic controller.

The heart of the Detective is a printed-circuit board called the Transimate, which carries a pair of custom integrated circuits that scan 29 external channels, plus three used for internal purposes, at a rate of one μ s per input, looking for transitions. The transitions may originate directly from the process machinery or from on-board timers on another custom IC.

In either case, when a transition on a channel is detected by the Detective's central logic unit—a chip consisting of gates and registers—the logic unit consults an on-board EPROM about the detected change. The 8-K EPROM has a 13-bit address word. Five of the bits are defined by the particular input channel, out of 32 possible, being scanned. Eight bits are assigned to stage definition, for a capacity of 256 process-control stages.



DERSIN: Defining a system in firmware speeds diagnostics.

The scanning ICs send 5 bits to the EPROM that tell it on what channel the

The test performance trap

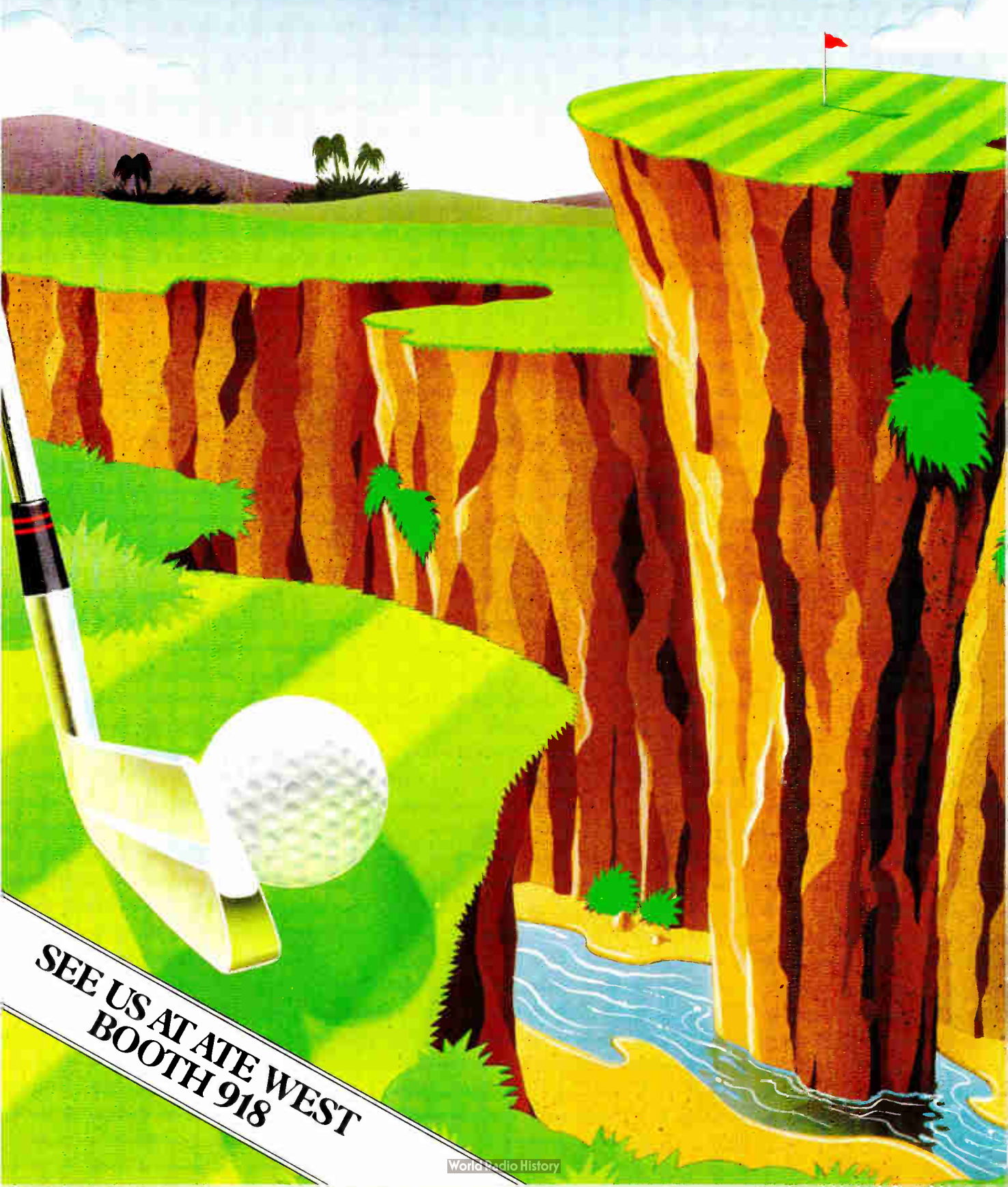

SEE US AT ATE WEST
BOOTH 918

Our business is to provide test solutions

Today's technological revolution creates dangerous illusions. You're concentrating on ever higher fault coverage and greater throughput, but are your test strategies flexible enough to meet constantly changing demands?

Or could they lead right back to your starting point?

At FACTRON, we have a new translation of ATE:

**ATE =
Applied Test Engineering**

We offer a new level of customer support in response to new challenges. You'll get help from engineers with a complete understanding of test and test problems. You can call in our experts at the earliest stage of product development to work with you and solve problems before they have a chance to affect production.

Help for your Company Worldwide

There are few companies with the capability, let alone the

knowledge, to help you on this scale. FACTRON is such a company.

Our large engineering teams in the U.S.A. and Europe are backed by support capability throughout the world. We're already far advanced in solving the problem of integrating design with test.

Do we genuinely mean you can consult us at the onset of product development? Yes. Because our test solutions prevent the development of test problems. We can show optimal routes or even suggest different approaches that could increase production or reduce costs. Or both.

Your test solution is our business

FACTRON capability is beyond the conventional ATE company, just as FACTRON systems and service extend beyond the conventional. Just a phone call will demonstrate our readiness to solve your problem. We know our business. **And it's our business to provide test solutions.**

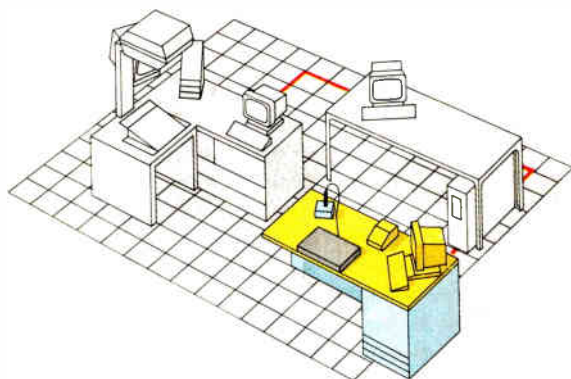

FACTRON SCHLUMBERGER, U.S.A.: 299 Old Niskayuna Road, Latham, New York 12110. Tel: (518) 783-3600

**FACTRON SCHLUMBERGER, Europe: Ferndown Industrial Estate, Wimborne, Dorset BH21 7PP, U.K. Tel: (0202) 893533
NISSEC SCHLUMBERGER, Japan: 1-2-10 Hirakawacho, Chiyoda-ku, Tokyo 102. Tel: (03) 2397411
SCHLUMBERGER SYSTEMS, Singapore: 12 Lorong Baker Batu, Singapore 1334. Tel: 7466344**

BENELUX Holland Tel: (040) 457745, FRANCE Tel: (1) 4687 3243, GERMANY Tel: (089) 638110, ITALY Tel: (2) 9233474, SWEDEN (8) 699733

**FACTRON AGENTS/DISTRIBUTORS
SPAIN Tel: (1) 2624913, SWITZERLAND Tel: (31) 442711, TURKEY Tel: (1) 338 3529**

Partners in Productivity

**FACTRON
Schlumberger**

Circle 46 on reader service card

World Radio History

transition was detected. At any given stage, the EPROM's data output tells the logic unit whether a transition is expected on that channel. If none is expected, the logic unit signals a malfunction. The EPROM may also store control outputs for an emergency shutdown, corresponding to alarm stages.

RECALL. The only microprocessor used in the system is employed as an interface between a first-in, first-out stack board and the supervisory personal computer. This board can recall the transitions detected for the last 29 stages, so that a sequence of events leading up to system failure can be traced.

Pierre Dersin, president of Transimatics, a subsidiary of Fabricom SA in Belgium, emphasizes that a microprocessor-based solution to the problem of real-time process diagnosis would be handicapped by software and operating systems, most likely resulting in substantially lower performance. "We use no operating software," says Dersin. "Everything is in firmware."

Attempts to use programmable logic controllers themselves for diagnostics often run into significant obstacles. Adding diagnostic functions can de-

EPROM and logic chip detect malfunctions in 32 microseconds

grade performance to unacceptable levels. The only way to maintain performance is to add costly memory.

In either case, the ladder diagrams used to program the controllers are cumbersome and require special skills. Their complexity increases engineering costs, particularly when changes in a process require modification of the diagnostic system. Finally, controllers have relatively slow scan rates, from 1 to 10 ms per input, often making it impossible for them to capture the first in a rapid series of malfunctions.

The Transimate board was itself initially marketed as a controller. Feedback from customers led Transimatics to reconfigure the product with an intelligent interface as a diagnostic system.

Ford will begin field trials of the device this month in a manufacturing environment, after successful lab tests at its Robotics and Automation Application Consulting Center in Dearborn, Mich. Bill Ford, a computer-applications engineer at the center, says the automaker developed—and later rejected—an in-house computer-based system for the diagnostic application for which the Detective is slated. "The problem is that if the computer goes down, there's no diagnostics for the system... and it's not as fast," he says. —Craig D. Rose

Cadnetix the standard C

Finally, full-function CAE for your standard IBM PC.

For a long time, full-function CAE and a standard IBM PC couldn't be mentioned together in the same breath. The Cadnetix PC System has changed all that.

Finally, an experienced CAE vendor has outfitted an unmodified IBM PC/AT™ or XT™ with the same excellent hierarchical schematic capture tools included on our high-end workstations. We've given you immediate access to real CAE component and semicustom libraries via Ethernet.™ And, we've made your PC a "window on the network," linking it to powerful Cadnetix engines for simulation, physical modeling and physical layout. All this without expensive alterations or add-on hardware. The Cadnetix PC System is a complete CAE resource that hasn't been converted into a high-cost hybrid.

The super-computer power of Cadnetix Engines, directly available to your PC's.

With Cadnetix, your IBM PC becomes much more than a normal entry-level CAE workstation. For fast analysis of your largest designs, Cadnetix gives you direct access from your PC to our full line of CAE Engines.



You'll develop designs on the PC, then compile and analyze them on high-performance engines tailored for accelerated compilation, simulation, physical modeling and database management. And Cadnetix has integrated all of these functions into a single network resource featuring both a RISC processor and a bit-slice processor to accelerate various applications tasks.

Our Analysis Engine is a versatile processing node offering you the choice of configurations you need for your design analysis environment. With up to 280 Mb of disk, mass storage for database management is essentially unlimited. Options include:

- Bit-Slice Engine with Simulation: This bit-slice application-specific accelerator speeds through logic simulations at 200,000 evaluations per second — 200 times faster than typical workstations. Worst-case analysis tools are standard.
- GP Engine: A general purpose engine providing accelerated compilation and SPICE. Based on a RISC architecture chip set, it has an effective operating rate of 10 million instructions per second. In addition, a compiler and debugger tool set allow you to accelerate 'C' programs which you develop.
- Physical Modeling Engine: This engine simulates



introduces AE workstation.

VLSI chips at vector rates of up to 16 MHz and accommodates devices with up to 364 inputs and 384 outputs. Vector storage of 512K x 91 bits provides for longer simulations and simultaneous analysis of up to 30 devices.

Powerful Cadnetix engines complement PC capabilities, achieving top efficiency in compute-intensive design tasks while supporting lowest-cost per engineer for routine access.

Now your PC has the capability of an entire design network.

The Cadnetix PC System is not just another PC software package. It is your window to complete, supported solutions for electronic systems design.

The NFS® protocol, a powerful networking standard, provides immediate and transparent remote file access to our full range of design tools: PC's for engineering design, high-performance workstations

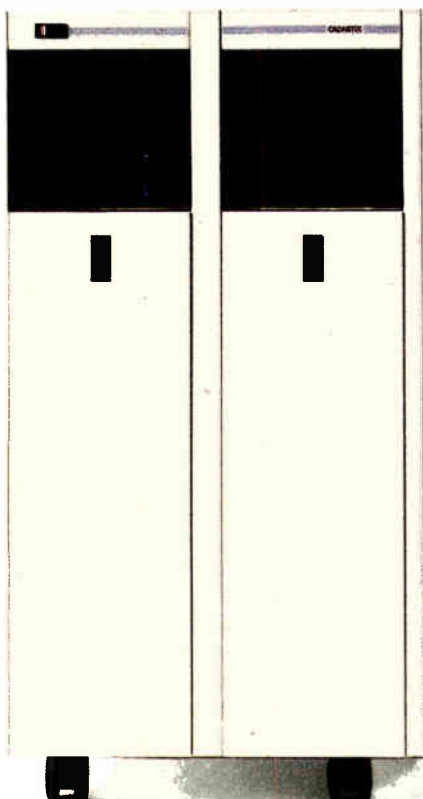

for advanced design tasks, high-capacity file servers for mass storage, engines for applications demanding peak power.

Cadnetix protects your investment with the most comprehensive set of data access standards available. With UNIX™ and EDIF, your data is always accessible. And with remote login capability, you can access any UNIX node on your network through the UNIX window on your PC.

Cadnetix has established the standard for ease of use with its industry-leading object-oriented user interface. Cadnetix has brought this interface to the IBM PC, giving you the shortest possible learning curve and eliminating a significant hidden cost of other systems.

Find out about the Cadnetix PC System. Discover the unlimited design potential of your PC.



CADNETIX Solutions for system design.

Cadnetix Corporation, 5757 Central Ave.,
Boulder, CO 80301 (303) 444-8075

IBM PC/AT and IBM PC/XT are trademarks of IBM Corporation. Ethernet is a trademark of Xerox Corporation. NFS is a registered trademark of Sun Microsystems, Inc. UNIX is a trademark of AT&T Bell Laboratories, Inc.

INTERNATIONAL NEWSLETTER

BRITISH SAY THEY HAVE A WAY TO SHARPEN LARGE LCD ARRAYS

A British government-backed research project, led by STC Technology Ltd., has come up with a way to get high-quality large-screen displays with ferroelectric smectic liquid crystals. LCDs now in use cannot handle large arrays without seriously degrading the picture quality. The Japanese build a thin-film transistor behind each picture element; that's fine for small displays but gets extremely complex in larger screens. STC, however, says that by using the memory properties of the ferroelectric smectic crystals, it has built a lab device with 4,000 picture elements and has simulated the crystals' behavior on a million-element screen. The researchers report switching arrays of picture elements greater than 1,000 rows at 64 μ s.

JAPAN SETS UP COPYRIGHT PROTECTION FOR SOFTWARE

To encourage greater enterprise within Japan's software industry, two government agencies are moving to make software eligible for Japanese copyright next spring. Copyrights help programmers to protect their work—presumably encouraging them to write more and better software. Software copyrighted in the U. S. will be protected automatically in Japan. The Software Information Center, established last week by the Ministry of International Trade and Industry in cooperation with the Ministry of Education, will administer the program. The center will store printouts of programs in microfiche for 50 years, the period for which protection will be provided.

PHILIPS' LOW-POWER SRAM COULD CLICK WITH BATTERY-POWERED GEAR

A 256-K static random-access memory under development at Philips Research Laboratories is shaping up as a natural for battery-operated equipment. Using less than 1 μ W of power in standby and 75 mW at 10 MHz, the SRAM has a cell area as small as 200 μ m², achieved by a relatively simple CMOS process. The six-transistor memory cell, in which both the npn and pnp transistors are cross-coupled, gets its small size from a 1.3- μ m double-metal technology with a single polysilicon layer on an epitaxial substrate. It's also fast: the 32-K-by-8-bit memory accesses in 40 ns.

HITACHI ADDS MEMORY-MANAGEMENT FUNCTION TO C COMPILER

Closing a performance gap in C-language compilers, Hitachi Ltd. has developed a compiler for its Z80-compatible 64180R1 microprocessor that can implement the memory-management function that translates the 64-K byte logical-address space into the 1-megabyte physical-address space. The new compiler will be sold initially as a VAX compiler; a version for the IBM PC is coming. The VAX version will ship in Japan on Jan. 21, at a price of \$3,400, and overseas on Feb. 20, with the price to be determined. In Japan, the PC version will cost about \$1,575; overseas prices are not set.

PRIVATE FIBER LINK TO CROSS THE ATLANTIC BY 1989

The first privately financed transatlantic fiber-optic link, PTAT-1, is scheduled to enter service in June 1989, hot on the heels of the first publicly funded system, TAT-8, which will be ready in 1988. STC Submarine Systems Ltd. of Greenwich, England, has been awarded a \$350 million order as prime contractor for PTAT-1 from Cable & Wireless and Tel-Optik. The line will span more than 7,000 km underwater, from Weston-super-Mare in England to Long Island, N. Y., with a spur to Sueswood Bay in Bermuda. The system will include three working pairs and a spare pair that can be used as a backup; each pair will carry 5,760 channels at 420 Mb/s and have 114 repeaters.

INTERPHASE PULLS A FAST ONE

V/SMD 4200



30 MBytes/s on VMEbus

INTERPHASE® shatters the old speed limits of the VMEbus with its second generation of VME disk controllers boasting 30 megabytes per second bus speeds and above. Using a new INTERPHASE technology breakthrough called the BUSpacket InterfaceSM ... the new V/SMD 4200 Cheetah and V/ESDI 4201 Panther triple existing VMEbus speeds and approach the VMEbus theoretical bandwidth of 40 megabytes per second!

SIMPLY THE FASTEST

The combination of the BUSpacket Interface and a large (128 KBytes) cache memory provide the V/SMD 4200 and V/ESDI 4201 with unequalled speed, and make them the fastest SMD and ESDI controllers by a factor of three. No one even comes close!

In simple terms, the new INTERPHASE technology

preformats packets of data to go across the bus before acquiring it. The INTERPHASE BUSpacket approach unharnesses the VMEbus from slow devices through deep, high-speed bus FIFOs and an asynchronous delay line-based state machine, which controls bus transfers. Data is emptied onto the bus in packets at speeds 30 megabytes per second and above.

STICK WITH THE WINNERS

The V/SMD 4200 and V/ESDI 4201 also incorporate the proven INTERPHASE features of the multitasking Virtual Buffer ArchitectureSM, Intelligent Caching, and zero latency operation found on other popular INTERPHASE

products. The four drive V/ESDI 4201 Panther even adds an integral SCSI port for easy addition of back up devices.

Both products complement INTERPHASE's high-performance V/Tape 3209 1/2" tape controller, and are **PLUG & PLAY** software compatible with the industry's most successful SMD and ESDI controllers, our V/SMD 3200 and V/ESDI 3201.

THEY'RE GOING FAST

To learn more about the fastest SMD, ESDI and 1/2" tape controllers around, call or write today ... but you better move fast ... INTERPHASE certainly is.

(214) 350-9000



INTERPHASE
corporation

2925 Merrell Road • Dallas, Texas 75229 • Telex: 9109976245 NASDAQ-NMS:INPH

Interphase International

93a New Street, Aylesbury, Bucks. HP20 2NY, England (0296)35661 Telex: 826715 AERO G

Interphase is a registered trademark of Interphase Corporation. BUSpacket Interface and Virtual Buffer Architecture, are service marks of Interphase Corporation.

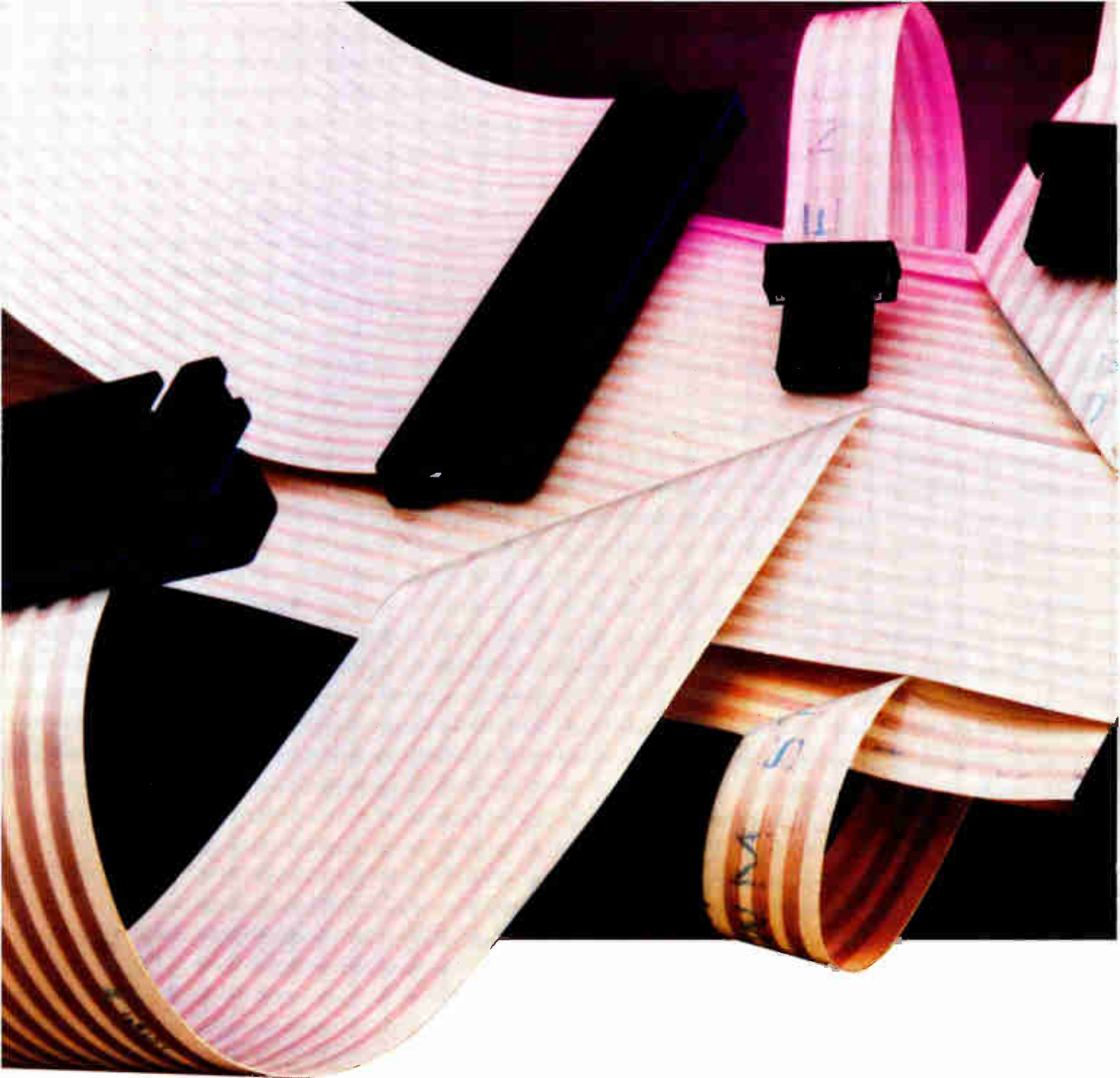

**This flat conductor
cabling system from
AMP lets you flex
your imagination, too.**

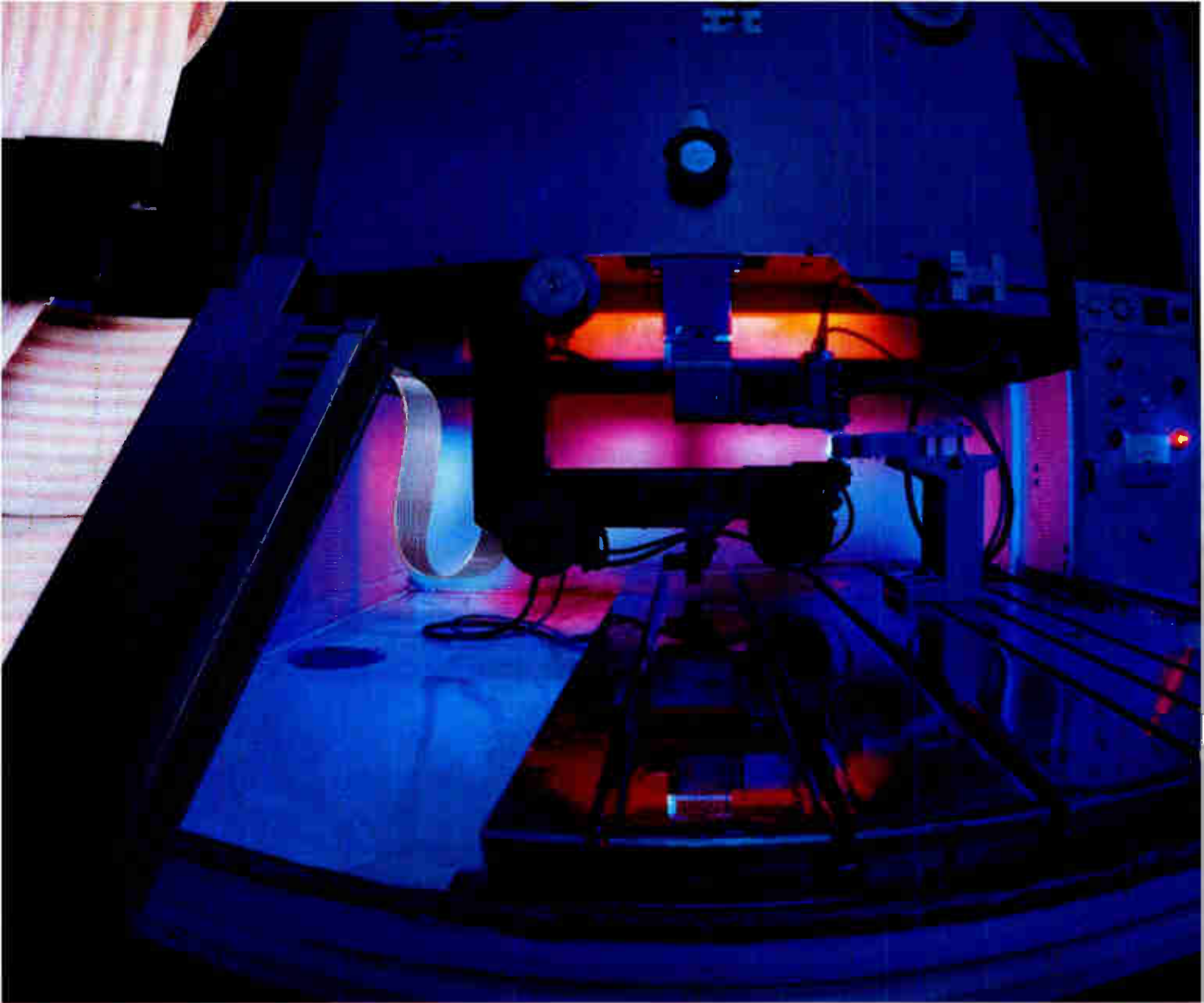

AMP is a trademark of AMP Incorporated

Flexible flat cable offers today's designers an attractive alternative to discrete wire — higher-density packaging and uniform conductor-to-conductor relationships. And, of course, it's flexible. To the tune of tens of millions of cycles.

Now, picture this. Our flex flat cable harnesses come complete and ready to install, and they intermate with a wide variety of

standard headers on .050" or .100" centers. And our cable and components are designed for high-productivity machine termination in your plant. Either way offers big savings for you.

Whether you need harnesses or components, we have ideas that

will free your design imagination. Without putting a big bend in your real-life budget.

Call (717) 780-4400 and ask for the FCC Information Desk. AMP Incorporated, Harrisburg, PA 17105-3608.

Circle 53 on reader service card

AMP Interconnecting ideas

Pressed for space? .100" center cable is just .013" thick, max. rated to 3A/conductor; .050" center cable is .011" thick, rated to 1.5A/conductor.

Flat conductors dissipate heat more efficiently. Ideal idea for connecting things in motion, from print heads to robotics.

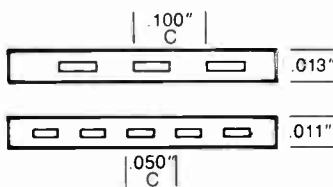

AMP Trio-Mate connectors for flat flex cable .004" to .015" thick. Staggered contacts reduce insertion force, wiping action assures reliable contact. Horizontal and vertical styles, 2-22 positions.

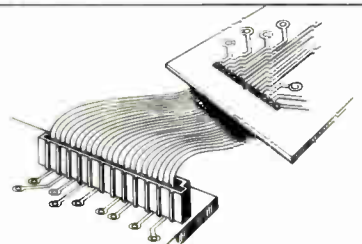

THE BRAINPOWER

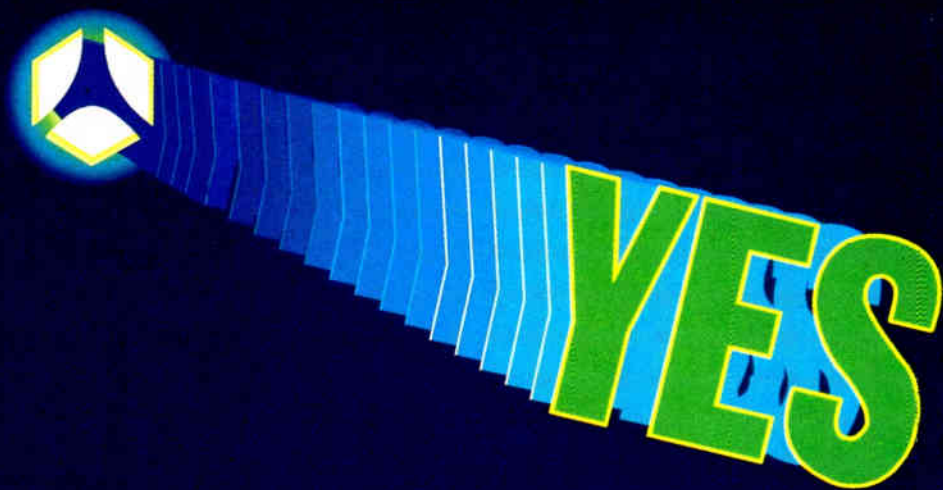

WE DIDN'T GET TO BE A WORLD LEADER IN DEFENSE ELECTRONICS BY SAYING NO.

At Thomson-CSF we say yes because we're equipped to say yes.

It starts with our products. Our line is probably the widest in the world. Our electronic systems cover the whole range of defense requirements of all three armed forces.

From detection to communications to data processing to simulation to electronic warfare to interception.



Sea Tiger radar.

On land...at sea
...and in the air.

What happens if our product isn't exactly what you want?

Well, we didn't make it to the top in defense electronics by telling our customers to take it—or leave it.

At Thomson-CSF we pride ourselves on our ability to adapt our existing product to

meet your precise needs in every possible way.

It's a matter of flexibility. And adaptability.

And the ability, when the others say no, to say yes.



A mobile Subscriber Radio Terminal of the RITA system.



The Crotale

EQUIPEMENTS ET SYSTEMES

23, rue de Courcelles
75362 PARIS CEDEX 08 - FRANCE
Tél.: (1) 45.63.12.12 - Télex : TCSF 204 780 F

Circle 54 on reader service card



THOMSON-CSF

THE BRAINPOWER. THE WILLPOWER. THE WINPOWER.

INSIDE TECHNOLOGY

SMART CARD

WILL IT CREATE
A BILLION DOLLAR
IC BUSINESS?

by Clifford Barney

Smart cards—wallet-sized plastic with embedded microprocessor and memory chips—are beginning to emerge as a marketplace, one that many see as the next semiconductor bonanza. Painting visions of potential applications almost anywhere digital information is processed, smart card enthusiasts predict multimillion-unit markets, all delightfully free of the need to surround chips with boards, computer iron, and cables. A lightweight card and a few contacts are all that is needed to

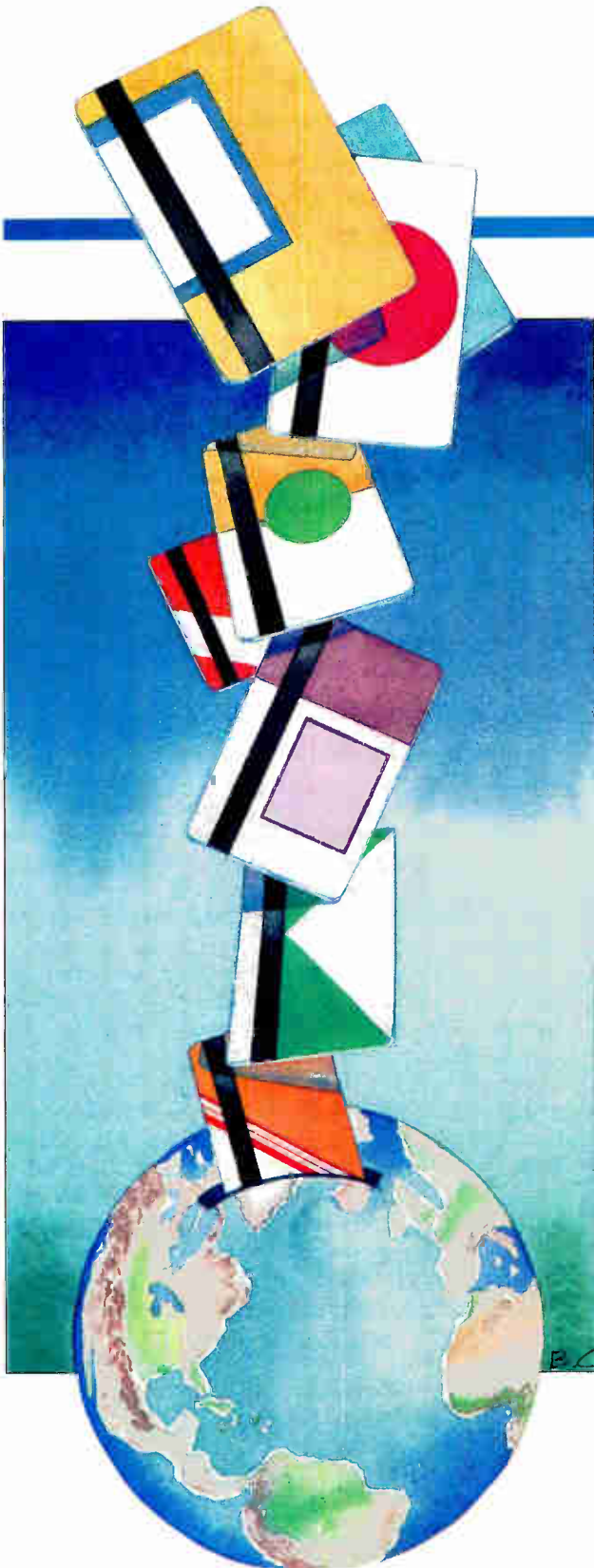

SMART-CARD TESTS PLANNED OR UNDER WAY	
Sponsor	Application
JAPAN	
Dai-Ichi Kangyo	Banking
Daiwa Bank	Shopping
Fuji Bank	Corporate banking
Mitsui Bank and Toshiba Credit	Banking and shopping
Sanwa Bank	Shopping
Seibu Bank	Medical
Sumitomo Bank	Shopping
Toshiba	Point-of-sale systems
Toyo Trust Bank	Financial management
EUROPE	
Credito Valtellinese, Italy	Savings
French PTT	Point-of-sale systems
French PTT	Public phones
French PTT	Telepayment
University of Paris	Student transcripts
UNITED STATES	
Bank of Virginia	MasterCard trial
Department of Agriculture	Food-stamp card
Department of Health, Education, and Welfare	National health insurance cards
J.C. Penney	Home banking
MasterCard	Point-of-sale systems
Visa	Supersmart card
Navy	Medical records

SOURCE: DATAQUEST INC

put a smart-card chip to work. But the ability to put intelligence on a card has outstripped the imagination to use it. Without unique applications, smart cards have remained a technical curiosity, some sort of bonsai computer. Now those new applications are beginning to appear, as chip and card makers develop more flexible ways of packaging control and memory.

Progress is most evident in France, where some 8 million cards are being used. Japan is closing in, with dozens of smart-card tests planned or under way. So far, however, the U. S. companies have lagged behind in developing both technology and applications.

One reason for the delay is that the market is hard to pinpoint. Because many of the products and chips are still undefined, most analysts estimate unit sales, rather than dollar volumes. For example, Sheridan Tatsuno of Dataquest Inc., a San Jose, Calif., market-research firm, pegs the U. S. market by orders of magnitude. This year, he says, hundreds of thousands of smart-card chips will be made. By 1988, the volume will be in the millions; by 1989, in the tens of millions; and by the 1990s, in the hundreds of millions. One explicit prediction comes from B. K. Marya, president of Catalyst Semiconductor Inc., a Santa Clara, Calif., company that has developed a smart card with 2-K bytes of memory (see p. 59). He says the market for microcontrollers has the

potential to grow to \$2 billion by 1992.

One problem with forecasts is that smart cards themselves are somewhat vaguely defined. Generally, most industry observers draw a distinction between "chip cards," which have on-board intelligence, and cards that only have memory capacity. Some people lump pure memory cards in with smart cards; others consider these "dumb cards" (see p. 58). Most people use the labels "smart card" and "chip card" interchangeably, but the former is a general term and the latter implies the presence of an integrated circuit, usually a microcontroller.

Regardless of the definition, the smart card is expected to generate a lot of business, with credit-card transactions bringing the most. So far, that market is developing very slowly, as bankers feel their way along unfamiliar ground.

While the financial community tries to decide how to use smart cards, niche markets are beginning in cards for what Tatsuno calls "3-M applications:" military, medical, and manufacturing uses, including process control, maintenance, security and access, and medical records.

In Japan alone, Tatsuno counts 40 tests scheduled or in progress, nine of them major (see table), involving 81 vendors of chips, cards, readers, and services. Besides Japanese printing companies, which make credit cards, Tatsuno reports that IC makers, materials manufacturers, and watch and calculator makers are all jumping in.

SINGLE CHIPS FOR JAPAN

Japan has already gone through a generation of multichip cards and is gradually switching to single-chip versions except where large amounts of memory are required. The major application is off-line shopping, in which banks "charge up" a card and merchants subtract, at the point of sale, the purchase price from the balance recorded on the card.

Dai Nippon Printing Co. is engaged in an experiment with banks and merchants in 10 cities for cashless shopping. Toppan Printing Co., Kyodo Printing Co., Hitachi Maxell, and Fujitsu also have off-line shopping tests. Dai Nippon has a medical-records experiment in which 50 hospitals use its cards to record visits to doctors. Toppan is using cards to charge employees for meals in the firm's cafeteria, and reportedly has a multi-application card in the works. Kyodo has a data card for use in personnel management and inventory control.

In France, a government-mandated smart-card effort is starting to generate some significant numbers. Last month, Thomson Semiconductor's MOS division marked the fabrication of its 15 millionth smart-card chip in a single year. The French have 7 million telephone chip cards and a million bank credit cards already in circulation, estimates Jerome Svigals, publisher of the newsletter *Smart Cards and Comments*. And the big wave of French cards has yet to hit: under

government directive, all French retailers must have smart-card readers by 1990, providing support for millions of cards.

Applications are already proliferating. Marc Lassus, general manager of Thomson's MOS division, says that his firm is developing new products for manufacturing-inventory control and for the trucking industry, to monitor vehicle performance. Smart cards are being used to record the transcripts of some 8,000 students at the University of Paris; the French national health-insurance program will draw on the results of that operation for its own smart card.

"We are confident that the market is going to explode very soon," Lassus says. "The problem is going to be to help the customer with a complete system, rather than just a piece of plastic with a chip on it. That, we have already mastered. Now it is just a question of new products fitting to an exact application."

In the U. S., however, only three field trials of smart cards are now going on; four more are planned. Tatsuno and Svigals say the Japanese and French are leaving the U. S. behind.

"Every major Japanese bank, retailer, equipment vendor, card supplier, or government agency involved with postal telegraph, health and welfare, or transportation is involved in tests," Svigals says. "There are industrial applications, taxi-meter cards, music-synthesizer cards. I have never seen anything in Japan that matches the scope and intensity of this technology."

By contrast, says Tatsuno, "The U. S. has been slow on its feet. The American firms say, 'There is no market here; why waste our time?' The Japanese say, 'There will be no market for five years, there is time to do the groundwork.'"

Tatsuno warns that smart-card customers are institutions, rather than individuals, so startup time includes two to three years of testing. "Volumes may not pick up until 1991," Tatsuno says, "but by then the technical game will be over. Unless you are in now, it's too late."

The U. S. market is not totally quiescent. Motorola Semiconductor, the sole major U. S. chip firm with a serious smart-card program, says it has more activity than it can handle. And a handful of smaller firms, like Catalyst, Seeq Technology, Exel Microelectronics, and Xicor, are exploiting electrically erasable memory technology to build "soft chips" that can multiply smart-card applications.

General Instrument Corp.'s Microelectronics Division in Chandler, Ariz., says that it is looking into smart-card chips with on-board EEPROM. An-



SEIDMAN: If MasterCard goes ahead, Visa will have to go along.

other division of General Instrument provided prototypes for a "supersmart" card, with a keyboard and display, that Visa is investigating.

But in general, the big U. S. chip firms are not convinced that smart-card applications warrant a major effort at this time. Neither Texas Instruments Inc. nor Advanced Micro Devices offers a smart-card chip. (Seeq, however, has a chip with on-board EEPROM built around the TMS 7000 microprocessor from TI.) Intel Corp. indicates a keen awareness of smart-card potential but little inclination to pursue it now.

The biggest U. S. player so far is MasterCard, which is aggressively promoting smart cards in two tests and has already distributed specifications for its next-generation bank cards to nearly 150 potential suppliers.

But financial smart cards in the U. S. are being held up while MasterCard and archrival Visa come to terms.

The gap between them is wide. MasterCard is going full-bore. It expects to have pilot quantities of terminals and cards available by next October or November, and to be in full-scale production by 1988. "We will have a minimum of six to eight major vendors," says John C. Elliott, MasterCard's executive vice president for electronic services. Further, Elliott adds, the cards will not be limited to financial transactions but will also be capable of keeping medical records and performing other functions. Siemens in

Tatsuno: "Americans say, 'There's no market here; why waste our time?' The Japanese say, 'There will be no market for five years, there's time to do the groundwork'"

West Germany, Bull SA, Motorola, and Omron in Japan are likely contenders. Cards for one of MasterCard's field trials are being made by MicroCard Technologies Inc. of Dallas, a Bull SA subsidiary, and contain a Motorola chip.

Visa general manager J. Pino Francini argues that cards that require a special reader are not cost-effective in the decentralized U. S. banking system. "We are not against chip cards; on the contrary, we fully believe it will come," Francini says. "But we are not for rushing ahead and turning banking upside down purely in the name of technology. Let's figure it out first, and then there are a hell of a lot of technologies out there we can use."

Stephen Seidman, publisher of the newsletter *Smart Card Reports*, thinks Visa may have no choice, however, because "If MasterCard goes ahead, it's hard to imagine that Visa would let it have the single say over how smart cards are used." Seidman adds that individual banks may force the issue by giving customers cards that carry a form of electronic Green Stamps, giving extra credit for use of a client's airline, hotel, or auto-rental service.

MasterCard has suggested a meeting next month to thrash out the future of smart cards in the U.S., but no date has been set.

Not everyone thinks smart cards are ready to fly. John Fisher, executive vice president of Banc One in Columbus, Ohio, compares them to the Concorde, as an example of a "fine but misplaced technology."

Fisher agrees with Francini that the U.S. banking industry is moving toward on-line storage of data, not storage distributed on cards. He claims that only 10% of the public has accepted the use of automatic-teller cards to obtain cash, leading him to think that smart cards will not win easy acceptance. "Nothing important will happen with chips for a decade," he says.

In any case, the embryonic market faces problems of cost, reliability, security, and standard-

ization, even as it tries to develop new applications. One-chip cards go a long way toward solving the first three, but standards are such a thorny issue that the earliest markets are in smaller applications where interoperability is not necessary. Japanese cards do not conform to the standards worked out by the International Standards Organization. Eventually, however, widespread use of smart credit cards will depend on adherence to standards.

'A POTENTIAL TO EAT SILICON'

The smart-card believers are not dismayed. "The smart-card market could be the next personal computer for chipmakers," says Michael Zillott, marketing manager of Seeq. "It has that potential to eat silicon." Zillott himself, however, does not expect the market to develop until the 1990s, despite the example of the European and Japanese firms that are already doing a lively business.

"A lot of people in the United States are too far from the market," says Marya. "They don't see why you need intelligence on a card. But the French see, and the Japanese aren't far behind. The smart card is just as intelligent as you want it to be. It can be a bank card, a security card, an inventory card—anything." □

DREXLER KEEPS PLUGGING AWAY WITH 'DUMB' OPTICAL STORAGE CARD

While many companies wrestle with the development of the smart card, Drexler Technology Inc. is ready to start production of a "dumb" card—a storage medium that holds up to 4 megabytes of laser-written optical storage. Drexler's brand-new Mountain View, Calif., plant can churn out 30,000 cards a day and will be able to make 100,000 a day by next April. That kind of production would create quite a bottleneck, however, because at the moment there are only a hundred machines in the world capable of reading the cards, according to the company's president and founder, Jerome Drexler.

Help is on the way. Drexler has licensed two dozen firms to make readers since announcing the card in 1981, and a number of those companies, mostly Japanese, have started to introduce products. This year, the Sumitomo Bank began testing a cashless banking system using the LaserCard and a reader made by Olympus Optical Co.; Toshiba Corp. has announced both read-only and read/write equipment; and both Computer Services



DREXLER: "Our card is the floppy of optical storage."

Corp. (CSK) and Nipponco of Japan have announced \$100 readers.

Drexler needs not only readers but also a second source for the cards before its new factory will be able to ramp up. Blue Cross of Maryland, which gave the LaserCard its first big push in May 1985 by agreeing to use it for medical records, told Drexler last July that it would not go into production until a second source had been signed.

Meanwhile, Maryland Blue Cross's LifeCard International subsidiary has also licensed technology rights to another laser card whose designers, Optical Recording Corp. of Toronto, say it can store 50 to 200 megabytes. The company says it will manufacture neither the card nor the readers, but is negotiating with 50 potential manufacturers of both, 25 of them in Japan. LifeCard will act as a distributor and will have first rights to any product arising from the technology.

For its part, Drexler, though it has energetically marketed licenses to make card readers, has retained rights to its cards, while nailing down the technology

with a dozen patents. "Eventually, we will have half a dozen second sources," says Drexler—but the first one will have to make a commitment to build a \$25 million plant, before the market has been established. To be willing to do that, Drexler concedes, "They will have to see a market." Drexler has no doubt that there is one; for two years, he has stuck to his prediction that 160 million cards a year will be sold by 1991.

Skeptics suggest that these are heady projections for a card that has never been field-tested (except by Sumitomo, whose test includes only 100 users and has just begun). But Drexler is already looking far beyond medical and financial applications, to using the cards in publishing and as an input/output device for personal computers and optical disks. A recent technical advance enabled the firm to double the amount of storage on the card, to 4 megabytes—meaning, Drexler points out, that the card can now store as many as 125 pages of graphic information as well as 800 pages of text.

"For the optical storage world, our card is the floppy disk," Drexler says. "Our biggest problem is shaking out of people's minds the idea that it looks like a credit card." —Clifford Barney

DOES CATALYST HAVE THE KEY TO SMART CARDS?

A tiny but powerful microcontroller from Catalyst Semiconductor Inc. may be the key that will unlock a worldwide billion-dollar business in smart-card chips. Measuring 4.5 by 5 mils by only 200 μm thick, the CAT61C580 chip is small enough to meet size requirements set by the International Organization for Standardization for smart-card applications, yet it packs 2-K bytes of electrically erasable, programmable read-only memory. That's at least four times the EEPROM of any other ISO-compliant smart-card chip now available using the same 2- μm CMOS design rules.

The Santa Clara, Calif., company achieved this density by stripping away the peripheral logic around the EEPROM and writing these functions into microcode. That left plenty of room for the 2-K bytes of EEPROM, and the chip is still about 30% smaller than competing devices that have only a fourth or less memory. What's more, Catalyst is working on an 8-K-byte chip, which will be made by shrinking the current 220- μm^2 EEPROM cell size to 80 μm^2 with a combination of proprietary design refinements and 1.5- μm geometries. The CAT61C580 is just being released; the 8-K-byte chip should be available next year.

Working in conjunction with joint developer Oki Electric Co., Tokyo, Catalyst designers modified an Oki microcontroller by adding a programmable logic array and 2-K bytes of EEPROM. (Fig. 1). They also managed to squeeze in 3-K bytes of ROM, 128 bytes of random-access memory, and enough electrostatic-discharge-protection circuitry to protect the chip from up to 15,000 kV, enough to protect against the static electricity generated by removing a credit card from a pocket or a billfold.

In addition, the CAT61C580 op-

Catalyst Semiconductor thinks that its new chip, which meets ISO smart-card standards and has 2-K bytes of EEPROM, could finally open up the market

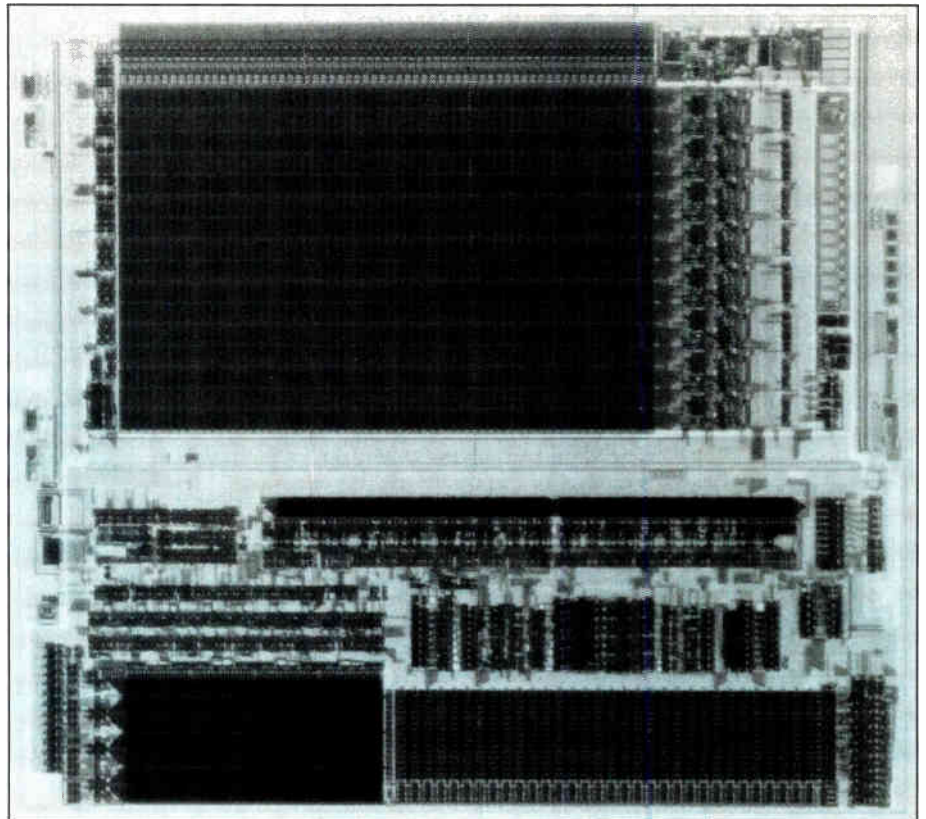

1. LITTLE GIANT. Catalyst's 8-bit microcontroller is tiny enough for use in smart cards, yet it has an elephant's memory.

erates at the ISO-recommended frequency of 4.9 MHz with a high-speed instruction-cycle time of 813.8 ns, allowing it to run at the ISO's recommended 9,600 baud through a single serial input/output pin. Power dissipation of the 8-bit chip is only 20 mW.

The architecture of the chip allows asynchronous, two-way communications through a single serial I/O pin. This eliminates the need for a universal asynchronous receiver/transmitter and an interrupt, reducing the number of pins to only five—one third to one half of what's required in other approaches.

A TANTALIZING IDEA

The idea of EEPROM-based microcontrollers has long captured designers' imaginations because of the wide range of applications—not only for smart cards, but also for robotics, artificial intelligence, industrial controls, consumer products, and more. But so far, applications have been limited to a small number of niche markets for controllers, because of the small amount of EEPROM that could economically share the same chip as the microcontroller. Smart cards are one application that promises to allow EEPROM-based microcontrollers to break out of their niche; now that such a powerful chip that meets ISO smart-card standards exists, that breakout could be imminent. And with the increased memory that is promised, the chips will have a crack at the full range of potential microcontroller markets.

Catalyst president and founder B. K. Marya claims his is the only chip that meets, and in some cases exceeds, all of the ISO requirements for smart-card applications, including area, thickness, electrostatic discharge, power dissipation, and speed. Of these, the first three are the most critical, he says.

"The thickness must be no more than that of a standard credit card, 200 μm . And the area must not only be 5 by 5 mils or less, but [the chip must] be as square as possible, to prevent the

possibility of breakage when the card is bent. In addition, the chip must be capable of withstanding the electrostatic discharge that builds up taking credit cards in and out of pockets and wallets." This buildup has been measured in excess of 10 kV, he says.

The 2-k-byte chip is aimed at a projected near-term market for smart cards that some estimate to be worth hundreds of millions of dollars (see p. 55). In a typical smart-card transaction, a card holder puts the card in a point-of-sale terminal. The terminal supplies the card with electric power and communicates to the card's microcontroller through pin contacts on the card's surface. The user is asked to enter a password. When the sale is rung up, the amount of the transaction is stored in the card's EEPROM, credited to the retailer's account, and debited from the card holder's credit balance, which is also stored in the card's memory. The card holder can replenish the credit balance at an automatic-banking machine.

What has held back the development of the EEPROM-based microcontroller market, Marya says, is the fact that, although stand-alone EEPROM parts of 16-K, 64-K, and 256-K densities are becoming commonplace, EEPROM-based microcontroller densities have trailed the stand-alone densities by at least four generations.

One way to achieve more on-board EEPROM is to advance the processing state of the art: scaling down the lateral dimensions from geometries between 2 and 3 μm to between 1.25 and 1.5 μm , and the vertical dimensions on the EEPROM from 150 to 250 \AA down to 80 to 90 \AA , which comes close to the limits at which EEPROMs operate reliably. The problem with this, says Marya, is that it requires manufacturers to push the process technology for microcontrollers beyond what is currently available even for stand-alone EEPROMs. And although such an advance is technically feasible for the high-volume applications that could use such large EEPROM/microcon-

troller combinations, the high cost of manufacturing such devices rules out their use. Marya says there is also the problem of reliability, which is critical for smart cards, where data integrity and security are important. So to make room for more EEPROM, Catalyst replaced the peripheral-function circuitry with microcode.

To get 2-K bytes of EEPROM into an ISO-standard smart-card chip, says Marya, "what is required is a fundamental rethinking of the architecture of EEPROM-based microcon-

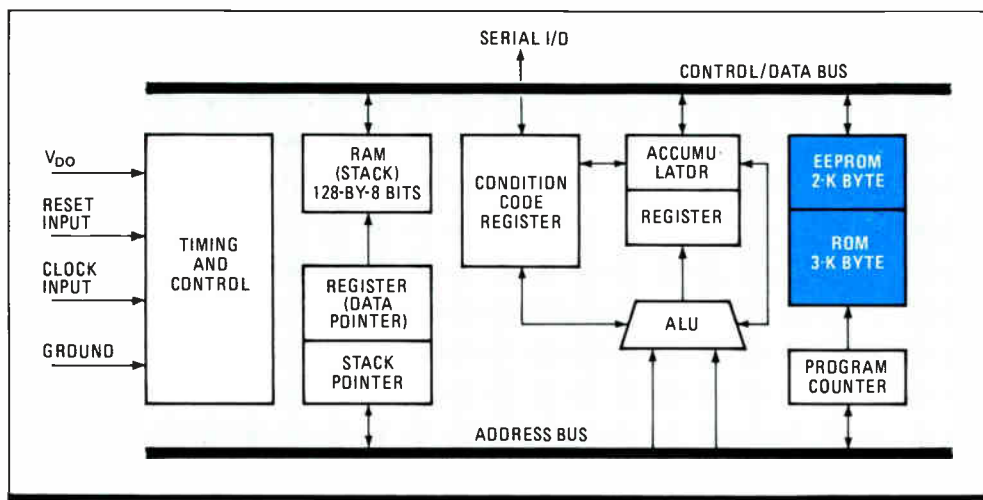

2. ATTRACTIVE SWAP. By writing the latch, timer, and test logic functions into microcode, Catalyst designers were able to free up more than enough room on the chip for 2-K bytes of EEPROM.

trollers. Basically, most current implementations are 'brute-force' affairs combining the functions of an EEPROM and a microcontroller on the same chip, without any modification whatsoever."

By writing the functions of the EEPROM's peripheral logic into microcode, Catalyst has freed up real estate for more EEPROM. "Essentially, we have taken a standard EEPROM device, stripped off such peripheral circuitry as the latches, timers, and self-test logic, and incorporated these functions into the microcode of the on-board 8-bit microcontroller (Fig. 2), resulting in a 5-by-4.5-mm die size," says Marya. To achieve these breakthroughs, Catalyst designers came up with an architecture that differs from standard single-chip EEPROM/CPU implementations in five fundamental ways.

First, even though it uses the same 200- to 250- μm^2 cell structure as the CPU, the 2-K-byte EEPROM takes up only half the area of the microcontroller. Second, the microcontroller's microcode has been expanded to include the latch, timing, and test functions usually associated with the operation of the EEPROM. Although this increases the area occupied by the microcode by 5%, eliminating the peripherals from the EEPROM circuitry saves 20% of the EEPROM's space.

Third, the bus architecture has been simplified. In the traditional one- and two-chip approach (Fig. 3a), at least six separate data, address, and control lines link the EEPROM and the CPU. Moreover, Marya says, the user has to provide necessary waveforms on control pins WE, OE, and CE, along with the valid data and address. The completion of programming is signaled via the RDY/BUSY pin, which has to be monitored by the microcontroller. In the CAT61C580, the interface between the CPU and the EEPROM is reduced to a three-bus structure (Fig. 3b), because the EEPROM's hard-wired latches and timer are eliminated. In addition, testing of the EEPROM is done internally, eliminating the need for test pads.

Fourth, the addressing scheme has been modified, says Marya, in that the EEPROM is above the ROM address space but, unlike the ROM, it is addressed through RAM. The addressing scheme is made efficient by eliminating page boundaries and providing both direct and indirect addressing of the RAM.

Finally, two additional registers have been added to the basic architecture: a B register to enhance the arithmetic logic unit's computation-intensive tasks, and a D register, which can be auto-incremented or -decremented to enhance the

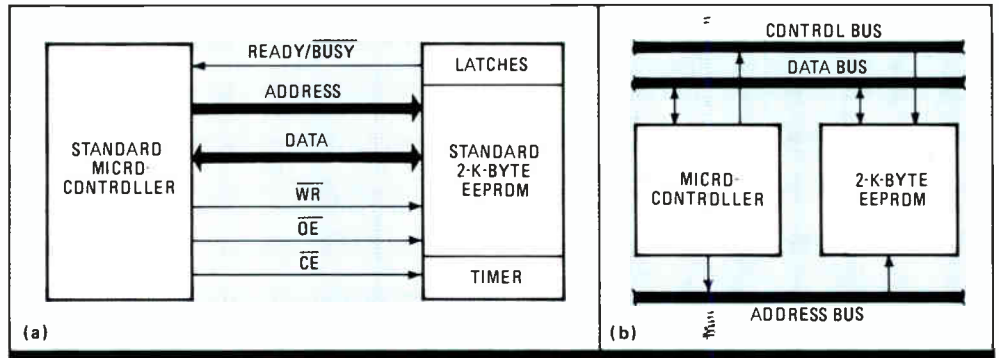

3. SIMPLIFIED BUS. By eliminating latches, timers, and test logic, the complex bus structure of a standard EEPROM-based chip (a) is replaced with a simpler three-bus arrangement (b).

speed of the RAM's read and write operations. The 128-by-8-bit RAM provides 32 levels of nesting, and it can be used as a stack for pop and push operations.

WHAT'S IN THE MICROCODE

Most of the read, write, and erase functions are performed using two simple move commands incorporated into the CPU's microcode, MOV₁ and MOV₂. The first command transfers data from the internal RAM to the EEPROM, erasing previous data after receiving the appropriate 24-bit security code. The second command reads data out of the EEPROM locations and into the RAM. With these commands, EEPROM programming is made totally transparent to the user. "This transparency adds an additional level of security and reliability, since, unlike other implementations, the actual mechanism of writing into EEPROM is never revealed to the user," says Marya.

In addition to these special instructions, there are the 95 other housekeeping commands usually incorporated into a microcontroller: 55 one-byte instructions, 35 two-byte instructions, and 5 three-byte instructions. However, the instructions have been modified to reflect the chip's use in smart-card applications. The large number and smaller width of instructions provide more programming power to the user, and that's important in smart cards, where programming space is limited to on-board ROM, says Marya.

Security is also essential for smart-card applications, because the user stores important financial and personal information in the card's EEPROM. So Catalyst designers incorporated a set of special instructions into the microcode and a program into the on-board ROM that allows a three-level security scheme. "In a credit card application, this would make it possible not only for the primary user, say the financial institution, such as MasterCard or Visa, to have an access code, but the issuing bank and the individual card user as well—the first incorporated into the nonerasable ROM when the chip is sold to the issuing institution, and the other two inserted into the EEPROM when the card is issued to a customer," says Marya. "In any transaction, all

three codes must be matched before any information is revealed to the user or any data is changed on the card—the first two between the card and the machine automatically, and the third by the user on request.”

The high voltage for erasing and programming the EEPROM cell is generated on the CAT61C580, so the chip needs only a single power supply of 5 V. Fabricated with a 2- μ m EEPROM process, which combines a 2- μ m CMOS logic process with a conventional high-voltage two-transistor, floating-gate tunnel-oxide EEPROM process, the chip's EEPROM is specified for 10,000 program-erase cycles and 10 years of data retention. The process uses dual oxides—a thin oxide to obtain high-speed EEPROM read capability and a thicker oxide to withstand the 21 V required for erasing and programming the cell.

In this scheme, Marya says, the user can change his code at regular intervals, as can the issuing institution via the automatic teller machine. Also, the card-reading machine can be programmed to disqualify the card after a certain number of unsuccessful attempts to enter the code. In addition, he says, further levels of security can be incorporated into the EEPROM, such as specifying several individuals who are autho-

rized to use the card, and their credit limits.

Catalyst is evaluating a number of strategies to take advantage of planned second-generation improvements. First, implementing the 2-K-byte architecture in 1.5- μ m CMOS and using the 80- μ m² cell that is now under development will reduce the die size of 2-K-byte devices by as much as 50%, while increasing the number of dice per wafer and lowering the cost of the finished devices. Alternatively, the same process improvements will allow an increase in EEPROM array capacity from 2-K bytes to 8-K bytes without substantially increasing the present die size. Finally, Marya says, the enhancements will allow fabrication of 16-bit microcontrollers with as much as 32-K bytes of EEPROM, opening a host of application areas that require real-time response, such as artificial intelligence, robotics, and high-performance industrial and military controllers. □

TECHNOLOGY TO WATCH is a regular feature of Electronics that provides readers with exclusive, in-depth reports on important technical innovations from companies around the world. It covers significant technology, processes, and developments incorporated in major new products.

MARYA: THE MICROCONTROLLER COULD BE THE NEXT GREAT 'GIZMO'

“For years the semiconductor industry has been looking for the electronic gizmo that would approach the dollar and unit volumes that digital watches, calculators, and video games generated,” says Bharat Kumar Marya—“B. K.” to his friends and associates. The president and founder of Catalyst Semiconductor Inc., Santa Clara, Calif., believes that smart cards are just the tip of the iceberg in a market for nonvolatile memory-based microcontrollers that he thinks may reach \$2 billion a year by the mid-1990s.

Marya, 38, thinks that many observers expect growth to come from the wrong places. “Almost everyone has turned their eyes toward personal computers and work stations, which have quickly moved from 8 to 16 to 32 bits,” he says. But as explosive as that market was at its beginning, it has begun to level off in terms of growth and penetration. Moreover, he says, the largest share of the profits went to original-equipment manufacturers and system integrators, not to chip manufacturers.

“The only market that has a good chance of recreating the bonanza of dollars and unit volumes of the past is the market for smart integrated-circuit cards built around EEPROM-

based, 8-bit microcontrollers,” says Marya, who points out that there are some 200 million banking and credit cards in circulation. He projects that by 1990 about 25% of these cards will be integrated-circuit-based. Beyond this, he says, there are other potentially huge replacement markets, such as telephone credit cards, as well as new applications, such as health-history cards, warranty cards, security cards, military dog tags, welfare cards, and passport cards.



B. K. MARYA

Although many of these potential IC-card applications are already being test-marketed in Europe and Japan, Marya says, the major market will ultimately be the U.S. “Ironically,

virtually no U.S. semiconductor company, with the exception of some tentative efforts on the part of Motorola, is taking steps to participate in this market,” he says. “U.S. companies must act fast, or we'll lose another major market.”

To enter Catalyst in this market sweepstakes, Barya set up a joint development agreement with Oki Electric Co., Tokyo, 18 months ago. “We provided the basic architecture modifications, the circuit design, and the EEPROM expertise,” he says. “They provided the process and fabrication capability.”

Maintaining communications and schedules for the joint project required many transoceanic flights by Marya, design manager Nagesh Challa, Catalyst senior design manager Samir Patel, and Tomoaki Yoshida, an Oki section manager in Japan.

Catalyst is Marya's second startup. His first, Exel Semiconductor, an EEPROM and EPROM manufacturer, was acquired this year by Exar Inc. Marya earned a BSEE from Punjab University, India, and an MSEE from the University of New Mexico. He has since directed the design, construction, and operation of fabrication lines at several companies, including Hewlett-Packard, National Semiconductor, Synertek, and Seeq Technology.

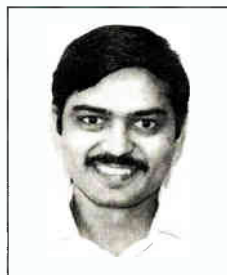

SAMIR PATEL

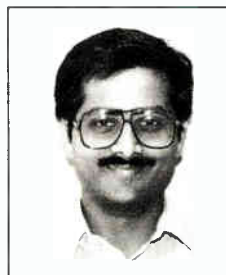

NAGESH CHALLA

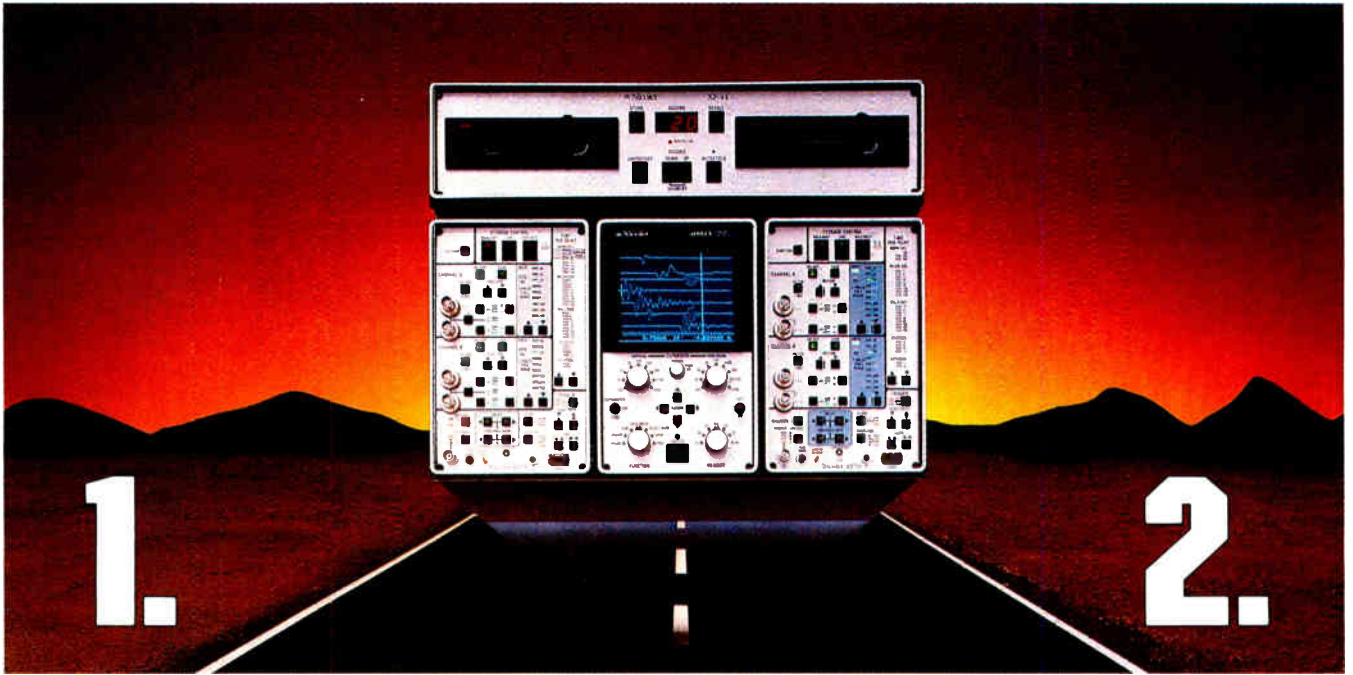

TWO DIGITAL SCOPES IN ONE.



The Acquisition.

With sweep speeds from days to nanoseconds and resolution up to 15 bits, the 4094 digital 'scope can capture the most elusive signals. Every plug-in has 16K of memory, viewable trigger set-up and independent pre- or post-trigger delay on each channel. Signal averaging is standard and our latest 10 MHz/12-bit plug-in even offers real time manipulation of the incoming signals. With two plug-ins the 4094 can record four channels simultaneously. Or even monitor two slow signals and capture high speed glitches at the same time. All under computer control or via manual operation: whatever your application demands.

The Analysis.

Expand and examine any waveform feature in detail. Use the dual cursors and numerics to measure the time or voltage of any point. Compare live or stored waveforms with each other or with pre-recorded references. Store signals on disk manually or automatically. Use pushbutton programs to manipulate the data or send it to your computer via GPIB or RS232 interface. Complete your report with a hardcopy plot using the XY/YT recorder or digital plotter outputs.

First Time, Everytime.

Don't miss important data because of set-up errors. From the World's first in 1973 to the latest models, Nicolet 'scopes are easy to use. Find out how they can be the quickest solution to your signal problems. For more information call 608/273-5008, or write Nicolet Test Instruments Division, P.O. Box 4288, 5225 Verona Road, Madison, WI 53711-0288.

NTE Nicolet



A solo PC user becomes a one-man gang when the computer is AT&T's PC 6300 PLUS. Equipped with Simul-Task, the computer can run several programs at once.

While this user prepares a budget forecast, his AT&T PC can simultaneously print out a letter and share data with a remote mainframe, or with the work group at right.

HOW TODAY'S MOST PRODUCTIVE PCs

Users of these AT&T systems can do more, and do it faster than users of other PCs.

The difference: a bit of technological lightning called Simul-Task. Armed with Simul-Task, the solo PC user becomes a one-man gang, and the small department becomes an army—more productive as well as more efficient.

The secret: Simul-Task technology allows today's AT&T computers to apply their power to several tasks at the same time.

Whether you work alone or as part of a group, you can now perform a database sort and print from a spreadsheet *at the same time* you edit a letter. You can send or receive electronic mail, or pull figures from a faraway mainframe *at the same time* you outline a report.

In a Simul-Task world, you need never interrupt one job to handle another. Quick as you can fire up

new work in the foreground, Simul-Task gets on with other work in the background. (Which, incidentally, is rarely more than a keystroke away.)

Nor need you wait, ever again, for the computer to slog through time-consuming backups and sorts. Simul-Task frees you from such dreary chores, so you can apply your brains to more creative work.

TRUE MULTI-TASKING FOR THE ONE, THE FEW, AND THE MANY.

Like adding a turbocharger to a high-performance car, Simul-Task applies a powerful productivity boost to the AT&T computers experts already regard as industry thoroughbreds in their own right.

AT&T's PC 6300 PLUS is ranked among today's premier single-user machines. The speed is intoxicating, the graphics razor-sharp. However, it is AT&T's Simul-Task that catapults this IBM*-compatible into a class of its own.



AT&T's 3B1 Computer supports up to 5 users, each doing several jobs at once. Analysts compare this system to refrigerator-size minicomputers costing ten times as much.

A unique one-two punch: AT&T's Simul-Task feature delivers advanced communications functions and the ability to run multiple programs at the same time.

With Simul-Task, this user can copy information from one application directly into another application, doing in minutes what used to take hours.

HELP THE LEADER...AND THE PACK.

Simul-Task unleashes the full potential of the "80286" processor chip, running virtually any of your PC programs — while doing several other jobs at the same time. Result: You have all the advantages of today's PC software, without the limitations of today's one-thing-at-a-time PCs.

AT&T's 3B1 Computer has power and memory to spare for work groups of up to 5 users, each doing several tasks at once. Larger members of AT&T's 3B family of multi-user computers can extend the advantages of Simul-Task to larger groups and to whole companies.

System planners, please note: All AT&T PCs and the entire 3B computer family were designed from the chassis up to share information with other machines, AT&T's own and those of other vendors. When the time comes for an integrated, office-wide system, you'll be ready. We make the pieces fit.

WOULD YOU LIKE A DEMONSTRATION?

Seeing is believing. AT&T would like to show you how today's most productive PCs can help any individual or any group in your company get more done with Simul-Task.

To learn more, and to arrange for a personal demonstration, please contact your AT&T Account Executive. You may also stop by any authorized AT&T supplier, or telephone 1 800 247-1212.

*IBM is a registered trademark of International Business Machines Corp.



AT&T
The right choice.

Score A Winning Touchdown with UMC



With backing from UNITED MICROELECTRONICS CORPORATION, one of our customers scored a winning touchdown with a voice control IC last year. He netted a profit of 2.5 million dollars on just one product. This is one of the many examples of how UMC helps its customers score financial goals.

UMC scored its first touchdown by becoming profitable 6 months after it went into operation and has been making a profit and registering phenomenal sales growth annually since then. Last year, 4 quarters of penalties left most companies sitting on the bench and several others were ejected from the game. UMC, however, still romped to a sales growth rate of 24.4%, which was the fourth best in the world and outscored 92% of the IC industry.

If you want to be on a winning team, go with a proven winner.....UMC.

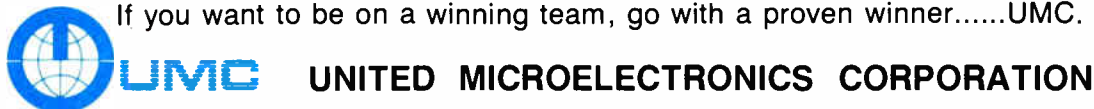

CORPORATE HEADQUARTERS: NO. 3, INDUSTRIAL EAST THIRD ROAD SCIENCE BASED INDUSTRIAL PARK, HSINCHU CITY, TAIWAN, REPUBLIC OF CHINA
SALES OFFICE: 9TH FLOOR, NO. 201-26, TUNHUA NORTH ROAD TAIPEI, TAIWAN, REPUBLIC OF CHINA TEL: (02)7152455 TLX: 28560 UMCTPE FAX: (02) 7166291
U.S.A. HEADQUARTERS: NMC CORPORATION 3054 SCOTT BLVD, SANTA CLARA, CA95054 U.S.A. TEL: 408-7279239 TLX: 172730 NMC SNTA FAX: 408-970054

HOW LINEAR IC DESIGNERS ARE BUILDING DENSER CHIPS

Like it or not, linear-circuit designers are being pushed into the VLSI era. Doing the shoving are system developers who keep demanding higher functional densities, higher speed, better accuracy and resolution, and easier-to-use devices. It's not an easy move for the IC designers; the characteristics that make a good digital process do not necessarily allow the design of good linear functions. Linear circuits are much more sensitive than digital circuits to second-order effects, such as those that come with scaling down transistors to smaller dimensions.

Despite those difficulties, linear-circuit designers are rising to the challenge with two approaches: scaling down existing 3- and 5- μm processes to 2 and 3 μm , and optimizing 1- and 1.5- μm VLSI processes for the fabrication of linear functions. Their solutions cover a wide range. Some designers are trying to optimize linear CMOS processes for high-density digital functions; others are taking high-density CMOS processes and trying to improve their linear characteristics; and still others are betting on a higher-performance mix of bipolar and CMOS. In terms of architecture, some are implementing linear subsystems on a chip, allowing digital designers to program a linear device as if it were a microprocessor peripheral. Where calibration is needed, designers are using digital calibration schemes based on nonvolatile memory, or devising sophisticated self-calibration schemes that allow devices to adjust and compensate automatically for errors.

The problem of implementing linear circuits at LSI and VLSI densities is particularly critical in CMOS, which is approaching 1- μm dimensions on the digital side. "As currently implemented, sub-2- μm digital CMOS, let alone 1- μm , does not allow the design of good linear functions," says Dave Fullagar, vice president of research and development at Maxim Integrated Products Inc., Sunnyvale, Calif. Whereas digital circuits are running into problems at 1 μm , linear

Linear functions do not scale down as well as digital functions. Nevertheless, systems designers have issued a density challenge—and it is being met

by Bernard Conrad Cole

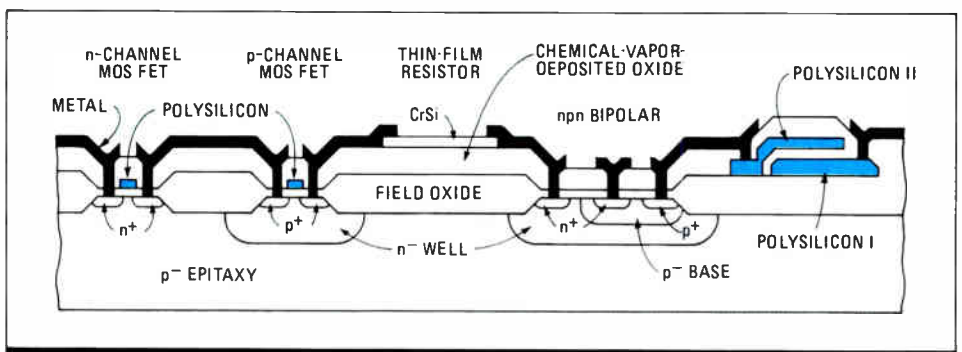

1. LINEAR VLSI. Aiming at densities approaching digital VLSI, General Electric has developed a 1.25- μm linear CMOS process using molybdenum-based resistors and isolated metal-to-metal capacitors.

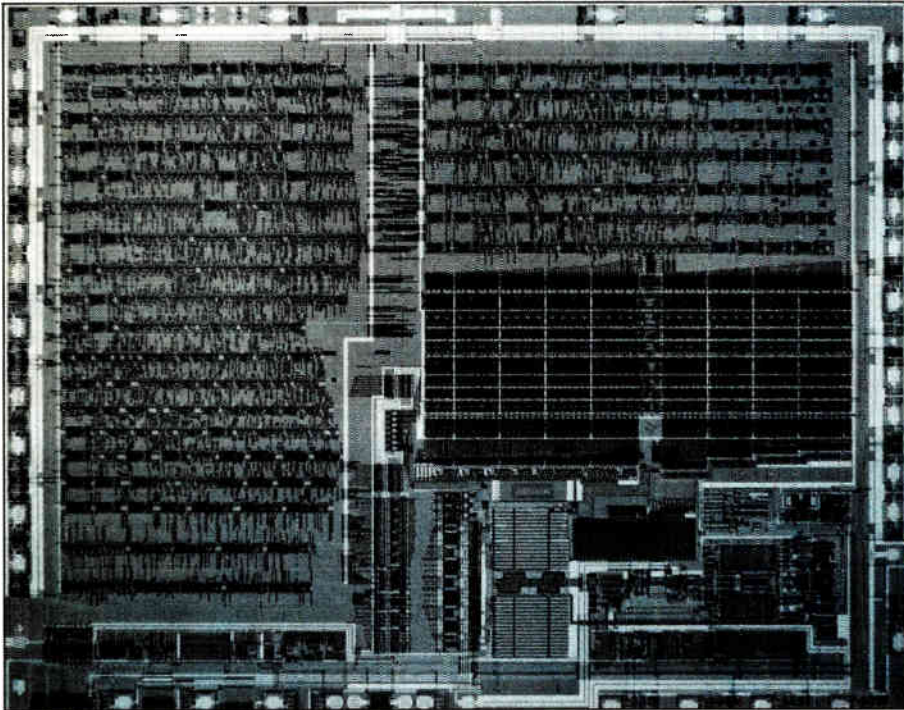

2. LINEAR SUBSYSTEMS. Crystal Semiconductor's linear VLSI-based data acquisition system on a chip eliminates many external linear and digital functions.

circuits run into the same problems much sooner, at around $2\ \mu\text{m}$ or so. As a result, says Fullagar, "most linear designers are happy enough with 3- and $4\text{-}\mu\text{m}$ CMOS processes, which are well understood and allow fabrication of good, reproducible, and reliable linear functions."

But, having achieved such high levels of integration on the digital side, systems designers are pressing to integrate high levels of linear functionality on the same chip, says Wayne Foletta, strategic marketing manager at Fairchild Semiconductor Corp.'s linear division in Mountain View, Calif. "And if that is not possible, at the very least they are asking that the stand-alone linear ICs move to a higher level of integration, incorporating the functions of several small- and medium-scale-integration devices in a single linear LSI or VLSI circuit."

SCALING DOWN CMOS

To meet these demands, several companies, including Texas Instruments, National Semiconductor, Fairchild, and General Electric, are scaling down their linear CMOS processes. At TI in Dallas, process engineers have developed a second-generation $3\text{-}\mu\text{m}$ LinCMOS process to meet the needs of complex data-acquisition and telecommunications applications requiring a high degree of analog and digital functional density on the same chip (see p.71). Fabricated in a p epitaxial layer grown on a p substrate to improve density and speed while at the same time reducing latchup, the Advanced LinCMOS process will be used to manufacture a new family of 8-bit analog-to-digital converters, plus a host of

other standard and custom ICs.

Similarly, National Semiconductor, Sunnyvale, Calif., is moving into production with its new $2\text{-}\mu\text{m}$ LCMOS process featuring the use of channel stops and lightly doped drain extensions to increase breakdown voltage to more than 60 V while retaining high-speed operation. It is used to fabricate quad analog switches that can handle rail-to-rail signals on supply voltages up to 20 V; a new series of switched-capacitor filters; and an 8-bit ADC with 19 multiplexed inputs and a serial data interface.

At Fairchild Semiconductor Corp., Mountain View, Calif., engineers in the Linear Division are moving into production the company's second-generation $2\text{-}\mu\text{m}$ linear CMOS process. LCMOS II features two-layer metal interconnections using a titanium/tungsten metallization scheme; differential oxidation of polysilicon gate, source, and drain re-

gions; and self-aligned siliciding of the source and drain regions and polysilicon interconnect regions. The process is aimed at fabricating complex linear and digital functions, such as modems and other communications circuits.

Taking a step past the current 2- to $4\text{-}\mu\text{m}$ processes being considered in the industry, GE is proposing to push the state of the art in linear CMOS to $1.25\ \mu\text{m}$ by taking a digital VLSI process and optimizing it for linear functions. At GE's Corporate Research and Development Center in Schenectady, N.Y., researchers have developed a two-layer metal process (Fig. 1) that incorporates molybdenum-based resistors and isolated metal-to-metal capacitors—both of which are critical elements in many linear circuits.

So far, GE is going it alone with a pure CMOS approach to a sub- $2\text{-}\mu\text{m}$ linear VLSI process. Even its Silicon Valley subsidiary, Intersil Inc., is ramping up a mixed bipolar-CMOS production line alongside its traditional CMOS facility. Also following this route are Analog Devices, Fairchild, Honeywell, and Micropower Systems [*Electronics*, Dec. 28, 1985, p. 35].

Neither CMOS nor bipolar will yield higher levels of integration alone, says Robert Albertson, product manager for data-acquisition ICs at Intersil, Cupertino, Calif. "In many respects, linear bipolar scales better than linear CMOS," he says. "But, important for combined linear-digital designs, CMOS gives you high density, while bipolar gives you high performance." So many traditional linear houses, such as Burr-Brown Inc. of Tucson, Ariz., are preparing for an eventual merging of bipolar and CMOS by developing tra-

ditional linear CMOS product lines in addition to their linear bipolar products. Others are looking at mixed CMOS-bipolar processes to get a good balance of high functional density and good linear characteristics in the near-1- μm range. Included in this category are Analog Devices, Fairchild Semiconductor, Honeywell, and Micropower Systems [*Electronics*, Dec. 28, 1985, p. 35].

These new linear VLSI processes are most dramatically impacting the design of mixed linear and digital circuits, such as telecommunications ICs and data-conversion devices. On the one hand, the higher functional density is making possible the fabrication of what Michael J. Callahan Jr., vice president of engineering at Crystal Semiconductor Corp. of Austin, Texas, calls "smart analog," but which might more accurately be described as linear VLSI subsystems on a chip (Fig. 2). On the other hand, the higher functional density is opening up new horizons for linear circuit designers in coming up with new and innovative ways to ensure greater accuracy and resolution, using techniques such as on-chip EPROM and self-calibration using weighted capacitor arrays.

Linear subsystems on a chip, which are under development by companies such as Crystal Semiconductor, Linear Technology, and Micro Linear, are being approached from two directions. In one approach, data conversion is being simplified by the incorporation of additional linear functions, such as the track-and-hold circuitry, the analog multiplexers, trimming circuitry, and potentiometer functions. In the other approach, the interface to the digital world—especially to microprocessors—is being simplified through the inclusion on board of not only the digital timing circuitry, but a full digital interface.

More than just a set of input and output lines modified to reflect the protocols of various microprocessor buses, this digital interface block on an analog-subsystem chip may include registers and microsequencer control logic.

"What this allows the system designer to do is to program and select specific converter features in a manner similar to that on any microprocessor peripheral," says John R. Croteau, data-acquisition product manager at Crystal Semiconductor.

The other effect of such linear VLSI CMOS processes on mixed linear and digital applications such as data conversion is that it has given designers the freedom to consider other alternatives to zener zapping and laser trimming. Zener zapping and laser

trimming are currently used to trim circuits and bring them within specified parameters after fabrication. The problem with these techniques is that they also introduce stresses and modifications to the silicon which affect offset, gain, and linearity. Moreover, the packaging and potting introduce additional errors, requiring manual calibration using external passive components to compensate for offset, gain, and linearity errors, says Charles Gopen, marketing vice president at Micro Linear Corp., San Jose, Calif.

These alternatives to zener zapping and laser trimming have resulted in the emergence of 12- to 16-bit accuracy in monolithic data converters, a level previously available only from hybrids. To get these accuracies, two approaches are being considered: open-loop systems similar to present configurations, but with a digitally based electrically erasable read-only memory used for calibration purposes; and closed-loop, self-calibration schemes that cancel out the inherent errors of data-acquisition devices.

EPROM-BASED CALIBRATION

Intersil, a pioneer in EPROM-based calibration in data converters, is using the technique in two 14-bit products: the ICL7115 ADC (Fig. 3) and the ICL7134 digital-to-analog converter.

In the ICL7114, combining a 17-by-17-bit EPROM with a thin-film, 17-bit, low-accuracy DAC implemented with a modified R-2R resistor ladder scheme produces redundant DAC codes that cover the analog output range, without any missing codes. Each bit value of the DAC is compared internally with an accurately calibrated input voltage, which is entered as a 17-bit word into the on-chip EPROM. A comparator decision to keep what it has determined to be a "good" bit causes the corresponding bit value to be accessed from the EPROM and added into the accumulator's register, while a decision to drop a "bad" bit leaves the accumulator's contents

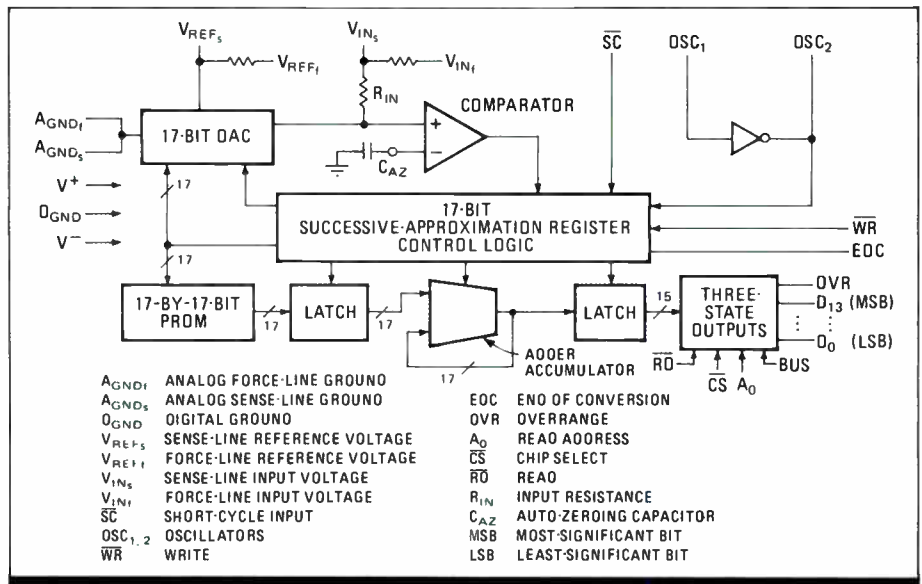

3. CALIBRATION EPROM. By replacing laser-trimmable resistors with EPROM, Intersil's converter gets 14-bit accuracy.

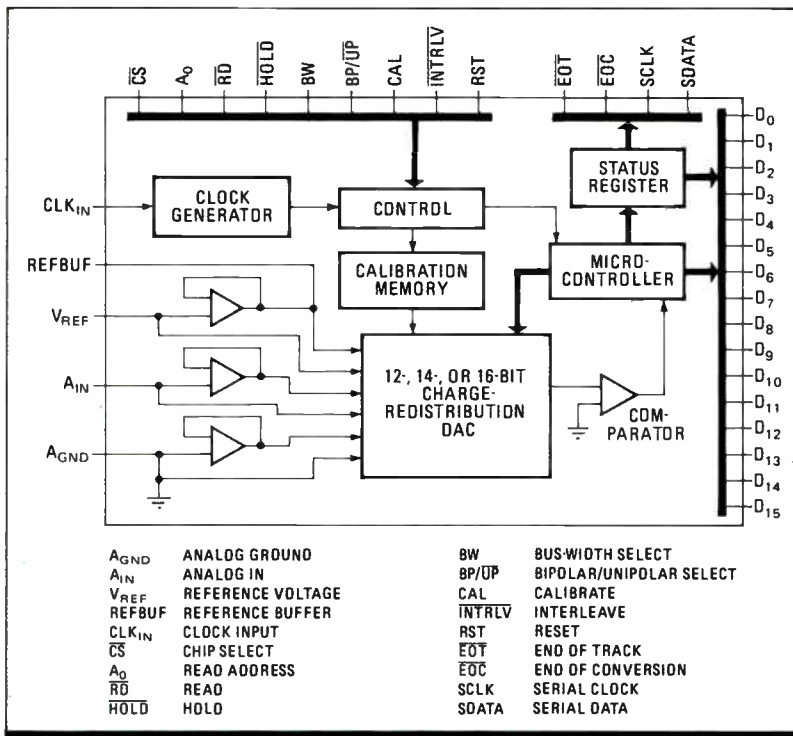

4. SMART ANALOG. Crystal Semiconductor combines self-calibration and on-chip controller and registers to achieve 16-bit accuracy.

changed. At the end of the conversion, the accumulator contains the sum of the values of the bits that were kept, representing the true input voltage. The 17-bit result is rounded off to 14 bits at the end of the conversion.

In Intersil's ICL7134 DAC, the on-board EPROM controls two error-correction DACs, the outputs of which are summed with that of the primary DAC. The accuracy of the first DAC can be as low as 9 bits. The EPROM contains 31 correction codes, one of which is selected for each combination of the most significant 5 input bits of the primary DAC. Not only is the linearity of the device calculated to less than $\pm\frac{1}{2}$ least-significant bit, but also the superimposition errors and the nonlinearities inherent in the internal feedback networks are all corrected by the same memory-coding scheme, says Intersil's Albertson.

In both devices, calibration programming of the memory space can be done after packaging and burn-in, which means that unlike in present laser-trimming, zener-zapping, and link-busting schemes, errors induced by potting pressures and thermal stresses can also be corrected. Moreover, Albertson says, none of the on-chip bit-setting resistors is disturbed in the memory-programming processes.

As an alternative, many companies are taking advantage of the density improvements possible with their second-generation linear CMOS processes to move from resistor-based architectures to more self-calibrated methods that use switching-capacitor charge redistribution for bit-weighting. These methods require more area than EEPROM-

based calibration.

Self-calibrated ADCs and DACs employ calibration cycles in which each bit is analyzed and checked for systematic errors generated by the random discharges of capacitors during periods when the device is not in use. These errors are then converted to a digital representation and stored for use in later conversions. In subsequent normal conversion cycles, an analog error signal is subtracted from the input signal. This error signal is generated by an error-correction DAC whose input is the sum of all the stored error signals corresponding to bits with the value of "1." The result is an input accuracy equivalent to a perfect capacitor array, one that produces no randomly generated or systematic error signals. The advantage of this approach, says Crystal Semiconductor's Croteau, is that calibration cycles need to be executed only infrequently, requiring only about 5 or 10 times the time of a normal conversion, and can thus be executed in a transparent manner between normal, sparsely timed conversions.

The self-calibration scheme that TI plans to use in its soon-to-be introduced family of 8-bit ADCs, for example, contains a calibration DAC based on such a bit-weighted capacitor approach. The calibration DAC compares the value of the charge on the most-significant-bit capacitor to the sum of the lesser capacitors. If their values are not equal, the difference is measured on the comparator and the comparator DAC, and the result stored in an on-chip 120-bit static random-access memory. Each capacitor in the array is tested similarly, in sequence. During signal conversion, the calibration DAC injects the error voltage stored in RAM into the comparator to cancel the capacitor error. As successive capacitors in the primary DAC are switched in, their error is retrieved from RAM and accumulated with the error of the other capacitors. The calibration DAC uses a digital accumulator to generate the total analog error correction, which is then injected into the comparator.

COMBINATIONS FOR CALIBRATION

A taste of things to come is Crystal Semiconductor's CS5016 (Fig. 4), a self-calibrating ADC subsystem on a chip that automatically provides true 16-bit accuracy over the full commercial temperature range. It achieves this by combining the switching-capacitor charge-redistribution technique with a track-and-hold amplifier, a microsequencer, and associated program registers. The microsequencer manipulates the capacitive DACs to trim the offset, gain, and linearity errors. Calibration can be directly controlled by the user by programming the program registers, or the chip can be placed in a mode where calibration occurs automatically and continuously. □

TI PROCESS BOOSTS LINEAR CMOS ICs TO LSI DENSITIES

Linear CMOS is blasting off for the realm of large-scale integration at Texas Instruments Inc. The Dallas company has scaled down minimum feature size to 3 μm in its Advanced LinCMOS process, from 5 μm in the first-generation LinCMOS. Now it can achieve the density levels needed for complex data-acquisition and telecommunications chips and other high-performance integrated circuits requiring the use of combined analog and digital circuitry.

Besides shrinking the LinCMOS process, TI technologists went to a low-resistance epitaxial layer instead of bulky guard rings between n- and p-channel devices. They also reworked the capacitor and resistor structures so that these devices occupy only a fourth of the area of equivalent devices in the older LinCMOS technology [*Electronics*, April 5, 1984, p. 145]. These improvements will make possible such new chips as high-resolution data converters that are not significantly larger than current converter ICs with lower resolution.

The TI engineers also developed process improvements that give IC designers a choice of two high voltages—10 and 15 V—in addition to the 5-v digital level. LinCMOS offered only 10 and 5 V, and designers had to choose between them. With Advanced LinCMOS, designers can use any two of the three voltage levels on the same chip, dramatically increasing their design options.

Advanced LinCMOS will also permit chip designers to make better use of switched-capacitor technology, opening the door to the implementation of highly advanced switched-capacitor filters with more poles on chip. For example, when applied to the fabrication of the TCM29C13 codec-filter combination, the scaled-down Advanced LinCMOS reduces chip size 42%, compared with versions fabricated using the original process. The performance of the new codec-filter IC also is significantly improved. Active power use is 6 mA compared with 8 mA in the older part, and standby power use is 0.8 mA versus 1.2 mA. Idle channel noise on the receive side is 5 dBrc0 compared with 7 dBrc0 in the earlier device, and on the receive side 11 dBrc0 versus 12 dBrc0.

The new linear process will also allow the cost-effective fabrication of high-speed single-chip products, such as

1. NEW LOOK. In Advanced LinCMOS, use of an epitaxial layer reduces latchup and eliminates need for guard rings between n- and p-channel devices.

The Advanced LinCMOS process gives the densities needed for high-performance data converters and other complex chips that combine analog and digital circuitry

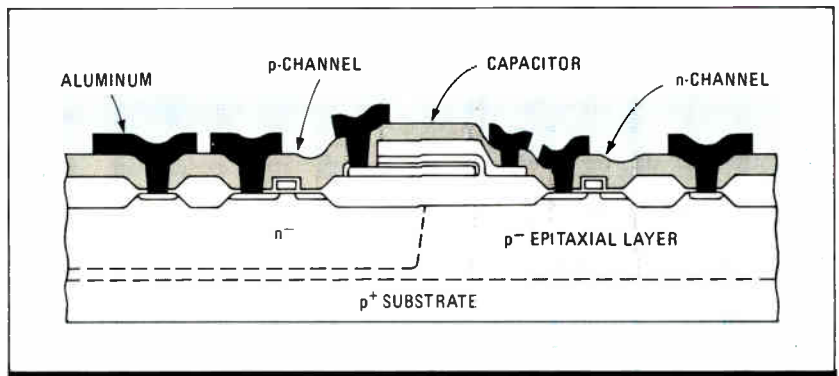

modems that combine digital and linear circuitry. Such a chip should provide a wider dynamic range than current combos—opening up new applications such as high-speed modems based on digital-signal-processing techniques and devices that can encrypt telecommunications signals.

Most significantly, Advanced LinCMOS will open the way to the cost-effective manufacture of high-performance data-acquisition products using self-calibration techniques. With the increased packing density, there will be room on chip for circuitry that allows automatic calibration of some or all of the bits. Self-calibration will make it possible to produce 12- to 16-bit chips providing the sub-30- μ s performance required for instrumentation applications without resorting to the expensive thin-film-resistor and

taxial layer grown atop a p^- substrate. It reduces the critical spacing of n^+ to n^- and p^- to n^- regions.

The use of the low-resistance epitaxial layer reduces latchup susceptibility and eliminates the need for guard rings between n- and p-channel devices. Because an LSI part contains many more individual transistors than a small- or medium-scale IC, single or multiple guard rings for each transistor would occupy a considerable portion of the total chip real estate.

Even though epitaxial material is more expensive than conventional material, its cost is less than the additional silicon required to incorporate guard rings on LSI devices. As a rule of thumb, the cost of an IC increases linearly with chip area up to 35,000 mils². But above 35,000 mils², the cost rises exponentially. So low-resistance epitaxy allows chip makers to hold down the chip size for both high yield and low cost while guarding against latchup.

Reducing feature size and substituting low-resistance epitaxial material for guard rings are important steps, but they are not enough to increase packing densities and maintain economical die sizes in components containing extensive analog circuitry. Both data-acquisition and telecommunications chips rely heavily on resistors and capacitors, so the capabilities of these components must be extended to keep die sizes within bounds.

One of the principal virtues of the original LinCMOS process is the control it gives chip designers over the capacitance of each of the two polysilicon layers. Designers also can modify the thickness of the second gate oxide without affecting the capacitors in the two poly layers. This independent control offers more versatility for implementation of complex ICs.

However, adding just a single bit of resolution to an analog-to-digital converter requires twice the capacitor area when the process technology uses binary-weighted switched capacitors, as does LinCMOS. Moving from 8 to 10 bits of resolution would require four times more capacitor space, which could make an ADC too expensive to be used in many applications.

So the TI technologists who developed the advanced LinCMOS process worked out a new capacitor structure consisting of an oxide-nitride sandwich. Thinning the capacitor's oxide layer is key to increasing its unit capacitance, since capacitance is inversely proportional to the thickness of the capacitor oxide. The result is an effective oxide thickness that is just a fourth that of the straight-oxide capacitors in LinCMOS and a fourfold increase in capacitance per unit area—all without significantly increased chip size.

Changes in the resistor implant dosage of Advanced LinCMOS have quadrupled sheet resistance, or resistance per unit area. With this improvement, a resistor of a given value can be

The packing density of Advanced LinCMOS will make room for on-chip self-calibrating circuitry in place of expensive thin-film resistors and laser-trimming techniques

laser-trimming techniques that must be used today to produce such high-resolution parts.

Reducing feature sizes is a straightforward approach to improving speed and to increasing packing densities, thereby increasing functionality while maintaining a cost-effective die size. The Advanced LinCMOS team identified 3 μ m as the minimum size capable of meeting its requirements. At smaller dimensions, the analog performance of the scaled transistors is inadequate, TI says. So 3 μ m is the appropriate size, even though advanced digital-only processes have moved into the 1- μ m region.

Like its predecessor, Advanced LinCMOS is a silicon-gate, double-level-polysilicon process (Fig. 1). However, where the n-well of LinCMOS is fabricated in a p-substrate, the n-well of the twin-well Advanced LinCMOS is fabricated in a p^- epi-

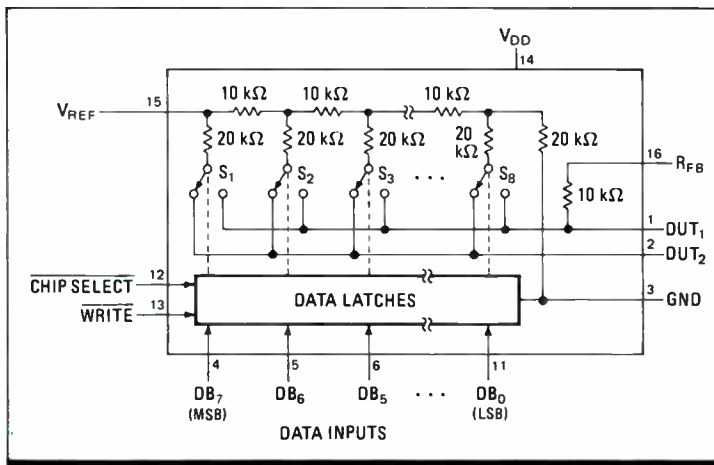

2. NO FILM. An Advanced LinCMOS 8-bit DAC can use a well-matched polysilicon resistance ladder, eliminating costly thin films.

made in just a quarter of the area required by LinCMOS technology. This improvement is the result of a design tradeoff made to increase sheet resistance while maintaining the temperature coefficient of expansion and retaining matching values comparable to the desirable performance of LinCMOS resistors.

While scaling down Advanced LinCMOS thinned the gate and made possible the 3- μ m minimum channel length, it also required the development of proprietary process enhancements to provide the required breakdown voltage and the targeted speed improvements. Moreover, operating voltages of linear ICs typically are higher than the 5 V common to digital circuits, and thicker gate oxides are commonly used to increase breakdown and operating voltages. TI has taken its process a step further by developing techniques for Advanced LinCMOS that make it possible to employ both thick and thin oxides on the same chip. Such an IC can handle a relatively high voltage and a lower voltage without requiring excessive silicon real estate.

With the Advanced LinCMOS process, chip designers can use either the first or second polysilicon level to provide the thick or thin oxide. The use of two oxides and selectively scaled transistors on the same die allows TI's chip designers to tailor the breakdown voltages of n-channel transistors. (P-channel transistors generally are not the limiting factor in CMOS technology.) Thin gate oxides and transistors with short channel lengths can be used for high-speed, low-voltage logic circuitry on one part of an Advanced LinCMOS chip, and devices with thick gate oxides and longer channel lengths can handle higher voltages elsewhere on the chip.

In this way, transistors with three recommended operating voltages can be produced: 5 V, using thin oxide in a transistor with a 3- μ m channel length; 10 V, using thin oxide in a transistor with a 4- μ m channel length; and 15 V, using thick oxide in a transistor with a 7- μ m channel length. The older LinCMOS process has two operating-voltage options: 5 or 10 V. The breakdown voltage is 30 V for Advanced LinCMOS, versus 20 V for the earlier process. TI says speeds improve by about 30%.

An example of what TI's Advanced LinCMOS brings to the game is an 8-bit digital-to-analog converter under development at the company. An enhanced, second-source version of an industry-

standard device, the Advanced LinCMOS product is 25% smaller than the original and has a settling time 40% faster. The DAC uses an R-2R resistance ladder (Fig. 2) fabricated in polysilicon. The high sheet resistance and good matching characteristics of Advanced LinCMOS resistors enable TI to use this approach, rather than a costly thin-film technology.

In the new DAC, TI process engineers needed to build a chip with control logic that could be interfaced to the relatively high voltages in the outside world, while providing elsewhere on the same chip the scaled-down transistors necessary for efficient, low on-resistance switches. Thanks to the flexibility inherent in the Advanced LinCMOS process, they could tailor the chip's transistors to the different roles.

The engineers also decided to trade off the digital performance of the device's control logic for higher voltage capabilities. Scaling up the digital transistors is accomplished in Advanced LinCMOS by increasing the oxide thickness and channel length of the transistor. This trade-off still allows the new DAC to be 40% to 50% faster than competing devices. □

THE PATH TO A BETTER LINEAR CMOS PROCESS

A new family of innovative telecommunications chips: that was the goal at Texas Instruments Inc. But to build those circuits, TI engineers needed a revised linear CMOS process that could produce single chips to handle the complexity of telecom functions.

TI's existing LinCMOS technology is the company's linear process workhorse, used in more than 200 standard and custom integrated circuits. But with a 5- μ m minimum feature size, it could only produce medium-scale ICs. So TI's process-development branch, working with the telecom design engineering group, decided to develop Advanced LinCMOS with 3- μ m minimum features.

"We achieved a more streamlined process that lays out 30% to 40% tighter than our current LinCMOS process and applies itself well to virtually every linear and telecom part we have looked

at," notes Lou Izzzi, senior designer on the project. Harry Davoody, system-engineering branch manager, agrees. "Before Advanced LinCMOS, we were unable to integrate the kinds of complex products that we can now. Advanced LinCMOS technology has given us the capability to offer our customers cost-effective systems solutions with catalog parts and custom circuits, telecom and a-to-d—you name it."

The process development took about 18 months, but the payoff has been big. With the high-end telecom chips and custom parts, "we are utilizing the process in product areas we never imagined before. It has really proved to be a winner," says Davoody.

Izzzi, a senior member of TI's technical staff, is manager of the data-acquisition design section. A graduate of New York Institute of Technology in 1977 with a

BSEE, he has served as senior designer for the development of many telecommunications and custom ICs.

Davoody is responsible for the definition of new telecom and data-acquisition products and technical support for linear customers. A graduate of the University of Texas at Arlington with a BSEE, he is working on an MBA at the University of Dallas.

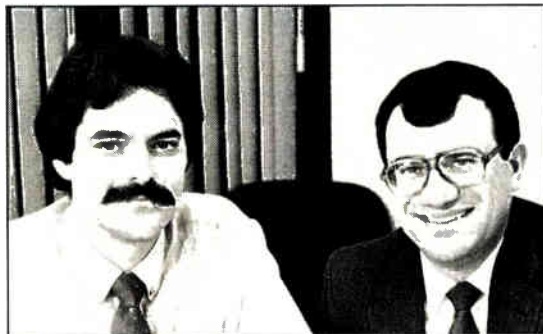

THE GENESIS. Izzzi (left) and Davoody needed LSI density.

MACSYMA solves mathematical problems analytically.

Just as computers revolutionized numerical analysis, MACSYMA automates symbolic mathematics and yields enormous improvements in speed, accuracy and modeling power.

If you work with quantitative models in scientific or engineering disciplines, MACSYMA can increase your modeling power. MACSYMA combines symbolic and numeric computation. And enables you to accurately manipulate symbolic expressions in a fraction of the time required manually.

Wide range of capabilities

MACSYMA offers the widest range of capabilities for symbolic computations in applied mathematics of any commercially available program. For example:

Algebra: MACSYMA can manipulate large expressions, expand, simplify and factor expressions, handle matrices and arrays and solve systems of equations.

Calculus: MACSYMA can differentiate, perform definite and indefinite integration, take limits, expand functions in Taylor or Laurent series, solve differential equations and compute Laplace transforms.

Numerical analysis: You can perform numerical analysis using MACSYMA™ language, compute with arbitrary precision arithmetic, use a library of numerical analysis routines and generate FORTRAN code.

Graphics and Interfaces:

MACSYMA can generate report-quality graphics in 2D or 3D, with perspective, hidden line removal and captions. MACSYMA also interfaces with mathematical text processors 'TeX' and 'Troff'.

Broad base of applications

Throughout the world thousands of scientists, engineers and mathematicians are using MACSYMA in such diverse applications as aeronautical design, structural engineering, fluid mechanics, acoustics, CAD, electronic and VLSI circuit design,

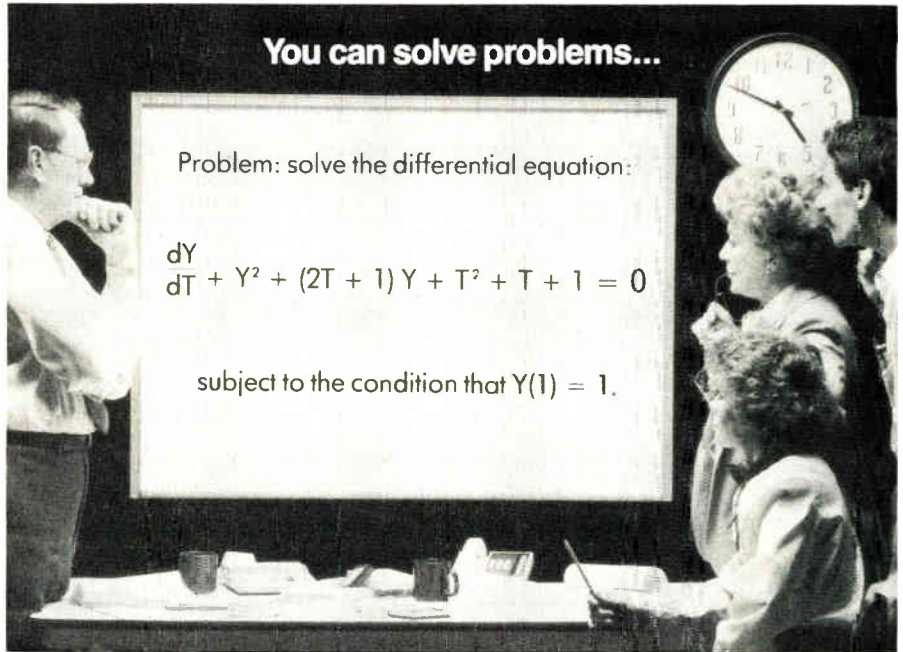

Symbolically...

```
(C1) DEPENDS(Y,T)$
(C2) DIFF(Y,T)+Y^2+(2*T+1)*Y+T^2+T+1;
(D2) dY/dT + Y^2 + (2T + 1)Y + T^2 + T + 1
(C3) SOLN:ODE(D2,Y,T);
(D3) Y = - %C %E^T - T - 1
          %C %E^T - 1
(C4) SOLVE(SUBST([Y = 1, T = 1],D3),%C),NUMER;
(D4) [%C = 0.5518192]
(C5) SPECIFIC.SOLN:SUBST(D4,SOLN);
(D5) Y = - 0.5518192 T %E^T - T - 1
          0.5518192 %E^T - 1
```

and Numerically.

```
(C6) FORTRAN(D5)$
      Y = -(0.5518192*T*EXP(T) - T - 1)
      1 / (0.5518192*EXP(T) - 1)
```

electromagnetic field problems, plasma physics, atomic scattering cross sections, control theory, maximum likelihood estimation, genetic studies and more.

Available on many computer systems

Current systems include:

- Symbolics 3600™ Series
- VAX™, VMS™ & UNIX™
- Micro VAX II™, VMS™
- SUN-2™ & SUN-3™
- Masscomp™ MC5500™

Other versions will be following soon.

For information on about all the ways MACSYMA can work for you, just call

1-800-MACSYMA.

In Mass., Alaska or Hawaii only call: (617) 577-7770.

Or please write to us at:

Computer Aided Math Group — Dept. M-EL4
Symbolics, Inc.
Eleven Cambridge Center
Cambridge, MA 02142

MACSYMA

The most comprehensive software for mathematical computing.

symbolics™

Your next step in computing.™

MACSYMA, SYMBOLICS and SYMBOLICS 3600 are trademarks of Symbolics, Inc. Micro VAX II, VAX and VMS are trademarks of the Digital Equipment Corporation. UNIX is a trademark of AT&T Bell Laboratories. Masscomp is a trademark of the Massachusetts Computer Corporation. SUN-2 and SUN-3 are trademarks of SUN Microsystems, Inc.

OUR CAPACITY IN MOSFETs IS WIDE AND DEEP.

With superior, more efficient technology, better voltage control, faster switching, bigger board space savings, lower temperatures, ruggedness and lower costs, the tide is running strongly toward MOSFETs.

That's why the smart thing to do is set a course for Schweber, the home port to the leaders in MOSFET production and technology—Fairchild, GE, IR, Motorola and RCA.

At every Schweber location, from the Atlantic to the Pacific, you'll find the depth and breadth of these premier lines in-stock for instant, off-the-shelf, computerized delivery. In addition, you'll find Schweber deep in experience and technological assistance.

For information and complete specifications, as well as all your MOSFET needs, contact your nearest Schweber location. When it comes to MOSFETs, Schweber is as powerful and dependable as the great oceans of the world.

SCHWEBER

THE MOSFET DISTRIBUTOR

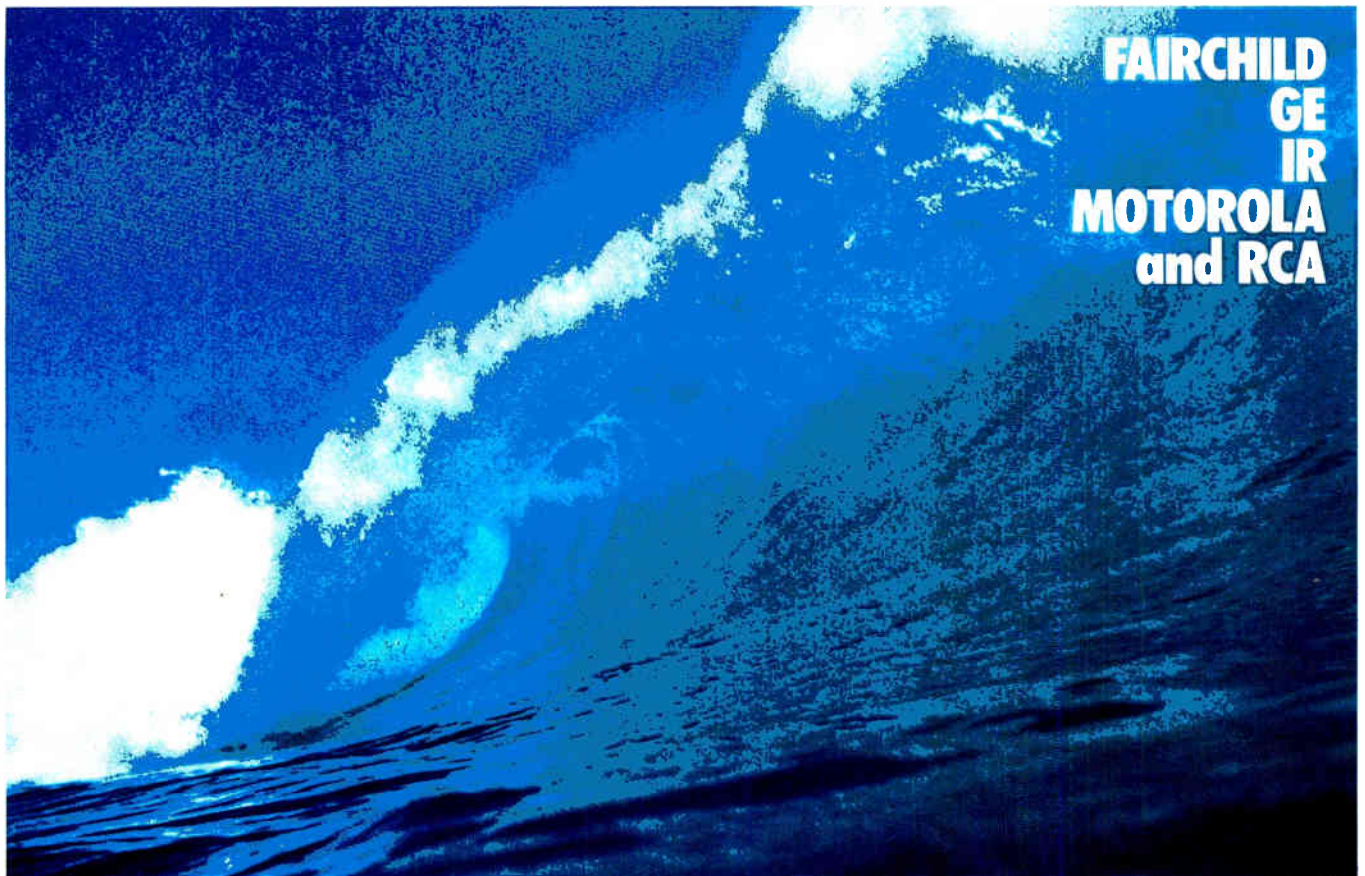

**FAIRCHILD
GE
IR
MOTOROLA
and RCA**

Northeast Bedford, MA 617/275-5100 • Manchester, NH 603/625-2250 • Rochester, NY 716/424-2222 • Danbury, CT 203/748-7080 **Mid-Atlantic** Westbury, NY 516/334-7474
Fairfield, NJ 201/227-7880 • Horsham, PA 215/441-0600 **Southeast** Baltimore, MD 301/792-4025 • Gaithersburg, MD 301/840-5900 • Raleigh, NC 919/876-0600
Norcross, GA 404/449-9170 • Huntsville, AL 205/895-0480 • Altamonte Springs, FL 305/331-7555 • Hollywood, FL 305/927-0511 **Midwest** Pittsburgh, PA 412/782-1600
Beachwood, OH 216/464-2970 • Livonia, MI 313/525-8100 • Dayton, OH 513/439-1800 • Elk Grove, IL 312/364-3750 • Brookfield, WI 414/784-9020 • Cedar Rapids, IA 319/373-1417
St. Louis, MO 314/739-0526 • Kansas City, KS 913/492-2922 • Edina, MN 612/941-5280 **Southern** Houston, TX 713/784-3600 • Dallas, TX 214/661-5010
Austin, TX 512/458-8253 • Tulsa, OK 918/622-8000 **Northwest** Englewood, CO 303/799-0258 • San Jose, CA 408/946-7171 • Sacramento, CA 916/929-9732
Seattle, WA 206/624-1183 **Southwest** Phoenix, AZ 602/997-4874 • San Diego, CA 619/450-0454 • Irvine, CA 714/863-0200, 213/537-4321 • Gardena, CA 213/327-8409
Canoga Park, CA 818/999-4702

© 1986 SCHWEBER ELECTRONICS CORPORATION



**SCHWEBER
ELECTRONICS**

Now for the First Time in a Digital Oscilloscope...

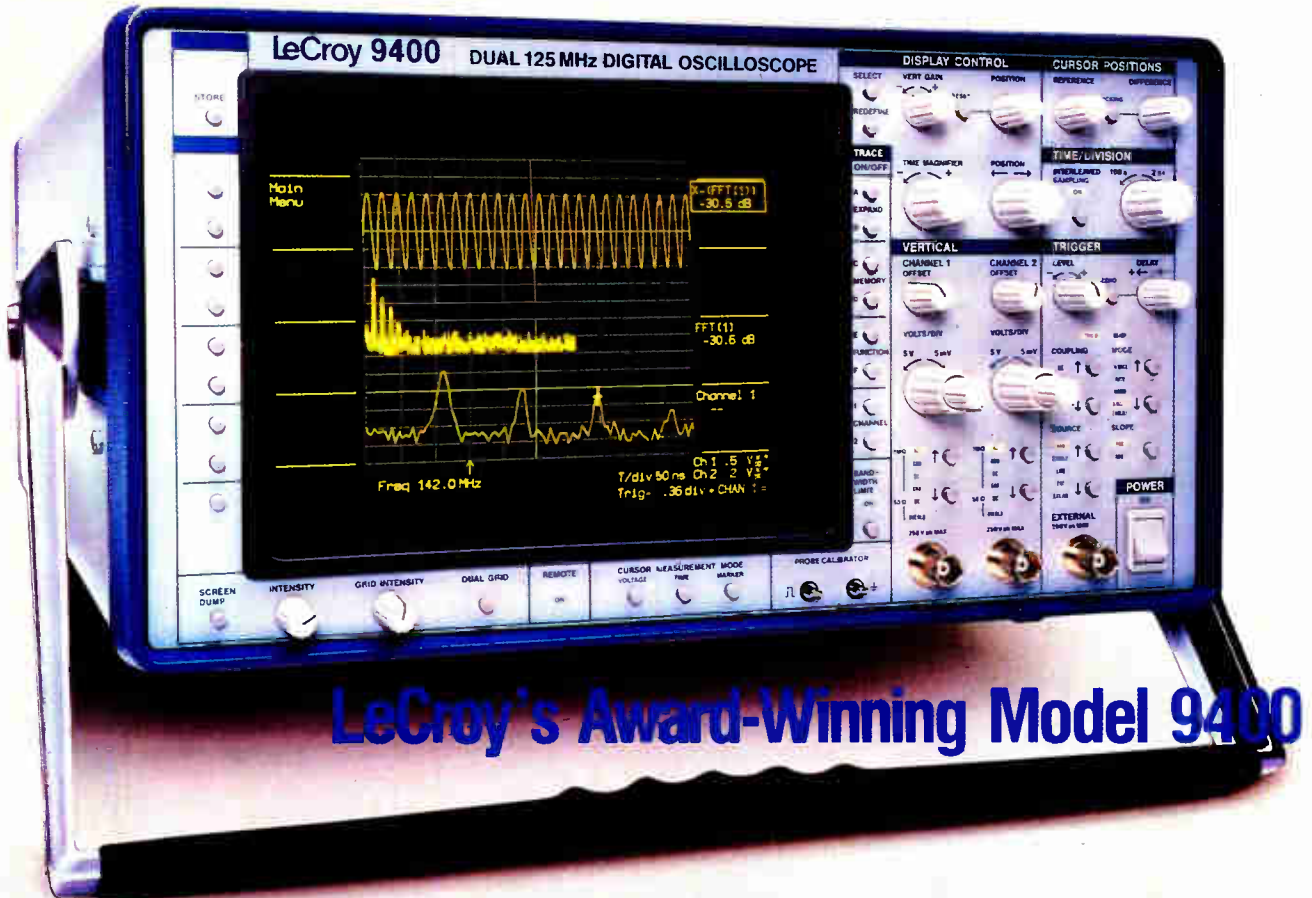

LeCroy's Award-Winning Model 9400

- Bandwidth in Excess of 125 MHz. 100 MS/S Digitizing Rate. 5 GS/S Random Interleaved Sampling Rate.
- $\pm 1\%$ DC Accuracy. Autocalibration.
- 32K Segmentable Acquisition Memories, Each Channel. Up to 192K Total Memory.
- Fast Fourier Transforms 50-25,000 Points.
- FFT Frequency Resolution; 1 milliHertz to 50 MHz.
- Signal Averaging in Time and Frequency Domains to 1,000,000 Sweeps.
- Digital Filtering and Extrema Mode.
- Fully Programmable Via GPIB and RS-232.
- Waveform Processing Mathematics: Integration, Differentiation, Arithmetics.

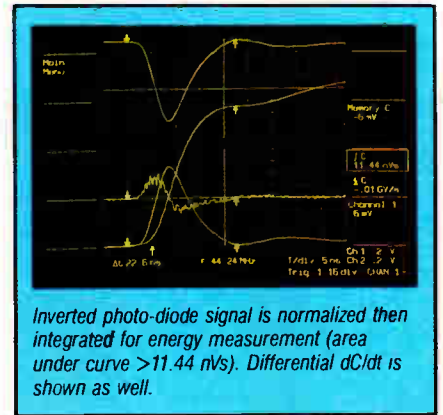
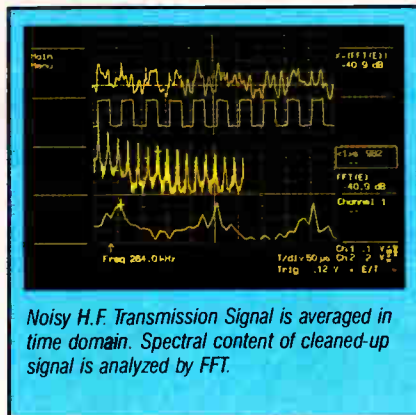
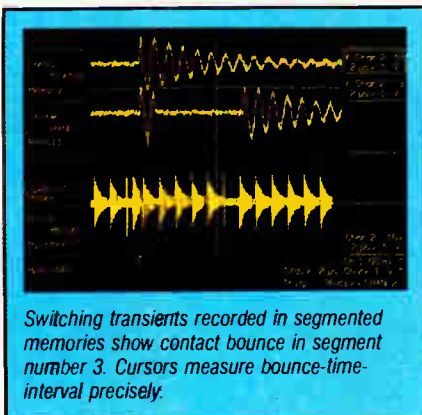

...Signal Processing in Both the Time and Frequency Domains!

UNPRECEDENTED PERFORMANCE IN A GENERAL PURPOSE DIGITAL OSCILLOSCOPE!

LeCroy's Model 9400 Digital Oscilloscope offers you more waveform measurement capability, more signal analysis power, longer memories and higher precision than any other digital scope. Here's how:

Start with wideband, dual-channel, simultaneous signal acquisition at 100 MS/S and a 5 GS/S random interleaved sampling rate with unmatched DC accuracy of $\pm 1\%$. Add a full complement of waveform processing mathematics and then offer more memory capacity than any other scope, like 192K! Memory that can be segmented into smaller sections allowing you, for example, to store up to 250 waveforms per channel for individual analysis and comparison.

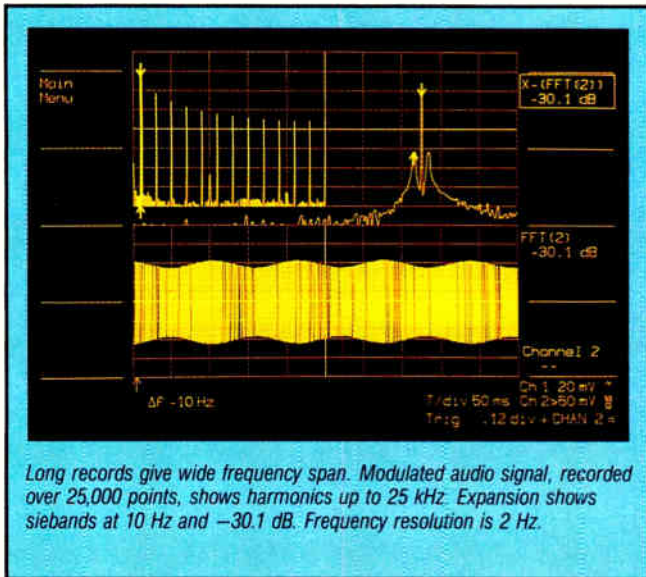

Long records give wide frequency span. Modulated audio signal, recorded over 25,000 points, shows harmonics up to 25 kHz. Expansion shows siebands at 10 Hz and -30.1 dB. Frequency resolution is 2 Hz.

And now, with **Fourier Processing**, you can examine the frequency constituents of your processed time-domain data over a **WIDER** range and with **MORE** resolution than has ever been possible before with any other **portable digital scope!** The 50-25,000 point FFT variable transform size provides unequalled resolution from 1 milliHertz to 50 MHz. Large transform size FFT's yield better and faster signal-to-noise improvement than signal averaging and enable you to separate closely-spaced frequency components for detailed analysis without an external computer. Multiple, menu-selectable display options present your spectra in familiar formats, such as power spectrum, power spectral density (PSD), real and imaginary, or magnitude and phase. And, with this versatile scope, you can instantly change displays or look at the same data in different formats **without changing setups.**

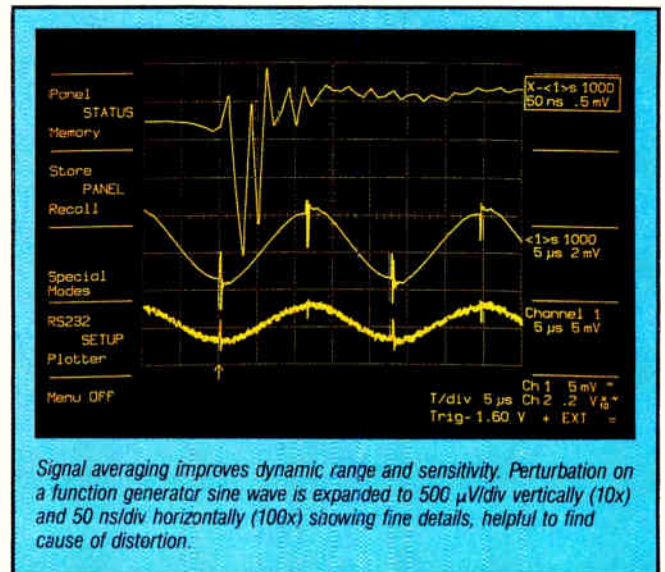

Signal averaging improves dynamic range and sensitivity. Perturbation on a function generator sine wave is expanded to $500 \mu\text{V}/\text{div}$ vertically (10x) and $50 \text{ ns}/\text{div}$ horizontally (100x) showing fine details, helpful to find cause of distortion.

And the 9400 has many more outstanding features! Unique features such as **summation** averaging up to 1,000,000 signals with offset dithering to increase the effective resolution by several bits. And, **continuous** (exponential) averaging with multiple weighting factors so you can quickly and easily minimize the effects of noise on your measurements. Do you have a time or amplitude drift problem? In its unique **EXTREMA** mode, the 9400 precisely tracks and records all extreme positive and negative values including glitches and spikes as short as 10 ns. And with its comprehensive waveform processing, the 9400 offers many powerful routines for performing signal characterization, mathematical analysis and post-processing of waveform data.

All this in a scope! And yet, with all of its **unprecedented capability**, LeCroy's Model 9400 remains as easy to use as your familiar analog scope. Let our field engineers show you how easy it is to put the power of the 9400 literally at your fingertips.

LeCroy . . . the Innovator in Instrumentation is Raising the Standards for Digital Oscilloscopes . . . Again!



To receive your free literature package or, for a demonstration, simply circle the reader service card or call (914) 578-6038.

LeCroy

700 South Main Street, Spring Valley, NY 10977, U.S.A., (914) 578-6097
Geneva, Switzerland, (022) 82 33 55 Sales and Service throughout the world.

WE BELIEVE THAT THE GENIUS OF THE FUTURE LIES NOT

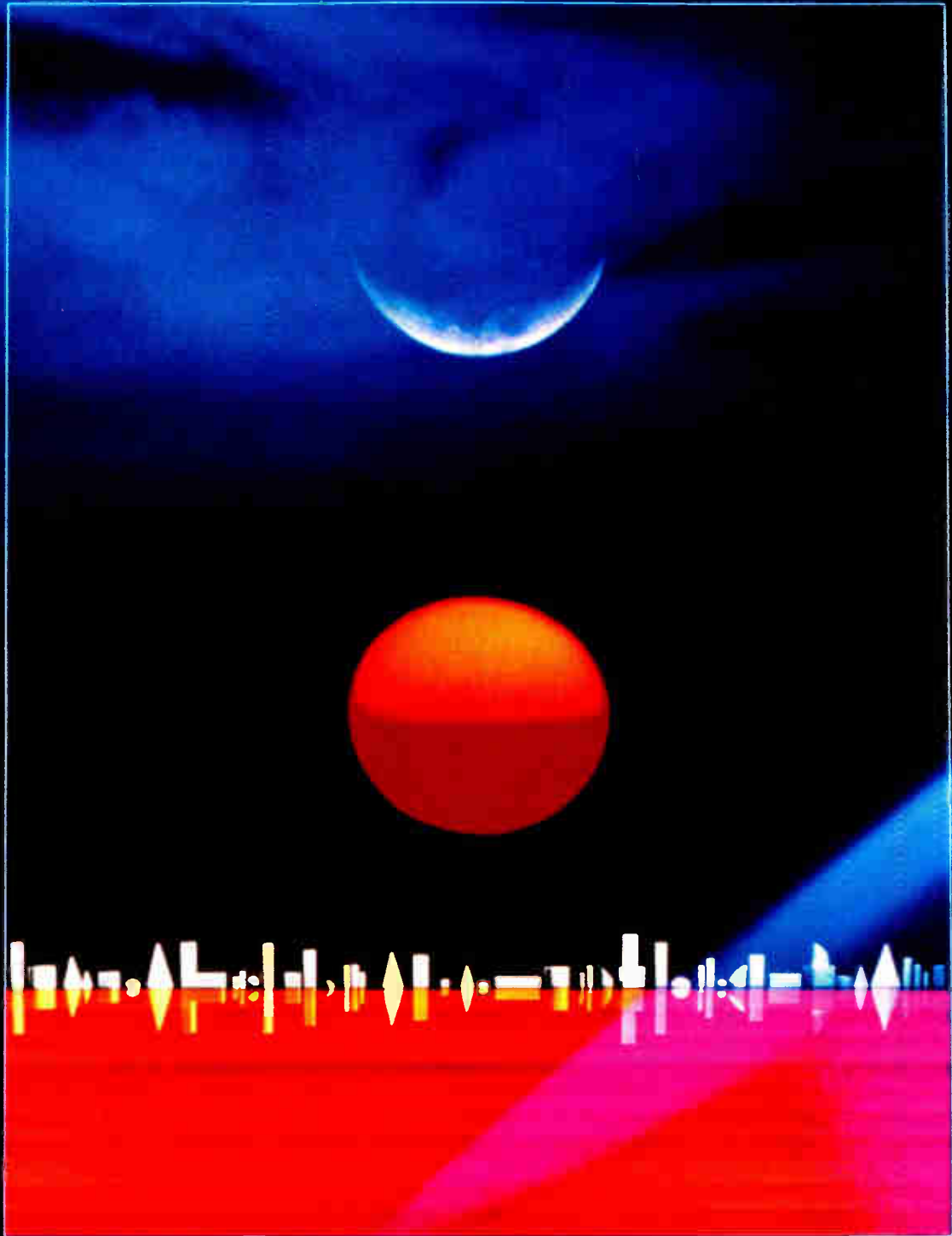

**BELL OF PENNSYLVANIA C&P TELEPHONE DIAMOND STATE TELEPHONE NEW JERSEY BELL
BELL ATLANTIC MOBILE SYSTEMS BELL ATLANTIC PROPERTIES BELL ATLANTIC SYSTEMS LEASING BELL ATLANTIC TRICOM**

IN TECHNOLOGY ALONE, BUT IN THE ABILITY TO MANAGE IT.

**Remote Access. Business
Nicety? Or Basic Necessity?**

In today's competitive business climate, providing 24-hour access to information or ordering systems can very well be the difference between closed for the night, and closing the deal.

At Bell Atlantic™, we open new doors in communications. And providing business with the technologies that can help it compete, like our public data network, is just the beginning. In the end, what sets us apart is our genius for managing these technologies to give you that competitive edge.

For more information about the Bell Atlantic companies, call toll-free 1-800-621-9900, Monday through Friday, 8:30 to 5:00 EST.



Bell Atlantic™

WE MAKE TECHNOLOGY WORK FOR YOU.™



**A BEEPER COMPANY BELL ATLANTICOM™ BELL ATLANTIC BUSINESS SUPPLIES
COMPUSHOP™/BELL ATLANTIC BUSINESS CENTER MAI CANADA SORBUS™ TELECOMMUNICATIONS SPECIALISTS, INC.**

World Radio History

LAYOUT TOOL STREAMLINES FULL-CUSTOM IC DESIGN

Caeco's R-Cells system provides reusable macros, automatic changes when one transistor is altered, and a facility for matching layouts to processes

Laying out full-custom, very-large-scale integrated circuits usually means working through a design one transistor at a time on a computer-aided-design system. But now a new software package from Caeco Inc. in Sunnyvale, Calif., promises to streamline VLSI layouts. Called the R-Cells VLSI Design System, the software features three specific capabilities that solve crucial layout problems.

First of all, an intelligent graphics interface enables the designer to create a macro design for an individual cell and then replicate the macro anywhere in a layout. In addition, each segment of the design is laid out in a relative-coordinate system, so that when the designer later reduces or enlarges a transistor, the layout automatically expands or contracts around the cell to accommodate the change. And for flexibility, a separate process-definition file can be configured to any process environment. A designer who wants to change processes changes the file, and the entire layout is altered to conform to the new design rules.

The first version of the R-Cells system, which is set for introduction next month at a price of \$30,000, will allow designers to create only the individual cells, which can be a single transistor or a more complex gate or flip-flop. Any changes to those cells will automatically change only the portion of the layout immediately adjacent to them. However, Caeco says a future extension of the system will expand the R-Cells concept beyond the cell to the entire layout, so that each cell will be related to its neighbor.

With the extended version, designers would be able to alter whole sections of a layout as easily as they will be able to change individual cells with the initial version.

The R-Cells capabilities represent major changes in the way full-custom VLSI circuits are designed, the company claims. Today, these ICs, which contain upwards of 500,000 transistors, are laid out by hand, one transistor at a time, on CAD

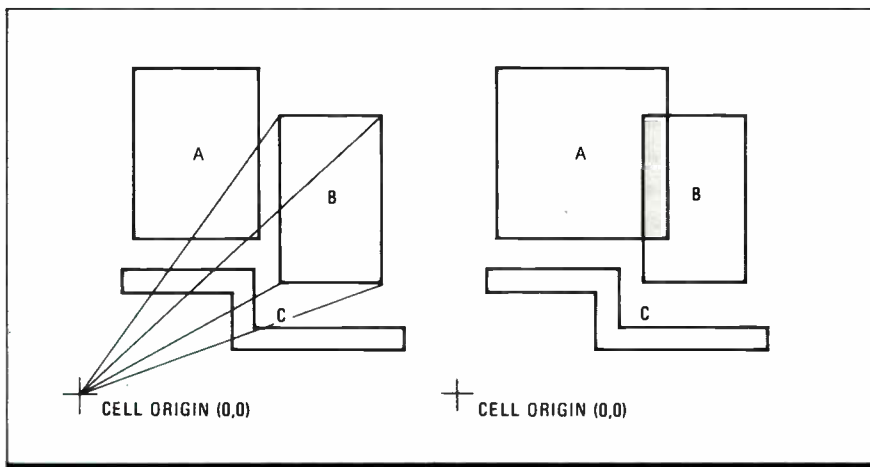

1. FIXED. Older, absolute-coordinate systems use fixed cell origins, so changing a polygon block can mean moving all adjacent blocks.

systems. Caeco says the new software will help make existing design tools more efficient by automating procedures that now must be done individually.

The package runs on work stations from Sun Microsystems Inc. of Mountain View, Calif., and Apollo Computer Inc. of Billerica, Mass. The system produces and can read the GDS-II Streams data-file format developed by Calma Co. of Milpitas, Calif., a de facto standard for CAD files.

Caeco's approach begins with the first step in a layout. Today, a designer begins a layout with a blank screen, on which he laboriously builds individual transistors by arranging polygons that represent metal and polysilicon over one another to form the transistor's base, emitter, and collector, a process called "polygon pushing." The methodology is at least 10 years old, says Caeco's Marlow Draney, director of software. Using this method, it takes up to four hand operations to build elementary transistors. Creating the same transistor with contacts for connecting to other devices can take eight operations. And building a bent gate—one that fits into a right-angle space—can take as many as 12 operations.

By contrast, the Caeco system allows a designer to define a transistor or cell and then replicate it where it is required in the rest of the layout. More important, he can define more complex cells—for example, a 4-bit counter—and reuse them elsewhere in the layout. Once the cell has been placed in the circuit, it can be edited to fit into the area surrounding it. The designer no longer has to push polygons to create a circuit element each time it is used; nor does he have to place each element separately in a layout. Other layout systems allow the designer to reuse portions of existing layouts, but they do not allow the replicated circuit to be edited.

With R-Cells, the designer can also capture each stage of the editing process as he uses the graphics-screen editor, and thereby create a new macro from any of those stages. To create a piece of reusable layout, he asks the editor to record the indicated piece of layout as a cell. "As the designer creates the macro, every operation he performs, every edit he makes, is encoded as part of the R-Cells description," says Mark Miller, Caeco's director of marketing.

The data is automatically written in the form of a macro description file. In addition, the designer can use the editor to place parametric references or prompting messages in the macro description file. Thus, when the macro is called later, the system can ask the designer invoking the macro for the size of the

device-level primitive, its aspect ratio, and any other programmable attributes of the macro. The macro cell resembles a subroutine call, in which the designer supplies the appropriate arguments or parameters.

Besides working faster, the designer will be able to get layout structures equivalent in density to those created by hand, and he can make changes to the layout after it has been automatically generated. For example, if a designer wants to place a straight gate in most areas but convert it into a bent gate that can fit into a specific area of a layout, he can edit the macro description file of the straight gate to add the new vertices for the bent gate, and he can vary the length and width of either leg of the right angle. Once that gate has been created, it too becomes a macro cell that can be reused.

REUSING EXISTING LAYOUT

The capability for editing and reusing an existing layout provides designers much more flexibility. This feature is made possible by a relative-coordinate system that describes the position of every polygon in a design. Other layout systems have used an absolute-coordinate system (Fig. 1), in which every polygon block in a cell is referenced to a fixed origin. If three blocks make up a cell, the location of the corners of block A is established by $x-y$ coordinates with respect to cell origin 0,0. The same is true for blocks B and C. If the width of block A increases, the designer must move block B the required amount of space to prevent A from overlapping B, thereby violating design rules.

In a relative-coordinate system (Fig. 2), every polygon block in a cell is referenced to a fixed cell origin, but each is also referenced to every adjoining block. In a three-block cell, for example, the corners of block A are referenced to adjacent blocks B and C. If the width of block A increases, the Caeco software automatically moves block B the appropriate distance to maintain the relation it had with block A before the latter was enlarged.

The relative-coordinate system determines

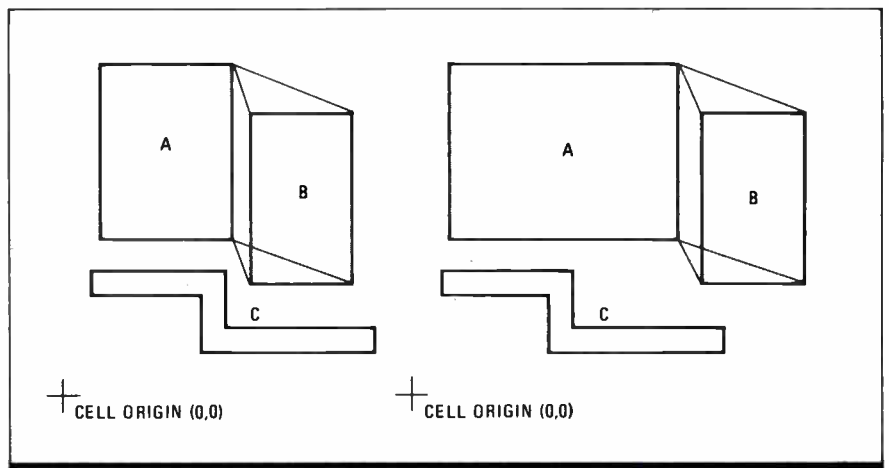

2. FLEXIBLE. Caeco's relative-coordinate system relates a block to cell origin and its adjacent blocks; changes automatically shift the adjacent blocks.

such design-rule requirements as polygon-to-polygon spacing, overlaps, and minimum and maximum device sizes. Devices can then be defined as complete entities, and as they are entered into the data base they can be intelligently edited as to their size, shape, placement, and orientation without disturbing the integrity of the design rules being used.

CHANGE THE DESIGN OR THE PROCESS

The designer therefore can adjust the finished layout if, for example, he discovers a gate in the middle of the design has to be changed because it affects the timing of the entire circuit. Being able to edit an existing layout is especially helpful when a layout is altered to improve electrical performance of a design. "If the designer does a simulation of a cell in a larger design that has been laid out and finds that one gate in the middle of the cell is a little too slow, he may need to fatten up the gate a bit so its speed will increase," says Miller. "The designer can use the R-Cells capability to expand that one gate without affecting the remainder of the layout and without creating a design-rule violation."

The relative-coordinate system accommodates changes that the designer wants to make in the design itself. To accommodate changes that oc-

cur in process technology, the R-Cells system keeps process data in a separate process-definition file. This allows the designer to change the file without having to change the layout data.

The process-definition file contains design rules and device characteristics. It can be configured to the particular process technology: CMOS, n-MOS, p-MOS, or bipolar. With the file, the designer establishes basic relationships between structures: for example, the distance between a polysilicon gate and a polysilicon wire that is not off the same node must be a minimum of 4 μm . The R-Cells capability uses the file to inform the system of the design rules. "It enables layout designers to design at the component level using transistors and wires, without having to concern themselves with the limitations of the process," says Draney. "Every time the designer lays out a gate, it instantly appears in a form that meets all the required design rules, ready for editing by the designer."

Caeco's overall goal is to make designers more efficient, by using the current generation of CAD systems as a foundation for the R-Cells system. "As a company," Miller says, "we are trying to build a software environment in which the productivity of existing layout tools can be increased." □

MAKING A CAREER OF IMPROVING LAYOUT TOOLS

Marlow Draney, Caeco Inc.'s director of software, started trying to improve software layout tools for integrated-circuit CAD systems soon after he graduated from Brigham Young University. As a designer of ICs at National Semiconductor Corp., he began tinkering with the layout software running on National's minicomputers.

"One problem I was keenly interested in was the limitations of macros in these layout systems," says Draney. "A designer could build a device and then replicate it at other points in the layout. But if the macro needed to be changed, he had to edit the macro by hand to ensure the changes met the design rules of the process."

"Marlow understood the IC-layout software problem," says Caeco's director of marketing, Mark Miller. "He struck on the idea of allowing the designer to define a macro in a relative-coordinate system, so that as the macro was changed, the cell itself would auto-

matically adjust its component parts to conform to the design rules."

That concept eventually found its way into Caeco's new layout software, the R-Cells VLSI Design System. Miller saw a preview of some of the R-Cells tools while he was working for a Caeco competitor, Daisy Systems Inc. of Mountain

View, Calif. The demonstration convinced him to leave Daisy and join Caeco.

By the time Miller came to work at the Sunnyvale, Calif., company, Draney was completing the first full version of R-Cells. "Caeco already had unique features that put them ahead of others in the field of IC-layout software," Miller says. Among those was a transistor that can be defined by parameters as opposed to simple polygons. Another was a real-time design-rule checker, one that detected rule violations as layout occurs, rather than one that could be invoked periodically to check the layout after some number of entries had been made.

A third was connectivity in the design-rule database. Rule checkers lacking connectivity data cannot distinguish between an error and the connection of two poly layers at a node. The designer has to examine each connection to determine which are errors.

"When I came on board and saw the R-Cells product, I knew the company had four features not found anywhere else in the market," says Miller. What the system still lacked at that point was a user interface that would allow easy use of the relative-coordinate system, a key feature. Miller's contribution to the project was to help define what that interface should be.

One of the features incorporated into the interface was the ability to allow the user to graphically specify relationships between elements of a cell. "One could relate the edge of one polygon to an adjacent polygon simply by pointing to the two on the screen and indicating that some specified spacing should be maintained," says Draney.

Now Caeco is setting its sights on more powerful layout tools. Draney thinks a future product will take the next logical step: it will extend the capabilities that R-Cells provide for individual cell design to the entire chip layout.

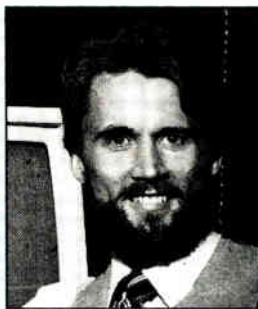

MARLOW DRANEY



MARK MILLER

COMBINING THE BEST OF STEP AND DC MOTORS

Seiberco Inc. is launching a controllable-drive motor that fills the cost-performance gap between a step motor and a brushless dc motor. It is marrying a sensor, driver, and controller to a specially designed two-phase motor (Fig. 1) for a system with the easy controllability of an inexpensive step motor and the performance of a costly brushless dc motor system (Fig. 2). The Braintree, Mass., company says its new AIM 2300 is suitable for many applications, such as microscope-focusing equipment, *x-y* tables, and antenna and telescope drives.

For applications requiring variable torque, relatively low speeds, and maximum position retention, the step motor fills the bill. For those applications with very high-speed requirements coupled with constant torque and where high cost is not an issue, the brushless dc motor is the answer. However, the characteristics of Seiberco's sensorimotor—the "i" is for integral position sensing—are sufficiently different from step motors and brushless dc systems to fill a need not covered by either.

The AIM 2300 exceeds 3,000 rpm, has torque characteristics of a brushless dc motor without needing an external sensor, and can handle applications that are cost-sensitive but need the dynamic performance of a brushless motor. Sensorimotor-based systems cost about 20% more than a step-motor system and half the price of a comparable brushless dc motor-based system.

Step motors are relatively easy to control because their commutation does not depend on position-feedback information. Steppers have many poles and are incrementally advanced, or stepped, from one equilibrium position to the next by a single pulse and a direction-control voltage. Stepper speed is proportional to pulse rate. However, useful rotation of step motors rarely exceeds 500 rpm.

Step motors are typically used for their good static performance and simple open-loop control applications. When high rotation speed and high peak torque are required, users turn to brushless dc motors. These types of motors have fewer poles, typically 4 to 12. And to close the position servo loop, shaft-position information needs to be monitored by the position sensors attached to the shaft.

Brushless motors can operate at 10,000 rpm but typically operate well below this

limit. At low speeds, however, these motors perform poorly and have difficulty maintaining static rest positions. Moreover, the cost of a brushless dc motor system plus external sensor and closed-loop controller is far higher than a step motor and its open-loop control interface.

But Seiberco offers the best of both worlds in terms of speed and cost. The AIM 2300 system is intended for automated positioning systems in a variety of industries. For example, the system has replaced a step motor in a wafer-test platform where the stepper lacked sufficient speed and needed an external sensor for position feedback. The comparable cost of outfitting the stepper with a resolver was greater than the cost of the AIM 2300 system.

BUILT-IN SENSOR

In a prototype integrated-circuit lead trimmer, the AIM 2300 system replaced a brushless dc system for positioning a cutting head. A slow speed specification required gearing down the brushless motor. Added to the cost of a sensor, the added gearing drove up overall machine costs. The AIM 2300 was able to provide sufficient torque at low speeds without gearing, and its built-in sensor provided more than enough position resolution to allow the machine designer to meet system and cost requirements.

Seiberco's motor is a two-phase, 18-pole unit that produces a pair of signals in quadrature. These signals indicate the shaft's position in relation to the stator. Properly processed, the sig-

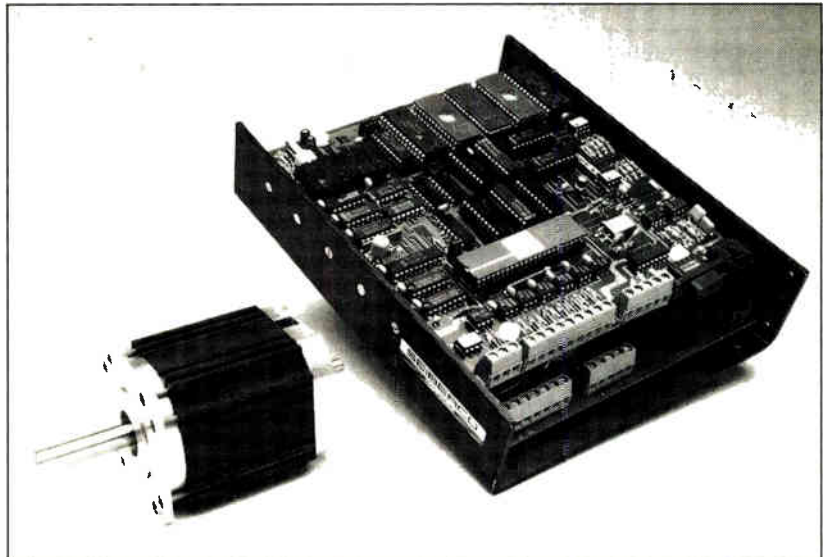

1. HIGH PERFORMANCE. The AIM 2300 motion-control system features a new motor design with internal position sensing and a microprocessor-based controller.

nals provide position-feedback information like that of an external sensor such as a resolver, but they add no shaft loading. Since the built-in sensor is an integral part of the motor, there is no added cost as in the case of an external sensor.

Dual H-bridge driver circuits supply power to each of the motor's phases. Each driver uses power MOS FETs switching at a chopping rate of 50 KHZ with relatively low conduction loss and heat dissipation. The drivers can deliver 40 W to 250 W of continuous power.

An Intel 8096 16-bit microcontroller provides the processing power to handle the real-time motor control within a 500- μ s cycle and has more than enough time to handle user-interface tasks in the background.

Real-time tasks include closed loop and proportional integral-derivative motor control. Pulse

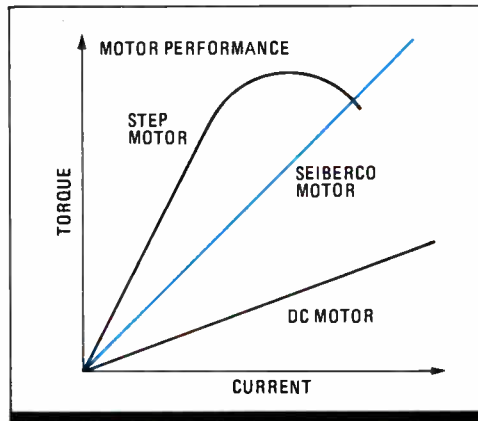

2. BLENDED MOTOR. Seiberco's motor combines the high torque-to-current ratio of the stepper with the linear torque-to-current ratio of the dc motor.

and direction signals, whether input directly or as pulse-train profiles computed by the 8096, are summed with position decoder signals and used by the PID algorithms to compute final gain values. This process is repeated every 500 μ s and ensures that the system will hold its static position or execute a motion profile well within the stated accuracy limits of displacement, velocity, and acceleration.

The motor's high performance is attributed to its novel design and the newer, high-energy, samarium

magnets in its magnetic structure, according to Ralph Horber, vice president of engineering.

Seiberco is offering three motor sizes with peak torques ranging from 90 to 270 oz-in. and continuous torques of 36 to 108 oz-in. Position resolution is 2,304 parts per revolution with position accuracy rated at ± 20 min of arc. Test results have been closer to ± 10 min of arc. \square

TECHNOLOGY TO WATCH

CAPACITIVE COUPLING SIMPLIFIES ISOLATION

Capacitive coupling is the key to Burr-Brown Corp.'s radical new way of providing signal isolation. The Tucson, Ariz., company's technique could simplify the design and packaging of isolation amplifiers and other circuits that require a buffer against harsh signal environments.

This three-chip hybrid technique can be widely applied in systems in which analog signals must be isolated from noise interference or very high voltage potentials that could occur because of an electrical fault. Typical applications are industrial process-control systems with multiple remote transducers, biomedical measurement systems, military equipment, power monitoring, and motor control.

Conventional hybrid isolation amplifiers typically use magnetic or optical coupling to reject high-voltage spikes and noise interference while transferring signals between various parts of a system or circuit. However, such amplifiers are complex and expensive to manufacture, often require assembly techniques in which alignment of the isolation barrier's parts is critical, and are difficult to automate. Breakdown-voltage ratings for typical isolation amplifiers are no higher than 1,500 V_{rms} . Even though the devices usually

operate below this value, however, undesirable interaction between input and output often occurs.

Using its new capacitive-coupling technique, Burr-Brown has developed a pair of unity-gain isolation-buffer amplifiers that ameliorate, if not eliminate, most of these limitations. The ISO102 operates at 1,500 V_{rms} , and the ISO106 operates at 3,500 V_{rms} . These amplifiers are supplied in 24-pin and 40-pin packages, respectively. Both packages are 600 mils wide.

A CAPACITIVE BARRIER

To achieve such high isolation-voltage ratings, the I/O elements of the isolation amplifier are separated by a capacitively coupled barrier in which a pair of 3-pF thin-film capacitors are formed on a standard single-layer substrate within the fired ceramic of the package. Rather than using standard plate-type capacitors, the ISO102 uses capacitance that results from the fringing electric fields surrounding adjacent lines of tungsten.

These lines are deposited in a spiral pattern whose lines are 0.63 mm apart on a 0.6-in.-wide ceramic substrate. Atop this pattern is fired a thicker ceramic layer, embedding the spiral capacitor in solid ceramic. With a dielectric strength of 15,000 V/mm , this ceramic-enclosed capacitor has a breakdown voltage of more than 9,000 V_{rms} and a barrier resistance in excess of 100 terohms.

In the top ceramic layer, windows are fabricat-

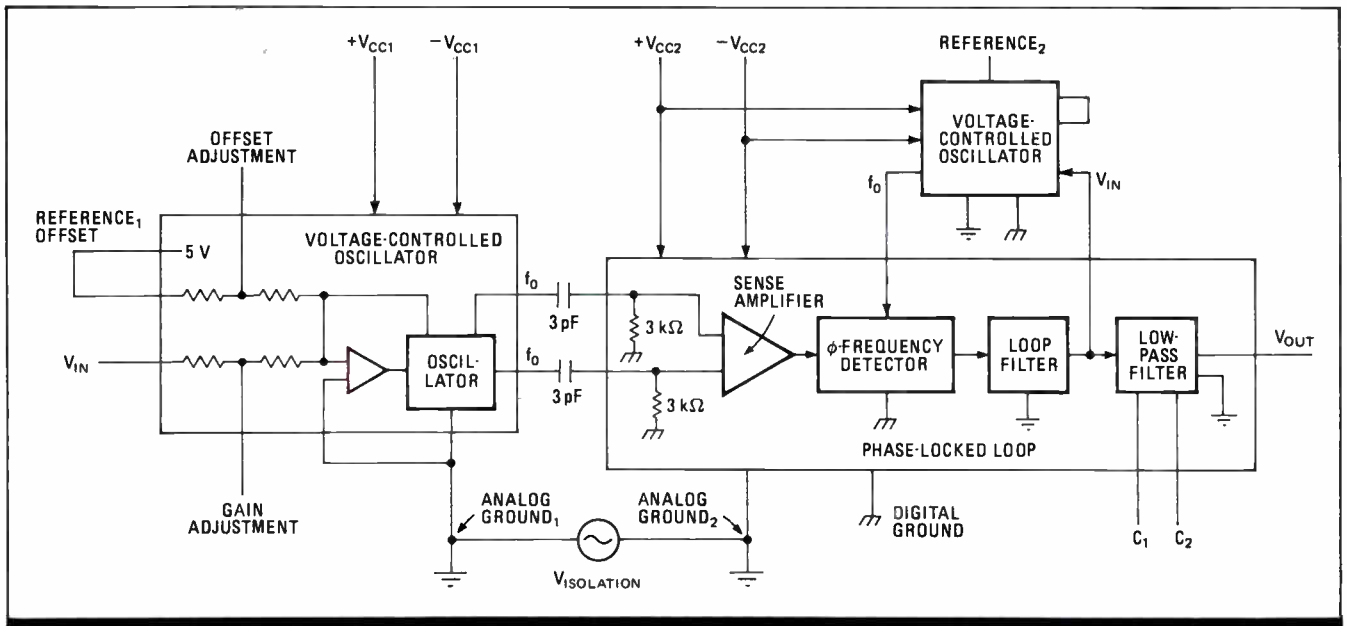

1. GETTING THE MESSAGE. Burr-Brown's ISO102/106 amplifiers couple signals across an isolation barrier by using digital signal modulation, a voltage-to-frequency conversion scheme, and carefully matched voltage-controlled oscillators.

ed, forming the cavities into which the I/O circuitry of the isolation amplifier is placed. On the input side is a proprietary voltage-to-frequency converter chip that is a voltage-controlled oscillator that transforms a ± 10 -V input signal into pulses ranging in frequency from 0.5 to 1.5 MHz. The pulses are generated in complementary form.

A two-chip decoder that senses the pulsed signal and reconstructs the input-level signal is on the output side of the isolation barrier. One chip contains a sense amplifier, a phase-locked loop, and an output filter, and the other contains a second VCO carefully matched to the input VCO by selecting adjacent dice on a single wafer and by careful laser trimming.

Rather than use the analog coupling methods in previous devices, Burr-Brown engineers have opted for a new digital signal-modulation technique to pass information across the barrier with a minimum of noise. In this technique, the ± 10 -V input-signal frequency modulates the 1-MHz output of the first VCO. The modulated signal is differentially coupled through the barrier capacitors to the demodulation circuit, which rejects any common-mode signals, including the isolation voltage.

Unlike analog methods, in which the isolation-mode rejection ratio—a change in the output signal divided by any change in the isolation voltage—degrades continuously with increasing isolation-voltage frequency, the differential signal in this approach is not affected by the barrier voltage, except if it exceeds the noise immunity of the signal.

2. IN SHAPE. The ISO102/106 amplifier forms signal-coupling capacitors by embedding metallic spirals in ceramic substrate.

As a result, the ISO102 and ISO106 have IMRR ratings more than two orders of magnitude better than previous optical and magnetic isolation-coupling techniques. Indeed, the only significant IMRR effects in the devices are minute, capacitively coupled currents in the analog ground connections. Typical IMRR for the ISO106 is -150 dB at 60 Hz, and for the ISO102, -120 dB at 60 Hz, independent of ambient temperature.

HOW THE CHIPS PERFORM

Settling time and overload recovery time for a -10 -V to $+10$ -V step is $100 \mu\text{s}$ to reach 0.25% accuracy. Wideband noise of the output signal is flat to below 0.1 Hz. At 70-KHz bandwidth, the dynamic range is 12 bits, doubling whenever the signal bandwidth is quartered, reaching 16 bits for a 280-Hz bandwidth. At full bandwidth, the 1-MHz carrier appears at the output as a 1-mV peak-to-peak ripple voltage. Frequency-response rolloff is -40 dB per decade. □

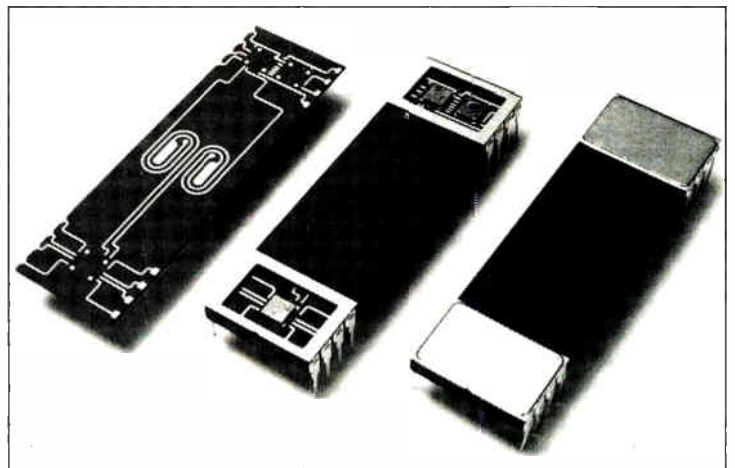

EXECUTIVE OUTLOOK: NO TECHNOLOGY SLOWDOWN

In the annual worldwide survey, executives and technologists see headlines on biMOS technology, practical GaAs products, real-world AI, optical disks, and networking

Without a doubt, next year will be an exciting one for executives in the worldwide electronics industry. That's what they expect; their only question now is, what kind of excitement?

On the positive side, managers look for rapidly changing technologies, which should continue to create new markets, obsolete present products, and shift company market shares. But *Electronics'* annual survey of industry executives on the outlook for the coming year is also laced with plenty of adversity. This feeling comes mostly from executives worrying about the health of their 1987 markets, something that will be the subject of in-depth forecasts to be published in the next two issues of *Electronics*.

Foreign managers expect to have their own set of problems next year. Japanese managers say they will have their hands full with the growing problems caused by the stronger yen (p. 89), while their European counterparts try to figure out what strategies they will need to keep from being run over by Japanese and American manufacturers (p. 90).

The same technologies kept popping up when executives around the world were asked what technologies would make the product headlines next year. Many managers expect to see major improvements in complementary-MOS chips and a speed-up in the march of CMOS toward greater market share. They also see news coming from those researchers working on relatively new processes that combine bipolar and MOS devices on the same die. Others anticipate that 1987 will be a big year for gallium-arsenide product breakthroughs, although some think that GaAs may be headed off at the pass by the faster speeds being achieved by bipolar silicon devices.

In computing, executives are sure they will be hearing about rapid progress in the optical-disk storage field, as well as the coming wave of systems based on 32-bit microprocessors, especially the Intel 80386. Developments in networking will come much faster next year, as will significant announcements in the areas of parallel processing and artificial intelligence.

Still others expect 1987 headlines to be made in the fields of computer-aided design, surface-mount technology, self-testing chips, smart power, and semicustom integrated circuits.

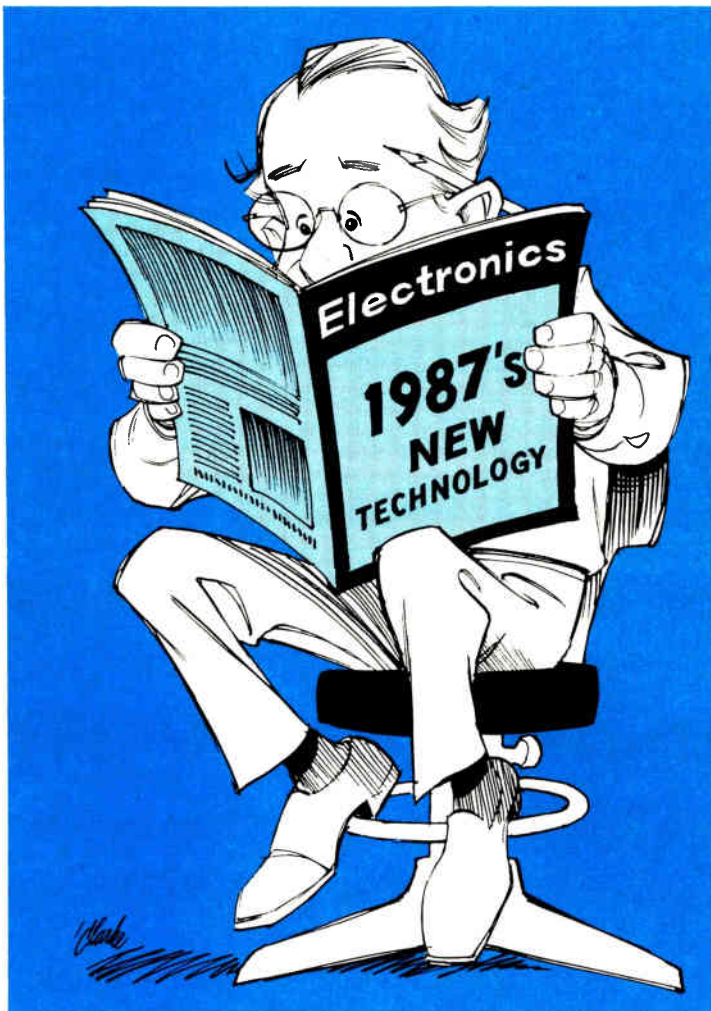

One executive expecting to see news of advances in CMOS technology is James R. Fiebiger, president of Thomson Components-Mostek Corp., Carrollton, Texas. He thinks high-density, high-speed CMOS with design rules of 1.5 μm or less and two layers of metal will garner attention. Daniel Queyssac, president and chief executive officer of SGS Semiconductor Corp., Phoenix, is another who predicts a "continuing move to CMOS throughout the year."

"We will see a further shift away from n-MOS to CMOS because of the speed and lower power dissipation the latter offers," chimes in Klaus Ziegler, vice president of marketing and sales in the Components Group of Siemens AG, Munich.

But there is an upstart challenger with some special capabilities of its own. BiMOS, a combination of bipolar and MOS, will prove significant because of the high performance it offers, as well as its ability to combine analog and digital functions on one chip, says Gollapudi R. Mohan Rao, Semiconductor Group vice president at Texas Instruments Inc., Dallas.

"BiMOS will make headlines next year because it is really starting to offer much higher performance in semicustom and mixed analog-and-digital systems," agrees Bob Hunt, general manager of the semiconductor division of STC Components Ltd, Fooks Cray, UK. "There are a lot of people requiring precision analog in combination with high-density logic functions, and BiMOS can provide this." Data acquisition is one area ripe for a BiMOS invasion, points out Charles R. Thurber, a staff engineer at General Electric Co.'s Intersil Inc. subsidiary, Cupertino, Calif. He thinks BiMOS will fuel big improvements in high-performance data converters.

Years of work on GaAs devices will yield marketable products next year, executives hope. "I think that next year will be the year when GaAs becomes recognized as a real technology," says Peter van Cuylenburg, managing director of Texas Instruments Ltd. in the UK and vice president of TI's worldwide semiconductor group. "I think there will be a range of large- and very-large-scale integrated random-logic products, such as arrays and processors. There are enough products under development that some will surface next year." Hans Weinerth, director at Philips GmbH, Hamburg, West Germany, also thinks GaAs will capture attention next year, "although economically it will still play a negligible role."

"The dark horse is the heterojunction bipolar GaAs circuit technology, which may surprise us," says Denos Gazis, assistant director of logic, memory, and packaging at IBM Corp.'s Thomas J. Watson Research Center, Yorktown Heights, N. Y. This has been an area of interest for a while, but "suddenly it's beginning to show signs of life," he says.

"We're trying to bring GaAs out of research and development into the real-world environment," says R. Ronald Duncan, general manag-

er, Microelectronics Research & Development Center, Defense Electronics Operations, Rockwell International Corp., Anaheim, Calif. But the wild promises made in the past continue to hurt the realistic development of GaAs technology. "GaAs will have to show its mettle very soon, or people will get disenchanted."

GaAs may well be squeezed out of the picture by fast CMOS on the one hand and improvements in bipolar technology on the other, says John Brothers, development executive for MOS at Plessey Semiconductors Ltd., Plymouth, UK. Doug Dunn, Plessey's managing director, agrees. "I think bipolar will be the biggest headline next year," he says. "If you look at the past five or six years, CMOS has made the headlines because it is a new technology with good performance. Meanwhile, bipolar has always had its strength in speed. It has seen pressure from CMOS on power and from GaAs on speed. But it has been making its own progress and is re-emerging."

In the computer industry, the hot story for 1987 looks to be optical-disk technology. Peter Giles, vice president and general manager of Eastman Kodak Co.'s Mass Memory Division, Rochester, N. Y., sees write-once optical disks and the first erasable-optical-disk systems getting started in 1987 and having real impact in 1988 and beyond in image- and information-management systems.

"Optical will be news," concurs James M. McCoy, president of Maxtor Corp., San Jose, Calif. Although optical storage "will continue to get a lot of 'share of mind,'" he says, "it will become

Intel's 30386 is a favorite in the 32-bit microprocessor shootout, but no winner is expected in 1987—the issue will be 'hotly contested for years'





Companies trying to push new products to market face many frustrating bottlenecks, among them the need to teach customers how to use them

clearer through 1987 that it won't happen overnight and won't displace major areas of the magnetic recording business—certainly not quickly, and not nearly to the extent that was believed a couple of years ago.”

McCoy is one of many executives who say they expect much news of the new generation of microprocessors. Like most others, he singles out the Intel 80386 as one to watch, noting that it “will bring improvements in small-system cost and performance at a continuing rapid rate.”

But the Motorola 68020 should not be discounted, says James Norling, executive vice president and general manager of Motorola's Semiconductor Products Sector, Phoenix. “The 32-bit shoot-out will be hotly contested for years,” he says. “The Japanese are finding the way in, too.”

One important benefit from 32-bit processors is lower system costs. “On the 386, you'll have Lisp and AI on a more cost-effective platform,” says Robert Miller, senior vice president at Data General Corp., Westboro, Mass. “Before, [customers] have had to buy a \$50,000 machine. Now, they'll spend less than \$10,000.”

AI in general is expected to make waves. AI-based man-machine interfaces, for example, will become common not only for computers but also for word processors, cash registers, and work stations, says Yutaka Iuchi, Division General Manager of the Information Systems Laboratories of Sharp Corp, Osaka, Japan. Hajime Sasaki, vice president of the Electron Device group at NEC Corp., Tokyo, says “LSI design methodology

will be greatly transformed by migration to AI technology. Expert systems will advance from tools to intelligent systems with the inclusion of sufficient knowledge to perform actual designs. Gate-array and semicustom design will rely heavily on AI as the designer population increases, with a shift from design-by-vendor to design-by-customer.”

Although less likely to produce breakthrough news, computer networking will make steady progress, executives say. For example, a wave of products based on the network model developed by the International Organization for Standardization is expected in Japan, says NEC's Hiroshi Hatta, an assistant general manager for the company's Information Processing Group.

Evolutionary developments will be made in networking technologies—digital signal processing, fiber optics, and software—says Timothy P. Sullivan, vice president for small systems and networks in the BNR labs of Northern Telecom Inc., Richardson, Texas. “The greatest breakthroughs will be in combining all of those things.”

Ken Olsen agrees. Regardless of the magnitude of any one development, the president of Digital Equipment Corp. says flatly, “Technologies never make headlines. The important things come from good engineering.” Development of networking capability and transparency will have the greatest effect on his company's business next year, he says, although convincing companies to open up their organizations to make productive use of networks is an ongoing struggle. The customers themselves are the big bottleneck in selling networks, Olsen maintains.

Asking executives about the bottlenecks encountered in bringing other types of new products to market elicits a wide variety of responses, ranging from insufficient funds, engineers, and work stations to testing problems, setting standards, and passing the baton from lab to design team to production people to marketing. There are many hurdles to clear, and which ones are encountered depends on the product.

One hurdle that stands out as being on the minds of many executives is the difficulty of making sure a product is mature, reliable, and compatible with existing systems. Another is training and supporting users in the use of a truly new product. Executives also harp on the problems of bringing products to market when the market itself is sluggish.

Apollo Computer Inc., for one, has instituted “exhaustive product-maturity testing”—something it didn't do two years ago—says David L. Nelson, vice president and chief technical officer. “[We] set up a large number of machines and test them for long periods of time under different conditions,” delaying the introduction of a new product, but ensuring a more solid product.

The time required for “analysis, development tests, environmental tests, field tests, and valida-

tion of our product, to make sure that we introduce something starting off that has high reliability and durability" is also cited by Donald J. Atwood, president of GM/Hughes Electronics Corp., Detroit. He sees some relief in sight in the form of improved simulation systems and modeling techniques. "There's no substitute for

building and testing," he says, "but [with modeling] we can short-circuit some of the need for building and testing every iteration."

When a wafer-etching product was brought out a few years ago by Applied Materials Inc., Santa Clara, Calif., it was enough to demonstrate the technology to get a share of market,

CAN THE JAPANESE COPE WITH THE SOARING YEN?

The Japanese electronics industry is painfully coming to grips with the rising value of the national currency. Industry leaders expect the impact of a strong yen—and the search for ways to maintain the flow of exports that provides a large part of their revenue—to remain a major challenge in the coming year.

They have their work cut out for them. The value of the yen has climbed more than 50% in about a year, driving prices up and sales down. At the same time, the Japanese are getting more competition from Asian countries that continue to enjoy a more favorable exchange rate with the U.S. dollar.

As a result, many export-oriented Japanese companies are being forced into defensive strategies that are ironically similar to those adopted by American and European businesses when they were threatened with a flood of Japanese imports. The parallels are pronounced enough for one Japanese executive to predict gloomily that his country, like the Western industrialized nations, is about to begin an inevitable decline as a manufacturing power.

Few share that extreme view. Indeed, some companies—those that import equipment necessary to their businesses—welcome the stronger yen. Most are not that lucky.

The dilemma posed by *endaka*, as the high yen is called in Japan, is simple, says Toshio Miamoto, managing director at Sony Corp. Compared with the dollar, the yen is now worth 50% more than it was in September 1985. All other things being equal, a company would have to raise its prices by 50% to maintain its profit margins. But to remain competitive, Sony has had to limit its price hikes to no more than 20%, and that applied to only a few products, Miamoto says. The difference has to be made up elsewhere.

The obvious solution is to cut costs, which all Japanese companies are trying to do. Hindering such efforts is the long-established policy of lifetime employment at large companies. Layoffs come only when "you've lost your last trump card," says Miamoto. "In Japan,

the labor wage is a fixed cost," he adds.

The alternative, of course, is to find cheaper labor elsewhere. "Japanese companies . . . will have to move some of their production overseas," says Tsuneo Uraki, general manager of the Marketing and Product-Planning Division for Hitachi Ltd.'s Computer, Telecommunication, and Office Systems Group. "Hitachi is building its 5-gigabit drives for large computers in Oklahoma. Consumer and components manufacturers may have to step up their purchases from NICs [newly industrialized countries], where good components are available. Hitachi may buy terminals from NICs."

Complicating the move offshore is the fact that the offshore countries are now competing with the Japanese. Partly in response, the Japanese are trying to promote their products as high-quality items, unlike the low-cost merchandise sold by the up-and-coming Asian countries. "Competition with Korea is very severe, but to a large extent only in standard products," says Sutezo Hata, senior executive managing director of Hitachi. "The development capabilities of the Koreans is not great. We can compete by stressing sophisticated products and newly developed products." Again, the effort is ironically similar to the claims of American companies a few

years ago that the Japanese excelled at producing cheap, imitative commodities but couldn't really compete at the top of the line.

Most companies are combining a number of approaches. "There are two strategies to cope with the high yen," says Hajime Sasaki, vice president of the Electron Device Group of NEC Corp. "We must sell high-value, advanced products, and we must move more production to lower-cost regions. The U.S. probably has cheaper labor costs than Japan. The NICs have even lower labor costs."

And some companies don't need to take any approach; the high yen works in their favor. For example, Sachio Senmoto, senior vice president of Daini-Denden Inc., one of four new common carriers challenging Nippon Telegraph and Telephone Corp., says that the rising currency helps his company because the U.S. and European equipment it uses is now cheaper.

But most electronics companies are net exporters, not importers. "Something like 50% of Japanese electronics products are exported overall," says Hata of Hitachi. "Many of our customers have export ratios of 60% to 70%."

The situation has left some Japanese managers uncharacteristically pessimistic. "There are no measures that are truly adequate. Neither cost reductions nor price increases are sufficient," says Yutaka Iuchi, division general manager of Information Systems Laboratories and group deputy general manager of the Information Systems Group at Sharp Corp. "Sourcing overseas is not a complete answer, because we don't want to weaken Japanese industry. If a manufacturer merely handles products from low-cost producers and loses the characteristics of a manufacturer, it will soon come to an unhappy end."

Sony's Miamoto takes an even bleaker view. He thinks Japan is slowly going the way of the U.S. and Europe, toward a declining manufacturing base. "It's inevitable," he says. "I'm always telling my U.S. and European friends, 'Don't worry. We are following you.'"



EUROPEANS WORRY ABOUT BEING RUN OVER BY THE U. S. AND JAPAN

The most important single issue confronting the European electronics industry is the growing threat of domination by the far larger U.S. and Japanese industries. For both executives and technologists, the question more than ever next year will be whether their businesses are in danger of being overrun by the competition from the West and the East, and if so, what they can do about it.

European executives agree that the overseas competitors represent a serious threat, although they disagree on the extent of that threat and what should or can be done about it. Most, however, do not favor wide-ranging intervention by their governments, generally on the grounds that nobody can win an all-out trade war.

One obvious alternative—cooperative efforts in research and development—gets mixed reviews. Many question the effectiveness of such existing projects as Alvey, the British fifth-generation computer program, and Esprit, the pan-European effort to develop information technology. Overall, though, European industry figures support such projects in principle, believing that if nothing else, they teach their members valuable lessons working together.

Whatever the possible countermeasures, the overseas competition is very much on their minds. "The U.S. and Japan are overrunning us to a major extent," says Bob Hunt, general manager of the Semiconductor Division at STC Components Ltd. in the UK. "The thing to be done is to improve our own capability. The problem in improving our own capability is the smallness in scale of our industry compared with Japan's."

Others take a more measured view. "There is real competition from Japan and the U.S., but I don't think they are overrunning Europe," says Doug Dunn, managing director of Plessey Semiconductors Ltd. in the UK. "There is a high use of U.S. and Japanese components in European systems. The European component industry should redouble its efforts to strengthen itself in its own market segments."

The idea that the threat

from the U.S. and Japan is very real, but that European companies can and do compete in selected market segments, is widespread. "The semiconductor market is dominated by the U.S. and Japan," says Peter van Cuylenburg, managing director of Texas Instruments Ltd. in the UK and vice president of TI's worldwide semiconductor group. "But in equipment, the European companies are much stronger. In the consumer market, the Japanese are predominant, but high-definition television could change this. Automotive is a big growth area. There is not an area of car electronics in this country in which there isn't world-class activity taking place."

In some cases, recognition of the U.S. and Japanese position amounts to acceptance of it. "If some of their products are better, why not accept it, the same way women accept French perfume as apparently superior?" asks Lubo Micic, managing director of the ITT Semiconductor Group in West Germany.

Regardless of how its members view the competition, the European electronics industry generally does not believe governments should protect them. Most industry figures argue for fair competition, not less competition. "We strongly support free trade," says Hans Weierth, a director at Philips GmbH in Hamburg in West Germany. "But it must be fair." As long as conditions are not equal, "we cannot afford to do without the customs levied against semiconductor imports."

Full-scale protectionist measures against all overseas competition would not work, most observers agree. Aside

from whatever value they assign to free markets as such, they fear retaliation. Micic, of ITT, points out that his company exports 60% to 70% of certain components.

At least one executive believes the answer lies neither with competition nor with protection, but with cooperation. "I think major equipment manufacturers in Europe should form technical alliances with powerful component suppliers and set up a mechanism where U.S. suppliers assist European manufacturers in getting access to leading-edge technologies," says van Cuylenburg of TI Ltd. "In return, they give U.S. suppliers a large share of business."

As for the potential for cooperation among European companies themselves, opinions vary widely. STC's Hunt says, "Alvey has done us an awful lot of good. It has got us to a position of advanced technology very quickly." But Paul Wynter of Advanced Text Systems declares, "Alvey and Esprit are a load of rubbish. Alvey is no benefit to anybody. You have to go through too much to get into it. It is all government PR. It can't effect marketing changes."

The general view is somewhere in between. John Brothers, a MOS development executive at Plessey, finds the projects valuable because they lessen risk. "You are just not as worried in putting 50% of the money into a project as you would be if you were putting 100% in," he says. He does have reservations: "The problem with these projects is that they are too long-term, say three to five years, and things change quickly. It is not easy to redirect the programs as things change in general."

Regardless of the obstacles, though, European companies eventually are going to have to cooperate at least in the pre-competitive stages of research and development, says Richard Epple, director for European research programs at AEG Research Center in West Germany. The value of the current programs may lie in their helping to make such cooperation easier, he says. The director of AEG Research Center, Stefan Maslowski, agrees: "Joint projects are teaching us to get along with each other."

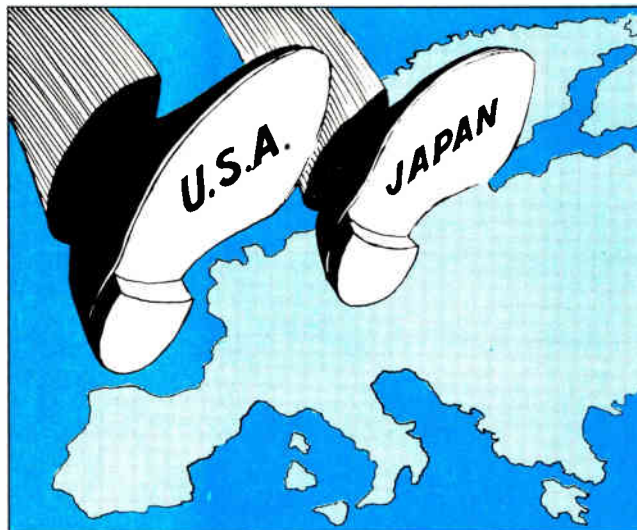

says Dan Maydan, vice president for the firm's Applied Deposition Technology Division. "Today, that's not enough. We have to demonstrate that the system is very reliable, that it is fully automatic, and that it is particulate-free."

"The thing that's most troublesome is making sure a system is [fully compatible], that it has all the interconnection capabilities you need," says Blaine Davis, corporate vice president for strategic and market planning at AT&T Co., New York. "In a closed [computer or network] architecture, bringing out new products is easier, because you don't have to worry about being able to accommodate other companies' products. But AT&T doesn't believe that the world is waiting for another proprietary architecture."

The very newness of new products can create education bottlenecks. Two types of efforts are aimed at this problem: supporting the user with tools and training, and making the product easier to use in the first place. In the field of semi-custom ICs, for instance, "it is becoming necessary to interface closely with customers and provide more support," says Sutezo Hata, senior executive managing director of Hitachi Ltd.

With completely new products, "the major problems are not in development," says Tsuneo Uraki, general manager of the Marketing and Product Planning Division of Hitachi's Computer, Telecommunication, and Office Systems Group. "Perhaps the major problem is that products are not designed to be sufficiently easy to use," he goes on. "The end user in general doesn't have time for new things because of a backlog of old work."

Users of semiconductors need training too. "Coming from semiconductor producers is a heavy innovative pressure, and it is especially the small and medium-sized firms that are having difficulty adapting to this pressure," says Philips' Weinert. Although chip makers are introducing new devices rapidly, he says, many users take too long to make them work in new products, so Philips and others are lending a hand in applying new circuits.

Power MOS FETs and power ICs, for example, "require engineers to relearn how to design their products," points out Alex Lidow, executive vice president of manufacturing and technology at International Rectifier Corp., El Segundo, Calif. He says it has taken seven years to establish enough knowledge of power MOS FETs such that rapid market growth can now take place.

New products may be needed to stimulate renewed market growth, but a slow market makes it difficult to introduce products. "The biggest bottleneck we have right now is paying the bills," says Charles Minihan, senior vice president and general manager for Perkin-Elmer's Semiconductor Equipment Group. "You can't fund R&D if sales are just too low and you don't have any money coming in."

Even after a product is ready, it stops in its



Although most electronics executives don't see direct harm to their companies in the new tax law, they agree it will make economic recovery slower in coming

tracks if market demand is too depressed. "There is lots of interest, but delays in buying," says SGS's Queyssac of some new products.

"The biggest bottleneck in 1986 has been the flatness of the market, which we think will change next year," agrees Nicholas Matelan, president of Flexible Computer Corp., Dallas. However, one of the biggest roadblocks to increasing business, he feels, is the tax bill.

When asked about the new U.S. tax code's effects upon their businesses in general and with respect to capital and R&D spending in particular, executives in the electronics industry are on the whole negative. A very small minority of those surveyed say their companies will be paying less taxes; outside that group, the best thing they can say for the new law is that its passage has relieved the uncertainty that prevailed while Congress worked on new tax legislation.

Many of those surveyed think the new code will have relatively little direct effect on their companies. Few think it will cut noticeably into R&D spending. Most, however, cite its dampening effect on capital spending and on business in general. And some representatives of the semiconductor industry say their companies are being materially hurt by the new law.

"Two things were left out of the tax code: help for small companies and tax-loss carry-forwards," says Matelan. "I think this is stupid, because 80% of all new jobs are created by small startup companies." Not only does the law offer no special aid to startups, but it will contribute to a general slowdown that will depress startup activity, according to Data General's Miller.

"I agree with the school that says it will have a negative impact on the economy for some time to come," says Gordon R. England, vice president, research and engineering, at General Dy-

namics Corp.'s Land System Division in Warren, Mich. By removing investment incentives, he says, the tax code will slow capital spending.

"The dilution of the tax credit [on capital goods] has made our customers much more cautious with their capital," according to Richard J. Boyle, vice president and group executive at Honeywell Inc.'s Industrial Systems Group in Minneapolis. As a result, "many of our marketplaces will be characterized by more cautious spending." The new code could lead to continued sluggishness in the computer business, he continues. "I think it will be a damper on many of the capital-goods markets."

Although Fiebiger of Mostek, Queyssac of SGS, and others do not think their companies will be harmed, many semiconductor executives are not so sanguine. Lidow from International Rectifier calls the tax reform "one of the most foolish policies of the last decade," largely because it

eliminates the provisions for fast depreciation.

"The new tax code is going to cause an overall reduction in capital spending and will have a negative effect on the industry in general," says Richard Funk, manager of standard IC applications at GE/RCA Solid State Division, Somerville, N.J. "The semiconductor industry is very capital-intensive. This is going to put very severe limitations on our ability to compete, and I think the government is going to have to take a second look at this. They'll have to modify it."

Not surprisingly, suppliers of capital equipment to semiconductor houses stand to lose. "I'm worried about the [loss of rapid] depreciation and the investment-tax credit," says Perkin-Elmer's Minihan. U.S. chipmakers will be less able to buy new equipment, and he thinks they need to do just that. "They need to revise their whole approach to manufacturing, and [the tax code] is going to slow things down."

TECHNOLOGISTS: TOOLS TO DRIVE CHANGE

Managers heading up research and engineering efforts in the worldwide electronics industry see the prospects for 1987 brightened considerably by the growing availability of better engineering tools to carry out their work. In *Electronics'* annual survey of industry executives on the outlook for the coming year, the research and engineering managers are quick to agree with industry leaders that the pace of technology change will continue at a good clip. They expect to achieve this progress with im-

proved tools, such as silicon compilers, computer-aided software generators, and expert systems, which they see coming on stream next year.

These tools are badly needed, too, because of the shortage of first-rate systems designers and manufacturing engineers. Some schools are moving to fill those needs, technologists say. The technologists don't expect manpower shortages to slow progress in the semiconductor sector in 1987, but the pace there is so furious that the rest of the electronics industry will be hard pressed to keep up.

Despite the hoopla and size of major military research and development programs, they will not be the technology drivers next year. Many technology leaders doubt whether the Strategic Defense Initiative will have any commercial impact in the near term, and they give the Very High-Speed Integrated Circuits program mixed notices at best.

Hanging most tantalizingly on the horizon now, according to technologists, are workable silicon compilers. Also not too far off, they say, are tools that will make it easier to write complex software. Artificial-intelligence techniques are expected to be brought to bear on the program-writing task. Expert systems could become important tools in the manufacture of ICs, aiding the operators of complex fabrication equipment. And software may also soon be available that helps engineers and researchers to pool their knowledge more efficiently.

Some silicon compilers are available now, but they are still regarded by many development engineers as embryonic. Major improvements are expected soon, so that engineers unfamiliar with IC design will be able to implement their systems in silicon without bringing in specialists

Next year will bring major advances in software tools: among them should be better silicon compilers, tools for writing programs, and expert systems for fab lines



to handcraft chip designs. One big deficiency of the current compilers is their inability to combine analog and digital circuits on a chip.

Overall, the level of dissatisfaction with the compilers remains high. They "far from satisfy our needs, as they lack complexity and flexibility," says Lubo Micic, managing director of the ITT Semiconductor Group, based in Freiburg, West Germany. With present systems insufficiently automated, the user must do too much work himself to make the best use of chip area, trying out different layouts. "We are dreaming of a fast and high-performance product that requires little human intervention," says Micic.

Others would forgo some automation in favor of broader capabilities, especially the ability to design analog chips and mixed analog-and-digital chips. Intersil's Charles Thurber is one of those waiting for "a really good, efficient layout tool, like a silicon compiler, for both analog and digital systems. I would be very happy to do all the layout if the tools were available," he says.

Takao Matsui, group executive in charge of technology at Toshiba Corp.'s semiconductor group, Tokyo, is another who wants a good set of analog-chip CAD tools, even if they aren't as automatic as a compiler. "Chips for consumer products account for about half of Toshiba's production," he says. "In this field we need many kinds of linear ICs." He especially wants a good test-pattern generator for analog circuits.

"In power ICs, we need CAD equipment and software to close the loop between testing, design, and simulation," agrees International Rectifier's Alex Lidow. "Progress in digital is well along, but not even started on the analog side."

"The industry needs better linkages between different CAD software packages, which are themselves okay if they could communicate," says SGS Semiconductor's Daniel Queyssac. And Apple Computer Inc.'s Lawrence G. Tesla, vice president of advanced technology, wants "a vendor-independent set of chip-design tools that let us do designs and go to more than one vendor. Typically, design tools fit only one vendor. But there are times when we understand fully what we want to do, low cost is critical, and we need to be able to get bids and go with lowest cost."

Others are looking for CAD tools that help with design not only at the chip and board level, but also at the systems level. Hitachi's Tsuneo Uraki says that a work station for systems design is under development at his company. "Such a work station is hard to buy, because its design is closely tied in with development methods." Systems are also needed for simulating and documenting systems-level designs, he says.

Systems engineers doing chip designs find themselves trying to work with IC design tools, says TI's Gollapudi Mohan Rao. He says the industry needs a way to translate silicon knowledge to printed-circuit-board design. "You could call it a true silicon compiler, true pc-board com-

piler, or true computer compiler. We need it and I think it is going to come," he predicts. David Topham, business manager, Cambridge Interconnection Technology Ltd., Cambridge, UK, wants "a system compiler so it can be a total package."

CAD software may come more and more to the aid of software writing itself. "Some type of software CAD is needed," says Sharp's Yutaka Iuchi. "Writing software requires the majority of personnel." "We must step up the use of AI to increase the quality of software," opines Kunio Ohkuwa, manager of the business, marketing, and product planning department of NEC Corp.'s Information Processing Group. "We must also use AI to increase software productivity."

"Internally, I see tools on the brink of a breakthrough for software productivity," says Northern Telecom's Timothy Sullivan. "I also see new tools that will help us better integrate and test the many options as we bring our products together. That is on the fringes of AI."

TI's Mohan Rao thinks AI will also soon come to the aid of process engineers. "Complex equipment must be built with expert systems that will automatically—99% of the time—perform diagnostics, synthesize the analysis, and take corrective actions," he says. "If you have a very expensive direct-step-on-wafer system which does not have effective throughput, you want an expert system to take care of the problem."

Tools may also soon become widely available

Electronics companies are competing for students who master manufacturing skills; they also want graduates who can combine technologies on a systems level

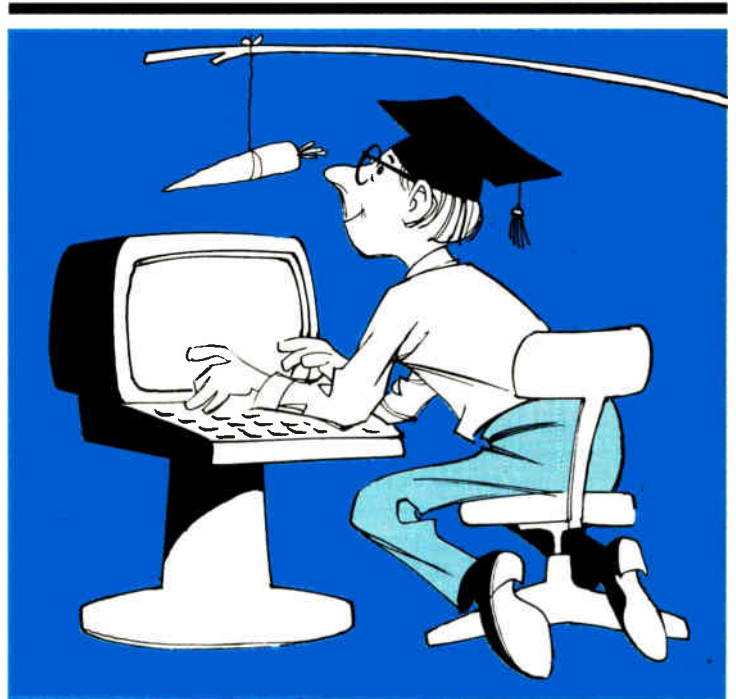

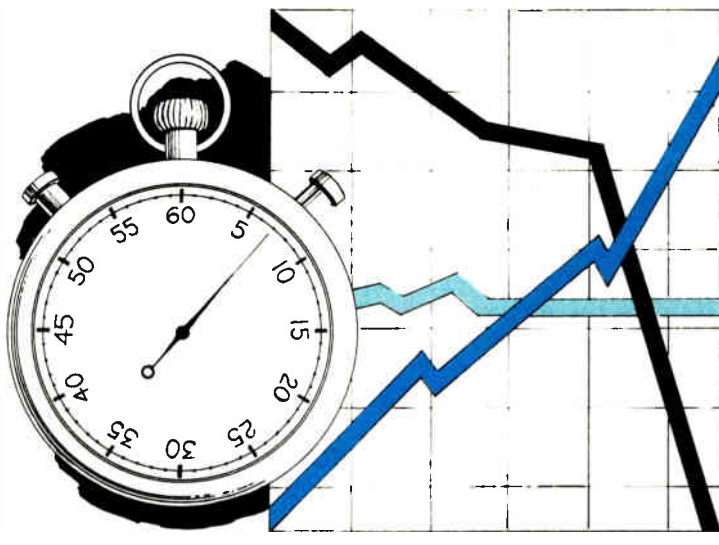

In the semiconductor sector, the pace of change is quickening—and systems makers say they are finding they can't keep step with the technology advances

that, instead of adding AI, serve to amplify human intelligence. Lynn Conway, professor of electrical engineering and computer science and an associate dean of the College of Engineering at the University of Michigan, Ann Arbor, points to a developing discipline known as collaboration technology or "group computing." It goes beyond distributed processing and computer networking to deal with tools "to aid with group processes," Conway says. "It's the development of software tools and protocols for interacting so people can have more productive meetings."

One narrow example is software tools used at Xerox Parc (Palo Alto Research Center) that help people keep track of an evolving argument or process involving multiple individuals participating at their own screens. These tools allow an individual to come back to his screen after an absence and more easily pick up on the process at the point where he left off. Conway says there is "a groundswell of research activity" in the field right now.

Many of the automated tools will help electronics manufacturers overcome their biggest staffing problems, for industry leaders agree that there is a worldwide shortage of top-notch manufacturing and systems engineers. These disciplines are becoming increasingly important as companies seek to cut manufacturing costs and increase the functionality of their products.

"Manufacturing skills are golden," says International Rectifier's Lidow. "Good manufacturing engineers are extremely important, [but] the supply is always short," adds Maxtor's James McCoy. Help is on the way: a few universities have begun to offer manufacturing engineering

programs, says Donald Atwood of GM/Hughes Electronics.

Manufacturing skills are not the only ones in demand. U. S. executives say that more than any particular specialty, they want engineers with broad backgrounds, capable of tying together technologies on a systems level. "The toughest ones to find are engineers who can apply technologies such as integrating fiber with signal-processing components and software," says Northern Telecom's Sullivan. That's why technologists praise the programs at the top engineering schools, Ivy League universities, and some of the better land-grant institutions, which have broad engineering programs.

Most industry leaders say that most of all they want bright, flexible engineers who are not too specialized. "We need multidisciplinary people," says Dan Maydan of Applied Materials.

The British also say they are short on practical, multidisciplinary engineers, while Japan faces a shortage of software engineers. "We are trying to hire [software] engineers," says Toshio Miamoto, managing director at Sony Corp., Tokyo. "But we cannot hire all that we want."

The British problem is altogether different, says Topham of Cambridge Interconnection Technology. "Practical engineers are needed," he says, "people who know which end of a soldering iron is hot. There are a lot of software engineers, but not enough real engineers."

GE/RCA's Richard Funk agrees. "Too many engineers are coming out of school oriented toward software and computer architecture," he says. "Hardware and laboratory experience are not getting as much attention as they used to."

Meanwhile, industry presses on. Managers of engineering and research see the pace of technological change as quickening in the semiconductor sector, but lagging in the rest of the electronics industry. Top engineering managers say that new tools and acute competition are holding chip makers to a feverish pace as they race to scale down geometries. The pace is so fast, in fact, that systems makers can't pack these new devices into functional equipment before the next-generation products are hitting the street.

"While integrated circuits get denser, faster, and more complex, systems makers find it hard to put these advances to use in their products," says IIT Semiconductor's Micic. "Hardware just cannot keep step with technology."

Fueling the competitive race are several factors, including economic considerations and advanced design tools. "The pace of technological development is speeding up," says Plessey's John Brothers. "I don't think silicon technology will slow down for 10 years, [because] the capability to design things has improved."

Not everyone is convinced that the technological growth curve will continue to rocket, however. "It's flattening out," says RCA's Funk. "The worldwide capacity for making chips is out-

stripping the available sockets, and the markets for computers, automobiles, and other equipment that use semiconductors is limiting the pace of technological growth."

Others say that as the technology matures, economic factors play an increasingly significant role. "If in the past the rate of technological change was determined by physics and engineering, in the future economic considerations will become an increasingly important factor influencing change," says Philips' Hans Weinerth.

Mohan Rao says chip technology will maintain its current growth rate for the next decade. He says memories are becoming more complex at a rate of about 35% to 40% per year, and random logic is increasing in complexity at about a 20% to 25% rate. That pace will remain steady until the next boom market begins to accelerate the semiconductor industry, he thinks.

As to what will push technology—at whatever pace—most technology leaders think SDI will be a major driver in the years to come, but debate lingers over how well SDI-derived advances will be integrated into commercial products. Many also worry that the VHSIC program, a Department of Defense project that is aimed at producing high-speed military ICs, may be too narrowly focused for its technology to make its mark in commercial products

"I have no doubt that simply attempting to do [what SDI calls for] is going to open up new frontiers in materials, information systems, sensors, and so on," says University of Michigan's Conway. But, she adds, "there's a question of whether we'll be able to exploit the stuff we get out of SDI for other than military purposes."

It seems clear that SDI will significantly effect development in some areas—particularly software and computing, for example—but other technologies, such as semiconductors, will be virtually unaffected by the program. "You are not likely to take the leading edge of [chip] technology and put it into a space application," explains Fiebigler of Thomson Components-Mostek.

SDI supporters point to the credit the space program was given for advancing technology in the 1960s and 1970s, but others—including those who dispute whether the space program played a major role in driving technology—say that SDI is different from past government programs because of the politics involved.

"I don't put it in the context of either a technology driver or a waste of money," says Honeywell's Richard Boyle. "I believe it's serving many purposes, both defense-wise and as a negotiating tool."

Boyle and others, such as Atwood of GM/Hughes Electronics, agree that only time will tell whether SDI technology really filters down into mainstream commercial products. "The big quarrel is that so little is known," says Atwood. "People say we shouldn't spend so much money when we don't know what's going to be pro-

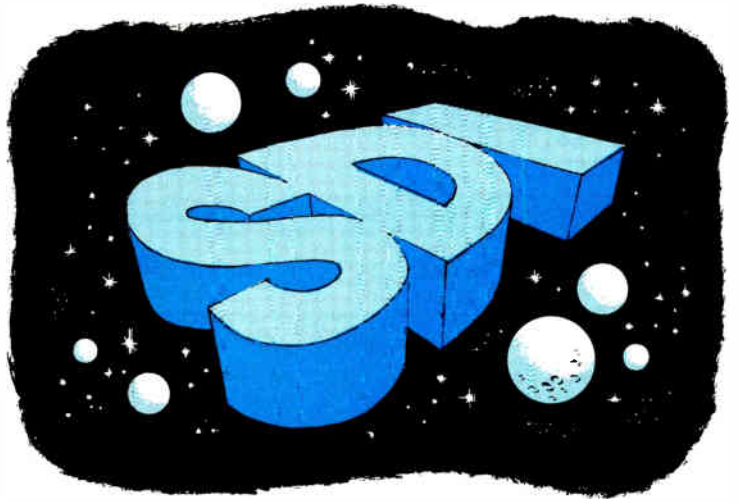

The Strategic Defense Initiative may be a technology driver in the years to come, but a strong debate is raging over its likely impact on commercial products

duced, but at the same time, the benefits to be gained are such that I support going ahead."

Others can see explicit payoffs. "I came from Bell Labs and was involved with SDI," says Maydan of Applied Materials. He thinks SDI will spur "the development of really big computers that will push new technologies."

The VHSIC program also has strong backing from executives and engineers. "VHSIC has been very successful," says Gordon England of General Dynamics. "It's influenced a lot of programs and products." He says the VHSIC program has been "directly beneficial for military signal and image processing, and it's been a driver in the commercial market."

But the program does have its critics. "VHSIC is in the wrong hands and is having limited impact," says Lidow of International Rectifier. VHSIC is "giving some drive to develop higher-density chips," says Maydan, "[but] it hasn't been organized to get the most out of the program." He says the program sought to step too far ahead of the current state of the art in semiconductor technology, and that in doing so it may have missed developments that could have come from the intermediate stages. "Usually, technology cannot jump," he says. "You have to go step by step."

VHSIC may already have affected commercial semiconductors by pressuring suppliers to squeeze chip geometries below 1 μm , but those new parts will take time to make it into military systems, let alone commercial products. "I don't see VHSIC as an art now being applied to future military systems," says Charles Miniham of Perkin-Elmer. "And it is not a technology driver—yet, at least—for commercial products." □

SEEKING THE ULTIMATE MICROCODE DEVELOPMENT SYSTEM?



Bit Slice

ASIC

VHSIC

Bipolar
Processors

DSP

CPU
Design

YOUR SEARCH IS OVER!

Speed, support and satisfaction. That's the HILEVEL approach to meeting *your* microcode development system needs, *without compromise*.

Microprogram development and debug is fast and easy, thanks to highly-productive software development tools combined with the most powerful hardware available. We back each system with unmatched service and support, and *the longest warranty in the industry*.

- **Guaranteed Access Time at Target Side of Pod.**
- **Most Powerful Logic Analyzer, with Exclusive Trace Waveform Display.**
- **Most Advanced Macro-Meta Assembler in the Industry.**
- **Toll-Free Applications Assistance.**
- **Memory Board Exchange Credit.**

And, we'll demonstrate an ease-of-use that invites comparison with any other system on the market.

Avoid compromises. Demand the finest. Call today.

DIAL TOLL FREE:
1-800-HILEVEL
In California, call
1-800-752-5215

HILEVEL
TECHNOLOGY, INC.

18902 Bardeen, Irvine, CA 92715 • Phone: (714) 752-5215 • TELEX 655316 • TELEFAX (714) 752-0724

Circle 96 on reader service card

World Radio History

PROBING THE NEWS

THE COMPETITION EXPLODES IN POWER MOS FETS

OUTLOOK IS FOR 40% ANNUAL GROWTH, BUT A SHAKEOUT MAY BE COMING

by Larry Waller

LOS ANGELES

The competition has turned scorching hot in power MOS FETs. The reason is simple. In a semiconductor business that currently is growing slowly at best, power is one of the fastest-growing segments, and more chip makers are trying to grab a piece of the action. A business where U.S. companies still dominate, power is shooting ahead for solid reasons—MOS FET drive circuitry is simpler and operating frequencies are higher than those of bipolar power transistors. Because of these advantages, MOS FETs are displacing their bipolar cousins at a rapid pace and are opening up a wealth of new applications—including some highly attractive ones in the auto market.

The prospect of a worldwide business growing at what some participants think could run at a 40% annual clip over the next five years from a 1986 base of \$210 million has competitors investing heavily. The top three players in particular—in order, International Rectifier, Motorola, and Siliconix—have anted up impressive amounts for product and technology development and manufacturing capacity. They aren't alone. As the battle for customers intensified in 1986, other big competitors from the U.S., Japan, and Europe have spent more money to develop MOS FET products and expand their activities.

While each player predictably insists that it has its own proprietary edge in technology or quality with its MOS FET parts, all of the competitors acknowledge that the current fight hinges on one factor. As one industry consultant puts it, "The MOS FET battle will be fought on that most basic of all sales issues—price." Agreeing is Paul V. White, vice president of marketing for Motorola's Discrete Semiconductor

Group. "There's product, reliability, and price. We're all pretty much even on the first two. So what does that leave?"

Consider what happened this year to two typical parts. The high-end IRF440, a 400-V model, slid from \$12.35 to \$8. And the commodity IRF520, rated at 100 V, dropped from \$1.11 to 90¢. MOS FETs had traditionally cost more than bipolar equivalents; now there is virtual parity for some parts.

Market leader IR, which had the field to itself for several years after the introduction of its Hexfet in 1979, sees the issue similarly, though it still claims a technology advantage stemming from its basic MOS FET patents and its longer experience in building the devices. "There's less and less product differentiation," concedes Alex Lidow, executive vice president for manufacturing and technology. "With time, MOS FETs become more and more of a commodity."

So the contenders have honed strategies, put their facilities in place, and sent marketers out on a blitz for more

customers. Seven companies are fighting for market share (see table, p. 98), maneuvering to capture the high ground, especially in the U.S. market.

■ **International Rectifier Corp.** The El Segundo, Calif., company is moving at flank speed in its effort to hold onto its No. 1 ranking. It hopes to gain a price advantage through manufacturing efficiencies gained from a new \$80-million plant designed to build MOS FETs. The plant will triple IR's capacity when it reaches full-scale production next year. Derek Lidow, executive vice president for marketing, says the goals are a "50% reduction in costs, which will permit us to take the price leadership." Furthermore, he says, the production cycle has been cut from weeks to only four days, which he says will enable IR to deliver product 10 days after receiving an order. But the cloud in the bright outlook is what one industry observer calls "IR's financial pressures from the cost of building such an expensive plant for a \$145 million company."

■ **Motorola Inc.** The largest U.S. entry in MOS FETs, and the world's leading discrete component supplier, finally got its act together in 1986. Among other moves, it dedicated a Phoenix fabrication line to making power devices; previously, they had been built in shared facilities. The Phoenix-based Discrete Semiconductor Group has made major commitments across the board to MOS FETs, beefing up design and marketing efforts, and earmarking even more of Motorola's massive MOS production capacity for them. Manufacturing is under way at Austin, Texas, and Japan, and work is scheduled to start next in Scotland. In pricing, Motorola played the major role in forcing levels down faster than the normal learning curve would call for, by up to 40% in the highest-volume, low-power

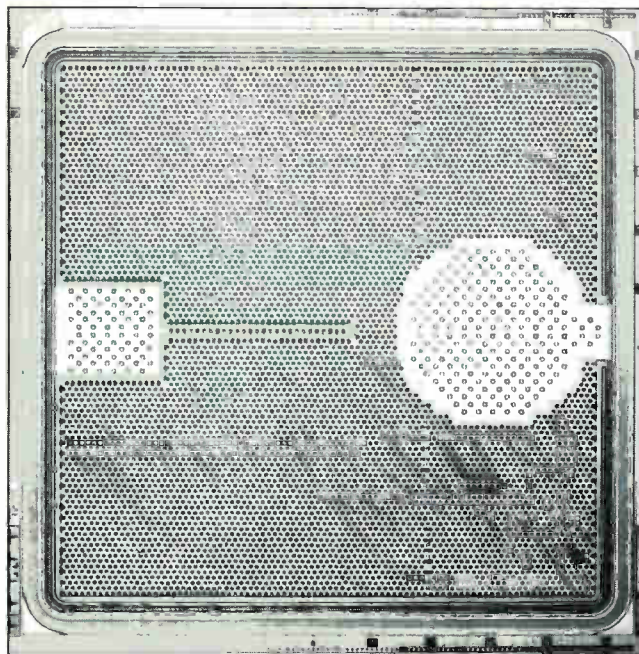

DENSE. Motorola's TMOS IV chip houses more than 1 million cells/in.² and is designed to withstand high energy in the avalanche mode.

lines. Nevertheless, some analysts believe the strong Motorola move, long expected by competitors who fear the firm's manufacturing and financial muscle, comes several years late. They say it was delayed by conflicting priorities with the company's profitable bipolar transistor business, which amounts to more than \$300 million yearly.

■ **Siliconix Inc.** The company is building its MOSpower line in the industry's only facility that employs 6-in. wafers and does fabrication in Class 1 clean rooms. Siliconix executives say the plant, costing more than \$30 million, gives the company the highest device yields in the business—some 11 times better than the common 4-in.-wafer-based production—meaning Siliconix is as well-armed as anyone to handle cost-cutting strategies. The only caveat from market watchers is whether it will stay the course in a commodity business, as its usual strategy is to target profitable niches. David Cooper, director of MOSpower for the Sunnyvale, Calif. company, says Siliconix is committed "to be one of the top two or three in MOS FETs."

■ **Hitachi Ltd.** The Japanese chipmaker ships only a moderate volume of power MOS FETs to the U.S., where they are used largely in personal computers and minicomputers for switching power supplies where frequencies exceed 100 KHz. Hitachi's S Series, employed instead of bipolar versions in audio amplifiers, fills a need that U.S. firms cannot meet, the company says. These devices provide 10 W to 125 W output at audio frequencies and 120 W at 100 MHz. Hitachi says it still plans to address mainly its home market, which has needs somewhat different from those in the U.S.

■ **Toshiba Corp.** The company is building a presence in the U.S. market with devices in the upper MOS FET power ranges—25 A, 500 V—and higher. It is avoiding the product areas of 150 V and lower, where competition has been most heated, says David Lanthier, product market manager at Toshiba's Electronic Component Business Sector in Tustin, Calif. The company has a substantial automotive effort in Japan and is planning to pursue this segment in the U.S., too. In the overall MOS FET picture, however, Toshiba would hold back its plans if price-cutting goes too far, he says.

■ **Siemens AG.** The Munich, West Germany, company earlier this year sold its Broomfield, Colo., plant, so it does not produce its SipMOS devices in the U.S. But it has plans to start building them again early next year in Santa Clara, Calif., where a new

IN SMART POWER, U.S. FIRMS LEAD	
International Rectifier	50*
Motorola	35
Siliconix	30
Hitachi	24
Toshiba	21
Siemens	20
GE/RCA	18
Other	12
Total	210
*Worldwide sales, millions of dollars SOURCE: ELECTRONICS	

power semiconductor division is now being set up. Responding to industry speculation that drastic price decreases earlier this year spurred Siemens to drop U.S. production, George Fodor, marketing director at the firm's U.S. division, says that Siemens, the European leader—with some 30% of the business—will continue to serve the U.S. market.

■ **RCA/GE.** The major question at the RCA Solid State Division in Somerville, N.J., a pioneer in power devices, concerns who will own the operation. Parent General Electric Co. is reported to be shopping around its entire merchant semiconductor operation, although there has been no official confirmation. One report names Siemens as a potential buyer, along with several Japanese companies. However, RCA, showing no apparent effects of the uncertainty, continues to hustle for business: it has brought out its MegaFET high-density device, which has 2 million cells per square inch. It also has won a \$1 million development contract for radiation-hardened MOS FETs from the government.

If the marketing battle is hard on participants, it will certainly make things easier for customers, who can expect lower prices and better service. This has not been the case all along, because power MOS FETs have been used principally by the military in switching power supplies, where higher switching frequencies pay off with better overall efficiencies and cheaper transformer costs.

With such limited market potential, prices stayed up.

Now, as prices continue to decline, the devices look like the power answer for new designs of industrial controls, power conversion, and perhaps ultimately the biggest market of all, variable speed control of electric motors. Modules designed for that task are moving toward the market from most companies and should surface next year. Siliconix, for example, has a module for variable control of air conditioners that uses six MOS FETs, and IR's Sixpak module powers Winchester disk drives.

Marketing executives aren't just looking at 1987 for solid growth. In fact, they are counting the days until 1988, when they expect to see the advent of a market many feel will be the best yet for MOS FETs. Says Siliconix's Cooper, "Automotive—that's the next real acceleration for MOS FETs."

Because automakers are even more secretive than military contractors, the MOS FET firms cannot discuss specific plans, but all of them have development links with the car companies. The potential is there for the power devices to replace the numerous relays on today's autos, and for switching via common buses that will replace miles of wiring in new models. Other potential applications are for motor control in "smart power" packages, which combine logic and MOS FETs, and for solenoid drivers.

While the next year should be an exciting time for MOS FET suppliers, the extreme pricing pressures likely to prevail will leave no room for inefficient producers. There could be a shakeout, and those close to the industry say that it would be no surprise in a high-stakes market segment such as MOS FETs to see an eventual lineup of no more than three major contenders. One would be Motorola, leaving IR and the others to fight it out for the remaining slots. As Ron Bohm, industry analyst at market-watcher Dataquest Inc., diplomatically says, "there will be a smaller supplier base after a year or so." □

IS THIS THE LAST ROUND OF MOS FET DENSITY DERBY?

MOS FET suppliers have traditionally showcased their technology by pushing densities ever higher, shoehorning more power cells onto the die. Not only does higher density help reduce the key on-resistance specification—which cuts power dissipation—but it also spotlights manufacturing skills.

The latest round of MOS FETs is an example. All of them have substantially more cells than the previous indus-

try standard of 1 million/in.². RCA Corp.'s MegaFET even boasts double that, with on-resistance lowered to 1.5 mΩ/square.

But this is the last round of the MOS FET density derby, predict technologists at International Rectifier Corp. and Motorola Inc. The cost of building chips denser than 2 million cells/in.² is not worth the benefits.

Instead, IR and others are recommending that custom-

ers choose a specific device for applications based on the optimum cell density in relation to desired voltage. Since this measurement is heavily cost-weighted, the standard is likely to become one that some buyers already employ: pennies per ampere at a given breakdown voltage. Now, the lower industry pricing level is 2c to 3c per ampere; IR says it expects to push this toward 1c at its new plant. —Larry Waller

Potter & Brumfield solves your design puzzle with the industry's lowest priced DIP SSRs and I/O modules.

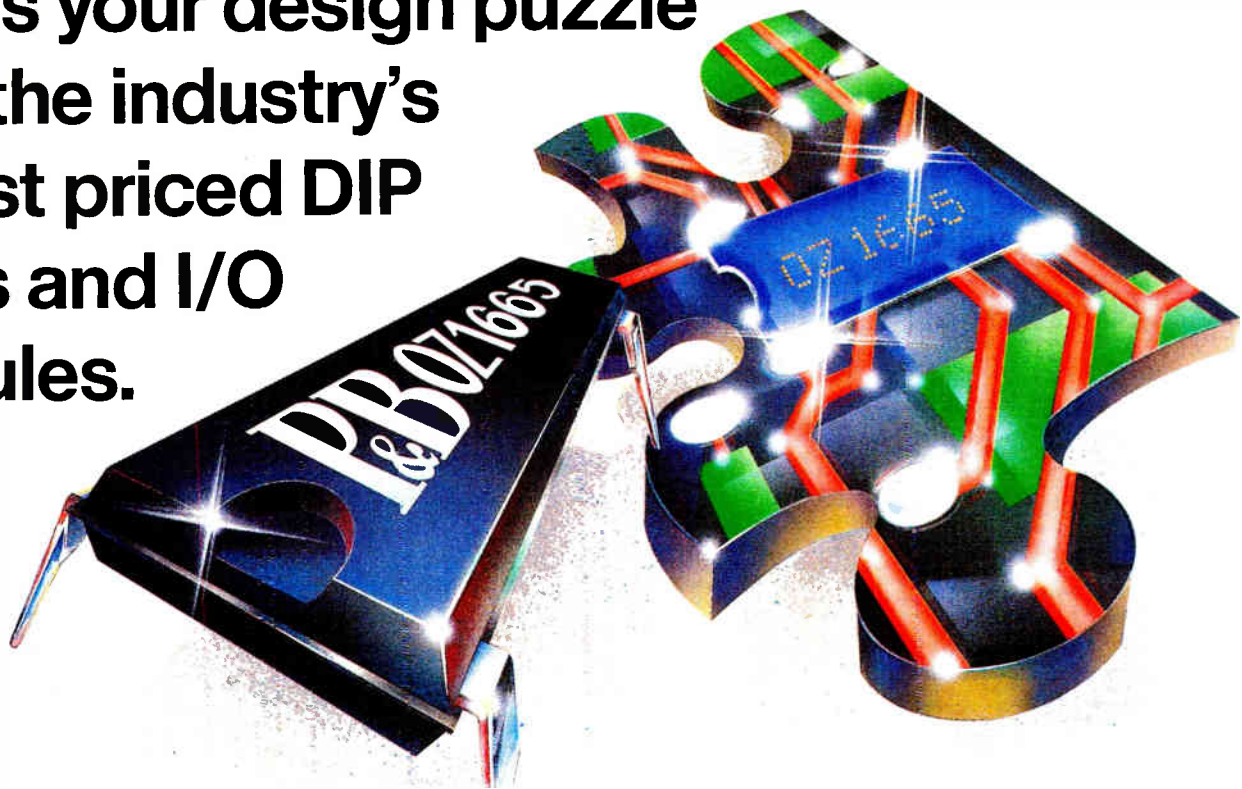

42 New DIP Models

Now P&B quality and the lowest prices in the industry join to provide the perfect solution to your design puzzle. Our 42 new solid state relays and I/O modules are the ideal interface between your microprocessors or control systems and real-world sensors and loads. These hybrid thick film devices are optically isolated from input to output and are available in standard and surface-mountable DIP packages. All models meet applicable UL, CSA, & VDE requirements.

Solid State Relays

The new OZ16 SSR series brings P&B quality to your 5mA to 1A rms switching chores. Input to the OZ16 can be either TTL-compatible 5V DC or DC current. Output circuitry features a zero voltage detector and inverse parallel SCRs. And output rating is 12 to 280V AC.

I/O Modules

Four different product lines allow you to meet a variety of your I/O needs. Input modules provide an active low output; output modules can be controlled from active low or active high logic. AC output modules use zero crossover switching to virtually eliminate transients and generated



EMI noise. And the IA8 series, which occupies just half the space of 16-pin models, can act as an AC/DC input module or a DC output module.

Find Out More

Complete your design puzzle with P&B quality—and the lowest price in the industry. To find out more about P&B relays and I/O modules, or for a copy of our new 1986/1987 General Stock Catalog, contact us today. Call toll-free 1-800-255-2550 for the name of your nearest P&B distributor or sales representative. Potter & Brumfield, A Siemens Company, 200 South Richland Creek Drive, Princeton, Indiana 47671-0001.

Regional Sales: Braintree, MA, (617) 848-6550; San Juan Capistrano, CA, (714) 493-4503; Princeton, IN, (812) 386-2130.

Potter & Brumfield A Siemens Company

Circle 99 on reader service card

Please send more information about P&B SSRs & I/Os.
 Please send 1986/87 General Stock Catalog.

Name _____ Title _____
 Firm _____
 Address _____
 City _____ State _____ Zip _____
 Phone _____

Potter & Brumfield Inc.,
 200 S. Richland Creek Dr., Princeton,
 IN 47671-0001

ONLY HITACHI

And only Hitachi CRT Readout Scopes offer:

- ScreenWriter™**
- CursorMeasurement™**
- GroundReference™ display**
- EventCounter™**

Exclusive ScreenWriter lets you write two 30-character lines of your own notes on the screen. Exclusive EventCounter digitally displays number of pulses within delay time or delayed sweep time. Built-in DVM and 5-digit, 0.1Hz resolution frequency counter display AC and DC voltage and frequency. Exclusive CursorMeasurement, with GroundReference level, displays values of all other important parameters. One Polaroid* photo gives you a complete record of the measurement — including your comments. Three-year warranty.

Hitachi offers 150MHz, 100MHz, and 60MHz Microprocessor based CRT Readout Scopes. Find out how much more scope you get for your money from Hitachi. Call 516-921-7200.

Or write Hitachi Denshi America, Ltd., 175 Crossways Park West, Woodbury, NY 11797.

In Canada: Hitachi Denshi, Ltd.,
65 Melford Drive, Scarborough,
Ontario M1B2G6. Tel. 416-299-5900.



Circle 100 on reader service card

Model
V1150:
150MHz
4 channels
8 traces
delayed sweep.
Mfrs. suggested
list price: \$2950

Convenient front panel key pad allows you to input Hitachi ScreenWriter characters, and set trigger conditions.

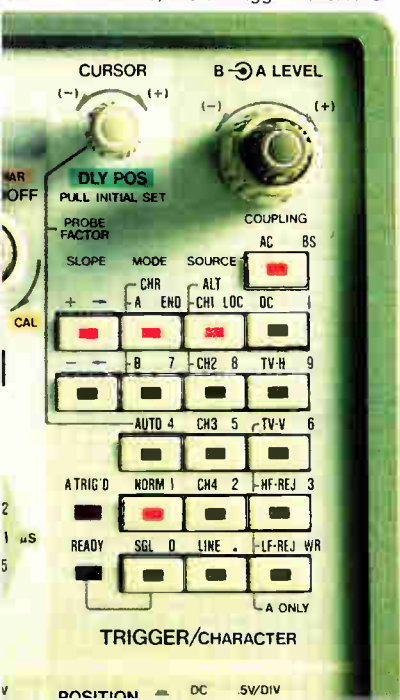

*Polaroid is a trademark of Polaroid Corporation

THE DOOR IS OPENING FOR CHIP-ON-BOARD ASSEMBLY

LOW COST AND HIGH DENSITY MAKE IT IDEAL FOR SMART CARDS

by Jerry Lyman

NEW YORK

Chip-on-board assembly—still a niche market in the U.S., but one with tremendous potential—is finally solving the various technical problems that have held it down. COB is now catching on in a growing variety of applications because it can provide high density and good performance at a low cost. And what could give the assembly technique a boost into the big time is the smart card, with its embedded chips, which may be on the verge of becoming a major mass market (see p. 55).

Because it is just about the ideal application, the smart card could propel COB into the heady position as one of the leading assembly techniques for U.S. manufacturers. COB, basically a method of wire-bonding integrated-circuit chips directly to printed-circuit boards, has only one real competitor in smart cards, a closely related technique called bare tape-automated bonding, or TAB. Both enable card designers to squeeze smart-card circuitry and components inside a 40-mil-thick package, but COB backers maintain that their technique has the advantage of greater design flexibility.

COB is already making inroads into solid-state memory packaging, telecommunications designs such as mobile cellular phones and pocket pagers, floppy-disk and Winchester-disk drives, and circuitry for miniaturized sensors. And it is being used increasingly in the production of both pin-grid arrays and leadless chip carriers that are based on small printed-circuit-board substrates with single chips wire-bonded on.

COB is able to do this because it is an inexpensive way to get all the advantages of a thick-film hybrid—such as dense component packaging and high performance [*Electronics*, May 26, 1986, p. 33]—by cutting out one of the hybrid's most costly components, its ceramic substrate. COB substitutes a pc board for a substrate, which can cost 40 times as much as the board. The tiny chip itself replaces packaged chips. Using the bare chip saves not only the cost of the package but 80% to 90% of the space the same chip in a packaged version would occupy.

If COB is so good, why hasn't it caught on yet in the world's biggest electronics market? It did enjoy a brief boom when it was used in simple plug-in read-only-memory modules for video games and low-end personal computers, but it sank along with those markets. Yet it has caught on overseas. COB is now used extensively in Japan and Europe in consumer electronics—watches, cameras, calculators, audio and TV sets. But U.S. engineers have generally shunned COB, not only because they have been worried about the technical problems but also because of sheer inertia.

SOLDER IS KING. This inertia can be traced to the fact that the U.S. pc-board industry is based on soldered connections, and it is not about to switch overnight to wire bonding. For the same kind of reason, the switch to surface mounting and tape-automated bonding has been agonizingly slow in the U.S., even though both technologies flourish in Japan.

The technological barriers that have tended to stymie COB in the U.S. are getting rid of heat, providing sufficient

protection to the chip, and getting good chip yields. Most American packaging engineers have centered their reservations on the heat-dissipating potential of the bare chips on a COB board, not to mention how well they are protected from the environment. Normally, these problems are taken care of to a certain extent in the package, whether it's a dual in-line, single in-line, chip carrier, or any other.

However, Alan Bertaux, president of Valtronic Inc. in Columbia, Md., one of the few U.S. companies exclusively devoted to COB, notes that his engineers have come up with epoxy-glass COB boards capable of dissipating 5 W. Packaged chips, depending on the package, can dissipate 0.25 to 1 W; bare chips with no special packaging can dissipate only 0.1 to 0.25 W.

Bertaux says that increased COB heat dissipation can be accomplished through the use of thicker copper cladding and wider pc conductors, metallizing the underside of a board, and even sandwiching an aluminum sheet between two thin glass-epoxy substrates. In that case, the overall package is no thicker

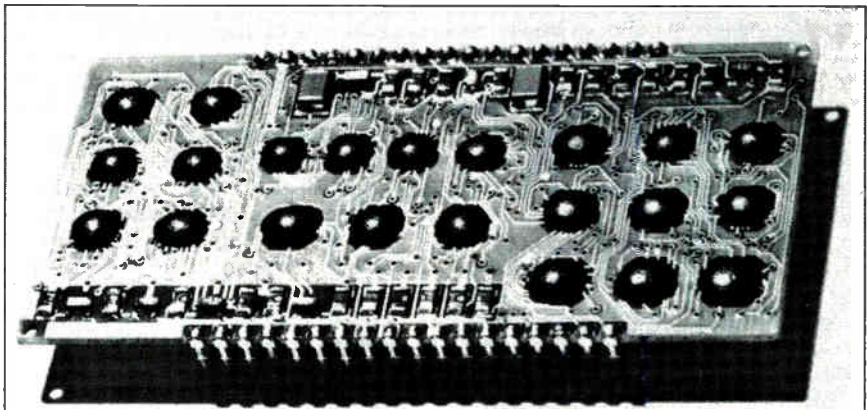
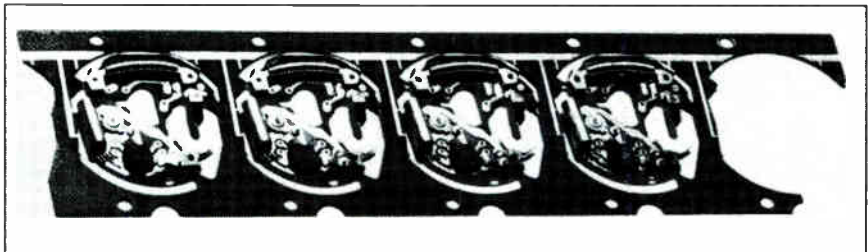

ALL ABOARD. Original chip-on-board—wire-bonding bare chips to pc boards—was used for wristwatches, top. More modern version has many more chips on a small board, bottom.

than a normal double-sided board, yet it provides excellent heat-transfer characteristics.

The environmental-protection issue is somewhat more complicated. One method that can be used to protect chips in the COB technique is to encapsulate them with a glob of epoxy or silicone. This method, also used in TAB, still has to prove itself as humidity-resistant and able to handle the possible mechanical stresses on the chip due to thermal expansions.

Valtronic is currently running tests based on MIL-STD-883, method 202, on encapsulated chips and says it will have results soon. In addition, the work being done by an Institute of Electrical and Electronics Engineers task force, which is seeking a silicone gel to protect chips in premolded plastic chip carriers, will also yield useful data on protecting bare chips bonded to pc boards. At the same time, within the IC industry itself there are many efforts under way to come up with even better passivation coatings for the surface of the chip than are currently in use, and this may be the eventual solution to a truly waterproof chip. **SOME OVERKILL.** Such work could be overkill. True hermeticity even with non-COB techniques is possible only in expensive ceramic packages that are aimed at military applications. In most applications the chip actually needs only

surface-mounted board when no packaged device was available, but he notes a potential deficiency in high-chip-count COB. Marcoux points out that the yield of complete COB assemblies suffers from the same dependency on individual chip yield as in the other bare-chip technology—thick-film hybrids.

It is an established fact that on a hybrid, as the number of chips goes up, overall circuit yield goes down, unless the individual chip yield is kept high. For instance, a chip yield of 0.8 in a 4-

For smart cards, tape-automated bonding will rival COB

chip hybrid theoretically results in a hybrid yield of 0.4, although a chip yield of 0.95 will result in a hybrid yield of 0.8.

However, Valtronic's Bertaux notes that most COB circuits use only one to five chips, which doesn't require an excessively high chip yield for acceptable circuit yield. In addition, he says, most COB companies are paying for chip inspection at the chip vendor. Valtronic itself doesn't shun multichip boards. It has made many and, in fact, recently landed a production order for a nine-chip COB array that is to be used in a cellular phone.

dent of card maker Drexler Technology Inc., is particularly optimistic; he predicts that 160 million cards a year will be sold by 1991.

At least one U.S. company, MicroCard Technology Inc. of Dallas, is already using COB on a pilot line for smart cards being used in a MasterCard test. The card's circuitry consists of a single custom chip—a microprocessor with electrically erasable programmable read-only memory—wire-bonded to a thin epoxy-glass substrate that is sealed within the card.

Byron Claghorn, vice president of engineering of MicroCard, says, "Smart cards have the potential to be one of the largest semiconductor applications in the world. Most adults in the United States already have two to three cards, and these surely will be converted to smart cards eventually."

To win a major share of the smart-card market, though, COB must beat out the competition coming from the backers of TAB. Smart Card Systems Inc. of Cherry Hill, N.J., for one, is already making a two-chip smart card based on multilayer TAB. It may not be simply coincidence that Smart Card Systems is a subsidiary of IMI Inc. of Cherry Hill, N.J., a producer of TAB tapes and assembly equipment.

TAB-bonded chips are excised from their tape and bonded or soldered to a pc board. The technique is used in Japan for consumer applications, and in both Japan and Europe by computer makers for large multilayer ceramic-circuit-board hybrids. In the U.S., TAB is still used mainly as an assembly method for bonding LSI and VLSI chips into packages or leadframes.

SUPPORTERS. Both COB and TAB have their advocates. Courtney Miller, packaging strategy manager at Texas Instruments Inc.'s Semiconductor Group in Dallas, says that chips on tape are both testable and also can be burned-in on the tape. This ensures that only those chips known to be good are being put down on a substrate. Although the chips put down for COB may be tested at a probe station at extra cost, he says, they cannot be burned-in at either the chip or wafer level. In addition, says Miller, the "bumping" or buildup of the extra metallization of the I/O pads of a chip serves to increase its resistance to humidity.

However, MicroCard's Claghorn says his company considered using TAB for its cards housing 8-lead chips, but decided that the technique was more suitable for a high-count pinout application. COB turned out to be more cost-effective. COB is also simpler: TAB requires special bumped chips, special bonding equipment, and a new tape pattern for each new card design. □

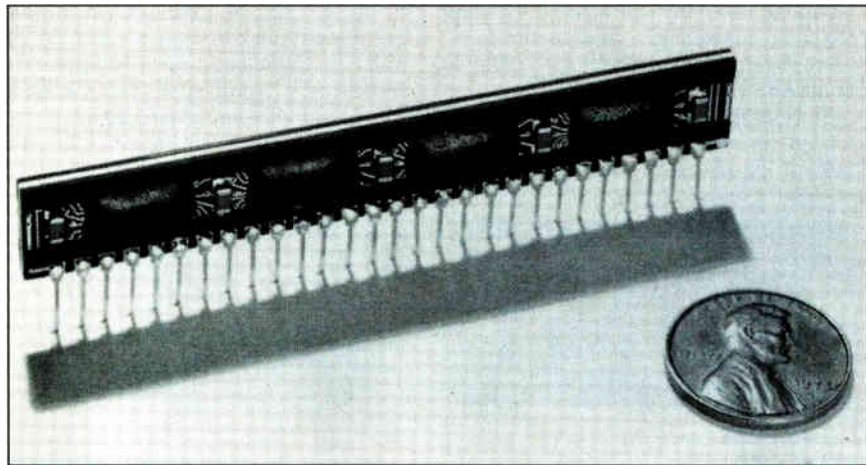

COB SANDWICH. Substrates sandwich aluminum strip for better heat transfer.

to be mechanically protected. For example, one of Valtronic's customers requested a module, for a pocket-pager, with fully conformal coating. A year later, the customer realized that this protection was really not needed and eliminated the requirement.

Finally, low chip yields worry some board assemblers. One of the acknowledged experts in surface-mounting technology, Phil Marcoux, manager of advanced technology of SCI Inc. of Santa Clara, Calif., says that his company, formerly known as AWI Inc., has occasionally mixed COB with a predominantly

Still, the flurry of COB activity so far accounts for only a small part of the total number of pc-board assembly techniques used in the U.S. COB still takes a back seat to surface mounting of small discrete components, or, in the great majority of cases, the tried-and-proven standard through-the-board technique.

So more than anything else, COB needs the smart card to hit the big time, and for that to happen, smart cards themselves have to do as well as many industry observers are expecting. Jerome Drexler, for example, the presi-



OP-400 BEATS 4 OF A KIND

Together At Last . . .

Four improved OP-07s in a monolithic quad — PMI's OP-400! High precision at one-quarter the power of four OP-07s, the OP-400 is the most accurate quad op amp you can get.

PMI's new quad op amp delivers outstanding gain linearity, with low offset voltage and drift — crammed into the standard quad pinout.

The OP-400 wins hands down!



	Single OP-07E	Quad OP-400E	
I_{SY}	4.0	0.725	mA Max (per amp)
A_{VO}	200	5000	V/mV Min
TCV_{OS}	1.3	1.2	$\mu V/^{\circ}C$ Max
CMRR	5	1	$\mu V/V$ Max
e_n	10.3	11.0	nV/ \sqrt{Hz} (10Hz)

For more information on PMI's new quad OP-400, please circle the inquiry number. Or, call us. 1-800-843-1515. In California, call 1-800-826-9664.

Precision Monolithics Inc.
A Bourns Company
Santa Clara, California, USA
408-727-9222

ANAHEIM: (714) 666-0140, LOS ANGELES: (818) 886-6881, SANTA CLARA: (408) 727-6616,
DALLAS: (214) 341-1742, CHICAGO: (312) 885-8440, ATLANTA: (404) 263-7995,
PHILADELPHIA: (215) 675-7600, BOSTON: (617) 794-0026



The precision solution.
Circle 103 on reader service card

TOSHIBA. NOW, 1 MB DRAMS



AREA SALES OFFICES: CENTRAL AREA, Toshiba America, Inc., (312) 945-1500; EASTERN AREA, Toshiba America, Inc., (617) 272-4352; NORTHWESTERN AREA, Toshiba America, Inc., (408) 244-4070; SOUTHWESTERN REGION, Toshiba America, Inc., (714) 752-9373; SOUTH CENTRAL REGION, Toshiba America, Inc., (214) 480-0470; SOUTHEASTERN REGION, Toshiba America, Inc., (404) 493-4401; MAJOR ACCOUNT OFFICE, Poughkeepsie, NEW YORK, Toshiba America, Inc., (914) 462-5710; MAJOR ACCOUNT OFFICE, BOCA RATON, FLORIDA, Toshiba America, Inc., (305) 394-3004; REPRESENTATIVE OFFICES: ALABAMA, Montgomery Marketing, Inc., (205) 830-0498; ARIZONA, Summit Sales, (602) 998-4850; ARKANSAS, Technology Sales Company, (512) 346-9940; CALIFORNIA (Northern) Elrepro, Inc., (415) 962-0660; CALIFORNIA (L.A. & Orange County) Bager Electronics, Inc., (818) 712-0011; (714) 957-3367; (San Diego County) Eagle Technical Sales (619) 743-6550; COLORADO, Straube Associates Mountain States, Inc., (303) 426-0890; CONNECTICUT, Datcom, Inc., (203) 288-7005; DELAWARE, Nexus Technology (914) 769-0382; FLORIDA, Sales Engineering Concepts, Inc., (305) 781-4800; GEORGIA, Montgomery Marketing, Inc., (404) 447-6124; IDAHO, Components West, (509) 255-6224; ILLINOIS, Carlson Electronic Sales, (312) 956-8240; R. E. P. S., (217) 438-6435; INDIANA, Leslie M. DeVoe Company, (317) 842-3245; IOWA, C. H. Horn, (319) 393-8703; KANSAS, D. L. E. Electronics, (316) 744-1229; KENTUCKY, Leslie M. DeVoe Company, (317) 842-3245; LOUISIANA, Technology Sales Company, (512) 346-9940; MAINE, Datcom, Inc., (617) 891-4600; MASSACHUSETTS, Datcom, Inc., (617) 891-4600; MICHIGAN, Action Components Sales, Inc., (313) 349-3940; MINNESOTA, Electric Component

FIRST AGAIN. AND 256 K CRAMS.

Toshiba technology leads the way again with the development of Ultra Large Scale memory devices that feature high speed access times.

1 MB CMOS DRAMS

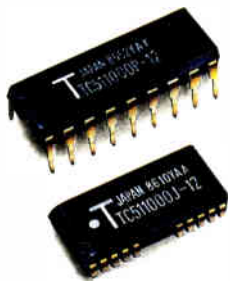

TOSHIBA is delivering now . . . all the 1Mb product you can use. In three different access modes. With speeds of 85, 100 and 120 ns. You have a choice of fast page mode,

static column or nibble mode. And you can get production quantities now.

TOSHIBA 1 Mb DRAMs

Part Number	Organization	Process	Speed	Mode	Package
TC511000 - 85	1 Mb x 1	CMOS	85 ns	Fast Page	18 pin
TC511000 - 10	1 Mb x 1	CMOS	100 ns	Fast Page	18 pin
TC511000 - 12	1 Mb x 1	CMOS	120 ns	Fast Page	18 pin
TC511001 - 10	1 Mb x 1	CMOS	100 ns	Nibble	18 pin
TC511001 - 12	1 Mb x 1	CMOS	120 ns	Nibble	18 pin
TC511002 - 10	1 Mb x 1	CMOS	100 ns	Static Column	18 pin
TC511002 - 12	1 Mb x 1	CMOS	120 ns	Static Column	18 pin
TC514256 - 10	256K x 4	CMOS	100 ns	Fast Page	20 pin
TC514256 - 12	256K x 4	CMOS	120 ns	Fast Page	20 pin
TC514258 - 10	256K x 4	CMOS	100 ns	Static Column	20 pin
TC514258 - 12	256K x 4	CMOS	120 ns	Static Column	20 pin

256K CMOS STATIC RAM



Toshiba's product development leadership continues. We were first with 16K CMOS RAMs.

First with 64K CMOS RAMs. And now first again—with 256K CMOS static RAMs. This 32K x 8 device features the lowest power consumption available today—only 5mA/MHz. Lower than any competitive product. And we offer speeds to 100 ns.

TOSHIBA 256K CRAMS

Part Number	Organization	Process	Speed	Standby Power	Package
TC55257A - 10	32K x 8	CMOS	100 ns	1mA MAX	28 pin
TC55257A - 12	32K x 8	CMOS	120 ns	1mA MAX	28 pin
TC55257AL - 10	32K x 8	CMOS	100 ns	100%A MAX	28 pin
TC55257AL - 12	32K x 8	CMOS	120 ns	100%A MAX	28 pin

(Now available in Plastic Flat Pack.)

ULTRA LEADERSHIP

Again Toshiba leads the way. With high speed access times. Now with Ultra Large Scale products. With ultra high quality. With ultra fast deliveries. Toshiba. The power in memories.

TOSHIBA. THE POWER IN MEMORIES.

TOSHIBA AMERICA, INC.

© 1986 Toshiba America, Inc.

Sales, (612) 933-2594; MISSISSIPPI, Montgomery Marketing, Inc., (205) 830-0498; MISSOURI, D.L.E. Electronics, (316) 744-1229, R.E.P.S., (618) 345-1808; MONTANA, Components West, (206) 885-5880; NEBRASKA, R.E.P.S., (913) 383-6228; NEVADA, Eirepro, Inc., (415) 962-0660; NEW ENGLAND, Datcom, Inc., (617) 891-4600; NEW HAMPSHIRE, Datcom, Inc., (617) 891-4600; NEW JERSEY, Nexus Technology, (914) 769-0382; NEW MEXICO, Summit Sales, (602) 998-4850; NEW YORK, Nexus Technology, (914) 769-0382; NEW YORK (Upstate) PI-tronics, (515) 455-7346; NORTH CAROLINA/SOUTH CAROLINA, Montgomery Marketing, Inc., (919) 467-6319; NORTH/SOUTH DAKOTA, Electric Component Sales, (612) 933-2594; OHIO, Steffen & Associates, (216) 467-8333, (419) 884-2313, (513) 293-3145; OKLAHOMA, Technology Sales Company, (512) 346-9940; OREGON, Components West, (503) 684-1671; PENNSYLVANIA, Steffen & Associates, (412) 276-7366, Nexus Technology, (914) 769-0382; RHODE ISLAND, Datcom, Inc., (617) 891-4600; TENNESSEE, Montgomery Marketing, Inc., (919) 467-6319; TEXAS, Technology Sales Company, (512) 346-9940, (713) 266-2473, (214) 437-5881; UTAH, Straube Associates Mountain States, Inc., (801) 263-2640; VERMONT, Datcom, Inc., (617) 891-4600; WASHINGTON, Components West, (206) 885-5880, (509) 255-6224; WEST VIRGINIA, Steffen & Associates, (419) 884-2313; WISCONSIN, Carlson Electronics, (414) 476-2790, Electric Component Sales (612) 933-2594; WYOMING, Straube Associates Mountain States, Inc., (303) 426-0890; CANADA, BRITISH COLUMBIA, Components West, (206) 885-5880; ONTARIO, Electro Source Inc., (416) 675-4490

Circle 105 on reader service card

HOW TO CONTROL PCB QUALITY ACROSS THE BOARD.

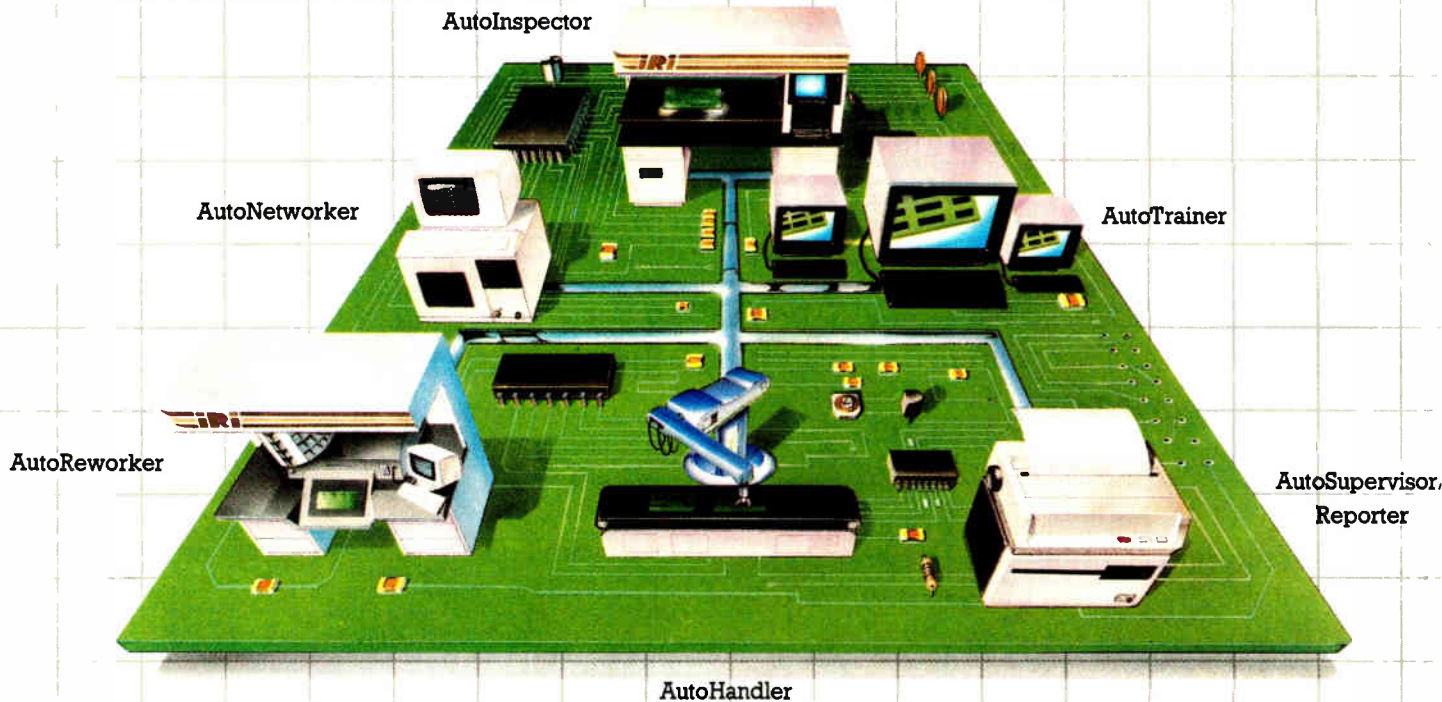

NOW THE IRI VISION INSPECTOR WORKCELL CAN OVERSEE THE ASSEMBLY QUALITY OF ALL YOUR ELECTRONIC COMPONENTS.

Now, with one automated vision product family, you can inspect SMDs, thru-hole components, solder paste, pre- and post-solder and bare boards and back plane and connector pins. Automatically.

The IRI Vision Inspector Workcell Series is a modular product system that can be configured to your manufacturing and assembly applications to perform inspection, rework, training, handling, supervision and reporting tasks across your inspection workcell.

The IRI AutoInspector. This multi-task, top and bottom board inspector performs high-throughput inspection of today's advanced SMDs, PLCCs, SOICs, and other SMT components with unprecedented speed and accuracy.

The IRI AutoReworker. When component placement errors are detected, this module provides a work repair station for expedited rework with board identification, laser guidance for location of the defective area, automatic parts presentation and vision verification.

The IRI AutoTrainer. Using color graphics, pull down menus and mouse-type controls, this user-friendly trainer reduces PCB inspection training to simple data base manipulations and down loading of CAD data bases.

The IRI AutoHandler. This module automates the handling of materials between stations, provides loading, unloading, robot transport and position registration for inspector workcell stations.

The IRI AutoSupervisor/Reporter. To keep management informed, a UNIX-based relational data base manager generates reports including part/board error analysis, product tracking, report generation, job/order status and part purging.

The IRI AutoNetworker. This network connection system provides network communications within the inspector workcell. External communication interface is provided to LAN, e.g. MAP, and X.25 networks in the factory.

For more information, call: Richard Carroll, V.P. Sales (619) 438-4424. International Robomation/Intelligence, 2281 Las Palmas Drive, Carlsbad, CA 92008



THE BEST VISION INDUSTRY HAS EVER SEEN.

Circle 106 on reader service card

World Radio History

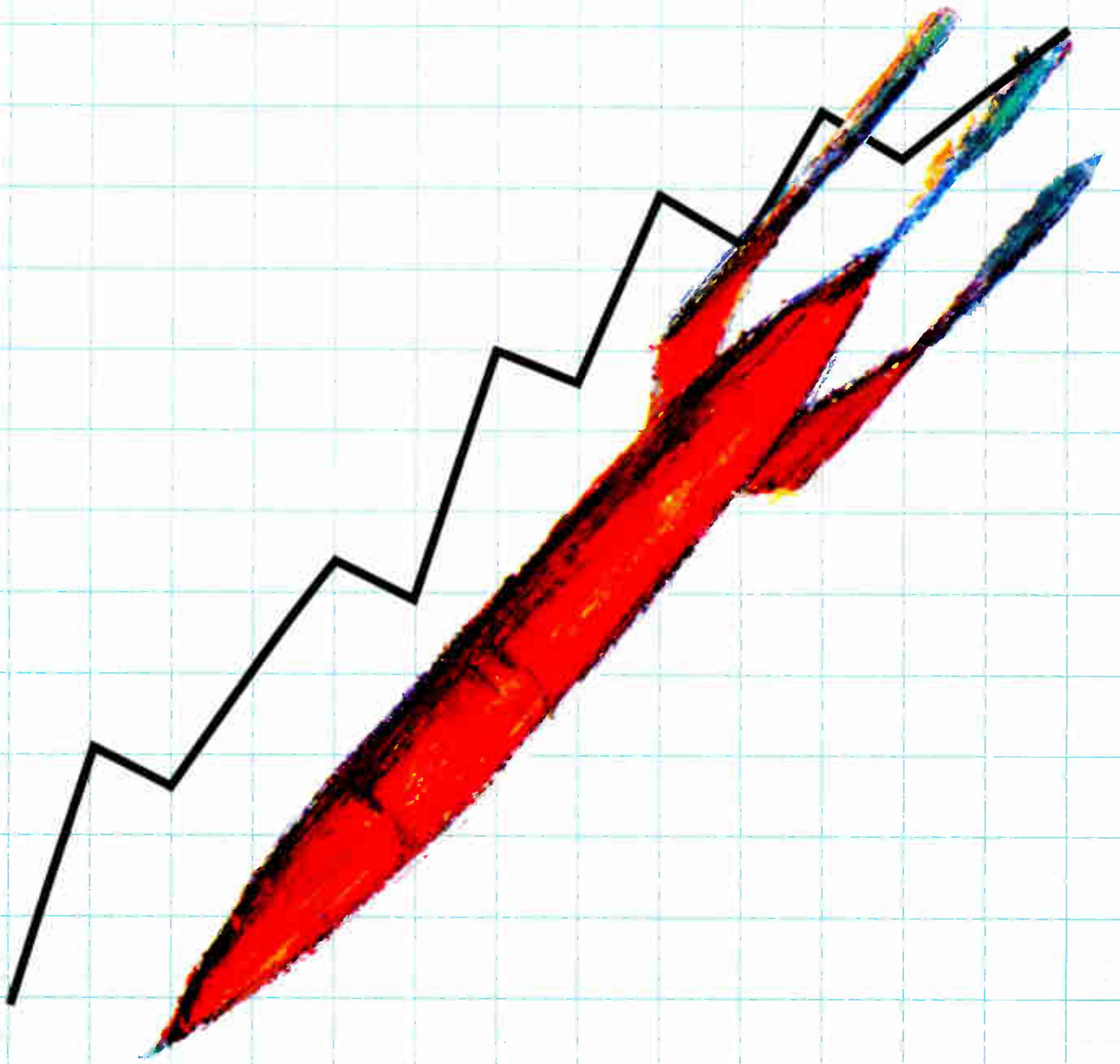

MILITARY ELECTRONICS OUTLOOK

SPECIAL ADVERTISING SECTION

Electronics
World Radio History

MIL-SPEC



Solder tails, wrap-type post and card extender versions.

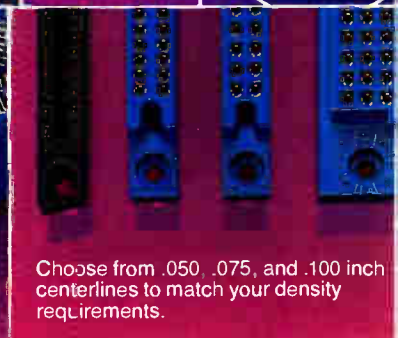

Choose from .050, .075, and .100 inch centerlines to match your density requirements.

MIL-C 55302.
We give you more
in a box.
No lid on our help,
either.

You want a MIL-C-55302 connector with a greater than run-of-the-mill pin count. A connector with options—in basic configuration, in packaging density. You want a box that won't box you in.

Get AMP on the line. We have the box that does it all. The AMP Box Contact two-piece connector. Encompassing 18 MIL-C-55302 slash sheet numbers, plus a wide range of commercial versions, our box connector mates up to 300 positions, with minimum insertion force.

Critical pin/receptacle alignment and four-point contact redundancy are assured, too, with our forgiving four-beam receptacle design. You can even terminate a number of different conductors into this box.

And with all of this you also get the help you need—from technical input and engineering assistance to prototype and production delivery. And whether you order one or one million connectors, you get the uniform quality you have a right to expect. Now give us the right to prove it.

For more information, call the AMP MIL-C-55302 Desk at (717) 780-4400. AMP Incorporated, Harrisburg, PA 17105.

MILITARY ELECTRONICS OUTLOOK

SPECIAL ADVERTISING SECTION

Defense-electronics spending to stay on flat trajectory for next few years

Defense-electronics companies may have a tough time finding new business during the next several years. The outlook for the industry is essentially flat until at least 1995, according to a forecast in this year's annual update from the Electronic Industries Association's Government Division. The only suppliers that can expect to continue to do well are those currently involved in major defense programs and smaller firms seeking

second-source contracts. To most industry watchers, many of whom expected the defense buildup of the early 1980s to start slowing, the EIA's projection is no surprise. It already has garnered a lot of support. For example, a study by the International Institute of Strategic Studies, which reports annually on world military trends, states, "The Reagan Administration's defense buildup is over." And a recent forecast

of the industry's near-term prospects from Henderson Ventures, the Los Altos, Calif., market researcher, says that budget-balancing legislation inspired by Gramm-Rudman will be instrumental in forcing a sharp decrease in military-electronics spending next year. According to the EIA, the Department of Defense's fiscal 1986 budget will contain \$55.6 billion for procurement, research and development, and

DEFENSE ELECTRONICS: MODEST INCREASES OVERALL

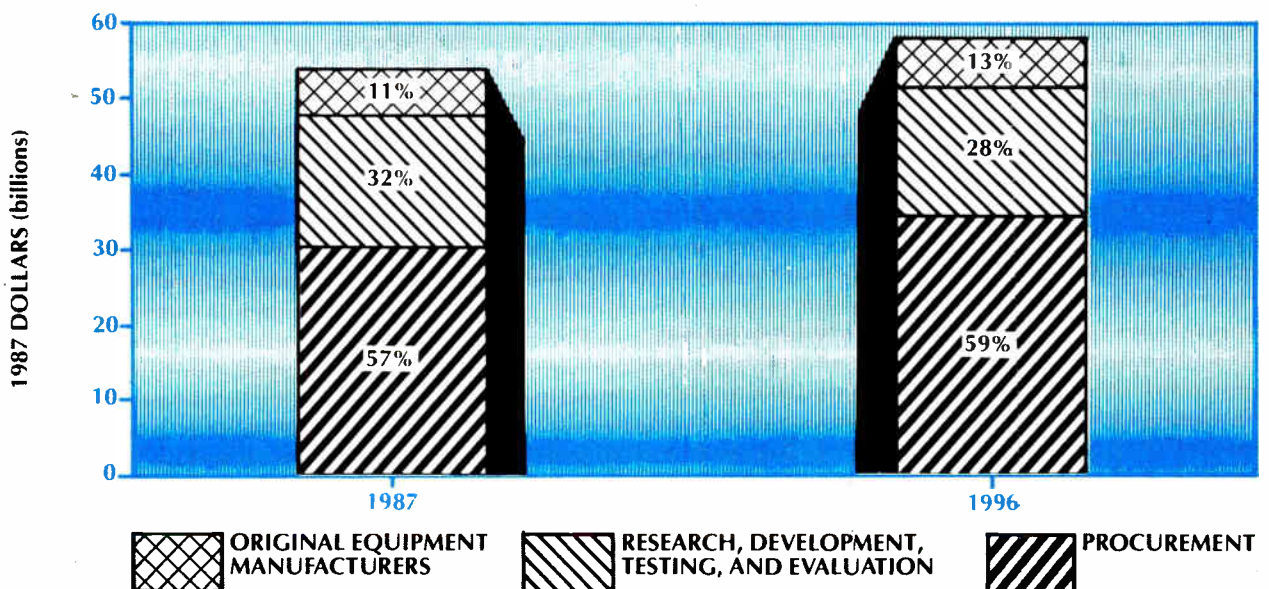

Source: Electronic Industries Association

MILITARY ELECTRONICS OUTLOOK

SPECIAL ADVERTISING SECTION

maintenance of electronics. That's barely more than the \$55.5 billion allotted in 1985. It then will drop to a low of \$52.6 billion in 1989 before rebounding, reaching \$58 billion in 1996.

Meanwhile, the total defense budget authority, which represents the enabling legislation that authorizes the DOD to spend money, will drop steadily—by 2.8% in 1987 and 0.5% in 1990. Electronic content should drop 3.7% in 1987, 0.9% the following year, and 1.1% in 1989, but it should gain a modest 0.1% in 1990.

The breakdown for defense electronics in fiscal 1987 goes like this, says the EIA: \$33.3 billion for procurement, \$16.1 billion for R&D, and \$6.1 billion for operations and maintenance, for a total of \$55.5 billion. Up to and including fiscal 1996, the EIA says that spending on R&D and operations and maintenance will remain fairly constant. Procurement, however, will be unsteady, dropping to \$30.2 billion in

fiscal year 1987 and to \$29.6 billion in 1989 when it begins to rebound, climbing to \$34.3 billion in 1996.

Major procurements identified

In other major procurement areas, the EIA forecasts the following for the next 10 years:

Aircraft—During the next five years, budgets should decline; gradual increases will start in 1992. The period is characterized by programs that take longer to complete than expected initially, some reduction of current programs, and modernization of existing systems, in lieu of new procurements. The electronics content for aircraft, however, will gain, from more than \$8 billion in 1987 to about \$10 billion in 1996.

Missiles—Budgets at first should decline sharply as such current strategic programs as M-X and Trident reach completion. Tactical missile production programs should retain strong support, however, and these

budgets will decline more slowly through 1996. Although electronic content will gain slightly, the impact of a big drop in spending on missiles will cut electronics spending from just over \$6 billion in 1987 to about \$5.5 billion in 1996.

Space—The increase in budgets is based on procurement of communication and reconnaissance satellites, military acquisition of expendable launch vehicles, and the Military Strategic Tactical & Relay program. No deployment of Strategic Defense Initiative hardware is expected. The projected electronic content in DOD space programs is already high—65%, or approximately \$2.7 billion in 1987. That should climb to 70% of defense space programs, or about \$4.7 billion, by 1996.

Ships—The 600-ship Navy either is completed or under contract. Modernization of this equipment and replacement of the fleet's older vessels should be the major expense during

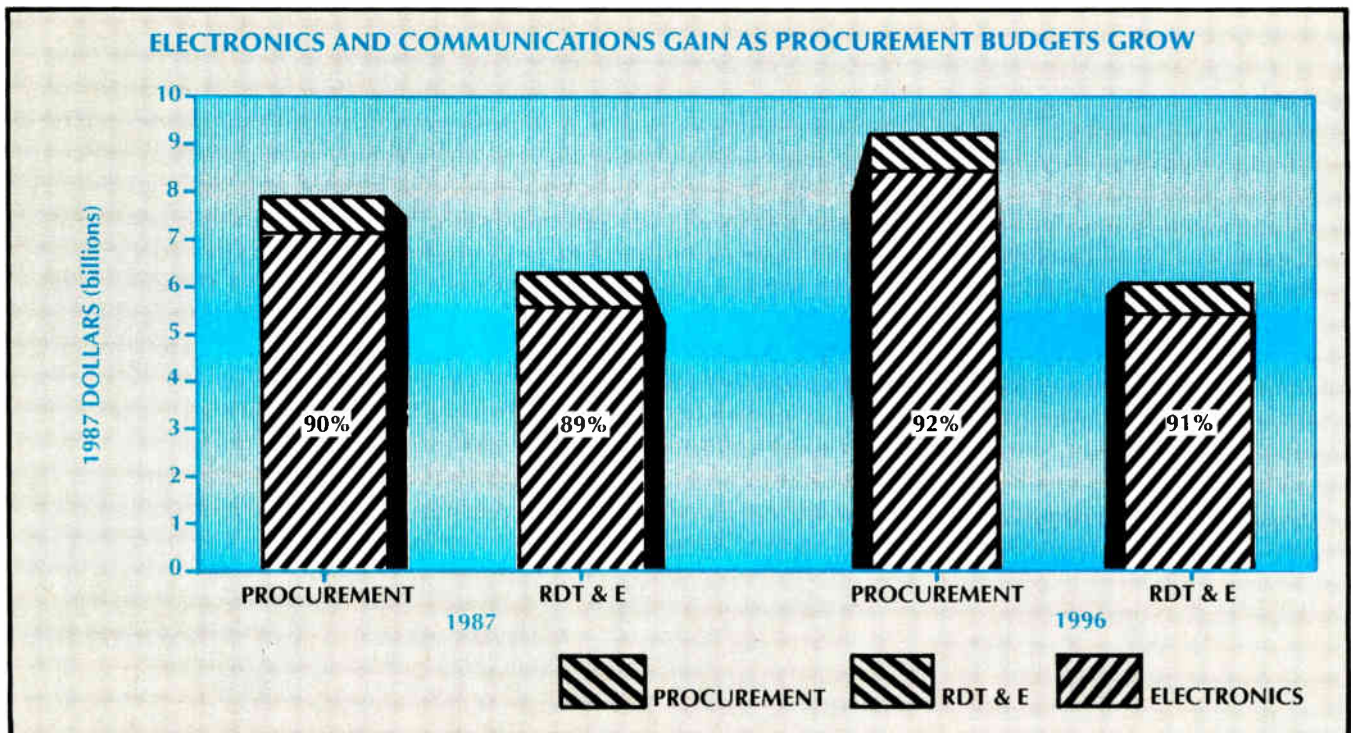

Source: EIA

Before you explore outer space, explore our rad-hard 16K RAMs that survive mega-rad doses!

Mega-rad RAMs with guaranteed survivability!

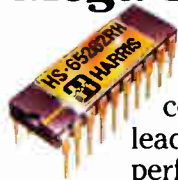

When you want mega-rad parts — not mega-promises — come to Harris, the mega-rad leader. We'll give you guaranteed performance:

- **Latchup free**...achieved using epitaxial starting material.
- **SEU immunity option**...cross-coupled resistors in the memory cells prevent soft errors.
- **DASH-Q Hi-Rel flow**...for space applications; perfect for communication, scientific, and military satellites.
- **6-Transistor memory cell**...lowest power consumption, maximum cell stability, radiation-hardened data protection no 4-T design can match.
- **CMOS/TTL compatible**...completely static operation with three-state output and CMOS or TTL-compatible inputs.

• Selection of rad-hard CMOS RAMs:

Organization	Part Number	Access Time (Typ.)
Synchronous		
1K x 1	HS-6508RH	160 ns
256 x 4	HS-6551RH	160 ns
4K x 1	HS-6504RH	150 ns
1K x 4	HS-6514RH	150 ns
64K Module 8K x 8 16K x 4	HS-6564RH	250 ns
Asynchronous		
16K x 1	HS-65262RH	100 ns
2K x 8*	HS-65162RH	100 ns

*Samples available 4 Qtr. 1986

For more information on the HS-65262RH RAM and the complete Harris rad-hard family of Memories, MUXes, Op Amps, μ Ps, Analog Switches and Gate Arrays call (305) 724-7521. Or write: Harris Custom Integrated Circuits Division, P.O. Box 883, MS 53-035, Melbourne, Florida 32902-0883.



FOR YOUR INFORMATION,
OUR NAME IS

HARRIS

Harris Semiconductor: Analog - CMOS Digital
Gallium Arsenide - Semicustom - Custom



"What can Harris
rad-hard ICs
add to your career?"

"Guaranteed survivability!"



MILITARY ELECTRONICS OUTLOOK

SPECIAL ADVERTISING SECTION

this period. Electronic content remains stable through 1996 at about \$3.2 billion annually.

Ordnance and weapons—Budgets should remain level. Expenditures will cover the procurement of existing equipment programs as well as the building and replenishing of war reserves. Emphasis on the acquisition of smart weapons should continue. Electronic content will inch up from \$1.2 billion in 1987 to \$1.3 billion in 1996.

Vehicles—The flat outlook is based on expectations that the DOD will emphasize maintaining current program production levels. Although electronics spending should increase about five percentage points by 1996, total annual spending will remain fairly stable at \$0.8 billion.

Requirements seen growing

Despite the sector's less than explosive gains, a recently published report from Prudential-Bache Securities, New York, argues that the need for military electronics is growing. Byron K. Callan, Prudential-Bache's defense-electronics analyst and author of the report, sees promising markets in command, control, and communications programs (particularly strategic ones), intelligence gathering, and upgrades to electronic-warfare systems.

He states that companies involved in upgrading strategic forces, naval electronic warfare, radar, and communications should see higher growth than other defense-electronics segments. He also believes that small to midsize firms will continue to hold their own in a market dominated by large electronics conglomerates. For one thing, second sourcing has greatly eased market entry, particularly for smaller firms. At the same time, Congress's push for increased competition among defense contractors has forced them to watch program performance more closely. Callan also expects more takeovers

within the industry, similar to the acquisition by Lockheed Corp. of Sanders Associates, and possibly at a more rapid pace.

In November, for example, Honeywell Inc., the Minneapolis computer and controls company, announced that it had agreed to purchase the Sperry aerospace group of Unisys Corp., Detroit, for \$1.03 billion in cash. The Sperry unit, best known for flight controls and instrumentation, will complement Honeywell's production of guidance and navigational equipment. Also last month, Goodyear Tire & Rubber Co., Akron, Ohio, said it already was talking with several companies interested in buying its aerospace subsidiary only a week after putting it up for sale.

Among other merger activity, Boeing Co., Seattle, recently tried to expand its holdings in defense electronics with the acquisition of Hughes Aircraft Co., Newport Beach, Calif., but lost out to General Motors Corp. Rockwell International Corp., Newport Beach, which Honeywell beat in the Sperry sale, reportedly continues to search for a major acquisition.

Military-industry analysts cite a variety of reasons for all these mergers and acquisitions, including the stable cash flows of established defense contractors and expected benefits from the new tax laws. In addition, analysts report that the stock of many defense suppliers is undervalued, a result of the slim defense-budget increases and new Pentagon policies that call for contractors to assume more risk and upfront investment.

Furthermore, merging with the right company could make it easier to win the fewer large contracts now available. For example, the merger of General Electric Co., the Navy's fourth largest contractor, with seventh-ranked RCA Corp. should yield a tougher competitor for Navy electronics contracts. Since the merger, GE has created two divisions in its defense and aerospace operations by combining

several of its existing businesses with RCA units.

Another reason for the spate of merger activity is expected advancements in design concepts and technology, says Prudential-Bache's Callan. Citing a recent Air Force report that sensors will be embedded in the skins of aircraft to make the planes more difficult to detect, Callan says that electronics will gain in importance and that in the future aircraft will be designed around their avionics rather than the other way around.

Star Wars tops R&D budgets

Nowhere is leading-edge technology sought more avidly than in SDI. As far as R&D is concerned, SDI will dominate the DOD's budget at least through the mid-1990s. The result: strong growth in R&D spending by the military for space programs over the EIA forecast's 10-year period. SDI's budget should grow from \$3.1 billion in 1987 to \$5.1 billion in 1991. Though it will slow after that, it should approach \$6 billion a year by 1996, the EIA says, with 60% to 70% going for electronics.

But contractors could have a tough time figuring out exactly where the DOD wants to spend its money, mainly because some parts of SDI's allocation are buried in other programs. For instance, the EIA estimates that two thirds of SDI's budget is built into space program R&D, and one third of SDI's R&D budget is included in Pentagon missile programs. These programs cover such areas as radiation-hardened, warning-equipped, anti-jam platforms designed to survive a nuclear exchange.

In fact, the equipment's ability to survive a nuclear attack is getting more emphasis. Program managers are looking closely at laser shielding, neutral-particle-beam and microwave hardening, and kinetic shielding, as well as at such active schemes as warning sensors and jammers. In a separate report on the military laser

WANTED CYPHER-1™

Our NSA-endorsed encryption chip:
more speed, less space than DES.

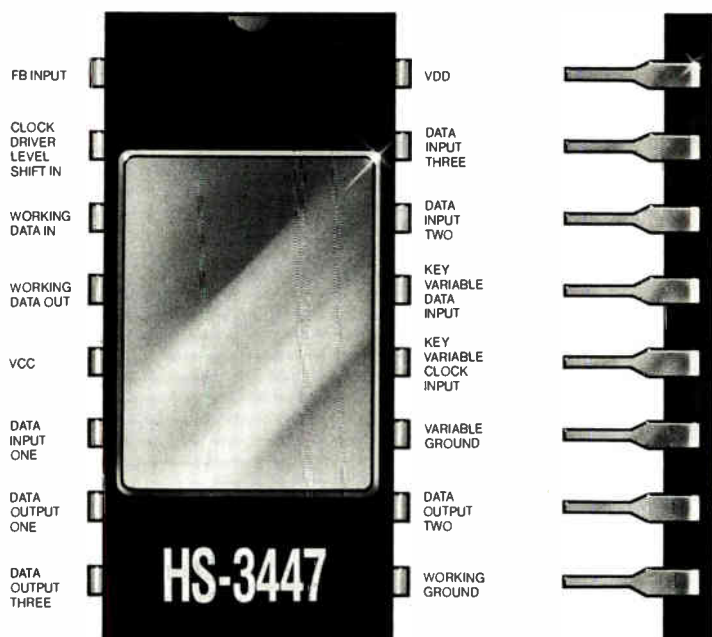

Now the high-speed data encryption chip once reserved for protecting America's defense secrets is available to communications equipment makers to protect sensitive but unclassified government or government-derived information, the loss of which could adversely affect the national security interest.

The Harris CYPHER-1™ circuit is embeddable and built with our proven low-power CMOS process. Compared with the decade-old DES chip, CYPHER-1™ is nearly 50% faster (20 megabits/second)—and its smaller size (16 pins versus DES' 40) makes it flexible enough to interface with almost any communications channel.

You'll find the CYPHER-1™ is the perfect encryption circuit in EDP applications—computer-to-computer links, telecommunications, satellite communications and local area networks.

The CYPHER-1™ circuit encrypts/decrypts via a serial data stream, rather than using the slower traditional block cypher process. In addition to cryptosecurity, the CYPHER-1™ chip is also perfect in systems using spread spectrum transmissions. Use it to build-in immunity to frequency jamming and signal interception in electronic warfare applications.

It's available in production quantities now.

DES is yesterday's technology. CYPHER-1™ is tomorrow's. Call Harris today.

For a data sheet and application information, call (305) 729-5757. Or write: Harris Custom Integrated Circuits Division, P.O. Box 883, MS 53-175, Melbourne, Florida 32902-0883.



CYPHER-1™ is a trademark of Harris Semiconductor.

Circle 113 on reader service card

Harris Semiconductor: Analog - CMOS Digital - Gallium Arsenide - Semicustom - Custom

FOR YOUR INFORMATION, OUR NAME IS **HARRIS**

MILITARY ELECTRONICS OUTLOOK

SPECIAL ADVERTISING SECTION

market, Frost & Sullivan states that SDI accounts for more than \$3.2 billion in laser funding for fiscal 1986, a share it will maintain at least through 1991. Developing concepts in directed-energy weapons now account for nearly 83% of the dollars in the space-armament sector, says Frost & Sullivan.

The New York market researcher points out that the ability to withstand nuclear bombardment is critical to satellite systems as well. In a recent study, it says, "If there is one common theme that underlies most defense agency efforts on military satellite communications systems, it is the endeavor to make them more

survivable and capable of functioning in an environment of protracted nuclear attack." The concern over survivability is a byproduct of the widening role that satellites play. The Milstar program alone uses more than one third of all military satellite dollars and could rise to half the market by fiscal 1991. Part of that effort is bound up in the

JUMP EXPECTED IN THE MILITARY SECURITY MARKET

Military security is gaining as a market opportunity for companies in the industry.

According to Honeywell Information Systems, which conducted a study of the market, the number of secure computer systems submitted for evaluation to the National Security Agency's National Computer Security Center (NCSC), Fort Meade, Md., will more than double in the next year.

NCSC requirements calling for the Defense Department to purchase only secure computer systems beginning in 1987 are expected to be a major factor in the market's expansion. Moreover, the NCSC, which has central responsibility for computer security within the federal government, will require all federal government agencies to purchase secure computer systems beginning in 1988.

The actions are part of a series of directives affecting the Pentagon and defense contractors. Last month, for example, the Reagan administration issued new guidelines restricting the release of a broad range of government data that is unclassified but nonetheless considered sensitive. Federal agencies are not getting additional authority to restrict release, however.

The directive is the result of a federal study aimed at limiting ac-

cess to unclassified information through public and government data bases. Initially focused on two government agencies—the Defense Technical Information Center and the National Technical Information Service—the study has been expanded to include private electronic data banks that hold potentially sensitive information. In fact, federal officials already have visited commercial on-line data-base concerns to determine whether their data (technical, economic, and so forth) ought to be secured.

More recently, the administration has ordered all federal agencies to identify sensitive data held in government computers so it can be protected with strict computer-security methods. Although the Pentagon always has made information security a high priority, the DOD is expected to reevaluate its own data bases under this new directive.

Diane Fountaine, director for information systems in the Office of the Assistant Secretary of Defense, recently told an audience at an industry meeting: "The question is not will there be restrictions or controls on the use of commercially available on-line data bases. The question is how will such restrictions or controls be applied." Her office has been formulating recommendations on restricting access to commercial

data bases. These recommendations could be announced at any time.

Although several solutions have been discussed, the general impact of this apparent change in national policy is likely to generate an even larger market for both information systems software and hardware.

Another growing sector in the military security market is that for Tempest-qualified computer systems. This equipment eliminates the unauthorized detection of electromagnetic emissions.

Some vendors in the field estimate the current Tempest market at \$0.5 billion. International Data Corp., a market researcher in Framingham, Mass., projects the market for this type of equipment at 500,000 unit sales annually by 1990.

So far, most developers of Tempest-approved equipment sell directly to the military. However, some specialists in the field are increasingly aligning themselves with major systems manufacturers, both to market their products to the military services as well as to develop products jointly.

The number of products, mostly computer systems and computer peripherals, developed under the DOD's Tempest security standard guidelines has grown to 200.

CTS is the source for standard military hybrids

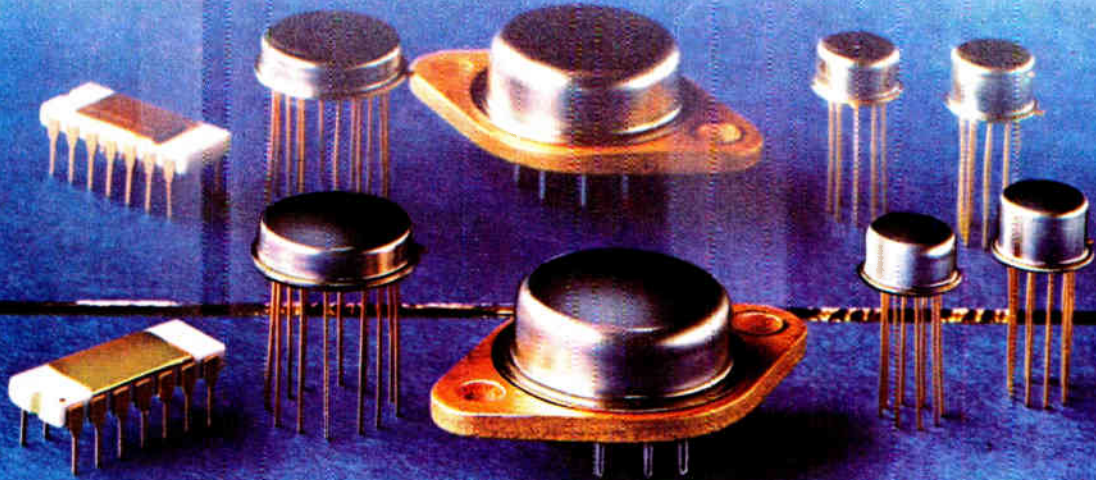

Need special screening, environmental testing, data logging or specific electrical testing? Contact us.

What a great alternate source for standard pin-for-pin Military Hybrid replacements! When you are faced with the "take-it-or-leave-it" attitude that some major suppliers have adopted on Military Hybrid standards—look to CTS Corporation, Microelectronics Division. CTS will provide Military Hybrids just as you want them. And, our prices are very competitive.

CTS has been a leading producer of custom Military Hybrids for over 20 years. Our hybrids are designed and screened to Mil-Std-883 requirements. We have complete quality conformance evaluation

capabilities as required in Mil-M-38510.

Don't settle for standard hybrids that don't meet your individual needs. Ask about the CTS0002, 6, 8, 21, 32, 33, 34 and 41 as alternates for the LH and DH series. We'll make your standards to custom requirements.

Write today for a product-for-product comparison chart, and technical data on customized "standards" that meet *your* specs. Contact: CTS Corporation, 1201 Cumberland Ave., West Lafayette, IN 47906. (317) 463-2565.

CIRCLE NO. 115

Advanced Air Force Communications System uses CTS Military Hybrid

The prime contractor for the Air Force SEEK TALK anti-jam voice communication system selected a CTS Hi-Rel unit as a primary microcircuit component. The need for high reliability in this system linking fighter aircraft with command stations was a major factor in the selection of CTS.

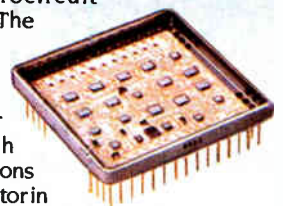

CTS® MEANS RELIABILITY

CTS CORPORATION • ELKHART, INDIANA



Voltage Controlled Crystal Oscillators
Standard and hybrid designs.
Phone: (815) 786-8411
CIRCLE NO. 161

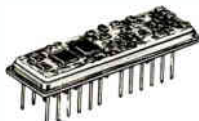

Custom Hybrid Circuits
for demanding medical electronics.
Phone: (317) 463-2565
CIRCLE NO. 162

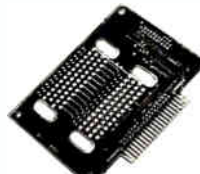

PC Boards Complex double-sided and multilayer.
Phone: (415) 659-1770
CIRCLE NO. 163



Connectors Custom PC board and military styles.
Phone: (612) 941-9100
CIRCLE NO. 164

MILITARY ELECTRONICS OUTLOOK

SPECIAL ADVERTISING SECTION

DOD's gallium arsenide program. GaAs circuits will play a vital role in transmitter and receiver modules in new phased-array radar systems, satellites, and avionics packages, not only in SDI and Milstar but also in other programs. More than a dozen contractors have submitted proposals to run a major new development program that could rapidly accelerate the technology.

Called Mimic, for microwave and millimeter-wave monolithic integrated circuits, the program's aim is to produce a reliable, affordable supply of complex GaAs chips for next-generation communications and weapons sensor hardware. Among the teams bidding on Mimic are

GM-Hughes Electronics and GE, Texas Instruments and Raytheon, Westinghouse Electric and Rockwell International, and TRW and Honeywell. Because of expected budget cuts, other elements of SDI won't fare as well near term. For example, a surveillance tracking system experiment and a long-wave infrared radar probe will likely be delayed, according to the EIA. A space-based radar project has been dropped and space-based experiments will be reduced.

Darpa changes seen

Budget cuts also have hit the Defense Advanced Research Projects Agency, established to advance the military's knowhow in information processing and expert systems. In some Darpa projects, funding is roughly 25% lower than requested. Darpa's budget came to approximately \$104 million for fiscal 1986.

Darpa continues to award contracts, however. One, for \$10.7 million, recently went to Encore Computer Corp., Marlborough, Mass., for a prototype system that can execute 1 billion instructions per second. The Naval Warfare Systems Command awarded the three-year Darpa contract to produce the system. In addition, AT&T Bell Laboratories last month picked up a Darpa contract valued at \$7.7 million to build a prototype computer for speech and image recognition.

Meanwhile, Darpa continues work on three of its current major programs: the development of an autonomous land vehicle, a battle-management system, and a system for feeding critical information to pilots in combat. The agency reported that an autonomous land vehicle, or smart truck, lived up to most of its design goals during a private demonstration in October. A public demonstration is scheduled for 1987. Martin Marietta Corp., Bethesda, Md., is the program's prime contractor, although other

companies, as well as the University of Maryland and Carnegie-Mellon University, are involved.

The battle-management program's goal is to develop a threat-warning system for the Navy. A prototype system is being developed for the aircraft carrier USS Carl Vinson; the Pacific Fleet Command Center is managing the work. Extending the project, Darpa added an air-land battle management system for the Army in 1985. The Army's Ballistic Research Laboratory at the Los Alamos National Laboratory in New Mexico is managing the program. The aim of the combat-pilot project, referred to as the pilot's associate, is a system to channel information from the plane's instruments and sensors through an expert system that prioritizes it and feeds the pilot only the information required at the moment. Two teams—one led by Lockheed, the other by McDonnell Douglas Corp., St. Louis, Mo.—are working on the program's first phase under contracts that were awarded last February. Darpa's top management is scheduled to meet this month to review and update its goals and programs.

The NATO co-op

Plenty of opportunities also exist outside the Pentagon. The North Atlantic Treaty Alliance, always a major market for military-electronics vendors, has suddenly become an even bigger one. As a result of recent U. S. legislation intended to encourage domestic and European defense contractors to jointly build weapons for their respective armed services, NATO has earmarked a total of \$345 million in military funds this year and next to finance the U. S.'s share of cooperative research into new weaponry.

NATO has proposed seven projects:

- A 155-mm guided artillery shell that tracks its target.
- A family of bombs and missiles that are fired from planes and home in on targets up to 70 miles away.
- An airborne radar system that spots

Quartz Crystals In 48 Hours!

That's right! In addition to normal delivery of less than 4 weeks, ECC leads the field with 48 hour service.

Quality is another reason ECC is a leader. ECC crystals offer superior performance for military, commercial, aircraft, mobile, marine and walkie-talkie applications.

Special needs? No problem! ECC can assist with any custom design or application.

- Military Approved
- Cold Weld & Solder Seal
- 800 khz to 200 mhz
- AT Cut
- Made to Spec



Electronic Crystals Corporation
1151 Southwest Blvd., Kansas City, KS 66103
(913) 262-1274 TWX-910-743-4170

Call or
Write For
Our Free
Catalog
Featuring
Over 85 QPL's





Bipolar military ICs: We still make 'em like they used to.

When you must have older bipolar military ICs, remember Lansdale: we serve the semiconductor aftermarket. Our products are those that others no longer make, assuring you that you'll always have a source.

You'll see many old friends on our product list. Like Raytheon's DTL 200 Series, Signetics DTL and TTL. Motorola's SUHL-TTL and others. And we can meet all your needs, even to the most exacting military standards.

We also do custom manufacturing, including Schottky TTL, linear and digital. And we can give you gold-doping where needed.

So don't go to the expense of designing-in a new part. Not when we still make 'em.

Exactly like they used to.

For further information contact

LANSDALE
SEMICONDUCTOR

Division of Electronic Technologies, Inc.

2330 Michigan Ave. • Santa Monica, California 90404
Phone: (213) 829-7663 • Telefax: (213) 453-1741

Circle 117 on reader service card

MORE BANG. LESS BUCK.

Why weapons systems designers are using Rantec standard military power supplies.

Rantec's standard military power supplies save weapons systems programs money. No costly non-recurring engineering expenses. No costly retooling. And, with over 600 different models to choose from, no costly design compromises on your part.

Also, no costly time delays waiting for product to develop or for manufacture. Which is very important when you consider it takes from 13 to 18 months and between \$125,000 and \$300,000 to get a custom military power supply.*

Giving up reliability by going standard? No way. First of all, our quality program complies with MIL-I-

45208 and meets the intent of MIL-Q-9858. Secondly, all of our power supplies meet or exceed MIL-E-5400, MIL-E-16400, MIL-STD-704, MIL-STD-1399, MIL-I-6181, and MIL-STD-461.

This extensive product line includes single and three phase AC input power supplies and DC-DC converters in single and multiple output power ratings to 1KW.

To find out how you can save money like your contemporaries by using Rantec standard power supplies which are qualified for airborne, shipboard, ground-fixed and ground-mobile use, contact us today.



Division of Emerson Electric Co.
9401 Oso Avenue, Chatsworth, CA 91311 • Tel: (213) 885-8223 TWX: 910-493-1247

*U.S. Navy/Industry Power Supply Ad Hoc Committee Estimates for Time and Cost.

Circle 118 on reader service card





It took Gould computers to train two generations on the same simulators.

Eight hard-working flight simulators that trained a whole generation of C-141 pilots had become obsolete. The Air Force studied the feasibility of refurbishing the 20-year-old simulators with the technology of the 1980's.

Burtek was selected to refurbish. And Gould computers were selected because first generation computers from the same company had successfully driven these simulators for 20 years.

Results? A new generation of pilots, copilots and flight engineers now receive greatly expanded training. They can practice the full range of C-141B flight capabilities in modern state-of-the-art simulators. Over 900 types of aircraft malfunctions can be simulated. Plus, these are the first DoD simulators to have computer automated performance certification.

The project was also cost effective. "We have saved the taxpayers

several million dollars without skimping on performance", reports Burtek.

Gould. Our computers drive today's simulators. Tomorrow's. And even yesterday's. Write or call for information.

**Gould Inc., Information Systems
Computer Systems Division
6901 West Sunrise Boulevard
Fort Lauderdale, Florida 33313
1-800-327-9716**

Circle 119 on reader service card

World Radio History

 **GOULD**
Electronics

MILITARY ELECTRONICS OUTLOOK

SPECIAL ADVERTISING SECTION

enemy targets and directs NATO forces to attack them.

- A multifunctional system for

information distribution, whose task will be to move data between headquarters and airfields.

- A NATO friend-or-foe identification system for aircraft.
- A data-distribution system with global range and low frequencies.
- A computer language for use by NATO weapons and command and control systems.

NATO commanders are expected to decide which programs will get the go-ahead in February. ■

FOR MORE INFORMATION

Amp Inc.

Harrisburg, Pa. 17105-3608
(717) 780-4400

Circle 108

CTS Corp.

1201 Cumberland Ave.
West Lafayette, Ind. 47906
(317) 463-2565

Circle 115, 161-164

Electronic Crystals Corp.

1151 Southwest Blvd.
Kansas City, Kan. 66103
(913) 262-1274

Circle 116

Gould/Computer Systems Division

6901 W. Sunrise Blvd.
Fort Lauderdale, Fla. 33313
(800) 327-9716

Circle 119

Harris Semiconductor Corp.

P. O. Box 883
Melbourne, Fla. 32902-0883
(305) 729-5757 Circle 113 (Cypher)
(305) 724-7521 Circle 110, 111
(rad-hard RAMs)

Lansdale Semiconductor

2330 Michigan Ave.
Santa Monica, Calif. 90404
(213) 829-7663

Circle 117

Connector Industries of America

639 N. Wayne Ave.
P. O. Box 15278
Cincinnati, Ohio 45215
(513) 733-3680

Circle 120

Rantec Power Systems

9401 Oso Ave.
Chatsworth, Calif. 91311
(213) 885-8223

Circle 118

Schweber Electronics

Jericho Turnpike
Westbury, N. Y. 11590
(516) 334-7474

Circle 122

Teledyne Relays

12525 Daphne Ave.
Hawthorne, Calif. 90250
(213) 777-0077

Circle 121

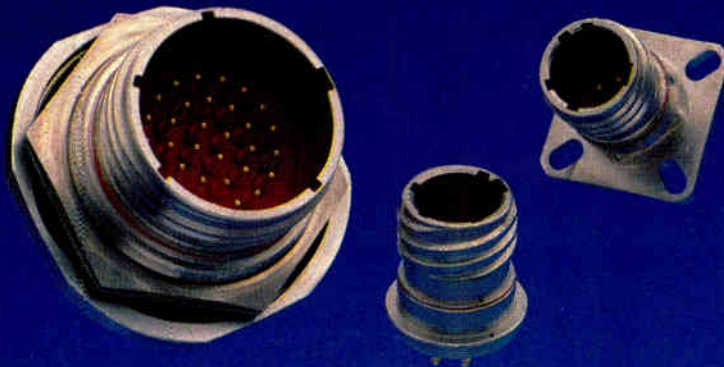

MILITARY QPL APPROVED MIL-C-38999 SERIES III HERMETICS FROM CIA

Connector Industries of America is now a Military QPL Approved supplier of MIL-C-38999 Series III hermetic receptacles. Our QPL approved connectors include the following military part numbers:

D38999/21Y	D38999/21N
D38999/23Y	D38999/23N
D38999/25Y	D38999/25N
D38999/27Y	D38999/27N

For applications requiring high density, high reliability and high performance in a MIL-C-38999 Series III hermetic connector, call or write for a free catalog.



MICRODOT INC.

CONNECTOR INDUSTRIES OF AMERICA

639 N. WAYNE AVENUE
P.O. BOX 15278
CINCINNATI, OH 45215
(513) 733-3680

CENTIGRID.[®] Possibly the world's most advanced EMR

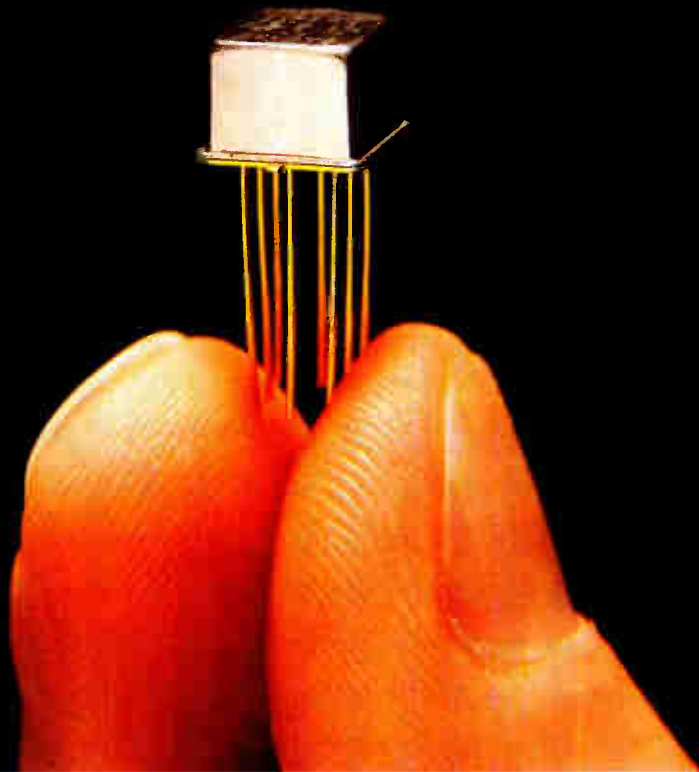

Our Centigrid relay is the vanguard of a new EMR generation. After all, it is the natural outgrowth of all those years of proven Teledyne TO-5 technology.

It is rugged. The uniframe-housed motor assembly is stabilized by the header at four points, making it very tolerant of mishandling during warehousing and assembly.

It is tiny. Takes up less than .15 sq. in. of board space. And its .100" grid spaced pinout permits direct PC board insertion without lead spreading. Since it is only .275" high, this makes possible very high board density.

It is an even better RF switch than the classic TO-5, providing high isolation and low insertion losses up through UHF frequencies. And it is fully qualified to levels "L," "M" and "P" of MIL-R-39016.

It draws very little power. The sensitive version dissipates 75% less power than the typical 1/2 crystal can. That can extend the battery life of your portable equipment by a significant margin.

To make sure you always get the Centigrid quality you expect, we designed our own automated production equipment. For instance, our microprocessor-controlled

header assembly system automatically tests the units while they are being produced, minimizing human error and insuring built-in reliability.

For twenty years, Teledyne TO-5 technology has been the standard of the industry. Now the Centigrid has taken that technology one giant step into tomorrow.

If you'd like complete technical information or applications assistance, call or write today.

 **TELEDYNE RELAYS**
Innovations In Switching Technology

12525 Daphne Ave., Hawthorne, California 90250 • (213) 777-0077
European Hqts: Abraham Lincoln Strasse 38-42, 6300 Wiesbaden, W. Germany • 06121-768
Belgium Sales Office: 181 Chaussee de La Hulpe, 1170 Brussels • (2) 673-99-88

U.K. Sales Office: Heathrow House, Bath Rd., Cranford, Hounslow, Middlesex, TW5 9QP • 1-897-2501
Japan Sales Office: Taikoh No. 3 Building, 2-10-7 Shibuya, Shibuya-Ku, Tokyo, 150 Japan • (3) 797-6956
France Sales Office: 85-87 Rue Anatole-France, 92300 Levallois-Perret • 1-7587160

Circle 121 on reader service card

COMPARE YOUR DISTRIBUTOR WITH THE MILITARY PROFESSIONALS AT SCHWEBER.

USE THIS CHECKLIST.

1. Does your distributor provide complete traceability with documentation? YES NO

Schweber maintains exceptional security for military products, observing 100% ESD handling procedures. We provide out-the-door traceability with documentation and paperwork to back up every military semiconductor.

2. Does your distributor offer immediate access to a broad range of high reliability products with fully certified, separate military warehousing capabilities? YES NO

You can depend on Schweber for the broadest range of Hi-Rel products delivered in the shortest time possible. Schweber provides separate environmentally controlled warehousing with an inventory of most frequently requested parts.

3. Is your distributor "Approved" by 26 leading manufacturers? YES NO

AMD, AMP, Amphenol, AT&T, Bendix, Bourns, Burndy, Corning, Fairchild, GE Semiconductor, Harris, Hewlett Packard, International Rectifier, Intersil, KEMET, Motorola, National, RCA, Robinson Nugent, SEEQ, Signetics, Sprague, Tectetics, Texas Instruments, Thomson-Mostek and Zilog.

4. Does your distributor offer specialization in military products? YES NO

Schweber is a leading national electronics distributor with 37 offices and military marketing specialists in each one. Military products are not a side line with us. Our military specialists are trained to help you with problems that are essential to national security.

5. Can your distributor give a rapid response to your military questions? YES NO

Thanks to Schweber's real-time, on-line computerized inventory, we can immediately track availability, pricing and location so you don't have to wait for answers to important questions, or delivery.

If you answered no to any of the checklist questions, contact the military professionals at Schweber.

SCHWEBER

THE MILITARY PROFESSIONALS

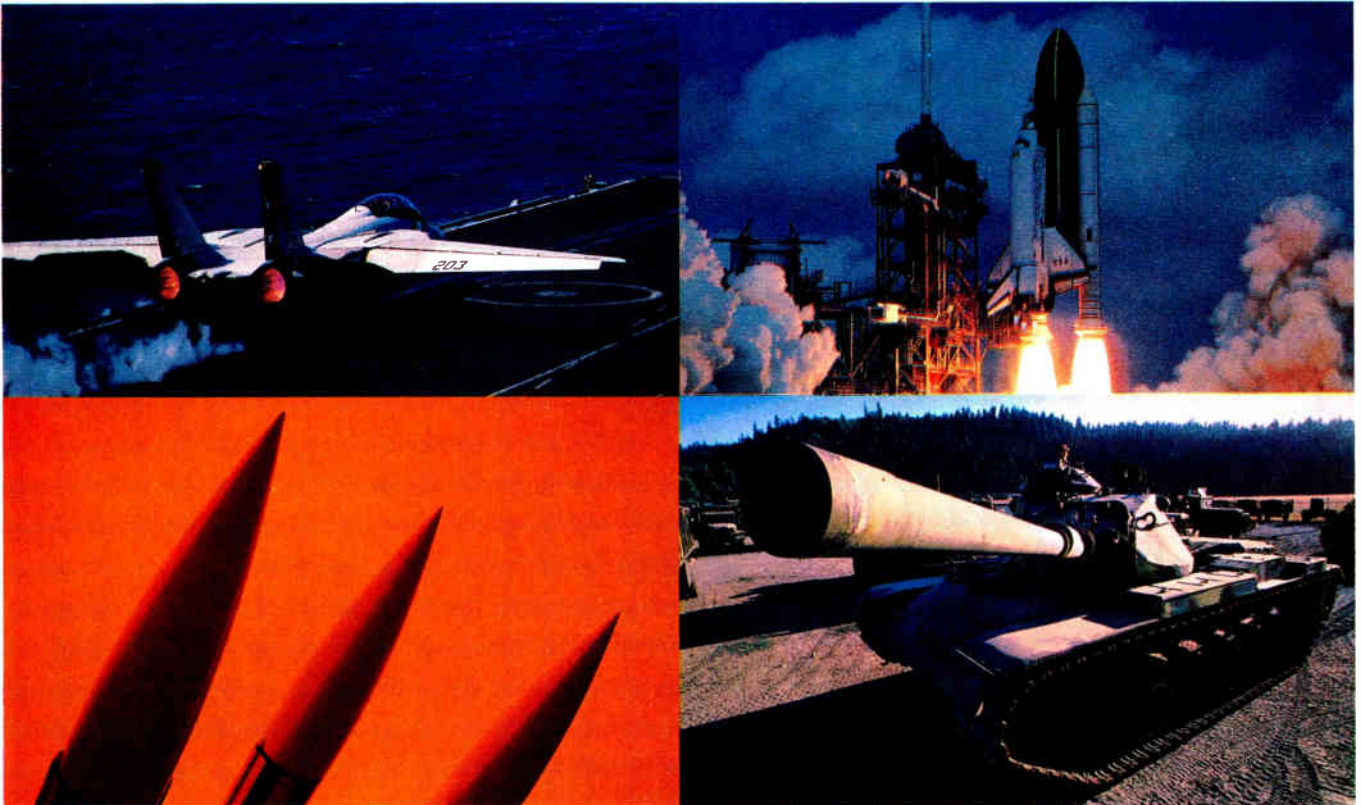

Northeast Bedford, MA 617/275-5100 • Manchester, NH 603/625-2250 • Rochester, NY 716/424-2222 • Danbury, CT 203/748-7080 **Mid-Atlantic** Westbury, NY 516/334-7474
Fairfield, NJ 201/227-7880 • Horsham, PA 215/441-0600 **Southeast** Baltimore, MD 301/792-4025 • Gaithersburg, MD 301/840-5900 • Raleigh, NC 919/876-0000
Norcross, GA 404/449-9170 • Huntsville, AL 205/895-0480 • Allamonte Springs, FL 305/331-7555 • Pompano Beach, FL 305/977-7511 **Midwest** Pittsburgh, PA 412/782-1600
Beachwood, OH 216/464-2970 • Livonia, MI 313/525-8100 • Dayton, OH 513/439-1800 • Elk Grove, IL 312/364-3750 • Brookfield, WI 414/784-9020 • Cedar Rapids, IA 319/373-1417
St. Louis, MO 314/739-0526 • Kansas City, KS 913/492-2922 • Edina, MN 612/941-5280 **Southcentral** Houston, TX 713/784-3600 • Dallas, TX 214/661-5010
Austin, TX 512/458-8253 • Tulsa, OK 918/622-8000 **Northwest** Englewood, CO 303/799-0258 • San Jose, CA 408/946-7171 • Sacramento, CA 916/929-9732
Seattle, WA 206/624-1183 **Southwest** Phoenix, AZ 602/997-4874 • San Diego, CA 619/450-0454 • Irvine, CA 714/863-0200, 213/537-4321 • Gardena, CA 213/327-8409
Canoga Park, CA 818/999-4702



© 1989 SCHWEBER ELECTRONICS CORPORATION

NEW

Mil. Spec. IC decoupling

New MICRO/Q II capacitors conform with MIL-C-39014D, STD 202F. Molded construction seals out moisture and humidity. Available in capacitances from .01 μ F to .30 μ F. You achieve effective noise control and reduce noise spikes, in conditions from -55°C through +125°C. Mount beneath DIP IC's to save up to 30% board space.

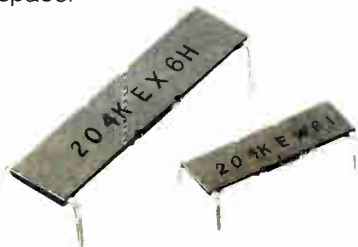

Circle 176 on reader service card

Improve existing board performance

MICRO/Q capacitors can be retrofitted to solve noise problems on existing boards. Because MICRO/Q caps share mounting holes with existing IC pins, no board redesign is required. Effective decoupling becomes a matter of adding one insertion step.



Circle 177 on reader service card

Simplify board layout and get a choice

MICRO/Q ceramic decoupling capacitors share board mounting holes with IC pins. You don't have to waste space on additional holes, as you do for standard caps. Simplifying board design opens up two very attractive options. Add more active devices with increased packaging density in the same space, or design the same package on a smaller board.

Either way, you win with MICRO/Q.



Circle 178 on reader service card

Design noise out of PGA and LCC packages

PGA MICRO/Q capacitors provide effective solutions to noise problems with VLSI PGA packages and LCC sockets. Design effective decoupling on complex multi-layer board layouts by fitting PGA MICRO/Q capacitors under PGA or LCC sockets. They occupy no additional board space and provide the low-inductance, high-frequency decoupling required by today's VLSI packages. Available in a range of pinout configurations.

Circle 123 on reader service card

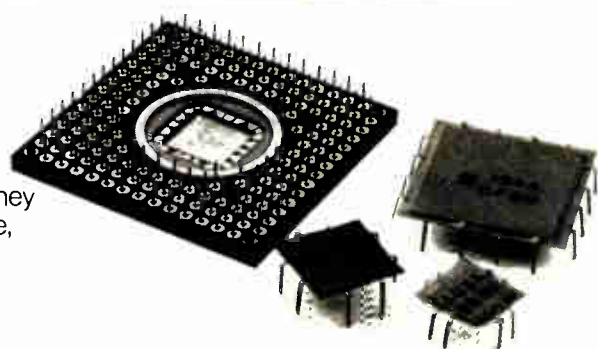

noise problems... space problems...

TOP THIS.

Rogers MICRO/Q® decoupling capacitors reduce voltage noise spikes in IC's, often by as much as a factor of ten. And since they're easily mounted *underneath* the IC, MICRO/Q capacitors conserve valuable board real estate, too. A range of configurations makes MICRO/Q flat capacitors especially effective at reducing noise on:

- 64K RAMS
- Video RAMS
- EPROMS
- Microprocessors
- Bus drivers/buffers
- Other IC's where noise spikes create performance problems
- Boards that need EMI/RFI fix
- CAD/CAM/CAE
- Telecommunications
- Minicomputers
- Printers and copiers
- Single-board computers

Find out how MICRO/Q capacitors reduce noise and provide better board density. Get the full story and a free sample. Call a Rogers MICRO/Q Product Specialist today, at (602) 967-0624.



ROGERS

Rogers Corporation
Circuit Components Division
2400 South Roosevelt Street
Tempe, AZ 85282

Distributed in the U.S. by the Genie Group; in Europe by Mektron NV, Gent, Belgium; in Brazil by Rogers Coselbra, São Paulo.

Circle 179 on reader service card

**Win \$1,000
Cash In
Electronics'
Annual
Advertiser
Audit Contest!**

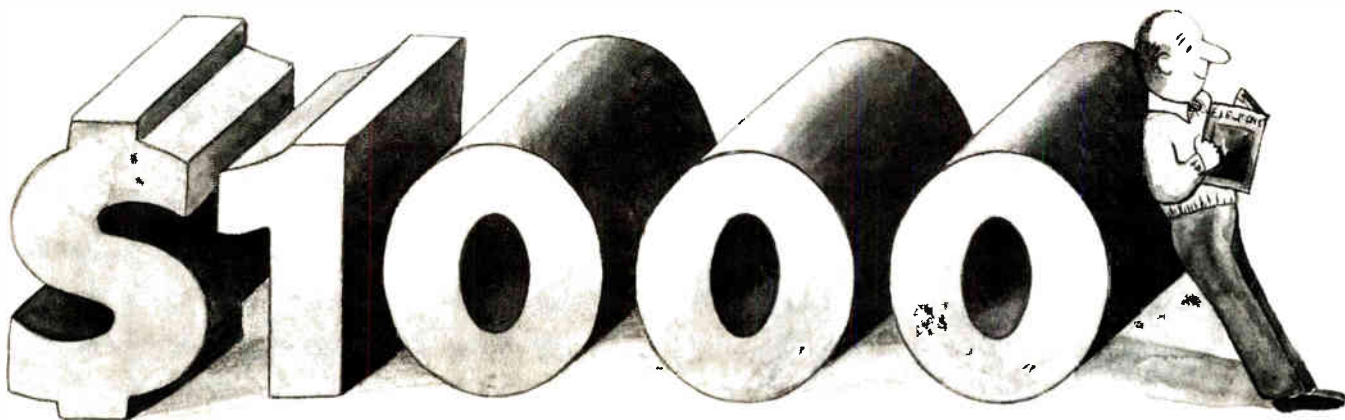

Watch for more details and complete contest rules in the January 8, 1987 issue.

It's easy to enter, and fun to win! Simply select the 10 ads in the January 8, 1987 issue of *Electronics* that you think will be best-read by your peers. List your selections on the entry card bound in the issue, or a reasonable facsimile. Whoever comes closest to selecting the 10 winning ads collects \$1,000 cash!

Electronics

**Attention Advertisers:
You can win \$1,000 too!**

All advertising and marketing personnel in companies and agencies are invited to participate along with our readers by filling out a Special Advertiser's Ballot included in the January 8, 1987 issue. Whoever comes closest to picking the 10 winning ads in this special advertiser's contest will receive an award acknowledging their skill in evaluating advertising, plus a free ad for their company—and \$1,000 cash!

How BURR-BROWN Create The High Resolution



Helped Nicolet Industry's Fastest Digital Storage Oscilloscope

The new ADC600 gives Nicolet's 4094 DSO System 12-bit resolution with 8-bit speed

When Nicolet wanted both high resolution and ultra-high speed for its new DSO digitizer module, they brought their specs to Burr-Brown, the leader in high performance analog-to-digital conversion technology. They left with a handshake commitment to solve their problem. They got the ADC600 12-bit, 10MHz sampling A/D converter.

"... more than we asked for."

"We subjected the Burr-Brown ADC600 to a series of tests including noise, distortion, linearity (differential and integral), and bandwidth at frequencies from DC to above 10MHz. The results of these tests, plus the straightforward interface to our system, convinced us to select the ADC600 for our application. They gave us more than we asked for."

Jim Hyatt
Product Design Manager
Nicolet Test Instruments Division

ADC600 is the first high resolution, ultra-high-speed sampling converter to combine small size, low power dissipation, and straightforward interfacing in a reliable, low cost design. It's complete with sample/hold, encoders, reference DAC, and timing circuits on a space-saving,

17-square-inch printed-circuit card. And it's easy to use, requiring only external power supplies and CONVERT command for operation.

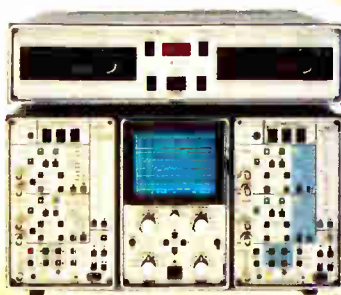

Key ADC600 Specifications

Resolution	12 bits
Sampling rate	10MHz min
Linearity error (200Hz) ..	± 1.25 LSB max
Harmonic distortion ($F_{IN} = 1$ MHz to 5MHz)	65dB
Input range	± 1.25 V
Signal-to-Noise Ratio	70dB
Power dissipation	8.5W
No missing codes	0 to +70°C

With ADC600, Burr-Brown continues a thirty-year tradition of solving customer problems through innovative designs, high quality manufacturing, and dedicated customer service and assistance.

*"Customer response
has been excellent."*

"The ADC600 provides state-of-the-art high-resolution digitizer performance in our already powerful 4094 digital scope. Many applications require 12-bit precision but also 8-bit speed; the Burr-Brown modules do both. Customer response has been excellent."

Dale Baldwin
Marketing Manager
Nicolet Test Instruments Division

If you have a data conversion problem, we invite you to contact Burr-Brown. You may be only a handshake away from the solution.

Burr-Brown Corporation
P.O. Box 11400, Tucson, AZ 85734
602/746-1111



Improving Data Conversion
Productivity

SELECT YOUR RESOLUTION

from Imagraph's proven family of IBM XT/AT/RT
Compatible Advanced Graphic Controllers

Display Resolution	Bits / Pixel				
	4	8	16	24	32

1280 X 1024/960	✓	✓	✓	✓	
1024 X 1024/768	✓	✓	✓	✓	
768 X 512/480		✓	✓	✓	✓
640 X 512/480		✓	✓	✓	✓
512 X 512/480		✓	✓	✓	✓

Optional 100% CGA emulation available

Each family member utilizes the latest VLSI ACRTC Graphic Chip (Hitachi HD-63484), 256K Video RAMs, and high speed Video DACs, allowing a performance spec that is 5 to 10 times faster than NEC 7220 based controllers and 2 to 3 times faster than Hitachi HD-63484 based designs not using Video RAM technology. Most boards available in both interlaced and non-interlaced format.



FOR YOUR IMAGING & GRAPHICS APPLICATIONS

2D/3D Mechanical
CAD

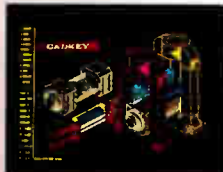

CADKEY

Tektronix 4115
Emulation

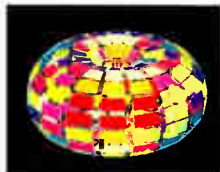

TGRAF

General
CAD



AUTOCAD

Image
Analysis



IMAGEPRO 1000

Electronic
CAD

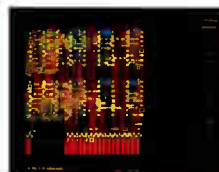

P-CAD

Designer
Graphics



ARTWORK

Imagraph's family of Advanced Graphic Controllers (AGC) are state-of-the-art, medium to high resolution display boards designed specifically for OEM and End Users' requirements in CAD, CAE, Graphic Arts, Presentation Graphics, Landsat, Medical and Scientific/Industrial Displays. All boards warranted for one year.

VME Bus versions also available.

IMAGRAPH

CORPORATION

800 West Cummings Park, Woburn, MA 01801
Telephone: (617) 938-5480... Telex: 4946300 IMAGTGI
Circle 128 on reader service card

ImagePro is a registered trademark of Media Cybernetics, Inc. Cadkey is a registered trademark of Micro Control Systems. Autocad is a registered trademark of Autodesk. P-Cad is a registered trademark of Personal CAD Systems, Inc. TGRAF is a trademark of Grafpoint, Inc. Artwork is a trademark of West End Film, Inc. Tektronix 4115 is a registered trademark of Tektronix Inc. IBM is a registered trademark of International Business Machines, Inc.

NEW PRODUCTS

HP CLAIMS ITS IC TESTER RUNS FASTER THAN ANY OTHER

IT OPERATES AT 128 MHz TO TEST MIXED-SIGNAL CHIPS WITH 182 PINS

Hewlett-Packard Co. has started shipping a mixed-signal integrated-circuit tester that it calls the fastest tester of any type now on the market. The system attains speeds of up to 128 MHz for testing analog-digital devices with as many as 182 pins, surpassing even high-speed digital very-large-scale-integration testers that operate at 40 MHz but can be multiplexed to attain a 80-MHz test rate.

Its faster performance over other mixed-signal IC test systems is even more impressive, since they offer maximum frequencies of 25 MHz. They also contained a maximum of 96 pins—one for each test channel.

In addition to enhanced speed and capacity, the HP9480 runs with low signal distortion—a total harmonic distortion of -60 dB compared with an industry performance standard of -50 dB. It offers a 50- Ω test environment through the device under test. Previous test systems could guarantee such an environment only to the test head. The 9480 carries a base price of \$650,000.

PRESSING NEED. The need for such a high-speed tester has become more pressing as applications for digital-to-analog converters and analog-to-digital converters that operate between 20 MHz and 100 MHz have increased. DACs used at the output of graphics-controller boards for driving high-resolution color monitors, for example, operate up to 100 MHz. This sector of the IC market will grow, according to VLSI Research Inc. of San Jose, Calif. In 1986, 1.2 billion DACs and 905 million ADC chips will be shipped, and the markets are expected to grow at a rate of 24% and 27%, respectively, through 1988.

To achieve its high speeds, the tester uses an eight-plane matrix of high-speed emitter-coupled-logic random-access memories. Each plane contains 2 K of emitter-coupled-logic RAM that can be from 16 bits to 128 bits wide.

Conventional test systems have one plane of memory. Digital stimulus patterns are applied by sequentially unloading one address after another. As a result, the tester is limited to the access speed of the ECI-RAM read cycle—

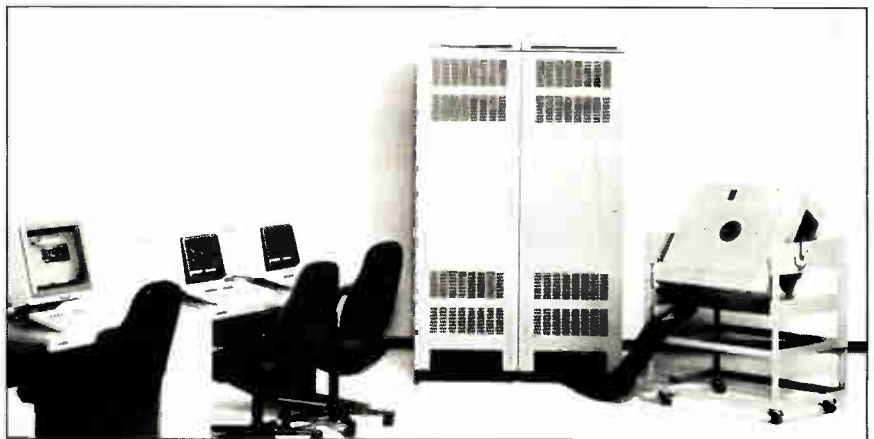

VALUE. HP's tester starts at \$650,000 but costs \$1.3 million fully equipped.

about 40 ns—hence the 40-MHz test rate. By contrast, HP's tester takes digital test patterns from plane to plane, allowing the instrument to overlap the ECL-RAM chip's read-cycle overhead. This overcomes the 40-MHz limitation to achieve the 128-MHz test rate.

In gathering response data, the test system strobes each word received from the device under test into the eight memory planes in the same way that stimulus is moved out of memory. It can generate and receive stimulus and response, respectively, every 8 ns.

To provide analog stimulus at a 128-MHz analog test rate while maintaining low distortion, HP has applied a technique called Fractional N Divider developed for its microwave signal sources. The 9480's analog stimulus source uses a 200-MHz crystal oscillator as its signal, then uses the Fractional N Divider to achieve a lower frequency. A benefit of the technique is its very low total harmonic distortion. At certain frequencies—1, 2, 5, 10, 20, 50, and 100 MHz—the divider produces an almost pure sine wave with a total harmonic distortion of -80 dB. At the 128-MHz frequency, total harmonic distortion is -60 dB.

For gathering analog responses, HP uses a technique developed for the company's 1-GHz oscilloscope, which uses a 40-MHz sampling rate to digitize its input waveform with 6 bits of resolution. Instead of using the 40-MHz sample

rate, the test system samples at 1-MHz rate and thus achieves a 12-bit resolution required to test high-resolution DACs currently being produced. The tester can use a lower sampling rate because—unlike a scope—it precisely controls the stimulus source.

A fully equipped system with all 128 channels installed costs about \$1.3 million. The system is ready three months after ordering, and HP has begun shipments.

—Jonah McLeod

Hewlett-Packard Co., 3000 Hanover St., Palo Alto, Calif. 94304.

Phone (415) 857-1501 [Circle 380]

UNIVERSAL COUNTER HAS BUILT-IN CRT

A microprocessor-based instrument from Enertec Instruments is the first universal counter with a built-in CRT display, the company claims.

Model 2721 measures frequencies up to 200 MHz with voltage sensitivity of 15 mV. An optional channel extends the instrument's frequency range to 1.25 GHz. It attains high sensitivity and noise immunity by utilizing two precisely set trigger levels that can be set at 30% of the signal amplitude. This also allows resolutions of 500 ps when the instrument operates in single-shot mode.

The counter comes with 17 measurement functions, including signal fre-



quency, period, phase and duty factor, rise and fall times, and peak-to-peak signal values. It includes a feature for totaling measurements.

Mathematical processes such as scaling, averaging, smoothing, and limiting may be applied to the result. In addition to its analog output, the 2721 records and displays on its CRT screen how the measured parameter changes with time. Three types of time bases are available, depending on desired stability. The instrument may be programmed to create hard copies of screen displays.

Available now with an IEEE-488 interface, the 2721 base unit costs \$4,600. Enertec Instruments Export Department, 5 rue Daguerre, 42030, St. Etienne Cedex 2, France.

Phone 77 25 22 64 [Circle 385]

MULTILAYER BOARDS GET CAD SOFTWARE

Visionics Corp.'s EE Designer II computer-aided-design software targets pc-board applications where surface-mounting design and multilayer capabilities are required. The software retains the functions of the company's products for schematic design, circuit simulation and board layout, but adds a graphics kernel that provides flexibility in creating components and pad shapes.

Designers can use EE Designer II to create ground planes on both sides of a pc board and to specify trace widths,

pad sizes, and several other options, including 5- and 12-mil grid spacings, and the ability to save design macros. The software also facilitates the production of fabrication drawings with related text through its automatic board-dimensioning and text-editor features.

Available now, the package costs \$1,875. A companion product, the AutoRouter II package for routing, costs \$1,475. Together, they cost \$2,975.

Visionics Corp., 1284 Geneva Dr., Sunnyvale, Calif. 94089.

Phone (800) 225-5669 [Circle 388]

IN-CIRCUIT EMULATOR COSTS LESS THAN \$600

Beck-Tech's Romice in-circuit emulator for testing and developing embedded microprocessing systems in personal computers uses a single plug-in slot and costs \$595.

Romice emulates ROM or EPROM on IBM Personal Computer ATs, XTs, or compatibles. Processor-independent, it operates in 4- to 32-bit systems. It clocks in at 64-K bytes in 15 s, has a standard access time of 200 ns, and offers an optional speed upgrade to meet 150- or 100-ns access times.

The emulation package includes a 24-in. cable and connector for 28-pin memory-device sockets.

Up to two of the cards can be plugged into a PC to provide 128 K of

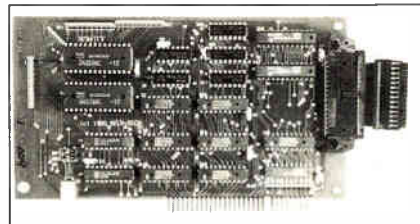

emulation memory. Disk-operating-system software is included to support a screen editor of the memory contents as well as other commands. Romice's flexibility permits the PC to perform other functions while the emulator is in emulation mode.

Beck-Tech, 41 Tunnel Road, Berkeley, Calif. 94705.

Phone (415) 548-4054 [Circle 386]

INTERFERENCE TESTER OPERATES IN 3 MODES

A bench instrument from MWB Messwandler-BAU AG of West Germany lets IC designers test for electrostatic discharge and power-line-interference susceptibility in three different simulation modes.

Model KNS is specifically intended for verifying product immunity to electrostatic discharge from people and to the power-line disturbances that can affect



high-density ICs in production areas.

Its electrostatic-discharge component is based on a human reactive-capacitance model of 150 Ω and 150 pF. Simulation voltage is variable to 6 kV at a repetition frequency of 1 Hz. An optional high-voltage test gun can be used to direct the discharge to the point of contact.

The three interference modes vary with impulse voltage, wave shape,

Test this pioneering feature for yourself. 45% capacity after 12 months storage.

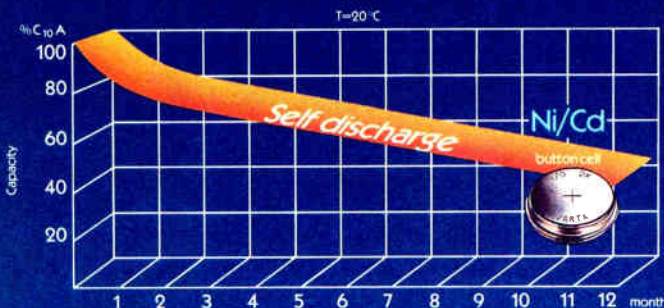

Rechargeable VARTA button cell batteries with mass electrodes have an extremely low self-discharge rate. Progress is outstanding: higher autonomy of the module - more

available capacity for long-term operation and display features.

Order your test batteries now!

VARTA Batterie AG, Am Leineufer 51, D-3000 Hannover 21
VARTA Batteries, Inc., 300 Executive Boulevard, Elmford N.Y. 10523-1202, USA
VARTA Private Ltd., P.O. Box 55, Bedok North Post Office, Singapore 9146



VARTA

Circle 130 on reader service card

ONE UPMAN CHIP.

Options. No other ASIC company is able to pack more logic, memory, processors or peripheral controllers on a single IC.

Integration. No ASIC supplier is better equipped to integrate large functional blocks in 2 μm and 3 μm geometries.

Speed and total control. No matter how unique your application or how elaborate, NCR puts the design tools in your hands to combine standard cells, supercells and compiled cells faster than you ever thought possible.

First-pass success. And we don't mean design starts. Or prototypes. We mean one of the highest design-into-production success rates of any ASIC supplier on the planet.

Long-range migration strategy. NCR helps prevent technology obsolescence. Your design evolves without the usual growing pains and without going through lengthy re-design cycles.

The competitive edge. NCR provides you with the CAD tools that can build a chip with functions and densities that outrival the competition.

A great track record. NCR takes devices all the way from concept through fabrication.

On-time. On-budget.

All you have to do is say when.

Call 303-226-9500 for our fact-filled ASIC data package.

Or write Commercial ASIC Products, 2001 Danfield Court, Ft. Collins, CO 80525.

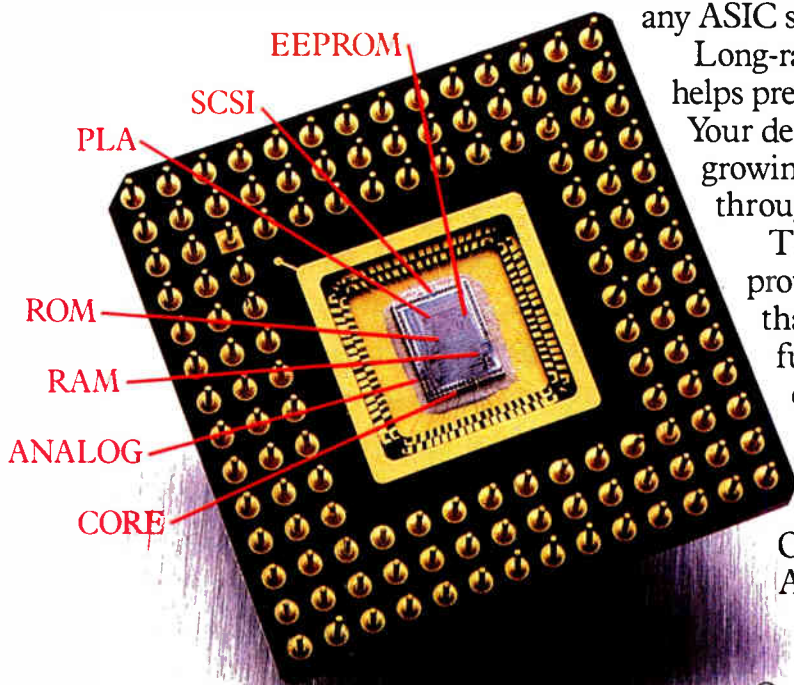

NCR

NCR Microelectronics Division

©1986

Circle 131 on reader service card

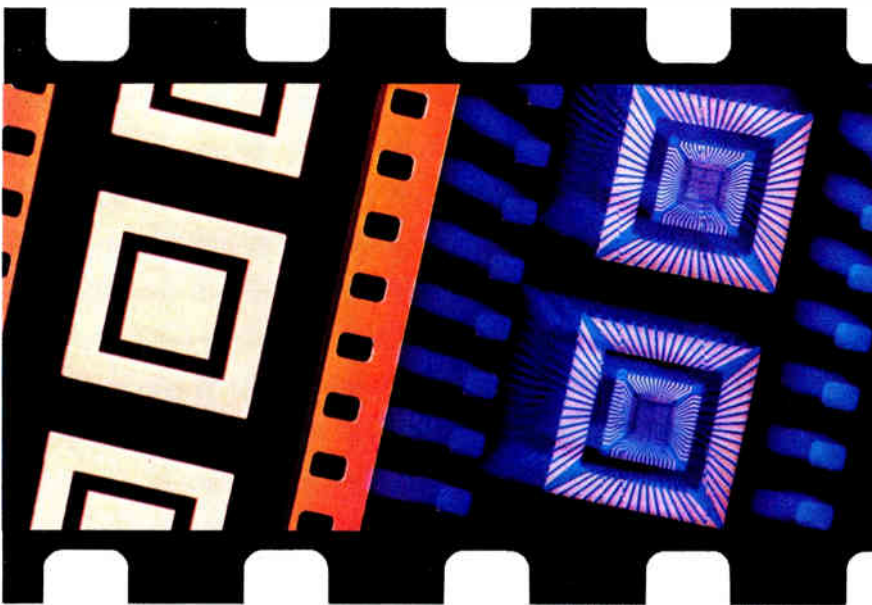

When you're designing for million-chip production, Rogers TAB materials help you get more into less.

Get 3-layer performance: High-volume chip mounting with up to 1000 leads calls for TAB. For cantilevered lead support, you've had to get along with the limitations of 2-layer tape. Now there's a better way . . . Rogers' Floating Annulus TAB (FA/TAB) puts an unsupported annular ring on 3-layer tape.

Get cost-efficiency: Adapt TAB packages to even the most complex chips without compromise using the FA/TAB system (patent pending). Get positive lead support in the X, Y and Z axes. Do full testing, reel-to-reel, right on the tape. You'll enjoy high insulation resistance as well as dimensional integrity, along with better than 95% yield rates.

Get automated processing: Automate your etching, bonding, testing and burn-in with reel-to-reel processing. You'll get chip mounting with improved mechanical, electrical and thermal properties, no adhesive outgassing, and ionic contamination so low that it's almost impossible to measure.

Get Rogers capability: There's a Rogers tape for every high-volume TAB application. Get the facts, plus a free sample for proof. Call a Rogers materials specialist today, at (602) 963-4584.



ROGERS

Rogers Corporation
Circuit Materials Division
Box 4000, Chandler, AZ 85244

Circle 132 on reader service card

U.S. Savings Bonds Now Earn 7.02%

U.S. Savings Bonds now earn market-based interest rates—like money market accounts. So you're guaranteed a competitive return no matter what happens to interest rates! All you need to do is hold your Bonds for five years.

For more information, call toll-free 1-800-US-BONDS.



U.S. SAVINGS BONDS

Bonds held less than five years earn a lower rate.

A public service of this publication.

source impedance, and polarity. The line-interference coupling network accommodates products with power ratings as high as 220 V and 10 A.

The instrument has been modified for use in the U. S. It will be distributed by Slaughter Corp. in the first quarter of 1987 at a base price of \$4,800.

Slaughter Corp., P.O. Box 1805, Ardmore, Okla. 73402.

Phone (405) 223-4773

[Circle 387]

PORTABLE HAS SCOPE, AVERAGER, METER

A microprocessor-controlled; multipurpose measuring instrument from the Yugoslavian company Iskra Electronics Corp. combines the functions of a digital oscilloscope, an averager, and a digital multimeter in a single, portable instrument.

At a \$1,500 base price, the Iskroscope LCD can be used for measuring and recording as well as for inspection and



testing of components and equipment. The instrument features a membrane keyboard with voice indication of manipulation commands and a tiltable LCD data display. The eight-pound unit folds into its own carrying case and can operate on rechargeable NiCd batteries, making it ideal for field work. It is available now from the company's U. S. distributor.

Iskra Electronics Corp., 222 Sherwood Ave., Farmingdale, N. Y., 11735.

Phone (800) 862-2101

[Circle 390]

WAVEFORM DIGITIZER HAS 10-BIT ACCURACY

Sequence Inc.'s Model 3000 waveform digitizer attains 10-bit amplitude resolution at a 1-ns sample interval and offers a 1,024-word acquisition memory with pre- and post-triggering capability.

The instrument also features a single-shot input bandwidth of dc to 350 MHz and a multifunction software package designed to allow up to eight Model 3000s to use a single personal computer for display and signal analysis.

Available now, the Model 3000, including the multifunction software package, costs \$28,500. Delivery is within 60 days of order.

Sequence Inc., 1650 Zanker Rd., San Jose, Calif. 95112.

Phone (408) 436-6065

[Circle 389]

A new direction in interconnection technology.

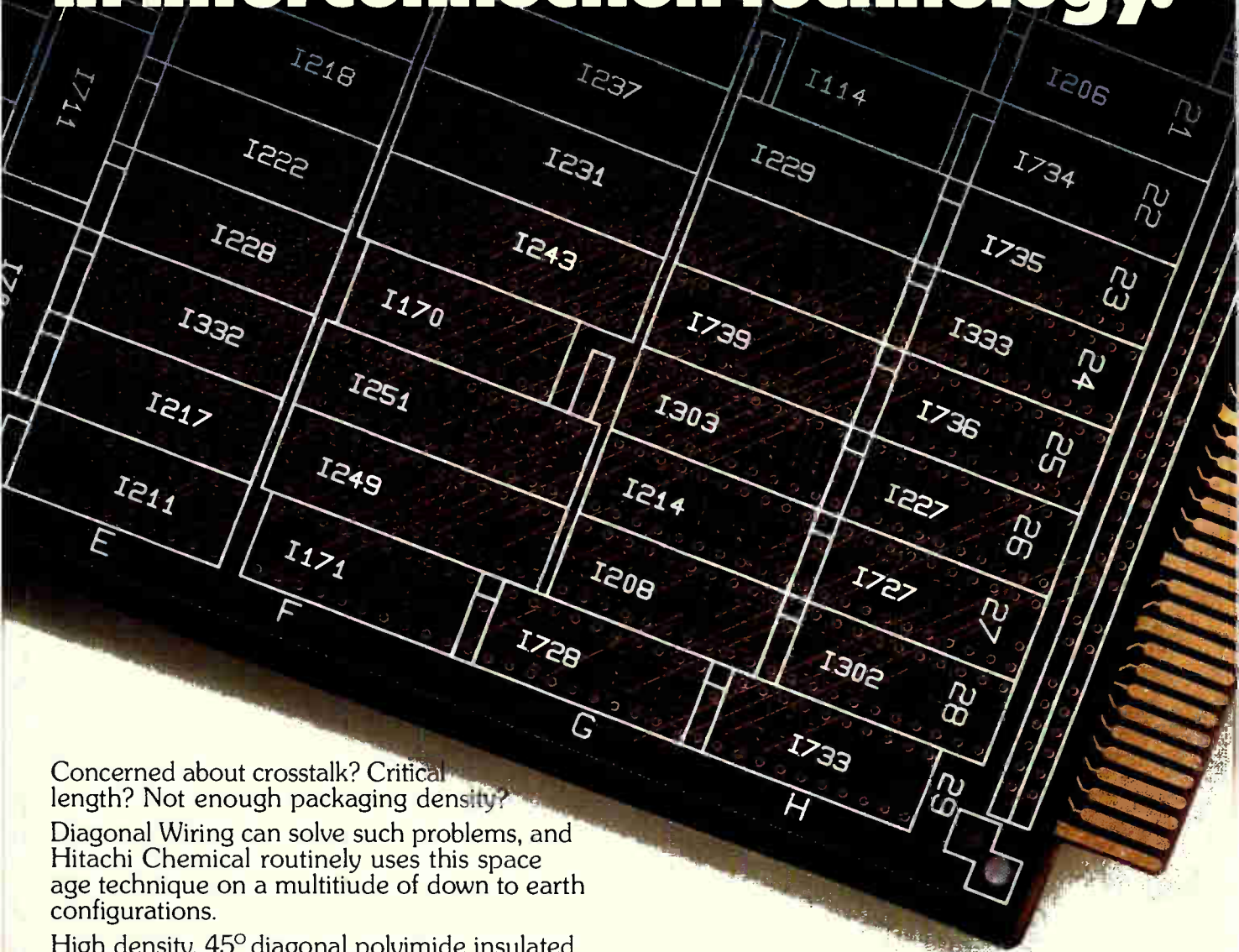

Concerned about crosstalk? Critical length? Not enough packaging density?

Diagonal Wiring can solve such problems, and Hitachi Chemical routinely uses this space age technique on a multitude of down to earth configurations.

High density, 45° diagonal polyimide insulated wiring reduces parallel lengths of critical conductors and decreases point to point routing distance. This minimizes crosstalk, facilitates critical length considerations, isolates special logic families like ECL, and greatly increases packing density. Multiwire® interconnection technology also makes controlled impedance easy.

Let us help you with your next board design. Hitachi offers a different angle with Multiwire interconnection boards including SMT and the latest trends.

HITACHI CHEMICAL COMPANY AMERICA LTD.

Sales Offices: 3469 Lawrenceville Hwy.
Suite 205
Tucker, GA 30085
(404) 938-9388

420 Lexington Ave.
New York, NY 10170
1-800-227-1529

4141 Blue Lake Circle
Dallas, TX 75234
(214) 960-9675

1333 Lawrence Expwy.
Santa Clara, CA 95051
(408) 244-2570

2000 West Park Drive
Westborough, MA 01581
(617) 366-4092

Multiwire® is a registered U.S. trademark of the Kollmorgen Corp.

Circle 133 on reader service card



Hitachi Chemical Co. Ltd.

Here's how IMC can help you...

Just circle any of these numbers on the reader service card and let **IMC** come to the rescue.

DC Motors and Motor/Encoders



IMC UNIVERSAL MAGNETICS CORP.
A DIVISION OF IMC MAGNETICS CORP.
1000 ROUTE 90A, JERICO, NY 11753

Circle Reader Service No. 165
Catalog features DC motors and motor/encoders along with performance data and specifications.

Custom Power Supplies



IMC IMC MAGNETICS CORP.
A DIVISION OF IMC MAGNETICS CORP.
1000 ROUTE 90A, JERICO, NY 11753

Circle Reader Service No. 166
Catalog shows how you can benefit from IMC's consolidation of resources as well as other information pertaining to their custom built power supplies.

TORMAX® Steppers and Controls



IMC IMC MAGNETICS CORP.
A DIVISION OF IMC MAGNETICS CORP.
1000 ROUTE 90A, JERICO, NY 11753

Circle Reader Service No. 168
Catalog features specialty stepping motors and listing of controllers to drive them. Also chapters on theory of operation, excitation modes and applications.

Synchron

- AC Timing Motors
- DC Motors
- Clock Movements
- Stepping Motors



IMC IMC MAGNETICS CORP.
A DIVISION OF IMC MAGNETICS CORP.
1000 ROUTE 90A, JERICO, NY 11753

Circle Reader Service No. 167
Catalog gives general specifications on Synchron® AC timing motors as well as Magna-Torc DC motors. Products include clock movements, chart drives and slip ring assemblies.

IMC VANEAXIAL FANS

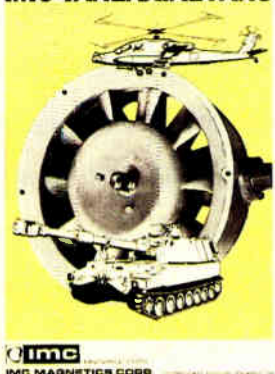

IMC IMC MAGNETICS CORP.
A DIVISION OF IMC MAGNETICS CORP.
1000 ROUTE 90A, JERICO, NY 11753

Circle Reader Service No. 169
Portfolio contains spec. sheets on IMC's complete line of large vaneaxial units. Fans are ideally suited for cooling applications requiring a large volume of air.



Vaneaxials

IMC IMC MAGNETICS CORP.
A DIVISION OF IMC MAGNETICS CORP.
1000 ROUTE 90A, JERICO, NY 11753

Circle Reader Service No. 170
Catalog contains information on air-movers rated for highest efficiencies. Included are charts as well as data on aerospace applications.

CENTRIFUGAL BLOWERS



IMC IMC MAGNETICS CORP.
A DIVISION OF IMC MAGNETICS CORP.
1000 ROUTE 90A, JERICO, NY 11753

Circle Reader Service No. 171
Catalog contains an extensive range of centrifugal blowers to meet a variety of cooling requirements.

The Motor Catalog

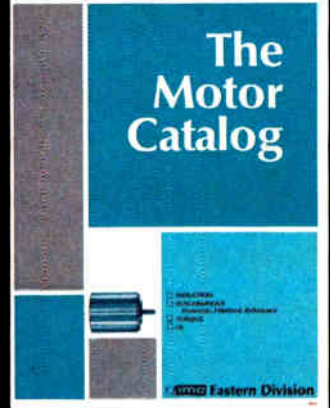

Circle Reader Service No. 172
Catalog is divided into sections for induction, torque and DC motors with sections devoted to technical information.

Keep Your Eye on IMC



IMC MAGNETICS CORP.
CORPORATE OFFICES Tel: (516) 938-0800
100 Jericho Quadrangle, Suite 221 • Jericho, NY 11753

QUAD-GATED DRIVER LETS BIPOLAR DO HARSH DUTY

RCA DEVICE INDEPENDENTLY LIMITS TEMPERATURE AND CURRENT ON FOUR OUTPUTS FOR PROTECTION IN TOUGH ENVIRONMENTS

GE/RCA Solid State Division has targeted automotive and industrial applications for its quad-gated inverting power driver by incorporating into a bipolar device the protective features needed in harsh environments.

Previous implementations in these applications were almost entirely CMOS. No bipolar entrants offered the same degree of protection. Samples in dual in-line packages and surface-mounted versions of the device are available.

Containing four-gate switches, the CA3262 is a 16-lead circuit that interfaces low-level logic to inductive loads such as ac and dc motors, heaters, and vacuum-fluorescent displays. A key feature is its independent over-current and over-temperature limiting provisions on each of the outputs. Outputs are capable of switching 600-mA load currents without introducing spurious changes in the output state.

To maintain maximum heat transfer from the chip—an important factor in the constantly varying environment of automotive applications—the two center leads are directly connected to the die substrate and ground bond pads. This reduces the junction-to-air thermal resis-

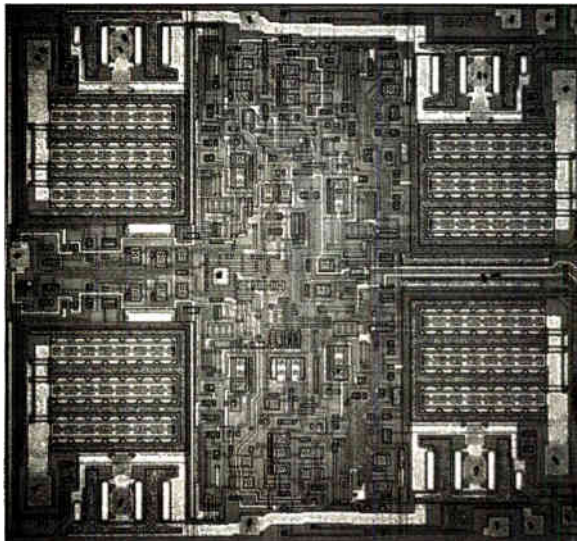

INTERFACE. RCA's quad driver connects low-level logic to inductive loads such as motors and fluorescent lamps.

tance in free air to no more than 50°C/W, on the average. Without the precautions taken to ensure high-performance heat transfer, a comparable device would typically have a junction-to-air resistance in free air of about 150°C/W.

If one output load is short-circuited, the remaining three outputs on the CA3262 function normally unless the 155°C maximum junction temperature of those outputs is exceeded. Also, the output stage does not change its logic state when in the current-limiting and thermal-limiting modes.

The CA3262 can drive as many as four incandescent lamp loads without modulating their brilliance. The devices can be cascaded to drive large loads.

Although its inputs are compatible with TTL logic or 5-V CMOS logic, the CA3262 can tolerate unusually high maximum input voltages. It can operate at a logic-supply voltage as high as 7 V and a logic-input voltage as high as 15 V. Output voltage is 50 V, and output sustaining voltage is 35 V. Featuring an output current of 1 A dc, the CA3262 has a power dissipation of 1.5 W.

In 1,000-unit quantities, the 16-pin device costs \$2.87 each in a plastic DIP and \$3.37 each when surface-mounted. They are available in production quantities.

—Bernard Conrad Cole

GE/RCA Solid State Div., Box 3200, Somerville, N.J. 08876. [Circle 360]

RECTIFIERS CAN BE SURFACE-MOUNTED

Philips International NV is fielding a family of rectifiers that offer performance and assembly advantages over conventional diodes. The company produced the new surface-mounted implosion diodes by adapting its existing implosion-diode technology to allow surface mounting on printed-circuit boards.

The SMIDs are fabricated by imploding a glass sleeve around the diode to form a high-integrity, cavity-free capsule. The encapsulating glass maintains excellent contact between the end studs and the diode crystal, resulting in low forward-voltage characteristics—about 10% to 15% lower than glass-bead diodes [*Electronics*, Aug. 21, 1986, p. 37]. Moreover, for the same size crystal, the cylindrical IDs are 20% to 30% smaller than ball-like glass-bead diodes.

Philips' 3.5-mm-long devices are 1.5 mm shorter than conventional diodes. The devices come in an SOD-87 package that can be packed on 8-mm tape instead of 12-mm tape, and they fit on a

wider variety of surface-mounting machines, according to the company.

SMIDs save board space and weigh half as much as glass-bead diodes with crystals the same size, which makes mounting easier and minimizes the ten-

dency of the diodes to roll during mounting. Their smaller diameter also requires less solder.

Philips decided to adapt its IDs to surface mounting because customers reported problems with existing 5-mm-

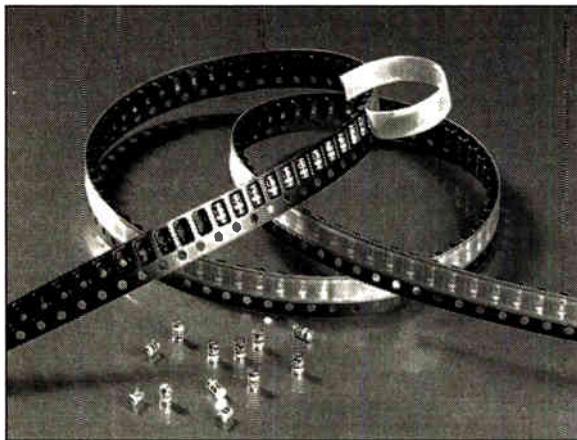

SMALLER. Philips' rectifiers can be packed on 8-mm surface-mounting tape instead of 12-mm tape.

long surface-mounted-devices, says Graham Hine, international marketing manager for diodes at Philips' Electronic Components and Materials Division (Elcoma). The new devices handle up to 1 A at 1,000 V.

The new rectifier family includes the general-purpose BYD17 series; the BYD37 series, for fast-recovery applications such as TV; the BYD77 series epitaxial-avalanche rectifiers, for switched-mode power-supply and high-frequency applications;

FREE!



Here's the data you need on AC power for ATE systems, laboratories, test facilities, robotics, quality control, data processing and more. It's all in our new full color catalog that features hundreds of AC Power Sources and Uninterruptible Power Systems. Call or write for your free copy.

(805) 684-8311 COLLECT



1142 Mark Avenue
Carpinteria, CA 93013

Circle 136 on reader service card

TECHNICAL INNOVATION EXPLORING INTO.....

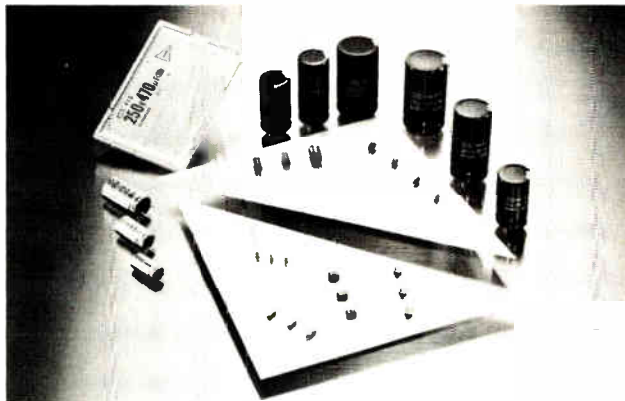

For years, Nippon Chemi-con has continuously been developing totally new products to help miniaturization, low cost, high reliability and performance of consumer application as well as of industrial. Nippon Chemi-con's products are always reflecting trends of customers demands.



NIPPON CHEMI-CON CORP.

7-8, Yutaka-cho 2-chome, Shinagawa-ku, Tokyo 142, Japan
☎(03) 785-1257, TLX:24618 KEMICON J

UNITED CHEMI-CON INC.
9801 W. Higgins Rd. Rosemont Illinois
60018, U.S.A.
☎(312)696-2000
TLX(230)283557 CHEMICON ROSM

SINGAPORE CHEMI-CON (PTE.) LTD.
17, Joo Yee Road, Jurong, Singapore
2261
☎(268)2233 TLX(872)26391 SPOCHM

EUROPE CHEMI-CON (DEUTSCHLAND) GMBH
Trautskirchener Strasse 6, D-8500
Nurnberg 80, West Germany
☎(911)326470 TLX(41)623754 CHEMI D

TAIWAN CHEMI-CON CORP.
13th Floor, Jling-Lurn Trade Bldg. No. 415
Sec. 4, Hsin-Yi Road, Taipei, 106 Taiwan
R.O.C.
☎(402)709-1795 TLX:25326 TCC TPE

Circle 173 on reader service card

and the BZD27 series of voltage regulators, for medium-power circuits.

Both the general-purpose BYD17 and fast-recovery BYD37 types feature a voltage range from 200 V to 1,000 V and an average 1.5 A of forward current. The corresponding values for the BYD77 versions are from 50 V to 400 V and 2 A.

The BZD27 series of voltage regulators have a nominal working voltage range of 7.5 V to 270 V. Certain types are available in the 300-to-510-V range on request, and the series will be extended to 3.9-V types in the future. The total power dissipation for this series is 2.3 W maximum. The nonrepetitive peak reverse power dissipation is rated at 300 W maximum.

Prices worldwide depend on importing country, but savings in mounting costs will more than offset the initially higher price, Hine says. In the U.S., Philips' distributor, Amperex Electronic Corp., says the rectifiers will be available in the first quarter of 1987. In volume quantities, BYD17 parts will cost 6c to 8c each; the BYD37, 7c to 10c; and the BYD77, 11c to 22c. The BYX27 regulators will be available in the second or third quarter of 1987. Prices for the BYX27 are not yet available.

-John Gosch

Amperex Electronic Corp., George Washington Highway, Smithfield, R.I. 02917. Phone (401) 232-0500.

Philips Elcoma, P.O. Box 523, 5600 AM Eindhoven, The Netherlands. [Circle 361]

AT&T'S 32-BIT CHIPS WILL RUN AT 24 MHz

AT&T Technology Systems has rounded out its 32-bit product line with a microprocessor that targets high-performance, multiuser, multitasking Unix computing systems. The company's fastest 32-bit microprocessor—its predecessors ran at 10, 14, and 18 MHz—is one of three integrated circuits in the WE 32200 microprocessor and peripherals chip set.

Fabricated using 1- μ m CMOS technology, the WE 32200 chip set supports clock speeds from 24 MHz to 30 MHz; the chips will initially be offered in 24-MHz versions only. The set consists of the WE 32200 central-processing unit, WE 32201 integrated memory-management unit and data cache, and WE 32206 math-acceleration unit. They are compatible with AT&T's existing WE 32100 chips.

The WE 32200 CPU features a 256-byte instruction cache, 32 registers, additional kernel and user registers, ad-

OUR FIRST STEP INTO THE USA



To provide you - the Ada "buyer" - with even better services, DDC International has now established a subsidiary in the U.S. You can reach us in Phoenix, Arizona, where

our Ada® Compiler System as well as related services are available now. For more information call us on (602) 863-6910

Ada® is a registered trademark of the U.S. Government (Ada Joint Program Office).



DDC International

DDC International, P.O. Box 32230, Phoenix, AZ 85064, (602) 863-6910

Circle 137 on reader service card

Lengths Ahead - the permanent magnets VACODYM®

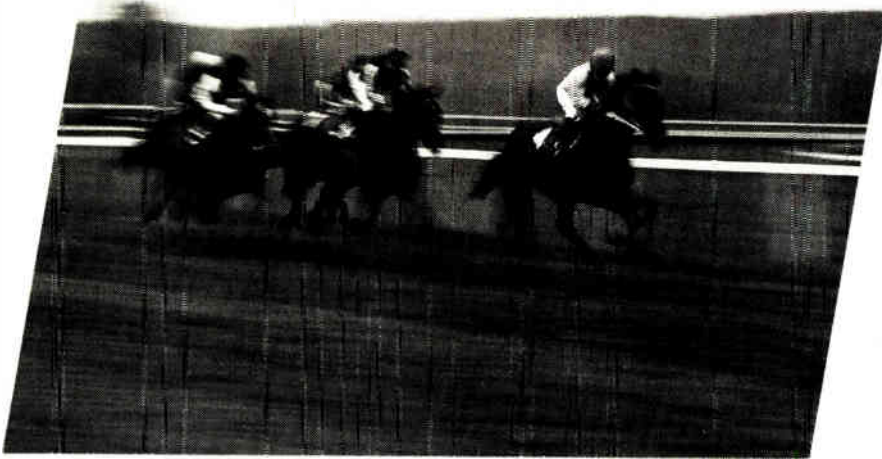

VACODYM - our new permanent magnet material has a top class performance. Its major feature: a high energy product (up to 290 kJ/m³) enabling powerful magnets with the smallest dimensions. VACODYM increases the performance of many applications whether in motors, medical equipment, electro-acoustic transducers, magnetic separators, toys or in many other fields.

Special requirements are no obstacle to us: VAC will advise you on the dimensioning and produce a tailor-made magnet system. Let VACODYM give you a head start.

VACODYM is produced with authorization of Sumitomo Special Metals

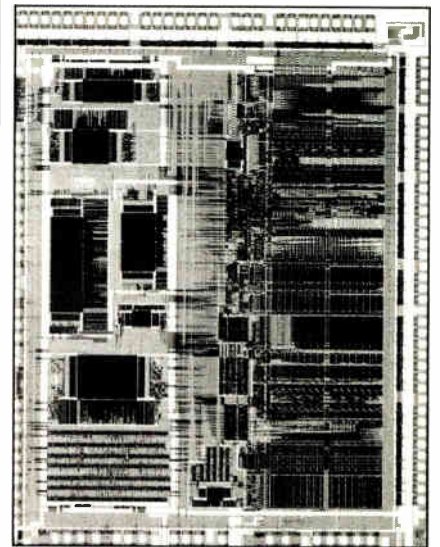

SPEEDY. AT&T's 32-bit WE 32206 floating-point coprocessor chip can execute 2.8 million Whetstones/s at 24 MHz.

...dressing modes to support array access, enhanced quick interrupt, and binary-coded decimal arithmetic instructions.

The WE 32201 memory-management-unit chip provides logical-to-physical address translation and access protection for the WE 32200 CPU. It features a 4-K-byte on-chip integrated data cache. This cache speeds system performance by supporting zero-wait-state virtual-memory accesses. Four of the caches can be linked for up to 16-K of cache memory.

For math-intensive applications, the WE 32206 math-acceleration unit relieves CPU overhead and improves performance by transferring math functions from software to hardware. AT&T claims that the chip is faster than any floating-point coprocessor on the market. To cite a standard performance benchmark, it can execute 2.8 million Whetstones/s at 24 MHz and 3.5 million Whetstones/s at 30 MHz. Although an Inmos Corp. chip has benchmarked at 4 million Whetstones/s, it will not be available until next year. Typically, competitors benchmark between 0.3 and 1 million Whetstones/s.

Some 1,500 Unix applications packages are available to take advantage of that speed. "As developer of Unix, we offer depth in support that's unmatched in the industry," says Al Hofmann, manager of microprocessor marketing. For programming in-house WE 32200 applications, AT&T offers a complete line of software development tools, including Fortran, C, Pascal, and Ada compilers. Also available are math and input/output libraries, a symbolic debugger, assemblers, and a firmware tool for encoding EPROM software.

Engineering samples of the WE 32200 chip set will be available in the second

M-1146

VAC
VACUUMSCHMELZE

VACUUMSCHMELZE GMBH

West Germany

Represented by: VACUUMSCHMELZE c/o Siemens Components, Inc.
186 Wood Avenue South · Iselin N.J. 08830 · Phone (201) 494-3530 · Tx WU 844 491

Circle 138 on reader service card

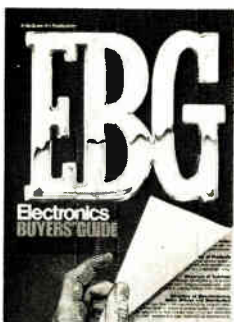

NOW AVAILABLE!

1986-'87

Electronics Buyers' Guide

The industry's most often-used directory:

- 3 directories in one.
- Lists more than 4000 products.
- Lists over 5000 companies.
- FREE current catalog retrieval service.

Send order with payment to: Barbara Copcutt

Electronics Buyers' Guide

McGraw-Hill House
Maidenhead SL6 2QL, England

Price: \$50 per copy
(Add \$30 for air mail)

CADDStation™

HOW DOES YOUR CAD/CAM SYSTEM COMPARE?

CADDStation™

YES NO

UNIX® POWER

A UNIX® Operating System offering ease-of-use, windowing, multi-tasking, inter-process communication, flexibility and a rich programming environment.

Your System

YES NO

FULL INTEGRATION

Industry standard systems technology such as a true high-speed 32-bit VME bus, a 32-bit MC 68020 CPU and Ethernet® interface. Combined with TCP/IP network protocols and graphics subsystems.

OPEN NETWORK

Able to operate alone, as nodes in LANs, or as diskless machines. Compatible with IBM, BSC and SNA. Plus the latest industry Network File System (NFS) based on Sun Microsystems technology.

LOW COSTS

Offered in a wide range of configurations, capabilities and prices. Options are available to you from \$20,000 for a network add-on. From \$50,000 for a stand-alone system. A price-performance ratio that maximizes ROI.

CADDS® 4x SOFTWARE

Simply put, the most widely installed and highly regarded CAE/CAD/CAM applications software in the world, and it's available now. Plus, other UNIX® third party software.

PROTECTED INVESTMENT

Makes obsolescence obsolete by developing and maintaining constantly compatible hardware and database systems that are your company's most valuable assets. And backs it up with worldwide service and support, training and ongoing R&D.

IBM is a registered trademark of International Business Machines Corp. UNIX is a registered trademark of AT&T Bell Laboratories. Ethernet is a registered trademark of Xerox Corp.



EL

I've compared! Please tell me more about the power, performance and price of CADDStation™ by Computervision. I'm considering CAD/CAM Now Please call me I'm gathering information at this time.

Name: _____ Title: _____

Company: _____

Street _____ City/Zip _____ Phone: _____

Mail to:
Computervision Corp.
Dept. 425A
100 Crosby Drive
Bedford, MA 01730



Another high voltage power supply
cut in half...



**The WH Series... 500 watts,
1/2 the space, 1/2 the weight
and we even cut the price!**

When Glassman packed 500 Watts @ 80kV into 10 1/2" of rack space a few years ago, it was a pretty impressive feat.

Although that may seem commonplace today, the next step, which we've just taken, isn't. We've packed 500 watts @ up to 75kV in half that space... 5 1/4". The WH Series is one half the size and weight of the PG Series models it replaces. In it, you get more regulated high voltage in less space than any other supply we know of.

To accomplish this, we've developed some new circuitry that we believe has increased the reliability of our already sound, field proven switch-mode technology.

If light weight, compactness, tight regulation, and high reliability are major factors in your high voltage power supply requirements, then call John Belden at 201-534-9007 for complete details on the new WH Series.

Innovations in high voltage power supply technology.

GLASSMAN HIGH VOLTAGE INC.

Route #22 (East), Salem Industrial Park, P.O. Box 551, Whitehouse Station, N.J. 08889
(201) 534-9007 • TWX 710-480-2839



Circle 140 on reader service card



**SMART WOMEN KNOW
HOW TO MAKE MONEY.**

It's easy, with U.S. Savings Bonds. Today's Bonds earn competitive, market-based interest rates—like money market accounts. Plus, there's a guaranteed minimum return and big tax advantages. For more information, call 1-800-US-BONDS.

U.S. SAVINGS BONDS 

Bonds held less than five years earn a lower rate than the guaranteed minimum. A public service of this publication.

World Radio History

quarter of 1987. Production quantities will be ready later in the year. In quantities over 100, the CPU chip will sell for \$500 per unit, the memory unit/cache for \$550, and the math acceleration unit for \$425.
—Alexander Wolfe

AT&T Technology Systems, 555 Union Blvd., Dept. KB, Allentown, Pa. 18103.
Phone (800) 372-2447 [Circle 362]

**TOSHIBA SRAM HAS
35-ns ACCESS TIME**

Toshiba America Inc.'s n-MOS static RAM features access times as low as 35 ns. It is organized as 8,192 nine-bit words to provide an extra bit for parity checking.

The TMM2089C targets applications in control-store memories, cache memories, graphics, and telecommunications.

A power-down feature results in a maximum operating current of 120 mA,

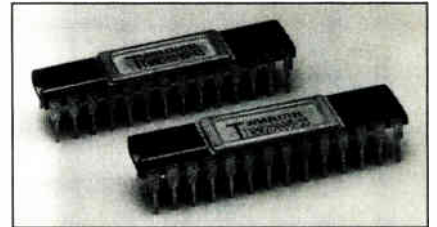

and 10 mA in standby mode.

Packaged in a 300-mil-wide, 28-pin ceramic DIP, the chip is available with access times of 55 ns, 45 ns, and 35 ns. The devices cost \$36.80 in 1,000-piece quantities, and delivery takes 8 to 12 weeks.

Toshiba America Inc., 2692 Dow Ave., Tustin, Calif. 92680.

Phone (714) 832-6300 [Circle 365]

**256-K CMOS EPROM
USES ONLY 65 mA**

A 256-K ultraviolet-erasable PROM from WaferScale Integration Inc. offers access times of 70 ns and is organized as a 32-K-by-8-bit array.

Fabricated with the company's 1.2-µm CMOS technology, the WS27C56F consumes 65 mA while cycling at full speed—less than one-fourth the power consumption of comparable n-MOS devices—while operating at twice the speed of n-MOS, the company claims.

It targets high-speed applications such as digital signal processing, and is available in a leadless, surface-mount package that reduces pc-board area requirements. It is also available in a conventional 28-pin ceramic DIP. Available in mid-January, the DIP version will cost \$82 per 100 pieces; the surface-mount version, \$110 per 100 pieces.

WaferScale Integration Inc., 47280 Kato Rd., Fremont, Calif. 94538.

Phone (415) 656-5400 [Circle 366]

AMD GLUE-LOGIC PALs FEATURE 15-ns DELAYS

Programmable-array-logic chips with delay times as low as 15 ns from Advanced Micro Devices Inc. are program-compatible with the company's previous PAL devices.

The AmPAL16XXB series features a 15-ns delay time and a 40-MHz frequency with maximum power-supply current of 180 mA. The AmPAL16XXAL series has a 25-ns delay time, and a 90-mA supply current. For even lower power consumption, the AmPAL16XXQ series operates at 35 ns and 45 mA.

The chips are software-compatible with AMD's current AmPAL16XX, AmPAL16XXA, and AmPAL16XXL series of PAL devices.

The family is used in a variety of glue-logic and state-machine applications, such as computers and add-on cards. In 100-unit quantities of plastic DIPs, the AmPAL16XXB chips cost \$5.85 each, and the AmPALXXAL \$3.70 each. Both are in production. The AmPAL16XXQ costs \$5 each in 100-unit lots and will be available in January.

Advanced Micro Devices Inc., 901 Thompson Pl., P.O. Box 3435, Sunnyvale, Calif. 94088. Phone (408) 732-2400 [Circle 368]

LOW-POWER REGISTER SUPPORTS 25 MHz

Zyrel Inc.'s 12-bit successive-approximation register runs at a guaranteed maximum speed of 25 MHz on less than 4 mA of current.

For use primarily in analog-to-digital converters, the Zy25HCT04 can also be used in ring counters and serial-to-parallel converters. Analog-to-digital converters capable of 5 million conversions/s can use the device. It is a 1.5- μ m CMOS replacement for Advanced Micro Devices Inc.'s bipolar chips, the 2504 and 25L04, according to Zyrel officials.

The 25HCT04 is available now in chip form and in plastic DIPs. Its 100-piece price is \$4.80 for the chip alone and \$5.50 in the plastic DIP.

Zyrel Inc., 1900 McCarthy Blvd., Suite 201, Milpitas, Calif. 95035.

Phone (408) 433-0488

[Circle 367]

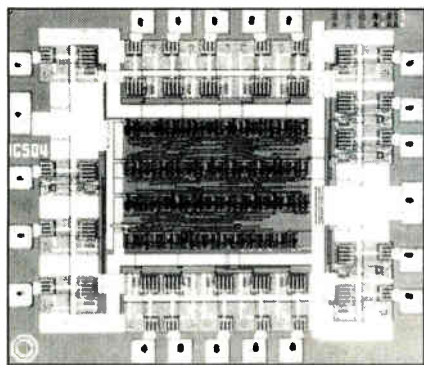

5 MIPS
@
25 MHz
AVAILABLE
TODAY-
MC68020.

Motorola's shipment of over 250,000 high-performance MC68020s to date accounts for more than 85% of 32-bit MPUs.



MOTOROLA

DUPONT'S MEMORY CARDS HOLD 1 Mb OF ROM OR RAM

COMPACT PACKAGES COMBINE SURFACE-MOUNT, CHIP-ON-BOARD, AND CONNECTION TECHNOLOGIES

Du Pont Co.'s Connector Systems Division has branched into a new field—chip-based memory cassettes that are capable of high-speed digital information retrieval. Three styles of the cassettes provide substantial memory capacity in handy packages that blend surface mounting, chip-on-board, interconnection, and materials technologies.

The memory cassette comes in three compact sizes in random-access-memory and read-only-memory versions, from 32 K through 1 Mb. The smallest, style M, for miniature, is 37 mm by 32 mm; the next, style S for standard, is 58 mm by 53 mm; and the largest, style CC, for credit-card size, is 58 mm by 85 mm. Style CC is the first 1-Mb credit-card-size RAM memory cassette, the company claims.

Each device has two parts: a cassette with an integral connector, and a mating header. A special pin-and-socket connector has been developed that can withstand a minimum of 10,000 mating cycles. Connector contacts are palladi-

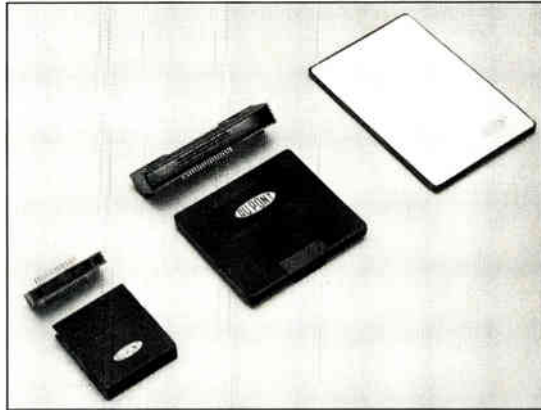

HANDY. DuPont's memory cards come in three convenient sizes and have a variety of applications.

um-nickel-plated with gold flash for durability. The miniature connector has its pins on 50-mil centers.

The 1-Mb CMOS static-RAM cassette consists of 16-by-64-K chips tape-bonded to a thin epoxy-glass printed-circuit substrate assembled inside a 120-mil-thick

plastic card case.

The nylon connector and header housings have 38 mechanically shielded male/female contacts. Polarized to prevent misapplication, the device provides electromagnetic-interference and static-discharge protection and includes a write-protection switch. Read/write cycle time is 350 ns. A 3-V lithium battery provides 2.5 years of data retention.

The S cassette can be used for either RAM or ROM packaging with 40 I/O contacts on 50-mil centers. It can accommodate 4-, 8-, or 16-K bytes of RAM or two or three times 128-, 256-, or 512-K byte ROM, depending on the number of memory chips desired. The M cassette has 30 I/O contacts and provides one or two times 128-K, 256-K, or 512-K ROM capacity.

Applications include text memory and type fonts of printers, electronic typewriters, and word processors; video/image memory for videotex, teletex, or CAD/CAM; language-instruction display for copiers; and software backup to floppy disks.

—Jerry Lyman

Dupont Co. Connector Systems Division,
30 Hunter Lane, Camp Hill, Pa. 17011.
Phone (717) 975-2000 [Circle 400]

LIGHT MONITORS, CONTROLS OWN OUTPUT

A lighting system from Lightgate monitors its own output and adjusts power to maintain the desired light-output level to within 1%. The system, called the LightSource 2010, also monitors incoming power to sense when a light source is about to fail. An optional programmable control cell, programmed by an IBM Personal Computer, allows the modulation of polarity, color, and intensity while maintaining the same output light level.

Lightgate, an Oakland, Calif., specialist in light-modulating products, developed LightSource 2010 for robot vision systems. However, Lightgate President Victor B. Kley expects it to be used as a component in a wide variety of applications in still photography and motion pictures and generally in the measurement and planning of lighting requirements. The system plays a key control role in a robotic wire and tape bonder built by Shinkawa of Japan and displayed this month at Semicon in Tokyo.

The programmable control cell utilizes liquid-crystal elements to modulate light output for maximum contrast. In a wire bonder such as the one displayed at Se-

micon, the robot sensor must distinguish between leads and lead spacings, Kley explains. If the light has high reflectivity, the robot will not always be able to distinguish between leads and spacings on the basis of contrast. Consequently, it will fail to make a certain percentage of the bonds.

Lightgate adapted a technique it developed for enhancing contrast in microscopes to eliminate glare in bonding applications. Only a few combinations of polarity, color and intensity will work

for any given situation. "We build a histogram of the problem and select the best set of solutions," Kley says. "With this kind of structured lighting, we can guarantee to deliver the contrast required 100% of the time."

The system can be controlled manually or remotely, or by a PC over an RS-232-C interface link. It responds in less than 15 ms to changes in light output, as detected by a photodiode. Under computer control, the system can link up to 16 light sources and control a total of 32 kW. Current versions use tungsten/halogen lamps; a discharge-lamp version is planned.

For applications where a continuous light source is required, such as an inspection line where a bulb failure will shut down the line, the 2010 can warn of impending problems. It monitors how much power is required to operate the bulb at its peak; when this value exceeds a certain boundary, the system signals that the bulb is about to fail.

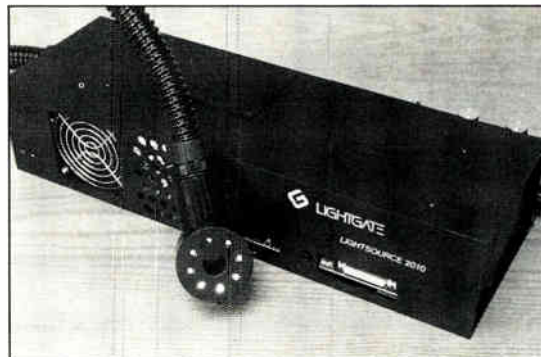

VERSATILE. Lightgate's programmable light source can be used in robot vision, photography, and motion pictures.

Find out how good Business Class can be.

TWA



TWA AND AMERICAN EXPRESS MEAN BUSINESS.

Discover the peace of mind that comes with TWA's

Airport Express® service. TWA recommends you reserve and pay for your tickets ahead of time with the American Express® Card, and get your boarding passes even before you get to the airport.

Plus, Business Class travelers enjoy many other special services like priority luggage drop-off and pick-up.

YOUR COMFORT IS OUR BUSINESS. TWA goes to great lengths and widths to ensure your comfort with extra leg and shoulder room. And on our 747s, Business Class travelers can find themselves sitting in the lap of luxury in our spacious Business Lounger™—the widest seat in the sky. And all of this special Business Class comfort is available not only across the Atlantic, but also on all TWA widebodies across America.

AMERICAN EXPRESS INTRODUCES GLOBAL ASSIST.™ Wherever business takes you, American Express' new Global Assist service provides worldwide emergency referrals. With one call, toll free, 24 hours a day, American Express will help Cardmembers find a lawyer, doctor, dentist, pharmacist, interpreter—or even suggest which visas or inoculations are needed for specific trips. And American Express has Travel Service Offices worldwide to help you with any changes in your travel plans.

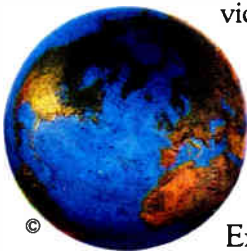

THE BEST TRAVEL AWARDS FOR FREQUENT FLYERS. Only TWA offers frequent flyers the opportunity to earn a free trip for two, First Class, around the world, as well as free travel to a variety of exciting, exotic places. And members of TWA's Frequent Flight Bonus® program who travel Business Class will earn 25% bonus miles on every flight.

THE IDEAL TRAVEL PARTNERS: TWA AND AMERICAN EXPRESS. There's a new spirit and vitality at TWA and we're determined to make sure your Business Class travel goes as smoothly and conveniently as possible. To ensure this ease, TWA gladly accepts the American Express Card with its instant acceptance at TWA counters worldwide. Don't leave home without it.®



TODAY'S TWA. FIND OUT HOW GOOD WE REALLY ARE.

WHO



YOU:

If you travel a lot you can benefit from the AT&T Card.

The AT&T Card will free you from coins and delays, give you an itemized record and AT&T's lowest rates for state-to-state calling, next to direct dialing. And it costs less than calling collect, or making coin calls out-of-state.

So, if you travel frequently, get the AT&T Card. It's as simple as dialing

1 800 CALL ATT, Ext. 229.



AT&T

The right choice.

The 2010 operates at 90 to 130 V and from 40 to 80 Hz. The light source alone costs \$2,000 for a single unit, and "under \$1,000" in quantity, Kley says. With the light-control module, the single-unit price is \$5,000. The systems are available now.

Lightgate, 6300 Telegraph Ave., Oakland, Calif. 94609.

Phone (415) 653-8500

[Circle 401]

VME BOARD HOLDS 32-BIT COMPUTER

Motorola Inc. is combining its 32-bit 20-MHz MC68020 central processing unit and MC68881 floating-point math coprocessor with 1 megabyte of dynamic random-access memory, putting all on a single VMEbus-compatible printed-circuit board.

The MVME133A-20 is a \$4,250 computing engine for real-time operations such as robotics, machine and numerical control, and image processing, say executives at the company's Phoenix, Ariz., microcomputer division.

A key feature of Motorola's new board computer is its software compatibility with the company's predecessor products. Designers can often integrate the 68020's high clock rates and other features into existing systems without undue compatibility problems, the company says.

The 68020 microprocessor features external 32-bit address-and-data-paths capability, enhanced addressing modes, and on-chip instruction cache.

The 68881 floating-point coprocessor fully implements the IEEE standard for binary floating-point arithmetic. It will

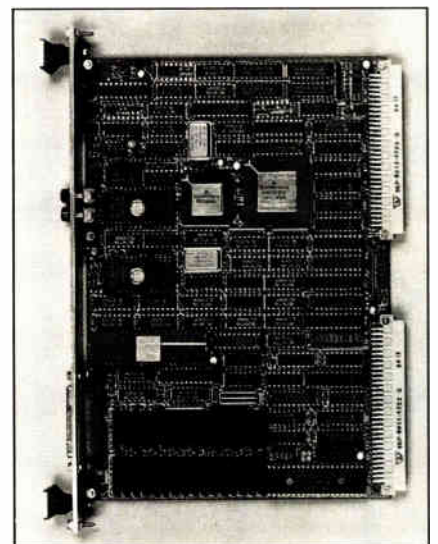

OPTIONS. Motorola's board computer can be fitted with software offering 32 debugging, up/downline load, and disk boot commands.

substantially improve speed in applications that require arithmetic computations over nonfloating-point processors, the company says.

The 68881 uses three standard types of operations: byte, word, and long-word integers; single-, double-, and extended-precision real numbers; and packed, binary-coded-decimal real numbers. Each operation supports seven data formats as well as a full set of trigonometric and transcendental functions.

Included in the MVME133A-20 board is one serial debugging port, one RS-232-C multiprotocol serial port, one RS-485/RS-422 multiprotocol serial port, three 8-bit timers, a real-time clock, and an A32/D32 VMEbus master interface.

The four 28-pin memory sockets are organized as two banks with two sockets per bank for ROM, programmable-ROM, erasable PROM, and electrically erasable PROM. This wide array of features provides the required functions for a large number of applications.

Options include a debugging package that offers 32 upload, download, and disk-bootstrap-load commands, as well as a full set of on-board diagnostics and an on-line assembler/disassembler.

The MVME133A-20 and the \$500 debug software package are available now.

-Ellie Aguilar

Motorola Inc., Microcomputer Division, P.O. Box 20912, Phoenix, Ariz. 85036. Phone (602) 438-3501 [Circle 402]

DIELECTRIC HIKES CAPACITANCE VALUES

Marcon America Corp.'s multilayer ceramic capacitors use a niobium-oxide-based dielectric material to achieve double the dielectric constants of conventional capacitor materials.

The TCD series offers a capacitance range of 0.1 to 47 mF and voltages of 50, 100, and 250 V dc from stock; 400-V devices are available on request. Special

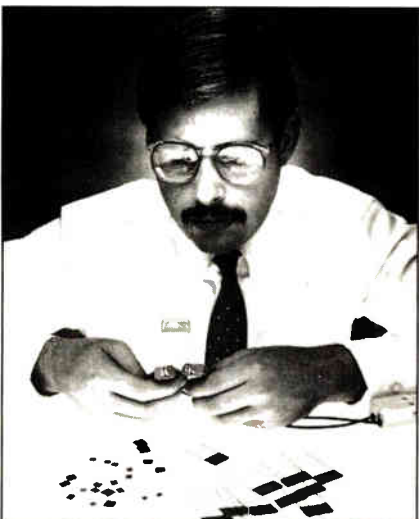

WHAT



IS IT?

It's the AT&T Public Phone. And it lets you place whatever type of coinless call you want to make. Just insert your AT&T Card into the slot and place your call. Many of the AT&T Public Phones will even give you video directions in four languages. What a smart phone!

Look for the AT&T Public Phones in airports and hotels. You can use them with or without your AT&T Card.

To get your AT&T Card, simply dial
1 800 CALL ATT, Ext. 229.



AT&T

The right choice.

Intelligent axis card brings new smarts to robots and automatic positioning.

- Complete control of a DC servo stage.
- Uses input from encoders or interferometers.
- Eliminates all electronic adjustments.
- Accepts simple commands from your host or personal computer.
- Allows fully coordinated multi-axis system (up to 30 axes).

Let us tell you more.



ANORAD

110 Oser Avenue
Hauppauge, NY 11788
Tel: 516-231-1990
TWX 510-227-9894

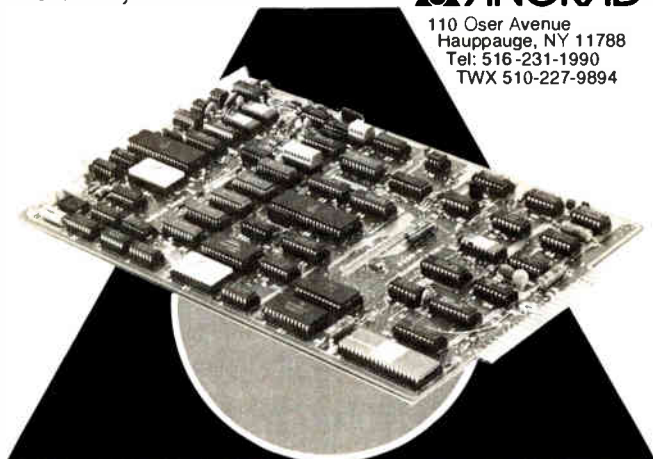

For information Circle 146. To have an application engineer call, Circle 199.

orders are also accepted for customized, surface-mounted multilayer capacitors.

Applications include surge protection for ICs, filtering for switching power supplies, and bypass decoupling.

Marcon America Corp., 310 Era Dr., Northbrook, Ill. 60062.

Phone (312) 564-2820

[Circle 405]

LINEAR MOTORS GIVE PRECISE POSITIONING

A family of linear motors from Stock Drive Products Inc. uses an electromagnetic system to hold friction to a minimum and to achieve microstep accuracies of 0.001 in. The Series 7302 and 7304 motors—for two- and four-phase operation, respectively—are designed for accurate positioning of *x-y* plotters; wafer processing; pc-board assembly; and automated-inspection systems.

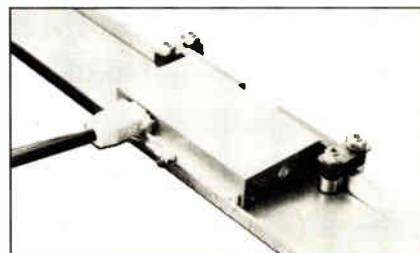

The motors replace conventional lead-screws or cable-pulley systems with a moving part controlled by electromagnets. It moves over a 0.005-in. air gap created by the electromagnetic field. The electromagnet's coils also move it linearly in microsteps of 0.001 in.

The company offers versions that operate over 36-in. or 72-in. magnetic platen. A two-phase device costs \$1,463. All models are available now.

Stock Drive Products Inc., 2101 Jericho Tpke., New Hyde Park, N.Y. 11040. Phone (516) 328-3330

[Circle 406]

We've got a job so important, it takes a retired person to do it.

After a lifetime of working, we want you to handle one more job.

Maybe the most important job you've ever done.

We want you to help give new lives to the 27 million Americans who are functionally illiterate.

Today, illiteracy has become an epidemic that has reached one out of five adults. But you can help stop it by joining in your community's fight against illiteracy.

Call the Coalition for Literacy at toll-free **1-800-228-8813** and volunteer. Beating illiteracy is a big job. But you may find it's the most rewarding job you've ever had.

**Volunteer Against Illiteracy.
The only degree you need
is a degree of caring.**



Coalition for Literacy

CONNECTORS OFFERED FOR FLAT CABLES

A family of connectors developed by the Ansley Electronics Division of Thomas & Betts Corp. allows the simultaneous mass termination of as many as 64 conductors in flat cables.

Space savings and reduced costs associated with flat cables compared with wiring harnesses are best realized when the multiple connectors in the cable are terminated simultaneously rather than one at a time, says the company.

The units include transition connectors, DIP socket connectors, and low-profile DIP plugs. The family includes 600 different units. All are fabricated in Pocan polyester resin reinforced with 30% glass fiber.

The connectors' electrical qualities include a dielectric strength of 492 V/mil and an arc resistance of 10 s. Their ten-

LEADER

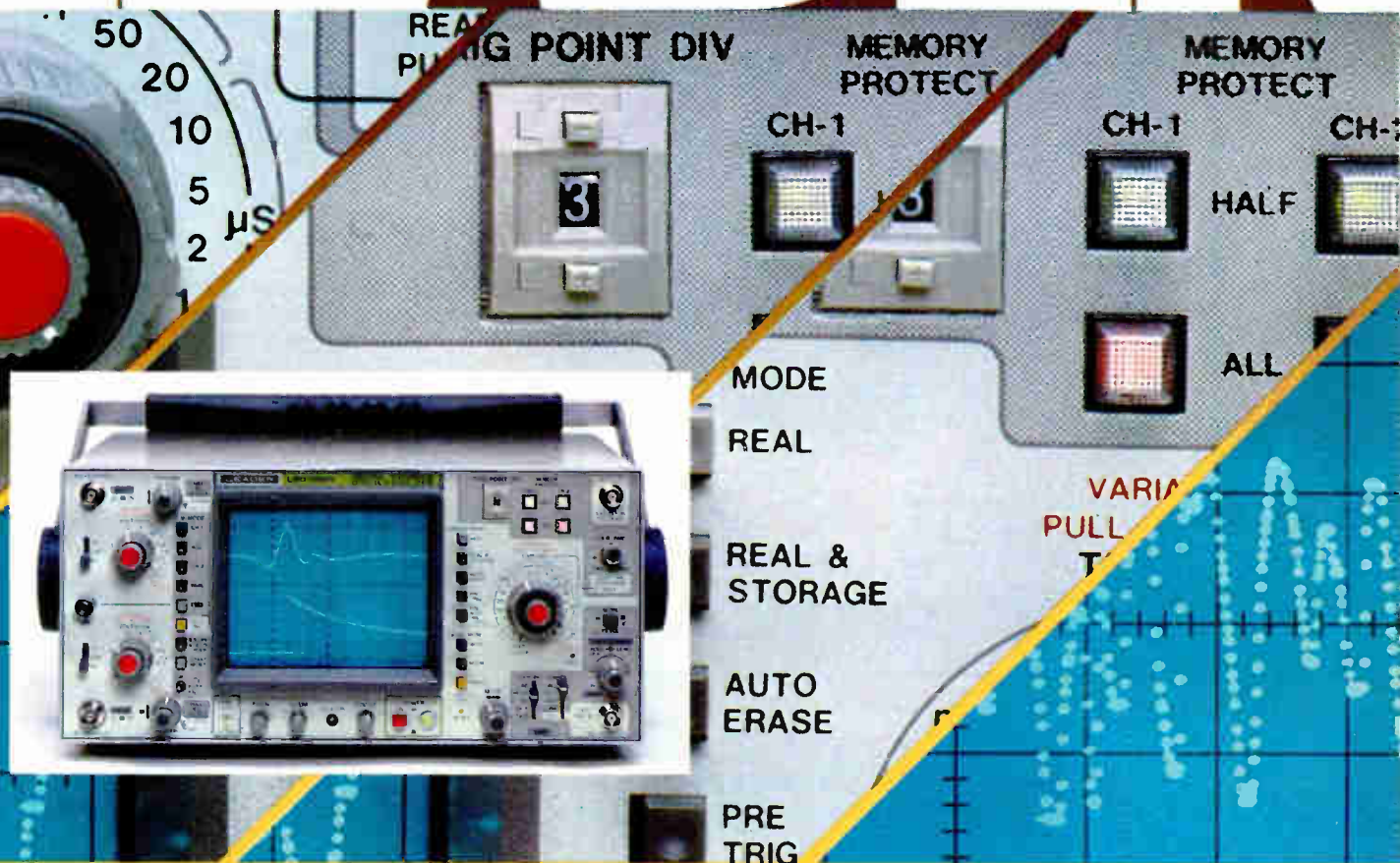

The Next Generation Digital Storage Oscilloscope.

Only the LBO-5825 has: Two Separate A/D Converters, True 5-MHz Digital Sampling Rate, Non-Volatile Memory, 35-MHz Analog Bandwidth, and a Very Affordable Price!

Makes other digitals obsolete.

When our competitors were rushing to produce their Digital Storage Oscilloscopes, Leader waited. We didn't care if ours was first... We wanted ours to be best! And the extra years we invested in research, development and perfecting the new technology really pays you big dividends. The LBO-5825 advances the state-of-the-art a giant step into the next generation.

Matchless features and performance.

No other Digital Storage Oscilloscope equals the 2-channel LBO-5825's performance, versatility, and value: most other units in its class have a 1 or 2-MHz digital sampling

rate and share a single A/D converter between channels. But, we gave the LBO-5825 a true 5-MHz sampling rate to provide higher resolution, even on fast single-shot signals. Two separate A/D converters ensure super-accurate, simultaneous, point-by-point, channel comparisons. An 8-bit, 2-channel by 1K-word non-volatile memory enables you to compare a real waveform to a stored reference or to record field-service waveforms for comparison in the shop. Its 14-day battery backup protects memory between charges or if ac fails. Up to 9-division pre-trigger view isolates transient causes. Roll mode makes the CRT read like a chart recorder. X-Y outputs are supplied for hard copies. The LBO-5825 is also a rugged Real Time Oscilloscope with a two-year warranty.

Call toll-free
(800) 645-5104

In New York State
(516) 231-6900

Ask for an evaluation unit, catalog, and the name of your nearest "Select" Leader distributor.

For professionals

who know the difference.

LEADER
Instruments Corporation

380 Oser Avenue
Hauppauge, New York 11788
Regional Offices:
Chicago, Dallas, Atlanta,
Los Angeles, Boston
In Canada call Omnitronix Ltd.
(514) 337-9500

Circle 147 on reader service card

We've got the machines to mark pc boards & small parts!

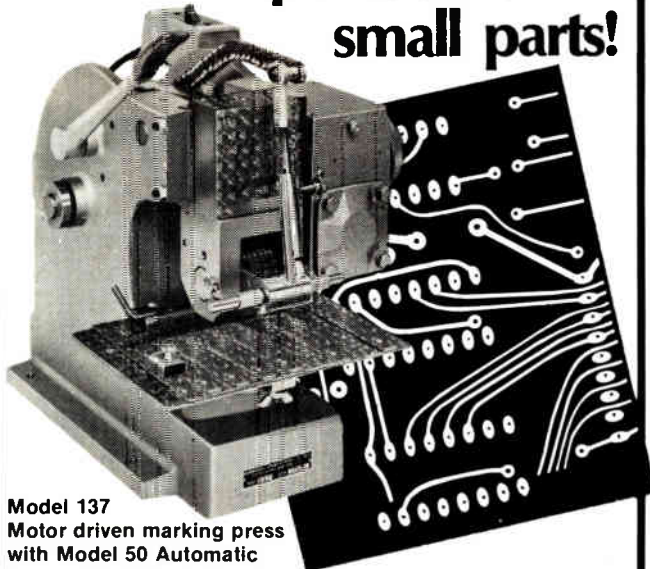

Model 137
Motor driven marking press with Model 50 Automatic Sequential Marking Head

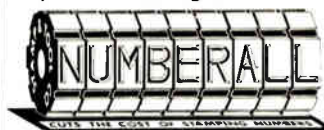

Write or Call for information and our complete catalog

NUMBERALL STAMP & TOOL CO., INC.
BOX 187, HIGH ST., SANGERVILLE, ME 04479 (207) 876-3541

Circle 148 on reader service card

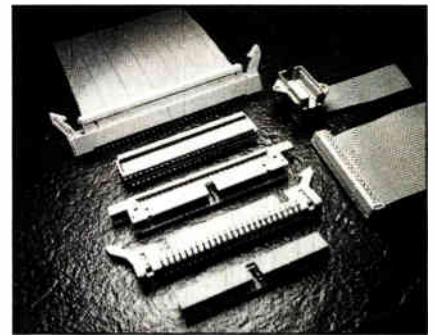

tile strength of 19,900 lb/in.² and flexural stress at break is 27,600 lbs/in.². All the connectors are available through distributors. Price depends on configuration and size.

Thomas & Betts Corp., Electronics Division, 920 Rt. 202, Raritan, N.J. 08869.
Phone (201) 469-4000 [Circle 407]

FINLUX EL DISPLAY CUTS POWER NEEDS

Finlux Inc. has reduced power requirement in its newest flat electroluminescent display by 30% by utilizing a proprietary energy-recovery circuit, says the company.

Power consumption of the MD512.256-40, including its power unit, is 11 W in typical use and 16 W maximum. Another benefit of the new drive scheme is an average 10°C decrease in the display-driver temperature, which results in longer life than previous models.

Graphics are displayed in a flicker-free yellow produced by an electroluminescent phosphor. The 4-by-8-in. display offers 67-line/in. resolution.

The display is available in preproduction quantities. The single-unit sample price for the display and power converter is \$1,115. In 100-unit quantities, the price is \$590.

Finlux Inc., 20395 Pacifica Dr., Suite 109, Cupertino, Calif. 95014.
Phone (408) 725-1972 [Circle 408]

RESISTORS SUIT DENSE PC BOARDS

The CR series of 1/8-W and 1/16-W chip resistors from International Components Corp. are designed for high-density use on pc boards and for small-to-large hybrid integrated circuits.

Innovative electrode construction and thick-film elements with glass coatings endow the resistors with high mechanical strength and electrical stability, the company says, and they operate between -55°C and 125°C.

Available from stock, they are priced as low as \$9.50 per 1,000 and come packaged on tape or reel.

International Components Corp., 105 Max-ess Rd., Melville, N.Y. 11747.
Phone (516) 293-1500 [Circle 409]

Gate Array and Standard Cell IC Vendor Directory 1986/7 ASIC UPDATE

Written by SOURCE III - Author of Gate Arrays

A 541 page directory that will aid in selecting the right semi-custom design house — including Gallium Arsenide.

It provides a step-by-step approach in dealing with vendors.

It organizes the vendor list by technology and covers both front and back end cost estimates.

Minimum volumes and delivery schedules are also detailed.

It contains a listing of 70 vendors and describes:

- Gate Array and Standard Cell Design Services Offered
 - Technology
 - Size
 - Speed
 - Development Cost
 - Production Cost
- Gate Array and Standard Cell Design Experience
- Development Process
- Prototype Cycle Times
- Corporate Background
- Address, Telephone Number, and Person to Contact
- Second Sources
- CAD Services Offered
 - Software
 - Hardware
 - Test
 - Layout



Send \$295 or your company purchase order. For a detailed table of contents contact:



Electronic Trend Publications
12930 Saratoga Ave., Suite D1
Saratoga, CA 95070
(408) 996-7416

Militarized Microprocessors

8086, 80186, 80286, 68000, 68020

**Multibus & VME
Compatible
Engineered for the
Military User**

- All I/O from bottom of boards
- Copper heat sinks
- Low insertion force connector
- On-board PROM programming
- ATR form factor (Multibus & VME)



AEROFLEX LABORATORIES, INC.

35 South Service Road
Plainview, NY 11803

For Immediate Information Call:
(516) 694-6700 or (516) 752-2300

Multibus is a trademark of Intel Corp.

Circle 149 on reader service card

The design engineer's dream: PC software plus the power & reliability of the STD BUS.

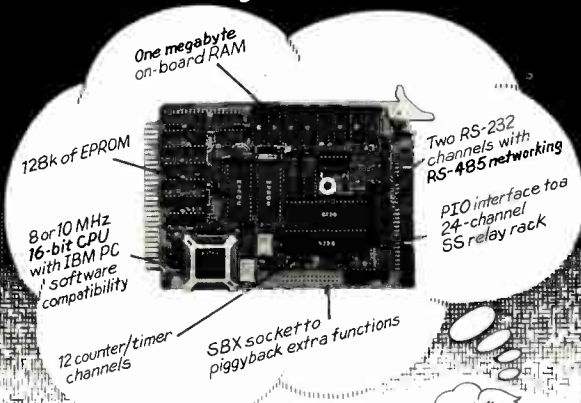

It's real on the CPU-188.

The STD BUS single board computer linking the engineer's desk with the factory floor.
From \$425 in single quantities.

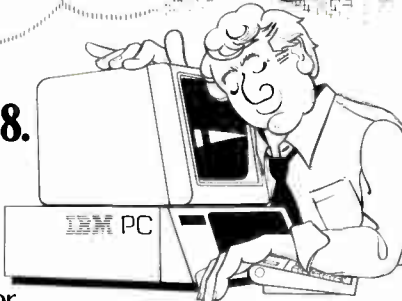

**Computer
DYNAMICS**
COMPUTER DYNAMICS SALES

107 S. Main St., Greer, SC 29651
(803) 877-8700

IBM PC is a registered trademark of International Business Machines Corporation

Circle 174 on reader service card

Circle 175 on reader service card →

EXAMPLE #8 How We Help Electronic Companies Compete



As a contract manufacturer, MRL fabricates, assembles, and tests printed circuit boards and electronic assemblies for the military, computer companies, medical companies, even cable TV companies.

MRL's 40 years of electronic experience in commercial and MIL-SPEC projects spans from manufacturing high-tech electronic assemblies to airborne instrumentation. From satellite telemetry systems to ground support equipment. Our experience ranges from 14 different industries and literally thousands of projects.

MRL is awarded contracts because of our in-house manufacturing expertise, state-of-the-art fabrication equipment, testing on our HP3065 automatic test center, and quality control standards... and because our single-source efficiency is so cost effective.

For contract manufacturing that can save you time, heavy capital expenditures and coordinating problems call 1-800-325-0223. Or send for brochure "We Make Technology Work For America."



MRL

3800 West Clay
St. Charles, MO 63301
314-946-6900

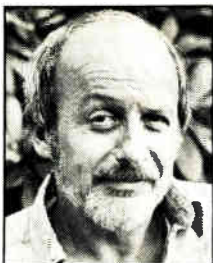

E.L. DOCTOROW



NANCY MILFORD



HERMAN WOUK



THEODORE H. WHITE

Some of their best works began in the same setting.

Whether their books begin in the south of France or the streets of New York City, all of these authors chose the same place to work — The New York Public Library.

It's where E. L. Doctorow did research for *Ragtime*. It's where Herman Wouk worked on *The Caine Mutiny*, Nancy Milford wrote *Zelda*, and Theodore H. White, *The Making of the President, 1964*.

Author Jerzy Kosinski said, "This library is probably the most important single address I can think of since my arrival in this country twenty-seven years ago."

The Library is important to so many others as well.

For children, it's a place to enjoy puppet shows and the magic of literature. For dancers and choreographers, it's a place to perfect their performances by viewing original films and tapes. For students, businessmen, scientists and artists, it's a place where learning is accessible and free.

For countless people, with needs of every kind, the Library is the perfect setting.



The New York Public Library
WHERE THE FUTURE IS
AN OPEN BOOK

MEETINGS

SMART III: Surface Mounting and Reflow Technology, EIA, *et al.* (2001 Eye St., N.W., Washington, D.C. 20006), New Orleans Hyatt Regency, New Orleans, La., Jan. 12-15.

Computer Graphics '87, Frost & Sullivan Inc. (106 Fulton St., New York, N.Y. 10038), Wesgate Hotel, San Diego, Jan. 14-16.

OFC/IOOC '87: Optical Fiber Communication Conference/International Conference on Integrated Optics and Optical Fiber Communication, IEEE Lasers and Electro-Optics Society, *et al.* (Optical Society of America, 1816 Jefferson Pl., N.W., Washington, D.C. 20036), Reno-Sparks Convention Center, Reno, Nev., Jan. 19-22.

Hybrid Microtech '87: Conference and exhibition for electronic interconnection technology, International Society for Hybrid Microelectronics (Hybrid Microtech Secretariat, 13 Firlands, Bracknell, Berkshire RG12 3SB, England), Heathrow Penta Hotel, Heathrow, UK, Jan. 19-21.

International Symposium on Modeling and Simulation Methodology, University of Arizona, *et al.* (Special Professional Education, Harvill Building/Box 9, Tucson, Ariz. 85721), Hotel Park Tucson, Tucson, Ariz., Jan. 19-23.

SYSCON: OEM Computer Peripherals Subsystems Conference & Exposition, Multidynamics Inc. (17100 Norwalk Blvd., Suite 116, Cerritos, Calif. 90701), Los Angeles Airport Hilton Hotel, Los Angeles, Jan. 20-21.

Uniform Conference and Trade Show, USR/group (4655 Old Ironsides Dr., Suite 200, Santa Clara, Calif. 95054), Washington Convention Center, Washington, D. C., Jan. 20-23.

Winter 1987 Usenix Technical Conference, Usenix Association (P.O. Box 385, Sunset Beach, Calif. 90742), Omni Shoreham, Washington, D. C., Jan. 21-23.

Southern Manufacturing Technology Show, National Machine Tool Builders Association (7901 Westpark Dr., McLean, Va. 22102), The Charlotte Convention Center, Charlotte, N.C., Jan. 26-29.

Advanced Semiconductor Equipment Exposition & Conference, Cartledge & Associates Inc. (1101 S. Winchester Blvd., Suite M259, San Jose, Calif. 95128), Santa Clara Convention Center, Santa Clara, Calif., Jan. 27-29.

Wincon '87, Aerospace and Electronic Systems Society (P.O. Box 6876, Burbank, Calif. 91510), South Coast Plaza Hotel, Costa Mesa, Calif., Jan. 27-29.

1987 Annual Reliability and Maintainability Symposium, IEEE, et al., (Gen Pettee, Lockheed Missiles and Space Co., P.O. Box 1269, Cocoa Beach, Fla. 32931), Dunfey City Line Hotel, Philadelphia, Jan. 27-29.

Computer Graphics New York '87, Exhibition Marketing & Management Inc. (8300 Greensboro Drive, Suite 690, McLean, Va. 22102), The Jacob Javits Convention Center, New York, N. Y., Jan. 28-30.

Measurement Science Conference, MSC (John Van de Houten, program chairman, TRW S/937, One Space Park, Redondo Beach, Calif. 90278), Irvine Marriott, Irvine, Calif., Jan. 29-30.

International Symposium on Pattern Recognition and Acoustical Imaging, International Society for Optical Engineering (P.O. Box 10, Bellingham, Wash. 98227), Newport Beach, Calif., Feb. 1-6.

International Conference on Data Engineering, IEEE Computer Society (1730 Massachusetts Ave., N.W., Washington, D.C. 20036), Pacifica Hotel, Los Angeles, Feb. 2-6.

Manufacturing Productivity Conference & Exposition, Society of Manufacturing Engineers (One SME Dr., P.O. Box 930, Dearborn, Mich. 48121), Expo Centre, Orlando, Fla., Feb. 2-5.

Aerospace Applications Conference, IEEE South Bay Harbor Section (Fausto Pasqualucci, Hughes Aircraft, 3100 Fujita St., Torrance, Calif. 90509), Vail, Colo., Feb. 8-13.

Communication Networks '87, CW/Conference Management Group (375 Cochituate Rd., Box 9171, Framingham, Mass. 01701), Washington Convention Center, Washington, D.C., Feb. 9-12.

Systems Design & Integration Conference, IEEE, et al. (Electronic Convention Management, 8110 Airport Boulevard, Los Angeles, Calif. 90045), Santa Clara Convention Center, Santa Clara, Calif., Feb. 10-12.

Southwest Optics '87, IEEE Lasers and Electro-Optics Society, *et al.* (Optical Society of America, 1816 Jefferson Place, N.W., Washington, D.C. 20036), Albuquerque Convention Center, Albuquerque, N.M., Feb. 9-13.

Electronics

1987 Recruitment Editorial Calendar

Issue Date	Feature	Closing Date	Issue Date	Feature	Closing Date
January 8	U.S. Market Forecast	December 22	July 9	Interconnections Non-Volatile Memories Siggraf Conference Preview	June 22
January 22	Foreign Market Forecast Application-Specific IC's	January 5	July 23	VLSI Packaging	July 6
February 5	Military IC's Laboratory Instruments Nepcon/West Preview	January 19	August 6	Fiber Optics 3D Graphics	July 20
February 19	Computer-Aided Engineering Hannover Fair Preview	February 2	August 20	RISC Technology Semicustom IC's	August 3
March 5	Online Transaction Systems ISSCC Wrap-Up	February 16	September 3	Japanese R & D Packaging	August 17
March 19	Optical Storage Single-Board Computers	March 2	September 17	Computer-Aided Software Graphics	August 31
April 2	Electro Preview Semiconductors	March 16	October 1	Automatic Test Equipment Surface Mounting Technology	September 14
April 16	VHSIC Networking	March 30	October 15	Technology Outlook Special Issue	September 28
April 30	Personal Computers Computer-Aided Engineering	April 13	October 29	Artificial Intelligence Materials	October 12
May 14	Software Special Issue Power Supplies Semicon/West Preview Custom IC Conference Preview	April 27	November 12	Wescon Preview Minisupercomputer Workstations Digital Signal Processing Paris Components Show Preview	October 26
May 28	Linear VLSI	May 11	November 26	Military Electronics Parallel Processing ISDN IEDM Preview	November 9
June 11	NCC Preview Computer-Aided Design Ultrascale Integration	May 25	December 17	Year-End Double Issue Executive Outlook ISSCC Preview GaAs Technology	November 30
June 25	Industrial Electronics Design Automation Conference	June 8			

For more information, contact Susan Barnes Ronga, National Recruitment Sales Representative, at (212) 512-2787



Director of Center for Microelectronic Design and Test

The College of Engineering at the University of South Florida, Tampa, invites nominations and applications for the position of Director of the Center for Microelectronic Design & Test (CMDAT). Recently, the Florida State Legislature appropriated seed funds to establish CMDAT as a major state research and educational resource for the rapidly expanding high technology industries in Florida and the Southeast.

The responsibilities of the Director will be: to develop a strong, broadly funded research and development program in VLSI, VHSIC and MIMIC & ASIC design, high frequency analog and digital circuit modelling and testability; to build a strong research team drawing on existing researchers as well as new staff members; to interface with academic programs in the education and training of graduate students; and to vigorously promote university/industry and university/government linkages.

The successful candidate should bring to this position demonstrated research and scholarly abilities, successful experience in obtaining major external research funding, management and administrative skills in forming and building research teams, and the ability to work with industry and federal research agencies. The candidate should have a terminal degree and be tenurable in either the Electrical Engineering Department or Computer Science and Engineering Department.

The University of South Florida is one of Florida's three public comprehensive research institutions with an enrollment of over 28,000 students. The main campus is in Tampa with regional campuses in St. Petersburg, Sarasota, and Ft. Myers. The College of Engineering has 85 full time faculty members and over 3,500 undergraduate and graduate students.

The University of South Florida is an equal opportunity and affirmative action employer. According to Florida law applications and meetings regarding applications are open to the public on request.

Please send resume and list of three references to:
Chair of Search Committee
Center for Microelectronic Design & Test
College of Engineering
University of South Florida
Tampa, FL 33620

Need Design Engineers?

Call

Susan Barnes Ronga
Electronics—Career Opportunities Section
(212) 512-2787

Electronics CAREER OPPORTUNITIES

Electronics
reaches over
130,000 readers

Upcoming 1987 Editorial Features:

January 8

U.S. Market Forecast

January 22

Foreign Market Forecast
Application-Specific IC's

February 5

Military IC's
Laboratory Instruments
Nepcon/West Preview

February 19

Computer-Aided Engineering
Hannover Fair Preview

March 5

Online Transaction Systems
ISSCC Wrap-Up

March 19

Optical Storage
Single-Board Computers

April 2

Electro Preview
Semiconductors

For more information, contact Susan Barnes Ronga, National Recruitment Sales Representative, at (212) 512-2787

Find the
Personnel
you need!

Place
your
recruitment
advertisement
in

**Electronics
Career Opportunities
Section**

Call

Susan Barnes Ronga

at

(212) 512-2787

Engineers

No one does it better.

And everyone in the business knows it.

When it comes to providing expert engineering and technology-based solutions across the life cycle of communications systems development, the decision-makers in the military, government and industry choose the Information Technology Center of Booz-Allen & Hamilton.

This universal recognition of our superiority has expanded our business and created a wide variety of opportunities for Electrical Engineers and Computer Scientists to join us at the leading edge of telecommunications, and command control communications and electronics.

Working in an inspiring, multidisciplinary environment, you'll anticipate problems that have yet to be posed, then apply your foresight and skill to solving them with new generation technologies. You'll keep the big picture in perspective as you delve into the details, working on a variety of assignments from conception to post-completion support.

You'll enjoy increased autonomy and the heightened sense of freedom generated by a positive, performance-oriented philosophy. You'll receive a highly competitive salary and generous benefits. And you'll advance rapidly in an encouraging setting that fosters individual achievement and growth.

To qualify for one of many positions now open in our metropolitan Washington facilities, you must have a BSEE or other appropriate technical degree. An advanced degree is a plus. Application areas include the following:

Electrical Engineers

- Data network design
- Secure voice
- Signal processing
- PBX data communications
- Acoustics (ASW)
- Communications security
- Satellite communications
- Integration and test
- Test and evaluation
- HF and RF systems
- Data communications
- Switching systems
- System design/analysis
- Transmission systems
- Telecommunications

Computer Scientists

- DBASE II/III
- LOTUS
- PROTOCOLS
- Software design
- Software development
- Data base design
- Data base development
- Systems integration
- Modelling
- Computer security

If no one does it better than *you*, you owe it to yourself to join one of the world's most respected technology and management consulting firms. Call Melanie Lawrence, 1-800-858-4630. Or rush your resume to her at Dept. 114, Booz-Allen & Hamilton Inc., 4330 East West Highway, Bethesda, Maryland 20814.

BOOZ-ALLEN & HAMILTON INC.

We are an equal opportunity employer. U.S. citizenship is required.

DOES WINDOWS.

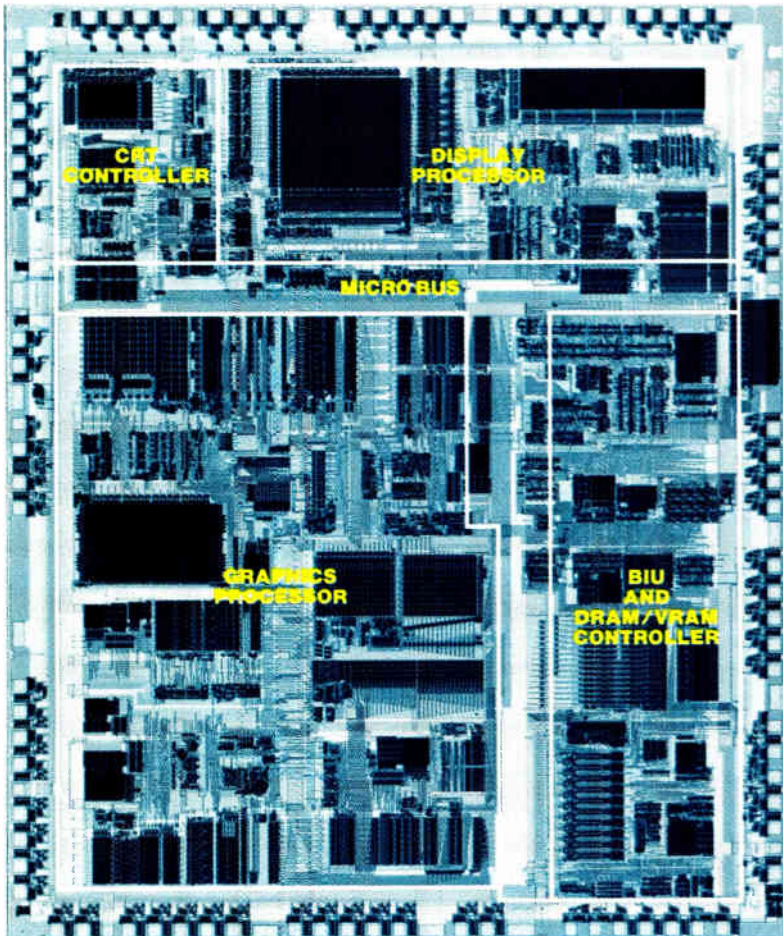

Intel's 82786 graphics coprocessor supports its family of 16- and 32-bit central processing units.

“Two completely different kinds of end customers seem to be fueling the embryonic graphics chip market: the personal computer user in business, and the designer on a work station. Intel Corp., long reported to be developing a graphics-oriented microprocessor, is finally announcing its 82786 graphics coprocessor for both applications.

Demand for multiple-windowing capability is on the rise, especially for multitasking chores in the office environment. The 82786 implements this capability in hardware. Each application can have its text and graphics drawn into separate regions of memory, which are then combined within windows of the same display. Large amounts of overhead associated with graphics tasks can be offloaded from the main system CPU by storing more text and graphics information in memory than is shown in the display...”

*Excerpted from an exclusive article
in the May 19, 1986 issue.*



Electronics

**THE LEADER IN NEW
TECHNOLOGY COVERAGE**

AVAILABLE!

1986-'87 Electronics Buyers' Guide

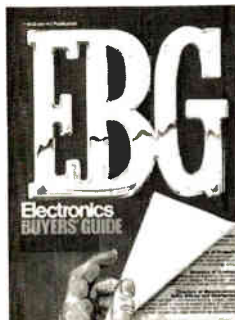

Order your copy today for the industry's most often-used directory:

- It's three directories in one
- Includes more than 4,000 product listings. (approx. 700 pages)
- Contains over 5,000 company listings (approx. 400 pages) including:
 - Company name, address and phone number.
 - Name and title of contact for sales information.
 - Number of engineers at plant and number of employees.
 - Annual dollar sales volume.
 - Local sales offices and manufacturers representatives.
 - Local distributors.
 - Instant referral to company's advertisements.
- Offers FREE current catalog retrieval service (approx. 1300 catalogs)

Price: \$40 USA & Canada
\$50 elsewhere
(add \$30 for airmail)

Send order with payment to:
Regina Hera

Electronics Buyers' Guide

1221 Avenue of the Americas
New York, NY 10020

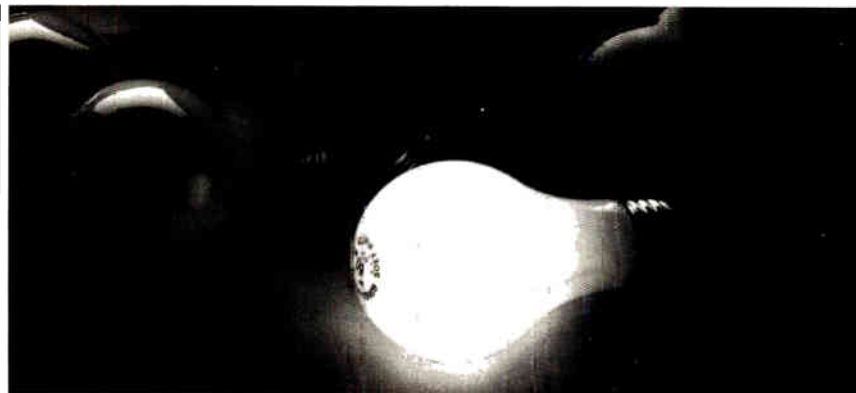

If all your assignments look the same look to us.

Routine. Nothing dulls inspiration quite like it. Yet most companies don't see it that way. They assign engineers to solve one kind of problem over and over again.

At Martin Marietta Denver Aerospace, we see things in a different light. Our engineers work in a matrix organization. Instead of routine assignments, you'll find a breadth of challenge.

And a breath of fresh air.

Because the Colorado Rockies provide our enviable backdrop for some of the finest facilities in the world. So when you've taken in all the high tech you need for one day, you can take off to fish, camp, climb or ski—practically in our back yard.

Explore aerospace and defense engineering opportunities in Systems • Electronics • Software Development • Software Quality & Test • Mechanical Engineering • Spacecraft Guidance & Control • Optics • Sensors • Radar Systems • Artificial Intelligence • and more.

Please send your resume to Martin Marietta Denver Aerospace, P.O. Box 179, G1311 P1073, Denver, CO 80201. No agencies, please. We are an affirmative action employer. U.S. citizenship required.

For a quick reply, don't forget to include the "P" number on your letter or resume.

MARTIN MARIETTA

We Get Results!

Place Your Recruitment
Advertisement Here!

Call Susan Barnes Ronga at *Electronics,
Career Opportunities*—(212) 512-2787

POSITIONS VACANT

South? Technical/Professional Placement
Network-Fee paid. Murkett Associates, Box 527, Montgomery, AL 36101.

POSITIONS WANTED

Electronic Engr, for hire. Microprocessor
based designs, controls, telecom. Contact or per diem. Mr. Barry Masel. 718-476-1516.

EMPLOYMENT SERVICES

Overseas — 75 Countries — Interviewing
now. All Fields — for Conn. interview. Send resume: Global Services, (O) Clinton, CT 06413. Transportation not paid to Connecticut.

SPECIAL SERVICES

Custom Switching Power Supply Design —
From concept to production model. High quality design, fast and reliable service, competitive rates. PEDAs, 833 The Queensway, Toronto, Ont., M8Z 5Z1, (416) 252-1581.

PROFESSIONAL SERVICES

Call

212-512-2556

PATENT SERVICES

Patentability Searches, Applications & Prosecutions • Marketing • Technology Transfer • Over a decade of service to the inventor.



CALL FOR FREE INFORMATION

AMERICAN INVENTORS CORPORATION
(800) 338-5656 In MA (413) 568-3753

COMPUTER SOFTWARE

FREE DEMO DISK

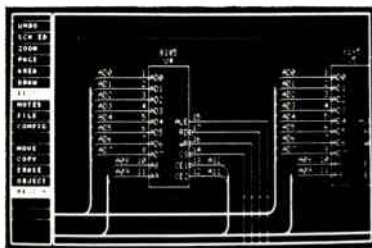

SCHEMA is a complete, integrated schematic drawing software package for IBM Personal Computers. Use **SCHEMA** with your PC to draw schematics and automatically generate design documentation such as Wire and Net Lists, Bills of Materials, Design Rule Checks, etc. **SCHEMA** is \$495 and supports most common PC hardware configurations. Call or write today for a free demo disk and brochure.

OMATION, INC.

1701 N. Greenville Ave., Suite 809
Richardson, TX 75081
(214) 231-5167



THE BEST Schematic Capture
IS ONLY \$495

- Runs on IBM PC/XT/AT or compatible, supporting most common graphic boards, printers and plotters
- Over 2000 unique library parts
- Part rotation & mirroring
- Rubberbanding of wires & buses when objects are moved
- Supports A through E size sheets
- True unlimited level hierarchy
- Visible grids, 5 zoom levels
- Color & monochrome graphics
- Draws non-orthogonal wires & buses
- Step & repeat with auto increment/decrement of labels
- Powerful keyboard macros & auto panning
- Net/wire list, BOM, design check & library creation utilities

OrCAD gives you so many features, nothing else even comes close. Why settle for anything less? At only \$495, you will discover that OrCAD/SDT is the most powerful and cost effective schematic design tool available. . . at any price!

Call today for your Free Demo Disk and brochure. All orders are shipped from stock for immediate delivery!

OrCAD Systems Corporation
1049 S.W. Baseline St., Suite 500
Hillsboro, OR 97123
(503) 640-5007



SPICE up your PC

Z/SPICE professional circuit simulation

Full version \$300 Student version \$79

ZTEC box 737, college place, wa 99324
(509)-529-7025

Advertising Sales Staff

Atlanta, Ga. 30319: Joseph Milroy
4170 Ashford-Dunwoody Road N.E.
[404] 252-0626

Boston, Mass. 02116:
M. E. "Casey" McKibben, Jr.
575 Boylston St.
[617] 262-1160

633-0155 Mobil Phone
Chicago, Ill. 60611: William J. Walker
[312] 751-3738
645 North Michigan Avenue
Cleveland, Ohio 44113:

[216] 496-3800
Costa Mesa, Calif. 92626: Fran Cowen
3001 Red Hill Ave. Bldg. #1 Suite 222
[714] 557-6292

Dallas, Texas 75240: Harry B. Doyle, Jr.
5151 Belt Line Road, Suite 907
[214] 458-2400

Englewood, Co. 80112: Harry B. Doyle, Jr.
7400 South Alton Court Suite 111
[303] 740-4633

Houston, Texas 77040: Harry B. Doyle, Jr.
7600 West Tidwell, Suite 500
[713] 462-0757

Los Angeles, Calif. 90010: Chuck Crowe
3333 Wilshire Blvd.
[213] 480-5210

New York, N.Y. 10020
Matthew T. Reseska [212] 512-3617
John Gallie [212] 512-4420

1221 Avenue of the Americas
Stamford, Ct. 06902
Albert J. Liedel
777 Long Ridge Road. Bldg. A
[203] 968-7115

San Mateo, Ca 94404:
Larry Goldstein, Jeffrey C. Hoopes, Paul Mazzacano
3rd Floor
951 Mariner's Island Blvd.
[415] 349-4100

Philadelphia, Pa. 19102: Joseph Milroy
Three Parkway, [215] 496-3800

Pittsburgh, Pa. 15222: Joseph Milroy
Suite 215, 6 Gateway Center, [215] 496-3800

Southfield, Michigan 48075:
4000 Town Center, Suite 770, Tower 2
[313] 352-9760

San Francisco, Calif. 94111:
Larry Goldstein, Jeffrey C. Hoopes, Paul Mazzacano
425 Battery Street
[415] 362-4600

Frankfurt/Main: Fritz Krusebecker, Dieter Rothenbach
19 Liebigstrasse, Germany
Tel: 72-01-81

Milan: Manuela Capuano
1 via Baracchini, Italy
Tel: 86-90-656

Paris: Jean - Christian Acis, Alain Faure
128 Faubourg Saint Honore, 75008 Paris, France
Tel: [1] 42-89-0381

Scandinavia: Andrew Karnig
Finnbodavagen
S-131 31 Nacka
Sweden

Tel. 46-8-440005
Telex: 17951 AKA S

Tokyo: Hirokazu Morita
McGraw-Hill Publications Overseas Corporation,
Kasumigaseki Building 2-5, 3-chome,
Kasumigaseki, Chiyoda-Ku, Tokyo, Japan
[581] 9811

United Kingdom: Art Scheffer
34 Dover Street, London W1
Tel: 01-493-1451

Business Department

Thomas E. Vachon
Director of Operations
[212] 512-2627

Leon Irgang
Circulation Director
[609] 426-5542

Roseann Lehmann
Office Administrator
[212] 512-3469

Customer Service
[212] 512-6643

Frances M. Vallone
Mgr./Marketing Adm.
[212] 512-6058

Patricia Parks
Billing Specialist
[212] 512-2589

Thomas M. Egan
Production Director
[212] 512-3140

Carol Gallagher
Production Manager
[212] 512-2045

Evelyn Dillon
Production Manager Related Products
[212] 512-2044

Classified Advertising

[212] 512-2556

Recruitment Advertising

Susan Barnes-Ronga
[212] 512-2787
[212] 512-2788

RELIABILITY PREDICTION SOFTWARE

ARE YOUR PRODUCTS RELIABLE?

RelCalc 2 automates MIL-HDBK-217D on your IBM PC!

Very easy to use. Demo package \$25.

T-CUBED SYSTEMS 31220 La Baya Drive, #110
(818) 991-0057 Westlake Village, CA 91362

Advertisers Index

‡■	Aeroflex Laboratories	149	Hi Level Technology	96	Noise Laboratory Co.	30
□	AMP Incorporated	52, 53, 108	‡ Hitachi America Inc. Ltd.	43	Numberall Stamp & Tool Co.	148
‡	Anarod Corporation	146	‡ Hitachi Chemical Co.	133	Philips CPMS	39, 40, 41
*	Anristu Corporation	6E, 7E	‡ Hitachi Denshi	100	* Philips Elcoma	10E, 11E
	Applied Microcircuits Corp.	14, 15	* Hitachi Maxell	137	* Philips T&M	1E, 3E
	AT&T Communications Int'l	144, 145	Imagraph Corporation	128	‡ Potter & Brumfield Inc.	99
	AT&T Information Systems	64, 65	‡■ IMC Magnetics Corp.	134	Precision Monolithic	103
	Behlman Engineering	136	Inmos Corporation	6, 7, 36, 37	‡ Prentice Hall	17, 18, 19
■	Bell of Pennsylvania	78, 79	International Robomation Intelligence	106	□ Rantec	118
	Burr Brown Corp.	126, 127	Interphase Corporation	51	Rockwell International	27
	Cadnetix	48, 49	* Iskra	43	Rogers Corporation	123, 132
	Cherry Electrical Products Corporation	9	ITT Cannon	2	* Rohde & Schwarz	19
‡	Computer Dynamics	149	□ Lansdale Semiconductor	117	□ Schweber Electronics	75, 122
	Computer Vision	139	‡ Leader Instruments	147	* Seiko Instrument	44, 45
□	CTS Corporation	115	LeCroy Corporation	76, 77	* Siemens AG	104, 105, 4E, 5E
*	Cypress Semiconductor	124, 125	MACSYMA	74	Soliton Devices Inc.	12
	Data Precision	35	□ Malco	120	*■ Teknecomp S.p.A.	2E
	Data Translation	24	MITel Corporation	2nd C	□ Teledyne Relays	121
‡	DDC International	137	* Mitsubshi	100	Thomson CSF	54
‡	Digital Equipment Corporation	20	* Molex	134	‡ Toshiba America Inc. (Memory Div.)	104, 105
□■	Electronic Crystals	116	Motorola Semiconductor Products Inc.	23, 141	Toshiba	4th C
	Electronic Solution	13	‡ MRL	149	TWA	143
*	Enertec Schlumberger	99	* Murata Mfg. Co.	12E	Vacuumschmelze	138
	Factron Schlumberger	46, 47	National Microelectronics (UMC Corporation)	66	Varta	130
*	Fujitsu Ltd.	131, 133	‡ NCR Microelectronics	131	■ Venus Scientific	8
	Glassman High Voltage	140	□ NEC Corporation	10, 11	Classified and employment advertising	
□	Gould Computer	119	* NEC Electronics (Europe) GMBH	20, 44	American Inventors Corporation	156
□	Harris Semiconductor	111, 113	Nicolet	63	Omaton Inc.	156
	Hayes Microcomputer Products	3rd C	Nippon Chem Con Corporation	136	Orcad Systems Corp.	156
	Hewlett Packard Company	28, 29			T-Cubed Systems	156
					ZTEC	156
					Career Opportunity	
					Booz Allen & Hamilton Inc.	153
					Martin Marietta Corporation	155
					University of South Florida	152

ELECTRONICS WEEK

HONEYWELL EXITS COMPUTER FIELD...

Honeywell Inc. is easing out of the computer business. The Minneapolis firm is splitting off Honeywell Information Systems into a new, separate company that will be managed by Compagnie des Machines Bull, Paris, which is buying a 42.5% share in the new company. Honeywell will also maintain a 42.5% stake in the business, and NEC Corp., Tokyo, will own the remaining 15%. Honeywell plans to take in about \$522 million on the deal. That includes about \$350 million to be paid by the new company for return of capital and repayment of debt, and about \$172 million from NEC and Bull. Honeywell says the sale will allow it to better concentrate its resources on its defense, aerospace, automation, and controls businesses.

... AND FORECASTS RARE LOSS FOR '86

For the first time in 95 years, Honeywell Inc. expects to see red ink on its year-end financial disclosure. The price at which the 101-year-old company is selling the majority interest in its computer business is based in part on a \$250 million discount off the unit's book value, which Honeywell claims to be \$900 million. Combined with other write-offs, the discount will force Honeywell to show substantial losses for its fourth quarter and year-end reports.

PANASONIC TO SELL CHIPS IN U.S.

Panasonic Industrial Co. has formed a new division to market semiconductors in the U.S. The Semiconductor Sales Division will start out with a line of power MOS FETs and a variety of memory and logic products, including a pair of 1-Mb random-access memories and families of gate arrays and standard

cells. The devices will be made by Panasonic's sister company, Matsushita Electronics Corp., of Kyoto, Japan.

AT&T, BOEING JOIN IN TELECOM BID

AT&T Co. and Boeing Co. say they will enter a joint bid for the Federal Telecommunications System 2000 program, a 10-year contract that could be worth as much as \$4.5 billion. Ironically, AT&T will be squaring off with a team that includes the seven regional Bell operating companies, which just two years ago were still part of AT&T. The BOC team includes some competition that should be more familiar to AT&T—Martin Marietta, the prime contractor; Northern Telecom; and MCI. The contract is being administered by the federal General Services Administration, which is expected to issue a formal request for proposals this month. The winner should be determined within a year.

W. GERMANY, CHINA TEST TV MEETINGS

West Germany and the People's Republic of China have started two-month trials in video teleconferencing among the 13 public video-conference studios run by the West German post office and a similar studio in China's capital of Beijing. West German and Chinese government officials and business managers will be able to use the 6,000-mile video link, which will carry both voice and full-motion color TV pictures, free of charge until the trials end Jan. 31.

FLEXIBLE COMPUTER SHORT OF CASH

Flexible Computer Corp., the Dallas maker of parallel-processing computers, postponed its annual stockholders meeting last week after disclosing that it was experiencing

a "severe working-capital shortage" and was in default on some of its obligations. The computer maker is revising its net income and sales figures for 1985 and the first three quarters of this year, when it had been reporting sales income before the deals had been completed. Flexible had reported a net loss in 1985 of \$7.6 million on sales of \$2.5 million, and through third quarter 1986, the company was \$3.2 million in the red on sales of \$4.2 million. Now Flexible's auditor, Arthur Andersen & Co., has withdrawn certification of the company's 1985 financial statement, and no date has been set for release of the revised figures. Flexible is seeking additional financing, but a spokesman warns there is "no assurance that [the search] will be successful."

PHILIPS SETS DEAL WITH MATSUSHITA

Philips International NV of the Netherlands and Matsushita Electronics Corp. of Japan are joining forces to launch a new family of 8-bit CMOS microcontrollers. Under the new agreement, Matsushita will manufacture and market the PCF84CXX family designed and developed by Philips. The pact is aimed at ensuring customers of two sources of supply as soon as the family hits the market.

TANDON WILL BUY MAKER OF BIG DISK

The Tandon Corp., Chatsworth, Calif., which has been repositioning itself as a supplier of IBM-compatible personal computers, is again paying attention to the disk drive market. Tandon is attempting to flesh out its line of disk drives, which reaches only 40 megabytes at the high end, by acquiring struggling Atasi Corp., San Jose, Calif. Atasi offers a 170-megabyte drive but barely survived Chapter 11 bankruptcy proceedings earlier this year.

Terms of the deal, which is not yet final, were not disclosed. Although Tandon will move volume production of Atasi drives to Singapore, the company says it has no plans for wholesale layoffs in the U.S.

AEL GETS 6% SHARE IN ISRAEL'S TADIRAN

Philadelphia-based American Electronic Laboratories Inc. is trading its 59% share in Elissra Electronic Systems Ltd., an Israeli defense-electronics maker, to Israel's largest electronics company, Tadiran Ltd., which already owns 41% of Elissra. In exchange, AEL will get a 6% stake in Tadiran, in an agreement that should be signed by the end of the year. Elissra, which makes equipment for electronic warfare and civilian and military telecommunications, had sales of \$60 million this year but is expected to report a \$4 million loss—its first in 19 years. Elissra blames the loss on increasingly high labor costs in Israel.

TEXTET ADDS WANG TO CUSTOMER BASE

Textet Corp. continues to sign up major hardware vendors for its electronic-publishing software, and Wang Laboratories Inc. of Lowell, Mass., is its latest partner. The agreement calls for Textet to integrate its software with the Wang VS line of mini-computers, which will then be distributed through Wang's regular channels. Earlier this year, Textet signed similar agreements with Sun Microsystems Inc. of Mountain View, Calif., Compugraphic Corp. in Wilmington, Mass. and I3D/Framatome in Paris. The Arlington, Mass., company says that it will continue to market its dedicated electronic-publishing systems independently, while continuing to pursue more cooperative arrangements.

If the card below has already been used, you may obtain the needed information by writing directly to the manufacturer, or by sending your name and address,

plus the Reader Service card number and issue date, to Electronics Reader Service Department, P.O. Box 2713, Clinton, Iowa 52735.

Electronics

December 18, 1986 This Reader Service Card expires March 18, 1987

Name _____ Title _____
 Phone _____ Company _____
 Street address (company | | or home | | check one) _____
 City _____ State _____ Zip _____
 Signature _____ Date _____

Was this magazine personally addressed to you? Yes No

5 Source of Inquiry-Domestic

Industry classification (check one)

- | | | |
|--|--|--|
| <input type="checkbox"/> A. Computers, Computer Systems and Equipment | <input type="checkbox"/> F. Test and Measurement Equipment | <input type="checkbox"/> J. Research & Development |
| <input type="checkbox"/> B. Communications, Communications Systems and Equipment | <input type="checkbox"/> G. Consumer Products | <input type="checkbox"/> K. Educational 2-4 Year College, University |
| <input type="checkbox"/> C. Military/Space Systems and Equipment | <input type="checkbox"/> H. Medical Systems and Equipment | <input type="checkbox"/> L. Other _____ |
| <input type="checkbox"/> D. Industrial Systems, Controls and Equipment | <input type="checkbox"/> I. Software | Please specify _____ |
| <input type="checkbox"/> E. Electronics Subassemblies, Components and Materials | | |

Your principal job responsibility (check one)

- | | | |
|--|--|--|
| <input type="checkbox"/> A. Corporate/Operating and General Management | <input type="checkbox"/> C. Engineering Services | <input type="checkbox"/> E. Manufacturing & Production |
| <input type="checkbox"/> B. Design & Development Engineering | <input type="checkbox"/> D. Basic Research | <input type="checkbox"/> F. Other _____ |

Estimate number of employees (at this location): 1. under 20 2. 20-99 3. 100-999 4. over 1000

1 16 31 46	61 76 91 106	121 136 151 166	181 196 211 226	241 256 271 348	363 378 393 408	423 438 453 468	483 498 703 718
2 17 32 47	62 77 92 107	122 137 152 167	182 197 212 227	242 257 272 349	364 379 394 409	424 439 454 469	484 499 704 719
3 18 33 48	63 78 93 108	123 138 153 168	183 198 213 228	243 258 273 350	365 380 395 410	425 440 455 470	485 500 705 720
4 19 34 49	64 79 94 109	124 139 154 169	184 199 214 229	244 259 274 351	366 381 396 411	426 441 456 471	486 501 706 900
5 20 35 50	65 80 95 110	125 140 155 170	185 200 215 230	245 260 275 352	367 382 397 412	427 442 457 472	487 502 707 901
6 21 36 51	66 81 96 111	126 141 156 171	186 201 216 231	246 261 338 353	368 383 398 413	428 443 458 473	488 503 708 902
7 22 37 52	67 82 97 112	127 142 157 172	187 202 217 232	247 262 339 354	369 384 399 414	429 444 459 474	489 504 709 951
8 23 38 53	68 83 98 113	128 143 158 173	188 203 218 233	248 263 340 355	370 385 400 415	430 445 460 475	490 505 710 952
9 24 39 54	69 84 99 114	129 144 159 174	189 204 219 234	249 264 341 356	371 386 401 416	431 446 461 476	491 506 711 953
10 25 40 55	70 85 100 115	130 145 160 175	190 205 220 235	250 265 342 357	372 387 402 417	432 447 462 477	492 507 712 954
11 26 41 56	71 86 101 116	131 146 161 176	191 206 221 236	251 266 343 358	373 388 403 418	433 448 463 478	493 508 713 956
12 27 42 57	72 87 102 117	132 147 162 177	192 207 222 237	252 267 344 359	374 389 404 419	434 449 464 479	494 509 714 957
13 28 43 58	73 88 103 118	133 148 163 178	193 208 223 238	253 268 345 360	375 390 405 420	435 450 465 480	495 510 715 958
14 29 44 59	74 89 104 119	134 149 164 179	194 209 224 239	254 269 346 361	376 391 406 421	436 451 466 481	496 701 716 959
15 30 45 60	75 90 105 120	135 150 165 180	195 210 225 240	255 270 347 362	377 392 407 422	437 452 467 482	497 702 717 960

YES, please enter my subscription to *Electronics* for the term checked below: Subscription Card

Name _____
 Title _____
 Company _____
 Div. or Dept. _____
 Co. address _____
 City _____ State _____ Zip _____
 Check here if you wish publication to be sent to home address:
 Street _____
 City _____ State _____ Zip _____
 Signature _____

Those not qualifying may pay higher than basic price.

	US	CANADA	MEXICO
<input type="checkbox"/> One Year:	\$32	\$ 51 CDN	17,850 Pesos
<input type="checkbox"/> Two Years:	\$55	\$ 86 CDN	29,925 Pesos
<input type="checkbox"/> Three Years:	\$76	\$117 CDN	40,950 Pesos

Payment enclosed Bill me
 Charge my subscription to: AMEX DC VISA
 MC-Bank# _____
 Acct# _____ Exp. _____
 Signature _____

Subscriptions are normally entered within 2 weeks, but please allow 4 weeks for shipment.

Please check which best describes your company's business at your location:

- Manufacturing Distribution Retailing Other _____
- Indicate the primary product manufactured or services performed at your plant. (place applicable letter in box)
- A. Computers, data processing and peripheral equipment, office and business machines
 B. Communications, data communications, telecommunications systems and equipment
 C. Navigation and guidance, aircraft and missile systems or equipment (oceanography)
 D. Test and measurement equipment
 E. Consumer products (TV, radio, hi-fi, recorders, home computers, appliances)
 F. Medical, industrial controls, systems or equipment
 G. Semiconductor production equipment (component insertion, coil winding, etc.)
 H. Electronic sub-assemblies, components and materials (passive, active components, IC's, discretes, hybrids, power supplies)
 I. Other manufacturers using electronics equipment as part of their product (machine tools, chemicals, metals, plastics, pharmaceuticals, etc.)
 J. Government and military
 K. Independent research and development laboratory or consultant
 L. Research and development organizations which are part of an educational institution
 M. Independent software developers
 N. Operators of communications equipment (utilities, railroads, police and airlines, broadcasting, etc.)
 O. Educational 2-4 year college, university
 P. Other _____

Indicate your principal job function, occupation and/or title (place applicable letter in box. If letters O, P, or Q are used, fill in name of college or university).

- A. Corporate Management (Owners, Partners, Presidents, V.P.'s, etc.)
 B. Operating Management (General Managers, Group Managers, Division Heads, etc.)
 C. Engineering Management (Project Manager, Chief Engineer, Section Heads, V.P. Engineering, V.P. Research and Development, V.P. Quality Control, etc.)
 D. Software Engineering
 E. Systems Engineering/Integration
 F. Quality Control Engineering (Reliability and Standards)
 G. Design Engineering
 H. Engineering Support (Lab Assistants, etc.)
 I. Test Engineering (Materials, Test, Evaluation)
 J. Field Service Engineering
 K. Research and Development (Scientists, Chemists, Physicists)
 L. Manufacturing and Production
 M. Purchasing and Procurement
 N. Marketing and Sales
 O. Professor/Instructor at _____
 P. Senior Student at _____
 Q. Graduate Student at _____

Indicate your principal job responsibility. (place the appropriate number in box)

1. Management 2. Engineering Management 3. Engineering

Estimated number of employees at this location. (check one)
 1 to 49 50 to 249 250 to 999 over 1000
 Date _____ Signature _____

All information is required for reentry of subscription

5511

For additional information on products advertised, new products or new literature, use these business reply cards.

Complete entire card.
Please print or type.

Circle the number on the Reader Service postcard that corresponds to the number at the bottom of the advertisement, new product item, or new literature in which you are interested.

To aid the manufacturer in filling your request, please answer the three questions.

All inquiries from outside the U.S. that cannot reach Electronics before the expiration date noted on the Reader Service postcard must be mailed directly to the manufacturer. The manufacturer assumes all responsibilities for responding to inquiries.

Subscriptions & Renewals

Fill in the subscription card adjoining this card. Electronics will bill you at the address indicated on the card.

**AFFIX
POSTAGE
STAMP
HERE**

Electronics

**P.O. BOX NO. 2713
CLINTON, IOWA 52735**

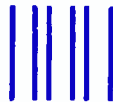

**NO POSTAGE
NECESSARY
IF MAILED
IN THE
UNITED STATES**



BUSINESS REPLY MAIL

FIRST CLASS

PERMIT NO 55

MARTINSVILLE, NJ

Postage will be paid by Addressee

Electronics

**CN 807
MARTINSVILLE, NJ 08836**



A complete list of things to know about 2400 bps modems.



Now that you've memorized that, here's a partial list of why a Hayes® Smartmodem 2400™ is best for you.

1. The Hayes Smartmodem 2400 allows you to communicate with the vast installed-base of 300, 1200 and 2400 bps "Hayes-compatible" modems. The Hayes Standard "AT" Command Set allows you to use Smartcom II® and other software that communicates.

2. Through synchronous/asynchronous technologies, the Smartmodem 2400 permits your PC to access mainframes, minis, and on-line services previously inaccessible through asynchronous-only modems.

3. The Hayes Smartmodem 2400 is efficient...it pays for

itself in just 4 hours of annual use over long distance.

4. The technology of the Smartmodem 2400 allows you to transfer volumes of files with confidence across the city or

across the ocean using Bell and CCITT standards.

5. The new Smartmodem 2400B™—a plug-in board for the IBM PC and compatibles—allows synchronous and asynchronous communication through the same Com port.

6. You will also get the Hayes standard 2-year limited warranty and the opportunity to extend the warranty to 4 years.

Best of all...you get Hayes. And that's all you ever really have to know!

For more information or technical specs, contact your authorized Hayes dealer. Or Hayes directly at (404) 441-1617.

Hayes Microcomputer Products, Inc., P.O. Box 105203, Atlanta, Georgia 30348.



Hayes®

Say yes to the future with Hayes.

Circle 901 on reader service card



2,000 sharper-than-ever characters all on a portable LCD display.

Toshiba's newest LCD modules give you 640×200 dot displays in a choice of two viewing sizes. One is approximately the size of a magazine, and the other about half that size.

Both sizes put an enormous amount of information on view . . . an array of 80 characters \times 25 lines. But still bulk and power consumption are at a minimum. Battery powered, these slim modules interface with various systems through LCD controller without renewing software.

Toshiba's advanced technology has also eliminated surface reflection and developed a sharper contrast which gives a brighter and easier to read viewing screen. And for low light or dark viewing an optional backlightable LCD is available.

These versatile LCDs are ideally suited for applications as displays for personal computers, POS terminals, portable word processors and other display terminals. You can also look to Toshiba with confidence for a wide range of sizes and display capacity to suit your LCD requirements.



TLC-363

TLC-402

Specifications

	TLC-402	TLC-363B
Display		
Number of Characters	80 \times 25 (2,000 characters)	80 \times 25 (2,000 characters)
Dot Format	8 \times 8, alpha-numeric	8 \times 8, alpha-numeric
Overall Dimensions (W \times H \times D)	274.8 \times 240.6 \times 17.0 mm	275.0 \times 126.0 \times 15.0 mm
Maximum Ratings		
Storage Temperature	-20° - 70° C	-20° - 70° C
Operating Temperature	0° - 50° C	0° - 50° C
Supply Voltage	VDD 7 V VDD - VEE 20 V	7 V 20 V
Input Voltage	0 \leq VIN \leq VDD	VSS \leq VIN \leq VDD
Recommended Operating Conditions		
Supply Voltage	VDD 5 \pm 0.25V VEE -11 \pm 3V Var.	5 \pm 0.25V -11 \pm 3V Var.
Input Voltage	High VDD - 0.5V min. Low 0.5V max.	VDD - 0.5V min. 0.5V max.
Typical Characteristics (25°C)		
Response Time	Turn ON 300 ms Turn OFF 300 ms	300 ms 300 ms
Contrast Ratio	3	3
Viewing Angle	15 - 35 degrees	15 - 35 degrees

Design and specifications are subject to change without notice.

TOSHIBA

Toshiba America, Inc.: Electronic Components Business Sector: Head Office: 2692 Dow Avenue, Tustin, CA 92680, U.S.A. Tel. (714) 832-6300

Chicago Office: 1101 A Lake Cook Road, Deerfield, IL 60015, U.S.A. Tel. (312) 945-1500

Toshiba Europa (I.E.) GmbH: Electronic Components Div.: Hammer Landstrasse 115, 4040 Neuss 1, F.R. Germany Tel. (02101) 1580

Toshiba (UK) Ltd.: Electronic Components Div.: Toshiba House, Frimley Road, Frimley, Camberley, Surrey GU 165JJ, England Tel. 0276 62222

Toshiba Electronics Scandinavia AB: Vasagatan 3, 5 TR S-111 20 Stockholm, Sweden Tel. 08-145600