

APRIL 21, 1982

AUTOMATION CHANGES OFFSHORE ASSEMBLY RULES/92

VLSI packaging dominates the components conference/ 121

Standard software in silicon moves into real-time systems/ 137

SIX DOLLARS A Mc GRAW-HILL PUBLICATION

Electronics®

142A UB0324 44042 MAY82
CS OSEURNE-JR
PERIPHILLON
BOX 324
BEAVERTON OR

97075

HIGH-DENSITY
DATA

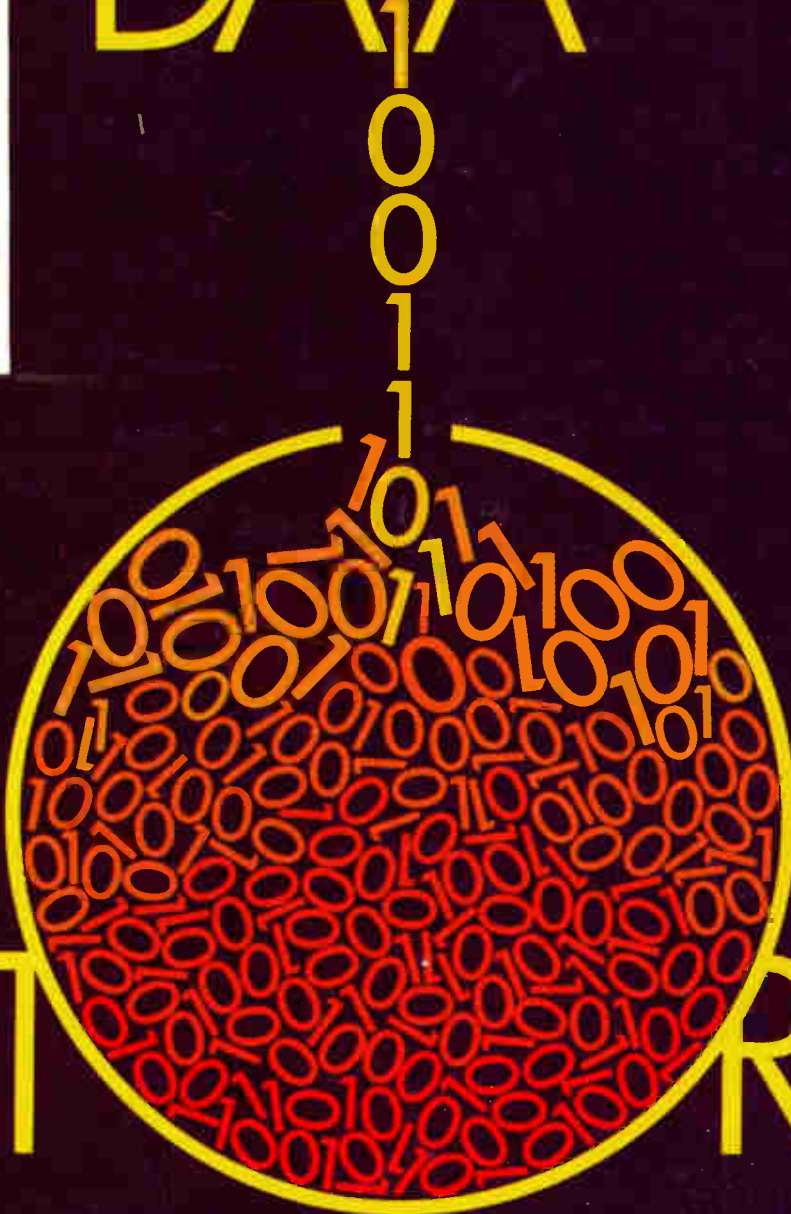

STORAGE

Universal Solution to Low Power Requirements

Raytheon's new micro-power switching regulators give you maximum flexibility when deciding how to optimize low power system performance.

Dynamic Features

Never before have such features been available in an 8-pin mini-DIP specifically designed for battery operated instruments or in battery backup systems.

- Low Battery Indicator Detection
- Remote Shut Down
- Temperature Compensated Band-Gap Reference
- 150mA Switch Transistor

Universal Applications

Raytheon's new series of switching regulators (RC4191, 92, 93) can be used as a building block in three basic applications: step-up, step-down and inverting.

High Efficiency

You no longer have to buy expensive batteries that absorb premium board space. In the step-up configuration these new devices can reduce the amount of cells required, limiting the size and cost of the battery, while making more board space available. The 4193, for example, operates over a wide input supply voltage range. 2.4V to 24 Volts, at



an ultra-low quiescent current of $135\mu\text{A}$ and achieve up to 80% efficiency.

Programmable

Two external resistors connected to pin-1 are all you need to program a voltage level that will provide a signal whenever the battery voltage drops to a predetermined level.

Volatile Memory Protection

Stored data, in a volatile memory, is valuable. AC powered systems without battery back-up lack the insurance your system should have. Raytheon's new switching regulators make battery back-up more efficient, less expensive and more profitable for you.

Versatility is unprecedented with Raytheon's new switching regulators. All of the details on these new universal regulators are available from your local Raytheon sales office, factory representatives, or authorized distributors.

Raytheon Company
Semiconductor Division
350 Ellis Street
Mountain View, CA 94042
(415) 968-9211

Device Number	Output Voltage	Operating Temperature Range	Max V_{REF} Limits @ 25°C	Max Line Regulation (% V_{OUT})
RC4191DE*	2.5V to 30V	0°C to +70°C	±2.0%	0.2
RC4192NB	2.5V to 30V	0°C to +70°C	±3.0%	0.5
RC4192DE	2.5V to 30V	0°C to +70°C	±3.0%	0.5
RC4193NB	2.5V to 24V	0°C to +70°C	±5.0%	0.5
RC4193DE	2.5V to 24V	0°C to +70°C	±5.0%	0.5

*Also Processed to 883B



Semiconductor Division
Circle 900 on reader service card

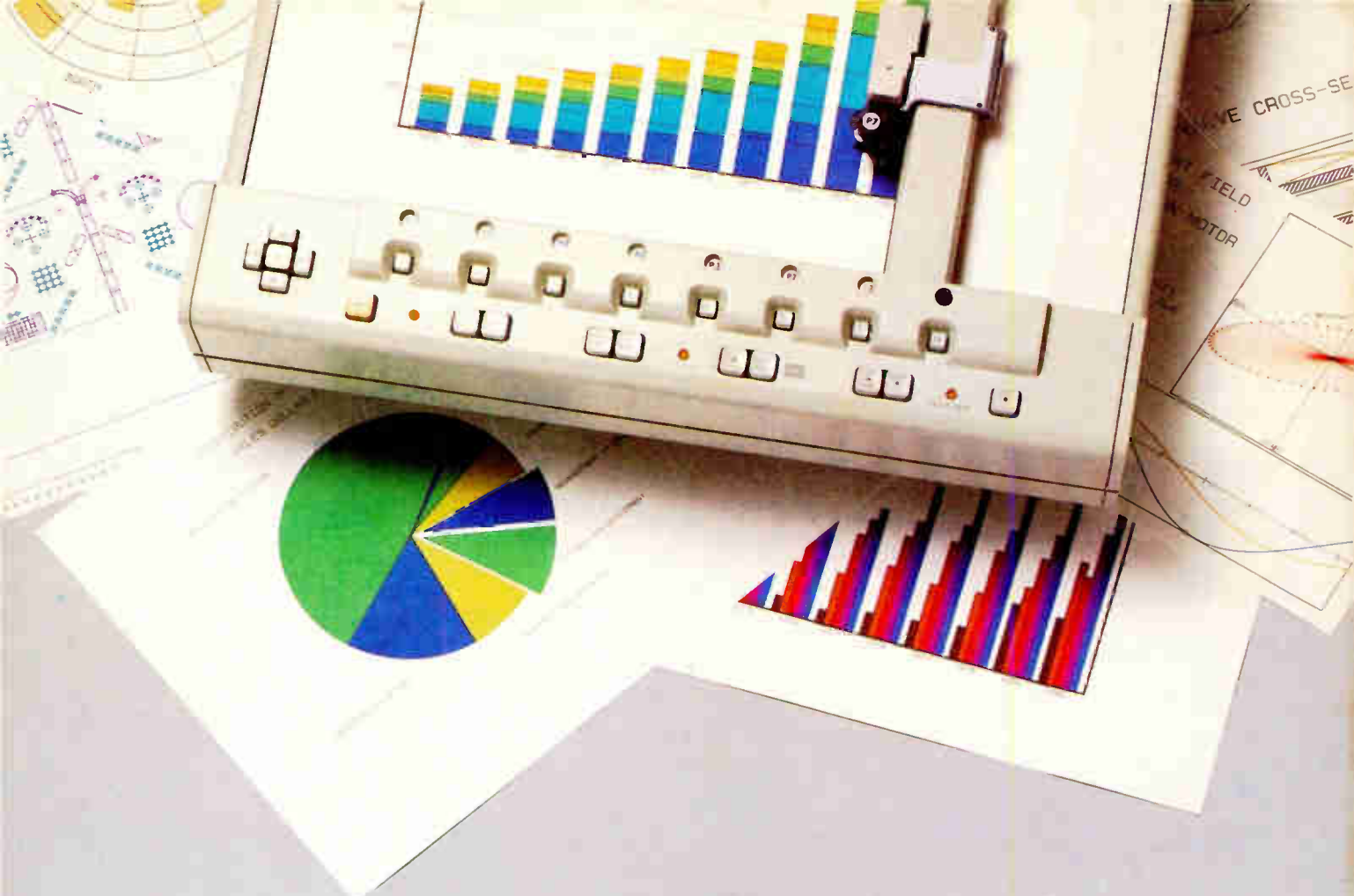

Send for a sample plot and see for yourself the real beauty of HP's new 8-pen plotters.

Hewlett-Packard's new 8-pen plotters bring true color capabilities to hard copy graphics. There are ten beautifully coordinated colors to choose from, all carefully selected for shading compatibility and line differentiation. And each pen color comes in two line widths.

HP plotters offer extremely fine resolution assuring superior line and character quality. High performance plotting coupled with automatic pen selection enables you to produce fully annotated graphs on paper or overhead transparency slides in minutes. Automatic pen capping keeps the pens fresh and ready for use, and a paper advance version is offered for unattended plotting applications as well.

HP makes a family of hard copy graphics products and software to meet a wide range of needs on a wide range of systems. For more information, write to Nancy Carter, Hewlett-Packard, 16399 West Bernardo Drive, San Diego, CA 92127, U.S.A.; or call Bill Fuhrer at (714) 487-4100.



Send to Nancy Carter, Hewlett-Packard, 16399 West Bernardo Drive, San Diego, CA 92127, U.S.A.; or call Bill Fuhrer at (714) 487-4100.

- Send me a free sample plot and product information.
- Have your representative call me.

My number is () _____

My Computer Model is: _____

My application is: _____

Name _____

Title _____

Company _____

Address _____

City _____ State _____ Zip _____

11104EL4



Circle 1 on reader service card

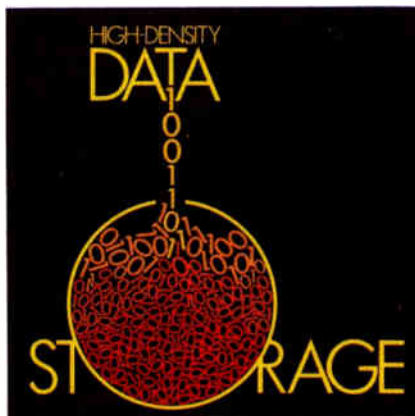

Cover by Art Director Fred Sklenar.

The Cover Story

A special report: High-density disk storage, 106

Materials, fabrication techniques, and drive mechanisms push magnetic-disk recording densities to new heights

Major New Developments

Disk memories

Vertical recording technology may give both hard and floppy disks 10 times higher linear bit densities, with Japanese companies leading the way, 89

IC fabrication

A commercially available electron-beam lithography system can resolve patterns as small as 0.5 μm , 73

Displays

Key advances in liquid-crystal and thin-film technologies will be out in front of the flat-panel pack at the Society of Information Display meeting, 100

New products roundup

A range of modems, operating from 300 to more than a million bits per second, vie for shares of a high-growth market, 159

Electronic Components Conference

Multilayer ceramic packages for VLSI circuits share the spotlight with optical hybrids, 121

NEWSLETTERS

Electronics, 33
Washington, 57
International, 63
Engineer's, 150
Products, 225

DEPARTMENTS

Highlights, 4
Publisher's letter, 6
Readers' comments, 8
News update, 10
Editorial, 12
People, 14
In my opinion, 24
Meetings, 26
Washington commentary, 58
New literature, 220
Career outlook, 229

SERVICES

Employment opportunities, 229
Reader service card, 237

Electronics Review

SOLID STATE

Linear designers get fast C-MOS gate arrays, 39

RESEARCH & DEVELOPMENT

Semiconductor research co-op kicks off in May, 40
SIA unveils its cooperative stars, 40

BUSINESS

Semiconductors may be turning upward, 41
West Europe shows an upturn, too, 41

MATERIALS

Coating blocks light on photosensitive chip, 42

QUALITY

Perception lag nags U. S. chip makers, 42

BUBBLE MEMORIES

Another bubble maker shows up in them thar hills, 44

SYSTEM DESIGN

Timing verifier separates checkout steps, 44

NEWS BRIEFS, 46

BROADCASTING

A-m stereo gets go-ahead, but no standard, 48

ELECTRIC VEHICLES

Fund batteries, GAO tells Congress, 50

MINICOMPUTERS

Separate processors take over for each other, 50

Electronics International

EAST GERMANY

Electron-beam system resolves patterns to 0.5 μm , 73

ITALY

Personal computer uses 16-bit Z8001 processor, 74

JAPAN

Watch display is electrochromic, 76

GREAT BRITAIN

Local net uses token passing, 78

Probing the News

DISK MEMORIES

Vertical recording promises vast increase in bit densities, 89

BUSINESS

Automation may erase advantages of offshore assembly operations, 92

ABROAD

On Taiwan, the new buzzword is 'information,' 96

DISPLAYS

Half of sessions at SID show are devoted to flat panels, 100

Technical Articles

COMPUTER & PERIPHERALS

The push to smaller, denser disk drives, 106

Thin-film disks drive densities to new highs, 108

Winchester cartridge challenges other backup systems, 112

Flexible-disk drive closes in on hard-disk densities, 117

ELECTRONIC COMPONENTS CONFERENCE

ECC embraces more than components and hybrids, 121

TEST & MEASUREMENT

Digital scope invades analog domain, 131

MICROSYSTEMS & SOFTWARE

Real-time operating system puts its executive on silicon, 137

SOLID STATE

Virtual-phase structure simplifies clocking for CCD image sensor, 141

DESIGNER'S CASEBOOK

State-variable filter trims predecessor's part count, 126
High frequencies, winding setup improve voltage conversion, 127
Diode plus op amp provide double-threshold function, 129

ENGINEER'S NOTEBOOK

Interfacing a 10-bit a-d converter with a 16-bit microprocessor, 146
Access-control logic improves serial memory systems, 149

New Products

ROUNDUP

Numerous modem introductions belie market uncertainty, 159

IN THE SPOTLIGHT

Wafer processor saves space, improves throughput, 165

INSTRUMENTS

50-MHz pulse generator is easy to operate, 168

COMPUTERS & PERIPHERALS

5 $\frac{1}{4}$ -in. Winchester disk drive stores 26 megabytes, 181

DATA ACQUISITION

16-channel analog I/O cards suit Q-bus systems, 190

MICROSYSTEMS

Programming unit can handle 256-K E-PROMs, 203

COMPONENTS

Low-profile DIP switch can be inserted automatically, 210

EDITOR-IN-CHIEF: Samuel Weber

SENIOR MANAGING EDITOR, *News*:
Arthur Erikson

MANAGING EDITOR, *Technical*:
Howard Bierman

ASSOCIATE MANAGING EDITORS:
Alfred Rosenblatt, Howard Wolf

ASSISTANT MANAGING EDITOR:
Margaret Eastman

SENIOR EDITORS: Ray Connolly, Kevin Smith

ART DIRECTOR: Fred Sklenar

DEPARTMENT EDITORS
Aerospace/Military: Ray Connolly
Circuit Design: Ashok Bindra
Communications & Microwave:
Harvey J. Hindin
Components: Stephen Evanczuk
Computers & Peripherals: Tom Manuel
Industrial/Consumer: William E. Suydam
Microsystems: R. Colin Johnson
New Products: Jeremy Young, Steve Zollo
Packaging & Production: Jerry Lyman
Software: R. Colin Johnson
Solid State: Roderic Beresford
Systems Integration: George Sideris
Test, Measurement & Control:
Richard W. Comerford

CONTRIBUTING EDITOR: John G. Posa

STAFF WRITER: Jesse J. Leaf

CHIEF COPY EDITOR: Margaret Eastman

COPY EDITORS: Marilyn A. Harris, David Kach,
Erik L. Keller, Benjamin A. Mason

ART: Charles D. Ciatto, *Associate Director*
Sachiko Inagaki, *Assistant Director*

EDITORIAL ASSISTANT: Penny Reitman

ADMINISTRATIVE ASSISTANT: Kathleen Morgan

EDITORIAL SECRETARIES: Lorraine Gibbs,
Janice Jung, Josephine Ortiz

REGIONAL EDITORS

Boston: Linda Lowe (617) 262-1160

Chicago: Wesley R. Iversen (312) 751-3811

Costa Mesa: Terry Costlow (714) 557-6292

Dallas: J. Robert Lineback (214) 458-2400

Los Angeles: Larry Waller (213) 487-1160

Palo Alto: Stephen W. Fields,

Martin Marshall (415) 968-2712

Washington: Ray Connolly (202) 624-7592

Frankfurt: John Gosch 72-5566

London: Kevin Smith 493-1451

Paris: Robert T. Gallagher 723-4656

Tokyo: Charles Cohen, Robert Neff 581-9816

McGRAW-HILL WORLD NEWS

Michael Johnson, *Editor*; James Smith, *Brussels*
Lois Bolton, *Milan*; Alex Beam, *Moscow*
Robert Skole, *Stockholm*

PUBLISHER: Paul W. Reiss

GENERAL MANAGER, DIRECT MARKETING
OPERATIONS: Horace T. Howland

DIRECTOR OF CIRCULATION: Frederick J. Kostbar

RESEARCH MANAGER: Margery D. Sholes

PROMOTION MANAGER: Jane DeCourt

MARKETING ADMINISTRATION MANAGER:
Frances M. Vallone

BOOKS & SPECIAL PROJECTS MANAGER:
Janet Elyer

SERVICE REVENUE ASSOCIATE:
June A. Noto

Cover: Disk drives get smaller, denser, 106

The state of the art in magnetic-disk drives is advancing rapidly, as demand grows for ever denser data storage in ever less physical space. Among the new technologies are thin-film disks with a ferrite head (p. 108), a drive that combines the advantages of Winchester and removable-cartridge technologies (p. 112), and a flexible-disk drive with hard-disk speed (p. 117).

Data storage's next leap looks like vertical recording, 89

For densities as high as 200,000 bits per inch, the next step is likely to be vertical recording, in which the magnetized areas of the medium are oriented vertically, instead of in parallel to the surface. Researchers in the U. S. and Europe are at work, but the Japanese are unquestionably in the lead.

Components conference crosses many boundaries, 121

This year's Electronic Components Conference takes off from its base of new developments in components and hybrids to include such fields as packaging very large-scale integrated circuits, manufacturing processes, optical hybrids, and even semiconductor processing and technology.

Digital scope reaches into analog realm, 131

By using what is called a dual-rank flash-flash converter, a digital storage oscilloscope can handle nonrepetitive waveforms with components as high as 50 megahertz. Thus the scope has waveform-storage capability that is comparable to analog equipment.

Executive module for operating system fits on two chips, 137

A real-time multitasking executive, supplied in two ultraviolet-light-erasable programmable read-only memories runs identically on the 68000, the 8086 and 8088, and the Z8000, with a version for the 16000 on the way. This standardized operating-system kernel is a prime example of a silicon software component.

Virtual-phase clocking speeds up CCD image sensor, 141

A structure that uses a single level of clocked polysilicon gates working together with grounded junction electrode (providing a second, virtual phase) permits a single pulse train to shift electrons down charge-coupled-device registers in an image sensor. The CCD sensor can scan images line by line accurately at high speeds.

And in the next issue . . .

A system on a chip for subscriber-line interfaces in the telephone network . . . what's in store at Electro/82 technical sessions . . . high-speed data conversion: three approaches.

April 21, 1982 Volume 55, Number 8
107,901 copies of this issue printed

Electronics (ISSN 0013-5070). Published every other Wednesday except the issue of Tuesday, Nov. 30, by McGraw-Hill, Inc. Founder James H. McGraw 1860-1948. Publication office 1221 Avenue of the Americas, N.Y., N.Y. 10020, second class postage paid at New York, N.Y. and additional mailing offices.

Executive, editorial, circulation and advertising addresses: Electronics, McGraw-Hill Building, 1221 Avenue of the Americas, New York, N.Y. 10020. Telephone (212) 997-1221. Teletype 12-7950 TWX 710-581-4879. Cable address: MCGRAW HILL NEW YORK.

Subscriptions limited to professional persons with active responsibility in electronics technology. No subscriptions accepted without complete identification of subscriber name, title or job function, company or organization, and product manufactured or services performed. Based on information supplied, the publisher reserves the right to reject non-qualified requests. Subscription rates in the United States and possessions \$19 one year, \$32 two years, \$47 three years; company addressed and company libraries \$24 one year, \$42 two years, \$59 three years; Canada and Mexico \$20 one year, \$33 two years, \$48 three years; Europe \$50 one year, \$85 two years, \$115 three years; Japan, Israel and Brazil \$70 one year, \$115 two years, \$165 three years; Australia and New Zealand \$95 one year, \$170 two years, \$240 three years, including air freight, all other countries \$50 one year, \$85 two years, \$125 three years. Limited quota of subscriptions available at higher-than-basic rate for persons allied to held server. Check with publisher for these rates. Single copies \$5.00. Please allow four to eight weeks for shipment.

Officers of McGraw-Hill Publications Company: Paul F. McPherson, President; Executive Vice Presidents: Daniel A. McMillan, III, Gene W. Simpson; Senior Vice President-Editorial: Ralph R. Schultz. Vice

Presidents: Kemp Anderson, Business Systems Development; Robert B. Doll, Circulation; James E. Hackett, Controller; Eric B. Herr, Planning and Development; H. John Sweger, Marketing.

Officers of the Corporation: Harold W. McGraw, Jr., Chairman and Chief Executive Officer; Joseph L. Dionne, President and Chief Operating Officer; Robert N. Landes, Senior Vice President and Secretary; Ralph J. Webb, Treasurer.

Title registered in U.S. Patent Office. Copyright© 1982 by McGraw-Hill, Inc. All rights reserved. The contents of this publication may not be reproduced in whole or in part without the consent of copyright owner. Where necessary, permission is granted by the copyright owner for libraries and others registered with the Copyright Clearance Center (CCC), 21 Congress Street, Salem, MA 01970, to photocopy any article herein for the base fee of \$0.50 per copy of the article plus \$0.25 per page. Payment should be sent directly to the CCC. Copying done for other than personal or internal reference use without the express permission of McGraw-Hill is prohibited. Requests for special permission or bulk orders should be addressed to the publisher. ISSN 0013-5070/81\$0.50+25

Subscribers: The publisher, upon written request to our New York office from any subscriber, agrees to refund that part of the subscription price applying to copies not yet mailed. Please send change-of-address notices or complaints to Fulfillment Manager; subscription orders to Circulation Manager, Electronics, at address below. Change-of-address notices should provide old as well as new address, including zip codes. Attach address label from recent issue. Allow one month for change to become effective. Subscriber Service: call (609) 448-8110, 9 a.m. to 4 p.m. EST.

Postmaster: Please send form 3579 to Fulfillment Manager, Electronics, P.O. Box 430, Hightstown, N.J. 08520.

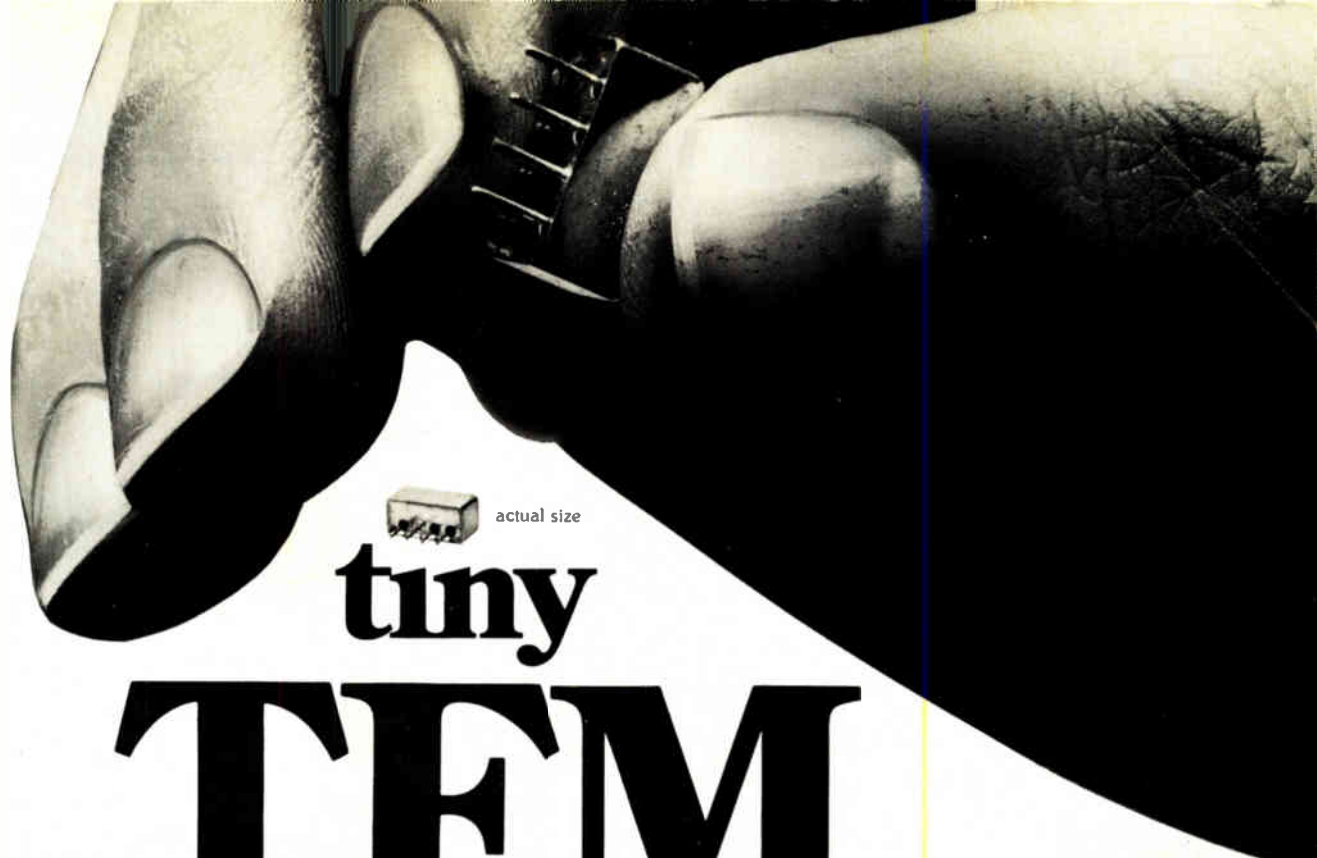

actual size

tiny TFM

the world's smallest hermetically-sealed mixers
40 KHz to 3 GHz, MIL-M-28837 performance*
 The TFM Series from Mini-Circuits from \$11⁹⁵

Increase your packaging density, and lower your costs... specify Mini-Circuits miniature TFM Series. These tiny units 0.5" x 0.21" x 0.25" are the smallest, off-the-shelf Double Balanced Mixers available today.

Requiring less PC board area than a flat-pack or TO-5 case, the TFM Series offer greater than 45 dB isolation, and only 6 dB conversion loss.

Manufactured to meet the requirements of MIL-M-28837*, the tiny but rugged TFM units have become the preferred unit in new designs for military equipment.

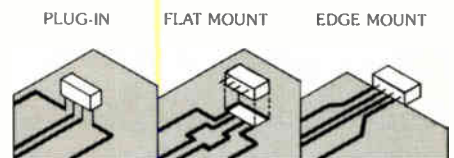

E-Z Mounting for circuit layouts
 Use the TFM series to solve your tight space problems. Take advantage of the mounting versatility—plug it upright on a PC board or mount it sideways as a flatpack.

MODEL	FREQUENCY, MHz		CONVERSION LOSS dB, TYPICAL		ISOLATION dB, TYPICAL						PRICE	
	LO/RF	IF	1 Octave from Band Edge		Lower Band Edge		Mid Range		Upper Band Edge		\$ EA.	QTY.
			LO-RF	LO-IF	LO-RF	LO-IF	LO-RF	LO-IF				
TFM-2	1-1000	DC-1000	6.0	7.0	50	45	40	35	30	25	11.95	(1-49)
TFM-3	.04-400	DC-400	5.3	6.0	60	55	50	45	35	35	19.95	(5-49)
TFM-4	5-1250	DC-1250	6.0	7.5	50	45	40	35	30	25	21.95	(5-49)
•••TFM-11	1-2000	5-600	7.0	7.5	50	45	35	27	25	25	39.95	(1-24)
•••TFM-12	800-1250	50-90	—	6.0	35	30	35	30	35	30	39.95	(1-24)
•••TFM-15	10-3000	10-800	6.3	6.5	35	30	35	30	35	30	49.95	(1-9)
•••TFM-150	10-2000	DC-1000	6.0	6.5	32	33	35	30	35	30	39.95	(1-9)

•••If Port is not DC coupled
 ••+10 dBm LO, +5 dBm RF at 1dB compression
 *Units are not QPL listed

For complete specifications and performance curves refer to the Microwaves Product Data Directory, the Goldbook, EEM or Mini-Circuits catalog

finding new ways...
 setting higher standards

Mini-Circuits

A Division of Scientific Components Corporation
 World's largest manufacturer of Double Balanced Mixers
 2625 East 14th Street, Brooklyn, New York 11235 (212)769-0200
 Domestic and International Telex 125460 International Telex 620156

Circle 5 on reader service card

500 Watts of H.F. Power

ENI A-500
broadband
power amplifier
delivers 500 W
0.3 to 35 MHz



Here is the biggest, toughest, ruggedest, solid state Class A linear amplifier we make. It's designed to stand up in hostile environments, yet it's easy to field service because all major subassemblies are "plug in" replaceable.

Designed for use in HF transmitters, RFI/EMI applications, linear accelerators, and gas plasma equipment, the ENI Model A-500 broadband power amplifier is capable of delivering more than 500 watts of output over the frequency range of 0.3 to 35 MHz.

And like all ENI power amplifiers, the A-500 features unconditional stability, instantaneous failsafe provisions, and absolute protection from overloads.

For more information, a demonstration, or a full line catalog, please contact us at ENI, 3000 Winton Road South, Rochester, N.Y. 14623. Call 716/473-6900 or telex 97-8283 ENI ROC.

ENI



The advanced
design line of
power amplifiers

Publisher's letter

The insatiable appetite of computers and microcomputers for memory continues to press technology to produce more and more bit capacity at ever lower cost. Semiconductor memories have dominated the pages of the press over the last few years, but most of the bits being moved and processed by today's computers are written into and stored in devices that depend on much older technology—namely, magnetic storage—and get their high performance from much less glamorous, but no less clever, mechanical engineering.

Despite the dependence on technologies with a longer history than semiconductors, however, there is yet much lively innovation, according to Computers & Peripherals Editor Tom Manuel.

Tom, who conceived, assembled, and edited the special report on high-density magnetic storage that begins on page 106, found plenty of evidence that this technology is not standing still. "One approach is to scale down the larger Winchester disk drives to 8- and 5¼-inch units and to squeeze performance from them, just as semiconductor manufacturers are shrinking memory chips and squeezing out more speed and capacity," he says.

"A second approach is to change form factors. Examples: the development of removable 5¼-in. Winchester cartridges by DMA Systems Corp., Santa Barbara, Calif., and the engineering of Winchester hard-disk performance and reliability by Iomega Corp. of Ogden, Utah, into a flexible disk in a removable cartridge that gives the advantages of both.

"The third branch of innovation is going into the magnetic technology itself," Tom says. "We're beginning to see the introduction of thin magnetic films in both heads and disks

with great potential in increased storage density. Whereas thin-film-head technology is still coping with problems of yield and reproducibility, thin-film disks combined with ferrite heads appear to be headed for a successful launch."

In the course of preparing his report, Tom came upon a growing interest in a totally new approach to magnetic storage: vertical recording. This is a technique that can increase storage densities by an order of magnitude and has the potential of making obsolete all the current disks now on the market. You'll find out all about it in Tom's Probing the news on page 89.

It's called the Electronic Components Conference, but that hardly does justice to the scope of the 60 papers that make up this year's program, according to Jerry Lyman, our Packaging & Production Editor. Jerry's beat includes an annual assessment of this important gathering, and each year he's amazed at its expanding charter. "There are components papers to be sure," he says, "but there are also presentations on packaging, connector manufacturing, hybrids, soldering and bonding, reliability, semiconductor processing, and much more."

For those with a nostalgic affection for vacuum tubes, there's even a paper on a new high-speed cold cathode tube for high-power switching. You can read about the offerings starting on page 121.

Time to order your *Electronics* editorial index

The index of all editorial material that ran in 1981 (Vol. 54) is now available. To get your copy, simply circle No. 370 on the reader service card inside the back cover. If the card is missing, order by letter from Kathleen Morgan, *Electronics*, 1221 Ave. of the Americas, New York, N. Y. 10020. The 1981 index is free; indexes for previous years can be purchased from our reprint department for \$4.00 each.

MODEL 1870 provides new functions that enable programming to FPLA and 64K-bit P-ROM's multi-job processing.



In the field of the logic, the LSI is marking revolutionary changes. Minato Electronics's "Model 1870" is a fully up-to-date achievement in a universal programmer. Designed for programming of logical devices such as FPLA. The "Model 1870" features a host of functions as a P-ROM programmer and offers easy operation. The replacement of the personality module permits not only programming of one MOS and bipolar device, but also easy and simultaneous gang-programming of 8 and 16 MOS devices. One of its significant features is that it permits the simultaneous gang-programming of 16 64K-bit P-ROMs, aiming at the anticipated 128K period. The "Model 1870" meets the current requirements as the P-ROM programmer, as well as the future requirements for LSI logic, by one unit. It responds to a wide variety of applications through its excellent performance, as a new-type universal programmer having great possibility.

- Very easy to operate
- Programs EP-ROMs, BIPOLAR PROMs, Single Chip Microcomputers, FPLA's, PAL's etc.
- Various kinds of personality modules (single-gang) and socket adapters
- 16K x 8 RAM standard—32 x 8 RAM optional
- Various test, check and protection functions for correct programming
- Various serial interface (option)
RS232C, 20mA current loop and TTL levels

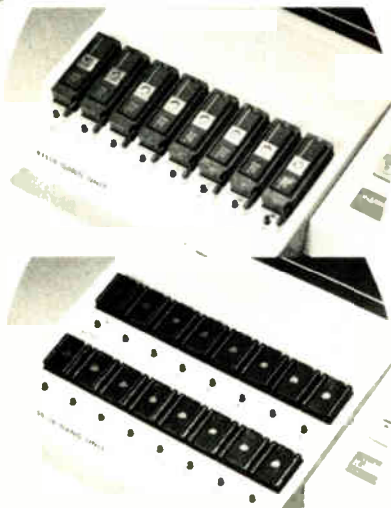

For further information, Please contact

- AUSTRIA
DES ELECTRONISCHE SYSTEM GMBH
A-1120 Wien, Fockygasse 51/3 Austria
Phone: 0222/83 01 91
- CANADA
CYBERNEX LTD.
Box 9086 Ottawa, Ontario Canada K1G 3T8
Phone: (613) 741-1540
- FRANCE
TEKELEC AIRTRONIC
Cite Des Bruyeres Rue Carle-Vernet 92310 Sevres
France
Phone: (1) 534-75-35

- FINLAND
PROFELEC OY
PL 67 00421 Helsinki 42
Phone: (90) 5664 477 Finland
- HONG KONG
SCHMIDT & CO. (H.K.) LTD.
28th Fl. Wing on Centre Hong Kong
Phone: 5-455644
- MALAYSIA
NIE ELECTRONIC (M) SDN. BHD.
P.O. Box 2167 Lot 2.22, Kompleks Selangor,
Jalan Sultan, Kuala Lumpur Malaysia
Phone: 03-24341
- SINGAPORE
LIM CHENG KOAN HOLDING PTE. LTD.
29, Hong Kong Street, Singapore, 0105.
Phone: 434626, 430358, 2243038
- SWEDEN
TELEINSTRUMENT AB
P.O. Box 4420 S-162 04 Valingby, Sweden
Phone: 08/380370
- SWITZERLAND
PRECITEK ELECTRONIC AG
Bahnhofstrasse 358b CH-8107 Buchs Zurich
Switzerland
Phone: 01-8442950
- TAIWAN
BURGEON INSTRUMENT CO., LTD
No. 90 Alley 83 Lane 211 Sec. 4 Nanking East Road
Taipei Republic of China
Phone: (02) 7646968, 7647017
- UNITED KINGDOM
MTL MICROTESTING LIMITED
Mill Lane, Alton, Hampshire GU34 2QG England
Phone: Alton (0420) 88022
- U.S.A.
OKURA & CO. (AMERICA), INC.
615 South Flower Street Suite No. 908 Los
Angeles, Calif. 90017 U.S.A.
Phone: (213) 624-8611



MINATO ELECTRONICS INC.

4105, Minami Yamada-cho, Kohoku-ku,
Yokohama, 223, Japan Phone: 045-591-5611
Cable: MINATOELEC YOKOHAMA
TELEX: 3822-244 MINATO J

Plastic Film Capacitors

Lead Spacing 5 mm

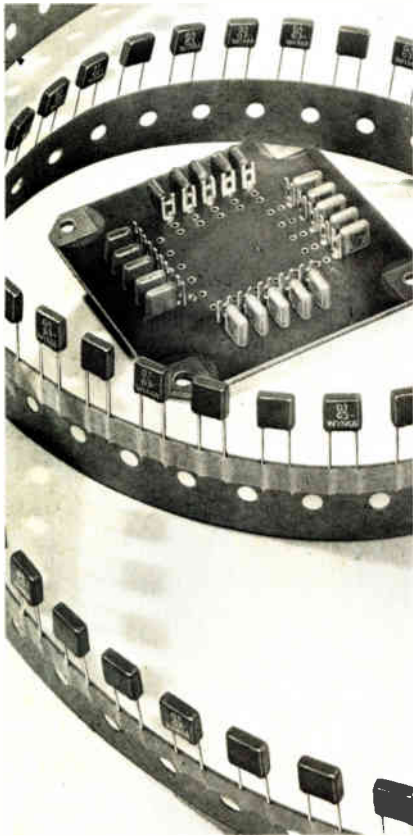

- Space saving design up to 1 μ F
- High capacitance/temperature stability
- Suitable for automatic insertion; available on tape for volume usage

WIMA MKS 2

Metallized polyester type providing extremely small dimensions at maximum capacitance/volume efficiency.

Ranges also include WIMA FKS 2/ WIMA FKC 2/WIMA FKP 2: polyester/ polycarbonate/polypropylene with metal foil electrodes.



WIMA PCM 5 mm

Capacitors:
Tomorrow's technology!

WILHELM WESTERMANN

Spezialvertrieb elektronischer Bauelemente
P. O. Box 2345 · D-6800 Mannheim 1
Fed. Republic of Germany

THE INTER-TECHNICAL GROUP INC.
North Dearman Street · P. O. Box 23
Irvington · New York 10533
(914) 591-8822

TAW ELECTRONICS CO.

4215 W. Burbank Blvd., Burbank
California 91505 · (213) 846-3911

Readers' comments

Reading, writing, and computers

To the Editor: Thank you for your badly needed article on the operating systems available ["Operating systems hold a full house of features for 16-bit microprocessors," March 24, p. 113], especially for the newer 16-bit machines on the market. However, I feel there was a big oversight in not mentioning such established operating systems such as the RT-11 from Digital Equipment Corp.

As a nonprofit foundation, we are packaging systems for schools centered on the Q-bus with 22-bit addressing. This approach allows all the students at a school to learn an operating system as they learn Basic, machine language programming, hardware concepts and word processing (or editing) and attain computer literacy. With RT-11, we have already done this in one rural school with some seventy 11th and 12th graders in 21 clock hours.

The operating system can run eight-user Basic in the foreground with, for example, a spooler in the background. More importantly, the RT-11's system generation capabilities allows students to build their own system monitors or operating systems in Fortran, Macro, Pascal, or other languages.

The operating system runs eight-and hardware options, it is very easy to overlook viable 16-bit (and 12-bit) options. By reading history, or in some cases, by living it, one finds it seems to take 8 to 12 years to debug and mature an operating system, although it appears somehow the new breed is zapping them to market in some six months. For the more-skeptical, there are established systems from DEC, Data General, and Intel, among others. Because their listings can be purchased, studied and manipulated, some of these also have greater teaching value.

I am sorry my limited experiences do not allow me to present what I feel are equally valid arguments for other older and wiser vendors. I simply wanted to support my case, such as it is, with real examples.

Elmo Knoch
National Braille Resources Inc.
Harrison, Ark.

8086/8087/8088 CROSS SOFTWARE PACKAGES

1 C cross compiler for the 8086. All facilities of the complete C language, including floating point for the 8087, are supported. Optionally, memory can be allocated for use with the 8088. Output is symbolic assembly language. The compiler is suitable for use in porting UNIX to the 8086.

2 Cross assembler / linker / librarian / down line loader for the 8086. Assembler input is an extension to that used by Intel. Loader output is a file in standard Intel hex format.

3 Simulator/debugger for the 8086. Capabilities include display, break-points, interpretive execution, as well as many others.

Host System: PDP-11 running RT-11, RSX-11M, UNIX/V6, UNIX/V7; or VAX-11 running VMS, UNIX/32V.

For additional information:



Advanced
Digital Products, Inc.

1701 21st Ave. S., Suite 222 · Nashville, TN 37212
Phone (615) 383-7520
Telex 4990476

Circle 260 on reader service card

Check

- Transistors
- Capacitors
- Diodes
- IC's

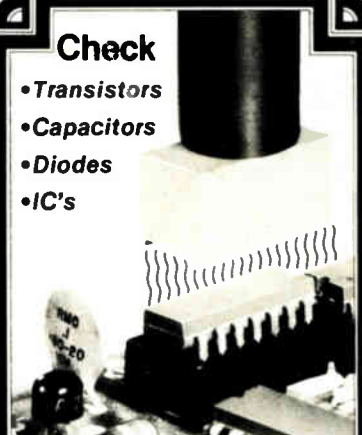

CONTROLLED HEATING
... where it counts

THERMO-PROBE

Heat any integrated circuit or electronic component to its rated temperature with a heat probe. Accuracy $\pm 3^{\circ}$ C or better. Or check the component's temperature with a thermo-couple probe. Model 810 Thermo-Probe does both. Reads out directly in $^{\circ}$ C and $^{\circ}$ F on a large $4\frac{1}{2}$ -inch meter.

MTI MICRO-TECHNICAL INDUSTRIES

23112 "C" Alcalde
Laguna Hills, Calif. 92653
(714) 855-4326
TWX (910) 595-1745

Circle 261 on reader service card

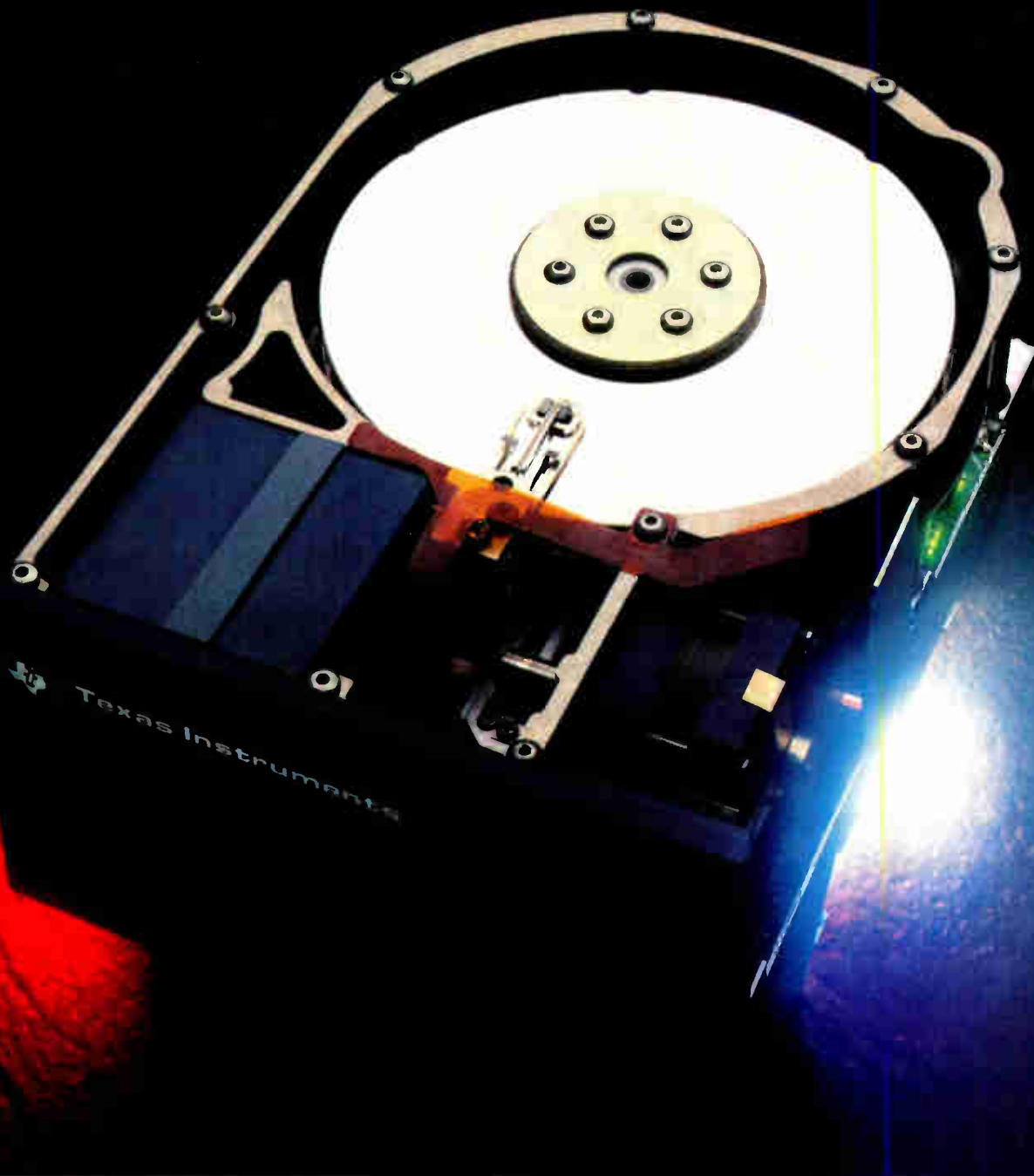

We deliver what the others promise.

The Texas Instruments 5¼" 6-and 12-Megabyte Winchester Disk Drive Family fits right into TI's tradition of perfecting our technology, production techniques and reliable performance.

That's why we can ship disk drives in large production quantities just when you want them. This ability to deliver has made us a leader in the OEM marketplace.

It's really not surprising that TI's Winchester Disks actually do what all the others promise.

After all, we invented the integrated circuit, the microprocessor and microcomputer. They're the key components that make computers what they are today.

As always, our worldwide support and service are part of

TI's tradition of giving you more than you expect. For information write: Texas Instruments Incorporated, P.O. Box 202145, Dallas, Texas 75220. Better yet, call us today: 1-800-231-4717. In Texas: 1-800-392-2860.



**TEXAS
INSTRUMENTS**

TINY SLIDE SWITCHES

with BIG applications

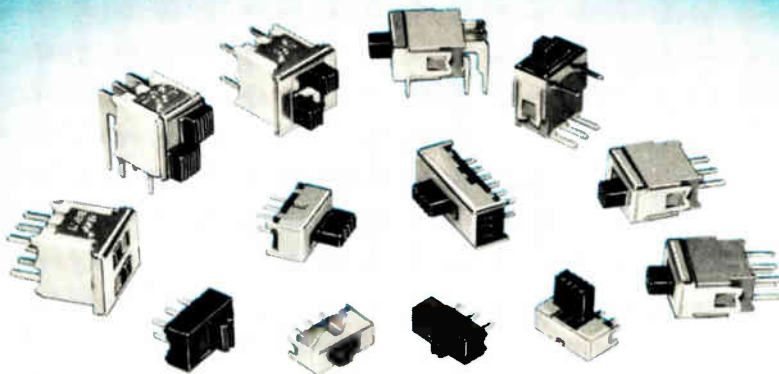

We have developed a vast array of subminiature slide switches which we call our TINY Series. Even our TINY of 2 years ago appears big when compared to our latest creations which have been reduced some 50%. Offering instrument grade switches with built-in engineering features to allow many years of use with little deterioration. A wide choice of standard types including 1, 2 and 4-pole, two or three positions with contacts in gold or silver. Our prototype shop is equipped to produce virtually any type of TINY switch. Simply give us your parameters and we'll do the rest. Our production capabilities tend to offer 4 to 8 weeks delivery on specials, but we have available many standard types from stock. We urge you to give us a try. Our quality is No. 1, our service is good and our prices are always competitive. Call (617) 685-4371 for additional information and free sample.

AUGAT

ALCOSWITCH

ALCO ELECTRONIC PRODUCTS, INC.
1551 Osgood St., No. Andover, MA 01845 USA

Canada: Augat Electronics Inc. Suite 103
6205 Airport Rd., Mississauga, Ontario, L4V 1E1
Europe: Augat France SA (Z.I. Sofilic) B.P.
440-CEDEX 94263 Fresnes, France

Circle 10 on reader service card

Keeping you ahead of the pack...

You (and we) are in a quick-moving business. News breaks frequently. Change is the name of the game. Awareness is the way to win.

Give us one hour of your time every two weeks and we will keep you aware of what's going on around you and around the changing world of electronics technology.

Keep ahead of the pack. Send in one of the subscription cards in this issue.



Electronics Magazine

News update

■ Last month Sperry Univac moved out the general manager and laid off more than half of the research and development staff of its floundering Mini-Computer Operation. These moves have led to speculation that Sperry might throw in the towel, after investing at least \$75 million, for its Irvine, Calif., operation.

Only last year [*Electronics*, July 28, p. 48], Sperry Univac tried to revitalize the group with new management and a revised product line. "Nothing has changed. Minicomputers are not Sperry's natural habitat," says Ulric Weil, vice president at Morgan Stanley & Co.

Ex-general manager Neil Gorchow, a 25-year man at Sperry who now awaits reassignment, began a thrust to sell minicomputers into Sperry's mainframe base. His replacement, Eugene B. Rawles, named marketing vice president when Gorchow came aboard, concentrated on sales to original-equipment makers. Rawles, who also has 25 years at Sperry, joined the mini-computer operation after Sperry acquired it from Varian Associates in 1977 for \$40 million.

Since making the purchase, Sperry has made little headway in increasing market share. For example, market-researching firm Dataquest Inc., Cupertino, Calif., does not list Sperry among the top 20 minicomputer firms. It notes that Sperry's overall computer operations grew by only 5.9% last year, and Sperry admits that "minicomputers have been hit harder [by the recession] than our other lines."

The layoffs drop the R&D staff to 225 and the total staff in Irvine to slightly below 300, a far cry from 1,200 only a year ago. Late last year, Sperry laid off 200 manufacturing personnel. It is in the process of transferring the remaining 300 to a Sperry facility in Salt Lake City.

However, Sperry pledges to "develop, build, and support" its V-77 family of 8- and 16-bit minicomputers. A 32-bit machine is set for introduction this month, but its prospects are not bright. "The market is flooded with 32-bit machines," notes Weil.

-Terry Costlow

For every engineering manager with the last word on purchasing an LSI/VLSI test system.

It's nice to know Tek is in the business.

When a million dollar decision rests on the tip of your pen, you need more than a nod from your engineering department that our products perform best.

Our LSI/VLSI test systems — true engineering tools — measure with precision the entire range of device performance that exists between good and just how good.

When you're evaluating your investment in an LSI/VLSI test system, you have a range of issues to consider.



Issues like life-cycle costs, time to market, training, documentation, service, long-term support, and Tek's renowned quality and reliability.

When you know Tektronix delivers all this, it's that much easier for the last word to be "yes."

For more information, contact a Sales Engineer at Tektronix.

U.S.A., Asia, Australia, Central & South America, Japan

Tektronix, Inc.
P.O. Box 4828
Portland, OR 97208
Phone 800 547 1512
Oregon only 800 452 1877
Telex 910 467 8708
Cable TEKTRONIX

Canada
Tektronix Canada Inc.
P.O. Box 6500
Barré, Ontario L4M 4V3
Phone 705 737 2700

Europe, Africa,
Middle East
Tektronix Europe B.V.
European Headquarters
Postbox 827
1180 AV Amstelveen
The Netherlands
Telex 18312

Why should the military settle for old technology?

The huge deficits being projected as a result of the Reagan economic program have justifiably brought military spending under intense scrutiny. The Administration's options on actions to close what appears to be an unacceptable gap between spending and income are beginning to focus on the immense proposed military budget. Part of the questioning of this budget centers on whether many of the programs being advanced are really needed. This is a strategic and political debate, and for the moment we'll leave the argument to those pundits who are more intimate with the pros and cons of that aspect of defense policy.

Another part of the doubts on military spending arises from the question of inefficiency, waste, and duplication in procurement practices. Seekers of savings question whether the nation is getting full value for the huge sums we the people are paying for our nation's defense. On this point, we submit, history provides no encouragement. The long and seemingly hallowed tradition of large cost overruns on military development and procurement programs—even when successfully completed—speaks for itself.

A major problem, not often discussed, stems from the long cycle time that is symptomatic of military procurement of large complex systems, a cycle time that often spans 10 years or more. While the specifications and the proposals and the brochures wend their way tortuously through the thickets of design definition, bid, acceptance, design prototype, and ultimately acceptance and production, the technology initially specified for use in the system may have undergone several generations of evolution or may have become entirely obsolete. The result is that the system that finally arrives in the field is operating with 10-year-

old technology and 10-year-old specifications, with a performance capability far below what is technically possible.

Part of the problem is the inherent conservatism of the military establishment, and this is certainly justified and necessary. Obviously, the national defense cannot gamble with unproved technology, and we're not arguing that this be done. We are arguing, however, for the utilization of available technology a lot sooner than is happening right now.

We think it's possible, and so do a lot of industry executives—like the semiconductor-firm vice president who, at a recent quality-control conference, pointed out the experiences of the automobile and computer industries. "In many ways," he said, "their requirements and specs are tougher than the military's. They are tough customers; they demand a lot. But they're getting the latest technology, and we're delivering it—on time." However, the layers of bureaucracy, the painstaking paperwork, and the infighting among entrenched factions in various branches of the Department of Defense discourage many of the companies responsible for major innovation in electronics over the past decade from participating in defense procurement.

The Very High-Speed Integrated-Circuits (VHSIC) program is designed to make available to the services by the late 1980s state-of-the-art technology in the form of very large-scale ICs that can be used in a number of military systems. Even if those circuits are forthcoming on schedule, getting the services to accept them and design them in is where the real battle will be fought. There is a good probability that those VHSIC parts may be 10 years old when they see their first system. Surely such waste is unacceptable.

When you can't get action out west...

COME EAST to CHERRY for CUSTOM ICs



We'll treat you like a CUSTOMER!

We're the "action now" people who take your custom IC needs as seriously as you do. We know your business can't afford delays. So we give you the prompt attention you expect.

With full custom IC capabilities and some of the most advanced technology anywhere, we can meet your design, production and delivery schedules for digital and linear bipolar circuits. Need both on the same chip? We've done it with I²L... successfully!

And, if a full custom design isn't quite what you need, one of our circuits that has been processed up to the point where it is ready for your interconnect mask can be finished to your specifications, saving design time and cost.

Call us today for ACTION! Dial (401) 885-3600 and ask for Custom IC Engineering Sales. Or write for this 12-page, full color brochure describing production of custom ICs the Cherry way.



CHERRY SEMICONDUCTOR

CHERRY SEMICONDUCTOR CORPORATION 2000 South County Trail, East Greenwich, RI 02818/ 401/885-3600

A wholly owned subsidiary of Cherry Electrical Products Corp., Waukegan, IL, U.S.A., 312 689 7700 • Worldwide affiliates and phone numbers: Cherry Mikroschalter GmbH, Auerbach, Germany, 09 643 181 • Cherry Electrical Products Ltd., Harpenden (Herts) England, (05827) 63100 • Cherro Brasil Industria E Comercio Ltda., Sao Paulo 55 (011) 246-4343 • Hirose Cherry Precision Co., Ltd., Kawasaki, Japan, 044 933 3511

Circle 13 on reader service card

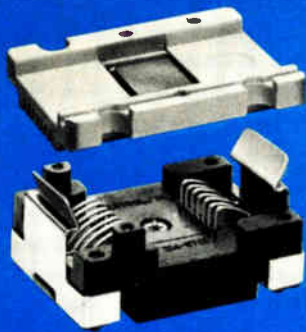

New Lidless "Soft Touch" Flat-Pack Sockets

Unique new Textool "Soft Touch" contact design prevents carrier warpage caused by excessive normal force!

Textool's new lidless "Soft Touch" flat-pack sockets virtually eliminate carrier warpage.

The unique design of Textool's "Soft Touch" contacts reduces the force exerted against a loaded carrier by as much as 66% that of similar available flat-pack sockets.

No carrier warpage, coupled with the elimination of lead damage



caused by dimpling and gold removal, makes this new socket ideal for the fast handling of flat-pack devices.

It is available in a choice of 14 or 16 lead versions which are pin for pin replacements for any comparable flat-pack socket.

The new lidless "Soft Touch" flat-pack socket, as is typical of most Textool test and production sockets, was developed as a solution to specific application demands. Textool's engineering experience offers design capabilities to meet the most demanding test socket requirements.

Detailed information on these and other products from Textool . . . IC, MSI, LSI, and VLSI sockets and carriers, power semiconductor sockets, and custom versions . . . is available from your nearest Textool sales representative or the factory direct.

**Textool Products Department
Electronic Products Division/3M**
1410 W. Pioneer Dr., Irving, TX 75061
214/259-2676



People

Santoro of Silicon Systems takes the custom-IC route

Carm Santoro expects some curiosity about his move from the job as vice president for integrated circuits at RCA Corp.'s \$240 million Solid State division to become president of Silicon Systems Inc., a \$13 million custom house. But he justifies the transition by saying, "Since 1975, I've held the fundamental belief that there was going to be a custom renaissance. And Silicon Systems has the rudiments to be at the forefront of it."

This renaissance will cause "almost the same type of change as going from discretes to ICs," he notes. Santoro says that during stints as group operations manager

for Motorola Inc.'s Solid State division and then group vice president for memories and microprocessors at American Microsystems Inc., he considered startups in the custom field but never found the right fit. He has been involved in MOS technology since receiving his doctoral degree in solid-state physics from Rensselaer Polytechnic Institute in Troy, N. Y., in 1967.

Santoro points to four aspects he feels a successful custom house must have. "The first thing you need is quick turnaround, using an elegant computer-assisted-design system. Second is design capability, or personnel. You also need a reasonable selection of technologies, and you've got to have fab," notes the 40-year-old executive. He says Silicon Systems has the first three, and its wafer fabrication facility should go on line this summer.

The wafer facility is being designed to support complementary-MOS and bipolar technologies, so the Tustin, Calif., firm will continue to go outside for expertise in n-channel

and p-channel MOS. Additionally, Santoro says he will maintain external C-MOS and bipolar second sources. Internally, C-MOS was picked because at present "it's the ultimate technology," although bipolar is still important because of its speed. He is maintaining external sources for the other technologies chiefly because the wide-ranging nature of customized products requires a diversity of approaches.

Santoro this month completed his analysis of the firm and reorganized it to streamline management by grouping related operations. He has also selected areas he will step away from, saying they are or soon will be commodity items that will not call for custom chips.

"We'll no longer be in voice synthesis or voice recognition. They're like watch chips: they come from the Far East as standards. We won't participate in automotive markets either," he says. Instead, the nine-year-old firm will focus on "rotating memory—where we have a major market share in read-write circuitry—telecommunications, custom-owned tooling—where we'll be a foundry—and the military."



Renaissance man. Carm Santoro expects a resurgence in custom ICs and sees his firm in the vanguard.

Casilli will use Genesis to create new companies

For Gerald S. Casilli, the cofounding of Millennium Corp. in Cupertino, Calif., some nine years ago was a dream—a dream that almost turned into a nightmare. Now, after a successful battle by Casilli and his management team to bring Millennium back to the \$13 million sales level of its heyday, he is ready to live another dream—as a venture capitalist in high-technology.

"I want to use my management

Ohmite can help you select the right resistor for your application with capabilities unequaled by any other manufacturer. We make more types, in a wider range of wattages and resistances than anyone else. You can be sure that our recommendations will not be influenced by product line limitations.

Our resistors range from 1 watt up to 1500 watts and from 1 megohm down to 0.005 ohm in the coatings you need. We can even provide 0.005 ohm resistors with 1% tolerance—a variance of only ± 0.00005 ohm! For special needs, we can custom wind virtually any size or type.

Our applications engineering department is the industry's most experienced, and can help you determine what type and size resistor will best handle your demands. Unlike some other manufacturers, we offer both vitreous enamel and silicone coatings and can recommend what's really best for your needs.

For many special applications, our evaluation goes beyond power ratings, value and tolerance. For example, in circuits encountering brief power surges, the invisible differences between two types of 5 watt resistors can mean the difference between long-term reliability and premature failure. We can help you design-in reliability.

FOR IMMEDIATE DELIVERY of standard products contact your local Ohmite distributor. For application assistance call your Ohmite sales office.

A 60 page resistor catalog is available from Ohmite Manufacturing Co., 3601 Howard Street, Skokie, IL 60076, 312-675-2600.



OHMITE

A NORTH AMERICAN PHILIPS COMPANY

Circle 15 on reader service card

Which wirewound resistor is best for your application?

Ohmite has the right resistors and the right application advice.

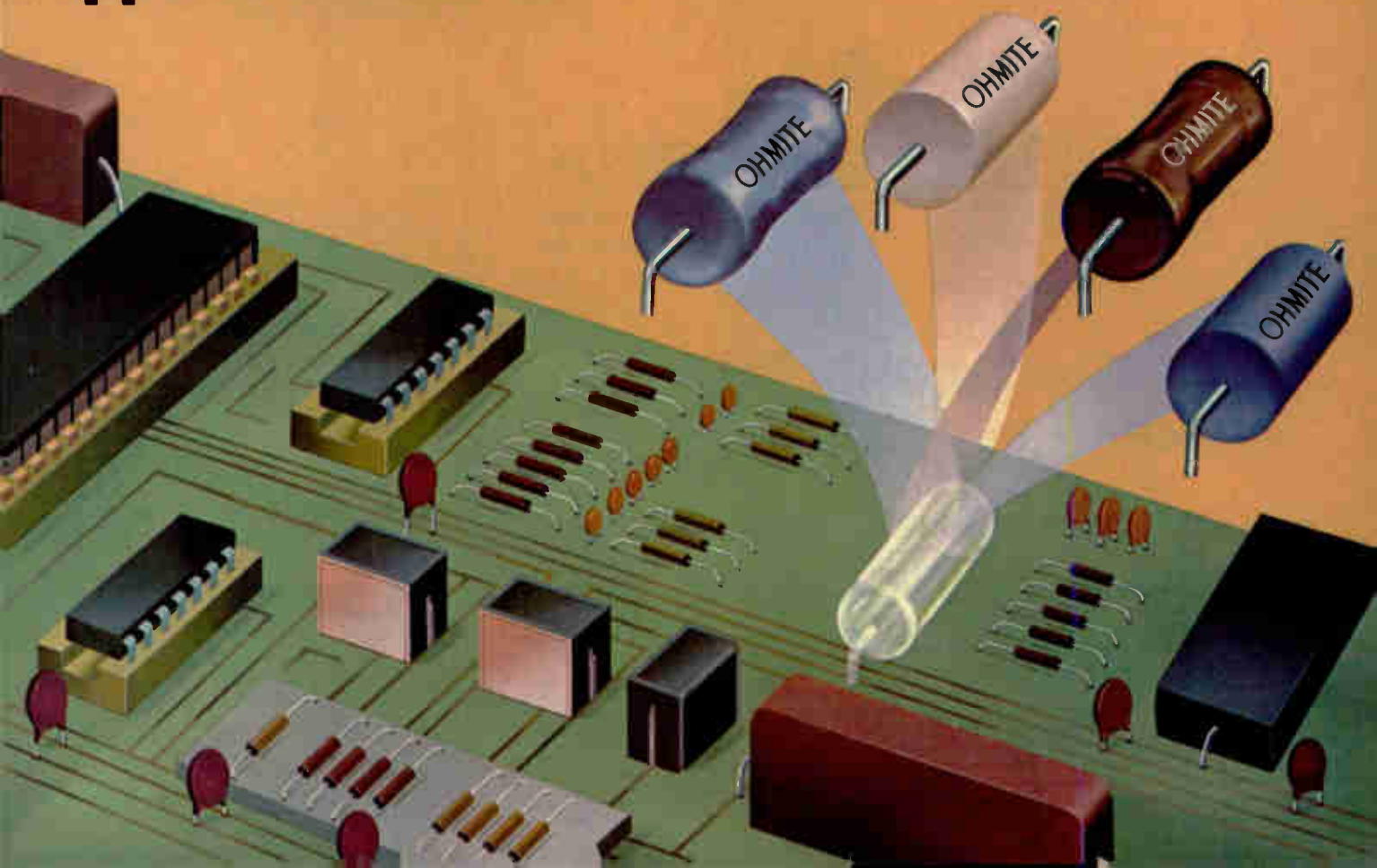

THE ZENDEX ZX-907 BUS TRACER

Monitors Multibus* Operation

The ZX-907 represents a major advancement in Multibus development tools. This processor-based board, in conjunction with an external CRT, interprets Multibus events by monitoring address, data and control lines. The on-board memory will store up to 1024 bus events. The interpreted results are displayed on the CRT in the form of action, memory or I/O location, and data.

- 40 bit wide trace
- 1024 Bus Cycle Storage in on-board RAM
- On-board 8085A-2 Processor
- Menu driven software trace control
- Breakpoint can be preset on Address = , <, >
- 8 or 16 Bit Processor Compatibility

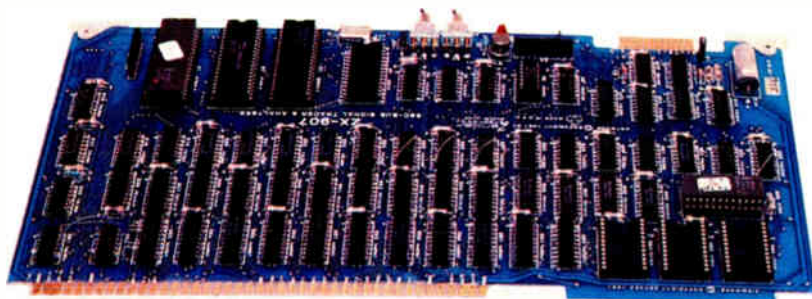

* TM INTEL Corp.

United Kingdom—Giltspur Microprocessor Systems
Tel. (0635) 45406; Telex 848507
France—Tekelec Airtronic
Tel. (1) 534-7535; Telex 204552F
West Germany—Allmos Elektronik
Tel. (089) 857-2086; Telex 5215111



Zendex[®]

6644 Sierra Lane, Dublin, California 94566
Tel.: (415) 828-3000 TWX 910 389 4009

Circle 16 on reader service card

1981 Electronics Buyers' Guide

The only book of its kind in the field. If you haven't got it, you're not in the market.

To insure prompt delivery enclose your check with this coupon.

Yes, please send me _____ copies of 1981 EBG.

I've enclosed \$30 per copy delivered in USA or Canada. Address: EBG, 1221 Avenue of the Americas, New York, N.Y. 10020.

I've enclosed \$52 for air delivery elsewhere. Address: EBG, Shoppenhangers Road, Maidenhead, Berkshire S16, 2Q1 England.

Name _____

Company _____

Street _____

City _____

State _____ Zip _____ Country _____

People



Venture. Gerald Casilli is ready with cash and management expertise for new firms.

experience to the benefit of these new businesses," says the 42-year-old Casilli. And some experience it has been. He helped to start Millennium, 10 years after joining General Telephone & Electronics Corp., and was president and chief executive officer of the high-flying maker of universal microprocessor development systems.

But then in 1979 its major customer, Tektronix Inc., decided to go into the development-system business for itself. Thus in a single swoop Millennium lost \$11 million of its \$13 million in sales for that year. Since then, the company has worked toward a comeback even as it was acquired by American Microsystems Inc. and AMI in turn was purchased by Gould Inc.

That experience behind him, Casilli, with a bachelor's in electrical engineering from the University of Pittsburgh, says that his new firm, Genesis Capital!Corp., in Los Gatos, Calif., initially will have some \$20 million in its fund, primarily from its limited partner, the First National Bank of Seattle. Casilli's preferences are new companies in computer-assisted design, computer-aided engineering, software, office and factory automation, communications, and other industries related to productivity enhancement.

"Venture capital is one place where one person can make a big difference," Casilli says. Now that he's gone from the Millennium to Genesis, he can help create some of that difference.

Centigrid[®] III

The world's first CMOS compatible EMR

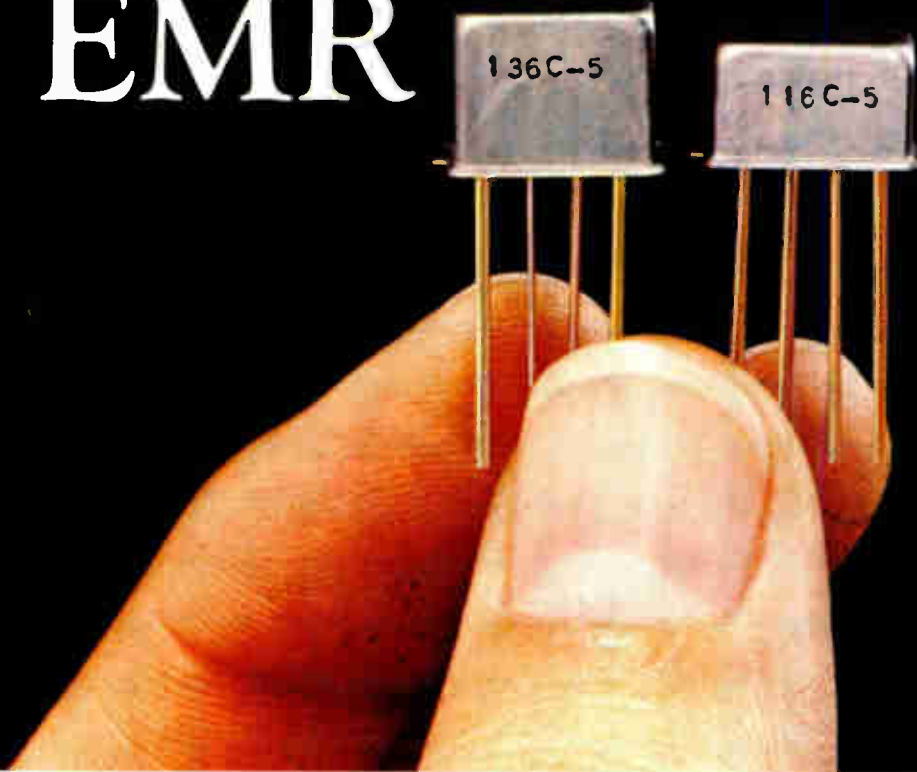

Now for the first time you can drive an electromechanical relay directly with the signals of most logic families—including CMOS. That means simpler board layout problems and reduced components counts for greater reliability.

The new Centigrid relay incorporates a power FET driver in the input to amplify the signal, protects it with a large Zener diode, and packs it all together with a DPDT relay and coil suppression diode in a tiny Centigrid

style can. And make no mistakes ... it is a Centigrid relay designed to meet the requirements of MIL-R-28776. Its ruggedness and proven contact reliability are industry bywords.

Ultraminiature Centigrid relays have proven extremely effective in applications where high board density and close board spacing are critical. Low power requirements make them exceptionally valuable for battery operation, and they have excellent RF char-

acteristics up through UHF.

The new Centigrid is available in both general purpose (116C) and sensitive (136C) versions. Call or write today for complete information or applications ideas.

 **TELEDYNE RELAYS**
The best little relays in the world.

12525 Daphne Ave., Hawthorne, California 90250 • (213) 777-0077
U.K. Sales Office: Heathrow House, Bath Rd., Cranford, Hounslow, Middlesex, TW 5 9QQ • 01-897-2501
European Hqtrs: Abraham Lincoln Strasse 38-42 • 62 Wiesbaden, W. Germany 6121-700811
Japan Sales Office: Nihon, Seimei Akasaka Building • 8-1-19 Akasaka, Minato-Ku Tokyo, 107 Japan (03) 403-8141

Circle 17 on reader service card

Tektronix introduces 132 state of the art logic analyzers, in one.

A new concept in logic analysis.

Now you can have a single logic analysis system that is both configurable and upgradable. All with unprecedented performance and flexibility.

It's the DAS 9100. A single mainframe that houses up to six card modules. With acquisition speeds up to 660 MHz, timing resolution down to an unprecedented 1.5 ns, data widths up to 104 channels and synchronous or asynchronous operations.

And for the first time, you can combine *pattern generation with data acquisition*. Pattern generation provides stimulus data widths up to 80 channels and speeds up to 25 MHz.

Need I/O capability? There's an option that adds RS-232, GPIB and hard copy interface. And another for a built-in magnetic tape drive system.

Select your own width and speed combination, for data acquisition.

DAS 9100 gives you four different data acquisition modules to use as building blocks. Each has its own data width and maximum speed: 32 channels at 25 MHz; 8 channels at 100 MHz with glitch memory; 4 channels at 330 MHz or two channels at 660 MHz. Modules can be combined to give you the performance you need.

Need high speed performance? One module can track your system clock (synchronously) at speeds up to 330 MHz or provide asynchronous sampling to 660 MHz. The eight channel module provides *both* synchronous and asynchronous sampling at 100 MHz. And the 32 channel module can be used to arm the trigger on those with higher acquisition rates.

To obtain the data width and speed your application calls for, simply select the appropriate combination of modules and add on later as your needs change.

To back it all up, there's powerful triggering, programmable reference memory and multiple clocks. Plus glitch triggering, with a separate glitch memory for



unambiguous glitch detection and our unique, new "arms mode" allows timing correlation between synchronous and asynchronous data.

DAS 9100 integrates the power of pattern generation with data acquisition.

At last, you can have a tool that covers your digital system debugging needs. By combining pattern generation and data acquisition modules, you can stimulate your prototype while simultaneously analyzing its operation. Allowing you to enter a whole new dimension of design analysis and verification.

Pattern generation capability is built around a 16 channel, 25 MHz module. Through additional expansion modules, you can raise the total to 80 channels while maintaining full system speed. The pattern generator allows interaction with the prototype through data strobe outputs and external control inputs, including an interrupt line. The generated pattern can even be changed based on the data acquired by the logic analyzer.

The DAS 9100 lets you start debug-

ging hardware even before your software is available. Pattern generation makes it all possible.

With plenty of room for mainframe options to fit your application.

A powerful I/O option adds RS-232, GPIB and hard copy interface for full remote programmability. A built-in magnetic tape drive using DC-100 cartridges is also available, so you can save whole or partial instrument setups for recall. Pattern generation routines and reference memory data also can be stored.

DAS 9100 easy-to-use keyboard and menu tie it all together.

Operation of your DAS 9100 is simple and straightforward. Selectable menus help you set up trigger conditions, select data formats, and define voltage thresholds. You can even define your own mnemonics to fit the data under test.

How does it all go together?

In whatever combination your application calls for, or choose one of these pre-configured packages from Tektronix:

The DAS 9101. 16-channels of data acquisition at 100 MHz.

The DAS 9102. 32-channel of data acquisition at 25 MHz plus 16-channels of pattern generation.

The DAS 9103. 32-channels of data acquisition at 25 MHz plus 8 more channels at 100 MHz. And 16-channels of pattern generation.

The DAS 9104. 80-channels of data acquisition, with 64-channels at 25 MHz and 16-channels at 100 MHz. Plus a 16-channel pattern generator with a built-in DC-100 magnetic tape drive.

Backed by Tektronix support.

You get a world-wide service organization, extensive documentation and applications assistance.

Contact your Tek Sales Engineer for more information. Or call us toll-free. 1-800-547-1512, in the U.S. In Oregon, 1-800-452-1877

For further information, contact:

U.S.A., Asia, Australia, Central & South America, Japan
Tektronix, Inc., P.O. Box 4828, Portland, OR 97208, Phone
800 547-1512, Oregon only 800 452-1877, Telex 910-467-8708,
Cable TEKTRONIX

Europe, Africa, Middle East Tektronix International, Inc.
European Marketing Centre, Postbox 827, 1180 AV Amstelveen,
The Netherlands, Telex 18312

Canada, Tektronix Canada Inc., P.O. Box 6500, Barrie, Ontario
L4M 4V3, Phone 705 737-2700

The One. Digital Analysis System.



Data Acquisition



Pattern Generation



Options

Tektronix
COMMITTED TO EXCELLENCE

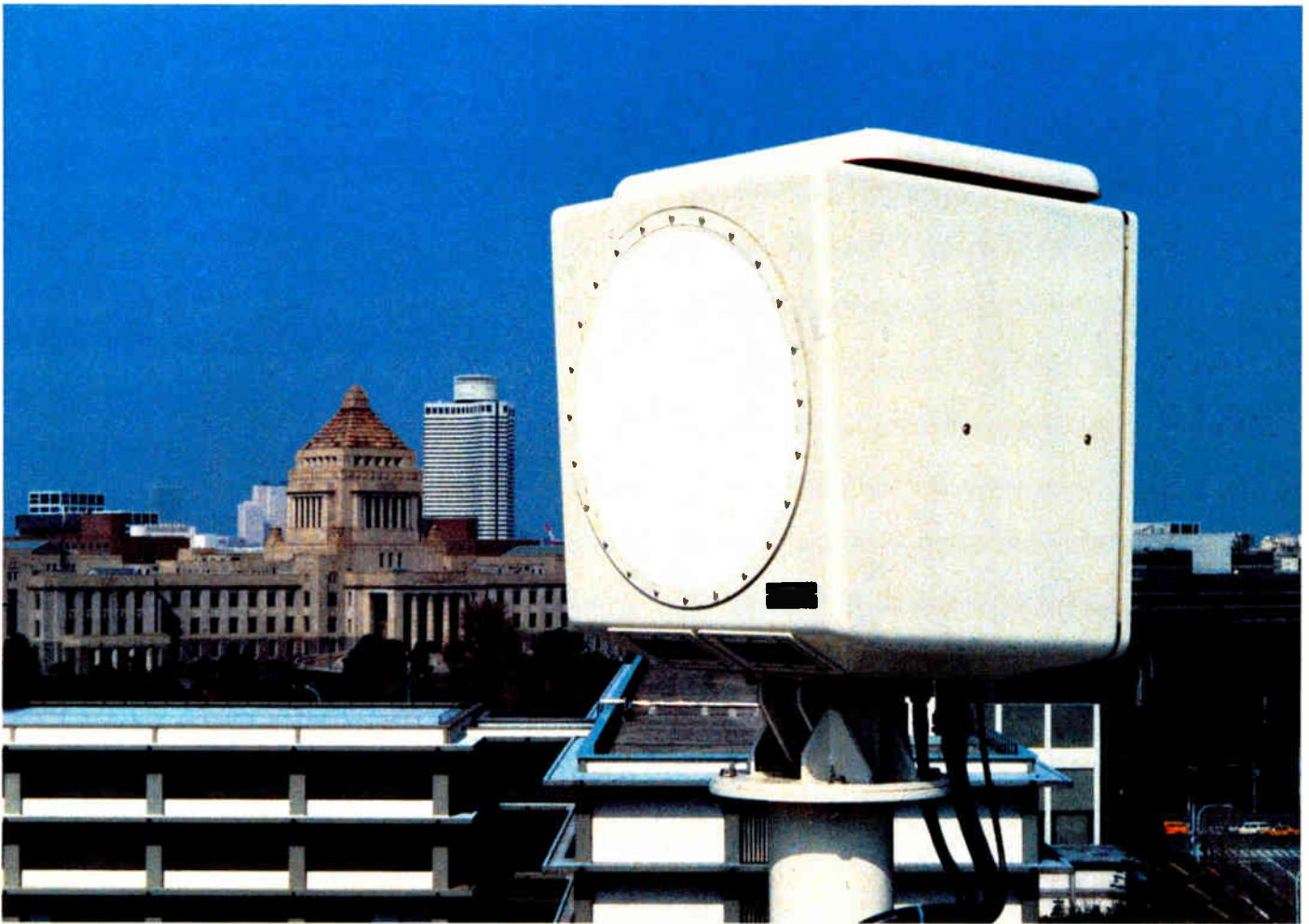

40GHz MULTIPLEX DIGITAL RADIO SYSTEM NOW IN SERVICE

The world's first 40GHz fixed multiplex digital radio system now links Japan's central government offices in Tokyo.

Developed by NEC, the system transmits information at a bit rate of 6.312Mb/s (equivalent to 96 VF channels). It consists of 40GHz multiplex radio equipment, PCM transmission

terminals, and remote control and supervisory equipment. With looped main and standby routes, the system is fully redundant and is designed to operate even during such disasters as earthquakes and floods.

Millimeter wave digital radio is considered very effective as a short-haul information link, especially for urban

areas. The millimeter wave permits broadband transmission and has good directivity, making interference-free system design and installation easy, as well as making possible a multiplex radio system. And equipment for millimeter wave communications are extremely compact.

In northern Japan, a university in Sendai plans to have its computer center connected to a campus 3.7 kilometers away by an NEC-equipped 40GHz millimeter wave digital radio data system.

NEC-EQUIPPED CRAFT DIVES TO RECORD DEPTH

By reaching a depth of 2,008 meters, a deep submergence vehicle has set a new Japanese diving record.

The Shinkai 2000, built for the Japan Marine Science and Technology Center, is 9.3 meters long, 3 meters wide, and weighs 24 tons. Its globular pressure hull is made of 3 cm thick super-high tensile strength steel to protect two pilots, one researcher, and electronic equipment from extreme water pressure.

NEC was responsible for integrating the control console of the Shinkai 2000. NEC also supplied underwater telephones, altitude/depth sonar, forward obstacle avoidance sonar, acoustic direction finders, a transponder and an emergency pinger.

The 1,553-ton support ship was also NEC equipped, with a precision depth echo sounder, high resolution side-scan sonar, and underwater telephones.



The Shinkai 2000 will be used to collect data for prediction of underwater earthquakes, to study deep sea plants and animal life in Japanese waters, and to explore for mineral resources within the deep sea bed.

NEW STAND-ALONE 8-BIT MICROCOMPUTER USES LESS POWER

A new CMOS stand-alone 8-bit microcomputer contains all the necessary functional blocks: 1 k byte ROM, 64 byte RAM, 27 I/O lines, on-chip 8-bit timer/event counter, and clock generator.

Compatible with industry standard NMOS 8048 and 8748 products, the CMOS μ PD80C48 reduces power consumption significantly. And its "Halt" and "Stop" modes further augment power conservation.

In the "Halt" mode, internal clocks and logic operations are discontinued. The oscillator, however, continues to function and all internal logic and

control status prior to "Halt" mode engagement are maintained. Power consumption under this mode is less than 10% of that during normal operation and less than 1% of the power needed for the 8048 operation.

The "Stop" mode saves even more power by discontinuing oscillator operation and retaining only the contents of the RAM.

The μ PD80C48 may also be employed together with other CMOS devices including I/O expander μ PD82C43 and memories.

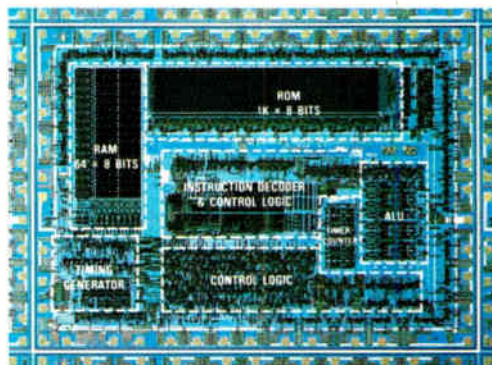

TELECONFERENCES GO BETTER WITH NETEC-X1

Enhanced teleconferencing is promised by NETEC-X1, a television interframe codec that converts NTSC color television signals with audio into low bit rate digital signals of 1.544Mbps.

NEC's new product has a data compression ratio as high as 1/40th of the conventional rate, so transmission cost is greatly reduced. In spite of this, NETEC-X1 reproduces pictures with excellent quality. The essential feature of the system is that it transmits only the difference between two

picture frames through a unique interframe coding.

On the audio side, the system uses a broader band for signal transmission than that of telephones, so that subtle vocal nuances can be discerned.

The NETEC-X1 can also be connected with coaxial PCM transmission links, terrestrial digital microwave links and TDMA satellite links.

NETEC-X1 applications other than teleconferencing include educational television, traffic or security control and remote medical diagnosis.

NEC

Nippon Electric Co., Ltd.
P.O. Box 1, Takanawa, Tokyo, Japan.

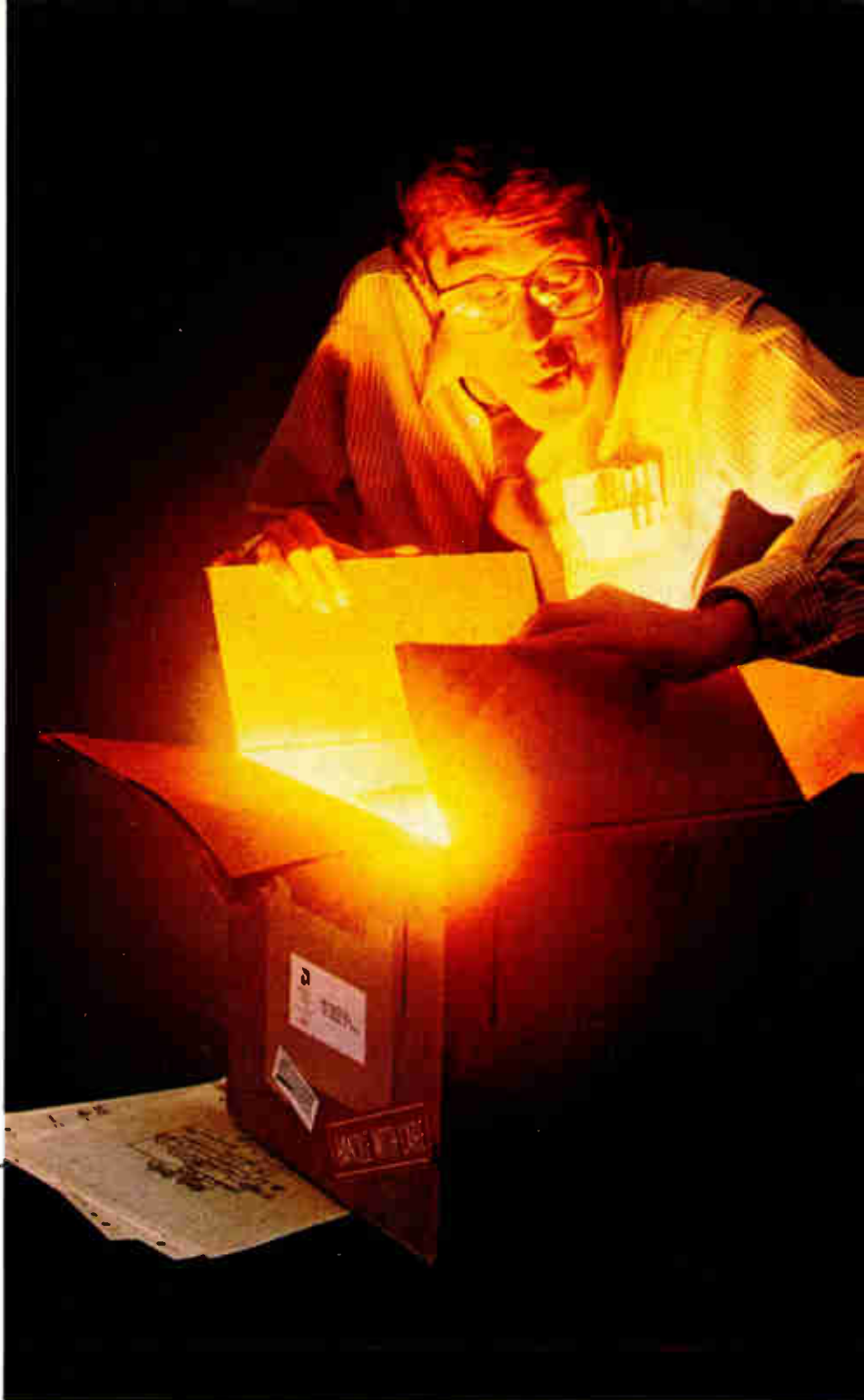

We've already shown you what IMOX™ can do for bipolar memories and digital signal processing chips.

Now, for the bit-slice processors. Two different slices, two different applications.

**FIRST, THERE'S
THE Am2901C.**

Thanks to IMOX, it's the first to break the 100ns micro-cycle barrier for 16-bit arithmetic. (That's worst case!) It's the fastest bipolar bit-slice

microprocessor ever made.

The Am2901C rips through arithmetic. It leaps through logic functions.

And, get this, there are over fifty high-performance

peripherals in the Am2900 Family and more on the way. Designing was never easier.

And, yes, it's available right now.

NEXT, THE Am29203.

The Am29203 will have a lot of features that make it

FAST ISN'T FAST ENOUGH ANYMORE.

faster for more complex functions.

Its dual I/O ports will allow twice as many data moves per cycle. Its 16 internal registers can be expanded indefinitely.

The single cycle BCD arithmetic will make the Am29203 the perfect choice for high-performance

small business computers.

And if all this sounds good, just wait until you see what AMD will be doing with IMOX in the future.

IMOX is our very advanced, ion-implanted, oxide-isolated process. It lets us make smaller, more complex devices than ever before.



IMOX lets us shrink the space between transistors, cut capacitance and decrease die size.

And IMOX isn't the only thing that nobody else offers. There's INT-STD-123.

Are you designing a high-performance system? Call or write AMD. We're a whole lot faster than fast.

The International Standard of Quality guarantees these electrical AQLs on all parameters over the operating temperature range: 0.1% on MOS RAMs & ROMs; 0.2% on Bipolar Logic & Interface; 0.3% on Linear, LSI Logic & other memories.

INT-STD-123

Advanced Micro Devices

901 Thompson Place, Sunnyvale, CA 94086 • (408) 732-2400
IMOX is a trademark of Advanced Micro Devices, Inc. ©1982 AMD

Circle 23 on reader service card

Computer innovation needs the university market

by Kenneth G. Wilson, *professor of physical sciences, Cornell University, Ithaca, N. Y.*



Universities and high-technology small businesses are closely linked. Small firms are often the only source of sophisticated computer equipment needed by universities, and universities are among the few buyers willing to take a risk on an innova-

tive product. However, this link is being severely weakened by the decline in university financial support.

Small businesses face two problems following a product announcement: bringing the product to maturity to fully meet market needs and company survival as this "growing up" occurs. The university market plays a critical role in supporting new firms during this time. In addition, university personnel test the device and then feed back performance data to the company along with suggestions for improvement. They often demonstrate novel product uses as part of their effort to stay competitive in their research. Students are given time to work with immature systems, and the experience helps provide them with up-to-date training.

Universities also help win commercial acceptance for successful product designs. They accept inquiries and site visits from potential commercial customers, and they can even provide comparative information on similar designs. The open and public character of the university encourages such interchanges.

Unfortunately, universities are increasingly unable to perform these essential economic functions and the effects are beginning to be felt. For example, Digital Equipment Corp., Prime Computer, and Amdahl all received an early boost to commercial success from the university market. On the other hand, Denelcor Inc., a small computer and component company based in Aurora, Colo., may not be so fortunate. It has designed a supercomputer called HEP—a major advance in computer architecture. With additional development, HEP could lead to sys-

tems many times more powerful than even the proposed Cray-2 and so compete with Japan's proposed fifth-generation computer hardware. It should be noted that the major U. S. manufacturers have not yet entered this fray.

Although several universities are eager to buy the system—despite the fact that it is untested, not very cost-effective yet, and lacking in associated software—its \$1.5 million price tag is too high for universities to receive financing from either Government granting agencies or private funding organizations. My fear is that Denelcor must now be less innovative so that its products can be sold immediately in commercial markets, thus slowing technological development.

Meanwhile, the Japanese fifth-generation computer effort will charge ahead. I fully expect that some top U. S. software designers will be eager to join this effort—once the Japanese hardware plans are clarified. Most ominously, Japanese industry is likely to learn how to use the awesome power of these systems before U. S. industry does.

The main hope the U. S. has to keep ahead of the Japanese challenge is to encourage collaboration between small businesses developing innovative computing systems and university research projects. This cooperation is particularly important for research projects that will demonstrate innovative uses of commercial systems, or for university computer-science research projects whose ideas are well-matched to a small business's computer design.

The growth in computing technology is straining the universities in other ways. For example, every computer purchased by industry or government leads to demands for more university-trained personnel.

To finance the many technological functions of universities, I propose a surcharge on all computing equipment sold in the U. S. that would be used for university support. It would enable universities to keep pace with the growth of computing technology and would help restore the vitality of new-product development to small businesses.

Electronics will periodically invite the expression of outside views on this page concerning issues of importance to the electronics industries.

Trust Pro-Log to build the universal MOS programmer you can update yourself.

**New System 90 programs
98% of all 5V MOS PROMs.
Now and in the future.**

Universal programming modules have been around for a while. But, until now, they have had one big drawback: whenever new devices came along, you had to send your module back to the factory for updating. And wait. And live without a programmer until you got it back.

Inconvenience like that just wasn't good enough for the perfectionists at Pro-Log.

That's why we took a little longer, worked a little harder, and developed the System 90, the universal programmer you can update yourself. On-site. By simply replacing a set of PROMs on the bottom of the System 90's PM9080 universal programming

module, you can be using your programmer while others are still waiting.

Always state-of-the-art.

The System 90 is designed to keep up with changing technology.

It programs 24-, 28- and 40-pin devices, including single-chip micro-computers. Remote PROM selection is standard via RS232C interface.

It supports more E²PROMs, including those requiring logarithmic rise times, than any other universal programmer.

And it's ready to support Electronic Signature devices.

Voltages, waveforms and timing are designed to stay within specifications, without adjustment, for the life of the system.

Backed by a 2-year warranty.

Based on the proven reliability of our 10,000 PROM programmers and 23,000 personality modules sold over the last eight years, we back our new System 90 with the industry's longest warranty: two years parts and labor.

For full technical details, write or call Pro-Log Corporation, 2411 Garden Road, Monterey, CA 93940, phone (408) 372-4593. Outside California, call toll-free: (800) 538-9570.

Australia, Werner Electronic Industries, Telex AA88405; France, Yrel, Telex 842-696379; Germany, Spezial Electronic, Telex 971624; Italy, Technitron, Telex 68071; Sweden, Logtek Elektronik, Telex 13695; Switzerland, Max Meier Elektronik, Telex 55448; United Kingdom, Technitron, Telex 858618.

 **PRO-LOG**
CORPORATION



How to Cut Shielding Application Costs by 50-80% Over Zinc Arc!

...and virtually match Zinc Arc in EMI/RFI Shielding Capability!

ELECTRODAG[®] 440 does it!

- Because it's so much faster and easier to apply
- Because it requires only standard spray equipment
- Because it adheres well without chipping
- Because it puts no stress on delicate components
- Because it's *stable*, both initially and after environmental testing, unlike conventional nickel coatings

With the latest "or else" FCC compliance demands, you can't afford to overlook performance — and savings — like these. Specify Electrodag 440. More than just a paint, it's the stabilized coating that meets every requirement — yours, your customer's: helps meet the FCC's.

Send for complete details on Electrodag 440, including test data.



Acheson
high technology coatings
ACHESON COLLOIDS COMPANY
Port Huron, Michigan 48060

Meetings

National Aerospace and Electronics Conference, IEEE (M. J. Terbay, Naecon '82, 4126 Linden La., Dayton, Ohio 45432), Dayton Convention Center, May 18-20.

Northcon/82 Show and Convention, Electronic Conventions Inc. (999 North Sepulveda Blvd., El Segundo, Calif. 90245), Seattle Center Coliseum, May 18-20.

International Defense Electronics Expo '82, Kiver Communications (Information Center, P. O. Box 338, Whitehouse, N. J. 08888), Hanover Fairgrounds, Hanover, West Germany, May 18-25.

Vehicular Technology Society Conference, IEEE (Eddie Simon, 1970 B St., San Diego, Calif. 92102), Town and Country Hotel, San Diego, May 23-26.

International Semiconductor Power Converter Conference, IEEE (E. E. Von Zastrow, General Electric Co., Building 37-478, P. O. Box 43, Schenectady, N. Y. 12301), Hyatt Hotel, Orlando, Fla., May 24-27.

Electro '82, IEEE (Dale Litherland, Electronic Conventions Inc., 999 North Sepulveda Blvd., El Segundo, Calif., 90245), Boston Sheraton Hotel, May 25-27.

Semicon/West '82, Semiconductor Equipment and Materials Institute (625 Ellis St., Suite 212, Mountain View, Calif. 94043), Fairgrounds, San Mateo, Calif., May 25-27.

Microcomputer Show '82, Japan Electric Industrial Development Association (3-5-8 Shiba Koen, Minato-ku, Tokyo 105), Tokyo Ryutsu Center, May 26-29.

Trends and Applications 1982: Advances in Information Technology, National Bureau of Standards (Allen Hankinson, NBS Administration Building, A209, Washington, D. C. 20234), NBS, Gaithersburg, Washington, D. C., May 27.

Electron-, Ion-, and Photon-Beam

Technology Conference, IEEE (P. H. P. Cheng, IBM Research Center, P. O. Box 218, Yorktown Heights, N. Y. 10598), New York, June 1-4.

Solar Technologies Conference and International Exposition, International Energy Society (American section of the IES, U. S. Highway 190 West, Killeen, Texas 76541), Albert Thomas Convention Center, Houston, June 1-5.

International Conference on Management of Data, Association for Computing Machinery (D. S. Batory, executive committee chairman, 512 Weil Hall, Gainesville, Fla. 32611), University of Florida, Orlando, Fla., June 2-4.

National Computer Conference, American Federation of Information Processing Societies Inc. (Betty Lou Cooke, Afips Inc., 1815 North Lynn St., Arlington, Va. 22209), Astorhall, Houston, June 7-10.

International Conference on Consumer Electronics, IEEE (Ken Barr, RCA Consumer Electronics, 600 North Sherman Dr., Indianapolis, Ind. 46201), Arlington Park Hilton Hotel, Arlington Heights, Ill., June 9-11.

Seminars

The VHSIC Packaging Seminar is being sponsored by the Solid State Products division of the Electronic Industries Association and the Joint Electron Device Engineering Council. The seminar will be held at Quality Inn Pentagon City, Arlington, Va., on May 18. For information, Call Daniel Amey at (201) 685-1600 or JEDEC at (202) 457-4971.

Beyond the Advanced Work Station, The Yankee Group, 89 Broad St., 14th floor, Boston, Mass. 02110. The event is being held at the Plaza Hotel, New York, June 1-2, and at the Hyatt Riskey Hotel, Palo Alto, Calif., June 15-16. For details, call Lisa Caruso, (617) 542-0100.

DMOS. FETS. SPI.

Lateral DMOS For Speed

SPI's family of Lateral DMOS FETs provide designers with THE high performance MOSFET technology for critical applications.

Sub-nanosecond digital switching.

Bidirectional glitch-free analog switches.

- SD 210 series (50 ohm singles)
- SD 222 series (10 ohm singles)
- SD 5000 series (50 ohm quads)

Use in sample and hold/video switching applications as well as high speed drivers and D/A and A/D converter designs.

Low noise, high gain amplifiers.

Low distortion, high gain mixers.

- SD 200 series (low power single gate)
- SD 220 series (medium power single gate)
- SD 300 series (low power dual gate)

Put the SD 200, 220 and 300 series in FM/VHF/UHF front ends, medium power rf transmitters and rf switching applications.

Start Designing Now

All of our Lateral DMOS FETs are available from stock now. And SPI can even supply hard to find devices immediately — at competitive prices.

Vertical DMOS For Power

SPI delivers a broad range of power FETs manufactured with the state-of-the-art Vertical DMOS process. High voltage, high current switching.

Low $R_{ds(on)}$ high current drivers.

- SD 900 series (450v, 12A, 1 ohm)
- SD 1000 series (450v, 8A, 2 ohms)
- SD 500 series (400v, 8A, 3 ohms)
- SD 1005 series (150v, 18A, 0.5 ohm)

Switch mode power supplies and motor speed control/line drivers are just a few of the application possibilities.

High voltage medium current switches.

Low $R_{ds(on)}$, medium current drivers.

- SD 1100 series (450v, 0.2A, 35 ohms)
- SD 1102 series (250v, 1A, 10 ohms)
- SD 1104 series (100v, 2A, 3 ohms)
- SD 1106 (VN10KM direct replacement)

SPI has the power FETs for applications in telecommunications switching (ringing plus battery voltages), solid state relays, switch/line drivers, test equipment and display drivers.

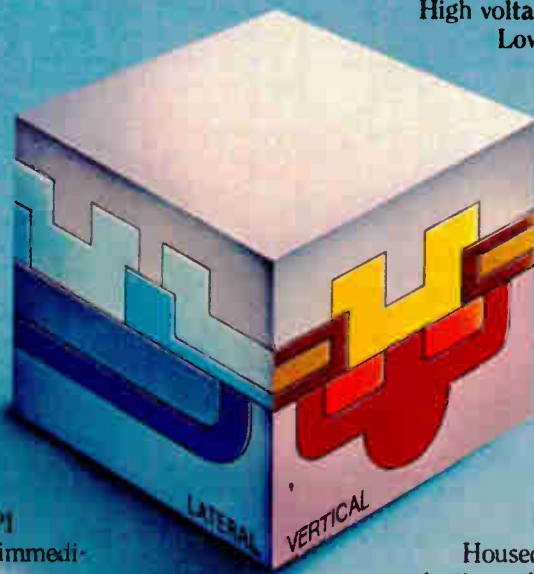

Lowest Cost Power FETs

Housed in a wide variety of hermetic and plastic packages, SPI power FETs also offer low prices and are available from stock. Contact SPI directly or through your local SPI sales representative or distributor listed below.

Sales Representatives: AL: J. R. Assoc. (205) 830-2130. AZ: Bob Anderson Co., (602) 266-2070. CA: Nor-Cal Assoc., Palo Alto (415) 961-8121. Astralronics, Ventura (805) 653-5991. FL: H. A., Inc. (305) 752-7520. IL: Sieger Assoc., Rolling Meadows (312) 991-6161. IO: Gassner & Clark, Co. (319) 393-5763. KA: Sieger Assoc. (913) 831-0133. MA: Compatible Components, Inc. (617) 835-3614. MI: J. C. Hofstetter Co. (313) 533-7788. MI: Arbotek Assoc. (301) 461-1323. MO: Sieger Assoc. (314) 739-7911. MN: Com-Tek Sales (612) 888-7011. OH: J. C. Hofstetter Co., Dayton (513) 296-1010; Medina (216) 241-4880. PA: J. C. Hofstetter Co. (412) 327-1410. OR: Hood Engr. Sales (503) 244-0760. TX: OM Sales Co., Inc., Dallas (214) 241-3876; Houston (713) 789-4426; Round Rock (512) 258-4424. WA: Hood Engr. Sales (206) 453-9375. Chip Distributor: Chip Supply, Inc., Orlando, FL. (305) 275-3810. Stocking Distributors: VSI Electronics, Inc., Santa Ana, CA (714) 557-7131. VSI Electronics, Inc., Sunnyvale, CA (408) 734-5470. Bond Electro Sales, Ventura, CA (805) 653-6487. ACT Rocky Mountain, Lakewood, CO (303) 233-4431. ADD Electronics Corp., East Syracuse, NY (315) 437-0300. Multassociates, New York, NY (212) 248-9700. ADD Electronics Corp., MA (617) 478-4200. ACT Tulsa, OK: (918) 583-2990. Active Component Technology, Addison, TX (214) 980-1888. ACT Austin, TX (512) 452-5254.



SEMI PROCESSES INC.

1885 Norman Avenue, Santa Clara, CA 95050, Tel: (408) 988-4004
TWX: 910-338-0025 SPI SNTA

SPI in Europe: Semi Processes Inc., Austin House, South Bar, Banbury, Oxfordshire, England. Tel: (44) 295-61138 Telex: 837594

In the Microworld, no one packs

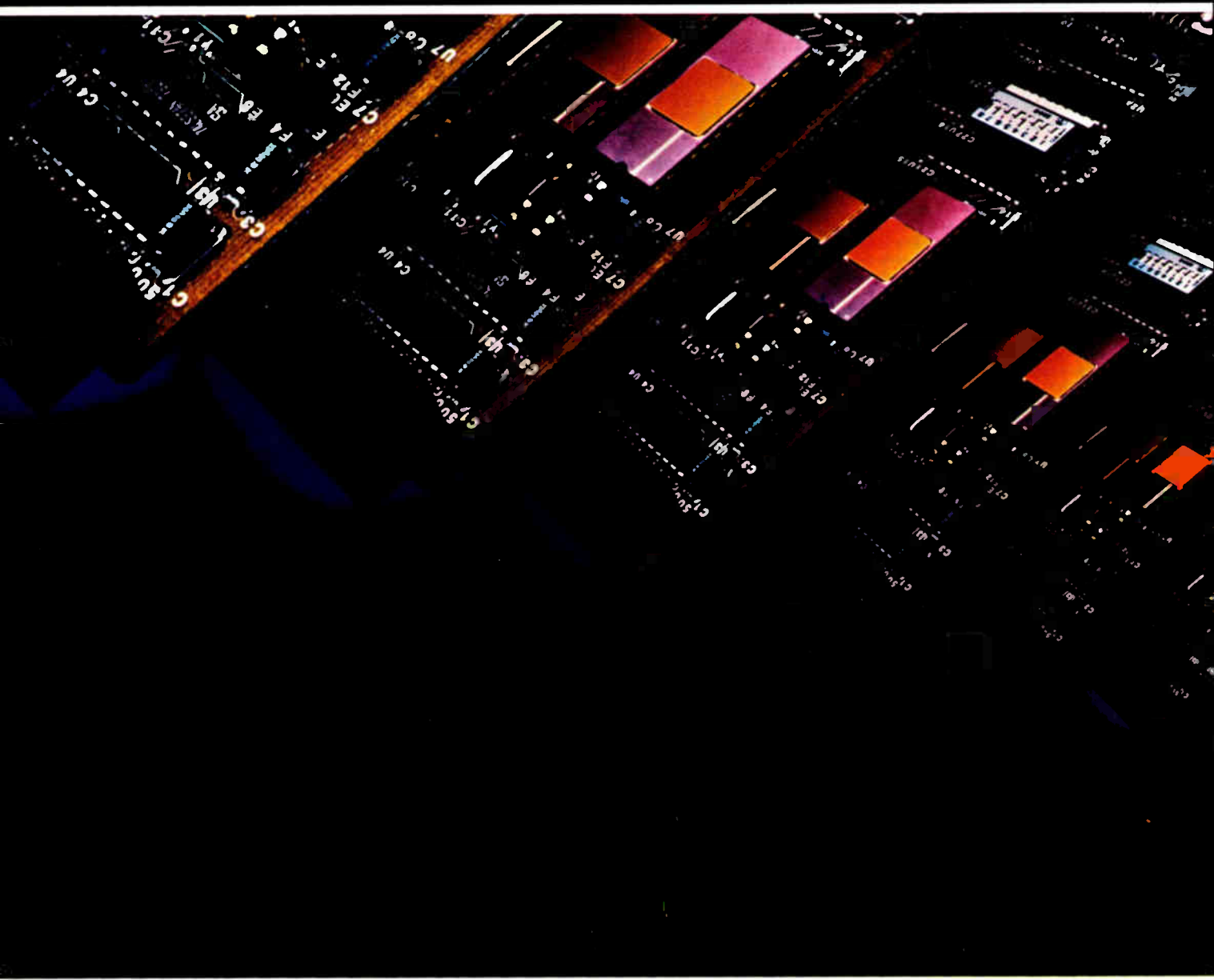

more computing power into one chip.

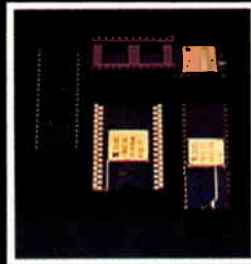

What microcomputer family is winning the lion's share of high-performance designs? It's Zilog's cost-effective Z8.

It packs a host of powerful features that simplify system design and provide high data throughput. Terminal manufacturers such as Lear Siegler and HP take advantage of its 128 general purpose registers and six levels of vectored interrupts to break through the bottlenecks normally encountered in terminal design. Qume and other printer manufacturers use the large RAM capacity to provide line buffering for their printers.

In the demanding disk drive market, Shugart and Apple make full use of the Z8's high bit-transfer rate to handle *both* data stream and motor control.

The Z8 is also a favorite in general purpose controllers developed by Paradyne and others.

There are now nine versions of the Z8 in all. They give you the option of 2K and 4K ROM without changing pin configurations. A Protopak version permits easy pilot production. Another version provides a pre-programmed BASIC/Debug capability. There is even a ROM-less version that will accept up to 128K of external memory — and save you up to 50% in costs.

To make Zilog's Z8 part of your Microworld, call your nearest Zilog sales office or write: Zilog, Inc., Components Marketing, 1315 Dell Avenue, Campbell, CA 95008.

Z8 is a registered trademark of Zilog, Inc.

Domestic

Scottsdale, AZ
(602) 990-1977
Campbell, CA
(408) 370-8120
Irvine, CA
(714) 549-2891
Van Nuys, CA
(213) 989-7485
Clearwater, FL
(813) 535-5571
Schaumburg, IL
(312) 885-8080

Burlington, MA

(617) 273-4222
Cedar Knolls, NJ
(201) 540-1671
Woodmere, OH
(216) 831-7040
Horsham, PA
(215) 441-8282
Austin, TX
(512) 453-3216
Dallas, TX
(214) 931-9090
Bellevue, WA
(206) 454-5597

International

London
England
0628-39200
Munich
Germany
01806-4035
Paris
France
778-14-33
Minato-ku
Tokyo, Japan
03-587-0528

Zilog

*Pioneering
the Microworld.*

An affiliate of EXXON Corporation



Copyright 1982 Tektronix, Inc. All rights reserved. Commodore and the Commodore logo are registered trademarks of Commodore International, Inc.

Smart color from Tektronix: Performance and clarity you should see for yourself!

The 4113 combines a crisp, clear color display with true zoom and pan, local segments, and the many other performance extras of the Tektronix 4110 Series. To appreciate the significance of the 4113, you must see it for yourself. No other color terminal so successfully merges high information density with comfortable viewability, or offers such powerful local capabilities at such an affordable price.

You'll see exceptional sharpness and image stability engineered into the 4113's 483 mm (19-inch), 60 Hz non-interlaced display. You can address a 4096 x 4096 point matrix, then zoom and pan to magnify any detail on the 4113's 640 x 480 display. As a result, plots developed on the highest resolution Tektronix displays, such as the 4114, are easily transferred to the 4113 for color enhancement.

You'll see how easy it is to access any of 4096 colors, or to command local graphics, using a

minimum of host computer time. The Tektronix Color Standard makes color specification remarkably simple. Work with 8 colors on-screen at once or, with optional bit plane, as many as 16 colors.

Powerful, highly expandable local intelligence lets you retain pictures and picture segments in local memory, then redraw and manipulate with a short command from the host.

The 4113's operating system is wholly compatible with all other 4110 Series terminals, as is its optional, integral flexible disk mass storage. The 4113 is available in either pedestal or convenient workstation configuration. For fast start-up, easy maintenance, CPU and terminal independence, you can take advantage of the Tektronix PLOT 10 Interactive Graphics Library: the most popular implementation of the 1979 SIGGRAPH proposal for a computer graphics standard.

Ask your Tektronix Sales Engineer for a hands-on demonstration. Or call Tektronix today for more information.



U.S.A., Asia, Australia, Central
& South America, Japan
Tektronix, Inc.
P.O. Box 4828
Portland, OR 97208
Phone: 800/547-1512
Oregon only: 800/452-1877
Telex: 910-467-8708
Cable: TEKTRONIX

Europe, Africa, Middle East
Tektronix Europe B.V.
Postbox 827
1180 AV Amstelveen
The Netherlands
Telex: 18312

Canada
Tektronix Canada, Inc.
P.O. Box 6500
Barrie, Ontario L4M4V3
Phone: 705/737-2700

Tektronix
COMMITTED TO EXCELLENCE

TISPP

The thermal/intelligent/strip/plotter/printer that . . .

Records

Records data from an analog and/or digital source.

Annotates

Prints annotations adjacent to areas of interest both during and after plotting.

Prints

Prints column data at 25 characters per second.

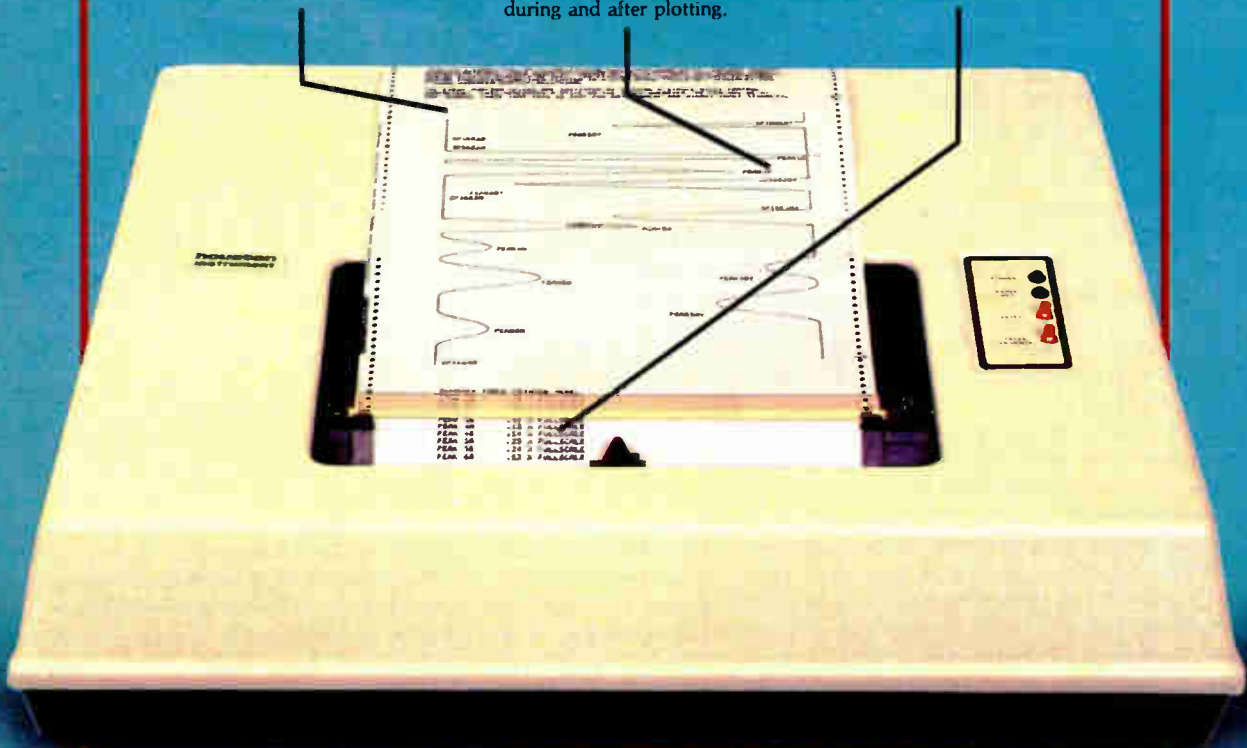

the Houston way

The Series 6000 TISPP (Thermal/Intelligent/Strip/Plotter/Printer) is the intelligent recorder specifically designed for use with today's new generation of microprocessor controlled instruments...

This is the one recorder capable of meeting your most sophisticated recording needs. Basically a thermal writing strip chart recorder, the TISPP can also print characters.

The TISPP is both RS-232-C serial and IEEE-488 - GPIB compatible. Under microprocessor control, it records data from either a digital or analog source and can function as either a strip chart recorder or a digital plotter. And it annotates the data, printing either during or after curve data input. Thermal plotting speed compensation provides uniform trace quality while plotting at speeds of up to 75 CM (30 in.) per second.

Take a look at these additional TISPP features. You'll see why TISPP is the one instrument that can satisfy most of your recorder/plotter/printer needs.



- Full scale analog sensitivity from 10 mv to 5 mv
- 12 bit binary full scale digital
- Chart speeds from one second per cm to 62 minutes per cm
- 0.3% full scale accuracy

- Available in one or two pen versions (with annotation on both curves)
- Prices from 1,795*. OEM discounts available, of course.

For complete information on the remarkable Series 6000, contact Houston Instrument, P.O. Box 15720, Austin, Texas 78761, (512) 835-0900. For rush literature requests, outside Texas call toll free 1-800-531-5205. For technical information ask for operator #2. In Europe contact Houston Instrument, Rochesterlaan 6, 8240 Gistel, Belgium. Telephone 059/27-74-45.

INSTRUMENTS & SYSTEMS DIVISION
Together...we'll create tomorrow.

BAUSCH & LOMB

Circle 32 on reader service card

Electronics newsletter

Sperry, CDC to unveil Z80-based computers

Following IBM Corp.'s lead, both Sperry Univac, Blue Bell, Pa., and Control Data Corp., Minneapolis, Minn., are readying small microprocessor-based computers to complement their mainframe lines. **Both are being offered in response to pressure from their customers** and will feature a Z80 microprocessor, CP/M operating system, and floppy disks for mass storage. These two, along with Hitachi's IBM Personal Computer look-alike, will be shown at the National Computer Conference in June.

Sales spurt seen for personal computers

Despite the lagging U. S. economy, personal-computer retailers remain optimistic about sales growth in 1982, according to a survey of over 400 dealers by Future Computing Inc., a market-research firm in Richardson, Texas. **Those polled last month indicated that they anticipate a 59% increase in sales.** The survey, which will be available in mid-May, also places the average 1981 sales of retail computer stores at \$993,000.

U. S. software firm to set up shop in Japan

A major microcomputer software supplier in the U. S. will become by midyear the first such firm to launch a subsidiary in Japan. Micropro International Corp. of San Rafael, Calif., is currently selling software through four Japanese dealers and **hopes to substantially boost sales by translating all documentation into Japanese,** then modifying its software packages to permit kana syllabary input and output, and finally developing full kanji capability for sales to Japanese microcomputer makers.

Reactive-ion etcher yields 0.5- μ m spacing

By combining properties of a plasma etcher and an ion-milling machine, Technics West Inc., a six-year-old San Jose, Calif., manufacturer of plasma-generation equipment for thin-film etching, has developed a unit that can etch aluminum interconnects 1 μ m deep on 0.5- μ m spacing. It is less complex than other such machines. Called a reactive-ion etcher, **it employs a concept developed by Bell Labs in which wafers are mounted on a hexagonal cathode** inside a stainless-steel bell-jar anode. Ions are collimated so that they strike the bottom of the etch pattern, rather than the side walls, essentially eliminating any metal undercutting.

Single chassis bridges differences in disks, backups

A single-chassis answer to proliferating differences between small Winchester disk drives and their tape backups is stirring interest even before its debut, reports its manufacturer, Distributed Logic Corp. The small Garden Grove, Calif., producer of disk and tape controllers says buyers of this equipment face widely varying requirements in power supplies, cooling, and mounting. **The heart of its "multiperipheral chassis" is a hybrid power supply** combining linear and switching features. The unit can handle 42 combinations of drives and backups from 12 manufacturers and sells for \$1,700.

Zilog, Toshiba sign technology exchange

Zilog Inc. of Campbell, Calif., and Japan's Toshiba Corp. have signed a technology-exchange agreement under which Toshiba will build and market Zilog's Z80 8-bit and Z8003 and Z8004 16-bit microprocessors. In return, **Zilog gets Toshiba's advanced complementary-MOS large-scale-integration process.** The move is seen as a way for Zilog to get into the C-MOS microprocessor business without having to develop a new process.

Toshiba is expected to announce a C-MOS Z80 by the first quarter of 1983 and a C-MOS Z8000 later that year. Zilog will have access to both designs. In the meantime, Zilog will soon start shipping the Z80L, an n-channel MOS low-power version of the Z80.

Xerox develops optical Ethernet

Xerox Corp. has put together the first fiber-optic version of its Ethernet local network. Known as Fibernet II, it is based on an interactive star architecture that provides signal reception, retransmission, distribution, and collision detection. **The 10-Mb/s prototype can handle up to 25 transceivers through duplex optical cables with each serving up to eight computers through a multiplexer.** A five-transceiver version is now operating at the Xerox Palo Alto (Calif.) Research Center.

Fairchild takes local net route for test management

Fairchild Systems Technology of San Jose, Calif., has climbed aboard the Ungermann-Bass local-network bandwagon with its own network, scheduled for introduction next month. For Fairchild, the move to the Ungermann-Bass-based scheme **represents a major shift in the computation and control of its test systems.** Fairchild will move from its own proprietary computer, the 24-bit FST-2, to a VAX 11/750 or 11/780, and it will shift its programming language from its proprietary Factor language to a superset of Pascal. The unbundled software required to turn its existing Sentry systems into network nodes will cost \$100,000 to \$170,000. With the computer and two network nodes, the network will cost \$250,000.

Also, Teradyne Inc. in Boston is readying a multidrop communications network that is much faster than its RS-232-C-based nets, the TSA and TSM. Built around a PDP-11/44 host, Teranet will transfer data at 100 kb/s and will support up to 250 systems.

Intel gets license for software system

Informatics Inc. and Intel Corp. have signed a multiyear agreement under which the Woodland Hills, Calif., software house will license its TAPS transaction-processing package to Intel. **This software, an on-line software development system, will be used in Intel's iTPS transaction-processing system.** The iTPS will be unveiled next month by the newly formed Commercial Microsystems operation in Phoenix, Ariz.

Addenda

Scientists in Bell Laboratories' program to develop a single-mode fiber-optic communications system for the Atlantic Ocean floor have reached another milestone. **The Holmdel, N. J., group has transmitted a 274-Mb/s signal 101 km without repeaters.** At that rate—what is termed a T-4 rate—a fiber can carry 4,000 voice conversations. . . . Cherry Semiconductor Corp. of East Greenwich, R. I., **has signed on Analog Innovation Inc. in Los Gatos, Calif., as the West Coast design center for its semicustom bipolar linear integrated circuits.** The ICs, called Genesis arrays, are similar to chips produced by Exar Inc. and Interdesign Inc., both of Sunnyvale, Calif. . . . After reviewing corrective actions taken to fix previously announced testing compliance problems, the Defense Electronics Supply Center **has recertified National Semiconductor Corp.'s plants** in Santa Clara, Calif., and Tucson, Ariz., for the production of MIL STD M38510 devices. National is due back on the Qualified Parts List next month.

At Data Instruments
**Revolutions Come In
Innovative Packages**



**The New
EA Pressure Transducer
Gets You Off
The Cost-vs.-Reliability
Merry-Go-Round**

Tired of going round and round on low cost-high quality compromises? For OEMs and large-volume users of pressure transducers, the new EA is a ticket OFF that merry-go-round.

Our unique design puts only stainless steel in contact with your pressure media, making it the most durable transducer of its kind. Unit-to-unit interchangeability is assured through computer-trimmed hybrid circuitry for calibration, temperature compensation, and signal amplification.

You get reliable performances with high outputs (5V) and high accuracies (1/2%) at very attractive OEM prices.

You'll want to hear more about the new EA . . . your ticket OFF the cost-vs.-reliability merry-go-round. Call us today. 617-861-7450.



 **DATA INSTRUMENTS**
Transducer Products Group

Data Instruments Inc., 4 Hartwell Place, Lexington, MA 02173, USA (617) 861-7450 TWX 710-326-0672

© 1981 Data Instruments Inc.

Circle 35 on reader service card

THE FIRST VIDEO SWITCHES

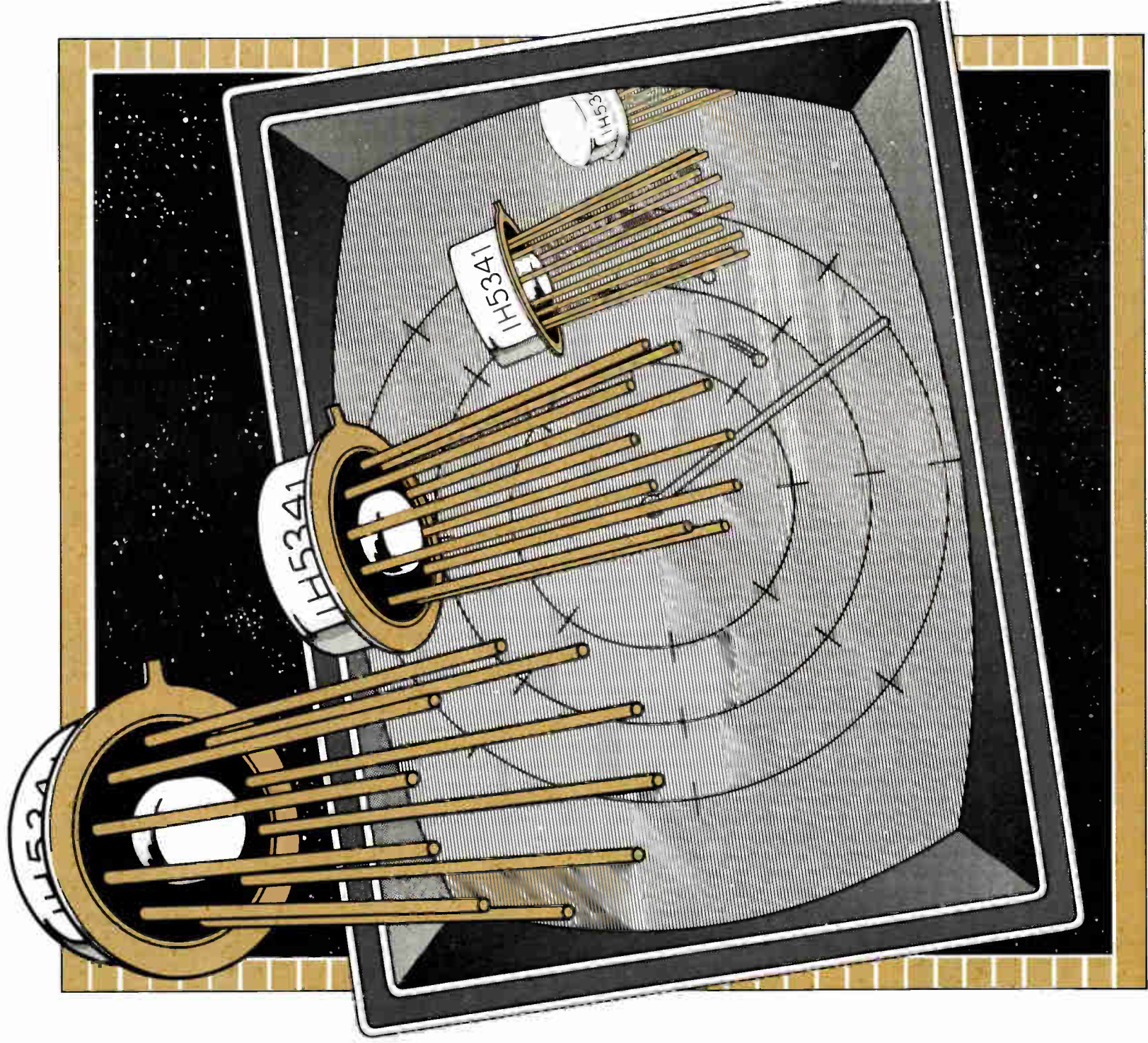

MONOLITHIC HAVE LANDED.

HIGH PERFORMANCE 100 MHz SWITCH—DUAL AT ONLY \$6.

Intersil's IH5341 is the first monolithic device that truly addresses video and R/F switching applications. With high off-isolation and on-resistance compatible with the video amplifiers and super-fast A/D converters found in today's video communications systems. Plus the low cost, low power consumption, small size, and reliability of advanced CMOS technology.

TRUE OFF-ISOLATION.

The IH5341 is a dual SPST monolithic CMOS switch that uses a series/shunt, or "T" switch configuration to achieve high off-isolation and low cross coupling: 60dB min. at 10MHz.

MATCHING ON-RESISTANCE.

The easy-to-use IH5341 provides a unique, low 75 ohm impedance, flat from DC to 100MHz. So it matches to your standard cabling and other system components. And with a signal loss of less than 3dB.

BEST OF SOLID-STATE HYBRID. BEST OF MECHANICAL.

The IH5341 provides the best features of solid-state hybrid switches — such as high speed switching ($t_{on} = 150ns$, $t_{off} = 80ns$) and guaranteed break-before-make switching. And the high off-isolation and low crosstalk of mechanical switches. And at \$6.00 (in 100's), the dual SPST IH5341 costs less and is more reliable than either hybrid or mechanical types.

TAKE ME TO YOUR LEADER.

Intersil. We're the innovators in low power CMOS technology and in its application to analog switch design. With the broadest and most advanced line of analog switches and multiplexers in the business. So you know the IH5341 is a product you can expect a lot from. Whether your applications are in R/F, radar, military or space communications, TV cameras, video displays, electronic warfare, or video special effects.

VIDEO SWITCH HOT LINE: (408) 996-5249.

Call the video switch hot line for complete details on the IH5341. If you prefer, contact one of the Intersil sales offices or franchised distributors listed below, or send the coupon.

INTERASIL SALES REPRESENTATIVES:

ALABAMA: (205) 883-9720 • ARIZONA: (602) 257-9015 • CALIFORNIA: (714) 695-2050, (415) 962-0660, (213) 883-7606 • COLORADO: (303) 779-0666 • CONNECTICUT: (203) 269-7964 • FLORIDA: (305) 830-9600 • GEORGIA: (404) 488-7025 • ILLINOIS: (312) 221-5018 • INDIANA: (317) 894-3778 • IOWA: (319) 377-8275 • MARYLAND: (301) 768-6666 • MASSACHUSETTS: (617) 890-0011 • MICHIGAN: (313) 348-3811, (616) 468-4200 • MISSOURI: (314) 731-5799, (816) 373-6600 • MAINE, NEW HAMPSHIRE, VERMONT: (603) 668-1440 • NEW JERSEY: (609) 235-8505 • NEW MEXICO: (505) 296-0749 • NEW YORK: (716) 424-4460, (315) 455-6611, (212) 291-3232 • NORTH CAROLINA, SOUTH CAROLINA, GEORGIA: (919) 781-1406 • OHIO: (513) 521-8800, (513) 293-4044, (419) 468-3737 • OKLAHOMA:

(918) 438-0511 • OREGON: (503) 649-8556, (503) 649-6177 • TENNESSEE: (615) 753-2921 • TEXAS: (214) 386-4888, (512) 451-2757, (713) 933-6021 • UTAH: (801) 973-7969 • WASHINGTON: (206) 568-0511, (509) 455-0189 • WISCONSIN: (414) 482-1111 • CANADA: (514) 323-3242, (416) 438-4610

INTERASIL FRANCHISED DISTRIBUTORS:

Advent (IN, IA) • Alliance • Anthem • Arrow • Bell Industries • Cardinal • CESCO • Component Specialties • Diplomat (FL, MD, NJ, UT) • Harvey Military Components • Kierulff • LCOMP • Newark • Parrott • R.A.E. Ind. Elect. Ltd. • RESCO/Raleigh • Schweber • Summit • Western Microtechnology • Wyle • Zentronics

INTERASIL

ANALOG PRODUCTS—SWITCHES
10710 N. Tantau Avenue, E42182
Cupertino, CA 95014
Telephone: (408) 996-5000
TWX: 910-338-0171

Gentlemen: I surrender!
Show me how to enlist the IH5341 in my video switching application. Send me literature fast!

Name _____
Title _____
Company _____
Address _____
City/State/Zip _____
My application _____
Approx. annual usage _____



Please send me a free Victor Hugo poster from your "Famous Quotations" series.

Function. Pulse. And save.

Global Specialties sets a new value standard. Twice.



Model 2001 Sweepable Function Generator. \$200.00*

Get the waveforms you need — 1 Hz to .1 MHz in five overlapping ranges: stable, low-distortion sine waves, fast rise/fall-time square waves, high linearity triangle waves — even a separate TTL square wave output. Plus high- and low-level main outputs.

An applied DC Voltage at the Sweep input can shift the 2001's frequency; or sweep up to 100:1 with an AC signal.

A pushbutton activates the DC Offset control, which shifts the output waveform up or down on command.

You'd expect to pay a lot more for all the 2001 can do!

Model 4001 Ultraviable Pulse Generator.™ \$235.00*

Here's a precision digital pulse generator with fast rise and fall times covering 0.5 Hz to 5 MHz in 5 overlapping ranges. With pulse width and pulse spacing each independently variable from 100 nsec to 1 sec for an amazing 10^7 :1 duty cycle range.

You'll find the 4001 delivers the pulse modes you need: Continuous, One-Shot, Triggered, Gated, Square Wave, even a Complement mode. The Trigger/Gate input, 50 Ohm variable output, TTL-level output and Sync output connectors are BNCs.

The 4001. Nothing does as much as well for anywhere near the price.

Smarter tools for testing and design.

**GLOBAL
SPECIALTIES
CORPORATION**

Call toll-free for details
1-800-243-6077
During business hours

70 Fulton Terr New Haven CT 06509 (203) 624-3103 TWX 710-465-1227
OTHER OFFICES San Francisco (415) 648-0611, TWX 910-372-7992
Europe Phone Saffron-Walden 0799-21682 TLX 817477
Canada Len Finkler Ltd. Downsview, Ontario

*Suggested U.S. resale. Prices, specifications subject to change without notice. © Copyright 1980 Global Specialties Corporation.

Circle 38 on reader service card

Linear designers get high-performance C-MOS gate arrays

by Stephen W. Fields, San Francisco regional bureau

Silicon-gate design runs faster, has lower offset than metal-gate devices, and offers closer component matching

Advanced-process development is the key to a new high-performance silicon-gate complementary-MOS array offering analog-circuit designers the same benefits digital-circuit designers have had with gate arrays—relatively low development costs and quick turnaround. With this array, designers can create many analog functions, including analog-to-digital, digital-to-analog, and voltage-to-frequency converters, and multipole switched-capacitor filters.

The array, which combines logic gates and linear-circuit elements, was developed by Telmos Inc., a year-old C-MOS gate-array house in Santa Clara, Calif. The company was founded by an old Silicon Valley hand, Jean Hoerni, the founder of

Intersil Inc., and also a founder of the former Fairchild Semiconductor.

A custom analog circuit often takes over a year of development and costs \$150,000 to \$200,000. However, a gate-array design, where only the final metalization layer is tailored, can be turned out in 12 to 16 weeks for \$30,000 to \$50,000.

Telmos dubs its analog-digital array, which is the first of a series, the TM6000. It was designed to implement systems requiring a-d, d-a, and precision analog signal processing and interfacing.

It contains 12 operational amplifiers with offset voltages of only 2 millivolts, typically, an open-loop gain of 80 decibels, minimum, and bandwidths of 5 megahertz. In addition, resistor matching is 0.5%, capacitor matching is 0.1%, and current sources are matched to 1%.

Other components include bipolar transistors, zener diodes, a band-gap reference, 32 flip-flops, and 300 logic gates. The component makeup of future arrays will depend on what

feedback Telmos receives from its customers, says Paul Nance, the firm's manager of engineering.

Process pluses. According to Nance, the TM6000's high performance comes from process innovation. "We employ ion implantation instead of diffusion for a tighter control over thicknesses—the p⁺ implants are 0.75 micrometer deep, the n implants are 0.5 μm deep, and the gate oxide is 500 angstroms thick—and plasma etching for most nitride and polysilicon layers." The thin gate oxide and the shallow implants enabled the firm to get the bandwidth and low offsets, adds Nance.

Bipolar master-slice analog chips have been around for some time, but are not low-power devices. Recently, several metal-gate C-MOS gate arrays with analog elements have been introduced. But according to the linear-circuit design manager at a major integrated-circuit company, "These C-MOS circuits don't offer decent analog performance. Typically they have op-amp offset volt-

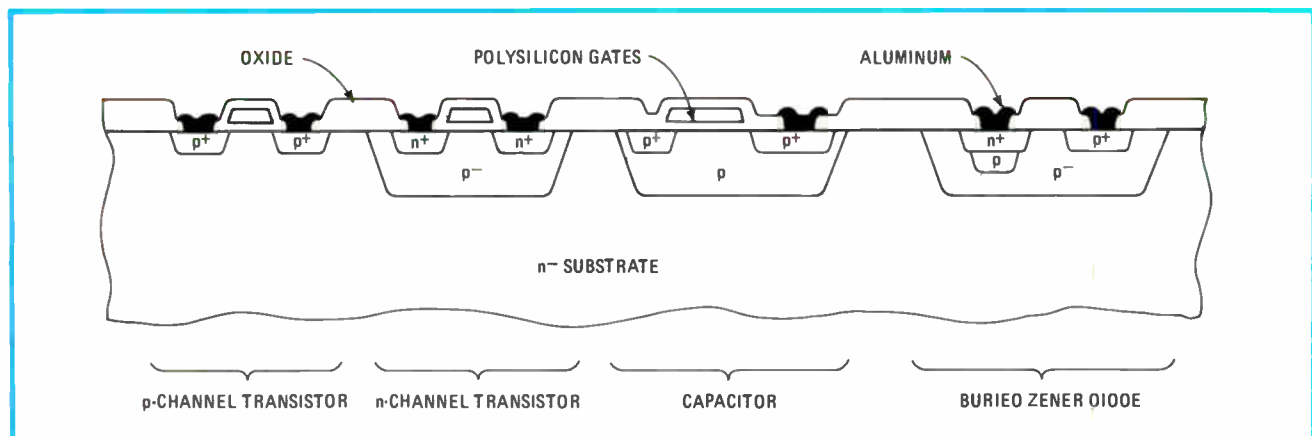

Array. Analog complementary-MOS gate array developed by Telmos Inc. places n-channel transistors in p wells, allowing the analog signals to switch above and below the well's bias point. The process also provides capacitors and zener diodes for the linear circuitry.

ages from 15 to 30 millivolts, which is relatively high, a bandwidth of only 1 MHz, and capacitor and current-source matching of only 5%."

The Telmos silicon-gate array employs a process specifically designed for analog circuits. In it (p. 39), n-channel MOS transistors are made in a p well implanted in an n-type substrate. N-channel transistors have better carrier-mobility characteristics than p-channel transistors and, as a result, are faster.

In the latest silicon-gate C-MOS processes used for digital circuits, the n-channel transistors are built directly into a p-type wafer. No well is used for them because the well adds capacitance, slowing the transistor's response. The p-channel transistors must then be built in an n well, but since most of the functions are built with n-channel transistors, this is a better tradeoff.

For analog circuits, however, there is an advantage to placing the n-channel transistors in a p well as Telmos does. The well can be biased at some voltage other than the substrate voltage. Typically it is biased at one half the supply so that an analog signal can swing positive or negative from this bias point.

Telmos engineers developed the process in cooperation with Synertek Inc. In return for allowing Telmos to use its facility, Synertek can market Telmos devices that are expected to be available later this summer. Nance expects Telmos to have a fabrication facility in 18 months.

Research & development

SIA research co-op kicks off in May

The multicorporate—and possibly multinational—Semiconductor Research Cooperative proposed last year by the Semiconductor Industry Association will begin operation May 3 with a \$5 million to \$7 million annual budget and 13 member companies initially.

Executive director of the cooperative will be Larry W. Sumney, who

SIA unveils its cooperative's stars

It was semiconductor star time in Washington, D. C., last week as Semiconductor Industry Association chairman Robert Noyce of Intel Corp. unveiled the association's Semiconductor Research Cooperative, its principal leaders, and the cast of supporting corporations.

IBM Corp.'s Eric Bloch, vice president for technical personnel development, is chairman of the 11-member cooperative board of directors. In addition to executive director Larry W. Sumney, the other nine directors of the organization are: Digital Equipment Corp. vice president C. Gordon Bell, Signetics Corp. president Charles C. Harwood, Fairchild Camera & Instrument Corp. director C. Lester Hogan, Motorola Inc. vice president William Howard, Intel chairman Gordon Moore, Honeywell Inc. senior vice president Carl Nomura, Control Data Corp. president Robert Price, Advanced Micro Devices Inc. chairman and chief executive W. J. "Jerry" Sanders, and National Semiconductor Corp. president Charles Sporck.

The steering committee of the cooperative will include representatives of three other member companies in addition to the 10 who hold director's chairs. The other corporations are Burroughs Corp., Hewlett-Packard Co., and Rockwell International Corp.

-Ray Connolly

leaves Government service after 20 years, the last four spent launching and directing the military's triservice Very High-Speed Integrated-Circuits program [*Electronics*, Sept. 22, 1981, p. 89]. Sumney, 42, and a physicist by training, will be making his first move into the private sector. Donald Borlage, VHSIC deputy program manager, will become acting program manager.

Designed to provide contract support to U.S. universities in long-term semiconductor research, the cooperative's charter says it will open its membership to foreign companies "provided that they pay fees reflecting the total integrated-circuit production or consumption of the total company, and that all other members have equal rights to participate in similar cooperative programs in the foreign countries." Few takers are expected because countries like Japan are unlikely to allow U.S. participation in national research and development efforts.

The organization will differ significantly from the Microelectronics & Computer Technology Enterprises Inc. consortium recently proposed by Control Data Corp.'s William Norris [*Electronics*, March 10, p. 97]. SIA chairman Robert Noyce of Intel Corp. notes, for example, that the co-op will support basic research at universities while Norris's concept is more oriented to development and

manufacturing techniques. Also, the research group will be a nonprofit organization, in contrast to the MCE consortium, which would be a profit-making enterprise.

Sumney, who will begin signing up new corporate cooperative members beyond the original 13 (see "SIA unveils its cooperative's stars"), says he expects the cooperative's annual budget to climb to a \$15 million to \$18 million level of support, and "realistically it will probably level off somewhere around \$25 million." A site for the organization still must be determined, he adds.

Intel's Noyce believes that the cooperative should not be situated on either coast or near a heavy concentration of industry—automatically ruling out Silicon Valley. Sumney concurs, and both agree that the co-op's location should have good air-travel connections and an environmental appeal to help in recruiting staff. Because of these factors, Colorado Springs, Colo., is getting serious consideration.

To develop long-range research strategies, the co-op will assess the potentials of systems and packaging alternatives for very large-scale integration; optical, electron-beam, and X-ray options for lithographic systems; semiconductor materials; reliability; and computer-aided design. For the short term, it will examine causes and effects of IC microstruc-

ture defects. In the high-risk areas of technology, it will look, for example, at prospects for gallium arsenide technology and total X-ray lithography systems. **-Ray Connolly**

Business

Semiconductor sales turning upward

From New England to Southern California, the semiconductor business is up and has been since January. Both manufacturers and distributors agree that the increase stems partly from a replenishing of depleted parts inventories by equipment manufacturers. But there are some strong market segments, notably personal computers and programmable video games. The U.S. economy overall, though, is anything but inspiring, and semiconductor producers, as a result are still wondering whether the apparent upturn can endure.

According to James Barlage, vice president of research for Smith Barney, Harris Upham & Co. of New York, the increase in semiconductor sales is not surprising. The pattern he points out, closely tracks earlier recessions. Barlage terms the current upswing "classic phase one of the recovery cycle, which is unfolding quite nicely."

This phase comes when customers start buying devices after depleting their inventories. The buying rate roughly equals consumption, with much of the business coming from customers who usually buy direct from chip-makers going to distributors who may give terms and deliver from stock.

Strong bookings. The major distributors, by and large, are signaling this turn. Hamilton/Avnet, Culver City, Calif., says that its book-to-bill ratio for March ran about 1.25, with semiconductor bookings very strong. March was a strong month, too, for Hall-Mark Electronics Corp., a Dallas distributor. A discordant note is sounded, however, by Norman Hurwitz, vice-president of Apollo Elec-

tronics Inc., Cambridge, Mass. "It's been business as sub-usual," he reports.

Barlage thinks that the industry is now in a transition to phase two. This is characterized, he says, by lengthening lead times, which are now occurring in most segments of the semiconductor business. Thomas P. Kurlak, vice president for research at Merrill Lynch, Pierce, Fenner & Smith Inc., in New York, points out that "lead times [for dynamic random-access memories] have stretched out to anywhere from 3 to 6 months, with Hitachi quoting 120 days for new customers and Nippon Electric Co. nearly having to go on allocation."

Other products are becoming tight as well, according to Kurlak. He estimates demand for logic and linear devices "is up 25% over levels five months ago." John Finch, vice president and general manager of National Semiconductor Corp.'s

Semiconductor division, reports that "lead times are [out significantly, particularly in our logic business where it's in the 10-to-18-week ballpark for some devices."

East Coast companies see much the same situation. "We have had an increase in sales this fiscal year and there is an improvement in our book-to-bill ratio," says a spokesman for RCA's Solid State division in Somerville, N. J. "But we see it as a bump in a down curve and don't expect any real upturn until the general economy has an upturn." Harris Semiconductor, Melbourne, Fla., sees some signs of improvement in the last month, but is not yet ready to say an upward trend has set in.

Key factor. Getting to phase three, which Barlage describes as an all-out boom, depends on the overall economic environment: it must improve dramatically. Smith Barney's own projections have this happening late in the year, leaving a hole in the

West Europe shows an upturn, too

Semiconductor markets in West Europe generally lag behind those in the U.S., but they are basically in step at the moment. Cautious optimism was the consensus of solid-state companies at the early-April Salon International des Composants Electroniques in Paris.

"Book-to-bill ratios started to improve beginning in November and went above one during the first quarter," according to André Borrel, a corporate vice president of the Semiconductor Sector of Motorola Inc. and director of the company's European operations. At a press briefing held during the Salon, Borrel told reporters that Motorola could not tell whether the upturn was merely a mild spurt caused by the rebuilding of inventory at equipment suppliers or the beginning of a solid market recovery. "There is no long-term ordering," he said.

At National Semiconductor Corp.'s European headquarters outside Munich, West Germany, marketing director Douglas Newman reports a first-quarter rise in book-to-bill ratios. "And it wasn't because billings were poor," Newman notes. His plots of bookings suggest a stretch-out in deliveries, and he remains uncertain about the real strength of the upturn.

Jacques Bouyer, managing director of RTC-La Radiotechnique-Compélec, a Paris-based components producer for NV Philips Gloeilampenfabrieken says his firm registered a turnaround in the past two or three months. Again, the book-to-bill ratio improved but delivery times remained short. "End users are running out of parts inventory, and this may be only a technical pickup," Bouyer says.

Much the same view of the market comes from Yves Thorn, a vice-president at Thomson-Efcis, the semiconductor subsidiary of France's largest electronics equipment maker, Thomson-CSF. "Our book-to-bill ratio is up strongly," Thorn said at the Salon, "and March was our best month for billings ever." France has a semiconductor market less dependent on consumer electronics than neighboring Germany and thus less dependent on the overall economy. Still Thorn, like most others in the business, cannot say for sure whether or not the upturn is real.

-Arthur Erikson

semiconductor improvement cycle for the third quarter. But unless interest rates soon fall and spur investments in capital equipment, the recovery could abort.

Still, a negative factor is that the large computer manufacturers have not increased their semiconductor buying. According to Finch at National, "We see second-tier accounts as well as distributors buying product, but the big boys have not come back yet."

Bill Davidow, senior vice president for marketing at Intel Corp., Santa Clara, Calif., which had an improved first quarter, agrees: "We look out and see that some customers are not doing that well. There are some relatively new customers like the personal-computer and video-game manufacturers whose sales are up, but our traditional customer base [in data processing] is still soft."

Paul Richman, president of Standard Microsystems Inc., in Hauppauge, N. Y., sums the industry mood up fairly well: "Our sales have been strong for three months. I don't know if it's a blip in the curve, but we're just thankful that orders are coming in." *-Electronics staff*

Materials

Coating will block light on photo chip

As more functions are integrated into light-sensitive semiconductors, chip manufacturers will be facing the task of blocking light from sensitive logic and control circuitry without obstructing the photodiodes.

To make this easier, Polytronix Inc., a semiconductor-packaging consultant in Richardson, Texas, has developed a light-blocking conformal coating that can be patterned directly on the wafer by conventional photoresist methods. The coating material, called PTX-205, can be placed on areas as small as 5 micrometers on a side, and the company anticipates that lines 3- μm wide or less could be painted as the material is improved.

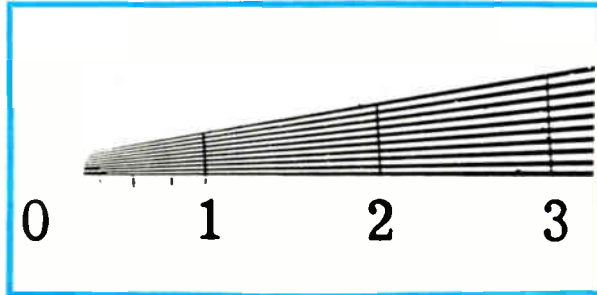

Blockers. Test pattern shows the definition with which the PTX-205 coating can be laid down on a wafer. Numbers indicate the spacing in mills between the centers of the white areas.

"One of the great concerns facing photo IC makers is light getting to the wrong parts of a chip," points out Lawrence A. Murray, a semiconductor industry consultant in St. Louis, Mo. "One way around the problem is in the design stage—one transistor's leakage is made to balance another's. But this cannot always be done, and that's when companies begin looking for a way to block the light." The coating would be of particular interest to those concerned about pinholes in the insulation layer between a metal shield and the die surface, Murray adds.

Generally, photodetector chip makers use metal layers, such as aluminum or gold, to protect areas of circuitry from signal-distorting light waves. These layers are usually vacuum-evaporated onto the wafer at a high temperature.

Though these metals block light, they are also electrical conductors. Therefore, the wafer substrate must be insulated from them. The new light-blocking material, on the other hand, is a dielectric and can be placed directly on the substrate, according to Les Linton, marketing manager for the year-and-a-half-old firm. A 5- μm -thick layer of the polymer will pass less than 3% of the light across a spectrum of the ultraviolet, visible, and near infrared.

On a chip. According to Linton, the new material will make it easier to produce a photo integrated circuit with both the diode and other circuitry on the same die, reducing both cost and chip handling. Many companies have been putting the diodes on one chip and the circuitry on a second. The two are then mounted

side by side on a motherboard or combined in a hybrid package.

Another hazard avoided is the potential for crosstalk posed by the metal layers, Linton continues. In addition, light reflected from the metal may affect the on-board photodiodes. The

PTX-205 coating reflects no light. It is applied by either spin, spray, or roller-coating methods. Typically, the coating would be 15 μm thick, Linton says.

Next the coating is cured, and the photoresist placed on top. The protective pattern is then exposed onto the wafer using a conventional photo mask. After the photoresist is developed, the unwanted PTX-205 is washed away with warm water. The coating is then hardened by baking the wafer for one hour at 300°C. Polytronix says the material will provide light protection for temperatures up to 350°C.

Other than to describe its coating as a "thermosetting polymer with a base formulation," Polytronix is secretive about the coating's chemistry. It is the company's first product. A pint, selling for \$400, will cover about 200 3-inch wafers, according to Linton. *-J. Robert Lineback*

Quality

Perception lag nags U. S. chip makers

As top quality-assurance officials of major semiconductor companies see it, the so-called performance gap between U. S. and Japanese parts largely has been erased. Now a new, and in many ways tougher, task confronts U. S. firms: how to correct the persistent, if misinformed, public opinion that Japanese components are still much less likely to fail.

"The situation has changed, but the perception of it has not," says

MAKE A CIRCUIT IN RECORD TIME AND SAVE MONEY. SEND FOR DETAILS.

Kodak Precision Line film LPF7 is the fastest printed circuit film we've ever made. And it also offers high line-edge acuity and excellent contrast...yet it costs about 25% less than our most popular Precision Line film! If you need a faster film for photoplotter or camera use, and you wouldn't mind spending a little less, send the coupon.

Yes, Please send details on Kodak Precision Line Film LPF7.

Name _____
Company _____
Address _____
City _____ State _____ Zip _____
Eastman Kodak Company, Dept. GA042, Rochester, N.Y. 14650

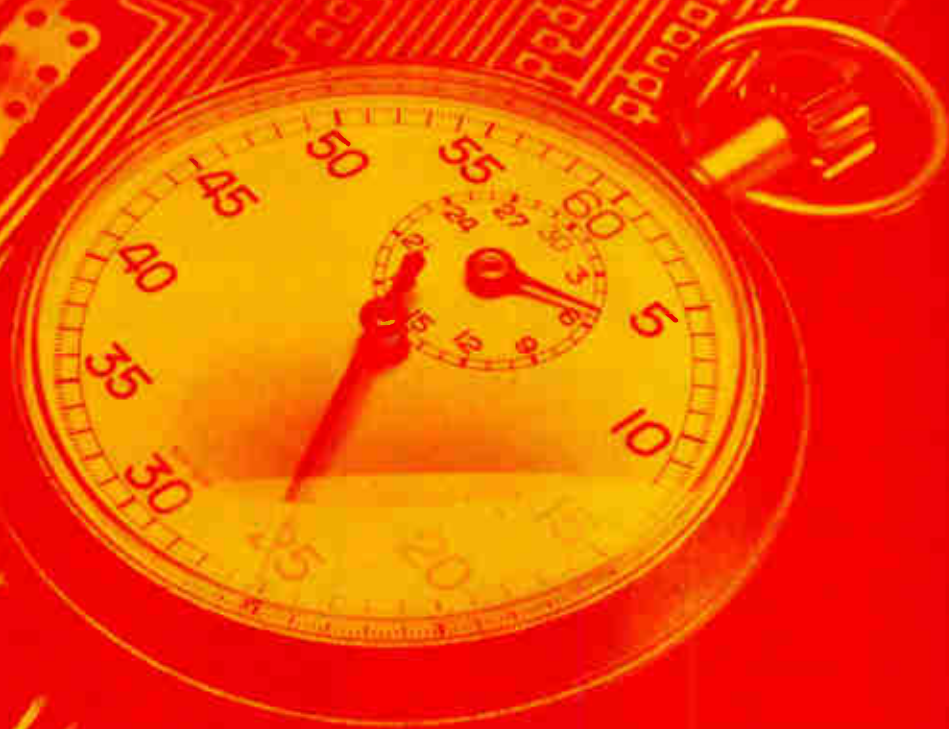

IF IT'S REPROGRAPHIC AND PHOTOGRAPHIC,

IT'S FROM KODAK



© Eastman Kodak Company, 1982

Circle 43 on reader service card

Joe Flood, who directs reliability and quality assurance for Motorola Inc.'s Bipolar division in Mesa, Ariz. Along with Willard Kauffman, vice president and director of component production and research, Intel Corp., Santa Clara, Calif., Flood gave views on these questions early this month at a Los Angeles conference on quality sponsored by the American Society of Quality Control.

Kauffman, in fact, questions whether any such gap actually existed to the extent it was perceived by Richard Anderson of Hewlett-Packard Co.'s Computer Systems division, who made public the results of his company's tests about two years ago [*Electronics*, April 10, 1980, p. 81]. Based on testing of 300,000 16-K random-access memories from three Japanese and three U.S. suppliers, the U.S. parts were deemed nearly six times more likely to fail.

A smarting U.S. industry reacted sharply, initiating many crash programs to foster quality. By year-end 1980, similar tests showed only a 2-to-1 quality gap, and the most recent data from HP, cited by Motorola's Flood, finds "almost no difference among 16-K parts."

However, according to Intel's Kauffman, the Japanese still excel in their "strategy to market quality." Proof of this is that industry opinion also ranks other products in the same category of success as the 16-K parts, he says. "We have to sell our quality in the same way. We have nothing to be ashamed of," he emphasizes.

Low returns. As an example, Kauffman offers Intel's 64-K erasable programmable read-only memory, "a hot item being shipped in quantity into Japan." Return rates from customers for this very complex integrated circuit, 198 mils on a side, show only 100 defects per million. This high level of quality had not been projected for the industry until the mid-1980s, he says.

Flood says his bipolar product lines showed overall defects down to 941 parts per million by the end of 1981. Only a year earlier this rate stood at 3,300 ppm, and it was up at 6,600 ppm in 1977 when quality pro-

Another bubble maker in them thar hills

When National Semiconductor Corp. left the bubble-memory business last August, it appeared that Intel Corp. would be the only U.S. supplier. A look around Motorola Inc.'s Corporate Research and Development Center, however, shows that magnetics is alive and well in Mesa, Ariz.

"We are steaming ahead," says Leonard Call, marketing manager for bubble-memory systems. "We are shipping samples, are in limited production of a 256-K module, and are starting to sample a 1-megabit unit."

Motorola's entire bubble effort is in Mesa, where new fabrication equipment is being rolled in to step up production. The company will sell systems and subsystems, but not chips. Estimates have placed the annual U.S. market for bubble chips and their support circuits at anywhere from \$10 million to over \$50 million [*Electronics*, Sept. 8, 1981, p. 41]. Initially the devices found a niche in systems for harsh environments because of their wide operating temperature range, but that may be changing.

"The whole market is now firming up and taking off," reports David Shrigley, strategic marketing manager of Intel's Nonvolatile Memory division in Santa Clara, Calif. "We are seeing greater market acceptance in higher-volume applications, such as portable instrumentation and computers."

Along with Intel, both Fujitsu Ltd. and Hitachi Ltd. have been in a position to market parts in the U.S. The next big question is who will second-source whom. Given the flurry of dropouts last year, when Rockwell International Corp., then Texas Instruments Inc., and next National quit the commercial bubble scene, customers are pressuring for alternate sources. "The whole situation is still very fluid," advises Motorola's Call. "Present customer commitments are making marriages difficult. There may be more possibilities at the 4-megabit level." "Watch for second-sourcing announcements to come thick and fast in the next few months," says Intel's Shrigley. Who will go with whom is still anyone's guess, because "everyone is talking with everyone else," as Call puts it.

-Roderic Beresford

grams were launched.

One user who can attest to quality improvements by U.S. component makers is Arch Pollino, director of the corporate test laboratories at Control Data Corp., St. Paul, Minn. He directs inspection of some 80 million to 90 million devices annually and reports that lot acceptance has reached 99% for major vendors, a figure he is exceptionally pleased with. "The key is close cooperation with suppliers," he says. In line with a top-management edict, CDC buys almost no Japanese devices.

Timely cooperation is an area where U.S. firms do lag the Japanese, notes Charles C. Harwood, president of Signetics Corp. of Sunnyvale, Calif. "Only a handful of our customers give us feedback. CDC is the exception," he notes. It is felt that U.S. industry cannot match the feedback achieved by its vertically integrated Japanese competitors.

Other U.S. executives not at the conference also regard the quality gap as a thing of the past. "It has

almost retreated to a nonissue," says Gordon Moore, chairman and chief executive officer of Intel. "The industry overall has made significant improvements, but I don't believe there ever was a gap. The differences week to week from any one vendor were greater than the differences from nation to nation."

Adds Anthony Holbrook, senior vice president for operations at Advanced Micro Devices Inc., Sunnyvale, Calif., "Quality has not been an issue for close to a year. It's not the U.S. versus Japan anymore—now it's individual companies against each other." **-Larry Waller**

System design

Timing verifier separates checkout

What do a comedian and a logic designer have in common? The answer is timing, though the former

THIS MICRO-SYSTEM TESTER FINDS MORE FAULTS



THE SOLARTRON 7201 'LOCATOR'

A SIGNIFICANT CLAIM FROM SOLARTRON

Most micro-system testers stop short of testing your complete system. Of course you need to test the microbus and system memory, that's just part of the problem. Some testers get no further than devices directly synchronised to the micro. To find all your system faults you need test equipment to do much more.

Before you choose a micro-system tester check that it meets these essentials:

- Tests at full systems speed
- Checks the micro chip itself
- Tests interrupt or DMA circuits
- Synchronises to and tests off-bus logic like video generators
- Finds faults in closed feedback loops – like Locator's unique trace analysis
- Uses signature analysis with industry-standard format so you can fault-find OEM supplied peripherals and parts
- Fault finds to component level – signatures get you to the faulty node – Locator's current probe can pin-point which IC is causing the trouble
- Provides frequency, timing, logic level and DMM facilities to check-out circuitry where signatures can't be used
- IEEE 488 bus plus a disc-based automated data-base program necessary for automated testing

Solartron's Locator can handle all this because it packs more measurement

performance than any other microtester. Add this to our range of in-circuit emulator pods (micropods) for test stimulus: 6800, 6802, 6809, 8080, 8085, Z80, 6502, 2650, 8086, available now with NEW intros in 1982 to include 9900, 68000, Z8000, 1802, 3870, 8048 series, then you have the most comprehensive micro-system testing package available.

To find out more, phone or write to the address below.

The Solartron Electronic Group

USA: – 17972 Sky Park Circle, Suite F, Irvine, CA. 92714
Tel: (714) 641-7137

UK: – Farnborough, Hampshire, GU14 7PW Tel: 0252 544433

GERMANY: – AM Kirchenhölzl, 15 8032 Gräfelfing, München
Tel: 089-854-3071

FRANCE: – 1, Rue Nieuport, 78140 Velizy-Villacoublay
Tel: 3-946-9650

SWEDEN: – Vesslevägen, 2-4, Box 944, S-18109 Lidingo
Tel: 08-765-2855

SWITZERLAND: – Badenerstrasse 333, 8040 Zürich
Tel: 01-52 88 80



SIGNIFICANTLY FROM SOLARTRON

Circle 45 on reader service card

works for laughs while the latter fears them. That is why the first commercial introduction of a Timing Verifier should be of interest to designers of everything from board-sized systems down to a single integrated circuit.

The timing of a logic design so that everything happens in correct sequence and with safety margins is as important as the logic itself. Often as difficult, time-consuming, and critically important is verifying this timing. The new product is actually a \$10,000 software add-on developed by Daisy Systems Corp., Santa Clara, Calif., for the Daisy Logician, a work station for simulating and verifying logic designs the company introduced last fall [*Electronics*, Nov. 3, 1981, p. 176].

Until now, timing must be checked on a logic simulator by simulating the entire logic for every change in timing or clock rate of concern. This uses up valuable computer time and cannot represent as complete a timing check as is possible with the Daisy verifier.

"You can't verify timing as completely as we can, even by building the system, because you can never purchase the worst-case parts intentionally," points out Daisy president Aryeh Finegold. "We have cleanly separated the logic simulation and timing into separate programs. There is no other commercially available way to do this."

Scald. Finegold has built the separation scheme on work done at the Scald project at Lawrence Livermore Laboratory in Livermore, Calif. [*Electronics*, July 31, 1980, p. 75]. But whereas the Scald relied on the laboratory's giant S-1 mainframe, Daisy's Logician distills it all down to a system built around two Intel 8086 8-megahertz, 16-bit microprocessors, 512-k bytes of random-access memory, and a bit-slice processor board. The price of each work station, including all software other than the verifier, is \$75,000.

Finegold adds that the Daisy Timing Verifier is not selective as to the technology it works with. "It can handle MOS, complementary-MOS, ECL or other bipolar circuits, or any

News briefs

Ion-implant service opens in Silicon Valley . . .

Chip designers are getting a pair of new services in the Silicon Valley area of California. High-current ion implantation is being provided by a company in Sunnyvale calling itself The Implant Center, which has a medium-current (10 to 20 milliamperes) implanting machine dubbed the Nova. Wafers from 2 to 5 inches in diameter can be sent to the center via air express, to be returned the next day. Ions implanted include boron, arsenic, and phosphorus, as well as the more unusual neon, silicon, and argon dopants. Also accommodated are broken and irregularly shaped wafers and wafers of gallium arsenide and other materials. The Nova can also handle double-charged ions for requirements above 200 kiloelectronvolts.

. . . while a silicon foundry offers 3- μ m C-MOS

Synertek Inc., the Santa Clara subsidiary of Honeywell Inc., is making available the state of the art in complementary-MOS logic—3-micrometer, silicon-gate technology. The company is looking for custom-design and foundry business, says Terry Leeder, director of custom marketing. It will be applying its H-C-MOS process, an n-well process optimized for 5-volt digital circuits. Gate delays are just under 1 nanosecond, Leeder says.

Motorola digs in for new IC plant

Testimony to its relatively sound position in the current semiconductor recession, Motorola Inc.'s MOS operation in Austin has broken ground on a second major production plant in the Texas capital city. Although no formal announcements have been made, Motorola is expected to move its Microprocessor division into the new complex, which will cost between \$80 million and \$100 million when completed in 1984. The MOS group hopes to begin moving personnel into the plant during the first quarter of 1983.

Florida software maker added to Comsat

Comsat General Corp.'s commitment to acquire a computer-aided design and manufacturing capability through acquisition of small companies was shown again early this month. Graphix Software Inc., an 11-employee, year-old Boca Raton, Fla., producer of computer-aided software, is the latest acquisition of Comsat General Integrated Systems Inc., itself only two years old [*Electronics*, Nov. 6, 1980, p. 55]. Graphix Software's principal product, called C-Logix, will be integrated with the CGIS effort known as Tegas, which involves computer-aided design and test of large- and very large-scale integrated circuits and circuit boards.

The acquisition is the third small company buy this year by Comsat General, the domestic communications subsidiary of its Washington, D. C.-based parent, Communications Satellite Corp. The earlier acquisitions assigned to the CGIS group in Austin, Texas, are: Amplica Inc., a Newbury Park, Calif., maker of solid-state microwave amplifiers, and Applied Silicon Technology, an Austin designer of IC masks.

Excimer lasers offer promise for lithography

The intense short-wavelength ultraviolet light of excimer lasers may help plunge optical lithography into the submicrometer region, scientists from International Business Machines Corp.'s San Jose (Calif.) Research Laboratory reported in late March. Precise 0.5-micrometer lines have been produced in resists using contact masking with exposure times as short as a few tens of nanoseconds with the lasers, whose wavelengths range from the near UV (350 nanometers) into the deep UV (under 200 nm), at an intensity that is over a hundred times that of conventional mercury or deuterium light sources.

Excimers also have less spatial coherence than most lasers, which eliminates the speckle, or interference, effects that have limited lasers' use in lithography so far. Semiconductor processors could up the speed of wafer exposure and obtain steeper wall profiles and more flexibility in choosing resist properties like resolution and etching characteristics.

Type MG Precision High Voltage Resistors from CADDOCK deliver 6 big advantages:



1. For maximum design flexibility, there are 19 standard models with 10 voltage ratings in the Type MG 'family'.

The Type MG family of high voltage resistors includes a selection of voltage ratings from 600 volts to 30,000 volts in various resistor lengths to provide maximum flexibility in the design of high voltage assemblies.

In addition to this wide range of voltage ratings, the Type MG family provides a selection of resistor diameters at many of the standard voltage ratings, as illustrated by the three models of 4,000 volt, 1-inch long resistors shown here.



Important performance specifications for all Type MG resistors include:

- Full power rating to +125°C.
- +225°C maximum operating temperature.
- Resistance values that cover the range from 200 ohms to 2000 Megohms.

2. The standard TC of 80 PPM/°C and resistance tolerances from 1.0% to 0.1% combine to improve circuit accuracy.

Through the full range of resistance values from 200 ohms to 2000 Megohms, the Type MG resistors maintain a temperature coefficient of 80 PPM/°C over the range from -15°C to +105°C, referenced to +25°.

The combination of precision and low TC achieves a significant improvement over other high voltage resistor technologies, particularly in the higher resistance values.

3. Overvoltage rating of 150% is standard for all models.

Every model of the Type MG resistors has a *standard* overvoltage/overload rating of 1.5 times the maximum working voltage where this level does not exceed 5 times the rated power. As an example, in the Model MG 815 this capability provides for short-term overloads as high as 45,000 volts.

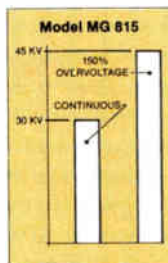

And for even tougher applications, special factory conditioning can boost the maximum *continuous* operating voltage of many models to 160% above the standard specifications.

4. Matched resistor sets with 0.1% ratio tolerances and TC tracking as close as 10 PPM/°C from -15°C to +105°C.

The temperature coefficient of Caddock Micronox® resistance films can be controlled to provide matched sets of Type MG resistors with ratio tracking within 10 PPM/°C and with ratio tolerances as close as 0.1% for ratios from 1:1 to 1:100,000.

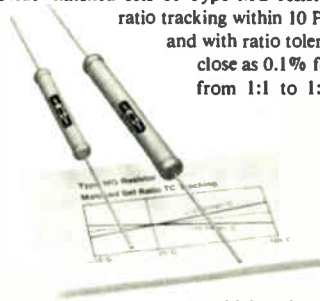

For high voltage divider applications, 2% ratio tolerance is standard.

5. Extended-life stability that is typically better than 0.02% per 1000 hours.

20,000 hour *continuous* load-life tests have proven the exceptional stability of Caddock Micronox® resistance films. This graph illustrating the 20,000 hour test results of the 10,000 volt rated Model MG 750 shows extended-life stability well within 0.02% per 1000 hours.

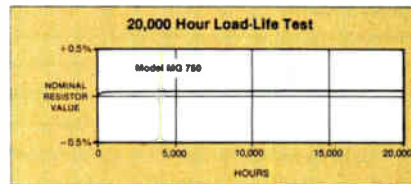

A complete data summary of these test results is available on request.

6. Exclusive Non-Inductive Performance.

Caddock's Exclusive Non-Inductive Design is the answer wherever there are special requirements for excellent high-voltage pulse fidelity and wide bandwidths.

To keep the inductance to an absolute minimum, the special serpentine pattern provides for neighboring lines to carry the current in opposite directions to achieve maximum cancellation of flux fields over the entire length of the resistor.



Caddock's advanced film resistor technology is the source of these outstanding advantages - advantages that are matched by a 20-year record of outstanding 'in-circuit' reliability.

Discover how easily these problem-solving resistors can improve the performance and reliability of your equipment, too.

For your copy of the 20th Edition of the Caddock General Catalog, and specific technical data on any of the more than 150 models of the 13 standard types of Caddock High Performance Film Resistors, just call or write to -

Caddock Electronics, Inc., 1717 Chicago Avenue, Riverside, California 92507 • Phone: (714) 788-1700 • TWX: 910-322-6108

CADDOCK

HIGH PERFORMANCE FILM RESISTORS

technology," he says. "The Scald verifier was set up for emitter-coupled logic alone."

At least one other company, however, is working on a similar system. Valid Logic Systems Inc., Sunnyvale, Calif., [*Electronics*, Nov. 17, 1981, p. 117] is developing Scald software to run on a variety of computers, but a date has not yet been set for an introduction.

Timing specs. The data base needed by the verifier is entered by the designer as the logic simulation is set up. For a printed-circuit-board product, for example, the designer puts in the timing parameters for each IC, taking them from the data sheets.

By plugging in successively higher system clock speeds, the designer can find out how fast the circuitry can go before it ceases to function. This kind of verification checks on things like race conditions, an all-too-familiar circumstance in which a logic pulse arrives on an input line either too early or too late. For example, a counter circuit that counts correctly at an 8-MHz rate may not maintain a proper sequence when operating at 10 MHz.

When circuits fail, the timing verifier points out which critical paths have been violated. The designer can then concentrate on improving the weakest parts of a circuit.

Check out. Circuit signals are analyzed to determine when they are changing, when they are stable, and whether the timing specifications of each component are being met. Taken into account are typical delays, as well as the minimum and maximum rise and fall times, wiring delay, clock skew, the three-state-enable delay, and, of course, the system's input specifications. Operation is also checked against the output timing requirements.

More specifically, the Daisy Timing Verifier checks setup and hold time, edge-to-edge relationships, minimum pulse widths, and the timing of overlapping signals, such as the relationship between the write-enable line and the address lines on a memory. One edge-to-edge relationship checked, for example, is the

row-address-falling to column-address-falling time difference on a dynamic RAM. On shared buses, the verifier also checks for contention. After performing all these tasks, the software then documents its results, flagging all the errors it is able to locate.

-Martin Marshall

Broadcasting

A-m stereo gets no standard

Much to the chagrin of U. S. broadcasters and radio makers, a-m stereo is heading toward a rather uncertain start April 26, when broadcasting may begin without any industry standard. Even more frustrating to station owners is that their own trade organization, the National Association of Broadcasters, was unable to choose a leader from among the five competing a-m stereo systems at its convention in Dallas earlier this month.

Placing the broadcast industry in this precarious situation is last month's decision by the Federal Communications Commission not to select a standard from systems proposed by Belar Electronics Laboratory Inc., Harris Corp., Kahn Communications Inc., Magnavox Consumer Electronics Co., and Motorola Inc. After years of studies, the FCC voted 6 to 1 to leave the choice up to "marketplace factors."

With the broadcasters dawdling, General Motors' Delco Electronics division may set a *de facto* standard. The giant automobile-radio maker intends to field-test all five systems. Delco will not make its choice known until July or later, reports Robert J. McMillin, director of engineering at the division in Kokomo, Ind., and it will be not until late in model year 1983, at the earliest, before GM offers a-m stereo in its car radios. Delco's decision could sway other radio makers to its choice.

At least one a-m stereo system representative in Washington, D. C., fears, though, that Delco may not move fast enough, and this will "give

the ball to the Japanese car makers, and they are going to run like hell with it—just like they did on small cars."

Broadcasters with a-m radio stations, of course, will go for the system that offers the highest potential number of listeners. They see stereo as their last hope for survival in the battle with the booming fm industry. The a-m sets cannot match fm in fidelity, but they outdo fm at pulling in distant stations.

Meanwhile, the transmitter makers continue to pitch broadcasters, and radio makers are evaluating the decoder chips they will need for a-m stereo radio, which will add \$2.50 to \$5 to the producer's cost.

Wait and see. In Japan, the giant radio-receiver makers seem to be taking a wait-and-see attitude until standardization is in sight in the U. S. All involved parties agree that a-m stereo is a long way off in Japan, where national radio policy is extremely conservative.

The country has only two fm stations, for example, despite applications filed as long as 10 years ago to build more. It is also considered unlikely that the Japanese government will establish a standard for radio makers.

Harris, however, is aggressively peddling its system in Japan and says it will make a decoder on a chip available this summer. Motorola has developed a single-chip decoder for its system, as well as a stabilizer circuit for receivers with mechanical tuning systems. Pioneer Electronics (USA) Inc. has endorsed the Magnavox system. It says it has "no specific development plans in this area," but believes the industry must have a single standard.

Sony confirms it has developed a decoder chip that automatically switches among the five proposed formats and is working on bringing its cost down. National Semiconductor Corp., the only U. S. producer with an a-m decoder chip on the market (the LM1981 designed to be used with the Magnavox system), is waiting for orders.

"We feel that the industry must arrive at a decision," says Dan

More Multibus.™ And less.

VMC 186 VIDEO MONITOR CONTROLLER 80 Character X 24 line alphanumeric and limited graphic display. Upper and lower case, Reverse, half-intensity, flashing, and underline attributes.

FDC 1680 FLOPPY DISK CONTROLLER WITH 16K RAM 4 single density drives. Automatic DMA into the dual-ported on-board 16K RAM.

SMD 2181 STORAGE MODULE CONTROLLER Same as SMD 2180 except *damned* fast DMA 24 bit addressing, 11 bit Error Correction, software selectable sector size and interleave. *Can transfer a full track in one disk revolution.*

WOC 2880 WINCHESTER DISK CONTROLLER Up to 8 drives with ANSI X3T9.3 interface. Very high speed DMA, 20 bit address. Software selectable sector size and interleave factor. 11 bit Error Correction.

We're constantly at work creating new capabilities for Multibus.

LAN 5180 LOCAL AREA NETWORK CONTROLLER Up to 255 devices are supported on a coaxial cable. Data rates up to 2 Mb/Sec. SDLC HDLC protocol. 20 bit DMA, automatic transaction completion, mailboxes. First in a family of LAN products.

HOC 1880 HARD DISK CONTROLLER Up to 4 cartridge (5440 type) disk drives. High speed 20 bit DMA. Automatic Retry. ECC, switch selectable sector size and interleave.

SMD 2180 STORAGE MODULE CONTROLLER Up to 4 SMD compatible drives (including CDC LARK), 8-300 MBytes, bit rates to 20 Mb/S. High Speed 20 bit DMA. ECC, switch selectable sector size and interleave.

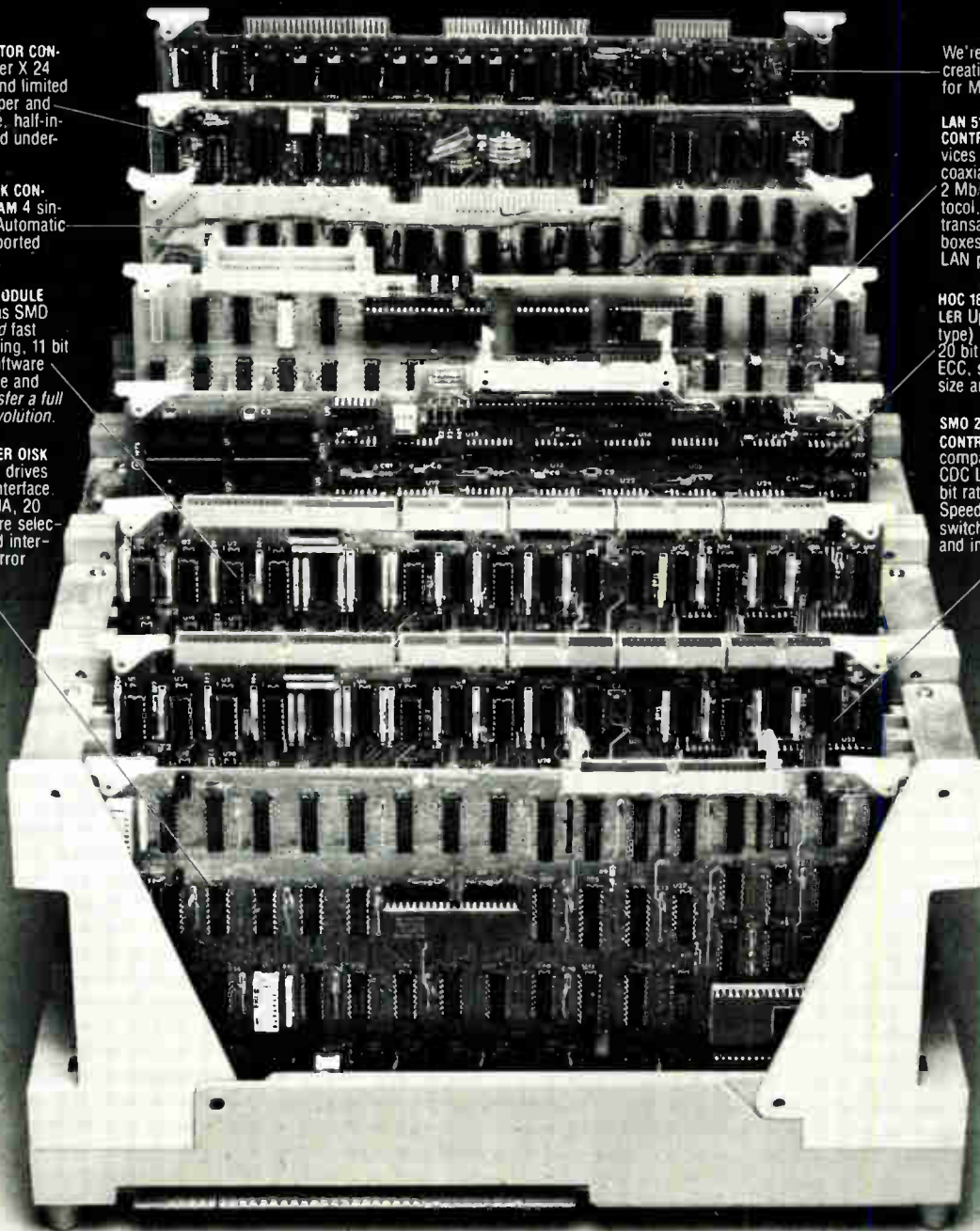

Now, the most talented Multibus specialists in the country bring you more Multibus options than ever before. And less.

More technology with less risk. More function

with less cost. And more support with less hassle.

When you're ready to expand your Multibus capabilities, talk to us. We're the specialists who give you more. And less.

Entire rigid disk controller family is software interchangeable. Automatic completion of simple multisector commands, automatic recovery from errors, bad track mapping, full sector buffering, extensive diagnostic reporting. Variable burst DMA in 8 or 16 bit systems. Software drivers and disk subsystems also available.



We stay ahead of our competition so you can stay ahead of yours.
13667 Floyd Circle/Dallas, Texas 75243/(214)238-0971

NEW PRODUCT CHARGE SENSITIVE PREAMPLIFIERS

FEATURING

- Thin film hybrid technology
- Small size (TO-8, DIP)
- Low power (5-18 milliwatts)
- Low noise
- Single supply voltage
- 168 hours of burn-in time
- MIL-STD-883/B
- One year warranty

APPLICATIONS

- Aerospace
- Portable instrumentation
- Mass spectrometers
- Particle detection
- Imaging
- Research experiments
- Medical and nuclear electronics
- Electro-optical systems



Models A-101 and A-111 are charge sensitive preamplifier-discriminators developed especially for instrumentation employing photomultiplier tubes, channel electron multipliers (CEM), microchannel plates (MCP), channel electron multiplier arrays (CEMA) and other charge producing detectors in the pulse counting mode.

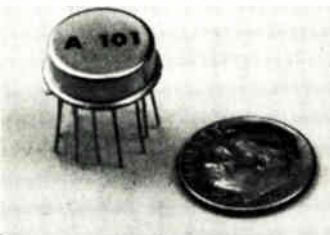

Models A-203 and A-206 are a Charge Sensitive Preamplifier/Shaping Amplifier and a matching Voltage Amplifier/Low Level Discriminator developed especially for instrumentation employing solid state detectors, proportional counters, photomultipliers or any charge producing detectors in the pulse height analysis or pulse counting mode of operation.

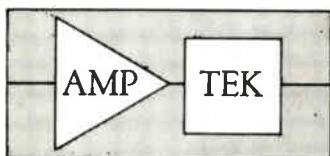
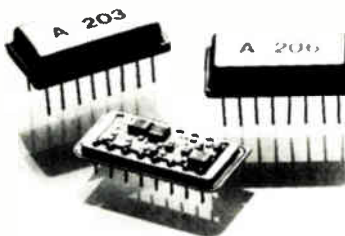

AMPTEK INC.

6 DeAngelo Drive
Bedford, Mass. 01730 U.S.A.
Telephone: (617) 275-2242

With representatives around the world.

Electronics review

Shockey, consumer linear marketing manager. "Once we get to the point where different systems are being promoted on the air and in the store, the public will get confused and lose interest." **-J. Robert Lineback**

Electric vehicles

Fund batteries, GAO tells Congress

Advanced batteries, not electric vehicles, should continue to get Federal research and development funds, reports the General Accounting Office. Its study shows that electric vehicles are only slightly closer to practicality than they were seven years ago despite a total of \$181 million in Federal funding.

Electric cars cost twice as much as conventional gasoline- and diesel-fueled vehicles, says the GAO. In addition, they do not even halfway meet the minimum range, speed, acceleration, and battery-life goals of automobile manufacturers.

Though the GAO concurs with the Reagan fiscal 1983 budget plan to totally eliminate electric-vehicle funding, the accounting office urged Congress to continue granting funds for advanced battery technology for the long term as, it points out, Japan is doing. The Reagan budget is dropping this funding on the premise that the technology should be supported by private industry alone. However, the GAO notes that it is unlikely that battery companies will perform much R&D without Federal funds.

Candidates. The aluminum-air battery is identified by the investigators as the most promising candidate for future electric vehicles. This battery may allow a car 250 miles between charges and promises rapid refueling by simply replacing aluminum plates and adding water.

"Laboratory bench-scale cells have been produced and successfully operated" under the Department of Energy's R&D program, says the GAO. Three other long-term development candidates it points to include batteries using lithium metal sulfide,

sodium sulfide, and zinc bromine.

The DOE, the study points out, has concentrated its near-term battery efforts on three types: improved lead-acid, nickel-zinc, and nickel-iron. The department's efforts have not funded any of the longer-term technologies.

Major U. S. automobile manufacturers and others have faulted Congress's 1976 legislative mandate for the DOE to design an electric vehicle as being "needlessly large." They said the DOE erred in concentrating only on near-term development and in testing prototype vehicles using batteries that could not produce significant increases in range, speed, acceleration times, and battery life cycles. **-Ray Connolly**

Minicomputers

Separate processors fill in for each other

Large minicomputer systems often use multiple processors for either redundancy or to parcel out dedicated functions like handling a display screen or the system's input and output. However, Basic Four Information Systems division, Tustin, Calif., is taking quite a different approach in the minicomputer system it introduced earlier this month. It is using three identical 16-bit processors to share everything.

"The processors are like three secretaries in a typing pool. If there's just one job, only one works. But if there are three or more jobs, they all work, each going to the next task as soon as she has time," says David Seigle, vice president, business planning. "It facilitates throughput and permits us flexibility in making changes in the future."

A side benefit is less downtime, he adds. The system can limp along with just two processors, if one is down, since they all can handle any task that comes in.

Basic Four, which specializes in making a wide range of small business computers for end users, is applying this new architecture to

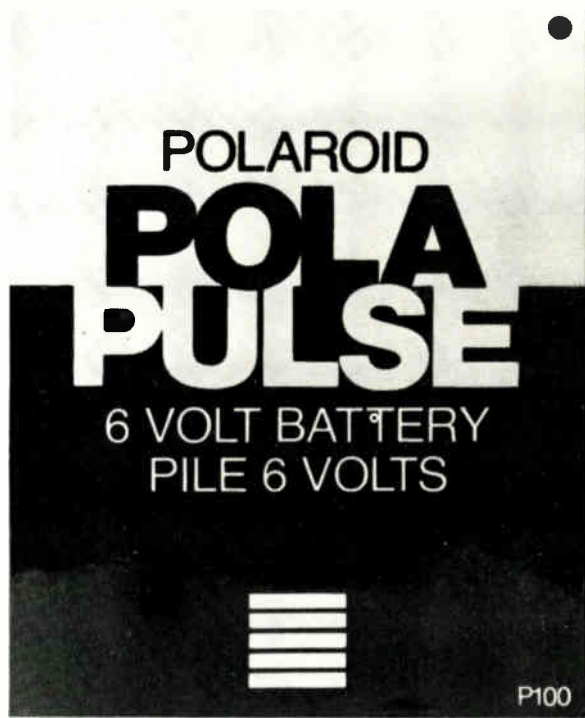

ACTUAL SIZE



The 6-volt wafer-thin battery that can change the shape of things to come.

We've developed a battery at Polaroid called the Polapulse P100. It's thinner and lighter than any conventional battery we've ever seen.

It can make products thinner, lighter and more compact than if they used conventional batteries. In some cases it can make a product easier to use. It can even help, in some instances, to increase profits.

Less cost, more profit.

For example, take the prototype for a printing calculator.



The Polapulse battery's unique card-in-slot replacement feature requires a one-piece, rather than a three-piece mold, saving 33% of a

manufacturer's plastic costs.

With less plastic the calculator is a sleek 6½ x 3¾ x 1½", weighs only 11.2 ounces, and saves 38% of packaging and shipping costs.

And since Polapulse needs fewer contacts, a manufacturer saves 70% of contact costs.

Equally notable is the particular ability of the Polapulse battery to power a printing calculator's motor with a surge of high current at the beginning of each print. It can then satisfy the high surge

demand with low internal resistance and fast voltage recovery.

Heavy duty lightweight.

Design engineers at D.E.I. Teleproducts, a West Coast manufacturer of line drivers, developed test equipment with the Polapulse P100 battery. D.E.I.'s new interface monitor and tester is less bulky and more portable because Polapulse is four times lighter than the conventional power source.



Polapulse has 6 volts of power packed into a one-ounce 3.73 x 3.04" parcel only .18" thick and offers high surge at short pulse. This provides D.E.I.'s new equipment with brighter, easier-to-see LED's.

The interface monitor and tester, only 5¾ x 4¾ x 1", has a larger face than comparable testers which permits bigger turrets spaced farther apart for easier connections.

Thin battery, wide appeal.

A new slide bolt, door-mounted burglar alarm owes its streamlined 4 x 3¼ x 1½", 8-ounce design to the Polapulse battery.

Again, the card-in-slot replacement feature makes an important contribution. The

burglar alarm can remain in place at all times. Even when changing batteries.

It is also virtually impossible to short out the battery by accidentally reversing polarity of the contacts.

The user does not experience perceived product failure. And, therefore, does not send the product back to the manufacturer for a repair that simply entails proper battery replacement.

Security is a Polapulse battery.

Every Polapulse receives 100% inspection, the sort of inspection reserved for major manufacturers' top-of-the-line power cells. Each Polapulse receives electrical and visual inspection at assembly and again after 60 days of controlled aging.

It also features a unique seal modeled on the Polapulse SX-70 film pack battery which boasts an infallible leakage record—no known leak damage in over 400 million SX-70 film packs.

Your chance to wield power.

Experiment with our Designer's Kit. It contains five Polapulse P100 batteries and a molded battery holder.

Send check or money order for \$16.75* (plus applicable taxes) to Polaroid Corp., Commercial Battery Division, Dept. A494, 784 Memorial Drive, Cambridge, Mass. 02139.

For more information about the battery that can change the shape of things to come, call us at (617) 577-4228, or write to the above address.

Polaroid

Our inventions can be your components.

Circle 51 on reader service card

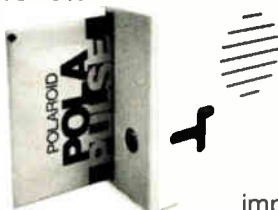

A FAST SOLUTION FROM ITT JENNINGS:

THE RJ2B. 30A, AT 2.5MHz, UP TO 10KV...AND 10 DAY DELIVERY.

Here's a reliable tool for your most demanding relay applications—a vacuum relay that offers high power capability in a small, rugged package. The RJ2B.

It will carry 30A at 2.5 MHz and withstand voltages up to 10KV. This lightweight relay (3 oz.) has a very low contact resistance, and is designed to outlast any conventional relay in applications such as antenna switching, antenna coupling, and pulse forming networks.

The RJ2B will operate at high altitudes, under pressure, at high temperature and vibration levels, and in many extreme environments. Because of the vacuum, its contacts are sealed for safe operation under volatile conditions.

Now the best part. It is available for quick delivery (10 days in most cases). Check with our applications department at 970 McLaughlin Avenue, San Jose, CA 95122, or call us at (408) 292-4025 and find out more about the RJ2B vacuum relay.



JENNINGS ITT

DIVISION OF INTERNATIONAL TELEPHONE AND TELEGRAPH CORPORATION

Circle 52 on reader service card

The magazine you're reading now could be your own.

Drop off the routing list. Get your own fresh, unclipped copy mailed to your home or office. Turn to the subscription card in the back of the magazine. If somebody has beat you to it, write: Electronics, P.O. Box 430, Hightstown, N.J. 08520.

Electronics review

support up to 64 work stations in what it calls its 810 system. The system has a minimum of 1.5 megabytes of main memory and a 57-megabyte Winchester disk drive with a 0.5-inch streaming tape drive as backup. A work-station system with a printer sells for \$117,679.

Bit slices. Basic Four uses three Advanced Micro Devices Inc. 2901 bit-slice processors. Selected for speed and low component count, they do not introduce the instruction-set limitation of an off-the-shelf microprocessor. "We could define our own instruction set and architecture," says Victor Mashikian, director of engineering, large systems, at the division, which is part of Management Assistance Inc., New York. "And if we choose, we can emulate a different set, not by changing hardware, but by using microcoding."

The processors work independently, each vying for work. They share all code in the system, including a single operating system. Flags built into the software select a processor for each task, taking 2 microseconds to pick it, if no blocking occurs.

When all three processors are busy, the operating system becomes the first piece of software picked up when one finishes its task. It then acts to apportion time as other processors complete tasks and are waiting for work.

Speed aplenty. Basic Four claims its combination of hardware and software creates throughput that is the highest of machines in the class of Digital Equipment Corp.'s VAX 750 and IBM's System 38. When all three processors are active, the model 810 can handle 15 million microinstructions per second. These microinstructions are 64-bit words written in a high-level version of Pascal used for the operating system. Expressed in machine instructions per second, the throughput ranges from 0.7 to 3.5 million instructions/s, depending on complexity.

The new computer extends Basic Four's product line at its high end and coincides with the company's introduction of a low-end \$5,995 microcomputer. **-Terry Costlow**

SCIENCE/SCOPE

Transistorized series-resonant-inverter (SRI) technology has been advanced to a resonant operating frequency of 200 kHz in another step toward minimizing inverter size and weight for spaceborne power-conditioning applications. The new Hughes SRI design uses power field effect transistors, which permit higher switching speeds. The design allows use of smaller inductors and capacitors, resulting in faster response to transient load changes and input-voltage variation. The SRI could be used as a beam power supply of an auxiliary propulsion thruster, or as a power conditioner for a high-power traveling-wave tube.

A new software system can translate naval tactical messages into understandable form. Messages within a command, control, and communications (C³) system are typically hard to understand because they are transmitted in telegram form and often omit subjects, direct objects, articles, prepositions, and punctuation. If grammatical errors creep in, messages can be rendered unintelligible. While conventional computer techniques can't make sense of a garbled message, a Hughes message understanding system called GRACIE can. Using artificial intelligence techniques, GRACIE understands general descriptions of flights of aircraft over ships, of attacks, and of encounters with hostile ships. It constructs grammatical sentences based on what it expects messages to be, referring when necessary to a "rule book" of examples. It can be adapted for other than naval use.

An advanced radio-telephone switching system for military shipboard communications eliminates the need for separate equipment for plain and secure voice channels. The Secure Voice Switch (SVS) system lets radio-telephone users select either secure or plain channels. It uses a microprocessor-controlled single audio switch. Large-scale integrated (LSI) circuits designed and manufactured by Hughes prevent crosstalk between the two kinds of channels. Hughes is producing the SVS system for the U.S. Navy for use aboard a wide range of ships, from frigates to aircraft carriers. The first production unit is being installed aboard the cruiser USS Long Beach.

A new family of compact helium-neon laser systems, with laser head and power supply contained in a single housing, has been introduced. The Hughes 3300 series lasers are available in six power ratings, from 0.4 to 6 milliwatts output power. They are suited for laboratory, research, industrial, and OEM uses -- including holography, data recording, spectroscopy, light-scattering, velocimetry, non-destructive testing, interferometry, and alignment systems.

Hughes is seeking engineers to develop advanced systems and components for many different weather and communications satellites, plus the Galileo Jupiter Probe. Immediate openings exist in applications software development, data processing, digital subsystems test, microwave/RF circuit design, power supply design, digital communications, signal processing, spacecraft antenna design, system integration test and evaluation, and TELCO interconnection. Send your resume to Tom W. Royston, Hughes Space & Communications Group, Dept. SE, Bldg. S/41, M.S. A300, P.O. Box 92191, Los Angeles, CA 90009. Equal opportunity employer.

Creating a new world with electronics

HUGHES

HUGHES AIRCRAFT COMPANY
CULVER CITY, CALIFORNIA 90230

(213) 670-1515 EXTENSION 5964

HIGH-PRECISION MILLIMETER-WAVE COMPONENTS



Count on THOMSON-CSF for top-quality mm-wave components. From 26 to 140 GHz, including a broad line of 94-GHz hardware, they feature extreme reliability and precision. **Send for our new catalog** to make your choice.

And if the standard models don't exactly fit your specs., ask about our custom-model capacities.

First-class mm-wave components from the pioneer and still world leader in mm-wave BWO's, THOMSON-CSF... a name to rely on!



THOMSON-CSF COMPONENTS CORPORATION ELECTRON TUBE DIVISION
301 ROUTE SEVENTEEN NORTH / RUTHERFORD, NEW JERSEY 07070 / TEL: (1.201) 438-23-00 / TWX: 710 989.7286.

BRAZIL
SAO-PAULO
THOMSON-CSF
COMPONENTES DO BRASIL LTDA
TEL. : (11) 542.47.22

FRANCE
BOULOGNE-BILLANCOURT
THOMSON-CSF
DIVISION TUBES ELECTRONIQUES
TEL. : (1) 604.81.75

GERMANY
MUNCHEN
THOMSON-CSF BAUELEMENTE
TEL. : (89) 75.10.84

UNITED KINGDOM
BASINGSTOKE
THOMSON-CSF
COMPONENTS
AND MATERIALS LTD
TEL. : (256) 29.155

ITALY
ROMA
THOMSON-CSF COMPONENTI
TEL. : (6) 638.14.58

SPAIN
MADRID
THOMSON-CSF
COMPONENTES Y TUBOS S.A
TEL. : (1) 419.88.42

SWEDEN
STOCKHOLM
THOMSON-CSF
KOMPONENTER &
ELEKTRONROR AB
TEL. : (8) 22.58.15

JAPAN
TOKYO
THOMSON-CSF
JAPAN K.K.
TEL. : (3) 264.63.46

Circle 56 on reader service card

VHSIC funding raised to nearly \$80 million

A \$14 million boost in fiscal 1983 funds for the Defense Department's Very High-Speed Integrated-Circuits program will raise its budget to nearly \$80 million, says outgoing program manager Larry W. Sumney (see p. 40). The increase approved by the House Armed Services Committee is **expected to go unchallenged in either chamber**, even though it runs counter to the trend of sharp reductions in other military research and development areas. The VHSIC budget for fiscal 1982 stands at \$65.7 million and at \$61.5 million in the projected budget for fiscal 1984.

Navy acts to cut EMI on ships

The Navy is beginning to make design reviews of all shipboard radiators of electromagnetic energy **to reduce ship detection levels and eliminate interference between on-board systems**. A spokesman says the program, called Topside Design Review, will extend "what we have done for years with high-frequency systems to include all electromagnetic frequencies."

Ku-band satellite would bypass local phone net

Newly-formed Advanced Business Communications Inc. wants to orbit two Ku-band domestic satellites by 1986 to provide a new service with blanket geographic coverage. The Federal Communications Commission filing by the McLean, Va., company says its \$260 million system will have 20 transmitters on each satellite. **Each transmitter would illuminate zones ranging from a quarter to half of the U. S. mainland**, depending on user demand, for improved cost efficiency. Customers, it claims, can select antenna sizes whose ultimate savings in local-loop usage would offset the transponder leasing costs. Frequency assignments sought are 14 to 14.5 GHz for the uplink and 11.7 to 12.2 GHz for the downlink.

Airline-industry satellite proposed to cut phone costs

The U. S. airline industry's telecommunications supplier, Aeronautical Radio Inc., is surveying its customers to see if they will support the company's plan for an industry-owned and -operated satellite network. George F. Mansur, president of the Annapolis, Md., company, believes it **has become essential for the airlines to defend themselves from ever-increasing communications costs** resulting from dependency on the Bell System's local distribution net. The Arinc proposal stems from the jolt airlines got last year when the phone company's low-cost Telpak bulk rates were declared illegal and the industry's total telephone bill jumped by \$150 million. Arinc says the charges for private-line services alone run \$12 million to \$14 million a month. One senior airline official welcomes the plan, but says it may be deferred until the industry recovers from its severe economic slump brought on by the fare wars that followed last year's deregulation.

DOD to merge its data networks

Defense Data Network is Deputy Secretary of Defense Frank Carlucci's name for the new military system that will replace Autodin II. The DDN is expected to embrace not only the troubled automated digital communications network **but also the more successful Arpanet and the newer Replica communications systems as well**. A decision on the package is not expected before August, although Carlucci notified Western Union Telegraph Co. on April 2 that its Autodin contract was canceled.

Science and insecurity come together

The conflict between scientific freedom and national security is bubbling on the front burner of Federal policy makers. In fact, it is close to boiling over, as scientists challenge the premise of the Reagan administration that tough new controls on free discussion and exchange of research and development data are required to prevent the Soviet Union from acquiring more U. S. secrets.

The fire under this new brew of proposals was lit in January by Adm. Bobby Ray Inman, deputy director of the Central Intelligence Agency. The match was his comment to a meeting of technology leaders that they and their colleagues should voluntarily submit technical papers, reports, and data on sensitive subjects to the Government for prepublication review and possible classification. If they refused, he warned, mandatory controls might result to prevent the "hemorrhage of this country's technology" to the USSR.

The fire was stoked recently with President Reagan's executive order that tightens security classification rules to a point, says one Government source, where "the bureaucracy can now classify almost anything it can manage to lay hands on." The unpopular move, say its critics in and out of the Administration, reflects the insecurity of Government and much of America's high-technology industries as the economy slides downward while the challenge to U.S. technological leadership escalates.

Getting educators uptight

Academia is convinced that it, not industry, will suffer most from Inman's proposal and Reagan's ruling, even though the CIA deputy director later conceded to a House Science and Technology subcommittee that open scientific exchange accounts for only a few of the total of American technological secrets lost to Russia and others. About 70% is the direct product of Soviet espionage, Inman says, and most of the remainder is transferred—often unwittingly—by U. S. companies, including multinationals, anxious to do business abroad. Assistant Secretary of Commerce Lawrence Brady believes that the role of multinationals is on its way to becoming a major public policy issue.

Meanwhile, the Department of Defense is busy developing a new list of "military-critical technologies," using some inputs from the departments of Commerce and State. Fiber optics is reportedly near the top of that list, and it and the others on the list would be precluded from foreign licensing and export in most cases;

public-meeting papers on them would be subject to prior review and censorship.

Rep. Albert Gore Jr. (D., Tenn.) opposes the Inman position. As chairman of the Science and Technology subcommittee on investigations and oversight, as well as a member of the permanent Select Committee on Intelligence, Gore argues that the U. S. must "not take even the first step down that road [toward a closed society] that makes Soviet research so pitiful."

One university leader says privately that the security issue threatens to widen, rather than help to bridge, the gap between high-technology industries and the academic community. Both sectors "have to work better together—indeed we have been told to do so in order to offset Government cutbacks in support for education and R&D," he points out. "But when companies keep their heads down on an issue as basic as this, educators resent it."

Private sector responds

Industries like electronics, however, are not unified on ways to address the security-control issue. Weapons makers, of course, favor tight restrictions, as long as they do not threaten foreign sales. Industrial and commercial electronics manufacturers say that existing statutes are sufficient to control illegal technology transfer if they are well enforced. Anyone familiar with the Export Administration Regulations and the International Traffic in Arms Regulations, to name but two, would have to agree that the laws now in place are adequate.

Nevertheless, a new panel of 18 leaders in U. S. science and technology is being formed by the National Academy of Sciences to take a year-long look at the relationship between academic research and national security [*Electronics*, April 7, p. 57]. It plans to identify two or three key technologies and use them as examples of the transfer of information and knowledge. At the same time, the Institute of Electrical and Electronics Engineers has formed a committee to do a parallel study of the issue.

It is to be hoped that all parties will conclude that the U. S. does not need one more big and expensive bureaucracy, composed of engineers and scientists, to review R&D before it can be publicly discussed, thereby delaying technological advance. American technologists may have to become more cognizant of the need to stem the draining of their most advanced work by overseas competitors. But the Reagan administration does not need to abrogate the Constitution to achieve that.

-Ray Connolly

FOR SWITCHED-MODE POWER SUPPLIES

TYPE 735P WHITE JACKET® CAPACITORS



- Ripple current capability: to 30 amps rms
- Operating frequencies: up to 100 kHz
- ESR: typically as low as 2 mΩ @ 100 kHz
- Capacitance values: 1 μF thru 30 μF
- Voltage ratings: 400, 200, 100 WVDC

Write for Engineering Bulletin 2752 to
Technical Literature Service, Sprague Electric Co.
35 Marshall Street
North Adams, Mass. 01247.

45D-1146



THE BROAD-LINE PRODUCER
OF ELECTRONIC PARTS

a subsidiary of QK Technologies

Circle 95 on reader service card

MORE Ω/in²

TYPE 420C SIP RESISTOR NETWORKS



- SIP thick-film resistor networks utilize only .006 to .011 sq. in. board space per resistor —at prices less than 2.5¢ per resistor in volume.
- Precision molded for dimensional uniformity required by automatic insertion equipment.
- 6, 8, 10-pin units with .200" low-profile. Resistance, 10 Ω to 1M Ω; tolerance, ±2% or ±1%.

Write for Engineering Bulletin 7041C to:
Technical Literature Service, Sprague Electric Co.
35 Marshall Street
North Adams, Mass. 01247.

45R-1131



THE BROAD-LINE PRODUCER
OF ELECTRONIC PARTS

a subsidiary of QK Technologies

Circle 96 on reader service card

FUSED MULTI-VOLTAGE CONNECTORS

SERIES 200JM6 DEVICES



- For international equipment manufacturers; accept standard IEC Type V 3-pin plug; operate with choice of 4 line voltages.
- Permit manufacturers to use a single standard connector for equipment operating at 100 to 120 VAC, or 220 to 240 VAC.

Write for Engineering Bulletin 8801 to
Technical Literature Service, Sprague Electric Co.
35 Marshall Street
North Adams, Mass. 01247

45F-1150



THE BROAD-LINE PRODUCER
OF ELECTRONIC PARTS

a subsidiary of QK Technologies

Circle 58 on reader service card

WHEN EQUIPMENT MUST MEET FCC RULES

SERIES JX5900 FILTERS

... U.L. Recognized



- General-purpose EMI/RFI line filters for equipment to comply with FCC and international standards.
- Meet 10 kHz to 30 MHz attenuation requirements.
- For operation at 125 or 250 volts, 50-60 Hz.

Write for Engineering Bulletin 8216 to
Technical Literature Service, Sprague Electric Co.
35 Marshall Street
North Adams, Mass. 01247.

45F-1155



THE BROAD-LINE PRODUCER
OF ELECTRONIC PARTS

a subsidiary of QK Technologies

Circle 59 on reader service card 59

We sell more magazines worldwide than our competitors give away free.

International Circulation (in thousands)

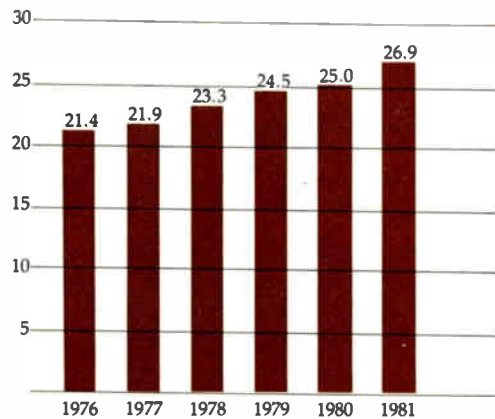

International Advertising Pages

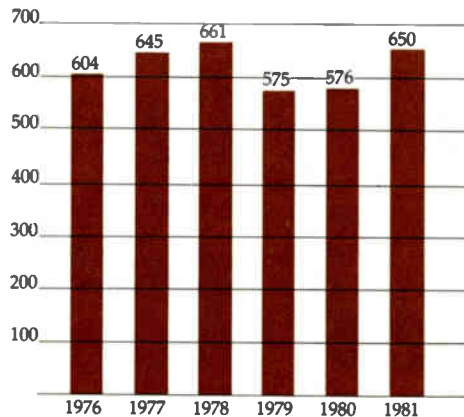

1. Largest international circulation:

Electronics magazine sells more subscriptions around the world than its competitors give away free . . . 26,923 in 127 countries.

2. Largest reader response:

Electronics magazine generates more advertising inquiries from more countries throughout the world than any other electronics publication.

3. Greatest advertiser acceptance:

Electronics magazine carries more than twice the number of international advertising pages as its nearest U.S. competitor.

4. Most international editorial published:

Electronics magazine publishes twice the amount of original editorial from outside the U.S. as any other electronics publication.

5. Incomparable international reporting:

Electronics magazine is the only U.S. electronics publication with full-time resident editors in Paris, London, Frankfurt, and Tokyo (2). Electronics also has the services of full-time resident World News editors in Bonn, Sao Paulo, Brussels, Milan, Singapore, Stockholm and Moscow.

6. Highest rated magazine:

Electronics magazine is rated best over its competitors in editorial importance and quality.

- Reports most timely international business and technical developments
- Most authoritative
- Reports most timely business and technical news
- Best state-of-the-art coverage
- Best at assessing the most important developments
- The only publication read most thoroughly
- "Must" reading upon receipt
- Preferred by advertisers for promoting company's capabilities
- Preferred by innovators as the place to publish their articles

Largest worldwide audience: 331,072.

Electronics magazine has the largest readership by important people in the worldwide electronics technology marketplace.

Electronics

Where important people read important editorial 

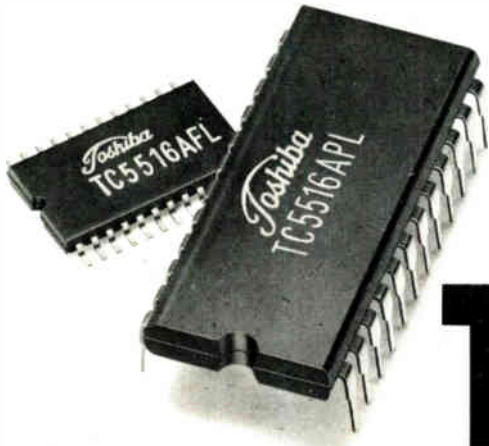

TOSHIBA'S 16K CMOS RAM uses only 5 nanoamps.

Toshiba's new 2K x 8 CMOS static RAM needs only 5 nanoamps (Typ) for data retention.

This means battery requirements are minimal. Which means space, weight, and cost requirements are also minimal.

Phone or write today, and we'll send you complete technical information on our new 16K CMOS RAM.

Toshiba also supplies the reliable 1K CMOS RAM, single chip microcomputers, and CMOS logic circuits.

In fact, we're the world's largest supplier of 4K CMOS RAMs.

Toshiba is a world leader in CMOS technology. We're constantly introducing new products that represent a significant advance in the state of the art.

Our new ultra low power 16K CMOS RAM is a good example.

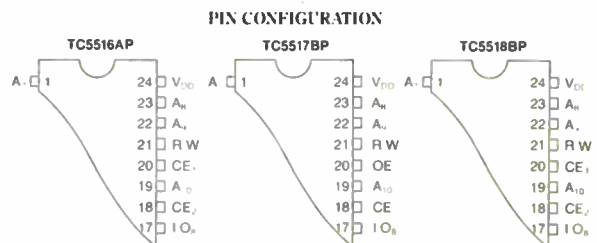

TOSHIBA AMERICA, INC.
Nobody makes CMOS better

Western Sales Office: Newport Beach, CA (714) 752-0373, Eastern Sales Office: Boston, MA (617) 742-2040, Central Sales Office: Minneapolis, MN (612) 831-2566



1982 NATIONAL PLASTICS EXPOSITION & CONFERENCE
JUNE 21-25, 1982, McCORMICK PLACE, CHICAGO
MATERIALS ■ MACHINERY ■ INSTRUMENTATION ■ TECHNOLOGY

mpe



the plastics show

If You Can Only Attend One Plastics Show, This Is It. 'The' Showcase of the U.S. Plastics Industry. Sponsored by The Society of the Plastics Industry, Inc.

NPE '82. The latest developments in plastics—new materials, energy-efficient machinery, cost-saving concepts. It happens only once every three years. And this year's Show will be 30% bigger than any previous NPE.

Whether you're a custom or captive molder, car maker or package designer—or whatever else your interest in plastics, you'll find a bonanza of value-

engineered products and ideas at the 1982 National Plastics Exposition and Conference, June 21-25, 1982 at Chicago's McCormick Place. Over 600 major companies in the plastics industry showing their best and latest offerings to some 50,000 attendees.

12 Conference Seminars



Leading plastics authorities will deliver up-to-the-minute reports themed on "The New Economics of Plastics"—technology updates, market forecasts, new product trends. In-depth discussions of CAD-CAM, revolutionary manufacturing innovation.

Save Time and Money Register in Advance

A modest \$10 advance registration fee buys...

- Unlimited 5-day access to all exhibits
 - 12 Conference Seminars
 - Free bus service between Show & hotels
- ...avoids the crush of registering when you arrive and saves 33⅓%.

1-800/433-1790

Call our toll-free 800 number at American Airlines for the most economical air travel accommodations available. On any carrier. If you order your ticket through this number and charge it to a major credit card, a special "fare check" system may net you a retroactive credit should a rate reduction on any airline take place on your route.



So there's no reason to wait. Write today for your pre-registration materials to: NPE '82; The Society of the Plastics Industry, Inc.; 355 Lexington Avenue, New York, New York 10017. Then call toll-free 800/433-1790 (in Texas 800/792-1160). For fast service ask for the NPE Special Reservation File No. S-5869.

 Sponsored by:
The Society of the
Plastics Industry, Inc.

Laser lays claim to 43% efficiency

Nippon Electric Co. says that a buried heterostructure laser now being used in its optical communications equipment has an efficiency of 43% at a 1.3- μm wavelength. **The Tokyo company's double-channel planar structure for the new laser is designed to efficiently block current from flowing through the regions on either side of the active layer**, leading to high measured efficiency. Currently available lasers have efficiencies of 20% or less because the high leakage current flowing through the blocking layer does not contribute to laser output.

U-groove isolation doubles device density

An isolation region shaped like a U can at least double the device density of bipolar large-scale integrated circuits, claims its developer, Japan's Hitachi Ltd. The new scheme decreases the minimum width of the isolation region from about 7 μm in the company's Isoplanar isolation process to about 3 μm . **Further, process-induced field-oxide imperfections known as birds' beaks are eliminated**, the company says. Also, isolation capacitance is cut by a factor of seven, increasing the speed of experimental circuits by up to 30%. Hitachi says that initially it will use the new process to increase densities in bipolar memories and that a process of this type will be necessary for 1-Mb MOS random-access memories.

Tape recorder calibrates itself

For its reentry into the wideband instrumentation recorder market, Racal Recorders Ltd., Hythe Southampton, Hants., UK, is introducing a 42-track high-performance instrumentation tape recorder that sets itself up. Calibration and equalization tasks are assigned to a microprocessor, thus reducing an operation that can take several hours to about 3 min. **The microprocessor also drives a small, built-in cathode-ray-tube display through which machine characteristics and recorder performance can be monitored.** Called Storehorse, the new 2-MHz wideband recorder can be used as a 14-, 28-, or 42-track recorder at tape speeds variable from 15/32 to 120 in./s with 15-in. coaxial spools and either 1- or 1/2-in. tape. It operates in intermediate band up to 600 kHz and wide band up to 2 MHz.

Flat-panel display for viewdata uses dc electroluminescence

A prototype 40-character-by-24-line flat-panel alphanumeric display that can display a viewdata page with a four-level grey scale will be offered to manufacturers before year's end by Phosphor Products Ltd., the Poole, Dorset, England, manufacturer of dc electroluminescent panels. Like ac electroluminescence, the technology produces an attractive, bright yellow-on-black legend, but at a potentially lower production cost. The dc version does not require capacitive coupling and, as a result, is cheaper and easier to fabricate. A viewdata display may cost around \$550 complete with driver electronics, but would require a major volume commitment. **Impetus for this latest development is the availability of integrated-circuit drivers with the necessary 70-v, 100-mA output**, which were custom-designed with Royal Signals and Radar Establishment funds by Swindon Silicon Systems Ltd. and processed by Plessey Semiconductors Ltd. More immediately, Phosphor Products is readying a dc 8-line-by-20-character display, also employing the new drivers.

NEC builds fastest Josephson logic gate

Nippon Electric Co. of Tokyo has unveiled an experimental resistor-coupled Josephson-junction logic gate that it bills as the world's fastest. Instead of causing a gate to switch by reducing the critical current with an applied magnetic field, as in conventional Josephson technology, NEC injects a control current directly into the gate, exceeding the critical current and causing the junctions to switch out of the superconducting state. **Eliminating the extra circuits that created the magnetic field reduces the surface area to an eighth that of previous Josephson devices** and cuts power consumption to $11.7 \mu\text{W}$. The switching speed of 10.8 ps at a 4.2 K temperature surpasses the previous reported best of 13 ps for such devices.

Solar module triples output

Increasing the output of commercially available solar-cell modules more than threefold, Munich-based Siemens AG will soon market a module putting out 120 w of power under full sunlight exposure. The new module, type SM 144, consists of 144 monocrystalline silicon disks, each 10 cm in diameter. **Large-diameter cells on a large module results in the increase over present maximum output of commercially available solar modules**, which is 35 w, Siemens says. Versions with nominal voltage ratings of 8, 16, 32, and 64 v will be available. The modules can withstand wind forces of more than 200 km/h and the impact of 25-mm-diameter hailstones hitting the module's surface at 80 km/h.

Betamax production beginning in Europe

Japan's Sony Corp. will soon begin manufacturing its Betamax video recorders in Europe. **Production starts at 5,000 units a month, but will be geared up depending on demand.** The first units are slated to come off its Stuttgart, West Germany, production lines in May. Also to begin this year is the construction by Sony of a video-cassette factory in Dax Pontonx, France. The Japanese company's total sales in West Germany last year came to about \$290 million; the target for this year is a hefty \$415 million.

AMD and Thomson set second-sourcing

A reciprocal sourcing agreement is in the offing between Advanced Micro Devices Inc. of Sunnyvale, Calif., and Thomson-Efcis of Paris, covering the AMD 29XX and 29XXX digital bipolar processor families and associated high-performance bipolar memories and Thomson data conversion and telecommunications circuits and microprocessor peripherals. **The first circuits to be transferred under the accord are AMD's 2901C bit-slice processor and 29516 16-by-16-bit multiplier for digital signal processors and Thomson-Efcis's 9340 video processor and companion 9341 character generator** for telematics applications. The agreement for both parties to manufacture pin-for-pin, fully compatible devices will run for five years with an option for two more.

Finland firm makes own ICs

Vaisala Oy has become the first Finnish company to begin manufacturing integrated circuits entirely with indigenous know-how and no foreign licenses. **The company's own complementary-MOS process and computer-aided circuit design will be used** for key components in its line of weather-observation instruments and humidity meters.

IS LEGAL TENDER
PUBLIC AND PRIVATE

WD27



02

WASH



SERIES
279X

A

Via
Gen
Pro

WASHINGTON
ONE DOLLAR

No other
floppy disk
controller gives
you so little
for your
money.

Making the leading edge work for you.

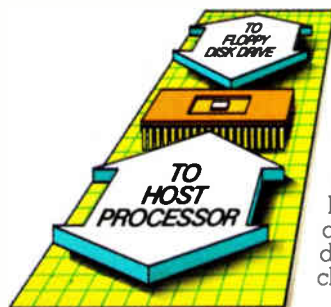

At Western Digital, getting less for your money makes good sense. Any way you look at it.

Because our new WD 279X is the first floppy disk controller that gives you everything on just one chip.

And we do mean everything.

Fact is, our incomparable new WD 279X packs all standard control functions for both 5¼" and 8" drives on a single, solitary +5V chip.

And all data separation and write precompensation functions are included on chip.

It's simply amazing. And so are the savings. The WD 279X will cut your design time, simplify system integration, conserve PCB real estate, cut component count and save hours of board assembly and testing.

What's more, the WD 279X comes in four different versions to accommodate both true and inverted data bus applications, as well as single and double-sided designs. And it's fully compatible with our industry standard WD 179X floppy disk controller family and Winchester disk controllers.

You can't buy a more cost-effective floppy controller.

But prove it to yourself. Just drop us a note on your letterhead and we'll make sure you get an evaluation unit. Absolutely free.

No other disk controller can offer you more for less.

WESTERN DIGITAL
C O R P O R A T I O N

So advanced

Tek 2213. \$1100



Performance

BANDWIDTH
Two channels, dc — 60 MHz to 20 mV/div, 50 MHz to 2 mV/div.

LIGHT WEIGHT
6.1 kg (13½ lbs.), 6.8 kg (15.0 lbs.) with cover, and pouch.

SWEEP SPEEDS
Sweeps from 0.5 s to 0.05 μ s (to 5 ns/div with X10 magnification).

SENSITIVITY
Scale factors from 100 V/div (10X probe) to 2 mV/div (1X probe). Accurate to $\pm 3\%$. Ac or dc coupling.

MEASUREMENT CONVENIENCE
Automatic intensity, automatic focus, beam finder for off-screen signals, full 8x10-cm CRT.

Tektronix tradition for excellence in designing and manufacturing oscilloscopes is recognized around the world. But, rather than rest on past laurels, we've veered dramatically from the traditional design path we ourselves established.

With the 2213 and the 2215, an entirely new form of scope is on the scene. Most remarkable about these new scopes is that their major design advances deliver full range capabilities at prices significantly below what you would expect to pay.

How has this been accomplished?

First, the number of mechanical parts in these new scopes has been reduced by 65%. Saving parts cost and ultimately improving reliability.

Makes sense. The fewer the parts, the less likely something will go wrong. And the less often something goes wrong, the more hours spent being productive.

Next, board construction was designed with the ultimate sophistication: simplicity. High performance is

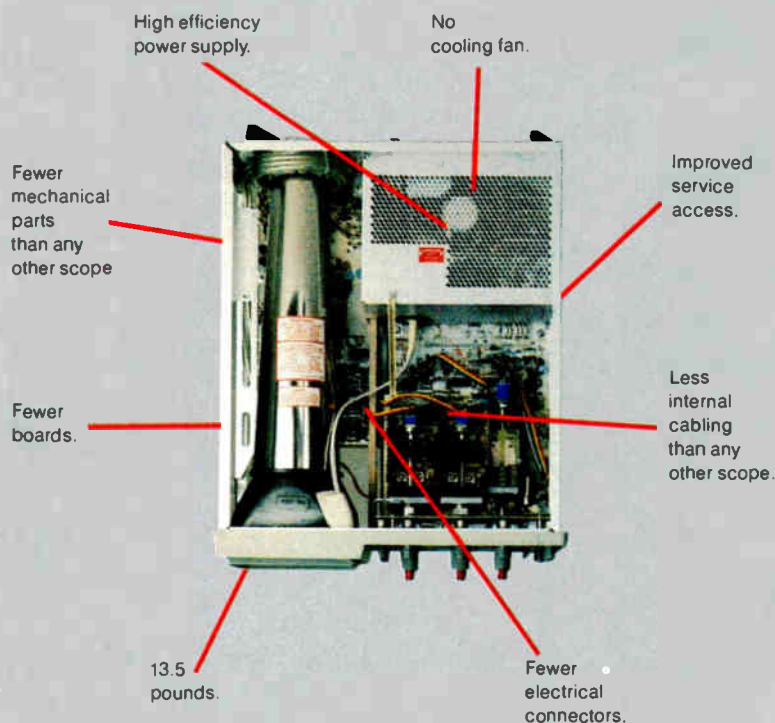

* FOB Beaverton, OR.
U.S. Prices.

they cost you less.

Specifications

DELAYED SWEEP MEASUREMENTS

2213: standard sweep, intensified after delay, and delayed; delay times from 0.5 μ s to 4 ms. 2215: increased delayed measurement accuracy to $\pm 1.5\%$; A only, B only, or A and B alternately with A intensified by B; B sweeps run after delay or separate trigger.

COMPLETE TRIGGER SYSTEM

Modes include TV field, normal, vertical mode, and automatic; internal, external, and line sources; variable holdoff; separate B sweep trigger on 2215.

NEW P6120 PROBES

High performance, positive attachment, 60 MHz and 10-14 pF at probe tip; light weight, flexible cables; new Grabber tips for ICs and other small diameter components.



Tek 2215. \$1400

achieved with fewer boards. (The 2213 has only one). Board electrical connectors are reduced in number — virtually eliminated in the 2213 — and cabling cut an amazing 90%.

Fewer components and fewer boards mean fewer steps in assembly, less testing, less likelihood of testing errors.

These are the direct efficiencies that keep prices low and reliability high.

The 2213 and 2215 also feature a high efficiency power supply and power-saving circuitry.

These innovations eliminate the need for a cooling fan and help make the scopes smaller, lighter and cleaner.

In addition, the power supply works all over the world (90-250 Vac, 48-62 Hz) without needing a line switch or a bulky line transformer. This special power supply also regulates fluctuations in line voltage, to assure calibrated measurements.

These are just some of the innovations built into the 2213 and 2215 to

reduce costs and improve performance.

Performance that's written all over the front panels.

The bandwidth for digital and high-speed analog circuits. The sensitivity for low signal measurements. The sweep speeds for fast logic families. And delayed sweep for fast, accurate timing measurements.

The advanced trigger system features a vertical mode for true alternate triggering on both channels. It even has a convenient signal-seeking auto mode. And it also triggers on either TV lines or fields at any sweep speed for video service.

These scopes have it all. They're lightweight for field work. They've got a bright, easy to view display. Automatic CRT focus and intensity. Beam finder. And the operating simplicity to fit a wide range of operator skills.

These are the advances in performance, cost savings and convenience that break tradition. But other traditions remain. Like fast, reliable ser-

vice support. Nearly 1300 people around the world to service Tektronix products exclusively. Plus the customer documentation, training programs and applications assistance that help to make Tek service the most comprehensive in the industry. And make your 2200 scope an even greater value.

For full information on the 2213 and 2215, contact the Tek office nearest you. Or have your technical questions answered or place your order via our new telephone sales service. Call 800-547-1845. From Alaska, Hawaii or Oregon, call collect 503-627-5402.

You just can't buy a more advanced scope, for anything less.

For further information, contact:

U.S.A.
Tektronix, Inc.
Delivery Station 19-100
P.O. Box 500
Beaverton, OR 97077
Phone 800/547-1845
From Alaska, Hawaii
or Oregon call collect
503/627-5402
Telex. 910-467-8708
Cable. TEKTRONIX

Canada
Tektronix Canada Inc
P.O. Box 6500
Barrie, Ontario L4M 4V3
Phone 705/737-2700

**Asia, Australia,
Latin America, Japan**
Tektronix, Inc
Americas Pacific Marketing
P.O. Box 500
Beaverton, OR 97077
Telex 910-467-8708

**Europe, Africa,
Middle East**
Tektronix International, Inc
European Marketing Centre
Postbox 827
1180 AV Amstelveen
The Netherlands
Telex 18312

Tektronix
COMMITTED TO EXCELLENCE

Increase productivity piece by piece or all at once.

Westinghouse introduces robotic solutions for automated electronic assembly.

One robot may be all you need to increase productivity in your electronic assembly operations. On the other hand, several robots may not be enough. It may take a complete automation package that combines robots and automated systems and controls—like CNC, DNC, Parts Programming, and Time Sharing.

Whatever it takes, you can count on advanced Westinghouse technology to help meet your needs.

Circle 72 on reader service card

Our Series 5000 robot, for example, is a programmable assembly robot capable of controlling multiple arms through 9 axes with remarkable $\pm 0.004''$

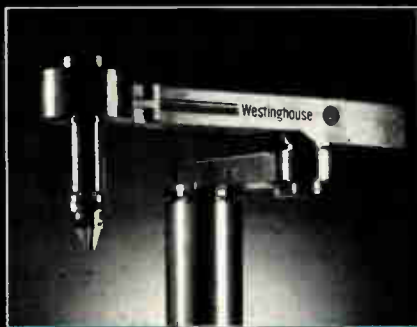

repeatability. In addition, its optional tactile and vision sensory systems permit close control of the entire assembly process.

And we will soon be introducing a unique family of high-speed, high-accuracy robots for light-load applications of 10 lb or less. They will have amazing $\pm 0.002''$ repeatability and will be able to operate under hazardous conditions when necessary.

We'd like to tell you more about our automation capabilities for electronic assembly procedures. Write to Westinghouse Electric Corporation, Industry Automation Division, 400 Media Drive, Pittsburgh, PA 15205.



We make
improved productivity
a reality—today.

 **Westinghouse**

East German E-beam system resolves to 0.5 μm

by John Gosch, Frankfurt bureau manager

Data-transfer rate topping
800 kilobytes a second
pushes throughput up to
eight 3-in. wafers an hour

When it comes to microlithographics, East Germany is truly world class. The latest example of its expertise in the field is an electron-beam exposure system that generates integrated-circuit patterns with 0.5-micrometer features under production-line conditions.

It is produced by VEB Carl Zeiss, the big Jena-based optics producer. Intended for mask fabrication and direct pattern generation on very large-scale ICs, the ZBA20 provides an up-to-tenfold improvement in productivity over its forerunner, the ZBA10/1, which is sold throughout the Eastern Bloc and in Japan.

Capabilities. The second-generation ZBA20 handles, for example, up to eight 3-inch wafers per hour, with the wafers having circuits of a complexity typical for 256-K random-access memories and with the data transfer from the equipment's control processor better than 800 kilobytes per second—all referenced to line widths of less than 1 μm . "With that performance, we are, as far as we know, among the world's front-runners," says Knut Kaschlik, head of the Photo- and Electron-lithographic department of the Jena enterprise.

Introduced at the spring fair in Leipzig, East Germany, last month and to go into production this year, the ZBA20 uses the same basic concepts that have proven themselves in

the ZBA10/1. These are vector-scan beam-deflection principles—in which only those areas on the wafer that need exposing are scanned—and a programmable-dimension rectangular beam. The latter's cross section can be varied between 0.1 and 12 μm on a side. This variable-beam concept is said to have been pioneered in Jena.

Also taken over from the ZBA10/1 are the stop-and-go wafer-and mask-displacement scheme based on laser-interferometric position measurements, as well as the coordinate transformation principles to obtain fine electron-beam alignment relative to the wafer or mask. "These concepts are prerequisites to achieving the up-to-tenfold produc-

tivity improvement with the new system," says Kaschlik.

To achieve the high data rate necessary for the high throughput, the ZBA20 uses more powerful hardware than did its predecessor, as exemplified by the system's data-processing gear. The kingpin item is the Soviet-built 16-bit processor Elektronika 100/25, a machine that is comparable to Digital Equipment Corp.'s PDP 11-34.

"Another development goal was to make the system capable of handling larger-diameter wafers to satisfy industry requirements," Kaschlik says. So, the ZBA20 accommodates not only 3- and 4-inch wafers, as does its predecessor, but also 5- and 6-in. wafers. Also, masks may be as

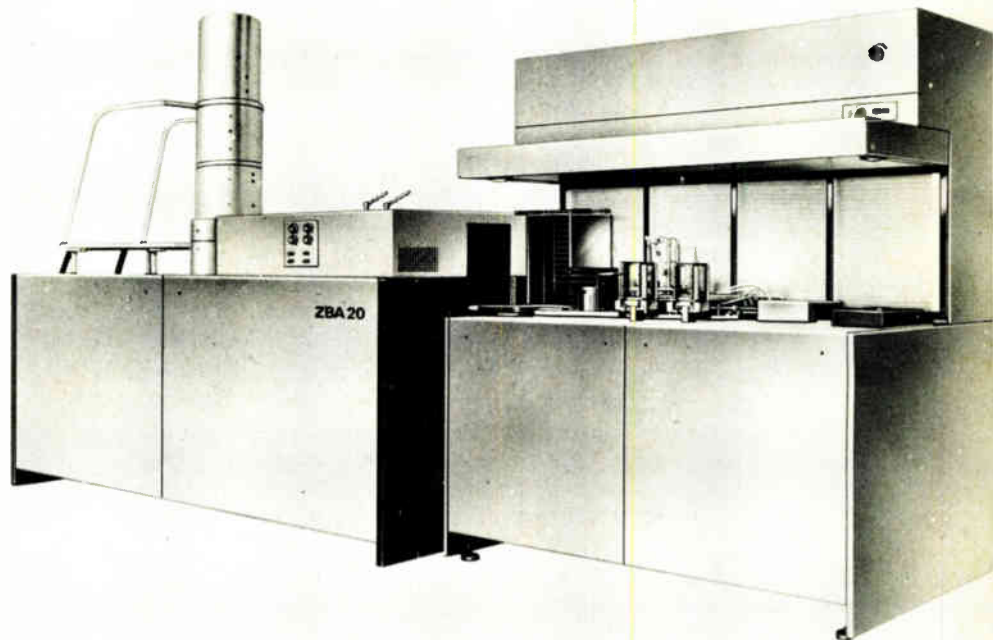

World class. The ZBA20 electron-beam exposure unit is designed for mask fabrication and direct pattern generation of VLSI circuits. It can handle wafers as large as 6 in.

large as 7 in. on each side. The system sports a maximum resolution of $0.2 \mu\text{m}$ and a registration accuracy of better than $\pm 0.15 \mu\text{m}$.

Of particular note is the ZBA20's ability to write lines inclined at a 45° angle on the wafer surface, which are increasingly being used in VLSI circuits. Significantly, the unit can write them at the same speed as it does those that are parallel to the chip's horizontal or vertical axes. This feat is accomplished by a neat patented trick: what is called a turn lens is used to electromagnetically rotate the longitudinal axis of the electron beam by 45° .

The object table, with a 162-mm displacement range in both the X and Y directions and working in a start-stop mode has a drive system that considerably reduces the wafer or mask displacement time between two line-structuring operations. The maximum displacement speed is 25 millimeters a second, and the resolution of the interferometric position measuring system is up to $0.02 \mu\text{m}$.

Italy

Personal computer uses 16-bit Z8001

What looked like simply a personal-computer launch when Ing. C. Olivetti & Co. SpA introduced its M20 was actually the beginning of a modernization of the Ivrea, Italy, company's entire middle range of computer systems. As is the M20, they will be based on the 16-bit Z8001 microprocessor from Zilog.

Thus it will be possible to use the M20 as an intelligent terminal with any of these forthcoming systems. As a personal computer, the M20 [*Electronics*, April 7, p. 64] is decidedly up-market, intended principally for small-business and professional applications.

"We are definitely somewhat away from the home computer market," says Steve Price-Francis, sales support manager for the M20. "But we plan to take 10% of the European personal computer market in 1983.

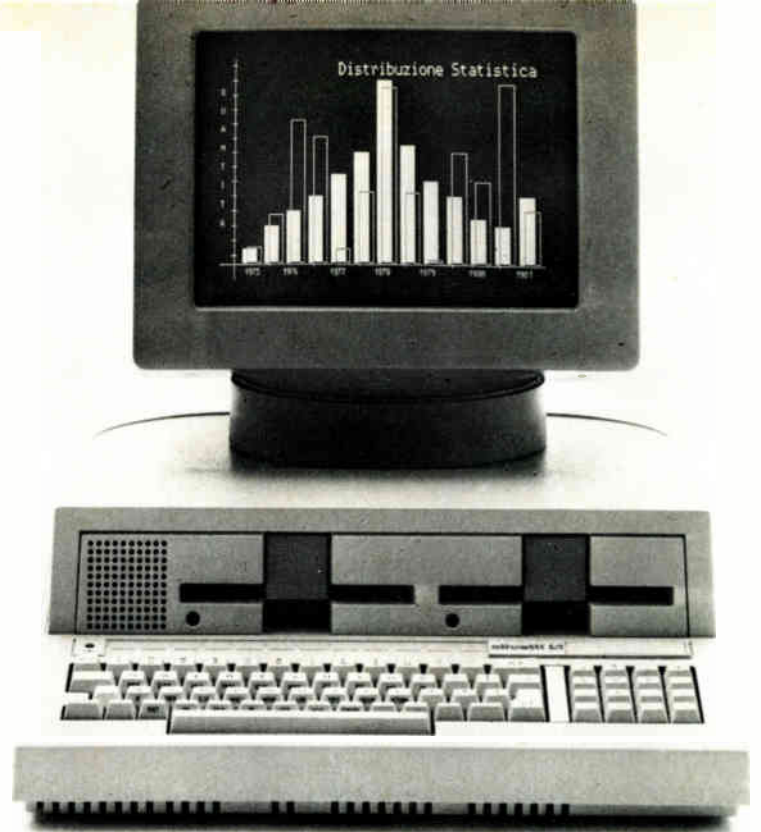

Forerunner. Olivetti's new M20 personal computer, meant for business and professional applications, is the first of a new line of systems to be based on the 16-bit Z8001.

And, since we are a late starter, our stance is very aggressive with regard to pricing."

The price for the basic M20 is \$3,000. A configuration including two minifloppy-disk units, monochrome display, 128-k bytes of random-access memory and a printer goes for about \$1,500 more. For the price, the M20 offers an impressive range of technical features, like a 16-bit bus for the Z8001, as opposed to the 8-bit bus that the IBM Personal Computer uses with its 16-bit microprocessor.

Window display. Other features include RAM expandability up to 224-k bytes, unformatted floppy-disk capacity of 320-k bytes or formatted capacity of 286-k bytes, and a display with bit-map technology that permits "windowing"—the division of the 511-by-256-point screen into as many as 16 independent displays. To achieve this, 16-k bytes of RAM are dedicated to the display. In the offing is an interface for a Winchester-type hard disk unit.

The company seems proudest of the user-friendly nature of the M20. "As there was no existing CP/M [operating system] for the Z8000, we particularly had an opportunity to study the user interface when we

designed the M20," explains Leonardo Mauri, product manager for the computer.

"As a result, the dialogue between the system and user is so easy that an 11-year-old was able to teach himself to write simple programs within two weeks." The company calls its offering PCOS for professional computer operating system.

Sales plans. Olivetti plans to sell the system through its network of direct outlets and indirect distributors who now handle the company's line of office machines and information-processing products. In addition, it may use computer-store chains, systems manufacturers, software houses, and computer consultants. As well as being sold on the European market, the M20 will be introduced in the U. S. in May and will also be marketed in Japan at about the same time.

Software support for the M20 will include a group of broad-based programs for the world market. Already available are programs like Multiplan, a VisiCalc-like offering; Olivetti's own word-processing program; and a computer-aided instruction system for user programming. Other applications programs, written to the standards and rules of the relevant

Here's Help from Fluke for System Builders with Deadlines.

The switching circuitry is a critical component of any Factory Test system. Until now, many people felt they had to design and manufacture the switch in order to meet their own critical specifications.

A new switch controller that's available now.

The new 2205A Switch Controller is designed to perform most of the switching functions in your automated test systems. Five different modules compatible with the 2205A mainframe are available for

Scanning, Latching, Actuating, and Matrix Switching functions. So you can configure the switching circuitry that's right for your application, with the convenience of an off-the-shelf component. This allows you to focus more time on the software, less time on the hardware. **The performance you've come to expect from Fluke.**

To insure the accuracy of your system, Fluke has incorporated the same analog measurement technology that makes our System DMM's the standard in the precision

measurement field. The 2205A is designed with guarded chassis and signal buses, to minimize unwanted noise and cross-talk. It also features circuit protection against input overloads and uses reed relays to achieve better accuracy and stability. In fact, the 2205A is designed to match the capabilities of our most precise DMM, the 8502A. The 2205A is also designed to meet current industry safety specifications. The result—greater confidence in each and every test.



The 2205A also features 100 channels scanning capability in one mainframe, with 1000 in extension chassis and up to 125 channels per second scan rate.

IEEE-488 and RS-232-C interface options are available. Prices start at less than \$2,500 for a scanning configuration with interface.

For more information on the 2205A, contact your local Fluke representative or contact us directly at 1-800-426-0361.



Fast-Response Coupon

IN THE U.S. AND NON-EUROPEAN COUNTRIES:

John Fluke Mfg. Co., Inc.
P.O. Box C9090, M/S 250C
Everett, WA 98206
(206) 356-5400, Tlx: 152662

IN EUROPE:

Fluke (Holland) B.V.
P.O. Box 5053, 5004 EB
Tilburg, The Netherlands
(013) 673973, Tlx: 52237

1217-9/2205
E2 4/82

- Send information on 2205A Switch Controller.
- Send information on Fluke System DMM's.
- Have a representative contact me for a demonstration.

Name

Title MS

Company

Address

City State Zip

Telephone () Ext.

For Technical Data Circle No. 75

country, either by an Olivetti subsidiary or a local software house, are under development, and many will be introduced with the computer. Within the next few months, the company plans to have an emulation program that will simulate the protocol and line communication of five IBM terminals—the 2770, 2780, 3741, 2968, and 3780.

Peripherals for the M20 will come from Olivetti's already existing range of plotters, electronic typewriters, and thermal, dot-matrix, and daisy-wheel printers. "The M20 uses the RS-232-C standard interface," says Price-Francis, "so it can use all of our peripherals except some designed before we changed to this standard." -Robert Gallagher

Japan

Watch electrochromic display responds fast with a single plane of tungsten electrodes

The first commercial use of an electrochromic display, in a digital wrist watch, is being quietly test-marketed in the U.S. and Europe by Dainisei-kosha Co. (Seiko). Unlike previous electrochromic displays that use top and bottom electrodes, Seiko's electrodes are positioned on a single plane, cutting response time. The display's performance also is improved with a new driver scheme.

Electrochromic displays are an attractive alternative to the commonly used liquid-crystal displays because they do not require a polarizer, and thus their dark-blue segments on a white background have higher contrast. Furthermore, without polarizers, they do not suffer from limited viewing angles.

They also have a memory characteristic that allows them to retain

display information without continuous drive—more than a day for the Seiko unit. Although it is nonemissive, the watch display consumes slightly more than twice the current of an LCD.

Going blue. Like other electrochromic displays, Seiko uses tungsten oxide electrodes immersed in an electrolyte for the number segments. A negative potential connected to the electrode causes injection of positive metallic ions and electrons into the oxide film changing it to tungsten bronze, which is blue. The reverse process bleaches the electrode back to its transparent state.

The bleaching process usually limits the speed of response of the display, but researchers at Seiko have developed a new fabrication method that improves performance consider-

ably. Instead of positioning the substrate perpendicular to the path of the tungsten oxide arriving from the deposition source, they rotated it so that the material arrives obliquely. This causes the deposited film to be anisotropic and the bleaching time to decrease.

For the optimum deposition angle, bleaching time reaches a minimum of one half to one third that for a display fabricated with the usual perpendicular orientation. Researchers further speeded up response with the single plane of electrodes. Actual response time is about half a second.

The transparent tin oxide electrodes are deposited on a glass substrate (see figure). The tungsten trioxide electrochromic electrodes are then deposited in a single plane overlaying them. Behind the electrochromic electrodes is a thin, white ceramic background plate.

The electrolyte consists of lithium perchlorate in an organic solvent. Because the assembly can be baked after fabrication, epoxy can be used to seal the glass plate, but low-temperature solder is used for the spot seal after filling the display with electrolyte.

Slow responders. A principal performance lag in some previously developed electrochromic displays was the inability to simultaneously turn segments on and turn others off. One solution—to add a large number of extra electrodes for simultaneous operation—suffers from slow response time and uneven optical density.

The driver circuits in the new display connect segments that must be turned on and those that must be turned off to opposite-polarity terminals of the power cells. Thus both operations are simultaneous.

In order to keep the display electrically and chemically balanced, the areas of segments being turned on must equal those being turned off. So each digit has three auxiliary (dummy) tungsten oxide electrodes hidden under the bezel. One of the auxiliary electrodes is about the same size as those in the number segments, and the other two are each twice as large giving an area that is

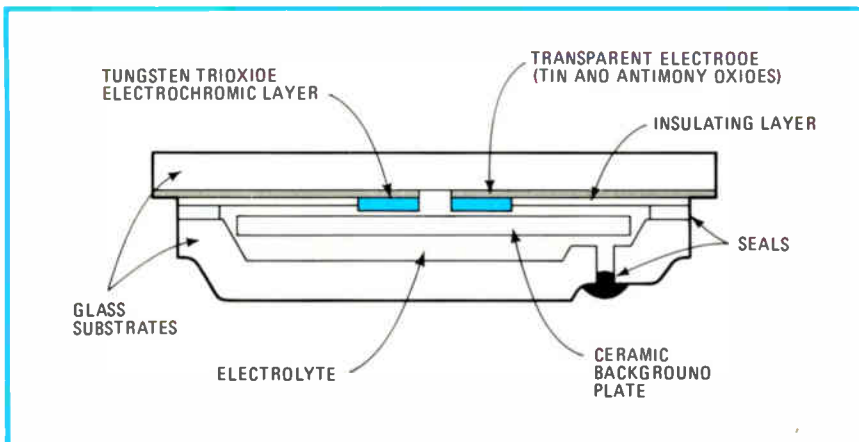

Quite a display. Electrochromic display gets its characteristic blue color when tungsten oxide film is turned to tungsten bronze by injecting positive ions and electrons.

Smart enough to automate testing without the keyboard. Think what else it can do.

You buy an instrument controller to solve problems, not create them. So we developed the 1720A with a unique touch-sensitive display specifically designed to put ATE system control at your operator's fingertips. With the removable keyboard protecting the program's security. Plug in the keyboard and the minicomputer intelligence makes the 1720A easy to program. Helping your programmer feel secure about easy software development and total program security.

Extensive minicomputer capabilities make programming a snap.

Don't let the simplicity of the 1720A fool you. At its core lies a powerful CPU,

the brains behind its software sophistication and programming ease.

Even the language is simple. The 1720A was designed to run BASIC, familiar to programmers for high-level commands. Our BASIC is adapted specifically to enhance

operations, so you have the advantage of speedy programming and operation with all the usual BASIC commands—plus a few of our own.

Dynamic string functions are also built into the language.

Sophisticated memory structure.

Direct memory storage is maximized with our Virtual Arrays features extending the working memory beyond the 24 k-byte main memory. Program chaining is also standard.

More good news for programmers.

For added flexibility, we offer a new Assembly Language option, callable from our BASIC.

Concerned about the future? The 1720A is a soft-loaded system. As our software engineers develop other languages, you'll be able to easily transfer your software applications programs.

Smart programming makes for smart operation, too.

The unique touch-sensitive display prompts your operators through a test procedure without touching a keyboard. And since inexperienced operators aren't fumbling over a keyboard, there's no worry over program security.

Write, call toll free 1-800-426-0361, or send in the coupon for our competitive comparison guide or a demonstration.



---(fast response coupon)---

1216-1/1720

IN EUROPE

Fluke (Holland) B.V.
P.O. Box 5053, 5003 EB
Tilburg, The Netherlands
+0131673973, Tlx. 52237

IN THE U.S. AND NON-

EUROPEAN COUNTRIES: E2 4/82
John Fluke Mfg. Co., Inc.
P.O. Box C9090, M/S 250C
Everett, WA 98206
(206) 356-5400, Tlx: 152662

- Send me a competitive comparison guide
- Have a salesman call

Name _____

Title _____ Mail Stop _____

Company _____

Address _____

City _____ State _____ Zip _____

Telephone () _____ Ext. _____

For technical data circle no. 77

equivalent to five segments.

Special high-current driver circuits, which occupy about a quarter of the watch chip, are needed for the display. However, since the display has inherent memory, the drivers can be turned off to save power, and therefore have three states—high, low, and floating, or don't care. The low-power decoder circuits, on the other hand, need only the standard

high and low outputs.

To mate the two, circuits between the decoders and drivers compare the present signal for each segment with that for the previous time period; if they are identical, the driver is forced into a floating output state while the segment state remains unchanged. The comparator uses a static flip-flop, with 16 transistors each.

—Charles Cohen

Great Britain

Ring-based low-cost local network uses token-passing scheme in fail-safe design

Weighing into the local-network race, Britain's Racal-Milgo Ltd., has developed a low-cost local net called Planet (for private local-area network). The token-passing net takes full advantage of custom large-scale integrated circuits to cut the price-per-data port to between \$700 and \$900—half to one quarter the cost of equivalent Ethernet ports.

Planet distributes computing power through a customer's premises by means of a twin coaxial-cable ring. To access the 10-megabit-a-second ring, a user has only to plug in a terminal access point, a compact microprocessor-based module measuring 17 by 19 by 3¼ inches that can comfortably fit on a user's desk and provides standard V24 computer interface ports.

Central director. Completing the system is a director unit, a compact module that sets up calls, monitors network performance, and manages the net. It, too, can be plugged into any cable access point in the net.

Initially, Planet is being offered with coaxial connections, but the technology is independent of the sending medium, says John Rance, who is head of hardware development in Bracknell, Berks. Both twisted-pair and fiber-optic links are under development.

Basically, Planet is a token-passing system, an approach that guarantees response time and latency. Such systems work by granting

access to the bus to the only holder of a token. When the holder has dispatched a data packet, the token is handed down the line, preventing a user from hogging the system.

The alternative approaches are contention-based systems such as Ethernet in which conflicting accesses to the network are resolved by contention algorithms. Token-based systems like Planet provide a more orderly approach to handling data, says Rance, who adds that IBM now appears to be putting its weight behind legitimizing this local-net approach [*Electronics*, April 7, p. 32].

Planet is broadly modeled on the Cambridge ring and, like it, uses the notion of empty electronic packets circulating continuously around the ring network. A packet is filled at any operational station with the information to be transmitted, together with a destination address code and other control bits—in all some 42 bits per packet. It then circles the ring to its destination where it is emptied of data and then allowed to continue.

The address and control bits in every packet reduce the available data rate to 3.5 MHz, but that, says Bob Jermyn, senior product marketing manager, is adequate for most user applications. For example, each interface port will initially be capable of 19.2 kilobits/s.

Racal diverges from the Cam-

AUTHORIZED DISTRIBUTORS

- AL • Huntsville, PIONEER (205) 837-9300
- AZ • Phoenix, FIESTA (602) 861-1141
- CA • Chatsworth, ANTHEM (213) 700-1000
Chatsworth, ARROW (213) 701-7500
Manhattan Beach, PRIME ELECTRO (213) 379-3642
San Diego, ANTHEM (714) 279-5200
San Diego, ARROW (714) 565-4800
Santa Ana, VSI ELECTRONICS (714) 557-7131
Sunnyvale, ARROW (408) 745-6600
Sunnyvale, BELL (408) 734-8570
Sunnyvale, DIPLOMAT (408) 734-1900
Sunnyvale, VSI ELECTRONICS (408) 734-5470
Tustin, ANTHEM (714) 730-8000
- CO • Denver, ARROW (303) 758-2100
Wheatridge, BELL (303) 424-1985
- CT • Danbury, DIPLOMAT (203) 797-9674
East Haven, JV ELECTRONICS (203) 469-2321
Wallingford, ARROW (203) 265-7741
- FL • Ft. Lauderdale, ARROW (305) 776-7790
Orlando, PIONEER (305) 859-3600
Palm Bay, ARROW (305) 725-1480
- GA • Norcross, ARROW (404) 449-8252
- IL • Elk Grove Village, PIONEER (312) 437-9680
Lombard, RM ELECTRONICS (312) 932-5150
Northbrook, CLASSIC COMPONENTS (312) 272-9650
Schaumburg, ARROW (312) 893-9420
- IN • Indianapolis, ARROW (317) 243-9353
Indianapolis, GENESIS (317) 257-2231
Indianapolis, PIONEER (317) 849-7300
South Bend, GENESIS (219) 287-2911
- MO • Baltimore, ARROW (301) 247-5200
Columbia, DIPLOMAT (301) 995-1226
Gaithersburg, PIONEER (301) 948-0710
- MA • Newton, GREENE-SHAW (617) 969-8900
Woburn, ARROW (617) 933-8130
- MI • Ann Arbor, ARROW (313) 971-8220
Livonia, PIONEER (313) 525-1800
Wyoming, RM ELECTRONICS (616) 531-9300
- MN • Edina, ARROW (612) 830-1800
Fridley, DIPLOMAT (612) 572-0313
Minnetonka, PIONEER (612) 935-5444
- MO • St. Louis, ARROW (314) 567-6888
- NH • Manchester, ARROW (603) 668-6968
- NJ • Moorestown, ARROW (609) 235-1900
Saddlebrook, ARROW (201) 797-5800
Totowa, DIPLOMAT (201) 785-1830
- NM • Albuquerque, ARROW (505) 243-4566
Albuquerque, BELL (505) 292-2700
- NY • Farmingdale, ARROW (516) 694-6800
Hauppauge, ARROW (516) 231-1000
Liverpool, ARROW (315) 652-1000
Liverpool, DIPLOMAT (315) 652-5000
Melville, DIPLOMAT (516) 454-6400
Rochester, ARROW (716) 275-0300
Rochester, ROCHESTER RADIO (716) 454-7800
- NC • Greensboro, PIONEER (919) 273-4441
Winston-Salem, ARROW (919) 725-8711
- OH • Centerville, ARROW (513) 435-5563
Cleveland, PIONEER (216) 587-3600
Dayton, PIONEER (513) 236-9900
Solon, ARROW (216) 248-3990
- OK • Tulsa, QUALITY COMPONENTS (918) 664-8812
- OR • Lake Oswego, BELL (503) 241-4115
- PA • Horsham, PIONEER (215) 674-4000
Monroeville, ARROW (412) 856-7000
Pittsburgh, PIONEER (412) 782-2300
- TX • Addison, QUALITY COMPONENTS (214) 387-4949
Austin, QUALITY COMPONENTS (512) 835-0220
Dallas, ARROW (214) 386-7500
Dallas, PIONEER (214) 386-7300
Houston, PIONEER (713) 988-5555
Houston, QUALITY COMPONENTS (713) 772-7100
Stafford, ARROW (713) 491-4100
- UT • Salt Lake City, BELL (801) 972-6969
- WA • Bellevue, ARROW (206) 643-4800
Bellevue, BELL (206) 747-1515
- WI • Mequon, TAYLOR (414) 241-4321
New Berlin, CLASSIC (414) 786-5300
Dak Creek, ARROW (414) 764-6600
- CANADA • FUTURE ELEC. • Pointe Claire (514) 694-9710
Calgary (403) 259-6408 • Downsview (416) 663-5563
Ottawa (613) 820-8313 • Vancouver (604) 438-5545
ZENTRONICS: Brampton (416) 451-9600
Calgary (403) 230-1422 • Edmonton (403) 463-3014
Montreal (514) 735-5361 • Nova Scotia (902) 463-8411
Ottawa (613) 238-6411 • Vancouver (604) 688-2533
Waterloo (519) 884-5700 • Winnipeg (204) 775-8661

Introducing 152 low-cost versatile slotted optical interrupter switches.

This new family from TRW Optron gives you the largest selection of slotted optical switches available today.

One hundred fifty two. That means the custom switch you thought you had to have might already be on our shelves.

You can choose your own lead spacing (.320" or .220"). Choose your mounting tabs (left, right, both or none). Choose your aperture widths (.050" or .010" over sensor, .050" or .020" over LED). Choose one of four Photologic™ outputs, or a photo transistor output with a broad range of output currents. Choose polycarbonate or polysulfone housing (polycarbonate for complete opacity to ambient light and infrared radiation, polysulfone for protection from dirt and dust). And all 152 are smaller, allowing use where space is limited. This standard family could provide you with the lowest cost solution to

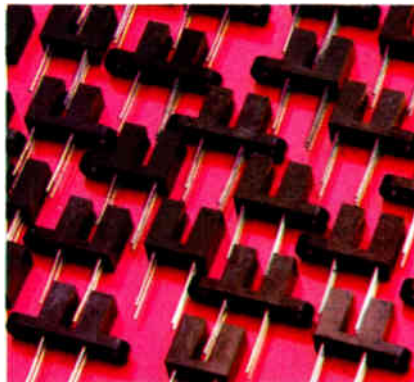

your custom need.

The OPB 860/870 family of switches includes an infrared emitting diode coupled to an NPN silicon phototransistor. Saturation levels are tested to guarantee TTL and LSTTL compatibility. The OPB 960/970 family consists of an infrared emitting diode coupled to an integrated photologic sensor. Testing insures drive capacity for 8 standard TTL loads.

Another innovative product from TRW Optron.

Let us send you a free package of sample housings and data sheets. Please specify your interest in photologic (OPB 960/970) or photosensor (OPB 860/870).

TRW Optron		E-4
1201 Tappan Circle Carrollton, Texas 75006 (214) 323-2200		
Please send: <input type="checkbox"/> Package and data sheet, OPB 860/870		
<input type="checkbox"/> Package and data sheet, OPB 960/970		
Name _____		
Company _____		
Div/Dept _____	Mail Code _____	
Address _____		
City _____		
State _____	Zip _____	

TRW OPTRON

An Electronic Components Division of TRW Inc.

CTS DIP Switch performance is "based on Plenco



206 Series CTS DIP Switches are used to conveniently program circuits in a wide variety of electronic equipment. They range from consumer products such as garage-door openers and video games to more sophisticated telecommunications, data processing and instrumentation applications.

CTS Keene, Inc., Paso Robles, Calif., manufactures these versatile switches, using our Plenco 597 phenolic molding compound for the switch's molded base.

The base plays a key role in switch performance; it must

provide rigid anchoring for the contacts and terminals. "Your 597 thermoset," reports CTS, "was chosen for its strength, insulation properties, dimensional accuracy and ability to withstand the high temperatures involved in soldering."

To switch in Plenco selection, experience and service on your own particular molding application, simply dial (414) 458-2121.

PLENCO
THERMOSET PLASTICS

PLASTICS ENGINEERING COMPANY
Sheboygan, WI 53081

Through Plenco research... a wide range of ready-made or custom-formulated phenolic, melamine-phenolic, alkyd and polyester thermoset molding compounds, and industrial resins.

Electronics international

bridge-ring concept by investing more intelligence in the central director, thereby simplifying the port electronics. In fact, the terminal access point fits on a single custom VLSI chip, developed by sister company Racal Microelectronics Ltd., which is teamed with an Intel 8051 single-chip microcomputer.

The custom chip has been optimized to process data on the fly at 10-Mb/s, presenting extracted data packets through a serial interface to the microcomputer. Initially, the chip was implemented in gate-array form but, to further cut real estate and hence costs, the fully custom version has now been developed in Racal's proprietary Oxy-complementary-MOS process.

Failsafe. The network also differs in the way Racal engineers have tackled one major drawback of ring-based systems—the catastrophic effects of a failure of any one of the constituent parts in the ring. With a fine touch of showmanship, they demonstrate the consequence by cutting one of the coaxial-cable pair during a live demonstration—with no apparent interruption in service to the ring users.

Like a knotted string stretched tight between two fingers, ring integrity is maintained by looping the cable back on itself at any cable-access point. So a failure of any one access point or cable run is automatically isolated within a second by the healthy elements surrounding it. Failure of the director, too, can be guarded against by holding a second director on standby.

Another advantage of investing intelligence in the director is the provision of advanced network services. Aside from monitoring data packets and ring integrity, for example, the director initiates all call setups, advising participants as to the address they must use.

It can also set up third-party calls, drawing on the services of a protocol converter, if necessary. In addition, it can provide password and security facilities, assign resource priorities, establish closed user groups, and assign permanent circuits among network users.

-Kevin Smith



GOULD BIOMATION

4500

Stop guessing at accuracy.

Introducing the world's most accurate 100 MHz digital oscilloscope.

The only scope with specified performance across the entire frequency range.

All measurement instruments have their performance limitations, but until now the precise margin for error was anybody's guess. The Gould Biomation 4500 is the first digital scope to specify and guarantee dynamic performance, so that you can make measurements based on specifications, not assumptions.

Among conventional analog scopes, a well-calibrated unit is rarely capable of better than 2% to 3% accuracy. And they don't stay calibrated long.

Most digital oscilloscopes do better than analog scopes at very low frequencies. However, they are less accurate at high frequencies, due to a degradation of dynamic resolution in the analog-to-digital converter section and non-linearities in the front-end section.

With a revolutionary design of both the analog-to-digital converter and front-end sections, plus microprocessor-controlled autocalibration, the 4500 is two to ten times more precise than its closest competitors. It tracks waveforms that have been difficult to

measure in the past— even those with full-scale risetimes as fast as 20 ns.

With a maximum digitizing rate of 100 MHz, the 4500 gives you better than 7-bit resolution at 1 MHz, more than 6 bits at 10 MHz and more than 5 bits at 35 MHz.

Benchtop or systems operation.

For electronic, industrial and scientific R&D, production testing, product design and other applications, digital storage makes benchtop viewing of signals easy. Raster scan displays are crisp and precise. On-line comparisons can be made against stored reference signals. And a floppy disk option allows storage of 30 waveforms—so you can capture data at the bench or in the field for later analysis.



For automatic test systems use, the 4500's GPIB, RS-232-C and high-speed memory output option card allow complete I/O interfacing to a GPIB controller or a minicomputer. It can even be left to "babysit" an experiment and capture events which occur at random times and elude conventional oscilloscopes.

Designed for ease of use.

You don't have to be a computer whiz to take full advantage of the microprocessor-based 4500. It has scope-like controls for easy operation by anyone familiar with an ordinary oscilloscope. A self-test routine checks the 4500's operation at power-up, and a user-evoked diagnostics set allows for detailed troubleshooting. The simple keyed menu selection guides you each step of the way.

Find out more about accuracy today.

For application notes and product brochure on the Gould Biomation 4500 digital oscilloscope, write Gould Inc., Instruments Division, Santa Clara Operation, 4600 Old Ironsides Drive, Santa Clara, CA 95050. Or call the Digital Oscilloscope people at (408) 988-6800.

 **GOULD**
Electronics & Electrical Products

Circle 81 on reader service card

GenRad announces TRACS.™ A revolutionary information system for improving the quality and yield of your P.C. boards.

At GenRad, we first came up with the idea for the automatic printed circuit board tester back in 1969. And over the years, we've added many more innovations that make it easier and faster to find board defects. However, we've never been satisfied with just finding defects. We also wanted to do something about preventing them.

Now, after some 25 man-years of effort, we're ready with the first system that can do it. TRACS. It's a true quality monitoring and management system that can actually help stop board problems before they become test problems. And we predict it will revolutionize the whole board manufacturing process during the next decade.

How does TRACS work? Well, if you've gotten into our puzzle at all you're well on your way to understanding. Because the first thing that a quality

monitoring system has to do is exchange accurate and timely information between manufacturing and test people.

The catch, of course, is timely. Repair loop data, to be of any use to manufacturing, has to be picked up and moved around in the most efficient way possible. And that's exactly what TRACS does. (Incidentally, the most efficient way to solve the puzzle is with 46 moves.)

TRACS helps you cut repair costs. Then it helps you reduce the need for repairs.

TRACS addresses the two most pressing needs in electronics manufacturing today. First, it remedies a couple of flaws in the test and repair loop itself. Namely, too much paper and not enough real-time information. As a result TRACS can reduce your actual cost to repair boards.

TEST #4 IN A SERIES. You are the Manager and your task is to interchange the two groups. The figures on the left can only be moved right and down. The ones on the right only left and up. You can move to an adjacent empty square or jump over one of the other kind. Diagonal moves are not permitted. There is a lot of pressure from competition so you must do it in the fewest number of moves possible.

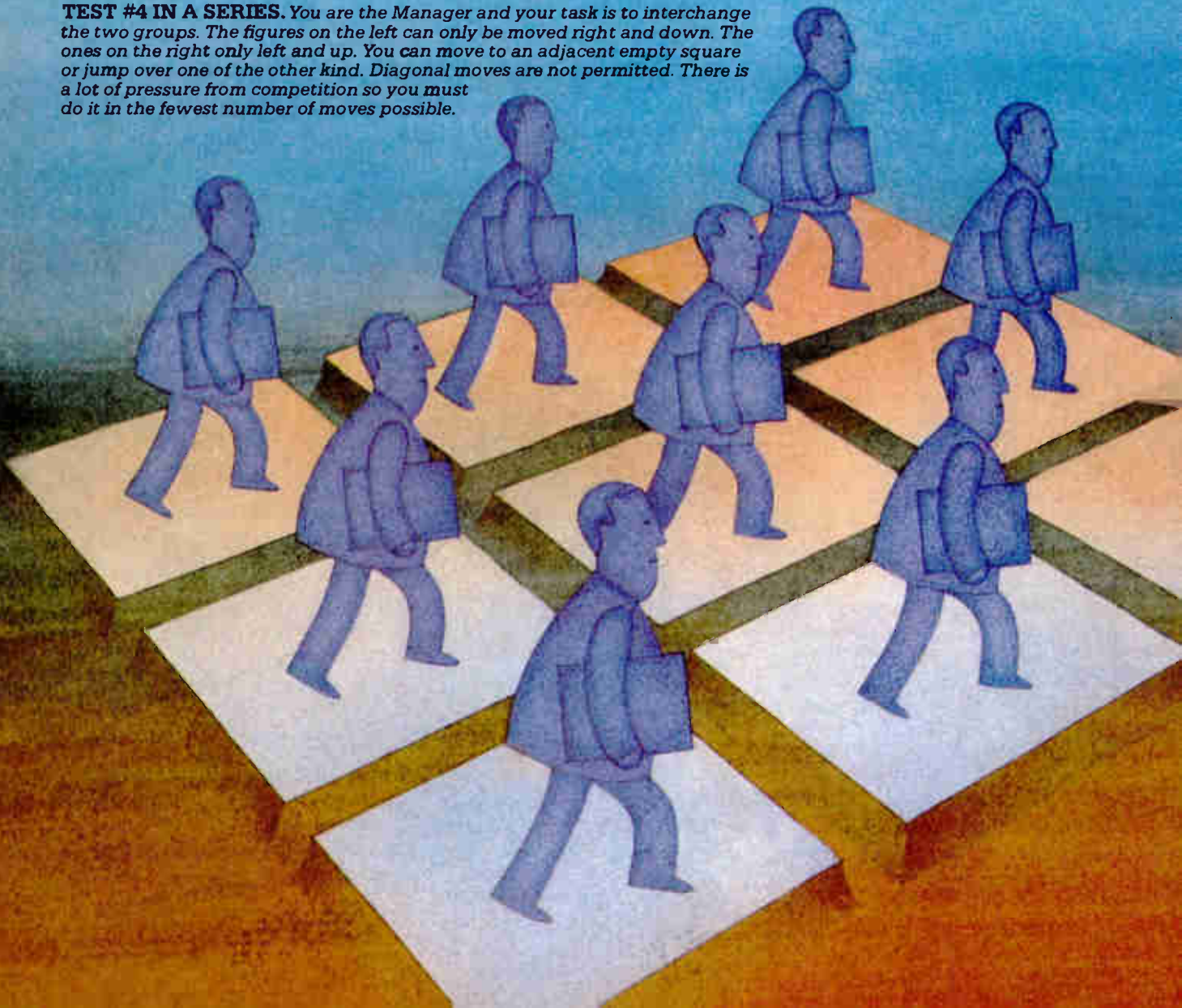

However, TRACS goes a lot further. It collects information generated along the entire test path and puts it to work. This data is fed back continuously to the people who can use it most — manufacturing. Giving them the chance to eliminate the cause of the defects before it's too late. And cutting down the necessity for repairs in the first place.

TRACS has three main hardware components. A central station, which acts as the master controller; a series of terminals for use by inspection and repair station personnel; and GenRad's high-speed data communications link, GRnet.™

Actually the system wouldn't be possible without GRnet, the first ATE network specifically designed for use in a high volume production test environment. GRnet is unique in that it can transfer data in parallel at a very fast rate and with high accuracy.

TRACS also has remarkable flexibility, facilitating additional testers and terminals as your needs change. And allowing it to adapt to a variety of configurations, from small to large.

TRACS software is high-level and utilizes menu-type formats. Which makes the system literally turn-key. And gives it the ability to be tailored to match specific production requirements. TRACS also provides automatic reports such as test trends and test results summaries, detailed defect reports and productivity information on test repair times.

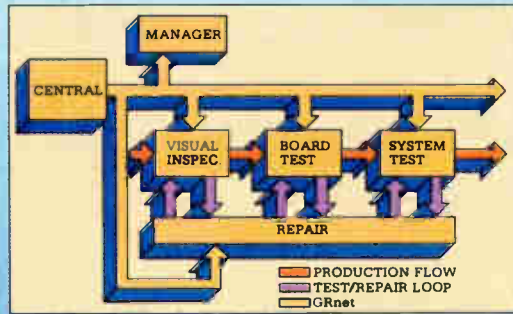

Automates the flow of information around the loop.

The next move is yours.

Finished the puzzle? We know how easy it is to get bogged down when you're trying to manage that much information. So we suggest you take a systematic approach, the way TRACS does. Try keeping track of every single move you make.

Now if you'd like to check our solution, write us on your letterhead. And if you'd like to move your test and production people closer together and improve the quality and yield of your boards, we'll fill you in on TRACS. Just contact us at: GenRad, Inc., 170 Tracer Lane, Waltham, MA 02254.

 **GenRad**
THE BEST IN TEST.



OKI Deals in Realities in 64K Dynamic RAM Supply and Demand.

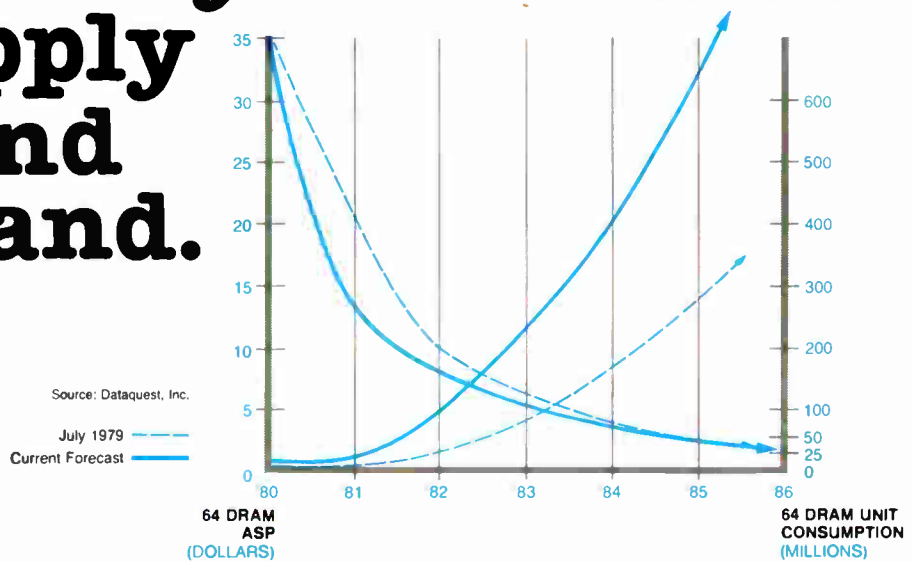

The facts. Industry requirements for the 64K DRAM are exploding much sooner than expected. For 1982 alone, a demand for 100-million parts, rising to more than 380-million pieces for 1984 — we forecast a severe capacity crunch. The strategic planning implications for OEMs are clear: early commitment is essential to maintain your technology edge; tying into a reliable volume supplier is critical.

**Unique availability.
Exclusive technical backup.**

OKI makes the hard realities in 64K DRAMs easier to take. Through high-volume capabilities in both plastic and ceramic. Through advanced VLSI technology that has produced our MSM 3764s: alpha particle-protected 65,536 bits of NMOS dynamic memory. With full "Environmental Testing Data" included with OKI 3764 technical specs.

Plastic and Ceramic
**64K DRAM
AVAILABILITY**
from OKI

**VOLUME SHIPMENTS
JAN 1 '82**
at
600,000 PIECES/MONTH
Increasing substantially
through 1982 and
beyond.

OKI 64K Dynamic RAMs — volume availability in plastic or ceramic, in 2 fast-access times with alpha particle protection.

Please send technical data pricing for:

() MSM 3764-15 (150 ns)
() MSM 3764-20 (200 ns)
() Include OKI's exclusive detailed "Environmental Testing Data".

OKI SEMICONDUCTOR Name _____ Title _____

Attach coupon to business card or letterhead and return to:
OKI Semiconductor, 1333 Lawrence Expressway, Santa Clara, CA 95051.
Or call Robert Reid. (408) 984-4842.

OKI-23-981

For Easy Prequalification of OKI 64K Plastic DRAMS:

**a Byte of
Memory for
Only \$64!**

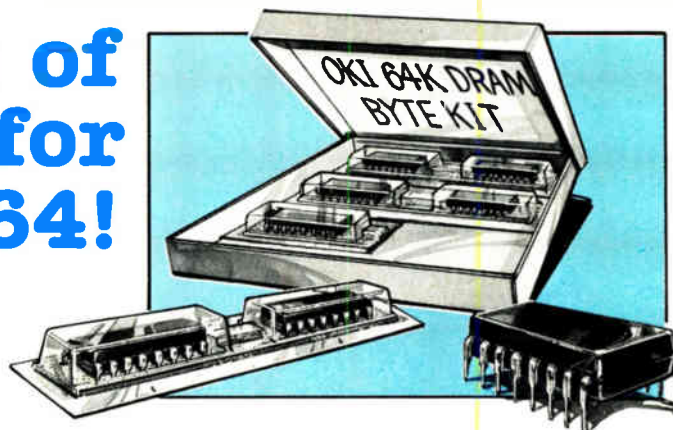

8 x 64K = \$64. A \$64 check to OKI Semiconductor delivers eight full-functioning plastic 200ns 64K Dynamic RAMs, with data sheet **plus** a summary of "Environmental Testing Data". Eight MSM 3764-20RS chips, packaged in a special money-saving Evaluation Kit — a very cost-effective way to check out a byte of DRAM on your boards. OKI answers the \$64 question of where to get VLSI memories **in plastic** for automated insertion equipment ... today! OKI volume production assures the volume quantities that OEMs need — to realize the 20-25% cost-savings available through robotized handling of high-density memory PC boards, in both production and testing.

**OKI meets volume demand
with off-the-shelf DRAMs
in plastic and ceramic.**

Now shipping at 800,000 pieces per month, with quantity capabilities rapidly expanding: OKI MSM 3764 DRAMS. Alpha-particle protected 65,536 bits of NMOS dynamic memory, fully environment tested — ready to go. With reliable volume availability secured by new large-scale OKI manufacturing facilities.

Eight Plastic
64K DRAMS
for only \$64

from OKI

SEND
for OKI's MSM 3764
Evaluation Byte Kit

TODAY

Request for OKI 64K Plastic DRAM Evaluation Kit

Please send ___ set(s) of the MSM3764 Byte Kit containing eight production-ready parts and full technical data. Offer limited to 6 kits per customer. Price per kit is \$64 plus \$5.00 for handling and delivery (\$69/kit total, sales tax included).

Check or money order for \$_____ enclosed.

Name _____ Title _____

Company _____ Tel (____) _____

Address _____

City _____ State _____ Zip _____

OKI
SEMICONDUCTOR

Return coupon order with check to: OKI Semiconductor, 1333 Lawrence Expressway, Santa Clara, CA 95051. All orders promptly shipped UPS. Offer expires April 30, 1982.

THE DSD 880 WINCHESTER SYSTEM.

MADE THE WAY
DIGITAL WOULD MAKE IT.

EXCEPT DIGITAL
DOESN'T MAKE IT.

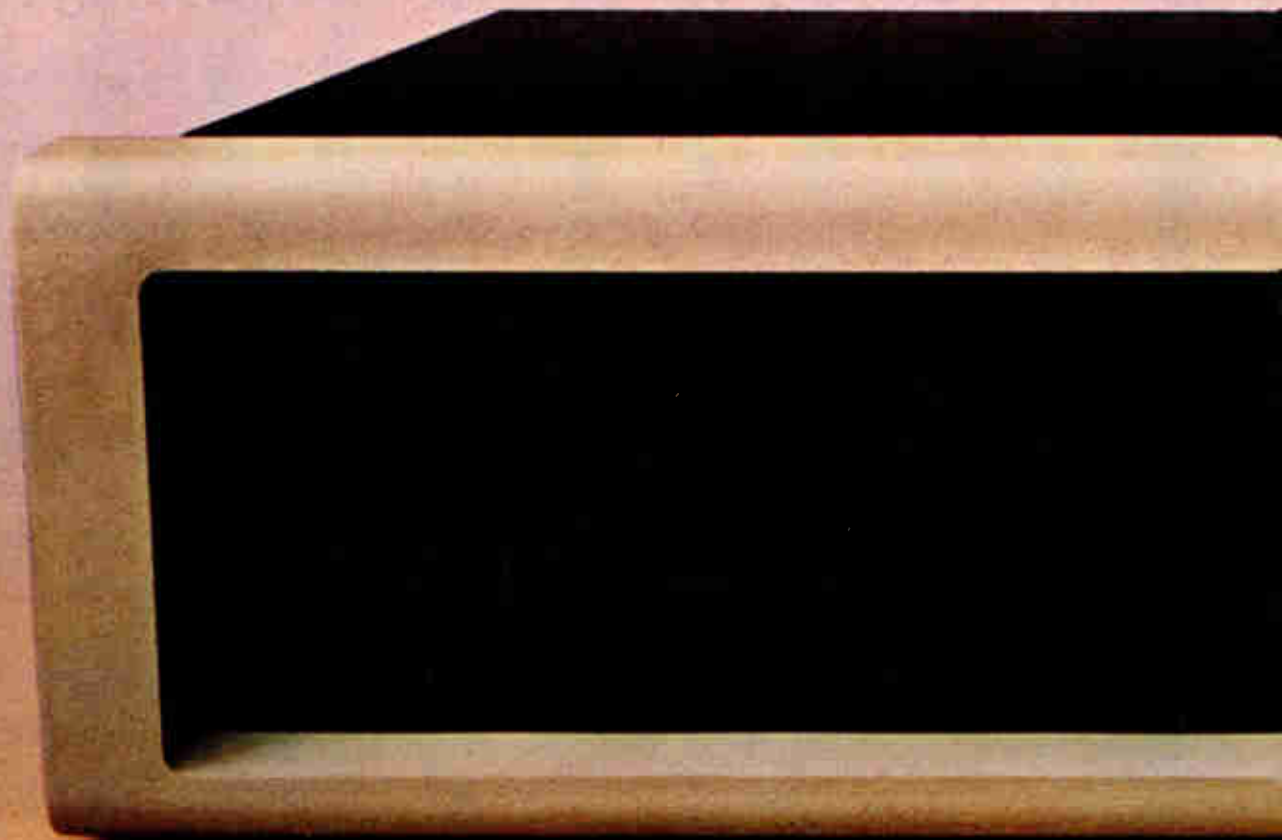

HyperDiagnostics, HyperService and Rapid Module Exchange are trademarks of Data Systems Design, Inc.
PDP is a registered trademark of Digital Equipment Corp.

"OEMS: Don't miss the new 700 Series of Multibus
Winchesters at NCC booth #A549, Astroarena, Houston."

The people at Digital are a pretty smart bunch. They make some of the finest small computers in the world. So we like to think that if they were to make a new storage system like our 880 Winchester/Floppy, they'd do it the same way we did.

First of all, they'd make it extremely reliable with extensive testing and by using one of the most reliable storage technologies known, the Winchester.

Next, they'd offer it in different capacities, like 7.8, 20.8, and 31.2 megabytes, with a choice of .5 or 1 Mb floppy back-up, or none at all.

These different configurations would, of course, be fully compatible with Digital's LSI-11 and PDP®-11 computers.

And the whole package would be extremely compact, just 5¼ inches high, so it would save space and fit in almost anywhere.

They might even add some on-board self-diagnostics, similar to our exclusive HyperDiagnostics,™ so you could test, exercise, and debug without a CPU. And cut down on your service costs at the same time.

Maybe they'd even institute a module swap program, something like our Rapid Module Exchange,™ which would be designed to get you

back up and running within twenty-four hours.

Finally, since this system would be so dependable, they'd be able to offer their extended service at a much lower price—much like we do with our own HyperService,™ which goes into effect when the 90-day warranty expires and covers everything.

And then, as if it weren't good enough already, they'd offer this remarkable storage system at a lower cost per megabyte than any comparable system.

The fact is, though, Digital doesn't make anything like this.

Which is why we make the DSD 880 Winchester system to go with your Digital computer.

And, why we make it the way we do.

Corporate Headquarters: 2241 Lundy Avenue, San Jose, CA 95131. Eastern Region Sales and Service: Norwood, MA, 617 769-7620. Central Region Sales: Dallas, TX, 214 980-4884. Western Region Sales: Santa Clara, CA, 408 727-3163.

DATA SYSTEMS DESIGN

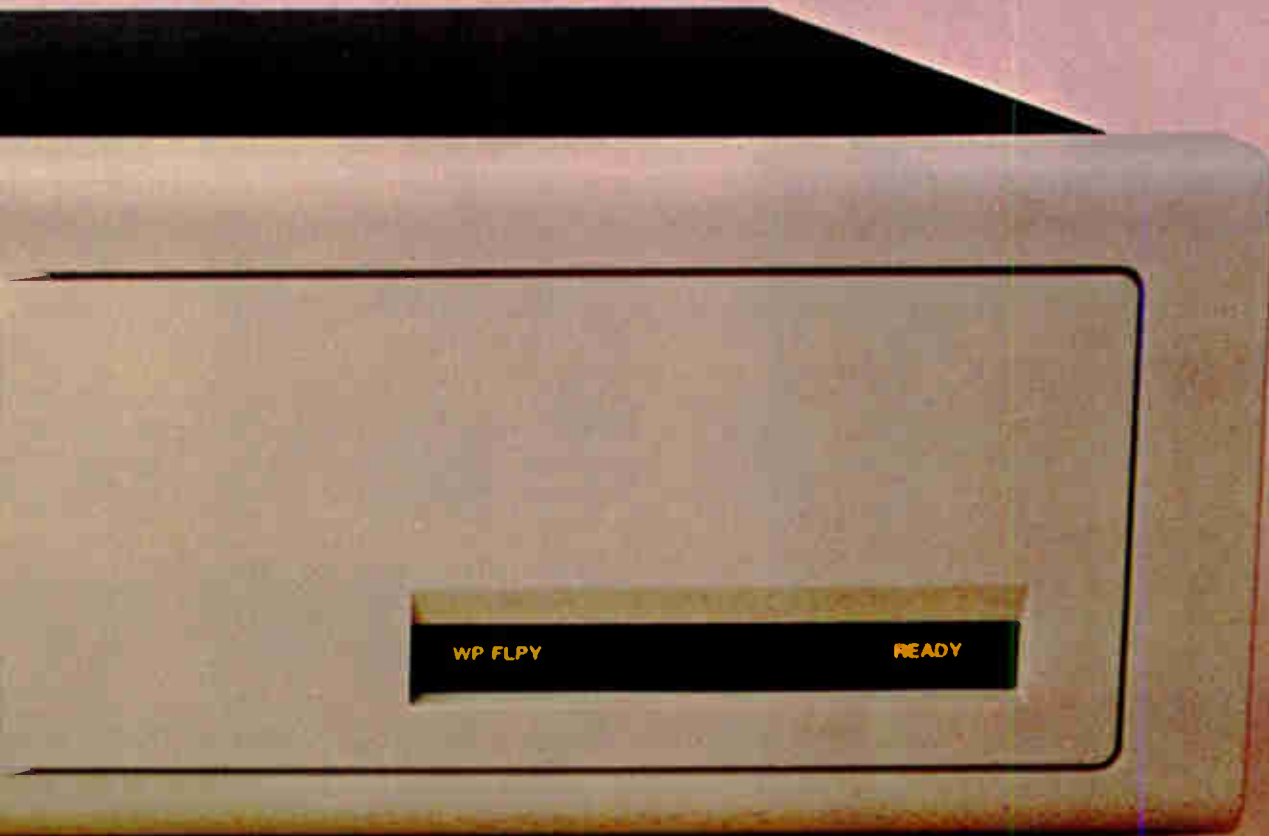

INTERNATIONAL SALES: Australia 03/644-3444; Belgium and Luxembourg 02/7209038; Canada 416/625-1907; Central and South America (office in U.S.A.) 415/967-8818; Denmark 01/83 34 00; Finland 90/28 50 11; France 03 956 81 42; Israel 03/2967 01; Italy 02/4047648; Japan 06/323-1707; Netherlands 020/45 87 55; New Zealand 4/693-008; Norway 02/78 94 60; Spain 34/833-2412; Sweden 08/38 03 70; Switzerland 01/730 48 48; United Kingdom 44/7073/34774; West Germany and Austria 089/1204-0; Yugoslavia 61/263-261.

Circle 87 on reader service card

How did we manage to get so big in micros?



Choice. That's what gives a good design engineer the ability to optimize designs.

And that's what Digital gives you in micro products. Nearly 40 choices ranging from our MICRO/T-11 MPU chips to our SBC and dual-height board micros to our powerful PDP-11 based boxes and systems. That's one of the broadest product lines in the industry, which means you can strike the best balance between cost and performance right from the outset.

But Digital's commitment goes far beyond our breadth of line. We also offer you the tools you need to get your product to market faster. Like multi-user software that cuts development time by allowing several programmers to work on a project simultaneously. A variety of high level languages that simplify the programming process significantly. And a new, sophisticated software system—MicroPower/Pascal—for our entire micro-computer family.

Digital's micros pay off in the long run, too, because every micro product we make has the same PDP-11 architecture as every other micro product we make. As well as every mini we make. That's why companies that started using our micros 6 years ago are still building on their original software investment,

By choice.

instead of starting from scratch with every new product.

And they can count on that same compatibility when we're ready to introduce the next, still more powerful generation of micros.

It's that kind of commitment that's helped us become the biggest company in micros today. The company of choice.

For complete details about our micro product line, simply call toll-free (800) 225-9222 and ask us to send Micros Information Package # N-79. In MA, HI, AK and Canada call (617) 568-5707.

Digital Equipment Corporation
Microcomputer Products Group
HL2-1/E10, 77 Reed Road
Hudson, MA 01749.

digital

Vertical recording promises new era

Japanese have head start in technology that could increase densities of hard and floppy disks by order of magnitude

by Tom Manuel, Computers & Peripherals Editor

Magnetic recording is about to take another giant leap, and Japanese companies are out front. Propelled by a relatively new technique called vertical recording, linear bit densities could increase by an order of magnitude in both hard- and floppy-disk drives—from 10,000 to over 200,000 bits per inch.

With commercial products expected as early as next year, all the major Japanese computer companies are working on products. Several U.S. and European competitors are also in the race.

In today's horizontal (longitudinal) recording, stray fields in the medium demagnetize it during writing—demagnetization increases with density. However, in vertical recording, the demagnetized field shrinks as density of magnetized regions increases. Ultimate density is thus limited only by the magnetic-wall width separating two reversely magnetized domains.

The potential prize is a big one—a

better shot at a significant share of an already huge, but still rapidly growing, market for data storage. One estimate of the 1982 worldwide market for hard- and floppy-disk drives is \$12 billion, growing to \$18 billion or \$19 billion by 1984.

Ahead. Experts on vertical recording in the U.S. say that the Japanese are way ahead because they have been putting out a greater effort for a longer period of time. Serious work in vertical recording has been going on in Japan for seven years.

Dennis E. Speliotis, president of Advanced Development Corp., Lexington, Mass., a consultant on magnetic recording technology, says "there is an avalanche taking place, and we are sleeping over here." He estimates that the Japanese are making an effort in vertical recording that is "20 to 30 times greater than that in the U.S."

In addition, he sees several advantages enjoyed by the Japanese. One

is that "there are at least a dozen Japanese universities working hard in this area, compared to only one—the University of Minnesota—in the U.S.

Another advantage Speliotis sees for the Japanese "isn't yet apparent, but it will be important in the long run. The Japanese virtually control the consumer marketplace, which the U.S. has given up, so they will be addressing the full range of consumer, as well as computer, applications for this technology, giving them a much stronger technological and marketing base."

Also noting that the Japanese "are very definitely much further ahead" is Paul Albert, a consultant in San Jose, Calif. "Except for IBM Corp., which has been working on vertical recording over the last three or four years, the U.S. is just getting started," he says.

At the 1982 Sendai Symposium on Perpendicular Magnetic Recording sponsored by Tohoku Uni-

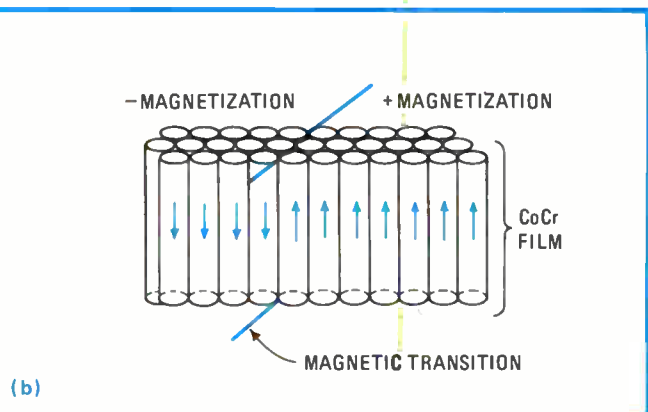
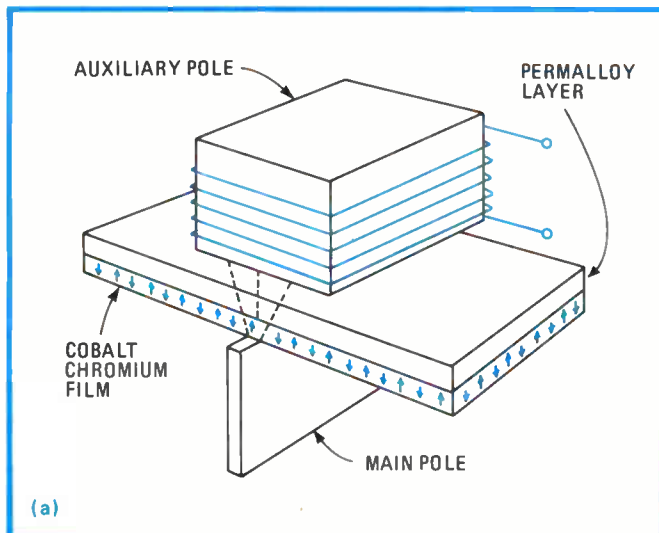

Standing up. A common head type for vertical magnetic recording in cobalt chromium alloy film has a single pole on each side of the medium, (a). The structure within the cobalt chromium layer is columnar with perpendicular anisotropy (b).

Probing the news

versity last month, 20 of the 22 papers were presented by Japanese researchers representing all the major electronics companies there (Fujitsu Ltd., Hitachi Ltd., Matsushita Electric Industrial Co., Nippon Electric Co., Nippon Telegraph & Telephone Public Corp., Sony Corp., and Toshiba Electric Co.) and several universities. Two papers and four attendees were from the U. S. Three other attendees out of the total of over 300 were from Ing. C. Olivetti & Co., SpA, Ivrea, Italy.

Chorus. Chao S. Chi, manager of the magnetic recording department at Sperry Corp.'s Computer Research Laboratory, Sudbury, Mass., and Ted A. Schwarz, manager of advanced component technology for Magnetic Peripherals Inc., Minneapolis, Minn., are members of the chorus agreeing the Japanese are the leaders in vertical recording. But Schwarz does not think they will be able to capture the total market, at least to the extent that they have, for example, in some consumer products areas.

"We [U. S. industry] are going to turn the tables on the Japanese by going over and studying intensively what they are doing, so we don't have to cover all that ground," says Schwarz. Although the Japanese will make inroads and seize a share of the vertical-recording market, there will be major U. S. companies involved as well, he maintains. "There also could be a start-up U. S. company or two that could hit it big in this technology," he says.

At least eight U. S. companies are now working on high-density data-storage products using vertical-recording techniques. They are, International Business Machines, Hewlett-Packard, Sperry Univac, Burroughs (through Memorex), and Control Data and Honeywell (through Magnetic Peripherals, which they own jointly along with CII-Honeywell Bull of France). In addition, three start-up companies—Vertimag Systems Corp. of Minneapolis, Lanx Corp. of San Jose, Calif., and Ibis Systems Inc. of Duarte, Calif.—are working on products using vertical recording.

On the European scene, Olivetti and CII-Honeywell Bull are both investigating the techniques. Olivetti is working on floppy disks coated with cobalt and chromium, the material that so far has demonstrated in all research the best characteristics for vertical recording.

CII-Honeywell Bull is investigating very high-density hard disks with a multilayer medium where the perpendicular anisotropic layer (probably CoCr) consists of microcolumns with diameters of about 200 or 300 angstroms separated by demagnetized fields of 300 to 500 Å. CII-Honeywell Bull has developed a special thin-film head for vertical recording, though conventional heads can be used. With this head and the multilayer medium, CII-Honeywell Bull expects to achieve densities greater than 100,000 b/in.

Back in the U. S., Vertimag may be the company closest to offering a product. Its president, Clark E. Johnson, says the company now has a working system using vertical

recording on a 5-megabyte, 5¼-in. floppy disk. Delivery of the system will begin in mid to late 1983 at an expected price of \$500 each in quantity with the disks to cost \$25, says Johnson.

Lanx and Ibis Systems are both working on small-diameter, large-capacity hard disks, while Magnetic Peripherals is building up its vertical-recording-technology group. Sperry Corp. is doing research on radio-frequency sputtered CoCr alloy, but, as Chi observes, "the sputtering process is probably going to be too slow for high-volume production."

Sperry, Vertimag, and the Japanese researchers are looking at other materials that could be applied to vertical recording by vacuum evaporation or chemical plating. Materials mentioned in papers presented at the Sendai symposium include cobalt ruthenium, cobalt nickel phosphorus, cobalt nickel manganese phosphorus, cobalt chromium rhodium, and cobalt chromium tantalum.

While the Americans and Europeans are focusing just on floppy disks or small hard-disk data-storage devices, the Japanese are looking at everything. Clark Johnson of Vertimag says that the Japanese plan first to attack the markets they are already strong in, such as consumer electronics, with small video recorders and digital audio-disk products. These products will be introduced at the January or June 1983 Consumer Electronics Show, he predicts.

Serious contender. The opportunity and the technology are attractive. For that reason, companies with a big stake in the magnetic-storage business or those that covet one have their work cut out for them now that vertical recording is becoming a hot topic. "People are at least starting to take vertical recording seriously [in the U. S.]," says consultant Albert.

He hopes this new interest will ignite inquiries among the physics departments in U. S. universities so that research in vertical recording will start. And Advanced Development's Speliotis says, "First, U. S. companies must realize this technology is the coming trend and take it seriously. Large companies must dedicate far more resources to it." □

How dense can they get?

It is not clear yet just how much density can be achieved through vertical-recording techniques. Some of the earliest data-storage products, most likely 5¼-inch hard or floppy disks, are expected to have very conservative densities of 20,000 to 40,000 bits per inch. However, densities of 80,000 to over 100,000 b/in. have been demonstrated in the labs, and such products could quickly follow. There is also no reason that track densities cannot be increased to 1,000 to 2,000 tracks/in. In digital-audio applications, according to one observer, Sony Corp. has demonstrated an inferred density of 445,000 b/in. From a magnetics point of view (disregarding mechanical-tracking considerations) densities of about 6.5 billion bits per square inch are feasible, and the ultimate theoretical limit may in fact be 10 times that, claims Dennis Speliotis, president of Advanced Development Corp. in Lexington, Mass.

-Tom Manuel

Introducing the first 50 nsec 12x12-bit multiplier.

TRW's OMICRON-B™* makes the MPY 112K the fastest (20 MHz — video rate) 12x12-bit multiplier available.

The 48 pin DIP VLSI multiplier gives you a combination of more usable board space and higher speed multiplication than you've ever had before.

You can multiply in two's complement or unsigned magnitude format, and you get a 16-bit product, perfect for video systems where real time digital signal processing is required at very high data rates.

All inputs/outputs are registered and TTL compatible, of course. (After all, TRW invented TTL.) Three-state output drivers, single +5V supply, and the price is right: just \$105 in 100s.



MPY 112K high speed Multiplier

Now in stock at Arrow Electronics and Hamilton/Avnet. For immediate information about the new MPY 112K 12x12-bit parallel multiplier, call us at (714) 457-1000 or return the coupon.

TRW LSI Products P.O. Box 2472 E4
La Jolla, California 92038

Please send data sheet on the new
MPY 112K.

Name _____

Company _____

Div/Dept _____

Mail Code _____

Address _____

City _____

State _____

Zip _____

***OMICRON-B™ is TRW's advanced 1 micron VLSI bipolar process, and is the first 1 micron process commercially available.**

TRW LSI PRODUCTS
An Electronic Components Division of TRW Inc.

Business

Automation may erase offshore edge

Chipmakers debate return to U. S. as labor costs rise in Asia and packaging becomes more mechanized

by J. Robert Lineback, Dallas bureau

A mixed bag of international politics, factory automation, rising world wage rates, and greater chip complexities clearly promises to alter the role of offshore semiconductor assembly operations in the 1980s. But predictions of exactly what those changes might be remain worlds apart.

Since the 1960s, Third World assembly plants—many located in Southeast Asia—have provided U. S. companies with pools of low-cost labor essential to remaining competitive in crowded global markets. However, with the prospects of higher levels of mechanization, a number of industry leaders believe once-labor-intensive work may soon be returning to the United States.

U. S. assembly plants, many suggest, will not only reduce the distance between wafer fabrication and packaging operations, but they will also lessen turnaround times, costly inventories, and investment risks.

The need for domestic assembly work also promises to increase as the electronics industries place more emphasis on low-volume semicustom and custom components.

Despite international inflation, rising Third World wages, and the potential for political unrest, a large number of American industry leaders continue to scoff at notions of a retreat from offshore production dependency. Some go even further to suggest a greater reliance on foreign factories, with wafer-fabrication lines soon moving closer to developing new markets, such as in Southeast Asia.

However, each new level of automation brings up the issue of onshore assembly, says Donald L. Elam, president of Stanford Microsystems International, the U. S. marketing arm of subcontract assembler Stanford Microsystems Inc. in the Philippines. "That topic seems to come up about every six months,"

Elam says. But each time it studies the issue, Stanford Microsystems concludes it remains advantageous to automate existing assembly lines in the Philippines, where labor costs still remain relatively low and its operations can run six days a week.

On the other hand, automation, faster turnarounds, and greater plant security were all factors influencing

Indy Electronics Inc. to locate its integrated circuit subcontract assembly operation in Manteca, Calif., explains Jacob Ratinoff, president, who has been involved in offshore production for years. "I believe that by being in the U. S. we can offer fast turnaround since we are closer to the U. S. fabrication facilities, and we can offer assurance that we don't have revolutions and we don't have typhoons. We also have the highest quality through automation." Business has been so good for the year-and-a-half-old subcontract assembler that it plans to boost employment from 400 to 1,500 by 1983, Ratinoff says.

Togetherness coming. At Mostek Corp. in Carrollton, Texas, where over 90% of IC assembly is done overseas, president Harold L. Ergott Jr. says he expects to see assembly work move closer to U. S. wafer production. "I don't think that you will see that in the next four or five years, but with time, we are going to see those areas [Third World nations] developing high standards of living," he explains. "Labor rates are going to go up, and there will be a point in time that there is going to be a crossover between the cost of doing business in some of the less developed countries and high levels of automation here in the U. S. There's nothing that says a semiconductor cannot go from a wafer to a completed unit—assembled and tested—on a totally automated line. I do expect that there will be a time, and certainly this century."

Motorola Inc. is reportedly considering increased domestic assembly with the construction of a new highly automated IC plant. However,

Getting it together. Workers at Texas Instruments plant in the Morazan Free Economic Zone in El Salvador on the assembly line. Automation could change offshore job patterns radically.



Introducing the world's fastest logic analyzer. Incomparable.

500 MHz for debugging mainframes and super-minis.

Now you can dramatically shorten the debug cycle in high-speed random and stored program logic design with our powerful new 500 MHz, 8-channel K500-D. With state-of-the-art 16-bit microprocessor control, 2K static RAM memory and GPIB interface for fully-automated operation, the K500-D is the industry's most advanced integrated test tool for the digital designer.

Resolution to 2ns.

Clocking via internal time base, or with your superfast system clock, the K500-D gives you the best timing resolution available in a logic analyzer today. Glitches, transitions and other critical events can be

captured and sampled every two nanoseconds. You can even track a channel of analog activity at the same time for troubleshooting analog/digital interface, or for high speed cause-and-effect relationships. Two trigger levels gives you precise data trapping

Advanced probe design.

Our probes were designed for high performance to cope with the speed and complexity of large systems, as well as complement the super high speed of the K500-D. Now, with 6-foot probes and hybrid buffering circuits in each probe tip, you can conveniently debug even the largest systems with minimum disturbance. With our unique scroll mode, you can probe hard-to-reach test points individually and build your timing diagram one channel at a time

Legendary ease-of-use.

Our new K500-D is even easier to use than our best-selling K100-D... and that's saying something. Its status and data displays permit easy, flexible programming and data analysis. You can expand horizontally X10, X20, or X50, and specify the display format in binary, octal and/or ASCII.



You owe it to yourself.

Any designer debugging mainframes or super-minis deserves full details on this revolutionary new logic analyzer. Write Gould, Inc., Biotration Division, 4600 Old Ironsides Drive, Santa Clara, CA 95050. Or call (408) 988-6800.

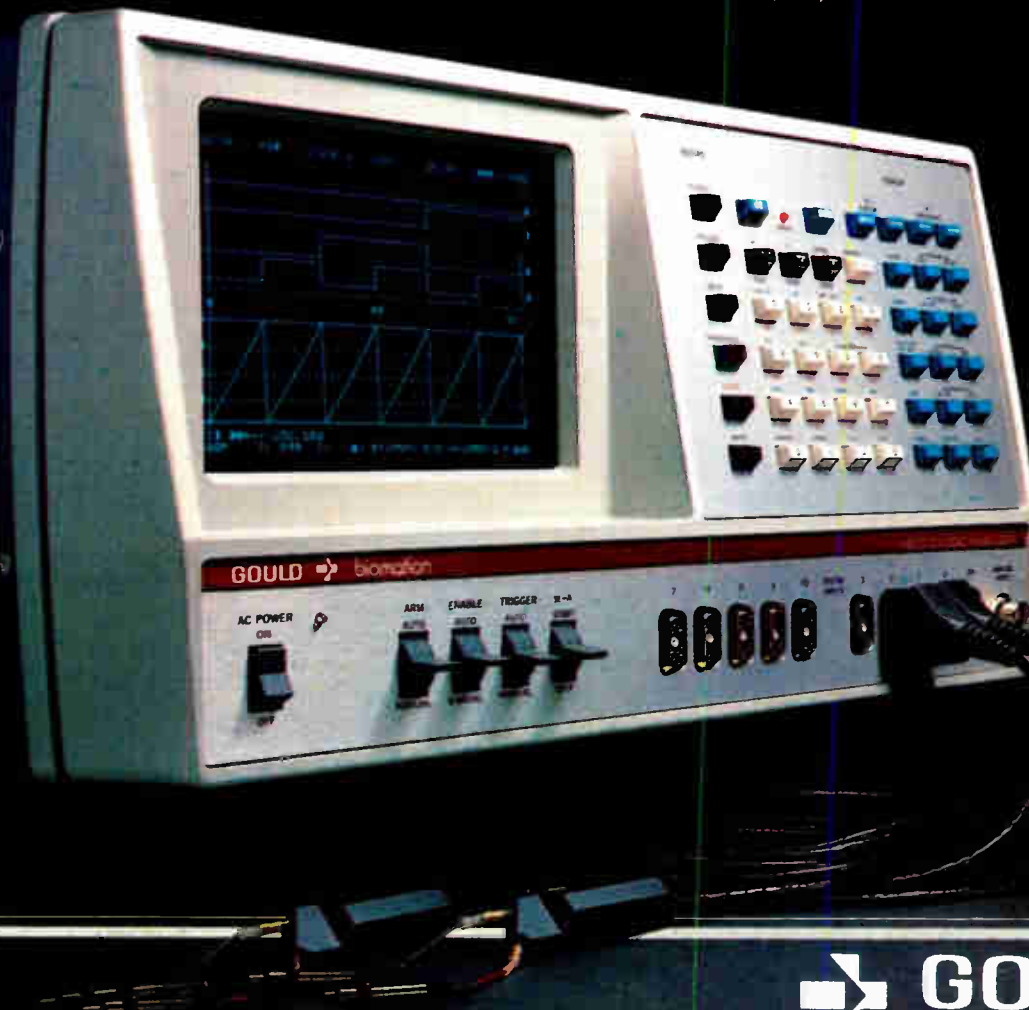

"We Bring You Freedom of Speech"

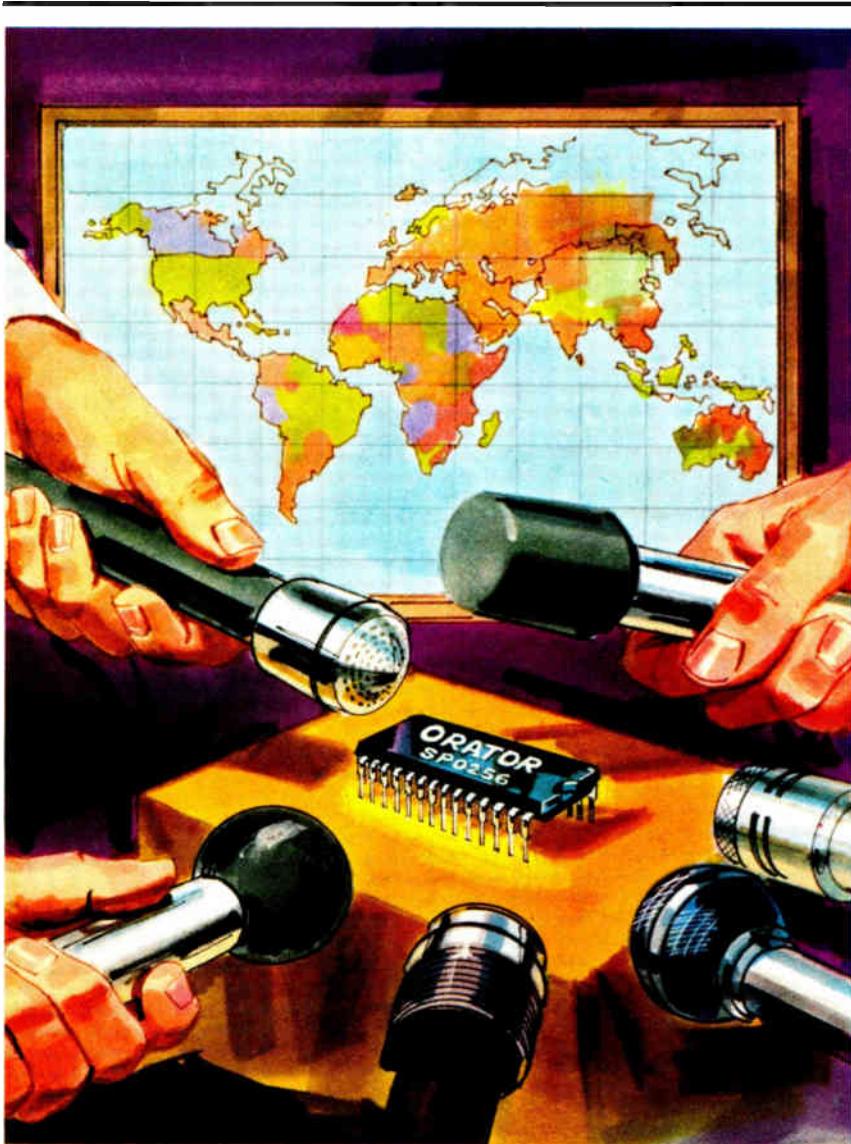

And the Orator™ line of speech synthesis products from General Instrument brings you freedom of choice, offering speech the way you want it.

Versatile Product Line

You can choose from a full range of speech synthesis products...a stand-alone, single chip speech processor, a complete voice synthesis module, add-on memory circuits, and control logic interface chips. Whatever you need to meet your application requirements.

The Orator SP0256 single chip synthesizer is easily interfaced with microcomputer/microprocessor based systems directly or through General Instrument interface chips. Its vocabulary can easily be expanded with your choice of 16, 32 and 128K add-on serial speech ROMs.

The Orator VSM2032 speech module needs only a power source and speaker to start talking.

Versatile Coding Techniques

Whichever speech system you select — single chip or complete module — General Instrument will provide speech the way you want it. For maximum human likeness, our Linear Predictive Coding (LPC) techniques give unsurpassed performance. And now for even larger vocabulary requirements, we offer an entire Allophone speech library on the SP0256 single chip.

Why not give your product a new dimension — speech from General Instrument. The way you want it. Call the office of the Microelectronics Division nearest you.



We help you compete.®

GENERAL INSTRUMENT

Sales Offices USA: CA, 213-322-7745 or 408-496-0844; FL, 813-577-4024; GA, 404-588-1375; IL, 312-981-0040; IN, 317-872-7740 or 219-291-0585; MI, 313-391-4070; MD, 301-269-6250; NH, 603-424-3303; NY, 516-733-3107; TX, 214-934-1654; EUROPE: London, 01-439-1895; Munchen, (089) 27 24 049; Paris, (1) 365 72 50; ASIA: Hong Kong, (5) 434360; Tokyo, (03) 473-0281.

Probing the news

Semiconductor Sector officials in Phoenix decline comment.

Meanwhile, Texas Instruments Inc. is pushing forward with its plans to install its first state-of-the-art wafer-fabrication line in Southeast Asia. The project, slated for Singapore in the next few years, is in line with the Dallas firm's efforts to establish semiconductor production lines in key geographical regions around the world. For years, TI has relied heavily on offshore fabrication lines in critical European and Japanese markets.

Taking a look. Intel Corp. of Santa Clara, Calif., has "toyed with the idea of putting wafer fabrication facilities offshore," says Eugene Flath, vice president and assistant general manager of the Components Group. "But this is a long, long program." Flath says no definite plans for offshore fabrication have been made, with the exception of a facility scheduled to open in Israel.

Many of the developing nations are now building their own electronics bases and may soon become the "new Japans," suggests Warren Davis, director of government affairs at the Semiconductor Industry Association. "It has come a long way since 1963 when Fairchild went into Hong Kong to do lead bonding," he recalls. "And in some of the countries, they have totally integrated their electronics with semiconductor operations and are now turning out black and white television sets."

Despite the continuing debate over long-term effects of automation, and rising offshore labor costs, most American firms continue to update assembly plants worldwide, says C. Scott Kulicke, president of Kulicke & Soffa Industries Inc. in Horsham, Pa. "If you are talking about the merchant suppliers, I would guess that probably between 85% and 95% of all devices are assembled offshore," he estimates. "It's been that way for 10 to 15 years and to me it doesn't look like it's going to change that quickly."

Not only are American firms continually updating assembly lines, but they are also rapidly installing burn-in ovens and final testing equipment

so that shipments can be made from the plant directly to the customer—many of which are also offshore. "Certainly, they are getting away from just 'pure' assembly overseas in the low-cost labor areas," observes Jim Mulady, test systems marketing manager for Fairchild Camera & Instrument Co., San Jose, Calif. "A lot of companies are moving final test into offshore assembly plants. In the short term, I think you'll see an acceleration of that."

Satellite link. RCA Corp., which is already testing devices in its Southeast Asian plants, is planning to use satellites as a way of linking offshore test computers with a central U. S. site at its LSI test operation in Palm Beach Gardens, Fla., says Joe Rauback, manager. Test programs then could be updated every 24 hours for the Fairchild Sentinel testers. Currently, changes in test programs are loaded on a disk or tape and then shipped to the plant. "It takes approximately three weeks from the time the program is updated to the time it's on line," he says. "That could be shortened to 24 hours."

At Eaton's Corp.'s semiconductor

U.S.	8.09
Mexico	1.54
Hong Kong	1.26
South Korea	1.10
Singapore	1.00
Taiwan	.90
Philippines	.62
Indonesia	.45

Figures from Integrated Circuit Engineering Corp.

equipment operation, James Bowen, vice president, says, "I think you will have a mixed review. My own feeling is that there is a high degree of patriotism setting in, which is good. But a lot of the statements made by people lately about automation solving all of their problems are probably premature. There are a lot of facilities in Southeast Asia and they cannot just abandon them."

Bill Bottoms, president of the Semiconductor Equipment Group at Varian Associates in Palo Alto, Calif., says automation will lessen emphasis on inexpensive labor, and he doesn't expect to see "a new push

into the next round of low-cost labor areas." Robert Graham, senior vice president of Applied Materials Inc., agrees, suggesting that future offshore plant locations will be linked more closely to key customer bases than they were in the past.

Joe Dibene, a consultant who also helps coordinate construction of offshore electronics plants, has "chased low-cost labor around the world" for his clients. Now he says, "I've reached the conclusion that it's not necessarily the problem anymore. The real issue is that not only do you need low-cost labor these days, but you must find ways of reducing materials costs." That can be done, he says, by Asian sourcing and more sophisticated automation, as well as low-cost labor.

Part of the current push to automate offshore facilities stems from rapidly increasing wages, says William I. Strauss, director of the Communications Group at Integrated Circuit Engineering Corp. in Scottsdale, Ariz. Strauss, who visited plants in the Far East last fall, estimates that on the average, semiconductor assembly wages in Southeast Asia have been climbing at 20% a year. "Of course, they are still much lower than in the U. S., but the rise is causing some subcontract assembly firms to move into other areas as well," he notes. "What we are seeing is that many of these houses are going into less-labor-intensive high-value types of services."

Keeping up. Like most contract assemblers, Dynetics Inc. has entered the testing business and increased automation throughout its Manila plant. Jerry Cheney, vice president for engineering and marketing in the U. S., says he expects to see some assembly work move back, but more complex chips and low-volume devices will be the root of that trend. Anthony Perrotta, president of Amkor Electronics Inc. in Valley Forge, Pa., says his firm is using increased levels of automation in its Korean plants as a means of keeping up with the more complex commodity chips appearing on today's market. "In many cases we make the capital decisions based not specifically on cost but rather on the need to maintain and optimize our quality level," he says. □

Electronics abroad

Buzzword in Taiwan is 'information'

Government helps consumer-oriented companies switch to ICs, computers, software, and telecommunications

by Robert Neff, Tokyo bureau

Taiwan's large consumer-oriented electronics industry is embarking on a major transformation. With strong guidance from the government of the Republic of China, the industry is putting far more emphasis on data processing, where growth will be faster, profit margins healthier, and employment opportunities greater for an increasingly sophisticated labor force. Not only will local companies become more innovative [*Electronics*, March 10, p. 100], but they will move much more aggressively into technology and development agreements with foreign firms.

In December, the National Economic Development Conference designated information, along with machine tools, as one of the nation's two strategic industries. "Information" is defined as integrated circuits, computer software and hardware, and telecommunications. The designation means a lot in a centrally planned economy like Taiwan's, where about half the capital spending is by the government.

Indeed, one recently adopted government plan calls for the expenditure of \$1.3 billion over the next seven years to help develop the information industry. Much of the money will go toward installation of 10,000 computers throughout the country, which as recently as June 1979 had only 761 operating computer systems. Through other programs and institutes the government is spending

in a variety of ways to train engineers and technicians, develop software design techniques, design, manufacture, and test mini- and microcomputers and integrated circuits, and provide research and development and investment incentives.



Fast growth. Chintay Shih, vice president of electronics trade group, says IC sales should come back this year after only modest growth in Taiwan's sluggish 1981 economy.

"For the electronics industry as a whole, the labor-intensive stage is gone," explains Shih-chien Yang, deputy director of the sectoral planning department in the government's Council for Economic Planning and Development. "Quality and diversification is the most important now." Yang supervised the creation of a 10-year electronics industry development plan that supposedly started in

1980 but is only now getting under way. The study comprises various measures to boost electronics production to \$3.25 billion in 1989 from \$840 million in 1979, while shifting the product mix to telecommunications, computers, and semiconductor production.

Signs of incipient change in Taiwan's electronics industry are already cropping up briskly:

- The domestic computer market is growing at an average 40% per year and a U. S. Department of Commerce-supervised study in 1980 projected a \$115 million domestic market in 1982.

- Export of microcomputers has already started, and one study forecasts total computer exports of \$360 million by 1985.

- Taiwan's first commercial IC fabrication plant, 100% locally owned, began operating in February.

- The government expects to achieve standardization

of the internal code for Chinese-character computer input sometime during the course of 1982.

- Several local firms have recently developed and started marketing their own Chinese-language computer system and terminals, monitors, and emulators.

Computermania. "Nowadays in Taiwan, everyone wants to get into computers as a new direction of investment. It seems to be the coming thing," says Yvonne Kwoh Ni, general manager of Management Data Systems Ltd., one of the doz-

Probing the news

ens of small software houses that have sprung up in the past few years. Most outside experts think the trend is healthy. Says an American economist based in Taipei, "What they can do is take existing technology and improve it, as Japan did 10 to 15 years ago. Once they get their feet wet in that kind of product development, they can get more innovative."

Integrated circuits are an example of cooperation with foreigners. In 1976, the government's Electronics Research and Service Organization licensed complementary-MOS design and production technology from RCA Corp. After several years of working with the technology, ERSO transferred it to United Microelectronics Corp. in return for a 10% share in the company. United, with \$21 million in capital, opened Taiwan's first commercial IC plant in February.

Higher tech. With a capacity of 28,000 four-inch wafers per month, the plant is producing C-MOS and n-channel MOS chips for watches, calculators, and telephone dialers. "Starting from our second year, we expect to introduce more advanced products," says president Robert Tsao, a former deputy director of ERSO.

Sales in the first year will be aimed mainly at domestic and Hong Kong markets, with entry into the U.S. planned for late this year. Tsao's sales target is \$6 million this year and \$15 million to \$20 million in 1983, 80% of which will be exports. He hopes to be profitable by then. "Yieldwise, we won't be inferior to any other IC producer in the world," Tsao claims.

Taiwan's current annual IC market totals about \$100 million and had been doubling every year until 1981, says Chintay Shih, deputy director of ERSO. Growth was very modest last year, reflecting a generally sluggish economy, but should rebound this year, Shih adds. "It's not necessary to enter high-technology fields like memory devices and microprocessors," says Hsin S. Lin, editor of ERSO's electronics development monthly. "Mature products are more profitable."

Taiwan Automation Co., flagship

UNIVERSAL ACTIVE FILTER...

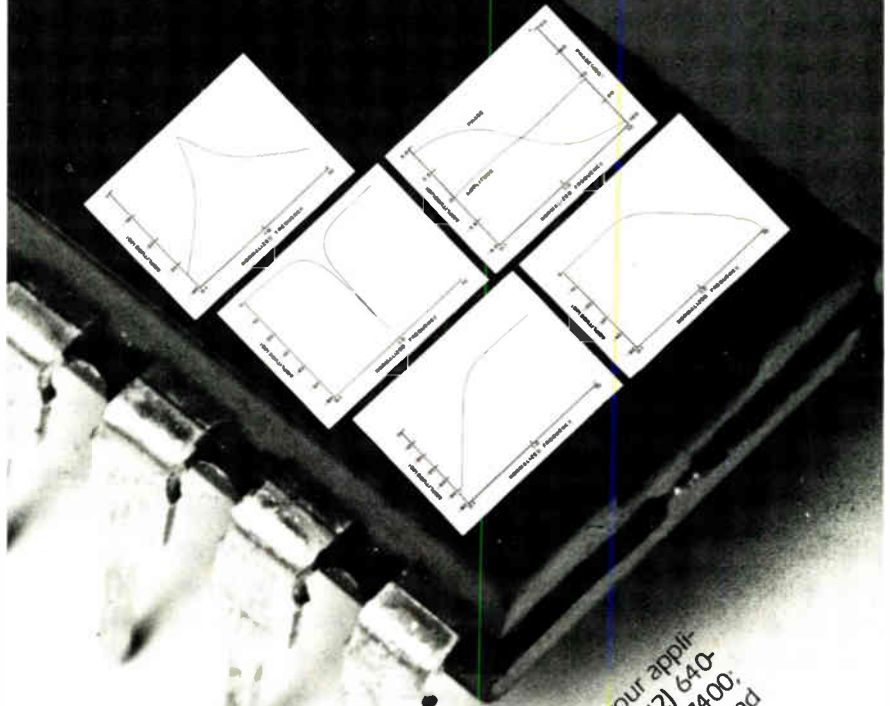

The R5620 is a unique second order UNIVERSAL ACTIVE FILTER packaged in an 18 pin DIP. Designed for the novice and experienced filter user alike, the device provides for simple digital selection of frequency, Q and filter type without the need for any external components or the need to solve equations. This device is the latest in a series of standard products available from RETICON using Switched Capacitor Filter Technology.

When looking for solutions to your filter needs, consult RETICON for off-the-shelf standard products or custom design and manufacturing.

Contact us on your application at Chicago (312) 640-7713, Boston (617) 745-7400, Japan (03-343-4411), England (0734) 790772, Germany (089) 918-060. Head office, G&G RETICON, 345 Potrero Avenue, Sunnyvale, California 94086; Telephone (408) 738-4266.



EG&G RETICON

System 5700 is a complete fiber-optic analog link of instrumentation quality. It has 1 MHz bandwidth and $\pm 0.2\%$ DC accuracy.



This is a self-contained data link with outstanding analog performance. It is exceedingly simple to use, consisting of two small modules connected by a fiber-optic cable ... which we will supply in any length, made up with mating connectors. Cabling without repeaters is practical up to two kilometers.

Our considerable experience in accurate F/O transmission of analog data is an important resource. There's a lot going on in fiber-optics at DMC, and we'd like to tell you about it. Please send for *Analog Link Design Data*.



Dynamic Measurements Corp.

8 Lowell Ave., Winchester, MA 01890. (617) 729-7870. TWX (710) 348-6596

Call our toll free number 800-225-1151.

Probing the news

of the country's largest data-processing conglomerate [*Electronics*, Feb. 10, p. 14], is also growing with outside help. Born as the local distributor for Intel Corp., the six-company group now takes in about \$35 million per year. Although Taiwan Automation has developed its own Chinese-language input terminals and software, it uses Digital Equipment Corp. minicomputers for its central processing units and Perkin-Elmer disk drives. Group chairman Matthew F. C. Miao claims to have sold more than 300 Chinese-language processing systems to date, including about a dozen to Hong Kong and Singapore.

Giant's steps. Tatung Co., Taiwan's largest electronics company, has lagged behind some more entrepreneurial firms in entering the information market. But president W. S. Lin reveals a host of plans, many of which involve Western partners. That the conservative, consumer-oriented Tatung is adopting such a strategy is strong evidence of the basic shift occurring in Taiwan. This year alone, says Lin, Tatung will:

- Establish a software house in a venture with a small U. S. company to write application packages and provide system support to purchasers of Tatung computers (now sold to original-equipment manufacturers).
- Start marketing a Tatung-designed and -developed personal computer, announced several years ago.
- Announce development of a mini-computer by a Tatung engineering group working in California.
- Decide on a U. S. or Japanese licensor for IC technology or a joint venture partner so Tatung can supply its own IC needs.

In addition, Tatung late last year opened a plant in Taiwan with Algol Technology Inc. of Redwood City, Calif., to produce video monitors and analyzers and computer terminals for export. Tatung is also designing its own Chinese character input terminal and plans to start exporting computer peripherals. Lin says he wants more than 10% of Tatung's sales to come from computer and IC products by 1985. Sales for 1981 are estimated at \$600 million. □

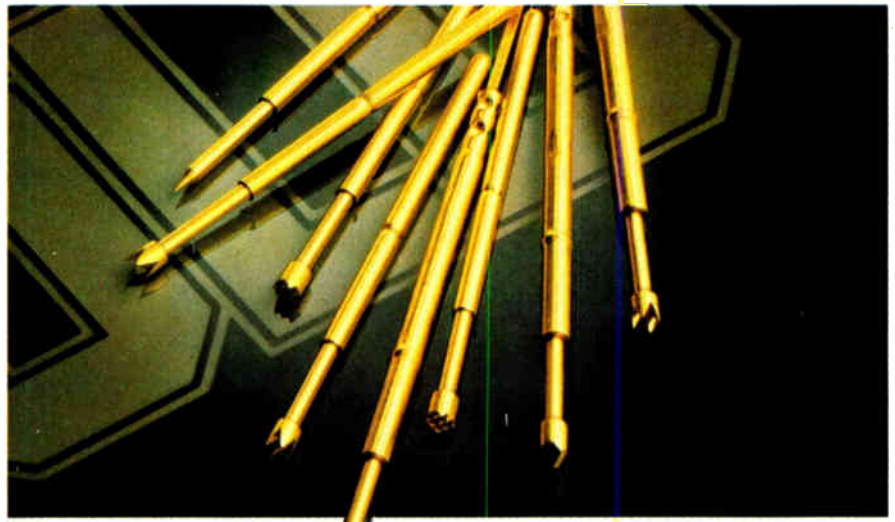

Fairchild Gold. Tough probes for your toughest tests.

Even in the toughest applications, user reports and our own tests show the Fairchild probe tip, plated with 50 millionths of gold, to have a consistent pattern of superior performance compared to other types of probe tips. We give you the largest diameter spring in the industry for dependable electrical contact and longer spring life. You get the closest possible tolerance between each component of the probe-receptacle set, and the receptacle will handle repeated probe replacements while retaining its tight fit to insure reliable continuity during testing.

Fairchild Test Systems / Mechanical Division

FAIRCHILD One Fairchild Sq.
Clifton Park
New York 12065
A Schlumberger Company 518-877-7042

Make your own tests with Fairchild's free samples. Send your request on your company letterhead and we'll send you our sampler pack which includes every tip style. You can request rhodium-tip samples, too. Go for the gold.



Circle 99 on reader service card

WORLDWIDE ELECTRONICS MARKETS

Electronics' highly respected 24th annual market forecast has been expanded to provide a 65-page in-depth look at the current and future demand for more than 800 electronic component and equipment products in the USA, Western Europe, and Japan—including 23 additional pages of market-estimate and growth-rate tables. Order today for immediate delivery of the *Electronics 1982 World Markets Forecast Data Book!*



Payment of \$150 (USA orders add local tax) must accompany order to: *Electronics Magazine Books*, 1221 Ave. of the Americas, New York, NY 10020 USA. Pro forma invoice will be sent upon request. Price includes first-class or air shipment.

Displays

SID to spotlight flat panels

Society for Information Display meeting to focus on liquid crystals and their thin-film drivers

by Roderic Beresford, Solid State Editor

When it comes to display technology, the solid state is not the only one worth watching—experts in all the phases of matter will be on hand in San Diego, Calif., May 10–14 for the 1982 meeting of the Society for Information Display. Thin films will lie down to help drive displays or emit light, gas discharges will glow, and liquids—the crystalline kind—will twist and turn in a variety of useful dances.

Nearly half of the 20 technical sessions will be devoted to flat-panel displays and their drive electronics. Though no single technique will receive all the attention, liquid crystals are clearly favored, and dozens of researchers will discuss thin-film-transistor arrays for driving dense matrixes of the low-power cells.

Still, plasma and electroluminescent panels will also be out in force, and one of the evening sessions will weigh the relative merits of these two types. The high-voltage drivers for these displays are now joining standard logic devices on silicon integrated circuits to make more compact and economical systems.

The venerable cathode-ray tube will not be lacking support either, as five sessions explore the advancing state-of-the-art projection-television systems, flight simulators, and even flat tubes. Rounding out the picture will be sessions on video disks, printers, and the man-machine interface.

Leading off the diverse presentations will be a keynote address by Francis Ford Coppola, the noted film director who is pioneering the all-electronic cinema at his Zoetrope Studios. "Zoetrope makes extensive use of video display technology to add flexibility in the production of

feature films," says Michael Lehmann, manager of electronic cinema at the Hollywood, Calif., studios. Zoetrope uses the HDTV (high-density television) system that was developed by Sony Corp. and CBS Corp. for 1,125-line high-resolution video.

"We can instantly monitor what we shoot on a video system that has resolution approaching that of film," adds Lehmann. The film makers do trial editing with the video tapes, and the system keeps track of the corresponding film frames for the final production. Furthermore, scripts are edited on word processors, and video tapes of any scene may be called up on the same display for quick production decisions.

Besides the instant feedback of

video monitors, Coppola also envisions high-resolution computer graphics capabilities for special effects. All in all, the talk will be highlighting a wealth of new display applications in the cinema.

Behind the picture. Meanwhile, the regular sessions will delve deeply into the basic technology that will support these coming generations of sophisticated display systems. Flat panels continue to receive intense scrutiny, with liquid-crystal varieties currently seen as the ultimate favorite for their low power consumption.

Much work on LCDs is aimed at getting around the multiplexing limitations on display size and at driving the dot matrixes efficiently. A static (that is, nonmultiplexed) addressing

SIGNIFICANT PAPERS ON FLAT PANEL TECHNOLOGIES AT SOCIETY FOR INFORMATION DISPLAY CONFERENCE		
Papers	Subject	Company
10.1, 10.2	Photoconductor-addressed electrophoretic displays resolve 100 to 250 lines/in.	Tektronix, Xerox
10.5	Viologen-based electrochromic cells withstand 10 ⁶ cycles.	Mitsubishi
12.4	Ac electroluminescent display's threshold reduced below 50 V.	NTT
12.6	Dc electroluminescent display built on silicon.	IBM
15.1	512-by-1,024-dot dc plasma matrix operates with 30-V drive.	Sony
15.2	1-m ac plasma panel has 1,200 by 1,600 dots.	Photonics Technology and Magnavox
16.6	Interconnection method doubles liquid-crystal display driver's capacity.	Bell Labs
16.7	Liquid crystals are addressed without multiplexing.	Asulab
18.1, 18.2, 18.3	Channel-electron multipliers yield flat CRTs.	Philips
18.4, 18.5	256-by-256-dot vacuum fluorescent panels achieve 60-to-80-line/in. resolution.	Ise Electronics, Naruma China Corp.
20.2	Lasers address 2,000-by-2,300-dot liquid-crystal matrix in projection display	IBM
20.7	Charge-coupled device addresses 256-by-256-dot liquid-crystal array.	Hughes

SYSTEM SUPERCHARGER

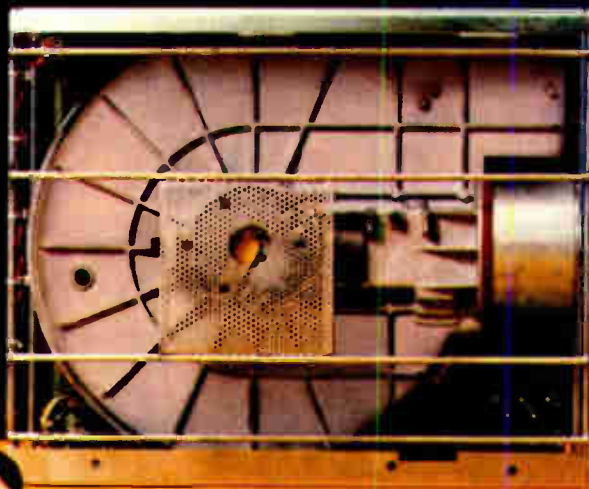
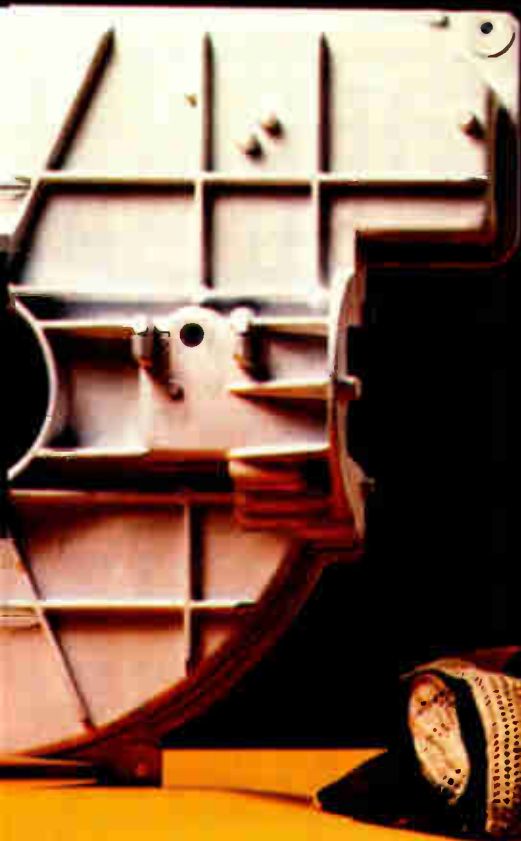

PRIAM's 158-megabyte Winchester Disc Drive

Supercharge your system performance with the 158-megabytes-per-unit capacity and fast voice-coil head positioning of PRIAM's DISKOS 15450. Multi-user and multiprocessor systems put demands on database size and response that only a high-performance Winchester disc drive like the DISKOS 15450 can satisfy.

PRIAM's 14-inch disc drive design has been proved in thousands of units shipped. It weighs only 38 pounds, and its brushless DC motor drive makes the DISKOS 15450 as mechanically simple as the turbocharger it resembles. No belts, no pulleys, no mechanical brakes. Compare the low price of the DISKOS 15450 with comparable drives. You'll agree that its cost/performance is far ahead of the pack.

All three PRIAM 14-inch drives, with capacities of 34, 68 and 158 megabytes, are

only 7" x 17" x 20" in size, including the optional power supply. They all have the same 1.04 megabyte/second data rate, and operate from the same interfaces. Standard PRIAM or optional SMD, ANSI or SMART/SMART-E Interfaces make integration of these high-performance drives into your system quick and easy.

PRIAM 8-inch drives have capacities of 11, 35, and 70 megabytes, with the same interfaces and the same grand-prix performance characteristics as PRIAM's 14-inch models.

Find out now how to get your systems into the pole position. Call or write today to:



PRIAM

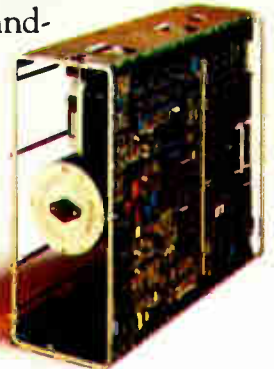

3096 Orchard Drive, San Jose, CA 95134 (408) 946-4600 TWX 910-338-0293

Other PRIAM
Sales Offices:

Boston
(617) 444-5030

New York
(201) 542-8778

Chicago
(312) 961-9654

Los Angeles
(714) 994-3593

Circle 101 on reader service card

VACTEC

SILICON PHOTOVOLTAIC DETECTORS

VACTEC photovoltaic cells are large area detectors, available **BLUE ENHANCED, LOW CAPACITANCE AND SOLAR** processes. Characterized for I_s and max. capacitance for **LOW CAPACITANCE** series.

VACTEC BLUE ENHANCED detectors with high radiometric sensitivity in the uv as low as 200nm with .16 typical and .1A/W minimum at 365nm. These large area devices (up to .8x.8 inch) are ideal for low level color separators, spectrophotometers and colorimeters. Vactec's care in processing provides stability in the uv (below 400nm) normally only found in small junction photodiodes.

VACTEC LOW CAPACITANCE cells have fast response. A .2x.2 inch cell, operating in the photovoltaic mode has rise/fall times less than 15 μ s with a 10K Ω load. For optical encoders, remote control and optical communications, smoke detectors, laser surveying and presence detectors.

VACTEC SOLAR process cells have high V_{oc} at low light levels. At 1.0fc (.05mW/cm²) typical V_{oc} is 200mV.

VACTEC Photovoltaic detectors are available as chips, with flying leads, mounted or in custom assemblies to your specifications. Single cells, duals and multiple cells in many standard sizes up to 1.25 inch diameter. Request Bulletin VTS4000.

**VACTEC,
INC.**

10900 Page Blvd.
St. Louis, MO 63132
(314) 423-4900
TWX 910-764-0811

Probing the news

technique will be demonstrated by Asulab in session 16. The Neuchâtel, Switzerland, laboratory says that the method is applicable to all types of crystals and yields better contrast, viewing angle, and response time than multiplexed driving.

Top density. One of the densest liquid-crystal panels ever will be displayed at session 20 by International Business Machines Corp.'s San Jose, Calif., research laboratory and General Products division in Los Gatos, Calif. A reflective smectic crystal for projecting images with a resolution of 2,000 by 2,300 picture elements is addressed by the heat from laser pulses. Eight gallium-aluminum-arsenide emitters scan the array through a fiber-optic cable assembly.

Building LCDs atop an array of passive or active control devices promises to extend the resolution of multiplexed displays to hundreds of dots. General Electric Co. of Schenectady, N. Y., will demonstrate a 180-by-240-dot matrix that is addressed through zinc oxide varistors. These devices are simpler to fabricate than thin-film transistors. Still, an array of transistors can yield much better performance. To achieve those benefits economically, the key is to fabricate active devices on cheap glass substrates. Many attempts to improve thin-film transistors produced that way will be shown in session 7.

Single crystals. Though more expensive than thin films, single-crystal silicon substrates are, of course, far more fully developed. Hughes Research Laboratories of Malibu, Calif., will show a 256-by-256-pixel LCD at session 20 that is controlled by a 1-square-centimeter chip of MOS charge-coupled devices.

Economical drive electronics have also been a stumbling block in plasma-panel development. Although the panels themselves are inexpensive to produce, the high voltages that are needed to drive the displays have required bulky and expensive discrete drive electronics.

Fabrication technology for integrating high-voltage MOS field-effect transistors with logic circuits is being studied by several companies [*Elec-*

tronics, Nov. 30, 1981, p. 108]. Those reporting on it in session 21 will include Texas Instruments, of Dallas, Telmos Inc., Santa Clara, Calif., Supertex Inc., Sunnyvale, Calif., and Hycom Inc., Irvine, Calif.

With widespread progress in driver technology, display makers are motivated to push ahead the basic panel techniques as well. Among the impressive advances that will be discussed in session 15 will be a 1-meter ac plasma panel. Custom-display producers Photonics Technology Inc. of Luckey, Ohio, joined forces with Magnavox Electronic Systems Co. of Fort Wayne, Ind., to produce the giant screen with 1,200 by 1,600 pixels. Panels as large as 512 by 512 picture elements with resolution of more than 100 lines per inch are also slated for the talk.

Vying with this effort for the highest-resolution plasma panel will be Sony Corp., Tokyo. It has developed a 127-line-per-inch dc plasma panel with a matrix of 512 by 1,024 dots.

Though plasma technology thus looks able to compete with CRTs in text display, the information-display workhorse is hardly resting on its laurels of many years of service. New techniques include flat CRTs and projection TV systems with high resolution.

Hitachi Ltd. of Mobarra, Japan, will show a camera tube and CRT for projecting 1,125-line images on a 55-in. screen. Zenith Radio Corp. of Glenview, Ill., and Philips Research Laboratories of Surrey, England, will discuss high-resolution projection TV systems in session 11.

Size and power. Compared with conventional CRTs, those employing channel electron multipliers are lighter, smaller, and consume less power. Philips is well versed in this technology and will present three papers on it in session 18. It can achieve, for example, a 14-by-18-cm CRT just a few centimeters thick.

Session 9 on optical storage will provide several reviews of the status of laser recording on disks. In a novel development, Energy Conversion Devices Inc. of Troy, Mich., claims to have achieved an erasable optical disk, in which up to 1,000 write-erase cycles are possible using laser pulses. □

SPUR!

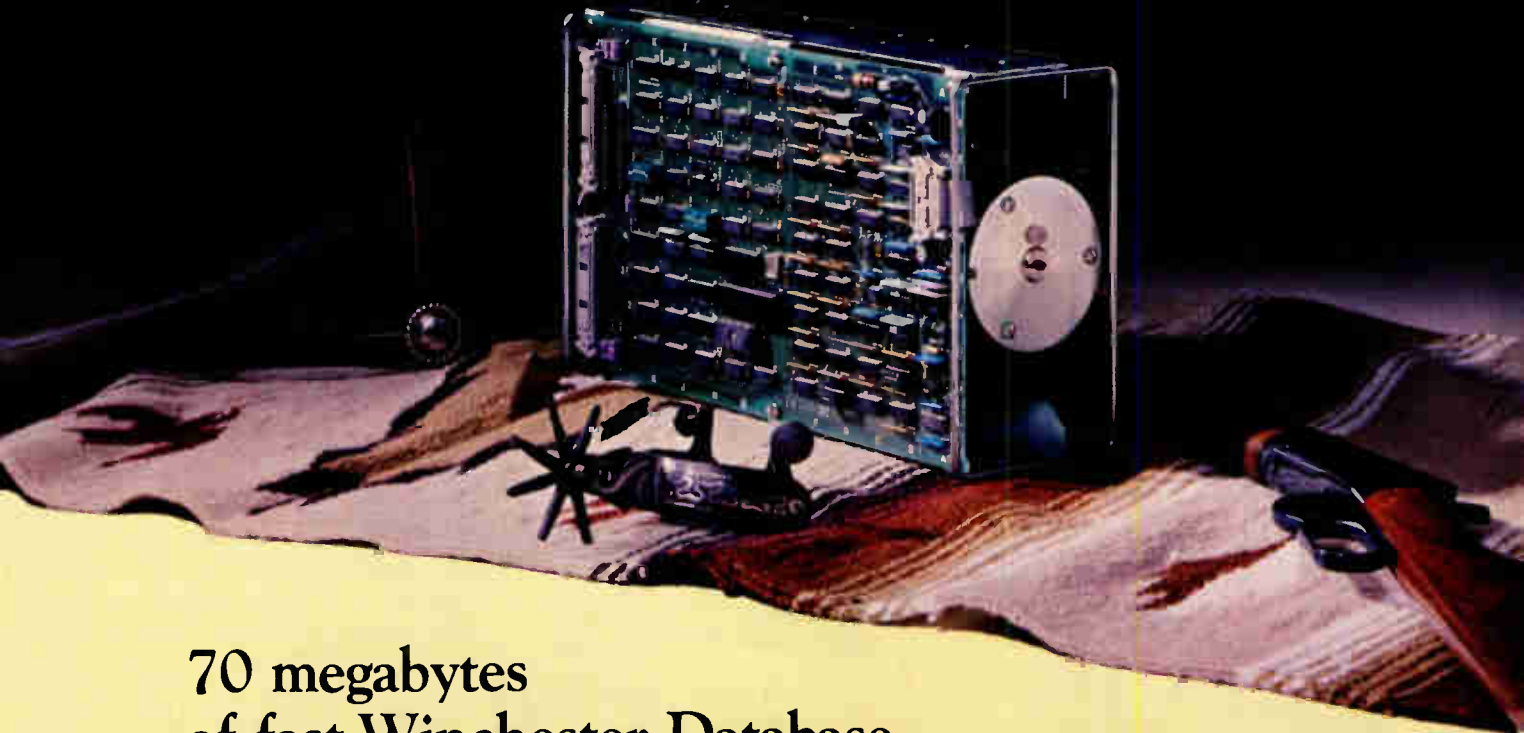

70 megabytes of fast Winchester Database to make systems respond

Systems respond faster, more powerfully, with PRIAM's DISKOS 7050 Winchester disc drive. As compact as a floppy disc drive, the 7050 packs 70 megabytes of database to make systems take off like a quarterhorse. A smaller-capacity, mustang version is also available in the 35-megabyte DISKOS 3450.

Shared-processor and multiprocessor systems react faster to user demands when spurred by the quick voice-coil data accessing of the DISKOS 7050. Pure and simple in design, the advanced technology 7050's use brushless DC motors to drive their discs. So they operate anywhere in the world with superb reliability.

PRIAM's interface permits you to groom your systems to user requirements, using PRIAM Winchester drives with capacities from 11 to 158 megabytes. ANSI and SMD interface options extend your systems integration freedom, and PRIAM's SMART and SMART-E interfaces can help to get your systems out of the gate more quickly.

Find out now how the DISKOS 7050 can get better performance out of your systems. Call or write to:



PRIAM

3096 Orchard Drive, San Jose, CA 95134 (408) 946-4600 TWX 910-338-0293

Other PRIAM
Sales Offices:

Boston
(617) 444-5030

New York
(201) 542-8778

Chicago
(312) 961-9654

Los Angeles
(714) 994-3593

Circle 103 on reader service card

"Market development? We have a planning

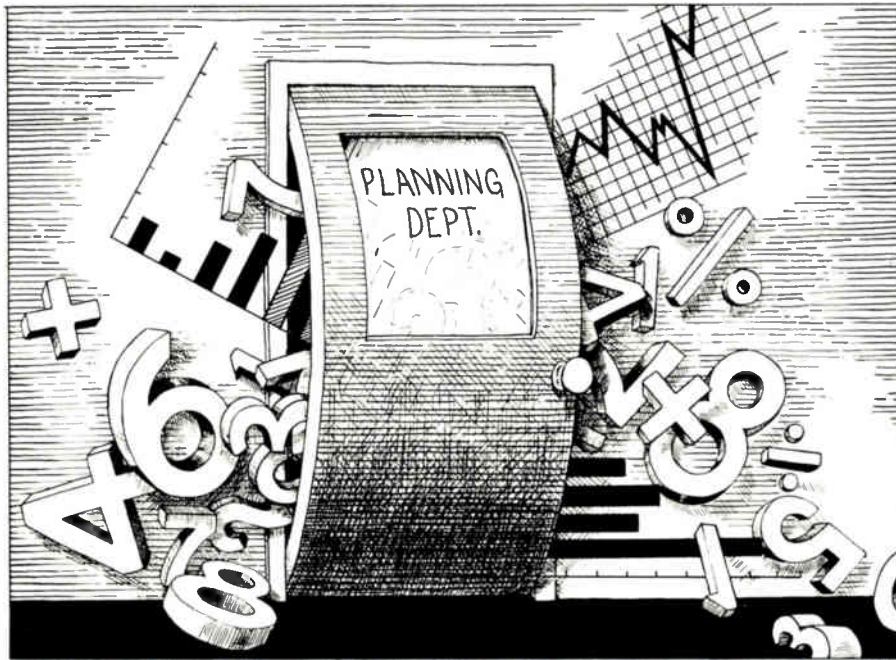

Three things
to consider about
long-range
planning and
market
development.

The key question on market development is: "Who is supposed to do it?" The planning department? The sales staff?

The fact is, most planning departments don't really do planning at all. They do statistics, projections, financial forecasts, trend extrapolations, and other ruler jobs. And most sales staffs do not do market development. They negotiate with *known* customers or prospects about *known* (usually close-in) requirements.

Thus, we pay our planners for trend data (but that's not planning) and our salesmen for orders (but that's not market development). Who will do the planning/ market development job? We hope you'll find some of our thoughts on this question constructive.

I The trouble with long-range planning.

Long-range planning is something everybody talks about, and very few do well. Long-range planning probably wastes more time and produces fewer results in our businesses than any other activity. Why?

- **The 5-year-plan syndrome.** We don't seem to be comfortable unless we have a 5- or 10-year financial forecast. So we get all balled up in statistics and sales/profit projections. We spend so much time massaging the numbers that we don't spend enough time really thinking about what we ought to do. And the more time we spend looking at those numbers, the more we tend to believe them—even though they weren't real in the first place. So if your banker or your board needs a 5-year plan, get out your ruler and give them one. That will leave you time to remember an important truth: We can forecast the future all we want, but that doesn't make it happen. *We have to go out and invent it.*

- **Starting at the wrong end.** In our planning, we usually start with what we are selling *now* (or what our competitors are selling) and try to figure out how much—and where—we can sell it in the future. What we *ought* to do is think about the possible world of the future, try to decide what will be needed or wanted, and then decide what we should do about it. We must stop internalizing our long-range goals ("How many ICs can we sell in 1987?") and start externalizing them ("What percentage of the factory cost of robots can we compete for with our technologies?").

department for that."

- "How's business?" "Don't ask." Our long-range planning and judgment is very much influenced by short-term business conditions. When we're hot, we hire people, build inventory, advertise like crazy, and produce spectacular 5-year plans. When we're cold, we play "keep the lights on" and our view of the future is mostly influenced by whether the telephone is ringing. When we're overbooked, our marketing people spend all their time expediting the factory. None of these situations is realistic. We must find a way to separate our growth objectives and activities from the day-to-day operation of the business.

2 The trouble with market development.

The main trouble with market development is that there just isn't enough of it. In electronics technology marketing, we find relatively few companies that have well-organized market development activities. Those that do seem to be the ones that are realizing the greatest growth and the highest profits. The payoff of market development shouldn't surprise us; we live in a business where the pace of technology provides new market opportunities almost every day. The trick is to identify and capture these opportunities. Proliferation, characteristic of the 1970's, will continue. Electronics technologies will continue to invade all kinds of industries, markets and applications where they are not an important factor today. This invasion will be led by microprocessors,

microcomputers and computers in the home, office and factory. This will not happen by accident. To achieve the growth that is possible, we must go out and force it to occur. That's what market development is all about.

3 Some suggestions.

If you don't now have a formal market development program or are not satisfied with the one you have, there are some things you might think about.

- **Start now.** It's the only way to expand your customer base, increase market share and position your company to achieve greater profits as business improves.
- **Organization.** Market development should be separated organizationally from the ongoing business. An organization charged with creating earnings per share has great difficulty pursuing future growth on a logical, consistent basis. If the same organization tries to do both, and business is good, then growth goals tend to become unrealistically high, and the budgets inflated. If business is lousy, growth programs get sacrificed in the name of short-term earnings.
- **Budgets.** Establish and review budgets for market development over a time period long enough to assure continuity of enterprise. The same period you use for your R&D budget is probably about right.

- **Objectives and goals.** Establish and communicate a concise set of objectives and activities. In general, the objective should be to build profitable new businesses on top of your present base. The activities should include identifying opportunities, prioritizing them, figuring out how the opportunity can be cracked and who the customers will be, matching capabilities and technologies to the opportunities, finding partners if required, and then going out and doing something.

- **Management.** The market development organization should report to the chief executive or chief operating officer. Otherwise it won't get the attention it deserves.

What's our angle?

We have two reasons for publishing these notes:

- Market development is the key to continued growth in the Electronics Technology Market. Advertising is a good, low-cost market development tool. If more companies get more serious about market development, Electronics will get more advertising.
- Companies with good market development programs tend to take a longer and more consistent view of their total marketing programs—including advertising. We don't like boom-and-bust any more than you do. Consistent advertising is good for Electronics.

Electronics

Where important people read important editorial 

This is the first in a series of advertisements on important marketing and advertising objectives for the 1980's. Your comments are welcome.

Electronics Magazine, 1221 Avenue of the Americas, New York, N.Y. 10020

Technical articles

THE PUSH TO SMALLER, DENSER DISK DRIVES

The seemingly insatiable demand for mass storage is fine-tuning every aspect of disk technology

by Tom Manuel, *Computers & Peripherals Editor*

□ As companies large and small race to computerize, their hunger grows for ever denser data storage occupying ever less physical space. Often, a low-cost microcomputer first whets a firm's appetite. Then, when it has successfully automated one function, it moves rapidly to automate the rest. At that point, a lot more storage capacity becomes necessary.

In response to this demand, suppliers of magnetic-disk drives are pushing hard to advance the state of their art. New materials, new ways of using those materials, and new drive mechanisms are emerging in a variety of new combinations. Some of these approaches are thin-film heads, thin-film-plated disks, vertical recording, and the application of big disk-drive head-positioning servos to the small drives.

Right now, flexible-disk drives (floppies or diskettes) come in two standard sizes, 8 and 5¼ inches in diameter. Their total storage capacities range from just over 100 kilobytes to 1.6 megabytes. Today's floppy-disk drives have track densities of 48 or 96 tracks per inch and linear bit densities ranging from about 2,500 to 6,800 bits per inch.

The 10-megabyte flexible-disk cartridge drive described in pages 117 through 120 by Roderick J. Linton of Iomega Corp., Ogden, Utah, pushes the state of the art in flexible disks. The Alpha 10, as it is called, combines the speed and reliability of hard disks with the convenience of removable storage. A unique head and disk interface achieves a linear bit density exceeding 24,000 b/in. and a track density of 300 tracks/in. However, at such a linear density, error correction becomes critical, and the article gives details of the efficient error-correcting scheme developed.

Hard-disk drives with much larger capacities and faster access come in three popular sizes—14 in. in diameter for medium-sized and large computer systems and scaled-down 8- and 5¼-in. diameters for today's prolific small computers. Capacities range all the way from

2.5-megabyte 14-in. cartridges and 5-megabyte 5¼-in. Winchester types up to the IBM 3380 and Storage Technology Corp.'s 8380 at 2,500 megabytes. Track densities of the smaller (5¼- and 8-in.) hard disks average about 200 to 300 per inch, using open-loop stepping-motor positioning mechanisms. Bit densities on the smaller drives range from 5,800 to 8,600 b/in.

On the very large disks, used in conjunction with dedicated closed-loop voice-coil positioning systems, track-per-inch densities are 800 or higher. Bit densities on the big hard-disk drives are about the same as the smaller ones, except for the very big ones where thin-film heads are used to get up to 15,000 b/in.

The article on pages 108 to 111 by Jack Taranto of Ibis Systems Inc., Duarte, Calif., describes a 5,000-megabyte drive that will use thin-film disks with a ferrite head. The first Ibis disk will have a linear density of 15,000 b/in., but the thin-film disk with ferrite-head technology promises densities greater than 20,000 b/in.

The small 8- and 5¼-in. Winchester drives offer the computer-system designer high capacity, quick access, and reliability, but flexibility is lost when all the storage is fixed within the drive—some alternative form of removable storage is needed for data and program input/output or for data backup. DMA Systems Corp., Santa Barbara, Calif., has therefore designed a new disk drive with 5 megabytes on one fixed disk and a 5-megabyte removable cartridge. In the article beginning on page 112, David Sutton tells how the drive joins the advantages of Winchester technology to those of removable storage. The bit density is 8,600 b/in., and an embedded track-following servo and voice-coil positioner help to achieve a track density of 450 to the inch.

Magnetic recording is far from being a mature technology. As this series of articles indicates, higher-density devices in a wide range of form factors are pushing it to even higher price-performance ratios. Though prices of individual drives do drop, the cost per byte comes down

much faster as storage density continues to increase. Among many other firms working on advancing this trend, two start-up companies, Atasi Corp., San Jose, Calif., and Evotek, Fremont, Calif., are building higher-density 5¼-in. hard-disk drives. These two companies are taking different approaches. Atasi will be increasing density through the use of a dedicated closed-loop servo voice-coil positioner of the type used in big, high-performance drives to increase the track density. Though the open-loop stepping-motor positioners are accurate enough to achieve up to 400 tracks/in., the voice-coil servos can more than double that to 900 to 1,000 tracks/in. Atasi's initial 5¼-in. drive will likely sport 600 tracks/in. and 8,650 b/in. Future versions will use increased track-per-inch densities of 725, 825, and 900. A later version will use a thin-film disk to increase the bit density to 15,000 b/in.

Evotek's approach is to stay with the stepping-motor positioner and its associated 367 tracks/in., but to increase the bit density. At the top end, using a thin-film disk, the Evotek line will have 16,250 b/in.

Although firms have been working on the development of thin-film heads [*Electronics*, April 7, 1981, p. 57], the heads are not yet being manufactured reliably with high yields and low cost. According to Jack Taranto, thin-film heads may have a future, but it could well be remote in view of the work that has still to be done. Another disk-drive industry leader, Michael C. Aguirre, engineering manager of thin films at Storage Technology

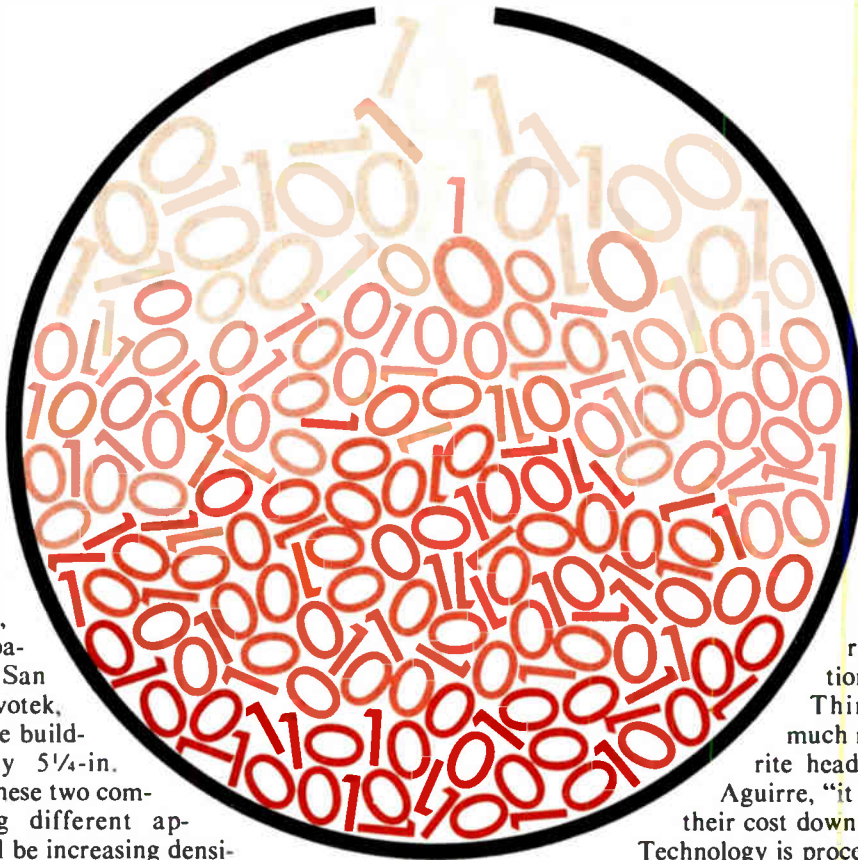

Corp. of Louisville, Colo., agrees. Aguirre says, "The biggest deterrent to thin-film-head use today is the lack of real volume production in the industry."

Thin-film heads are much more costly than ferrite heads and, according to Aguirre, "it will take time to get their cost down."

However, Storage Technology is proceeding with thin-film head development for both disk and tape drives, while researchers at STC and elsewhere are injecting more life into magnetic recording by investigating the properties of unusual magnetic materials and types of recording. The research center of CII-Honeywell Bull in the Paris suburb of Les Clayes sous Bois is experimenting with cobalt crystallized over chrome deposited on glass [*Electronics*, Nov. 17, 1981, p. 67]. The cobalt-chrome disk looks promising for densities in excess of 25,000 b/in. Also, research is under way at the laboratories of Ing. C. Olivetti & Co., Ivrea, Italy, in putting the cobalt-chrome combination on floppy-disk material.

After improvements in thin-film disks, thin-film heads, and head-positioning mechanics reach expected physical limits with the current longitudinal recording pattern, the next big jump in magnetic recording density looks to come from vertical recording. In this, the magnetized areas in the medium are oriented vertically through the thickness of the medium instead of in parallel with the surface (see p. 89). The bit density expected from vertical recording may be initially 40,000 to 60,000 b/in. and will likely top 100,000 b/in., with some possibility of even several hundred thousand.



Thin-film disks drive densities to new highs

This alloy-coated disk, overwritten by a ferrite head, promises more than 20,000 bits per inch, also proves easier to manufacture than thin-film heads

by Jack Taranto, *Ibis Systems Inc., Duarte, Calif.*

□ In the push to higher data-storage densities and capacities, disk-drive designers have been casting around for the perfect combination of technologies for both head and disk. So far, the state of the art has been struggling to pair the newly devised thin-film head with disks coated with the more conventional ferrous oxide particles. Ibis Systems has reversed the pairing, however, combining a thin-film disk with a ferrite head. The company has been so encouraged by the new duo's potential for greater density, it has made a major commitment to a 5-gigabyte drive so constructed, prototypes of which are due out later this year [*Electronics*, Feb. 10, 1982, p. 39].

The new approach takes advantage of an improved, precisely controlled proprietary mix of thin-film disk-coating materials—nickel, cobalt, and phosphorus—that provides remanence of 8,000 gauss and coercivity of 500 to 600 oersteds for good signal conditioning. Although initial densities will be about 15,000 bits per inch, the company is setting its sights on a figure more in the region of 24,000 b/in.

In comparison, the IBM 3380 thin-film head and oxide-disk setup has a bit density of more than 15,000 bits per inch and a track density of slightly over 800 tracks/in. Both these densities have been attained by means of thin-film recording heads that record data at approximately 10,000 transitions or flux reversals per inch, which can be expanded to about 15,000 b/in. with a complex encoding scheme generally known as a run-length-limited code. However, for reasons that will be discussed later, thin-film heads have yet to fulfill their promise; further, they are hard to manufacture and require a heavy capital outlay in equipment.

The Ibis drive contains four head-disk assemblies, compared with two for the IBM 3380, and is housed in a cabinet that is only about 20% larger. The Ibis unit will transfer data as fast as the 3380, at 3 megabytes per second, and will be plug-compatible with it.

Recording is accomplished by magnetizing small regions of a film of magnetic material that has high coercivity and high remanence. The areas where the

direction of magnetization changes are called magnetic transitions or flux reversals. Figure 1 illustrates the process schematically. Energizing the winding of the head produces a magnetic field that extends across the magnet's gap to magnetize the recording film. As the direction of the write current is reversed, the direction of local magnetization of the medium is also reversed, thus producing the transitions across which the direction of magnetization changes by 180°. The resulting magnetic transitions vary the flux distribution in the medium. Changes in flux direction and density can be sensed by the recording head when it is operating in reverse as a read head, producing a signal voltage across the terminals of the winding.

In high-performance disk drives the recording head is usually designed as an aerodynamic "air" bearing that

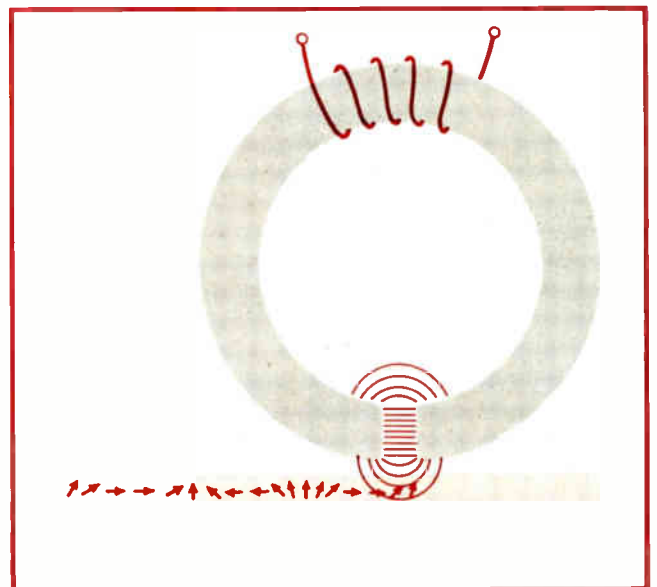

1. Magnetic recording. Passing a thin film of magnetic material by a recording head creates small magnets. Flux reversals induced many times a second across the magnets can store information that can be read indefinitely or erased and replaced with new data.

lifts the device to a predetermined flying height above the disk surface as the disk spins and drags the ambient air with it. Typical flying heights have been on the order of 20 to 40 microinches, although heights closer to 10 $\mu\text{in.}$ have been incorporated in more recent designs.

Conventional recording heads have ferrite read-write elements, with the slider on which they are mounted made of ceramic or bulk ferrite. The slider is shaped by grinding and lapping, with glass bonding generally used to form the read-write gap and the whole slide assembly. The read-write coil in such heads is wirewound.

A thin-film head, on the other hand, is made by depositing all the magnetic elements of the head by sputtering, evaporation, or plating on a passive substrate that constitutes the air-bearing slider.

Media classification

Media can also be classified in two broad categories, particulate and thin-film. The former, or oxide media as they are often termed, generally consist of iron oxide particles dispersed in an organic binder and applied to a polished aluminum disk in a coating 20 to 50 $\mu\text{in.}$ thick. Such ingredients as aluminum oxide are often added in fabricating oxide disks to improve wear and abrasion resistance in the contact start-stop mode. Buffing or burnishing of the surface of the disk improves its finish, and a lubricating film gives the proper friction at the head and medium interface. Typical coercivities for iron oxide media are 300 to 500 Oe, with remanence on the order of 1,000 G. Any tailoring of these parameters has been limited as their range is largely determined by the physical properties of the iron oxide particles.

Thin-film media employ a continuous metallic film deposited by electroplating, electroless plating, or sputtering. The recording film is usually of cobalt or nickel or both, plus a certain amount of phosphorus. Controlling the total electrical charge in electroplating or the deposition time in electroless plating and sputtering makes it possible to produce recording films of any thickness—even down to 1 $\mu\text{in.}$

Varying the relative amounts of cobalt and nickel can increase the remanence, and adjusting the phosphorus content and certain other deposition conditions can act to raise the coercivity. As an example, on thin-film disks with a film thickness of 3 $\mu\text{in.}$, remanence of 8,000 G, and coercivity of 500 to 600 Oe can be produced consistently in a manufacturing environment.

Thin-film disks are generally given a hard overcoat so that they will resist wear and corrosion. Most thin-film recording media are deposited over a nonmagnetic electroless nickel-phosphorus layer plated over the aluminum substrate. The electroless nickel-phosphorus layer, which is very hard, is polished so that it is smooth down to less than a microinch. Consequently, it interfaces well with the head.

The magnetic gap of a conventional head (Fig. 2a) has practically infinite pole tips; that is, the tip is much larger than the gap. Figure 2b shows the signal from this head for an isolated transition in the medium. Magnetic transitions are usually detected by differentiating the signal and finding the point of zero crossover that represents the position of the peak amplitude of the signal. Figure 2c illustrates the magnetic gap and finite-length pole-tip structure of thin-film head. Because of the mag-

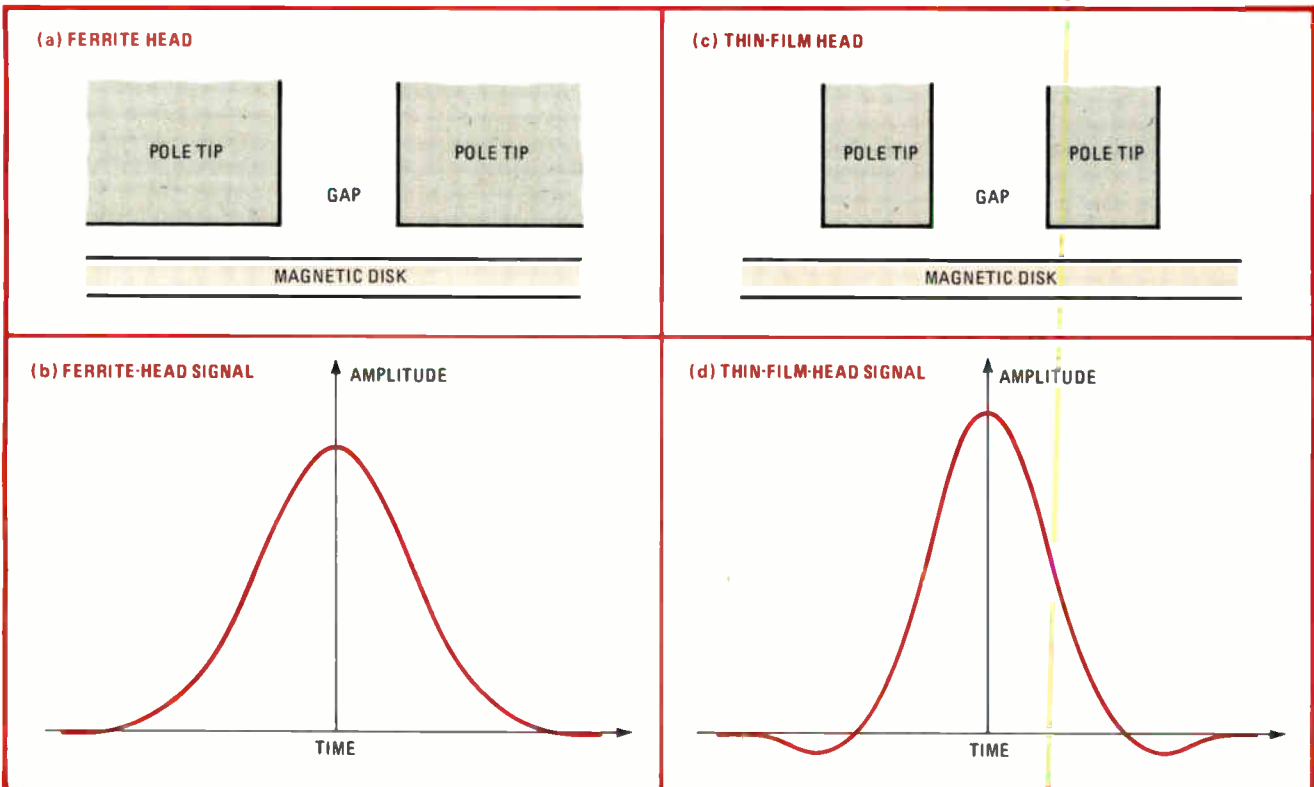

2. Gaps and waveforms. Conventional ferrite read-write heads present what amounts to infinite pole tips and a small gap (a)—the signal waveform due to reading one flux transition with this head resembles (b). Thin-film heads with finite pole tips (c) produce a waveform like (d).

Other recording technologies in the crystal ball

As the limits of current magnetic recording technologies—generally known as longitudinal recording—are attained, the imagination strays to what the future has in store. The table compares potential densities in magnetic and optical recording.

For example, recent U. S. and Japanese developments in a new technology known as perpendicular, or vertical, recording point to bit densities exceeding 100,000 transitions per inch, achieved in sputtered thin recording films with perpendicular anisotropy. In vertical recording, the magnetic recording film can only be magnetized in a direction normal to the surface of the film. Because such adjacent magnetic regions aligned perpendicular to the surface and magnetized in opposite directions tend to attract each other, much higher transition densities can be attained compared with longitudinal recording, where the tiny magnets repel each other.

Vertical recording was first attempted by IBM researchers many years ago. More recently, since the mid-1970s, significant progress has been made by research workers in Japan, the U. S., and Europe. Professor Shunichi Iwasaki and his co-workers at Tohoku University in Sendai, Miyagi Prefecture, Japan, have demonstrated recording up to 100,000 flux changes/in. on a sputtered cobalt-chromium alloy thin film.

There is a growing interest in vertical recording. For example, an international symposium on vertical magnetic recording was held recently at Tohoku University. In addition, several Japanese and U. S. disk-drive and computer companies are working to develop vertically recorded disks. Ibis Systems is among them, having just formed a new division in Santa Clara, Calif., to develop mass-storage devices in the middle range of disk drives in the 100- to 500-megabyte category using vertical recording. The perfection of the technology could eventually pave the way for small drives with several hundred megabytes of storage.

Optical recording has also been a candidate for high-

density recording. However, digital magnetic recording has been able consistently to provide error rates not exceeding 1 error in 10^{10} , and optical recording is still several orders of magnitudes away from achieving those levels. Furthermore, optical media are not erasable, making them incompatible with present magnetically based systems. Nevertheless, the optical technique is too promising to discard and will probably find its niche in the archival storage of images and documents, where high bit-error rates can be tolerated.

Although there are no announced data storage products using optical disk technology, quite a few companies are working on them [*Electronics*, May 5, 1981, p. 97]. Thus products are likely to appear in the near future.

MAXIMUM RECORDING DENSITIES ACHIEVABLE BY VARIOUS DISK TECHNOLOGIES

Technology	Density		
	Bits per inch	Tracks per inch	Bits per square inch
Longitudinal magnetic recording — thin-film heads (3380 type)	15,000	800	12×10^6
Longitudinal magnetic recording — thin-film disk with ferrite heads	25,000	1,200	30×10^6
Perpendicular magnetic recording	100,000	1,200	120×10^6
Optical recording	15,000	15,000	225×10^6

netic-field distribution of the finite-length pole-tip geometry, signals read by such a head from a magnetic transition show undershoots on both sides of the signal peak, as indicated in Fig. 2d.

In addition to signal amplitude, other important characteristics of the recording process are the signal-to-noise ratio and the timing of the signal. In order to read a magnetic transition in its true position, it must be detected within an interval known as the bit-cell time. Failure to read a magnetic transition within these tolerances results in a data error.

Displaced peaks

Several factors contribute to timing errors, which, if they exceed a certain portion of the bit-cell time, can also lead to data errors. The most significant timing error, known as peak shift, is caused by the superposition of signals from adjacent transitions. Figure 3 shows the relative motions of the peaks as superposition develops.

Generally, as the bit density increases, so also does the superposition effect, resulting in a larger peak shift. To obtain the total timing error, other time shifts introduced

by the various data-channel circuit elements and correlated noise like overwrite residue must be added to peak shift. The superposition of gaussian noise on the signal produces additional timing errors and results in random data errors.

Figure 4 illustrates for various combinations of heads and disks the relationship between worst-case peak shift and recording density (expressed in terms of flux reversals/in.) using modified-frequency-modulation (mfm) encoded recording. Mfm recording is the simplest run-length-limited code where adjacent magnetic transitions can be as close to each other as one bit-cell time and no farther apart than two bit-cell times. The worst-case peak-shift pattern in any recording code is that which has transitions with the maximum spacing and the minimum spacing directly adjacent.

As can be seen from the first curve, the peak shift for a ferrite head and oxide disk increases sharply with transition density. It should be noted that the total time-window tolerance available in mfm recording is a quarter of the bit-cell time. A peak-shift value of about a tenth the bit-cell time is considered a reasonable limit if

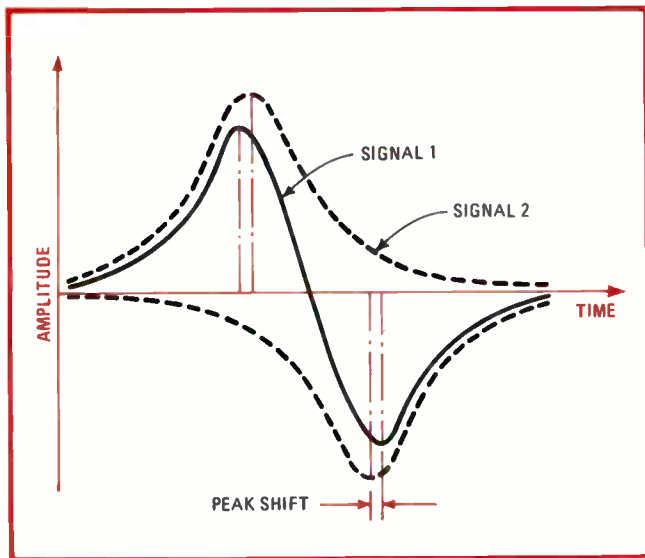

3. Peak-shift problem. The peak of a signal waveform from the read-write head starts to shift as adjacent signals begin to crowd in. When the peak shifts get too large, the individual peaks become hard to identify, and consequently data errors increase rapidly.

acceptable error rates are to be expected. The first curve also indicates that transition densities more than 8,000 to 10,000 per in. encounter excessive peak shift, which means that ferrite-head technology cannot be extended beyond these densities with oxide disks. Run-length-limited codes can extend density somewhat beyond the 10,000-b/in. limit.

Signals from thin-film heads with finite gaps also exhibit peak shift from transition crowding. However, the undershoots of the waveform cause a negative peak shift at low transition densities that vanishes as density increases. Peak shift increases very rapidly beyond where it crosses zero. Similar characteristics are obtained with thin-film heads both on oxide and thin-film media, with somewhat better results on the latter, as seen in the second and third curves.

Recording characteristics of thin-film disks show greater capabilities for high-density recording than oxide disks because the first can be made much thinner, resulting in better definition of the signal waveform. Ferrite heads and thin-film disks show peak shifts (the fourth curve) that imply densities greater than 15,000 per in.

Going to the limit

However, transition densities over 10,000 per in. with ferrite heads and oxide media show excessive peak shift and loss of signal resolution. Studies made on thin-film heads by both experiments and computer modeling have indicated that the general relationship between peak shift and transition density is not changed to any substantial degree by modifying the parameters of the heads within feasible ranges.

It has been found that the zero-crossover point for this curve for an oxide disk can be made to occur at transition densities below 10,000 per in., but cannot, for all practical purposes, be made to substantially exceed that number. As a consequence of the very rapidly increasing peak shift after this point, the only way to

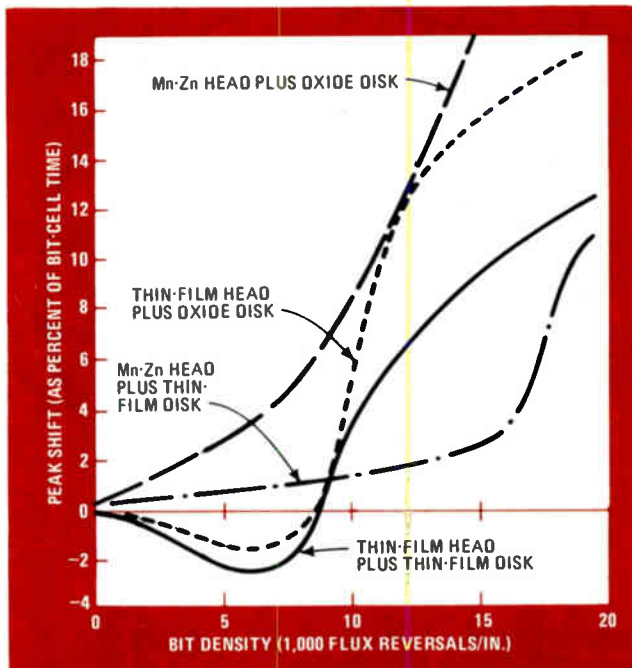

4. Winning combination. Four combinations of head type and disk composition exhibit quite different peak shifts as a function of recording density in mfm recording. The Mn-Zn head and thin-film disk show the lowest peak-shift rise as density increases.

obtain high recording densities with thin-film heads has been to limit transition density to about 10,000 per in. and to increase the bit density by 50% (by resorting to more complex run-length-limited codes).

Thin-film heads may not be capable of appreciably exceeding the kind of densities currently provided by the IBM 3380 and similar disk drives. The disadvantage of utilizing them at these and greater recording densities are low signal amplitude, marginal overwrite, and narrow timing margins.

Both an advantage and a disadvantage, thin-film heads are made of Permalloy, which has high permeability of frequencies above 100 megahertz whereas ferrites exhibit decreased permeability at higher frequencies at data rates in excess of 30 to 35 megabits/s. Unfortunately, the thin Permalloy film in thin-film heads suffers from eddy-current losses that could greatly reduce permeability at higher frequencies. Therefore, to reduce eddy-current losses and keep permeability high, it is necessary to laminate the Permalloy films with dielectric insulation, similar to what is done in transformers, greatly complicating the manufacturing process. So far, attempts to fabricate heads with such laminated pole pieces in France and the U. S. have had very low yields.

In all, the lack of supply of quality thin-film heads has made the ferrite head-thin-film disk pairing more attractive to disk-drive manufacturers. Enhancing their appeal is the fact that besides much better timing tolerances at high recording densities, thin-film disks exhibit better S/N ratios and can be overwritten by the more efficient ferrite heads. Finally, laboratory experiments have borne out the possibility that transition reversals or bit densities of over 20,000 per in. can be achieved already with the present state of the art. □



Winchester cartridge challenges other backup systems

A 5.25-inch Winchester system stores 5 megabytes on a fixed disk and 5 megabytes on a removable cartridge

by David Sutton, *DMA Systems Corp., Santa Barbara, Calif.*

□ An idealist venturing forth with a small purse—say, under \$15,000—might search in vain for a computer system that had a vast storage capacity packed in a small space, half of which was removable so that the fixed portion was easily backed up, and with both fixed and removable parts highly reliable.

Still, the idealist would hardly be accused of squandering his money if he were to settle on the Micro-Magnum 5/5 from DMA Systems Corp. Combined with 5 megabytes of fixed storage and a like amount of removable storage are input/output and a reliable Winchester-disk backup, all in a small, self-contained unit requiring no preventive maintenance.

The unit was designed with the ideal in mind. After surveying the market, the company picked its way carefully along a path fraught with design pitfalls in order to improve upon fixed Winchester-disk drives of similar size and capacity but with only external magnetic tape or floppy-disk drives for backup. This conventional backup setup suffered in reliability compared with the hard Winchester disk.

Compelling pluses

Yet there were other advantages. The all-Winchester combination eliminates the external backup device and its separate controller, decreasing space and power requirements significantly. Because the cartridge's transfer rate is as high as the fixed disk's, backup time is reduced. Further, as a result of the compact design, which uses the same technology for both the fixed and removable storage, some parts can double up on functions. For example, one spindle motor, one control subsystem, and one head positioner handle both disks. So, besides space, power, and backup time, fabrication cost is slashed. Another benefit is that the Micro-Magnum 5/5 cartridge conforms to the standard proposed by the American National Standards Institute—a feature that portends more than one source for the product.

The market survey queried system manufacturers and integrators, disk suppliers, and computer-industry consultants in order to generate the new product's design

parameters. The survey led to some general specifications for the mass-storage needs of a desktop system for small business, word processing, networking, personal computing, intelligent terminals, and similar applications. Survey results strongly indicated that the ideal small-computer system should sell for \$15,000 or less and include as its components a central processing unit, printer, 10-megabyte mass storage, one to four terminals, and a means for data input/output and backup. Every design decision was guided by the goal of a reliable and cost-effective solution to the problem of backing up mass storage.

According to the survey, typical fixed-disk mass storage in a small-computer system incorporated either a flexible disk for I/O and backup or a flexible-disk I/O with tape backup. However, many computer systems of somewhat larger size were based on a 14-inch combination-fixed-and-removable-disk drive providing 5 to 10 megabytes of formatted capacity each for the fixed and removable media. No other means of I/O or backup was used. Reliability was the key factor in selecting fixed-and-removable-disk drives rather than other, external means for backup in systems of this class.

This fixed-removable disk concept became the cornerstone for the specifications of the Micro-Magnum 5/5, but it was also destined by its maker to be a drive that could fit into the same space as conventional 5.25-in. Winchester units.

Design challenges

To meet the product's design specifications, it was necessary to fit two 5-megabyte formatted disks, one fixed and one removable, into a package then being used for a 5.25-in., two-fixed-disk Winchester drive. The height and width constraints of this package were formidable challenges. The 3.25-in. drive height dictates a single disk cartridge, and the industry-standard spindle assembly would not allow a fixed- and removable-disk drive even with this cartridge, so a new spindle design was the first order of the day.

Five megabytes a disk with a conventional data track

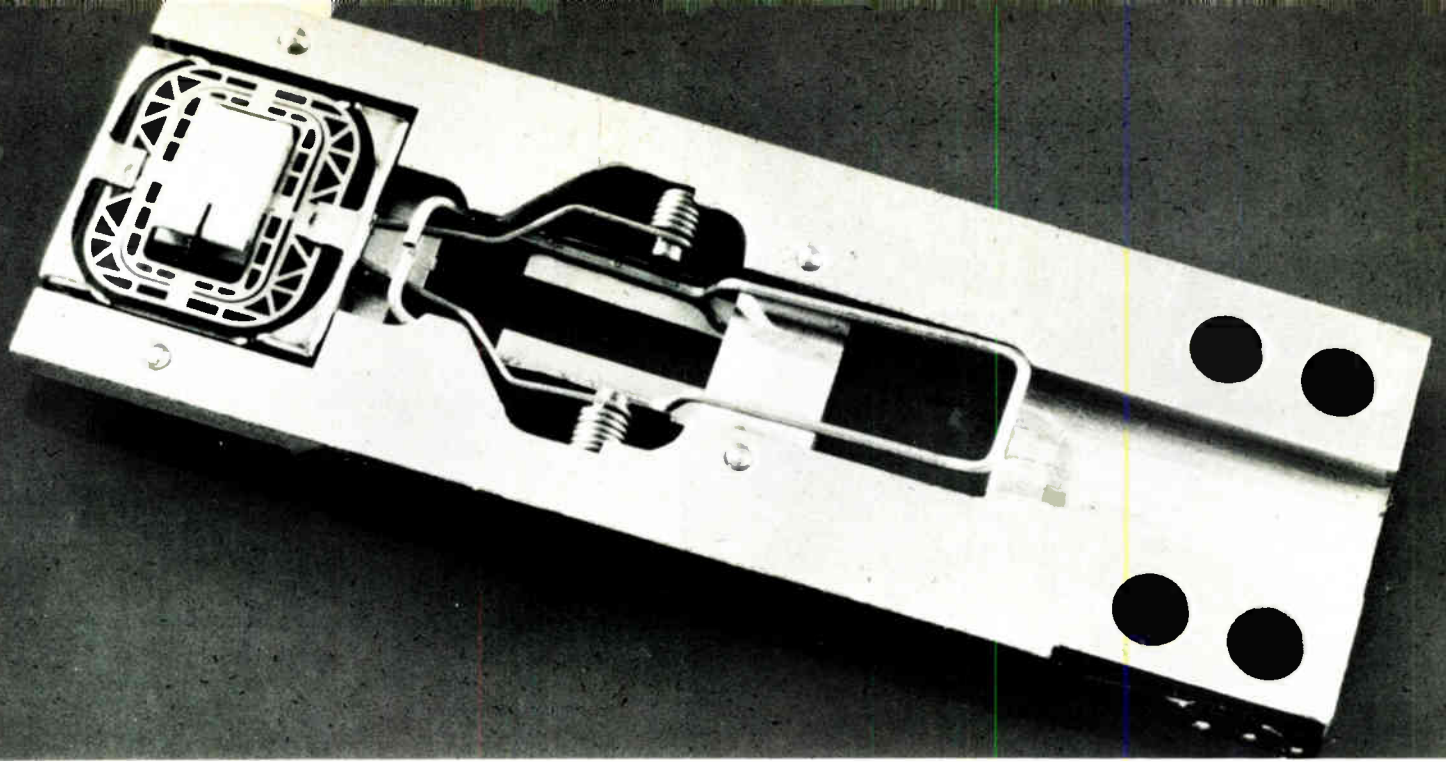

1. Head of the class. In this composite head assembly, the ferrite core (left) is supported and protected by glass and ceramic. A patented flexure assembly holds the head allowing vertical motion while maintaining the all-important air bearing.

format meant 306 tracks of thirty-two 256-byte sectors on each surface. Allowing space for spare sectors, spare tracks, and an outside head-loading zone indicated a recording density of 450 tracks/in. and 8,600 flux changes/in., assuming modified-frequency-modulation encoding. The standard nickel-zinc-ferrite Winchester head was found to have insufficient signal output at these densities, and the manganese-zinc (MnZn) monolithic ferrite type was marginal. Thin-film heads were considered, but were rejected because it was felt the technology was not mature enough to merit a commitment to production.

From several viewpoints, the preferred head was a composite one. With a discrete MnZn core inserted and glass-bonded into a ceramic Winchester-type air-bearing shape, its mechanical durability is greatly enhanced, for the ceramic protects the core, while the glass bonding supports the core at its fragile edges.

Magnetically, the discrete MnZn core offered more signal output since it has a shorter flux path than the monolithic head and less parasitic inductance. Most important, the composite head is based on conventional manufacturing technology and so is at present available in volume production. The composite head assembly is shown in Fig. 1.

Obtaining 450 tracks/in. implied a track width of about 0.0017 in., which required that tracking errors be less than 200 microinches, including such effects as cartridge-registration errors, temperature gradients, spindle runout, and head track-width tolerance. This demanded a track-following servo system for head positioning because cartridge-seating error alone can exceed the maximum positioning error, if cartridge interchange and wear of the centering mechanism are considered.

The question arose as to whether to employ an embedded servo or a continuous track-following servo system.

Embedded servo has track-following signals interspersed with the data, whereas continuous servo requires an entire disk surface to be dedicated to servo information only. With room for only one disk in the fixed area of the drive, the need for a full surface of servo information would mean doubling recording density on the other surface of the disk to maintain the same capacity.

In addition, alignment differences among the four heads in a drive and from one drive to another represent possible errors from cartridge interchange. Precise adjustment of heads in drive manufacture and later in the field would be needed to keep these errors from causing trouble. However, such field-maintenance requirements would be unacceptable, according to the market survey.

Embedded servo digs in

Embedded servo eliminates the need for precise head alignment, increases the surface available for data recording, solves the problems of cartridge interchange and thermal-expansion compensation, and also makes it possible to increase track density in the future (see "The strait and narrow path to interchangeability," p. 116).

Of course, the decision was not free of compromise because sampled-data systems—such as embedded servo—require complicated electronics. Moreover, the added cost of writing servo data on both surfaces of every disk is not to be taken lightly. However, the technology for embedded servo is well established in contemporary products, so the basic technical risk was considered minimal.

There were additional design compromises associated with embedded servo—not least the extra time required to reposition the selected head over the track when switching heads, and the obligation for the maker to prewrite sector-header information (hard sectoring)

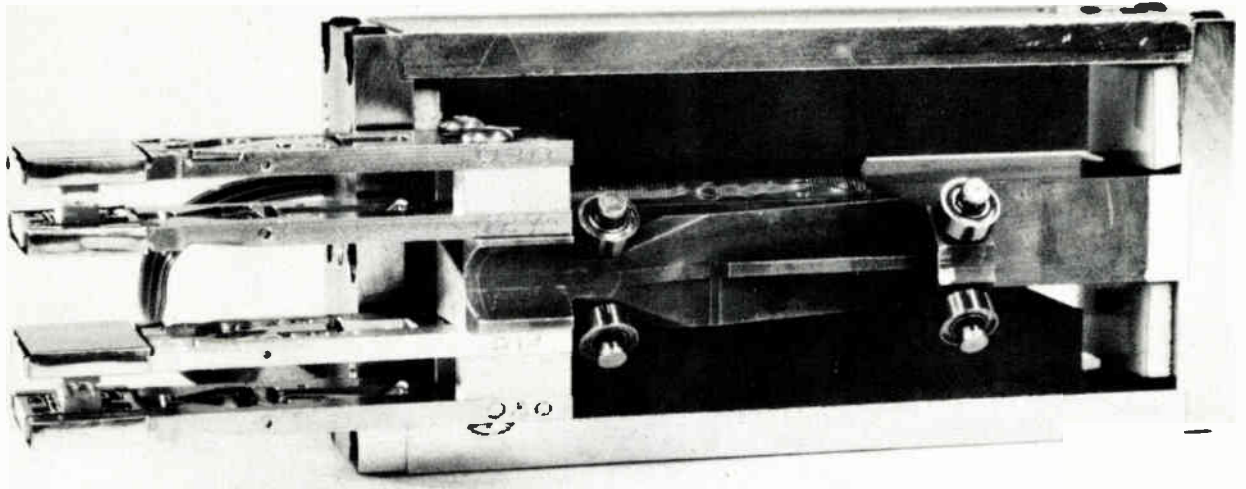

2. Put it there. Positioning the read-write heads to within ± 100 microinches, this unique linear-motor positioner has a side-mounted carriage for the heads. Compared with the conventional coaxial technique, the side-mounted approach shortens the drive depth.

because sector size is fixed at the time of manufacture by the embedded-servo fields.

Combining the need for a fast access time—50 milliseconds on average, according to the market survey—with the embedded servo track-following system mandated that a voice-coil head positioner be used. The choice was between either a rotary or a linear voice-coil positioner. If package length were the primary consideration—8 in. being the preferred length—a rotary positioner would have been used because it is compact and can be tucked into one corner of the drive. However, the company's major concern again was reliability, and here the rotary system came up short in several ways.

One problem was that its performance is very sensitive to the stiffness of the rotating arm and the mass of the head at the end of the arm. In most high-performance positioners of this type, the arm must pass over the surface of the disk in order to achieve the required stiffness. In a drive with a removable disk this would necessitate opening a whole side of the cartridge. In addition, the need to extract the heads from a cartridge for its removal further burdens the positioner design with an increased stroke length. A longer stroke means a longer arm and hence a greater likelihood of structural resonance problems.

Keeping out the riffraff

The nod to the linear motor (Fig. 2) was based first on the control it would give over contaminants that might enter a cartridge while it is outside the drive. With this motor, the opening in the cartridge can be much smaller and so also the risk of contaminant entry. Another advantage of the linear positioner is that the heads move on a radial line, giving the best possible tolerances for cartridge interchange. Also, structural resonances in the head-carriage assembly are easier to deal with.

The basic framework of the design was now in place: two disks, 5 megabytes fixed, 5 megabytes removable; head and media performance of 450 tracks/in. and 8,600 flux changes/in.; embedded servo; and a linear voice-coil positioner. The remaining design choices, as with earlier ones, were formulated largely on the basis of reliability—that is, the ability of the drive mechanisms to survive the design life of the product in the field without preventive maintenance.

An early move was to design the new head mechanics so the Winchester air-bearing head could be loaded dynamically. That is, the air bearing is launched onto the disk surface when the spindle is up to speed. Three reliability advantages are achieved by doing this:

- The head can be designed so the air-bearing surface never touches the disk. This was verified by high-speed photographic studies of head loading and unloading, shot at 4,000 frames per second.
- When the drive has been started and the purging cycle completed, heads can load without the stop-and-restart cycle required by the standard Winchester head, because there is no possibility of setting the air bearing down on contaminating particles.
- Heads can be completely retracted from the media and latched into their rest position when the cartridge is to be removed, the drive is shut down, or power is lost.

In the Micro-Magnum 5/5, the heads are retracted clear of the cartridge compartment during cartridge loading and unloading and whenever the drive is not running. Therefore the delicate head structures will not be damaged, and the heads will never contact the disk when the drive is transported. This marks a major improvement over most fixed-media Winchester drives where the heads are left on the disk surface. With such drives, shock and vibration during movement of the drive from one location to another can cause head motion and

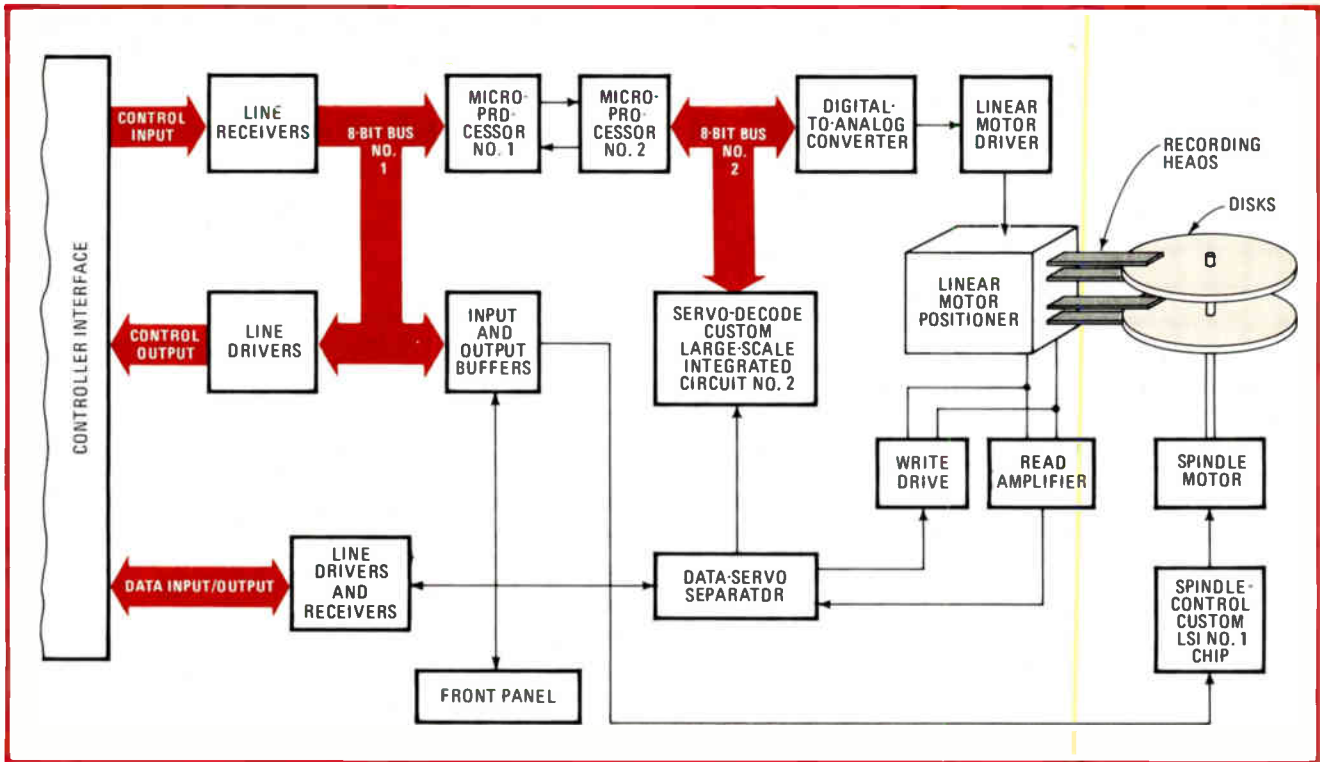

3. Block party. Two microprocessors—the interface processor (No. 1) and the servo processor (No. 2)—and two custom chips, for servo decoding and for spindle control, pack in most of the electronics needed in the Micro-Magnum 5/5 disk drive.

damage to the disk surface that degrades the reliability of the system.

The need for control of contaminants within the disk enclosure was why the Micro-Magnum was endowed with a high-capacity closed-loop air system. One feature of this design is a fan at the bottom of the spindle motor that generates enough flow to pass the entire volume of air in the system through the recirculating filter once a second. During a purge cycle, this flow efficiently removes those contaminant particles that may have been introduced by the insertion of a cartridge. In contrast, most present fixed-Winchester drives rely on the rotation of the disks to cause air movement, an approach that simply cannot circulate air as effectively as a fan.

Clean room

The cartridge has a door that closes the head opening and a clamp that secures the disk hub to the cartridge housing, to exclude contaminants when the cartridge is outside the drive. Inside the drive itself a door closes, sealing the heads inside the clean-air system after they are retracted from the cartridge. This double-door system ensures that contaminants on the external surfaces of the cartridge and inside the receiver slot are excluded from the clean environment of the head-disk interface. On start-up, the total volume of contaminated air introduced into the system is limited to that inside the cartridge at the time of insertion.

The Micro-Magnum air system can in fact operate with some degree of air leakage at the cartridge. The fan impeller raises the pressure in the cartridge above ambient pressure so all leaks are outward and contaminants are prevented from entering the system. Leakage is

made up by air pulled into the system through a specially designed breather filter. Both the recirculating and breather filters have a design life of five years with no filter change required in the normal office environment.

Several Micro-Magnum design choices were related to controlling the unit's internal temperature, another key element of reliable operation. One way to reduce heat was to use ± 12 -volt dc supplies for the spindle and linear motors. Another was to place motor drivers on a heat-sink board at the back of the drive, where it would be thermally isolated from the main deck. Also, provisions were made for air entry through the front panel of the drive so that a fan in the user's system could provide cooling air flow for the drive electronics.

Shock mounting of the drive had to be included because the unit is typically used in an office environment, where normal operator activity causes shock and vibration. As mentioned previously, vibration control during drive shipment is not critical, because heads are retracted when the unit is not in operation.

Usage alone will determine how successful the unit's design is in withstanding a projected maintenance-free five-year product life. The various mechanisms are expected to meet the following design goals: the number of cartridge insertions and removals in a drive will total 20,000; any single cartridge will withstand at least 5,000 in and out cycles in any drive; and the head and carriage assembly will load and unload the heads to the disks approximately 50,000 times.

Electronic packaging of the Micro-Magnum required that all the functions of a typical full-size 14-in. disk drive of the early 1970s fit into a case the size of a small shoebox. These functions are shown in the block diagram

The strait and narrow path to interchangeability

The embedded-servo approach makes it possible to achieve interchangeability of the removable disk cartridge within the Micro-Magnum family, regardless of the drive model into which it is loaded. The technique is so effective that it can adjust for errors due to thermal expansion of mechanical parts, friction in the cartridge, offset due to tilt of the drive, and runout of the disk.

The servo data is recorded on both the fixed and removable disks of the Micro-Magnum 5/5 to guide the unit's read-write heads. This data is "embedded" during the disk's manufacture and is contained in the 26 bytes at the start of each sector.

Positioning the head using the embedded servo is a two-step process. First, coarse positioning locates the proper track, and then fine positioning guides the read-write head in a path directly over the track's center.

The coarse-positioning process works digitally to move the read-write head to the proper track. Tracks are numbered from 0 to 310 (there are 5 spare tracks) and the code for each track number is prerecorded as part of the 26-byte embedded-servo format in each sector of that track. As the head crosses a track, it reads the servo data, and a software routine calculates a demand velocity based on the difference between current track location and target track. Demand velocity is converted from a digital signal into an analog one and applied as an input to the linear-motor servo that controls the head's velocity. As track difference decreases, the demand velocity is reduced to bring the head to rest at the target track.

When the head is within half a track of the target location, fine positioning takes over. It employs an analog method based on the format shown in the figure. Segments A and B consist of bursts of recorded signals displaced in time from each other. The edges of A and B are along the center lines of tracks, so that a head exactly centered on a track will read equal amplitudes from both segments. If the head moves to either side of center, one amplitude will go up and the other down. The difference is detected and used as an error signal to drive the linear motor servo. Therefore, the head always seeks a zero error and maintains its proper position down the center of the track, resulting in the best signal-to-noise ratio and lowest error rate.

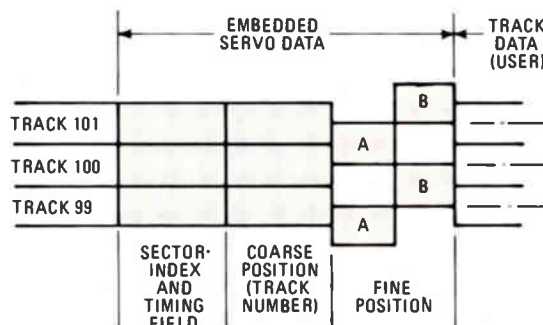

of Fig. 3. Complicating the design were the embedded servo and voice-coil positioner.

Initial printed-circuit-board estimates pointed to a microprocessor-controlled system in order to minimize space requirements. In fact, a dual-microprocessor system was incorporated to conserve space and partition functions to make firmware design easier.

One microprocessor is dedicated to interface and status functions that include all controller input and output lines, front-panel functions, safety checks, and fault algorithms. In addition, it preformats seek commands into the form required by the second microprocessor, which controls all the internal command lines of the positioner servo system.

The second microprocessor receives embedded-servo information from the servo decoding circuit—a custom large-scale integrated circuit—so it has all the information required to perform the basic disk-drive servo functions such as track following and seeking, rezeroing, and loading and retracting the heads.

The partitioning of functions between the processors results in a faster response. For example, the second processor may perform a seek while the first one continues to handle all interface and safety functions, enabling emergency situations to be handled faster than could be done with a single microprocessor.

To achieve the needed packing density, two complementary-MOS gate-array custom ICs were developed. The underlying philosophy in this design effort was to limit the custom ICs to low-risk types to replace ones of

small- and medium-scale integration. Also, the custom designs had to maintain functional isolation.

The first of the two functions to be committed to custom designs was the servo control of the spindle, which was accomplished by a 200-gate array that includes spindle-motor commutation circuits, a spindle-speed control servo, a speed-safety function, and a 10-megahertz crystal oscillator.

Decoding gate array

Second, to decode of the digital information in the embedded servo fields, a 500-gate array was developed. Functions included in this second array are detecting erase-gaps, decoding sector and index marks and track locations, checking timing, and generating sampling pulses for fine position information.

This chip also checks hardware to preserve embedded-servo information before clearing the way for a write operation, because if the drive were ever to overwrite the embedded-servo fields, data could be lost from either disk. Therefore a series of hardware and software safety checks must be found to be in agreement before a write operation can proceed.

The hardware functions are gated directly to the heads, responding in microseconds to any unsafe condition. There are also software checks used to enable the write function. The software will not proceed with a write operation until two successive embedded-servo sectors have decoded the same track identification and no fault conditions have been found in the drive. □



Flexible-disk drive closes in on hard-disk densities

Capable of correcting burst errors of up to 4,096 bits, the drives' unique parity-sector technique takes up only 1.6% of a 10-megabyte flexible disk

by Roderick J. Linton *Omega Corp., Ogden, Utah*

□ High densities and low error rates, always difficult to achieve in hard-disk technology, are even harder to attain in floppy-disk drives. Yet, using an 8-inch single-sided flexible disk in a hard plastic cartridge, the Omega Alpha 10 has already managed to rival the performance of even Winchester hard-disk technology by storing as much as 10 megabytes of formatted data on a single disk with an average access time of 35 milliseconds and a reliability of under 1 nonrecoverable bit error in 10^{12} bits.

To obtain this performance, the designers of the Alpha 10 developed a new head-and-disk coupling system, based in part on the Bernoulli effect, that reduces the head-disk gap to 10 microinches (see "Bernoulli to a disk drive's rescue," p. 118). They also came up with a unique parity-sector error-correction scheme that stores parity information for a group of sectors in a special error-correction sector. The Bernoulli technology gives the unit a data density of 24,000 bits/inch; the parity-sector scheme makes such densities viable by permitting the drive to correct bursts of errors up to 4,096 bits long while using up only 1.6% of the disk's data space.

Other technological advances over standard floppy-disk drive design were required to realize the potential for greater bit and track density. An advanced analog read-write channel was designed to reliably handle the densely packed data bits, and a new accurate head-positioning servo control was designed so the Alpha 10 can handle a density of 300 tracks/in. (see "Staying in the middle of track," p. 119).

Thus, the Alpha 10 drive can accurately record data at over 18,000 magnetic-flux changes/in. on a higher-coercivity, oxide-coated, Mylar disk. Through the use of a proprietary run-length-limited (RLL) encoding scheme, the effective data-bit density is thus increased to over 24,000 b/in. The RLL encoding scheme translates the data-bit combination entering the drive into a compacted bit combination that is actually written on the disk. Translation algorithms that squeeze in more bits than the number of flux changes that can be recorded get complex, but in general, they are designed to mini-

mize the number of flux transitions required to represent an incoming data-bit pattern.

At linear bit densities of 24,000 b/in. and higher, however, some new techniques also are needed to guarantee data integrity through the read-write channel and to correct errors that may result from such things as media defects and contamination.

Errors hard and soft

Data errors in both flexible and rigid magnetic-disk-storage systems may be classified as either transient (soft) or permanent (hard). Transient errors are typically caused by random electrical-noise bursts, contaminants that may temporarily disturb the head-disk relationship, momentary off-track positioning of the head, or other random phenomena. Such errors are typically not of concern to the error-correction scheme since they are by definition recoverable with retries.

Permanent errors, however, are typically the result of media damage. Such damage may be magnetic—that is, a transient noise burst may have created glitches in a section of prerecorded data, or stray magnetic fields in the system may have degraded the signal. Alternatively,

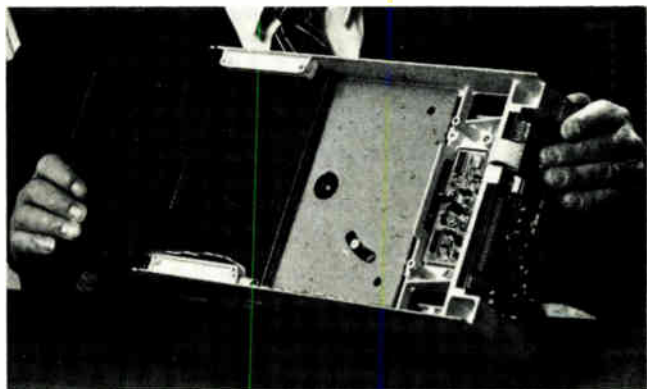

1. High concentration. The Alpha 10 disk-drive holds 10 megabytes of fully accessible data on an 8-inch flexible disk enclosed in a rigid plastic cartridge. The data can be accessed in 35 ms with reliability rivaling that of a Winchester-technology drive.

Bernoulli to a disk drive's rescue

The design of the Alpha 10 disk drive contains three unique stages of media stabilization to progressively reduce the amount of media flutter in the region of the read-write gap (see figure).

The first level of stabilization is the Bernoulli plate, whose action is based on the Bernoulli effect in fluid mechanics. Developed by eighteenth century Swiss mathematician Daniel Bernoulli, the effect states that the pressure of a stream of fluid (here air) is reduced as its speed of flow is increased. Thus, as the disk rotates in close proximity to this stationary plate, the natural pumping action causes air flow between the disk and the plate, and a low-pressure condition is created, which tends to pull the flexible disk toward the plate. By controlling the amount of new air introduced into the system at the disk hub, it is possible to prevent the disk from actually touching the plate. In this equilibrium position, the flexible disk assumes a relatively stable, flutter-free rotation.

The second level of stabilization comes from a small ring called the coupler installed around the read-write head. This coupler ring constitutes a smaller Bernoulli surface that draws the disk into still closer proximity and further reduces disk flutter in the region of the head.

Finally, the aerodynamic design of the head itself provides the third level of media stabilization. Over the read-write gap the disk achieves a flying height of less than 10 microinches.

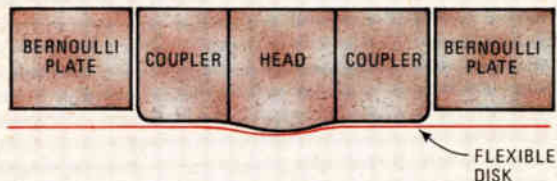

it may be physical—caused by such damage as scratches, digs, and embedded contamination. The existence of some permanent errors requires a disk drive to have an error-correction scheme that can correct large burst errors if there is to be no data loss.

In typical 8-in.-disk systems with bit densities of up to 8,000 b/in., designers commonly adopt an error-detection and -correction scheme capable of handling error bursts up to 13 bits long. The overhead, or disk space, needed to record the correction bytes is usually 1% to 2.5% of the total disk capacity. Efforts to increase the number of bits that can be corrected using one of these common burst-error techniques will drive the overhead inexorably and dramatically upward.

The general approach to error-correction coding (ECC) on magnetic-disk storage systems involves the use of cyclic redundancy checksums (CRCs). One simple example of the use of CRCs is in error detection. A CRC generator may be viewed as a large divide circuit where the divisor is a polynomial that has been preselected for certain properties, the dividend is the data to be stored on the disk, and the remainder is appended to the end of the data string.

When the data is read from storage, it is divided again by the same preselected polynomial, and the remainder is compared against the previous remainder that was appended to the data record. If an error in the data has occurred during a read operation, the two remainders will not match and an error will be flagged.

Making a correction

For error correction, the same general method is used, in that a polynomial is selected and then used in the generation of error-correction bytes, which bytes are appended to the data written on the disk. On read-back, the correction bytes are regenerated and compared with those originally appended to the data field. The difference between the two data fields provides the necessary information for a mathematical correction of the data bits in error. The particular polynomial selected and the number of bits appended to the data, in general, deter-

mine the correction capability of the code.

Though a 13-bit correction scheme may be adequate for densities up to 8,000 b/in., it is inadequate for the much higher density of 24,000 b/in. of the Alpha 10 drive. The usual causes of errors on a disk—bad spots on the disk or dirt particles between the head and disk, for example—affect the same physical space on a disk independent of the disk density. In a system with three times the bit density, the same cause of error is likely to affect three times the number of bits. Thus in order to provide effective (and efficient) error correction at densities of 24,000 b/in. and greater, the Alpha 10 designers had to find a different approach.

Parity by sector

The Iomega parity-sector ECC is designed to handle losses of up to 4,096 bits of data. To understand how this ECC scheme works, it is necessary to examine the track and sector format of the Alpha 10 drive. Figure 2 shows the division of each data track into 70 identical sectors. Each sector contains a total of 648 bytes of which 512 are actual user data. The other bytes are for sectored-servo position information, synchronization bytes, identification fields, and so on. The data field is divided into two records of 256 bytes. Each 256-byte record contains its own variable-frequency-oscillator synchronization field (VFO/SYNC) and its own CRC field, which is used for error detection but not for error correction.

Only 64 of the 70 available sectors on the track are used for data. Five additional sectors are available as spares should any of the regular 64 sectors become unusable. In addition, one sector per track is reserved for error correction and is known as the parity or ECC sector. This sector is formatted exactly like all other sectors except that the information written into its two data records provides the correction code for all other sectors on the track.

The correction code is generated by performing a sector-parallel, exclusive-OR operation on all data sectors around the track and then writing the result in the data field of the ECC sector.

Staying in the middle of the track

The Alpha 10 disk drive uses a unique sectored-servo approach to control the head position with respect to the track. Each of the 70 sectors on the track contains a servo field that has been prewritten in the factory to provide positional information to the control system. These servo fields are offset from the data tracks by a half-track, as shown in the figure. When the servo code is read, the relative amplitudes of the A and B field peaks indicate how far the head is from a track center.

Servo peak detectors on the analog controller board check the amplitude of the A and B peaks and send the results to a differential amplifier. The difference between the amplitude of the A and B peaks is an error signal whose amplitudes will indicate the amount the head is off track. The digital controller uses this position error signal to determine what head movement commands it should send to the actuator across the servo-current command lines to maintain proper track following.

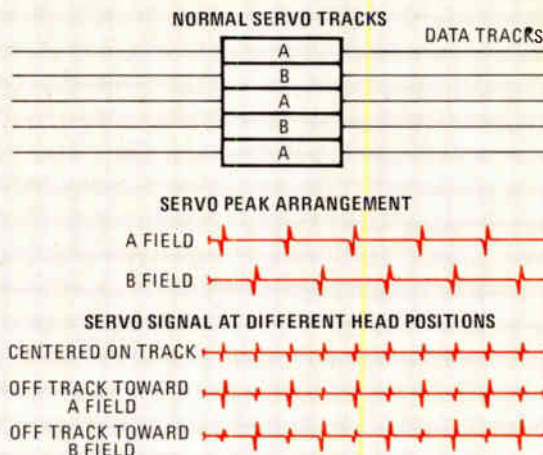

Figure 3 provides an example of the ECC-generation and data-correction techniques using ideally small sectors. The technique works exactly the same for 64 sectors of 512 bytes each. During ECC-generation, the ECC sector is generated by progressively exclusive ORing sectors 1 through 5. (An exclusive-OR operation is defined

such that the result will be 1 if either of the other two input bits is 1 but not both.) During data correction an unreadable sector can be restored by using the same progressive exclusive-OR technique but substituting the ECC sector for the unreadable sector. These operations are performed in special registers within the Alpha 10 controller under microcode control.

Write operations on the Alpha 10 automatically update the ECC sector on the track being written. Any CRC checks that occur during read operations will automatically activate the error-correction system. All of these activities are transparent to the host system. Corrected data is always transferred to the host.

Parity for performance

The parity-sector technique is capable of restoring an entire data sector that is in error (512 bytes, all told). Also, since it generates correction codes separately for each of the two 256-byte data records within a sector, it can also correct more than one sector in error in a track, as long as the defects exist in different data records (for example, a defective record 1 of sector A and a defective record 2 of sector B). It cannot correct more than one

2. Fancy formats. The track of the Alpha 10 is formatted into 70 sectors, each with 512 bytes of data. One sector on each track, called the ECC sector, is used for error-correction coding, and five sectors are set aside as spares that can replace bad sectors.

TRACK FORMAT

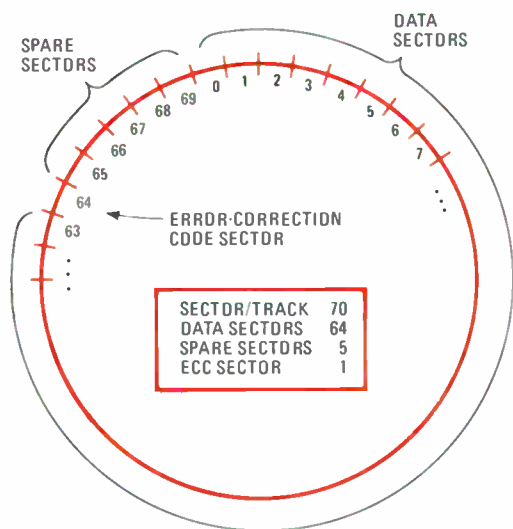

SECTOR FORMAT

PAD	SERVO FIELD	GAP		SECTOR ID FIELD		GAP		DATA 1 FIELD		GAP		DATA 2 FIELD	
PAD	SERVO FIELD	VFD	SYNC	ID	CRC	VFD	SYNC	DATA	CRC	VFD	SYNC	DATA	CRC
24	40	20	1	4	2	17	1	256	2	22		256	2

BYTES 24 40 20 1 4 2 17 1 256 2 22 256 2

ID = IDENTIFICATION CRC = CYCLIC REDUNDANCY CHECK SUM SYNC = SYNCHRONIZATION VFD = VARIABLE FREQUENCY OSCILLATOR

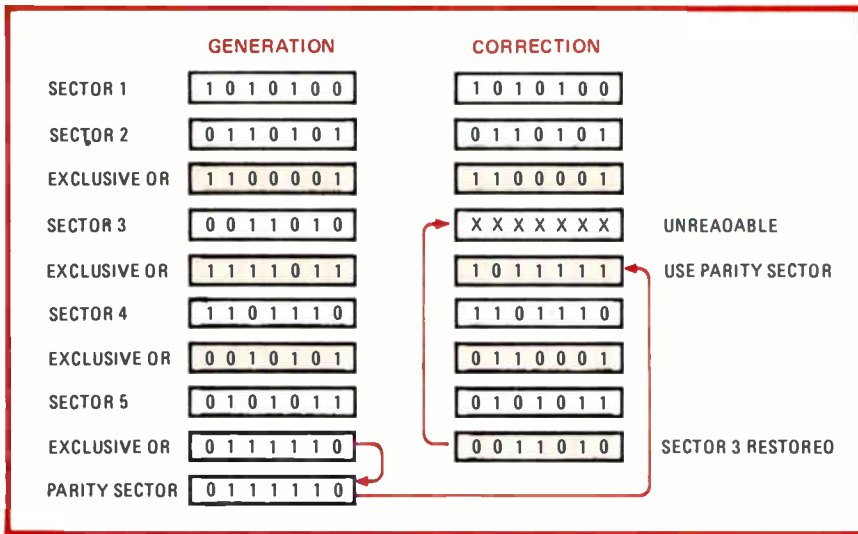

3. Bit magic. This example of the parity-sector ECC scheme shows only a few ideally small sectors in order to illustrate the error-correction process, which works identically when applied to a greater number of large-sized sectors. An exclusive-OR of successive sectors produces the parity sector.

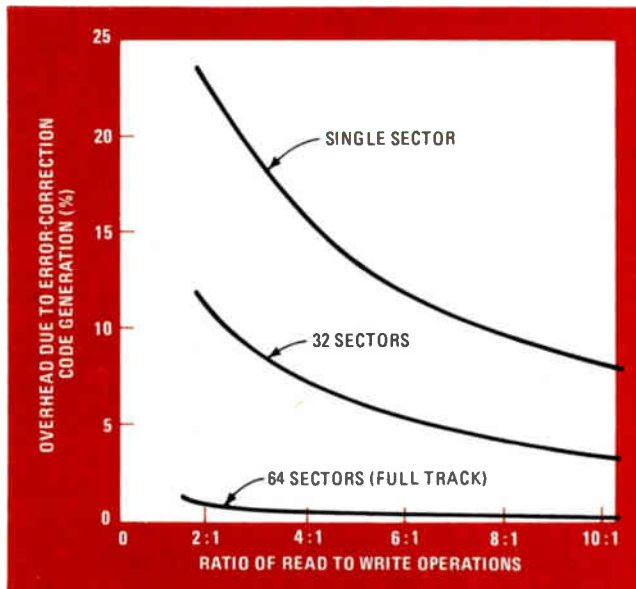

4. Cost-effective. The major cost of error-correction coding is the amount of time that it takes for generation of the ECC data. In the parity-sector ECC scheme for the Alpha 10, the cost becomes negligible when used over a full 64-sector track.

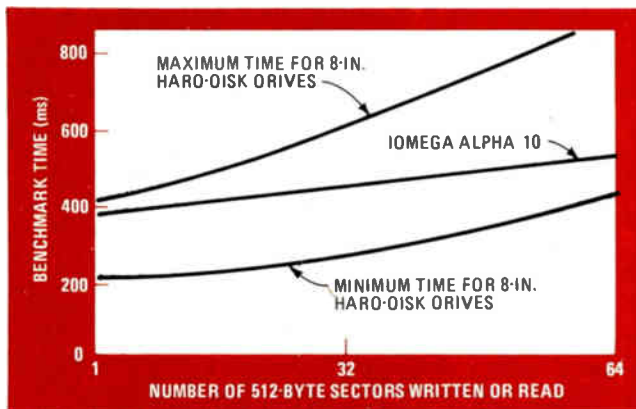

5. Reading and writing. A comparison of the performance of the Alpha 10 with various 8-inch hard-disk drives shows that it can keep up with them. The benchmark test was the time required to do one random writing operation and four random reading ones.

sector if the defective records are the same. A defect spanning a sector boundary and affecting record 2 of the first sector and record 1 of the second sector is correctable. Likewise, a defect spanning two records within a single sector is correctable.

Since each write operation to the Alpha 10 requires a corresponding update to the ECC sector on that track, there may be some performance overhead involved. However, the overall effect of the ECC on system performance depends on two factors: the number of sectors being written in a typical write operation and the overall ratio of write operations to read operations in a given system environment.

Figure 4 summarizes the ECC generation overhead in the Alpha 10 as a function of the number of sectors written and the ratio of read operations to write operations. It is estimated that for most typical system environments the number of read operations will be at least four times the number of write operations. For full-track writes (for instance, in copy or back-up mode), the performance impact is essentially zero.

Figure 5 compares the performance of the Alpha 10 with that of a group of high-performance 8-in. rigid-disk drives with both removable and nonremovable media. The benchmark test used to calculate the data is defined as the total time required to do one random write operation and four read operations. That time includes head seek, latency, write, read, and write verify times. The horizontal axis indicates whether the benchmark is tested with single-sector, 32-sector, or 64-sector write-read operations.

The minimum and maximum ranges were calculated from performance specifications published by the respective drive manufacturers. It can be seen that the Alpha 10 with parity-sector ECC compares very favorably with this class of high-performance rigid-disk devices. The ECC function of the Alpha 10 subsystem can be enabled or disabled by a system-level command at any time. Thus, a user may enhance the performance of the drive by running for periods of time without ECC protection. In addition, at the end of a work period, the cartridge can be ECC-protected, if desired, by the issuance of the ECC-enable command. □

ECC embraces more than components and hybrids

Fine-line thin-film substrates, integrated capacitors, and the laser processing of thick films are all topics at this year's Electronic Components Conference

by Jerry Lyman, *Packaging & Production Editor*

□ As in past years, the stated purpose of the 1982 Electronic Components Conference is to present new developments in components and also hybrid circuits. But this year's ECC, to be held May 10-12 in San Diego, Calif., does much more.

The conference's 16 sessions also cut across technologies like VLSI circuit packaging, manufacturing processes, optical hybrids, and even semiconductor processing and technology. The first two of these topics dominate the conference, with three and two sessions respectively. But each of the single sessions, like those on optical hybrids and passive components, for example, contain much material of interest to the electronics specialist. There is even a paper on the development of a cold-cathode tube for high-temperature electronic operations in geothermal applications.

The three packaging sessions comprise 16 papers covering all aspects of the subject, from mechanical configurations to thermal and electrical considerations. Perhaps the most important paper comes from the Honeywell Corporate Technology Center in Bloomington, Minn. In it, J. P. Cummings, R. Jensen, and D. Kompelien take a look at the technology base that will be needed for packaging future very high-speed and very large-scale integrated circuits.

The three authors note that the advances currently being made in VHSIC and VLSI circuit densities necessitate the development of new concepts, designs, material systems, and processing approaches for IC interconnection and packaging. Circuits with 500 input/output connections and a clock rate of 500 megahertz are now being designed. Such a

speed means that the conductor network in a package must be treated as a set of transmission lines. Line impedance, the critical line length for termination, ohmic drops, and interline isolation become critical to package performance, while the dielectric material in a multilayer configuration must be chosen carefully for an appropriate dielectric constant and loss.

These design considerations led Honeywell's engineers to conclude that VHSIC and VLSI chip interconnection needs could best be met by a thin-film-based, single- or multi-layer package. A thin-film approach was chosen for its fine-line capability. With thin-film conductors, a chip with a relatively high gate count can be directly attached to a thin-film chip extender, so that fewer layers are required to interconnect a multichip or multilayer configuration than in a thick-film system.

Honeywell uses two approaches to generate lines

about 10 micrometers wide and thick on ceramic substrates. Selective plating can achieve dimensions limited only by the resolution and thickness of the photoresist. Ion-beam milling, unlike selective plating, is a subtractive process and requires only a photoresist thick enough to withstand the milling operation. Sapphire, alumina, and silicon nitride ceramics were chosen as substrate materials, being relatively lightweight and possessing good thermal dissipation, electrical insulation, and mechanical strength. Some upgrading of the surface finish was found necessary to obtain the fine-line conductors.

Polyimide was selected as the dielectric material for the new package because of its relatively low processing temperature (less than 300°C) and its low dielectric

1. Dielectric for VLSI package. Honeywell's scanning electron photomicrograph shows a serpentine pattern with 10- μ m-wide lines and spaces plasma-etched into a 6- μ m-thick polyimide film—the dielectric layer of a multilayer thin-film substrate.

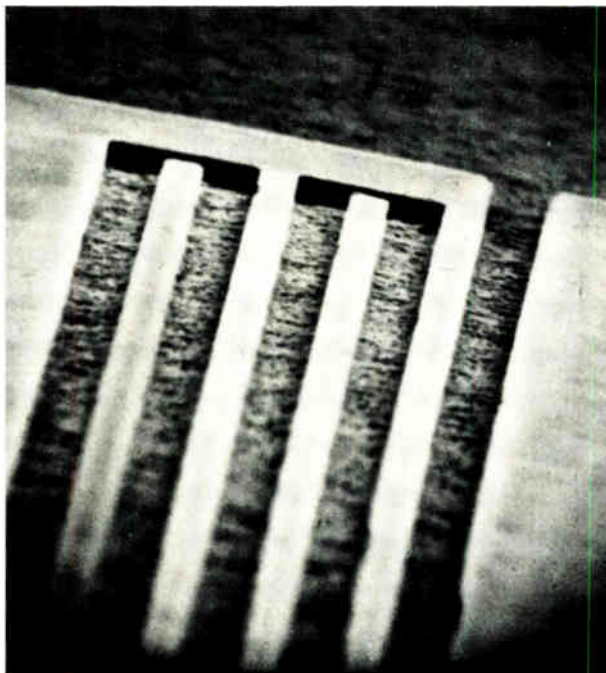

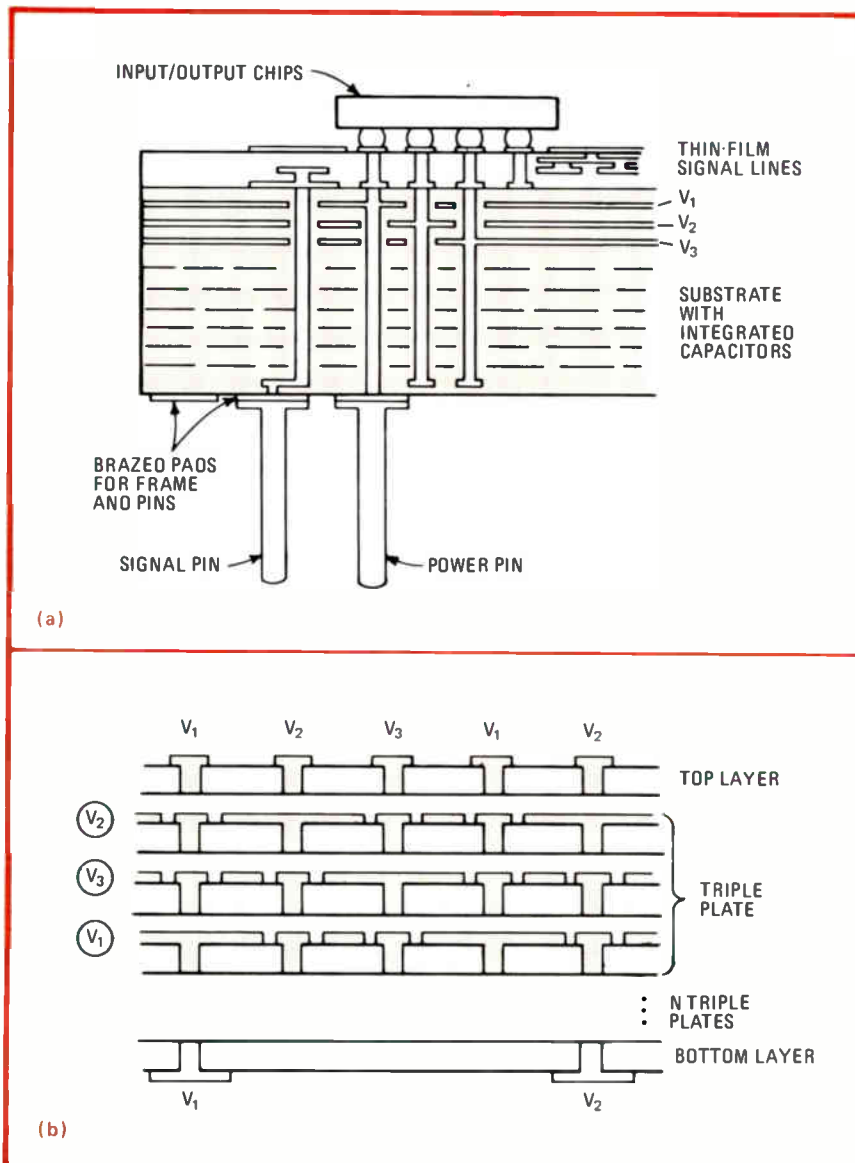

2. Horizontal capacitors. IBM's multilayer ceramic (a) has a horizontal-capacitor layer (b). To build this layer, green sheets first have vias punched and filled with metal paste. After paste is applied to the layers, the sheets are stacked, laminated, and fired.

the number of driver circuits and a decrease in rise times and voltage swings. The changes will require at least an order-of-magnitude reduction in the inductance of the current path through the package from the decoupling capacitor to the chip. This requirement can be satisfied only by low-inductance capacitor designs, close proximity of the capacitors to the chips, and an opposing current flow in those power contacts located close to each other.

The IBM authors discuss three approaches to this problem. One is a horizontal-capacitor substrate—the least revolutionary change from today's typical multilayer substrate. Next, an extremely low-inductance structure with vertical capacitor plates is presented. Finally, the concept of isolated individual capacitors buried in a substrate is suggested.

The horizontal-capacitor design is the traditional multilayer ceramic structure, in which the layers are arranged horizontally (Fig. 2a). Three voltage levels are shown on three planes. Vias through the planes are obtained by punching holes in the ceramic green sheets and filling them with a metalizing paste prior to lamination. Unscreened doughnut areas form the isolation dielectric

between the vias and the voltage planes. Figure 2b shows the horizontal-capacitor layers of a multilayer ceramic chip-carrier. The capacitance required determines the number of sheets, their thicknesses, and the desired properties of the dielectric material.

The vertical-capacitor design represents an optimum configuration for an integrated-capacitor substrate with the lowest possible inductance. The current in the capacitor plates flows in opposing directions, so that inductance is reduced to its lowest levels.

Shown in Fig. 3 is an exploded perspective of the vertical-capacitor substrate. The top segment is the capacitor structure, with input and output current passing through tabs on the top and bottom of the metal planes. The middle segment is the body of the structure, which contains not only the slots for insertion of the top segments but signal and reference vias that also pass through the substrate. The bottom segment consists of layers for redistributing the signal and power vias to appropriate pins plus an upper layer with screened slots for capturing tabs of the capacitor plates. The capacitor

constant (3-4), an asset for high-speed circuits. The polyimide was either spray- or spin-coated onto the substrate. Both wet chemical and reactive plasma processing was used to define the metalization of the multilayer packages. An example of plasma-etched polyimide is shown in Fig. 1.

Buried capacitors

Another extremely innovative packaging article is "A Ceramic Capacitor Substrate for High-Speed Switching VLSI Chips" by D. A. Chance, C. W. Ho, C. H. Bajorek, and M. Sampogna at International Business Machines Corp.'s Thomas J. Watson Research Center in Yorktown Heights, N. Y. The paper discusses the various forms of integrated-capacitor substrates that are essential to realizing multilayer ceramic chip-carriers.

An integrated chip-carrier may carry up to 100 chips on a 10-by-10-centimeter substrate. If each chip requires a capacitance of 40 nanofarads, then the substrate needs a total capacitance of 4 microfarads. Future trends in high-performance systems point toward a quadrupling of

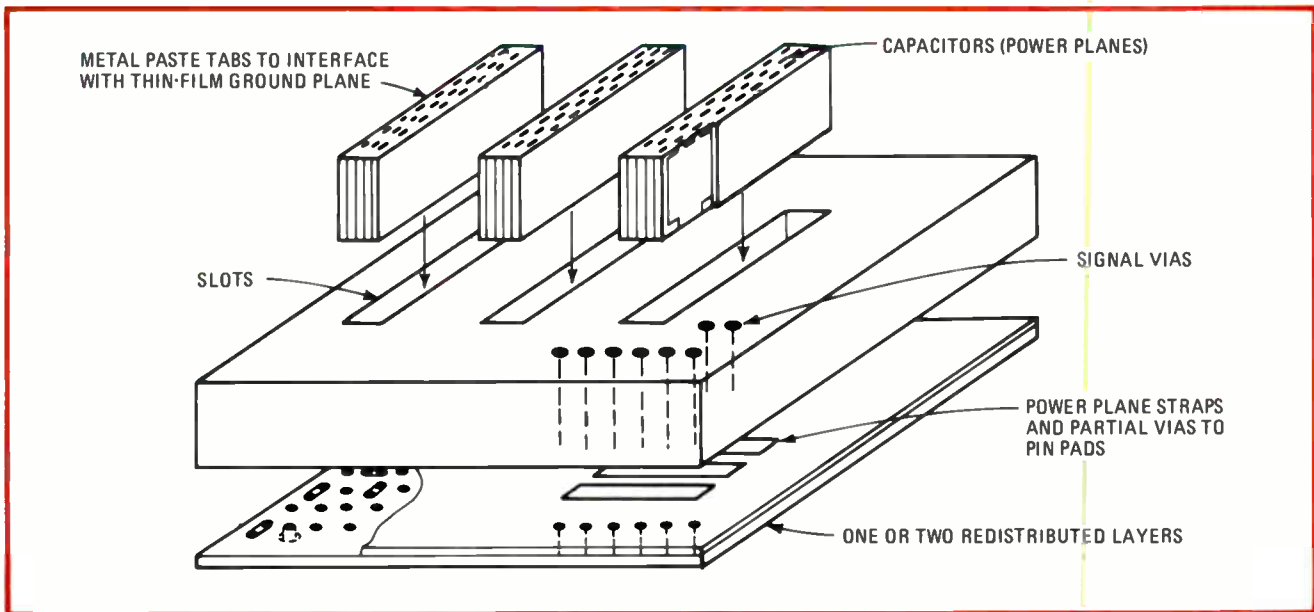

3. Up and down. Decoupling capacitors may be integrated vertically, as this exploded view of an IBM design shows. The capacitor plates are arranged, so that current in adjacent capacitor plates flows in opposing directions and mutual inductance is thus reduced to a minimum.

segments are separately laminated and sized prior to insertion into the slots.

The third proposal is for a dot-capacitor substrate. Small capacitors sandwiching material with a high dielectric constant between metal planes would be dispersed throughout the substrate. However, this idea has not yet been thoroughly evaluated.

Some preliminary results on switching noise for the integrated-capacitor substrates have been calculated on the basis of estimated effective inductances. The optimum substrate is shown to be the vertical-plane type.

Laser-fired thick films

The manufacturing sessions have a mix of 12 papers that range from an unusual application of the laser in a very practical fast-turnaround procedure to a down-to-earth description of a pressure-cooker test for chips in premolded plastic packages.

In one of the most outstanding papers of the conference, Takaaki Ohsaki, Etsuji Sugita, and Satoru Yamaguchi of Nippon Telegraph & Telephone Corp.'s Musashino Electrical Communication Laboratory tell how they used a neodymium: yttrium-aluminum-garnet laser to make a multilayer thick-film hybrid circuit with three times the interconnection density of conventional thick-film hybrids. The laser, under computer control, draws the pattern of conductors into a layer of thick film while simultaneously firing them. The same laser also drills extremely thin vias. This procedure speeds turnaround and lowers design costs since all artwork and screens are eliminated.

The starting point of the Musashino process is to print specially developed conductor paste over the entire surface of an alumina substrate. The covered surface is then irradiated by a scanning continuous-wave laser beam. Then the unirradiated surface is dissolved by an organic solvent. What remains is the desired conductor pattern for the first layer.

Next a conventional dielectric paste is screened over the entire surface and fired. Vias are then drilled in this layer by a scanning pulsed laser beam. These steps are repeated till as many interconnection layers as desired have accumulated on the alumina substrate.

The main mechanism for the conductor pattern formation is the thermosetting of the paste due to the laser beam's energy. Results show that this technology can create 30- μm -wide conductors, given a 20- μm -diameter beam and 10- μm -thick paste.

Via diameter was found to be a function of laser power and pulse rate. Consequently, 30- μm -diameter vias with a 30- μm -thick dielectric layer were fabricated by a pulse laser with a peak power of 2 kilowatts.

An actual multilayer substrate was fabricated using this technique. Measuring 80 by 80 millimeters, the substrate had two conductor layers and one dielectric layer. The conductors were 40 μm wide and the via holes were 40 μm in diameter. The circuits fabricated were highly stable and reliable in operation, according to the authors. This new technique is analogous to electron-beam lithography in IC processing and could be applied to packaging large multichip hybrids.

Another laser-oriented paper, by Allen E. Zinnes of Bell Laboratories, Allentown, Pa., describes a fast-turnaround procedure for fabricating limited quantities of prototype thick-film resistor networks within four to six weeks after receiving a schematic. Circuits with up to 18 terminals for 0.300-inch-wide dual in-line packages and with up to 12 terminals for 0.350-in.-high single in-line packages can be accommodated. This procedure is of particular importance when a given network's resistor values or interconnections or both might be changed after fabrication of the initial model.

In this system, resistors are placed at fixed locations on a substrate and connected by a dedicated conductor grid. A laser cuts open any unwanted lines in the grid. The resistors, all the same size and screened from stan-

standard pastes, are laser-adjusted over a wide range of values. A blocking-out technique removes unwanted resistor patterns from the standard resistor screens.

Up to four different circuits of the same type may be made at the same time. No custom layout is required for a given network; instead, a routine analysis is made to determine which conductor lines should be cut open and which resistor patterns need to be blocked.

Damp-proof premolded DIPs

Premolded packages have some distinct advantages over the postmolded type. For one thing, they can be more easily handled automatically. Secondly, they allow the encapsulation of the IC in a soft, compliant silicone compound. This material protects the chip from stress during package assembly, preventing cracking or piezoelectric effects. But there is still the doubt over whether the postmolded package can stand up under high-temperature or very humid conditions.

A paper by Arnold Rose and Manfred Fischer tells about testing 24-pin premolded DIPs at Signetics Corp., Sunnyvale, Calif. In the Signetics test, a passivated, fine-aluminum-line interdigitated array was wire-bonded to a premolded 24-lead DIP. The cavity of the package was filled with a silicone gel and sealed with a lid.

This packaging system was exposed to long-term steam pressure under both biased and unbiased electrical conditions at 121°C and 15 pounds per square inch gauge. Test data indicated that fewer than 10% of the chips underwent corrosion-induced failures in 1,000 hours of testing. Conventional postmolded epoxy devices under similar conditions experienced a 50% failure rate in less than 100 h.

Optical hybrids, the topic of session 4 of the ECC, is a technology of increasing importance. However, building an optical hybrid raises problems even for engineers knowledgeable in standard thick- and thin-film circuits.

For example, a conference paper by John Williams of Bendix Corp.'s Kansas City division in Missouri describes the manufacturing problems and solutions that are involved in making a hybrid-circuit light detector.

The detector uses a 3/4-by-1-in. transparent sapphire substrate on which a thin film of metal is deposited and selectively etched to produce conductor patterns and an optical window. A photodiode is mounted with a transparent adhesive over the window on the component side.

Four areas presented problems here: the adhesion of the metallization to the sapphire substrate; wire bonding to metallization on sapphire; finding a transparent adhesive for attaching the photodiode; and finally solder-

sealing the final hybrid thin-film light detector.

Two thin-film metallization systems were evaluated—chrome plus gold, and titanium plus palladium plus electroplated gold. Samples of both were subjected to different combinations of the following process conditions: 900°C firing, tantalum nitride underlayers, and resistor stabilization. The results indicated that the adhesion of the chrome-gold metallization to sapphire was superior.

After this step, a wire-bonding evaluation was undertaken for this metallization. Gold wires 1 mil thick were thermosonically bonded to various components, including ICs, diodes, transistors, capacitors, and resistors. The bond pull strength was evaluated before and after a 96-h 150°C bake. Both pre- and post-bake pull strength was excellent.

Sylgard 186, a silicone-based transparent adhesive, served to attach the photodiode to the sapphire material. The tensile strength of the adhesive was evaluated by using different thicknesses and subjecting them to environmental tests. Excellent pull strengths resulted through all phases of the evaluation.

Solder sealing had no bad effects on the sapphire substrate. Seven packages were solder-sealed to the gold-chrome metallization with no damage to the sapphire.

An optical-pulse generator hybrid

A directly coupled optical-pulse generator is described in a paper by Geoffrey Herrick of Tektronix Inc., Beaverton, Ore. The hybrid is used for fiber-optic testing. Its package allows efficient coupling of a laser diode output into a graded-index optical fiber with a 50- μ m-diameter core. The system is designed for easy alignment in manufacturing and for mechanical stability in the field.

The complete optical-pulse generator is diagrammed in Fig. 4. The hybrid consists of a low-impedance thick film of gold on a beryllium oxide substrate, four high-power double-diffused MOS field-effect transistors, four chip capacitors, and a gallium-aluminum-arsenide laser diode. The

laser chip is bonded to a BeO submount, which in turn is mounted on the substrate. The optical fiber is fed through a Kovar tube and is bonded to an alumina standoff. A chip resistor protects the gates of the static-sensitive FETs.

Optical coupling of the laser is done by aligning a 4-foot-long optical fiber with the output beam of the laser diode. After the fiber end has been cleaved and aligned with the laser output beam and then epoxied to the standoff, the fiber is sealed in the Kovar tube with a

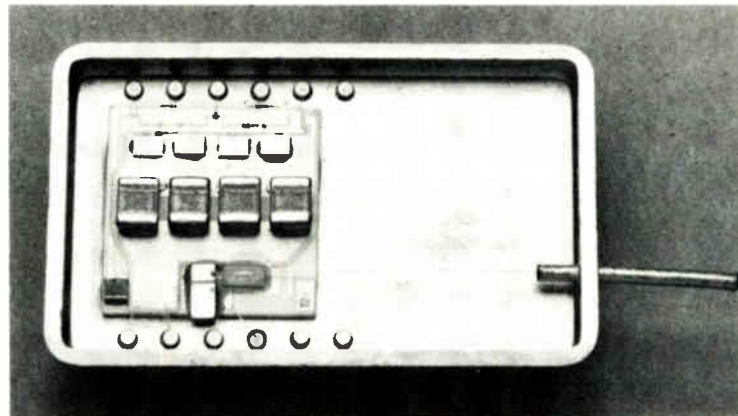

4. Optically pulsed. A direct-coupled optical-pulse generator hybrid fabricated at Tektronix uses thick-film gold on a beryllium oxide substrate and houses four double-diffused MOS field-effect transistors, four chip capacitors, and a laser diode. The laser beam is fed out through the optical fiber.

5. Sprytron. Sandia National Laboratories has developed this ceramic cold-cathode tube for 250°C operations. All its elements use high-temperature materials. The tube is used to switch high-power pulses in the non-destructive evaluation of geothermal wells.

low-permeability epoxy.

This optical-pulse generator produces square waves at an nominal wavelength of 820 nanometers. The maximum pulse width is 50 nanoseconds at a 5-kilohertz pulse rate. The hybrid will switch up to 20 amperes at 8 volts into the laser diode with a rise time of less than 5 ns.

High-temperature electronic components and circuit design is one topic covered in session 15, which nominally concerns resistors. A paper given by Hsi-Tien Chang of Sandia National Laboratories, Albuquerque, N. M., covers an aspect of electronic circuits capable of operating up to 250°C that is seldom touched upon—high-power circuitry.

Surprisingly, to implement this circuitry, Sandia is in the process of developing a high-power, high-speed cold-cathode tube to be used as a substitute for silicon controlled rectifiers or thyatron tubes. The tube will be used for various nondestructive evaluations of the casing and cement of geothermal wells.

For fast electronic switching of high current levels, an SCR is commonly used in transistor circuit design. Unfortunately most SCRs are rated only up to 125°C, for at higher temperatures they will conduct even without a trigger pulse.

The thyatron is another candidate for high-power, high-speed switching. But as a hot-cathode tube, it requires a lot of energy, which it is not practical to transmit from the earth's surface to a logging instrument at the bottom of a deep well.

Sandia's cold-cathode vacuum-discharge tube comes closest to the characteristics of an SCR yet can operate at high temperatures. Called a Sprytron, it is distinguished by a fast response time, short recovery time, and high hold-off voltage.

Sprytrons work as well at 250°C as at normal ambient temperatures because they are made with high-temperature materials. In the geothermal well's temperature range, these materials exhibit no significant change in their properties.

Figure 5 is the cross section of a Sprytron. To remove gaseous impurities, the tube is exhausted at 600°C for several hours during processing. To operate it, a fast-rising trigger pulse is applied to the probe to cause a spark, initiating plasma across the carbon film between

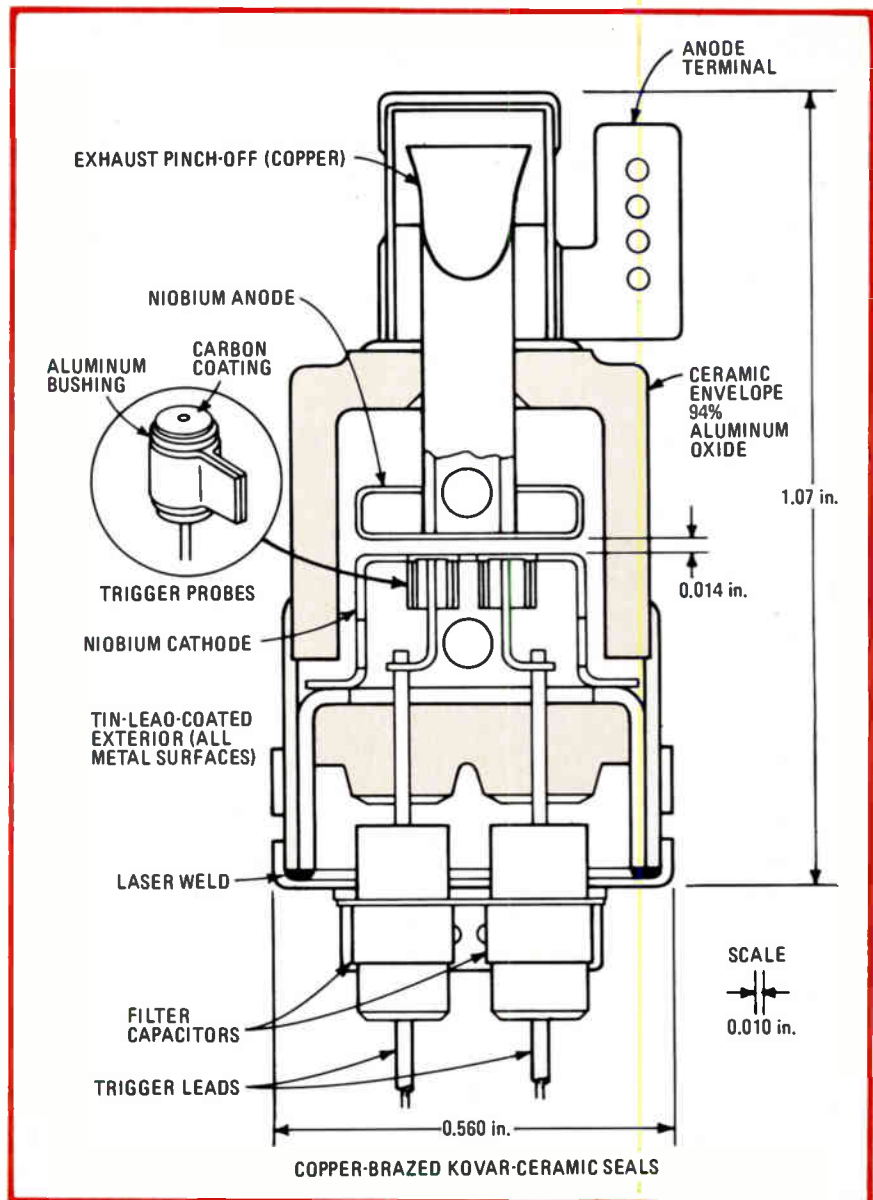

the trigger pin and cathode. This trigger plasma expands into the vacuum between the electrodes and results in a vacuum arc discharge between them.

The main discharge produces a high current limited only by the external circuit and the tube's voltage drop, which is in the 10-to-30-v range. The high-current arc also vaporizes the cathode material and gradually erodes the cathode. This shortcoming, however, is being overcome in a Sandia program to upgrade the cold-cathode tube. Recently a prototype tube successfully ran for 200,000 switching operations.

Moreover, the Sprytron was initially designed for only 200 operations, for which it required a minimum anode potential of 200 to 300 v depending upon circuit parameters, for a guaranteed arc discharge. Since that high voltage might cause the insulation of a logging cable to break down, it would be desirable to be able to operate the tube at only about 100 to 150 v for those 200,000 operations. Sandia is investigating tube design modifications to this end. □

State-variable filter trims predecessor's component count

by James H. Hahn
Interface Technology Inc., St. Louis, Mo.

A state-variable active filter, even though it requires three operational amplifiers and eight passive components, is widely used because it is less sensitive than other filter designs to component changes, provides high Q and gain, and can operate at fairly high frequencies. A new design using fewer parts simplifies the standard filter¹ yet provides the same bandpass characteristics and low sensitivity.

A conventional state-variable circuit (a) is composed of summing amplifier A₁ and integrators A₂ and A₃. When high-pass output E₂ is eliminated and the first integrator is treated as the summing amplifier, the bandpass transfer function of the revised circuit (b) becomes:

$$H_{bp}(s) = \frac{E_3}{E_1} = \frac{-s/C_1 R_1}{s^2 + sa + b}$$

$$\text{where } a = \frac{R_2 C_2 (R_3 + R_4) + R_4 C_1 R_5}{R_2 R_3 C_1 C_2 (R_3 + R_4)}$$

$$\text{and } b = \frac{R_4 (R_1 + R_3)}{C_1 C_2 R_1 R_2 R_5 (R_3 + R_4)}$$

In addition, the two-pole bandpass form of the circuit is preserved. If R₅ is eliminated and left an open circuit, the a and b terms simplify to:

$$a = \frac{R_4}{C_2 R_2 (R_3 + R_4)} \text{ and } b = \frac{R_4}{C_1 C_2 R_1 R_2 (R_3 + R_4)}$$

Comparing the transfer function to the general form:

$$H_{bp} = \frac{s\omega_0 H_0 / Q}{s^2 + s(\omega_0 / Q) + \omega_0^2}$$

When H₀ is the value of H_{bp} at $\omega = \omega_0$ and Q is the quality factor:

$$\omega_0 = \left[\frac{R_4}{C_1 C_2 R_1 R_2 (R_3 + R_4)} \right]^{1/2}$$

$$\text{and } H_0 = -Q^2 = \frac{-C_2 R_2 (R_3 + R_4)}{C_1 R_1 R_4}$$

Solving for R₁ and R₂:

$$R_1 = \frac{1}{\omega_0 Q C_1} \text{ and } R_2 = \frac{R_4 Q}{(R_3 + R_4) \omega_0 C_2}$$

With the above equations, a two-pole active bandpass filter (c) is realized by choosing C₁, C₂, and R₃:R₄ for the given value of ω_0 and Q and then computing R₁ and R₂. If the passband gain is high, an attenuator can be used at the input with R₁ serving as the attenuator's

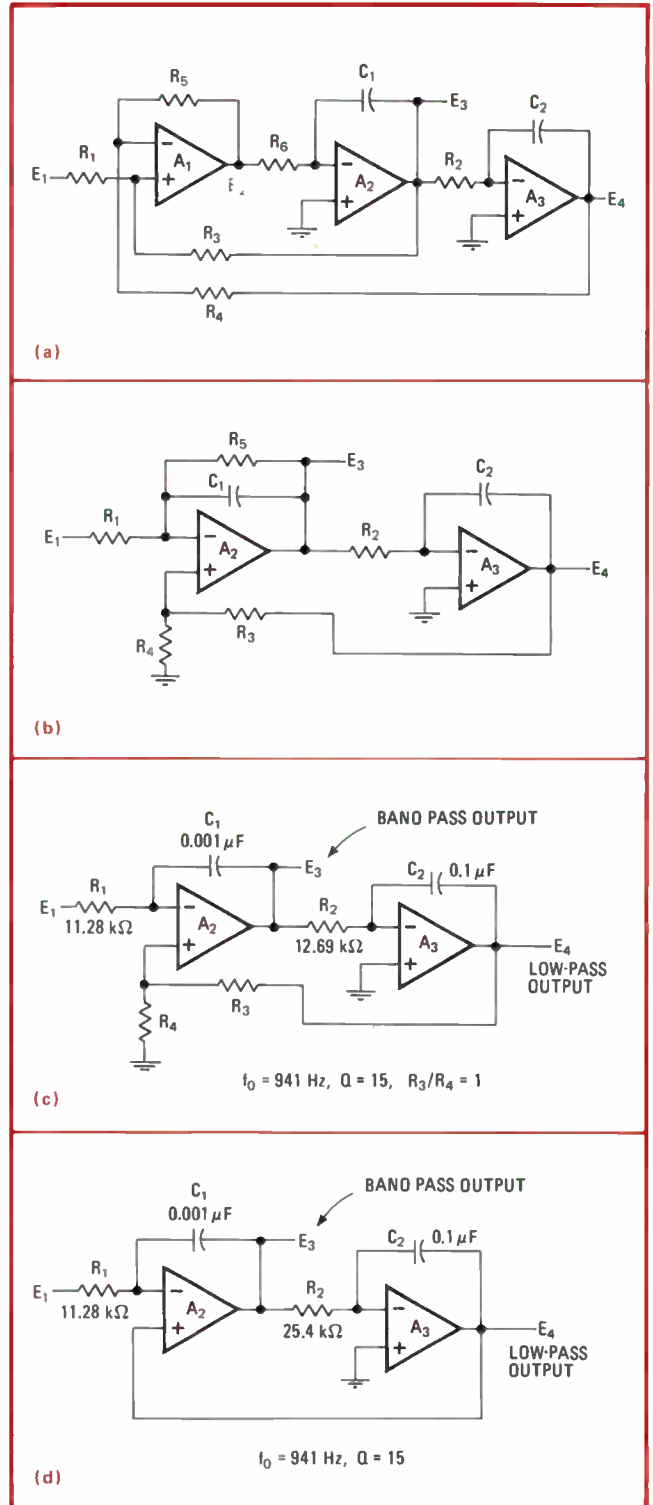

Reduced. The conventional state-variable filter (a) is simplified (b) when highpass output E₂ is eliminated and integrator A₂ is treated as a summing amplifier. This circuit is further reduced by creating an open circuit across R₅. A reduced two-pole bandpass state-variable filter for $f_0 = 941$ Hz, $Q = 15$, and $R_3/R_4 = 1$ is shown in (c). A version with R₄ and R₅ open and R₃ = 0 is shown in (d).

equivalent series resistance. The circuit can be further reduced (d) by letting R_4 be an open circuit and $R_3 = 0$ ohm. This modification gives:

$$\omega_o^2 = \frac{1}{C_1 C_2 R_1 R_2} \text{ where}$$

$$R_1 = \frac{1}{\omega_o Q C_1} \text{ and } R_2 = \frac{Q}{\omega_o C_2}$$

The simplified configuration uses much less power and fewer components than the conventional circuit to achieve the same low sensitivities. If C_2 is greater than C_1 , the circuit's near ideal performance will not be degraded by second-order effects, such as finite amplifier gain. The filter is also useful for low-pass applications. □

References

1. J. Graeme, G. E. Tobey, and L. P. Huelsman, "Operational Amplifiers—Design and Applications." McGraw-Hill, 1971, p. 304.

High frequencies, winding setup improve voltage conversion

by David W. Conway
 Universal Engineering Corp., Cedar Rapids, Iowa

Designed to meet high-voltage requirements, this efficient and inexpensive dc-to-dc converter finds use in devices like photoflash equipment and capacitive-discharge ignition systems. The design produces 450 volts at 250 milliamperes from a 12-to-16-v dc supply. The high-power output and high efficiency of the circuit is attributed to high-frequency operation and the use of insulating tape between the layers of the transformer's secondary winding.

A push-pull-amplifier configuration comprising power field-effect transistors Q_3 and Q_4 is driven by integrated circuits U_1 through U_3 . Oscillator U_1 generates 150 kilohertz, which is halved to 75 kHz by flip-flop U_2 . The

high-voltage output is adjusted with potentiometer R_1 . When R_1 is at its minimum resistance, the output voltage is at its highest.

This converter is much smaller than competing designs because high frequencies are used. The output transformer's secondary is first wound on the bobbin. In

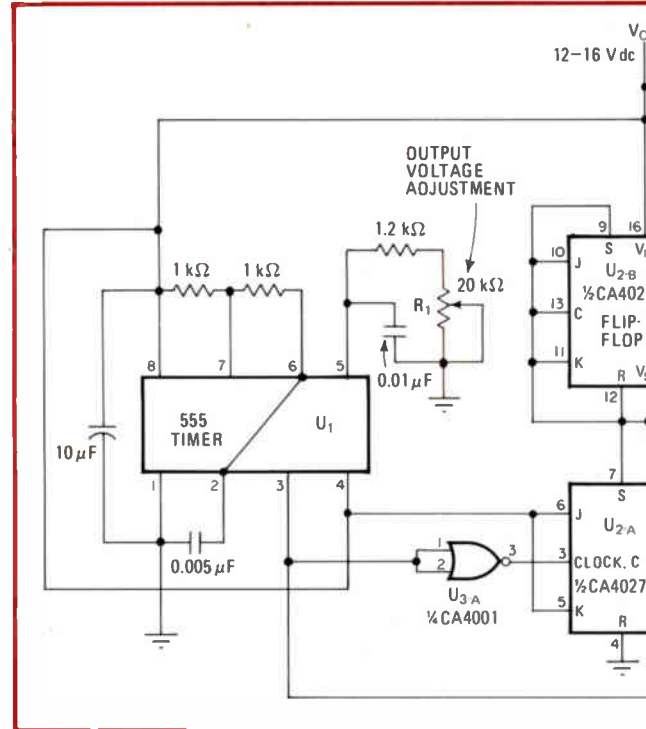
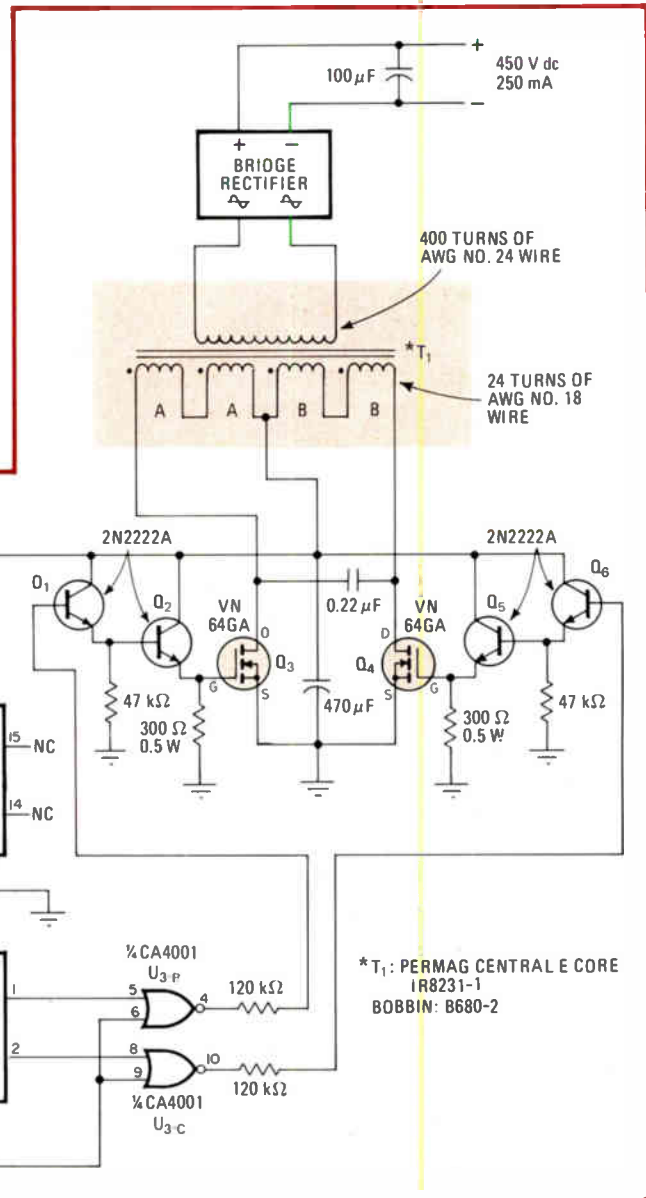

High-voltage converter. Oscillator U_1 , frequency divider U_2 , and buffer U_3 drive power FETs Q_3 and Q_4 in a push-pull configuration to generate 450 V at 250 mA. A power efficiency of about 90% is attributed to transformer's winding techniques and the use of high frequencies.

NO ONE MAKES SPECIALTY METALS flatter, thinner, wider.

(And we do it to precision tolerances.)

- STAINLESS STEEL
- NICKEL ALLOYS
- CARBON STEEL FOIL
- HIGH TEMPERATURE ALLOYS
- SPECIAL METALS
- THICKNESSES - .0005" to .020"
- WIDTHS - .040" to 42"
- STRIP & FOIL - up to 42" wide, .002" thin.
- FINISHES - from reflective bright to dull matte.
- TEMPERS - annealed ¼, ½, ¾, full hard, extra high tensile or specific tempers.

Teledyne Rodney Metals' innovative metallurgists, skilled engineers and local salespeople are ready with solutions to your needs and problems. Ask us.



TELEDYNE
RODNEY METALS
THINOVATORS® in Precision Rolled Metals

U.S. Regional Offices and Service Centers:

Teledyne Rodney Metals: P. O. Box E-915, New Bedford, MA 02742 Phone: 617-996-5691 TWX 710-344-1347

Teledyne Rodney Metals of California: 7305 Paramount Blvd., Pico Rivera, CA 90660 Phone: 213-942-2238 TWX 910-586-1377

Teledyne Rodney Metals of Missouri: 10855 Metro Court, Suite 1, Maryland Heights, MO 63043 Phone: 314-872-3522 TWX 910-764-0907

Teledyne Rodney Metals of Pennsylvania: 1045 Pulinski Road, Ivyland, PA 18974 Phone: 215-441-0205 TWX 510-665-6710

For information on Teledyne Rodney Metals' worldwide offices, please call our New Bedford Office. ◦

addition, 400 turns of the secondary winding are composed of eight layers of about 50 turns a layer, with each layer insulated from the other. 3M's Permacel 0.0025-inch-thick insulating tape separates the layers.

The two layers of wire that make up the primary winding are referred to as sections A and B. A 48-in. piece of AWG No. 18 wire is folded in half to obtain a bifilar strand, 24 in. long, that is wound as section A on the bobbin. Six bifilar turns fill the cross section of the

bobbin to form this layer. Similarly, section B is wound with six bifilar turns of AWG No. 18 wire on top of Section A. The windings are interconnected in series and properly phased to form a 24-turn primary winding. Scaling the turns ratio can provide additional output voltages as necessary. □

Designer's casebook is a regular feature in *Electronics*. We invite readers to submit original and unpublished circuit ideas and solutions to design problems. Explain briefly but thoroughly the circuit's operating principle and purpose. We'll pay \$75 for each item published.

Diode plus op amp provide double-threshold function

by Pavel Novak
Fraunhofer Institute for Solid State Technology, Munich, West Germany

Medical instruments that produce a signal or alarm when physiological measurements like heart rate or blood pressure reach undesirable levels need window comparators, which usually comprise two operational amplifiers each (a). But a new circuit cuts the op-amp requirement by half and achieves the comparators' double-threshold function by means of a simple diode.

When input voltage V_{in} reverse-biases diode D_1 , V_{in} appears at the op amp's noninverting input (b). In addition, inverting input voltage V_n is the sum of supply

voltage V_b and V_{in} . For this condition, $V_{in} = V_p$ (noninverting input voltage), and switching occurs when $V_p = V_n$. As a result, the upper threshold voltage V_u is now written as $V_u = V_b R_1 / (R_1 + R_2)$.

On the other hand, when the input voltage forward biases D_1 , the voltage at the noninverting input is $-V_d$, where V_d is the voltage across the diode under a forward-bias condition. The relationship for this second threshold voltage is now: $V_x = -V_b (R_3 / R_2) - V_d [1 + R_3 (1/R_1 + 1/R_2)]$ when $V_u \geq 0$ and $V_x \leq -V_d$.

This particular circuit leaves no room for threshold-voltage adjustment, but may be modified through the use of two potentiometers (c). Potentiometer R_4 sets D_1 's reference potential, V_a . In addition, resistors R_1 and R_2 are replaced with pot R_5 . The new set of threshold voltages are given by: $V_u = V_a$ and $V_x = V_a - V_d(1+r)$, where $r = R_3/R_1$. The window $V_u - V_x$ is valid when it is greater than or equal to V_d . Its characteristics are shown in (d). □

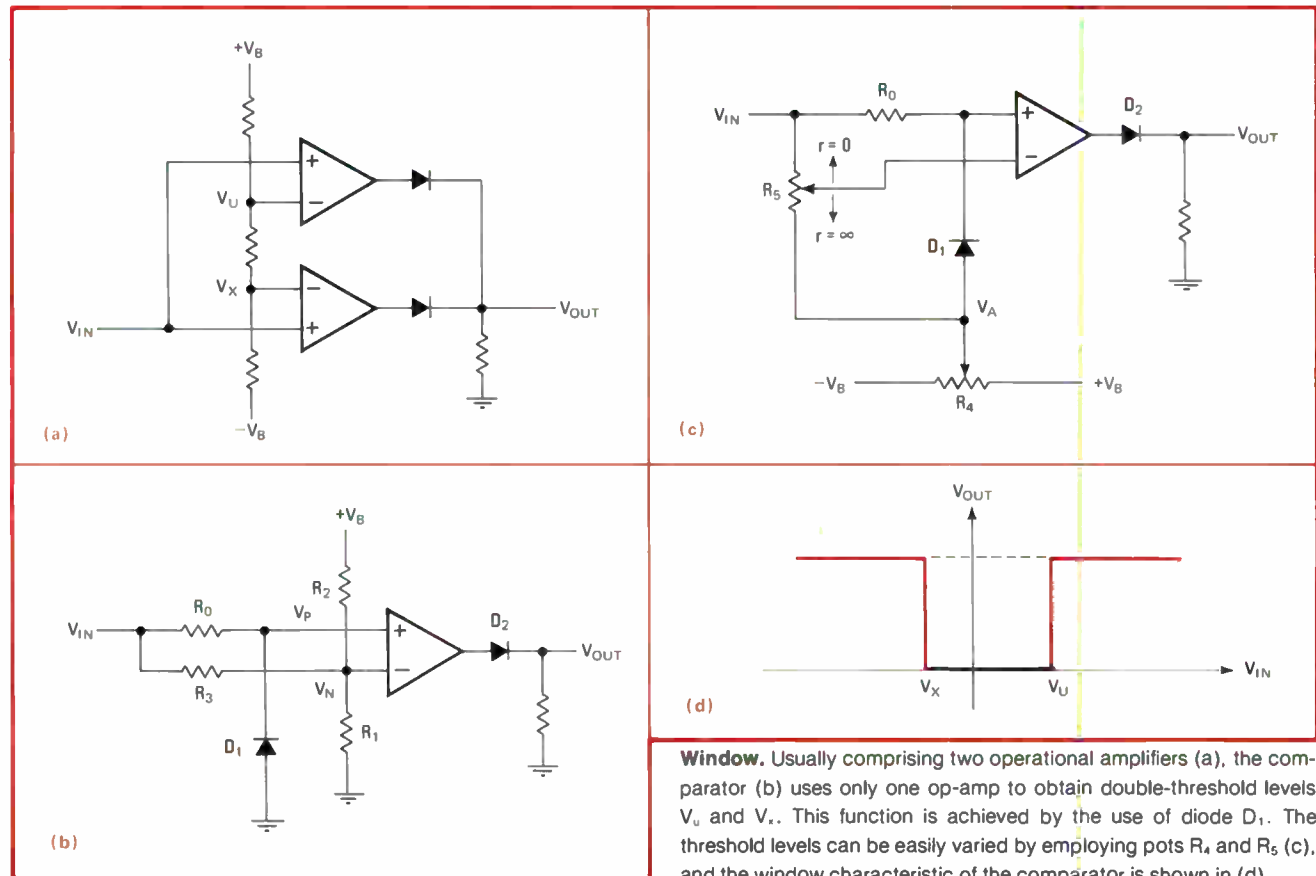

Window. Usually comprising two operational amplifiers (a), the comparator (b) uses only one op-amp to obtain double-threshold levels V_u and V_x . This function is achieved by the use of diode D_1 . The threshold levels can be easily varied by employing pots R_4 and R_5 (c), and the window characteristic of the comparator is shown in (d).



TRW Metal Glaze™ is the only thick film resistor that goes a step beyond ordinary metal film.

The secret is in the proprietary glaze systems, the unique design, and automated production techniques.

For ruggedness, performance and reliability, our thick film Metal Glaze resistors are unmatched anywhere.

Unique construction with patented thick film element fired at 1000°C to solid ceramic core.

TRW's Metal Glaze is up to 100 times thicker than vacuum deposited metal films. It's ideal for all types of applications, including automotive, telecommunications, computers, industrial electronics and military equipment.

Only thick film discrete encapsulated in a rugged molded jacket, like carbon comps.

TRW Metal Glaze resistors are molded for excellent mechanical strength and uniform body; not conformally coated like other metal film and carbon film resistors.

Exclusive high temperature soldered capless terminations. No press fitted end caps or welds.

The result is excellent pull strength and no substrate damage during assembly. With the additional protec-

tion of the molded jacket, the ¼ Watt Metal Glaze resistor can withstand a 20 lb. pull test.

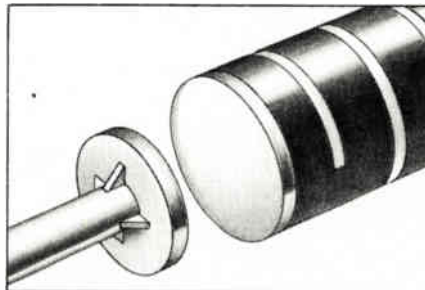

Precision design tolerances are backed by over 100 million unit hours of life test data.

Resistance changes under load are often less than ±.5%, even after 10,000 hours, which is equal to years of equipment life.

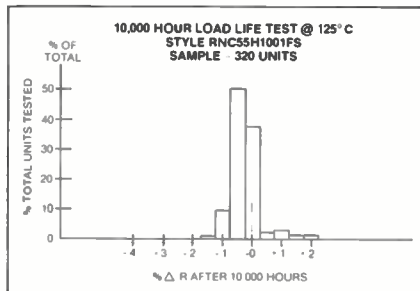

Outstanding power ratings 2x MIL/EIA standards. With excellent surge capability.

Now, our ¼ W can be rated up to ¼ W. Our ½ W sizes can be rated at ½ W and the 1W size up to 3 Watts at 70°C.

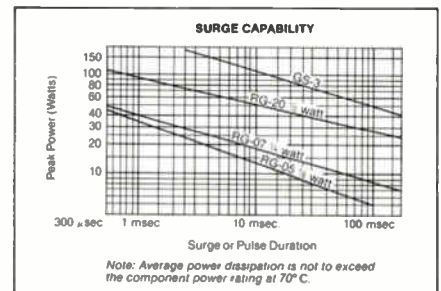

MIL qualified to RLR05-32, RN50-65, and RNC55-65.

Our RG series is qualified to all applicable MIL Specs. And with its exceptional shelf life characteristics, our RLR07, 20, and 32 units are drop in replacements for RCR carbon comps, but with better performance.

Call your local TRW/IRC distributor.

Or Fixed Resistor Distributor Operation. (215) 923-8230. For technical information call (704) 264-8861, or write: TRW/IRC, P.O. Box 1860, Greenway Road, Boone, NC 28607.

TRW IRC RESISTORS

Another product of a company called TRW.

Digital scope invades analog domain

Using a new type of converter, emitter-coupled-logic memory, and a low-jitter sample-and-hold circuit, scope traps waves with 50-MHz components

by Jack Caldwell, *Gould Inc., Instruments Division, Santa Clara, Calif.*

□ The domain of the digital oscilloscope has traditionally been the low-frequency transient area; above approximately 10 megahertz, digital scopes have never displaced their analog forebearers. But through the design of a new type of analog-to-digital converter, the recently introduced Gould Biomation model 4500 [*Electronics*, March 24, 1982, p. 166] is able to accurately digitize nonrepetitive waveforms having frequency components as high as 50 MHz. Thus, it makes possible waveform storage comparable with that of analog scopes while affording the waveform manipulation and analysis that only digital processing can easily provide.

The most widely used a-d converters are, in ascending order of conversion rate, the integrating, tracking, and successive-approximation types. And while the fastest of these is capable of providing very high resolution—on

the order of 12 bits—maximum conversion rates are on the order of 500 kilohertz, or 2 μ s. Since it was a design goal to achieve a conversion rate of at least 100 MHz using a converter capable of 8-bit resolution, these types were quickly eliminated from consideration.

The fastest practical a-d converters available today are parallel, or flash, converters. Since these are less common, it is useful to examine their operation.

As shown in Fig. 1, flash converters usually have two voltage references, a chain of highly accurate and stable

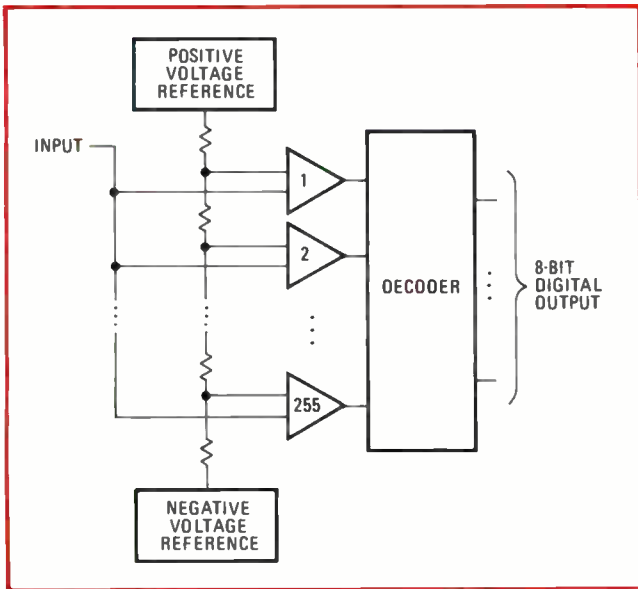

1. Flash back. The fastest conversion technique possible today is the flash, or parallel, converter shown above. However, to get an 8-bit output, 255 precision comparators and 256 precision resistors are required, often making the cost of such units prohibitive.

2. Rankings. The dual-rank converter in (a) uses only two 4-bit flash converters but loses speed because of the need to reconvert the output of one. The single-rank converter (b) works at a 100-MHz sampling rate, but is still too expensive.

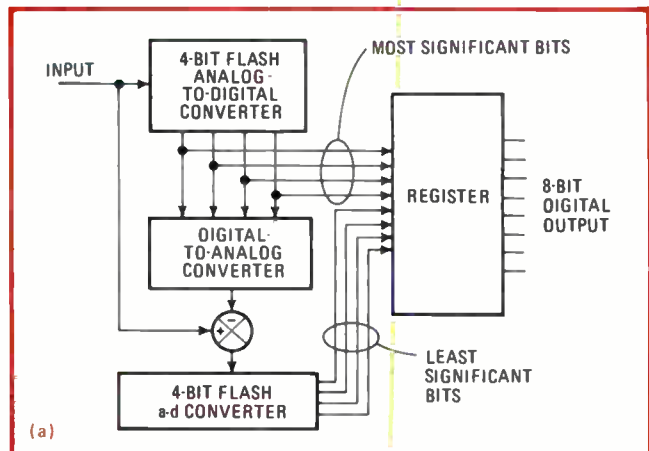

(a)

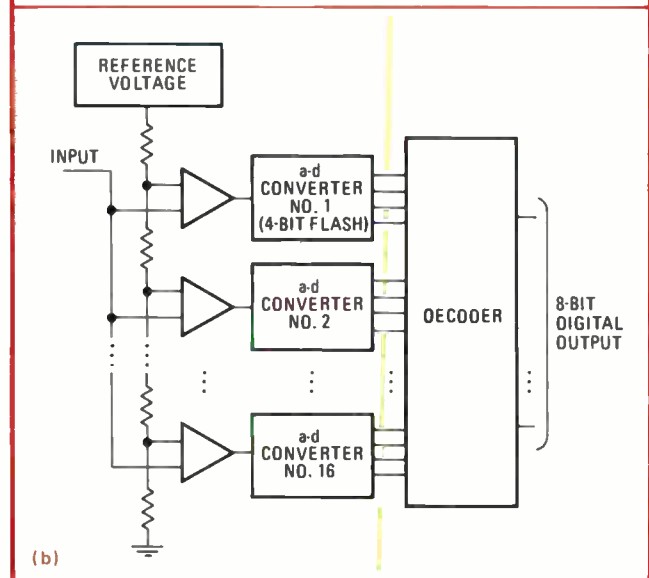

(b)

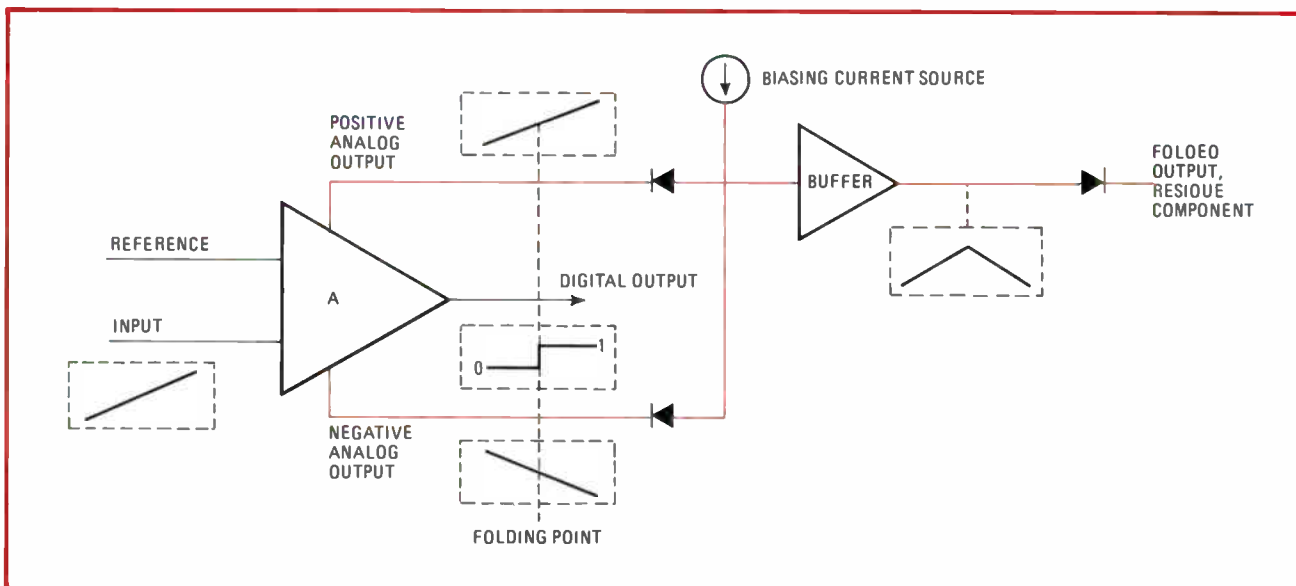

3. New to the fold. A new type of circuit devised for the model 4500, the folding circuit (shown in color above), produces a residue proportional to the level of the input (shown here as a ramp). The residue represents the segment of the overall input not resolved by the comparator output. Once the comparator changes state, the residue is inversely proportional to input.

resistors, and $2^n - 1$ comparators, where n is the number of bits the converter can resolve. The inputs to each comparator are a precisely known voltage picked off from a point in the precision-resistor chain and the signal to be digitized. The precision voltage inputs, and hence the resistor values, are chosen so that there is established an increment of exactly 1 least significant bit for each comparator stage.

Working in parallel

The entire input signal is fed to each comparator stage simultaneously (hence the name, parallel converter), and if it exceeds the reference voltage for that comparator, the comparator puts out a logic 1 signal. Thus in a short space of time—about 2 nanoseconds—there is a bar-graph-like output of 1s up to the comparator whose voltage reference input is slightly more than the actual input. The comparator outputs are then converted into a binary-coded output by translational logic.

One of the best commercial flash converters is the Am6688 from Advanced Micro Devices Inc., Sunnyvale, Calif. This unit, which has built-in precision references and decoding circuitry, is able to operate at 100 MHz, but produces only a 4-bit output. It is possible, however, to combine such converters in a number of ways to obtain 8-bit outputs.

One way that designers often choose to obtain an 8-bit output is by using what is called a dual-rank converter (Fig. 2a). In this design, the output of the first flash converter, or rank, is reconverted into an analog signal and subtracted from the actual input. The residual voltage is then fed to the second rank, and the result is an 8-bit signal, with the first rank providing the most significant bits and the second the least significant bits. However, converting the first rank's digital output using a d-a converter adds to the total conversion time; with the fastest parts available today, the best conversion rate that can be obtained is about 50 MHz.

A second possible configuration was developed and considered during the instrument's design—a single-rank converter. Seen in Fig. 2b, this design can operate at 100 MHz, but has the disadvantage of requiring sixteen 4-bit flash converters, which would make the resulting units very expensive.

To combine the cost advantages of a dual-rank converter with the speed of the single-rank converter, the 4500's designers devised a new form of converter, which is called the dual-rank flash-flash converter. The unique advantage of the DRFF converter is that the first stage's output does not have to be reconverted into analog form; the analog residue is created at the same time as the digital output so that both halves of the conversion are performed almost simultaneously.

Back in a flash

Key to this performance is the operation of the comparator element, which produces analog residues that can be combined almost instantly. As seen in Fig. 3, the comparator not only produces a digital output, but a positive and negative image of the input signal. This image tracks the form of the input, but its levels are determined by the level of the input current source, which tracks the input reference level.

The blocking diodes serve to fold the analog output about the input point at which a logic 1 is produced—hence the name folding circuit. In the first rank of the converter (Fig. 4), eight such circuits are used, and their individual analog outputs are combined to produce the analog residue, which is the input to the second rank.

To further increase the resolution of the first rank, a digital comparator is connected between the negative analog output of one major stage and the positive output of the next lower stage. In this way 15 outputs differing by 1 LSB are derived in the first stage, which allows the decoding circuitry to produce the four most significant bits, which are expressed in Gray code format.

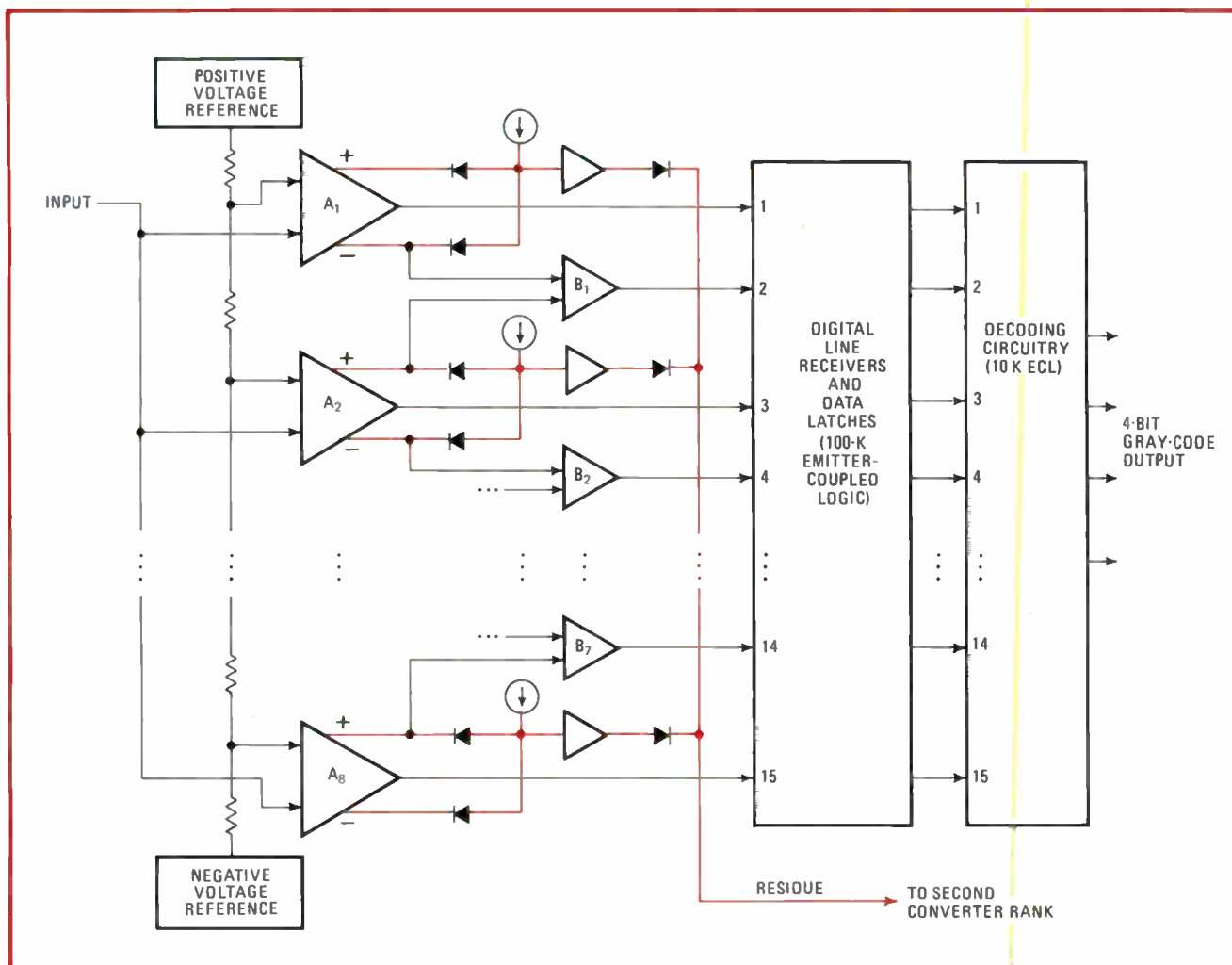

4. Flash, flash. Using the folding circuit of Fig. 3, a new converter type, the dual-rank flash-flash, can be built for less than a single-rank flash converter. It works at 100 MHz because the folding circuit produces an analog residue that is passed to the next rank without conversion.

As seen in Fig. 5, a half-sine-wave input will produce residues in eight distinct segments, or windows. The residue represents the difference between the four most significant bits and the remaining, undigitized analog segment of the signal. Since the residue is fed directly to the second rank of the converter, the digital outputs from both ranks appear almost simultaneously—generally within less than 2 ns of each other.

However, the code forming the second stage is a 4-bit binary one. These mixed codes are strobed into memory in less than 4 ns, and when the data is to be displayed, the scope's microprocessor decodes them into a straight 8-bit binary code. Since the scope display is of the raster-scanning rather than the direct-writing type, there is ample time for this decoding process.

Cutting costs

The result of using this type of converter is that only two 4-bit flash converters are needed, and even with the extra line receivers, data latch, and folding circuitry, the cost is approximately one half that of a single-rank 8-bit converter. Using the converter's 100-MHz sampling rate, an effective resolution of better than 5.4 bits was achieved when the half sine wave that was used to test

the instrument had a frequency of 35 MHz.

Since the converter can work at a sampling speed of 100 MHz, the memory that stores converted data, and its associated circuitry, must be capable of handling 8-bit codes every 10 ns. This is accomplished by overlapping memory sections with 20-ns cycle times. The basic building blocks for this waveform storage are 256-by-4-bit random-access memories, organized in two groups of eight per channel. The resultant memory array makes available 1-k byte of storage for each channel when both channels are used, or 2-k bytes for a single channel.

Accurate reflection

At the front end of the converter, the signal being digitized must remain stable and jitter-free if the digitized results are to accurately reflect the signal under analysis. A sample-and-hold network preceding the converter is thus used to freeze the input long enough for it to be converted without incurring an excessive amount of error. However, a major problem is that the sample-and-hold network must be able to charge up and settle to within better than $\pm 0.15\%$ of the level (± 1 part in 512, or $\pm 1/2$ LSB) in less than 10 ns.

Since it takes about 3 ns to charge the hold capacitor,

The digital scope and the digitizer: what's the difference?

Technologically, there seems little difference between the digital oscilloscope and the digital waveform recorder or digitizer. Today both rely heavily on the performance of hybrid analog-to-digital converters, high-speed memory, and microprocessors to capture and analyze unknown signals. In addition the hard performance specifications—digitizing rate, effective bits, memory size—are critical to the ultimate capabilities of both.

But while the units are similar in many respects, the applications for which they are intended make them different in significant ways. The waveform recorder is basically designed to work only as part of a system. For such applications, it is generally assumed that, if a waveform display is needed, some other element in the system—such as the controlling computer or a plotter—will present it visually. Thus, the digitizer does not have an integral cathode-ray tube.

In addition, since a system is likely to have a controller, the software and controls needed to manipulate waveform data are not part of the digitizer's design. Also, it is generally assumed that the user of such systems is fairly sophisticated, and the digitizer's controls can thus be oriented more toward an engineer than a technician; the primary targets for digitizers are the research lab, the designer's bench, and automated test systems. The latest

digitizer, HP's 5180, has a 10-bit, 20-megahertz converter that provides 7.5 effective bits at 10 MHz.

The digital oscilloscope, on the other hand, is intended to bridge a variety of applications. Though it can also serve as part of a system, its integral display and data manipulation routines also make it a production tool. In most cases, anyone familiar with an analog scope should be able to use a digital one, and in cases where there is a menu for setting the digital scope up, even untrained users can quickly become proficient.

Since the scope generally will not be tied to an external computer, its internal processor is usually capable of performing certain common operations. The unit usually has cursors that let a user pick out values on a waveform it then can display numerically. Some units even can calculate peak-to-peak readings and frequency. Such ease of use is not only beneficial in the factory, but makes the digital scope a sensible field-service tool as well.

At present, it is necessary that potential buyers carefully consider the range of applications for which they will need an instrument before they make a purchase. But as modular design advances, users will be able to configure digitizers with the software and displays they need, and the distinction between the digital scope and the digitizer will be in the hands of the user.

-Richard W. Comerford

the associated amplifier circuitry must settle very quickly, in 7 ns or less. Also, the amplifier section needs to be extremely well balanced in order to inject no current into

the capacitor: even a very small amount would appear as a direct error component in the measurement.

The sample-and-hold network is built around a monolithic Schottky-diode bridge driven by a bootstrapped, balanced amplifier and emitter-coupled-logic-compatible circuitry with a 350-picosecond rise time. The diode bridge is compensated by a feedback loop to balance it and prevent unwanted charge from being deposited on the sample-and-hold capacitors, a phenomenon usually referred to as blow-by. The net result of using this circuit configuration is a network with less than a 40-ps aperture uncertainty and a resolution of more than 7 bits at 10 MHz. To make this accuracy meaningful, the amplifier circuitry that precedes the sample-and-hold circuit must also be highly accurate.

Front-end circuitry

In many instances, the front end of conventional oscilloscopes suffers in performance because of problems caused by thermal time constants in the differential amplifier sections. Usually, these effects are reduced by placing emitter resistors in the differential pair. Then several RC combinations are placed across the emitters to help equalize the total time constants; an accuracy to within 1% can be achieved if enough are used.

For the 4500, the overall accuracy specification calls for a major reduction of thermal constants, to less than 0.1%—a difficult goal to achieve with front-end and attenuation circuitry that will not only accurately track waveforms with rise times as low as 10 ns but also keep over- and under-shoot to less than 0.1%. The solution is to use a proprietary circuit that is biased so that the instantaneous power dissipation in the differential pair is always equal. No resistors are placed between the

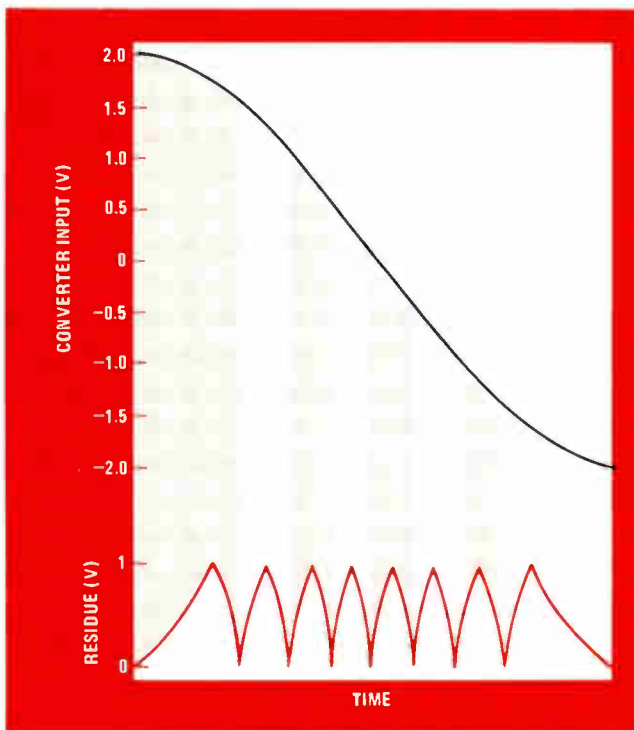

5. Residue. The residue voltage, seen in solid color above, swings through a 1-V range in each window (alternating bands), which correspond to the ranges of comparators A₁ through A₈ in Fig. 4. The folding points correspond to the midpoints of each window and also the trip points of B₁ through B₇.

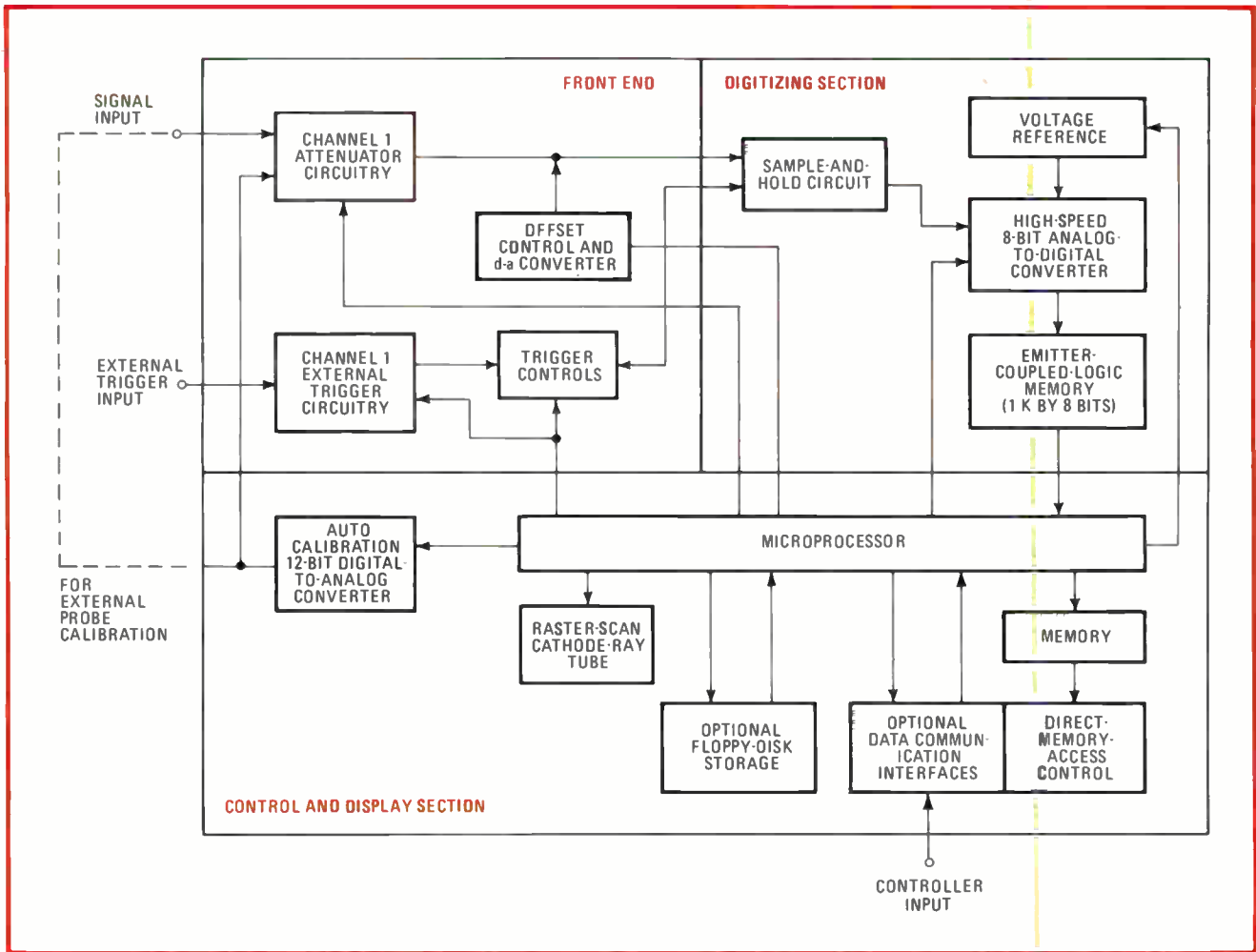

6. Full scope. Controlling the converter (upper right) and the front-end circuitry (upper left) is an 8-bit 8085 microprocessor. The processor also feeds a 12-bit d-a converter (lower left) whose output is used for automatic internal calibration and can also be used for probe calibration.

emitters, and each transistor instantly matches the power dissipation of the other.

All three front-end amplifiers contain this circuit, along with an operational-amplifier servo control to suppress dc effects, two independently regulated voltage supplies that bias the load resistors, and controlled current sources in the differential pairs. The internal bandwidth of each amplifier is much greater than 35 MHz, guaranteeing that the amplifier will remain very stable when measuring waveforms at very high frequencies. The roll-off at 35 MHz is set by an internal filter and helps to further stabilize the front end while providing a measure of protection against aliasing caused by signal components higher than 50 MHz.

Controlling offset

The offset control circuit is another that differs from the norm. Even in high-quality oscilloscopes, offset is frequently off by 3% or more of full scale. For the model 4500, the specification calls for a maximum error of $\pm 0.2\%$ of the offset range, plus $\pm 0.5\%$ of the difference between the selected offset and the zero reference level. The circuitry used to accomplish this includes a 12-bit d-a converter and digital command inputs, with the offset being applied immediately after the first amplifier

section. The relationship of all these circuits can be seen in Fig. 6.

To maintain overall accuracy over prolonged periods of time, it is necessary to compensate for errors caused by thermal drift and component aging. With conventional equipment this implies a need for periodic calibration, and for highest accuracy, calibration before each experiment or measurement. The 4500 solves this problem by including a microprocessor-controlled autocalibration loop in its circuitry, as shown in the figure.

The microprocessor instructs a 12-bit d-a converter to generate a high-precision plus- or minus-full-scale voltage that is measured by the front-end circuitry and converted by the a-d converter. The microprocessor then compares the a-d converter's digital output to the expected value, adjusting the voltage levels at each voltage reference until the output matches the expected value to more than an 8-bit resolution. In this fashion, any gain inaccuracies in the front-end circuitry are compensated by adjusting the a-d device's full-scale "window," providing high accuracy for the total system performance. In addition to the internal gain adjustments, automatic calibration capabilities may be extended to include probes connected to the inputs, thus compensating for the entire measuring system. □

BETTER THAN EVER

SHARP Liquid Crystal Dot Matrix Display Unit offers ...

<SHARP'S DOT:
"MATRIX LCD">* BETTER
THAN EVER TYPE LM-40201
40CHARA=2LINE

LM-40201
40 chara. 2 Lines

5 x 7 DOT MATRIX ALPHA-NUMERIC

- Clear Characters • Wider Variations
- Reliability under stringent temperature ranges.
- Compatible interface with TTL and CMOS
- CMOS-level compatible, consequently 8-bit parallel outputs from a microcomputer can be easily connected.

LM-24102

!"#\$%&'()*+,-0123456789:;:

- Ascii code characters can be on display.
 - +5V ~ 7V single power supply.
- Now SHARP makes the readout easier to see and greater versatility available by adding 40 and 80 alpha-numeric Dot Matrix Display Unit with 5 x 7 dot.

LM-40101

0123456789:;<=>?@ABCDEFGHIJKLMNQPQRSTUUV

LM-80101

SHARP'S DOT/MATRIX LCD UNIT(LM-80101)US#3074#E I:0123456789:;<=>?@! "#. _@ABCDEFGHI

Driver ICs also available.

LH-5001
LH-5002
LH-5003
LH-5004



Dot Matrix LCD Drivers.

SHARP'S 5x7 DOT MATRIX LCD UNITS.

Parameter	Character number (character x line)	Unit outline WxHxD (mm)	Character size WxHxD (mm)	Supply Voltage (V)
* LM-06151	6 Character. 1 Line	60x40 x 14.5	4.8x7.5	+5,
* LM-14151	14 Character. 1 Line	93x47 x 13.5	2.65x3.75	+5,
LM-24102	24 Character. 1 Line	175x46 x 12	3.3x5.05	+5, -5
* LM-24151	24 Character. 1 Line	174x51 x 13.5	3.3x5.05	+5,
LM-40101	40 Character. 1 Line	175x45.4x15	2.32x3.28	+5, -5
* LM-40151	40 Character. 1 Line	177x46 x 13.5	2.32x3.28	+5, -5
LM-40201	40 Character. 2 Lines	230x50 x 15	3.4x4.8	+5, -5
LM-80101	80 Character. 1 Line	310x90 x 12	2.32x3.28	7V-13.5V

*Character generator built-in.

• All types (except LM-06151) can display cursor line (5 dots)

SHARP CORPORATION
International Division
Electronic Components Sales Dept.
22-22, Nagaike-cho, Abeno-ku, Osaka 545, JAPAN
Phone: (06) 621-1221 Cable: LABOMET OSAKA
Telex: J63428 Attn: OSKPA (LABOMET A-D)

U.S.A.: SHARP ELECTRONICS CORPORATION
Sharp Plaza, Paramus, New Jersey 07652
Tel: (201) 265-5600 For further information,
Contact: Mr. M. Miyagawa

EUROPE: SHARP ELECTRONICS (EUROPE) GMBH
SonninstraÙe 3, 2000 Hamburg 1, F.R. Germany
Tel: (040) 28511 Attention: Mr. Y. Goto

Real-time operating system puts its executive on silicon

A software component as standard as a TTL device, this kernel runs identically on three 16-bit microprocessors

by John Tinnon, *Hunter & Ready Inc., Palo Alto, Calif.*

□ The invasion of real-time applications by 16-bit microprocessors would be advancing much faster if standard operating-system software were available. As things are, programmers find they can spend up to 60% of their time on just writing the basic mechanisms needed to support a real-time system's multiple concurrent tasks.

These support mechanisms are, however, common to all real-time systems, so they are a prime candidate for time-saving standardization—especially in the form of silicon software components, which are as easy to use as hardware. The Versatile Real-Time Executive, or VRTX (pronounced “vertex”), is just such a silicon software family. Read-only-memory chips containing VRTX are already available for the three most popular 16-bit microprocessors, the 68000, the 8086 and 8088, and the Z8000. A fourth version for National Semiconductor's 16000 is under development.

Prepackaged real-time multitasking executives, also called operating-system kernels, are nothing new. Vendors of single-board computers have been supplying them for several years. But unlike VRTX, these earlier executives are designed to run only on a specific target board and require a particular host system for development. Also unlike VRTX, they generally do not permit custom designs unless the user is willing to buy the source code and modify it extensively.

VRTX offers interrupt-driven task scheduling, intertask communications and synchronization, dynamic as well as static memory allocation, real-time clock support, and character input/output. It is also compact and fast, occupying only 4-K bytes of memory and taking only about 100 microseconds to switch tasks (Table 1).

Supplied in two 2716 ultraviolet-light-erasable programmable read-only memories, this operating-system kernel is a true silicon software component. Like an Ada package, it serves as a building block out of which larger systems can be constructed. And unlike executives supplied on disk that require modification in order to adapt to a particular

hardware configuration, it makes no assumptions about the board on which it will be running.

In effect, it simply adds 22 high-level instructions to the processor's existing repertoire (Table 2). Being written entirely in position-independent code, it can be located anywhere in the user's address space and as a result can easily be retrofitted to an existing design. Its interface with the target board is an external configuration table that may occupy as few as 28 bytes of main system memory.

More than that, this silicon kernel was designed from the start to reach beyond the microprocessor board. A uniform mechanism exists for supplementing it with both user-defined system calls and user-defined interrupt handlers. As a result, it is possible to add not only simple, device-dependent interrupt handlers but also more complex logical functions, such as administering a file structure.

Task management

The basic logical unit controlled by VRTX is the task, which is a logically complete execution path through user code that demands the use of system resources. A task is not the same as a program, which is merely a section of code, whereas several tasks may share the same code.

The user may write as many as 256 unique tasks to run under VRTX. He or she assigns each task a priority

TABLE 1: PERFORMANCE DATA FOR VRTX REAL-TIME EXECUTIVE FOR THREE MICROPROCESSORS*

Operation	Execution time (μs)*		
	VRTX/8002	VRTX/68000	VRTX/86
Create a task	128	144	191
Send message (with task switch)	129	143	173
Send message (without task switch)	53	59	111
Receive message (task waits)	110	130	133
Receive message (message waiting)	32	38	66
Maximum time interrupts are off (no time slicing)	$13 + 6n^†$	$14 + 7n^†$	$16 + 8n^†$

*Clock rate is 8 MHz. †n = number of tasks.

TABLE 2: THE 22 VRTX SYSTEM CALLS FOR CONTROLLING USER'S TASKS

Task control	
Task create	creates a ready-to-run task with the specified priority and start address plus (optionally) an identification number
Task delete	deletes a specified task from the system
Task suspend	suspends a specified task by setting its status as suspended
Task resume	resumes a previously suspended task by resetting its status as ready-to-run
Task priority	changes the priority of a specified task
Task inquiry	obtains the ID number, priority, and/or status information about a particular task
Communication and synchronization	
Post message	sends a message from one task to another via a specified mailbox location
Pend for message	receives a message via a specified mailbox location either from another task or from an interrupt handler; if no message is immediately available, the calling task is suspended until a message is received
Character input/output	
Get character	receives the next input character from the designated I/O device
Put character	transmits the next output character to the designated I/O device
Wait for character	suspends the calling task until a specified character is received from the designated I/O device
Clock management	
Task delay	suspends the calling task for a specified number of clock intervals
Get time	obtains the current value of the system clock
Set time	sets the current value of the system clock
Time-slice	enables round-robin scheduling among tasks of equal priority
Memory management	
Get block	allocates a block of memory
Release block	de-allocates a block of memory
Interrupt interface	
Post from interrupt	sends a message from an interrupt handler to a task via a specified mailbox location
Exit from interrupt	invokes a task rescheduling upon completion of interrupt handling
Timer interrupt	used by an interrupt handler to signal expiration of a clock interval
Receiver interrupt	used by an interrupt handler to signal receipt of an input character
Transmitter interrupt	used by an interrupt handler to signal its readiness to transmit an output character

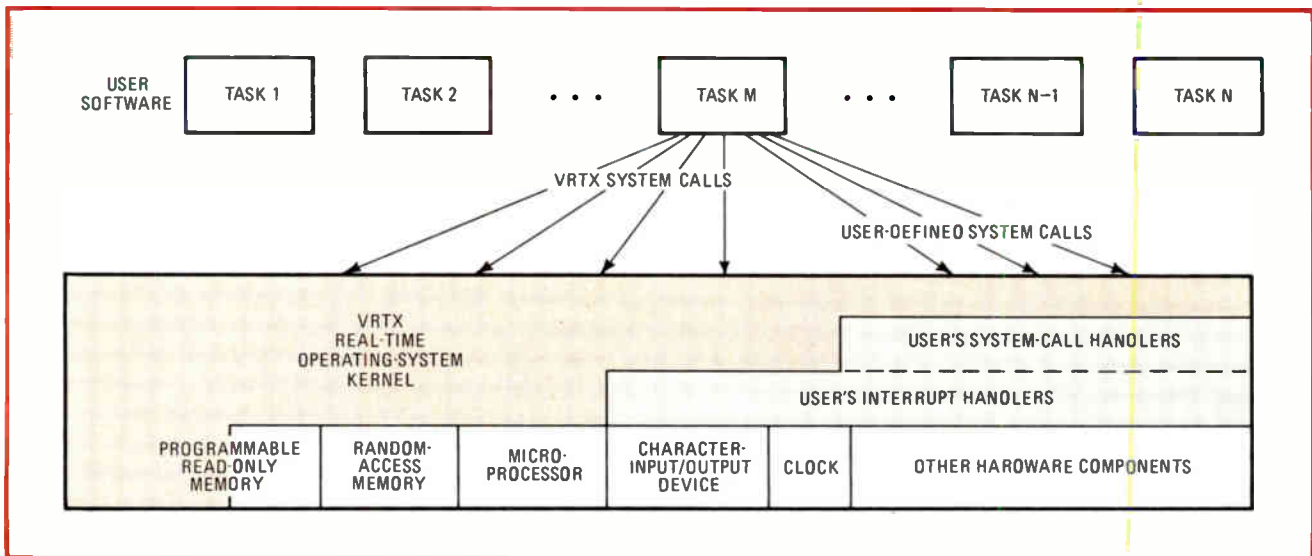

1. VRTX architecture. The real-time multitasking executive, VRTX, provides 22 system calls that can greatly simplify the embedded system programming of 16-bit microcomputers in real-time applications. The user supplies his own interrupt handlers and device drivers.

level, and VRTX allocates control of the processor sequentially to the highest-priority task that is ready to execute. The kernel supports as many as 256 levels of priority. It employs an event-driven, round-robin scheduling algorithm and, if a clock is present, also permits task delays to occur.

Tasks may create other tasks, and they may delete, suspend, resume, and change the priority of themselves or other tasks. They may also need to send messages to one another. Two simple system calls, `SC_POST` and `SC_PEND` form a completely general mechanism for communication and synchronization. Tasks can send or receive 2- or 4-byte values to or from any memory location (which may, of course, be pointers to large data structures). If a location is empty, a task trying to receive will remain pending until a message arrives.

These communication and synchronization mechanisms are similar to the corresponding mechanisms in Data General Corp.'s Real-Time Operating System (RTOS), a widely used minicomputer operating system. The approach obviates the need for complex predefined entities (or objects) such as mailboxes, semaphores, message headers, and exchanges. It also makes mutual exclusion and resource locking easy to perform. For instance, resource locking can be implemented simply by arranging for all the tasks trying to use a resource to remain pending at the same location; as each task finishes with the resource, it sends a message to that location waking up the next task.

Real-time support

A real-time system must by definition respond quickly to external interrupts. Under VRTX, user-supplied interrupt handlers can adjust the scheduling of critically important tasks to unexpected events.

By analogy with the intertask communication mechanisms just mentioned, the `UI_POST` command allows an interrupt handler to post a message to a waiting task upon the occurrence of a significant event. The `UI_EXIT` command forces immediate rescheduling after the inter-

rupt handler finishes. These two commands serve as a general interface between VRTX functions and device-dependent service routines.

Like the microprocessor itself, the silicon software kernel makes no assumptions about the interrupt structure that the user will choose to implement. The Z8000 uses a data structure called the new program status area (NPSA) to define the addresses of user-supplied interrupt-service routines. Aside from requiring that system-call traps be routed through VRTX, the user is completely free to use the NPSA directly to specify the entire interrupt structure. Similarly, VRTX/86 uses 32 vectors from the interrupt vector table leaving all other interrupt vectors to the user. VRTX/68000 uses trap 0 in the exception vector table. The kernel occupies a position that is hierarchically above the interrupt service routines, as shown in Fig. 1.

Going by the clock

Many VRTX applications will require a real-time clock and at least one character-oriented I/O device such as a terminal. Therefore, support for these devices is fully integrated into VRTX. The user need supply only a small hardware-dependent interrupt-servicing routine for each such device. VRTX, in turn, will manage all the logical operations needed to supply user application tasks with a full repertoire of associated clock management and character I/O commands. It is important to realize, however, that this kernel has been designed to operate quite satisfactorily independently of these devices—even the clock is not essential.

The VRTX commands to support character I/O and a clock fall into two categories: calls from user tasks and calls from interrupt handlers. For the clock, VRTX recognizes four user calls (`SC_GTME`, `SC_TIME`, `SC_TDELAY`, and `SC_TSLICE`) and one call from the clock service routine (`UI_TIMER`). Employing the first two calls, user tasks can get the value from the clock counter and set a new value for the counter. The remaining two user calls implement task delays and round-robin scheduling. The

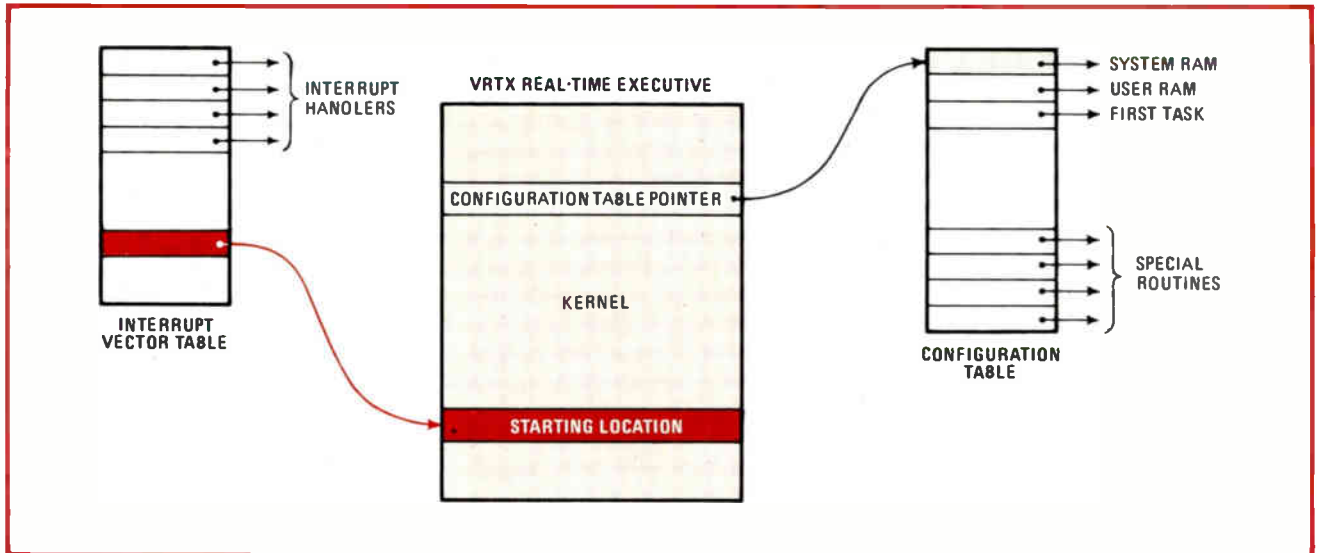

2. System integration. Only two connections are required to interface VRTX with other system software—a pointer to the location of VRTX, and a pointer with the location of the configuration table that resolves all the hardware dependencies of the host environment.

UL_TIMER call, issued from an interrupt handler, simply notifies VRTX that a time interval has expired.

For character I/O, VRTX supplies three user calls (SC_GETC, SC_PUTC, and SC_WAITC) and two calls from interrupt handlers (UI_RXCHR and UI_TXRDY). The first two implement standard system-call get-character and put-character functions. The third user call allows a user task function as a “watchdog” for a particular character (for example, CONTROL-C). The two calls received from interrupt handlers will implement the necessary hand-shaking functions.

Managing memory

One of the basic functions provided by a real-time executive is memory management. VRTX supports dynamic as well as static allocation of memory blocks. In dynamic allocation, the two system calls allow user tasks to get and release blocks of memory. A separate stack is provided for each task.

The Z8000 status lines can distinguish among four address spaces for system code and data and for user code and data. Similarly, the 68000 distinguishes among supervisor program and data and user program and data. The kernel has been carefully designed to ensure complete compatibility with boards that actually effect such a separation. Of course, nothing precludes the use of VRTX with designs that do not utilize separate memory spaces. In addition, VRTX/86 is also compatible with the 8086 segmented memory architecture.

The user-supplied configuration table along with simple, device-specific user-supplied interrupt handlers interface VRTX with its environment. The table is VRTX’s window on the rest of the board. It occupies 42 bytes on the 68000, 32 bytes on the 8086, and as little as 28 bytes on the Z8000. With it, the user can specify all the parameters needed by the kernel for a configuration.

One location in VRTX points to the base of the configuration table, and one vector in the interrupt vector table points to the VRTX starting location. These two pointers are the only links between the silicon kernel and the rest

of the board. Values in the configuration table specify the start of system RAM and of user RAM, the length of user memory, the maximum number of tasks, and the location of any special routines that the user might wish to be invoked whenever a task is switched, created, or deleted, or the system is initialized. Figure 2 is a diagram of the relationships among VRTX, the configuration table, and the interrupt vector table.

Users who may want to add system calls to support special I/O devices have only to add a one-word pointer to the configuration table. Entries in this table can also be made to specify user routines for initializing special devices at system start-up or saving the state of custom devices on task switches. For example, if the user has a floating-point processor in the system, it will be necessary to save its registers on a context switch. Almost no other operating systems, even the user-configurable ones, give the designer the option of easily adding user save routines and initialization routines to the system scheduler. When VRTX was designed it was realized that easy extendability would be a key requirement for silicon software components, so these hooks were included.

Hooks and handlers

Next on the list of future silicon software components to be developed by Hunter & Ready is a file handler. This component will manage disk files—reading, writing, allocation, and so forth—in a manner similar to Unix. It will be hierarchically structured and will include schemes for fast access, possibly using what are called Indexed Sequential Access Methods. In addition, it will be supported by a library of hard- and floppy-disk drivers also cast in silicon. Together, they will enable users to implement a sophisticated file system by selecting from a catalog of standard components. In fact, VRTX already has the hooks installed to allow the file handler to be grafted onto existing designs without sacrificing throughput. Beyond the file handler are component data-base managers, network interfaces, and communications packages. □

Virtual-phase structure simplifies clocking for CCD image sensor

Grounded junction electrodes work with single level of clocked polysilicon gates to shift signal electrons down the charge-coupled-device registers

by Eugene F. Rybaczewski,
Texas Instruments Inc., Central Research Laboratory, Dallas, Texas

□ Ever since semiconductors replaced vacuum tubes in signal processors, engineers have sought to replace optical-imaging tubes with solid-state devices to get small size, low power consumption, positional stability, reduced cost, and compatibility with solid-state logic. A first step in solid-state image sensing—useful for facsimile transmissions—is a device that can accurately scan, at high speed, one line of an image and generate a proportional electrical signal.

Thus considerable research and development has gone into charge-coupled-device image sensors, which can scan images line by line fast and accurately and give position-sampled data that may be controlled and processed by digital logic. Now headed for commercialization is the virtual-phase CCD sensor chip (Fig. 1) with the simplest clocking yet: a single pulse train applied to one level of polysilicon gates.

As well as simplifying clocking, this design [*Electronics*, Jan. 27, 1982, p. 39] reduces noise and increases sensitivity to light, compared with other charge-coupled technologies. The virtual-phase structure uses a pn junction (a virtual electrode) biased at the substrate dc potential, instead of a second level of clocked polysilicon gates. This virtual phase produces the same charge-packet transport function as does the second clock in conventional two-phase CCDs.

In the basic image-sensing system shown in Fig. 2, a standard 8½-by-11-inch document is scanned a line at a time by being moved past the CCD sensor. The image is reduced by a 10× lens and focused on the sensor. Each line is read out as an analog signal that goes to a video processor, which converts the data into formats suitable for transmission to such equipment as a printer, telephone, or display. Using the CCD clock signals, the timing controller selects the readout rate and vertical resolution and the exposure time, which is synchronized with the scanning of the document. For this system,

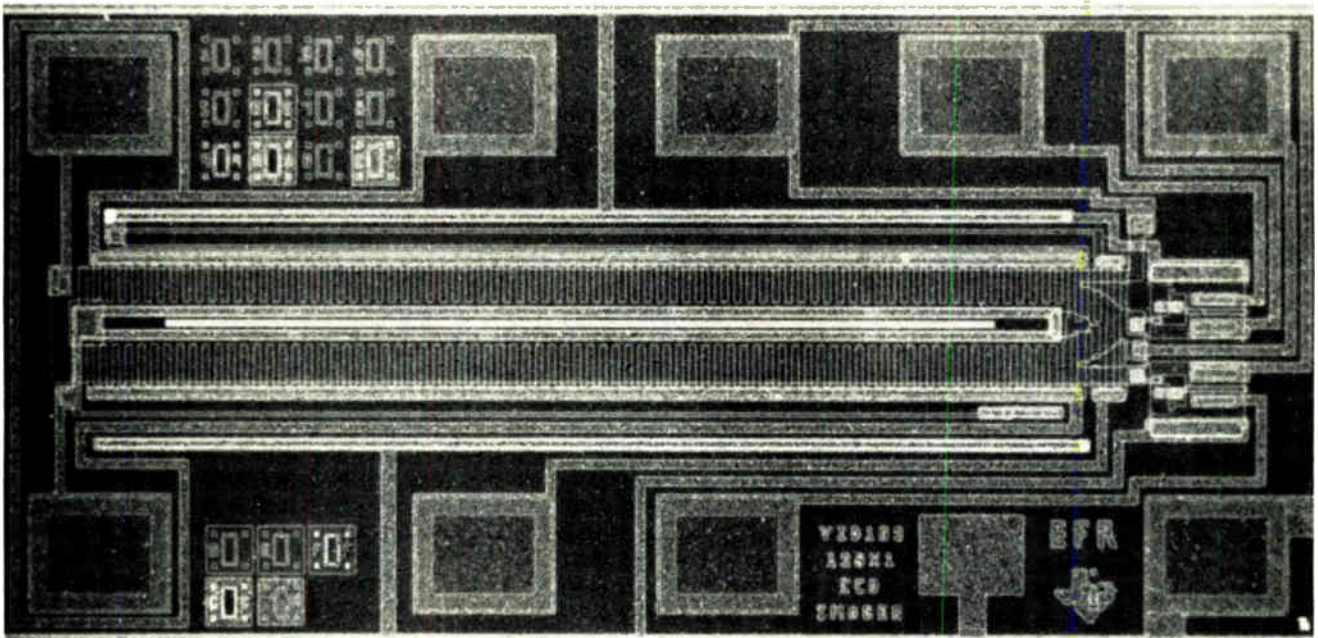

1. Line of sight. A 128-element charge-coupled-device linear image sensor uses a single level of polysilicon gates in its shift registers. The narrow rectangle in the center defines the photosites; flanking finger-like structures are the CCD transport registers.

2. Electronic mail. The major components of an electronic mail system are pictured here. A mechanical scanner moves the optical image in front of a CCD image sensor, whose output is processed for transmission to a terminal, printer, or other display.

using an exposure time of 10 milliseconds per line and a 200-kilohertz data rate, the document could be completely scanned with a resolution of 200 points per horizontal inch and 200 lines per vertical inch in 22 seconds. Faster scan rates can be readily achieved by reducing the exposure time and also increasing the clock frequency.

With an eye on this class of applications, Texas Instruments has been actively involved in CCD fabrication since the early 1970s. In 1979, TI's Jaroslav Hynecek announced the virtual-phase structure. The virtual-phase device's fabrication and clocking differ substantially from all other CCDs: only a single layer of polysilicon gates, and hence only a single clock, is necessary to transfer charge packets along the register (see "Virtual-phase CCDs revealed," p. 143). Other types of CCD configurations require two or three overlapping layers of gate electrodes, as well as two to four separate clocks for charge transfer.

This improved technology makes for lower-cost sensors with simpler clock circuits, giving uniform images, low dark currents, and high quantum efficiency throughout the visible spectrum. Like other CCDs, these parts consume little power and operate stably and reliably.

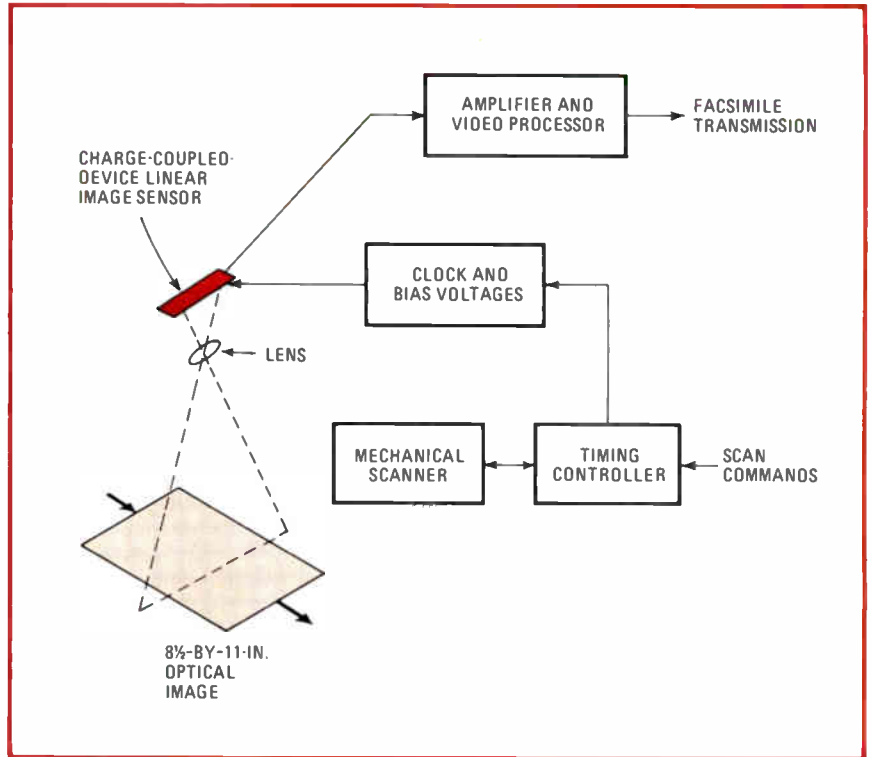

All commercial CCD imagers from TI now use the virtual-phase process, and a standard family of linear image sensors is being developed. The first two members are the TC102 128-element sensor, shown in Fig. 1, which could serve as a character reader, and the TC101 1,728-element unit, which can scan an 8 1/2-in.-wide page with a resolution of about 200 points/in.

Except for the number of photoelements, the 101 and 102 are constructed and operated in the same manner. In them (Fig. 3), the photosensitive areas, or photosites, are

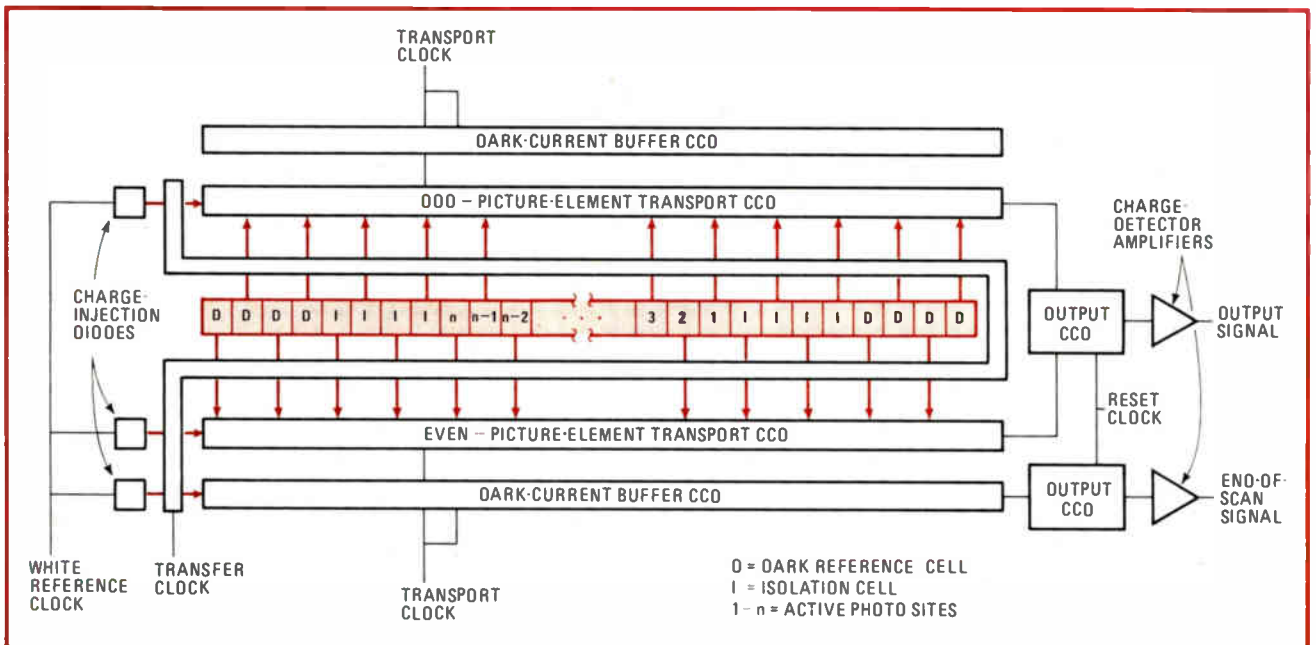

3. Sensor architecture. Signal charge (indicated by solid color) enters the transport shift registers under control of the transfer clock and is shifted through them to the output amplifiers. A white-reference signal is injected at the beginning of each scan.

Virtual-phase CCDs revealed

The virtual-phase charge-coupled device is a variation of the conventional buried-channel CCD. It replaces one layer of polysilicon gates with a virtual electrode—a heavily doped p-type region near the silicon surface. As shown in the figure, a virtual barrier and well are created under this grounded virtual electrode by varying the dose and position of n-type implants.

The device's clocked electrode is fabricated in much the same way as in a conventional two-phase CCD. A shallow n-type implant is placed under the clocked electrode, producing the clocked well region. The remaining portion of the clocked electrode is the clocked barrier region.

The combination of the clocked barrier and well and virtual barrier and well form the elementary structure of a CCD. When light is incident on the device, electron-hole pairs are generated in the depletion region and electrons accumulate in the potential wells. Then the clocked electrodes transfer the charge by moving their corresponding potential wells above and below the levels of the virtual electrodes' barriers and wells.

The charge-transfer efficiency, which is related to the fraction of the signal charge transferred from one well to the next, is just as high as in the two-phase structure, allowing these devices to operate at the same high frequencies—above 10 megahertz. The elimination of one of the clock phases simplifies not only the drive circuits, but also the silicon processing. Without overlapping gates, device yields are higher: shorts between the overlapping electrodes are a common failure in two-phase CCDs.

Because virtual-phase technology eliminates one layer of polysilicon, fewer photons are absorbed in the electrodes. This results in a higher quantum efficiency for all wavelengths—particularly important for the short ones (blue and green) that are usually greatly attenuated. The improved spectral response is illustrated in the graph, where it can be seen that the quantum efficiency of a

virtual-phase CCD is near 70% at 0.4-micrometer wavelengths. The efficiency of conventional two-phase CCD can be as low as 20% at this wavelength.

Finally, virtual-phase CCDs typically have much lower dark currents than do two-phase structures—2 nanoamperes per square centimeter, compared with 10 nA/cm² or more. The main source of dark current is the energy states at the silicon-silicon-dioxide interface. The effect of these interface states is eliminated in the virtual-electrode region because they are filled with holes and the electron lifetime is very short. The states under the clocked electrode generate dark current only when the transfer gate goes high—a small fraction of the total cycle time. The net dark current is thus less than in two-phase CCDs.

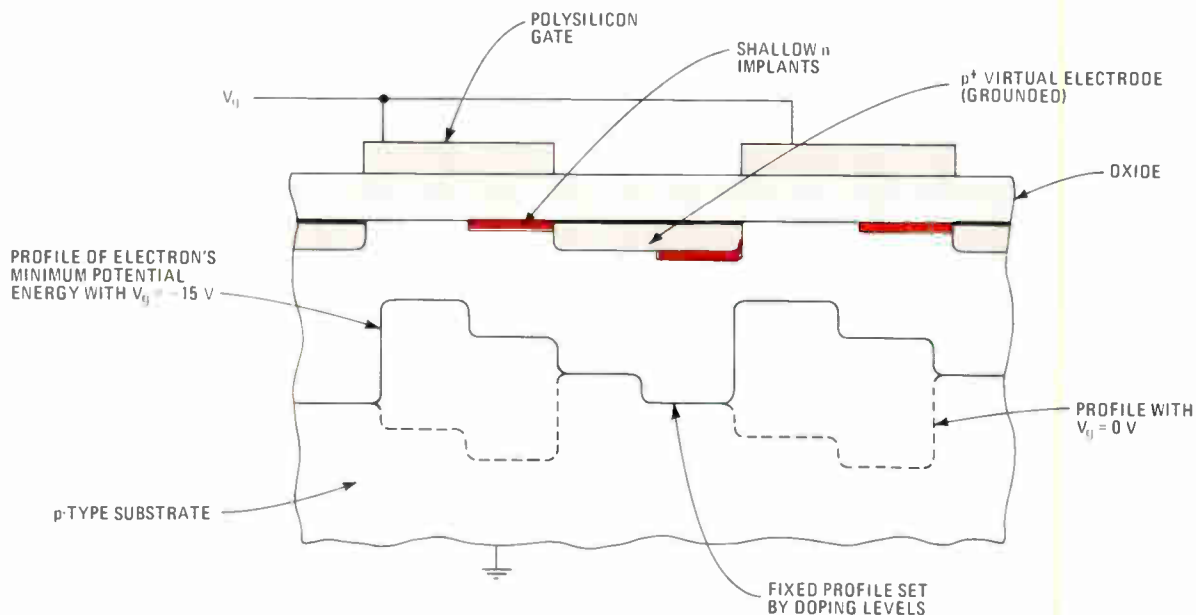
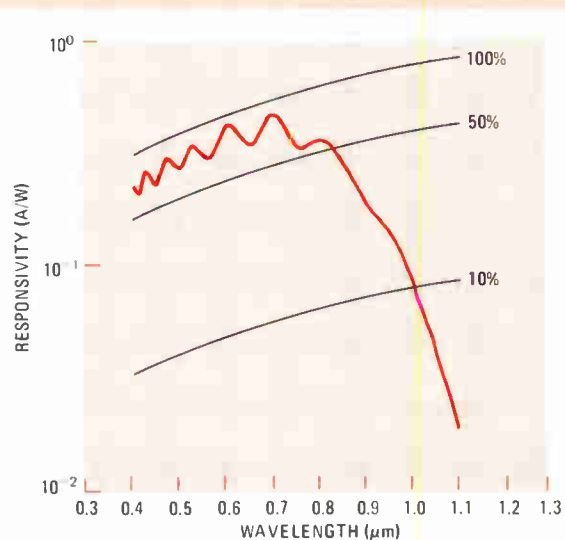

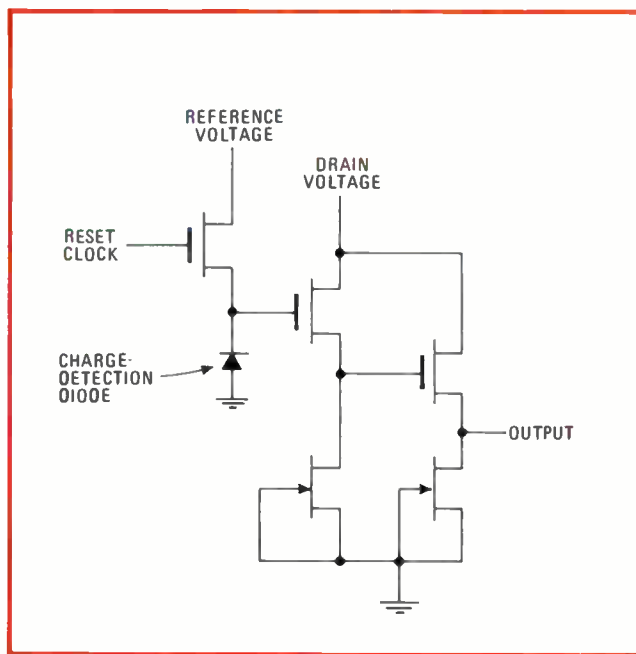

4. Charge detector. A simple FET amplifier converts signal charge packets into voltage levels for transmission or recording. Charges from the CCD shift register change the voltage on the reverse-biased diode. Two source-follower stages buffer the resulting signal.

0.5 mil on a side, arranged on 0.5-mil centers. Light falling on the photosites creates electron-hole pairs in the single-crystal silicon. Channel-stop diffusions isolate adjacent photosites, so that electrons collect in them in proportion to both the incident light intensity and the exposure time of a scan.

For each photosite, the saturation light intensity is about 27 microwatts per square centimeter for a 10-ms exposure to a light source with a color temperature of 2,854 K, modified by a 2-millimeter-thick infrared filter. This saturation level gives a nominal output signal of 1 volt. In order to maintain the high spatial resolution of the sensor and hence of the scanning system, the light source should emit in the blue-green region of the visible spectrum, where quantum efficiency and modulation-transfer function are high.

The charge packets are transferred from the photosites, labeled 1 through *n* in Fig. 3, to the transport CCDs for serial shifting to the output amplifier. The exposure time is controlled by the transfer clock. When this clock goes high, the charge packets move into the transfer-gate region from the photosites. When it returns low, the charge packets are transferred into the CCD transport shift registers.

The line of photosensitive elements has a transport register on either side, with the odd-numbered photosites feeding one register and the even-numbered sites feeding the other. The charge packets are transported down these two shift registers and reconstructed in the original serial sequence by the output CCD in preparation for a charge-to-voltage conversion by the output-signal charge-detector amplifier (Fig. 4).

Even without incident light, thermally generated electrons tend to accumulate during a scan and form background noise that adds to the image-signal output. In

order to monitor the magnitude of the dark signal independently of the light intensity, dark-reference picture elements (labeled *D* in Fig. 3) are at both ends of the linear image sensor. Isolation pixels (labeled *I* in Fig. 3) separate the image pixels from the dark-reference pixels. The dark pixels provide one of two reference levels, the other being a white-reference signal output that typically is about 70% of the maximum signal. These two reference levels are useful for exposure control and signal-level evaluation in the video-processing circuit that handles the image-intensity data.

Dark-current noise

Thermally generated electron noise also occurs in the chip's periphery, and to protect the data-transport registers from this noise, two additional CCD shift registers flank them. Also, one of these dark-current buffers carries a reference end-of-scan charge that provides a 0.5-v signal alerting the controller that a line scan has been completed and the system should begin a new cycle.

The white-reference signals are injected into the transport CCD shift registers at the same time that the end-of-scan signal is injected into its buffer CCD, by the combination of the transfer and white-reference clocks. The first white-reference signal arrives at the output at the same time as the end-of-scan signal.

In addition to the white-reference and transfer clocks, the device requires reset and transport clocks. The high and low voltage levels of the transport, reset, and transfer clocks are nominally 0 and -15 v. Each of these three clocks is shunted by an on-chip resistor protecting the respective gates from damage by static charge.

The voltage of the white-reference clock, which drives the charge-injection diodes, is always positive. This voltage is 12 v or higher and drops to about 6 v to inject charge. Voltage values less than 5 v may cause charge flooding and loss of charge-packet definition.

Just two dc voltages—the amplifier drain voltage and amplifier reference voltage—are required. The charge-detector amplifier requires approximately +18 v to bias the amplifier drains. The drain current is about 6 milliamperes under normal operating conditions.

When the reset clock is high, the charge-detection diodes are biased to the reference voltage, about 6 v. The current that flows in the reference-voltage line includes the charge in the end-of-scan shift register and the signal charge from the two transport CCD registers. The total current is normally less than 5 nanoamperes. However, the reference must be able to deliver up to 10 microamperes for operation at high data rates.

For high-speed operation, the signal and end-of-scan outputs should be buffered by low-impedance amplifiers that provide the current required. In digital applications like facsimile transmission, the transport, reset, and transfer clocks may all use the same high and low levels. However, for applications that need very low clock feed-through and high optical output uniformity, the high and low levels of each clock should be adjusted independently. The white-reference signals can be used to monitor the charge-transfer efficiency. If the clock voltage levels are too low, a drop in the transfer efficiency will be reflected in this signal. □

The Aromat DS—the relay that hit the telecommunications industry like a bolt of lightning!

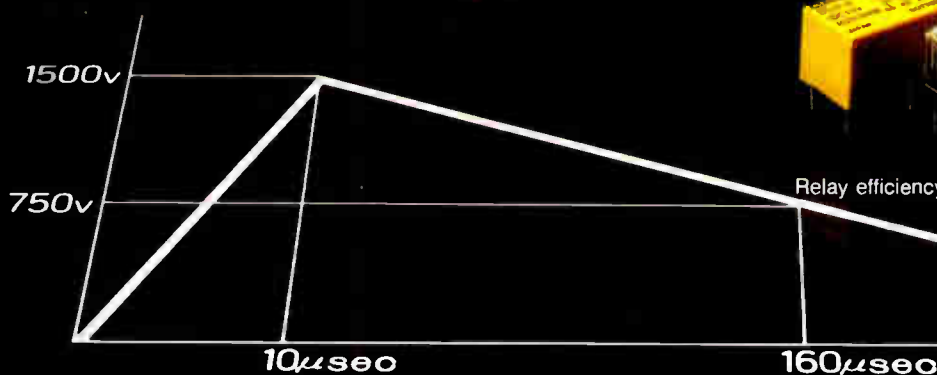

The sum of all contacts' switching capacity (VA) =
 Relay efficiency (η) = $\frac{\text{Operating power (W)}}{\text{Volume (cm}^3\text{)}}$

Relay efficiency means energy saving. A higher output/input ratio is attained in a smaller volume by the effective use of a permanent magnet system design.

The Aromat DS relay has had such a striking effect on the telecommunications industry because it was designed to meet FCC lightning surge requirements in just 0.11 cubic inches.

- Lightning surge 1500V FCC Part 68
- Dielectric strength 1000Vrms
- Small size787" L
 × .390" W
 × .386" H

Telecommunications contact rating 0.1 amp @ 50V DC
 10 × 10⁶ OP elec. life
 Bell ringing circuit
 10⁶ OP elec. life

- Standard contact rating . . . 2 amp @ 30V DC
 5 × 10⁵ OP elec. life
- Minimum coil operating power 196mW
- Low heat sensitivity only 10% change in pick-up @ 80°C (conventional relays 24%)

Available in:
 Gold-Clad, Silver Palladium Contacts
 Latching Function
 Sealed Amber Type



Your free sample and catalog:
 For your free sample of the extraordinary Aromat DS, and additional specifications, call your local distributor, or write Aromat at the nearest address below.



Aromat
 Member of Matsushita Group

Relays for Advanced Technology

- Aromat Corporation**
- Corporate Headquarters:**
 250 Sheffield Street
 Mountainside, NJ 07092
 (201) 232-4260
- Eastern Sales Division:**
 250 Sheffield Street
 Mountainside, NJ 07092
 (201) 232-4260
- Central Sales Division:**
 311 Lively Blvd.
 Suite 1
 Elk Grove Village, IL 60007
 (312) 593-8535
- Western Sales Division:**
 10400 N. Tantau Avenue
 Cupertino, CA 95014
 (408) 446-5000

Interfacing 10-bit a-d converter with a 16-bit microprocessor

by Sorin Zarnescu
Westwood, Calif.

Eight-, 10-, and 12-bit analog-to-digital converters cannot easily impart their knowledge to 16-bit microprocessors, like Intel's 8086, because the received output is not in 2's complement form and the sign bit has to be extended. However, a match can be made with this design, which can offer programmable interrupt control. In addition, only one input instruction is needed to read the contents of the a-d converter. As an example, Analog

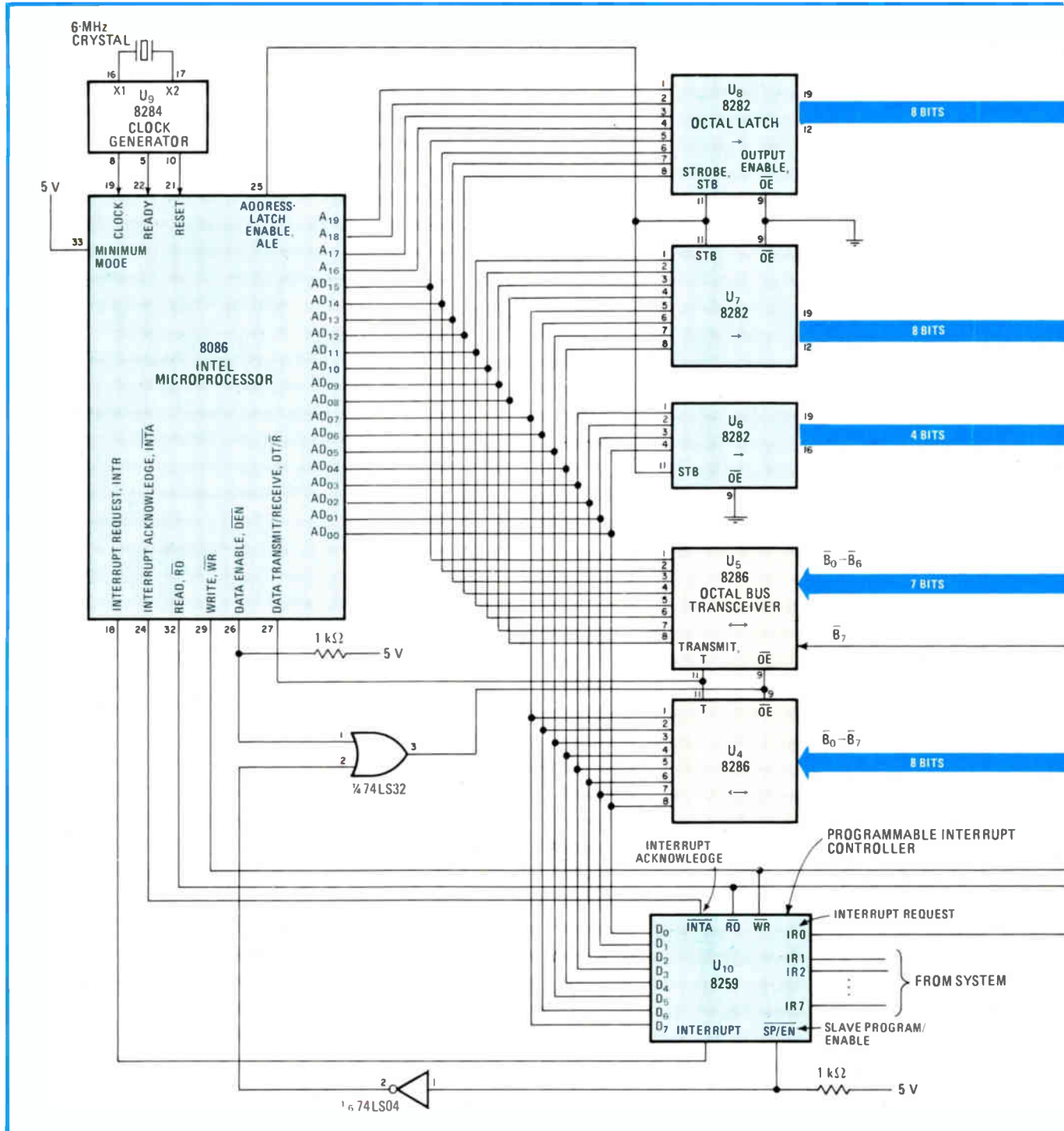

Devices' 10-bit a-d converter, AD571, is used.

Because the a-d converter's output code is offset binary, the most significant bit is inverted and used to control octal line driver-receiver U_3 . When the input is positive, the MSB is zero and the octal driver is open. As a result,

seven MSBs are 0. On the other hand, when the input is negative, the octal driver is in its tristate mode and the MSB is 1, resulting in seven MSBs also being 1.

After receiving the data-ready interrupt through programmable interrupt controller U_{10} , the microprocessor

Interface. The circuit provides an easy and fast way to interface Analog Devices' AD571 10-bit a-d converter with Intel's 16-bit 8086. The decode logic provides the a-d converter with signals for reading the data and starting the conversion.

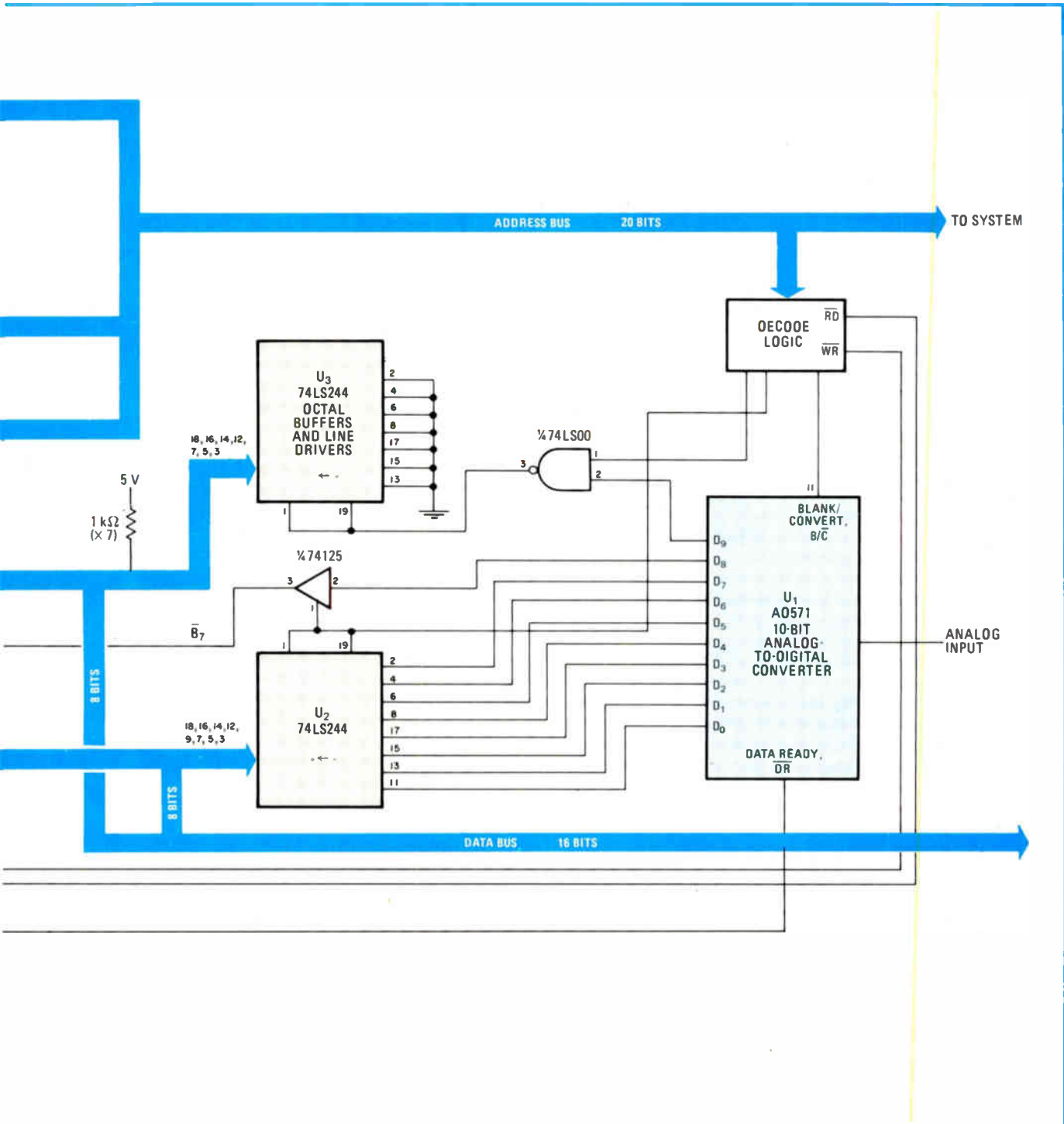



Socket Connectors
IDS Series—Optional strain relief.

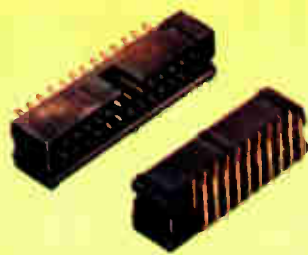

Low Profile Headers
IDH/LP Series—Low profile for high density packaging.



Edge Card Connectors
IDE Series—Three mounting options available.



Transition Connectors
IDT Series—Cover latch swivels for easy cable insertion.



NEW "K" series Sockets and Headers
MIL-C-83503 compatible, plus positive mating/keying options that can't go wrong.



"D" Connectors
IDD Series—9, 15, 25 and 37 pin and socket.

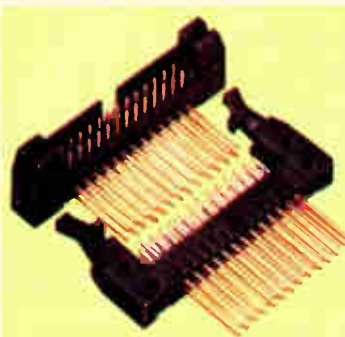

Standard Headers
IDH Series—Straight or right angle, ejector/latches available.

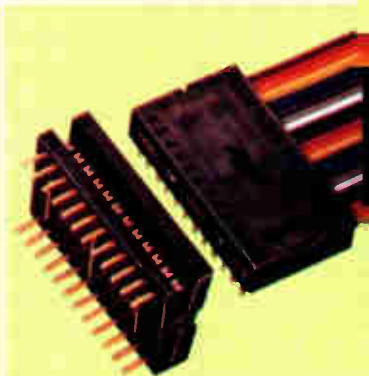

Cable plugs
IDP Series—Tapered pins for easy insertion.

90% ain't bad

Yes, the 10% that most people don't use is missing. But everything else you need in IDC Flat Cable Connectors is available from RN, off-the-shelf.

When we say RN has a *full line* of IDC Flat Cable interconnection components, we want to tell it like it is. We are *delivering 90%* of everything available in IDC connectors today. And, chances are, you'll never have need for the 10% that's missing. Most people don't.

Check into the many advantages of the complete RN flat cable system:

- Fewer pieces for faster assembly, reduced inventory.
- Highly competitive pricing—in all quantities.
- Assured reliability and compatibility of cable and connectors—RN supplies both.

100% gas-tight reliability

is assured by the proven RN "tight-grip" contacts. Total normal force is applied directly against cable. No chance for gas penetration or corrosive build-up even in hostile environments.

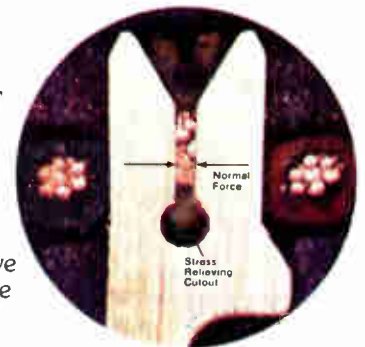

Microphoto



WRITE TODAY for the new catalog featuring the full line of RN IDC flat cable connectors.

RN ROBINSON NUGENT, INC.

800 East Eighth Street, New Albany, Indiana 47150 Phone: (812) 945-0211 TWX: 810-540-4082

Circle 148 on reader service card

A SEQUENCE FOR THE INTERRUPT ROUTINE

Mnemonics	Symbolic address	Comments
INP	CONV	: READ DATA
OUT	CONV1	: B/C̄ LINE BROUGHT HIGH
⋮	PROCESSING	
OUT	CONV2	: B/C̄ LINE BROUGHT LOW (START CONVERSION)
IRET		: RETURN

reads the data through an input command also supplied by U_{10} . Since the 8086 has a multiplexed address and data bus, U_6 , U_7 , and U_8 are used as latches for the address. In addition, the address-latch-enable output of the processor clocks U_6 , U_7 , and U_8 . Octal bus transceivers U_4 and U_5 provide buffers for the data bus.

The direction of data on this bus is controlled by the data transmit-receive pulse that is generated by the processor. In addition, the data-ready output from the converter is used as an interrupt-request input for U_{10} . The decode logic provides the signals for reading the data and starting the conversion (see table). □

Access control logic improves serial memory systems

by Robert G. Cantarella
Burroughs Corp., Paoli, Pa.

File storage systems used in large scientific processors or computers need serially organized dynamic random-access-memory systems to transfer blocks of data from one memory unit to another in a serial order. Dynamic RAM devices used in such secondary stores need to be refreshed in a fixed cyclic order to keep the cost and latency low. This refresh logic loop further reduces latency, while retaining the cost advantage of a serial organization, and refreshes the memory at twice the minimum rate. In addition, zero latency is guaranteed with block transfers of at least L milliseconds.

When an initial transfer request XFERRQST occurs, the requester's address RQSTADDR is loaded into the refresh counter, which resets the refresh loop. This set-

ting initiates the transfer (XFERSTART) with zero latency. The refresh address is then held in the refresh counter. Because the refresh loop is cycling at twice the required frequency, all bits are properly refreshed within L ms. The reset is then enabled only after a full cycle has completed when the time-out down counter is loaded with L ms. However, this action only occurs when the time-out down counter is zero.

After the transfer request is initiated, access is granted either when the requester's address is identical to the refresh address or when the time-out down counter is zero. Thus latency is a function of the requester's address and the time since the last reset. As a result, a block transfer of L ms guarantees that the next transfer request will be granted immediate access.

The system performs like a random-access memory but retains the cost advantages of a serial-memory system. The constant refresh rate results in a steady current drain, thereby reducing the cost of the power-supply system and storage cards. □

Engineer's notebook is a regular feature in *Electronics*. We invite readers to submit original design shortcuts, calculation aids, measurement and test techniques, and other ideas for saving engineering time or cost. We'll pay \$75 for each item published.

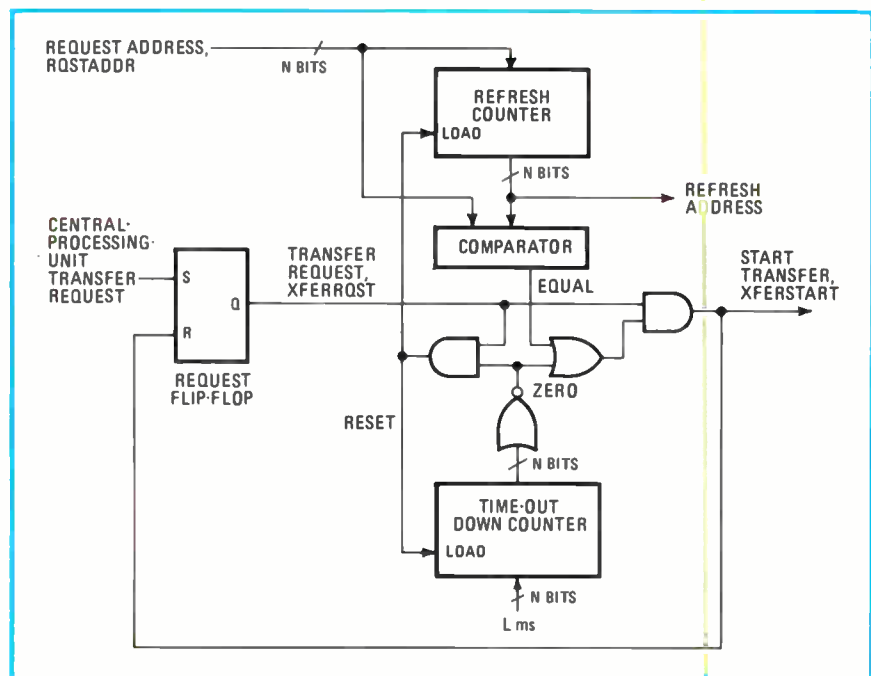

Access. The access control logic refreshes the memory at twice the requisite frequency to keep the latency low. Access is granted when the requester's address is identical to the refresh address or the time-out down counter is zero, whichever occurs first. Block transfer of L ms guarantees zero latency.

Build-it-yourself unit monitors ionized-air blowers

An analytical tool that monitors the static neutralizing performance of ionized-air blowers can be built from standard electrical and mechanical components. It is used to help protect static-sensitive electronic components during assembly. The test unit, called an ion-flux monitor, consists of a 6-in.-square metal plate charged to 3,000 v dc positioned behind and parallel to a 6-in.-square metal grid with a 0.25-in. mesh. The metal grid is connected through a nanoammeter to ground. **Because the grid is grounded, it acts as an electric shield for the highly charged plate, limiting the sampling of ions to those physically propelled through the grid.** Ion distribution from any ionized-air blower can be monitored by placing the blower at the end of a work table and then positioning the ion-flux monitor sampling grid at various points on the table. More information on building the monitor is available from 3M, Static Control Systems, Department ST82-13, P. O. Box 33600, St. Paul, Minn. 55133.

Reset circuit keeps program running

A simple reset circuit developed by Dan Stern of Bayly Engineering in Toronto, Canada, restarts a microprocessor when its program fails. The technique depends upon a watchdog pulse from one of the input/output lines that is present as long as the program is running in the normal routine. **When this pulse is missing, the circuit sends a reset pulse to the microprocessor that restarts the program.** Two retriggerable monostable multivibrators with clear features are used to generate this reset pulse. The watch pulse is fed through a NAND gate to the first one-shot, whose output is used to control the second one-shot. When the program fails and the watchdog pulse disappears, the output of the first one-shot triggers the second to generate a low pulse at its output. This pulse is then fed to the RESET input of the microprocessor. A feedback technique is used to repeat the process until the watchdog pulse reappears.

Tested chip carriers on motherboards ready in two weeks

"Speedy delivery" is the name Hybrid Services gives its two-week turnaround service for chip-carrier motherboards that are designed to customer specifications. The North Reading, Mass., company **can package any monolithic integrated circuit into chip carriers and test them for electrical and mechanical integrity and reliability.** Packages consist of dual and single in-line multilayer ceramic carriers that maximize space utilization and reduce interconnections on printed-circuit boards and improve circuit performance and yield. The service is available for both high and low volumes.

What's the weather like?

Before transporting, storing, installing, or using a product, manufacturers should have a detailed knowledge of both natural and man-made hazards, according to "Classification of Environmental Conditions, Part 1." For example, a product could be damaged through severe changes in climate, **be impaired through contact with chemicals, or have its efficiency reduced through electromagnetic disturbances.** The report, which classifies environmental parameters and their severities, is put out by the International Electrotechnical Commission, 1, rue de Varembe, 1211 Geneva 20, Switzerland and costs 44 Swiss francs.

-Steve Zollo

Signal Generators from Marconi. They will change your way of thinking.

Think about testing receivers quickly. Wouldn't it speed your operations if all your signal generators gave the same answers and if your operators could recall complete test settings at the touch of a button even after the instrument had been switched off. Or when setting up a GPIB system, wouldn't you like your controller to be able to learn the settings of the generator.

Think about maintaining your signal generator easily. How much down time could microprocessor assisted fault diagnosis and recalibration from the GPIB or front panel save you? Wouldn't you like the reliability of a cool-running instrument, with no noisy fan to maintain.

Think about cost... would

2018 and 2019 Well Worth Thinking About

80kHz to 520MHz or 80kHz to 1040MHz frequency coverage

Non-volatile memory

Save operator time – recall up to 50 settings at any time – even after switch off

RF Level offset

Save arguments – standardise your microvolt and compensate for cable losses

GPIB Talker facility

Save program preparation time – let the GPIB controller learn the instrument settings

Reverse Power Protection

Save maintenance costs – no more burnt out attenuators to repair

Recalibration via Keyboard or GPIB

Save recalibration costs – adjust r.f. level and f.m. deviation calibration without removing the covers

Fully programmable

Save measurement time – automate your testing

a quality signal generator giving all this with wide frequency coverage and 10Hz resolution really cost more than you can afford? Marconi have a pleasant surprise for you!

Contact Marconi today – they will change your way of thinking.

Circle 151 on reader service card

marconi instruments

100 Stonehurst Court
Northvale, New Jersey 07647
Telephone: (201) 767-7250
Telex: 710-991-9752
(West): Telephone: (714) 857-2326
UK: Telephone: 0727 59292
FRANCE: Telephone: (1) 687-36-25
GERMANY: Telephone: (089) 84 50 85



Hard Facts on the T3340 for the Hard-Pressed Test

ADVANTEST™
The new generation in LSI/VLSI Testing from Takeda Riken.



The Most Advanced Architecture — Now Available in a 40MHz VLSI Test System

The Takeda Riken engineers are proud to present the T3340 — a VLSI test system with the 40MHz data rate and 256 pin test capacity to handle the ICs you're faced with today and those that tomorrow's device technology will likely present. All of this capability is the product of the Takeda Riken ADVANTEST concept and provides the troubled test engineers of today's IC device manufacturer with the ability to perform characterization, Q/A reliability testing, and incoming inspection while maintaining a respectable level of cost performance for a system of such versatility.

And the Takeda Riken engineers won't leave you high and dry — this system is fully backed up in the US by the ADVANTEST Division, a highly capable sales and service organization.

Guaranteed Overall Timing Accuracy of ± 800 ps

The ADVANTEST concept of overall timing accuracy provides an extremely tight guardband, thereby contributing significantly to test repeatability. The T3340 VLSI test system features an integrated



Advanced circuitry keeps Takeda Riken ahead in VLSI testing.

system of timing error compensation for extremely high overall accuracy. Accuracy, of course, that shows

up in the driver/comparator specs for skew. And, more than that, timing generator non-linearities, jitter, and comparator errors that cannot be electrically prevented are also improved.

This guaranteed timing accuracy spells ± 800 ps accuracy for the high speed test station, with test repeatability held to within ± 100 ps, thereby providing pin-point convergence.

The family of Takeda Riken ADVANTEST systems

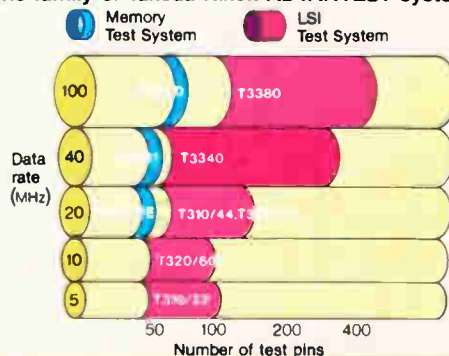

40MHz VLSI Test Systems Engineer.

T3340 Capabilities

40MHz Testing of 256 Pin Devices

The T3340 is just not another tester claiming a 40MHz data rate. This 40MHz system is backed up by the fact that any pin may be used as a full I/O pin with programmable active load. This is the key to achieving a high throughput in testing VLSI devices with a large number of pins.

Cross-Boundary Single-Range Timing Generator
Clocks and strobes can be set cross-boundary with 125ps resolution, and no dead band exists in either the present or the next test cycle.

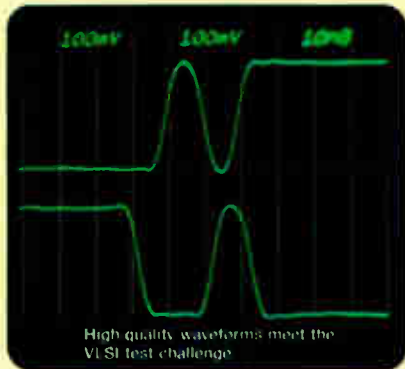

The digitally controlled timing generator used in the T3340 is designed to be able to generate all conditions for data rate, clock and strobes using a single range, providing schmoo plots and margin data unheard of before. These timing features satisfy virtually all VLSI timing requirements.

1+16 DC Test Units for High Throughput

The T3340 test system may be fitted with one Universal DC Test Unit and up to 16 (for 256 pin systems) Multi-DC Test Units, cutting the time required for parametric testing of large VLSI devices to 1/20 normal.

64K Vector Buffer and 16M Bytes of Storage

To facilitate the use of CAD-generated test data, a 64K deep stimulating and expected vector buffer is available in addition to 16M bytes of pattern storage (the optional super buffer memory). The system is designed to eliminate overhead time required to transfer such pattern data.

Proven MOST-XII Software System

The easy-to-use, field-proven MOST-XII software system is the ideal medium to support operator-to-DUT communications. Even after compilation, a process completed 3 to 5 times faster than with most test systems, the test plan may be freely and interactively modified at the source program level. The system manages the TP-1 32-bit super-processor and supports multi-user operation.



ADVANTEST

Testing solutions for today and tomorrow.

ADVANTEST systems are developed and manufactured by Takeda Riken, 1-32-1 Asahi-cho, Nerima-ku, Tokyo 176, Japan in cooperation with N.T. and T. Musashino Electrical Communication Laboratory.

* See us at SEMICON WEST, May 25-27
Bay Meadows, San Mateo, California

For more information, write or call our distributor:

ADVANTEST Division, Nichimen Co., Inc.

1185 Ave. of the Americas, New York, NY 10036 Phone: (212) 536-0571 Telex: 12017

Circle 153 on reader service card

This symbol means faster measurement system development. . .

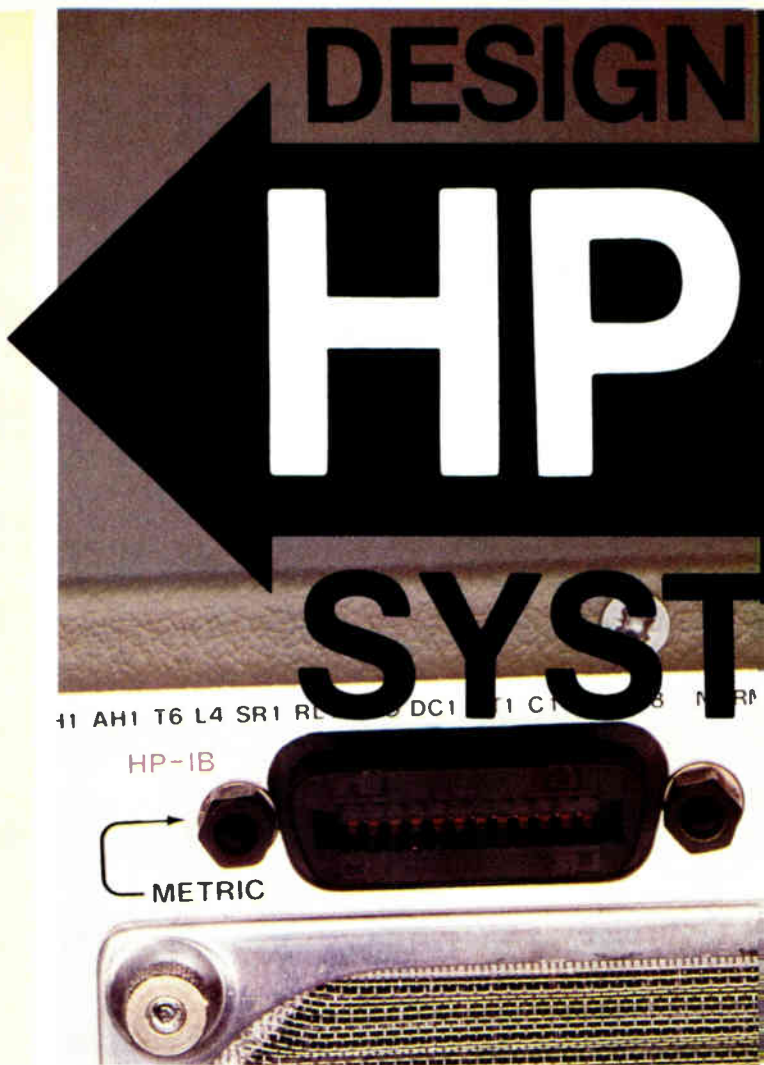

The familiar HP-IB (Hewlett-Packard Interface Bus) symbol is HP's way of identifying instruments and computers that conform to the IEEE-488 standard. But it means much more than just bus architecture and system compatibility. The HP-IB symbol also stands for the documentation and support that helps you get a measurement system operational in weeks instead of months.

Five reasons why you'll save time and effort.

Choose HP when you need a measurement system and you get these advantages: 1) All devices and all documentation come from a single source which means consistency in design and documentation. 2) Every member of the HP-IB family of instruments and computers — over 140 in all — is designed for and tested to rigid HP-IB standards of compatibility. 3) Just as important, every HP-IB device comes with complete and comprehensive documentation that's easy to follow and consistent in its approach to implementation. You'll receive service manuals and operating manuals that typically include a guide to the implementation of computer based systems. 4) You



can choose from more than 100 HP application notes. Many of these will teach you how to accomplish specific measurements in conjunction with the controlling computer. Software examples are included in a number of these to help you get to a solution even faster. In fact, one of these examples may be just what you need for your exact application. And many HP application notes list the results of performance tests to help you verify proper system operation. 5) HP also offers training, system engineering support and on-site service . . . assistance from start to finish. But these aren't the only reasons HP is the logical choice for measurement system development.

Over ten years of experience to call on.

When you design and build a measurement system, you can have the confidence of working with the company that was there when the need for a standard was realized. HP invented the 3-wire handshake technique and ever since then we've been designing and building HP-IB compatible components. By choosing an HP instrument or computer, you get the benefit of over 10 years experience in interface bus architecture, and how it can best be implemented.

Choose from a wide variety of computers.

With more than 140 different HP-IB instruments and computers to choose from, you can configure the measurement system that's just right for your application.

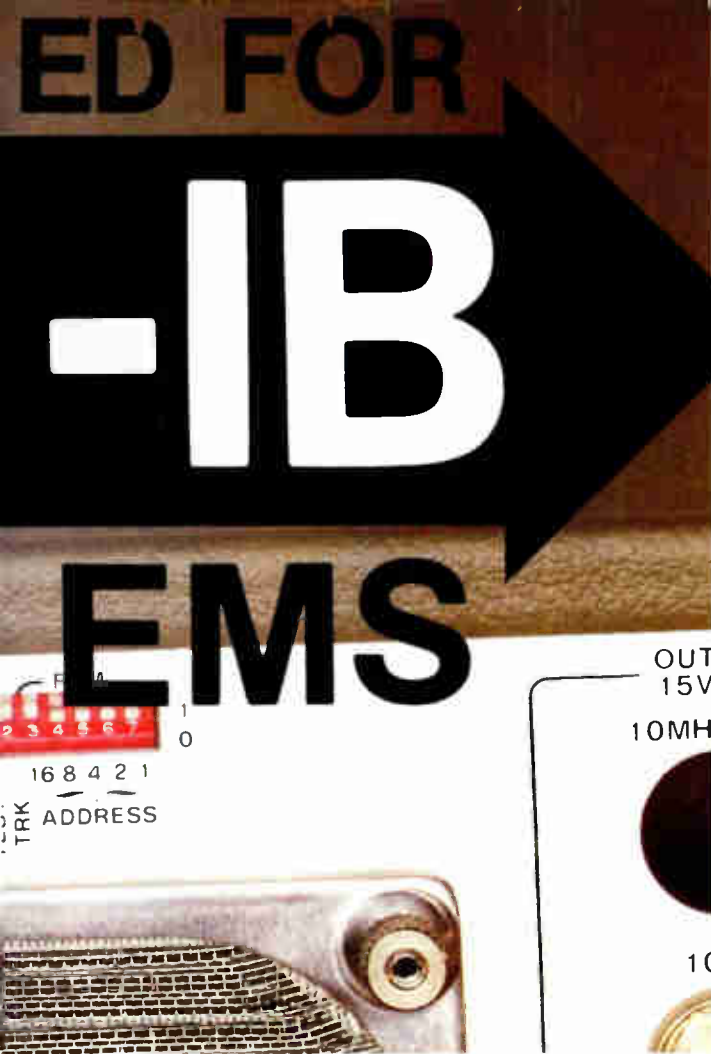

because it stands for system documentation and support on more than 140 HP-IB instruments and computers.

For your computing controller, you can choose from among the seven members of HP's powerful, flexible 1000 series family. Or you can select one of five friendly and flexible desktop computers. All HP computers have powerful, high-level languages that make it easy for you to write application programs.

Sticking with you.

HP offers all "Designed for Systems" devices with post-warranty support you can count on. You can continue this beyond the normal warranty period with an HP Maintenance Agreement. That means you'll enjoy yearly fixed cost, regularly scheduled preventive maintenance, priority response, and even more.

Meet the HP-IB family.

To find out how HP-IB compatible instruments and controllers can speed you to a faster system solution, send for our free brochure, "Do your own system design in weeks, instead of months." Just write: Hewlett-Packard, 1507 Page Mill Road, Palo Alto, CA 94304. Or call the HP regional office nearest you: East (201) 265-5000. West (213) 970-7500, Midwest (312) 255-9800, South (404) 955-1500, Canada (416) 678-9430.



HP-IB: Not just a standard, but a decade of experience.



AMPEX EXPANDS



14" Capricorn™



8" Scorpio™



5-1/4" Pyxis™

**With a galaxy of
high-performance
Winchester disk drives
and tape backups.**

Ampex is a leader in high-capacity Winchester technology. We've put together an aggressive, highly-experienced disk engineering group and it's paying off in disk drives that are configured to span the entire spectrum from 4 megabytes to 1 gigabyte. Take our new high-capacity drive families: 14" Capricorn disk drive with 165 and 330 megabytes; 8" Scorpio disk drive with 50 and 83 megabytes; and 5-1/4" Pyxis disk drive with 4, 8, 12 and 16 megabytes. They combine outstanding technical innovation with high performance and cost-

YOUR UNIVERSE



Virgo Streaming Tape Drive™

effectiveness. And we back them up with our new Virgo 1/2" 40 megabyte IBM format compatible streaming tape drives and our fixed/removable media Superwinchesters in 16/16, 48/16, and 80/16 megabyte capacities. We're high performance in our technical support, too, as well as in clean-room production capabilities that mark us as a major manufacturer committed to Winchester technology now and in the future.

Today, find out how Ampex can expand your universe. You'll discover that when it comes to disk drives, memories and

terminals, now more than ever Ampex is the designer's choice.

Call our Marketing department at (213) 640-0150. Or write Ampex Memory Products Division, 200 North Nash Street, El Segundo, CA 90245.

AMPEX

Ampex Corporation • One of The Signal Companies

The Designer's Choice.

Circle 157 on reader service card



HOT SPECS: THE MT8912 ISO²-CMOS PCM FILTER.

When the specs are examined, it's clear that the Mitel MT8912 PCM Transmit/Receive filter can offer your application significant advantages.

Low power consumption is just one such advantage. The MT8912 operates at a mere **20 mW** typical without power amps. Other units come in at as much as 280 mW.

Idle channel noise. With the MT8912, it's extraordinarily low—typically **6dBm** total C message noise at output.

Consider too the MT8912's **power supply rejection ratio: 40 dB** at 1kHz. In addition, the Mitel MT8912 is pin for pin compatible with the Intel I 2912. It meets AT&T D3/D4 and CCITT G712 specifications. The receive filter includes **sinx/x** correction and there is external gain adjustment of both transmit and receive filters.

All in all, it's a case of hot specs guaranteeing you hot performance.

Find out more about what the Mitel MT8912 can do for your application by contacting your local Mitel sales office.

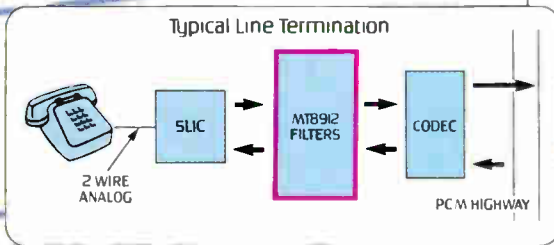
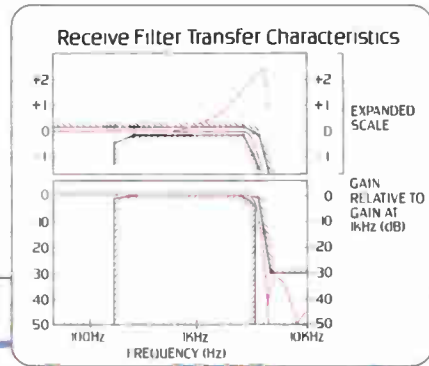
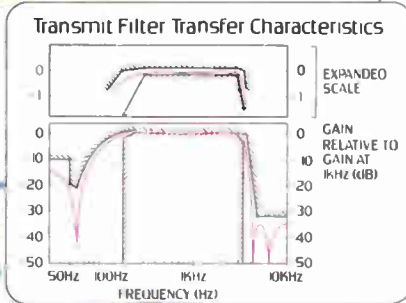

MITEL SEMICONDUCTOR

United States: 2321 Morena Blvd., Suite M, San Diego, California, U.S.A. 92110.
Telephone (714) 276-3421, TWX: 910-335-1242.
P.O. Box 17170, 600 West Service Road,
Dulles International Airport, Washington, D.C., U.S.A. 20041.
Telephone (703) 661-8600, TWX: 710-833-0865.

Canada: P.O. Box 13089, Kanata, Ontario, Canada K2K 1X3.
Telephone (613) 592-5630, Telex: 053-3221, TWX: 610-562-8529.

Europe: 33/37 Queen St., Maidenhead, Berkshire, England SL6 1NB
Telephone 0628-72821, Telex: 849-808.
Bredgade 65A, 2nd Floor, 1260 Copenhagen K, Denmark
Telephone (01) 134712, Telex: 19502.

Asia: TST P.O. Box 98577, Kowloon, Hong Kong.
Telephone 3-318256, Telex: 34235.

Copyright 1981 Mitel Corporation

BUILDING BETTER COMMUNICATIONS

Modems of all types proliferate

Low-cost 300-b/s parts, multi-megabit/s broadband units, and those filling other gaps turn up, despite market uncertainty

by Harvey J. Hindin, *Communications & Microwave Editor*

Modem manufacturers refuse to listen to naysayers and blithely proceed to introduce products at a breathtaking rate (see "Whither modems?," p. 160). These range from megabit-per-second units suitable for broadband local networks and IBM-type equipment to inexpensive 300-b/s devices designed for direct connection of home computers. Recent introductions illustrate the diversity of these devices, which are vying for portions of a market projected to be \$1 billion by 1984.

Typical of high-end units is a modem series from Interactive Systems/3M. It permits communications between the commonly used IBM 3274 terminal-control unit and up to 32 remote terminals over a single RG-62 coaxial cable. In other words, the 3M model 6600 series IBM-attach modems, as they are called, permit expansion without adding more cables.

To implement this expansion, the data must be multiplexed from a group of 3274 controller ports into one serial port over a single (usually existing) cable. At the remote-modem locations, the data stream is demultiplexed back into the separate bit streams and distributed to each terminal.

Slow alternative. Of course, it has always been possible to locate 3274 control units remotely. Although this tactic eliminates the need for additional cable, it also reduces throughput because communication takes place over a relatively slow link.

The 6600 modems offer another possible advantage. When baseband data-communications networks can no longer handle additional terminals, data-communications users can

upgrade to a broadband network with greater capacity. The 6600 series modems are designed to be reconfigured from baseband to broadband and are available in 32-, 8-, and 4-port configurations. The price of a 32-port unit is \$6,632. Quantity discounts are available and delivery is from stock.

A small firm, Anchor Automation, has addressed the other end of the market spectrum with what it

says is the world's first under \$100 direct-connect modem intended for personal computers. The \$99 Signalmaker Mark I is available from stock and designed to operate from a self-contained 9-v battery. A wall-plug power-supply module is also available.

Both voice and 300-b/s full-duplex data can be handled in an asynchronous format with a direct connection to the telephone line. The

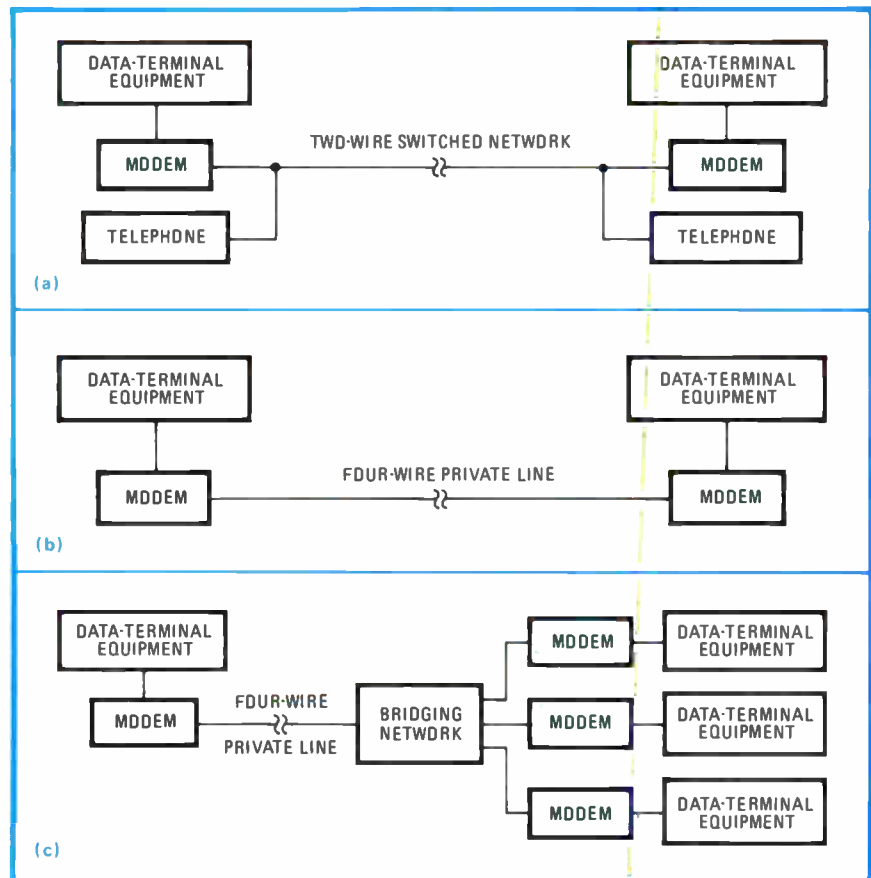

Flexible. The Rixon TA208A/B modem can handle half-duplex communications over a standard two-wire switched telephone network, and performs automatic answering functions (a). Various configurations are possible when a four-wire private line is used (b and c).

New product roundup

RS-232-C cable from the modem to the computer is built in. An audible tone, instead of the usual light-emitting diode, indicates the presence of a carrier signal.

Also geared to the home computer but designed to handle viewdata, the 1180 modem family has been announced by the International Telephone & Telegraph Corp. Available in sending or receiving configurations, the 1180 (see photo) functions at up to 300 b/s full duplex on switched telephone networks and meets recommendation V.21 of the International Consultative Committee on Telegraphy and Telephony (equivalent to the U.S.'s RS-232-C).

Dual units. The originating unit is designated the 1180A, and the answering unit is the 1180B. For viewdata needs (transmission at 75 b/s and reception at 1,200 b/s), the 1182A modem is available for use in full-duplex split-speed operation on standard switched telephone facilities. Its companion modem, the 1182B, provides the required transmission at 1,200 b/s and reception at 75 b/s. Both modems have an automatic connect and disconnect feature.

According to their maker, the 1180 family units are optionally available with TTL- and complementary-MOS-compatible interfaces.



Viewdata applications. ITT's series 1180 modems are designed to link home or office users with viewdata information services. Data travels one way at 75 b/s and the other way at 1,200 b/s.

Whither modems?

Modem manufacturing is a tough business. Intense competition with dozens of suppliers—many selling identical products or relabeling the work of others—are old problems. The incorporation of modems in data-generating and -receiving gear and the appearance of large-scale integrated circuits that perform many or all modem functions when incorporated in terminals are both factors that add to the modem marketing manager's woes. What's is more, American Telephone & Telegraph Co.'s Dataphone Digital Service (DDS)—if it becomes popular—will eliminate the need for modems in many installations at data rates up to 56 kb/s—the bulk of the market.

One estimate of the modem market's size (complicated by the cross-sales and label-changing mentioned), from General DataComm Industries Inc. of Danbury, Conn., says that total worldwide modem shipments in 1981 were \$820 million, and that this figure will grow to \$1,411 million by 1984. The loser here is the low-speed modem market, which will drop from \$42 million to \$31 million. In contrast, 9,600-b/s modems will soar from \$270 million to \$456 million, with similar growth at 1,200, 2,400, and 4,800 b/s.

The major long-range uncertainty for the modem manufacturer is the effect of AT&T's end-user-oriented Dataphone Digital Service. Connecting 96 cities with a 56-kb/s digital data capability, the service may drastically reduce the need for modems. However, installation of DDS has not been speedy, and, so far, its effect has not been seen by most manufacturers. In fact, taking advantage of the situation, some of them have asked the Federal Communications Commission for permission to provide some DDS interface—until now an activity only of AT&T. Needless to say, AT&T has objected; the FCC's decision is expected this year. The modem vendors also hope to make connection equipment for AT&T's Advanced Communications Service (ACS) as it comes on board.

-H. J. H.

Power can be supplied from the modems' associated data-terminal equipment at ± 12 and 5 v dc, or from an external supply.

The 1180, when it is used as a viewdata modem, couples a human to a computer. Butler National Corp. has also come up with a mod-

em for such coupling, but its Adas VIII, a voice and data modem, can communicate with the user in English by means of voice synthesis.

When interfaced with a host computer, Adas VIII can be used to perform standard originate and answer modem functions. It is connected by a self-contained telephone coupler circuit to a standard telephone line. At the other end of the transmission line, the mod-

em connects to the host via an RS-232-C interface, through which all instructions to the Adas can be issued and status indications and modem data communicated. Adas VIII costs between \$2,500 and \$3,500, depending on software options; delivery is in 120 days.

Closed-circuit television and some office-of-the-future applications call for a different breed of modem, synchronous units operating at megabit/s data rates. Comtech Data Corp. is offering such a broadband modem as part of its 500 series. These modems are designed for transmitting high-speed digital data with individual data rates from 56 kb/s to 7 Mb/s over a single cable. The M500 can handle three full-duplex circuits in a broadband local network. It is available in 90 to 120 days and costs up to \$4,650.

Midrange. Medium-speed modems with state-of-the-art features are also turning up. Penril's Data Communications division has designed a modem to provide data communications over short-distance nonloaded metallic cable pairs or

Move into Woven's World



Flat Harness Cables

Woven Flat Harness Cables. Woven or hand-tied to meet individual specifications. Your choice...complete with branches, break-outs and terminations. No insulation tears. Minimal crosstalk and reflection assures tight signal control. Choice of wire types and terminals. In coax or twisted pairs. Insulations include polyimid silicon, TFE, FEP, and other exotics. Or breakout with fiber optics or pneumatics. Woven... 'way to go for clear signal control.

 **WOVEN ELECTRONICS®**
A Division of Southern Weaving Company

P. O. Box 189, Mauldin, S. C. 29662. Phone 803/963-5131.

Woven is a world ahead

Circle 161 on reader service card

New product roundup



Put a Johanson in your circuit.

The name Johanson has become synonymous with variable capacitors. For over 35 years our trimmer capacitors have been the industry standard of excellence.

Johanson variable capacitors are designed for RF applications from HF through microwave frequencies. They incorporate a patented self-locking constant torque drive mechanism* insuring uniform torque and low dynamic noise. They feature high capacity per unit volume, temperature stability and high Q.

Electronic Accuracy through Mechanical Precision

The logo for Johanson Manufacturing Corporation, featuring the name "Johanson" in a large, elegant, cursive script font, enclosed within a thin, dark oval border.

Manufacturing Corporation

400 Rockaway Valley Road Boonton, New Jersey 07005
201-334-2676 TWX 710-987-8367

*U S Patent No 3,469,160

local channels at 2,400, 4,800, 7,200, 9,600, or 19,200 b/s. It is expected to be available midyear for \$595.

The Penril 8192 provides automatic adaptive equalization of the received signal. This eliminates the manual equalization setup required on most other short-haul modems. The automatic equalization also facilitates multipoint operation by independently equalizing the signal from each remote modem, doing away with operator intervention. The 8192 features remotely controlled digital loopback testing and a pattern generator and detector for self-test capability. Options allow the selection of special operating characteristics in the field.

Another contender. Also in the medium-speed class (4,800 b/s) the TA208A/B from Rixon Inc. transmits and receives synchronous serial binary half-duplex data over AT&T's two-wire switched network or full-duplex over four-wire private lines (see diagram, p. 159). In the private-line mode, optional voice- and data-alternating equipment may be added.

When the switched network is used, the modem features automatic answer under control of the data terminal. In this mode, use of a standard 500- or 565-type phone enables use of the alternate voice or data option without additional equipment. Availability is from stock for \$1,695 for the unpackaged card version.

Anchor Automation, 16130 Valerio St., Van Nuys, Calif. 91406. Phone (213) 997-6493 [401]

Butler National Corp., Suite 204, 800 West 47 St., Kansas City, Mo. 64112. Phone (913) 888-8585 [402]

Comtech Data Corp., 350 North Hayden Rd., Scottsdale, Ariz. 85257. Phone (602) 949-1155 [403]

Interactive Systems/3M, P. O. Box 33600, St. Paul, Minn. 55133. Phone (612) 736-2701 [404]

ITT, Data Equipment and Systems Division, Suite 8927, One World Trade Center, New York, N. Y., 10048. Phone (212) 839-0500 [405]

Penril Corp., 3204 Monroe St., Rockville, Md. 20852. Phone (301) 984-8225 [406]

Rixon Inc., 2120 Industrial Parkway, Silver Springs, Md. 20904. Phone (301) 622-2121 [407]

Digital Troubleshooting

The new Data I/O 1310A/1320A Digital Troubleshooting System allows a technician to verify correct data streams and identify failed components simply by probing test nodes and watching or listening for a correct indication. It eliminates practically all documentation.

The 1310A Signature Verifier and 1320A Stimulus Control Unit test beyond the limitations imposed by most signature analyzers. They enable a technician to conduct thorough and complete testing beyond the microprocessor bus.

The 1310A/1320A can test circuits asynchronous to the MPU "kernel." The 1310A can test non-microprocessor circuits designed for signature analysis and with the 1320A you can test microprocessor circuits that have not been designed for signature analysis.

The 1310A allows random instead of a fixed test sequence because

MINIMAL HARD COPY DOCUMENTATION

BEYOND THE BUS TESTING

RAPID, ACCURATE, RANDOM TESTING

correct signatures are stored in a PROM Module. With the 1320A you can use your own software development tests. Technicians can isolate failures quickly so that valuable time is spent solving problems rather than finding them.

But the real test of Data I/O's new Digital Troubleshooting System is on your bottom line. The 1310A/1320A make excellent dollar sense.

- Troubleshooting is easier. You don't need to use your most experienced technicians.
- You don't need to employ complex test equipment.
- You can test beyond the microprocessor "kernel."

If you'd like to learn more about Data I/O's revolutionary new system, simply circle the reader service number or contact Data I/O.

Another innovation from Data I/O, your productivity partner.

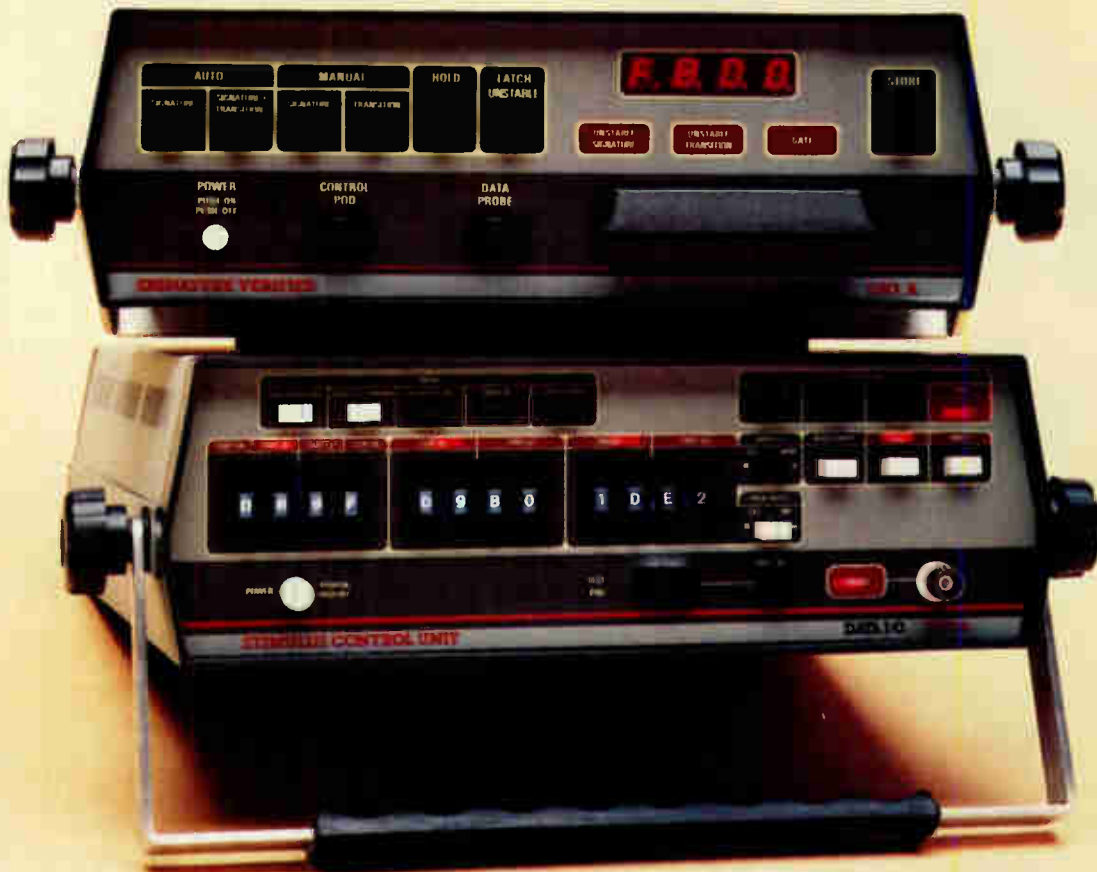

Data I/O Corporation, 10525 Willows Road N.E., C-46, Redmond, Washington 98052. For immediate action, contact us directly, CALL TOLL FREE: 800-426-1045. In Washington, Alaska and Hawaii, call 206-881-6445. Europe: Vondelstraat 50-52, GE, Amsterdam, The Netherlands, Tele: (20) 186855. Japan: Sankei Building 1-8, Sarugaku-cho, 2-Chome, Chiyoda-Ku Tokyo 101, Japan, Tel. (03) 295-2656.

DATA I/O

Circle 163 on reader service card

Need 'lytics for smooth signals on both ends of your power supply?

We call Panasonic TSW and HF Series capacitors "The Clean-Up Crew" because they're specifically made to smooth out the input and output signals in power supply applications.

TSW aluminum electrolytics are ideal for power supply inputs. They offer high volumetric efficiency and feature a self-mounting terminal design, with a unified terminal pitch of .394" (10mm). They're available in 6 can sizes and all popular capacitance/voltage values (up to 15,000 μ F and 250 VDC!), with close capacitance tolerance (-10% to +30%) and an operating temperature range of -40° to +85° C.

Compact HF Series electrolytics offer very low impedance at high frequency, excellent characteristics over the operating



temperature range, high ripple current and long life (2,000 hours at 105° C). Our HF capacitors are available in a variety of sizes and popular capacitance/voltage values (up to 2,200 μ F and 63 VDC), with a capacitance tolerance of -10% to +50%.

Building quality power supplies isn't an easy job. To do it right, be sure to call in The Clean-Up Crew: Panasonic TSW and HF Series aluminum electrolytic capacitors. We'll soon be making them in our new plant in Knoxville, TN. For complete information, specs and prices, write or call today: Panasonic Company, Electronic Components Division, One Panasonic Way, Secaucus, NJ 07094; (201) 348-5244.

Call in the clean - up crew.

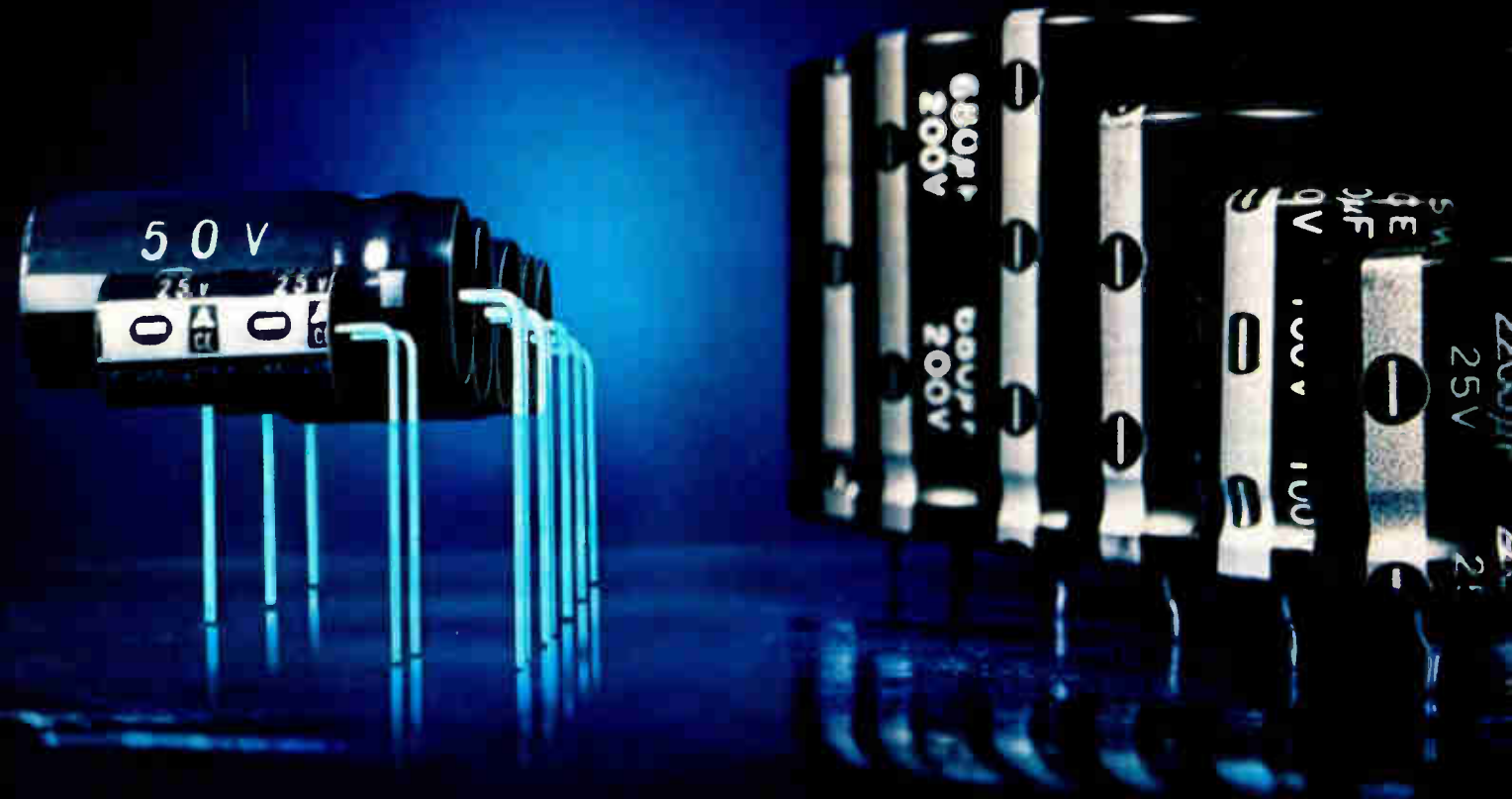

Panasonic[®]
just slightly ahead of our time

Wafer processor saves space and time

System's floor-space needs and throughput are improved; a compact oven, cleaning module, and intelligence are also added

by Linda Lowe, Boston bureau manager

A second generation of wafer-processing equipment from GCA Corp. will be unveiled at next month's Semicon West in San Mateo, Calif. With 30% to 50% better throughput and improved uniformity and reliability, the Wafertrac II system outperforms the company's Wafertrac system, which was introduced in 1976 and currently has an installed base of about 1,000 systems. The new system also occupies as much as 56% less floor space, according to the firm. Senior sales engineer Bruce I. Donsker estimates that production will be well under way by the third quarter.

Wafertrac II also departs from its predecessor in introducing intelligent process modules and a host computer, says Donsker. "In fact, each Wafertrac II module contains more memory capacity than does Wafertrac I's system controller," he asserts. The modules, equipped with Intel 8085 microprocessors and 16-K bytes of random-access memory, communicate with each other and with the 8086-based Wafertrac II host via RS-232-C links.

The host, which can support six Wafertrac II systems, develops process programs off line for downloading to the individual systems. It adds redundancy to the systems, intervening in the case of a communications failure among the system modules, and it performs system diagnostics either on or off line if a module should fail. The host processor has 64-K bytes of RAM, 16-K bytes of erasable programmable read-only memory, 256-K bytes of floppy-disk storage (more can be added), and an intelligent controller interface. Several hosts can communicate with one

another in compiling and storing processing-line histories.

New modules in Wafertrac II include a cleaning unit and a redesigned oven for drying and baking wafers at various points during processing. The 9-by-9-in. cleaning module contains a transducer head that applies ultrasonic energy uniformly to a cleaning solution flowing over the wafer. This process removes dust and other particles, smudges, and fingerprints, typically in 20 to 30 seconds, half the time required by high-pressure air-jet cleaners of the kind used on the original Wafertrac, asserts Donsker. The cleaner can operate three different dispensing lines, making possible programmable applications of different chemical solutions for different processes or at different points in one process.

Wafertrac II's oven serves to dry

wafers after cleaning, cure photoresists applied to wafers, and bake exposed and developed photoresists prior to etching. It also measures 9 by 9 in., whereas the first Wafertrac system's oven is 45 in. long, Donsker points out.

The oven returns to a relatively old method for baking wafers, the hot plate. But this hot plate has holes through which a vacuum chuck pulls wafers tightly onto the plate, increasing the uniformity of contact and thus the speed and uniformity of heating. Wafertrac II typically takes two to three seconds to heat a wafer from room ambient temperature to 130°C, reducing the time required to cure a photoresist on the wafer to 35 or 40 s from the first Wafertrac's typical 800 to 1,000 s, Donsker says. He adds that uniformity across the wafer is within $\pm 1/2^\circ\text{C}$ for a 4-in.





You won't be sticking your neck out

Not if you let MICRO LINK's Bus Oriented System Support STD BUS cards take the gamble out of your next design.

Our BOSS™ line of STD BUS cards provides the building blocks for your system, and is as easy to use as inserting a new card and its associated software control. Get the solutions you need by using the cards in our deck.

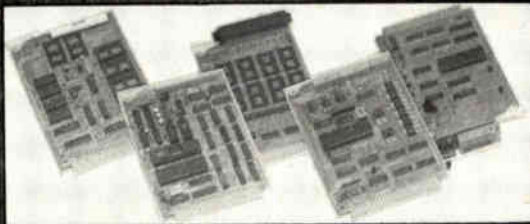

Don't take chances. Call or write to Micro Link today for the complete list and Technical data of the cards in our deck.



624 S. Range Line Road
Carmel, Indiana 46032
Phone (317) 846-1721

New products

wafer and $\pm 1^\circ\text{C}$ for a 5-in. wafer. "That's five to six times better than anyone else, including the original Wafertrac." The oven's speed pays multiple dividends, Donsker notes, "because it's used more often in the process cycle than any other module."

Other of Wafertrac II's modules, like the photoresist-coat and -develop units, remain much the same as on the first version, except for being scaled down and repackaged. All the system's modules are simple plug-in units, Donsker notes: "Undo four screws and pull one out—that's all there is to it." The virtue of such simplicity, he adds, is that a failed module can be "removed with minimal disruption of precious uptime."

Another of Wafertrac II's strong points lies in fault detection, according to Donsker. "Over half the system's original software is for diagnostics, which the host computer can run on or off line down to the board level of any module. Our goal within the year is to take that further, down to the function level."

Recipes. He also takes pride in the system's documentation. "GCA will supply baseline processing-characterization data on the operation of all modules on the system. I don't know any other supplier that is willing to guarantee that this or that 'process recipe' will yield specific, detailed results." The baseline data will not cover all possibilities, but it will allow users better control as they generate their own process programs. He adds that the host computer's software "makes software changes in process programs an order of magnitude easier than in the original Wafertrac system."

Pricing of the Wafertrac II, while not yet firmed up, will be "roughly comparable to that of the earlier system—within 10%," estimates Donsker. GCA currently has a number of the systems in evaluation at customer sites, and several more evaluation units are expected to be available by the time of the system's Semicon West introduction.

GCA Corp., IC Systems Group, 208 Burlington Rd., Bedford, Mass. 01730. Phone (617) 275-9000 [338]

CMOS UARTs from RCA are pin-for-pin replacements for Harris, Intersil parts.

The competitively-priced CDP6402 is available for immediate delivery in volume.

RCA's new CMOS UART is a pin-for-pin replacement for the Harris HD6402 and the Intersil IM6402:

- Baud rate to 200K bits/sec @ 5V, 400K bits/sec @ 10V
- 3.2 MHz @ 5V, power 7.5 mw, typical
- Operates from -40°C to +85°C

- Fully programmable with externally-selectable word length, parity inhibit, even/odd parity and 1, 1½, and 2 stop bits
- Automatic data formatting and status generation
- \$4.95 (plastic package, 100+ price) Ideal for interfacing computers or microprocessors to asynchronous serial data channels. Applications include modems, printers, peripherals, remote data acquisition systems

and serial links in distributed processing systems.

Available in plastic or ceramic packages, the CDP6402 is available for immediate delivery in volume.

So if you're looking for a very reliable source for CMOS UARTs, why not call "Old Reliable"? We're the people who pioneered CMOS.

For more information, contact any RCA Solid State sales office or appointed distributor.

RCA Solid State headquarters: Somerville, NJ. Brussels. Sao Paulo. Hong Kong. **Circle 167** on reader service card

Now you have a new reliable source for UARTs.



"Old Reliable"...

RCA

Instruments

Pulse generator is easy to use

50-MHz instrument flags incompatible settings, has 5-ns rise and fall times

Digital techniques are taxing the capabilities of pulse generators more and more as faster and more complex logic devices are designed into electronic equipment and enter markets like the automotive and machine-tool sectors. Built to cope with the demand for higher performance and more versatility is a general-purpose pulse generator from Hewlett-Packard GmbH, the Böblingen (West Germany) arm of the Palo Alto, Calif., company.

Priced at \$4,780—far less than existing general-purpose pulse generators, claims the firm—the HP8112A is an easy-to-operate instrument that is fully programmable through an IEEE-488 bus. It has a 50-MHz repetition rate and puts out pulses from 100 mV to 32 V peak to peak. Pulse rise and fall times as short as 5 ns (between 10% and 90% of amplitude) suit the unit for stimulating of fast logic devices.

The instrument's various trigger and external-modulation modes add much sophistication to test operations in research, development, and production, points out Wolfgang Flender, product marketing manager for logic-signal sources at the Böblingen facility, which is the center of HP's pulse and function-generator development and manufacturing activities. The 8112A also promises to extend the application range beyond that of competitive pulse generators. Simultaneous use of trigger and modulation modes allows simulation of complex signals like pulse trains that are amplitude-modulated with low-frequency noise.

Speed. The fast transitions permit measuring, for example, the slew rate of operational amplifiers and driving integrated circuits made with TTL, complementary-MOS, and n-channel MOS technologies. Because transitions are less than 3.5 ns from 20% to 80% of amplitude, the unit is fast enough even for emitter-coupled-logic devices.

In addition to the fixed 5-ns transition mode, the 8112A boasts a variable linear and cosine transition mode. The linear mode facilitates evaluating, say, trigger circuitry with ramps or sawtooth signals, and the cosine mode eases simulating smooth-transition signals without high-frequency components (like data stored on disks or tape).

"We have found that many users want a pulse source that, besides a strong digital capability, gives good analog performance," observes Walter Benger, product marketing engineer for the 8112A. To meet this need, the instrument offers features for analog applications, such as offset and various analog-modulation modes for digital signals. The device's high offset—up to 15.9 V with amplitude variable down to 200 mV—comes in handy for setting the correct bias points for checking diode and transistor performance.

Delay mode. Effective over the full 50-MHz range are the modulation modes for pulse period, width, delay, and amplitude. Of particular note is the delay mode, realized for the first time in a pulse generator, says Benger. It provides a convenient means for simulating, for example, propagation delay time or the delayed signals such as are encountered in radar systems, a job that until now required dedicated or custom-made instruments.

Jitter simulation. The pulse-period control mode works over a 1:10 range, so a linear one-decade sweep can be generated by applying a 1-to-10-V ramp to the control input. With a low-amplitude sinusoidal input signal, jitter can be simulated for testing the performance of phase-locked-loop circuits.

The 8112A provides a constant-duty-cycle mode that is programmable in 1% steps from 1% to 99%. With only one command, signals of constant energy can be generated. Thus, damage to sensitive components due to excessive energy input is avoided. For example, light output from a light-emitting diode can be optimized without overloading the LED.

Many users may find the instrument's ease of operation the strongest reason for buying the 8112A. As Flender points out, pulse generators often tax the operator's patience because parameters like pulse period delay, width, and pulse leading and trailing edges tend to affect each other. Also, specific relationships among various parameters must be maintained. For example, the pulse





Circle 169 on reader service card

A good reflection on your product

A clear, protective conformal coating can reflect the final step of quality and reliability for your PCBs and other electronic products.

And because all coating requirements are not alike, Miller-Stephenson offers a choice of acrylic, silicone, urethane and varnish. All are in aerosol containers for easy application in controlled areas.

Coatings are clear for component identification and all provide excellent electrical insulation and resistance to moisture and fungus. Products protected with the coatings can still be repaired, reworked, and resprayed.

To select the right coating for your special application, send for our Conformal Coatings Comparison Chart. We'll also send you our full-color catalog of the complete line of Miller-Stephenson products for electronics. Write: Miller-Stephenson Chemical Company, George Washington Highway, Danbury, Connecticut 06810. Or phone: (203) 743-4447.

miller-stephenson

Los Angeles/Chicago/Toronto/Danbury

QUALITY PROBLEMS?

We Can Find Failures Before Your Customers Do

Thermotron has been solving quality problems for 20 years for the aerospace industry with environmental simulation stress screening.

Call Us 616-392-1492

Ask for Stress Screening Consultant

We Can

- Save you money
- Improve your product's image

We Have

- Largest design and application engineering staff in the industry
- Largest product support organization to provide "after sale service"

THERMOTRON

Thermotron Industries, Inc., Kollen Park Drive, Holland, Michigan 49423

A SUBSIDIARY OF  WEHR CORPORATION

New products

width must always be smaller than the pulse period. It is often difficult to keep tabs on these relationships.

But with the 8112A, error-free pulse waveforms can be set up as easily as can a sine wave with a function generator. A mere touch of the set key generates a stable pulse train with a 50% duty cycle, minimum delay, and with the transition time either at 10% of period or 5 ns, depending on the selected mode.

Watchdog microprocessor. A microprocessor selects a specific ratio of the timing parameters according to the period and maintains that ratio when the period is varied. Final parameter values are entered with three vernier keys, each key acting on one digit of the instrument's 3½-digit LED display that shows the selected parameters.

The 8112A generates a warning when incompatible front-panel settings are made or wrong instructions are sent over the IEEE-488 bus. In manual operation, flashing LEDs indicate which parameter or mode combinations are not permitted. When an incorrect command is received over the bus, a service request is transmitted. When subsequently interrogated, the instrument puts out an error description—for example, "level error" or "pulse-width error."

Flender attributes the instrument's low cost to two factors. In addition to his company's long-term experience in signal-generator design, he cites the use of custom large-scale integrated circuits. A number of ICs perform several tasks—for example, pulse-rate generation, pulse-width and pulse-delay control, and error recognition. Besides cutting costs, the use of custom ICs helps reduce equipment weight and size. As a result, the 8112A weighs in at only 13 lb and measures 9 by 21 by 45 cm.

Given the instrument's price-performance ratio, Flender is convinced his company can maintain its competitive edge in the hotly contested pulse-generator market. Worldwide, that market climbed to an estimated \$31 million last year. It is predicted the market will grow an average of



This computer-enhanced image of an infra-red thermograph shows heat distribution in the fusible link of a Buss fuse during special testing. The geometry of each fuse link is designed by Bussmann engineers to provide protection during specific electronic conditions.

Put the heat on Bussmann's new circuit-protection plant and Tech Center to design a fuse just for you.

Call (314) 527-1254.

At Bussmann's St. Louis headquarters we have a new plant and Tech Center dedicated to the solution of electronic protection problems. Involved in it are more than half of the technical people in the fuse industry devoted to electronic protection.

It's a "critical mass" of engineering talent, where the interaction of sophisticated ideas are producing new developments daily.

We have 14,392 fuse types in the Buss line today, each representing the solution to a protection problem. We know it's just the beginning.

That's why we invite you to call us with your problem in electronic protection.

We want to be able to have another great answer when you ask: "What have you done for me lately?"

Call Ron Mollet, Senior Applications Engineer at Bussmann (314) 527-1254. Let him show you what we can do for you. Solving your problems is how Bussmann stays on top. Bussmann Division, McGraw-Edison Company, P.O. Box 14460, St. Louis, Missouri 63178.

McGraw-Edison

Bussmann

"WHAT HAVE WE DONE FOR YOU LATELY?"

Circle 171 on reader service card

Protect critical electronic equipment from power fluctuations with a Deltron Line Regulator

72 models from 1 to 8 KVA – to keep your systems going even through severe brownouts



NEW!
LOW COST!

For more information call or write Deltron for Bulletin 141.

COMPARE THESE FEATURES

- ✓ 98% efficiency
- ✓ ½ cycle correction
- ✓ Virtually zero distortion
- ✓ No annoying acoustic noise
- ✓ Frequency insensitive
- ✓ All power factors
- ✓ Input reflects load power factor almost perfectly
- ✓ Smallest size and weight
- ✓ Most models from stock
- ✓ All this at the lowest price in the industry!

AC 39

Deltron inc. / P.O. BOX 1369
WISSAHICKON AVENUE ■ NORTH WALES, PA 19454
PHONE: 215/699-9261 TWX: 510/661-8061

Circle 172 on reader service card

1981 Electronics Buyers' Guide

The only book of its kind in the field. If you haven't got it, you're not in the market.

To insure prompt delivery enclose your check with this coupon.

Yes, please send me _____ copies of 1981 EBG.

I've enclosed \$30 per copy delivered in USA or Canada. Address: EBG, 1221 Avenue of the Americas, New York, N.Y. 10020.

I've enclosed \$52 for air delivery elsewhere. Address: EBG, Shoppenhangers Road, Maidenhead, Berkshire S16, 2Q1 England.

Name _____

Company _____

Street _____

City _____

State _____ Zip _____ Country _____

New products

12% to 13% annually during the coming years. Delivery time for the HP8112A is 12 weeks.

Hewlett-Packard Co., 1501 Page Mill Rd., Palo Alto, Calif. 94304 [351]

Hewlett-Packard SA, Ch-1217 Meyrin 2, Geneva, Switzerland [352]

Vibration analyzer

tests structures

The Modal Investigator is a vibration analyzer for mechanical structures that automatically excites and measures the test article over a frequency range of 1 to 8,000 Hz with a $\pm 0.1\%$ resolution. The unit is equipped with a shaker table, drive-point sensor, analysis probe, and dis-

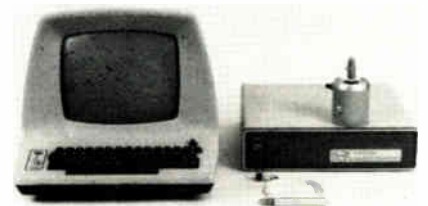

play terminal. An RS-232-C interface is standard, permitting the instrument to be interfaced with a calculator, computer, or printer. Larger shakers and other sensors may be directly integrated.

Specific functions include survey, which rapidly scans a specified frequency band and identifies resonances, antiresonances, damping factors, and modal coefficients; track, which servo-locks on a single mode and reports changes in its parameters that result from structural modifications; and map, which traces out node lines and modal motion with a manually guided analysis probe. Other functions allow for forced-response analysis, mass cancellation, and comparison of two analyses, each containing as many as 20 modes. The device has self-testing diagnostic features and comes in English and French versions.

Designed for quality-assurance screening, isolating product faults, and measuring manufacturing variability, the complete system is priced

innovation*

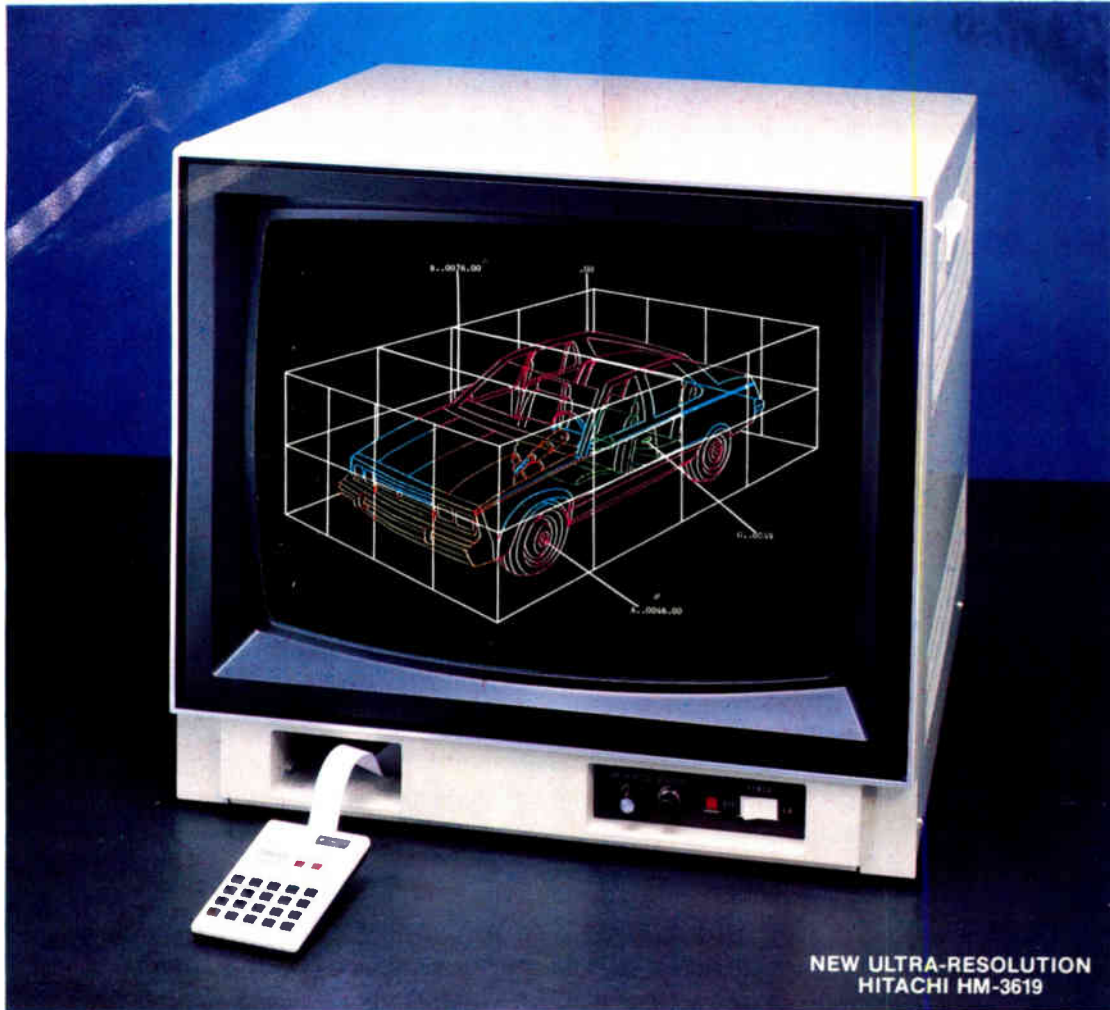

NEW ULTRA-RESOLUTION
HITACHI HM-3619

* 1. TOTALLY NEW 2. WITHOUT EQUAL 3. REDEFINES STATE-OF-THE-ART

HITACHI DOES IT AGAIN

Leaving the competition in the stone-age is the new Hitachi HM-3619 ultra convergence **1,000 line** RGB color monitor. With an amazing **Digital Dynamic Convergence™** of within 0.3mm it offers images of superior sharpness throughout the entire screen—another example of Hitachi's technological leadership.

IN-LINE GUN SUPERIORITY

Unlike others, Hitachi took the time and care to perfect an in-line gun system that really works.

DIGITAL SUPERIORITY

And Hitachi has successfully surpassed old fashioned analog systems, leading the way into digital exactness.

EXCLUSIVE DIGITAL CONVERGENCE CONSOLE™

Hitachi now introduces the amazing, **Digital Convergence Console™**, a part of Hitachi's exclusive **Digital Dynamic Convergence™** system, which can quickly and easily allow sector adjustments to be made from the palm of your hand. Available now with the HM-3619. It allows you to go a step beyond ultra-resolution.



COLOR DISPLAY MONITORS • CLEARLY THE FINEST

6 PEARL COURT, ALLENDALE, NJ 07404
3540 ARDEN ROAD, HAYWARD, CA 94545

MORE TO COME

This is the beginning of a new generation—the Hitachi leadership generation. Find out more by contacting your Hitachi color monitor representative or call: **East (201) 825-8000 or West (415) 783-8400.**

© HITACHI AMERICA LTD. 1982



Conap Conformal Coatings for Printed Circuits

• Proven Reliability • High Performance

Expect Conap's conformal coatings to be different. Each product in this family of polyurethane and epoxy coatings was developed specifically for protecting printed circuit boards and electrical/electronic parts from adverse environments.

They are not intended for use as general purpose protective coatings or for other purposes. This accounts for their high quality performance in circuit board applications. Reliable performance attested to by years of successful on-the-job service and backed with a full staff of customer service specialists.

Broad Selection of Coatings

Conap's economical, easy-to-process printed circuit coatings include both single component and two part systems conforming to MIL-I-46058C, Type UR requirements. There are formulations for dipping, spraying, or brushing. Coatings that cure at room temperature or elevated temperatures. Available in quart, gallon, 5-gallon and 55-gallon containers as well as convenient, easy-to-use, aerosols.

High Performance Properties

Films are available to provide excellent resistance to reversion, abrasion, impact, chemicals and solvents, fungus, thermal shock. Good electrical properties are a common denominator.

These coatings will protect assemblies from water, high humidity, contamination, and other severe environmental conditions. At the same time, they can ruggedize units against shock and vibration.

Excellent adhesion, uniform coating thickness, and easy repairability are other important features.

Free Bulletin, Low Cost Evaluation Kits.

Send for Conformal Coatings Brochure C-110 containing complete specifications and information on inexpensive evaluation kits.

Conap Means Many Things

• Epoxy and Urethane Resins • Chemical Specialties • Adhesives, Sealants and Coatings • Potting and Casting Systems • Fabricated Elastomer Components. For an over view of Conap's complete capabilities, write on letterhead for copy of Brochure FB-1.

CONAP

Conap / Olean, N.Y. 14760 / 716-372-9650

New products

at \$9,880. Delivery takes 30 days after receipt of order.

Fox Technology Corp., 45 Old Hook Rd., Westwood, N. J. 07675. Phone (201) 666-5105 [353]

Single meter measures many passive-circuit aspects

Rolling many functions into one unit, the IMF-600 digital impedance and multifunction meter measures voltage and current (dc and true root-mean-square), resistance, capacitance, inductance, conductance, dissipation, and (optionally) frequency. The only other general-purpose instrument needed in addition to the IMF-600, the maker claims, is an oscilloscope.

Included with the unit are a companion limits comparator for selecting all functions on a go/no-go basis; four-terminal shielded Kelvin connectors for measuring very low or high impedances; and analog and optional digital outputs. In addition, the IMF-600 is fully protected on all functions, and its 1-kHz crystal control ensures a basic accuracy of within 0.1%.

The option to measure frequency from 200 Hz to 20 MHz sells for \$169, while the digital-output option adds \$149 to the basic unit's \$929. Delivery takes six weeks.

IET Labs Inc., 534 Main St., Westbury, N. Y. 11590. Phone (516) 334-5959 [354]

Voltage standards unit offers 2-ppm/year stability

Bridging old and new standards technologies, the Trancell-III/SC, a transportable solid-state dc voltage reference standard, can be used to compare and trace the legal volt with both the older saturated-cell and the more recent electronic voltage standards.

The instrument is available with one, three, or four diode-cells, each of which provides reference outputs of 1.01814 v, the voltage across the diode (V_z), and a buffered 10 v. V_z

When reliability is imperative.



Where conditions demand the ultimate in power supply dependability, Abbott has been the outstanding choice for over 20 years. The "V" Models (60 Hz to DC) offer you this proven reliability plus many important features that make them ideal for exacting military applications where MIL-STD-810C performance is called for.

ENVIRONMENTALLY PROTECTED. Hermetically sealed and encapsulated to meet the severe environments of humidity, salt spray, sand, dust, etc.

SHOCK RESISTANT. Encapsulation protects unit from shock and vibration. Case is strong, copper-plated steel.

LOW EMI/RFI. Exceptionally low noise, these units meet the EMI and RFI requirements of most systems.

WIDE RANGE. 140 standard "V" Models are available with outputs from 5 VDC to 59 VDC and 5 to 240 watts.

ENGINEERING SUPPORT. Abbott factory-direct salesmen are electrical engineers and provide professional help in solving your particular power source problems. In addition, our application engineers are experienced electronic system designers. This team is available to assist you in making the proper power supply selection.

SERVICE AFTER SALE. Abbott service does not end with delivery. Our application and customer service engineers make sure our products function successfully in your application. Another good reason to specify Abbott. Abbott Transistor Laboratories, Inc., Power Supply Div., Western Office: 5200 W. Jefferson Blvd., Los Angeles, CA 90016. 213/936-8185. Eastern Office: 1224 Anderson Ave., Fort Lee, NJ 07024. 201/224-6900.

SEND FOR NEW FULL LINE CATALOG.
1,355 MODELS



69,700 HRS. MTBF.

IN NAVAL SHELTERED ENVIRONMENT

Calculated according to MIL HDBK 217C at 50°C. Each Abbott Power Supply undergoes no less than 41 inspections and tests including critical testing of all incoming materials and components per MIL-STD-105D, exhaustive mechanical and electrical testing, and a severe hermetic seal pressure immersion test. Our workmanship standards and quality assurance program have qualified Abbott for many applications requiring MIL-STD-454.

abbott

MILITARY POWER SUPPLIES



The assignment: Find fast, appropriate solutions to design problems that involve pushbutton, rotary, slide, keyboard or key switches.

The result: Standard, customized or custom switch proposals from ITT Schadow's Rapid Response Team.

At ITT Schadow, we specialize in taking basic switch designs and adapting them to fit your specific applications.

But that's not all. We also know when to save our customers money by recommending standard, off-the-shelf designs — and how to develop all-new switch configurations in situations where nothing less will do.

Just as important, we're able to provide a quick turnaround. Our factory's Rapid Response Team is set up to evaluate your design problems on

short notice and respond with electrical, mechanical, and physical drawings of a workable solution, along with tooling and pre-production requirements, a cost quotation, an implementation schedule and realistic delivery dates.

ITT Schadow switches include products for push-

button, rotary, slide, keyboard, and key switch applications. Many are based on patented designs; all are designed to provide an attractive physical appearance together with unexcelled electrical performance. For more information, contact your ITT Schadow manufacturer's representative or distribu-

tor. Or, if you're interested in a particular type of switch that you've seen in our catalog, write us directly on your company letterhead and we'll send you a free sample.

ITT Schadow Inc., a subsidiary of International Telephone and Telegraph Corporation, 8081 Wallace Road, Eden Prairie, MN 55344. Phone (612) 934-4400
TWX: 901-576-2469
Telex: 29-0556



Have a sales person call circle #176

Send literature only circle #243

Schadow **ITT**

New products

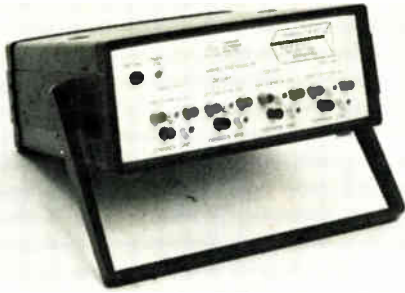

stability is better than 2 ppm/year, the 10-v buffered output is stable within 5 ppm/year, and the 1.01814-v output is generated across a fixed-ratio divider whose ratio is stable within 2 ppm/year. Two potentiometers on the rear panel let users adjust for any changes or drift in the 10-v and 1.01814-v outputs.

For comparing a saturated cell with values traceable to the National Bureau of Standards, the 1.01814-v output is used. For comparing NBS-traceable values with another solid-state reference bank, the V_z and 10-v outputs may be employed. All three outputs may be compared with each other through a Kelvin-Varley divider.

Prices range from \$2,500 for single-diode-cell units to about \$9,500 for four-diode-cell versions. Delivery takes three months.

Standard Reference Labs Inc., Coan Place,
P. O. Box 388, Metuchen, N. J. 08840.
Phone (201) 549-9280 [355]

Units join forces to test synchro-resolver signals

An automatic test system, comprising the model 5310 synchro-resolver simulator and the model 8810 synchro-resolver angle-position indicator, simulates, measures, and reads out synchro-resolver information. Packaged in tandem for 19-in. rack-mounting, the system forms the basis of an automatic and/or manual test set for simulating, calibrating, and monitoring most synchro-resolver-related systems and components.

Standard features of the 5310 include full remote programmability for line-to-line level, reference levels,

A/D CONVERTER 15 BITS 2 μ SEC

Not a dream, not in the planning stage, but a reality now! Phoenix Data's ADC 1215 H is a reliable, proven performer that has been used successfully by several customers for over a year.

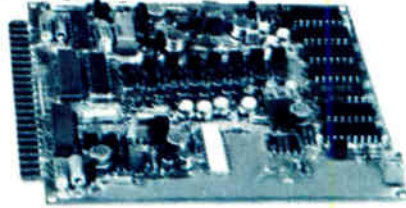

Now, you can count on a true 15 bit A/D Converter that has a maximum conversion time of 2 μ sec . . . all this on a single P.C. Board measuring 5.5" x 4.5" x 0.5" high!

Optional Features:

- A -55°C to 125°C temperature range is available.
- A high reliability version is available.
- An encased version will be available.

For additional information contact: Srinii Iyer



Phoenix Data, Inc.

3384 WEST OSBORN ROAD, PHOENIX, ARIZONA 85017 · PHONE 602/278-8528

Circle 177 on reader service card

UNITRONIX means DEC

TERMINALS
MODEMS

PDP 11/03, 11/23 + 11/44
SYSTEMS

With RLO1s & RLO2s
or Winchester Drives

INTERFACES

FLOPPYS

Std. & Custom Software

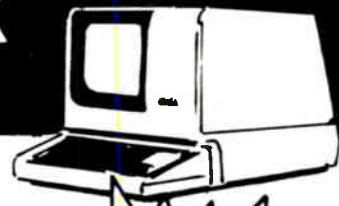

IMMEDIATE
DELIVERY
from \$6MM
warehouse
inventory

SAVINGS SPOTLIGHT

****FREE****

DEC Personal Computer
with purchase of a computer system

CALL FOR LATEST PRICES

(201) 231-9400

Sales or Lease Avail.



UNITRONIX CORPORATION

197 Meister Ave. • Somerville, NJ 08876 • TELEX: 833184



CMOS Gate Array and Bipolar Master Slice Technology

STC Microtechnology offers rapid product development cycles, simplified design methods and competitive pricing structures for semi-custom LSI.

CMOS Gate Array

- Advanced silicon gate two-level-metal technology
- 300-block & 960-block configurations
- Totally automatic placement and routing

Bipolar Master Slice

- 'Macro Cell' design approach (Op Amp, VCO, Comp Macros available)
- High-speed technology
- Easy-to-use design layout sheets

Take advantage of Microtechnology's total in-house capability---from design through final testing---for fast engineering turn-around time.

For more information, call Lori Hiatt at STC Microtechnology; (303) 673-4307. She can help you put CMOS gate array or bipolar master slice in your products.



MICROTECHNOLOGY

A Subsidiary of Storage Technology Corporation

2270 South 88th Street Mail Drop G1
Louisville, Colorado 80027

New products



synchro or resolver mode, and output angle. The 5310 has 36-arc-second accuracy and a 3-v ac output.

The model 8810 has 0.001° resolution, automatic ranging for 11.8-, 26-, or 90-v line-to-line synchro or resolver signals, automatic phase correction, and a bright 0.55-in.-high gas-discharge planar display. The type II tracking converter has front-panel control and input terminations but retains rear-connector input/output programming.

The packaged system, delivered 12 weeks after receipt of order, sells for \$8,015.

North Atlantic Industries Inc., 60 Plant Ave., Hauppauge, N. Y. 11788. Phone (516) 582-6500 [356]

IEEE-488-to-Multibus interface bows at under \$600

Entering the market with a \$595 price tag, the ZT 85/18 IEEE-488 controller interface for Multibus systems enables such a system to hook multiple IEEE-488-compatible instruments, peripherals, and computers to a single input/output slot. All Multibus systems, including those based on the 8086 and 68000, can be equipped in this way to direct the operation of attached devices and receive data from them.

The card boasts a 40-kb/s programming I/O speed, but does not support direct memory access. Accessories supplied with the interface include software-driver routines, manual, and cable. A phone-in consulting service is provided to aid users with problems. The ZT 85/18 will become available in May.

Ziatech Corp., 3433 Roberto Ct., San Luis Obispo, Calif. 93401. Phone (805) 541-0488 [357]

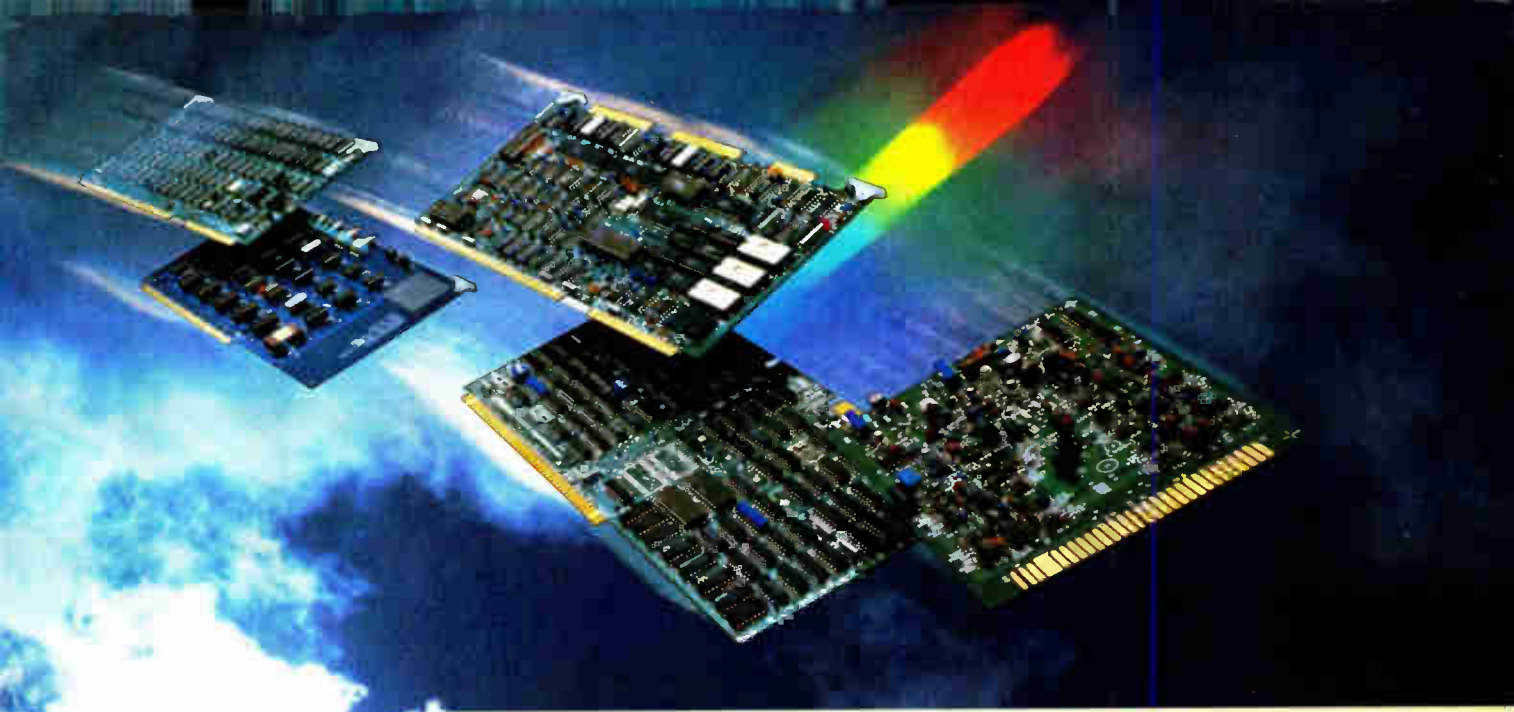

Introducing the Zehntel Series 300.

**A revelation for those who think
they can't afford in-circuit testing.**

Buy only the analog/digital test power you need now.

Now there's an alternative for manufacturers who covet larger test systems but can't justify the cost.

With our new Zehntel Series 300 instruments and systems, you can create a powerful in-circuit test system at low cost. And keep your options open for configuring a larger-scale system as your needs grow.

Creative solutions under \$50,000.

The Zehntel 310 gives you full analog and digital in-circuit testing starting at \$39,950. It is fixture compatible with larger Zehntel 800 systems and features many of the same sophisticated test capabilities.

Like ISODRIVE for LSI, MSI and SSI testing.

High-level shorts/continuities algorithm. Self-test fixture. Complete documentation.

For analog-only testing, the Zehntel 320 is your most cost-effective solution at \$34,950.

Or build your own in-circuit system with our Zehntel 300, a do-it-yourself kit of test modules without the cabinetry and interface, priced at only \$24,950.

Design your own computerized ATE.

For low-cost, true in-circuit test capabilities, connect the Zehntel 310 or 320 to any computer, using the RS232, ASCII, parallel or IEEE-488 interface and your system is complete. Or, if you prefer, we

will integrate an HP-85 computer into the system for you.

Or upgrade your current in-house test system by adding the in-circuit test power of the Series 300.

For high-volume testing without the expense, several Series 300 testers can be linked to a host computer for a network of dedicated test stations.

Get the complete revelation.

Write or call Zehntel, Inc., 2625 Shadelands Drive, Walnut Creek, CA 94598, 415 962-6900.



Zehntel
a PLANTRONICS company

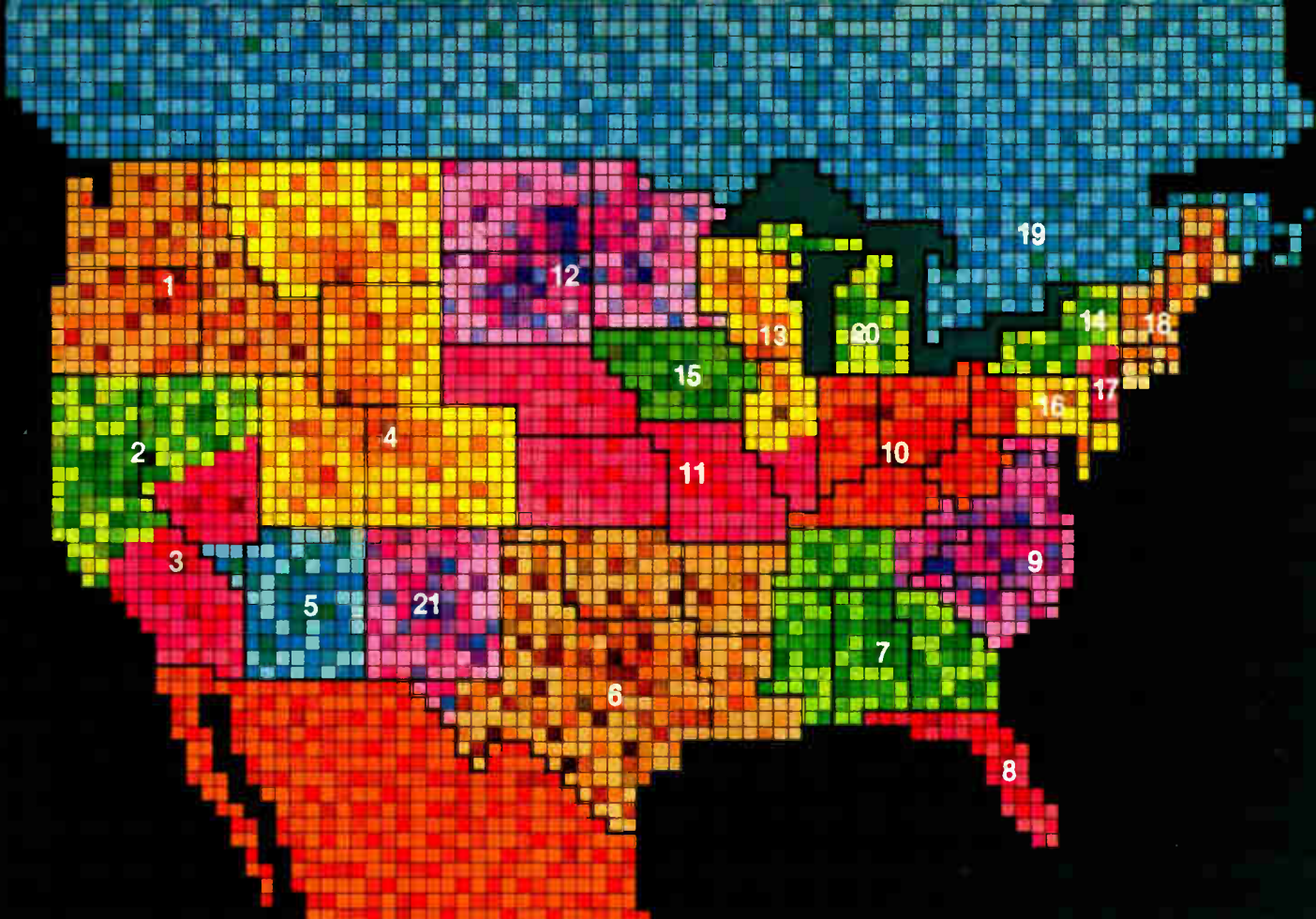

Now, you can draw on NCR's semiconductor experience - coast to coast and year after year. Consider the facts.

1. NCR pioneered MNOS and, now, SNOS

With twenty-one MNOS patents since 1972, NCR has designed and developed seventeen non-volatile memory devices. And from our MNOS products to our exciting new SNOS (Silicon Nitride Oxide Silicon) 4K NV-RAM, you can count on NCR innovation.

2. We're in the merchant market to stay

NCR's commitment to the merchant market is long term. We're spending \$155 million on the expansion of existing chip making facilities. That's because we're thinking about the future—as you are—and preparing for it.

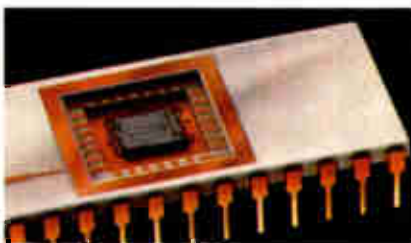

3. Experienced technical representatives coast to coast

Over one hundred representatives in North America are trained and ready to support your requirements—from technical applications to prompt customer service. Of course, they're backed by NCR Microelectronics expertise if and when needed.

4. NCR semiconductors—quality you can count on

Our ten years of experience as a manufacturer of semiconductors has taught us quality and reliability are essential elements of any chip. It's no

wonder we're one of the world's leading manufacturers of MNOS non-volatile memories.

NCR—NV MEMORY GUIDE

Device No.	Organization	Type
2051	32x16	WAROM
2055	64x8	WAROM
7033	21x16	WAROM
1400	100x14	WAROM
3400	1024x4	WAROM
2811	2048x4	EAROM
2168*	2048x8	EAROM
2161*	2048x8	WAROM
4485	512x8	NVRAM

*Pin conservative bus structured devices

MNOS p-channel description:
WAROM—Word alterable ROM
EAROM—Electrically alterable ROM

Industrial and Military temperature ranges available

For more information, call your local NCR Microelectronics representative. Or contact Dave Major at NCR Microelectronics Division, Box 606, Dayton, Ohio 45401. Our toll free number is (800) 543-5618, in Ohio (513) 866-7217.

NCR
Microelectronics Division

NCR Microelectronics Technical Representatives

- 1a N.R. Schultz Company
Bellevue, WA 206/454-0300
- 1b N.R. Schultz Company
Beaverton, OR 503/643-1644
- 1c N.R. Schultz Company
Boise, ID 208/377-8686
- 2 Costar, Inc.
Cupertino, CA 408/446-9339
- 3a Orion Sales, Inc.
Glendale, CA 213/240-3151
- 3b Orion Sales, Inc.
Tustin, CA 714/832-9687
- 4 Wescom Marketing, Inc.
Broomfield, CO 303/465-2234
- 5 B.H.&B. Sales, Inc.
Phoenix, AZ 802/269-7069
- 6a Oeler & Menelaides, Inc.
Dallas, TX 214/361-8876
- 6b Oeler & Menelaides, Inc.
Houston, TX 713/772-0730
- 6c Oeler & Menelaides, Inc.
Austin, TX 512/453-0275
- 7a Electronic Marketing Associates, Inc.
Atlanta, GA 404/448-1215
- 7b Electronic Marketing Associates, Inc.
Huntsville, AL 205/837-7363
- 8a Hutto-Hawkins-Peregoy, Inc.
Maitland, FL 305/831-2474
- 8b Hutto-Hawkins-Peregoy, Inc.
Fort Lauderdale, FL 305/971-5750
- 8c Hutto-Hawkins-Peregoy, Inc.
Clearwater, FL 813/797-4447
- 9a Zucker Associates, Inc.
Raleigh, NC 919/782-8433
- 9b Component Sales, Inc.
Baltimore, MD 301/484-3647
- 9c Component Sales, Inc.
Richmond, VA 804/270-9470
- 10a Rich Electronic Marketing, Inc.
Carmel, IN 317/844-8462
- 10b Rich Electronic Marketing, Inc.
Fort Wayne, IN 219/432-5553
- 10c Rich Electronic Marketing, Inc.
Louisville, KY 502/499-7808
- 10d Rich Electronic Marketing, Inc.
Dayton, OH 513/237-9422
- 10e Rich Electronic Marketing, Inc.
Cleveland, OH 216/468-0583
- 11a Rush & West Associates, Inc.
Olathe, KS 913/764-2700
- 11b Rush & West Associates, Inc.
Ballwin, MO 314/394-7271
- 12 Sieger Associates
Bloomington, MN 612/884-7788
- 13 Sieger Associates
Rolling Meadows, IL 312/991-6161
- 14a Precision Sales Company
Liverpool, NY 315/451-3480
- 14b Precision Sales Company
Pittsford, NY 716/381-2820
- 14c Precision Sales Company
Binghamton, NY 607/648-8833
- 14d Precision Sales Company
Pleasant Valley, NY 914/635-3233
- 15 REP Associates Corporation
Marion, IA 319/393-0231
- 16 Tritex Sales, Inc.
Haddonfield, NJ 609/429-1551
- 17 Tri-Tek Associates
Wantagh, NY 516/221-7600
- 18a New England Technical Sales
Corporation
Burlington, MA 617/272-0434
- 18b New England Technical Sales
Corporation
Meriden, CT 203/237-8827
- 18c Nets Limited
Malahide Co. Dublin
Republic of Ireland 450-635
- 19a Cantec Representatives, Inc.
Ottawa, Ontario, Canada
613/725-3704
- 19b Cantec Representatives, Inc.
Brampton, Ontario, Canada
416/791-5922
- 19c Cantec Representatives, Inc.
Quebec, Canada 514/683-6131
- 20 Enco Marketing, Inc.
Bloomfield Hills, MI 313/642-0203
- 21 Rocky Mountain High, Inc.
Albuquerque, NM 505/292-3360

New products

Computers & peripherals **5¼-in. unit holds 26 megabytes**

Four-disk Winchester drive
accesses in 90 ms, average,
performs own diagnostic tests

A 5¼-in. Winchester-technology disk drive that packs in 26.67 megabytes of unformatted storage is, says Rodime Ltd., the largest capacity available in any 5¼-in. unit today. Be that as it may, there is no disputing the Winchester's compact physical size, at 8 by 5¼ by 3¼ in., is comparable with most 5¼-in. floppy-disk drives, allowing direct physical replacement. It also can use the same 5- and 12-v dc supplies.

Designated the RO 200 series, the new range is largely based on the RO 100 series launched last fall [*Electronics*, Oct. 6, 1981, p. 181] and consists of four basic models ranging from the single-platter RO 201 to the four-platter RO 204. Each platter accommodates 5.25 megabytes of formatted or 6.67 megabytes of unformatted data.

Targets. From the outset, says Malcom Dudson, marketing manager of the firm, "our design target was to achieve 5 megabytes per platter." But to get their four-disk-per-drive Winchester off to a smooth production start, the firm first introduced it as a 16-megabyte system—then a pacesetter. With capacity now boosted 60%, data stored on mini-floppy-disk drives such as Digital Equipment Corp.'s RLO 1 or RLO 2 will directly and economically map onto Rodime's disk drive (with 256 bytes per sector and 32



The only DZ11 Compatible Multiplexor for LSI-11.
And it has RS-422 plus RS-232 and current loop capability-

MDB makes the difference!

Now you can have it all for your LSI-11 or PDP[®] 11 system! Full DZ11 multiplexor performance with the added benefit of EIA-RS-422 long line capability — communicates at distances to 3000 feet (914.4m) at rates to 19.2K baud. What's more, MDB's DZ11 multiplexors let you combine RS-422 with EIA-RS-232 in any combination up to a total of eight lines on a single board. Or combine RS-232 with current loop in the same way. Eight and sixteen channel RS-232 DZ11 multiplexors are also available. No more doubling up on boards, distribution boxes, rack space or price. You see the results in your system's performance and cost.

And that's not the only difference we can make to you. MDB has line printer controllers that are completely self-testing and we make more controllers for more computer/printer combinations than any company in the world. MDB offers PROM modules with window mapping, communications interfaces that support X.25 and a unique LSI-11/23 system with 22 bit addressing and up to 4 Mbytes of memory. From purely compatible to purely incredible all MDB products are built with exceptional quality and responsiveness to customer requirements. Our boards are warranted for a full year, many are available off the shelf and they can be purchased under GSA contract #GS-OOC-02851.

Call or write for all our specifications — the MDB differences that make a difference.

*Trademark Digital Equipment Corp.

MDB
SYSTEMS INC.

1995 N. Batavia Street
Orange, California 92665
714-998-6900
TWX: 910-593-1339

Circle 111 for referenced product. For complete information, circle 112 for PDP, 114 for LSI, 113 for DG, 116 for P-E, 115 for Intel, 117 for IBM.

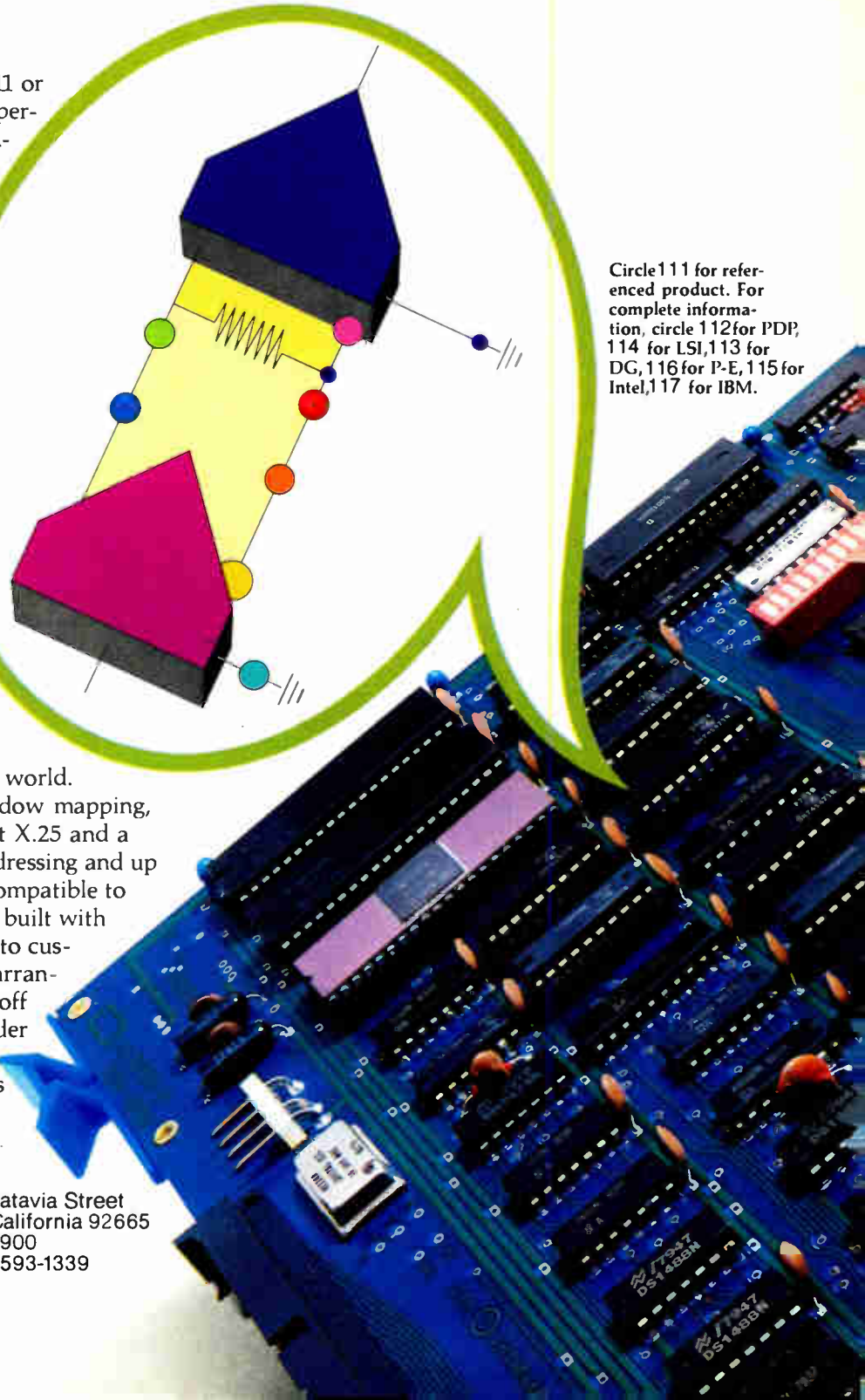

8086 SOFTWARE

From Dynamic Microprocessor Associates, Inc.

EM80/86™

An emulator which will permit an 8086, using 86-DOS (IBM Personal DOS, MS-DOS, SB-86*) or CP/M-86*, to run CP/M* programs written for 8080 without modifications. *Complete system \$200.*

THE FORMULA™

An information manager incorporating characteristics of a data base manager, a word processor, and a compiler language into a "system language" for application development. Delivered with the General Accounting System including General Ledger, Accounts Payable, and Accounts Receivable. *Complete system \$595; manual only \$60.*

ASCOM™

The Asynchronous Communication Control Program allows a microcomputer to communicate with another computer through a serial port; ideal for interfacing with a time sharing system. Includes various protocols and supports both batch and interactive processing. *Complete system \$175; manual only \$20.*

UT86™

System utilities designed to improve the user friendliness of systems using 86-DOS. UT86 provides neatly formatted and sorted directories, interactive copy routines which permit selection of individual files or groups of files, formatted file printouts with pagination and headings, and more. *Complete system \$180.*

THE FOUNDATION™

An advanced data entry and query language. *Available Summer 1982.*

DMA • WE SPEAK YOUR LANGUAGE

Dynamic Microprocessor Associates, Inc.

545 Fifth Avenue, New York, New York 10017 • (212) 687-7115

We ship prepaid and COD orders. Shipping & Handling charges extra: \$5 UPS areas; \$7 non-UPS areas, Mexico, Canada; \$10 + elsewhere. MasterCharge and VISA accepted. *Trademarks: 80-DOS, Seattle Computer Products; CP/M and CP/M-86, Digital Research; SB-86, Lifeboat Associates; MS-DOS, Microsoft.

Circle 184 on reader service card

New products

think has chosen the disk for the Eagle multitasking Unix-based microcomputer system. Rodime expects to ship 20,000 units in 1982 and is expanding facilities to achieve outputs of 60,000 per annum.

Eventually, Dudson sees Rodime moving to other recording media, such as thin films. Other manufacturers are already moving in that direction. "It was our original aim with the RO 100 series to provide for later enhancements by setting ourselves the highest engineering standards, particularly on actuator accuracy," says Dudson.

Prototypes will be available in May, and volume deliveries will begin in August. In single-unit purchases, the 201 is \$1,145 and the 204 is \$2,005; in lots of 500, they are \$680 and \$1,190, respectively.

Rodime Ltd., 12-14 Edison House, Fullerton Road, Glenrothes, Fife KY7 5QR, Scotland [361]

23591 El Toro Rd., Suite 208, P. O. Box 1122, El Toro, Calif. 92630 [362]

Single-sided optical disk holds 1,250 megabytes

Having the storage capacity of fifty 14-in. double-sided magnetic disk platters, the single-sided 12-in. Drexon II optical disk can store up to 1,250 megabytes of data. Data is recorded on the disk by melting 0.5- to 5- μ m-diameter holes in its reflective surface with a laser. The archival life of the disk is expected to exceed 10 years because of the material's stability. This material may be used for laser recording over the entire visible spectrum and into the near-infrared range—440 to 830 nm.

Control information may be recorded on the disk through ultraviolet polymer molding of a transparent dielectric pattern on the surface of the disk or by using photolithographic processes when the disk is manufactured.

A typical Drexon II disk, the 30-cm D-1201B will sell for \$700 each in lots of 30. When production reaches 100,000 units a year, the



REQUIRED READING FOR ELECTRONIC DESIGN ENGINEERS: CAMBION CATALOG 800

When it comes down to selecting the definitive design reference source in the electronic components field, get Cambion's Catalog 800 listing over 23,000 different components—connectors, terminals, inductive products, handles, and much more associated hardware. Cambion's reputation for high quality, reliability, and worldwide off-the-shelf availability, plus our special attention to custom-designs have made us a near-legend in our own time. The Catalog 800—designed to make your design concept a design reality. Get your copy today!

CAMBION
The Right Connection.

Midland-Ross Corporation
Cambion Division
445 Concord Avenue
Cambridge, MA 02238
Tel: (617) 491-5400
Telex: 92-1480
TWX: (710) 320-6399

MIDLAND ROSS

TRANSWAVE'S Tiny BASIC MICROCOMPUTER K-8073

The Computer That

Recaptures Simplicity

STD (MOD) BUS 4.5 x 6.5 in.
5 Volt Only—Cassette
Tape In/Out—2 Sense—
3 Flags—Interrupts

1K Byte Local RAM
[Expandable to 33K]

ART/RC Master, For Single
Wire Data I/O Of 128 Slave Units

Real Time Clock
W/Ext. Battery Backup
Yr, Mo, Wk, Day, Hour, Sec.

RS-232 For CRT
110—4800 Baud

INS8073 Microinterpreter
Tiny BASIC Processor

Autostart EPROM
2K Byte

Utilities Firmware, For
Software Dev., EPROM 2K

EPROM—2K Byte
[Expandable to 24K]

EPROM Programmer, 2K
Byte Prm. Decoded—Req.
Ext. 25V Only

PPI, Programmable I/O,
24 Lines

PPI Interface Ribbon
Connector

Development Station
\$225

DI-8020
20 CHN A/D
\$262

DO-8028
8 CHN TRIAC
Controller
\$296

K-8073
Microcomputer
\$388
SINGLE UNIT

No. 1
in
Tiny
BASIC

INPUT ►►►►► DECISION ►►►►► OUTPUT

TODAY'S NEEDS

How many times have you thought about designing or purchasing the ultimate intelligent control system but were discouraged by the R&D time or price? Transwave took the initiative of designing one for you. Combining versatility with low cost, the K-8073 Tiny BASIC Microcomputer has already taken the lead in the process control market. Programming is reduced to mere hours because of the on-chip Tiny BASIC Microinterpreter. I/O is extended to previously unheard of limits because of the on-board ART/RC (Asynchronous Receiver Transmitter/Remote Controller).

This processor-like chip provides bi-directional serial communication between the K-8073 and its remotely located peripheral I/O devices. In addition, the K-8073 can operate in a stand-alone, satellite, or host mode. When interfaced thru RS-232, you can utilize your host computer, large or small, for polling, editing and mass data storage.

INPUT

The DI-8020 is a 20 channel A/D input module designed to collect data from remote sensors monitoring temperature, humidity, light, pressure, etc. Each A/D module is capable of monitoring 16 analog and 4 digital signals. Remarkably versatile, the DI-8020 is adaptable to any environment.

In addition to an extensive input range, this A/D module eliminates the usual installation hassles because of the unique ART/RC communications route. A single twisted pair or coaxial wire serves as the bi-directional DPW (Data Pathway) between the DI-8020 and the K-8073 Tiny BASIC Microcomputer.

DECISION

After receiving data, the K-8073 executes from your EPROM based Tiny BASIC program.

OUTPUT

Completing the cycle of I→D→O is the DO-8028: an 8 channel TRIAC Control Module. This board features 8 optically

isolated TRIACS with a maximum rating of up to 300 Watts AC control per channel. Receiving commands from the K-8073 via the full duplex DPW, you can daisy chain as many as 128 of these "slave" stations.

STAND ALONE SIMPLICITY

Whether you free your mainframe, free your mini or start from scratch, you can let closed loop control be the minimum configuration it should be. These cards are exactly the fundamental pieces needed for today's control applications. To order your K-8073 or for further information on the Vanderbilt Series 8000 Product Line, write or call: TRANSWAVE CORPORATION, Cedar Valley Building, Vanderbilt, PA 15486 Phone: (412) 628-6370.

TRANSWAVE
COMPUTER DIVISION OF UTSC

Circle 185 on reader service card

OUTSTANDING CAPACITORS

Make Custom Electronics your source of supply for highly reliable capacitors:

K-Series Mica Capacitors

Maximum volumetric efficiency in high voltage applications. Write for K-Series TechniTips.

C-Series Mica Capacitors

Solid capacitors for maximum reliability. Capacitance to 10 μ f; voltage to 50 KV. Write for C-Series TechniTips.

Precision Film Capacitors

Standard capacitors of DuPont Teflon® for critical circuits at temperatures to 200°C. Write for Bulletin T-1.

CUSTOM ELECTRONICS, INC.
12 Browne St., Oneonta, NY 13820
PH: 607-432-3880 TWX: 510-241-8292



CUSTOM



The SBA Region II Subcontractor of the Year

Circle 186 on reader service card

Customized

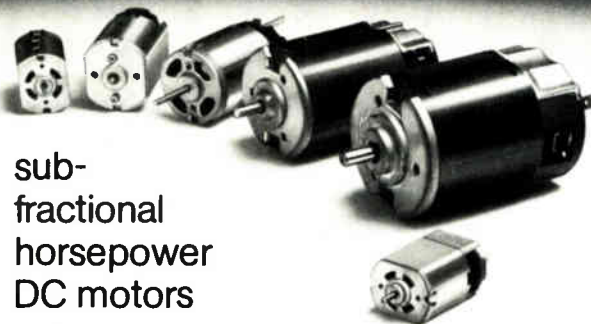

sub-fractional horsepower DC motors

Buehler Products, Inc. offers a complete line of permanent magnet DC motors that are performance rated to your specific application for maximum cost effectiveness. These customized, long life Buehler motors are available with a wide variety of options in voltage, current, torque, speed, electrical connections, and frame size. They're used worldwide in office products, business machines, cameras, computer peripherals, tape recorders, marine and automotive applications. Write for full details on the Buehler FHP motor line.

FHP permanent magnet DC motors
Miniature brushless DC fans
Miniature gear motors

BUEHLER PRODUCTS INC., P. O. Box A, Highway 70 East,
Kinston, North Carolina 28501, (919) 522-3101



186 Circle 247 on reader service card

New products

manufacturer claims that each disk is expected to cost around \$100.

Drexler Technology Corp., 2557 Charleston Rd., Mountain View, Calif. 94043. Phone (415) 969-7277 [363]

Low-cost computer terminal sets up link automatically

The ZT-1 terminal connects to telephone lines with a modular connector and can automatically dial, gain access to a computer, and request information. In addition, the ZT-1 can be used as an electronic typewriter with a printer connected to its parallel interface.

The VT52-compatible terminal's modem can also be used as an automatic dialer for voice calls. Telephone numbers, computer-account numbers, and passwords need only be entered once. Afterwards, they can be used by selecting the letter of the alphabet from the menu that matches the number.

The terminal eliminates the complicated procedures—escape codes setting the bit rate, manually dialing phone numbers, entering account numbers, and character control for password entry—that are necessary each time a standard terminal is used.

The ZT-1, with a 62-key keyboard and ZVM-121 video monitor, sells for \$695 and will be available next month.

Zenith Data Systems, 1000 Milwaukee Ave., Glenview, Ill. 60025. Phone (312) 391-8181 [364]

100-character/s printer supports ZT-1 terminal

In support of Zenith's ZT-1 terminal comes a series of printers capable of printing at a minimum speed of 100 characters per second. The printers are fully compatible with all of the functions, capabilities, and operating modes of the ZT-1.

One model in the line, the MPI 88G, sells for \$749 and is supplied as standard with both tractor and fric-

500 Watt Switchers

Probably the most cost effective power supplies in the world.



RSF Series

Sub-Modular construction, an ACDC exclusive, assures high MTBF and low MTTR. The latest LSI inverter circuitry, power semiconductors and fault/error detection IC'S reduce parts count for a truly modern, cost effective design. Quality is assured through a 48-hour burn-in and hard copy test data with every unit. RSF units are also available with an optional filter to meet FCC 20780 and VDE 0871 requirements. At about a dollar per watt in OEM quantities, you can't beat it.

Feature	Function	Benefit
Sub-modular construction	Eliminates internal wiring; lowers production cost.	Higher reliability, low MTTR; easy to test and trouble shoot. Lower cost; quick delivery.
Design based on proven product.	The best features of our highly popular "RS" and "EAGLE" series in a new 500W package.	Low risk . . . a new product with proven reliability.
Proportional drive	Switching transistor drive circuit.	Switching Transistor failure does not damage control circuit. Few components, thus higher MTBF and lower cost.
A complete 500W family	Singles, dual, triples and quads.	One supply to replace multiple supplies or upgrade system.
High power dual model	Two 400W channels (500W total max.)	Ideal for CMDS, Micro processors, ECL, or test systems.
External switch for 115/230 VAC	Easy conversion of 115/230 VAC.	Universal usage; no additional cost.

Additional Features and Benefits • Bi-directional forced air • Designed to meet MIL spec shock and vibration in shipping • Inhibit, remote sense, margining, over voltage, over current protection • Extended hold-over • Vacuum impregnated, high frequency shielded magnetics • Low ESR output caps • Inrush protection • Outputs of 2 thru 28 VDC • Options include power fail, crowbar, output out-of-tolerance, VDE0804 hipot, reverse air • 100% screening of primary active devices • Steel chassis and cover provide strength, EMI suppression

RSF 501 SINGLE OUTPUT UNIT		RSF 102 HI-POWER DUAL OUTPUT UNIT		RSF 502 DUAL OUTPUT 500W MAX.			RSF 503 TRIPLE OUTPUT/RSF 504 QUAD OUTPUT 500W MAX.					
OUTPUT VOLTAGE	MAX OUTPUT CURRENT IN AMPS	Combine any 2 of the following (500W max.)		OUTPUT VOLTAGE	MAX. CURRENT RATINGS IN AMPS		OUTPUT VOLTAGE	MAX. CURRENT RATINGS IN AMPS				
		OUTPUT VOLTAGE	MAX OUTPUT CURRENT IN AMPS		OUTPUT 1	OUTPUT 2		OUTPUT 1	OUTPUT 2 & 3	OUTPUT 4	SEMI-REG. OUTPUT 4	
2	100A	2	50A	2	N/A	16A	2	N/A	8A			
5	100A	5	80A	5	80A	16A	5	80A	8A	5A		
12	42A	12	33A	12	33A	16A	12	33A	8A	2A		
15	35A	15	27A	15	27A	14A	15	27A	7A	2A		
24	21A	24	17A	24	17A	8A	24	17A	4A	1A		
28	18A	28	15A	28	15A	7A	28	15A	3.5A	1A		
							24	*				24V @ 4A 6A PEAK
SINGLE OUTPUT \$575.00		HI-POWER DUAL OUTPUT \$739.00		DUAL OUTPUT \$650.00			TRIPLE OUTPUT \$695.00/QUAD OUTPUT \$745.00					

acdc electronics 

401 Jones Road, Oceanside, CA 92054 • (714) 757-1880 • TWX 910-322-1470

Circle 187 on reader service card

See us at Booth 305
ELECTRO 82-Boston

4-way lever switch

...p.c. board compatible

Introducing Cap-
itol's new 4-Way
Lever Switch, with
p.c. board termi-
nals. Switch lever
action... lock or
momentary. Actually
2 switches in one —
saves space and money!
Durable stainless steel shaft.
houses stainless steel block.
Nylon pivot block.
Tarnish-free Palladium
contacts offer over 1-
million trouble-
free cycles. 3AMPS.
110 VAC. Non-in-
ductive. Available with
360° compatibility.
Write or phone
today for all the details.



**Capitol
SWITCH**

The Capitol Machine
and Switch Company
87 Newtown Road
Danbury, CT 06810
203/744-3300

Circle 188 on reader service card

POWER SUPPLY UNITS!

AC/DC power supply unit
Custom versions also available

POWER PACK BOARDS with toroidal transformers for use as supply boards with direct current outputs (filtered, non-stabilized), also in conjunction with secondary-cycle switching controllers; voltage ranges from 8-48 V. Current ranges from 1-12 A. Single or double voltage systems, Standard European Format, compact design, low S value, high efficiency (minimum temp. rise).

CLOCKED POWER SUPPLY UNITS
All system-related direct voltages possible. Standard European Format, stabilized power supply unit with +/- voltages at current levels of up to 20 A, minimum ripple, power-fail, signal, temperature and mains monitor, power failure, by-pass up to 25 ms, secondary voltage monitor (absolute value), definable cut in/cut out sequence of the secondary voltage.

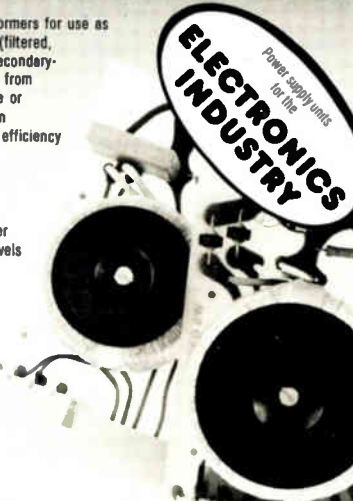

Power supplies
for the
**ELECTRONICS
INDUSTRY**

W. SEDLBAUER GMBH
PRECISION MECHANICS AND ELECTRONICS PLANT
D-8000 Munich 90 · Quagliostr. 6 · Phone (089) 6 51 40 57 · Telex 5-24 873

188 Circle 248 on reader service card

New products

tion paper feed. The dot-matrix printer, which comes with a parallel and an RS-232-C serial interface, is currently available.

Micro Peripherals Inc., 4426 South Century Dr., Salt Lake City, Utah 84107. Phone (801) 263-3081 [365]



Color terminal accesses
videotext services

A videotext data terminal for most time-sharing and data-base computer networks includes a built-in modem for relaying communications through the user's telephone. It also has provisions for displaying alphanumeric and graphic information on a television screen.

Among the unit's features are a 58-key alphanumeric keyboard with two user-definable keys and a 16-key calculator keypad. Other features include color graphics, a resident ASCII or dynamically redefinable character set, reverse video, a software-selectable large-character format, and an expansion interface for peripherals. In addition users can write and store programs in Basic, Fortran, Pascal, and Cobol.

The resident character sets may be displayed in either a 40-character-by-24-line or 20-character-by-12-line format. Color graphics allows individual characters and background to be displayed in one of eight selectable colors.

The VP-3501 lists for \$399 and is available now.

RCA Solid State Division, Route 202, Somerville, N. J. 08876. Phone (201) 685-6423 [366]

More pins. Less mating force. Our MIL-C-55302 connector has both.

In fact, you can mate the 240-position size without mechanical assists. Once it's in place, it stays there—despite severe vibration. The four-beam receptacle assures contact redundancy, and its forgiving design eliminates critical pin/receptacle alignment.

The AMP Box Contact two-piece connector is ideal in high performance areas like avionics and computers. It's totally reliable, proved in service and more versatile than ever. Especially now that we've added discrete wire, coax and flat flex cable versions.

You get a lot in this box.

AMP Facts

Configurations:
Board-to-board
Wire-to-board
Wire-to-wire

Centerlines:
.100", .075" or .050"

Positions:
10 to 240

Current rating:
3 amperes (1000 series)

Temperature Rating:
-55°C to +125°C.



Crimp, solder and wrap type contacts available.

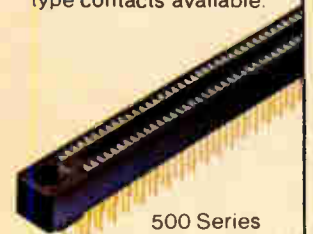

500 Series includes coax and flat cable options.

For more information,
call the AMP Box Contact Connector
Information Desk at (717) 780-8400.

AMP Incorporated, Harrisburg, PA 17105.
AMP is a trademark of AMP Incorporated

AMP means productivity.

CIRCLE
NUMBER
125

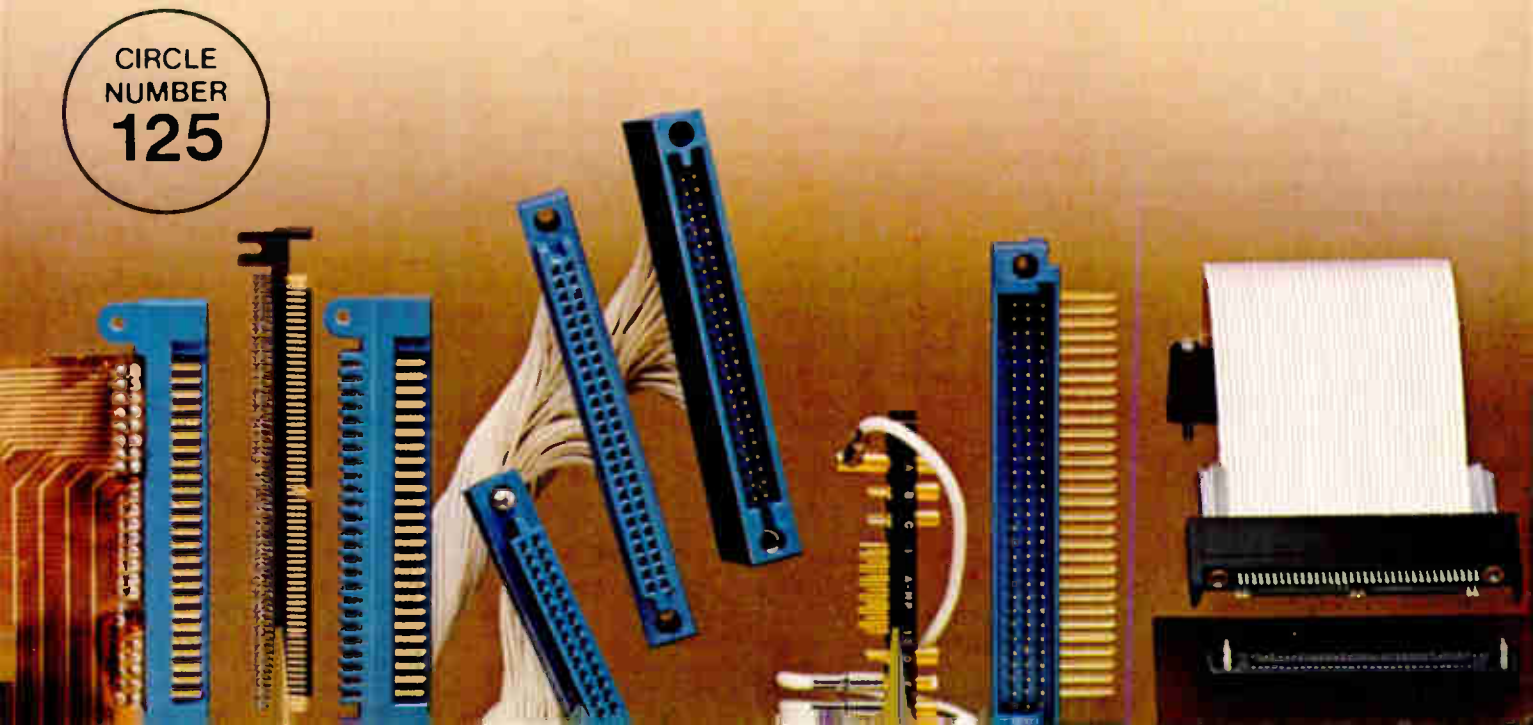

Data acquisition

Analog I/O cards plug into Q-bus

16-channel cards accept any combination of differential or single-ended inputs

Joining the ranks of data-conversion suppliers is a Chelmsford, Mass., startup, Grant Technology Systems Corp., whose first products are two series of analog boards for Digital Equipment Corp.'s LSI-11, -11/2, and -11/23 and Falcon single-board microcomputer systems. According to A. L. Grant, president of the firm, both series afford a wider range of features than do comparably priced competition. He says the boards are also unique in accommodating the four-level-interrupt architecture that DEC recently introduced for its Q-bus systems.

Subsystems. Models 116, 117, 118, and 119 are a series of 12-bit analog-input and analog-input/output subsystems built on a standard DEC dual-height board and are capable of 30,000-sample/s speeds. They contain 16 analog-input channels, and the software supports wiring of the boards for any combination of single-ended, pseudo-differential, and differential inputs on a single board. Channel addressing takes place in selectable auto-incrementing or parallel-loading modes.

The 116-119 series boards' input channels accept four software-selectable input ranges: ± 5 , ± 10 , 0 to 5, and 0 to 10 v. An optional programmable-gain amplifier permits software selection of signal gains of 1, 2, 4, and 8 in the models 116 and 117 and of 1, 10, 100, and 1,000 in the 118 and 119 models. Input linearity error is $\pm 1/2$ least significant bit maximum with no missing codes over the full-scale range. The common-mode-rejection ratio for pseudo-differential and differential inputs is 76 dB, minimum.

The series also accommodates

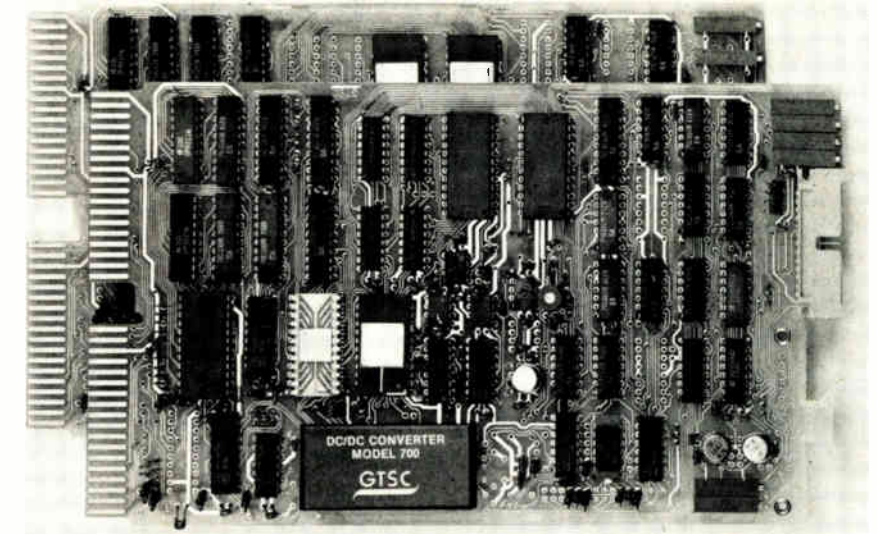

applications that use low-level, slowly varying dc inputs (5 mV full scale) to high-speed high-level dc inputs (10 v full scale). An on-board dc-to-dc converter permits operation from a host's 5-v power supply.

Models 118 and 119 of the series additionally include two channels of 12-bit digital-to-analog conversion for outputs of up to ± 10 v full scale. Jumper-selectable output ranges are 0 to 10, ± 5 , and ± 10 v. Output offset error is less than $\pm 0.2\%$ of full-scale range, and an on-board potentiometer can adjust that to zero. Maximum output settling time to within $1/2$ LSB takes 2 μ s for a 1-LSB change and 10 μ s for a full-scale change. Output nonlinearity is a maximum of $\pm 1/2$ LSB with no missing codes over the full range.

Other features of these boards include internal and external triggering, random- and sequential-mode access, and register and vector addressing. The boards, available next month, will cost from \$650 to \$910 in lots of one to nine. Delivery is from stock to 30 days.

The firm's models 202 and 204 are analog-output boards with optional digital I/O capabilities. Also supplying 12-bit resolution and packaged on dual-height boards, the 202 with its two output channels and the 204 with its four channels have jumper-selectable ranges of 0 to 5 or 10, ± 5 , and ± 10 v. Output linear-

ity error is $\pm 1/2$ LSB maximum, and differential linearity is to ± 1 LSB with no missing codes. The $\pm 0.2\%$ offset error is adjustable to zero. Both boards have standard oscilloscope-control circuitry and an on-board power converter for operation using a host's 5-v supply.

Options. The models 202 and 204 optionally include eight open-collector digital I/O lines, configurable in any desired combination of inputs and outputs. Other options include 4-to-20-mA current-loop outputs for process control applications, a TTL-compatible output for driving graphics peripheral devices, and third-wire ground-sensing circuitry for protection of digital-to-analog outputs in remote applications.

Models 202 and 204 are priced at between \$525 and \$675 in quantities up to nine. Delivery takes a maximum of 30 days.

Grant Technology Systems Corp., 11 Summer St., Chelmsford, Mass. 01824. Phone (617) 256-8881 [381]

Monolithic d-a converter reaches 16-bit resolution

The HI-DAC16, a 16-bit monolithic current-output digital-to-analog converter has accuracy, temperature stability, and 16-bit performance comparable to those of expensive

Fact: The best 96 TPI 5¼" floppy is now better than ever.

Our Second Generation Floppy

It's a recognized fact that Micropolis is the undisputed leader when it comes to 96 Track-Per-Inch 5¼" floppy disk drives. We've delivered over 300,000 – more than all the others combined. And our drives are used by most media manufacturers as reference standards.

We designed our drives for double track density from the beginning, using a multiple step, silent stainless-steel leadscrew for highest positioning accuracy, a temperature compensated loop, and a superior diskette clamping mechanism.

A Chassis Within a Chassis Plus Industry Standard Mounting Holes and Bezel

Our new 1115, second generation 0.5 (single head) and 1Mbyte (double head) floppies have a unique "chassis within a chassis" for unparalleled electrical shielding and reduced mounting stress. We've added a jewel follower to our positioning leadscrew for less friction and wear, and have reduced track-to-track access time to a solid 6 ms. The motor tach is no longer necessary since speed control is taken directly from the spindle pulley. This eliminates the need for an electrical adjustment as well as variations over time from belt and pulley wear.

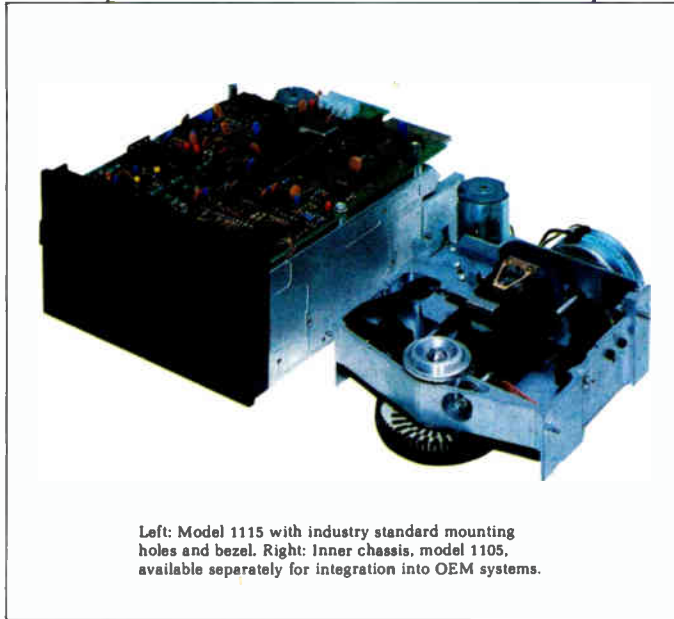

Left: Model 1115 with industry standard mounting holes and bezel. Right: Inner chassis, model 1105, available separately for integration into OEM systems.

Another plus—our drive is micro-processor controlled, so there are no electrical adjustments, time drifts or pot settings, and field replacement of the PC board is a snap.

All this means longer life, greater environmental tolerances, higher reliability, faster throughput, less service, and easier upgrading, adding up to one conclusion: With Micropolis you can step up to 96 TPI with confidence.

Twice the Capacity at Less Than 30% More Cost

You can step up from 48 TPI to a solidly engineered Micropolis 96 TPI drive with no packaging or chassis modifications, and minimal hardware and software

changes, immediately getting a 100% increase in capacity for less than 30% more cost. And it's easy to do with our new 1115 floppy which has industry standard mounting holes and bezel.

Also, you save valuable space. 1Mbyte in our 5¼" floppy compared to 0.5Mbyte or less in 48 TPI drives.

So step up to Micropolis, get more capacity for the dollar in the same space, with minimal investment in engineering.

Soon We'll be Shipping 2,000 Double Track Density Drives Daily

Another reason why you can step up to 96 TPI with confidence is Micropolis' ability to deliver field proven double track density 5¼" floppies in very large quantities. Our new 60,000 square foot plant is dedicated exclusively to the production of these drives. We are well on our way to delivering 2,000 each day.

Proven Performance, Lowest Cost per Byte, Multiple Sources

Multiple competitors are geared up to supply a market demand that will more than triple during 1982. You can compare before choosing, and once you do, we're sure you'll choose Micropolis to upgrade to 96 or 100 TPI and improve your system performance and customer appeal.

MICROPOLIS™

21123 Nordhoff Street • Chatsworth, CA 91311
(213) 709-3300 / TELEX 651486

Growth positions available
for talented people.

HEAR THIS ...NOW!



**SMALL, RUGGED,
IMPROVED.
BUILT TO USE LESS POWER
... and it's inexpensive.**

The new AT-20 piezo ceramic transducer replaces speakers and electro-mechanical devices. It is about .8" in diameter, with 1000-hour design life. Generates 80 to 100 dBA at 2.5 to 5.0 KHz. Features P.C. board mounting with brass pins. Operates at -20C to 60C, with maximum voltage of 50V. For full details, write: Projects Unlimited, Inc., 3680 Wyse Road, Dayton, Ohio 45414. Phone (513) 890-1918. TWX: 810-450-2523.



Circle 192 on reader service card

19" POWER SUPPLY UNIT

The new 19" frame compact
power supply system
for microcomputers

- With integrated power pack and backplane wiring for European and US-format PCB's
- Ideal as a plug-in or desk unit for INTEL/MOSTEK/MOTOROLA/RCA/SIEMENS/TEXAS/ZILOG

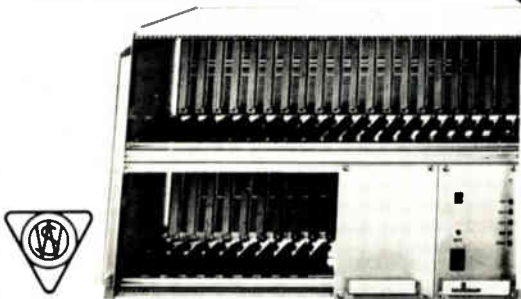
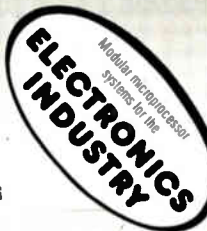

W. SEDLBAUER GMBH

PRECISION MECHANICS AND ELECTRONICS PLANT
D-8000 Munich 90 · Quagliostr. 6 · Phone (0 89) 6 51 40 57 · Telex 5-24 873

192 Circle 249 on reader service card

New products

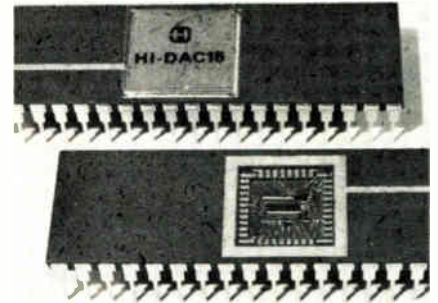

hybrid converters. The circuit is offered in two versions: -DAC16B and -DAC16C. Both have a 16-bit resolution and are compatible with complementary-MOS and TTL.

Dielectrically isolated, the devices have a leakage current specification 30% better than equivalent geometries, and internal parasitic capacitances of only 10 pF, typically, that help achieve rise and fall times as low as 10 ns. This isolation also eliminates the need for silicon controlled rectifiers and thus provides freedom from latchup. The devices' maximum current-settling time is 3 μ s; typically it is 1 μ s.

The B version, priced at \$100 each in 100-unit quantities, is monotonic to 16 bits at room temperature and 15 bits over a 0°-to-75°C operating range. Its integral nonlinearity over its 0°-to-75°C operating temperature range is $\pm 0.0045\%$ of full scale for 14½ bits of relative accuracy.

In comparison, the C version, at \$60 each in like quantities, is monotonic to 15 bits at room temperature and 14 bits over its 0°-to-75°C operating range. Its relative accuracy is 13½ bits. Both units are available from stock.

Harris Corp., Semiconductor Group, P. O. Box 883, Melbourne, Fla. 32901. Phone (305) 724-7800 [383]

8-bit a-d converter
is adjustment-free

Requiring no adjustment, the ADC-5101 8-bit analog-to-digital converter operates over the full military temperature range of -55° to +125°C. In addition, versions sub-

Electronics / April 21, 1982

THE NEW DATA I/O 121A PUTS EPROM PRODUCTION PROGRAMMING BACK ON SCHEDULE.

If you're programming more EPROMs than ever before, and anticipate even higher volumes in the future, the 121A will deliver the throughput and yields your schedules demand.

The 121A is a smart, sophisticated production tool. It can duplicate 20 devices at once, or program complete sets of EPROMs simultaneously: up to 20 devices per set, each with a different data pattern.

121A is all business:

- It programs more than 50 different 24 or 28 pin EPROMs without changing hardware.
- It has the stamina to operate continuously, shift after shift, because of its heavy duty power supply and cooling systems.
- It lets you program with confidence because of extensive device testing and verification. The 121A uses approved programming algorithms.

Complete flexibility

The 121A can operate as a stand alone programmer or as part of a complete production programming station on line to a computer or Data I/O Data Control Unit (DCU). The Data I/O DCU enables you to access data patterns directly from a diskette and load them into RAM without the nuisance of papertape or master devices, and supports Data I/O systems for high volume bipolar programming.

Two models available

If your production needs don't include programming complete EPROM sets, the new Data I/O 120A Gang Programmer is an economical alternative. The 120A offers the throughput of the 121A without set programming or editing capabilities.

Another innovation from Data I/O, your productivity partner.



CLONE 20 DEVICES AT ONCE, OR...

PROGRAM COMPLETE SETS OF EPROMS.

Data I/O Corporation, 10525 Willows Road N.E., C-46, Redmond, Washington 98052. For immediate action, contact us directly, CALL TOLL FREE: 800-426-1045. In Washington, Alaska and Hawaii, call 206-881-6445. Europe: Vondelstraat 50-52, GE, Amsterdam, The Netherlands, Tele: (20) 186855. Japan: Sankei Building 1-8, Sarugaku-cho, 2-Chome, Chiyoda-Ku Tokyo 101, Japan, Tel: (03) 295-2656.

DATA I/O

Circle 193 on reader service card



PEARSON Wide Band, Precision CURRENT MONITOR

With a Pearson current monitor and an oscilloscope, you can measure pulse or ac currents from milliamperes to kilooamperes, in any conductor or beam of charged particles, including those at very high voltage levels.

This monitor is physically isolated from the circuit. It is a terminated current transformer whose output voltage precisely follows the current amplitude and waveshape. A typical model gives an amplitude accuracy of +1%, -0%, 20 nanosecond rise time, droop of 0.5% per millisecond, and a 3 db bandwidth of 1 Hz to 35 MHz. Other models feature 2 nanosecond rise time, or a droop as low as 1% per second.

Whether you wish to measure current in a conductor, an electron device, or a particle accelerator, it is likely that one of our off-the-shelf models (ranging from 1/2" to 10 3/4" ID) will do the job. We also provide custom designs to meet individual specifications.

Contact us and we will send you engineering data.

PEARSON ELECTRONICS, INC.

1860 Embarcadero Road
Palo Alto, Calif. 94303, U.S.A.
Telephone (415) 494-6444
Telex 171-412

New products

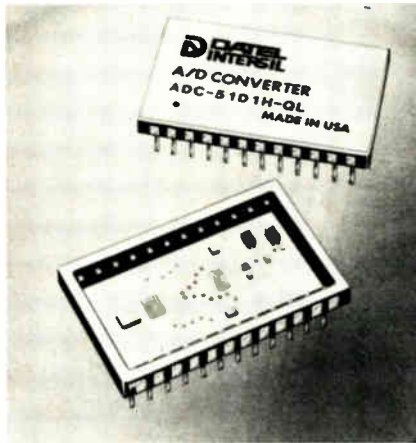

jected to 100% screening in accordance with methods 5004, 5008, and 5009 or MIL STD 883 Class B (as amended by MIL-M-38510) are available.

The successive-approximation technique gives the -5101 a conversion time of only 900 ns, maximum. Its full-scale absolute accuracy error is only $\pm 1/2$ least significant bit, maximum, at 25°C and only ± 2 LSBs maximum, over the full military temperature range.

The device has nine pin-programmable input-voltage ranges and its output, available in serial or parallel, is TTL-compatible. Output coding is straight binary for unipolar operation and offset binary for bipolar operation.

The -5101 is also available in commercial and industrial grades—all models are housed in 24-pin hermetically sealed ceramic packages. In quantities of 1 to 24, pricing ranges from \$185 to \$294 each. Delivery takes up to six weeks.

Datel Intersil, 11 Cabot Blvd., Mansfield, Mass. 02048. Phone (617) 339-9341 [384]

14-bit d-a converter multiplies in all quadrants

A unique bit-decoding technique gives the MP3140 multiplying digital-to-analog converter an integral linearity within 0.004% and a differential linearity within 0.003%. The 14-bit complementary-MOS device, integrated on a single chip, is monolithic over the commercial and mili-

Tomorrow...



design your product in Boca Raton

Environment affects creativity. That's why some respected names are building R&D facilities in Boca Raton's Arvida Park of Commerce. Its 850 acres adjacent to I-95 combine environment, location, lifestyle and more in a highly creative manner. Send for our brochure full of facts on taxes, labor, area dynamics and more.

Contact Gerard Zell,
Arvida Park of
Commerce P.O.
Box 100, Boca
Raton, Florida
33432. Arvida Realty
Sales, Inc., Realtor.





*SA 600 disk drive photo and media platters courtesy of Shugart Associates, and head arm assembly courtesy of INFOMAG

Literate IC's for your Winchester disk drive.

SSi's first read/write Winchester IC developed in 1976.

In 1976, Silicon Systems developed its first read/write monolithic bipolar integrated circuit for the IBM-type 3350 Winchester disk drive. Dubbed the SSI 104, it integrated all of the required read/write, control, and data protection functions on one chip in a flat pack that could be mounted directly on the head arm assembly. The SSI 104 soon became the industry standard.

Now meet the SSi family of IBM-type Winchester IC's.

Today, SSi offers a whole family of IC's for the IBM plug-compatible Winchester market. The SSI 104 and 105 read/write circuits and associated servo amplifier are available now for use with the IBM-type 3340/3350 ferrite-head series; and two new circuits, the SSI 114 and

116, are soon to be introduced for the new IBM-type 3370/3380 thin-film-head series. SSi's "literate" chips not only read and write data on the disks, but they also detect fault conditions and provide for head selection.

IC's for micro's, mini's, streamers, and tape drives too.

For the rapidly expanding 5¼-inch micro and 8-inch mini-Winchester market, Silicon Systems offers its SSI 115; and for 14-inch IBM non-compatible drives there's the SSI 108. In fact, SSi has also developed more than a dozen custom IC's for rotating memories of various designs, including floppies, streamers, and tapes. So if the exact chip you need is not already in our line—we have the technology and experience to make it for you.



- Please call me.
 - Please send me product information on your SSi family of disk-drive read/write IC's.
 - Please send me a copy of your "Custom Integrated Circuits" brochure.
- If you're in a hurry, call Roger Budris at (714) 731-7110, Ext. 135.

Name _____

Company _____

Address _____

City _____ State _____ Zip _____

Phone _____

Silicon Systems incorporated
14351 Myford Road, Tustin, CA 92680



Silicon Systems
incorporated

dual output clocks for
Z8000 or Z80A
Z8000A or Z80B

2.5-6 MHz MOS
5-12 MHz TTL



NEW!

Model K1160AA
crystal clock oscillators

These thick-film hybrid crystal clock oscillators with active pull-ups provide the precise MOS-compatible output to drive Zilog or Zilog-equivalent microprocessors; they also provide a TTL-compatible output, at twice the processor frequency, for other timing needs.

Each single, all-metal welded DIP saves board space needed by the approximately 17 discrete components it replaces, and eliminates production man-hours wasted analyzing oscillator circuits and matching crystals to circuit components.

Plug the K1160AA clock into your microprocessor circuit design and satisfy all your system timing requirements.

Circle No. 237

clock oscillator
for **-40°C to +85°C**
para-military or extended
temperature applications



NEW!

Model K1158A
crystal clock oscillator

This thick-film hybrid crystal clock oscillator in an all-metal welded DIP package is available from 1 MHz to 30 MHz with $\pm 0.01\%$ (all-inclusive) stability, operates to specification over the temperature range of -40 to +85°C. Screening to MIL-883B is optionally available.

The single-package oscillator concept not only saves board space, it also saves design, labor, and overhead costs.

Plug the K1158A into your extended-temperature-range application.

Circle No. 196

Zilog, Z80 and Z8000 are trademarks of Zilog, Inc.
Motorola, K1160AA and K1158A are trademarks of Motorola Inc.

Contact Jim Riff



COMPONENT PRODUCTS
2553 N. Edgington
Franklin Park, IL 60131
312/451-1000
TWX: 910-227-0799
Telex: 4330067

New products

tary operating temperature ranges.

The chip's transfer function is divided into 16 segments (determined by bits 1 to 4), each consisting of 1,024 discrete voltage levels (determined by bits 5 to 14). Bits 1 and 4 are digitally decoded into 15 bits that drive 15 equal current sources. As a result, the matching accuracy requirement is reduced for the resistors and C-MOS switches.

The device, housed in a 20-pin ceramic dual in-line package, accepts ac or dc reference voltages, multiplies in all four quadrants, and has latchup protection. In quantities of 25 to 99, the military-grade version sells for \$89. The commercial-grade version is available for \$30 in like quantities. Delivery takes two to four weeks after receipt of order.

Micro Power Systems Inc., 3100 Alfred St., Santa Clara, Calif. 95050. Phone (408) 247-5350 [385]

Unit links optically isolated
transducers to computers

A parallel input/output interface, the Opto 22 module, can link up to 24 ac or dc industry-standard optically isolated solid-state relay modules and transducers with computer systems. The I/O lines are bidirectional and are for Cosmac Micro-board computer systems.

The complementary-MOS device dissipates little power—typical current draw is 10 mA from a 5-V supply—and requires no special cooling machinery. The module's output stage can sink 14 mA and source 20 μ A. It operates over the -40°-to-+85°C temperature range.

A built-in interrupt structure allows the software to generate an interrupt signal in response to changes in one or more signal lines. Interrupts can be selected for low-to-high and high-to-low transitions. In addition, interrupts can be masked on a bit-by-bit basis. In lots of 100, the CDP18S662 sells for \$173 and is available now.

RCA Solid State Division, Route 202, Somerville, N. J. 08876. Phone (201) 685-6423 [386]



**HEWLETT
PACKARD**

Desktop & Mini
Computer Products

SAVINGS ALL MODELS

98458/C 9836A HP1000L
9835A/B 9826A w/Winchesters

CALL OR WRITE
FOR FREE CATALOG

digital resources inc.

Box 23051 Portland, OR 97223 USA
503-246-0202
International Sales Telex 360-143

Circle 251 on reader service card

**C Band
Satellite
Uplink
Station**

Complete Uplink Electronics
-System with Varian dual TWT
400 W power amplifier and solid
state driver. Frequency
range 5.925 to 6.425 GHz.
Includes Up/Down con-
verter, Demod/Demux
units and receiver. All
equipment mounted in
19" racks. Meets all
ICSC specifications.
Manufacturer: Califor-
nia Microwave.

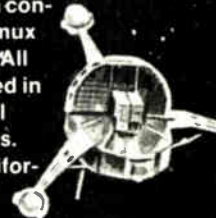

Radio-Research
Instrument Co., Inc.
2 Lake Avenue Extension
Danbury, CT 06810
Tel: 203-792-6666
Tlx: 962444 Radar Dury

Circle 252 on reader service card

Power play.

Six ways to handle your power supply needs ...from B&K-PRECISION

Now you can choose from six B&K-PRECISION lab power supplies and have the supply that's exactly right for your needs.

For high TTL loads, choose the new 1654. With an output that's variable from 2-6 Vdc, the 1654 packs 10 amps in reserve. Features include remote sensing, to measure and regulate output voltage directly at the load, and overvoltage protection. For CMOS and linear circuitry the 1652 dual-output supply provides two 0-25 Vdc outputs at 1.5 amps. With opto-isolator controlled auto-tracking, it's even more versatile than two separate supplies.

The B&K-PRECISION 1650 is one supply

that can replace three. It features a 5 Vdc, 5 amp output for digital needs and two auto-tracking 0-25 Vdc outputs. The outputs are fully isolated.

The popular 1601 is ideal for a wide range of solid-state applications. It supplies 0-50 Vdc with up to 2 amps. It's high voltage counterpart is the 1602. The 1602's primary output is 0-400 Vdc at 200 mA, complemented by a 0 to -100 Vdc bias supply and 12.6/6.3Vac outputs.

Rounding out the field is the compact 1640. Designed specifically to power mobile equipment, it delivers 11-15 Vdc at 0-3 amps.

All B&K-PRECISION power supplies feature voltage and current metering, full overload protection and floating outputs. They're all designed for cool power, so you won't be buying a bench warmer. The prices are attractive too.

If you need a power supply fast, you can score with immediate delivery at your local B&K-PRECISION distributor. For details, call toll-free **1-800-641-4627** (in Illinois 312-889-8870).

Circle 197 for free demonstration

Circle 253 for additional information



Model 1640 \$150



Model 1601 \$345



Model 1602 \$365



Model 1650 \$375



NEW Model 1654 \$395



NEW Model 1652 \$465

B&K PRECISION DYNASCAN CORPORATION

6460 W. Cortland • Chicago, IL 60635 • 312/889-9087 TELEX: 25-3475

International Sales, 6460 W. Cortland Street, Chicago, IL 60635 USA: TELEX: 25-3475

Canadian Sales, Atlas Electronics, Ontario

\$995

IS ALL IT TAKES TO BEAT THE "POWER OF TEN" RULE.

It's the old question of when to test. We think the 'power of ten' rule makes the decision easy.

The rule:

The cost of replacing a defective component increases ten-fold with each step of manufacture.

It's the difference between catching a defective component at incoming inspection for 30 cents, or completing your circuit board before discovering it. Now the cost is \$3.00. Install the board in the equipment and repair costs jump to \$30. Let it get into the field, and the rule still applies. You can see that it doesn't take long for your profit to take a beating.



Start at the beginning

Test your components before you install them in the board with a low-cost 252 LRC bridge from ESI. You'll be able to test passive components for L, R, C, G and even D. That means you can structure your test to the factors that are important to your application.

With a basic accuracy of 0.25%, you'll have confidence in your tests. When the part reads good, you can be sure that it really is.

To get more information fast, give our Measurement Engineer, Steve Blum a call, toll-free. He'll show you how to beat the power of ten rule with an ESI 252 bridge.

The leading
edge
in LRC testing



Electro Scientific Industries, Inc.

800 547-1863

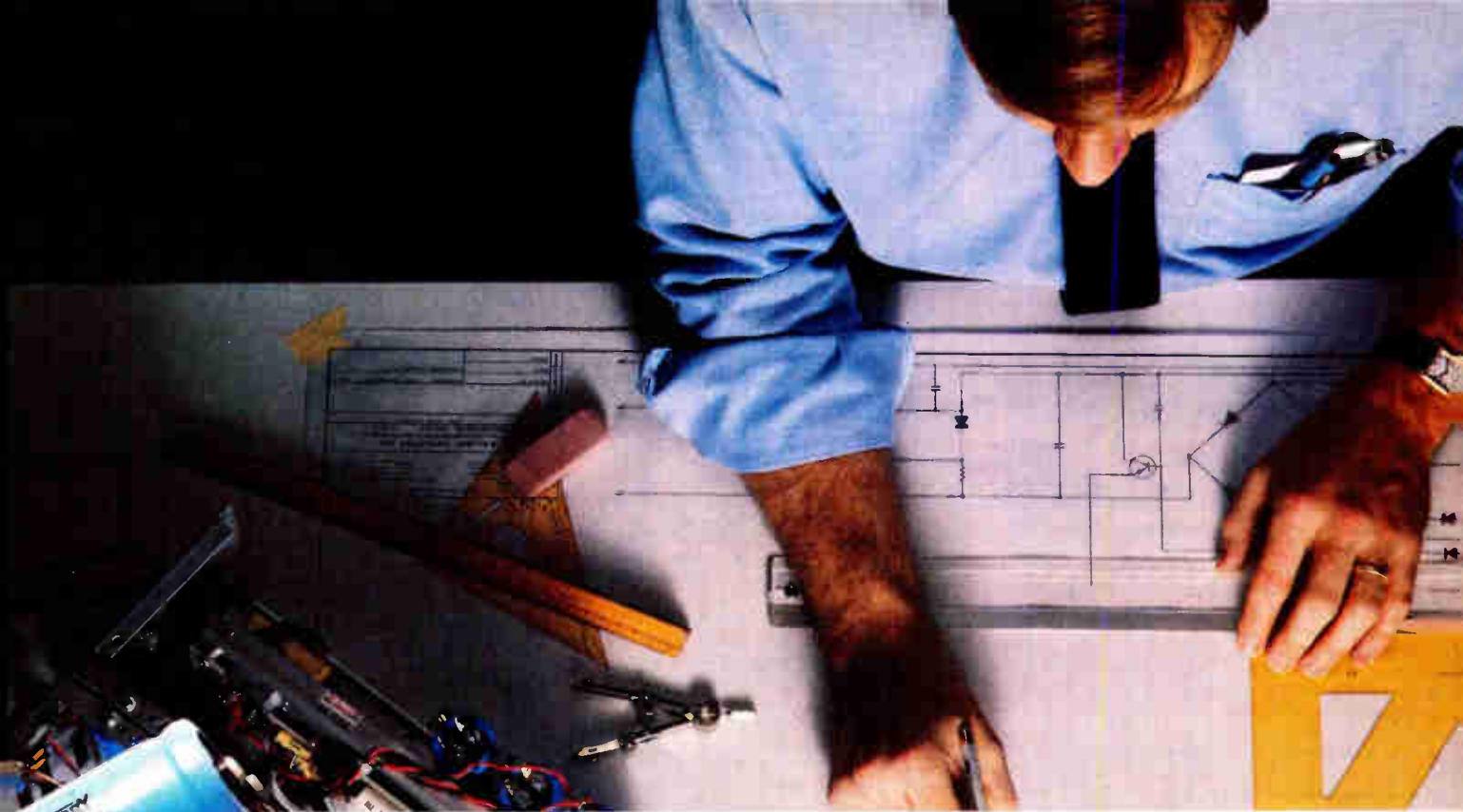

AVOID POWER STRUGGLES.

Mallory's comprehensive line of aluminum electrolytic capacitors simplifies your search for switching regulator power supply capacitors. You have the convenience of one source supply for virtually any electrical and environmental characteristics you need. And the reliability of the Mallory name.

- The new CGO output capacitor with symmetrical capacitance and controlled ESR for high frequency operation.
- High capacitance type up to 320,000 mfd, at 3 VDC and 8000 mfd at 100 VDC.
- Small lead-mounted types for PC boards.
- Operational temperature ranges of 85°C maximum and 105°C maximum
- High frequency types with low inductance at 20 KHZ
- All of them designed for exceptionally low ESR values and high ripple current ratings

Mallory makes your power system design and specifying job easier. So avoid power struggles. Contact your nearest Mallory authorized distributor, or write or call Mallory Capacitor Company, Mallory Components Group, P.O. Box 372, Indianapolis, IN 46206. (317) 636-5353.

DESIGNS FOR YOU.

MALLORY

ELECTRICAL/ELECTRONIC GROUP

EMHART

Circle 199 on reader service card

100 MHz CLOCK RATES. THE WORD'S GETTING AROUND FASTER THAN EVER.



Introducing the RS-680.

You probably think it's enough just to be the electronic industry's first 100 MHz digital signal generator.

But the RS-680 is also the industry's first stand-alone, 8-channel parallel programmable timing generator capable of operating with 10 ns resolution. And the first 16-channel parallel programmable data generator capable of operating at 50 MHz rates.

It will generate even the most complex timing waveforms (perfect for checking out sophisticated IC's). And it has 50 ohm outputs for both ECL and TTL levels. Use it as a bench instrument. Use it within an ATE

system as a synchronizer, modulator, trigger or gating generator.

As a word generator you get one, two four, eight or sixteen channels with up to 4 K bits.

As a timing simulator you get up to 256 states on up to eight simultaneous channels with resolution as low as 10 ns.

You can trigger it automatically or manually; or use it in a continuous, single cycle burst (up to 4 K cycles), or single-step word modes.

Finally, there's one instrument that does it all. With speed. With power. And with innovative circuitry that combines ECL, MOS and Bipolar technologies.

If you don't need all this capability, our companion Model RS-660 is available at lower cost.

You get 20 MHz clock rates in the word generator mode and 50 ns resolution in the timing simulator mode. Most other features are similar.

The RS-680 and RS-660. A descriptive brochure is available for each model, so call or write for the one you'd like. That's the fastest way to get more words.

interface
TECHNOLOGY

A Dynatech Company
150 East Arrow Highway
San Dimas, California 91773
(714) 599-0848
TWX: 910-581-3847

One Source. Every critical step of the way.

Omni-Etch™: tomorrow's machine for tomorrow's processes...today.

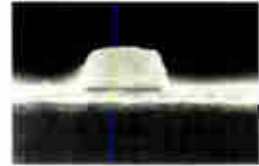
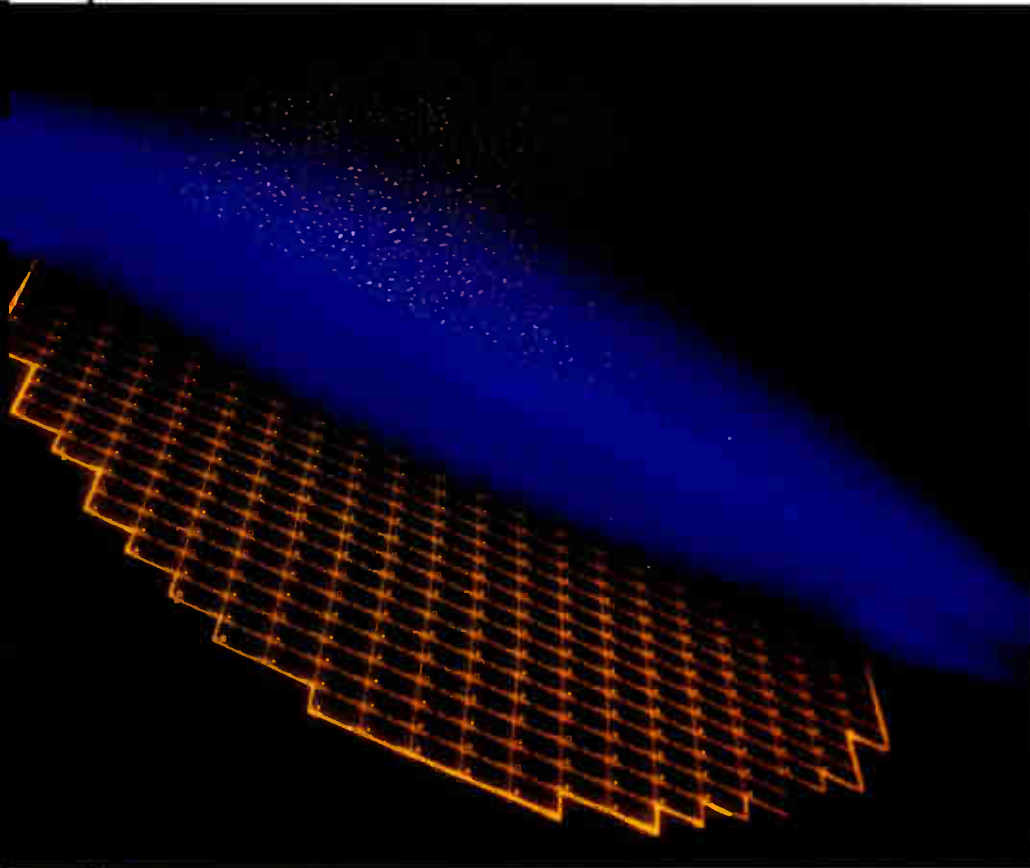

| 2 μm |

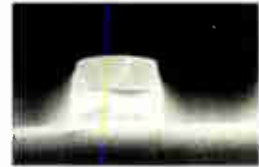

Top SEM shows resist pattern, lower SEM shows results of aluminum etching with Omni Etch system.



ETCH RATE: 5000 Å/min.
SELECTIVITY: Oxide 20:1
Resist 7:1
PRESSURE: 1.2 torr
POWER: 2.0 W/cm²
FREQUENCY: 13 MHz

Why develop tomorrow's processes on yesterday's equipment? Perkin-Elmer's Omni-Etch 10000 lets you develop your dry etch processes on the same machine you will use on the production line to meet your advanced VLSI production requirements.

The sophistication of the Omni-Etch approach allows you to develop two separate processes at the same time on the same machine! Because all key process elements are cross calibrated and tightly controlled, the process you develop in the lab transfers

directly to any Omni-Etch machine on the production line anywhere in the world.

Only the Omni-Etch offers cassette-to-cassette operation, 32-bit minicomputer controlled single-wafer etching, automatic alignment with no edge contact, and individual end point control. Etching can be anisotropic or isotropic, at up to sixty wafers per hour. A unique chamber-within-a-chamber design allows simultaneous wafer descumming, etching and stripping.

Plus, there's a whole library of

software you can use to shorten development time.

If you want a head start on tomorrow's processes, today, contact Perkin-Elmer, Semiconductor Operations, 50 Danbury Road, Wilton, Connecticut 06897.



PERKIN-ELMER

BOONTON'S NEW RF MICROWATTMETER

Most instruments with microprocessors work like a charm under controller command — but they can be a real puzzle when you try to operate them manually. Boonton's new 4210 is microprocessor-based, but with a difference: It is designed to simplify manual r.f. power measurements.*

- Zeroing is automatic: one button stores and corrects for zero offsets.
 - Ranging is automatic: select either Power or dBm mode and the 3½ digit display and annunciators show the value.
 - Ratios are automatic: any reading may be used as a reference, and later readings displayed in dB relative to that reference.
- The 4210 may be ordered with a variety of Boonton power sensors. Diode sensors, featuring high

Simple, But Not Simple- Minded

sensitivity, low drift, and a 70 dB dynamic range, are available for power levels from 1 nW (-60 dBm) to 100 mW (+20 dBm) and frequencies from 200 kHz to 18 GHz. Thermocouple sensors, with true r.m.s. indication, cover 1 μ W (-30 dBm) to 10 mW (+10 dBm), 10 MHz to 18 GHz.

For more information, or a convincing demonstration, call Boonton Electronics or your local representativekeep the puzzlement out of measurement!

*For programmable applications, ask about the Model 4200. It offers full bus compatibility, and is available with dual input channels for direct measurement of reflection coefficients.

BOONTON ELECTRONICS CORP.

PO Box 122, Parsippany, NJ 07054
(201) 887-5110

Circle 202 on reader service card

BOONTON

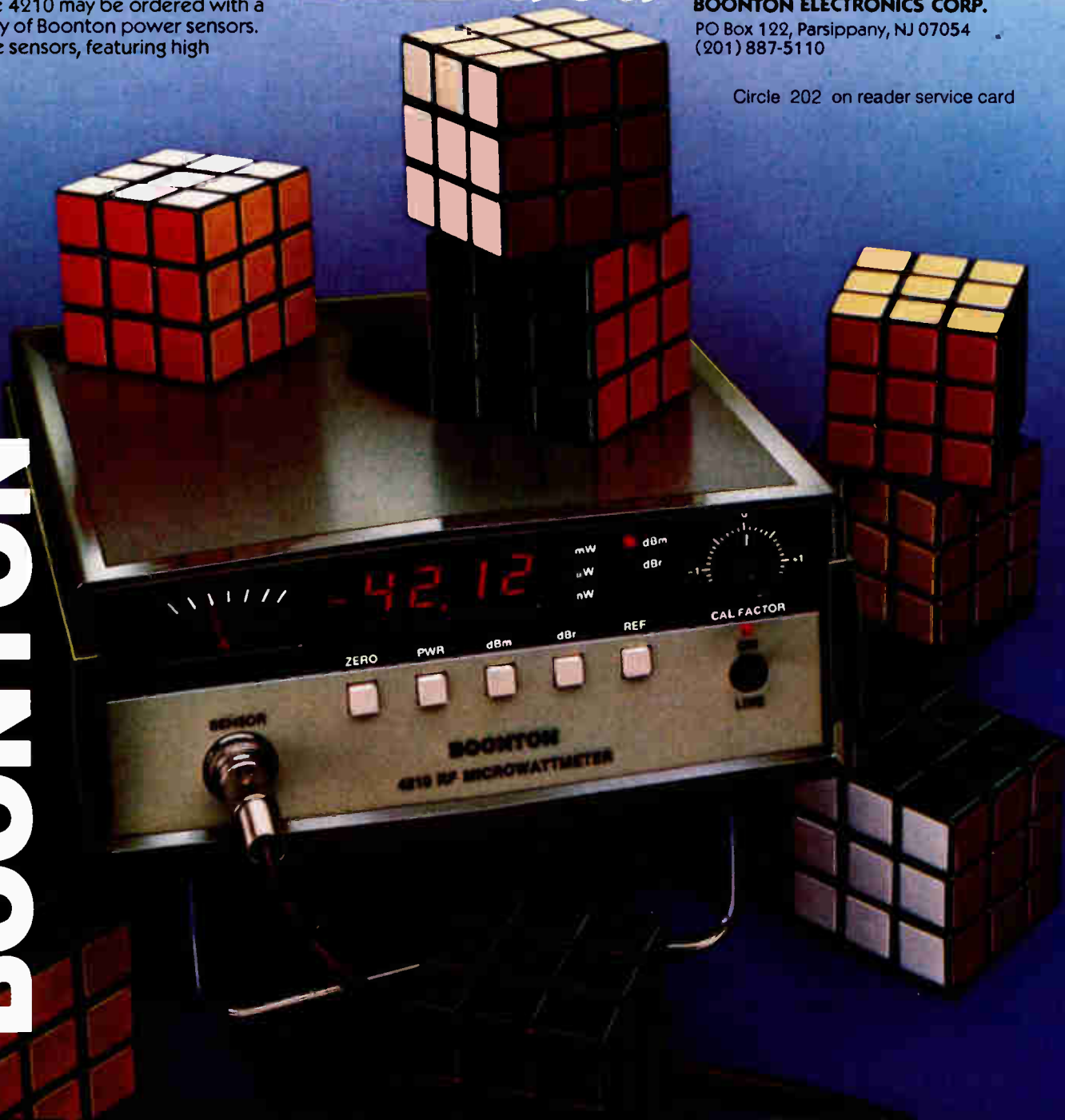

Microcomputers & systems

Unit programs 256-K E-PROMs

High-end PROM programmer permits editing, has module for MOS microcomputer work

Designers are already planning systems that will use 256-K erasable programmable read-only memories and Kontron Electronic Inc. is keeping up with them. It will cope with larger memory chips by offering the Engineering PROM Programmer (EPP), which is compatible with personality modules created by the company for its MPP 80 programmable logic programming mainframe. The EPP mainframe has the basic capabilities of the MPP 80, but adds features like a 16-character 5-by-7-dot matrix display.

The EPP also introduces a search mode that allows the user to key in a search for data resident in the EPP's random-access memory. In addition, it has a list mode, which can display the program data in binary, octal, hexadecimal, or decimal formats. A new multidevice performance module, the MDM (for MOS development module), allows for 16-bit data to be split into 8-bit data blocks, or it allows 8-bit data blocks to be interlaced into 16-bit blocks.

Display mode. Rather than the standard display mode, which demands that both starting and ending addresses be defined each time a device is programmed, the EPP has a compressed display mode in which a single keystroke can be used to implement most operations over the entire address range of the specific device being programmed.

When programming programmable array logic, a designer sometimes wants to protect his design by blowing the last fuse on the PAL part, and the EPP allows the user to do this with a single function key. Once the last fuse is blown, the PAL will perform its logical functions, but

it will no longer be readable as an array of fuses. This function key is implemented as a shifted mode of the hexadecimal keyboard, and there is room for other specialized functions to be added.

Logic functions. There is also a logic mode on the EPP that allows the user to change stored data systematically using AND, OR, and exclusive-OR conventions. If, for example, one has 8-bit characters in RAM in which only the first 7 bits define the ASCII character, the user may want to ensure that the 8th bit is kept at logic 0. The logic mode would allow him to perform an exclusive-OR operation with 7F, which would reset the last bit on every byte to 0.

A small ultraviolet-light eraser is built into the EPP and its erase time can be set by software at up to 99 minutes. Its display shows the remaining erasure time.

When a cathode-ray-tube terminal is connected, the EPP provides a built-in cursor-controlled line editor. The standard unit has one interface for RS-232-C or current-loop communications, and a second RS-232-C interface or a parallel interface can also be purchased as options. Transmission rates up to 2,400 b/s are selected with a switch in a dual in-line package, as is parity on-off, odd-even, and the choice of one or two stop bits.

The EPP mainframe price is set at \$3,000. However, prices for the optional RS-232-C interface, the Centronics-compatible parallel interface, and the IEEE-488-bus interface have not been set yet.

To make sure that a device is pro-

grammed properly, the EPP has a number of checking capabilities. It performs a cyclical redundancy check on both address and data and has provisions for error recovery. It checks telephone-line delays for remotely programmed data and includes echo-suppression capability.

Checkout. The unit also checks for reversed devices and shorts on-chip power-supply lines and displays an error-current message when they are wrong. It tests the address and data lines for shorts and displays an error-data or error-address message if it finds one. It also checks the socket adaptor of the MDM to make sure that the right kind of device has been inserted.

The MDM performance module allows the programming of 25 different MOS and complementary-MOS devices, including 40-pin single-chip microcomputers. "To handle that many devices on our previous PROM programmer, we would have needed several performance modules," observes Keith Barnes, general manager of Kontron's Redwood City, Calif., facility. The MDM will be priced at \$1,295, and, as with the EPP, delivery is in 45 days.

Kontron Electronic Inc., 630 Price Ave., Redwood City, Calif. 94603. Phone (415) 361-1012 [371]

16-channel unit lets Apple sample 20-kHz waveforms

Transforming an Apple II microcomputer into a precision laboratory instrument, the Applegator II includes specific applications software



New products

for chromatography, spectroscopy, colorimetry, and flow measurement, as well as general-purpose software for pulse integration and data acquisition. Professional reporting, extensive use of video graphics, floppy-disk storage of raw data and results, interrupt-driven sampling, and thorough documentation distinguish this



software, the developer claims.

The instrument includes a 16-channel, high-speed, 12-bit analog-to-digital converter and a precision timer. It can sample waveforms at rates up to 20 kHz and store up to 10,000 data points. While sampling, the Applegrator also plots the data on the screen and computes the both true sum and sum of squares for each channel.

After sampling, data may be reviewed in either expanded or compressed form. Integrals of selected portions of the sampled waveform may also be computed, and peak-detection routines allow reporting of peak heights, widths, areas, and retention times. Available now as an upgrade package, Applegrator sells for \$3,980 and with the Apple, for \$6,480.

Dynamic Solutions Corp., 61 South Lake Ave., Suite 309, Pasadena, Calif. 91101. Phone (213) 577-2643 [373]

Synthesizer speaks as text is entered

With an unlimited English vocabulary, the Prose 2000 text-to-speech converter, a speech synthesizer board, converts ASCII-coded text into immediately intelligible, clearly enunciated speech output. The manufacturer's proprietary synthesis-by-rule firmware, resident in the unit, allows words and sentences to be

spoken with human-like intonation.

An 8086 microprocessor, a single-chip formant synthesizer, and 108-K bytes of erasable programmable read-only and random-access memory are used to produce spoken English in real time at rates up to 250 words/min. Additional on-board circuitry performs data input/output, digital-to-analog conversion, and audio amplification to directly drive a loudspeaker. The Prose 2000 board is Multibus-compatible and contains an RS-232-C port.

The Prose 2000 text synthesizer does not contain or require a stored speech vocabulary. Text is converted to speech using a five-step process: text normalization, phonemics, allophonics, prosodics, and speech parameter generation.

The Prose 2000 is available in two forms: a single Multibus-format board costing \$3,500 and as a peripheral in an enclosure with a power supply and connectors for \$4,800. Shipments begin this month. Telesensory Speech Systems, 3408 Hillview Ave., P. O. Box 10099, Palo Alto, Calif. 94304. Phone (415) 856-8255 [374]

Card lets Personal Computer run CP/M, adds memory

A combination of a circuit board and software, called Baby Blue CPU Plus, makes the IBM Personal Computer compatible with programs produced for other microcomputer systems. It has a built-in memory of 64-K bytes, a Z80B microprocessor, and software that enables it to run CP/M-80-based programs.

Baby Blue makes available more than 20,000 existing software packages that the Personal Computer owner is presently unable to use. In addition, when not used with CP/M-80 programs, Baby Blue's onboard memory is functionally identical to an IBM 64-K-byte memory board, and provides that much additional storage to the computer's native central processing unit and operating system.

The Baby Blue card is simply plugged into an existing slot in the

Personal Computer. The \$600 card is available now.

Xedex Corp., 645 Madison Ave., New York, N. Y. 10022. Phone (212) 247-1400 [376]

Array processor gives Multibus units 1 million operations/s

Users can get 1 million floating-point operations/s out of a Multibus microcomputer system by plugging in the Micro Number Cruncher. The SKYMNK-M, a 32-bit floating point array processor, is packaged on two single-board computer modules that plug into the Multibus backplane.

With the processor, a Multibus system is capable of performing up to 1 megaflop with 32-bit single precision and, for computations subject to roundoff error, 48-bit extended precision. This speed allows scientific and engineering users of microcomputer systems to perform arithmetically intensive operations interactively on real or complex data using a variety of supported mathematical algorithms such as digital filtering, convolution, fast Fourier transforms, and thresholding.

The unit is tightly coupled to the host microcomputer through the Multibus, which enables it to share the host's memory and operate under the control of the host's operating system. This approach eliminates the need for special memory as part of the array processor and makes it

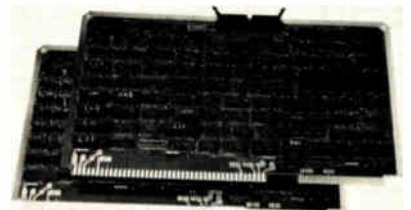

unnecessary to move data between processors before each function. The SKYMNK-M is priced under \$4,000 in large quantities, and is available in 30 days.

Sky Computers Inc., Foot of John Street, Lowell, Mass. 01852. Phone (617) 454-6200 [375]

The challenge: conformance to VDE and international standards

The solution: AIRPAX IPG and SNAPAK® magnetic circuit breakers.

For the export market, your product must conform to international and VDE specifications. AIRPAX engineers designed the IPG and SNAPAK to comply with the spacing requirements of VDE 0730, IEC 380, and IEC 435 standards.

You now have the benefits of precision magnetic "stand alone" protection—with choices of handle actuation, colors, illumination, terminals, and hardware. Also, the IPG will mount in any equipment that currently uses the UPG and UPL style breakers.

"Hotline" delivery is assured for prototype requirements. Find out how we can help you meet the challenge of international standards with positive, reliable circuit switching and protection.

Specifications are in our new catalog. Write or call AIRPAX/North American Philips Controls Corp., Cambridge Division, Woods Road, Cambridge, MD 21613, telephone (301) 228-4600.

The Intelligent Choice.

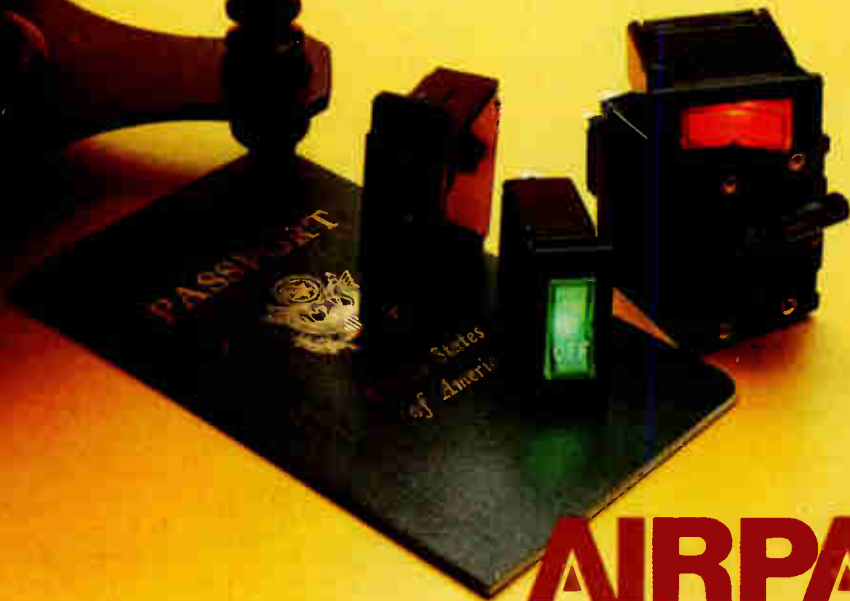

AIRPAX®

NORTH AMERICAN PHILIPS CONTROLS CORP.

Cambridge Division

Associates
States and foreign countries
proprietorship for worldwide distribution
promotion of the aforementioned computer programs
by Lifeboat Associates as exclusive marketing agent.

Author's Name _____



AS AN AUTHOR THIS MIGHT BE YOUR MOST IMPORTANT LINE.

If you've tried to market your own program, you've probably run into a virtual brick wall of problems. Problems that require time, energy, funds, personnel and expertise to solve.

Lifeboat Associates invites you to bring your problems to us. That way you can do what you do best: create quality software. And we can do what we do best: sell it.

As an international publisher of quality computer software with a strong relationship among business, professional, programming and personal computer users, as well as micro- and minicomputer OEM's, Lifeboat Associates has sold and fully supported more software programs by more authors for more machines to more users in more countries than anyone else.

And we do a lot more than sell. Lifeboat also provides:

- Full after sales support
- A multitude of media formats
- OEM sales
- Extensive promotional campaigns through Lifeboat's *Software Desk Reference*™, specially designed OEM private label catalogs, foreign catalogs, brochures, flyers and direct mail
- Advertising
- Advertising preparation
- Marketing services throughout a wide network of affiliates, dealers and distributors
- Translation facilities into foreign languages
- Seminars
- Typesetting services
- And lots more

So if you've expended your time and genius in writing a great program, bring it to Lifeboat. We'll expend our time and genius in publishing it.

Write for a copy of the *Lifeboat Author Guide*.



Lifeboat Associates

World's foremost software source

1651 Third Avenue, New York, New York 10028

Copyright © 1981, by Lifeboat Associates. Software Desk Reference is a trademark of Lifeboat Associates.



NEW FOTOFORM® ± .0001 in. PRECISION!

Plus 1 μ" smoothness, Ø porosity, 750°C resistance, 488 Knoop hardness, 4400 v/mil dielectric strength.

Now, you can specify extraordinary precision, plus the exceptional properties you need, in Corning FOTOFORM glass and FOTOCERAM® glass ceramic products. We'll custom design holes, slots, and other shape geometries for consistent, cost-efficient small or large volumes. Even 50,000 holes per sq. in. can be held within ±.0001 in. tolerances with our advanced photosensitive glass technology and new facilities. Ideal for substrates, sliders for disc memories, nozzles for ink-jet printers, cell sheets in gas discharge dis-

plays, wire guides for dot matrix impact printers, and fluidic devices.

BUG US.

For specifics on our new precision, physical properties, prototype development, and production capabilities call (607) 974-7595, or write: Corning Glass Works, Electronic Materials Dept. MS-5124, Corning, New York 14831. FOTOFORM and FOTOCERAM are registered trademarks of Corning Glass Works

CORNING

Circle 207 on reader service card

McGraw-Hill Bookstore

Authors of

Introduction to VLSI Systems

and winners of the

Electronics magazine

1981 award for achievement

Carver Mead and Lynn Conway

OCTOBER 20, 1981
ANNUAL TECHNOLOGY UPDATE
Programmable VLSI crosses software to the forefront,
altering strategies in production, test, and equipment design 114

Electronics

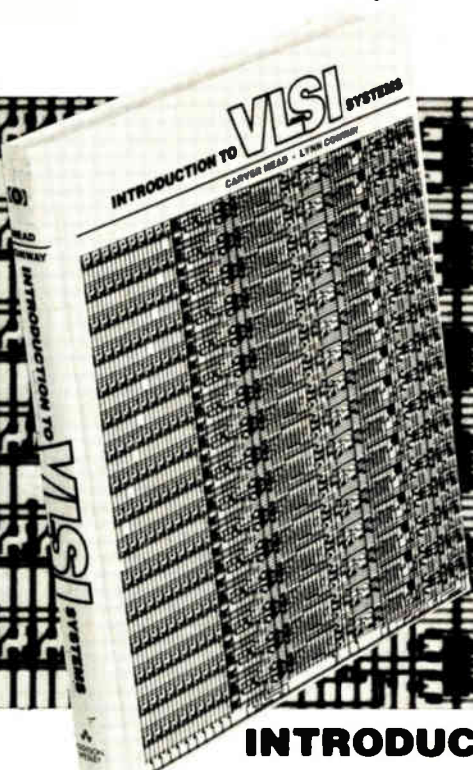

INTRODUCTION TO VLSI SYSTEMS

- * Essential background material for electrical engineering and computer science professionals
- * Enables the reader to fully span the range of abstractions from the underlying physics to complete VLSI digital computer systems
- * The effects of scaling down of device dimensions is stressed, thus anticipating coming changes
- * Chapter material can be digested in any order

Carver Mead is Professor of Computer Science, Electrical Engineering, and Applied Physics at the California Institute of Technology.

Lynn Conway is a Research Fellow and Manager of the VLSI System Design Area at Palo Alto Research Center, Xerox Corporation.

The first book published on the architecture and design of very large-scale integrated systems, and still the authority! Contains all the basics necessary to undertake integrated system design at the architectural, logical, circuit, topological, and geometric layout levels of abstraction, including comprehensive design examples covering all these levels. 416 pp. \$30.50

Contents:

MOS devices and circuits. Integrated system fabrication. Data and control flow in systematic structures. Implementing integrated system designs: From circuit topology to patterning geometry to wafer fabrication. Overview of an LSI computer system, and the design of the OM2 Data Path Chip. Architecture and design of system controllers, and the design of the OM2 Controller Chip. System timing. Highly concurrent systems. Physics of computational systems.

Published by Addison-Wesley and available at:

The Professionals' Information Center

208 Circle 208 on reader service card

McGraw-Hill Bookstore

1221 Ave. of the Americas
New York, New York 10020

E421



Please send me _____ copies of **Introduction to VLSI Systems** by Mead and Conway at \$30.50 each.

Check or credit card: Visa Amer Exp MasterCard

Account No. _____ Expires _____

Name _____

Address _____

City _____ State _____ Zip _____

Add applicable sales tax plus \$2.50 postage and handling for the first book, \$1.00 for each additional book.



I am Gunther Schroff

**My job is the production of 19"-Systems
for Electronics Packaging.
In Europe my company has gained the leading
position in this market section.**

Now I offer you a product line that stands up to every comparison of quality, design and function.

This is the reason such companies as Hewlett Packard, Bosch, Daimler-Benz, GEC Elliot, Honeywell, IBM, Leitz, Philips, Rank-Xerox, Siemens and many others are among my customers.

I am convinced I can offer you an interesting plus to Electronics Packaging in the highly demanding U.S. electronic market.

We have established modern facilities for production, service and distribution in Warwick, Rhode Island.

Please send for our comprehensive catalog and price-list. I am looking forward to working with you.



See us at these shows:

Electro '82, Boston · Nepcon East, NY · Wescon, Anaheim ·

Midcon, Dallas

Schroff®

19" Systems for Electronics Packaging

Production and Distribution in the U.S.

Schroff Inc.

170 Commerce Drive · Warwick, R.I. 02886

Telephone (401) 732-3770 · Telex 952 175

Circle 209 on reader service card

Components

DIP switch has low profile

Automatic insertion equipment handles 8-position switch in dual in-line package

Stacking density for circuit boards requiring switches in dual in-line packages can be improved with the K40 switch from American Research & Engineering. The eight-position single-pole, single-throw switch comes in a low-profile 16-pin package that is only 0.160 in. high, which the firm says is some 50% lower than competitive DIP switches.

At a width of 0.300 in., the K40 is also about 25% narrower than competitive switches. Because its profile matches that of a typical integrated-circuit package, it can be used with standard automatic insertion equipment, points out James Liautaud, president of the firm.

The K40's low profile is due to a design that also gives it only quarter the parts count of some other switch designs, Liautaud says. At the same time, the design improves reliability by bifurcating each switch contact,

thus adding redundancy to each on-position connection. Each switch contact in the K40 travels 0.040 in. over the hot contact surface, as against 0.010 in. in some switch designs, thus eliminating the intermittent-connection problems experienced with some DIP switches, the firm says.

Contacts. Beryllium copper contacts are plated with 30 mils of gold over 100 mils of nickel. Initial contact resistance is 50 m Ω , and resistance after the rate life is 100 m Ω .

The K40 was developed initially for use in programming a micro-processor to adapt to various types of mobile-radio equipment employed in the European market. However, it is expected to find use in a variety of applications in which its low profile and capacity for automatic insertion will be an advantage.

The eight-position switch is 0.840 in. long and has leads on standard 0.100-in. spacings and row-to-row centers of 0.300 in. Leadframes are molded into the housing.

Switch actuators on the K40 are flush with the housing. Rated switch life is 2,000 actuations. The operating temperature range is 0° to 190°F.

The K40 is priced at 79¢ each in any quantity and is available now from stock.

American Research & Engineering, 1500 Executive Dr., Elgin, Ill. 60120 [341]

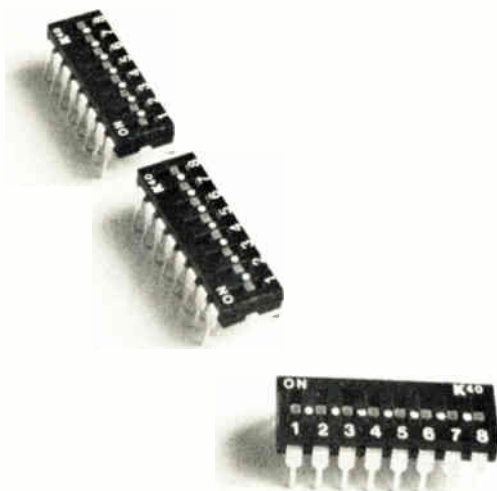

Keyboard features low profile for use in portable equipment

Conforming to the new DIN profile-height standards (0.5 in.), MK059-001 boosts compact key spacings (0.7 in.). The off-the-shelf keyboard is targeted for portable terminals and desktop applications. Measuring 4½ by 10¾ in., the keyboard uses the sealed domeswitch technology.

The patented construction activated by a 3.5-oz force provides hys-



teresis that eliminates teasing. The unit's breakaway feel gives the typist comfortable key feedback, according to the company.

The electrical-switch-matrix output of the MK059 is compatible with the RCA CDP 1871 C-MOS keyboard encoder; custom microprocessor interfaces will be provided at additional cost. Switch outputs are terminated at 0.025-in. straight pins located on the back of the printed-circuit board. Delivered from stock, the MK059 sells for \$41.50 each in 1,000-piece quantities.

Advanced Input Devices, West 250 A. I. D. Drive, Coeur d'Alene, Idaho 83814. Phone (208) 765-8000 [344]

Green light-emitting diode gives 60-mcd intensity.

An improved gallium phosphide green light-emitting diode gives General Instrument's series of high-efficiency, solid-state green lamps a luminous intensity as great as 60 mcd, two to three times brighter than the first generation of green lamps. The devices have a viewing angle as great as 100° and, at an ambient temperature of 25°C, they

Power One's International Series - The New World Standard in D.C. Power Supplies

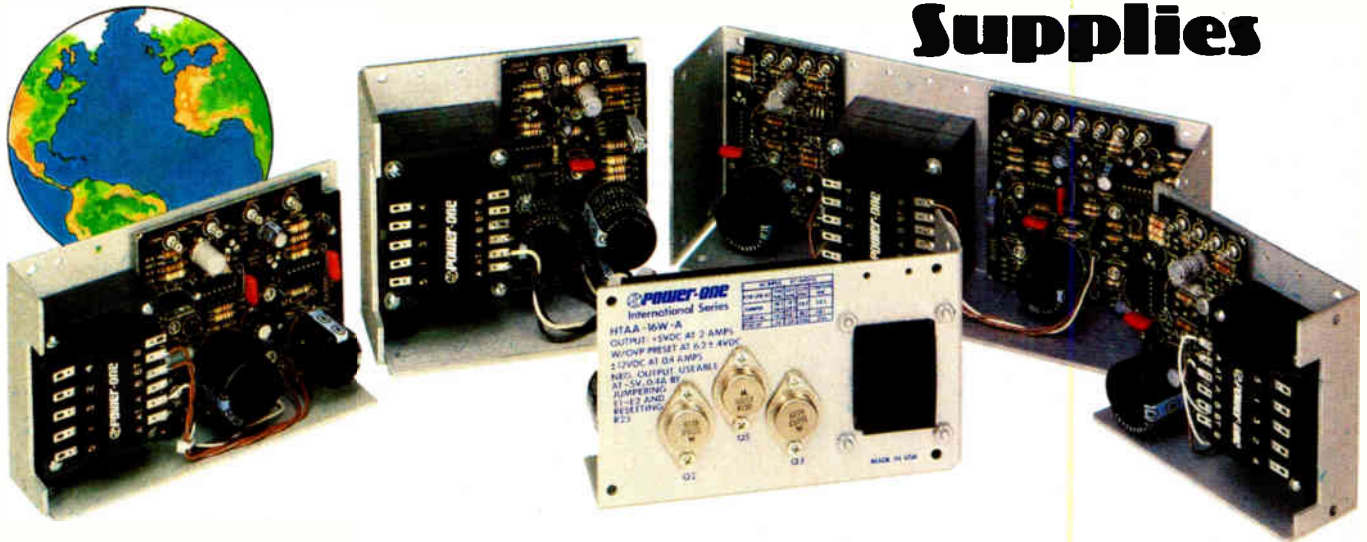

One Power Supply for the Whole World

At last... a world standard in high reliability open-frame power supplies. Designed specifically for products sold throughout the world to make your international marketing simpler. And more profitable.

Meets International Safety Requirements, Worldwide

The International Series can be used anywhere, for almost any application. It's the only power supply available that meets the most important requirements of VDE, UL, CSA, BPO, IEC, CEE, and ECMA. This was achieved by using our new patented winding process featuring separate, fully enclosed primary and secondary windings. This unique construction complies with worldwide safety standards, including:

Leakage Current, Line to Ground: 5.0 μ A
 Spacings, Live Parts to Dead Metal: 9.0 mm
 Other than Field Terminals: 5.25 mm

Dielectric Withstand Voltage,

Input to Ground: 3750 VAC
 Input to Outputs: 3750 VAC
 Outputs to Ground: 500 VAC

Wide Choice of AC Input Power

Each unit is rated at 100, 120, 220, 230, and 240 volts, 47 to 63Hz. So wherever your products are headed, one standard off-the-shelf power supply will serve. No more costly stocking of different units for different destinations.

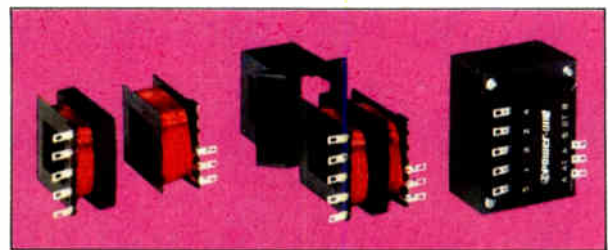

Power-One's patented International Series transformers feature separate, fully enclosed, primary and secondary coils. Meets safety requirements of VDE, UL, CSA, BPO, IEC, CEE, and ECMA.

SINGLE OUTPUT MODELS			DUAL OUTPUT MODELS				TRIPLE OUTPUT MODELS						
MODEL	VOLTAGE / CURRENT	PRICE (1-24)	MODEL	OUTPUT #1	OUTPUT #2	PRICE (1-24)	MODEL	OUTPUT #1	OUTPUT #2	OUTPUT #3	PRICE (1-24)		
5 VOLTS			± 12 TO 15 VOLTS										
HB5-3/ OVP-A	5V @ 3A	\$ 32.95	HAA15-0.8-A	12V @ 1A OR 15V @ 0.8A	-12V @ 1A OR -15V @ 0.8A OR -5V @ 0.4A	\$ 42.95	HTAA-16W-A	5V @ 2A	9 TO 15V @ 0.4A	(-9 TO 15V @ 0.4A OR -5V @ 0.4A	\$ 54.95		
HC5-6/ OVP-A	5V @ 6A	\$ 54.95	HBB15-1.5-A	12V @ 1.7A OR 15V @ 1.5A	-12V @ 1.7A OR -15V @ 1.5A OR -5V @ 0.7A	\$ 54.95	HBAA-40W-A	5V @ 3A	12V @ 1A OR 15V @ 0.8A	-12V @ 1A OR -15V @ 0.8A OR -5V @ 0.4A	\$ 75.95		
HNS-9/ OVP-A	5V @ 9A	\$ 74.95	HCC15-3-A	12V @ 3.4A OR 15V @ 3A	-12V @ 3.4A OR -15V @ 3A	\$ 87.95	HCAA-60W-A	5V @ 6A	12 TO 15V @ 1A	(-12 TO 15V @ 1A OR -5V @ 0.4A	\$ 89.95		
HDS-12/ OVP-A	5V @ 12A	\$ 84.95	HDD15-5-A	12 TO 15V @ 5A	(-12 TO 15V @ 5A	\$ 129.95	HCBB-75W-A	5V @ 6A	12V @ 1.7A OR 15V @ 1.5A	-12V @ 1.7A OR -15V @ 1.5A OR -5V @ 0.7A	\$ 99.95		
HE5-18/ OVP-A	5V @ 18A	\$ 119.95	5 VOLTS PLUS 9 TO 15 VOLTS										
12 VOLTS													
HB12-1.7-A	12V @ 1.7A	\$ 32.95	HAA512-A	5V @ 2A	9 TO 15V @ 0.5A	\$ 49.95	CP131-A	5V @ 8A	12V @ 1.7A OR 15V @ 1.5A	-12V @ 1.7A OR -15V @ 1.5A OR -5V @ 0.7A	\$ 119.95		
HC12-3.4-A	12V @ 3.4A	\$ 49.95	HBB512-A	5V @ 3A	9 TO 15V @ 1.25A	\$ 59.95	HDBB-105W-A	5V @ 12A	12V @ 1.7A OR 15V @ 1.5A	-12V @ 1.7A OR -15V @ 1.5A OR -5V @ 0.7A	\$ 134.95		
HN12-5.1-A	12V @ 5.1A	\$ 69.95	HCC512-A	5V @ 6A	9 TO 15V @ 2.5A	\$ 94.95							
HD12-6.8-A	12V @ 6.8A	\$ 79.95											
HE12-10.2-A	12V @ 10.2A	\$ 109.95											
15 VOLTS													
HB15-1.5-A	15V @ 1.5A	\$ 32.95											
HC15-3-A	15V @ 3A	\$ 49.95											
HN15-4.5-A	15V @ 4.5A	\$ 69.95											
HD15-6-A	15V @ 6A	\$ 79.95											
HE15-9-A	15V @ 9A	\$ 109.95											
24 VOLTS													
HB24-1.2-A	24V @ 1.2A	\$ 32.95											
HC24-2.4-A	24V @ 2.4A	\$ 49.95											
HN24-3.6-A	24V @ 3.6A	\$ 69.95											
HD24-4.8-A	24V @ 4.8A	\$ 79.95											
HE24-7.2-A	24V @ 7.2A	\$ 109.95											
			SINGLE OUTPUT MODELS						DISK DRIVE MODELS				
			MODEL	VOLTAGE / CURRENT	PRICE (1-24)				MODEL	OUTPUT #1	OUTPUT #2	OUTPUT #3	PRICE (1-24)
			28 VOLTS										
			HB28-1-A	28V @ 1A	\$ 32.95				CP205-A	5V @ 1A	-5V @ 0.5A	24V @ 1.5A/1.7A PK	\$ 75.95
			HC28-2-A	28V @ 2A	\$ 49.95				CP206-A	5V @ 2.5A	-5V @ 0.5A	24V @ 3A/3.4A PK	\$ 99.95
			HN28-3-A	28V @ 3A	\$ 69.95				CP162-A	5V @ 3A	-5V @ 0.6A	24V @ 5A/6A PK	\$ 129.95
			HD28-4-A	28V @ 4A	\$ 79.95				CP323-A	5V @ 2A	12V @ 4A	24V @ 3.5A/8A PK	\$ 79.95
			HE28-6-A	28V @ 6A	\$ 109.95				CP379-A	5V @ 6A	-5V @ 1.2A OR -12V @ 1.2A	24V @ 3.5A/8A PK	\$ 129.95
									CP384-A	5V @ 9A	-5V @ 1.2A OR -12V @ 1.2A	24V @ 2A/8A PK	\$ 129.95

New International Series Models

"Innovators in Power Supply Technology"

POWER-ONE D.C. POWER SUPPLIES

Power-One, Inc. • Power One Drive • Camarillo, CA 93010 • Phone: 805/484-2806 • 805/987-3891 • TWX: 910-336-1297



Phone or write for new brochure... see what it takes to set a new standard for the world!

Circle 211 on reader service card

"SURGE FREE"

SURGE ABSORBABLE DISCHARGE TUBE (FOR CIRCUIT PROTECTION)

POINT

- (1) Usable at wider ambient condition, especially good under high humidity.
- (2) Visibility for operation.
- (3) Compact and easy assembly
- (4) Stable characteristics

APPLICATION

Computer circuit
Communication equipment
Home Appliance
Aircraft and Automobiles

TYPE

Type	Breakdown Voltage (V) dc	Insulation Resistance (Ω)	Maximum Surge Current (8 μ s/20 μ s) KA	Life Times at 500A
SA-80SS	80 \pm 10%	10 ⁷ min	0.7	3000
SA-200SS	200 \pm 10%	10 ⁷ min	0.7	3000
SA-80	80 \pm 10%	10 ¹⁰ min	1.5	3000
SA-140	140 \pm 10%	10 ¹⁰ min	1.5	3000
SA-200	200 \pm 10%	10 ¹⁰ min	1.5	3000
SA-250	250 \pm 10%	10 ¹⁰ min	1.5	3000
SA-300	300 \pm 10%	10 ¹⁰ min	1.5	3000
SA-7K	7000 \pm 1000V	10 ¹⁰ min	—	5000
SA-10K	10000 \pm 1000V	10 ¹⁰ min	—	5000
SA-180(3) three elect. rode disch. urge tube	180 \pm 10%	10 ¹⁰ min	2.5	10000

Change of Ez by cycling discharge (Model)SA-80

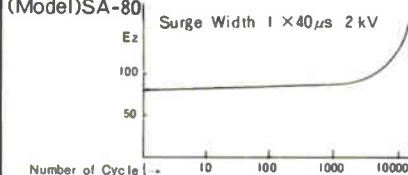

MAIN PRODUCT

NEON GLOW LAMP, XENON FLASH LAMP,
RARE GAS DISCHARGE LAMP
MINIATURE : BLACK-LIGHT, UV-LIGHT,
FLUORESCENT COLOR-LIGHT.

ELEVAM ELECTRONIC TUBE CO., LTD.

EXPORT DIVISION

NO. 17-8CHUO 2-CHOME
OTA-KU, TOKYO JAPAN
TELEPHONE : 03(774)1231-5
TELEX : 246-8855 ELEVAM

New products

dissipate 120 mW, maximum.

The green lamps, comparable in brightness with the firm's red LEDs, are available in a T-1 (MV54XXX series) lamp size with a diffused lens; a T-1 $\frac{1}{4}$ (MV64XXX series) size with a diffusing and a nondiffusing lens; and in a rectangular shape (MV54XXX series), 0.250 by 0.150 in., that can be stacked on end in an

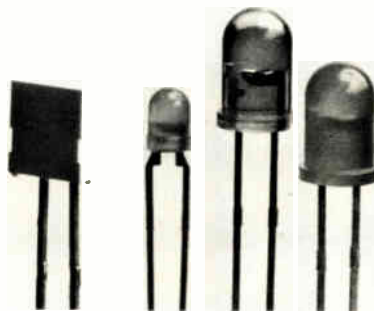

X or Y direction on a lead spacing of 0.100 in.

All the green LEDs are direct pin-for-pin replacements for the first-generation lamps, as well as replacements for comparable devices from Hewlett-Packard Co. The manufacturer claims that all have a wider viewing angle and are brighter than comparable lamps. In 100-unit quantities, pricing ranges from 28¢ to 48¢ each, and the lamps are available from stock.

General Instrument Corp., Optoelectronics Division, 3400 Hillview Ave., Palo Alto, Calif. 94304. Phone (415) 493-0400 [343]

Intelligent LED module

can be viewed from 8 ft

Said to have from two to four times the display area of conventional units, the DL-3416 light-emitting-diode display with 0.225-in.-high characters is targeted for use in instrumentation that is to be viewed from a distance (typically up to 8 ft). Each intelligent module consists of a red four-character 16-segment (plus decimal) LED with a built-in complementary-MOS integrated circuit.

The IC contains memory, an ASCII read-only-memory decoder, multiplexing circuitry, and drivers. Data

entry is asynchronous. Further, a display system may be built with any number of devices since each position can be addressed independently and will continue to display the character last stored until replaced by another.

The module, which comes in a solid plastic package, measures 0.8 by 1.3 by 0.5 in. It operates from a 5-v power supply and draws up to 200 mA peak, 150 mA typically. It has a 500-ns access time and is compatible with standard TTL levels. The DL-3416 has a $\pm 40^\circ$ viewing angle and is specified for operation from -20° to $+65^\circ\text{C}$. In 100-piece quantities, it sells for \$29.95 each, with delivery from stock.

Siemens Corp., Litronix Division, 186 Wood Ave. South, Iselin, N. J. 08830 [346]

Snap-action switch fits

in many standard sockets

Unlike conventional switches, which operate with standard preformed metal bistable blades, the series 551 data-entry switch contains a patented snap-action blade that provides a tactile and audible signal on use. The switch is particularly well-suited to printed-circuit-board applications, because its terminal-pin layout is compatible with dual in-line packages, permitting it to be plugged into many standard sockets.

With the patented blade, contact pressure alone causes over-center snap action. The blade is forced over center by the contacts, so a slow break is unlikely. In addition, over-center snap action has no performance degradation over time, the manufacturer claims, and, coupled with high contact pressure just before break and on make, gives the switch tease-proof performance.

The series 551 meets MIL-STD 3786 and can be used in avionics and many other applications. With a tested life of over 1 million cycles, the unit sells for \$3 each in large quantities. Delivery is in four weeks.

Hoffman Engineering Corp., P. O. Box 300, Old Greenwich, Conn. 06870. Phone (203) 637-1719 [347]

UNPRECEDENTED DESK TOP CAPABILITIES

The AP445-HP9845 Connection



Now you can add the proven, high-speed computation abilities of Analogic's AP400 Series array processors to your Hewlett-Packard HP9845 Desk-Top Computer.

Augmenting the HP9845 with an AP445 creates a powerful engineering tool. The combined ease of use of a desk-top and high computation speed of an array processor gives design engineers new flexibility for analysis and simulation. Similarly, test engineers now have a computing system which can test filters, A/D converters, and other components and subsystems at speeds compatible with real-time test signals. The rapid computation of FFT's, correlations, and convolutions provides wide latitude for the design of test algorithms. Programs in HP BASIC control all this computing power.

• High Throughput Speeds

With the same powerful computing capabilities of the AP400, the AP445 can boost the throughput rates of the HP9845 several hundred times, without sacrificing the "friendliness" of the desk-top computer.

• High Performance Computing with a Portable System

This powerful, yet economical, computing system is also portable. The AP445-HP9845 combination can handle real-time signal processing in the field or at remote stations. The flexibility provided by the ruggedness of this high performance computing system also permits real-time signal analysis out on the factory floor or in high-performance test cell operations.

• HP Basic Programming

The high-speed computing power of the AP445 is accessed by programs written in HP BASIC, including data acquisition inputs directly to auxiliary ports of the AP445.

Free Information

Write today for further information on the AP445 and AP400 Series array processors. Our data sheet includes typical system throughput speeds and a sample program using the AP445-augmented HP9845. Or call Marketing Manager at (617) 246-0300 X2217.

AP445 Features

- **Fast—**
Computes a 1024-point real FFT in 7.2 ms.
- **Large On-Board Memory—**
64K words of 24-bit bipolar RAM is standard.
- **Simple Hookup—**
Connects to the HP9845 with a single cable and HP98032A interface (included).
- **Low Power Consumption—**
Requires 130 W, nominal, from 117 Vac or 240 Vac @ 50/60 Hz (100 Vac optional).

ANALOGIC

Analogic Corporation □ Audubon Road □ Wakefield, MA 01880

Circle 213 on reader service card



Four new Datel-Intersil data acquisition hybrids

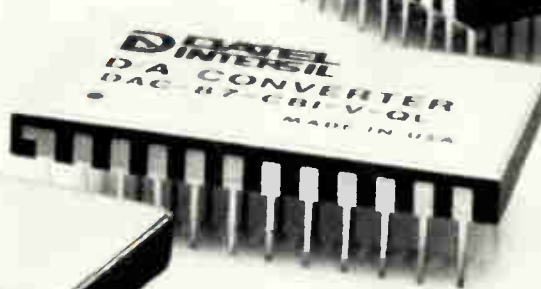
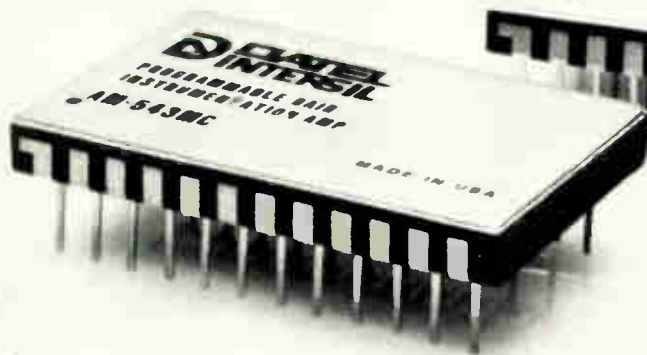

- **AM-542 Digitally Controlled Instrumentation Amp:** Digital gain selection, 1-1024; $1\mu\text{V}/^\circ\text{C}$ offset drift; \$129.
- **DAC-87 Hi-Rel 12-Bit D/A Converter:** -55°C to $+125^\circ\text{C}$ operation; MIL-STD-883B screening available; \$139.
- **AM-543 Digitally Controlled Instrumentation Amp:** Digital gain selection, 1-128; $6\mu\text{s}$ settling time; \$139.
- **SHM-7 Video-Speed Sample-Hold:** 40 ns acquisition time; 0.1% max. linearity error; dual outputs; \$129.

Advanced production, quality assurance and test facilities make Datel a leading source for quality hybrid products. Datel is an excellent source for hybrids used in commercial, industrial and scientific systems, including DAC-85/87s and other industry standards. You'll like our delivery schedules, too. Up to twice as fast as some suppliers.

Write for your complete technical and application data. Or call us at our Instant-Information Hot-Line Number: 1-617-339-9341, Ext. 100.

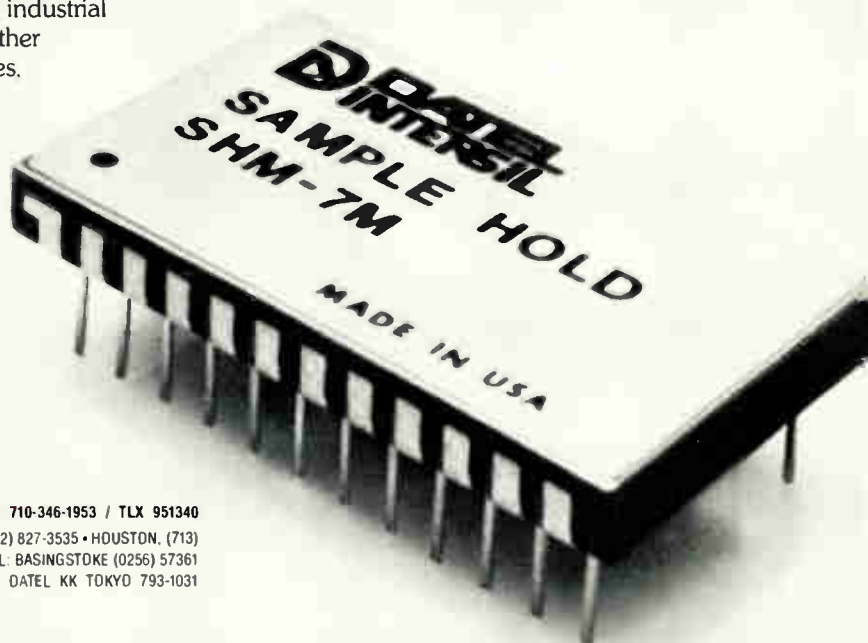

D **DATTEL**
INTERSIL

11 CABOT BOULEVARD, MANSFIELD, MA 02048 / TEL. (617) 339-9341 / TWX 710-346-1953 / TLX 951340
SANTA ANA, (714) 835-2751 • SUNNYVALE, CA (408) 733-2424 • DES PLAINES, IL (312) 827-3535 • HOUSTON, (713) 939-7271 • DALLAS, TX (214) 241-0651 • OVERSEAS: INTERSIL DATTEL (UK) LTD - TEL: BASINGSTOKE (0256) 57361
• INTERSIL DATTEL SARL 601-57-11 • INTERSIL DATTEL GmbH (089) 77-60-95 • DATEL KK TOKYO 793-1031

Circle 214 on reader service card

Three ways to trim your circuits!

Try Allen-Bradley trimmers for the beginning of something good. You'll find these rugged industrial trimmers offer consistent quality resulting from automatic testing and assembly of the devices and decades of manufacturing experience. Most important, you'll get the service you expect from A-B, including local stock from a nationwide network of distributors. For your free sample, fill out and mail coupon below to Allen-Bradley, Electronics Division, 1201 S. 2nd St., Milwaukee, WI 53204.

Type 81

0.25" dia., single turn

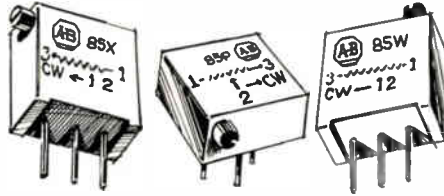
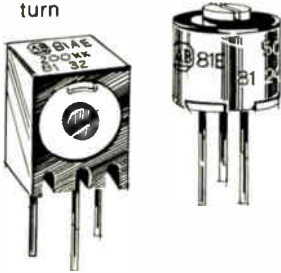





Type 85

0.375" square, multi-turn.

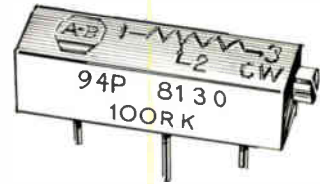
Type 94

0.75" long, multi-turn, 0.25" or 0.35" high.

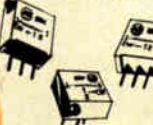

ALLEN-BRADLEY	BOURNS	BECKMAN
<p>TYPE 81</p> 	3329	82
<p>TYPE 85</p> 	3299	66
<p>TYPE 94</p> 	3006	89

SEND FOR FREE SAMPLES TODAY!

Allen-Bradley Company, Electronics Division,
1201 So. 2nd St., Milwaukee, WI 53204

Gentlemen: Please send me the following free trimmer sample for test and evaluation.

Type 81 Type 85 Type 94

Name _____ Title _____

Company _____

Address _____

City _____ State _____ Zip _____



ALLEN-BRADLEY

FOR PERFORMANCE IN PROTOTYPING OR PRODUCTION, RAP WITH CAMBION

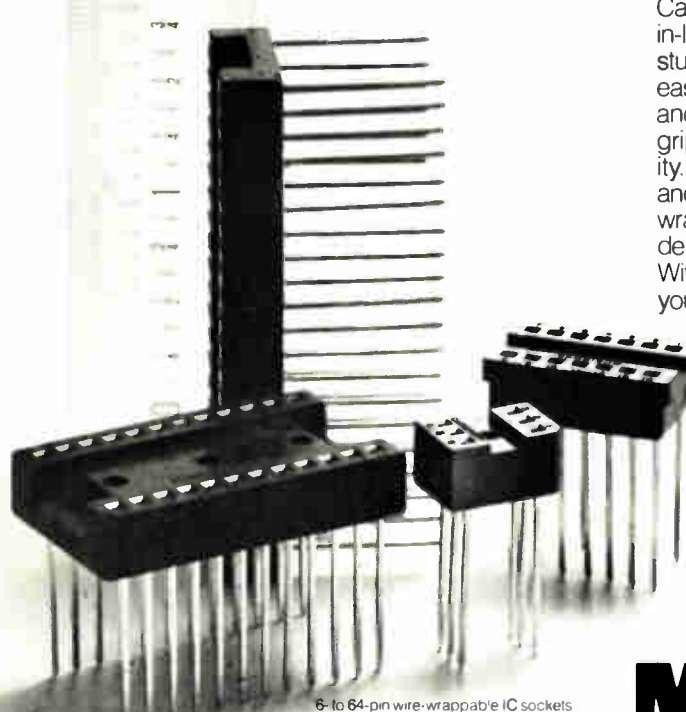

6- to 64-pin wire-wrappable IC sockets

Cambion's wide range of wire-wrappable 6- to 64-pin dual, in-line, IC sockets provide gas-tight sealing keeping the bad stuff out and the good stuff flowing through. They offer an easy insertion/extraction ratio saving you a lot of *time, effort, and money*. Our wrapost IC sockets are truly square-edged, grip IC leads securely and assure maximum contact reliability. In addition, for both the cost-conscious design engineer and the frugal procurement specialist, Cambion wire-wrappable IC sockets are *cost-efficient* and available for delivery at a computer controlled moment's notice! With Cambion's time-tested, field-proven components, you can *assume* quality, and free your time for *true* design engineering.

CAMBION
The Right Connection.

Midland-Ross Corporation
Cambion Division
445 Concord Avenue
Cambridge, MA 02238
Tel: (617) 491-5400
Telex: 92-1480 TWX: (710) 320-6399.

MIDLAND ROSS

Circle 216 on reader service card

See Us In Booth #102, Electro '82

New. From A P PRODUCTS. TC-48 & TC-64 IC Test Clips.

A P Test Clips - the best little troubleshooters around - are now available in the industry's broadest line, ranging from 8 to 64 contacts. TC-48 fits chips with .5" to .6" row-to-row spacing and TC-64 fits chips with .9" spacing.

Both have the same standard features that are found in the full line of A P Test Clips. For the name of the distributor nearest you, call TOLL FREE, 800-321-9668. (In Ohio, call collect: (216) 354-2101)



A P PRODUCTS INCORPORATED
9450 Pineneedle Drive
P.O. Box 603
Mentor, Ohio 44060
(216) 354-2101
TWX: 810-425-2250
In Europe, contact A P PRODUCTS GmbH
Baumlesweg 21 • D-7031 Weil 1 • W. Germany

A P PRODUCTS
made the first IC Test Clips
... and they are still the best.

216 Circle 254 on reader service card

Electronics / April 21, 1982

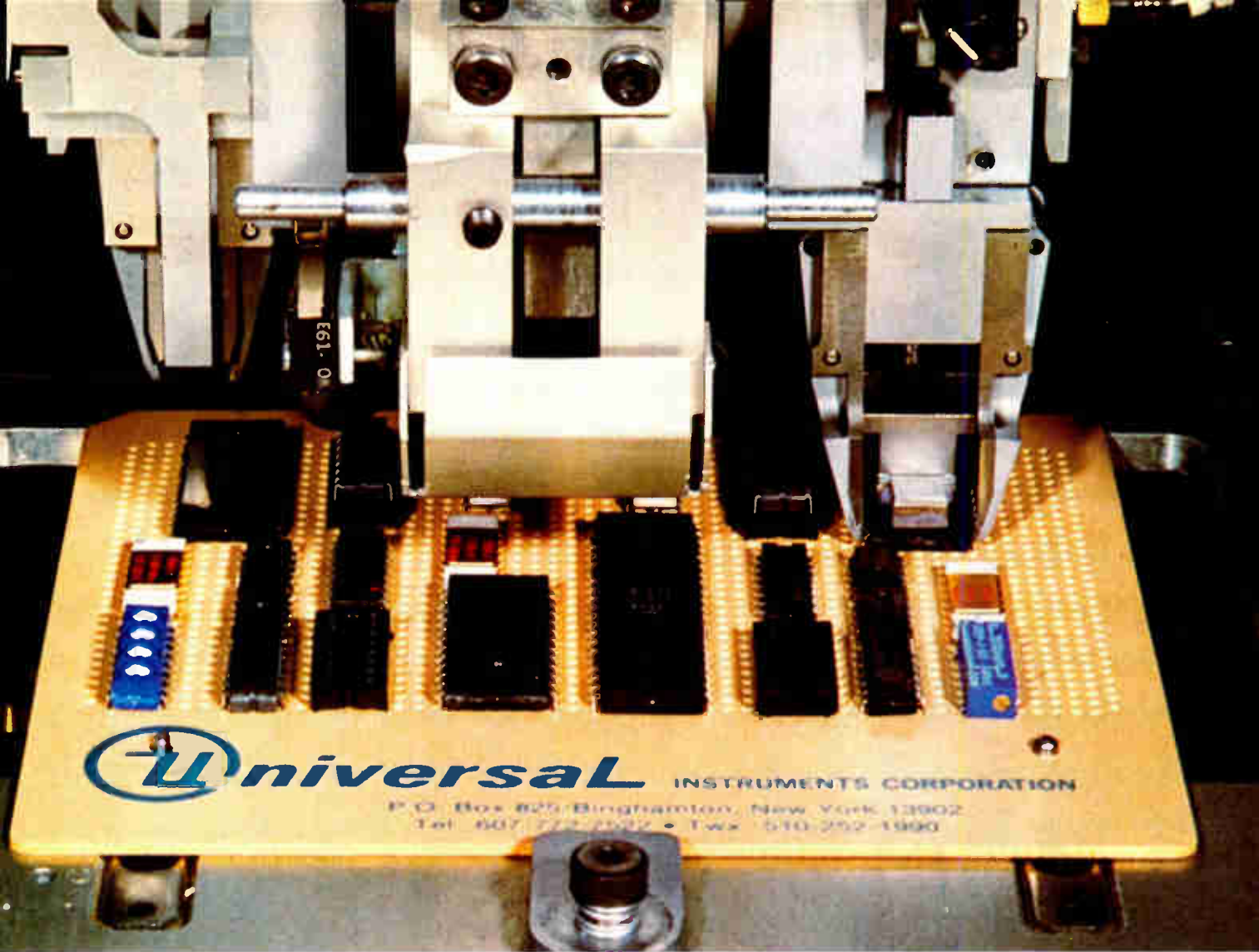

Now "Multi-Module" has higher density socket insertion and DIP verification.

Universal's family of "Multi-Module" DIP insertion machines opens the door to new, far higher levels of productivity. Now a single machine can automatically insert DIPs with two different lead spans in a single high speed sequence.

Insertion can include:

- .300" DIPs and sockets, ■ .400" DIPs and sockets, ■ .600" DIPs and sockets, ■ 2/4 lead devices, ■ Box capacitors.

Standard features include up to 72 input magazines, programmable inward/outward clinching and LED diagnostics. Optional verification assures that each component is functional, the correct type, and properly oriented.

Ask your Universal sales engineer to show you our "Multi-Module" video tape, or send for information.



Subsidiary of **DOVER CORPORATION**

Universal Instruments Corporation ■ Box 825, Binghamton, New York 13902 ■ Tel: 607/772/7840 ■ TWX: 510/252/1990

Circle 217 on reader service card

SPECIAL REPORT: June 2

Automatic Program Generation

If you produce automatic application programs, or if you sell computers and peripherals, you should advertise in the June 2 issue of *Electronics*.

88% of Electronics' important subscribers use and/or buy software. Of these:

65% use and/or buy operating systems

59% use and/or buy application packages

This exclusive Special Report, by our Software editor Colin Johnson, will analyze and interpret *all* the important technological and business news on automatic program generation.

Your customers—our worldwide readers—will learn about:

- "The programmer on a disk"
- Comparisons of automatic programming tools
- The newest mix of old hardware/new software
- The market
- "Friendly software"

Advertising closing: May 10

Be sure your advertisement will be read and acted upon by the largest worldwide audience of important people in the Electronics Technology Marketplace—331,072. Call Betty Preis to reserve space at (212) 997-2908. Or, contact your local Electronics salesperson.



Electronics

Where important people
read important editorial

JMC
Graw
Hill



MS-DOS™ gives you the only complete set of software tools for 16-bit systems. Now. From Microsoft.

Systems and Applications. Now. The success of any microcomputer system depends on the amount of software available for it. And, the ease of writing more. Microsoft™ MS-DOS is the only single-user operating system fully supported by Microsoft's 16-bit languages: BASIC Interpreter, BASIC Compiler, COBOL, FORTRAN and Pascal. Plus, the Multi-Tool™ family of applications software... starting with the Multiplan™ electronic worksheet.

More software. Soon. IBM chose MS-DOS as the primary OS for the IBM® Personal Computer. Lifeboat Associates chose MS-DOS as the 16-bit, single-user DOS it will support. And Microsoft will continually introduce new applications and systems software for MS-DOS. The implication is clear: MS-DOS is going to be even better supported. Fast.

Easier conversion. MS-DOS was written to make conversion of CP/M-80® programs simple. Simpler, according to programmers, than conversion to CP/M-86™. Again, the implication is clear.

Better system features. MS-DOS offers features unavailable under either CP/M-80 or CP/M-86: device independent I/O, advanced error recovery, variable length records, and full program relocatability in order to take

MS, Multiplan, Multi-Tool, and Microsoft are trademarks of Microsoft Corporation. CP/M and CP/M-80 are registered trademarks of Digital Research, Inc. CP/M-86 is a trademark of Digital Research, Inc. IBM is a registered trademark of International Business Machines, Corp.



advantage of the extended addressing capabilities of the 8086 and 8088 microprocessors. And MS-DOS' descriptive error messages make it a user-friendly OS.

Leadership in microsystems. Microsoft led the industry into the 8-bit world when we put BASIC on the first microcomputer. Now, we're leading the industry into the 16-bit world with the first complete set of software tools for the 8086 and 8088 microprocessors. The MS-DOS operating system. Languages. Utilities. And, applications software.

Planning an OEM system? Return the coupon below for complete OEM information on MS-DOS and Microsoft's complete set of tools for 8086 systems. Can't wait? Call our OEM Accounts Manager.

MICROSOFT

Microsoft Corporation
10700 Northup Way
Bellevue, WA 98004 (206) 828-8080
TLX 328945

I'm interested. Send me complete information on MS-DOS for OEM's.

NAME _____

COMPANY _____

ADDRESS _____

CITY _____ STATE _____ ZIP _____

In Japan: ASCII Microsoft, 102 Plasada, 3-16-14 Minami Aoyama, Minato-ku, Tokyo, Japan

Circle 219 on reader service card

Frequency Problems?

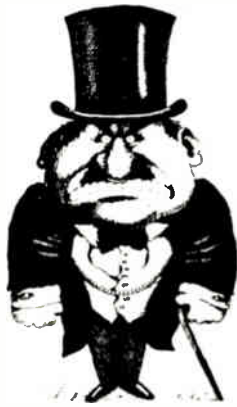

DRAT

What's a DRAT? . . . a cost effective solution to your precision frequency control problems. DRAT is a Doubly Rotated AT cut crystal.

PIEZO CRYSTAL COMPANY uses precision X-ray techniques, both rotating and static, to define the temperature/frequency characteristics of the DRAT at any X and Z angle rotation combination. The crystal is then cut not only with the traditional single rotation off the Z axis, but with another rotation off the X axis — producing a virtually stress free crystal blank. And that will make you virtually stress free when dealing with precision frequency control!

PIEZO SYSTEMS then takes the DRAT and makes it the heart of a PIEZO SYSTEMS oscillator. Every order, whether crystal or complete oscillator, is handled on an individual basis, and can be custom engineered to your specifications, or to meet your requirements.

The PIEZO DRAT assures you of:

- Low Phase Noise During Vibration
- High Drive Capability
- High "Q"
- Low Aging/Retrace
- Low "G" tipover
- Fast Warm-up

When you need a solution to your frequency control problems, think **DRAT**.

When you think **DRAT**, think **PIEZO**.

When you think **PIEZO**, think high quality, excellent service, prompt delivery.

And while you're thinking about **PIEZO**, write for a complete catalog on our products. Do it TODAY, or you'll be screaming **DRAT** the next time you have a frequency control problem!



100 K Street
P.O. Box 619
Carlisle, PA 17013

Telephone
(717) 249-2151
TWX
510-650-2280



New literature

Telecommunications books. Available now, the 1982 Telecom Library catalog claims to be a central source for all books, training materials, research reports, periodicals, and training seminars on aspects of telecommunications, data communications, distributed data processing, and office automation. Contact Telecom Library, 205 West 19th St., New York, N. Y. 10011, call (212) 691-8215, or circle reader service number 421.

Rules to write by. To help authors understand the requirements and procedures for presenting and marketing software, Lifeboat Associates is offering "Guidelines for Software Authors." The guide provides authors with a logical, step-by-step outline that details procedures and considerations addressed by a publisher on receipt of software. Also a question-and-answer section tells how an author may submit a software program. For further information, write to Lifeboat Associates, 1651 Third Ave., New York, N. Y. 10028 or call (212) 860-0300. [422]

Video primer. Understanding the fundamentals of video and the associated waveforms is eased with the TV-video-sync primer, application note 5953-3900. Special sections include the U. S. National Television Systems Committee broadcast standards and nomenclature, a discussion of NTSC, PAL (phase-alternation-line), and Secam (Séquential Couleurs à Mémoire) systems of color transmission, and a glossary of TV and video terms. For a copy, write to Hewlett-Packard Co., 1820 Embarcadero Rd., Palo Alto, Calif. 94303. [423]

In the pocket. The "Pocket Computer Newsletter," now entering its second year, provides information for users of pocket computers like the Sharp PC-1500 and Radio Shack PC-2 that are programmable in Basic. The publication regularly provides equipment and software reviews, operating tips, practical programs, technical information, and reports on the experiences of users.

For subscription information, contact The Pocket Computer Newsletter, 35 Old State Rd., Oxford, Conn. 06483 or call (203) 888-1946. [424]

Software for Harris computers. Users of any of Harris Corp.'s computers will be pleased to see the fourth edition of its software directory. The directory lists and describes the broad range of application and system software available for the entire family of Harris high-performance super-minicomputers. The 108-page directory is available at no charge from the Marketing Communications Department, Computer Systems Division, Harris Corp., 2101 West Cypress Creek Rd., Fort Lauderdale, Fla. 33309 at (305) 974-1700. [425]

Fun and games. Capitalizing on the popular VIC 20 and the anticipated popularity of the new Ultimax, Commodore's Computer Systems division will publish "Power/Play." The magazine will contain information on new products, applications, games, programming tips, home learning, telecommunications, users clubs, and any other helpful information. The premier issue will be available in the spring and publication will be quarterly in 1982. For subscription information, contact Commodore Business Machines Inc., 681 Moore Rd., King of Prussia, Pa. 19406. [426]

Using logic analyzers. A free application note, No. 112, gives an overview of the various types of logic analyzers available and defines the kind of digital-system design and development problems that each type of analyzer can solve. The brochure describes the features and uses of the time and data domains of multipurpose logic analyzers. For a copy, contact Gould Inc. Instruments Division, 4600 Old Ironsides Dr., Santa Clara, Calif. 95050. [427]

PAL handbook. An updated and expanded handbook for designing with programmable-array-logic circuits includes specifications and de-

SAME SERVICE...



CPX

NEW IMAGE!

The biggest Disc Drive Users in over 44 countries depend on us for Disc Parts and Depot Service.

We deliver fast at prices you won't believe.

**AMPEX
CENTURY DATA (CAL COMP)
CONTROL DATA
DATA GENERAL
DATA POINT
DIABLO
DEC
HEWLETT PACKARD
IBM**

**IOMEC
ISS-ITEL
MICRODATA
MEMOREX
PERTEC
SPERRY UNIVAC
WANGCO
WESTERN DYNEX**

**When today's demands are yesterday's needs...
Give us a call.**

COMPUTER PARTS EXCHANGE

19821 Nordhoff Street • Northridge, CA 91324

PH: 213-709-4003 Telex 18-1537

Contact Us For The Name Of Your Nearest Distributor

***NOW, Do-it-Yourself
ATE solutions
you can live with...
comfortably.***

Don't toss and turn at night trying to get the most out of your test and measurement instruments, computer, and IEEE 488 bus.

Not when there's already a proven ICS product that's right for your application.

It will do the job faster and more cost effectively . . . and let you sleep better at night.

ICS offers a world of IEEE 488-controllable devices like RS-232C-to-488 and BCD-to-488

couplers . . . bus expanders and extenders . . . isolators . . . analog couplers . . . analyzers.

If just the right device doesn't exist, you can take advantage of our experience and capabilities to quickly, easily and economically have us meet your needs.

Give us a call to find out more about the world of IEEE 488 solutions available from ICS. You'll sleep better tonight.

ICS ELECTRONICS CORPORATION
(408) 298-4844

1620 Zanker Rd. · San Jose, CA 95112
TWX 910-338-7810



Circle 222 on reader service card

McGraw-Hill's Electronic Bookshelf™ is on the Air!

Ask your computer to call (212) 997-2243 for the latest info on our computer and electronics books. The system is up daily from 6 pm to 8 am and 24 hours on weekends.



New literature

sign instructions for 20- and 24-pin PAL circuits as well as the recently introduced hard-array logic and hard-array-logic medium-scale integrated devices. The 680-page guide provides an introduction to PAL, including data sheets, logic diagrams, and more than 50 applications. Priced at \$12, the handbook may be obtained from Monolithic Memories Inc., Advertising Department, 1165 East Arques Ave., Sunnyvale, Calif. 94086. [428]

Using ultrasonics. The 24-page "Industrial Ultrasonics User's Guide" explains ultrasonic theory and the principles of operation of ultrasonic level and flow devices in specific industrial applications. In addition, the booklet describes the capabilities and options that enable ultrasonics to be incorporated into a variety of automated control systems. For a free copy, contact Wesmar Industrial Systems Division, Box C19074, Seattle, Wash. 98115 or call (206) 285-2420. [430]

Data-communication devices. Collected in the 1982 Black Box catalog are over 200 items specifically designed for today's data-communications system, including detailed product descriptions, photos, and prices. The catalog highlights such items as three models of IBM-compatible protocol converters, a programmable communication adapter, over 20 models of interface converters, and 22 different data switches. It may be obtained for free from Black Box Catalog, Mayview Road at Park Drive, P. O. Box 12800, Pittsburgh, Pa. 15241. [429]



Engineers and other Aerospace Professionals

Get involved at Martin Marietta and help launch a new era in space and technology.

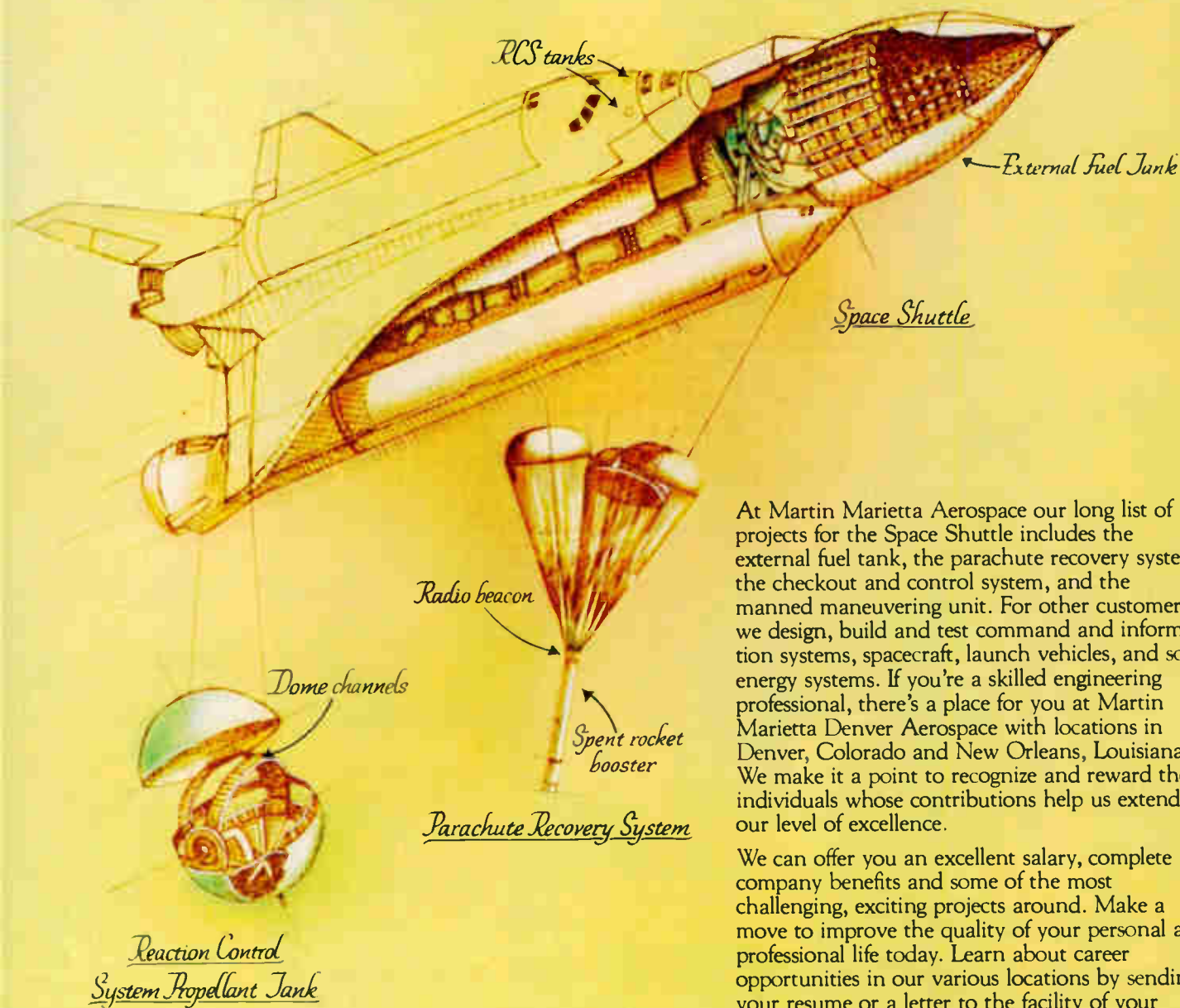

At Martin Marietta Aerospace our long list of projects for the Space Shuttle includes the external fuel tank, the parachute recovery system, the checkout and control system, and the manned maneuvering unit. For other customers, we design, build and test command and information systems, spacecraft, launch vehicles, and solar energy systems. If you're a skilled engineering professional, there's a place for you at Martin Marietta Denver Aerospace with locations in Denver, Colorado and New Orleans, Louisiana. We make it a point to recognize and reward those individuals whose contributions help us extend our level of excellence.

We can offer you an excellent salary, complete company benefits and some of the most challenging, exciting projects around. Make a move to improve the quality of your personal and professional life today. Learn about career opportunities in our various locations by sending your resume or a letter to the facility of your choice.

In Denver: P.O. Box 179, Mail #D-1311, Denver, CO 80201; **In Orlando:** P.O. Box 5837-MP#9, Orlando, FL 32855; **At Vandenberg AFB:** Box 1681, Vandenberg AFB, CA 93437; **In New Orleans:** Michoud Assembly Facility, Box 29304, New Orleans, LA 70189; **In Baltimore:** 103 Chesapeake Park Plaza, Baltimore, MD 21220.

We are an equal opportunity employer, m/f/h.

MARTIN MARIETTA

Circle 223 on reader service card

Introducing

SYSTEM 720

the *complete* system for data acquisition/reduction

For the first time, demanding DAS users can obtain a complete, high-performance data acquisition system without going to a high priced, risky custom system. For critical measurements, these users need *speed, accuracy and reliability* . . . qualities long associated with the Neff System 620 family of data acquisition products. Now, *these same qualities are available in a fully integrated system.*

The use of System 620 instrumentation equips System 720 with the most powerful and flexible analog front end available. Consider these features: 50kHz throughput, 120dB CMRR, 15-bit resolution, signal conditioning, automatic computer controlled calibration and many other sophisticated options. Add a computer, carefully selected peripherals, complete DAS software and a FORTRAN development system and you have the *complete* System 720.

You'll be in control. No third-party hardware integration or software design . . . no interface worries . . . and future system expansion is as easy as plugging in cards.

System 720 is the result of Neff's 25 years experience in serving DAS users. *High performance, reliability and versatility are built into each system.* Find out more. Send for our System 720 brochure or, for immediate answers, call us toll free: (800) 423-7151; in California, (213) 357-7151 collect.

NEFF
INSTRUMENT CORPORATION

700 South Myrtle Ave., Monrovia, CA 91016
TWX 910-585-1833



Test monitor combines three instruments

Within three months, Tektronix Inc., Beaverton, Ore., will begin delivering a three-in-one portable test monitor that combines the functions of a waveform monitor and vectorscope (standard television trouble-shooting tools), and oscilloscope. The monitor is being **targeted at countries that use the National Television Standards Committee guidelines**. The portable 380 NTSC test monitor is priced at \$5,150 and is now being made in Japan by the Sony-Tektronix joint venture. An optional battery pack is available for \$800.

5¼-in. drive uses Sony cartridge format

Look for Tandon Corp. to expand its line of 5¼-in. floppy-disk drives with a cartridge drive employing the Sony cartridge format. The drive, tentatively set for announcement at the National Computer Conference next month, **will have a 256-k-byte capacity, and is expected to be a half-height model**, permitting two drives to be mounted in the space taken by a standard 5¼-in. unit. The drive, still unnamed and unpriced, uses cartridges rather than standard media for greater durability.

Interface links voice and data switching system to X.25 nets

An X.25 interface is being added to the family of InteNet Packet Controllers for format and protocol conversion supported by InteCom Inc.'s Integrated Business Exchange, IBX S/40. With the X.25 IPC addition, to be announced at the International Communications Association show next month, users of the Dallas, Texas, firm's voice and data switching system will have access through asynchronous devices to packet data networks like Telenet and Tymnet. **The X.25 controller will employ the packet assembly/disassembly function to access the networks**. Also supported are X.3, X.28, and X.29 protocols. When available in the first quarter of 1983, the X.25 addition will cost IBX S/40 users about \$20,000.

Mail system gets high-, low-end options

Amtel Systems Corp., of Sunnyvale, Calif., has announced two new options for its Messenger II electronic mail and message-delivery system [*Electronics*, Feb. 10, p. 249]: **a low-cost message light that notifies users of messages and an 80-column page printer for users who frequently receive long messages**. The \$100 message light option is designed for users who receive a relatively small number of incoming messages. The device simply flashes on and off to let the user know when he has messages waiting, rather than printing out the full text. The page printer is intended for users at the other end of the spectrum—those who receive a large number of long messages, such as those that are sent over TWX and Telex networks. Priced at \$1,990, the device prints out messages on full-size fan-fold paper.

Screen editor's price increases

Effective May 1, Rational Data Systems is raising the prices for Scred and RDS Pascal, software products for Data General systems. **New license fees for RDS Pascal range from \$3,000** for a version for the RDOS or DOS operating systems to \$4,500 for the AOS or AOS/VS versions, up from \$2,500 to \$3,500. Prices for Scred, the New York firm's screen editor, range from \$950 to \$1,200, up from \$850 to \$1,000.

Give Your Flexible Disk Drive A Heart of Gold:

Specify Sankyo "Core Parts" for quality and cost efficiency.

Up-to-the-second know-how gives Sankyo a reputation for quality and cost efficiency. The same strong technological base enables Sankyo to supply every part and component to help you build a truly remarkable product. We call our line "Core Parts," and you will too. They get to the core of your problems promptly.

**SPECIFY
SANKYO**

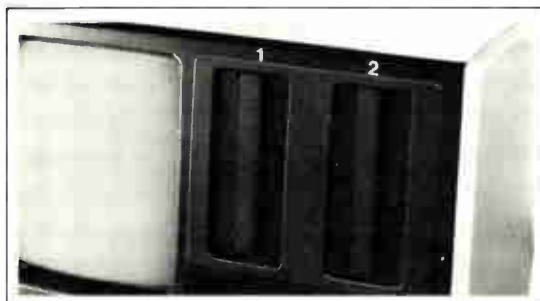

• Sankyo Plunger
(Whisper-Quiet
Operation/High-
Speed Design).

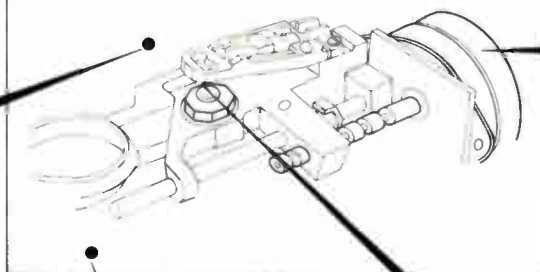

• Sankyo Stepping
Motor.



• Sankyo Direct Drive Brushless Servomotor.



• Sankyo Read/
Write Head for
Flexible Disk
Drive.

For more information, write to Sankyo at the address below:



Sankyo

Sankyo Seiki Mfg. Co., Ltd. Electronic Equipment Div.

Export Dept. 17-2, 1-chome, Shinbashi, Minato-ku, Tokyo 105, Japan,
Tel: (03) 502-1157 Telex: 29548

QUALITY STARTS HERE

*Applied Materials
1982 Spring
Technical Seminars
Monday, May 24, 1982*

The search is on throughout the semiconductor industry for higher quality circuits to compete in world markets. But quality semiconductors start with quality production systems and processes.

Applied Materials is committed to exploring new approaches to wafer fabrication technology that hold promise for improving the quality of semiconductors. Five such approaches now being explored will be discussed at our 1982 Spring Technical Seminars at our facility in Santa Clara on Monday, May 24, the day before SEMICON/West '82.

Please join us and share in these discussions of the quality-producing technology of the future.

 **Applied Materials**
3050 Bowers Avenue
Santa Clara, CA 95051

See us at SEMICON/West '82, Booth #508-517.

SUBSTRATE EFFECTS IN MOS VLSI

Presented by
Dr. Richard C. Foss, President
MOSAID, Inc.

The role of the substrate in MOS VLSI, both in determining device parameters and as a coupling medium for spurious signals, will be evaluated, along with circuit parameters which depend on the substrate, such as the MOSFET threshold voltage and the various depletion capacitances associated with diffused and induced junctions.

DRY ETCHING APPLICATIONS FOR ADVANCED DEVICES

Applied Materials technologists will describe a new dimension in ion-assisted plasma etch technology for advanced devices.

ION ASSISTED PLASMA ETCHING OF ALUMINUM AND ITS ALLOYS

Etching of Al, Al-Si, Al-Cu, and Al-Cu-Si at high throughput will be described, including specific characteristics of a high quality etch.

VLSI INTERCONNECT TECHNOLOGY

This session will review VLSI interconnect needs and the results being achieved with CVD tungsten processes.

ION IMPLANTATION PROCESS QUALITY CONTROL AND SYSTEM CHARACTERIZATION

This session will detail results of a research program to analyze the system implications on process quality in the use of high beam powers in ion implanters.

APPLIED MATERIALS 1982 SPRING TECHNICAL SEMINARS

There is no charge for the seminar.

Date: Monday, May 24, 1982

Location: Applied Materials, Inc., 3400 Central Expressway,
Santa Clara, California

To attend the seminars, please complete the registration form and mail to: Corporate Communications, Applied Materials, Inc., 3050 Bowers Ave. M/S 0506, Santa Clara, CA 95051. For additional information, call (408) 748-5503.

Check one:

Morning Session (8:00-11:30 a.m.);

Afternoon Session (1:00-4:30 p.m.).

Sorry, can't make it, but please send information.

Name _____

Title _____

Company _____

Address _____

City/State/Zip _____

Phone _____

Joint Venture Opportunities

NORTH WEST ENGLAND—THE IDEAL PLACE FOR A WEDDING

Many manufacturing enterprises in North West England are seeking business co-operation agreements with American companies. We have the details. If your company requires a partner in the U.K. why not use us as your marriage broker—there is no fee! We cater for all forms of partnership—manufacture under licence, technical co-operation, exchange of know-how, acquisitions, mergers, etc.

North West England is proud to be the world's most experienced industrial region. It is the birthplace of the industrial revolution but traditional industries like textiles have given way to electronics, aerospace, nuclear energy, pharmaceuticals, oil and gas—to name just a few of our modern industries which are in the vanguard of technological developments. Over 350 American enterprises have direct investments here and many more have lucrative joint ventures with British companies.

If you are in the marriage market, let us know your requirements. We have some willing brides and will send you their vital statistics.



NORTH WEST INDUSTRIAL DEVELOPMENT ASSOCIATION BRAZENNOSE HOUSE BRAZENNOSE STREET MANCHESTER M2 5AZ ENGLAND TEL: 061-834 6778 TELEX: 667822 CHACOM G/INWIDA
Circle 228 on reader service card

SCRED AOS AOS/VS
 RDOS DOS MP/OS

Pascal AOS AOS/VS
 RDOS DOS MP/OS

...two ways to soften your Data General hardware

SCRED Screen editor for DG and non-DG terminals.

PASCAL ANSI/IEEE standard with extensions.

Rational Data Systems

205 East 42 Street New York City 10017
212-697-5855 TWX 710-581-6016

228 Circle 255 on reader service card

BEASTS OF BURDEN

Integrated attachment set
 also insensitive to vibration
NEW!

Secondary capacities up to 7500 VA; standard models up to 1000 VA (VOE/SEV approved); custom models by request (samples at short notice); option: flat /large Ø or upright/small Ø.
New: with integrated attachment set up to 250 VA;
PRINT version up to 100 VA
 (rock-solid, no loosening, no pressure load on the winding and no damaging); low noise and leakage, no humming, minimum temperature increase, open and sealed designs.

... the mighty ones



polytronik GMBH
 Wilhelm-Kuhnert-Straße 26
 8000 München 90
 Tel. (089) 6514028 · Telex 05-215383

Circle 256 on reader service card

Career outlook

IBM is top choice

What engineer has not gone through the exercise that begins, "If I had it all to do over . . ."? Part of the fantasizing that follows invariably concerns the ideal place to start one's career.

A survey of beginning engineers has just surfaced that helps answer that question. Conducted by Deutsch, Shea & Evans of New York, a recruitment advertising and consulting firm, and Graduating Engineer magazine, the survey was based on responses from 1,790 student readers of the magazine in all disciplines—80% of them bachelor-level students, mostly seniors, 16% at the master's level, and 3% working for their doctorates. Of the respondents, 13% were women.

Not surprisingly, the No. 1 finisher among all disciplines, with 16% of the soon-to-be engineers considering it the ideal employer, was Interna-

tional Business Machines Corp. Next, with 11%, was Bell Laboratories, and third, with 10%, was Exxon Corp. Among electronics (253 persons), electrical (287), and computer scientists and engineers (154), IBM and Bell Labs also finished first and second. However, although electronics and electrical engineers agreed that Hewlett-Packard Co. ranked third, computer majors saw things differently and placed Digital Equipment Corp. in third place and HP fourth.

Interestingly, with the survey divided into seven disciplines plus an eighth listing for all combined, electronics-related companies led all but two lists. IBM topped five, and General Electric Co. was first choice of 387 prospective mechanical engineers. Nonelectronics leaders were Bechtel Group Inc. for 208 future civil engineers and Exxon for 193 students with majors in chemical engineering.

EMPLOYER CHOICES* BY BACHELOR- AND GRADUATE-LEVEL ENGINEERING STUDENTS (IN %)

All student respondents (1,790)	Electrical students (287)	Electronics students (253)	Computer science and engineering students (154)			
International Business Machines	IBM	24	IBM	28	IBM	43
Bell Laboratories	Bell Labs	18	Bell Labs	26	Bell Labs	24
Exxon	HP	16	HP	20	Digital	14
General Electric	TI	12	TI	12	HP	13
Hewlett-Packard	GE	11	Motorola	12	Intel	12
Boeing	Westinghouse	8	Intel	10	TI	8
Texas Instruments	GTE Sylvania	7	Digital	8	Honeywell	7
Lockheed	Harris	6	GE	8	Harris	7
Bechtel	Honeywell	6	Honeywell	8	Lockheed	7
Rockwell	Digital	6	Fairchild Industries	6	Wang	7
Fluor	Intel	6	Harris	6	GTE Sylvania	6
Du Pont	Rockwell	5	Rockwell	6	GE	5
General Dynamics	Lockheed	5	GTE Sylvania	5	Data General	5
Westinghouse	Schlumberger (1)	5	Hughes	5	Hughes	5
Digital	Hughes	4	Westinghouse	5	NCR	5
Intel	General Dynamics	4	Boeing	5	Atari	4
Honeywell	Fairchild Industries	4	Xerox	4	Motorola	4
Eastman Kodak	Sperry Univac	4	Martin Marietta	4	Sperry Univac	4
National Aeronautics and Space Administration	NASA	4	NCR	4	TRW	4
General Motors	Du Pont	3	TRW	4	United Technologies	4
U. S. Navy	Eastman Kodak	3	GM	4	General Dynamics	3
Stone & Webster	Houston Lighting & Power	3	General Dynamics	4	NASA	3
Hughes	Martin Marietta	3	Wang	4	(3)	
GTE Sylvania	(2)		United Technologies	3		
United Technologies			RCA	3		

* Ranked by total mentions for first, second, and third choice as employers. Notes: (1) Includes Fairchild Camera and Instrument. (2) Exxon, GM, Motorola tied for 24th with 2.8%. (3) American Telephone & Telegraph, Exxon, Fairchild Industries, Martin Marietta, and Tektronix tied for 23rd with 2.6%.

Source: Graduating Engineer

POSITIONS VACANT

Engineers — discrete, personal, reputable national fee paid placement serv. Murkett Assoc. Box 527, Montgomery, AL 36101.

Antarctic Job Opportunity — Utah State University will have an opening for a Research Engineer to carry out ionospheric measurements at Siple Station, Antarctica. The primary responsibilities of this position will be the operation and maintenance of a vertical incidence High Frequency radar system and equipment making optical measurements of the night sky. Minimum requirements are a B.S. Degree, practical experience in digital and analog electronics and experience with computer software. The period of employment is expected to be from Summer 1982 to February 1984; the position requires that the engineer be resident at Siple during the Antarctic winter. Applicants should submit a resume describing their qualifications and reasons for wanting to go to Antarctica and request three letters of reference to be sent by 15 June 1982 to F. T. Berkey and J. R. Douppnik, Center for Atmospheric and Space Sciences, UMC-34 Utah State University, Logan, Utah 84322. Telephone (801) 750-2982. USU is an Equal Opportunity Employer M/F.

Electronics Technology Instructor for two year degree program. Masters in EE preferred, minimum of 5 years field and/or teaching experience. Basic electronics plus communications, digital systems, microprocessing processors and instrumentation. Start August 19, 1982. \$14,414 to \$32,299 (81-82 schedule). Inquire V.P. Academic Services, Lincoln Land Community College, Springfield, IL 62708. EOE (217) 786-2267.

Software Engineer — B.S. in computer science. Challenging position with high technology rapid growth company. Will develop microprocessor based automatic image analysis, machine control, and data acquisition software. Must be self-starter, able to call own shots. Working knowledge of Intel 8 and 16 bit processors, DEC, FORTRAN and Macro II helpful. Salary \$20,904 plus excellent benefits. Please apply at Ohio Bureau of Employment Services. 216-434-2141.

POSITIONS WANTED

Microcomputer Expert for hire. Contract or per diem. Programming, products with a brain, circuitry. Mr. Masel, 212-476-1516.

Multidisciplinary EE, US citizen, two graduate degrees, 20 years microwave, telecommunications and biomedical European experience in governmental and industrial research, and international consulting project planning and administration, seeks position in North America. Favor location in snow country as suits family avocation of cross-country ski racing and coaching. PW-5951, Electronics.



Take a peak into your future.

By utilizing the latest computer-aided design techniques and CMOS gate array technology, United Technologies Microelectronics Center has become an important new influence for VLSI circuit designs.

Now, we're beginning to develop advanced CAD tools that go beyond gate array technology and move toward total system design.

This innovative technology is being developed at our state-of-the-art R&D facility located at the base of Pikes Peak in beautiful Colorado Springs, a city that combines Rocky Mountain living with a healthy economy.

And we're backed by United Technologies Corporation, a \$13 billion, Fortune 50 company that spends \$2 million each day on R&D.

So, if you're the type of individual capable of joining world-class microelectronics talent and taking on exciting challenges daily, then call Les Gaskins collect at (303) 594-8000. Or write UTMC, 1365 Garden of the Gods Road, Colorado Springs, CO 80907. All inquiries are confidential.



**UNITED
TECHNOLOGIES
MICROELECTRONICS
CENTER**

UTMC is an equal opportunity employer m/f/h/v

© 1982 United Technologies Microelectronics Center

Engineers

- Design
- Development
- Project
- Software

\$20,000-\$50,000

Riddick Associates Engineering Division specializes in placement of electrical and electronics engineers with top companies on the East Coast and throughout the U.S. We provide advice on careers, resumes and interviews for a position tailored to your skills. Client companies pay all fees. For details call or send resume in strict confidence to Phil Riddick, President.

**Riddick
Associates, Ltd.**

13 Koger Executive Center
Norfolk VA 23502
Area 804-461-3994

SALES REP WANTED

with contacts in computer industry for Midwest major plastic molder now making large computer low-pressure housings, covers and cabinets. Please call:
313-979-5000 Mr. M. Ladney

TO ANSWER BOX
NUMBER ADS
Address separate envelopes (smaller than 11" x 5" for each reply to:

POSITIONS WANTED

International civil servant, 49, Canadian citizen, born and educated in South America, seeks field position at executive level with transnational organization. Top level managerial skills offered, result oriented individual. Expertise in various fields which include: Systems, Finance, Accounting, Audit and Resources; Computer / Communications know-how, Computer Programming. Long work experience in various, non-industrial, business/technology oriented environments. Higher, multidisciplinary (North-American and non North-American) education. Fluency in several languages. Good knowledge of the Americas and Western Europe. Write to V.L., P.O. Box 1014, Station A, Montreal, Canada H3C 2W9. Telephone: (514) 282-0122.

EMPLOYMENT SERVICES

Electronic engineering growth positions with clients located nationally. Our service is enhanced by the fact that I am an EE with 20 years in industry and over 10 years in placing professionals on an employer fee paid basis. Send your resume to Joe Torcassi, Director, J. Anthony & Associates, PO Drawer AD, Lynchburg, OH 45142 513/364-2305.

Box Number
(As indicated)
Electronics
Box 900, NY 10020

MCGRAW- HILL'S ELECTRONIC BOOKSHELF IS ON THE AIR!

Ask your computer to call 212/997-2243 for the latest info on our computer and electronics books. The system is up daily from 6 pm to 8 am and 24 hours on weekends.

XEROX 400 TELECOPIER

To enable you to get your Classified Advertising type-written copy into this section at the last possible minute, we've installed a XEROX 400 TELECOPIER (which also receives copy from other makes) in our New York home office.

If you have a telecopier, just call the number below to see if your equipment is compatible. If you don't have a telecopier, call and we'll help you locate the nearest one. It could even be in your own firm or building.

NOTE: The Xerox 400 cannot accept photos or art, but as always, there is no charge for typesetting and layout service.

**CALL
(212)
997-6800**

HARDWARE ENGINEERS

MOVE UP. IN A COMPANY WHERE STATE-OF-THE-ENGINEER IS AS IMPORTANT AS STATE-OF-THE-ART.

If you're an experienced hardware engineer, you owe it to yourself to take a good look at our company, where growth and long-term contracts are the rule, not the exception. Where a positive, stimulating environment keeps bright, creative people challenged and fulfilled. Where salaries and benefits are among the best in the business.

OPPORTUNITIES FOR HARDWARE ENGINEERS:

- wide range of jobs:
 - systems analysis, design, development, test and integration in the following areas: computer-based intelligence and reconnaissance systems, command and control systems, electronic warfare, communications systems, digital image processing.
- state-of-the-art technology:
 - high-speed digital logic and signal processing
 - communications theory, digital and analog design, and filter design
 - antenna/arrays for precision direction-finding systems
 - RF & IF processors & microwave integrated circuitry
 - microprocessor bit-slice, and high-speed, parallel pipeline processors utilizing MOS, TTL & ECL
 - high probability of intercept receivers

If you have a degree and 3 or more years of experience, don't delay—send your resume to: **Professional Placement, E-Systems, Inc., Garland Division, P.O. Box 226118, Dept. MU29 Dallas, Texas 75266.**



E-SYSTEMS

Garland Division

The problem solvers.

An equal opportunity employer M/F, H, V.

INTERNATIONAL OPPORTUNITY AUDIO VISUAL

The King Faisal Specialist Hospital and Research Centre in Riyadh, Saudi Arabia has current openings in its Audio Visual Department. The AV Department is responsible for the educational and television needs of the employees and dependents of the 250 bed acute care referral facility.

The following positions are available:

CHIEF TV ENGINEER: BSEE, 8 yrs. related experience (2 as supervisor) in the design and maintenance of CCTV systems and other AV equipment.

TV ENGINEER: BSEE, 5 yrs. experience in maintenance and repair of TV or Video systems. Must be familiar with TV cameras, monitor systems, video tape recorders and cable.

TV TECHNICIAN: AA Electronics or 2 yrs. trade school or military equivalent plus 5 yrs relevant experience—at least 2 of those years maintaining and repairing TV and video systems. (Single Status)

Benefit package includes attractive salary, 30 day annual leave, free transportation, furnished lodging, free medical care, bonus pay and bonus leave. Two year contract.

For further information, please send resume to: Kathleen Langan, Personnel Consultant, Hospital Corporation of America-International Division, P.O. Box 550, Nashville, TN. 37202.

HCA International Division

INSTRUMENTATION SPECIALIST UNIVERSITY OF PETROLEUM & MINERALS DHARAN, SAUDI ARABIA

The University of Petroleum & Minerals, Dhahran, Saudi Arabia, is seeking for its Chemistry Department a full-time specialist to service the Department's major instrumentation—Varian XL-200 multinuclear superconducting FTNMR spectrometer, Enraf-Nonius CAD-4 diffractometer, Ribermag GC/MS, Jarell-Ash Model 850 atomic absorption spectrometer, Jarrell-Ash 3.4 meter emission spectrograph, and P. A. R. model 370 electrochemistry system. New acquisitions will include Varian E-109 and Bruker ER 200 D-SRC-15/22.5 EPR and ENDOR Spectrometers.

Applicants should have sufficient experience in electronics in a major university or industry and be knowledgeable in the operation and maintenance of computer-interfaced instrumentation. Responsibilities will include the maintenance, troubleshooting and repair of these instruments.

Minimum regular contract for two years, renewable. Annual salary up to US\$30,000 plus allowances. Free air-conditioned and furnished housing provided. Free air transportation to and from Dhahran each year. Attractive educational assistance grants for school-age dependent children. All earned income without Saudi taxes. Ten and half months duty each year with 45 days vacation with salary plus other fringe benefits as per policy.

Apply with complete resume on academic, professional and personal data, together with a recent photograph, list of references, copies of certificates/diplomas/degrees, home and office addresses and telephone numbers to:

Dean of Faculty & Personnel Affairs
University of Petroleum & Minerals
P. O. Box 144
Dhahran International Airport
Dhahran, Saudi Arabia

NOTICE TO EMPLOYERS:

Why we can recommend our readers for the top jobs

The subscribers to this magazine have qualified professionally to receive it. They are also paid subscribers—interested enough in the technological content to have paid a minimum of \$19 for a subscription.

As subscribers to ELECTRONICS, our readers have told you several things about themselves. They are ambitious. They are interested in expanding their knowledge in specific areas of the technology. And they are sophisticated in their need for and use of business and technology information.

Our readers are now in senior engineering or engineering management, or they are on the road toward those levels. In either case, they are prime applicants for the top jobs in almost any area.

If you are interested in recruiting the best people in electronics, these pages are open to you for your recruitment advertising.

Our readers are not "job-hoppers". To interest them you will have to combine present reward with challenge and opportunity for future career advancement.

The cost of recruitment advertising on these pages is \$119 per advertising inch. For information call or write:

Electronics

Post Office Box 900, New York, NY 10020
Phone 212/997-2556

Abbott Transistor Labs	175	‡ Deltron, Inc.	172	Micropolis	191
ACDC Electronics	187	Digital Equipment Corporation	196	Microsoft	219
Acheson Colloids	26	Digital Equipment Corporation NPM Micros	88	Micro Technical Industries	8
• ACL, Inc.	176	• DuPont DE Nemours Berg Electronics Division	43	■‡ Miller-Stephens Chemical Company, Inc.	169
Advanced Digital Products	8	Dynamic Measurements	98	Miller Technology	236
Advanced Micro Devices	22,23	Dynamics Microprocessor Associates	184	Minato Electronics, Inc.	7
• AFGA Geveert	4E	‡ Eastman Kodak Company Graphic Markets Division	43	■ Mini-Circuits Laboratory	5
Airpax Division North American Philips Corporation	205	EG&G Reticon	97	Mitel Corporation	158
■ Alco Electronic Products	10	Electro Scientific Industries	198	■ Motorola, Inc.	196
■ Allen Bradley	215	■ Electronic Navigation Industries	6	• Murata Manufacturing Company, Ltd.	18E
■ Amp, Inc.	189	Elek-Tek, Inc.	235	National Plastics Exposition	62
Ampetek, Inc.	50	Elevam Electronic Tube Company, Ltd.	212	NCR Corporation	180,181
‡ Ampex Memory Products Division	156,157	Elographics, Inc.	182	□ NEC	64B
• Ampex Corporate	19E	□ EMM	64A	Neff Instrument Corporation	224
Analogic Corporation	213	4S Computer Engineer	234	Nippon Electronic Company, Ltd.	20,21
• Analog Devices	164	Fairchild Mechanical Division	99	Northwest Industrial Development Association	228
• A.O.I.P. Mesures	17E	John Fluke Manufacturing Company	75,77	• Northern Ireland Department of Commerce	169
A.P. Products	216	Fujitsu Ltd.	72	Ohmite	15
• A.P.E.M.	16E	General Instrument Corporation Discrete Semi Division	68,69	OKI Semiconductor	84,85
Applied Materials, Inc.	227	General Instrument Microelectronics	94	‡ Panasonic	164
Apollo	54,55	■ GenRad	82,83	■ Pearson Electronics	194
Aromat	145	■ Global Specialties Corporation	38	Perkin-Elmer Semiconductor Operations	201
Arvida	194	Gould Inc. Instrument Division SC Operations	80A-80B,81,93	• Philippe Elcoma	2E,3E
• Avantek	173	• Gould Inc. Instrument Division	152,153	• Philippe T&M	8E
B&K Precision Division of Dynascan Corporation	197	■ Hewlett Packard	1,154,155	Phoenix Data, Inc.	177
□ Bank of America	48A-48D	‡ Hitachi	173	■ Piezo Crystal	220
Beusch & Lomb Houston Instruments Division	32	Hughes Aircraft	53	Plantronics Zehntel	179
Beckman Instruments EPG	3rdC	ICS Electronics	222	Plastics Engineering Company	80
■ Boonton Electronics	202	Interface Dallas	49	• Plessey Semiconductor Solid State Division	148
Buehler Products, Inc.	186	Interface Technology	200	Polaroid Battery Division	51
■ Bussman Division, McGraw Edison Company	171	Intersil	36,37	Polytronik GmbH	188,192,228
■ C&K Components	235	• Iskra Commerce Marketing	13E	Power One, Inc.	211
Caddock Electronics, Inc.	47	• ITT Capacitors	60	Priam Corporation	101,103
Cambion Division Midland Ross Corporation	184,216	ITT Jennings	52	■ Pro-Log	25
The Capitol Machine & Switch Company	188	■‡ ITT Schedow Incorporated	176	■ Projects Unlimited	192
■ Cherry Electrical Products	13	■ Johanson Manufacturing Corporation	162	■ Radio Research Instrument Company	196
■ Clairex Electronics	4thC	• Lemo SA	20E	• Rational Data Systems	228
Computer Parts Exchange	221	Lifeboat	206	Raytheon Company Semiconductor Division	2ndC
■ Conap, Inc.	174	MDB Systems, Inc.	183	RCA Solid State	167
Corning Glass Works	207	Mallory Capacitors	199	■‡ Robinson Nugent	148
■ Custom Electronics	186	■ Marconi Instruments	151	• Rohde & Schwarz	1E
Data Instruments, Inc.	35	Martin Marietta	223	Sankyo Seiki Manufacturing Company Ltd.	226
Data I/O Corporation	163,193	■ Matsuo Electric Company Ltd.	166	Schroff	209
Data Systems Design	86,87	McGraw-Hill Bookstore	208	• S.E.C.I. S.p.A.	157
Datel-Intersil	214	‡ Micro Link Corporation	166	Semi Processes, Inc.	27
				Sharp Corporation	136

EUROPEAN COMPUTER ENGINEERS
SEEKS CORPORATION WITH/ OFFERS SERVICES TO/ LARGER ORGANIZATIONS THAT CAN UTILIZE OUR EXPERIENCE

SERVICES: Computer engineering services in Europe installation, maintenance, etc. with repairs down to chip/component level

DEVICES EXPERIENCE: We are experienced with the following type devices: Tapes: 800-1600-6250 BPI; Discs: Floppies to 200MBYTE Drives; Print: Line and Matrix printers; Nets: Networks employing BSC/SNA.

SYSTEMS EXPERIENCE: IBM 370 — 303X — 43XX — Univac 90; PDP 11 — LSI11— MAC16 Texas 980; Eclipse — Novas.

CONTROLLERS: 4S builds controllers for all above mentioned devices and systems

LANGUAGES: German English Scandinavian (French)

INSTALLATIONS: From South: Marseille to North: Oslo

CUSTOMER BASE: Current customer base is large newspapers and printers in Europe

ADDRESS: 4S COMPUTER ENGINEERING GMBH

**CONTACT: P.O. Box 1368
D-5202 Hennef 1 Germany
Tel: (2242) 5688 TLX: 889 714
Jo Christiansen**

Circle 234 on reader service card

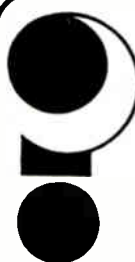

NEED SERVICE ON YOUR SUBSCRIPTION TO ...

Electronics

*Do you want to change your address?
Have you missed an issue?
Was your copy damaged?*

CALL (609) 448-8110*

FOR IMMEDIATE HELP



*9 a.m.-4 p.m. EST

• Siemens Corporation	161
Silicon Systems	195
Solartron	45
Sprague Electric	59
STC Microtechnology	178
‡ Takeda Riken Industry Company, Ltd.	152, 153
• TEAC Corporation	20E
Tektronix	6E, 7E, 11, 18, 19, 30, 31, 66, 67
• Telecontrolli	145
■ Teledyne Relays	17
Teledyne Rodney Metals	128
Teradyne, Inc.	70, 71
Texas Instruments Digital Systems	9
Textool Products/3M	14
Thermotron	170
Thomson CSF/DTE	56
• Thorn EMI Datatechnology Ltd.	10E, 11E
‡ Toshiba America	61
Transwave Corporation	185
TRW/IRC Resistors	130
TRW Optron	79, 78
TRW/LSI Products	91
• Trio Test Instrument Division	156
US Virgin Island Industries Development Comm.	182
Unitronix Corporation	177
Universal Instruments	217
■ Vectec, Inc.	102
Vector Electronics	236
• Wandel un Goltermann	15E
• C.G. Wedgwood & Company	14E
Western Digital	65
■, ‡ Westinghouse Electric Corporation	72
Wilhelm Westermann	8
‡ Woven Electronics	161
Zendex Corporation	16
Zilog	28, 29

Classified and employment advertising	
E-Systems, Garland Division	231
Hospital Corporation of America-International Division	
Riddick Associates, Ltd.	232
United Technologies Microelectronics Center	230
University of Petroleum & Minerals	232

For more information of complete product line see advertisement in the latest Electronics Buyers Guide

- * Advertisers in Electronics International
- ‡ Advertisers in Electronics domestic edition
- Advertisers in regional issue

Advertising Sales Staff

Advertising sales manager: Norman Rosen
3200 Wilshire Blvd., South Tower
Los Angeles Calif. 90010 [213] 487-1160

Market managers:

Computers & Peripherals: Frank Mitchell, Boston
Test & Measurement: Don Farris, San Francisco
Semiconductors: Norman Rosen, Los Angeles

Atlanta, Ga. 30309: John J. Uphues
100 Colony Square, 1175 Peachtree St., N.E.
[404] 892-2868

Boston, Mass. 02118: Frank Mitchell
Paul F. McPherson, Jr.
607 Boylston St., [617] 262-1160

Cleveland, Ohio 44113: William J. Higgins III
[312] 751-3738

Fort Lauderdale, Fla. 33306: John J. Uphues
3000 N.E. 30th Place, Suite #400
[305] 563-9111

New York, N.Y. 10020
Matthew T. Reseska [212] 997-3617
Albert J. Liedel [212] 997-3616

Philadelphia, Pa. 19102: Joseph Milroy
Three Parkway, [215] 496-3800

Pittsburgh, Pa. 15222: Joseph Milroy
4 Gateway Center, [215] 496-3800

Chicago, Ill. 60611
Jack Anderson [312] 751-3739
William J. Higgins III [312] 751-3738
645 North Michigan Avenue
Southfield, Michigan 48075: Jack Anderson
4000 Town Center, Suite 770, Tower 2
[313] 352-9760

Dallas, Texas 75201: John J. Uphues
2001 Bryan Tower, Suite 1070
[214] 742-1747

Denver, Colo. 80203: Harry B. Doyle, Jr.
655 Broadway, Suite 325
[303] 825-6731

Houston, Texas 77040: John J. Uphues
7600 West Tidwell, Suite 500
[713] 462-0757

Los Angeles, Calif. 90010: Chuck Crowe
3200 Wilshire Blvd., South Tower
[213] 487-1160

Costa Mesa, Calif. 92626: Edward E. Callahan
3001 Red Hill Ave. Bldg. #1 Suite 222
[714] 557-6292

Palo Alto, Calif. 94303: Don Farris,
Larry Goldstein, Lauren Scott
1000 Elwell Court, [415] 968-0280

Paris: Michael Sales
17 Rue-Georges Bizet, 75 116 Paris, France
Tel: 720-16-80

United Kingdom: Simon Smith
34 Dover Street, London W1
Tel: 01-493-1451

Scandinavia: Andrew Karnig and Assoc.
and Simon Smith
Kungsholmsgatan 10

112 27 Stockholm, Sweden
Tel: 08-51-68-70 Telex: 179-51

Milan: Ferruccio Silvera and Elio Gonzaga
1 via Baracchini, Italy

Tel: 86-90-656

Brussels:
23 Chaussee de Wavre
Brussels 1040, Belgium
Tel: 513-73-95

Frankfurt/Main: Fritz Krusebecker
Liebigstrasse 27c, Germany
Tel: 72-01-81

Tokyo: Akio Saijo
McGraw-Hill Publications Overseas Corporation,
Kasumigaseki Building 2-5, 3-chome,

Kasumigaseki, Chiyoda-Ku, Tokyo, Japan
[581] 9811

Business Department

Thomas M. Egan
Production Director
[212] 997-3140

Carol Gallagher
Production Manager
[212] 997-2045

Betty Preis
Production Manager Domestic
[212] 997-2908

Evelyn Dillon
Production Manager Related Products
[212] 997-2044

Sharon Wheeler
Production Assistant
[212] 997-2843

Frances Vallone
Reader Service Manager
[212] 997-6058

Electronics Buyers' Guide

H.T. Howland, General Manager
[212] 997-6642

Regina Hera, Directory Manager
[212] 997-2544

Classified and Employment Advertising

[212] 997-2897



C&K introduces the **DIP** Switch that's making waves.



Actual Size



C&K Components, Inc.
15 Riverdale Avenue, Newton, MA 02158
Tel: (617) 964-6400, Telex: 92-2544, Twx: 710-335-1163

C&K does it again with a reliable, inexpensive DIP Switch that **can be wave soldered without the use of boots, caps or tapes.** This new switch utilizes a unique open base design to allow solvent cleaners to flush out all contaminants around electrical contacts.

Available in 2 thru 10 pole configurations with a positive detent slide mechanism that eliminates accidental switching. Wiping contacts are gold over nickel with solder clad or gold plated terminals.

If you don't believe our new DIP Switch is making waves, send for a free engineering sample and try one on us. See for yourself why C&K is — The Primary Source Worldwide.

Write or call (617) 964-6400.

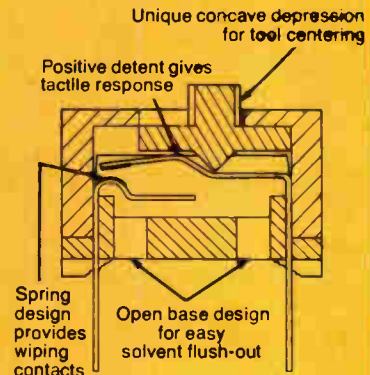

"Visit us at ELECTRO/82,
Booth 101-103"

Circle 235 on reader service card

hp HEWLETT PACKARD 7470 **hp** HIGHER PERFORMANCE 7470 **hp** HEWLETT PACKARD 7470 **hp** HIGHER PRODUCTIVITY 7470

THE **LOW COST** PLOTTER

With a choice of Interfaces to work with

APPLE • COMMODORE • HEWLETT PACKARD • IBM
PERSONAL COMPUTERS

- Inexpensive to own
- Easy to operate
- Charts in minutes
- Superior resolution
- 2-pen auto plotting
- May use up to 10 COLORS
- For paper presentations
- For transparency presentations



\$1125
mfr sugg list
\$1550

Quality graphics made affordable by Hewlett Packard and Elek-Tek. The revolutionary new HP-7470 personal computer plotter helps you chart such diverse data as statistical analysis, sales - profit-debt, engineering analysis, production and machine efficiencies, reports and forecasts. Return on equity and capital, project schedules, Working capital and cash flow, "what if" planning, market shares and more and more and MORE.

OF COURSE, it's **hp** HEWLETT PACKARD quality, reliability, service, support and SOFTWARE AVAILABLE so you don't need to program.

CALL TOLL-FREE 800-621-1269 (except Illinois, Alaska, Hawaii)

Accessories discounted too. **Corporate Accounts Invited.** Mastercharge or Visa by mail or phone. Mail Cashier's Check, Money Order, Personal Check (2 wks to clear). Add \$4.00 1st item; (Alaska, Hawaii, Puerto Rico, Canada add \$8.00 first item) \$1.00 ea. add'l shpg. & handl. Shipments to IL address add 6% tax. Prices subject to change. **WRITE for free catalog. ALL ELEK-TEK MERCHANDISE IS BRAND NEW, FIRST QUALITY AND COMPLETE.**



ELEK-TEK, inc.

6557 North Lincoln Avenue, Chicago IL 60645
(800) 621-1269 (312) 677-7660

Circle 257 on reader service card

BUILD YOUR COMPUTER BREADBOARDS & INTERFACES FASTER AND EASIER WITH NEW VECTOR PLUGBOARDS

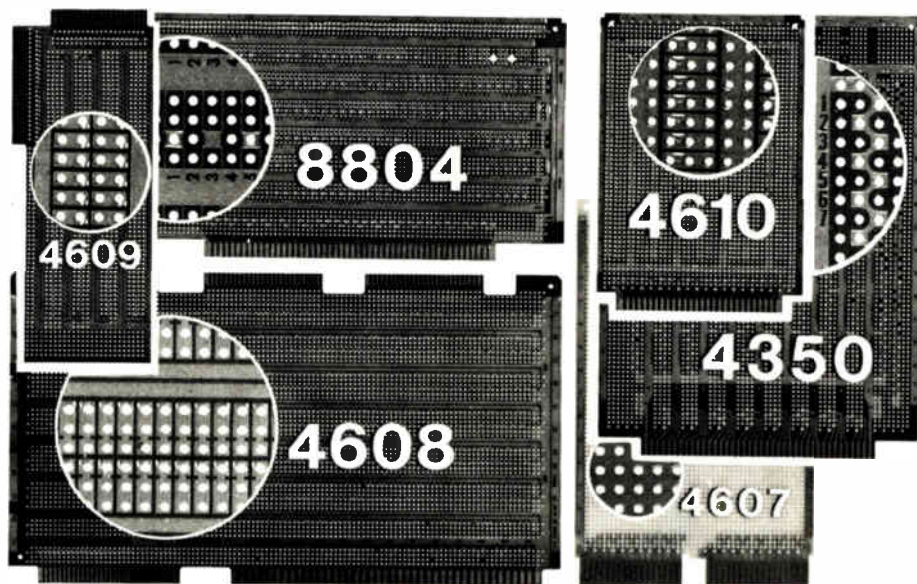

4610 series — for STD-BUS-WW, solderable and unpatterned models.

4608 series — for Intel/National SBC/BLC 80-WW solderable, or unpatterned.

8804 series — for S-100. Five models available.

4607 — for DEC LSI-11/PDP8-11, Heath-11.

4609 — for Apple II, Super-Kim, Pet Commodore with Expandamem.

4350 — for TI 980 Computer.

4611 series — for Motorola Exorciser,™ Rockwell AIM65 expansion.

Send for FREE brochure!

New RACK MOUNTING CAGES & ENCLOSURES AVAILABLE.

Everything in this ad is available through distributors or factory direct, from stock, if not available locally.

 **Vector Electronic Company**
INCORPORATED

12460 Gladstone Ave., Sylmar, CA 91342; (213) 365-9661, TWX (910) 496-1539

748010

Circle 236 on reader service card

See us at Electro Booth No. 1510

MORE POWER, MEMORY, I/O CAPABILITY AND PERFORMANCE

Introducing the MCPU-800 one year anniversary.

For over a year now, Miller Technology has been delivering a little single board microcomputer with some pretty big features.

- 4 MHz Z80A CPU
- 64K or 16K bytes RAM
- 4 ROM sockets hold up to 32K bytes ROM or EPROM (2K, 4K or 8K)
- 32 Parallel I/O bits
- Fully programmable serial port
- Software control of memory configuration on 16K boundaries
- IOEXP line under software control, MEMEX and MCSYNC fully supported

- Completely STD bus compatible
- Single +5 supply
- Low power: 5 w typical
- Software support:
 - MONITOR
 - 2K BASIC
 - 8K BASIC
 - Both Basics support ROM-able code.
 - CP/M® compatible—ask for tech note #8102

— Optional RS-232 interface +5 only

Shipped Only After 100 Hour Burn-in.

We've got 'em ready to ship — allow 2 weeks for delivery on small quantity orders.

For information on the only no frills, pure

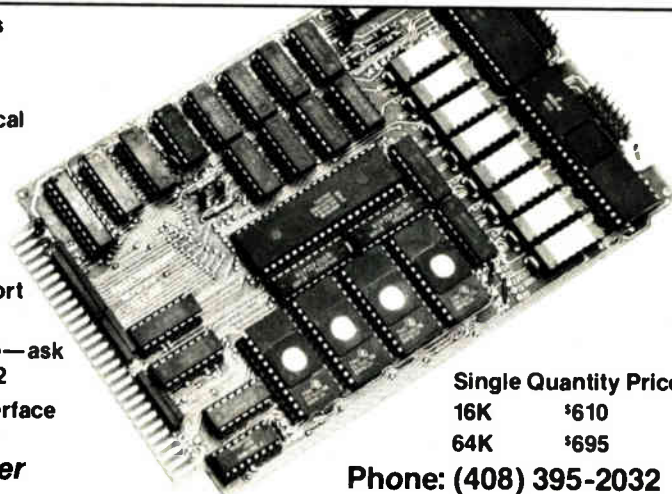

Single Quantity Prices
16K \$610
64K \$695

Phone: (408) 395-2032

647 N. Santa Cruz Ave.
Los Gatos, CA 95030

® Trademark of Digital Research

performance single board microcomputer get in touch with Miller Technology today.

MILLER
technology

Electronics

Reader Service

For additional information on products advertised, new products or new literature, use these business reply cards.

Complete entire card. Please print or type.

Circle the number on the Reader Service postcard that corresponds to the number at the bottom of the advertisement, new product item, or new literature in which you are interested.

To aid the manufacturer in filling your request, please answer the three questions

All inquiries from outside the U.S. that cannot reach Electronics before the expiration date noted on the Reader Service postcard must be mailed directly to the manufacturer. The manufacturer assumes all responsibilities for responding to inquiries.

Subscriptions & Renewals

Fill in the subscription card adjoining this card. Electronics will bill you at the address indicated on the card.

Electronics

April 21, 1982 This reader service card expires July 21, 1982

NAME _____ TITLE _____

PHONE (_____) _____ COMPANY _____

STREET ADDRESS (Company or home check one) _____

CITY _____ STATE _____ ZIP _____

Was This Magazine Personally Addressed to You? Yes No

Industry classification (check one):

- a Computer & Related Equipment
 b Communications Equipment & Systems
 c Navigation, Guidance or Control Systems
 d Aerospace, Underseas Ground Support
 e Test & Measuring Equipment
 f Consumer Products
 g Industrial Controls & Equipment
 h Components & Subassemblies

5 Source of Inquiry—DOMESTIC

- j Independent R&D Organizations
 k Government

Your design function (check each letter that applies):

- x I do electronic design or development engineering work.
 y I supervise electronic design or development engineering work.
 z I set standards for, or evaluate electronic components, systems and materials.

Your principal job responsibility (check one)

- t Management
 v Engineering Management
 r Engineering

Estimate number of employees (at this location): 1. under 20 2. 20-99 3. 100-999 4. over 1000

1 16 31 46	61 76 91 106	121 136 151 166	181 196 211 226	241 256 271 348	363 378 393 408	423 438 453 468	483 498 703 718
2 17 32 47	62 77 92 107	122 137 152 167	182 197 212 227	242 257 272 349	364 379 394 409	424 439 454 469	484 499 704 719
3 18 33 48	63 78 93 108	123 138 153 168	183 198 213 228	243 258 273 350	365 380 395 410	425 440 455 470	485 500 705 720
4 19 34 49	64 79 94 109	124 139 154 169	184 199 214 229	244 259 274 351	366 381 396 411	426 441 456 471	486 501 706 900
5 20 35 50	65 80 95 110	125 140 155 170	185 200 215 230	245 260 275 352	367 382 397 412	427 442 457 472	487 502 707 901
6 21 36 51	66 81 96 111	126 141 156 171	186 201 216 231	246 261 338 353	368 383 398 413	428 443 458 473	488 503 708 902
7 22 37 52	67 82 97 112	127 142 157 172	187 202 217 232	247 262 339 354	369 384 399 414	429 444 459 474	489 504 709 951
8 23 38 53	68 83 98 113	128 143 158 173	188 203 218 233	248 263 340 355	370 385 400 415	430 445 460 475	490 505 710 952
9 24 39 54	69 84 99 114	129 144 159 174	189 204 219 234	249 264 341 356	371 386 401 416	431 446 461 476	491 506 711 953
10 25 40 55	70 85 100 115	130 145 160 175	190 205 220 235	250 265 342 357	372 387 402 417	432 447 462 477	492 507 712 954
11 26 41 56	71 86 101 116	131 146 161 176	191 206 221 236	251 266 343 358	373 388 403 418	433 448 463 478	493 508 713 956
12 27 42 57	72 87 102 117	132 147 162 177	192 207 222 237	252 267 344 359	374 389 404 419	434 449 464 479	494 509 714 957
13 28 43 58	73 88 103 118	133 148 163 178	193 208 223 238	253 268 345 360	375 390 405 420	435 450 465 480	495 510 715 958
14 29 44 59	74 89 104 119	134 149 164 179	194 209 224 239	254 269 346 361	376 391 406 421	436 451 466 481	496 701 716 959
15 30 45 60	75 90 105 120	135 150 165 180	195 210 225 240	255 270 347 362	377 392 407 422	437 452 467 482	497 702 717 960

Electronics

April 21, 1982 This reader service card expires July 21, 1982

NAME _____ TITLE _____

PHONE (_____) _____ COMPANY _____

STREET ADDRESS (Company or home check one) _____

CITY _____ STATE _____ ZIP _____

Was This Magazine Personally Addressed to You? Yes No

Industry classification (check one):

- a Computer & Related Equipment
 b Communications Equipment & Systems
 c Navigation, Guidance or Control Systems
 d Aerospace, Underseas Ground Support
 e Test & Measuring Equipment
 f Consumer Products
 g Industrial Controls & Equipment
 h Components & Subassemblies

5 Source of Inquiry—DOMESTIC

- j Independent R&D Organizations
 k Government

Your design function (check each letter that applies):

- x I do electronic design or development engineering work.
 y I supervise electronic design or development engineering work.
 z I set standards for, or evaluate electronic components, systems and materials.

Your principal job responsibility (check one)

- t Management
 v Engineering Management
 r Engineering

Estimate number of employees (at this location): 1. under 20 2. 20-99 3. 100-999 4. over 1000

1 16 31 46	61 76 91 106	121 136 151 166	181 196 211 226	241 256 271 348	363 378 393 408	423 438 453 468	483 498 703 718
2 17 32 47	62 77 92 107	122 137 152 167	182 197 212 227	242 257 272 349	364 379 394 409	424 439 454 469	484 499 704 719
3 18 33 48	63 78 93 108	123 138 153 168	183 198 213 228	243 258 273 350	365 380 395 410	425 440 455 470	485 500 705 720
4 19 34 49	64 79 94 109	124 139 154 169	184 199 214 229	244 259 274 351	366 381 396 411	426 441 456 471	486 501 706 900
5 20 35 50	65 80 95 110	125 140 155 170	185 200 215 230	245 260 275 352	367 382 397 412	427 442 457 472	487 502 707 901
6 21 36 51	66 81 96 111	126 141 156 171	186 201 216 231	246 261 338 353	368 383 398 413	428 443 458 473	488 503 708 902
7 22 37 52	67 82 97 112	127 142 157 172	187 202 217 232	247 262 339 354	369 384 399 414	429 444 459 474	489 504 709 951
8 23 38 53	68 83 98 113	128 143 158 173	188 203 218 233	248 263 340 355	370 385 400 415	430 445 460 475	490 505 710 952
9 24 39 54	69 84 99 114	129 144 159 174	189 204 219 234	249 264 341 356	371 386 401 416	431 446 461 476	491 506 711 953
10 25 40 55	70 85 100 115	130 145 160 175	190 205 220 235	250 265 342 357	372 387 402 417	432 447 462 477	492 507 712 954
11 26 41 56	71 86 101 116	131 146 161 176	191 206 221 236	251 266 343 358	373 388 403 418	433 448 463 478	493 508 713 956
12 27 42 57	72 87 102 117	132 147 162 177	192 207 222 237	252 267 344 359	374 389 404 419	434 449 464 479	494 509 714 957
13 28 43 58	73 88 103 118	133 148 163 178	193 208 223 238	253 268 345 360	375 390 405 420	435 450 465 480	495 510 715 958
14 29 44 59	74 89 104 119	134 149 164 179	194 209 224 239	254 269 346 361	376 391 406 421	436 451 466 481	496 701 716 959
15 30 45 60	75 90 105 120	135 150 165 180	195 210 225 240	255 270 347 362	377 392 407 422	437 452 467 482	497 702 717 960

Electronics Reader Service

If the cards below have already been used,
you may obtain the needed information
by writing directly to the manufacturer,
or by sending your name and address,
plus the Reader Service number and issue date,
to Electronics Reader Service Department,
P.O. Box No. 2530, Clinton, Iowa 52734.

Affix
Postage
Here

Electronics

P.O. Box No. 2530
Clinton, Iowa 52735

Affix
Postage
Here

Electronics

P.O. Box No. 2530
Clinton, Iowa 52735



Lasting relief.

When you're suffering from electronic component deficiencies, the best medicine is Beckman.

You'll get fast, lasting relief from those nagging pains associated with poor quality, high prices and late deliveries.

Fast because Beckman's worldwide sales, service and distribution network is waiting to serve you.

Lasting because Beckman is committed to serving the electronics industry with components of superior quality and reliability.

Precision Potentiometers and Dials

The broadest line of precision potentiometers and turns-counting dials in the industry.

Trimming Potentiometers

High performance cermet trimmers with superior setting stability and reliability.

Digital Multimeters

18 standard 3½ digit handheld and bench portable multimeters offer high-performance in field and lab. Built tough to last.

Planar Gas Displays and Systems

The brightest, most readable displays in the world are Beckman raised cathode and screened image displays. Now available in a wide variety of display designs, modules and subsystems.

Liquid Crystal Displays

Large area LCDs offer maximum design flexibility for low power applications. Available in standard and custom packages.

Precision Resistor Networks

Continuing in precision thin film networks, Beckman offers a broad range of resistance values with outstanding tempco tracking to meet high precision, tight tolerance analog applications.

Hybrid Microcircuits

A leader in custom military hybrid microcircuits and standard high reliability, low power A/D and D/A converters.

More than ever, Beckman is the right electronic prescription. Electronic Technologies Group, Beckman Instruments, Inc., 2500 Harbor Boulevard, Fullerton, CA 92634.

The best medicine in electronics.

BECKMAN

SILICON OPTO CHIPS from Clairex



**PHOTOTRANSISTOR
CHIPS**

**PHOTOVOLTAIC
DIODE CHIPS**

**PHOTODARLINGTON
CHIPS**

**Now you can make your own hybrids,
arrays, solid-state relays and special sensors.**

The Clairex line of silicon photodetector chips consists of four photodiodes, five phototransistors and one photodarlington transistor. The diodes are intended for use in the

voltaic mode. The phototransistors are each available in two sensitivity ranges. All chips from Clairex have gold backings to facilitate ohmic bonding and are 100% tested before being

packaged in glass vials filled with Freon.

Call 914-664-6602 or write Clairex,[®] 560 South Third Avenue, Mount Vernon, New York 10550.

CLAIREX ELECTRONICS

A Division of Clairex Corporation

Circle 902 on reader service card