

MAY 19, 1981

REVISING MICROSYSTEM SOFTWARE BY PHONE/155

European businesses to set up their own satellite systems/97

One-board controller handles disks and backup media/160

SIX DOLLARS

A Mc GRAW-HILL PUBLICATION

International

Electronics®

The drive for quality and reliability

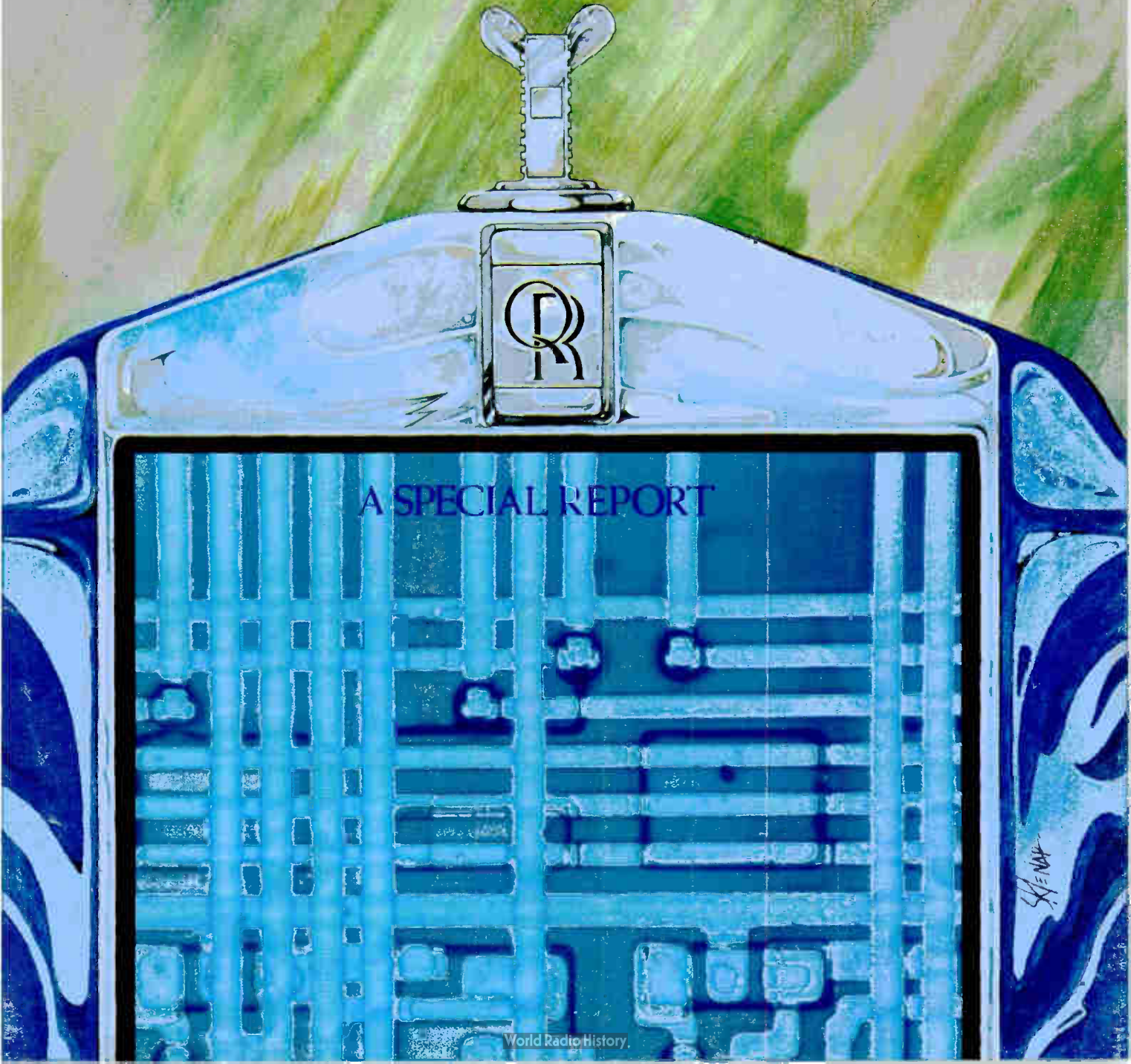

A SPECIAL REPORT

World Radio History

OUR PHILOSOPHY:

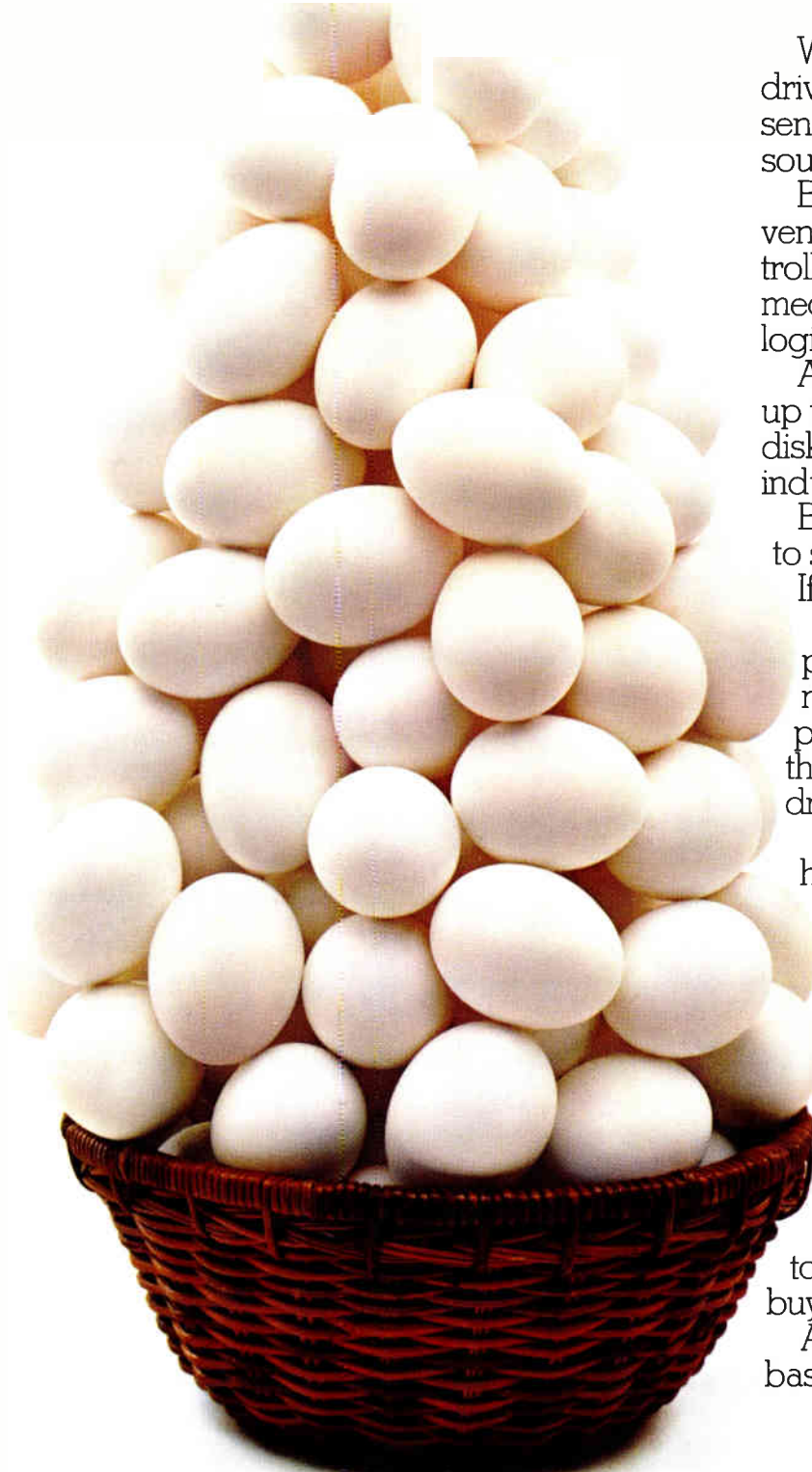

When it comes to choosing disk drives, we think it makes perfect sense to buy them all from one source.

Because dealing with several vendors means man-years of controller redesign, months for mechanical redesign and massive logistics for spare parts.

All of which costs money. In fact, up to \$500,000 for each additional disk drive vendor, according to industry estimates.

But that's money you don't have to spend.

If you specify Shugart.

We're the single source that can provide all the floppy and low-cost rigid disk drives you need for your present systems. And the source that will be able to provide the drives you need for future systems.

Thanks to our experience in high-volume manufacturing and our ongoing development of new drives.

At the same time, our application engineering team and worldwide field engineering force can minimize design time and maximize uptime. All of which saves you even more money.

Which is why you might want to rethink your philosophy about buying drives from several sources.

And put all your eggs in one basket. Ours.

Shugart

Right from the very start.

475 Oakmead Parkway, Sunnyvale, CA 94086 Telephone (408) 733-0100.

Circle 900 on reader service card

World Radio History

Chances are, the most frustrating part of your engineering problem has already been solved.

Until now, you've either had to put up with the format of a centralized or time-share system, or write your own routine analysis programs from scratch.

Now there's another alternative. With Hewlett-Packard's vast library of applications software for desktop computers, the chances are good you'll find a program that closely matches your needs. And that means a big head start in getting your solutions up and running.

Our Software Catalog lists over 300 titles, with more being added all the time. From analog and digital circuit simulations to digital filter design to microwave circuit synthesis. Many of these programs are written by engineers just like yourself, with similar applications. So you won't have to be a computer expert to get to your solutions.

And because you simply plug the applications cartridges into the computer, development time is that much shorter—usually less than a day, instead of weeks or months.

Power and local control in one compact unit.

That's the advantage of an HP desktop computer. It's an easy-to-use computing resource that gives you the power of computers many times larger (and more expensive)—without compromising the need for individual control over your application.

So take a little time to browse through our library, and save a lot of time later on. For a complete list of all the titles in our Software Catalog, return the coupon. Or write to Hewlett-Packard, Attn: Marvel Ross, Dept. 6101, 3404 E. Harmony Rd., Ft. Collins, CO 80525.



**HEWLETT
PACKARD**

Yes, I'd like to find a quicker way to solve my engineering problems. Please send me your list of desktop applications solutions included in your Software Catalog.

Name _____

Title _____

Phone _____

Company _____

Address _____

City/State/Zip _____

Mail to: Marvel Ross, Dept. 6101, 3404 E. Harmony Rd.,
Ft. Collins, CO 80525

40102
HPDC40

Now Available...

IW AMPLIFIERS

0.05-1200 MHz from \$199

- Broadband ... each model multi-octave (see table)
- High linear output ... up to 30 dBm (1 W)
- Gain ... available from 16 dB to 27 dB
- Very flat gain response ... ± 1 dB
- Connectors ... BNC Std; SMA, TNC, N available
- Compact ... 3.75" \times 2.60" \times 1.92" (ZHL-A Models)
4.75" \times 2.60" \times 2.22" (ZHL Models)
- Self-contained heat sink
- One-week delivery



ZHL-2-8

If your application requires up to 1 watt for intermodulation testing of components ... broadband isolation ... flat gain over a wide bandwidth ... or much higher output from your frequency synthesizer or signal/sweep generator ... MiniCircuits' ZHL power amplifiers will meet your needs, at surprisingly low prices. Five models are available, offering a selection of bandwidth and gain.

Using an ultra-linear Class A design, the ZHL is unconditionally stable and can be connected to any load impedance without amplifier damage or oscillation. The ZHL is housed in a rugged $\frac{1}{8}$ inch thick aluminum case, with a self-contained hefty heat sink. BNC connectors are supplied; however, SMA, TNC and Type N connectors are also available. Of course, our one-year guarantee applies to each amplifier.

So from the table below, select the ZHL model for your particular application now ... we'll ship within one week!



ZHL-1A

MODEL NO.	FREQ. MHz	GAIN dB	GAIN FLATNESS dB	MAX. POWER OUTPUT dBm 1-dB COMPRESSION	NOISE FIGURE dB	INTERCEPT POINT 3rd ORDER dBm	DC POWER		PRICE \$ EA. QTY.
							VOLTAGE	CURRENT	
ZHL-32A	0.05-130	25 Min.	± 1.0 Max.	+29 Min.	10 Typ.	+38 Typ.	+24V	0.6A	199.00 (1-9)
ZHL-3A	0.4-150	24 Min.	± 1.0 Max.	+29.5 Min.	11 Typ.	+38 Typ.	+24V	0.6A	199.00 (1-9)
ZHL-1A	2-500	16 Min.	± 1.0 Max.	+28 Min.	11 Typ.	+38 Typ.	+24V	0.6A	199.00 (1-9)
ZHL-2	10-1000	15 Min.	± 1.0 Max.	+29 Min.	18 Typ.	+38 Typ.	+24V	0.6A	349.00 (1-9)
ZHL-2-8	10-1000	27 Min.	± 1.0 Max.	+29 Min.	10 Typ.	+38 Typ.	+24V	0.65A	449.00 (1-9)
ZHL-2-12	10-1200	24 Min.	± 1.0 Max.	+29 Min.*	10 Typ.	+38 Typ.	+24V	0.75A	524.00 (1-9)

*Total safe input power +20 dBm, operating temperature 0° C to +60° C, storage temperature -55° C to +100° C, 50 ohm impedance, input and output VSWR 2.1 max. +28.5 dBm from 1000-1200 MHz

For detailed specs and curves, refer to 1980/81 MicroWaves Product Data Directory, Gold Book, or EEM.

2625 East 14th Street Brooklyn, New York 11235 (212) 769-0200
Domestic and International Telex 125460 International Telex 620156



World's largest manufacturer of Double Balanced Mixers

Mini-Circuits

MINI-CIRCUITS LABORATORY

A Division of Scientific Components Corp

C46 REV F

Circle 2 on reader service card

125 Technical Articles

A THREE-PART SPECIAL REPORT

The drive for quality and reliability, 125

COMMUNICATIONS

EE-PROM goes to work updating remote software, 155

COMPUTERS & PERIPHERALS

Single-board controller interfaces hard disks and backup media, 160

MICROSYSTEMS & SOFTWARE

Special-purpose processor makes short work of host's I/O chores, 165

DESIGNER'S CASEBOOK: 150

ENGINEER'S NOTEBOOK: 170

37 Electronics Review

- MEMORIES: Electron beam targets faults and reconfigures chips, 37
- SOLID STATE: Cleavage process offers low-cost gallium arsenide, 38
- FIBER OPTICS: Master slice forges light-wave links, 39
- MILITARY: \$320 million sought for VHSIC . . . , 40
. . . radiation threat draws attention, too, 41
- TRADE: Japan may cut semiconductor tariff, 42
- INDUSTRIAL: Motorcon to highlight motion-control progress, 44
- COMMUNICATIONS: Analog-digital functions tested simultaneously, 46
- NEWS BRIEFS: 48
- NCC: Office automation sparks show interest, 58
- Zilog bridges 8- and 16-bit gap, 62

69 Electronics International

- JAPAN: Vhf power MOS FETs aim at U. S. fm transmitters, 81
- FRANCE: Copper replaces gold in hybrid ICs, 82
- JAPAN: Kanji word processor has two-handed input, 84
- GREAT BRITAIN: Decals plus master plan speed C-MOS ULA design, 86
- NEW PRODUCTS INTERNATIONAL: 7E

97 Probing the News

- COMMUNICATIONS: Europeans plan pair of business satellites, 97
- INFORMATION PROCESSING: Videotex' direction is still far from clear, 101
- DISPLAYS: Liquid crystals lead flat-panel derby, 104
- MEMORIES: Removable cartridges inch up on disks, 106
- COMPANIES: Millennium goes on the offensive, 110

183 New Products

- IN THE SPOTLIGHT: Automatic tester troubleshoots microsystems, 183
- Trigger trace analyzer fills debugging gap, 188
- 12-bit d-a converter settles in 35 ns, 192
- MICROSYSTEMS: Faster 1802 is up in yield, 196
- Entry price falls for HP 1000 computer system, 196
- INSTRUMENTS: Six-point probe reads resistivity, 204
- Digital rf millivoltmeter has analog display, 204
- COMMUNICATIONS: Rf amplifier delivers 1,000 W, 212
- COMPUTERS & PERIPHERALS: Thermal strip-chart recorder prints its own grid, alphanumerics, 216
- A raft of disk drives makes the National Computer Conference scene, 218
- PACKAGING & PRODUCTION: Laser systems mark wafers and DIPs, 221
- Burn-in tester exercises RAM, 221
- SOFTWARE: Package brings Pascal to 8086, 227

Departments

- Highlights, 4
- Publisher's letter, 6
- Readers' comments, 8
- News update, 12
- People, 14
- Editorial, 24
- Meetings, 26
- Electronics newsletter, 33
- Washington newsletter, 65
- Washington commentary, 66
- International newsletter, 71
- Engineer's newsletter, 174
- Products newsletter, 229
- Career outlook, 231
- Services**
- Reader service card, 21E
- Employment opportunities, 232

EDITOR-IN-CHIEF: Samuel Weber

MANAGING EDITORS
Technical: Raymond P. Capece,
Alfred Rosenblatt
News: Gerald M. Walker
International: Arthur Erikson

ASSISTANT MANAGING EDITORS:
Howard Wolff, Margaret Eastman

SENIOR EDITORS: Ray Connolly, Bruce LeBoss

ART DIRECTOR: Fred Sklenar

ASSOCIATE EDITOR: Benjamin A. Mason

DEPARTMENT EDITORS
Aerospace/Military: Ray Connolly
Circuit Design: Vincent Biancamano
Communications & Microwave:
Harvey J. Hindin
Computers & Peripherals: Tom Manuel
Industrial/Consumer: Gil Bassak
Microsystems & Software: R. Colin Johnson
New Products: Jeremy Young,
Packaging & Production: Jerry Lyman
Solid State: John G. Posa
Test, Measurement & Control:
Richard W. Comerford

CHIEF COPY EDITOR: Margaret Eastman

COPY EDITORS: Mike Robinson,
Charlotte Wiggers, David Kach

ART: Charles D. Clatto, *Associate Director*
Paula Piazza, *Assistant Director*

EDITORIAL ASSISTANT: Penny Reitman

EDITORIAL SECRETARIES: Patricia Randall,
Dawn Ramsay, Janice Jung,
Christina Lindauer

REGIONAL EDITORS

Boston: James B. Brinton,
Linda Lowe (617) 262-1160

Chicago: Wesley R. Iversen (312) 751-3806

Costa Mesa: Terry Costlow (714) 557-6292

Dallas: J. Robert Lineback (214) 742-1747

Los Angeles: Larry Waller (213) 487-1160

Palo Alto: Bruce LeBoss, *Manager*
Martin Marshall, *Computers & Instruments*
(415) 968-2712

Washington: Ray Connolly (202) 624-7592

Frankfurt: John Gosch 72-5566

London: Kevin Smith 493-1451

Paris: Arthur Erikson,
Robert T. Gallagher 720-20-70

Tokyo: Charles Cohen,
Robert Neff 581-9816

McGraw-Hill WORLD NEWS

Michael Johnson, *Editor*, James Smith, *Brussels*

Lois Bolton, *Milan*; Alex Beam, *Moscow*

Robert Skole, *Stockholm*

PUBLISHER: Paul W. Reiss

GENERAL MANAGER, DIRECT MARKETING
OPERATIONS: Horace T. Howland

DIRECTOR OF CIRCULATION: Frederick J. Kostbar

RESEARCH MANAGER: Margery D. Sholes

PROMOTION MANAGER: Jane De Court

MARKETING ADMINISTRATION MANAGER:
Frances M. Vallone

BOOKS & SPECIAL PROJECTS MANAGER:
Janet Eylar

Cover: Quality and reliability efforts move into high gear, 125

Pressed hard on one side by strong competition and on the other by the demands of customers who themselves are feeling a competitive prod, U. S. semiconductor firms have embarked on ambitious programs to boost the quality and reliability of their products. This special report takes a detailed look at the reasons for and the nature of these efforts. Part 1 covers the changes chip makers are effecting in manufacturing, from technology and design to failure analysis (p. 125). Part 2 focuses on the organizational techniques and structures management is bringing to bear to make quality and reliability the concern of virtually every employee (p. 137). Part 3 discusses the needs of equipment makers (p. 141).

The cover is by Art Director Fred Sklenar.

Videotex schemes abound, 101

The announcement of AT&T's entry into the fray at this week's Videotex '81 conference in Toronto highlights the fact that the technology and business of providing data services to homes and businesses is not only still in the infant stage, but highly unsettled as well. AT&T will join Britain's Prestel and Ceefax, France's Antiope, and Canada's Telidon, with Japan off on its own and the U. S. an open field.

EE-PROM calls on telephone for software update, 155

An electrically erasable programmable read-only memory has come to the aid of microprocessor-based systems that need frequent revision. This fast, link-addressable read-mostly memory is especially suited for downline loading and can be updated inexpensively by telephone.

Single-board controller for storage devices is not choosy, 160

An intelligent controller shows itself to be highly adaptable: capable of handling Winchester, floppy-disk, and streaming tape drives for both primary and backup storage, it adapts the transfer rates to suit a wide variety of host systems.

I/O processor minimizes additional timing circuitry, 165

A one-chip peripheral controller for microsystems has been designed to be both intelligent and easy to hook up. It achieves the former by relying on a microcomputer for its core and the latter by adding such specialized hardware as a dual-ported random-access memory and semaphore registers.

And in the next issue . . .

The Japanese semiconductor industry: a special report . . . testing bubble memories . . . a second-generation 16-bit microprocessor chip set . . . linearizing thermistors.

May 19, 1981 Volume 54, Number 10
105,303 copies of this issue printed

Electronics (ISSN 0013-5070). Published every other Tuesday except the issue of Monday, Nov. 30, by McGraw-Hill, Inc. Founder: James H. McGraw 1860-1948. Publication office: 1221 Avenue of the Americas, N.Y., N.Y. 10020; second class postage paid at New York, N.Y., and additional mailing offices.

Executive, editorial, circulation and advertising addresses: Electronics, McGraw-Hill Building, 1221 Avenue of the Americas, New York, N.Y. 10020. Telephone (212) 507-1221. Teletype 12-7960 TWX 710-581-4879. Cable address: MCGRAW HILL NEW YORK.

Subscriptions limited to professional persons with active responsibility in electronics technology. No subscriptions accepted without complete identification of subscriber name, title or job function, company or organization, and product manufactured or services performed. Based on information supplied, the publisher reserves the right to reject non-qualified requests. Subscription rates: in the United States and possessions \$19 one year, \$32 two years, \$47 three years; company addressed and company libraries \$24 one year, \$42 two years, \$59 three years. Canada and Mexico \$20 one year, \$33 two years, \$48 three years; Europe \$50 one year, \$85 two years, \$115 three years; Japan, Israel and Brazil \$70 one year, \$115 two years, \$165 three years; Australia and New Zealand \$95 one year, \$170 two years, \$240 three years, including air freight; all other countries \$50 one year, \$85 two years, \$125 three years. Limited quota of subscriptions available at higher-than-basic rate for persons allied to field served. Check with publisher for these rates. Single copies: \$6.00. Please allow four to eight weeks for shipment.

Officers of McGraw-Hill Publications Company: Paul F. McPherson, President; Executive Vice Presidents: James E. Boddorf, Gene W. Simpson; Group Vice President: Daniel A. McMillan; Senior Vice President:

Editorial: Ralph R. Schulz; Vice Presidents: Kemp Anderson, Business Systems Development; Robert B. Doll, Circulation; James E. Hackett, Controller; Eric B. Herr, Planning and Development; H. John Sweger, Marketing.

Officers of the Corporation: Harold W. McGraw, Jr., President, Chief Executive Officer, and Chairman of the Board; Robert N. Landes, Senior Vice President and Secretary; Ralph J. Webb, Treasurer.

Title registered in U.S. Patent Office; Copyright © 1980 by McGraw-Hill, Inc. All rights reserved. The contents of this publication may not be reproduced in whole or in part without the consent of copyright owner. Where necessary, permission is granted by the copyright owner for libraries and others registered with the Copyright Clearance Center (CCC), 21 Congress Street, Salem, MA 01970, to photocopy any article herein for the base fee of \$0.50 per copy of the article plus \$0.25 per page. Payment should be sent directly to the CCC. Copying done for other than personal or internal reference use without the express permission of McGraw-Hill is prohibited. Requests for special permission or bulk orders should be addressed to the publisher. ISSN 0013-5070/81\$0.50+.25.

Subscribers: The publisher, upon written request to our New York office from any subscriber, agrees to refund that part of the subscription price applying to copies not yet mailed. Please send change-of-address notices or complaints to Fulfillment Manager; subscription orders to Circulation Manager, Electronics, at address below. Change-of-address notices should provide old as well as new address, including zip codes. Attach address label from recent issue. Allow one month for change to become effective. Subscriber Service: call (609) 448-8110, 9 a. m. to 4 p. m. EST.

Postmaster: Please send form 3579 to Fulfillment Manager, Electronics, P.O. Box 430, Hightstown, N.J. 08520.

We're proud of our tiny part in the space shuttle program.

Thousands of products have contributed to the successful launch and return of the space shuttle, Columbia. And our products were among the tiniest.

By design.

Entran manufactures a broad line of ultra-miniature accelerometers and pressure transducers. These tiny, high accuracy instruments have very little mass to interfere with the system being tested, and won't distort your test scale.

Because they are so small they can be mounted almost anywhere for the ultimate in applications flexibility. And they leave plenty of room for other electronics.

Our devices have been used to obtain critical test data for the Columbia throughout its development. From the early scale-model wind tunnel tests, to main engine testing, through full-scale vibration testing of the entire shuttle and into actual flight.

Now our devices will be used to gather data for a series of intricate on-board experiments.

Our products are rugged enough to function in the toughest applications.

To find out how our tiny accelerometers and pressure transducers can help you, please write to: Entran Devices, Inc., 10 Washington Avenue, Fairfield, N.J. 07006. Or call (201) 227-1002.

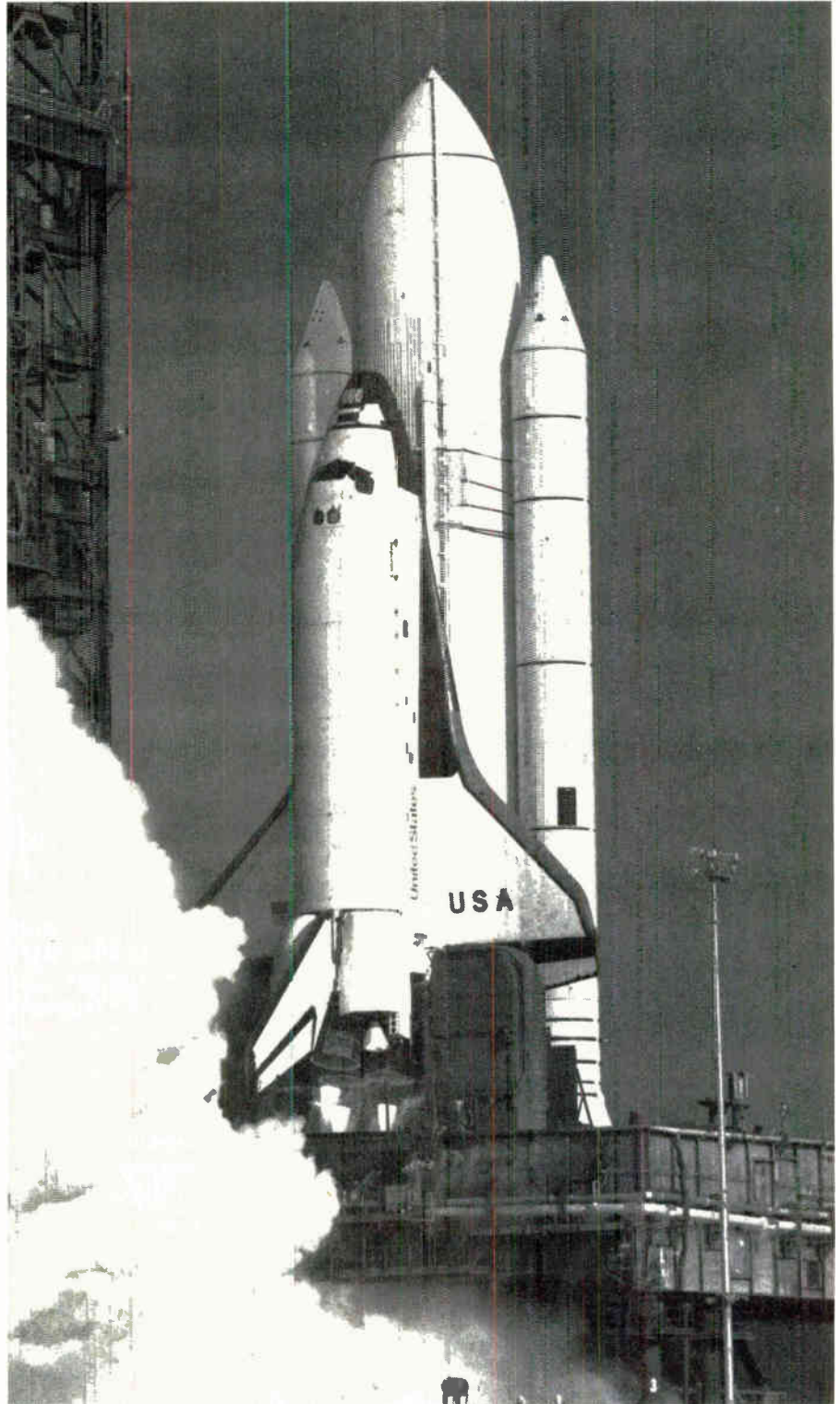

Pressure transducer.
EPI-080, only 0.080" diameter.



Accelerometer.
EGA-125D, less than 0.5 gram.

Entran Devices, Inc.

(Our tiny products help make big projects possible.)

Never before...

200 watts of RF power with incredible versatility.

3200 L spans
250 kHz to 150 MHz.



Now there's a completely solid state power amplifier that provides 200 watts of linear power over a frequency range from 250 kHz to 120 MHz. And at 175 watts, the range extends to 150 MHz.

Imagine the wide range of applications you can cover with this single Class A linear unit. All you need is any standard signal or sweep generator and you have the ultimate in linear power for RFI/EMI testing, NMR, RF Transmission, and general laboratory applications.

And, like all ENI power amplifiers, the 3200 L features unconditional stability, instantaneous failsafe provisions, and absolute protection from overloads and transients.

The 3200 L represents a breakthrough in RF power versatility and packaging. Never before has there been anything like it commercially available anywhere!

Contact us for a demonstration of the 3200 L and our complete catalog on the other amplifiers in our wide line. ENI, 3000 Winton Road South, Rochester, NY 14623.

Call 716/473-6900, or Telex 97-8283 ENI ROC.

ENI



The advanced
design line of
power amplifiers

Publisher's letter

The dedication and enthusiasm are hard to miss. The commitments are strong. The results are paying off.

These statements describe the quality movement that is sweeping the electronics industries, particularly the semiconductor companies and their major customers. The special report starting on page 125 analyses the various aspects of this trend in the U. S. semiconductor industry.

Prepared by Al Rosenblatt, technical managing editor, and Jerry Lyman, packaging and production editor, this report is the result of interviews conducted at dozens of companies by our staff in the U. S., Japan, and Europe.

"If there is one message that comes through," comments Al, "it is that quality is profitable. By removing the costs of rework, the damage from lost business, and the belief that quality can only come from testing, testing, and more testing, these programs have had an impact on the bottom line."

The report has three parts covering the melding of quality into the entire manufacturing process, the organization of people into quality programs, and finally a perspective on how users' demands are affecting the quality movement.

The first part covers the gamut of integrated-circuit manufacture from front end, assembly, and packaging to test, failure analysis, and even customer interface. In preparing this part Jerry found that two elements of enormous importance to quality as perceived by users have nothing to do with design. One is the large percentage of "failures" caused by errors in order paperwork, mislabeled parts, and components that get into the wrong bin—in other words,

nonelectrical causes. The second is the problem of test correlation, that is, making sure that the vendor and the buyer are testing the same parameters in the same way.

The examination of quality organizations brought a variety of company styles to light. The movement has caused some unusual changes. Managers are being rated on quality performance as well as revenues. Quality circles are participating in "bottom-up" decision making. Perhaps most important, top management is putting its strong stamp of approval on the quality programs.

As for the users—they're demanding a lot these days. In fact, some of the top companies have completely altered the definition of acceptable quality levels by moving required failure rates from 1,000 parts per million to 100 or 200 ppm. In addition, some aim to eliminate incoming inspection and, in effect, to go from receiving dock to production line. Pressure for quality improvement is coming from computer companies and auto companies, in large part because they also view quality as a competitive weapon. Consumer electronics companies are also cracking down for much the same reason.

Another important point emerges from this report—the quality programs are in place to stay. These are not crash programs that will fade away during the next market boom. If anything, the electronics industries may be setting the pace for others.

Wanted: a Business Trends editor

A newly established department of the New York editorial staff of *Electronics* offers a unique opportunity for a skilled communicator interested in the business side of technology. We seek an experienced business journalist with a good statistical or market research background in the electronics field. An EE or an MBA in market research or an economics degree would be eminently desirable. Send your résumé to the Editor-in-Chief, *Electronics*, 1221 Avenue of the Americas, New York, N. Y. 10020.

Our up-to-date techniques have enabled one-touch operation. Compact and Economical Gang P-ROM Programmer Model 1861

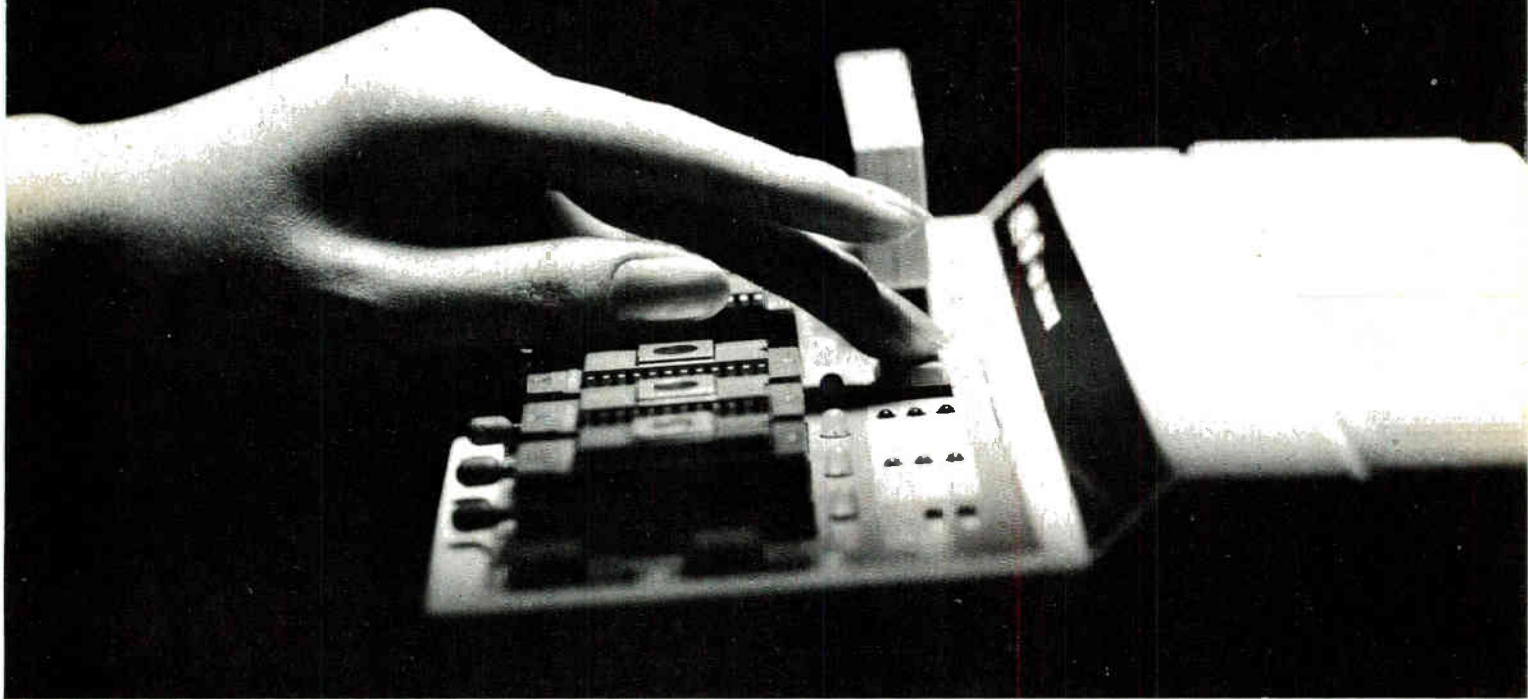

Mode specification is also feasible through the one-touch button operation. Excellent performance and operability are built in the compact cabinet designed for simultaneous multi-programming of up to 8 MOS devices. Multi-programming is also essentially a one-touch operation.

“Model 1861” permits simultaneous programming of 8 MOS devices through one-touch operation.

The Model 1861 is designed to permit simultaneous multi-programming of up to 8 MOS devices through one-touch operation. The mode may be specified by the one-touch button operation. Three kinds of select cards are supplied. A serial I/O, specified by the customer capable of editing data is contained in the standard configuration. In addition, a PTR (option) with a high speed of 400 ch/sec. may be externally contained. Excellent performance now comes in a compact size.

- i2716 (i2758), i2732, i2732A, TMS2532 and compatible. (selected by three supplied select cards.)

“Model 1860” meets a wide variety of applications through one-touch operation.

The Model 1860 is capable of programming MOS and bipolar devices through the replacement of the personal and socket module. Operations may be performed by the one-touch pressing of the mode button. The specifications of the PTR and data editing are the same as those of Model 1861.

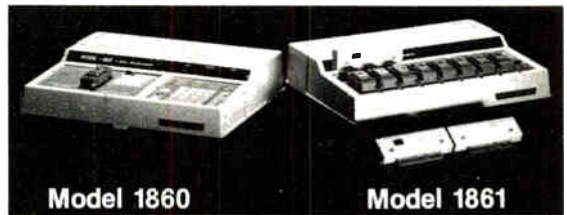

P-ROM Programmers Model 1860 Series			
		Model 1860	Model 1861
Interface (standard)	Serial	RS-223C and 20mA current loop (or TTL level) switch selectable.	RS-232C, 20mA current loop, or TTL level selectable as specified when ordering
	Parallel	PTR parallel interface PTR (PRE-400A option) with a rate of 400 ch/sec.	
Size, weight		290 (W) × 208 (D) × 65 (H) mm, 2.5kg	290 (W) × 208 (D) × 75 (H) mm, 3.5kg



MINATO ELECTRONICS INC.

4105, Minami Yamada-cho, Kohoku-ku, Yokohama, 223, Japan Phone: 045-591-5611
Cable: MINATOELEC YOKOHAMA
TELEX: 3822-244 MINATO J

Circle 7 on reader service card

Plastic Film Capacitors

Lead Spacing 5 mm

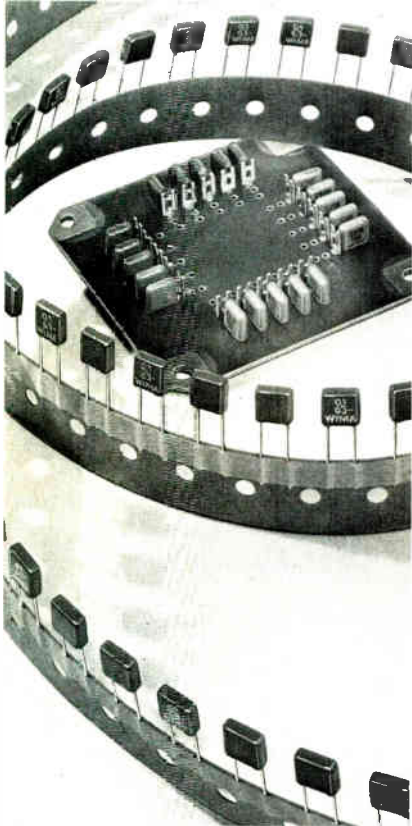

- Space saving design up to 1 μF
- High capacitance/temperature stability
- Suitable for automatic insertion; available on tape for volume usage

WIMA MKS 2

Metallized polyester type providing extremely small dimensions at maximum capacitance/volume efficiency.

Ranges also include WIMA FKS 2/ WIMA FKC 2/ WIMA FKP 2: polyester/ polycarbonate/polypropylene with metal foil electrodes.

WIMA PCM 5 mm
Capacitors:

Tomorrow's technology!



WILHELM WESTERMANN

Spezialvertrieb elektronischer Bauelemente
P. O. Box 2345 · D-6800 Mannheim 1
Fed. Republic of Germany

U.S. Sales Offices:

THE INTERNATIONAL GROUP INC.

North Dearman Street · P. O. Box 23
Irvington · New York 10533 · (914) 591-8822

TAW ELECTRONICS CO.

4215 W. Burbank Blvd., Burbank
California 91505 · (213) 846-3911

Readers' comments

Is ECL losing ground?

To the Editor: Regarding "Low-V inverter logic outperforms ECL yet saves power" [Feb. 24, p. 41], the low-voltage inverter (LVI) configuration described by IBM Corp.'s Richard Konian appears to be an extension of the basic TTL totem-pole output circuit. Use of capacitors as suggested will give rise to undesirable repetition-rate and duty-cycle effects on the circuits' switching performance. In addition, I find the circuit (barring misprint error) lacks a threshold or sharp transition region (V_{in} versus V_{out} transfer curve) between 1 and 0 states. Perhaps this circuit was intentionally designed to be another variation of nonthreshold logic (NTL). In any event, I predict the computer industry will continue using emitter-coupled logic until a truly better circuit is invented.

Walter C. Seelbach
Fountain Hills, Ariz.

■ **The author replies:** *ECL is a circuit technology with a formidable and well-deserved reputation. I personally hold ECL in high esteem; I'm sure computer designers will place it high on their list of circuit technologies to be considered for future products. Perhaps someday the low-voltage inverter (LVI) will make that list, too.*

I want to stress that the LVI circuit is at this point an experimental technology. Preliminary findings suggest that it has potential as an attractive alternative to ECL and TTL, but I cannot claim that the LVI will replace any existing technologies.

Mr. Seelbach is correct in pointing out that the LVI is in fact a variation of nonthreshold logic. However, LVI is significantly different from the basic TTL totem-pole output circuit and has only one emitter-base junction to turn on and off, all of which reduces signal swing and hence raises performance.

The TTL totem pole has two emitter-base junctions to turn on and off, and they are connected through an emitter-follower action that further reduces the gain. Therefore, to achieve full circuit turn-on and turn-off, a larger signal is required. Reduced performance is the net result. Also, TTL has a longer electrical path than does LVI between input and output.

LVI has no problem with repetition-rate and duty-cycle effects because the correct RC time constraints are chosen in the emitter branches. The circuit's switching performance is unhampered because the capacitors discharge in step with the rise time. This means the circuit is available for complete switching capability on all of the subsequent signal inputs.

Helping the healthy

To the Editor: We were very pleased to see our good friend Q. T. Wiles featured in the April 7 People column [p. 14]. However, Mr. Wiles, though a shareholder and a director of Corcom Inc., has at no time taken over the company, nor has he made any attempt to. He may have helped "established but financially troubled firms get back on a growth curve," but Corcom has never been financially troubled and was on a fast growth curve for several years prior to Q. T.'s association with us. As a director, he has given us counsel, constructive criticism, and guidance. This has been invaluable in helping us to remain the leader in the power-line, radio-frequency-interference filter business.

Werner E. Neuman
Corcom Inc.
Libertyville, Ill.

Corrections

In "One-chip alarm scares auto thieves" (May 5, p. 146), several errors crept in.

First, what is shown in the schematic as a hidden switch is actually the car's courtesy light; the hidden switch connects all lines marked 12 V to the car battery. Next, though R_2 is not identified, it is the 100-kilohm resistor in the upper right-hand corner of the schematic; C_2 should be 2,000 microfarads. Finally, the transistor and diode driving the horn relay should be types BD135 and 1N4001, respectively, or the equivalent.

In the same issue, in "Compiler set unifies high-level languages for easy OEM multilingual capability" (p. 40), the phrase "for Basic C" in the second paragraph should read "for Basic and C languages."

The Associate Producer.

IMMEDIATE
DELIVERY

820 RO Receive-Only Printer

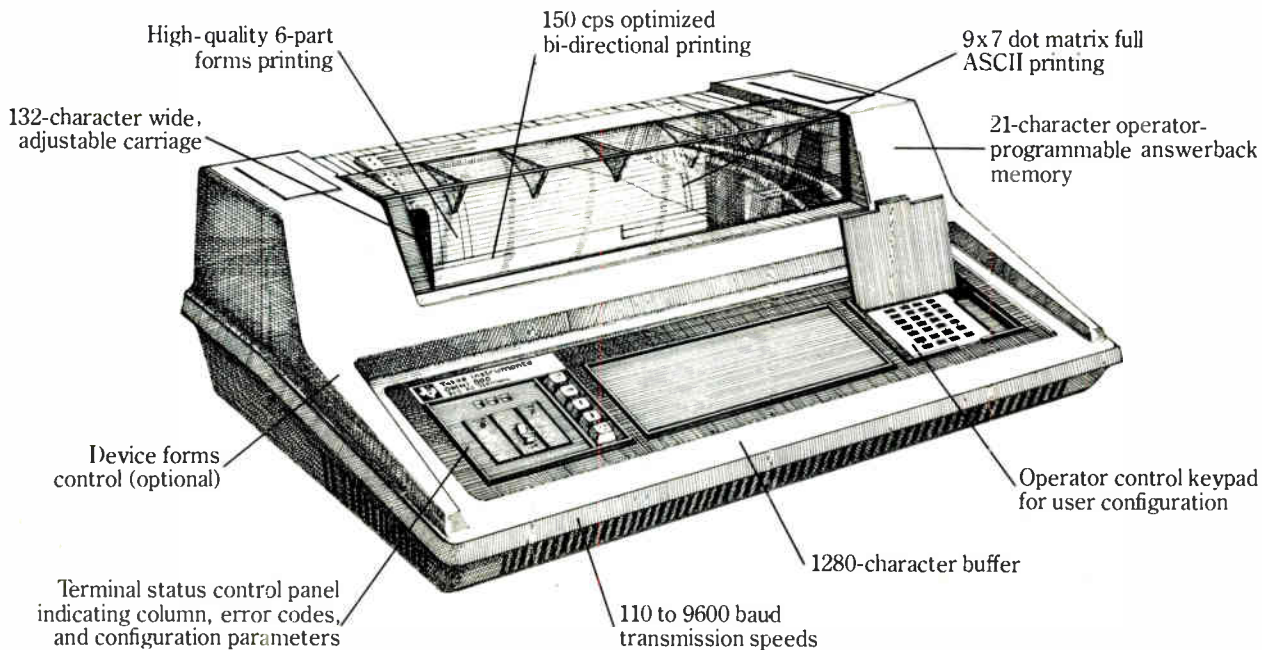

The OMNI 800* Model 820 RO Printer has the same designed reliability as its associate, the 810 RO. With more standard features and options like expanded and compressed printing, the 820 RO offers greater flexibility for additional applications. And, should application needs change, the 820 RO is easily upgraded to a KSR model for a modest cost. The productive 820 RO Printer has all the quality and performance you associate with the OMNI 800 Family.

TI is dedicated to producing quality, innovative products like the Model 820 RO Printer. TI's hundreds of thousands of data terminals shipped worldwide are backed by the technology and reliability that come from 50 years of experience, and are supported by our worldwide organization of factory-trained sales and service representatives.

For more information on the 820 RO, contact the TI sales office nearest you. In Europe, write Texas

Instruments, M/S 74, B.P.5, Ville-neuve-Loubet, 06270, France, or phone (93) 20 01 01. In Asia Pacific, write Texas Instruments Asia Ltd., 990 Bendeemer Rd., Singapore 1233. Telex RS 21399, or phone 2581122.



*We put computing
within everyone's reach.*

*Trademark of Texas Instruments Copyright © 1981, Texas Instruments Incorporated.

TEXAS INSTRUMENTS
INCORPORATED

Circle 126 on reader service card

The International
guarantees these ele
parameters over the
ture range: 0.1% on M
0.2% on Bipolar Logi
on Linear, LSI Log

INT. STD. 123

Standard of Quality
Statistical AQLs on all
operating tempera-
tures; OS RAMs & ROMs;
Logic & Interface; 0.3%
Failure rate & other memories.

We changed the rules. We decided this business needed a nice new set of AQLs. And here they are. Guaranteed. Talk to us about all the parts you can get with INT-STD-123 for free. We don't make them like they used to.

Advanced Micro Devices 

901 Thompson Place, Sunnyvale, CA 94086 · (408) 732-2400

Now RCA Microboards go to extremes.

RCA CMOS Microboards now operate from -40°C to +85°C.

- Extended temperature range on most boards, including:
 - all computer boards
 - memory boards
 - digital I/O
 - analog I/O
- Burned-in at 85°C for 72 hours.
- 100 percent function-tested before and after burn-in.
- **All this at no extra cost.**

The extended temperature range, combined with the low power consumption, high noise immunity and portability of CMOS, make these boards ideal for:

- Remote data acquisition

- Outdoor control systems
- Hostile industrial environments
- Environmental monitoring.

Now RCA CMOS Microboards can run hot or cold for only \$99.* For a complete list and pricing of these Microboards contact any RCA Solid State sales office or appointed distributor.

Or contact RCA Solid State headquarters in Somerville, N.J. Brussels, Belgium. Sao Paulo, Brazil. Hong Kong. **Or call Microsystems Marketing toll-free (800) 526-3862.**

* U.S. optional distributor resale, 100+ price, 604 Microboard computer

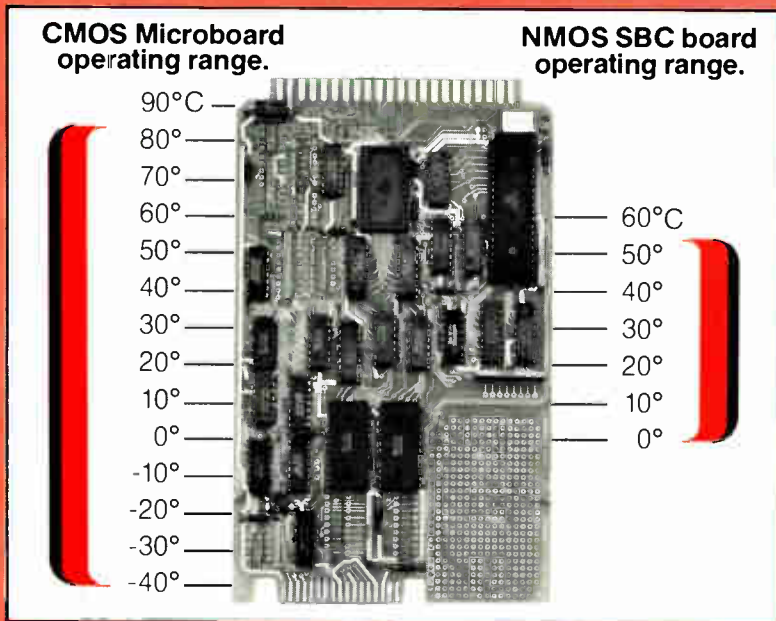

RCA

**Another reason to
switch to CMOS.**

Circle 12 on reader service card

World Radio History

News update

■ The U. S.-originated chip-packaging technology of tape automated bonding is fast becoming an international affair. Now manufacturers of the tape and of the bonding equipment and other production gear are beginning to appear in Europe, particularly in France and Switzerland.

As it happens, France is one of the world leaders in the application of TAB technology to automated assembly lines [*Electronics*, Dec. 18, 1980, p. 100]. The large digital hybrids of CII-Honeywell Bull are notable examples, as are the chips used in the Swiss watch industry.

In TAB technology, integrated circuits are soldered by automated mass bonding machines to the inner lead pattern of spiderlike copper interconnections that are etched on successive frames of a copper-coated insulating film. Then the tape carrier can be bonded to a hybrid substrate, a dual in-line package, and so on.

It is clear that the influence of the CII-Honeywell Bull and Swiss TAB operations has given impetus to the new European suppliers. Among these are:

■ Rhône-Poulenc Systemes SA in Creteil, France, which is supplying three-layer tapes with several different sprocket formats for reels of TAB chips—35, 16, or Super 8 millimeter—and made of either polyester or polyimide materials.

■ In Switzerland, Nivarox SA in La Chaux de Fonds is beginning to supply three-layer polyester or polyimide tapes in widths of 8 to 175 mm.

■ As for tape-handling and bonding equipment, another Swiss operation, the Farco division of Les Fabriques d'Assortiments Réunies SA in Le Locle, is offering several outer-lead bonders aimed at the hybrid market and a mechanism that permits testing TAB chips on reels (licensed from CII-Honeywell Bull).

Meanwhile, back in the U.S., Exxon Chemical Americas has closed its Bayport industrial complex south of Houston, thereby terminating its production of Tradlon polyparabanic acid film. This demise leaves the TAB field clear for DuPont's polyester and polyimide to be the favored materials.

-Jerry Lyman

Electronics/May 19, 1981

Piher Introduces...

METAL FILM RESISTORS

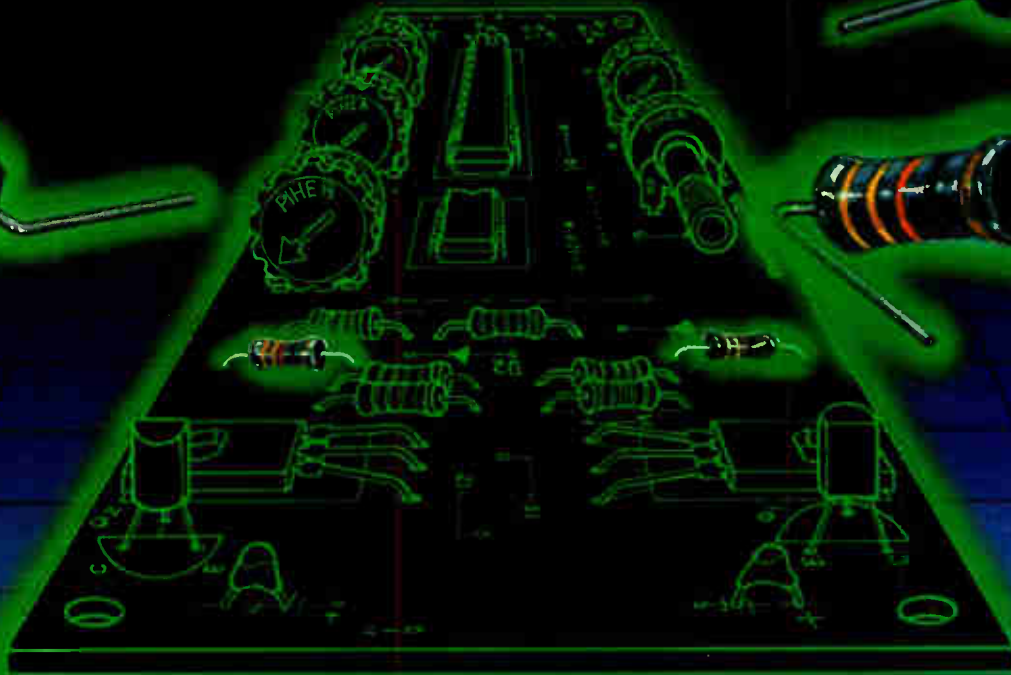

The latest electronic circuitry requires the use of more sophisticated components. At Piher we're looking into your future. So now, besides our complete line of carbon film resistors, 10mm and 15mm trimmers, slide potentiometers, and even zero ohm resistors, we can also supply you with precision metal film resistors.

With a tolerance of 1% and temperature coefficients of either 50ppm/°C or 100ppm/°C, the Piher lacquered metal film resistor is designed to fit the needs of your critical circuits. And



soon, we'll have the semi-precision 2% and 5% metal film resistors at a cost that will make carbon composition resistors obsolete.

Call toll free 800-323-6693 today for more detailed cost and technical information on this advanced circuitry component.

Piher International Corporation, 505 West Golf Road, Arlington Heights, Illinois 60005, 312-640-8300.



PIHER

"at the heart of today's technology"

Circle 13 on reader service card



Textool is your best "single source" for test *and* production sockets!

Now, Textool applies its years of experience as a leading supplier of zero insertion pressure (ZIP) and other test sockets to offer you the convenience of filling your test and production socket requirements from a single source.

Textool's expanding line of specialized ZIP DIP®, pin grid and chip carrier production sockets is designed with the durability and quality required for a test environment, yet in sizes and at low costs essential to production sockets.



As IC's become more complex and expensive, socket quality and design are of ever increasing importance. The value of one destroyed device well exceeds the total cost of buying several sockets. Considering this fact,

Textool continues to design quality and reliability into all their sockets to help keep your test and production expenses at an absolute minimum.



Detailed information on Textool's complete line of sockets/carriers for test, burn-in and production applications is available on request.

**Textool Products Department
Electronic Products Division/3M**
1410 W. Pioneer Dr., Irving, TX 75061
214/259-2676



People

Mathewson tells Americans that Scotland is the place

The word from Scotland, according to George Mathewson, is actually an offer: "Let's do business." For Mathewson, the new chief executive of the Scottish Development Agency in Glasgow, that means convincing high-technology firms seeking an entrée to the European Economic Community that Scotland is the place for their new plants.

The 40-year-old engineer—he holds a doctorate in electrical engineering from St. Andrew's University in Fife and an MBA from Canisius College in Buffalo, N. Y.—is uniquely equipped to talk to American executives about Scotland. He spent five years working in Buffalo for Bell Aerospace Corp., where he managed research and development in advanced avionics systems.

Mathewson is enthusiastic about the attractions of his homeland and its 5 million people. "Scotland has a history of technologically advanced innovation that goes back two centuries—Scottish engineers have had a role in most of the major developments that gave the world its industrial base," he says.

For electronics companies, the country is an ideal location, he maintains. "We offer membership in the common market and the low tariffs that go with it, a sophisticated engineering society with eight technical colleges, a skilled labor force, and a strong work ethic. In fact, the average worker loses only one day a year because of strikes. What's more, our people are used to working for foreign firms and have a strong international attitude," he adds.

Mathewson tends to downplay the current competition with Ireland for American investment. "They are doing an excellent selling job," he says, "but we've been doing it longer and have many more electronics companies from the U. S. Some of our other American companies have been in place since the beginning of the century."

The Scots apparently have been doing a bit of selling: employment in



Enticements. George Mathewson sings the virtues of Scotland as a European base.

foreign companies has grown from 8% of the total of manufacturing workers in 1964 to 17% in 1980. And, as a final word to the wise, Mathewson points out that if U. S. companies do not invest in Europe, the Japanese will.

Carlson says it in software for Western Digital systems

In selecting an executive with software expertise rather than a hardware background, Western Digital Corp. has established early on the importance of programming in its push to enter the microcomputer systems market. That executive, William E. Carlson, new vice president and general manager of the firm's Advanced Systems division, says the operation will become one of the three major product areas for the Newport Beach, Calif., company.

The 34-year-old Carlson recently ended a five-year stint as program manager of the Defense Advanced Research Project Agency's software technology group, heading that agency's role in the development of Ada [*Electronics*, Feb. 10, p. 127]. Prior to that, he supervised a programming team at U. S. Air Force headquarters in Washington, D. C. Although his background in the evolution of the new language outfitted him for the development of Ada products currently being designed,

LSI-11[®] AND PDP-11[®] DISK STORAGE SUBSYSTEMS



COST EFFECTIVE/HIGH PERFORMANCE

First Computer Corporation offers a wide range of CMD/SMD/MMD/FMD disk storage subsystems for PDP-11 computer systems. These subsystems offer users a cost effective—high performance alternative for applications demanding large capacity disk storage.

HARDWARE/SOFTWARE COMPATIBILITY

All disk storage subsystems utilize Emulex microprogrammed emulating controllers which are fully software transparent to both the PDP-11 hardware and software.

INSTALLATION AND SERVICE

First Computer can provide installation and service for end-users desiring on-site warranty. Responsive service can be provided by over forty Control Data field service centers located in most major metropolitan areas.

REPUTATION AS A LEADER IN PDP-11 SYSTEMS

First Computer Corporation has built a reputation based on quality, reliability and service. During the last five years we have shipped over 1,000 PDP-11 systems to satisfied customers worldwide. We continue to protect this reputation by offering only the very best. Disk storage subsystems can be provided to meet most application requirements from the following selection guide:

HIGHEST QUALITY AND SUPER RELIABILITY

The disk drives utilized in these subsystems are manufactured by Control Data Corporation the world's largest independent supplier of peripheral equipment. Control Data builds quality and reliability into its disk drives because CDC designs and manufactures each of the critical components—heads, media and servo.

FULLY INTEGRATED AND TESTED

ALL disk storage subsystems are configured, integrated, and tested by First Computer Corporation to provide you with a totally plug-compatible disk storage subsystem. These subsystems can be installed on your system and be up and running the standard DEC diagnostics and operating systems within minutes.

MODEL	STORAGE CAPACITY		OPERATING SYSTEM EMULATION		MODIFIED HANDLER
	Removable	Fixed	RT-11	RSX11-M / RSTS/E	
9448-32	16	16	2 13.7MB RPO2's	2 13.7MB RPO2's	YES
			2 13.9MB RK06's	2 13.9MB RK06's	NO
9448-64	16	48	4 13.7MB RPO2's	4 13.7MB RPO2's	YES
			4 13.9MB RK06's	4 13.9MB RK06's	NO
9448-96	16	80	6 13.7MB RPO2's	6 13.7MB RPO2's	YES
			6 13.9MB RK06's	6 13.9MB RK06's	NO
9730-80	—	80	3 20.8MB RPO2's	3 20.8MB RPO2's	NO
			1 67.4MB RMO2	1 67.4MB RMO2	NO

MODEL	STORAGE CAPACITY		OPERATING SYSTEM EMULATION		MODIFIED HANDLER
	Removable	Fixed	RT-11	RSX11-M / RSTS/E	
9730-160	—	160		2 67.4MB RMO2's	NO
9762	80	—	3 20.8MB RPO2's	3 20.8MB RPO2's	NO
				1 67.4MB RMO2	NO
9766	300	—		1 253.7MB RPO6	YES
				1 256.1MB RMO2	YES
9775		675		1 552.5MB RPO6	YES
				1 552.5MB RMO2	YES

CDC-1

- © Registered trademark of Control Data Corporation
- © Registered trademark of Emulex Corporation
- © Registered trademark of Digital Equipment Corporation
- ™ Trademark First Computer Corporation



TWX NUMBER 910-651-1916

computer corporation
corporate square/825 north cass avenue/westmont, illinois 60559/(312) 920-1050

SOUTHERN REGION
Houston, TX (713) 960-1050

WESTERN REGION
California (To be announced)

NORTH CENTRAL REGION
Chicago, IL (312) 920-1050

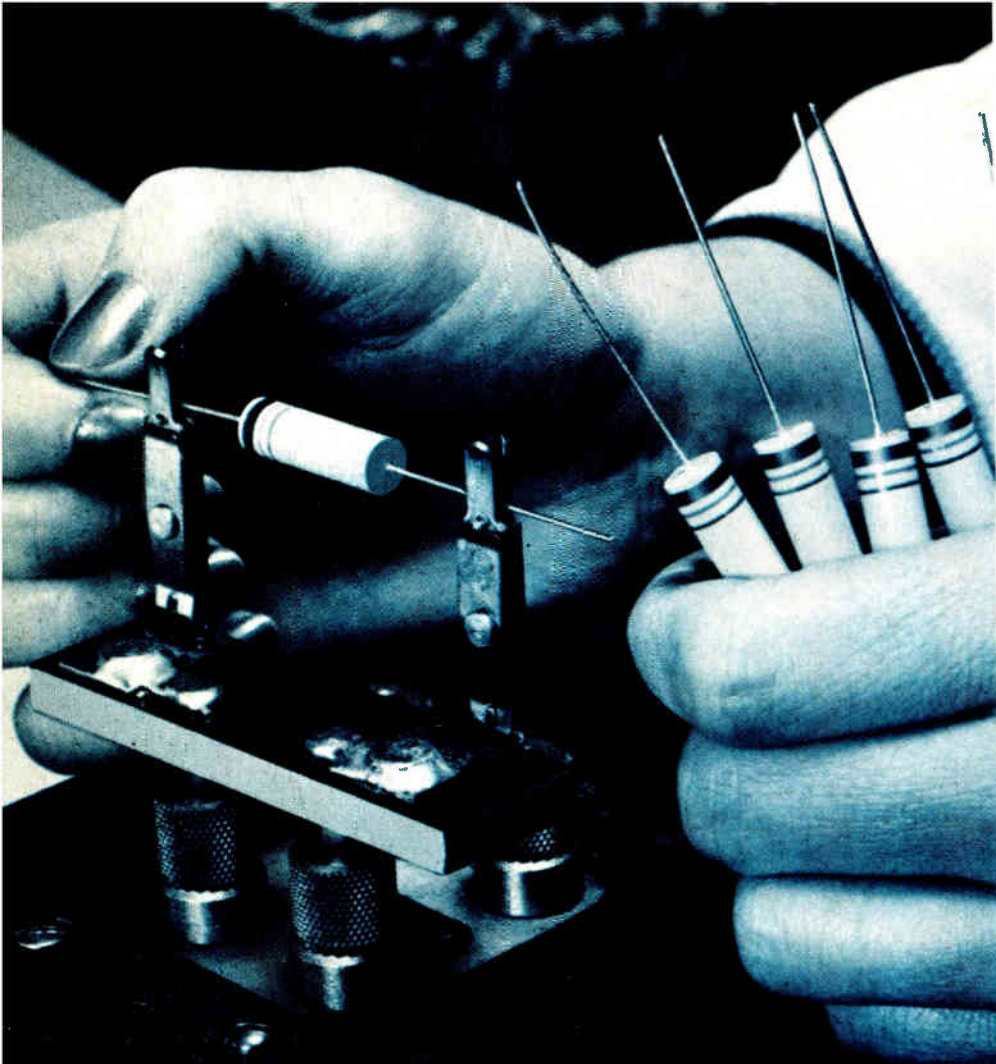

The 30 years experience built into this coil is your assurance of maximum reliability.

Over 30 years experience in producing coils to meet rigid military and aerospace specifications has established a firm tradition of quality at Delevan. This very real concern for dependable performance is reflected in all Delevan inductive components, whatever their end use might be.

At every production stage from material selection, coil winding and encapsulation, to final testing, calibration, identification and packing, our own rigid standards of quality control are your assurance of maximum reliability at a realistic price. Why gamble on the reliability of your product with second best components.

When your reputation is on the line, only the best is good enough. Get all the facts from your local Delevan representative or call the factory direct.

Delevan
Division



AMERICAN
PRECISION
INDUSTRIES INC.

270 QUAKER RD., EAST AURORA, N.Y. 14052 • TEL. 716/652-3600 • TELEX 91-293
OTHER DIVISIONS & SUBSIDIARIES INCLUDE AIR QUALITY BASCO, DELTRAN,
AMERICAN PRECISION INDUSTRIES (U.K.) LTD., DUSTEX OF CANADA, INC.

World Radio History

People



Getting started. William Carlson sees his role as selecting applications for systems.

Carlson's role will be much broader than that. "My real contribution will be in the application I select," the Massachusetts Institute of Technology graduate says.

The package that will go with the microcomputer systems will be "a core that provides a basic set of tools" for original-equipment manufacturers, who will write the actual application programs for end users, notes Carlson. Software will initially be written in Pascal, with Ada capabilities to follow.

All products of the division will be marketed by a newly formed team that will report to Carlson, with new and existing distributors and representatives also handling the systems. The group currently numbers 10 persons, but it is expected to grow quickly once product announcements loom on the horizon.

Carlson sought the aid of his alma mater for technology to complement Western Digital's ongoing work for his first product after coming on board early this year. Under a recently signed agreement, the company will license the technology developed at the college.

Western Digital will integrate and manufacture these microcomputers, which function as networking nodes, and market the individual work stations for prices ranging from \$5,000 to \$50,000. Carlson will not comment about other pending products, other than to say the firm's microcomputer products will adapt main-frame ideas. □

Centigrid.TM

The world's smallest EMR footprint.

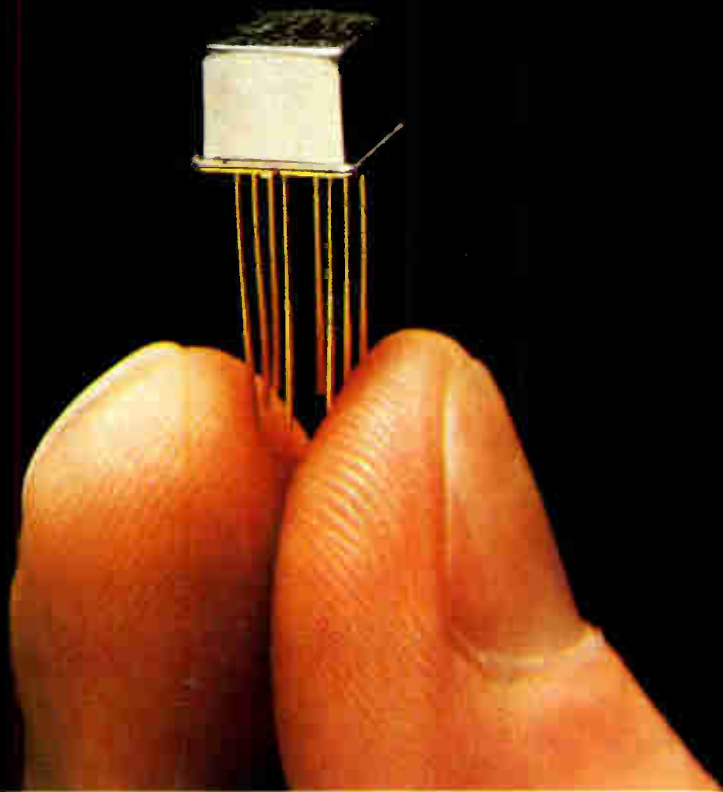

Our Centigrid Relay occupies all of .14 sq. in. of board space. Which makes it the smallest subminiature relay in the world. And its .100" grid terminal spacing permits direct pc board mounting.

The Centigrid's unique internal configuration and all-welded construction also make it the most rugged relay in its class. Both the general purpose and sensitive versions use very little operating power.

They have excellent rf switching characteristics through UHF. And they are qualified to levels "L," "M" and "P" of MIL-R-39016.

Teledyne has been an industry leader for over twenty years. We've used our technical expertise and manufacturing know-how to create the world's finest subminiature electromechanical and solid state relays. That's how we were able to take our proven TO-5 technology and

develop the popular Centigrid Relay family.

If you'd like complete technical information about our Centigrid relay, or applications assistance, please call or write today. We're here to help you.



TELEDYNE RELAYS

The best little relays in the world.

Teledyne Relays 12525 Daphne Ave., Hawthorne, California 90250 (213) 777-0077

U.K. Sales Office: Heathrow House, Bath Rd. MX, TW5 9QP 01-897-2501

European Hqtrs.: Abraham Lincoln Strasse 38-42 • 62 Wiesbaden, W. Germany 6121-700811

World Radio History

Only one name can mass terminate any cable you name.

The one name is AMP. We pioneered the mass termination technique for lowering costs. And we've perfected it, so that we can mass terminate practically any cable you're using—whether it's jacketed or ribbon or coax or twisted pair.

We do it with the widest variety of connectors, too—from subminiature Ds to receptacle to card edge. And that includes the greatest spread of positions and mating headers. All made



to save you time in production and money in your product. Assemblies, as well, are available in all styles. All tested. All proved with our proven slotted-beam design.

Just name the cable you need. We'll mass terminate it reliably.

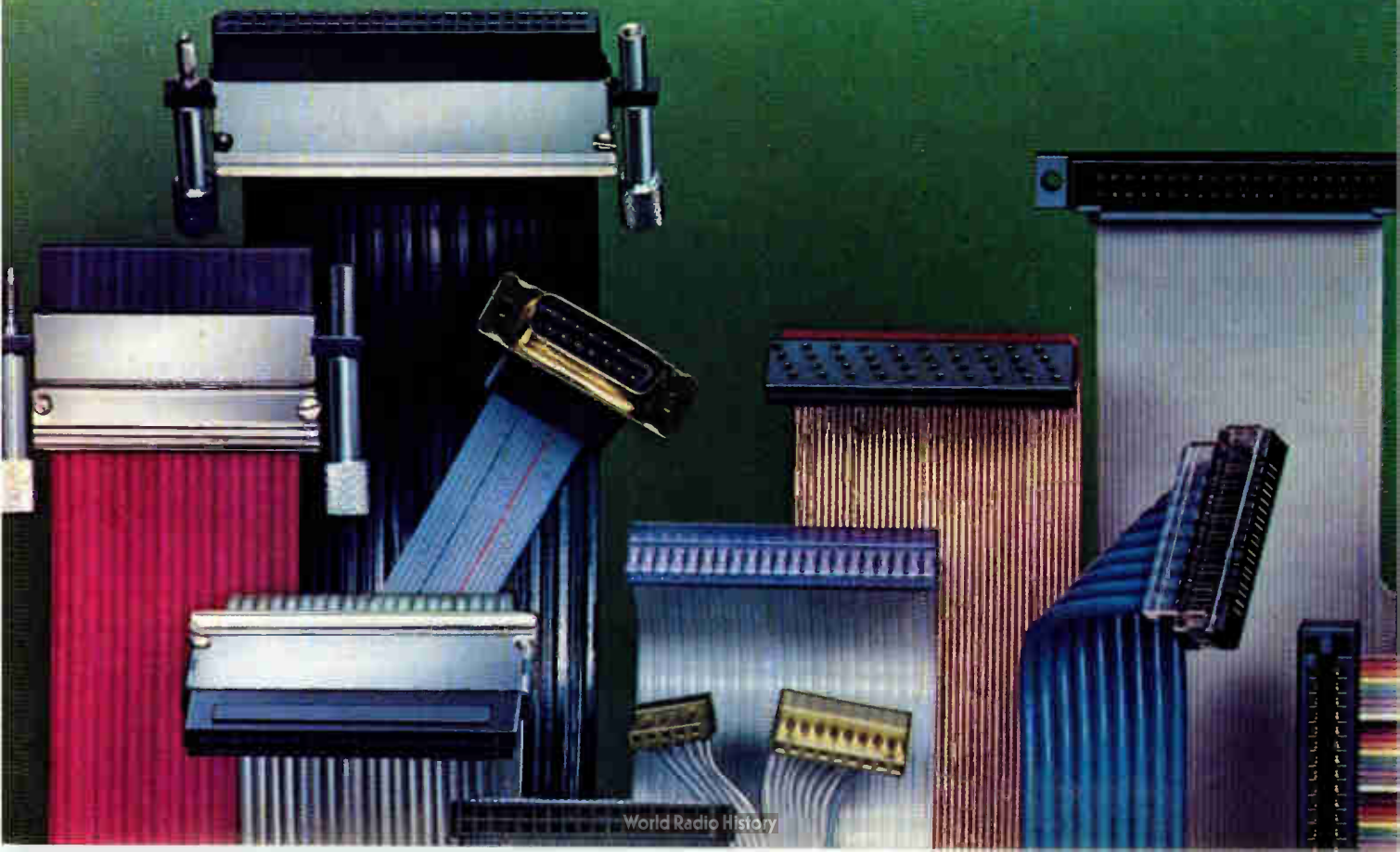

AMP Facts

Ribbon coax cable/connectors

- 50, 75 or 93 ohm ratings on .100" centers
- 95 ohm rating on .125" centers
- standard .025" post mating and paddle board types
- board mount pin headers and I/O post compatibility

Transmission cable connectors

- designed for 50, 75, 90 or 100 ohm cable on .025"
- compatible with shared or separate ground cables
- redundant dual gold-plated spring members at the contact/post interface
- .100" x .100" or .125" x .250" industry standard interface
- common grounding buss

Flat flexible cable connectors

- single or double row housings
- pin, receptacle, card edge and solder tab styles
- capability to mix flat cable and discrete wire in the same housing
- conductive ink capability

The only mass terminated coaxial cable.

Uniquely cost-effective transmission cable.

Greater packaging density with flat flexible cable.

For more information,
call the AMP Mass Termination Desk at (717) 780-8400.

AMP Incorporated, Harrisburg, PA 17105

AMP is a trademark of AMP Incorporated

AMP means productivity.

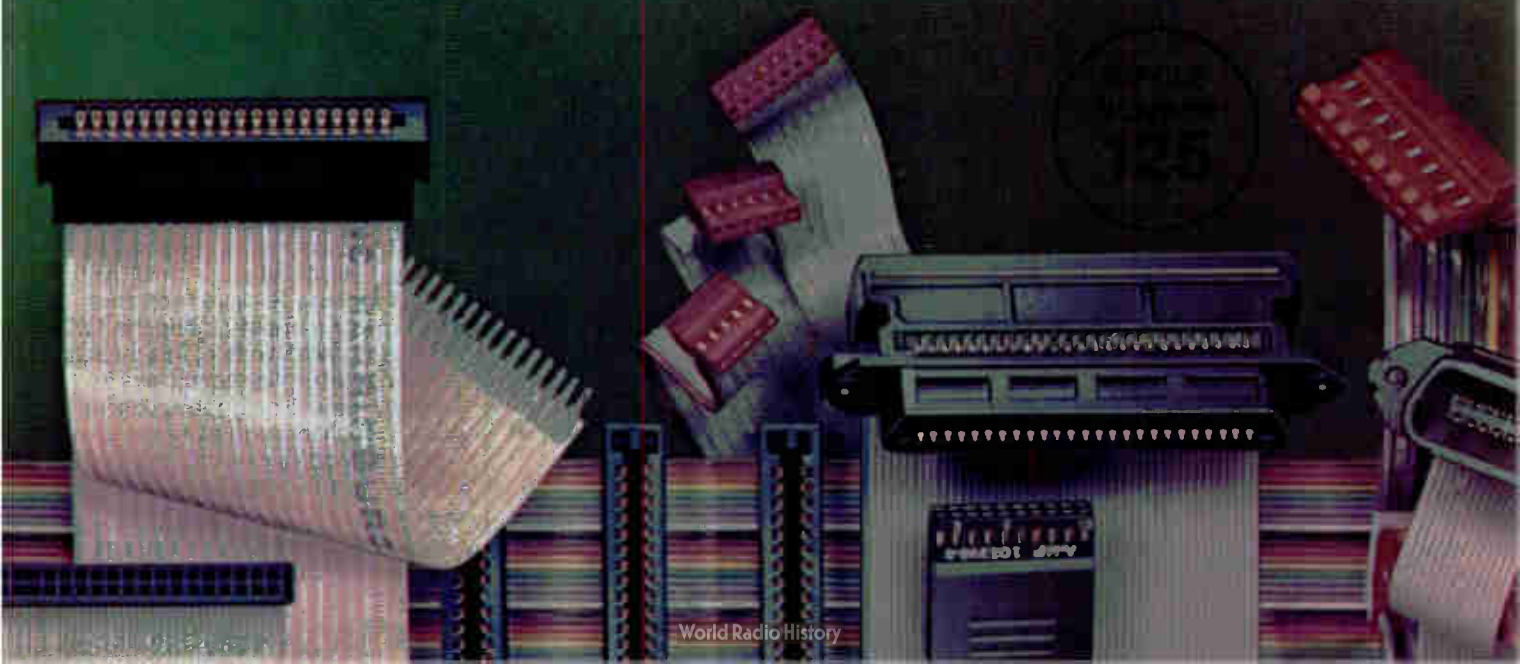



Intel's Series 90/iQX. The memory

Intel's new Series 90/iQX is the first standard Intelligent Memory System to offer continuous operation and high maintainability at low cost.

Now, for the first time, OEMs can design systems with built-in protection against errors, downtime, and excessive maintenance costs. How? With Intel's new Series 90/iQX.



Series 90/iQX Intelligent Memory System

The iQX controller adds the intelligence of an iAPX 86 microcomputer

to the standard Series 90 Memory System. Intelligence that monitors memory operation directly, detects and corrects errors, runs local or remote diagnostics, and reallocates memory space as required. All without burdening the host system.

Fault-tolerant operation

Hard errors or soft, Series 90's iQX controller uncovers them. Soft errors are simply "scrubbed" and corrected. In case of hard errors or device failure, the controller routes data around the problem, allocating spare memory as needed. It then logs the error for future reference.

With protection like this, the Series 90 system will continue operating uninterrupted until all spare memory is filled.

And thanks to the iQX's memory status reporting, your customer will know well in advance of memory resource problems. Which not only improves data integrity, but increases reliability and reduces maintenance dramatically.

Instant diagnostics

To keep users continually apprised of conditions within their memory system, the iQX controller provides easy access to its complete diagnostic file. Information can be accessed by the host system either automatically via a simple message-driven software interface, or manually, using the iQX's Service Communicator. This detachable terminal allows technicians to instantly retrieve diagnostic data in plain English through a compact, alphanumeric keyboard/display. With no interruption of the host computer's operation.

For fast, simple maintenance, system diagnostics inform the user of any

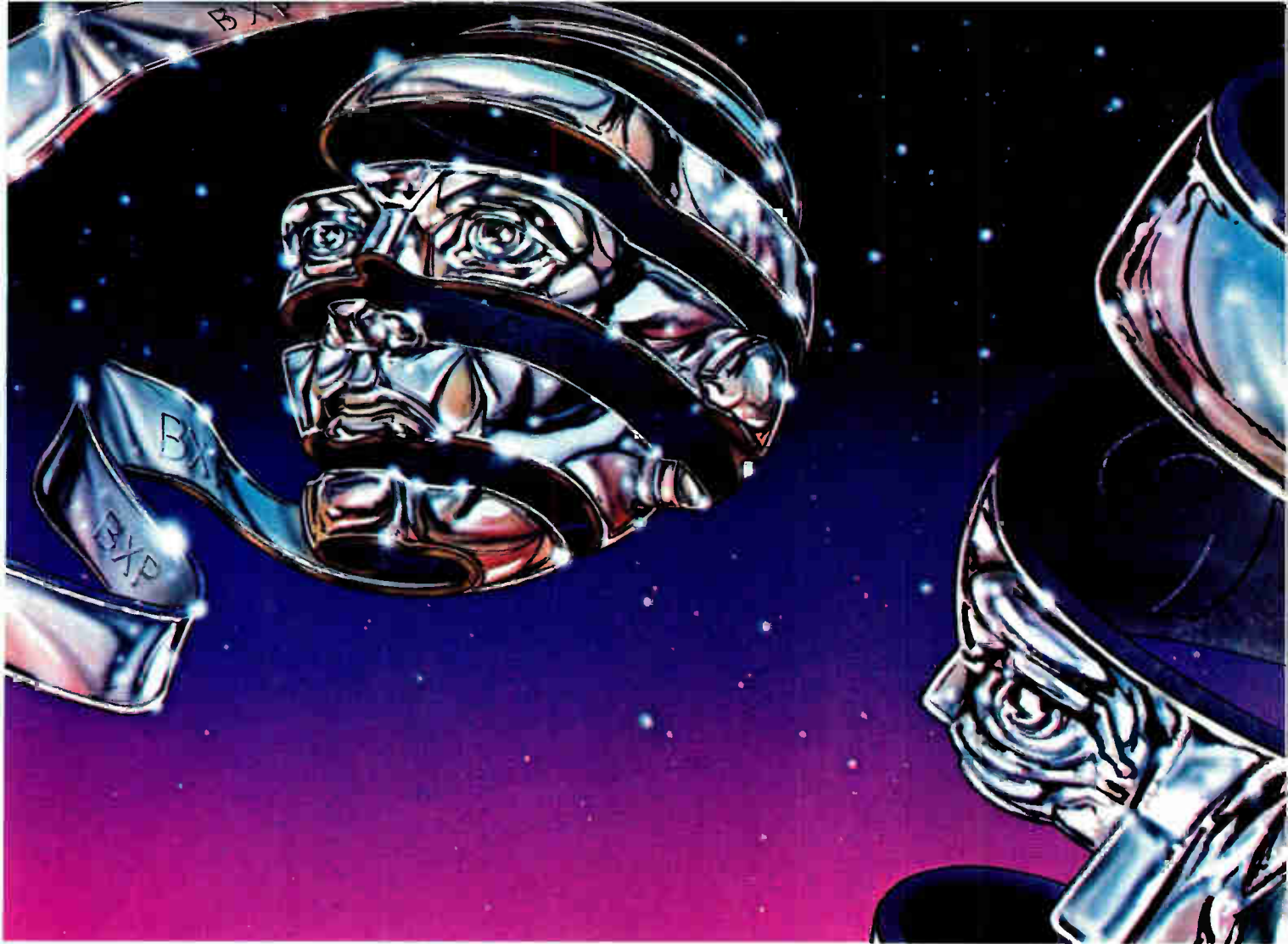

machine with non-stop intelligence.

errors it has tracked — soft or hard, correctable or avoidable — and their precise location by row and column.

Many problems can also be solved using the iQX's memory tasking capability to move data blocks as required. Then too, the iQX monitors the system's power supply and signals a warning if voltages drop critically. As a final, double protection, the iQX controller even diagnoses its own operation continuously.

Diagnosing from a distance

To reduce maintenance costs for remote systems and networks, iQX diagnostics can be accessed over phone lines through a single diagnostic station. By being able to analyze problems from afar, you'll eliminate unnecessary service visits and shorten those that are required. And since one diagnostic station can easily serve up to 150 installations, the set-up and ongoing diagnostic costs are contained as well.

Consider the economics

The iQX's protection features offer important economic advantages for systems OEMs. Because of the increased demand for fault tolerance in today's marketplace, systems equipped with iQX capability add significant value to your products. In fact, many applications simply could not be justified economically *without* such self-healing and remote maintenance. Now, through Intel's leadership in 16-bit microprocessing, the Series 90/iQX brings you this capability at an incremental price only nominally above that of ECC alone.

In sum, iQX gives your systems state-of-the-art fault protection, reduced maintenance costs, and therefore increased value. Best of all, Intel is delivering Series 90 systems with iQX right now. For detailed information, return the coupon to Intel Corporation, 3065 Bowers Avenue, Santa Clara, CA 95051. Telephone (408) 987-8080. For hot line service, call (800) 538-1876.

- My needs are immediate; have a Sales Engineer call.
- Please rush me — by first-class mail — Series 90/iQX technical literature.

Name _____

Title _____

Organization _____

Address _____

City/State/Zip _____

Telephone () _____

Mail to:
Intel Corporation
3065 Bowers Avenue
Santa Clara, CA 95051
(408) 987-8080

Europe: Intel International, Brussels, Belgium.
Japan: Intel Japan, Tokyo. United States and Canadian

intel® delivers solutions

E-5

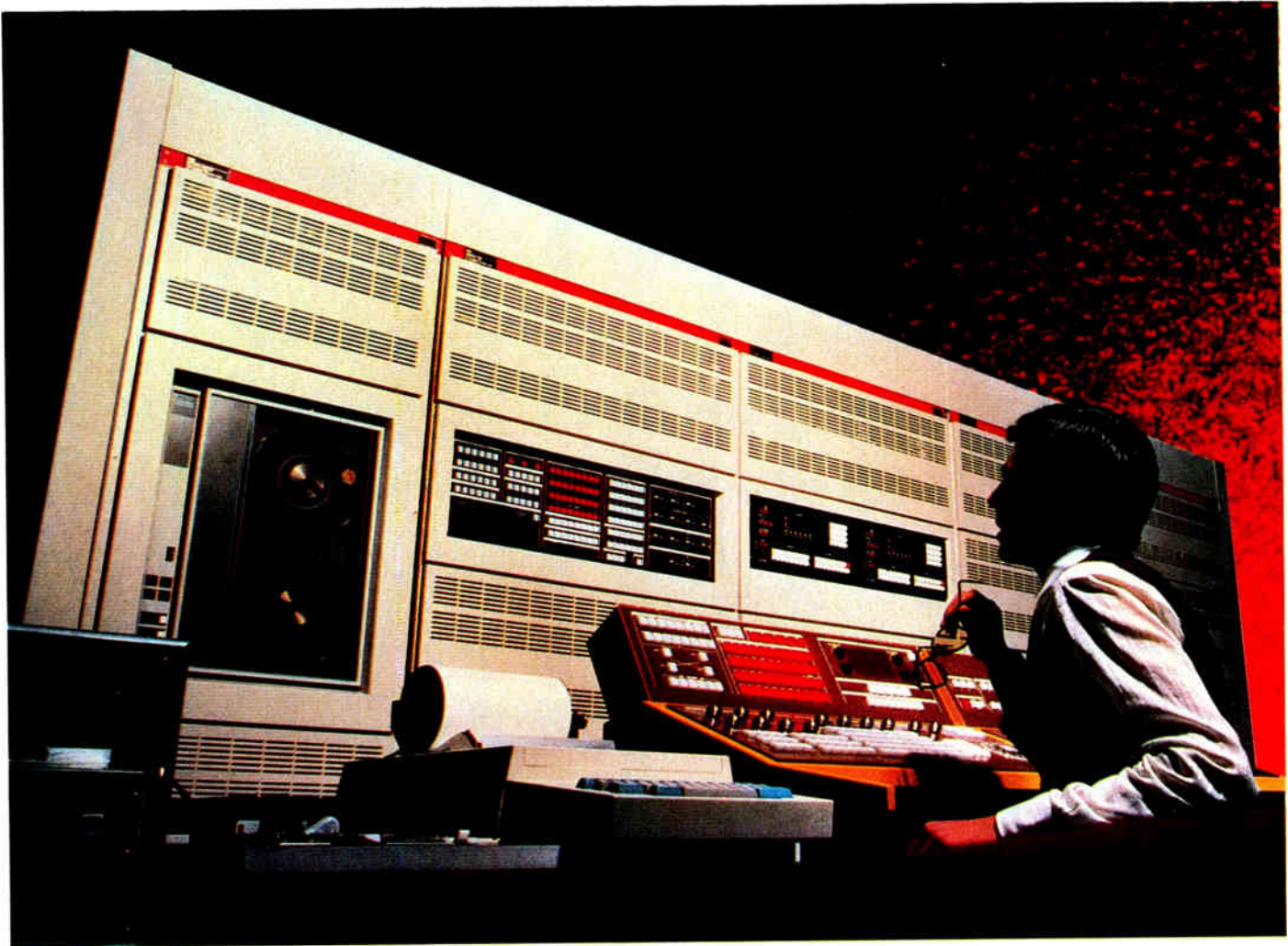

COLOMBIA SIGNS NEC FOR TELECOMMUNICATIONS PROJECTS

Empresa Nacional de Telecomunicaciones de Colombia (TELECOM) has awarded NEC contracts for three major telecommunications projects.

A total of 53 digital switching systems and eight domestic satellite communications earth station systems will be used to expand Colombia's telephone service, and to provide a nationwide

satellite communications system.

The first project is the installation of NEAX61 central office digital switching systems in 16 principal cities throughout the country. The second project calls for 28 NEAX61 systems in smaller cities.

NEC satellite communications earth stations, which make up the third project, will be located in eight cities and

towns. These earth stations are equipped with 7.5m diameter antennas and can accommodate 12 to 60 telephone lines and one television channel each. They will have access to Intelsat IV until Colombia launches its own communications satellite, SATCOL.

The third project also includes nine NEAX61 systems, seven of which will be installed at earth station sites.

When the new central office systems are in operation, Colombia will have a total of 88 NEAX61 digital switching systems with 114,000 subscriber lines.

LASER RADAR
SCANS SKY

An NEC-developed laser radar system is playing an important role in meteorological research.

Installed atop the headquarters of the Meteorological Research Institute (Meteorological Institute of Japan), the laser radar monitors air pollution and the movements of air in the middle atmosphere—the troposphere and stratosphere—so as to produce data for predictions about earth's future ecological condition. It also measures such meteorological parameters as the amount of aerosol, and temperature and humidity, in the middle atmosphere.

Although designed to scan the sky 40km above the surface of the earth, the laser radar can detect aerosol at an altitude of 60km. Laser beams reflected from aerosol are processed through a photon counting method or an analog method using a digitizer. The laser's optical sub-system includes a transmitter, a receiver, optics, power supply units and a pedestal. The observation sub-system has signal processors with a 16-bit microcomputer, controllers, a CRT display, a line printer, etc.

Last year the laser radar attracted public attention when it monitored volcanic ash floating on the prevailing westerlies above Japan 10 days after the eruption of Mount St. Helens.

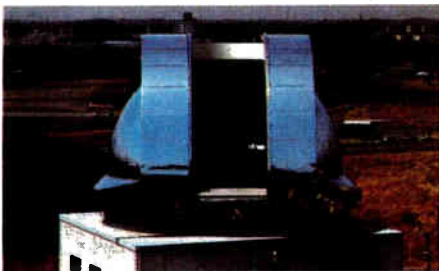

NEC ARROWWRITERS TELEPRINT
FASTER AND BETTER

Two new dot-matrix teleprinters for computer and communications applications offer a high printing speed (80 ch/sec) and excellent print quality.

NEC Arrowriter M55 is an electronic page teleprinter for five unit code. It is designed to meet the CCITT No. 2 recommendations and can be connected to any telex exchange anywhere in the world.

Use of a specially designed 9 × 7 dot-matrix printing system reduces printing noise to a minimum. In fact, the M55 is much quieter than a con-

ventional electric typewriter even when its paper tape punch and reader are in operation.

The M55 comes in five models, including Electronic Send/Receive versions that have editing facilities similar to those of a word processor.

The other Arrowriter, NM8000, is a compact Receive Only bidirectional 9 × 9 dot-matrix serial printer that meets the CCITT No. 2 and No. 5 standards or ASCII. It is available with three types of interface units—modem/current, ODA and Centronics.



MINI MULTILAYER CERAMIC CAPACITOR
TAKES UP TO 400 μ fd

NEC has developed a new miniature multilayer ceramic capacitor with a capacitance of up to 400 microfarads—more than 100 times that of any other multilayer capacitor on the market.

The NEC product also features low impedance in the high frequency range, a small equivalent series resistance, a large allowable ripple current, and a semipermanent service life.

The successful development of this

capacitor can be attributed to a new ceramic material which can be sintered at a temperature as low as 900°C, in contrast to conventional materials which are sintered between 1,300°C and 1,400°C.

The 400 μ fd multilayer capacitor will be used in switching power supply units, computer terminals, communications equipment and audio products. It will be offered in several types, according to capacitance.

NEC

Nippon Electric Co., Ltd.
P.O. Box 1, Takanawa, Tokyo, Japan.

The quality fallout

In typical American fashion, the U. S. electronics industries have responded to a challenge with determination and decisive action. The challenge: attaining new levels of quality in electronic components and equipment—levels pushed by Japanese competitors in the battle for market share and now demanded as their due by equipment makers and their customers everywhere. And the response? U. S. companies are looking at their entire operations in a new light and are reorganizing them and making other changes—some of them radical—to elevate the quality levels of their products.

Already the results are tangible. As our special report in this issue shows, the quality of those U. S. semiconductors found wanting a year ago is drawing even with that of Japanese devices. And equipment makers, too, are reaping dividends in lower testing, repair, and warranty costs. It seems certain that very soon U. S. and

Japanese competition for market share will be fiercely fought only on performance, price, and delivery—with equal quality assumed. And that's as it should be.

Although the quality issue is on its way to being put to rest, the fallout from the U. S. effort to get there is bound to be with us from now on—and that can only be good. For, as our report shows, the major ingredient in any quality improvement program is the dedication and involvement of people. Out of these new quality-conscious programs are emerging new and healthy attitudes about cooperation among engineers, those on the production line, and management personnel.

This new consciousness of the need for teamwork and pulling together for a common goal, instead of the we-them antagonism that has sometimes prevailed, may very well be the ultimate benefit of the drive on quality.

A shortsighted science policy

The United States is pursuing an unintelligent policy on science and technology. Its slashes in established programs and elimination of planned ones will weaken the nation's posture in disciplines ranging from space to medicine and even in military preparedness—ironically, one of the buzzwords of the Reagan Administration. Not only that, but now we see that the policy is angering America's partners and allies.

The deputy science director of the European Space Agency was recently moved to rush to New York for a meeting with officials of the National Aeronautics and Space Administration. The reason: ESA has put \$100 million into the International Solar Polar Mission as its share of the cooperative effort to put one American and one European satellite over opposite poles of the sun, and now the Americans, without warning, have decided not to go ahead with their half.

And that's to cite just one example among many. Dismay is flowing from other allies and partners in France, West Germany, and Japan as the Reaganites wield their budget-cutting tools on all manner of international programs in science and technology.

There is also a political side to the scenario. In the words of Jean-Pierre Fouquet, the space attaché at the French scientific mission in Washington, "We prefer to cooperate with the United States for political reasons. Our only alternative is to say to the Soviet Union, 'Are you ready to cooperate with us?'"

While that warning may be a bit of Gallic overstatement, it is to be hoped that President Reagan and his advisers will soon realize that they are dealing with more than raw numbers when they next devote their attention to America's science and technology future.

What's so special about Pro-Log's new 4 MHz Z80A card?

You can't tell by specs alone.

It's not just the state-of-the-art 4 MHz clock rate that makes our new 7804 STD BUS card something special.

It's not just the on-board counter/timer with four cascadable channels.

Or the byte-wide memory that allows mapping and strapping in any combination up to 8K bytes of RAM and 32K bytes of ROM and PROM, or up to 65K bytes with the companion 7704 memory card.

Dynamic RAM refresh, power-on reset, bi-directional address and control bus for DMA . . . all are features you can get from other STD BUS card manufacturers.

What's extraordinary is the quality.

Our new Z80A CPU card is built by Pro-Log—the people who designed the STD BUS concept.

Like every one of our STD 7000 series cards, this Z80A CPU card is built with proven, industry-standard parts. All components are 100% tested and burned-in. It's designed to work reliably with all of our STD BUS interface and I/O cards, and to keep on working and working in the field.

We're so proud of our high quality that we back it with a one-year parts and labor warranty.

That's why our customers ask us to build STD BUS cards they could get somewhere else. Because no one builds cards with Pro-Log's attention to quality and reliability.

Ask our customers.

Find out what our customers say about using Pro-Log STD 7000 cards. Write or call for our STD BUS applications brochure, plus technical data on our new 7804 CPU card, its companion 7704 memory card, and our full line of STD BUS products.

Pro-Log Corporation, 2411 Garden Road, Monterey, CA 93940, phone (408) 372-4593.



PRO-LOG
CORPORATION

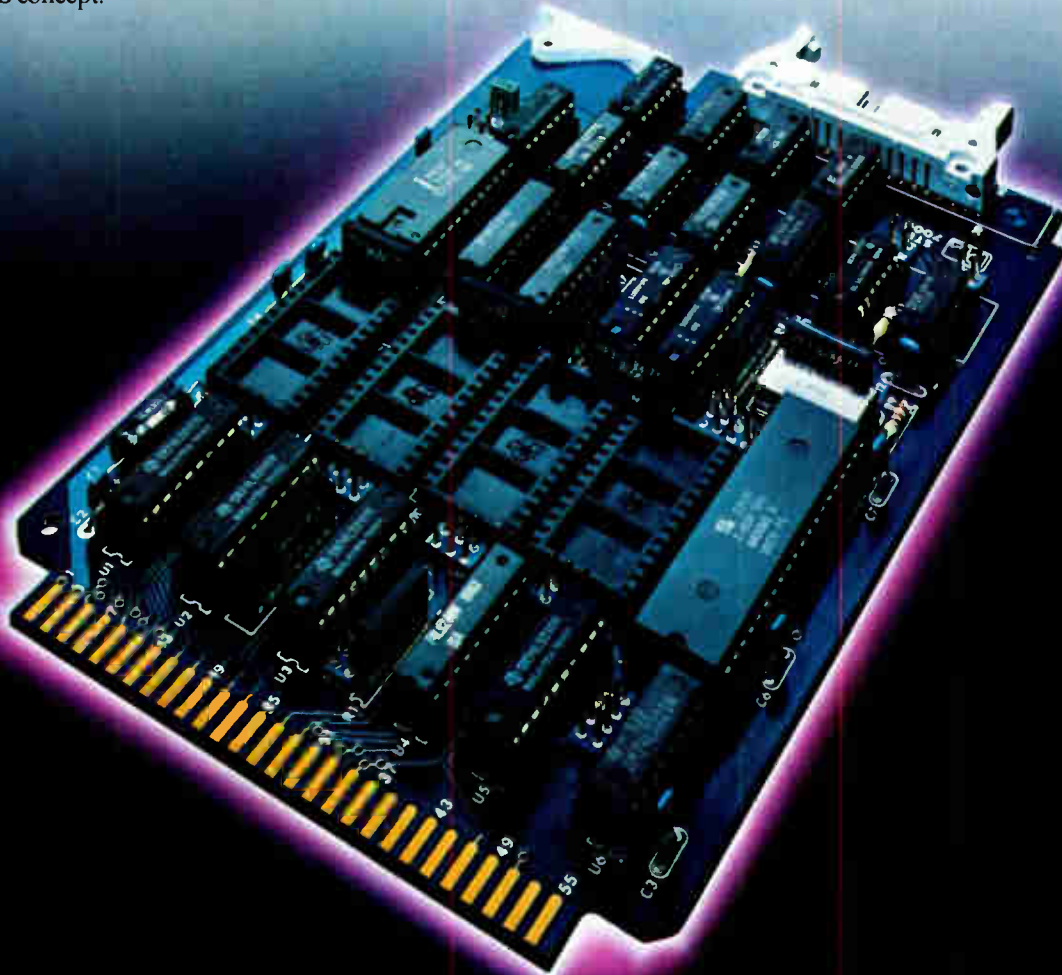



Steal the fu

Now you can get your hands on Intel's 2764 EPROM for just \$16.

That's also the price we'll guarantee you for deliveries of 10,000 or more in first quarter, 1982.

And it's good for one today.

Which means you can start to design 64K non-volatile programmable memory into your system right now.

And know by the time your system goes into production, the volume price for 64K will be \$16.

We can make that guarantee

because Intel's 2764 is already in high volume production. And it has the same size die as our 2716—thanks to our high density HMOS*-E process.

That's why our 2764 is already on its way down a super fast price curve that other 64K EPROMs haven't even started.

Of course, the 2764 comes with all the innovations that have made our 2716, 2732 and 2732A EPROMs industry standards.

Access times down to 200

nanoseconds to increase your system throughput time.

Two-line control that eliminates bus contention to maximize data reliability.

And along with that, there's our EPROM reliability that comes from 5 million hours of accelerated HMOS-E life tests.

Plus a JEDEC-standard pinout for byte-wide memories.

So you can switch from 16K to 64K in no time—with a minimum of change.

ture for \$16.

To put your hands on a 2764 (450ns) EPROM, just fill out this coupon. Take it to your authorized Intel distributor or Intel sales representative, along with any \$100 Intel order and \$16.

Then reach for the sky.

For information on our EPROM family, contact Intel Corporation, 3065 Bowers Avenue, Santa Clara, CA 95051. Or call (408) 987-8080.

*HMOS is a patented Intel process.

This coupon good for one 450ns 2764 EPROM at \$16 when accompanied by any \$100 Intel order. Limit one per customer. Offer expires August 31, 1981.

Name _____ Company _____

Address _____ City _____

State _____ Zip _____

Phone _____

My application _____

Estimated 64K usage _____

Europe: Intel International, Brussels, Belgium.
Japan: Intel Japan, Tokyo. United States and Canadian distributors: Alliance, Almac/Stroum, Arrow Electronics, Avnet Electronics, Component Specialties, Hamilton/Avnet, Hamilton/Electro Sales, Harvey, Industrial Components, Pioneer, L. A. Varah, Wyle Distribution Group, Zenronics.

intel delivers solutions

E-5

Circle 29 on reader service card

BIOMATION K700-D

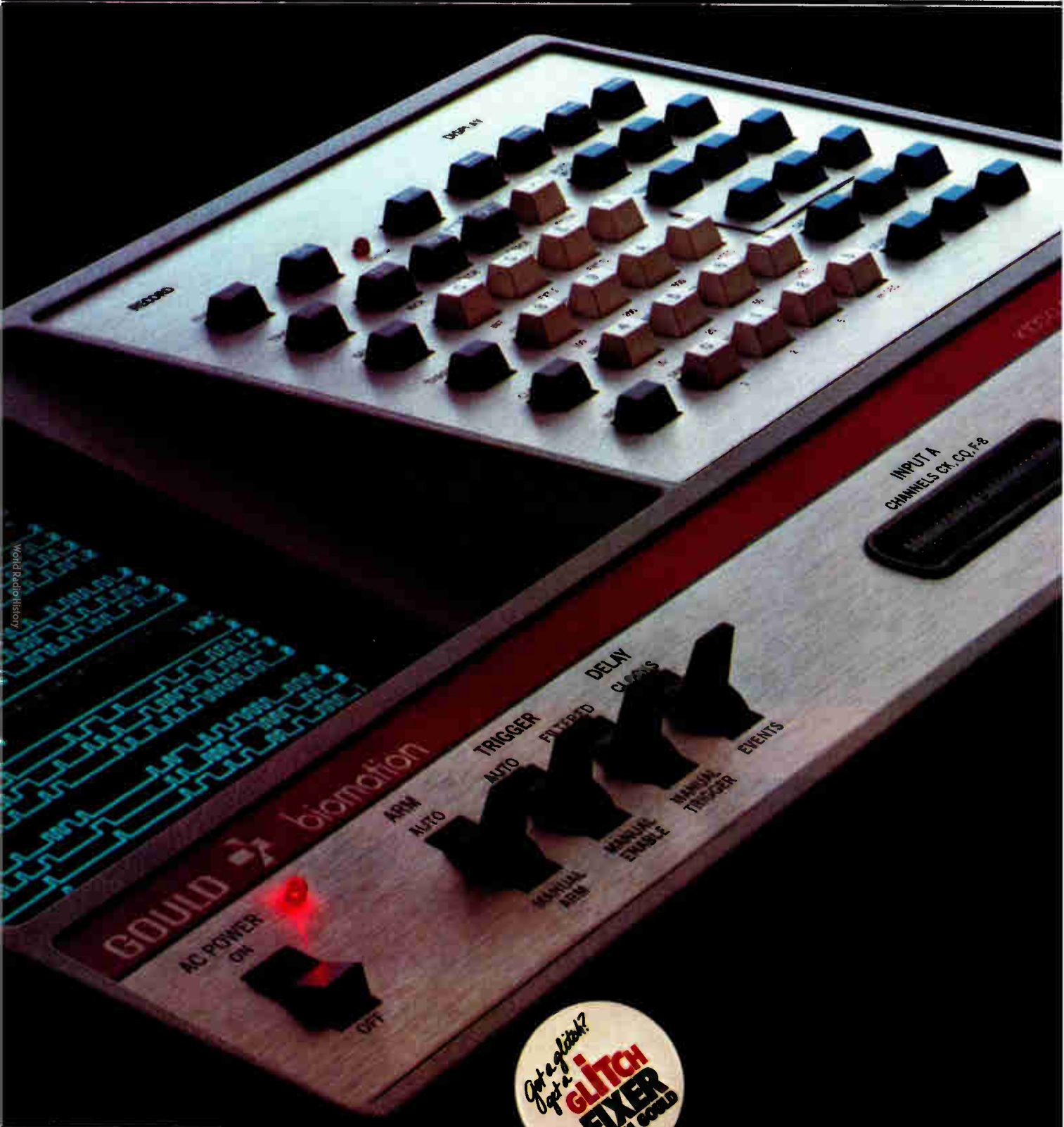

World Radio History

Got a glitch?
Get a **GLITCH**
FIXER
from GOULD

Compare this general purpose logic analyzer with the currently accepted industry standard.

The K100-D wins over Hewlett-Packard's 1615A hands down!

Logic designers have made Gould's powerful Biomation K100-D our fastest selling logic analyzer

mode to catch glitches as narrow as 4 ns. It gives you the most precise logic analysis for today's high speed microcomputer, main-frame and microprocessor systems. Best of all, you're already prepared for faster designs as they arrive.

binary or ASCII. And the list goes on and on.

The final analysis.

To help you evaluate these two fine instruments before you buy, we've prepared a point-by-point *competitive comparison* of the two. If you're designing and debugging high-performance digital systems, you'll want to read this document carefully. To get your free copy, just use the reader service number or write Gould Inc., Biomation Division, 4600 Old Ironsides Drive, Santa Clara, CA 95050. For faster response, call 408-988-6800.

Compare capacity.

The K100-D's 1024 word memory is *four times as deep as the 1615A's*. This dramatically extends the length of data you can trap from your system at any one time. And that means faster, more accurate debugging. In addition, the K100-D's standard 16 channel format can be expanded to 32 channels for work on the new generation of 16-bit microprocessors.

Compare your productivity.

Finally, the K100-D makes designers more productive with convenience features superior to those of the 1615A. The K100-D has a larger keyboard, plus an interactive video display. Comprehensive status menu. Data domain readout in hexadecimal, octal,

ever. You'll see why once you compare it to its nearest competitor, the 1615A from Hewlett-Packard.

Compare clocking speed.

With a 100 MHz clock rate, the K100-D gives you resolution to 10 ns—*five times better than the 1615A's*. Use the K100-D's latch



Hewlett-Packard 1615A
A very good logic analyzer



Speed: to 20 MHz
Resolution: 50 ns
Memory: 256 words
Channels: 8 timing & 16 data,
or 24 data

Biomation K100-D
The industry's finest logic analyzer



Speed: to 100 MHz
Resolution: 10 ns
Memory: 1024 words
Channels: 16 timing or 16 data,
or 32 data

 **GOULD**
An Electrical/Electronics Company

Circle 31 on reader service card

TISPP

The thermal/intelligent/strip/plotter/printer that . . .

Records

Records data from an analog and/or digital source.

Annotates

Prints annotations adjacent to areas of interest both during and after plotting.

Prints

Prints column data at 25 characters per second.

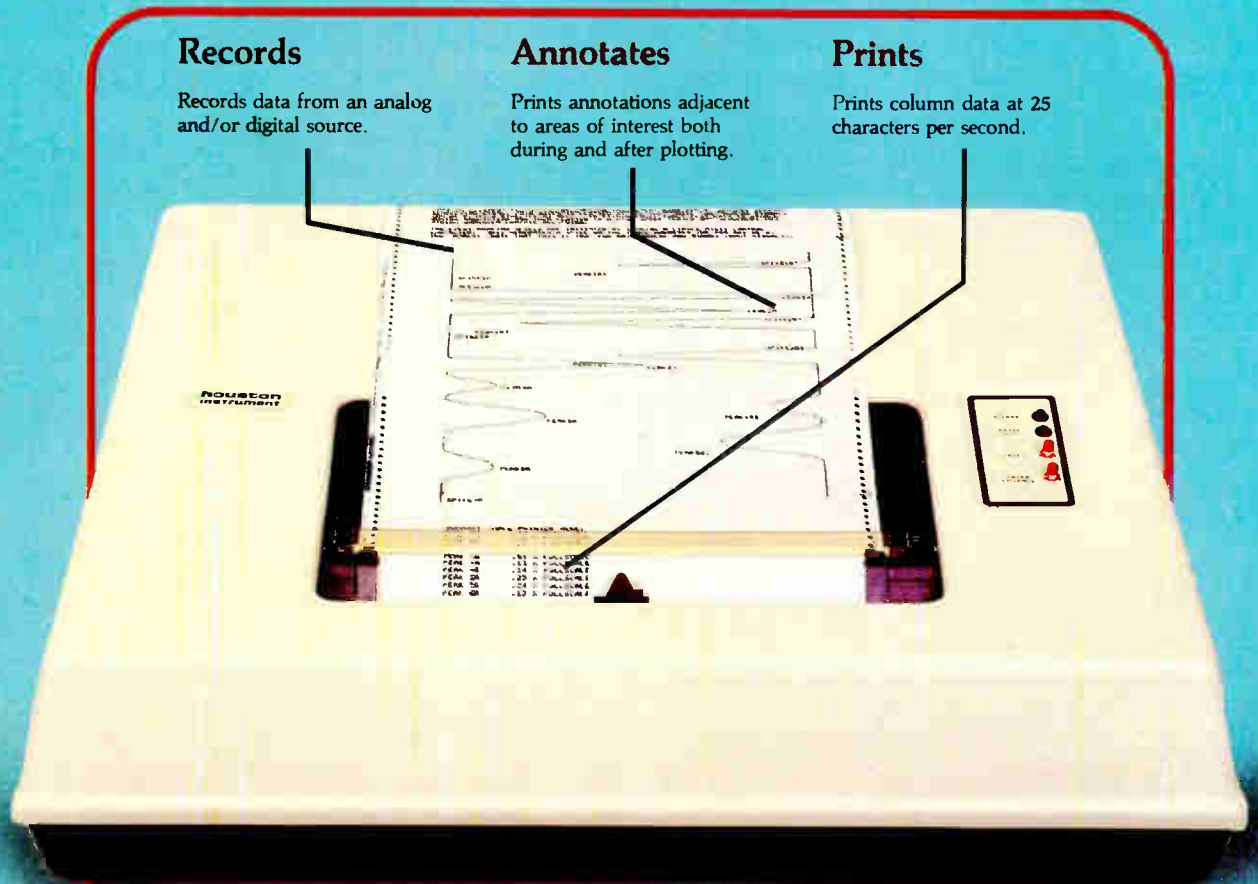

the Houston way

The Series 6000 TISPP (Thermal/Intelligent/Strip/Plotter/Printer) is the intelligent recorder specifically designed for use with today's new generation of microprocessor controlled instruments...

This is the one recorder capable of meeting your most sophisticated recording needs. Basically a thermal writing strip chart recorder, the TISPP can also print characters.

The TISPP is both RS-232C serial and IEEE-488 - GPIB compatible. Under microprocessor control, it records data from either a digital or analog source and can function as either a strip chart recorder or a digital plotter. And it annotates the data, printing either during or after curve data input. Thermal plotting speed compensation provides uniform trace quality while plotting at speeds of up to 75 CM (30 in.) per second.

Take a look at these additional TISPP features. You'll see why TISPP is the one instrument that can satisfy most of your recorder/plotter/printer needs.



- Full scale analog sensitivity from 10 mv to 5 mv
- 12 bit binary full scale digital
- Chart speeds from one second per cm to 62 minutes per cm
- 0.3% full scale accuracy

- Available in one or two pen versions (with annotation on both curves)
- Prices from 1,795*. OEM discounts available, of course.

For complete information on the remarkable Series 6000, contact Houston Instrument, One Houston Square, Austin, Texas 78753. (512) 837-2820. For rush literature requests, outside Texas call toll free, 1-800-531-5205. For technical information ask for operator #2. In Europe contact Houston Instrument, Rochesterlaan 6, 8240 Gistel Belgium. Phone 059/227-445. Telex Bausch 81399

houston instrument
GRAPHICS DIVISION OF
BAUSCH & LOMB 

® Registered trademark of Houston Instrument
* U.S. domestic price only

IC tester combines linear, digital checks

Called an integrated tester, the latest MTS77 production-oriented automatic circuit tester from LTX Corp. is, if not the fastest, probably one of the most comprehensive testers yet unveiled. Its developers say that it is capable of simultaneously exercising both the digital and the linear portions of complex circuits such as flash converters or analog processors. Key to the new capability is a newly developed high-speed pattern-generation subsystem that allows the MTS77—originally developed for linear testing—to **routinely deliver vector sequences as long and as complex as any digital tester's at speeds of 12.5 MHz.** The unit also offers coordinated but independent vector sequences at synchronized but different speeds, which LTX says is essential for testing calculator chips and codecs. The Westboro, Mass., firm's new instrument will bow at this week's Semicon West/1981 show in San Mateo, Calif.

Apple to offer Canadian videotex

Apple Computer Inc. of Cupertino, Calif., acting on the heels of Radio Shack's announcement of its videotex terminal, has gotten together with computer graphics specialist Norpak Ltd. of Pakenham, Ont., Canada, to give Apple machines a videotex capability. **They will design and manufacture an interface card for the Apple 2 and 3** that will enable them to use Telidon, Canada's videotex technique that is competing with France's Antiope and England's Prestel for the home and office-of-the-future information market (see p. 101). According to André Sousan, president of Apple Canada Ltd., the interface card will be distributed worldwide.

Zenith gives up on Nu computer

After delivering several prototypes to the Massachusetts Institute of Technology last year [*Electronics*, July 3, 1980, p. 48], Zenith Data Systems Corp. of Glenview, Ill., has quietly dropped its plans to market a sophisticated computer system known as Nu that was to be based on an MIT design. **However, Western Digital Corp. of Newport Beach, Calif., has picked up an MIT contract to develop and market the technology** (see p. 14). Zenith sources say the decision to scratch the project was made because the system, to sell for \$25,000 to \$50,000, would have required significantly more extensive marketing, service, and support programs than the company has in place—its Z-89 minicomputer retails for \$3,000 to \$4,000 for a typically equipped model and is sold by dealers.

Air Force looks hard at proposals for small vhf receivers

As part of its Minimum Essential Emergency Communications Network (MEECN) program, the U. S. Air Force Electronic Systems division at Hanscom Field, Mass., is evaluating classified feasibility studies of what may be the smallest-ever very low-frequency receivers. Reports were submitted by Rockwell's Avionics and Missiles Group, the AIL division of Cutler-Hammer, GTE's Communications System division, and Westinghouse. **Linear and digital very large-scale integrated circuits and state-of-the-art hybrid devices permit the small size.** Microprocessors are used to control cutting-edge analog and digital signal-processing circuits to lower the noise that is expected in a post-nuclear-attack radio environment; they are employed as well to manage dual polarization multi-antenna diversity systems. The units also would use relatively minute ferrite-loaded loop antennas installed in the fuselages of B-52 or FB-111 bombers. Prototype development could begin within two years and production by the mid-1980s.

Laser spots up to 10 solder faults per second

A laser-based system that inspects solder joints for bubbles, delaminations, crystalizations, occlusions, and other failure-producing flaws has been developed by Vanzetti Infrared & Computer Systems Inc., Canton, Mass. A laser beam heats each joint and an infrared photodetector measures the rate of temperature increase, the maximum temperature, and the temperature decay rate. This information is then processed to yield a go/no-go decision on up to 10 joints per second. **System developers say that the \$75,000-to-\$150,000 system will pay for itself within nine months** given the rate of poor joints on today's flow-soldered printed-circuit boards.

TI Image sensor needs only one level of polysilicon

Charge-coupled-device technology has emerged as a dominant choice for large-area image sensors such as those being used to build solid-state vidicons. However, the CCDs have been plagued by low yields because of their high density and because redundancy is out of the question. To simplify the process and improve the number of good chips, Texas Instruments Inc. has come up with an experimental CCD structure that does not require two levels of polysilicon; instead, **one of the levels is replaced with self-aligned ion implants**. This virtual-phase technology, as TI calls it, has already been used by the Dallas-based chip maker to build a 490-by-328-element sensor featuring low dark currents, excellent uniformity, and a blemish-free picture.

Solution offered to Interface, control woes

To help solve designers' problems with interfacing and controlling subscriber line cards, National Semiconductor Corp. has developed a digital line-interface controller (DLIC) that will be ready in sample quantities late this year or early next. The Santa Clara, Calif., firm's 40-pin TP3100 will simultaneously handle line-circuit, line-processor, and system interfaces and time-slot and port-assignment control, while maintaining all necessary protocols. **"The controller can reduce the chip count on a subscriber line card by a 4:1 factor,"** says Sam Badawi, director of telecommunications marketing. It will handle up to 128 channels and two or more duplex serial-switching ports. It uses a parallel bus interface to link with the parallel interface of such codecs as National's own forthcoming TP3050 in order to keep systems operating as fast as possible.

Addenda

Texas Instruments Inc., Dallas, will expand its Distributed Network Operating System (DNOS) **to support IBM Corp.'s Systems Network Architecture (SNA) as well as the X.25 international protocol**. DNOS, a general-purpose, multitasking disk-based operating system for the DS990 computer family, was introduced last February. . . . Announced more than two years ago [*Electronics*, April 12, 1979, p. 110] with dazzling performance claims, Censor Inc.'s SRA-100 step-and-repeat projection aligner will finally get a chance to show its stuff now that Intel Corp. has taken delivery of the first one. Liechtenstein-based Censor guarantees a resolution of 1 μm and registration accuracy to within $\pm 0.1 \mu\text{m}$ Radiation-hardened chips being designed at Sandia National Laboratories in Albuquerque, N. M., will be pin-compatible with Intel's 8085 microprocessor and associated memory chips. **The lab is using complementary-MOS rather than Intel's n-MOS process.**

Data Instruments Pressure Transducers

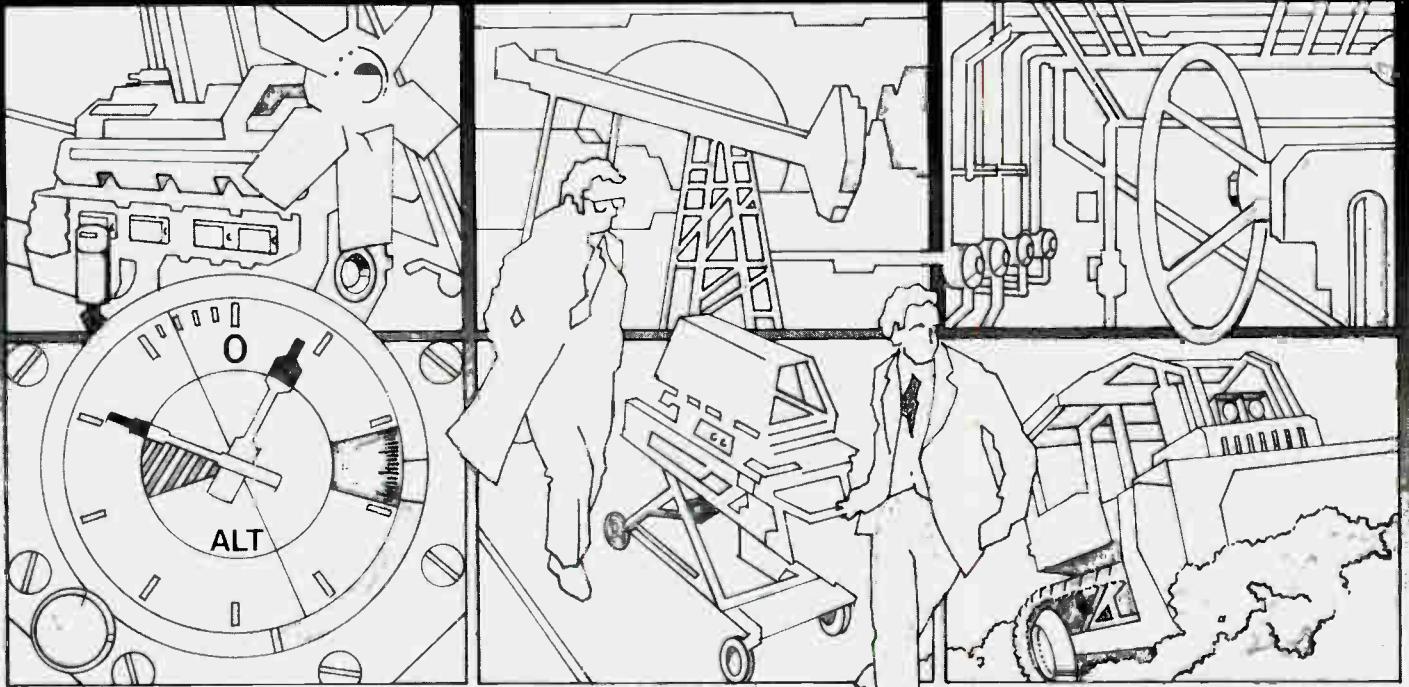

RELIABILITY Has To Be Tough.

The proving grounds for pressure transducers are in some of the roughest spots on the globe. Subject them to hydraulic fluids, saline solutions, chemicals, or hot oils, and Data Instruments transducers still give reliable performances. Stress them in heavy machinery, earth pressure sensors, or deep sea equipment, and Data Instruments transducers keep on working. Unique stainless steel cases isolate our transducers from corrosive elements and harsh environments to ensure the reliability that you count on.

Remember Data Instruments for the "forgettable" pressure transducers . . . the tough ones you can install and forget. If you could use a reliable partner in your job, call us and discuss your application. Or ask for our new "Pressure Transducer Applications Guide." Call today: 617-861-7450. *We work best under pressure.*



DATA INSTRUMENTS INC.

4 Hartwell Place, Lexington, Mass. 02173
617-861-7450 TWX 710-326-0672

Circle 35 on reader service card

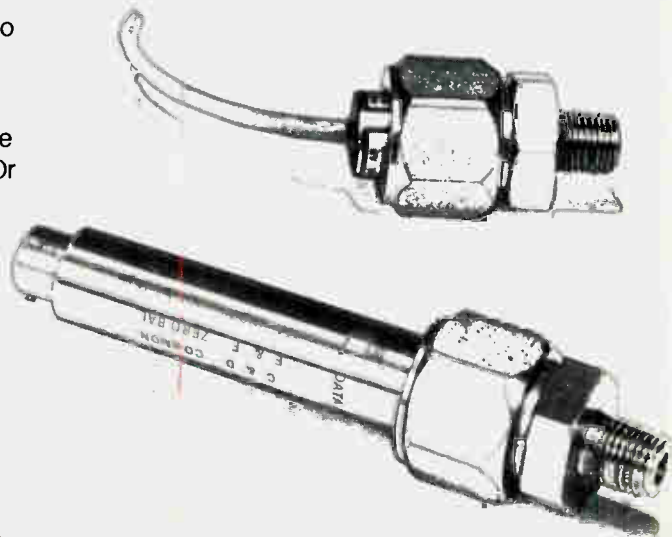

You can't buy a better frequency counter than our new 6001.

Even if you spend \$300 more.

Count the extra range. The extra precision. The dollars you save. And you understand why, at \$425,* our new Model 6001 650 MHz Precision Frequency Counter offers you more value than those of other leading manufacturers.

A look at the competitive models** from B&K, Ballantine, Data Precision, Fluke and Hewlett-Packard will tell you why.

You can spend as much as \$695 and get a range of only 10 Hz to 600 MHz (as compared with our guaranteed 5 Hz - 650 MHz).

You can spend

\$620 and get only 1/10 the precision (± 5 ppm as compared to our 0.5ppm).

You can settle for a six- or seven-digit display instead of our eight. Half the range and one-fifth the accuracy at about the same price. Or spend considerably more, for equal precision and extra features you'll probably never need.

It's this simple: if you're looking for a high-precision, wide-range counter, nothing compares to our Model 6001. With its

switchable audio-band low-pass filter. Selectable 0.1/1.0/10-sec. gate. Internal/external timebase selection. Unit-count mode. High-brightness display. True TTL inputs. Built-in temperature-controlled oven. And NBS-traceable standard. To name just a few of its many advantages.

Make your own comparison. Ask us for full specs and a demonstration.

The rest is a matter of dollars and sense.



70 Fulton Terr. New Haven, CT 06509 (203) 624-3103. TWX 710-465-1227
OTHER OFFICES: San Francisco (415) 421-8872. TWX 910-372-7992
Europe: Phone Saffron-Walden 0799-21682. TLX 817477
Canada: Len Finkler Ltd. Downsview, Ontario

GLOBAL SPECIALTIES CORPORATION

Call toll-free for details
1-800-243-6077
During business hours

*Suggested U.S. resale. Prices, specifications subject to change without notice. **Comparison based on manufacturers' literature and suggested resale. © Copyright 1980 Global Specialties Corporation

Circle 36 on reader service card

Electron beam finds memory faults, reconfigures chips

by John G. Posa, Solid State Editor

Probing test devices on chip spots defects; a stronger beam can program nonvolatile cells

Combine an electron-beam probe and a modicum of on-chip test devices and the result is an effective means of spotting and correcting defective subsystems on the very large-scale and wafer-sized integrated circuits of the future. Researchers working at the Lincoln Laboratory of the Massachusetts Institute of Technology are rapidly pushing towards that goal.

By striking tiny targets on the die with the beam, they are able to inject pulses of current. By adding an on-chip serial test bus, they can use the beam to route internal circuit nodes out a single bonding pad. To date, they have even latched flip-flops by hitting the targets.

In addition, the research team headed by staff member David C. Shaver has been able to program nonvolatile memory cells by penetrating through thick oxide layers with a stronger beam. Such cells could be used in a read-only memory array, or they could drive switching circuits in order to mask out defective areas of a VLSI chip.

The probe point for the electron beam is a diffused well, as shown in part (a) of

the figure, with sides no bigger than the minimum feature of the process being used. Conceivably these tiny wells could be peppered throughout the circuit and left in place during production without severely diminishing yields. In current IC development, space-eating test pads for metallic probes must be incorporated on chip but can be removed for production runs.

Shaver's team at the Lincoln Lab in Lexington, Mass., has actually come up with two different ways of injecting inputs. In the simpler method, the electron beam strikes a diffused n-type well, causing the negative electrons to create a forward bias on the diode formed by the junction of the well and the substrate. The forward bias pulls the well to ground, which is the potential of the p-type substrate.

To test combinatorial logic, the researchers devised the on-chip circuit shown in (b) of the figure. The electron beam successively hits the diodes hooked onto linear strings of inverters and clocked by the pass-

transistor logic, thereby setting up just about any state for a block of combinatorial logic.

In detecting an output, nodes of interest are connected to gates of MOS field-effect transistors. The drain of each MOS FET connects with the single-conductor bus that runs to the output pad. In series with the source of each FET is a well-substrate diode. When the beam hits one of these diodes, the signal under test is allowed onto the multiplexed test bus.

Programming. The team found that a stronger beam could be used to program nonvolatile storage elements like polysilicon floating gates without diode targets. The beam simply generates electron-hole pairs in the oxide and the more mobile electrons charge up the gate. Though this kind of cell is low in area and high in retention, erasure is difficult

Bull's-eye. Diffused wells form diode probe points for electron-beam signal injection (a). A circuit with these diodes included can test combinatorial logic (b).

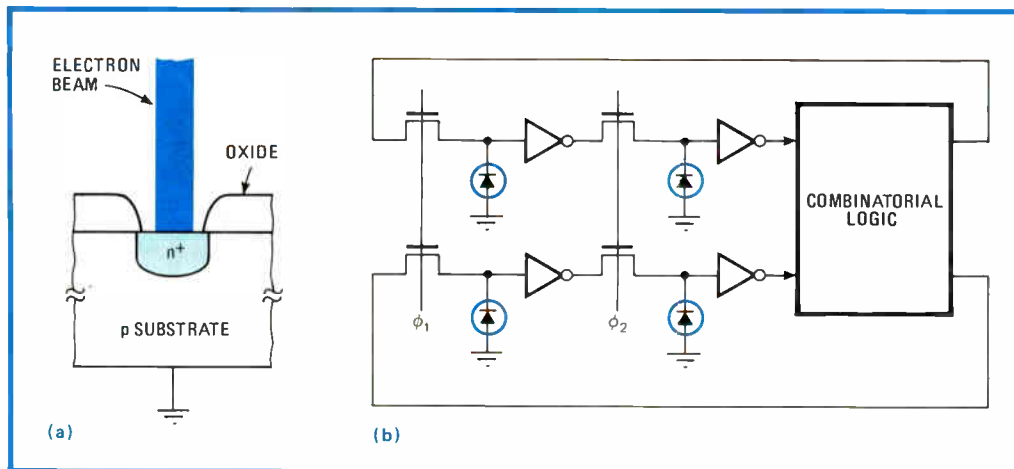

without using such means as ultraviolet light.

Thus Shaver began investigating field-oxide FETs, in which a conductor atop a thick-field oxide passes over the region between two isolated doped wells. Such a structure is not unusual, since it can occur naturally in normal processing. But the Lincoln Lab set out to capitalize on its characteristics.

In a field-oxide FET, the conductor can be metal or polysilicon, and the wells can be source-drain regions or diffused interconnections. So the resulting structure resembles an FET but with field oxide instead of the usual thin-gate oxide.

To program the transistor, an electron beam penetrates the conductor and generates electron-hole pairs in the underlying thick oxide. A positive bias is applied to the conductor, which attracts electrons and repels the positive holes in the direction of the substrate where they become trapped at the interface of the oxide and the substrate. The resulting buildup of positive charge in the device creates a surface inversion layer that shorts out the two diffused wells.

Erasing is possible, says Shaver, by biasing the conductor negatively while the beam is activated. This forces electrons toward the substrate where they recombine with holes and erase the cell. Right now Shaver is testing the retention time of this storage cell, "which is certainly stable for a great many hours, more than enough time to conduct tests," he says.

Solid state

Cleavage process offers low-cost GaAs

Easy-to-produce and inexpensive gallium arsenide (GaAs) is in the offing as a result of an Air Force-sponsored program also at Massachusetts Institute of Technology's Lincoln Laboratory in Lexington, Mass. A growth process called Cleft produces single-crystal GaAs

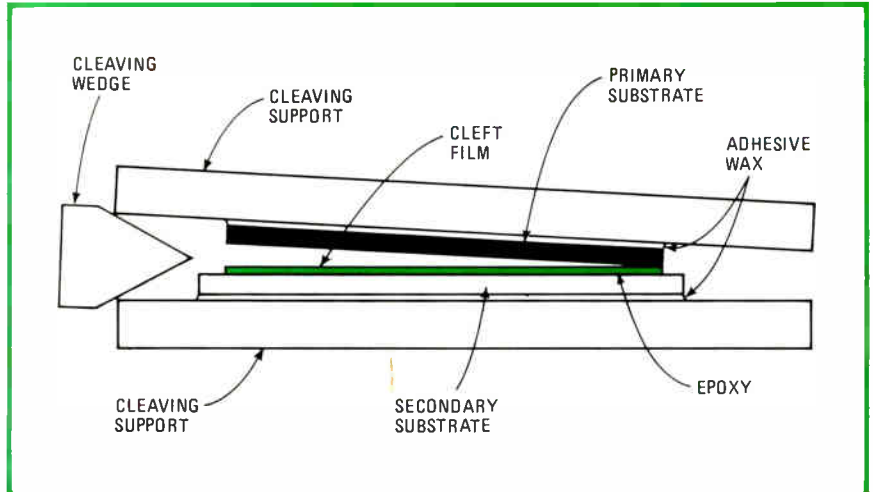

Separation. Wedge cleaves a GaAs thin film and its supporting secondary substrate from the primary substrate and the growth mask (not shown) on which the film was grown.

in exceptionally thin wafers, and promises exceptionally low costs.

An obvious application would be high-efficiency solar cells since Cleft-grown, 10-micrometer-thick cells have already demonstrated conversion efficiencies of 17% and efficiencies of 20% are within reach, says John C. C. Fan, assistant group leader at the laboratory. Fan adds that there is much interest in industry because of the potential price-performance ratio of Cleft-grown cells. Possible licensees are already being attracted even though the process is still in the lab.

Cleft stands for cleavage of lateral epitaxial films for transfer [*Electronics*, Dec. 18, 1980, p. 35]. It's not the bulk growth approach, but uses chemical vapor deposition to grow very thin slabs of GaAs on reusable single-crystal growth substrates. Cleft was developed by Fan and Lincoln Lab staff members Carl O. Bozler and Robert W. McClelland.

The process. A "growth mask" is made of a material with poor adhesion to GaAs, such as a carbonized photoresist, and is laid down over an original, single-crystal "growth substrate"—there are slits in the mask about 50 micrometers apart and 2.5 μm wide. During chemical vapor deposition, new epitaxial material grows up through the slits and spreads rapidly across the face of the mask, forming a thin GaAs layer with high lattice uniformity. The

shape of the substrate sets the shape of the wafer.

When the new layer grows to the desired thickness, its newly formed surface is epoxy-bonded to a 0.25-millimeter-thick glass secondary substrate. Then the original GaAs growth substrate, and the secondary substrate are wax-bonded to 5-mm-thick glass plates that provide support during the cleavage step. When this sandwich is complete, a wedge is inserted in one side (see illustration) and tapped gently. This action separates the glass secondary substrate and new layer of GaAs from the growth substrate.

The process is simple, and Fan maintains it is well suited to eventual automation. Also the exposed surface is extremely smooth, with undulations of only 200 to 300 angstroms, he says. In some cases, no surface preparation is necessary. For some surfaces, a quickly deposited epitaxial layer is all that is needed. Because almost any reasonable combination of length and width or diameter is possible, wafers may be shaped to fit the available area—an important factor in solar cells.

Cost-effective. The result is a far cry from melt-grown GaAs. Not only must melt-grown GaAs be sawed into wafers but the wafers are typically 300 to 400 μm thick—as much as 100 times thicker than Cleft-grown wafers. In addition, these thick wafers must be polished

and often smoothed epitaxially before they can be used. Thus, Cleft saves on materials costs, and a mature Cleft process should offer production cost savings as well, two important manufacturing points since GaAs wafers made by standard techniques sell today for about \$15 per square inch. "We may not be able to cut GaAs cost by a factor of 100," says Fan, "but there is hope that we could come close."

The team is investigating silicon

wafers grown by the Cleft process. Since the basic material is so inexpensive to begin with, the large cost savings possible with GaAs may not occur.

The group says it already has used Cleft to grow another costly semiconductor material, indium phosphide, and in addition, says that Cleft may lead to new approaches to the fabrication of multilevel integrated circuits or ICs on insulating substrates.

-James B. Brinton

Fiber optics

Master-slice approach easily forges light-wave transmitters, receivers

In a move to reduce manufacturing lead times on custom fiber-optic integrated circuits, Honeywell Inc.'s Optoelectronics division (formerly Spectronics) plans to exploit the master-slice concept that allows designers to work on the functional

block level, thereby cutting the 24-to-27-month development time of these circuits by up to 12 months.

Under the program—which parallels the objectives of custom-logic-gate arrays—users can tailor receiver and transmitter bipolar chips to

their needs by connecting predefined functional blocks that are located on the master slices. These functions are linked together in the final stages of production, giving the customer a specialized product plus the benefits of higher volume [*Electronics*, Oct. 9, 1980, p. 155].

Offerings. To initiate this operation, the Richardson, Texas, firm will be offering three standard receivers and two standard transmitters made from these slices. Chief scientist J. R. Biard says the products are in the final test phase. Sample devices will be available in late July, with production parts due for delivery in the last quarter at under \$50 each in quantities of 100.

"We decided to use the functional level because it lets us do a better job of optimizing the performance for a fairly wide range of products," Biard explains. "If you use the component level, you would in theory have more flexibility, but you also must start from scratch every time. The functional level will give us a shorter

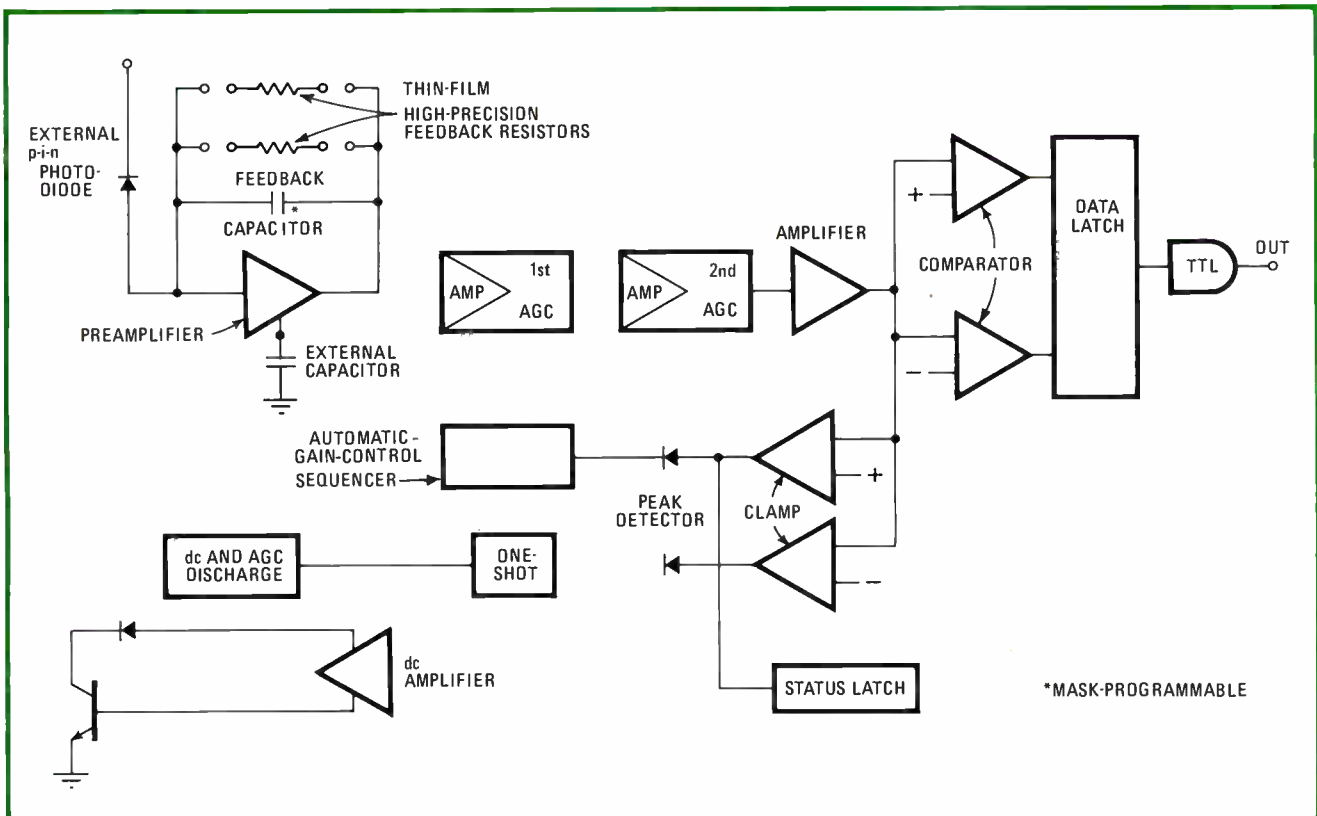

Block selection. Honeywell is offering receivers and transmitters that exploit the master-slice concept. The receiver version, partly shown here, has 15 different functions on a chip measuring 64 by 85 mils. The user tailors its operation by choosing how blocks are connected.

turnaround time," he remarks.

However, Honeywell's master-slice customers will not be limited to options at the functional level. "In some instances, when we need to treat the slice at the component level and build up other functional configurations, we can go back and make some changes," Biard says. "We've got one comparator circuit on the receiver chip that we can reconfigure into a dc amplifier—there are extra contacts on some of the resistors in the comparator block that are not used when it is operating as a comparator."

Changes possible. The framework of the process also allows simple component changes in the final two metal layers of the wafer. But "this would, of course, tend to increase the turnaround time and cost," Biard says of such changes.

Six different types of functions have been located on the transmitter chip, which is 62 by 83 mils in area. Fifteen types have been placed on the 64-by-85-mil receiver chip. Depending upon how these blocks are connected, the chip can operate in a wide range of modes, including transparent code modulation and input data modulation (continuous or burst data). These connections may also customize the chips for various bandwidths.

The functions on the transmitter are: two output drivers; externally programmable current sources; mode-selection logic; an externally programmable pulse-width control; TTL input logic; and a power supply and regulator.

As the figure (p. 39) shows, blocks appearing on the receiver are: an externally programmable bandwidth preamplifier; an internally programmable gain-stage; an internally programmable bandwidth-setting stage; two automatic-gain-control stages; two peak-detector stages; two switch amplifiers; two data comparators; a data latch; a TTL data-output stage; a channel-status latch; a TTL status output stage; a dc amplifier; AGC staging amplifiers; a dc and AGC discharge control; and a power supply plus regulators.

When coupled with Honeywell's

Sweet Spot light-emitting diode and p-i-n photodetector, the master-slice transmitter and receiver can handle a 2-kilometer link at 25 megabits per second.

-J. Robert Lineback

Military

40% boost sought in VHSIC budget . . .

The Defense Department is pushing for a budgetary increase to \$320.5 million for the six-year effort to develop very high-speed integrated circuits (VHSIC) over the program's life following the award of \$166.7 million to six companies for Phase 1 of the program.

With a \$95.5 million budget increase, the program's new funding level will be well above the most recently published \$225 million total. Larry W. Sumney, the Defense Department's VHSIC project director, says the program could use \$15 million more in funds during fiscal 1981, which ends Sept. 30, with another \$21 million in fiscal 1982 to start with.

Under the three-year Phase 1 awards [*Electronics*, May 5, p. 34], contractors will start pilot produc-

tion of VHSIC devices having features as small as 1.25 micrometers, as well as their application to subsystem brassboards (see table). Phase 2 will start in 1984 and involve system demonstrations of the 1.25- μ m technology, plus pilot production of ICs—with features possibly as small as 0.5 μ m—provided they can meet military specifications.

The selection of six Phase 1 contractors, instead of the three anticipated by much of the industry, is attributed by Sumney to three things. "First, there's the need to make sure that we cover all technologies," he says, such as bipolar, including various Schottky logic types and triple diffusion, as well as bulk complementary-MOS, C-MOS-on-sapphire, and n-type MOS.

Other reasons. Second, Sumney says, is "the need to make sure we adequately cover architectural approaches" in VHSIC's push for functional commonality in the original processing. Finally, there is the program's need to develop brassboard circuits of interest to all three armed services.

A clear indication of VHSIC's rising star is the Military Source Selection Board's choice of two contractors for each of the three services, instead of one each. Thus,

PHASE 1 VHSIC AWARDS				
	Prime contractors (team members)	Three-year value (\$ millions)	System application	Technology
Air Force	Westinghouse Electric Corp. (National Semiconductor, Boeing, Control Data, Harris, Mellon Institute)	33.8	airborne tactical radar processor	C-MOS and C-MOS on sapphire
	Honeywell Inc.'s Aerospace and Defense Group (none)	19.9	electro-optical missile-guidance processor	bipolar
Army	Hughes Aircraft Co.'s Strategic Systems division (Union Carbide)	27.4	battlefield information distribution system	C-MOS on sapphire and bipolar
	Hughes Research Laboratory (Perkin-Elmer)	8.6	electron-beam lithographic equipment	
	Texas Instruments Inc. (none)	22.7	multimode fire-and-forget missile	bipolar and n-MOS/memory
Navy	IBM Corp.'s Federal Systems division (Northrop)	19.9	submarine sonar	n-MOS
	TRW Defense and Space Systems (Motorola, Sperry Univac)	34.4	electronic warfare	triple-diffused bipolar and C-MOS

The GarbageCollector

The little SystemChip™ for all the other stuff.

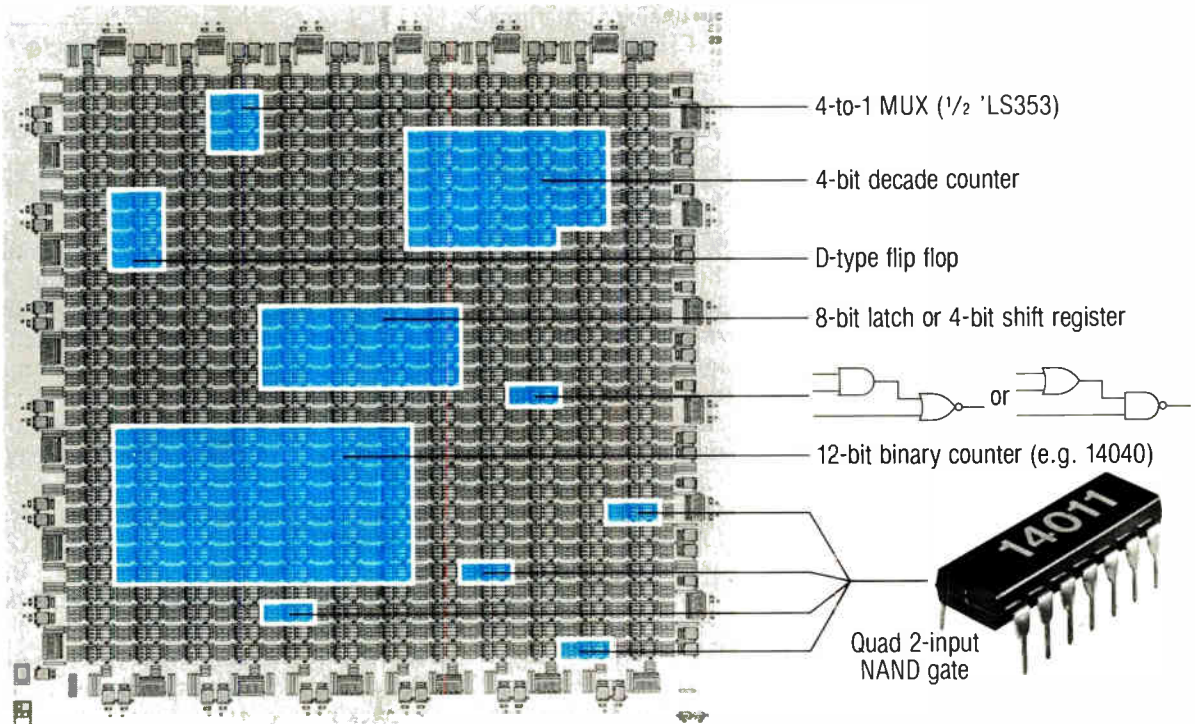

73% of the gates available left for your garbage logic.

Our small gate array chips let you compress all the miscellaneous logic garbage of your new system onto one circuit. We've got more than two dozen tried and true CMOS chips in our repertoire that give you high reliability, attractive pricing and your choice of packaging. And our in-house CAD gives you fast turnaround (how's five weeks sound?).

So if you've got the big system functions handled already with standard parts, you can leapfrog your competition with gate arrays as small as 50 gates or as big as 2240 or more. Put us to work. Send us your logic diagram for a quick confidential quote. We'll be happy to help you take out the garbage.

**INTERNATIONAL
MICROCIRCUITS
INCORPORATED**
Gate Array Leadership

3350 Scott Blvd., Santa Clara, CA 95051
Tel: (408) 727-2280, TWX: 910-338-2032

there were only three losers in the competition: Raytheon Co., Lexington, Mass.; Rockwell International Corp., El Segundo, Calif.; and General Electric Co., Fairfield, Conn.

However, it is probable that the losing companies will plow ahead on their own to at least track the new developments in the program. For example, a strong commitment to a high level of VHSIC-like research and development is being made by GE, which made a substantial investment in its losing effort.

No change. "Frankly, there will be no change in our in-house commitment to VLSI technology," says Robert Kroeger, VHSIC program general manager at GE. "Of course, we're disappointed by the loss—there's no other way to say it," he adds.

At Rockwell International's Defense Electronic Operations, a statement said the firm would continue work on the C-MOS and C-MOS-on-sapphire devices proposed in its bid. The third losing team leader, Raytheon Corp., did not comment.

Some losing team members will continue to benefit from subcontracts from winners as well as from on-going support contracts under the Phase 3 segments of VHSIC. Perkin-Elmer Etec Inc., Hayward, Calif., is such a company. It will share in the Army's \$8.6 million optional award to Hughes Research Laboratories, Malibu, Calif., to develop electron-beam lithographic equipment. P-E also has two Phase 3 awards worth nearly \$1.9 million in microlithographic development. They are part of the more than 50 Phase 3 awards worth more than \$30 million that are now under way. **-Ray Connolly**

. . . radiation threat draws attention, too

The potential of the Very High Speed Integrated Circuits program turns on designers of military space equipment, but they face some major hurdles first. Mainly, these concern the critical need for further work on radiation hardening to enable the

faster, denser VHSIC chips to survive in space.

"There are many unique environmental and performance requirements for space systems," says Air Force Maj. John A. Criscuolo. "These go beyond the triservice commonality goals of the Phase 1 VHSIC program." He is VHSIC project officer at the U. S. Air Force Space division, El Segundo, Calif., where he also heads advanced electronics technology programs.

Criscuolo emphasized the eagerness of space system designers to gain access to VHSIC's forthcoming military-grade microelectronics, but he points out that the triservice program's radiation hardness specifications of 1×10^4 rads for silicon chips is only a fifth of the minimum Air Force goal for space-bound very large-scale integrated circuits.

The Air Force goal derived from analysis of space radiation data for typical orbits during a five-year mission and takes into account aluminum shielding in the spacecraft. Criscuolo points out that even greater radiation tolerances are needed for devices to cut shielding weights and increase safety margins.

Other space-related troubles give pause to spacecraft designers considering VHSIC chips—starting with their inaccessibility once in orbit. Heat dissipation from dense packing and extremely demanding qualification specs for ensuring reliability are two more.

Paper. Criscuolo will discuss relationship between VHSIC and spacecraft technology in a paper to be delivered at next week's Fourth Biennial University/Government/Industry Microelectronics Symposium at Mississippi State University in Starkville.

Besides working with VHSIC planners to identify space mission requirements during the all-important Phase 1 of the program, Air Force researchers plan to study the resulting designs for adaptation to the USAF Space division's needs and to plumb space systems requirements such as programmability, fault tolerance, and on-chip testing. If serious shortfalls appear, propos-

als could be sought from contractors that are not involved in Phase 1, Criscuolo reports.

The Space division and its consultant, Aerospace Corp., have already put together a plan adapting VHSIC chips in a program called Space-Hardened Advanced Processing Elements. Shape's objective is to establish lead times and deliver chips that can survive in space, but it is not yet funded. **-Larry Waller**

Trade

Japan may cut semiconductor tariff

American and Japanese tariffs on semiconductors could be equalized at 4.2% by April 1982—five years earlier than anticipated—if the Japanese Diet approves an agreement in principle reached in Washington, D. C., earlier this month. The agreement between the Reagan Administration and Prime Minister Zenko Suzuki during his recent summit-meeting visit to the U. S. was disclosed recently by U. S. Trade Representative William Brock.

Japan's 10.1% tariff on semiconductor imports, close to double the 5.6% duty imposed by the U. S., has generated strong criticism among American exporters, who have been unhappy with the 1979 trade agreement under which semiconductor tariffs in the two countries would not become equal until 1987.

Reaction. The Semiconductor Industry Association, which has taken the lead in pressuring the Reagan Administration to speed up the tariff cuts, hailed the agreement as a breakthrough but cautioned that it will not automatically open the Japanese market to U. S. exports.

A Washington-based official of an SIA member company was less optimistic, noting that the tariff equalization could "result in Japan accelerating its exports of integrated circuits" to the U. S. ICs accounted for most of the American semiconductor trade deficit with Japan last year. Though the 1980 U. S. semi-

Why it pays to enlist EAROM.



Richard L. Wiker, author of the ERADCOM study on *Electrically Alterable Read Only Memory* reports:

"The use of MNOS EAROMs and WAROMs in military memory systems has now become a low risk, cost effective, alternative to bulky, costly, less reliable magnetic and rotational memories. While MNOS is a relatively mature technology in moderate commercial use, military grade parts have either had their availability restricted by the manu-

facturer or had to be individually characterized and screened by the potential user. The improved prospect for MNOS use in military memories is derived from the sale of High Reliability versions of the ER2810 and ER3400 by General Instrument. This removes a long standing hurdle in seeking an electrically alterable non-volatile memory technology that can be compatibly packaged with other IC's in a relatively dense efficient approach. The expanding use of these and similar parts in a variety of military systems is also providing the reliability and life cycle cost information necessary to support the use of MNOS memory devices, in hi-rel systems."

General Instrument Hi-Rel EAROMs meet full military temperature requirements (-55°C to $+125^{\circ}\text{C}$) and are processed and

screened per Mil-M-38510/Mil-STD-883B. With bit densities from 512 to 8192, EAROMs offer clear-cut advantages over rotating memories, core, RAMs and UV PROMs as charted below.

Write General Instrument Microelectronics Ltd., Regency House, 1-4 Warwick Street, London W1R 5WB, England, or call 01-439-1891.

Features	EAROM	RAM & Battery	UV PROM	TAPE	CORE	DISC
Word Alterability In-System	Yes	Yes	No	Yes	Yes	Yes
Access Time	$\frac{1}{2}\mu\text{s}$	$< 0.5\mu\text{s}$	$< 0.5\mu\text{s}$	secs	μs	ms
Re-programming Time	11ms	$< 500\text{ns}$	15 mins	secs	μs	ms
Radiation Hardness	good	poor	poor	good	good	good
Temp Range	-55°C to $+125^{\circ}\text{C}$	ltd by battery	-55°C to $+125^{\circ}\text{C}$	limited	limited	limited

We help you compete.[®]



GENERAL INSTRUMENT

conductor trade surplus totaled \$347 million worldwide, it would have been larger had there not been a \$223 million trade deficit with Japan.

The prospect of accelerated IC imports from Japan seemed to be supported by Prime Minister Suzuki. Asked what new markets he sees developing in the U. S. for Japan, he replied, "Perhaps semiconductors." Hastening to add that the U. S. is "still far ahead of us" in semiconductor development overall, he observed that "in some types of ICs, Japan may be ahead."

Uncertain. In Japan, passage of the tariff cut is not assured. The Ministry of International Trade and Industry plans to submit a bill to the Diet that would implement the cut by about April 1982. However, the Finance Ministry is opposing the measure on the grounds that Japan can't afford to give up any more of its revenue sources.

Japanese semiconductor firms are informally supporting MITI's move in hopes that it will cool down trade conflict with the U. S. Representatives of U. S. semiconductor companies stationed in Japan are guardedly optimistic. As one summed it up, "It's a step in the right direction. Every little bit helps." -**Ray Connolly and Robert Neff**

Industrial

Motorcon to highlight motion control

As factories strive to increase productivity and reduce energy use, electronic technology is gaining ground in industrial applications. The impact of its new techniques and products is especially powerful in the control of mechanical motion, because motion of some kind is part of any industrial process.

"There are no industries that are not affected by motion control," says James Guild, conference director of Motorcon 81, a symposium centered on the exchange of information on the latest developments in electronic

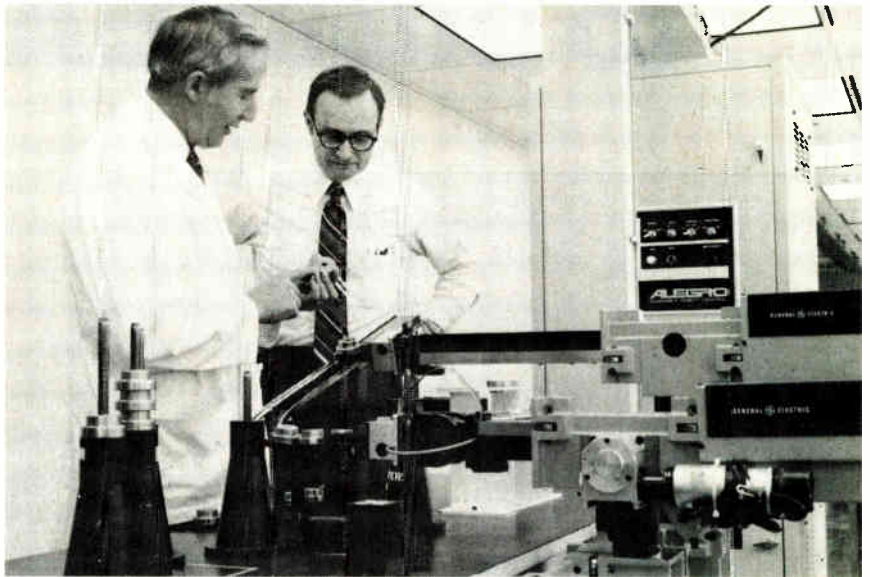

GE whiz. General Electric's Allegro, a small rail-guided robot arm, can sense size differences of 1 millimeter. Robots are just one area to be covered next month at Motorcon 81.

motion-control systems. "The more control you can put on a process, the better: for example, the manufacture of optical fibers would not even be possible without modern electronic motion control."

The first Motorcon gathering, scheduled for the week beginning June 8 in Chicago, will consist of papers, exhibits, and workshops covering the spectrum of motion controls, including motors, drives and controls, feedback sensors, power semiconductors, and robots.

What trends in motion control will the show highlight? First, ac motors are being designed for higher efficiency—up to 25% more than standard versions—essentially by using more copper and better steel.

"Years ago nobody cared about the efficiency," says David C. Montgomery, program manager for high-efficiency products at General Electric Co., Hendersonville, Tenn. "People have always looked at motors as a commodity item. But today, with power costs up, you spend as much money driving a motor as you do on the purchase price. With a high-efficiency version you will sometimes pay back the cost of a motor in six months."

Dc and stepper motors are making even greater use of digital, rather than analog, electronic drive circuits

for more precise, drift-free position control. Microprocessors, coupled with new digital position sensors, are used to execute complex, adaptive-drive algorithms that were beyond analog-only controls.

The new dc motors provide faster and more stable motion in closed-loop systems. Alternatively, lower-cost stepper-motor drive circuits eliminate overshoot and oscillation—frequent drawbacks to using stepper motors for positioning.

PWM into play. Digital electronics is used more and more in the drive amplifiers, too, as pulse-width modulation eliminates the linear-mode drive transistor as a means of varying the power going to a motor. With PWM, drive transistors are either on or off—dissipating less power than linear devices, which incur high losses when used for limiting motor speed. The development of fast, rugged MOS switching transistors and low-cost intelligent digital controllers now make PWM practical for industrial applications.

Perhaps the ultimate example of the importance of motion control is embodied in the robot, now held as a key element in attaining higher levels of industrial productivity. Robots currently available perform massive, dirty tasks like welding and moving subassemblies, but coming on fast is

To brilliantly mate digital and synchro, check our DSC 1734/5 series.

Memory Devices' DSC 1734/5 Series is ideal for users seeking a higher power output digital to synchro converter unit (4.5VA).

Both the 400Hz and the 60Hz converters contain internal amplifiers as well as reference transformers and isolated outputs. Thereby making external amplifiers and transformers unnecessary.

Conventional pin-out configuration (with the exception of the unnecessary $\pm 15V$ and $+5V$ power supply pins) means that the DSC 1734/5 Series can easily be used to replace existing digital to synchro converters and improve output drive capability.

The 14 bit 1734 Series and the 12 bit 1735 Series share the pronounced advantage of almost negligible Radius Vector variation both with changing angle and load, plus those concrete and immediate benefits of economies of space and cost (because of no external power supply requirements).

Check for yourself on this real turning point in DSC technology. For Full details on the DSC 1734 and 1735 Series, contact:



MEMORY DEVICES

Central Avenue,
East Molesey,
Surrey,
England KT8 0SN.
Tel: 01-941 1066.
Telex: 929962.

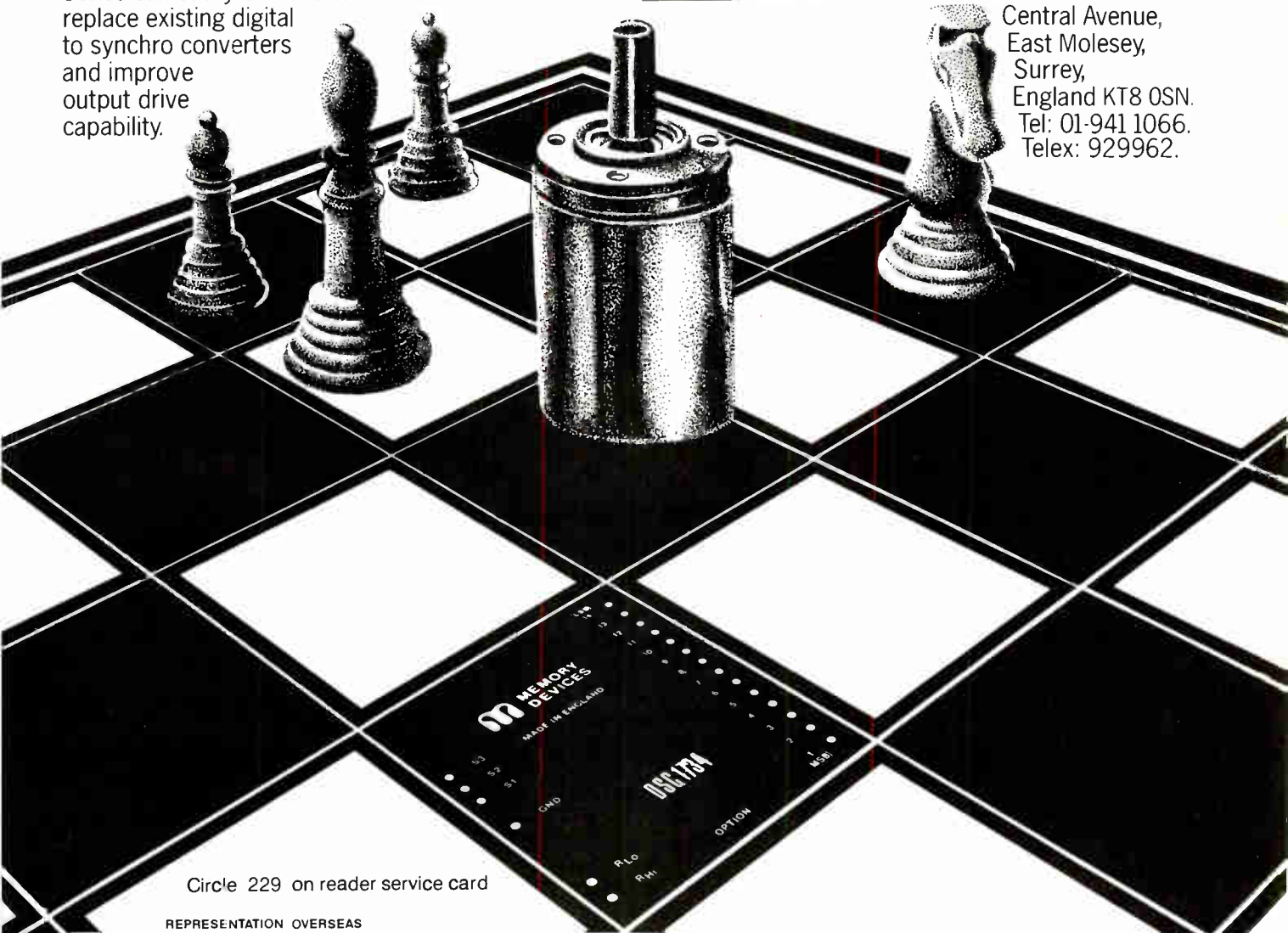

Circle 229 on reader service card

REPRESENTATION OVERSEAS

Australia
Parameters (PTY) Ltd
Melbourne office - Tel 90 7444
Telex: AA33012
Sydney office - Tel 4393288
Telex: AA25021

Belgium
Klaasing Bebelux N.V.
Jan Van Ruyswijklaan 278 2020
Antwerpen Tel (31)37 4803 4
Telex: 32969

Denmark
Analog Devices A/S
Marelsundvej 46D 2730 Herlev
Tel (2)845800 Telex: 35280

Finland
S. W. Instruments Ltd
Wallinkuua 5 0053 Helsinki 53
Tel (80) 7 38 265 Telex: 1224111

France
Analog Devices S.A.
Centre d'Affaires SILIC 12 Rue le
Corbusier Batiment Iena Cite X L
204 94533 Rungis
Tel (1)687 3411 Telex: 200156

France
Analog Devices S.A.
281 Route d'Espagne 31 076
Toulouse Cdex
Tel (61)40 3877 Telex: 531747

France
Analog Devices S.A.
Agence Est - Sud-Est Immeuble
Le Polygone 23/25 Avenue de
Constantine 38100 Grenoble
Tel (1676)22 21 90
Telex: 560285F
PB No 106
70 Anna-Marie Javouhey 61000
Alencon Tel (33)26 07 61

Germany
Analog Devices GmbH
8000 München 2 Mozartstrasse 17
Tel (89)530319 Telex: 523712

Germany
Analog Devices GmbH
2110 Bucholz 5 Tiedemannsweg 5A
Tel (04)187 381 Telex: 2189375

Germany
Analog Devices GmbH
7500 Karlsruhe Seiterichstrasse 5
Tel (721)616075 Telex: 7825871

Germany
Analog Devices GmbH
1000 Berlin 12 Kantstrasse 54
Tel (30)316441

Germany
Analog Devices GmbH
Theodor-Heuss-Allee 3 5000
Köln 80 Tel (022)1586006

Holland
Klaasing-Reuvers B.V.
Beneluxweg 27 4904 SJ
Oosterhout The Netherlands
Tel 01620-51400 Telex: 54598

Italy
Teletron S.P.A.
61 Viale Dell'Aeronautica 00144
Roma Tel (6)591 7785
Telex: 614032

India
Darbari Industries (Agencies)
24 Mahatma Gandhi Marg
Allahabad 211001 Tel: 3385 or
3386 Telex: 0540-220

Japan
Analog Devices of Japan Inc
7-8 Kojimachi 4-Chome Chiyoda-
Ku Tokyo Tel (03)263 6826
Telex: J28440

Japan
2-19 Nakatsu 1-Chome
Cyodo-Ku Osaka Tel (06)372
1814 (06)372 9769

Norway
Estronic Klokkegardet 31
1364 Hvalstad Tel (2)1786010
Telex: 10761

Sweden
Analog Devices A.B.
P.O. Box 20093, F-16120, Bromma
Tel (8) 282740 Telex: 12831

Switzerland
Analog Devices S.A.
Rue de Berne 9 CH-1201 Geneve
Tel (022)31 57 60 Telex: 289096
Zurich office: Tel (01)840 0777

United Kingdom
Memory Devices Ltd
Central Avenue East Molesey
Surrey England Tel (01)941
1066 Telex: 929962

Now! A Complete Catalog of U.S. MILITARY Capacitors



• Over 250,000 capacitors listed • Hundreds of pictures
• 700 pages • Only \$50.00

This book is beautifully made for your permanent use. It is essential to engineers and buyers specifying U.S. Mil-Spec capacitors. This catalog is the result of years of research and writing by a leading distributor of Mil-Spec capacitors. It covers completely all Mil-Spec styles with important details on over 250,000 Mil-Spec part numbers. All companies buying capacitors should have this book.

Order Today

National Capacitor 11731 Markon Drive,
Garden Grove, California, U.S.A. 92641
TWX: 910-596-1316. Phone: (714) 892-7749

ENCLOSE CHECK (U.S.A.) PAYABLE TO NATIONAL CAPACITOR

National Capacitor 11731 Markon Drive,
Garden Grove, California, U.S.A. 92641
TWX: 910-596-1316. Phone: (714) 892-7749

Please show quantity of books you want to order.

_____ Books \$50 each in U.S.A. and Canada.
Shipping pre-paid.

_____ Books \$50 each International. Books
will be shipped surface mail (please
allow 10 weeks for delivery).

_____ Books \$75 each International. Books
will be shipped airmail (please allow 2
weeks for delivery).

Name _____

Company _____

Address _____

City/State/Country/Zip _____

NATIONAL CAPACITOR
SERVING HIGH TECHNOLOGY

Electronics review

a breed of lower-cost, more agile robots that can do precise assembly work.

Thus, an important Motorcon session will cover factory automation and robots. John Hill, session chairman and president of Microbot Inc., Menlo Park, Calif., sees low-cost robot arms using stepper motors as a major development.

The precise feedback mechanism of the dc servo loop, which pushes the cost of a single servo package up to \$1,000, can be replaced with sophisticated software and stepper motors "at less than a twentieth of the cost," says Hill. "The cheaper, faster robot is coming, and this is largely due to software." -Gil Bassak

Communications

Single pass tests analog-digital parts

As combined analog-digital devices in the form of codecs, voice synthesizers, charge-coupled-device filters, and modems-on-a-chip have made their way into communications systems, test instruments that can handle these devices have lagged behind.

One such test system has been developed by Robert A. Hum, manager of test systems for Bell-Northern Research in Ottawa, Canada. Hum and his colleague Dewi L. Williams told attendees at the Electronic Components Conference in Atlanta last week that the system can perform digital tests at a blinding 20-megahertz rate with a timing resolution of 1 nanosecond.

Double-timing. What's more, Hum said, the integrated analog-digital test system, as it is known, can do its digital job while simultaneously performing analog tests at a bandwidth of up to 50 kilohertz and a dynamic range of greater than 90 decibels. This kind of speed makes the system attractive for production line testing.

Key to the efficiency of the new system, Hum points out, is the fact that, for example, it tests both the digital and analog functions of a

codec entirely by digital methods. Thus there is no need to transfer each device from one test set to another, as was done at Bell-Northern during production testing.

This capability is particularly important for an operation like sister firm Northern Telecom Inc., which will produce more than a million codecs in 1981. For Northern, the test set does 1.5 million separate measurements on codecs in just 45 seconds. And if that is not fast enough, Hum says that "with more development work, we can foresee cutting the test time from 45 seconds to less than 7."

The test system's subsystems include a custom-made memory management unit, an autonomous buffer controller, a digital tester, an array processor, a memory, and an a-d and a d-a converter. All of these "use commercial parts and software as far as possible because of the problems that always seem to accompany custom designs," he says.

The digital testing in the system is entirely conventional and is based on the Tektronix AP-120 characterization/test system. However, the analog testing is unique and is done in the discrete quantized time domain. Analog signals are converted into or from digital time series and pro-

Checking it out. Bell-Northern's Robert A. Hum goes over his new analog-digital chip tester. Behind is the Tektronix S 3250 that handles the digital part of the test.



ROMS

AMI's got them all. And more.

A lot of suppliers can make a few of the ROMs you need. But American Microsystems can supply ROMs for *all* your needs . . . and more. Here's why.

A ROM is more than just specifications. It's a semi-custom product and building it is more like manufacturing custom rather than standard components. Our 15 years experience in custom circuits has helped us build the industry's most sophisticated custom production system. With it we can track and control your ROMs through every step of production.

This ensures that you get the ROMs you need, like you want them, when you need them.

Our custom experience also means if no standard ROM will do, we can customize it for a perfect fit to your application.

To find out more about why American Microsystems' memories offer you more, return the coupon below or call Dick Norby at (408) 246-0330.

AMI
AMERICAN MICROSYSTEMS, INC.

**The Leader
in Custom MOS**

SIZE	AMI PART	AMI ROM SPECIFICATIONS COMPATIBLE WITH EPROM	SPEED
8K	S68308	2708	450 ns
16K	S6831B	2716/2516	450 ns
16K	S6831A	—	450 ns
16K	S68A316	2716/2516	350 ns
32K	S68A332	2732	350 ns
32K	S68332	2532	450 ns
32K	S2333	2732	350 ns
64K	S68A364	68A764	350 ns
64K	S2364	2764	350 ns
64K	S68B364*	68A764	250 ns

DELIVERY: 5 WEEKS FROM PATTERN
VERIFICATION TO PROTOTYPE

* COMING SOON

I want to know more about AMI's memory making.

- Please send me "The ROM Book".
- Have your application engineer contact me.

Name _____ Title _____
 Company _____
 Address _____
 City _____ State _____ Zip _____
 Phone _____

Return to:
 Memories
 American Microsystems, Inc.,
 3800 Homestead Road,
 Santa Clara, CA 95051

EL 5-19

Have an EMI/RFI PROBLEM?

Let ERIE help
with an efficient,
cost effective
solution.

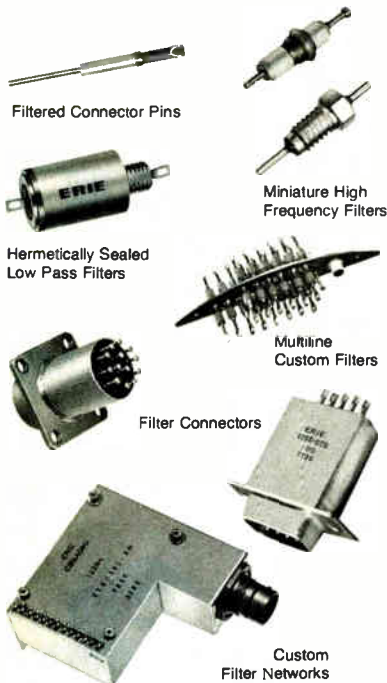

The world leader in EMI/RFI Filter design and manufacturing offers you complete filtering support . . . from initial design consultation through final testing of the completed filter product.

ERIE does it all! Application assistance, custom design, prototype and high volume production . . . all available from one facility. With our complete performance and environmental test capability, ERIE is your best source for solving EMI/RFI problems.

For 25 years and thousands of designs, ERIE has developed cost efficient solutions in the following EMI/RFI applications:

MILITARY ELECTRONIC SYSTEMS
HI-REL/AEROSPACE APPLICATIONS
MEDICAL & TEST INSTRUMENTATION
INDUSTRIAL SYSTEMS

Write for our complete catalog . . . EMI Filters. Or call 613-392-2581.

ERIE

ERIE TECHNOLOGICAL PRODUCTS, LTD.
Trenton, Ontario, Canada
613-392-2581

Electronics review

News briefs

Radio Shack package plugs TRS-80s into IBM computers

The Radio Shack division of Fort Worth, Texas-based Tandy Corp. is offering its first software that allows its TRS-80 model 2 business computer to interface with IBM Corp. equipment. The new packages offer on-line standard bisynchronous communications, remote job entry for batch processing, and 8-inch diskette compatibility. The \$995 bisync feature permits the model 2 to interface with IBM 360, 370, and 303X series computers and utilizes most IBM 3270 communication techniques. The \$995 RJE mode allows the computer to become a terminal with 3780 and related communication protocols. The \$249 diskette reformatting program translates the IBM diskette format into Radio Shack's TRSDOS format.

Mostek, Motorola join forces on codecs

In yet another second-source contract between Mostek Corp. and Motorola Inc., the two firms have agreed to exchange information on coder-decoder integrated circuits. The pact covers Motorola's MC14400 and Mostek's MK5300 families of single-chip codec-filters. Also, the Carrollton, Texas, MOS maker has the option of second-sourcing Motorola's MC14416 time-slot assigner circuits. Mostek expects to see silicon on its part in the second half of 1981, and Motorola's MOS operation in Austin, Texas, is already offering sample units. In April, the firms announced an agreement on Motorola's 68000 16-bit microprocessor [*Electronics*, April 21, p. 41].

Xerox launches high-speed digital fax machine

In a new assault on the facsimile market, Xerox Corp., Stamford, Conn., is introducing a digital machine that can send a page of text anywhere in the world in 30 seconds. Interestingly enough, the model 495 works through the telecommunications network but does not contain the heavily promoted Ethernet interface—an indicator that the Xerox-proposed local network standard still has a way to go to reach the hardware stage. Replacing the slower analog 485, the 495 includes such features as automatic dialing. The data-compression algorithms that contribute to its high speed also are designed to make the machine compatible with other fast facsimile units from Xerox and other companies. The 495 will be available for \$12,000 to \$15,000 toward the end of this year.

cessed by algorithms especially developed by Hum and Williams for this application. The processing package in the digital part of the system is adapted from a BNR in-house codec design and simulation program, called Filcod, that can model codec design parameters.

Subsystems. The hardware has two sections. The digital part is the Tektronix S3250 test system, a commercial product. The analog system has been put together by combining a Digital Equipment Corp. LSI-11/2 with 256-K bytes of memory and a Floating Point Systems AP-120 array processor. These are interfaced with custom hardware such as the autonomous buffer control, the memory management unit, and the a-d and d-a converters.

"The throughput of the system

has been optimized for distributed real-time control," Hum reports. "The PDP-11/34 issues commands to the LSI-11/2 and then continues to the LSI-11 and then continues with its own task, until the LSI-11 responds. The AP-120 and the buffer control are also semi-independent of the LSI-11. All this allows simultaneous execution of several tasks each on its respective processor."

All the analog processing performed by the AP-120 is done on discrete quantized waveforms generated by the 16-bit a-d unit. This quantizing is controlled by the autonomous buffer control. The autonomous buffer control also performs serial digital transactions with an 1804 test station, which is part of the Tektronix S 3250. "Any number of bits up to 16 can be used in each transaction," he says.

continued on page 58

NATIONAL ANTHEM[®]

SEMICONDUCTOR NEWS FROM THE PRACTICAL WIZARDS OF SILICON VALLEY.

Bringing integrity to long distance busing.

**NEW DS3662 TRAPEZOIDAL BUS TRANSCEIVER
VIRTUALLY ELIMINATES CROSSTALK
OVER LONGER BUSES THAN EVER BEFORE.**



Reliable
16K bipolar
PROMs

Low cost
bubble
memory
boards

The 10 Amp
MOOSE[™]
adjustable
voltage
regulator

Reliable
Mil/Aero
PROMs

The J-FET
solution

The leading
edge in power
op amps

The SuperChip[™]
8488 controller
board

μ P-compatible
DACs

Self-contained
precision
instrumentation
amp

Free literature—
details inside

Digitalker COPS Data Acquisition Logic Transistors Hybrids Linear Interface Bubble Memory
RAMs/ROMs/PROMs Transducers Displays Custom Circuits Optoelectronics
Memory Boards Microprocessors Development Systems Microcomputers Modules Mil/Aero

The trapezoidal DS3662 puts quiet transmission on the bus.



The industry's first trapezoidal transceiver allows higher data rates with lower distortion over longer distances.

The DS3662, National's new quad high speed trapezoidal bus transceiver, represents a major step forward in transmission integrity and overall system dependability.

Precise trapezoidal bus waveforms reduce noise coupling, without sacrificing the maximum data rate. The receivers use low pass filters to further enhance noise immunity.

The result is at least an order of magnitude increase in allowable bus lengths than ever before possible.

AC specs guaranteed. The DS3662 — a pin-for-pin functional replacement for the standard 8641 transceiver — offers guaranteed AC specifications over the entire temperature and supply voltage range.

It also features glitch-free power up/down protection on the driver outputs. So entire cards can be brought on-line or off-line without adding any noise to the system bus.

Greater transmission integrity. The DS3662 is actually immune to noise pulses

up to 20ns. So this new trapezoidal device does a great deal toward enhancing overall system performance even when used with conventional bus transceivers.

For a data sheet and application information, check box 082 on this Anthem's coupon. 

Higher data rates and integrity over longer lines.

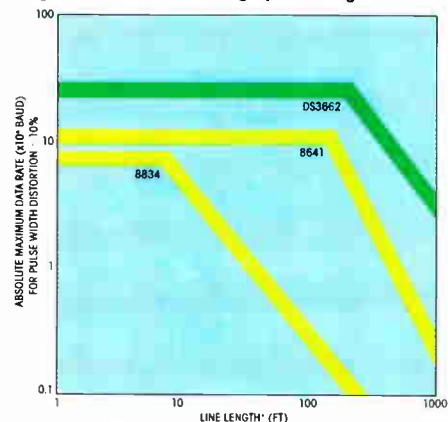

*Twisted pair cable (22 AWG stranded), terminated 180 Ω, 390 Ω, 50% duty cycle.

Solving servo problems with the fastest, cleanest power op amp ever.

The linear leader redefines the "leading edge" in power op amp design with their new LH0101.

National's new LH0101 series op amps are the fastest, cleanest power op amps now available. Others can match the 2A continuous or 5A peak output current, but no one comes close in any other major parameter.

To begin with, its 10V/μsec slew rate is four times faster than the nearest competition, National's own LH0021. And its 300KHz full power bandwidth is fifteen times wider than the rest.

Plus, by using a BI-FET™ input stage, the LH0101's 300pA input bias current is 100 times less than any other comparable amp on the market. And if this isn't enough, the LH0101 also offers extremely low distortion specs: 0.008% with undetectable cross-over distortion.

So the LH0101 is ideal for such demanding tasks as head positioning servos for hard disks.

An endless list of applications. With this kind of performance plus good availability in both commercial and military versions, applications are endless.

In addition to head positioning servos, the LH0101 is perfectly suited for inertial guidance platforms, synchro drivers, CRT deflections yoke drivers for graphic displays, power DACs for Automatic Test Equipment, motor drivers, and super-fidelity audio systems. And these are just a few applications to consider.

For the data sheet and application information on these high performance power op amps, check box 080 on this issue's National Archives coupon.

The LH0101. Tomorrow's reality today from the Practical Wizards of Silicon Valley. 

BI-FET is a trademark of National Semiconductor Corporation.



National blitzes the Mil/Aero market with reliable PROMs.

An entire fleet of bipolar PROMs guarantees an extra measure of reliability in mil-spec applications.

The Practical Wizards are taking the Mil/Aero PROM market by storm with 15 hi-rel devices to choose from.

And all 15 have survived the rigors of National's 883B/RETS™ program, the same totally compliant Class B screening offered on their 1100 other Mil/Aero products.

Practicality prevails. National's technical expertise puts them out in front with significant bipolar advances that make practical sense.

Their DM77S190 and DM77S191, both state-of-the-art 16K bipolar PROMS, are perfect examples. They're as fast and as large as any in the industry. And their titanium-tungsten fusing and high volume Schottky production process gives them rock-solid reliability.

These full mil-temp high-speed PROMs are Schottky-clamped for a typical address access of 40 ns and a typical enable access of 20 ns. In addition, they use PNP inputs to reduce input loading. And they incorporate TRI-SAFE™ for low voltage programming.

Fuses that last. National's titanium-tungsten fuses are made of a very stable and reproducible metal combination which resists oxidation.

National uses an on-chip Darlington programming circuit that "pulse shapes" the programmer's input and sends a very fast, high energy current pulse to the selected fuse.

This minimizes local heating and produces a wide gap in the fuse link, one free of residual conductors and without deteriorating hermeticity. The result is the industry's most reliable PROM.

Additionally, the titanium-tungsten fusing allows a low 10.5V programming voltage. And that eliminates the need for guard rings and wide spacings.

Reliable PROMs from proven processes.

As an additional measure of practical reliability, this family of PROMs uses titanium-tungsten as a buffer between the aluminum interconnect and the platinum-silicide "barrier."

National can fill any socket by offering a full line of TRI-STATE® or open collector devices, ranging from 256 to 16K bits.

Their tight quality control and practical innovation pay off in highly reliable, high volume products. In the TRI-STATE PROMs, for example, only 11 failures have been observed in 2.7 million hours of testing. Not one of the failures was fuse-related.

Full support for PROM programming.

The Practical Wizards not only supply the PROMs, but all the tools necessary to

program them.

STARPLEX™, the fully developed development system, includes an optional Universal PROM Programmer and all the required PROM personality modules. So beginning to end, you can't go wrong with National's Mil/Aero bipolar PROMs.

The product table in this article gives the part number, organization and T_{AA}. But for more information on these and other long-lasting memories, check boxes 096 and 062 on the National Anthem coupon. **2**

TRI-SAFE, TRI-STATE and STARPLEX are trademarks of National Semiconductor Corporation.

PROM SUMMARY TABLE

PART NUMBER	T _{AA} (MAX COMM)	ORGANIZATION
DM54S188-288J/883B	35	32 x 8
DM54S287-387J/883B	50	256 x 4
DM54S570-571J/883B	55	512 x 4
DM54S472-473J/883B	60	512 x 8
DM54S474-475J/883B	65	512 x 8
DM74S573J/883B	60	1024 x 4
DM77S184-185J/883B	55	2048 x 4
DM77S190-191J/883B	65	2048 x 8

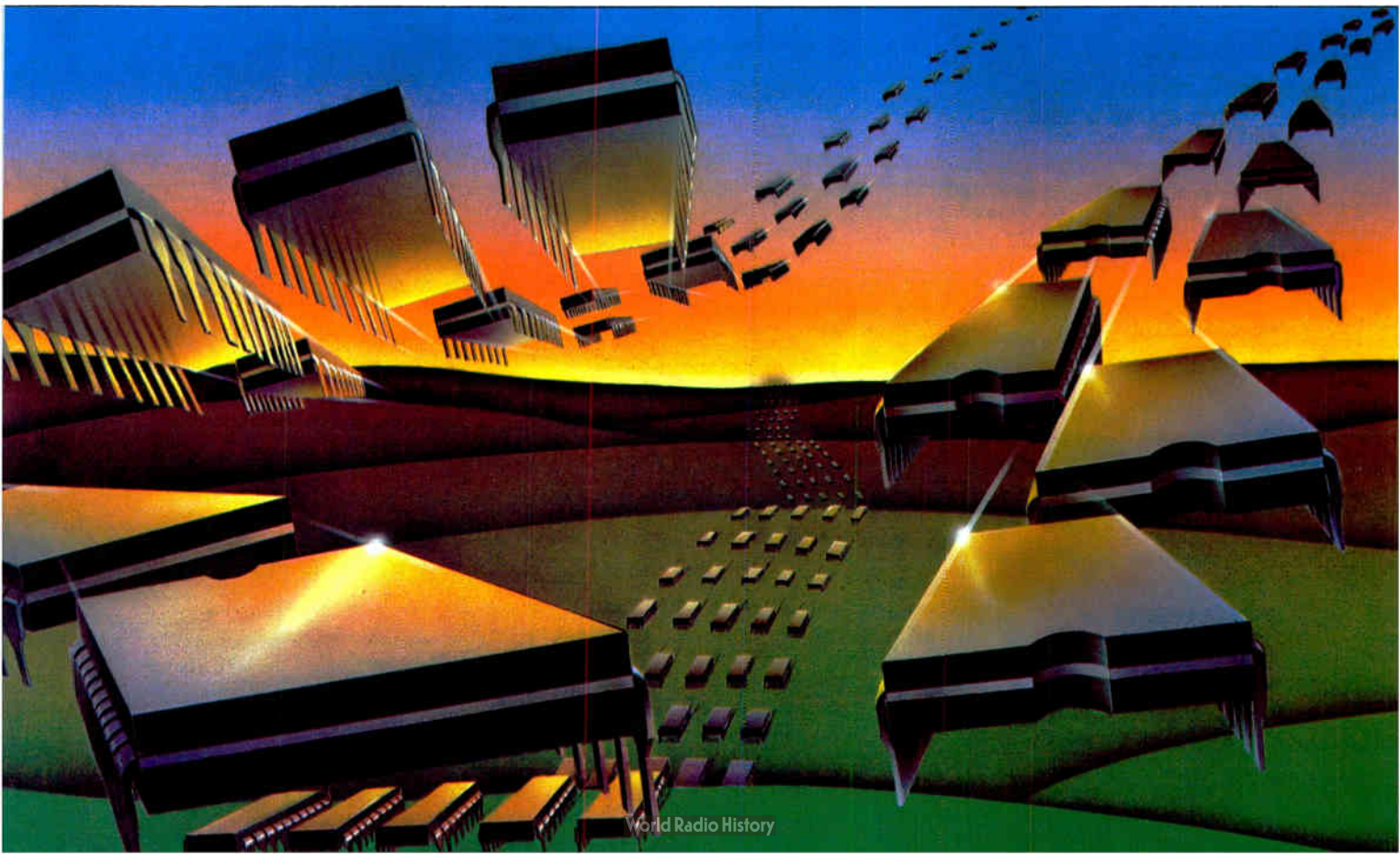

New μ P-compatible converters bridge the gap from D to A.

National's line of low-cost 8-, 10- and 12-bit CMOS MICRO-DAC™ converters are double-buffered for maximum versatility.

The number of microprocessor-based designs requiring digital-to-analog conversion is increasing at an incredible rate.

In response to this demand, the linear wizards are now offering a full line of low-power CMOS D/As that interface very easily to any 8- or 16-bit μ P bus. These double-buffered converters contain both an input latch and DAC register plus all the μ P logic necessary for simplified design and reduced board space.

DOUBLE BUFFERED MICRO-DAC CONVERTERS

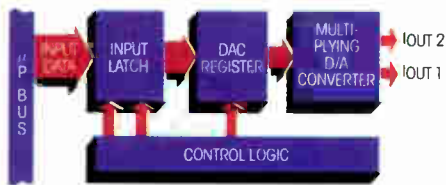

And since they're all monotonic with differential non-linearity specified over temperature, they fit particularly well in either fixed or multiplying reference applications such as servo control or synchro-to-digital converters. Thanks to their low cost, these new 8-, 10- and 12-bit D/As can also be used as programmable gain amps, digital attenuators, band-pass filters and more.

All digital inputs are TTL-compatible for more extensive interface flexibility. Their 20-pin (.3" wide) packaging keeps board

space usage down while their 20mW power consumption—a factor of 10 lower than bipolar—extends battery life in portable equipment.

The high accuracies obtained by using these devices are largely due to their "end point" linearity: just set zero and full scale and linearity is met.

And to make them even more versatile, National's 8-bit DAC0830/31/32, and 12-bit DAC1230/31/32 D/As have identical pin-outs for easy interchangeability.

For complete details on the entire line of low-power MICRO-DAC converters, check boxes 051, 057 and 073 on this issue's National Archives coupon.

At National, the practicality keeps on coming through. 

MICRO-DAC is a trademark of National Semiconductor Corporation.

PRODUCT SUMMARY TABLE

PART NUMBER	DIP SIZE	RESOLUTION (BITS)	ACCURACY (% OF FSR)
DAC0830	20	8	0.05
DAC0831	20	8	0.10
DAC0832	20	8	0.20
DAC1000	24	10	0.05
DAC1001	24	10	0.10
DAC1002	24	10	0.20
DAC1006	20	10	0.05
DAC1007	20	10	0.10
DAC1008	20	10	0.20
DAC1208	24	12	0.01
DAC1209	24	12	0.02
DAC1210	24	12	0.05
DAC1230	20	12	0.01
DAC1231	20	12	0.02
DAC1232	20	12	0.05

Worlds ahead in data acquisition technology.

National Semiconductor, the Practical Wizards of Silicon Valley, is the world's largest supplier of data acquisition components. Over the last year, for example, they shipped over 5 million A/Ds—more than anyone else in the industry.

The key to their lead over the rest of the pack is their high volume production capabilities and extensively broad line, and their commitment to high performance at a low cost. With all of their transducers, amplifiers, filters, MUXs, sample and hold circuits, references, A/Ds and D/As, there's a National part for every application.

In addition, they're the only supplier utilizing technologies of bipolar, CMOS, NMOS and hybrid along with thin-film resistors and laser trim.

This is just a glimpse into what they're up to—designing high technologies into practical high performance data acquisition components.

National, the dedicated leader in data acquisition technology and components. 

MICRO - DAC CONVERTERS
←



National creates the boards no one else could. SuperChips.™

SuperChips are the Multibus™ board-level solutions to your total system needs. Only National's broadline approach and technical expertise could make SuperChips a reality.

As an industry leader in state-of-the-art components, it's only natural that National should produce the industry's most powerful line of board-level system solutions. Their strong technical expertise and manufacturing muscle assure both the capabilities of their products and confidence of their customers.

The broadest family of problem-solving boards. With over 100 SuperChip products available, the Practical Wizards have more

board-level solutions for more system configurations than anyone else.

For example, everyone has boards that compute and remember. There's no trick to that. But only National has boards that translate (the BLC-8488 intelligent GPIB controller board), talk (the BLX-281 speech synthesis module) and measure (the BLC-8737 and BLC-8715 analog I/O boards). The fact is, no one else in the industry can touch National when it comes to board-level technology.

12-Month Warranty. National also stands alone in the warranty business. Their entire SuperChip line carries a full 12-month warranty, the longest in the industry. Because anything less than that is less than the best.

SuperChips give you innovative system solutions based on superior design capability and leading edge technology.

Nobody knows more about building chips than National does, so they're a natural for building practical and reliable board-level products made from those chips.

For complete details on the entire line of SuperChips be sure to check box 083 on this issue's National Archives coupon.

SuperChips. Because man cannot live by chips alone. 

SuperChip is a trademark of National Semiconductor Corporation.
Multibus is a trademark of Intel Corporation.

J-FETs—the time-proven solution to increased signal sensitivity demands.

The reliable back-to-basics solution to design overcomplexity.

National is known throughout the industry for their high performance line of J-FETs. They make over 500 standard products using 18 processes. And they're all available in quantity now.

The result is a J-FET for virtually any application problem.

The economics of plastic. No one offers plastic J-FETs with leakages as low as National's. Their PN4117A—normally used in smoke detector applications—has a leakage

current of 1.0 pA max, 0.3 pA typical. Copper lead frames offer low thermal EMF voltages in ultra-low leakage switching applications such as digital volt meter range switches.

But the best news is National's plastic J-FETs offer leakages comparable to the metal can versions, with plastic devices costing 50% less. So now versatile plastic packages can be designed into applications requiring extremely tight specs.

J-FET practicality is basic reliability. The J-FETs' versatility allows them to rescue designs wrought with overcomplexity. And

National's broad line of both single and dual J-FETs offers a flexibility of design along with competitive pricing and solid reliability. Together they give engineers considerable freedom of choice.

Check box number 074 on this issue's National Archives coupon or contact your local distributor or NSC sales rep for additional information. For application assistance, call one of National's FET Wizards at (408) 737-5554.

And start getting back to basics with high performance J-FETs.

Bubble memory bursts price barrier.

¼Mbit bubble memory boards for under \$1800* available now from National.

National introduces the lowest priced ¼Mbit bubble memory board available—the BLC-9250. It's a non-volatile MULTIBUS™ and Series/80 compatible bubble memory board. And it's easily expandable to 1056K bytes with the BLC-9101 expansion board.

Suddenly, bubble memory becomes a cost-efficient choice for system design and life cycle enhancements. What's more, both the BLC-9250 ¼Mbit board and the BLC-9101 1Mbit expansion board are available in volume right now.

Smaller, faster and more reliable memories. National's bubble memory sub-systems use dense 16-pin memory modules designed to save board space. They have the smallest

package and least number of pins for their density in bubble memory today.

In addition, they offer an average access time of 7ms and an average data rate of 75K bits per second. And they out perform others by a factor of 10 in reliability tests.

National's family support. Since both the BLC-9250 and BLC-9101 (and all Series/80 boards) are MULTIBUS-compatible, they interface with a wide variety of development systems. Including National's advanced STARPLEX™ development system with ISE™ and CP/M operating system.

For more information check box 065 on the National Archives coupon.

STARPLEX and ISE are trademarks of National Semiconductor Corporation.

MULTIBUS is a trademark of Intel Corporation.

*Single-piece U.S. price only.

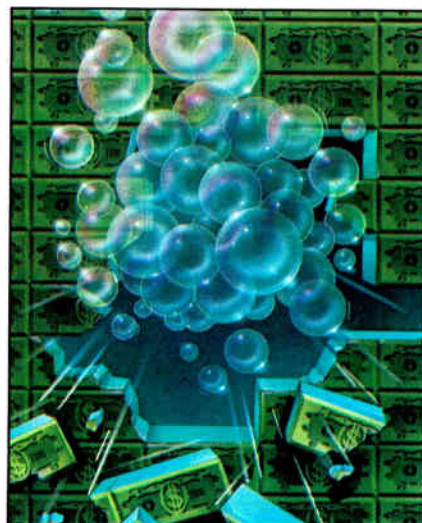

Titanium-tungsten fuses improve the reliability of 16K PROMs.

National's bipolar PROMs guarantee an extra measure of reliability, thanks to titanium-tungsten fuses and today's high volume Schottky production processes.

National's 87S190 and 87S191 state-of-the-art 16K bipolar PROMs are an example of their bipolar wizardry. They're as fast and as large as any PROMs in the industry. And yet their titanium-tungsten fuses and high volume Schottky production process gives them rock-solid reliability.

These high-speed PROMs are Schottky-clamped for a typical address access of 40 ns and a typical enable access of 20 ns.

They use the same basic production flow as for other standard Schottky bipolar PROMs (from 256 to 8K bits) plus PALs and the 2900 bit slice family. It's a proven process that works time-after-time.

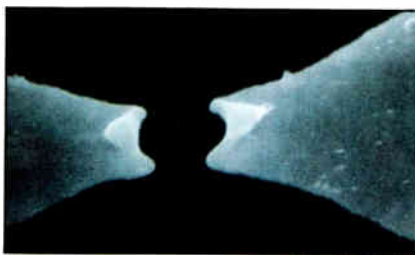

SCANNING ELECTRON MICROPHOTOGRAPH OF NATIONAL'S TITANIUM-TUNGSTEN FUSES IN THE OPEN STATE.

For more information check box 096 on the National Anthem coupon.

PROM SUMMARY TABLE

PART NUMBER	T _{AA} (MAX COMM)	ORGANIZATION
DM74S188/288	35	32 x 8
DM72S287/387	50	256 x 4
DM74S570/571	55	512 x 4
DM74S472/473	60	512 x 8
DM74S474/475	65	512 x 8
DM74S572/573	60	1024 x 4
DM87S180/181	60	1024 x 8
DM87S184/185	55	2048 x 4
DM87S190/191	65	2048 x 8

National's 10 Amp MOOSE™ is five years ahead of the pack.

The linear leaders are the first to introduce a 10 Amp monolithic adjustable voltage regulator. It uses National's revolutionary new MOOSE fabrication process that leaves the rest of the industry far, far behind.

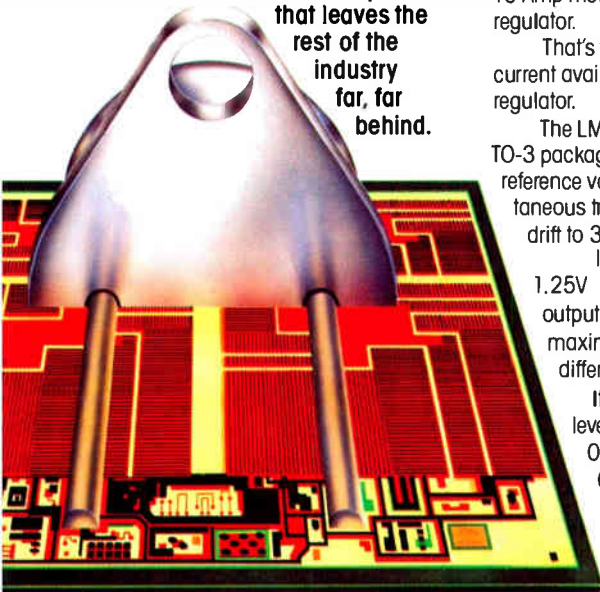

MOOSE combines discrete power transistor and modern monolithic linear technologies. By combining both processes, the linear leaders have developed the world's first 10 Amp monolithic adjustable voltage regulator.

That's far and away the highest output current available in any adjustable IC voltage regulator.

The LM396—available in the standard TO-3 package—features on-chip trimming of reference voltages to $\pm 0.5\%$, with simultaneous trimming of reference temperature drift to 30ppm/ $^{\circ}\text{C}$.

It's continuously adjustable from 1.25V to 15V and can satisfy higher output voltages as long as the maximum input/output voltage differential (20V) is not exceeded.

It can also handle 10A with power levels up to 70W. It also features 0.005%/V line regulation and 0.07%/A load regulation.

High performance, low price.

The advanced MOOSE process results in a 2:1 reduction in die size and significant leaps

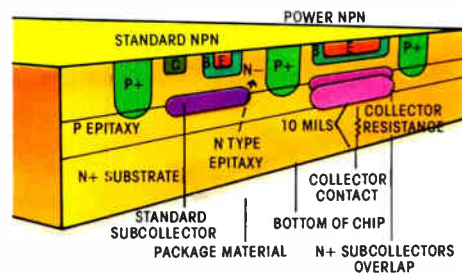

MOOSE PROCESS

in operating efficiency. These advances, backed by National's manufacturing expertise, strict quality control procedures and large volume production, result in a low \$12.35* unit price for the LM396 in 100 piece quantities.

You can expect to see a complete array of MOOSE-based devices from National in the future. But then, who would expect less from the linear leaders?

To get the full picture on MOOSE, check box number 069 on the National Anthem coupon in this issue.

*U.S. price only.

MOOSE is a trademark of National Semiconductor Corporation

The totally self-contained low noise instrumentation amp with 12-bit accuracy.

With 0.2 μV peak-to-peak input noise voltage and 1 ppm gain non-linearity, the LH0038 allows precise gains ranging from 100 to 2000.

National, the recognized leader in linear circuitry, is offering their LH0038 precision instrumentation amplifier to design engineers working on data acquisition and related systems.

The LH0038 is the most complete single package instrumentation amp available because it requires no external resistors. In fact, the LH0038 contains four amplifiers, an extremely low-noise input stage and a precision thin-film resistor network—all in a single 16-pin metal DIP.

The pin-strap gain options on the LH0038 range from 100 to 2000, which

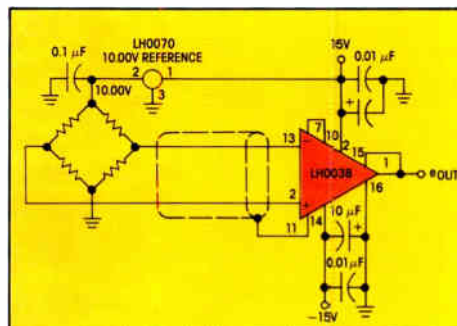

X1000 BRIDGE AMPLIFIER

makes it ideal for amplifying very low-level signals (such as thermocouples, low impedance strain gauges, etc).

High-performance specifications. A

large part of the LH0038's success in the industry is reflected in some of its key specs.

The LH0038 exhibits an excellent common-mode rejection ratio (114dB at a gain of 1000) and a closed loop gain error of only 0.5% (also at a gain of 1000).

In addition, the LH0038's input offset voltages are an ultralow 0.25 $\mu\text{V}/^{\circ}\text{C}$. The settling time to 0.01% is typically between 60 and 120 μsec .

Also available in mil-spec version. In addition to National's own stringent REL and QA standards and procedures, a version of the LH0038 amp is also available that meets military standard 883 level B specifications.

For more information on the LH0038 precision instrumentation amp, check box 084 on the National Archives coupon.

The LH0038 single package instrumentation amp—another minor miracle from the Practical Wizards of Silicon Valley.

National creates the controller board no one else could. The BLC-8488 SuperChip.™

The BLC-8488 forms a new high-speed intelligent interface between Multibus™ and IEEE 488-1978 (GPIB) systems.

National's new BLC-8488 SuperChip makes the interface between GPIB-compatible devices and Multibus systems faster and easier to use than ever before. So easy, in fact, that all the designer needs to know about GPIB is how to configure the necessary I/O Control Blocks (IOCBs).

And the BLC-8488's 125 KB/sec throughput rate makes it over 20 times faster than the competition. So it makes the most of the GPIB's 1 MB/sec maximum data transfer rate.

Master/Slave versatility. On the GPIB side, the BLC-8488 conforms to all IEEE 488-1978 interface specifications—with a cable included for connection to male and/or female GPIB connectors.

But on the Multibus side, the micro-processor-based controller board serves equally well in either a master or slave configuration.

And in addition to 1 KB of private RAM it can address up to 1MB of system memory. The BLC-8488 also contains 2 KB of public dual-port RAM that's mappable anywhere in the 1 MB memory area.

The SuperChip solution. This SuperChip versatility is even further extended to allow flexible interrupt handling/generation arrangements.

It's no surprise that the Practical Wizards are making some of the industry's hottest boards. It's just a practical extension of their technical expertise as a leading manufacturer of state-of-the-art semiconductor components.

For complete information on the new BLC-8488 intelligent GPIB controller board, simply check box number 081 on the National Archives coupon below.

SuperChips. Because man cannot live by chips alone. 

SuperChip is a trademark of National Semiconductor Corporation.
Multibus is a trademark of Intel Corporation.

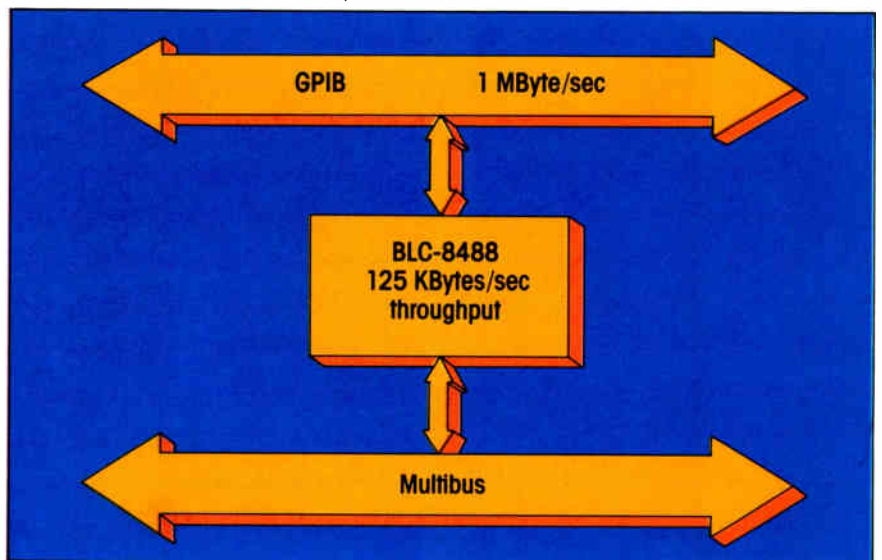

What's new from the National Archives?

051 Data Conversion/
Acquisition Data Book
(\$7.00)

052 Free Subscription to
the Data Update

057 MICRO-DAC
Converter Data Sheets

062 Reliability Handbook
(\$12.50)

065 BLC-9250 and
BLC-9101 Bubble
Memory Data Sheets

069 LM396 "MOOSE"
Data Sheet and
Adjustable Voltage
Regulator Brochure

073 Data
Conversion/Acquisition
Brochure

074 Additional J-FET
Information

080 LH0101 Op Amp
Data Sheet

081 BLC-8488 Data Sheet

082 DS3662 Data Sheet

083 SuperChip Family
Information

084 LH0038 Data Sheet

096 Bipolar PROM Update

For desired information, mail coupon to:

National Semiconductor Corporation
2900 Semiconductor Drive
Mail Stop 16251
Santa Clara, CA 95051

In Europe, mail coupon to:

National Semiconductor GmbH
Industriestrasse 10
D-8080 Fürstentfeldbruck
West Germany

Enclose check or money order based upon appropriate currency. Make checks payable to National Semiconductor. All prices shown are U.S. prices only. Add applicable state and local sales tax to your order. Allow 4-6 weeks for delivery. This coupon expires on August 31, 1981.

NAME _____

TITLE _____ PHONE _____

COMPANY _____

ADDRESS _____

CITY _____ STATE _____ ZIP _____

 **National
Semiconductor**
The Practical Wizards
of Silicon Valley

Shugart did it first. Decitek did it better.

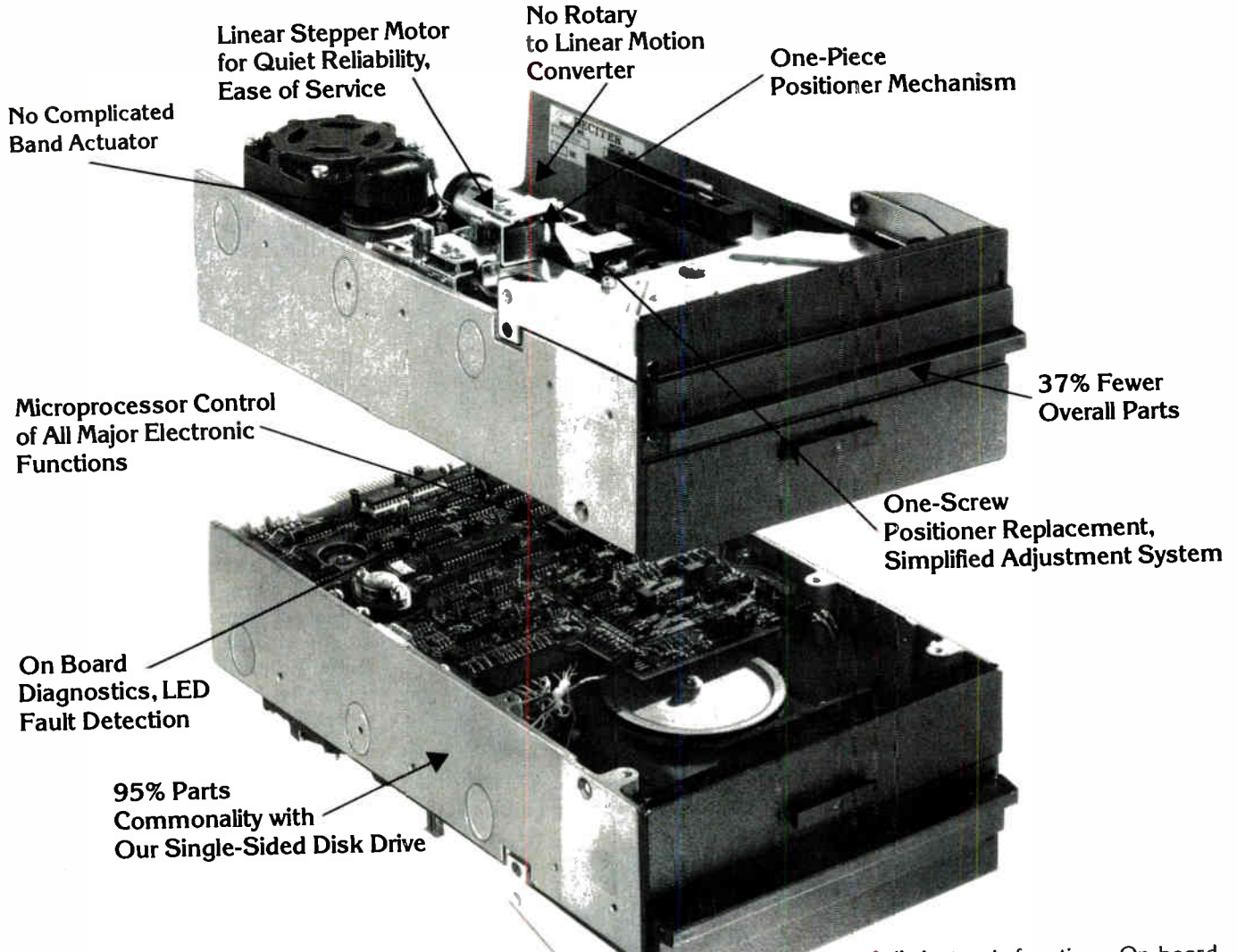

Our new 8-inch double-sided floppy disk drive is everything that is great about Shugart's model. But that's where the resemblance ends.

100% Compatibility and More

Physically, electronically and cosmetically, our drive is 100% compatible with Shugart's—even right down to its standard color. Our holes are all in the right places. We're 100% interchangeable. Put their drive and our drive side by side in front of you and you wouldn't know which is which. Because it's what you don't see that makes the difference.

Our drive has 37% fewer parts. 50% greater reliability. A warranty that's twice as long as any other in the industry. A linear stepper motor that runs 50% quieter, takes less than 30 minutes to replace on site and can be installed and adjusted via one screw using one inexpensive tool. It uses microprocessor control providing optimum effi-

ciency and reliability of all electronic functions. On-board diagnostics are a standard feature, as well as a LED fault indicator. And, unlike any other drive in the industry, our new double-sided model shares a 95% parts commonality with our single-sided drive. That means one set of spares serves both.

Better on the Bottom Line

And who says something better has to be either hard to get or more expensive. In fact, many of the improvements we've made to make our drive more reliable, more functional and more serviceable have also contributed to manufacturing efficiencies. Meaning our drive is available now, and available at prices that are equal to or less than those being quoted by the leader.

No. We weren't first. We're just better, any way you look at it. Decitek, 129 Flanders Road, Westboro, MA 01581 (617) 366-8334.

DECITEK

Driven to Perfection

Circle 57 on reader service card

Assure Superior Performance in High Quality Radio and Sound Equipment

Our computer controlled test systems – which increase both quality and productivity – are in use, on-line, today!

They are checking the complete range of high performance parameters in thousands of AM/FM Stereo radios, amplifiers, tape players and associated equipment.

Ease of use and cost effectiveness allow faster and more comprehensive testing than ever before.

Contact us for complete information.

We're programmed
to help you



re RE INSTRUMENTS AS
Emdrupvej 26, 2100 Copenhagen Ø, Denmark
Phone 01-18 44 22 Telex 22211 re dk

Circle 174 on reader service card

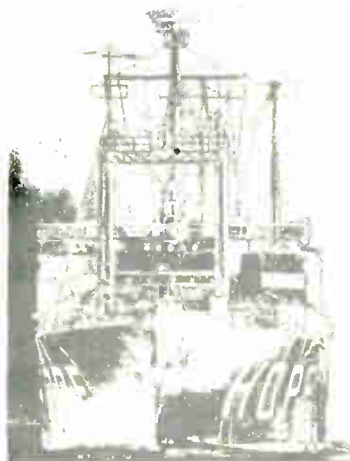

HOPE The project a ship launched.

First there was the hospital ship S.S. HOPE, now retired. Today HOPE is an established project which has carried its goal of improving health through education to 24 developing countries of the world and the United States:

Give to:

PROJECT HOPE Department A
Washington, D.C. 20007

Electronics review

ucts is "unbelievable," said Samuel J. Irwin, president and chairman of Irwin International Inc., Ann Arbor, Mich., whose model 510 unit is currently in production.

Another interesting display came from Cipher Data Products, San Diego, Calif., which showed a prototype speech-synthesis addition to its Microstream half-inch streaming tape drive. "It's not a product yet. We just want to survey customer response to this type of thing," notes product manager Roy Ford. The prototype uses National's Digi-Talker and some interfacing circuitry to add voice output to the 40-megabyte tape drive. Upon power-up, it says "Hello," and upon completion of its self-checking routines it says, "I am functional." Ford estimates that such an option would add about 5% to the cost of a tape drive in volume production.

Software-defined character fonts were also present, such as that held in a single-board computer from Symbiotic Systems Inc. of Santa Cruz, Calif. Symbiotic Systems' Stratos computer allows an unlimited number of light-pen-created characters to be loaded onto a disk and recalled as needed. The user can mix foreign-language characters and mathematics and graphics symbols along with different type styles in a word-processing environment. The \$6,400 microcomputer package includes a detachable keyboard, dual floppy-disk drives, a cathode-ray tube, and an assortment of software.

Attendance. NCC '81 did not match the 80,000-plus turnout at last year's event in Anaheim, Calif. But the 73,526 attendees who blew into the Windy City's expansive McCormick Place provided booth traffic that put smiles on the faces of the record 544 exhibitors.

Though inquiries may have been down, the number of serious requests for product information was up this year compared to previous NCC shows, said Charles Deeg, the exhibit manager for Control Data Corp., Minneapolis, Minn. Other exhibitors at the 230,000-square-foot exhibit area echoed that sentiment. Because of inadequate space available in

There's a powerful new source in the electronic fuse market.



We're Gould Shawmut®, and we've been making fuses exclusively for the electrical industry since 1893.

In fact, we manufactured the wire for the first fuse invented by Thomas Edison. In more recent history we introduced the first complete line of low voltage current limiting fuses in America. The first single element time delay fuse, the first miniature 1000 volt fuse for Nautilus class atomic submarine service and much more. Our leadership in fuse technology is recognized throughout the electrical industry.

Now we're extending our expertise into the electronics industry, so you have an alternative source: A new line of miniature fuses for low voltage, over-current protection. In stock. Ready for immediate

delivery. And made by Gould Shawmut.

You'll be hearing a lot from us in the future.

For more information about our glass and miniature fuses write: Gould Inc., Electric Fuse Division, Newburyport, MA 01950.

Tel: (617) 462-6662, 462-3131/Telex: 94-7427.

In Canada: 406 Adelaide St., E., Toronto, Ontario M5A 1N4.

Tel: (416) 366-1981/Telex:

06-219717.

 **GOULD**

An Electrical/Electronics Company



SERIES SE3000

Lightweight, instrumentation recorders

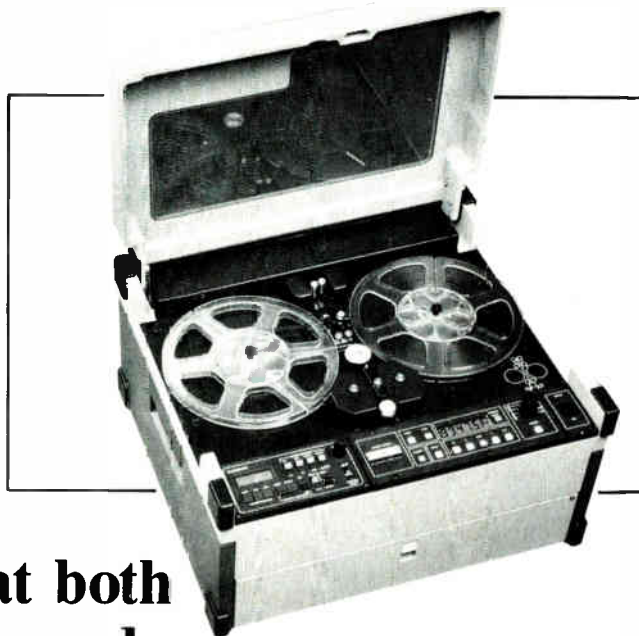

that both
you and your
budget can carry

These IRIG compatible ¼ and ½ inch portable instrumentation recorders are the first to offer the features and performance of 1 inch laboratory recorders that weigh and cost much more.

- 8 tachometer or tape servo controlled speeds, from 15/32 to 60 inches/second
- IRIG compatible recording up to 40 kHz FM, 300 kHz direct, and 0.5 Mbit/second HDDR
- 4, 7, 8, or 14 record/reproduce channels, plug in for any mix of FM, direct, and HDDR, fully aligned for 8 speed operation
- Built-in calibration, complete electronics-to-electronics checkout (FM and direct)
- Choice of interchangeable ac or dc power supplies

Call today. You'll be surprised how little a 55 lb, 14 channel portable instrumentation recorder can cost. Or write for our new 4 page brochure.

EMI EMI Technology Inc.
Instrumentation Division

6445 Powers Ferry Road Atlanta, GA 30339
Telephone (404) 952-8502 TWX: 810-766-2267
Toll Free Instrumentation Service: 800-243-2572

A Member of the THORN EMI Group

Sales Offices:

- Newport Beach, CA 92660
Telephone (714) 760-1955
- Reston, VA 22091
Telephone (703) 620-6056

International:

SE Labs (EMI) Ltd.
Spur Road, Feltham, Middlesex
TW14 0TD, England
Telephone 01-890-1477 Telex: 23995

Electronics review

New York, NCC '82 has been rescheduled for June 7-10 in Houston's Astrohall, where up to 256,000 square feet of exhibit space will be available.

All booths have been sold, and there is already a waiting list, say show officials. -Wesley R. Iversen and Martin Marshall

Zilog bridges 8-to-16-bit gap

For designers using the Z80 who want the higher throughput of 16-bit machines without losing compatibility with its extensive software base, the coming Zilog Z800 was disclosed at the National Computer Conference. It has operation codes that will be totally compatible with the Z80, so that Z80-based software will run three to five times faster on the new processor without revision.

The Cupertino, Calif., company will offer the Z800 in two versions—a multiplexed Z800-bus-compatible version that supports 16-bit data transfers and a nonmultiplexed package compatible with the Z80 bus. The idea behind the multiplexed part is to make it possible to upgrade hardware now with the Z800 for easy accommodation of a Z8000 when software becomes available for that processor. Scheduled for sometime in the second half of 1982, the Z800 will sell in the \$10 range.

8 to 16. The Z800 is the first 8-bit machine to support 16-bit hardware while retaining compatibility with previous-generation software. The approach taken by Intel with the 8088 and Texas Instruments with the 9980 is to offer 8-bit bus versions of their 16-bit processors so that current equipment can execute 16-bit code while maintaining an 8-bit bus.

Perhaps Motorola's 6809 design is the closest relative to the Z800. However, that part does not maintain total operation-code compatibility with the 6800, nor does it support 68000 bus structures. It does offer five times the speed of the 6800, plus some internal 16-bit data paths for the user. -R. Colin Johnson

“Important development for STD Bus users: Total analog I/O capability from Data Translation.”

Fred Molinari, President

Picture this.

A complete and comprehensive line of analog I/O for STD Bus microcomputers – the DT 2742 series. I/O that works with *any* STD Bus CPU. Including STD 8085, STD 8080A, STD 6800, STD 6809, and STD Z80.

We offer A/D boards for analog input, D/A boards for analog output, input channel expansion, DC-DC conversion, everything.

We can supply performance parameters sufficient to solve most any application problem.

In all, we stock more than 50 different boards. And each includes a fully shielded DATA X II™ module which virtually eliminates ground loops and digitally-induced noise.

What's more, ours is the only line that provides user selectable interrupt structures.

In fact, we offer *two* kinds. Software polled and vectored interrupt. Both conform to the latest standards of the STD manufacturers group.

Good news, STD Bus users, we offer more than 50 analog I/O boards. Complete with two ways to handle interrupts. Our boards operate with any 8-bit STD Bus microcomputer, including STD 8080A, STD 8085, STD 6800, STD 6809, and STD Z80.

Now let's discuss accuracy.

If 12-bit resolution won't do, we can give you



14 bits. Or even 16 bits.

On top of all this, we promise to deliver your boards within five working days. Or about five times faster than the “competition.” We think this enormous assortment of analog I/O and our five-day delivery are just what the industry needs – so tell all your friends.

Data Translation cannot be overexposed.

For more information write Data Translation, 100 Locke Drive, Marlboro, Massachusetts 01752. Or call (617) 481-3700. TELEX 951646. In Europe: Data Translation Ltd., Rockwell House, 430 Bath Road, Slough, Berkshire/England SL1 6BB (06286) 3412. TELEX: 849862.



DATA TRANSLATION

INTERNATIONAL SALES OFFICES: ARGENTINA, Buenos Aires 93 2557; AUSTRALIA, N.S.W. (02) 818 1166; BELGIUM, Brussels 02-352135; CANADA, Toronto 416-625-1907; DENMARK, Copenhagen (01) 83 34 00; ENGLAND, Stockport 061-442-9768; Slough 06286-3412; FINLAND, Helsinki 90 377787; FRANCE, Meudon La Foret 6306835; GERMANY, Puchheim (089) 80 1602; INDIA, Bombay 231040; ISRAEL, Ramat Hasharon 03-237959; ITALY, Milano 34.93.041; JAPAN, Tokyo (03) 244-1111, (03) 437-5471; NETHERLANDS, Rijswijk 070-996360; NEW ZEALAND, Wellington 693-008; NORWAY, Oslo (02) 229850; PORTUGAL, Lisboa 545313; SPAIN, Barcelona (93) 301 7850; SWEDEN, Vallingby 08 38 00 65; SWITZERLAND, Zurich 01/7241410.

DATA X II is a trademark of Data Translation Inc.

For years, Wavetek function generators have been known for their versatility (and their low prices). Now there is a 50 MHz Programmable Waveform Synthesizer with all the versatility you expect from Wavetek. Not only can it be triggered and gated, it can deliver tone bursts too. Plus LIN/LOG sweeping, and a choice

of triangle, ramp, sine, square and haversine outputs. At levels up to 20Vp-p into 50Ω.

Even the programmability is more versatile. Dual microprocessors accept input in any order or format. Implement instructions one at a time, or instantly change to a complete new setup. The programming is

fully compatible with GPIB.

For more information, and the typically Wavetek price (surprisingly low), write or call us today. Wavetek San Diego, P.O. Box 651, 9045 Balboa Ave., San Diego, CA 92112. Tel (714) 279-2200; TWX 910-335-2007.

WAVETEK[®]

Circle #64 For Demonstration

Circle #65 For Literature

A 50 MHz Programmable Waveform Synthesizer that triggers and gates like a function generator.

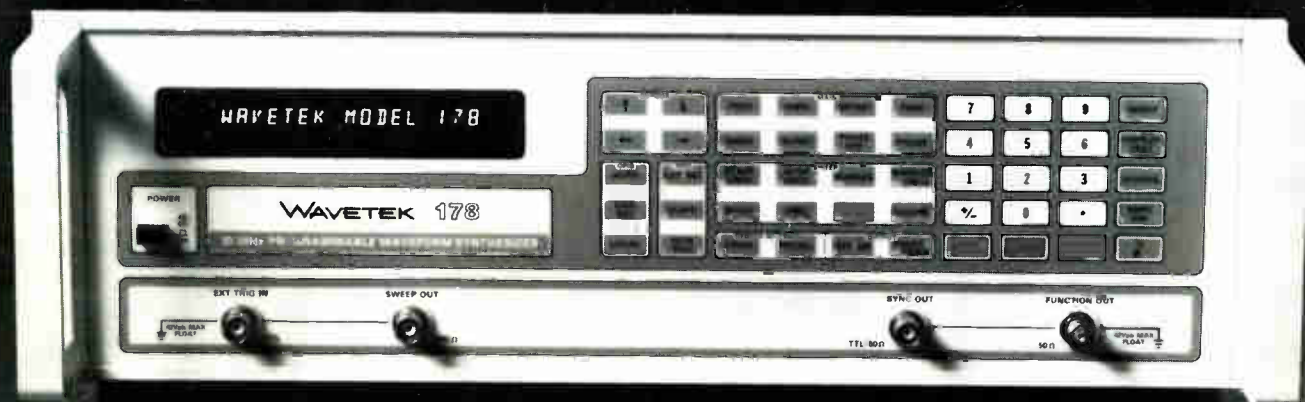

It must be from Wavetek.

Joint military R&D explored by Japan, U. S.

Watch for military electronics, particularly avionics, to highlight future joint weapons-development programs between the U. S. and Japan—if the government of Prime Minister Zenko Suzuki can make them politically acceptable in Tokyo. Japanese defense officials who accompanied Suzuki during his recent summit meeting in Washington, D. C., say privately that **the country would like to undertake joint development programs on subsystems that could hold down costs** of Japanese weapons bought from the U. S., like the McDonnell Douglas F-15J fighter aircraft. A memorandum of understanding on joint military research and development was signed by both countries in 1966 but never implemented. “Selling this idea at home will be extremely difficult,” says one Suzuki staff member.

Business TV channels assigned by FCC

Development of the hotel entertainment and business video markets got a boost from the Federal Communications Commission with its authorization this month of licenses for omnidirectional transmissions on three 6-MHz channels in the 2.5-GHz band and point-to-point transmissions in bands above 13 GHz. The latter bands were selected, the FCC said, because they are the only ones that can provide the 20-MHz channel widths necessary for high-quality “multihop” directional transmission of more than one transmitter-to-antenna relay. The availability of channels above 13 GHz, which are subject to attenuation by rain or snow, could spur development of new systems using these frequencies, the FCC believes. **Licensees will be limited to distributing material that they own or have distribution rights to**—for example, omnidirectional microwave transmission of entertainment programming directly to hotels using the 2.5-GHz band or point-to-point transmission of business data between offices at the higher frequencies.

Cost expected to force Divad cuts

Further cost increases are expected to force Army cutbacks in its projected purchase of 618 mobile division air-defense gun systems, known as Divad, now priced at more than \$5.1 billion—**125% more than forecast when development began in 1978**. Ford Aerospace & Communications Corp.’s Aeronutronic division in Newport Beach, Calif., won the competition with General Dynamics Corp.’s Pomona (Calif.) division early this month. Ford got a \$159 million award to complete development and tests, plus options to buy 276 Divad systems over three years. Army officials say, however, that they may have to reduce the total and stretch it out beyond 1987, thereby almost guaranteeing further increases.

Millicom approved for cellular tests

Millicom Inc. has received Federal Communications Commission approval for operational tests of the New York City company’s mobile cellular communications system in the Raleigh-Durham, N. C., area [*Electronics*, June 19, 1980, p. 61]. Millicom’s Washington counsel, Larry Solomon, says the company is “quite pleased” with the FCC’s authorization of 490 base transmitters and 250 of its lightweight portable units being designed in cooperation with IBM, Harris, and E. F. Johnson. **First large-scale tests of the system are scheduled for January 1984**, he adds.

The Pentagon attacks procurement

To turn the Pentagon procurement process around is an awesome undertaking, yet that is exactly what Secretary of Defense Caspar W. Weinberger plans to do. He has assigned the task to Deputy Secretary Frank C. Carlucci, whose prior experience in dealing with the Federal bureaucracy and Congress could possibly make the new program work.

"The secretary and I are determined to reduce substantially cost overruns, deploy adequate quantities of needed systems that are operationally effective and ready, and do this in the shortest possible time," says Carlucci, who quickly acknowledges that the task is indeed easier said than done. It is an effort that will require extensive cooperation and changing attitudes from the Congress, the military services, and industry.

The new program to improve the management of weapons system acquisition follows by one month the changes laid down by Weinberger in the Planning Programming and Budgeting System. The latter proposal stresses the need for more long-range planning and the delegation of greater authority to the individual military services and their program managers [*Electronics*, May 5, p. 64].

Cutting technological risks

The new program's strongest signal for military electronics system designers in Government and industry is that proven and supportable technology will be favored over state-of-the-art advances in order to shorten acquisition time and costs. "We must examine evolutionary alternatives which use a lower risk approach to technology than solutions at the frontier of technology," Carlucci says.

Complementing that conservative approach will be a program called P³I for preplanned product improvement. Its goal is to permit future upgrades using advanced subsystems on weapons already in the field. These upgrades will be based on experience and proven need matched against available funds in future years.

"Readiness and sustainability of deployed weapons are primary objectives," Carlucci points out, "and must be considered from the start of weapons systems programs." The P³I program will be the first to be implemented, and Carlucci has called for the under secretary of defense for research and engineering to come up with a program plan by early June. "That should not be difficult," says one Department of

Defense official, "since P³I will be in large part merely formalization of what the services have been doing for some time—replacing parts of old systems with better ones."

Implementing other cost-cutting procedures, however, is likely to prove to be a mixed bag for Carlucci. DOD insiders, for example, see little difficulty in simplifying administrative procedures and paperwork and in assigning greater responsibility to project managers. On the other hand, they foresee difficulty in getting project managers to realistically estimate total program costs very early in the program. "That may be asking too much of a manager whose program is competing with others for budget dollars. In that respect, he is just like a contractor: if he comes in too high, he may lose," a Defense Department official explains.

Confrontation with Congress

What appeals most to industry managers in the Carlucci program are those portions that are certain to face the greatest congressional opposition. Among them are the multiyear procurement contracts, faster writeoffs of capital investments that enhance plant productivity, greater funding early in a program for prototype development for testing, and increased contract incentives for meeting reliability and maintainability goals.

"Reliability incentives in contracts will probably have the least difficulty up here, provided they are carefully drafted," says one Armed Services Committee staff member on Capitol Hill. "But I doubt that Congress would ever approve funding a program several years in advance without insisting on annual reviews and cancellation rights."

Faster writeoffs of contractor capital investment is rated as a "maybe" by another congressional official. But Carlucci's drive for a waiver of socioeconomic programs in the areas of small-business participation, minority and disadvantaged hiring, labor surplus, equal employment, fair labor practices, safety in manufacture, and environmental protection is expected to get short shrift in the House.

Nevertheless, the Secretary of Defense and his deputy have made a start at gaining control of a procurement process that has come close to undoing a number of their predecessors. "If they get half of what they want working in four years," says one Air Force colonel, "they should get a medal."

-Ray Connolly

We can match your versatility.

Your requirements are matched by our versatile systems.

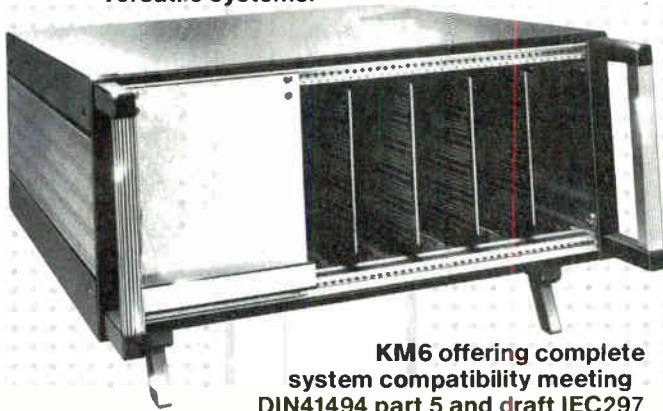

KM6 offering complete system compatibility meeting DIN41494 part 5 and draft IEC297 specifications.

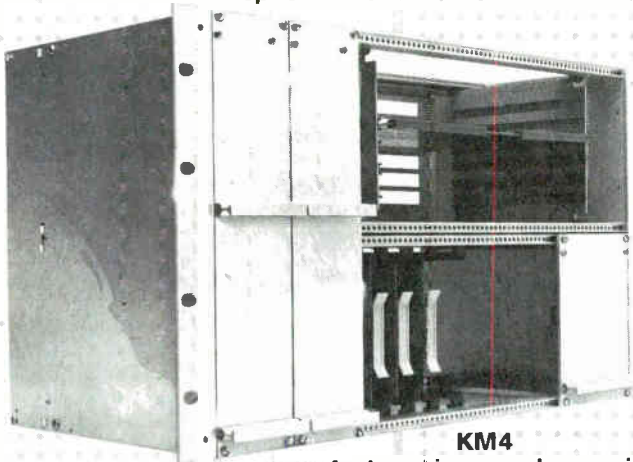

KM4 manufactured in accordance with DIN41494 parts 1-4. Accepts Eurocard and International card sizes including the horizontal card mounting facility.

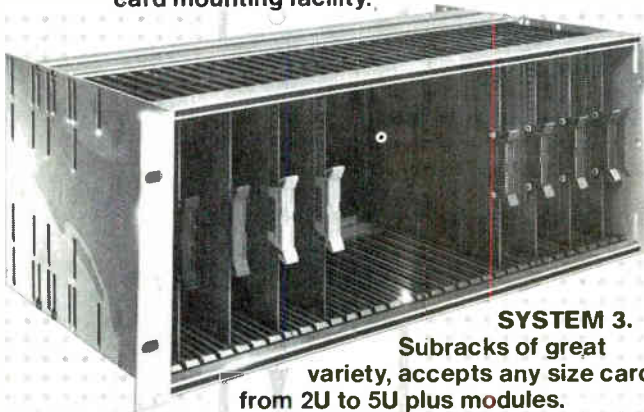

SYSTEM 3. Subracks of great variety, accepts any size card from 2U to 5U plus modules.

Drawer Units for horizontally mounted card systems.

Special Configurations and custom panel work to order.

Bus Bars and Connectors, compatible with Eurocards, International cards, modules and racks.

All systems are easy to assemble and have a wide range of accessories and applications.

Backed by Vero's high quality. Available ex-stock, internationally.

Indications of Vero's versatility.

vero

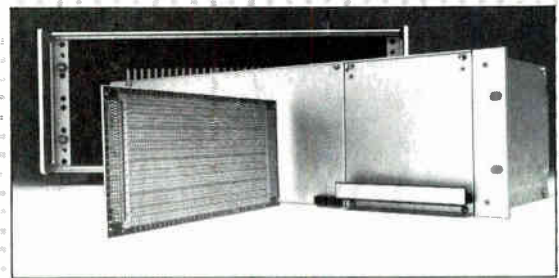

BASICALLY YOU NEED VERO

Vero Electronics Ltd. Industrial Estate, Chandler's Ford, Hampshire, SO5 3ZR

Tel: Chandler's Ford (04215) 60211

Please tick appropriate box.

I want to know more about card frames.

I would like further details about the whole Vero range of products.

Name

Position

Company

Telephone No.

Address

E1CF2

WHO MAKES THE FASTEST PRECISION OP AMPS?

 **TELEDYNE PHILBRICK**

Get your hands on a Teledyne Philbrick 1443, 1435, or 1437 if you're tired of wrestling fast amplifiers that are unstable or precision amps that are too slow. Evaluators find these devices the most stable, easy to use high speed op amps they've encountered. The 1443, for example, has a GBW product of 2GHz and settles a 10V step to $\pm 1\text{mV}$ in 150nsec (max). As a follower, it has a 3dB BW of 120MHz, slews at $1000\text{V}/\mu\text{sec}$ (min), yet has 35° of phase margin with a 54pF capacitive load...using no exotic circuit techniques. The 1435 and 1437 offer similar stability with the 1435 settling to $\pm 1\text{mV}$ in 70nsec and the 1437 having the best overall performance in a TO-99 package. All operate -55 to $+125^\circ\text{C}$ and offer 883 screening. Teledyne Philbrick is a leading manufacturer of precision, high speed and high power op amps for both military and commercial applications. We also manufacture extremely fast A/D-D/A converters, V/F-F/V converters and S/H amplifiers.



 **TELEDYNE PHILBRICK**

Get YOUR hands on the latest specs for Philbrick op amps!

Send me data sheets Have a local representative call

My application is: _____

Name _____ Title _____

Company _____ Tel. _____

Address _____ M/S _____

City _____ State _____ Zip _____

 **TELEDYNE PHILBRICK:** Allied Drive @ Route 128, Dedham, MA 02026
Tel: (617) 329-1600

EI

Electronics

International[®]

Output and driver MOS FETs
target fm transmitters: page 81

A kit for designing C-MOS uncommitted logic arrays employs
a master plan plus decals representing logic functions: page 86

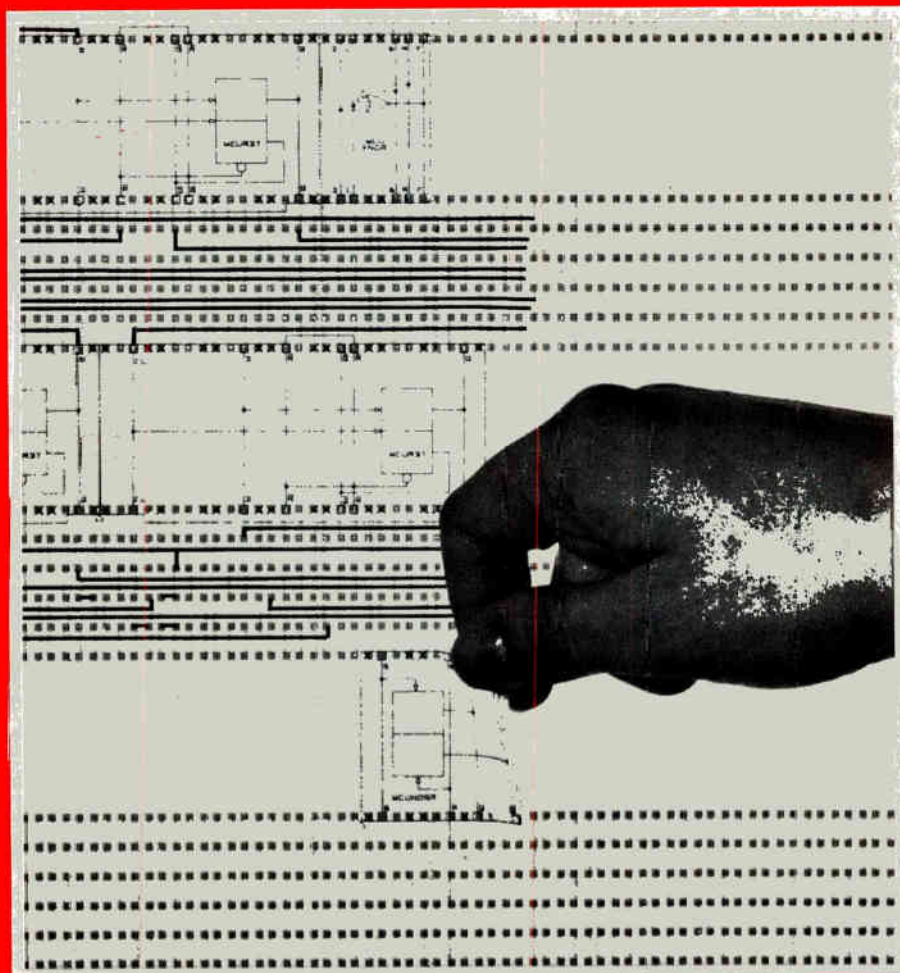

Germanium the First.

'At GPD we reign supreme as the world's No. 1 source for Germanium devices,' says Oliver O. Ward, also known as Oliver Germanium, President of Germanium Power Devices Corporation.

'We supply a full line of small signal devices, including Mesas, from 50mW up, as well as all the well-known high power transistors, including the world's first 100A device on a single chip.

'If you have existing circuits based on Germanium technology, there's no need to redesign.

'We make devices to all the well-known specs: JAN, EIA, and Pro-electron AC, AD, ADY, ADZ, ASZ, AY, AUY, and ASY.

'Plus all the devices you used to buy from TI (JAN 2N404-A, JAN 2N1302-1309), Motorola (MP500-506, 2N4276-4281, 2N4048-4053), Delco (DTG1010, 2N1100, DTG2000-2400A) GE (2N524-527, 2N1370-1381, 2N1924-1926), Siemens, Mullard, Philips, Newmarket, SGS-ATES and Thompson-CSF.

'And there are many applications where Germanium is clearly the first choice, with its excellent VSAT and low current drain.

'We, at GPD, will be manufacturing Germanium devices as long as you, the customer, want them. Send for the Imperial Catalogue.'

Germanium Power Devices Corporation

Austria Rieger GmbH, Marxergasse 10, A-1030 Wien 3, Tel: 0222-73 46 84, Tlx: 131087 rieger a/Omni Ray GmbH, Vertriebsbüro Wien, Prinz Eugen-Strasse 36, A-1040 Wien, Tel: 0222-65 64 31, Tlx: 132712 omray a. Benetux BV DIODE Laboratorium Voor Electronentechniek, Hollantlaan 22, 3526 AM Utrecht, Holland, Tel: 030-884214, Tlx: 47388/Ruc Picard Str. 202, 1020 Bruxelles, Belgium, Tel: 02-4285105, Tlx: 25903. Denmark E. V. Johansen Elektronik A/S, Titangade 15, DK 2200 Copenhagen N, Tel: 0451-83 90 22, Tlx: 16522. France Davum, Dept TMC, 11 Rue Racine, PO Box 28, 93121 La Courneuve, Tel: 836-84-01, Tlx: 210311F (PUBLI). West Germany Solicom Elektronik GmbH, Mondstrasse 10, 8000 Munich 90, Tel: 089-66 10 27, Tlx: 05-22870. India Kirloskar Electric Co. Ltd., Bangalore 560 055, Tel: 366771-4 (Marketing) 35311-8 (other depts), Tlx: 0845-230 & 0845-790. Italy Syscom Elettronica Spa, Via Gran Sasso 35, 20092 Cinisello Balsamo, Milano, Tel: 02-6.189.159 and 02-6.189.251, Tlx: 330118/Eurelettronica S.r.l., Sede, 20145 Milano, Via Mascheroni 19, Tel: 049-81 851, Tlx: 39102 THOMELFC. Norway Nordisk Elektronik (Norge) A/S, Mustadsvei 1, Postboks 91-Lilleaker, Oslo 2, Tel: 0752-13800, Tlx: 856-16963 (AJCO NM). Portugal Ditrans Componentes Electronica, Lda, Av. Miguel Bombarda 133, 1.D, 1000 Lisboa, Tel: 54 53 13. Republic of South Africa L.Electron (Pty) Ltd., 704 Main Pretoria Road Hootweg Wynberg PO Box 10544, Johannesburg 2000, Tel: 406 290, Tlx: 8-2333. Spain Kontron SA, Costa Brava, 13, Edificio Mirasierra, Madrid-34, Tel: 734 84 13, Tlx: 23382. Sweden Satt Electronics AB, Agency Sales Division, PO Box 32006, S-126 11 Stockholm, Tel: 08/81 01 00, Tlx: 10884. Switzerland Omni Ray AG, 8008 Zurich, Dufourstrasse 56, Tel: (01) 478200, Tlx: 53239. UK Representative Wintronics, 71 Tunnel Road, Tunbridge Wells, Kent TN1 2BX, Tel: 0892-44811, Tlx: 957567. UK Agents Jermyn Industries, Sevenoaks, Kent, Tel: 0732-50144, Tlx: 95142. /Consort Electronics Ltd., Rosebank Parade, Reading Road, Yateley, Camberley, Surrey, Tel: 0252-871717, Tlx: 858809.

GPD Box 65, Shawsheen Village Station, Andover, Mass 01810.
Telephone: (617) 475-5982. Telex: 94-7150 GPD Andr.

Circle 70 on reader service card

Will next Assembly nationalize France's electronics industries?

The French electronics industries are waiting for the result of the National Assembly elections later next month to see if the two giant French electronics conglomerates, Compagnie Générale d'Electricité and Thomson-Brandt, will be nationalized as part of newly elected French President François Mitterrand's economic program. Meanwhile, ranking executives at CIT-Alcatel and Thomson-CSF, the groups' principal subsidiaries, believe that only the parent holding companies would be nationalized and that the effect on day-to-day business would be minimal, at least at the outset. **Socialist party headquarters confirm that the groups would retain their present identities.**

Other candidates for nationalization are CII-Honeywell Bull (47% American-owned); Avions Marcel Dassault-Breugnot; St. Gobain-Pont-à-Mousson, which has a joint integrated-circuit project with National Semiconductor Corp.; and defense contractor Matra SA, which has joint IC ventures with Intel Corp. and Harris Semiconductor Products division.

Optical communications flourish in Germany

Large-scale activities in optical communications are being started in both parts of Germany. In their section of Berlin, the East Germans are putting into operation an optical cable that is 16 km (about 10 miles) long for public services from the city center to a suburb. **The 13-mm-thick cable handles 120 voice channels simultaneously on each one-fiber line.** Meanwhile, in West Germany, postal authorities are preparing to let contracts to six or so firms for a \$70 million project called Bigfon, the acronym for the German for broadband integrated glass-fiber local-communications network. Five hundred subscribers in seven cities will participate next year in the trials, which will investigate the practicality of **accommodating assorted services such as voice, data, text, television, stereo radio, and videophone communications on a single line.** A somewhat similar system is being set up in Manitoba, Canada [*Electronics*, Dec. 4, 1980, p. 70].

UK frequency-agile radio gets to market first

Although it failed to win a share of the U. S. Army's Sincgars program to develop a frequency-agile very high-frequency radio system for 1987, Racal-Tacticom Ltd. of Reading, Berks., pressed ahead with one as a private venture. Now the company is ready to deliver its first Jaguar-5 systems under an evaluation contract from the British Army and a service contract from one member of the North Atlantic Treaty Organization. By being early to market, **Racal may yet meet an interim U. S. requirement for frequency-agile radios, before Sincgars enters production,** and also position itself for any standardization moves by NATO. To dodge interception and enemy jamming, Jaguar-5 hops several hundred times a second between any 1 of 256 channels on each of nine bands between 30 and 88 MHz. It also includes a data-encryption unit.

10-kW industrial laser designed in Israel

A prototype of the most powerful and most advanced industrial laser in the world has been built by Metal Working Lasers International Inc. of Tel Aviv. The 10-kw carbon dioxide laser, which emits an infrared ray with a wavelength of 10.6 μm , **achieves its performance by the use of systems and technologies never before integrated in one laser,** according to managing director Shmuel Gonen. A marketable product with applications in the metal-working, electronics, ceramic, and chemical industries should be **available within two years,** according to the firm.

Philips' digital audio system gains first Japanese licensee

Last week Nippon Columbia Co. became the first Japanese firm to license the technology for compact disk systems developed by NV Philips Gloeilampenfabrieken [*Electronics*, Jan. 13, p. 102]. It expects to start sales of both digital audio disk players and recorded disks by the end of 1982 and has taken this initiative because **it expects other manufacturers to standardize on the same digital audio system** in the near future. The company already has a pilot plant in operation.

State-of-the-art microstrip antenna built in West Germany

A microstrip antenna for frequencies up to 40 GHz has been developed by engineers at AEG-Telefunken's development laboratories in Ulm, West Germany. Like other such state-of-the-art antennas, it is small, measuring 2.5 by 12.5 cm by 0.25 mm thick. The device consists of **96 half-wave resonators arranged in four rows on a flexible glass-fiber-reinforced Teflon substrate**. Its beam width at 40 GHz is 3.5° in the magnetic-vector plane and 26° in the electron-vector plane.

Hitachi to make chips in Bavaria?

Hitachi Ltd. is taking a hard look at the feasibility of diffusing memory wafers in West Germany, where it currently packages 16-K MOS dynamic random-access memories and 4-K complementary-MOS RAMs and plans to start packaging 64-K RAMs this fall. The Japanese firm, which sells some \$1 billion worth of semiconductors worldwide each year, at present leases a facility at Landshut, some 30 miles northeast of Munich. It plans to open its own \$30 million plant there later this year and **may make another \$50 million investment to set up diffusion lines there by 1983**.

ICL to stay independent

Britain's International Computers Ltd. will not be taken over by a U. S. computer manufacturer after all; the British government had been pushing the loss-making company into merger talks with Sperry Univac and Control Data Corp., among others, but **got cold feet when no adequate safeguards were forthcoming that a significant research, development, and manufacturing capability would be retained in the UK**. Now it has put together a three-point rescue package comprising a \$588 million credit guarantee, new management, and probably an expanded product strategy. This last would have the company fill out its product portfolio by manufacturing under license equipment in high-growth market sectors.

Japanese presence in Europe's VCR market grows

West Germany's AEG-Telefunken, France's Thomson-Brandt, and Britain's Thorn EMI Ltd. are near **an agreement with the Victor Co. of Japan** that will give the three European firms a manufacturing stake in the booming local market for video cassette recorders. But the move will further threaten the only VCR of European design—the system made by the Philips-Grundig partnership that, according to Mackintosh Consultants Co. of London, holds a 15% share of the 1.3 million unit market as against the 60% of the VHS system manufactured by JVC and the 25% of the Betamax made by Sony Corp., also of Japan. Under the agreement, AEG-Telefunken expects to manufacture 400,000 VCRs, video cameras, and video disk recorders a year at its West Berlin plant using parts from its partners in France and the UK.

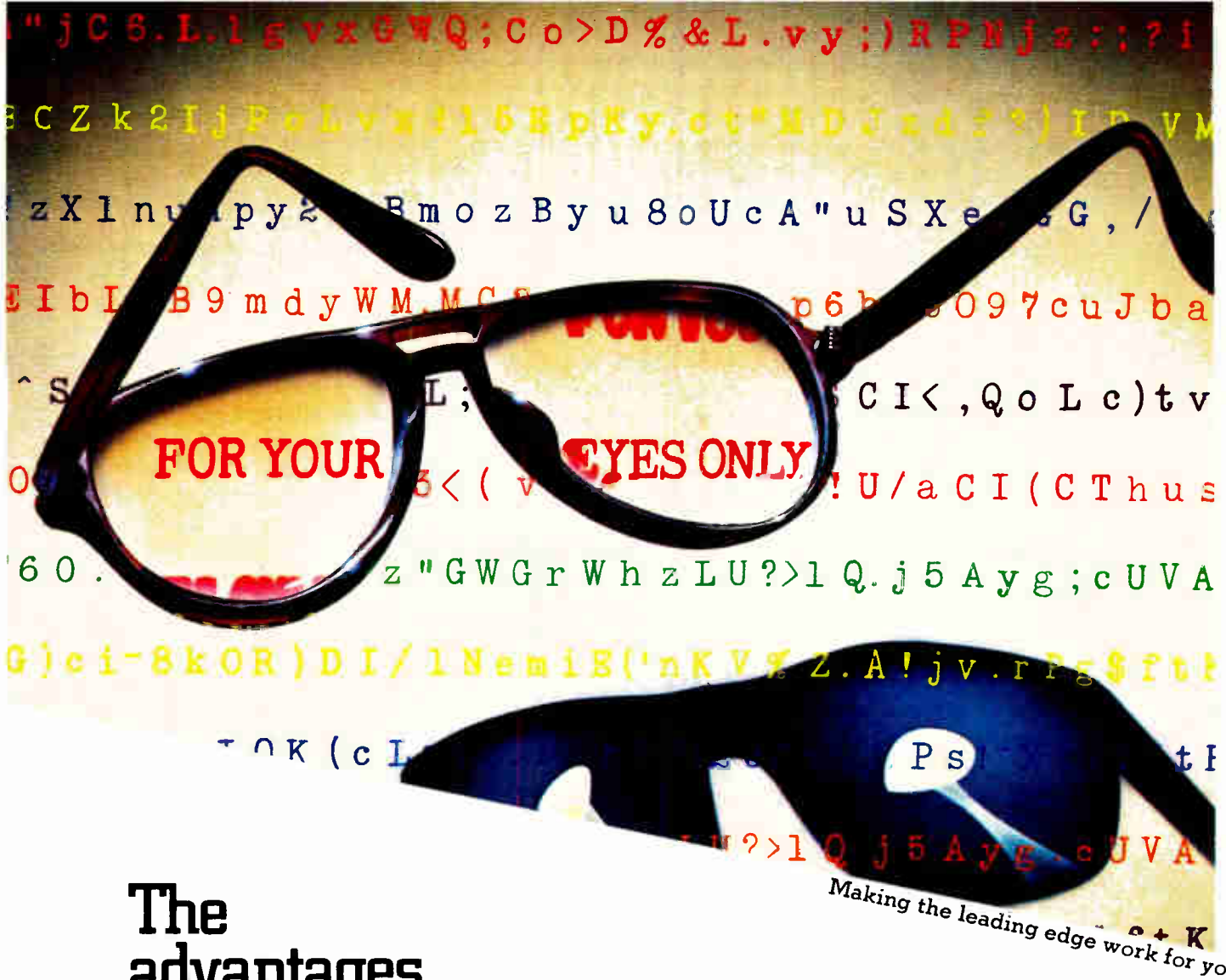

The advantages of data encryption are now plain to see.

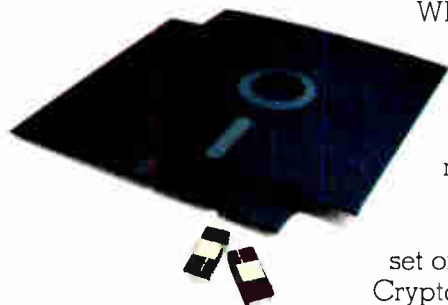

The writing's on the wall. File security is the feature more and more end-users are demanding. Especially in word processing and small business systems. And that can translate into a significant product advantage. If you make the effort to include data encryption in your next design. Fact is, implementation's never been easier. Or more cost-effective. Thanks to Western Digital's WD 2001 data encryption device. Based on the NBS Data Encryption Algorithm, our compact WD 2001 is a single-chip solution that delivers full NBS certification, a 1.3 Mb/s throughput rate and can be bus or hardware controlled. It's also available for immediate delivery. So contact Western Digital for your own set of WD 2001 specs. And all the latest on our CryptoPrimer™ development kit. There's more profit in seeing things our way.

WESTERN DIGITAL
C O R P O R A T I O N

Telecommunications Division, 2445 McCabe Way, Irvine, CA 92714, (714) 557-3550.

The benchmark that counts Zilog's price-smashing 16-bit

Only Zilog's Z8000™ family matches CPU performance to your application.

The best suit in the world won't do you any good if it doesn't fit. Only Zilog, with eleven 16-bit CPU, CPU/MMU combinations can give you a fit tailor-made to your application. Add in the high

level language C or Pascal and you have performance that can't be beat—by anyone, least of all at prices anywhere near Zilog's rock bottom lows.

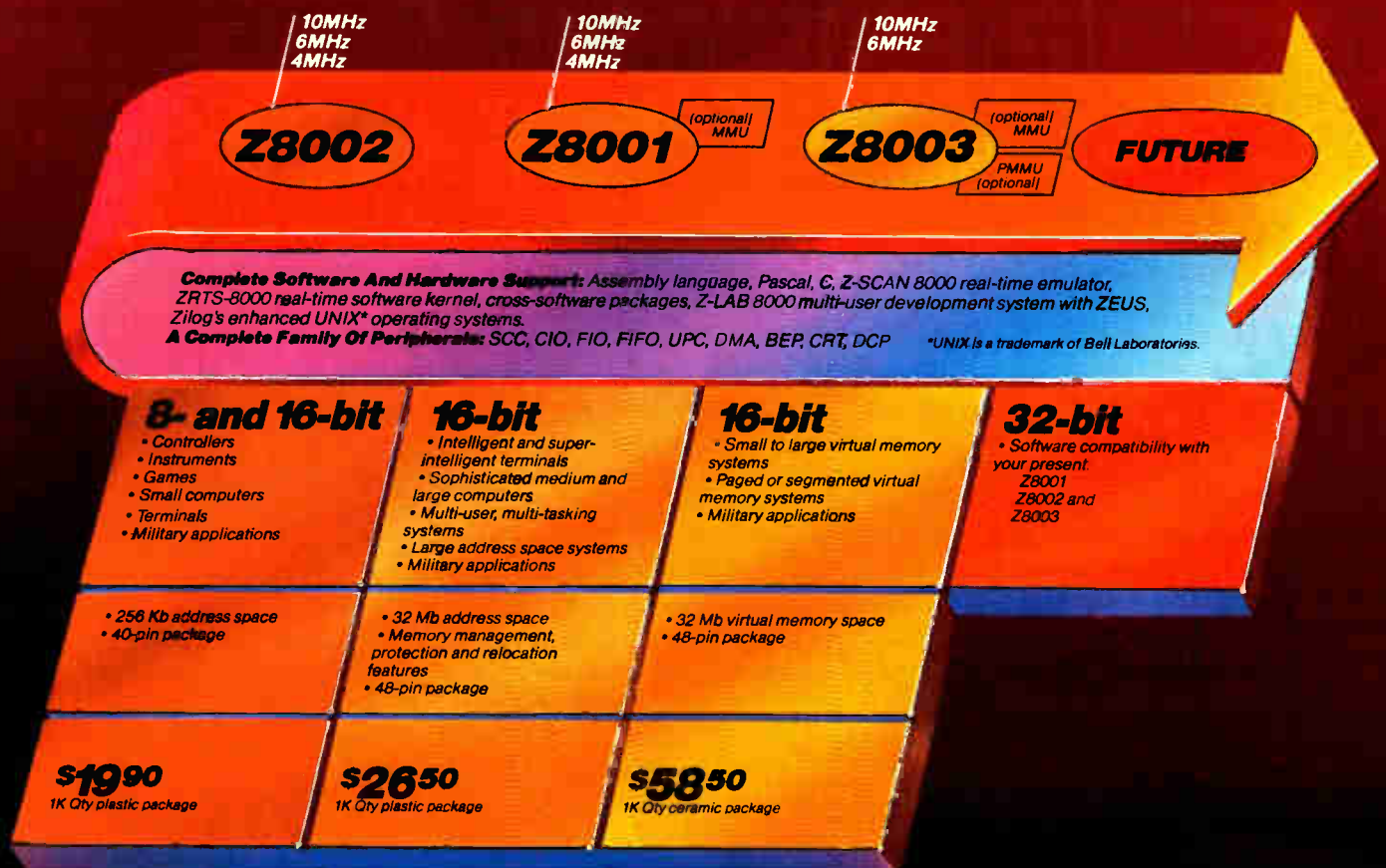

is yours. CPU's can prove it.

Try a benchmark on us.

Proof? We'll benchmark *your* application. Free. Then, you can decide for yourself that the Z8000 family is the best buy for *your* application.

Across the board compatibility.

Your plans change. Your products grow. Zilog has designed the entire Z8000 family—including tomorrow's planned 32-bit machines—to be completely software compatible. You can move on to higher performance, higher capability CPU's, today and in the future. No one else makes that promise.

Across the board software and hardware support.

We have a complete family of software and hardware tools for every application development need. We can offer you a growing family of peripherals (there are already nine) so sophisticated they're the first choice to support even competitive CPU's!

Call today.

To find out more. To arrange for your benchmark. To get the best performance for the price anywhere. 10460 E.ubb Rd., Cupertino, CA 95014. (408) 446-4666. Or contact your nearest Zilog distributor.

Zilog
makes it happen
for you.



Zilog

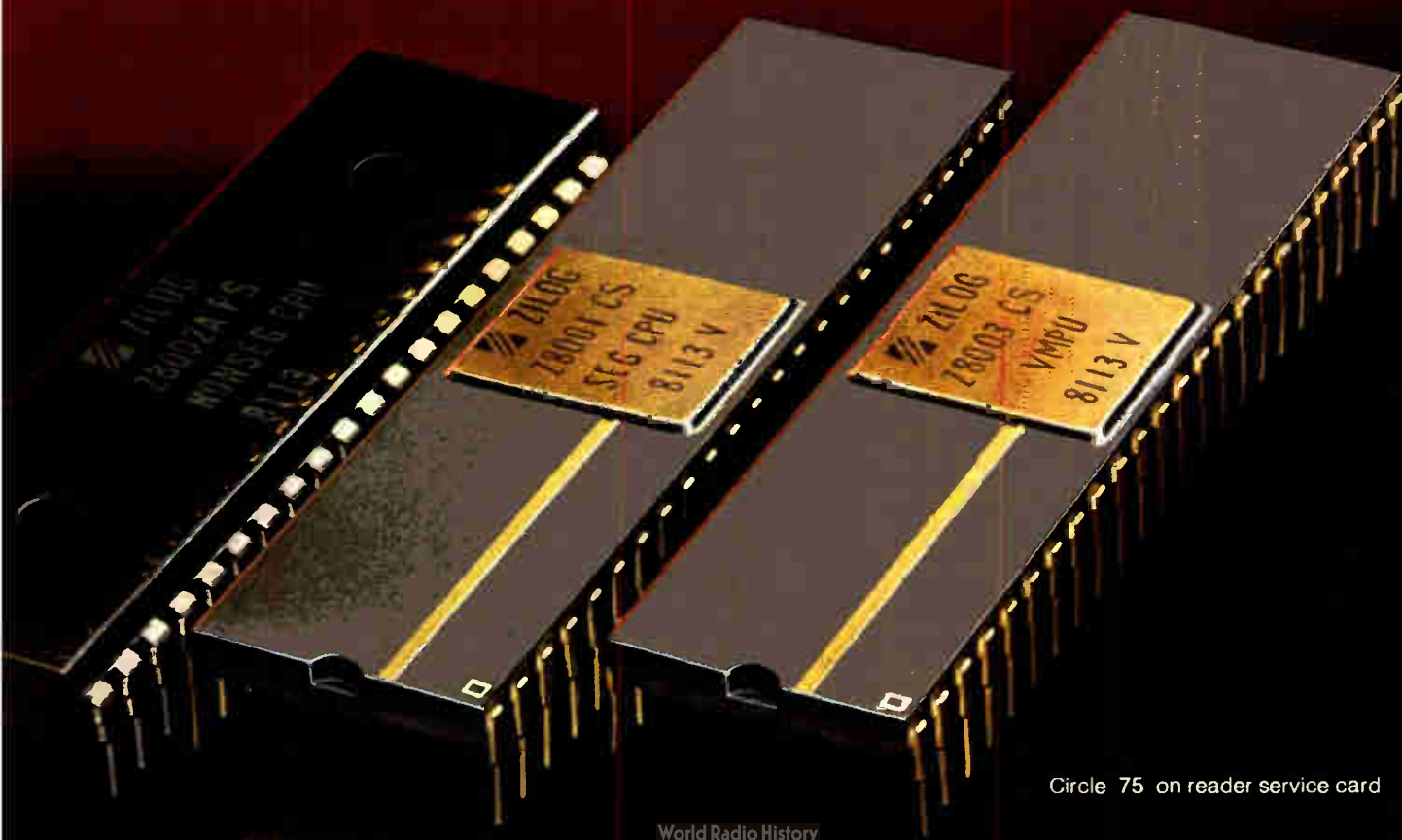

Circle 75 on reader service card



If you're still looking for the best 5 1/4"



floppy drive, you haven't found us yet.

Hard to believe, perhaps, but no one ships as many 5¼" floppy drives as we do. No one builds a 5¼" rigid drive with as much storage. No one knows more about high-volume, high-quality electromechanics. And no one else designs and produces their own head from start to finish. In fact, no one, but no one, builds as much of their own product. You see, at Tandon, we simply make more of what we make. Tandon. 20320
Prairie, Chatsworth, CA 91311, (213) 993-6644.

Tandon

The most successful disk drive company you never heard of.

Circle 77 on reader service card

Z80 COMBO CHIP

Four functions in one
reflects design simplicity
at its best.

MOSTEK

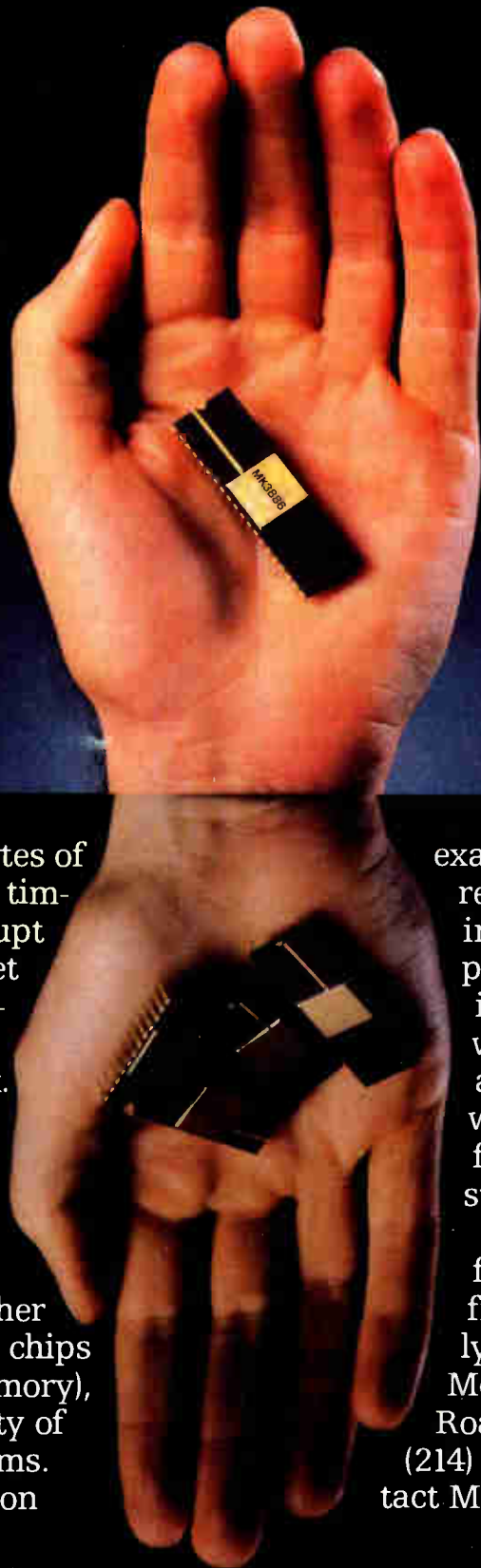

A serial I/O port. 256 bytes of RAM. Two programmable timers. Three external interrupt channels. Now you can get all of them in one integrated circuit: The MK3886 Combo Chip from Mostek.

This 5-volt only, 40-pin DIP is design simplicity at its best. The kind that means superior cost efficiency, fewer parts count, less board space, and higher reliability. With just three chips (Combo, Z80 CPU and Memory), you can configure a variety of highly versatile Z80 systems.

A sampling of application

examples: As an intelligent remote data logger. Or an interrupt driven intelligent peripheral controller. Or an industrial security system with serial interface. Or as a building block in a "two-way" cable TV network. Or for a patient monitoring system. That's the versatility of the Combo Chip. In fact, no other chip simplifies Z80 design so efficiently. Find out why. Contact Mostek, 1215 West Crosby Road, Carrollton, TX 75006 (214) 323-1801. In Europe, contact Mostek Brussels 762.18.80.

Vhf power MOS FETs taking aim at U. S. fm transmitters

by Charles Cohen, Tokyo bureau manager

Lateral devices from Hitachi have better drain efficiency and power gain at 100 MHz than vertical MOS FETs

Frequency-modulation transmitters in the U. S. may soon feature solid-state output and driver devices from Japan. Hitachi Ltd. has developed for this application a very high-frequency MOS field-effect transistor with a typical output of 180 watts at 100 megahertz that can easily be connected in parallel for outputs of up to several kilowatts. A smaller device for use as a driver is also available. The firm sees the U. S. with its ubiquitous small fm stations as its prime market; there are very few fm stations in Japan.

The new MOS FETs' high drain-to-source breakdown voltage of 180 volts, together with their high inherent thermal and electrical stability, makes them ideal for the application. They can be operated from an 80-v power supply, about three times that for bipolar devices and more than double that for MOS devices from Siliconix and Communications Transistor Corp. Currents are correspondingly smaller, greatly reducing losses, which vary with the square of the current.

Simpler circuitry. Because current flow through FETs decreases with increasing temperature, current density equalizes throughout each device rather than gathering in a hot spot as in bipolar transistors. Multiple devices can be connected in parallel and operate efficiently without needing complex load-sharing or

bias circuits. Low sensitivity to mismatching eliminates the need for isolators, which are often required with bipolar transistors but have losses of 5% to 10%. The low feedback capacitance of 0.5 picofarad for the output devices and 0.3 pF for the driver devices eliminates the need for neutralization. Also, lack of charge storage permits pulsed operation.

The 3-decibel cutoff frequency of the devices is 300 megahertz, allowing operation with reduced output to at least 250 MHz. At frequencies in the 100-MHz band, drain efficiency is typically 80% and power gain exceeds 14 dB, beating the performance of both bipolar transistors and vertical MOS FETs. Hitachi engineers say that the latter have characteristics intermediate between those of

bipolar devices and lateral MOS FETs like their device. Other disadvantages of MOS FETs designed for vertical current flow in the chip are that the design does not lend itself to incorporation of gate-protection diodes and the bonding wire to the source may be long.

Physical parameters. The channel of the output device has a width of 18 centimeters to give it a forward transconductance of 1.25 siemens and a maximum current rating of 8 amperes. A molybdenum gate is used to keep the resistance-capacitance time constant low enough for the desired high-frequency performance. Even so, the gate consists of multiple parallel segments, each 1.6 millimeters wide.

The device is fabricated on a 32-

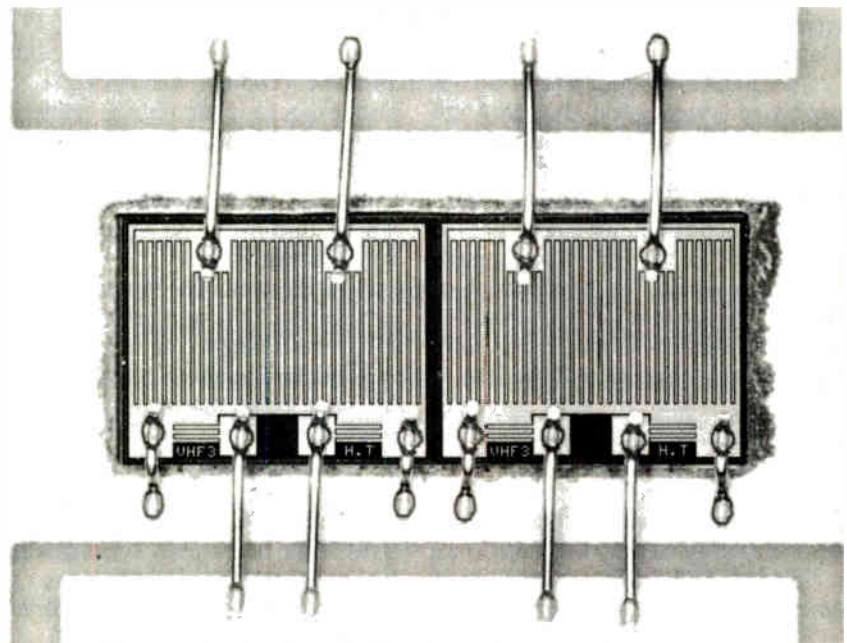

Minimal. Extremely short leads unite the source line of a strip-line package to the source of Hitachi's output vhf power MOS FET, made up of two adjacent chips from the same wafer.

LASER MARK

Clearly the Best Mark
in the World

No more critical parts geometry, type pressure problems, smearing or costly downtime. The "inkless" LaserMark® provides high speed pulsed permanent coding with no moving parts, no wear, more reliability. Code changes take only seconds with a simple template. Easy installation and compatibility with most equipment saves you money.

For marked samples, performance data and specifications, call (613) 592-1460, Telex 053-4503, or write to: Lumonics Inc., 105 Schneider Road, Kanata (Ottawa), Ontario, Canada K2K 1Y3.

* LaserMark is a registered trademark of Lumonics Inc.

Actual mark magnified approx. 6.25x

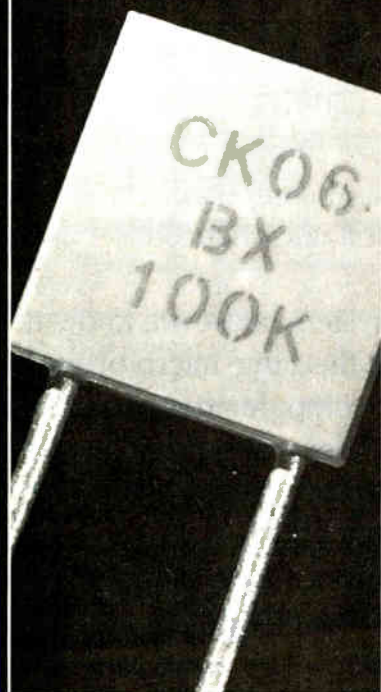

LaserMark®,
the Mark of the 80's

Electronics international

Honeywell divisions, Honeywell Information Systems in Minneapolis and the Micro Switch division of Freeport, Ill. -Robert T. Gallagher

Japan

Kanji word processor has two-handed input

The rapidly growing word-processor market is being counted on to aid a Japanese firm that can no longer expand its sales of industrial instrumentation and test equipment as fast as it desires. Hiroshi Shibuya, product marketing manager at Yokogawa Electric Works Ltd., says that Japanese-language (kanji) word processors are an excellent match for the capabilities that the firm developed in the process control field, among them microcomputer, servo, and recording systems.

The company's new Wordix word processor employs a two-handed input system very similar to the one used on Japanese newspapers and the IBM mainframe computer input keyboard [*Electronics*, Oct. 11, 1979, p. 73]—except that Yokogawa allots 231 rather than 216 keys to the right hand. The 24-by-24-dot-matrix serial printer features a thermal transfer ribbon from which the head transfers pigmented material onto plain paper (rather than causing pigmented regions to appear on ther-

mally sensitive paper). A built-in dual minifloppy-disk drive and a 12-inch cathode-ray-tube monitor completes the system, which sells in Japan for \$10,800.

Other units are available to extend the range of applications and the convenience of the system. An off-line kanji serial printer using movable type is available for contracts and papers for submission to government offices, which by law must be typewritten or printed, as well for letters.

Choice. Built jointly with kanji typewriter firm, it uses Yokogawa's power servo technology to call up any of about 3,000 pieces of type in a file for each character printed. Input to the printer is a minifloppy disk containing pages of text prepared on the word processor—an off-line input scheme chosen so that the printer could handle the work of several typists and be located where its noise would not bother anyone keying in a manuscript. The price of the movable-type kanji printer is \$9,100. Also available is an input-only processor (without a matrix serial printer) for \$5,500, and a matrix serial printer for \$6,400.

The word processor is built around a locally produced 8085A, one of the three 8-bit microprocessors used as standard by the firm. The pattern generator for the approximately 3,000 characters in the read-only memory uses 22-K bytes of ROM accessed by input/output memory



New ventures. On the left above is Yokogawa's word processor complete with CRT monitor. On the right is its movable-type printer, with access to 3,000 kanji characters.

A P jumped the competition...

with the first tools designed specifically
for flat cable jumper systems.

mapping. When they become available in the very near future, 256-K mask-programmed ROMs will be used. Processor programming is incorporated in 32-K bytes of ROM, while 32-K bytes of random-access memory, mostly dynamic but including some static, is used by the processor and for composing documents.

Personalized. In addition to the character information in the large ROM pattern generator, another 72 characters can be hand-crafted by the operator, usually by copying matrix positions of parts of standard characters. Furthermore, an option permits an almost 4,000 additional standard characters on a floppy disk to be accessed, for a total of more than 7,000 standard characters plus 72 hand-crafted ones.

Yokogawa says it chose the two-handed input system rather than the kana-syllabary-to-kanji conversion schemes used by many others to ease the task of typists using the machines. Conversion schemes require constant and tiring concentration on the CRT monitor to select characters and check them for correctness. In Yokogawa's system the character selected for a given combination of keys is unique and a skilled typist need not pay too much attention to the monitor. Although it might take a little more time to learn the keyboard, Yokogawa believes that is not a serious disadvantage as it expects the machine will be used mainly by professional typists, rather than by casual users.

Word processors, however, are actually Yokogawa's second new product line. The company was growing at a rapid clip selling process control equipment to petroleum refineries and other industries when the oil shock of 1974 put an end to its double-digit growth. The firm did not have the option of emphasizing test equipment because the faster-growing products had been folded into Yokogawa-Hewlett-Packard Ltd. when that joint venture with HP was started in September 1963.

So in order to achieve the double-digit growth desired by president Shozo Yokogawa, a son of the founder and now 66, the firm

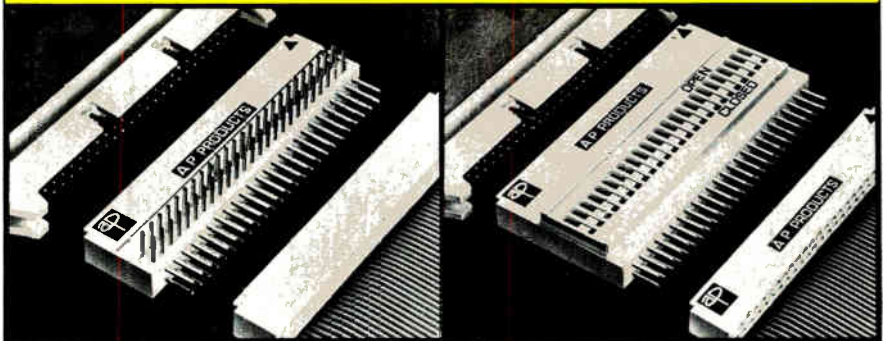

The Intra-Connector

- Mates in-line with standard double-row socket connectors.
- Has one set of female contacts and two sets of male at right angles, providing instant line-by-line probeability.
- Can also act as a "cube tap," letting an existing system daisy-chain into new areas.

The Intra-Switch

- Plugs in-line, and each line is independently switched with a small slide switch built into the housing.
- Great for diagnostic and quality testing.
- Great for programming or selective line inhibiting.

Both the Intra-Connector and the Intra-Switch are available in 20, 26, 34, 40 and 50 contact versions.

Ideal tools for flat ribbon/connector system designers and users. For lab technicians, field service engineers, test engineers and computer hobbyists.

Get the jump on **your** competition and order these two new A P products today!

For the name of the A P distributor nearest you, call toll-free 800-321-9668. In Ohio, call collect (216) 354-2101.



A P PRODUCTS INCORPORATED
9450 Pineneedle Drive
P.O. Box 603
Mentor, Ohio 44060
(216) 354-2101
TWX: 810-425-2250
In Europe, contact A P PRODUCTS GmbH
Baumlesweg 21 • D-7031 Weil 1 • W. Germany

Circle 85 on reader service card

Leaders in Electronics

The only reference devoted solely to biographies of the most influential people in electronics

- corporate executives • technical managers • designers and developers • government and military officials • academics • editors/publishers • securities analysts • trade/professional group directors • consultants ... plus an 80-page index of biographies by affiliation.

Prepared by the staff of **Electronics** magazine. 5,240 biographies. 651 pages, clothbound. \$39.50

Electronics Magazine Books

P.O. Box 669, Hightstown, NJ 08520
(609) 448-1700, ext. 5494

Send me _____ copies of *Leaders in Electronics* @ \$39.50 plus applicable sales tax. McGraw-Hill pays regular shipping and handling charges on pre-paid orders.

Payment enclosed Bill firm Bill me

Name _____

Company _____

Street _____

City _____ State _____ Zip _____

Signature _____

Electronics international

entered into an agreement in late 1976 with General Electric Co. to manufacture X-ray scanners. For the fiscal year that just ended on March 31, medical electronics accounted for 17% of Yokogawa's sales. For the 1982-83 fiscal year they are expected to rise to 20% of a total that is growing by about 12% a

year, with sales for that year forecast at \$468 million all told. As for the Wordix word processor, the firm expects it to make up 5% of its sales during the same fiscal year.

To keep the record straight, it should be noted that an earlier office product from Yokogawa was a menu-driven plotter called the

Graphmate. Announced late last year, it can compose a wide range of graphs and charts and can even draw but at a price of \$3,100 will account for less sales volume than the Wordix machine.

-Charles Cohen

Great Britain

Master plan speeds C-MOS ULA design

Laying out VLSI uncommitted logic arrays need be no more complex than assembling a jigsaw puzzle, believes Micro Circuit Engineering Ltd. The newly spun-off subsidiary of Britain's Smiths Industries Ltd. has come up with a design kit in which the jigsaw pieces are functional subsystems recognizable from any catalog of complementary-MOS small- and medium-scale integrated circuits.

The designer need only affix each stick-on transparency, or decal, representing a logic function to a master plan of the uncommitted logic array matrix and then mark in interconnections between cells on the tracks indicated. The technique allows a designer to work at the technology level he is most familiar with, in contrast with earlier transistor-level ULA approaches.

"The idea," says general manager Ian Pearson, "is that the user need have no specialist semiconductor design experience. The transistors have no visibility for him, though we can show him what's in each cell if he wants to put together a special circuit such as a primitive linear circuit." By working at such a level of complexity, Pearson expects to contain the problem of very large-scale integration design since the task of manually entering a customer's design is reduced markedly.

The same approach to bipolar ULA design is espoused by Micro-Circuits Engineering of Nuremberg, West Germany, and Palm Beach, Fla., which are related to each other but unrelated to the Cheltenham, Glos., firm, despite the name.

The ability to compress a week's

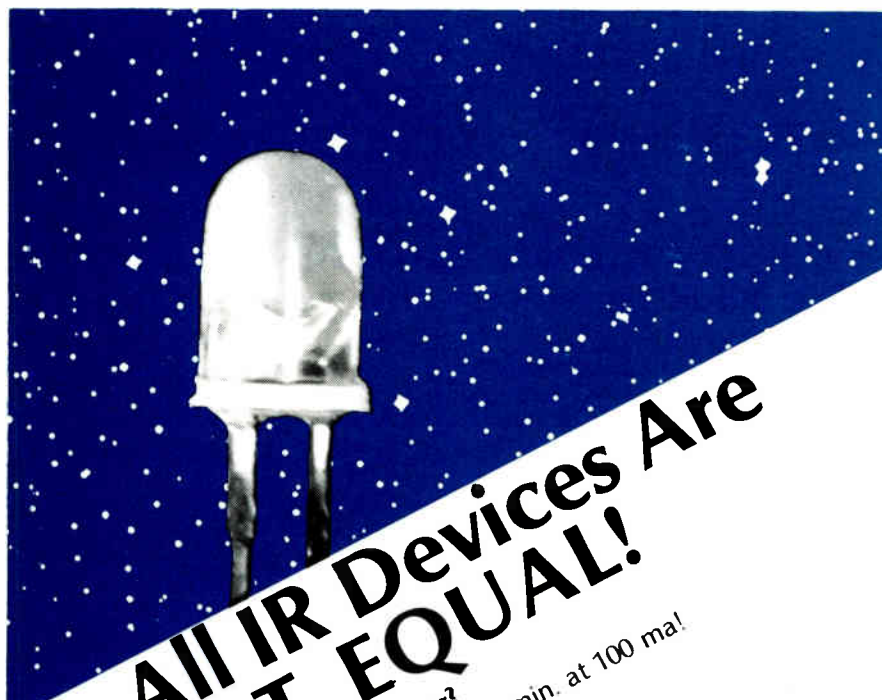

All IR Devices Are NOT EQUAL!

Need a Super Power IR emitter?
Try Xcicon's GaAlAs - up to 12 mw min. at 100 ma!

Need a specific package?
Xcicon offers over 40 standard emitters.

TELL US WHAT YOU NEED
Whether it is hermetic or plastic, 940 nm or 880 nm, high output or super high output, wide or narrow angle, we can help you. And, if you prefer to package your own we can provide you the finest materials available.

WE WANT TO FILL YOUR NEEDS.

Xcicon
Xcicon Excellence

5 Hemlock St.
Latham, New York 12110
518 783 - 7726
TWX 710 - 444 - 4962

digitization into a day by working at the cell instead of the transistor level contributes to a fast turnaround, from receipt of design to first prototypes, of six to eight weeks. Also to speed turnaround, the firm has addressed other bottlenecks in the mask-making and test areas: mask making is subcontracted out to several suppliers, while the test area has been equipped with logic simulators and a large Fairchild test system. The design charge for 10 tested prototype circuits is around \$15,000 if a customer lays out his own circuit. Extra circuits cost from \$33 each depending on the array.

For starters. To kick off its new ULA design service, Micro Circuit Engineering is offering four high-speed ULAs spanning a range of 560 to 2,014 gates, all engineered in a high-density silicon-gate C-MOS process. Typical propagation delays are 6 nanoseconds for a two-input NAND gate at 5 volts and a temperature of 25°C. The 2,014-gate array, to be available in two months, will be followed by a 3,000-gate device, now in design. The input/output pinout varies with the array size: the 2,014-gate array, for example, has 74 bonding pads, but the company recommends users to limit themselves to 64. Devices are available in ceramic dual in-line packages, Cerdips, flatpacks, or chip-carriers or as naked dice.

The company buys prediffused wafers from abroad—from Mitel Semiconductor Inc., the Canadian C-MOS manufacturer, and American Microsystems Inc. But soon it will also be able to tap local sources, since Plessey Semiconductors Ltd. and Marconi Electronic Devices Ltd. are bringing high-density C-MOS processes on stream under license from Mitel. The 12-year-old design group uses a scanning electron microscope for quality control of wafers and as a diagnostic aid.

Layout resembles that for a cell-based custom-designed microcircuit: in both cases, fully characterized functional elements are called up from a logic library. But the similarity ends there: whereas a custom-designed microcircuit is a unique

Speech Synthesis

adds personality to your products

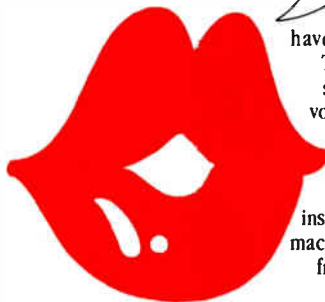

No lights, buzzers or numbers have ever replaced the human voice.

Telesensory Systems makes speech simple by offering a choice of three voice response boards. Simple to interface, simple to use.

Consider speech for automated test equipment, process control, instrumentation, elevators and business machines. Speech modules are available from Telesensory for as little as \$125 in single quantities.

- SPEECH 1000 — Natural sounding, life-like speech with linear predictive coding.
- Series III — Low-cost versatility with waveform encoding (invented by Forrest Mozer).
- Series II — Most economical synthesizer board with vocabulary.

Whether you're prototyping or in production, turn to Telesensory for board level products supported by our own low-cost vocabulary generation services. Call (415) 856-0225 for a speech demonstration.

Telesensory Speech Systems

3408 Hillview Avenue, P.O. Box 10099, Palo Alto, CA 94304, (415) 856-TALK

Circle 87 on reader service card

CAMBION V-LP* IC SOCKETS

Now available in 2 different styles and in 8- to 64-pin positions, are Cambion's new, *Very-Low-Profile (.093") Series 703-43XX IC Sockets:

- **ROUND-PIN, SOLDER TAB VERSION** for mounting flush to PC boards. Use also as PROM carriers. Adhesive fit.
- **SQUARE-EDGE, WIRE-WRAPPABLE VERSION** orients each leaf of the 4-leaf Beryllium Copper spring contact to engage the sides and edges of IC leads for increased reliability! Press mount.

Machined body provides rigidity for pin alignment and for IC insertion/extraction. Ask for evaluation samples and the new IC Socket Catalog! Cambridge Thermionic Corp., 445 Concord Avenue, Cambridge, MA 02238, Tel: (617) 491-5400, Telex: 92-1480, TWX: (710) 320-6399.

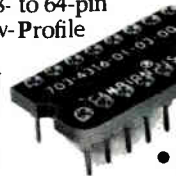

CAMBION
The Right Connection.



A PROFIT MARGIN UP TO 63%*

*REPORT BY ROBERT R. NATHAN ASSOCIATES, INC.

That's what electronics makers can average in the U.S. Virgin Islands

Here are a few reasons why:

- You can qualify for a tax subsidy equal to 90% of your federal income taxes as well as on customs duties and excises on raw materials.
- You can also obtain relief from all other local taxes for a period of 10 to 15 years.
- Plus this unique bonus: Up to 50% of your Virgin Islands high technology product can consist of foreign components and still enter the huge U.S. market duty free. No other Caribbean area offers this incentive for those who qualify... and all under the American flag.



ALL THIS ONLY IN THE U.S. VIRGIN ISLANDS



Virgin Islands Industrial Development Commission
1270 Ave. of the Americas, New York, N.Y. 10020

In confidence and without obligation tell me how I might make 39-63% profit in the U.S. Virgin Islands.

Name: _____ Title: _____

Company: _____

Address: _____

Major product or service: _____



Electronics international

product, requiring a complete mask set, a ULA can be specified by a final interconnection mask applied to a stock of prediffused wafers. Each ULA circuit bears a regular matrix of identical cells within which are a number of uncommitted components. The masked metalization layer connects cells internally and externally.

Large library. Engineers at the company have already characterized a library of over 55 logic functions, among them 18 different gate configurations; a half-adder plus inverter and a full adder; 19 different register cells; address decoders; and seven peripheral circuits, some with three-state outputs. The component section has been carefully thought out: for example, registers of any length can be assembled from first-, middle-, and end-bit logic elements, while each of the segment address circuits for a seven-segment display are separately available. A further 50 cells that use dynamic instead of static logic to achieve a 30% increase in gate density are in engineering right now.

The system designer works with the self-adhesive decals that represent these elements, assembling them in any appropriate sequence in a special grid format that designates areas of busing where cell interconnections are made.

Compact cell. The oxide-isolated C-MOS process, says Pearson, is ideal for ULA technology, as it provides two interconnection levels: a polysilicon level for underpasses and the final metalization layer. To this the company has added a compact cell design that it claims increases circuit densities by as much as 20%. In addition, Pearson adds, engineers quickly familiarize themselves with the technique and are soon attaining a 90% cell utilization.

Just as significantly, by working at a higher level of complexity, the design task has been limited to one that can be handled manually. The company's approach may eventually be implemented on a computer-aided design system, but when that happens, it will be by choice and not necessity.

-Kevin Smith

LED'S AND PIN DIODES

FOR 0.84 μm OPTICAL COMMUNICATIONS

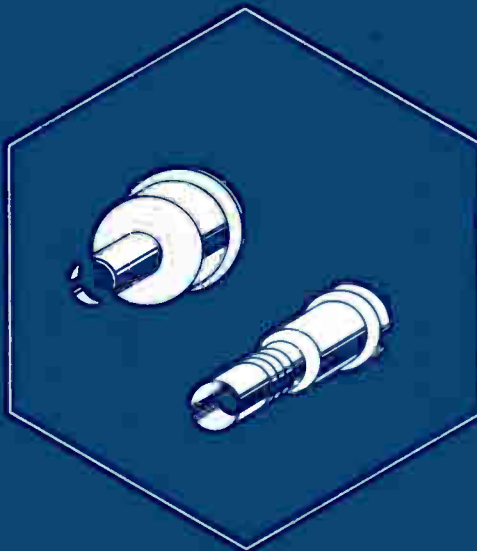

Subminiature
and KMR / SMA cases

FEATURES

- Rod-type encapsulation pre-matched to most connectors; matched parameters for transmitter and receiver.
- Assured reliability.
- High gain-bandwidth product.
- Linear and homogeneous characteristics.

TYPICAL LED'S CHARACTERISTICS

- Power coupled to fiber = 190 μW at 100 mA.
- Rise time and fall time = 6 ns.
- Linearity: rejection mode = - 40 dB (2nd harmonic) / - 50 dB (3rd harmonic)

ADDITIONAL INFORMATION

A new catalog covering our complete line of optical components is now available upon request.



THOMSON-CSF
COMPONENTS

THOMSON-CSF DIVISION COMPOSANTS MICROONDE
101, BD MURAT - 75781 PARIS CEDEX 16 - FRANCE - TEL. (33.1) 743 96 40 - TELEX 204780 TCSF F

BENELUX
THOMSON S A N V
BRUXELLES 2 648.64.85

BRAZIL
THOMSON CSF
COMPONENTES DO BRASIL
SAC PAULO 11 542.47.22

DENMARK
SCANSUPPLY
COPENHAGEN 11 83.50.90

FINLAND
OY TOP COMPONENTS AB
HELSINKI 10 49.01.37

ITALY
THOMSON CSF
COMPONENTI
MILANO 2 688.41.41

JAPAN
THOMSON CSF JAPAN K.K.
TOKYO 3 264.63.41

NORWAY
TAHONIC A/S
OSLO 2 16.16.10

SPAIN
THOMSON CSF
COMPONENTES Y TUBOS S.A.
MADRID 11 419.65.37

SWEDEN
THOMSON CSF
KOMPLEMENTER &
ELEKTRONROR AB
STOCKHOLM 8 22.58.15

SWITZERLAND
MODULATOR S A
LIEBEFELD BERN 31 59.22.22

UNITED KINGDOM
THOMSON CSF COMPONENTS
AND MATERIALS LTD
BASINGSTOKE (256) 29.155

U.S.A.
THOMSON CSF COMPONENTS
CORPORATION
CLIFTON (201) 779.1004

WEST GERMANY
THOMSON CSF
BAUELEMENTE GMBH
MÜNCHEN (89) 76.75.1

Who gives you wide microcomputer plus multi-emulation capability... plus constant system extension...?



8085



Z80



2650



World Radio History



support...

PMDS – Philips Microcomputer Development System – lets you get to work immediately with today's most important chips, thanks to a range of quickly interchangeable, plug-in MABs (Microcomputer Adapter Boxes). And that range is continually being updated to cover new μ Ps coming onto the market.

Available now is full support for 8085, Z80, 2650, 6809, 6500 family and 6500/1. To be added in the coming months are 6800, 6802, 6808, 68000, 8048 family and 8400 family. So PMDS is a highly versatile system, that keeps pace with your changing demands. In addition, PMDS has a powerful multi-emulation capability that allows simultaneous emulation of up to 4 different microprocessors to debug complex systems using synchronized or inter-related breakpoints, giving a complete picture of overall system performance.

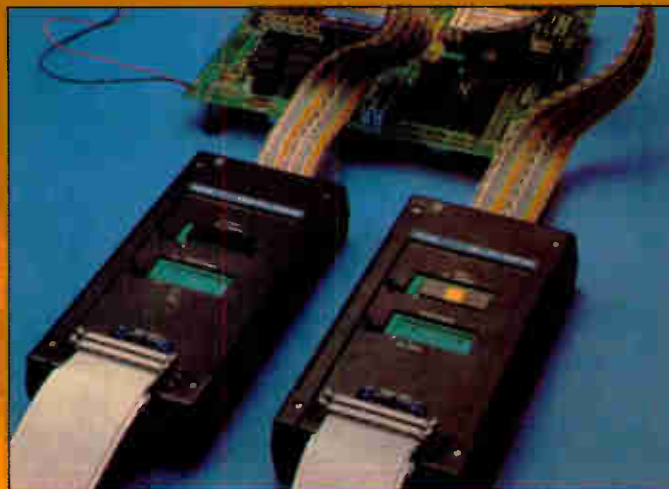

Multi-emulation in a 2-microprocessor system.

Other powerful PMDS development tools include: **PASCAL** for simple programming of 8085, Z80 and 6809 with extensive debug facilities; **real-time emulation** for testing and debugging at true system speed – up to 5 MHz for 8085-A2, 4 MHz for Z80A, 2 MHz for 68B09 etc.; **step-by-step logic analysis** with a 255-word, 48-bit wide trace memory to show you events in program and external history using pre-selected breakpoints; **symbolic debugging** with automatic cross-referencing of symbolic values to absolute hexadecimal values; and **I/O simulation** using built-in software commands to specify PMDS system elements.

And with PMDS, these tools are easy-to-use, thanks to interactive software that gives full operator guidance. To find out more about PMDS' comprehensive development tools, wide micro-computer coverage and programmed system extension, contact Philips Industries, Test & Measuring Dept., TQIII-4-62, 5600 MD Eindhoven, The Netherlands.

...Philips, of course!

PHILIPS

RCK

niROCEr®

STANDARD
ELEMENT



ACTUAL SIZE

If ultra precision resistors concern you, have a look at the different lines of products already manufactured with our technology.

INCREASING
OHMIC VALUES

RCK02

0,5W at 70°C
0,33W at 125°C
1Ω... 200 kΩ
± 0,005% ... ± 1%

RCK04

1W at 70°C
0,6W at 125°C
2Ω... 400 kΩ
± 0,005% ... ± 1%

RCK05

1,2W at 70°C
0,9W at 125°C
3Ω... 600 kΩ
± 0,005% ... ± 1%

RCK06

1,5W at 70°C
1,2W at 125°C
4Ω... 800 kΩ
± 0,005% ... ± 1%

INCREASING POWER

S118

RTK 3

ULTRA PRECISION
HERMETIC SEAL

RHK



A VERY HIGH PRECISION RESISTIVE ELEMENT WITH ULTIMATE POSSIBILITIES

The design and technology of very high precision resistors have progressed considerably in recent years.

Nowadays, users frequently need from a resistor such performances as :

- initial tolerance of 0.005%
- temperature coefficients less than 1 ppm/°C
- 2000 hours' load life stability at Pn 125°C better than 0.002%.
- rise time of a few nano seconds.

SFERNICE in France and its subsidiary in the United States, RESISTOR RESEARCH CORPORATION are among the few manufacturing companies that have made their first priorities the development of an industrial process that fulfills these needs.

This original and complex process, known as "Microcer ®", permits series manufacture of a standard element.

The standard element

The basic element consists of a square chip, 0.2" x 0.2" x 0.025" (5,4 x 5,4 x 0,635 mm) in size, made of a ceramic substrate to which a thin resistive foil (100 microinches thick/2,5 micrometers) is bonded.

This foil is then treated by a proprietary manufacturing process that trims it up to the very true ohmic value specified by the customer.

Two flexible ribbons welded to the foil provide the necessary electrical connections.

Because it is a fine metal foil, the resistor has the specific electrical stability of solid metal.

Special thermal treatment and bonding technology combine to give these resistors extremely low thermal coefficients, associated with excellent reproducibility.

Our etching process permits line width down to 3 micrometers to a tolerance of 1 micron. It is then possible to achieve :

- ohmic values to a precision of better than 10⁻⁵
- extremely short rise times required for rapid electronics (planar structure, self-inductance cancelled out between two conductors).

The requirement of very good thermal conductivity dictates the choice of alumina as a substrate.

The flexible ribbons insulate the resistive element from the mechanical and thermal strengths arising when the user solders the assembly.

A wide range of very high-precision and extremely stable products has been developed from this resistive element.

If you do not find your exact requirement in this range, we will be glad to help you personally, either in our European plant or our U.S. subsidiary, to develop a high-precision product that answers your needs.

For further information, please contact :

worldwide except U.S.A. : SFERNICE 115-121, bd de la Madeleine B.P. 17 - 06021 Nice Cedex FRANCE
Tél. (93) 87.58.90 + 470261

in U.S.A. : RESISTOR RESEARCH Corporation
11515 Sunset Hills Blvd
Reston, Virginia 22090
Tel. (703) 435-2000 TWX 710-831-0344

NETWORKS

RE series 20 - 30 - 40

DIL
- Network R/2R
- Kelvin Varley Divider
- All special requirement

CUSTOMERISATION (Method Numbers)

- sets of resistors
- TC Tracking
- Tolerance matching
- All customer specification



0,5W at 70°C
100 Ω at 200 k Ω
± 0,01% ... ± 1%



0,5W without heat sink / at 25°C
0,1W on heat sink
10 Ω ... 600 k Ω
± 0,01% ... ± 1%
Hermetic seal > 10⁻⁷ Atm.

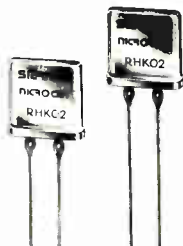

up to ± 0,001%
hermetic seal better than
10⁻⁷ Atm.
stability better than 5.10⁻⁶/year

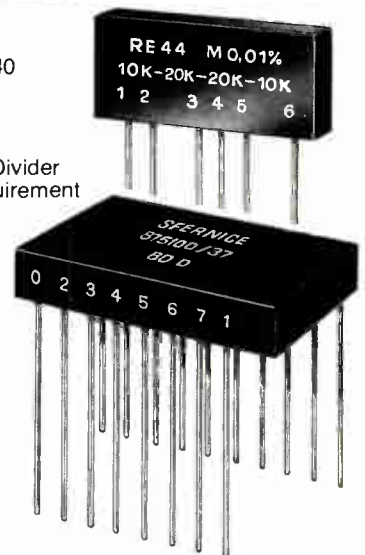

SFERNICE

SOCIETE FRANÇAISE DE L'ELECTRO-RESISTANCE

117, BOULEVARD DE LA MADELEINE

06021 NICE CEDEX - FRANCE

TEL. (93) 87.58.90 - TELEX 470 261

SIEMENS

Something to treasure: the SAB 8086 made in Germany by Siemens



An important announcement for all those who are searching for a reliable partner and supplier of the 16-bit 8086 microcomputer system:

Our new VLSI production center in Munich forms the technical foundation of our product spectrum. There we now manufacture a variety of VLSI circuits with 2 μ m structures.

Take just one example: the SAB 8086, representing the microcomputer technology of today. As for the technology of tomorrow, we're already busy developing 1 μ m structures. In Siemens you have a strong partner who offers you everything belonging to the 8086 system family: processors, additional VLSI system components, development systems,

software, boards as well as training and applications support. Contact your nearest Siemens representative and ask for a quote – comparing our price and performance will pay off. Details are also available by writing to this address: Siemens AG, Components Group, Infoservice – SAB 8086, Postfach 156, D-8510 Fürth.

Siemens – your reliable partner for microcomputer systems

Z80 in module interfaces CP/M with microcomputer

by Kevin Smith, London bureau manager

IEEE-488 bus connects box between Pet and its disk drive; system gains use of software trove, 60-K bytes of RAM

CP/M is the industry's best supported and most widely used microprocessor disk operating system, yet it does not run on the 6520-based Commodore Pet, Europe's best-selling microcomputer system. Now, a small, fast-thinking British manufacturer of microprocessor add-ons has come up with an interface module that allows the CP/M operating system to talk to the Pet microcomputer, unlocking for it a vast storehouse of high-level software.

The black box fits between the Pet's floppy-disk drive and the Pet microcomputer, with all connections made through the standard IEEE-488 interface port on all three units. "You plug in the mains, put in your CP/M disk, and away you go," says Dereck Rowen, who, together with Robin Bailey, founded Small Systems Engineering two years ago.

Inside the black box is a Zilog Z80 plus 64-K bytes of memory sitting on a single printed-circuit card. Virtually a complete microcomputer in itself, it will retail for approximately \$1,000, but in addition to gaining access to a battery of high-level languages the user adds 60-K bytes of random-access memory to his system and off-loads the Pet for other tasks, considerably enhancing his system.

The attractions of the package to Pet owners are considerable. "The Commodore Pet is an extremely

well-packaged low-cost microcomputer, but it lacks breadth of software. It's been driving users nuts," says Rowe, who at one time worked for Commodore's British marketing operation. Admittedly, Pet users have achieved wonders with its rudimentary 8-K Basic and a big library of application software already exists—much written by scientific users attracted by the 488 port, which makes the Pet useful as an instrument controller.

But to move the Pet squarely into the professional and business sector, a full complement of high-level languages is needed. CP/M, says Rowe, has such facilities, supporting at least two versions of Cobol—one

from Microsoft, the other from Britain's Microfocus—APL, Algol, Lisp, Microsoft Basic, two versions of Fortran, and many varieties of Pascal, as well as a raft of program development aides from Lifeboat Associates and others.

There are other attractions: for example, the Pet can be made to look like any of the standard computer terminals, such as the Hazeltine 1500, and so can run WordStar and other word-processing packages. Apart from the 488 port, the conversion module also incorporates an RS-232-C serial interface port, through which it can drive any standard printer. A purchaser has only to specify the protocol and transmission



New products international

rate he wants and it will be set up in the factory by means of eight internal dual-in-line-package switches.

With Pet computers selling in Europe at the rate of 1,000 a month, Rowe reckons theirs is an attractive market for this add-on. First in the queue could be Britain's schools, which have already bought 15,000 Pets, according to Rowe, yet the department of education recently stated that hardware for computer education must be capable of supporting a full complement of high-level languages. Small Systems' add-on would allow the installed base of Pet computers to comply with this requirement.

Small Systems has other enhancements in mind: further upstream is a 25-megabyte hard-disk drive that "looks like an enormous floppy disk" to Pet users. The company will also make CP/M available on other target machines: within two months, for example, CP/M will be available on the Hewlett-Packard 85 desktop computer.

Small Systems has an intimate knowledge of the IEEE-488 bus protocol, having sold 6,500 low-cost IEEE interfaces. It uses this expertise to arrange a dialogue between the HP-85 and the CP/M disk, front-ended by its Z80-based conversion module.

The company says it has produced the first prototypes of its CP/M conversion module using 16-K dynamic RAMs and is now readying a version using 64-K chips. Production of these, it says, is just weeks away. The group is also negotiating with Microfocus Ltd. to sell the hardware in the U. S. through the latter's Santa Clara, Calif., office.

Small Systems Engineering Ltd., 2-4 Canfield Pl., London NW6 3BT, England [441]

Autoranging LCR bridge is accurate to within 0.25%

Its automatic LCR bridge outperforms instruments three times its price, claims Aim Cambridge Ltd. Priced at approximately \$1,080, the LCR Databridge 401 measures Q



factor, in addition to inductance, capacitance, and resistance. The bridge has eight decade ranges and displays the measured result on a 4-digit display. It is specified to be accurate to within 0.25% of reading.

The instrument is fully autoranging, but the range can be locked. It distinguishes automatically between inductors and capacitors and offers optional digital outputs for a limit comparator. Measurements can be made at either 100 Hz or 1 kHz, and either series- or parallel-equivalent circuit values can be displayed.

An internal 2-v bias supply is available for the measurement of electrolytic capacitors, as is an integral four-terminal test fixture. The company ascribes the instrument's cost-effectiveness to a Zilog Z80 microprocessor and novel analog techniques.

Aim Cambridge Ltd., Burrell Road, Industrial Estate, St. Ives, Huntingdon, Cambridge, England [475]

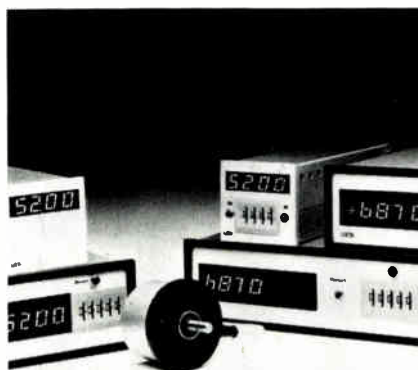

The K 8004-TA tachometer has a 1-to-10,000-rpm range, and the K 8004-1F digital counter has a preset facility for programming a given level of count. Both have a four-digit light-emitting-diode display. Logik AB, 46 Toppevaosvej, Canlose DK-2760 Malov, Denmark [442]

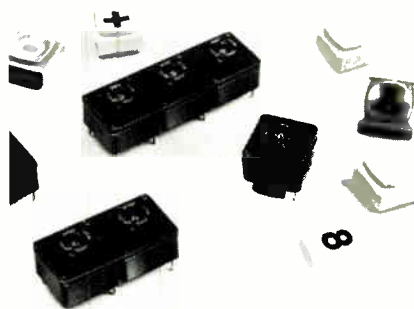

The Cosmos range of miniature push buttons are modular in design and completely sealed. They have a contact life of 10^6 operations, a 125-mA-at-24-V switching capacity and 10-m Ω contact resistance and operate between -40° to $+85^\circ\text{C}$. SECME, 88 Ave Gallieni, 93170 Bagnole, France [443]

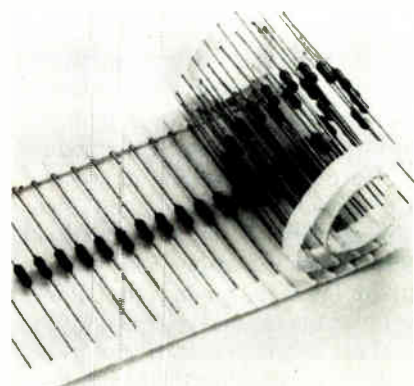

Type MFR4 metal-film resistors have a power rating of 0.25 W at 70° or 0.125 W at 125°C over the resistance range of 10 Ω to 1 M Ω in the E24 and E96 series of values. Temperature coefficient is 100 ppm/ $^\circ\text{C}$. Welwyn Electric Ltd., Bedlington, Northumberland NE22 7AA, England [444]



A 19-in. desktop console gives the user a choice of mounting positions with either steel panels or Vero's 3U or 6U sub racks. It provides adequate space for a keyboard or test jig. Vero Electronics Ltd., Enclosures Division, 362 Spring Rd., Sholing, Southampton, England [445]

SIC SAFCO



Sic Safco Capacitors

Belgium S.P.R.L. CLOFIS Tél. (2) 657.18.05 Télex 22 693
Danemark DANOTHERM Tél. (1) 703681 Télex 19187
Finland DUALTEK Tél. (358) 04.60.011 Télex 123369
Germany THOMSON C.S.F. Tél. (89) 7.67.51 Télex 522916
Italy EURELETTRONICA Tél. (2) 498.18.51 Télex 332102
Netherlands VAN REIJSSEN E. Tél. (15) 56.92.16 Télex 38126
Sweden ULVECO Tél. (764) 66060 Télex 13514
Switzerland A.I.P. Wild Tél. (01) 363.10.20 Télex 57184
United Kingdom CETRONIC Tél. (0920) 87.10.77 Télex 817 293



SIC SAFCO

44, avenue du Capitaine Glamer
B.P. 82
93402 Saint-Ouen Cedex
Tél. 257.11.73 Télex 290498

New products international

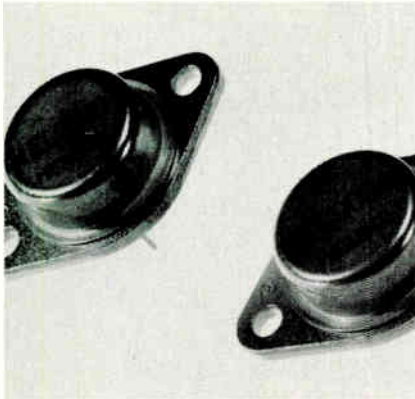

Two power MOS field-effect transistors, the MEL 9040 and the MEL 9050 will withstand up to 400 and 450 V, respectively. They have a standard operating voltage of 25 V and maximum drain current of 8 A. Matsushita Electronics Corp., 1-1 Saiwai-cho, Takatsuki, Osaka 569, Japan [446]

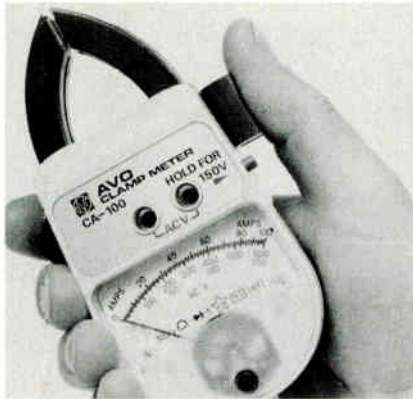

The CA 100 is an analog clamp meter that measures currents from 2 A up to 100 A ac without breaking the circuit and ac voltages from 0 to 150 V and 0 to 600 V. It is suitable for low-current measurements on appliances. AVO Ltd., Archcliffe Road, Dover, Kent CT17 9EN, England [449]

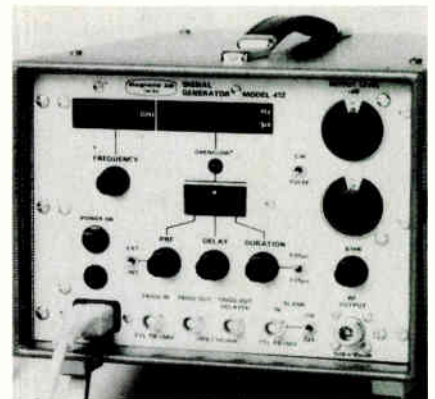

The model 412 signal generator provides a pulse or continuous-wave output over the frequency range of 2.7 to 3.3 GHz, which reads out on a digital panel. Another panel reads pulse duration, repetition frequency, and delay values. Magnetic AB, Box 20036, 161 20 Bromma, Sweden [452]

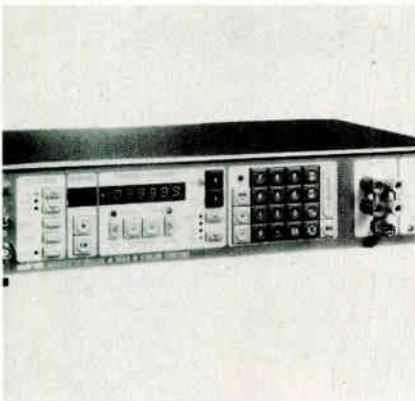

The Adret 104 dc standard has three voltage ranges—1.1, 11, and 110 V full scale—and can supply a maximum of 110 mA. It has a polarity-independent four-wire guarded floating output. Adret Electronique, 12/14 Ave. Vladimir Komarov, 78190 Trappes, France [447]

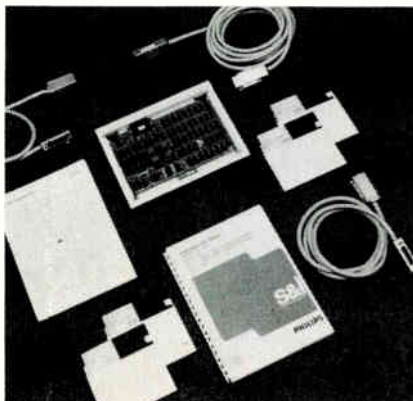

The PM 8495 and 8496 Instrumental Basic software and the PM 4471 IEC-bus interface hardware turn the PM 4421 PMDS into an instrument controller. NV Philips Gloeilampenfabrieken, Science and Industry Division, P. O. Box 523, 5600 AM Eindhoven, the Netherlands [450]



The TM354 is a 3 1/2-digit multimeter with five functions in 14 ranges to measure dc from 1 mV to 1,000 V, ac from 1 to 500 V, dc current from 1 μ A to 2,000 mA, and resistance from 1 Ω to 2 M Ω . Sinclair Electronics Ltd., London Road, St. Ives, Huntingdon, Cambs. PE17 4HJ, England [453]

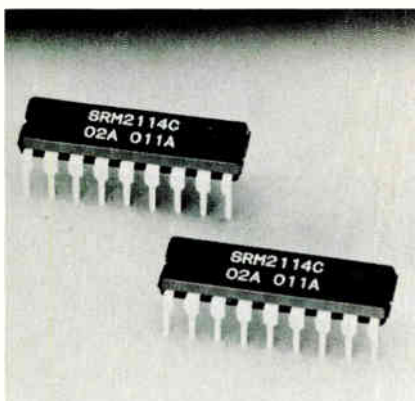

The SRM2114, a 1,024-word-by-4-bit static complementary-MOS random-access memory, has an access time of 250 ns maximum and a supply current of 40 μ A maximum on standby and 35 mA maximum in operation. Suwa Seikosha Co., 3-3-5 Yamato, Suwashi, Nagano 392, Japan [448]



The M 65 R is a plug-in power-line surge protector that protects equipment with semiconductors against transient surges in ac power lines. It contains a surge arrester for controlled arcing when overvoltages are high. Citel, 8 Av. Jean-Jaures, 92130 Issy-Les-Moulineaux, France [451]



The Propysic MCM polypropylene metalized capacitor operates at -25° to $+85^{\circ}$ C. It has a capacitance of 1 to 31.5 μ F and a voltage range of 250 to 400 V. The range is intended for ac current applications. SIC-SAFCO, 44 Avenue du Capitaine Glarner, 93400 Saint-Ouen, France [454]

Testing transceivers in **service** and **production**

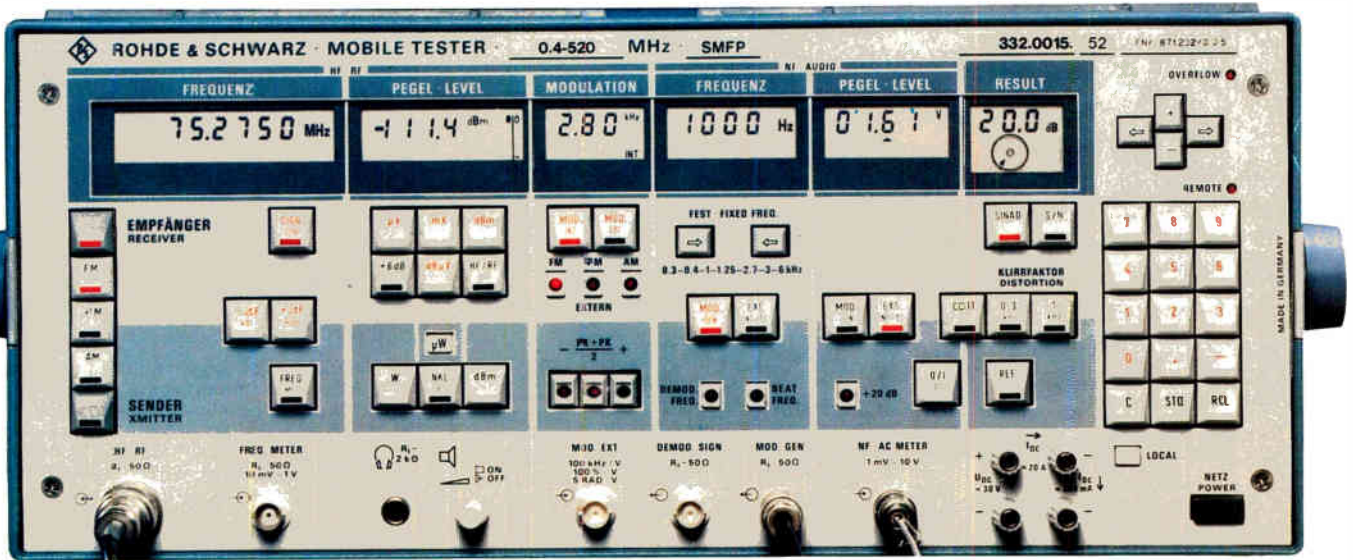

Press the PTT button of the transceiver and that's enough, the SMFS/SMFP does the rest – it automatically measures all the basic parameters in transmit and receive modes and shows the results really clearly.

SMFS/SMFP – the compact testers for mobile and stationary use, for manual or computer-aided operation.

Mobile tester SMFS (left)
0.4 to 520 (1000) MHz

- Portable tester for indoor/outdoor servicing, production and lab use
- Simple, μ P-aided operation with automatic switching between complete transmit/receive tests: measurement of distortion, S/N, SINAD; search routines (e.g. for sensitivity) at the push of a button
- Much shorter testing times, no more operator errors
- Compact, and can be battery-powered in mobile use
- Options: for adjacent-channel power measurement and extension to 1 GHz

Mobile tester SMFP (right)
same as SMFS, plus:

- All measurements computer-controlled (e.g. with our process controller PPC)
- Easy-as-can-be programming with optimized Basic routines
- Flexible program generation for servicing, production and quality assurance – also with hardcopy printout of test results
- Complete control of the test item with built-in relay switches and TTL control lines

Ask for the data sheet
Transceiver testers SMFS/SMFP

Rohde & Schwarz GmbH & Co. KG
Postfach 80 14 69
D-8000 München 80
Federal Republic of Germany

Telex 523 703 (rus d)
Phone internat. +(4989) 4129-1
Independent concern
(established 1933)
represented in 80 countries



ROHDE & SCHWARZ

Electronic measurements · Broadcasting
Radio communications and monitoring

World Radio History

Circle 254 on reader service card



Ceramic Resonator **CERALOCK**®

For clock pulse generator of micro-processor

New Generations of Microcomputers Develop with Ceralock Pulses.

Based on ceramic technology accumulated over the past years, Murata has developed a small ceramic resonator "Ceralock" as a clock signal resonator indispensable for the oscillation circuit heart of microcomputers. A wide frequency range from 190KHz to 30MHz is available in series to meet an increasing demand for microcomputers for consumers' use. Use MURATA's "Ceralock" for square/sine wave oscillator, remote control system for color TV, tone generator of telephones, VCO oscillator and car electronics.

• Features

1. Small and light-weight
2. Wide temperature range and highly stable oscillating frequency
3. Oscillating circuit requires no adjustment when "Ceralock" is used with various ICs.
4. Higher accuracy than LC or RC. Small but highly efficient. Suitable for mass production.
5. High mechanical strength ensures the use in household electronic equipment and cars.



Ceramic Capacitors for CSA are also available

Char.	Part Number	CSB Series	CSA Series
Frequency Range		190-800KHz	2.5-30MHz
Vibration Mode		Area Vibration	Thickness Vibration
Frequency Accuracy(at 25°C)		±2KHz	±0.3%max
Stability in Temp. (-20-+80°C)		±0.3%max. (7ppm/°C)	±0.3%max. (20ppm/°C)
Agein(for ten years)		±0.5%max.	±0.5%max.
Resonant Resist.		20Ω max.	40Ω max.

(): Typ. Value



MURATA MFG.CO,LTD.

Headquarters: Nagaokakyō-shi, Kyoto Japan.
 Phone: 075-921-9111 Telex: 5429-901 MURATA J
 Phone: 404-952-9777 Telex: 0542329 MURATA ATL
 Murata (Europe) GmbH Phone: 0211-48-4062 Telex: 89855-48 MMEG D
 Murata Electronics Singapore(Pte)Ltd. Phone: 255-4233 255-4023 Telex: 21127 MURASIN
 Murata Company, Limited (Hong Kong) Phone: K-308291-2 Telex: 88208 HKMRT HK
 Taiwan Murata Electronics Co., Ltd. Phone: 02-582-4218-9, 582-4210 Telex: 22177 SIELTP
 Murata Korea Branch Phone: 778-2283 Telex: K25858 MURASUL

New products international

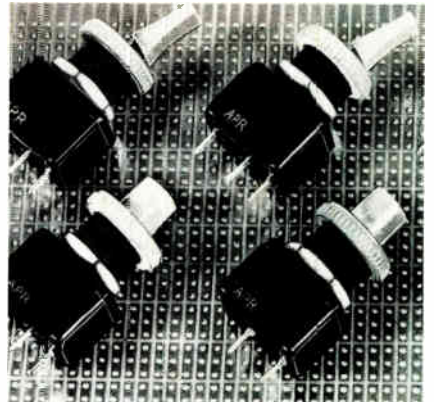

The 4400 series of toggle switches and the 4800 series of push-button switches are for printed-circuit applications. They have a rating of 3 A at 250 V ac, a contact resistance of 10 mΩ maximum, and no metal parts on the exterior side. APR, 82270 Montpezat-de-Quercy, France [455]



The nexus 5400 terminal has 160 standard characters and can assign to each picture element any color out of the 4,096 available. Outside connections are made through plug-in modules. Kashiwagi Research Corp., 2-21-13-105 Aobadai, Meguro-ku, Tokyo 153, Japan [456]

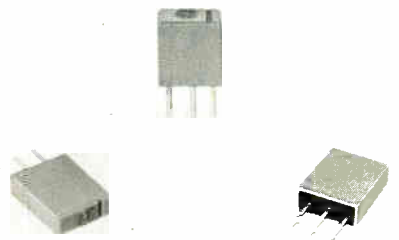

The model MF-3 mechanical filter is 0.2 cm³ in volume and has a broad and flat bandpass centered at 455 kHz. It has a selectivity at ±9 kHz of 23 dB or more and is for use in miniature car radios, transceivers, and cassette recorders. Mitsumi Electric Co., 8-8-2 Kokuryo, Chofu, Tokyo 182, Japan [457]

Test receiver ESH 3 10 kHz to 30 MHz

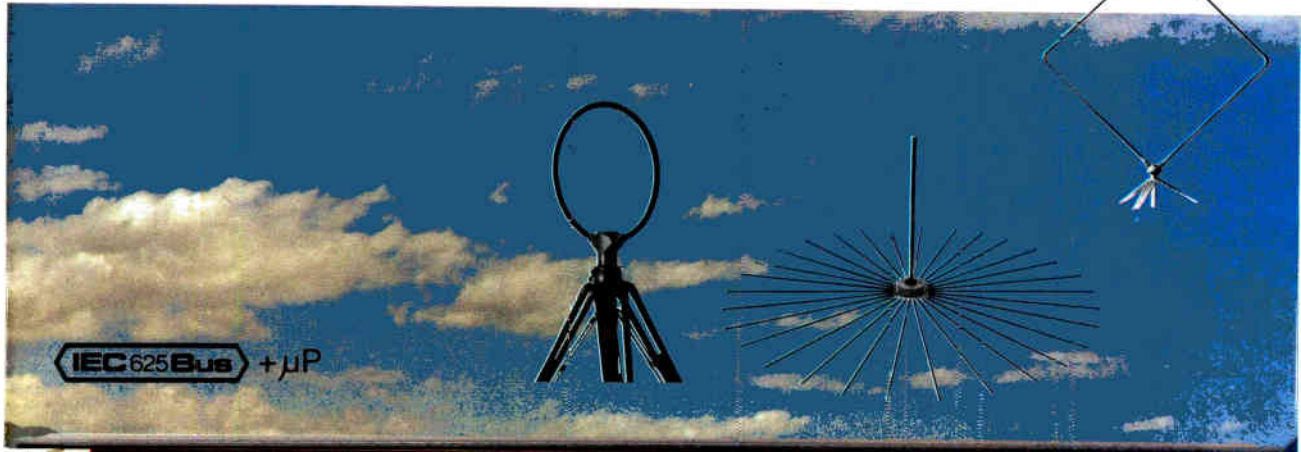

IEC 625 Bus + μ P

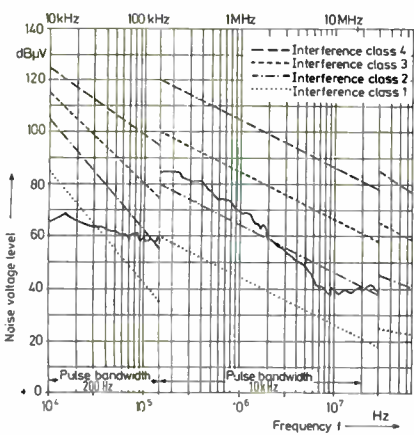
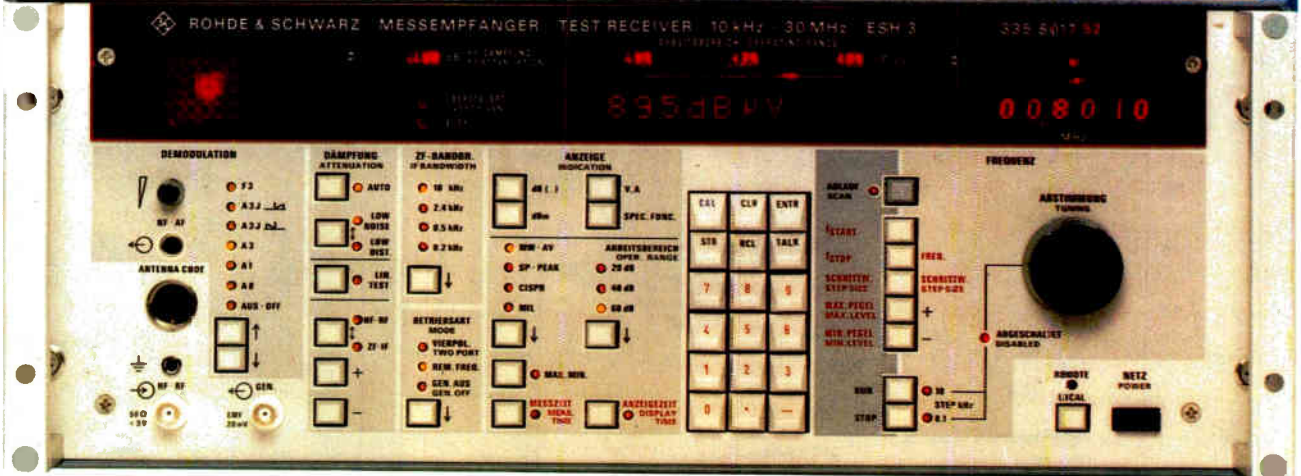

Measurement of broadband noise (peak value), recorded with ESH 3 and XY recorder

System-compatible (IEC/IEEE 488 bus), **precise** and versatile – a true test receiver of the 80s, for wanted signals and interference (CISPR, MIL, VDE, VG).

The ESH 3 can store nine complete device settings, **drive** five frequency-band recorders, printers, XYT recorders, **scan** any five frequency bands.

- The ESH 3 can measure**
- voltage: dB (μ V), dBm, μ V to V
 - current: dB (μ A), μ A to A
 - broadband noise: dB (μ V/MHz), (μ V to kV)/MHz, dB (μ V/m/MHz), (μ V to kV)/m/MHz
 - field strength: dB (μ V/m to V/m) and extra parameters like
 - modulation depth
 - FM deviation
 - frequency offset

Precision
Error of level indication: < 1 dB
(for field strength: < 2 dB)

Accessories
Test antennas, probes, artificial mains network

Ask for more information about
Test receiver ESH 3
Accessories ESH 2/3-Z

Rohde & Schwarz GmbH & Co. KG
Postfach 80 14 69
D-8000 München 80
Federal Republic of Germany

Telex 523 703 (rus d)
Phone internat. +(4989) 4129-1
Independent concern
(established 1933)
represented in 80 countries



ROHDE & SCHWARZ

Electronic measurements · Broadcasting
Radio communications · Radiomonitoring

Windjammer® blowers provide multi-function working air

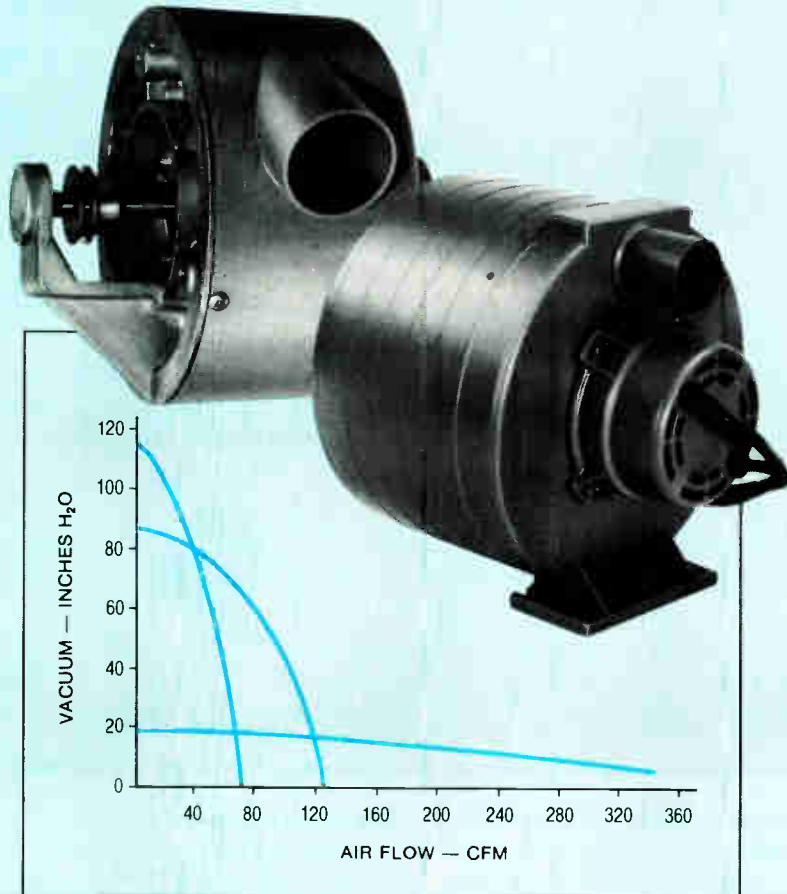

One air system for pressure, vacuum or both

Windjammer high-performance blowers supply vacuum and/or pressure for a wide variety of jobs. Typical applications include tape transports, card sorting, vacuum hold down, air sampling and cooling.

These blowers are designed specifically for environments where high noise levels would be objectionable and

feature carefully balanced components. They can be supplied for belt drive or complete with motor.

Lamb Electric engineers can work with you to develop a Windjammer system tailored to your requirements. And, we can schedule quantity deliveries to meet your production requirements. Contact AMETEK, Lamb Electric Division, 627 Lake Street, Kent, Ohio 44240. (216) 673-3451.

AMETEK
LAMB ELECTRIC DIVISION

New products international



Trim Cap trimmers have a capacitance of 120 pF, which is twice as large as the existing Trim Cap TZ Series. They use a temperature-compensating capacitor material for a low temperature coefficient. Murata Manufacturing Co., 2-26-10 Tenjin, Nagaoka-kyoshi, Kyoto 617, Japan [458]



A range of dc micromotors now includes a 15-mm-diameter, 23-mm-long motor that uses samarium-cobalt magnets, a low-inertia rotor, and precious-metal brushes to develop 640 mW. Stall torque is 23.4×10^{-4} Nm. Portescap UK Ltd., 204 Elgar Rd., Reading RG2 0DD, England [459]



The Pact 220 teleprinter has a semiconductor memory of 16,000 characters instead of the paper-tape device found in conventional machines. It has a printing speed of 50 characters/s. Philips Elektronikindustrier AB, Terminals and Telecommunication, S-175 88 Järfälla, Sweden [460]

Versatile, fast and economical

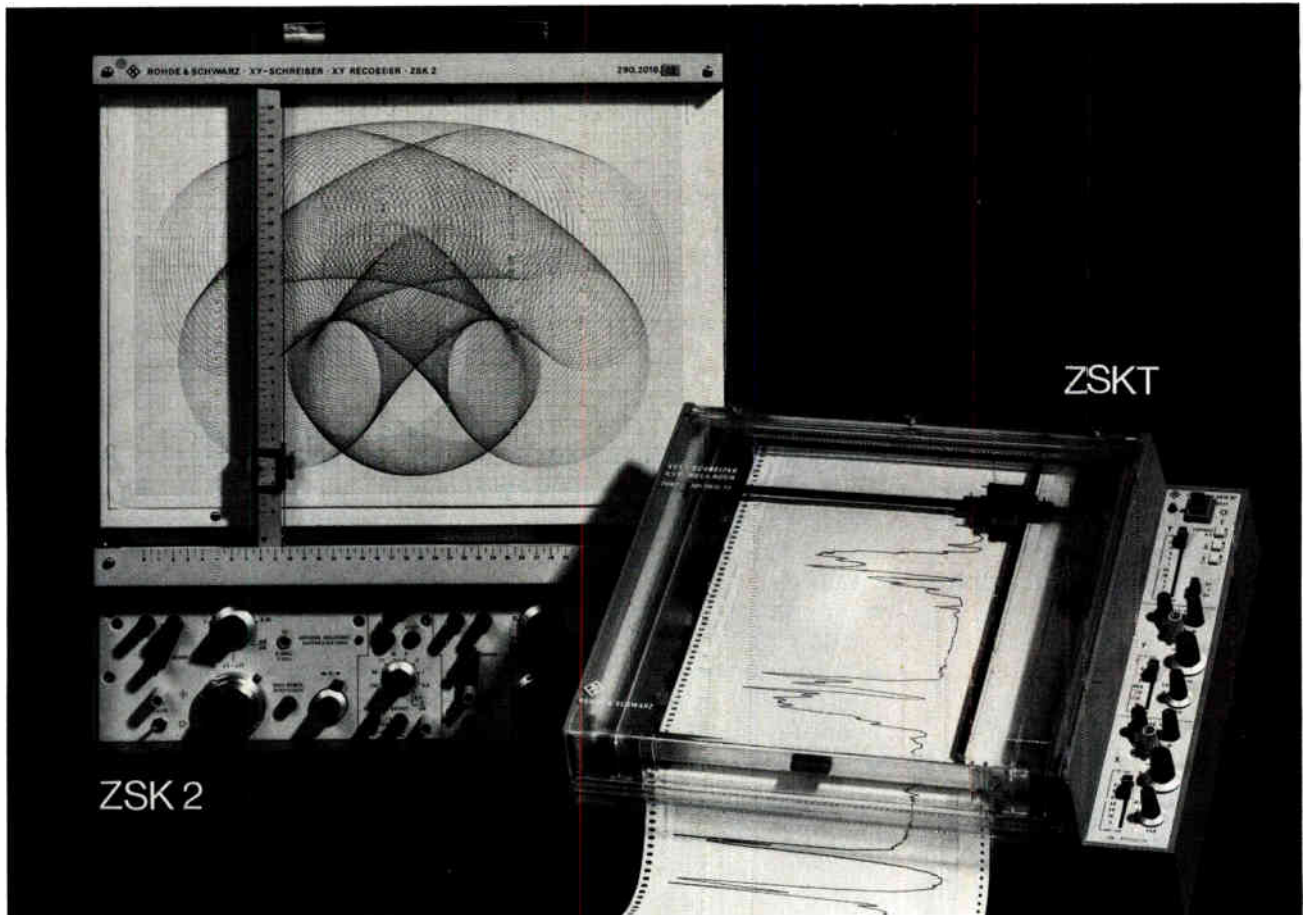

On the basis of just two units Rohde & Schwarz are able to offer a range of recorders to meet all needs. Both have electronically limited writing area, extremely low overshoot of less than 1 mm and the same dynamic characteristics on both axes.

Precision XY recorder ZSK 2 with identical characteristics, independent of position, in X and Y channels. Switchable for format DIN A3 or DIN A4, for YT mode too with a timebase. Writing speed > 110 cm/s in both directions, constant calibrated setting of deflection factor between 10 $\mu\text{V}/\text{cm}$ and 5 mV/cm plus controlled zero shift (max. ± 1 writing width, up to ± 100 cm with external signal). Common-mode voltage 100 to 500 V, DC and AC common-mode rejection 120 to 200 dB.

Four models are available:

1. **universal** with floating, guarded input amplifier; timebase generator
2. **standard** with differential-amplifier inputs
3. **laboratory** with timebase
4. **laboratory** without timebase

High-speed compact recorder ZSKT for XY and YT modes with line or battery power

with the very best dynamic and system characteristics at an unequalled low price. Maximum writing speed 120 cm/s in both directions. In XY mode 50 sheets of DIN A4, in a 15-m roll, can be switch-advanced, or separate sheets can be inserted. YT recording (max. 250 h/roll) with ten speeds between 1 and 1200 mm/min or external pulsed control of the stepping motor. Deflection factor 5 mV/cm to 1 V/cm. Zero shiftable by ± 1 writing width. Straightforward incorporation in automated systems with 19-inch adapter. Remote control of start/stop, format advance and pen position.

**Ask for the data sheets
ZSK 2 and ZSKT**

Rohde & Schwarz GmbH & Co. KG
Postfach 80 14 69
D-8000 München 80
Fed. Rep. of Germany

Electronic Measurements and
Radio Communications. Development,
manufacture, sales and service.
Known for "electronic precision".
Independent concern (establ. 1933),
represented in 80 countries.



ROHDE & SCHWARZ

SIEMENS

A hundred million guardians combat surges with metal oxide and rare gas

Voltage surges caused by inductive and switching transients, sparkovers and lightning are unavoidable, but they can be governed with metal oxide varistors and gas arresters from Siemens.

Siemens metal oxide varistors SIOV are extremely voltage-dependent resistors with a symmetrical protection characteristic. Features:

- protection level from 16 to 2000V
- surge current handling capability up to 40kA
- energy absorption up to 5kJ
- response time < 25ns

The introduction of the metal-cased SIOV-C series has extended our standard program to about 200 types.

Gas arresters SVP

(surge voltage protectors) provide highly-effective protection by means of gas discharging. If the protection level is exceeded, a "controlled" electric arc with a surge current handling capability of up to 60kA is ignited within nanoseconds, thus shortcircuiting the surge.

More than 120 million of these arresters in both glass and ceramic technique, are protecting communications, telemetering, and telecontrol installations all over the world.

Detailed information on both of these protector types is contained in our 1980/81 product program, which can be obtained from: Siemens AG, Bereich Bauelemente, Infoservice, Postfach 156, D-8510 Fürth, quoting "Surge Arresters".

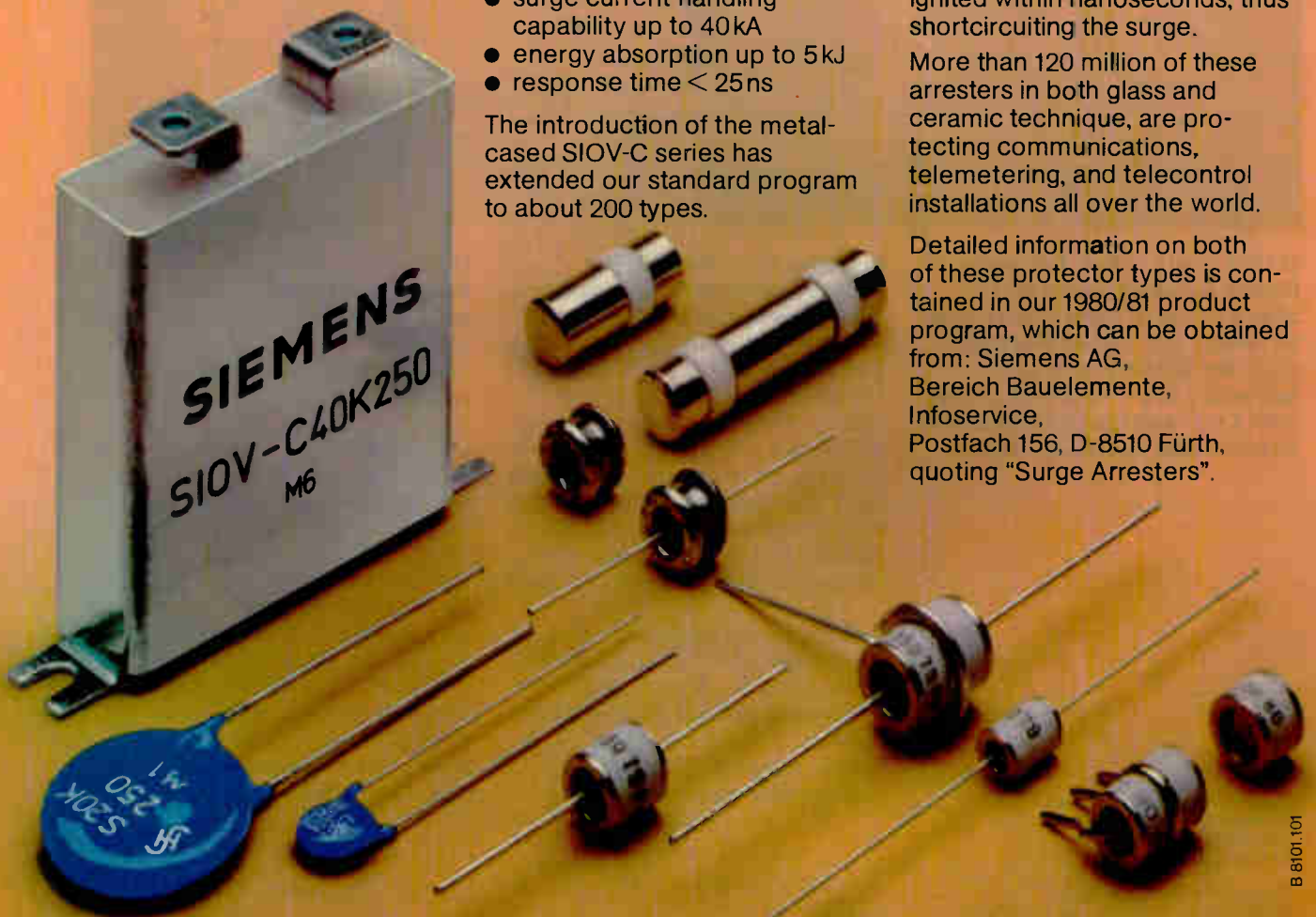

Tailor-made protection from Siemens – worldwide

Circle 259 on reader service card

World Radio History

B 8101.101

New products international

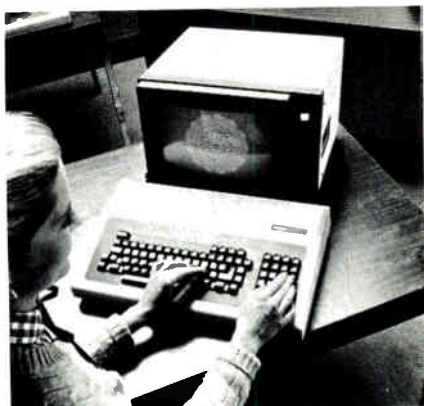

The Barco GD 33 high-resolution color data display is designed to be used with Digital Equipment Corp.'s GIGI terminal. It features a 33-cm cathode-ray tube and has red, green, blue, and synchronization inputs. Barco Electronic NV, Noordlaan 5 B 8720 Kurne, Belgium [461]



Analog multimeter type UNI 35 has 21 measuring ranges for voltage, current, and resistance and is accurate to within $\pm 2.5\%$. It is protected against overloads up to 250 V ac and dc. Müller & Weigert GmbH, Kleinreuther Weg 88, D-8500 Nuremberg, West Germany [462]



The two-stage power-line filter type FN 345 incorporates an IEC connector. It is simple to install, is no more than 30-mm in depth, and protects systems from powerline noise. Attenuation is better than 60 dB over a 1-to-300-MHz range. Schaffner AG, CH-Luterbach, Switzerland [463]

TEAC TOOK OUT BRUSHES TO BUILD IN RELIABILITY.

Unique Long Life Brushless DC Motor

So reliable (lifetime 10,000 hours) that we let it run continuously. No motor start-up time. No electrical noise to bother CRT displays either.

Controlled Frame Expansion

We matched the thermal expansion rate of the frame to that of the media. Head misalignment is greatly reduced.

Choice of 2 Recording Methods: MFM/FM

Data capacity can be doubled using MFM. No write precompensation is necessary.

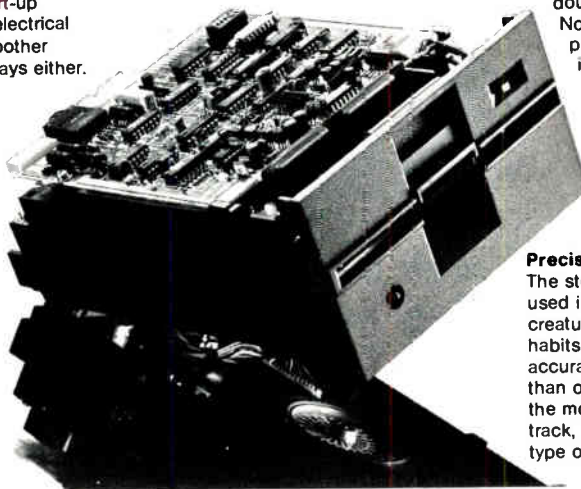

Precision Head Seek

The stepping motors used in floppy disks are creatures of strange habits, stopping more accurately at some steps than others. TEAC steps the motor 4 times per track, eliminating this type of error.

The super-reliable brushless DC motor used in our FD-50 series 5 1/4 Floppy Disk Drives lasts 10,000 hours.

3 Models FD-50A/50C/50E, 3 Formats

The FD-50A is a single-density, 48 tpi, 40/35 track model. In 35-track mode it is fully compatible with the Shugart SA-400. The FD-50C is a double-track-density, 100 tpi, 77 track model, and compatible with the Micropolis 1015. The FD-50E is an industry-standard double-track-density 96 tpi, 80/70 track model.



TEAC CORPORATION: 3-7-3 Naka-cho, Musashino, Tokyo, Japan Tel: (0422) 53-1111 Tlx: 2822451, 2822551

• U.S.A. TEAC Corporation of America, Tel: (213) 726-0303 • Canada R.H. Nichols Co., Ltd., Tel: (416) 661-3190 • Hongkong Dah Chong Hong Ltd., Tel: 5-261111, 5-226258 • New Zealand W. & K. McLean Ltd., Tel: 587-037 • Australia Jacoby Mitchell Pty. Ltd., Tel: (02) 26 2675 • South Africa Mayfair Sales (Pty) Ltd., Tel: (011) 29-2921 • United Kingdom Tekdata Electronics Limited Tel: 0782 813631 • West Germany nbn Elektronik GmbH, Tel: 08152/390 • Holland Simac Electronics B.V., Tel: 40-533725 • Belgium & Luxembourg Simac Electronics, Tel: 02-219.24.53 • France Tekelec Airtronic S.A. Tel: (1) 534-75-35 • Italy A.E.S.S.E.S.P.A., Tel: 54.64.741-2-3 • Spain Atario Ingenieros S.A., Tel: 733 0562, 733 3700 • Switzerland Wenger Datentechnik, Tel: 061/50 84 84 • Denmark Danbit, Tel: (03) 141515 • Sweden Scantele AB, Tel: 08-24 58 25

* If no distributor is listed above in your area, please contact us directly for further details about our products.

Circle 260 on reader service card

Leaders in Electronics

The only reference devoted solely to biographies of the most influential people in electronics

• corporate executives • technical managers • designers and developers • government and military officials • academics • editors/publishers • securities analysts • trade/professional group directors • consultants ... plus an 80-page index of biographees by affiliation.

Prepared by the staff of **Electronics** magazine. 5,240 biographies. 651 pages, clothbound. \$39.50

Electronics Magazine Books

P.O. Box 669, Hightstown, NJ 08520
(609) 448-1700, ext. 5494

Send me _____ copies of *Leaders in Electronics* @ \$39.50 plus applicable sales tax. McGraw-Hill pays regular shipping and handling charges on pre-paid orders.

Payment enclosed Bill firm Bill me

Name _____

Company _____

Street _____

City _____ State _____ Zip _____

Signature _____

NEWS FROM PHILIPS

SUBSCRIBE NOW!



Going into its third year, "Electronic Components and Applications" serves a growing worldwide readership with indepth coverage of recent developments from the laboratories of Philips Electronic Components and Materials Division. Contents of the latest issues typify the range of topics:

- LSI frequency synthesis
- new type of hybrid stepping motor
- serial I/O for microcomputers
- ICs for car radios
- highlight handling with TV camera tubes
- a.c. motor control
- fibre-optic communications
- microprocessor for viewdata
- ceramic magnets for d.c. motors

- semiconductor laser for information readout.

Anticipating the Berlin Funkausstellung, a forthcoming article will describe new ICs to take advantage of the stereo/dual sound tv transmissions due to start in West Germany late this year.

Subscription rate per volume (four issues) is Dfl. 30,00. Check the reader service number for a specimen copy.

Circle 261 on reader service card

GTOs UP TO 1500 V, 50 A

Since announcing our gate turn-off (GTO) switches last September, the range has now been extended to 25 A, and samples of 50 A devices are expected in two months' time.

Wide interest has been shown in our GTOs which combine the high blocking voltage of a thyristor with the ease of gate drive and fast switching normally associated with bipolar transistors and Darlingtons. These devices are fast, three-terminal, four-layer pnpn devices similar in construction to a conventional thyristor. They can be driven directly by TTL circuits and microprocessor output ports.

The new devices listed below are suitable for a very wide range of applications from ignition to CRT deflection, and from motor control to switched power supplies.

Circle 262 on reader service card

Type	ITCRM (A)	IT(AV) (A)	V _{DRM} (V)					Envelope
			600	850	1000	1300	1500	
BT157	10	2,2	—	—	—	—	—	TO-220
BTW58	25	6,5	—	—	—	—	—	TO-220
BTV58	25	10	—	—	—	—	—	TO-220
BTW59*	50	12	—	—	—	—	—	TO-238
BTV59*	50	15	—	—	—	—	—	TO-238

*Types with isolated base

LEADLESS CHIP RESISTORS FOR AUTOMATIC PLACEMENT

We are now producing a full range of leadless chip resistors, RC-01, which offer many advantages to electronic equipment manufacturers using automatic assembly. This new RC-01 range covers resistance values from 1 ohm to 10 Megohms with a tolerance of $\pm 5\%$ and $\pm 10\%$. The power rating is 0,125 W at 70°C and the stability is better than 1% after soldering.

The principle advantages of this RC-01 range are small size (3,2 x 1,5 x 0,6 mm), flat surface (which enables the use of vacuum handling in automation), good taping quality, excellent solderability, low temperature coefficient throughout the range (better than $\pm 200 \cdot 10^{-6}/K$), and low precious metal content. Robust construction allows the RC-01 resistors to be immersed completely in a solder bath at 255°C for one minute, enabling them to be mounted on the soldered side of a printed circuit board and the other discrete components on the reverse side (mix print). A RC-01 resistor is constructed on a small rectangle of high grade ceramic material on which a resistive metal glaze layer is screened and then given a protective coating. A specially designed metal contact strip at each end of the resistive glaze ensures optimum solderability and contact reliability.

The standard packaging comprises 4000 chip resistors in a reel of perforated tape (bandolier packaging) while bulk tape packaging is available as well.

Circle 263 on reader service card



Electronic Components and Materials

NEWS FROM PHILIPS

HIGH CV SOLID ALUMINIUM CAPACITORS



Our new 123-series of axial-lead solid aluminium capacitors utilizes advanced technology to achieve a high CV product per unit volume. These capacitors feature high reliability, good stability, long life, reverse voltage acceptance, no limit to discharge current, tolerance to

high ripple current, infinite shelf life and wide temperature range.

These qualities, coupled with relatively low cost, give the capacitors many advantages over tantalum types. The CV combinations have been designed so that the capacitors can be used as direct replacements for tantalums.

The capacitance range is from 2,2 μF to 680 μF , with 1000 μF available on request. Working voltages range from 6 to 40 volts and the temperature range is -55 to 125°C . The 123-series can be used above 85°C without voltage de-rating and they have a life expectancy greater than 20 000 hours at $+125^\circ\text{C}$.

Circle 265 on reader service card

CHARGE REGULATOR MODULES FOR SOLAR POWER SYSTEMS

A series of nine different charge regulator modules for solar power systems, type numbers CRSM 1020/1074, are announced. These modules are for use in photovoltaic solar power systems where accumulator buffering is employed to span sunless periods. Current applications include remote telecommunications repeater stations, emergency telephones on motorways, nav aids (radars, buoys, light houses), cathodic protection units and telemetry equipment.

Based on the series regulator principle, the modules consist of a battery voltage sensing unit, a transistor switch for the photovoltaic current, and a low battery voltage alarm unit. Some of the modules, ideal for use in moderate climates, have a temperature compensated system which compares the battery voltage with a preset temperature-dependent voltage, thus compensating the temperature coefficient of the battery voltage. Up to eight independent sensing and switching circuits are employed in some types to enable groups of solar modules to be switched in and out according to

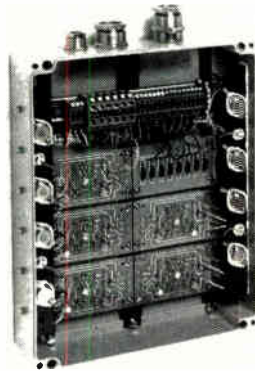

the battery voltage.

The CRSM series covers a power range from approximately 100 W to 1 kW. For higher powers than one module can handle, extra modules can be connected in parallel at their output terminals. The modules are protected against lightning transients.

The modules are supplied in hermetically sealed (class IP65) aluminium boxes. High reliability consistent with that required for telecommunications has been achieved by component derating and burn-in test procedures.

Circle 264 on reader service card

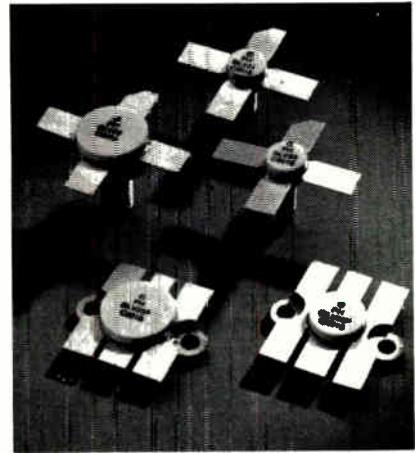

LINEAR V.H.F. POWER TRANSISTORS

A new range of linear v.h.f. power transistors meet the stringent requirements for r.f. drivers and power amplifiers in television transmitter and transposer equipment. At present, the series comprises the BLV30, BLV31, BLV32F, BLV33 and BLV33F which provide peak sync output powers of 1,5 W to 19 W under class-A conditions at a heatsink temperature of 70°C . Under these conditions, the intermodulation distortion measured by the three-tone method does not exceed -55 dB.

All transistors of the BLV30 series have multiple base and emitter islands. This geometry, coupled with very shallow diffusion, reduces the collector-base capacitance and thus ensures high gain and good linearity. Diffused emitter ballast resistors provide even current distribution resulting in optimum temperature profiles and consequent long life. Gold-sandwich metallisation further extends their lifetimes by minimising electromigration.

Circle 266 on reader service card

Philips Industries
Electronic Components and
Materials Division
Eindhoven - The Netherlands

PHILIPS

ITT Multilayer Ceramics. The ultimate decouplers.

You'll find ITT multilayer ceramics capacitors almost everywhere. In sophisticated aerospace communications equipment; the new generation of digital telephone exchanges; home and business electronic gadgetry. All with one thing in common - the need for reliable decoupling capacitors.

ITT Capacitors pioneered multilayer technology and have continued to develop materials and processes to give product performance to match today's IC requirements. Low impedance and low inductance at high frequency are an

integral design feature together with the high volumetric efficiency associated with multilayer ceramics.

We are already moving ahead with tomorrow's product. With the design of improved dielectric constants and electrode systems, building on our total control of production processes, from raw material selection to final product.

Multilayer ceramics from ITT are available worldwide, in all the usual styles and values. So couple your requirement with our expertise - it's the ultimate combination.

ITT CAPACITORS

South Denes, Great Yarmouth,
Norfolk NR30 3PX.





Smart enough to automate testing without the keyboard. Think what else it can do.

You buy an instrument controller to solve problems, not create them. So we developed the 1720A with a unique touch-sensitive display specifically designed to put ATE system control at your operator's fingertips. With the removable keyboard protecting the program's security. Plug in the keyboard and the minicomputer intelligence makes the 1720A easy to program. Helping your programmer feel secure about easy software development and total program security.

Extensive minicomputer capabilities make programming a snap.

Don't let the simplicity of the 1720A fool you. At its core lies a powerful CPU,

the brains behind its software sophistication and programming ease.

Even the language is simple. The 1720A was designed to run BASIC, familiar to programmers for high-level commands. Our BASIC is adapted specifically to enhance **IEEE-488**

operations, so you have the advantage of speedy programming and operation with all the usual BASIC commands—plus a few of our own.

Dynamic string functions are also built into the language.

Sophisticated memory structure.

Direct memory storage is maximized with our Virtual Arrays features extending the working memory beyond the 24 k-byte main memory. Program chaining is also standard.

More good news for programmers.

For added flexibility, we offer a new Assembly Language option, callable from our BASIC.

Concerned about the future? The 1720A is a soft-loaded system. As our software engineers develop other languages, you'll be able to easily transfer your software applications programs.

Smart programming makes for smart operation, too.

The unique touch-sensitive display prompts your operators through a test procedure without touching a keyboard. And since inexperienced operators aren't fumbling over a keyboard, there's no worry over program security.

Write, call toll free **1-800-426-0361**, or send in the coupon for our competitive comparison guide or a demonstration.

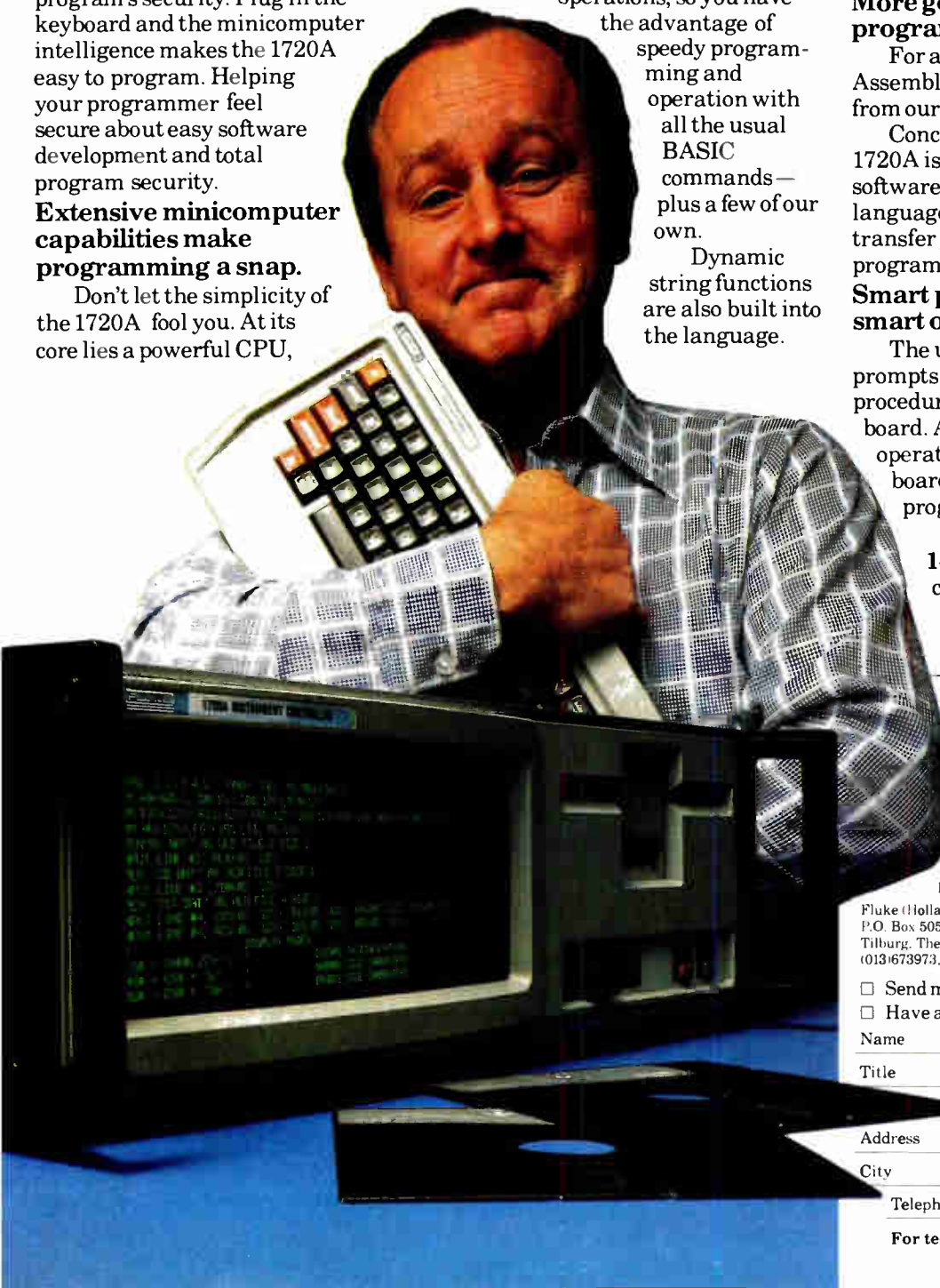

----- (fast response coupon) -----

IN EUROPE: Fluke (Holland) B.V., P.O. Box 5053, 5004 ER Tilburg, The Netherlands (013) 673973, Tlx: 52237

IN THE U.S. AND NON-EUROPEAN COUNTRIES: John Fluke Mfg. Co., Inc. P.O. Box C9090, M/S 250C Everett, WA 98206 (206) 356-5400, Tlx: 152662

- Send me a competitive comparison guide
- Have a salesman call

Name _____

Title _____ Mail Stop _____

Company _____

Address _____

City _____ State _____ Zip _____

Telephone (_____) _____ Ext. _____

For technical data circle no. 89



40% SMALLER, 40% LIGHTER. FREQUENCY COUNTERS FROM SYSTRON DONNER.

Advanced technology. Maximum portability.

Systron Donner is making portable frequency counters a lot more portable.

Take, for example, our 26 GHz Model 6246A: It's a full 40% smaller and lighter than our friendly competitor's equivalent. Forty percent!

And that's not all. There's also a ton of leading-edge performance packed inside that little exterior: A sensitivity of -25dBm. Dynamic range of +52dB. Low 35W input power. High FM tolerance. (Not to mention that it's the only truly portable counter that can provide full coverage to 26 GHz.)

A model for every range: 100MHz, 512MHz, 1250MHz, 4.5GHz, 18GHz, 26GHz.

In portable counters, Systron Donner covers the spectrum. With models for every frequency range. And at prices that are more than competitive. Check the chart and see what we mean.

SD Portable Models	Frequency	Price
6246A	26 GHz	\$4850
6245A	18 GHz	\$4350
6244A	4.5 GHz	\$3300
6243A	1250 MHz	\$1150
6242A	512 MHz	\$925
6241A	100 MHz	\$725

Simplified front panel. Easy operation.

There's more good news: When you take a look at our control panel, see how we've simplified and clarified it. Then

compare it with our friendly competitor's front panel...Enough said?

Enough said.

Plus, thin-line systems models: 1-3/4 inches high!

Even more good news: For you people who need systems counters, we've got you covered. For 26 and 18 GHz, Models 6246A and 6245A are fully programmable with an option that interfaces them to the IEEE-488 bus. And for 1250MHz, 512 MHz and 100MHz, we offer a special ultra-thin series that takes up only 1 3/4 inches of rack space.

And, of course, all of these counters provide exceptional dynamic ranges, excellent AM and FM tolerances and the kinds of sensitivity levels that make them very well suited to permanent systems installations.

SD Thin-Line Models	Frequency	Price
6043A	1250 MHz	\$1700
6042A	512 MHz	\$1500
6041A	100 MHz	\$1210

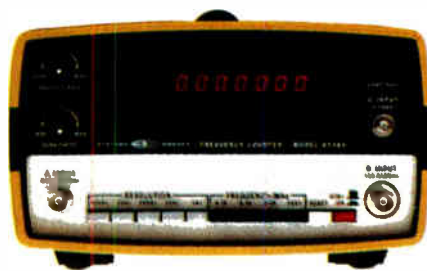

Only from Systron Donner.

So, next time you're in the market for a really portable frequency counter or a truly space-saving rack-mount counter, remember, there's only one place to go for the answers: Systron Donner.

For additional information, call us. Or send in the coupon. We'll rush you complete product literature — along with a list of our representatives in your area.

Prices listed are U.S. domestic. Prices and specifications subject to change without notice.

SYSTRON DONNER INSTRUMENT DIVISION/CFE

E51981

2727 Systron Drive, Concord, CA 94518
Phone: (415) 676-5000
TWX: 910-481-9479

Dear Systron Donner,
I had no idea you people made such small, lightweight frequency counters; please rush me a set of literature on your full line.

Name _____
Title _____
Company _____
Address _____
City/State/Zip _____
Phone _____

**SYSTRON
DONNER**
Member THORN EMI Group



Get money back from Rockwell International.

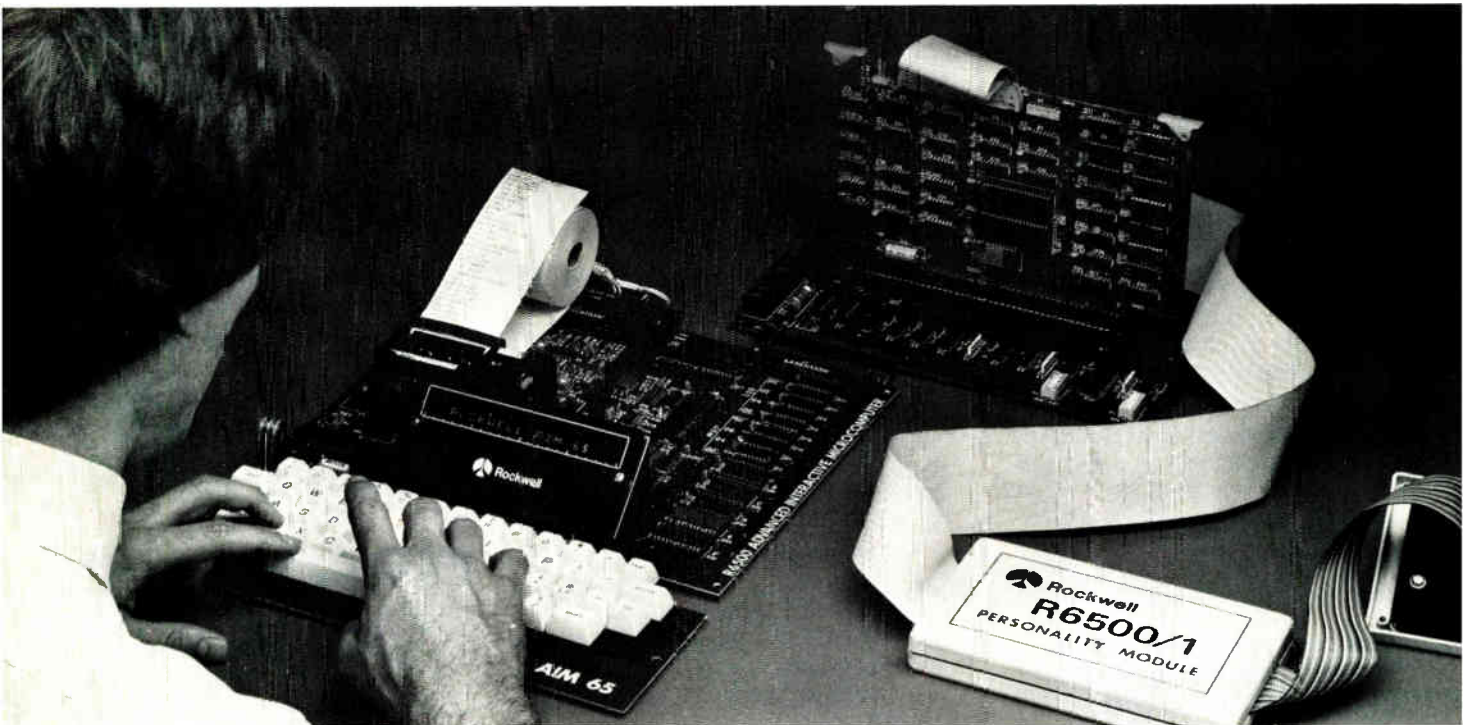

The easy way to evaluate R6500 performance is now easier

No argument. The data you generate operating your equipment with competitive microprocessor systems is the best criteria for decision making.

Expensively impractical? Not if you want to generate your own data on third-generation R6500 multi-chip or one-chip systems. Rockwell's AIM 65 microcomputer makes your evaluation easy. The hardware cost is hundreds, not the conventional thousands of dollars.

You use Assembly or high level languages to quickly program selected equipment functions. You easily interface your equipment's components with AIM 65's on-board, versatile I/O. You generate system thruput

data with on-board programmable interval timers.

It's easy with AIM 65. Now our money-back offer makes it easier.

ROCKWELL'S MONEY BACK OFFER:

Purchase an AIM 65 to measure R6500 cost-effectivity. When you buy a minimum of \$2,500 R6500 devices — multi-chip systems including CPU's or R6500/1 one-chip systems — we'll refund 10%, up to \$500, of the initial device invoice. You keep the AIM 65, of course. This one-to-a-customer offer applies only if you buy an AIM 65 between April 13 and August 31, 1981, and order R6500 devices within six months of your AIM purchase.

GET DETAILS NOW:

Call toll-free today for the nearest Rockwell Rep or Distributor Salesman. He'll explain all the details of our AIM 65 money back offer. In the U.S. call 800-854-8099 (in California, 800-422-4230). In Canada, call 416-494-5445. Or Write: Rockwell International, Electronic Devices Division, RC55, P.O. Box 3669, Anaheim, CA 92803 U.S.A.



Rockwell International

...where science gets down to business

Now! One-chip microcomputers offer R6500 performance.

Presenting the Rockwell R6500/1 series: single-chip, 8-bit microcomputers and microcontrollers that are software compatible with the R6500 family, provide fast execution speed and may be interfaced readily with all R6500 I/O and memory devices.

R6500/1 features include 1.5K to 3K bytes of ROM, 64 to 192 bytes of RAM, 23 to 56 I/O ports, multiple use counter/timers, serial communication port, bit manipulation, expansion bus, multiple bus interface, directly executable RAM with low power standby, and multiple interrupts.

Rockwell. Your systems source.

To facilitate system and program development, Rockwell supports the R6500/1 series with emulator devices and interface

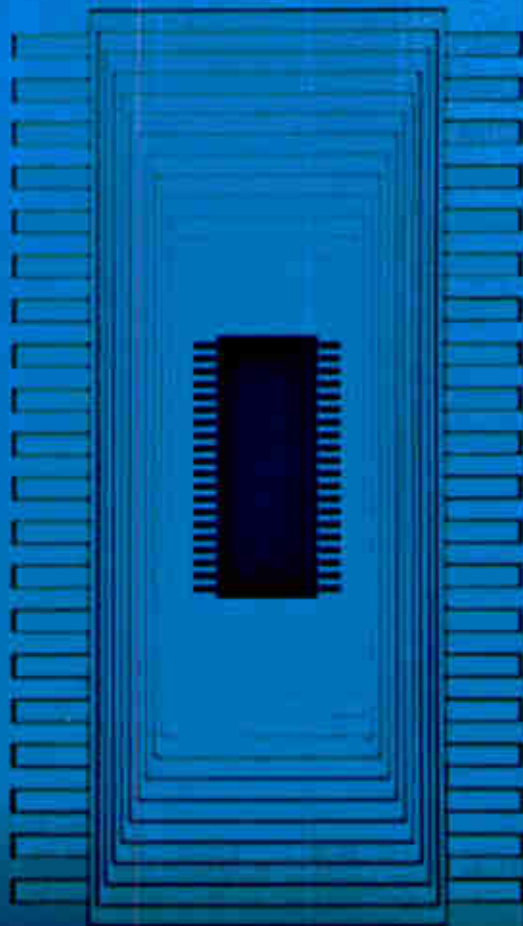

lines to external memory, plus evaluation modules. One R6500/1 even is available as a back-pack emulator that accepts PROMs or ROMs in an on-chip socket. Additionally, the SYSTEM 65 microcomputer development system with R6500/1 personality module supports full-up hardware and program development, as well as in-circuit user simulation. Call Rockwell International toll free at 800-854-8099 (within California, 800-422-4230). Or write: Rockwell International, Electronic Devices Division, RC55, P.O. Box 3669, Anaheim, CA 92803.



**Rockwell
International**

where science gets down to business

Circle 95 on reader service card

R6500/1

THE OPTICS ALONE ARE WORTH THE PRICE

Now get more room to work, high power, and exciting new optics with the AO Series 1860 Industrial Microscope. □ Here's the ultimate in image quality, contrast and resolution. And unlike other scopes that depend on vertical stage movement for focusing, the 1860 utilizes an exclusive focusing nosepiece principal that revolutionizes the ease and speed of wafer inspection. □ And the fixed stage height provides excellent stability and easier use of the

ancillary equipment, such as micro-probes, micromanipulators, carousels, and other stage hardware. Result: masks, wafers and other components are moved on and off the stage faster. □ Only AO offers built-in halogen lamps with 10,000 hours of life and a full 20 mm. field of view... no other scope even comes close. □ The unique AO Series 1860 - another American idea

in human engineering for the technologies of the 1980's. For a demonstration see your AO dealer or representative, or write for our brochure: American Optical, Instrument Division, P.O. Box 123, Buffalo, NY 14240.

The versatile 1860 accepts cameras for documentation and is available with attachments to accommodate several viewers simultaneously.

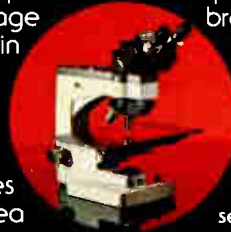

ANOTHER AMERICAN IDEA



Circle 96 on reader service card

World Radio History

AO
American Optical®

Europeans plan business satellites

Eutelsat to handle \$100 million project involving 17 nations despite political obstacles and doubts that services are needed

by Kevin Smith, London bureau manager

Following the example of the U. S., 17 European nations plan to launch a pair of locally manufactured satellites in 1983 to handle computer traffic, teleconferencing, electronic mail, and other business services. The 17, through their government-regulated postal and telecommunications agencies (known as PTTs) have combined in a management organization called Eutelsat to fund the \$100 million project.

But by most accounts, the immediate commercial prospects for such a service are uncertain. The development is being pressed in fulfillment of the PTTs' monopoly obligation to provide customers with the services they demand or, as with France, in recognition of the strategic importance of satellite technology. Such services may well become big data carriers by 2000, but right now their future is clouded by political, technical, and commercial problems.

To start with, Europe is smaller than the U. S., so dedicated satellite links will be more expensive to operate on most routes than terrestrial links. Admittedly, a single satellite hop can provide a wideband data link on demand if terrestrial links are not available, but the Europeans aim to meet such demands within the next 10 to 15 years by developing a continent-wide digital telephone network. Even so, that provides a window in which to establish satellite systems, but politics could still stymie a pan-European service.

Hard bargain. The present unanimity has been hard won and follows long and protracted bargaining. According to British Telecom managing director Peter Benton, the compromise solution patched togeth-

er at a December meeting of Eutelsat is to use a two-satellite service with incompatible technologies. Eutelsat will rent capacity on the French government's Telecom 1, a multirole six-transponder bird operating in the time-division multiple-access mode.

Additionally, the European Communications Satellite, or ECS, which is primarily an Anglo-Italian project, is to be retrofitted with a business

systems transponder operating in the frequency-division multiple-access mode. This technology, it is claimed, cuts the earth station costs by a third, to about \$200,000, compared with TDMA systems, but it will almost certainly be made obsolete by second-generation business-satellite systems.

Both satellites will work with an 11-gigahertz uplink and a 14-GHz downlink. Ground stations will be

Communications link. Eutelsat's proposed business-systems satellites will utilize 4-meter rooftop dishes. This experimental model was provided by Britain's Marconi Communications.

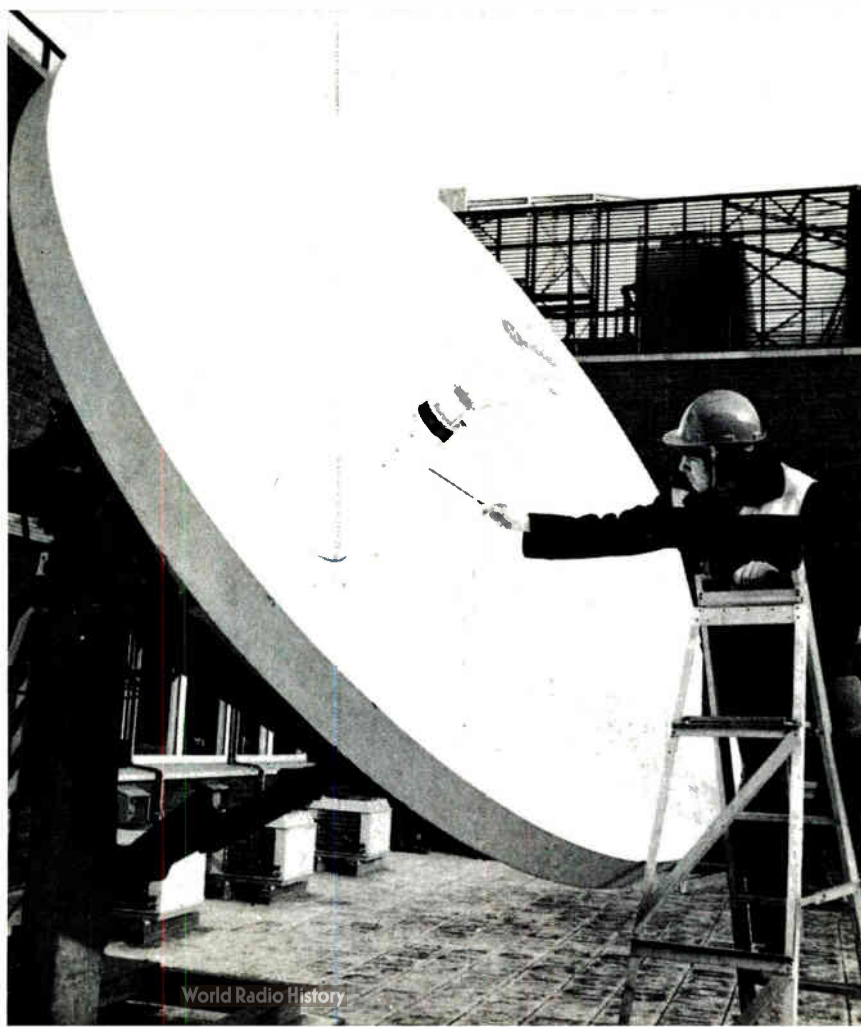

Probing the news

linked to small 4-meter local neighborhood antennas; small businesses will be connected to those by digital ground links. Though the antenna front ends will be common to both systems, they will not be able to talk to each other. One reason for this odd compromise might be to give other European manufacturers a foothold in the ground-station market, since French manufacturers already have a head start in supplying slimmed-down TDMA terminals for business applications. Also, some of the earliest potential users—including one UK news agency—are interested in the low-cost broadcast capability of FDMA systems.

Terra firma. European PTTs still expect the bulk of future high-speed digital data traffic to travel along terrestrial links. "We are uncertain about the commercial prospects for the European satellite service, but we still must make the service available if our customers want it," says Friedrich-Wilhelm Bodemann, head of the satellite communications section at the West German post office's development center in Darmstadt. "Europe is not the United States, where satellite communications may pay off," he says.

Instead, the PTTs are banking heavily on their upcoming digital network, using a common 64-kilobit/second channel capacity that

should meet most business requirements. Low-cost fiber-optic links will figure largely in these plans: British Telecom, for one, intends to use fiber-optic digital trunks starting in 1983 to link its System X digital net. "Celestial services," says Bodemann, "must run in parallel with the terrestrial networks."

French view. In France, Michel Popot, project director in the Direction Générale des Télécommunications for the Telecom 1 satellite, concedes that it will eventually be replaced by other communication networks even as he exudes optimism about its prospects. Telecom 1, he says, will arrive just in time to act as a catalyst for new communications services that the French label "Télématique."

The French opted for their own satellite rather than a European one largely for reasons of industrial strategy. On the one hand, they want French industry to be capable of building communications satellites with as little outside help as possible. On the other, they want to be in control so as to stimulate the direct development of French data-communications activities.

Across the channel, the British government has yet to come up with a satellite strategy, so the initiative has been left to British Telecom and private industry. The Eutelsat satellite business service accord is in large measure due to British Telecom's painstaking negotiations, as is the

untidy technical compromise. Like other organizations, British companies doubt the commercial viability within Europe of a dedicated satellite business service such as Eutelsat's.

Marconi Space & Defense Systems Ltd., for one, believes that the best way to put such a service on a sound commercial basis is to combine a transponder for direct-broadcast television and business services in an advanced satellite payload. Such a service, they argue, if operated over Europe or even nationally, could be a sound commercial proposition. It could also run into major political problems.

Alternatives. One candidate for the task is the European Space Agency's L-Sat or a derivative of it. L-Sat is a second-generation satellite, with both direct broadcast and business transponders on board, due to be launched in 1985. Unlike ECS or Telecom 1, it is a multibeam system with on-board switching between beams; it thus can put down an accurately defined microwave footprint, permitting direct broadcast to rooftop antennas.

L-Sat is primarily an Anglo-Italian venture, as France and West Germany have pulled out of the heavy satellite direct-broadcasting project to go it alone. Now several other consortiums are being formed to address the European market for direct broadcasting by satellite, and though this is the primary objective, they, too, may decide to add a business satellite payload.

Marconi, for example, is actively seeking British Telecom support for its proposal. Another consortium, called Satellite Television, suggests using Eutelsat satellites linked to a local area receiver serving a cable network, an approach that bypasses some tricky political problems. But what is needed most to make business satellite communications take off is a rapid growth in the kind of service that eats bandwidth. Such a service, says B. G. Evans of England's Essex University, is teleconferencing, but despite his bullish growth predictions, one of the biggest uncertainties remains the rate at which the screen will catch on among corporate managers as a substitute for business travel. □

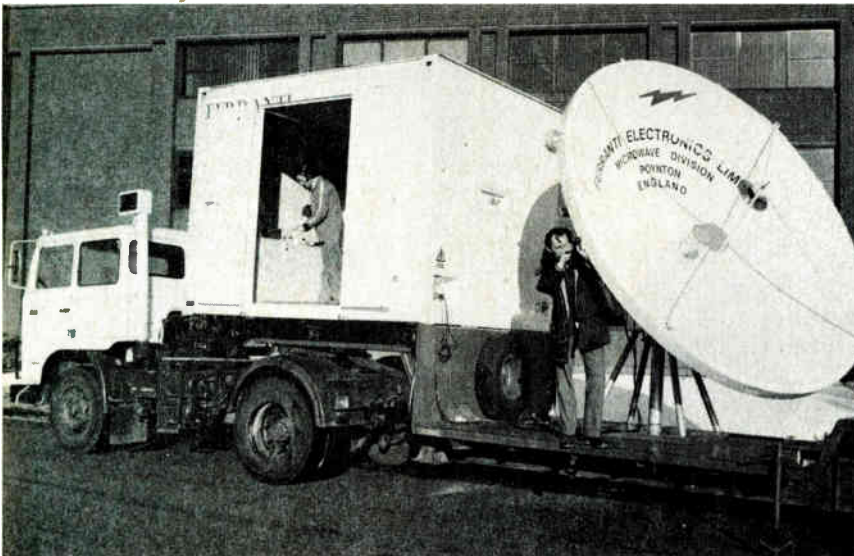

Trial system. For customer trials starting this year, portable antennas such as this from Ferranti Microwave will be used to measure reception in various areas to be served.

BAUSCH & LOMB INNOVATION!

For fast, accurate inspections of wafers, hybrids, and multi-layered chips, specify Bausch & Lomb MicroZoom™ Microscopes... the *only* microscopes with both the high magnifications and long working distances demanded by these semiconductor applications.

No more pieced-together compromises! Bausch & Lomb innovation has produced a unique long working distance microscope with magnifications to 1000X and working distances from .5" to 1.2".

And, MicroZoom Microscopes also include these innovations:

- Continuously in-focus 1X to 2X zoom range. Focus once, then zoom to optimum magnification with no lost time refocusing.

- New 50X LWD objective to give you the optimum (up to 1000X) for pre-etch and post-etch inspections.

- Wide field images let you see a full ¼" chip, crisp and erect, for fast, accurate interpretation.

- Advanced tungsten-halogen vertical illumination system provides contrast control and true color rendition. A must for accurate

photomicrographs!

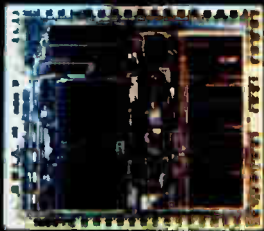

A full ¼" square chip can be viewed at the lowest magnification, 22.5X.

- Special MicroZoom Prober Models, designed for mounting on your probe station, add greatly to the safety, speed, and accuracy required for critical autopsy probing applications.



When faster assembly and inspection are required, choose Bausch & Lomb StereoZoom® Microscopes. Large working distances to 10.5".

Zoom ranges from 1X to 7X. Magnifications to 280X.

For critical work in wafer fabrication inspections, select Bausch & Lomb BALPLAN® Incident Light

Microscopes with magnifications up to 1500X and the clarity of six versatile illumination modes.

All three of these fine microscopes accept a full range of high performance photomicrographic

equipment and versatile accessories.

Write or call today for complete information, applications assistance or a demonstration.

For inspection reliability, performance and innovation, THINK BAUSCH & LOMB.



BAUSCH & LOMB 

Rochester, New York 14602 USA 716-338-6000, TWX 510-253-6189 TELEX 97-8231, CABLE Bausch & Lomb

Regional Offices **SOPD International CANADA** Bausch & Lomb Canada Ltd., Don Mills, Ontario **EUROPE** Bausch & Lomb GmbH, Muenchen, Germany, Bausch & Lomb France S.A. Versailles, France, Bausch & Lomb U.K. Ltd., Epsom Downs, Surrey, Bausch & Lomb Italiana S.p.A. 00198 Rome, Italy **FAR EAST** Bausch & Lomb (Hong Kong) Ltd. Shaukeiwan and Singapore, BLJ Co. Ltd Tokyo.

ISO-CMOS™ When we developed the ISO-CMOS process at **THE HIGH SPEED**, we also developed a **LOW POWER** way of thinking. We ensured that **REVOLUTION** applications for the technology were kept foremost in mind—every step of the way.

Design Philosophy? Right from the start we made sure that our integrated circuit designers were exposed to the system environment, not just the component environment. In developing worldleading PABXs this perspective allowed Mitel Semiconductor to develop integrated circuits with well thought out general purpose interface capability.

Quality and Reliability? Our ISO-CMOS production technique and our quality assurance screens are based on MIL Standard 883 Test Methods and Procedures. Every ISO-CMOS device is hermetically packaged and 100 percent burned in. So ISO-CMOS quality and reliability is built in at the start of the process and is maintained through to completion.

Availability and Capacity? Mitel Semiconductor products are being marketed world-wide, with a supporting network of sales offices and distributors. In addition to a continuing expansion of manufacturing capacity by Mitel Semiconductor, Mitel ISO-CMOS devices are now sourced under licence by three major manufacturers, making our products and process the number one multi-sourced choice for new designs.

ISO-CMOS. It has created a revolution in the telephone, PABX and digital logic markets based on a capability for high speed, low power and high density. The continuing evolution of this superior technology is assured by the ongoing commitment by Mitel to the process.

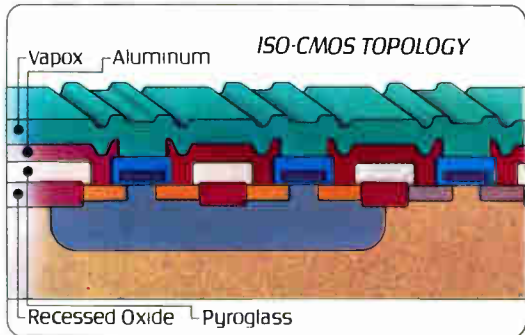

Discover what Mitel Semiconductor can do for you, by contacting your local Mitel sales office.



MITEL SEMICONDUCTOR

United States: 2321 Morena Blvd., Suite M, San Diego, California, U.S.A. 92110.
Telephone (714) 276-3421. TWX: 910-335-1242.
P.O. Box 17170, 600 West Service Road,
Dulles International Airport, Washington, D.C., U.S.A. 20041.
Telephone (703) 661-8600. TWX: 710-995-0026.

Canada: P.O. Box 13089, Kanata, Ottawa, Ontario, Canada K2K 1X3.
Telephone (613) 592-5280. Telex: 053-3221. TWX: 610-562-8529.

Europe: 33/37 Queen St., Maidenhead, Berkshire, England SL6 1NB
Telephone 0628-72821, Telex: 51-849-808.
Bredgade 65A, 2nd Floor, 1260 Copenhagen K, Denmark
Telephone (01) 134712. Telex: 19502.

Asia: TST P.O. Box 98577, Kowloon, Hong Kong.
Telephone 3-318256, Telex: 34235.

TM Trademark of Mitel Corporation
Copyright 1981 Mitel Corporation

BUILDING BETTER COMMUNICATIONS

Information processing

Videotex' direction still unclear

AT&T entry into already crowded display-technology field compounds puzzle of who will pay for what type of service

by Harvey J. Hindin, Communications & Microwave Editor

With the nascent videotex industry being pulled in many directions by competing technologies for data delivery via television and personal computer, the entry of giant American Telephone & Telegraph Co. with its own standard is adding to the confusion. And not only is there a plethora of delivery techniques, but there also is some question about who should deliver what.

The scheduled revelation of AT&T's move into the business of the interactive home and office of the future, and its decision to eschew Britain's Prestel, France's Antiope, and Canada's Telidon standards,

was the bombshell at the Videotex '81 meeting in Toronto this week. Bell's videotex will, naturally, use the telephone, says a spokesman, adding that "the Bell System standard does not favor Telidon or anyone else's approach." Moreover, he says, "Bell is an advocate of compatibility," which is no surprise, since it is in the company's interest to have everyone talk to everyone else via in-place national phone networks.

Compatibility is no pipedream: much work has been going on to make the three existing standards work together. On the other hand, just how far the others will go to

comply with AT&T's requirements remains to be seen. They already have, after all, a relatively wide installed base.

In any event, the AT&T matter proves that the latest phenomenon of the information revolution is still a wide-open field where no one can predict what is going to happen. The United States, though it lags well behind Canada, England, and France in its development of the services, techniques, and products that can be brought to the home and office of the future by two-way television, is a good example of the fluid situation. According to John Tyde-

DIVERSITY OF U.S. VIDEOTEX TECHNOLOGY

	Delivery technique				Display format (rows by characters)				Display			Input device		
	phone line	cable TV	fm subcarrier	broadcast TV	32 x 16	32 x 20	40 x 20	80 x 24	home TV set	computer terminal or home computer	extra TV set or monitor	numeric key pad	alphanumeric keyboard	key pad plus keyboard
AT&T/EIS Albany	✓						✓				✓		✓	
AT&T/EIS Austin	✓						✓		✓					✓
Belo/Sammons		✓					✓		✓			✓		
Cabletext		✓												
CBS				✓								✓		
Closed Captioning				✓										
CompuServe	✓				✓					✓			✓	
Cox		✓			✓				✓			✓		
Datacast			✓										✓	
Green Thumb	✓				✓				✓			✓		
KSL-TV				✓		✓			✓			✓		
OCLC	✓				✓				✓			✓		
QUBE		✓			✓				✓			✓		
The Source	✓							✓		✓			✓	
Times Mirror		✓												
Viewtron	✓								phase 2		phase 1			✓
WETA-TV				✓								✓		

Note: This chart is illustrative only; it does not show every user's approach in each area.

Source: Institute for the Future

Probing the news

man of the Menlo Park, Calif., Institute for the Future and Laurence Zwimpfer of the New Zealand Post Office, "users in the United States will likely have a choice of three or possibly four delivery approaches to videotex. These include over-the-air broadcast, coaxial-cable broadcast, telephone-network-based TV systems, and personal computer terminals." The four different display formats, three different display devices, and three different user-input devices for the four delivery technologies—not counting AT&T's—are more clear evidence of the lack of coordination in the industry (see table).

U. S. videotex trials include systems based on Prestel, Antiope, and Telidon. Even the standards that exist, few as they are, are of little aid in decision making. For example, those three systems all fit within the guidelines established at the Consultative Committee on International Telegraphy and Telephony meeting held in Geneva in November 1980. What's more, there is little doubt that the meeting of the Conference of European Postal and Telecommunications Administrations' telecom-

munications executive committee at Innsbruck, Austria, this month will further bless the existing systems that have been proposed for a unified European videotex standard. Be that as it may, what is important, as all the presenters at Videotex '81 pointed out, is that now, as Prestel's Stephens puts it, "videotex has become an international industry."

One attempt to establish an international videotex network is going to be launched by Prestel International. W. W. Shrimpton, managing director of Logica PI Ltd. in England, which is a consultant to the British government's British Telecom, says that "the first international videotex service will start in the second half of this year." It will supply data bases to business users in Britain, West Germany, the U. S., and Switzerland, among other countries. Highly specific information such as shipping news and commodity prices will be offered.

Market confusion. The fact that the first international videotex service will cater to a well-defined market is no accident. It has been very difficult for would-be entrepreneurs to define just what people need and are willing to pay for among the various information-retrieval, games

and entertainment, transaction-oriented, electronic-mail, data-processing, and home-management services that videotex can supply.

In contrast to the U. S. approach of tests by an uncoordinated group of suppliers from cable television, newspapers and magazines, television stations, telephone companies, and just about everyone eager to test the new waters, Japan has gone the sole-source route. In the person of its domestic communications umbrella organization, Nippon Telegraph & Telephone Public Corp., it has conducted but one uniform test for the last two years. "Thus far, it has proved quite successful," S. Harashima, director of NTT's visual communication bureau, told conference attendees. "And," he added, "the second experimental service is planned to start in August."

Careful Swiss. Like the Japanese, the Swiss have special language needs. But this is a mere matter of logistics; more important is the choice of display technology. Switzerland has been testing a system based on the Prestel approach for two years. According to Peter A. Gfeller, technical director, and Pierre E. Schmid, manager of the data systems division of Switzerland's Standard Telephon und Radio AG in Zurich, the use of Prestel up to now "implies no prejudice for the choice of system for the next stage of testing, which is scheduled to begin in 1983."

Indeed, the ever-pragmatic Swiss are eager to introduce what the Standard Telephone people call "the more advanced graphic methods of Telidon." For the Swiss, the way to accomplish this feat is "coexistence," through inexpensive multi-mode terminals that can switch between formats.

The concern with display technology is important, but by no means do all participants in the videotex game agree on the degree of its importance. For example, K. E. Clarke, head of Prestel research and development, and B. L. Fenn, a British Telecom research engineer, make no apology for saying that "internationally, the videotex community overrates display technology at the expense of the network, where many of the real costs and problems lie." □

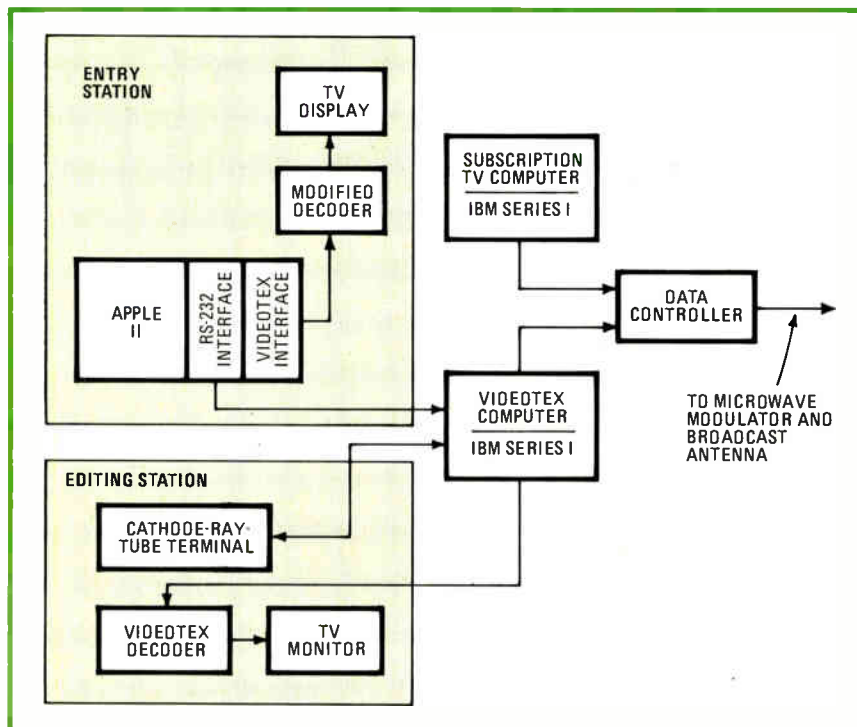

Different. In one test, in Florida, data is on aural carrier's subcarrier instead of the usual vertical blanking interval of subscription TV. The diagram shows the data-entry point.

If you can't find the right program in our new catalog, it probably hasn't been written.

As the world's largest publisher of professional software for micro-computers, Lifeboat Associates offers the largest selection of state-of-the-art programs. And our new catalog has more to offer than ever. We also add the crucial dimension of after-sales service and full support to everything we sell. Order your free catalog today.



For a free catalog, mail coupon to Lifeboat Associates, 1651 Third Avenue, New York, NY 10028. Or call (212) 860-0300. Telex 640693 (LBSOFT NYK)

Name _____ Title _____
Company _____
Street _____
City _____ State _____ Zip _____

Our catalog contains full descriptions and specifications of the following:

<p>DISK OPERATING SYSTEMS</p> <p>CP/M CONFIGURED FOR: APPLE II DATEPOINT 1550/2150 ICOM MICRO DISK ICOM 3712 ICOM 3812 ICOM 4511/PERTEC D3000 INTEL MDS MICROPOLIS FLOPPY DISK MITS/ALTAIR MOSTEK MDX NORTH STAR OSI C3 OSI C3B OSI C3C Prime TRS-80 MODEL II MP/M FOR INTEL MDS</p> <p>HARD DISK INTEGRATION MODULES</p> <p>CORVUS WITH APPLE II SOFCARD CORVUS WITH S100 AND TRS-80 MODEL II ICOM 4511/PERTEC D3000 KOMAN PLUS CDC PHOENIX XCMP SM/S PLUS CDC PHOENIX XCMP DF10 FOR PERTEC D3000</p> <p>SYSTEMS TOOLS</p> <p>BUG AND UBUG SID DESPOOL TRS-80 MODEL II DISLOG CP/M DISTEL CUSTOMIZATION EDIT UNLOCK EDIT-80 WORD-MASTER FILETRAN XASM-18 IBM/CPM XASM-48 MAC XASM-65 MACRO-80 XASM-68 PASM XMACRO-86 PLINK ZDT PMATE Z80 DEVELOPMENT RAID PACKAGE RECLAIM ZSID</p>	<p>TELECOMMUNICATIONS</p> <p>BSTAM BSTMS</p> <p>LANGUAGES</p> <p>ALGOL-80 muSIMP APL/V80 'NEVADA COBOL BASIC-80 PASCAL/M (COMPILER) PASCAL/M* BASIC-80 PASCAL/MT+ (INTERPRETER) PASCAL/Z BDS C COMPILER PL/I-80 CBASIC-2 S-BASIC CIS COBOL TINY C COBOL-80 TINYC TWO FORTRAN-80 W'SMITHS C JRT PASCAL COMPILER muLISP XYBASIC</p> <p>LANGUAGE AND APPLICATIONS TOOLS</p> <p>BASIC UTILITY MDBS.DRS DISK MDBS.RTL DATASTAR M/SORT FOR FABS COBOL-80 FORMS 1 FOR CIS PEARL COBOL PSORT FORMS 2 FOR CIS QINSORT COBOL STRING BIT MAGSAM III STRING /80 MAGSAM IV SUPER-SORT ULTRASORT II</p> <p>WORD PROCESSING SYSTEMS AND AIDS</p> <p>MAGIC WAND TEX LETTERRIGHT TEXTWRITER III MICROSPELL WORDSTAR SPELLGUARD WORDINDEX</p> <p>DATA MANAGEMENT PACKAGES</p> <p>CONDOR MDBS HDBS MDBS QRS</p> <p>GENERAL PURPOSE APPLICATIONS</p> <p>CBS SELECTDR IV SELECTOR III-C2</p>	<p>MAIL LIST APPLICATIONS</p> <p>MAILING ADDRESS (PTREE) MAILMERGE FOR WORDSTAR NAD POSTMASTER</p> <p>BUSINESS APPLICATIONS</p> <p>ACCOUNTS PAYABLE (PTREE) ACCOUNTS PAYABLE (SSG) ACCOUNTS RECEIVABLE (PTREE) ACCOUNTS RECEIVABLE (SSG) GENERAL LEDGER II (CPAIDS) GENERAL LEDGER (PTREE) GENERAL LEDGER (SSG) GLECTOR FOR SELECTOR III-C2 INVENTORY (PTREE) INVENTORY (SSG) PAYROLL (PTREE) PAYROLL (SSG)</p> <p>NUMERICAL PROBLEM-SOLVING TOOLS</p> <p>ANALYST STATPAK FPL T/MAKER MU MATH</p> <p>OTHER SPECIALIZED APPLICATIONS</p> <p>DATEBOOK EQ-1 PAS-3 DENTAL PAS-3 MEDICAL PROPERTY MANAGEMENT (PTREE)</p> <p>BOOKS AND PERIODICALS</p> <p>APL - AN INTERACTIVE APPROACH ACCOUNTS PAYABLE & ACCOUNTS RECEIVABLE: CBASIC 8080/280 ASSEMBLY LANGUAGE THE C PROGRAMMING LANGUAGE CRASH COURSE IN MICROCOMPUTERS FIFTY BASIC EXERCISES GENERAL LEDGER-CBASIC INTRODUCTION TO PASCAL LIFELINES</p>	<p>THE PASCAL HANDBOOK PASCAL USER MANUAL AND REPORT PAYROLL WITH COST ACCOUNTING-CBASIC STRUCTURED MICROPROCESSOR PROGRAMMING USING CP/M-A SELF-TEACHING GUIDE</p> <p>ACCESSORIES</p> <p>DC 300 DATA CARTRIDGE HEAD CLEANING DISKETTE FLIPPY DISK KIT FLOPPY SAVER</p> <p>Program names and computer names are generally trademarks or service marks of the author or manufacturing company.</p> <p>All software products have specific requirements for hardware and additional associated software (e.g. operating system or language)</p> <p>All products are subject to terms and conditions of sale</p> <p>Prices and specifications are subject to change without notice</p> <p>All Lifeboat software requires CP/M unless otherwise stated.</p> <p>Copyright © 1981 Lifeboat Associates. No portion of this advertisement may be reproduced without prior permission</p>
<p>ORDERING INFORMATION. COMPUTERS SUPPORTED INCLUDE:</p> <p>ADDS Multivision RT AVL Eagle RB Altair 8800 B1 Altos A1 Apple CP/M 13 Sector RG Apple CP/M 16 Sector RR BASF System 7100 RD Blackhawk Micropolis Mod II Q2 CDS Versatile 3B Q1 CDS Versatile 4 Q2 Columbia Data Products A1 COMPAL-80 Q2 CSSN Backup T1 Cromenco System 3 A1 Cromenco System 2 SDSS R6 Cromenco System 2 DDSS RX Cromenco System 2 DDDS RY Datapoint 1550/2150 Single Sided AA Datapoint 1550/2150 Double Sided AB Delta Systems A1 Digi-Log Microterm II RD Digital Microsystems RS Durango F-85 RL Dynabyte DB8/2 R1 Dynabyte DB8/4 A1</p>	<p>Exidy Sorcerer + Lifeboat CP/M Q2 Exidy Sorcerer + Exidy CP/M RW Heath H8 + H17/H27 disk P4 Heath H89 + Lifeboat CP/M P4 Heath H89 + Magnolia CP/M P7 Heath H89 + Heath CP/M B2 Helios II R3 ICOM 2411 Micro Floppy A1 ICOM 3712 R3 ICOM 3812 R3 ICOM 4511 5440 Cartridge CP/M 1.4 D1 ICOM 4511 5440 Cartridge CP/M 2.2 D2 IMS 5000 A1 IMS 8000 R2 IMSAI VDP-40 A4 IMSAI VDP-42 R4 IMSAI VDP-44 R5 IMSAI VDP-80 R4 ISC Intecolor 8063/8360/8963 A1 Intelec Superbrain DOS 0.1 A7 Intelec Superbrain DOS 0.5 RJ Intelec Superbrain DOS 3 x A1 Intelec Superbrain QD RF Kontron PSI-80 RS MITS 3200-3202 A1 MSD 5.25 in. BC Meca Delta-1.5. 25 in. P6</p>	<p>Micromation A1 Micropolis Moc I Q1 Micropolis Moc II Q2 Morrow Discus P4 Mostek P7 NEC PC-8001 P7 North Star Single Density B2 North Star Double Density R3 North Star Quad Density P3 Nylac Micropolis Mod II A1 Ohio Scientific 23 D1 OKI IF-800 D2 Onyx C8001 R2 Pertec PCC 20E0 A1 Processor Technology Helios II B2 Quay 500 R4 Quay 520 R5 RAIR Single Density A1 RAIR Double Density A1 Research Machines 5.25 in. R7 Research Machines 8 in. R7 SD Systems 5.25 in. RJ SD Systems 8 in. RS Sanco 7000 5.25 in. RF Spacebyte BC TEI 5.25 in. RC TEI 8 in. P6</p>	<p>TIP R2 TRS-80 Model I STANDARD R3 TRS-80 Model I + FEC Freedom RN TRS-80 Model I + Micromation A4 TRS-80 Model I + Omikron 5.25 in. RM TRS-80 Model I + Omikron 8 in. A1 TRS-80 Model I + Shuttleboard 8 in. A1 TRS-80 Model II P2 TRS-80 Model III A1 Vector MZ Q2 Vector System 2800 A1 Vector System B Q2 Vector VIP R2 Vista V-80 5.25 in. Single Density RB Vista V200 5.25 in. Double Density P8 Zenith 289 + Zenith CP/M P7 Zenith 289 + Lifeboat CP/M P4 Zenith 289 + Magnolia CP/M P7</p> <p>SS = single sided SD = single density DD = double sided DD = double density</p> <p>The list of available formats is subject to change without notice. In case of uncertainty, call to confirm the format code for any particular equipment</p>

LIFEBOAT WORLWIDEE

Lifeboat Inc.
3-23-8 Nishi-shinbashi
Minato-ku, Tokyo, 105 Japan
Tel: 03-437-3901
Telex: 2422723 (ASRTYDJ)

Lifeboat Associates, Ltd.
PO Box 125
London WC2H 9LU, England
Tel: 01-836-9028
Telex: 893709 (LBSOFTG)

Lifeboat Associates GmbH
PO Box 168, Aegerstrasse 35
CH 6340 Baar, Switzerland
Tel: 042-31-2931
Telex: 865265 (MICO CH)

Intersoft GmbH
Schlossgartenweg 5
D-8045 Ismaning, W. Germany
Tel: 089-966-444
Telex: 5213643 (ISOFD)

Lifeboat Associates, SARL
10, Grande Rue Charles de Gaulle
92600 Asnieres, France
Tel: 1-733-08-04
Telex: 250303 (PUBLIC X PARIS)

Lifeboat Associates

Software with full support.

Displays

LCDs lead flat-panel display derby

Japanese companies are showing prototypes of handheld TV sets using liquid crystals, though Sinclair's flat CRT shines

Of all the approaches to a low-power, flat-panel display suitable for handheld television sets—which are expected to begin appearing in 1982—liquid-crystal displays appear to be the long-term winner. Already prototypes of LCDs with several thousand picture elements (pixels), all from Japan, have combined good contrast and size with their inherent low-power advantage. Still, other technologies cannot yet be ruled out, and one—actually a flat cathode-ray tube—has aesthetic advantages in its brightness and product maturity.

In Japan, the Tokyo-based Hitachi, Sharp, and Toshiba are in the forefront with LCD developments. Also, Shinsu Seiki Ltd. of Hirooka, which also owns Seiko Ltd., the watch manufacturer, unveiled at the National Computer Conference in

Chicago earlier this month a 1-by-1¼-inch LCD panel with a 210-by-200-pixel array.

The display is only 3 millimeters thick, and the maximum fall time of a dot signal is 100 milliseconds. The combination provides a good black-and-white video image with no noticeable ghost. The NCC display worked from a videotape player with a second panel in a transistor-radio-sized package, which included the tuning electronics, receiving local commercial television. The panel draws only 10 milliwatts and has excellent contrast. Though only a prototype, it shows how far LCD technology has come.

Many connections. One of the problems with LCDs lies in the number of interconnections that must be made to the panel—hundreds of

rows and a comparable number of columns. Hitachi Ltd., which demonstrated its 45-by-60-mm (equivalent to a 3-in.-diagonal measurement) LCD panel at the Society for Information Display meeting in New York last month, relies on a multiplexing scheme to keep the number of interconnections manageable, but also maintains that matching the resolution of conventional TVs is not necessary: in fact, its 120-by-160-pixel panel has only one sixteenth the resolution of conventional TVs. Eiji Kaneko of the company's Central Research Laboratory explains that “the reduced number of pixels is acceptable because the human eye cannot clearly discriminate among pixels in a display of this size.” Nevertheless, in attempting to produce a more natural image, Hita-

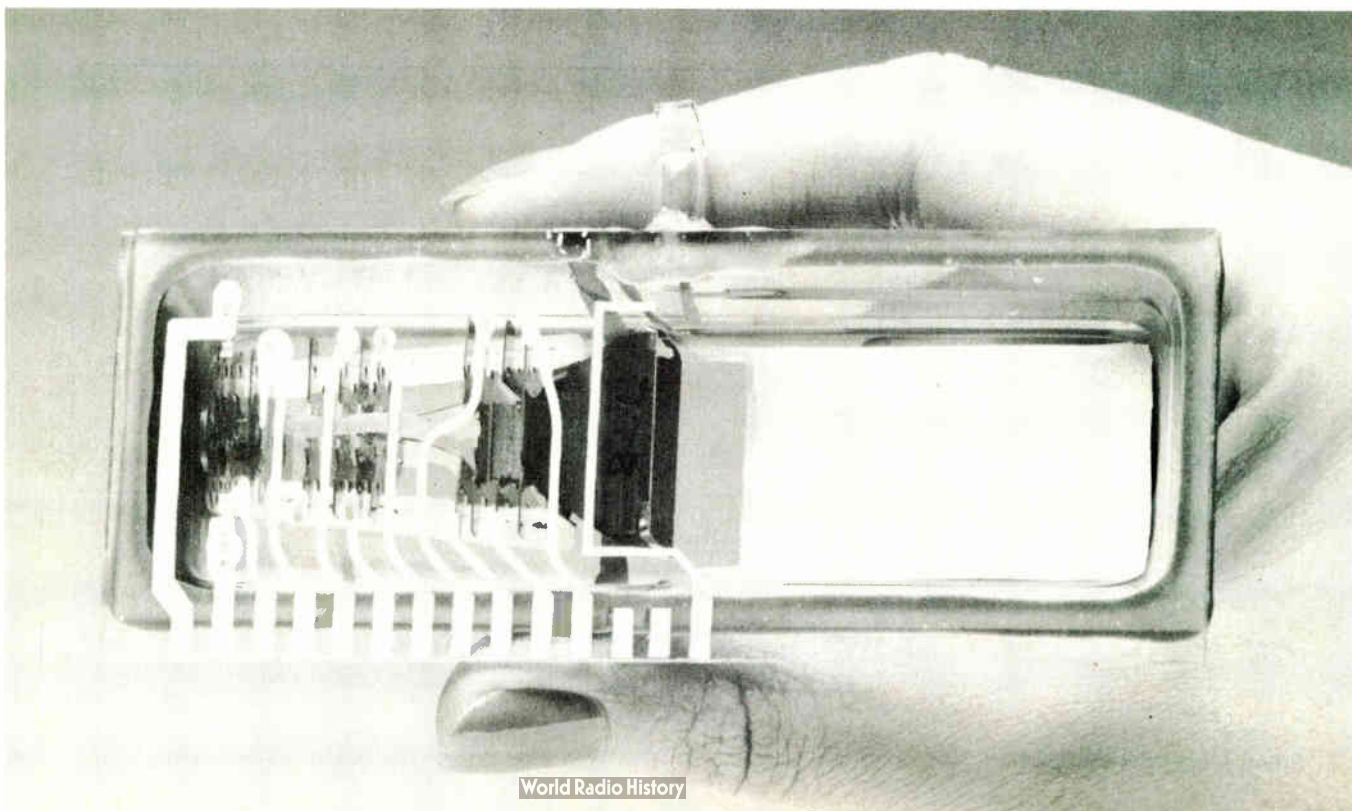

chi uses a technique called gamma compensation.

The Hitachi display is actually part of a complete prototype television measuring only 146 by 95 by 30 mm and weighing with its four pen-light batteries a mere 480 grams (about a pound). Total power dissipation of the unit is 1.3 watts.

Perhaps the best picture at the SID show appeared on the screen of Clive Sinclair's flat CRT. Sinclair, the driving figure behind the stream of miniaturized products from Sinclair Research Ltd., Cambridge, England, showed a tube with a picture diagonal of 2 in. and a depth of 0.75 in. To achieve so narrow a profile, the tube's electron beam is fired from

one side of the display area. Initially, the trajectory of the beam is parallel to the plane of the display; it is angled downward by an ingeniously simple set of electrostatic deflection plates that require one tenth the power of conventional, magnetically deflected CRTs—30 mw.

Doubly bright. The beam passes between a metal-backed phosphor-coated screen and a transparent repeller electrode of equal area. The picture is viewed through this electrode so that the image is seen from the same side as the electrons impinging on the phosphor. The result, says Sinclair, is twice the picture brightness for a given beam current, compared with a standard tube.

Less promising flat-panel technologies include light-emitting-diode arrays and vacuum fluorescent panels. Though interesting in the way it sandwiches 6,144 red and green LEDs into an array that offers images in shades of red, yellow, and green, a panel shown by Sanyo Electric Co. at the SID can draw several amperes and so will be limited to graphics terminals. A 128-by-128-pixel vacuum fluorescent display from Ise Electronics Corp. in Ise, Japan, also shown at SID, had only fair brightness and, according to its inventors, potential for better resolution, but draws 676 milliamperes of heater current to get its 76.6-by-71.8-mm display area. □

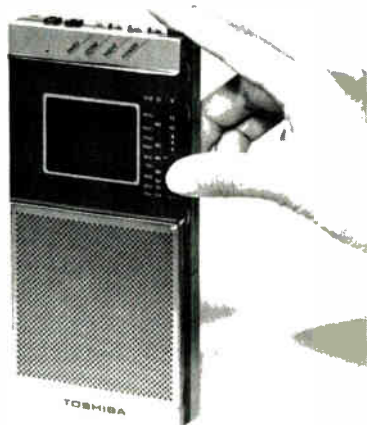

Picture show. Flat-panel displays shown to those who took in the recent Society for Information Display meeting in New York were, left, a cathode-ray-tube model from Sinclair that is only 0.75 inch deep; above, one from Toshiba that uses liquid crystals; and, below, a version from Sanyo that sandwiches 6,144 red and green light-emitting diodes into an array.

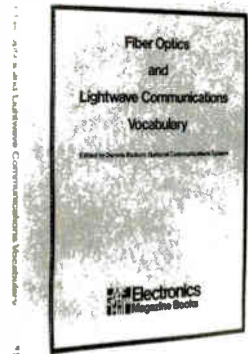
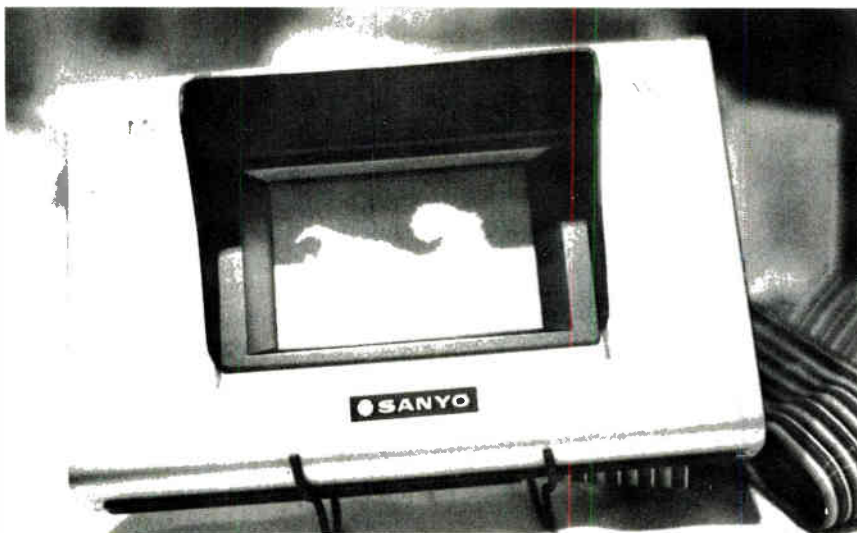

FIBER OPTICS VOCABULARY

The basic reference document on fiber optic and lightwave communications for those who design, develop, operate, use, manage, or manufacture communications or data processing equipment and components.

- 1400 entries, with
- inversions and cross-references
- index of terms

Order your copy today!

Electronics Magazine Books
P.O. Box 669, Hightstown, NJ 08520
Tel. 609/448-1700, ext. 5494



Send me _____ copies of *Fiber Optics and Lightwave Communications Vocabulary* @ \$12.95 plus applicable sales tax. McGraw-Hill pays regular shipping and handling charges on pre-paid orders.

Payment enclosed Bill firm Bill me
Ten-day money-back guarantee.

Name _____

Title _____

Company _____

Street _____

City _____ State _____ Zip _____

ELT

Memories

Removable cartridges inch up on disks

Innovative media schemes and positioning technologies appear as memories seek to back up or replace Winchester drives

by Tom Manuel, Computers & Peripherals Editor

Driving for denser and roomier removable-medium magnetic-storage devices as backups or alternatives to the rapidly proliferating 8-inch and 5¼-in. Winchester disk drives, manufacturers are inventing new media schemes or positioning technologies. In the spotlight at this month's National Computer Conference in Chicago were a 1-in. tape-cartridge, an 8-in. high-energy floppy-disk cartridge, a 5¼-in. Winchester disk cartridge, and a 3¼-in. floppy-disk cartridge.

Among the most interesting of these new products is the Alpha 10, a drive that stores 10 megabytes of formatted data on 8-in. flexible disk cartridges. Introduced by Iomega Corp. of Ogden, Utah, it uses a patented media-stabilization and read/write head technology, along with a track-following embedded servo-positioning system to pack 300

tracks/in. and 24,000 bits/in. on one side of an 8-in. high-energy floppy-disk cartridge from 3M Co. Average access time is 35 milliseconds.

The Iomega technology is a non-contact, flying technology—not unlike Winchester disk technology, which has the medium fly over the head instead of the reverse. Previously, all floppy-disk technologies involved head-to-medium contact.

The diskette spins close to a Bournoulli plate, where the balance of pressure and air flow stabilizes the disk into a flat, almost rigid, surface flying 0.08 in. above the plate. The read/write head, mounted on a rotary actuator, protrudes through a slot in the plate. The shape of the head and its mounting are designed to extend the Bournoulli flow in the vicinity of the head to make a close coupling of the head and medium, producing an air bearing between

the read/write gap and the disk of just under 10 microinches.

The repeatable stability of the very low-flying height is achieved aerodynamically. While the low-flying medium allows more bits per inch, a sectored servo pattern of 70 servo fields on each track provides the closed-loop servo system with the information to overcome the dimensional instability caused by temperature fluctuations. The result is a spacing that is 300 tracks/in.

Spare. The data is formatted into 306 tracks, each with 64 data sectors and the 70 servo fields. Each data sector holds two 256-Kbyte records. To overcome defects in the medium, the Alpha 10 has four spare tracks and five spare sectors on each track. One sector on each track is used for writing error-checking and -correction codes. The error-correction code can correct up to one complete sector of data. The ECC and spare sector/track scheme achieves a nonrecoverable error rate of less than 1 in 10^{12} —comparable to Winchester disk rates.

The Alpha 10 storage subsystem, which will be available in limited quantities for evaluation in August, with volume shipments beginning in October, consists of the drive, an integral controller based on large-scale integrated circuits and with a high-level intelligent host interface, and a disk cartridge. In quantities of 500, the drive will be priced at \$1,250; the controller, which can control up to four drives, at \$950; and the cartridges at \$39.50 each.

Another unique media scheme is used by Pragma Data Systems Inc. of Sunnyvale, Calif., in its model 2000 direct-access tape-cartridge

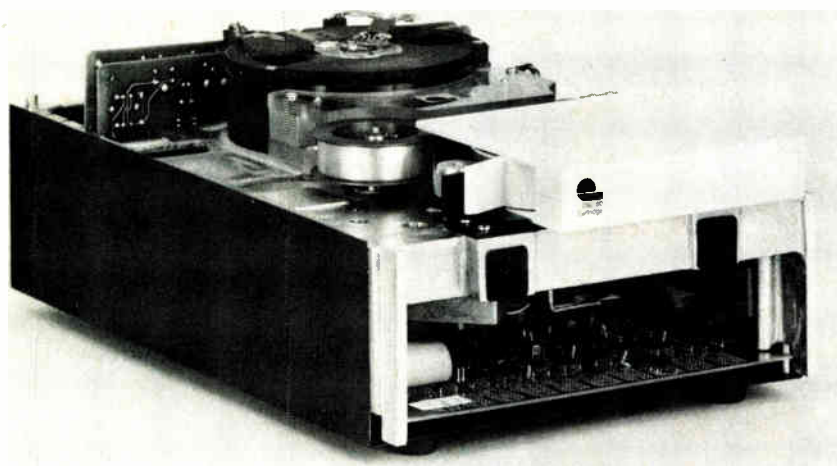

Lid off. Under the hood of PerSci's floppy-disk drive is a track-following embedded servo mechanism that increases density to 150 tracks/inch. The usual figure is 48.

You're On The Right Track with CEC/Bell & Howell Recorders

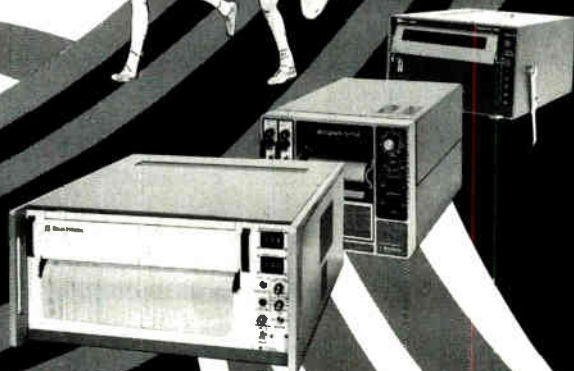

CEC/Bell & Howell manufactures a complete line of DATAGRAPH® recorders for the commercial, industrial, scientific or military specialist . . . one who demands the finest quality, the last word in technology, and a name he can trust.

Our all-new HR2000 Datagraph is the world's first *all solid state* recorder. It contains a unique programmable light gate array, which produces unexcelled linearity on direct print photo sensitive papers ranging in size from 3 5/8" to 12" in width. Up to 28 channels of signal inputs are provided for maximum flexibility.

Other models are engineered to meet a wide spectrum of requirements in channel capability, frequency response, paper width, price and portability.

Ask us for Datagraph details. Compare. You'll find you're on the right track!

CEC DIVISION

360-Sierra Madre Villa, Pasadena, California 91109



BELL & HOWELL

CEC is a registered trademark of Bell & Howell

Circle 107 on reader service card

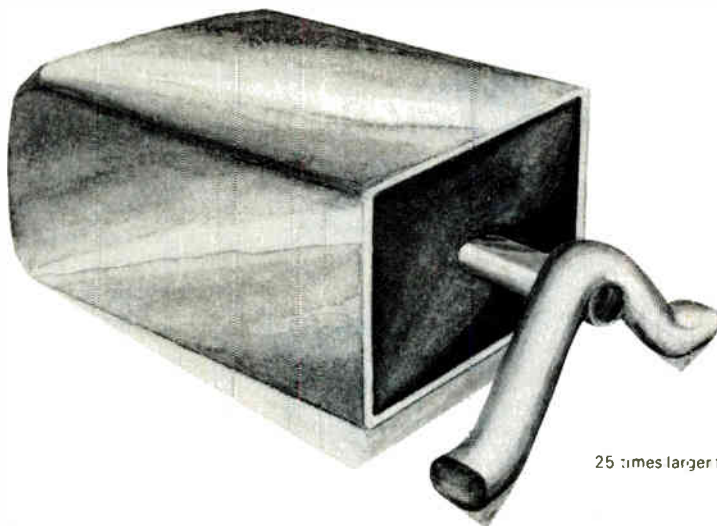

25 times larger than life

A great capacity for punishment

Designed to meet the requirements of the hybrid circuit manufacturer, the Tansitor chip tantalum capacitor is completely encapsulated in a metal case and is able to withstand handling and reflow solder-

ing at high temperature. This chip can be mechanically orientated and is consistent in size. Available in 6 sizes, with a capacitance range of 0.1 to 220 mfd; 2 to 50 Volt. Write or 'phone for further data.

Tansitor solid tantalum chips

Tansitor Electronics, Inc.
West Road, P.O. Box 230, Bennington,
Vermont 05201 Phone: (802) 442-5473
TWX: (710) 360-1782
Tansitor - reliable in so many ways

Probing the news

drive. The 2000 stores 80 megabytes of formatted data on a 1/2-in. magnetic-tape cartridge, the first to use 1/2-in. tape. The cartridge tape format is 615 blocks, each containing 131-K bytes. Data reading and writing are done on each block, while the tape is held still, by two diametrically opposed heads on a servo-con-

trolled rotating drum scanner. The heads are offset by 16 tracks; as the scanner is moved longitudinally along the block of tape, two tracks are accessed.

The scanner can be positioned transversely across the tape in 16 track positions, for a total of 32 tracks, with each track within a block storing 4,096 bytes. Track switching is done in 9.4 ms, average latency (within a block) is 10 ms,

and the time required to switch blocks is 250 ms. To its host computer system, the model 2000 appears to be a 32-head disk with 615 cylinders, where each cylinder contains 131-K bytes and has access characteristics that are similar to those of a Winchester disk. In quantity, the 2000 will cost about \$2,000.

Choice trio. Three other removable-media storage products shown at the NCC offer unique choices for the system designer. For example, PerSci Inc. of West Los Angeles, Calif., announced a floppy-disk drive that uses a track-following embedded servo mechanism to increase density to 150 tracks/in. (the usual figure is 48), providing an unformatted data capacity of 8.4 megabytes on both sides of two 8-in. diskettes. The model 899 uses completely standard media.

In addition, Sony Data Products division of Sony Corp. of America, Paramus, N. J., showed its 3.5-in. microfloppy-disk drive, which can store 218.8-K bytes (single density, unformatted) and 437.5-K bytes (double density, unformatted) on 3.5-in. floppy disks mounted in rigid plastic cartridges.

A removable 5 1/4-in. Winchester disk cartridge also entered the market at the Chicago show. New World Computer Co., Costa Mesa, Calif., continuing its development of high-speed multiple-head small Winchester disk drives, brought out the Mikro-Disc 5, a 5 1/4-in. model with both fixed and removable Winchester disk cartridges. Each removable cartridge contains a proprietary low-mass multihead assembly, a digital linear positioner that raises the heads when powered down, and the disk in a sealed cartridge. The cartridges can be either an 8-head model, which writes on one side of the disk and stores 2 megabytes of unformatted data, or a model with 16 heads that stores 4 megabytes on both sides. In quantities of 500, the cartridges will cost \$300 for the smaller and \$500 for the larger capacity unit. The drive is available in five models: from the 2/0, with just 2 megabytes of fixed storage, to the 4/4, with 4 megabytes of fixed capacity and 4 megabytes of removable storage. The prices in lots of 500 range from \$496 to \$1,196. □

Get your Green Book now—free.

Valuable discount coupons worth \$3000 toward the purchase, lease or rental of scopes, recorders, meters and more.

Without it your next test equipment acquisition could cost you more than it should. Lots more.

USIR can provide

you with any test instruments you need. With service nobody can beat ... And now the Green Book saves you thousands of dollars!

You get it all from USIR: top brands, nationwide service, guaranteed delivery, and flexible financing. Including our new Extended Term Rental program

that combines the convenience of renting with the lower rates of leasing.

Send the coupon today and get the best possible deal on test equipment. From USIR.

United States Instrument Rentals, Inc.



A U.S. Leasing Company

Save up to \$3,000 this year on test instruments.

Don't buy, rent or lease any test equipment without the USIR Green Book.



O.K. USIR, send me your free Green Book, with \$3000 worth of discount coupons.

Name _____

Title _____

Company _____

M.S. _____

Phone _____

Street _____

City/State/Zip _____

USIR, 2988 Campus Drive, San Mateo, CA 94403,
(415) 572-6600.

ELEC 5/19/81

Compare CalComp Graphics COM for better price/performance.

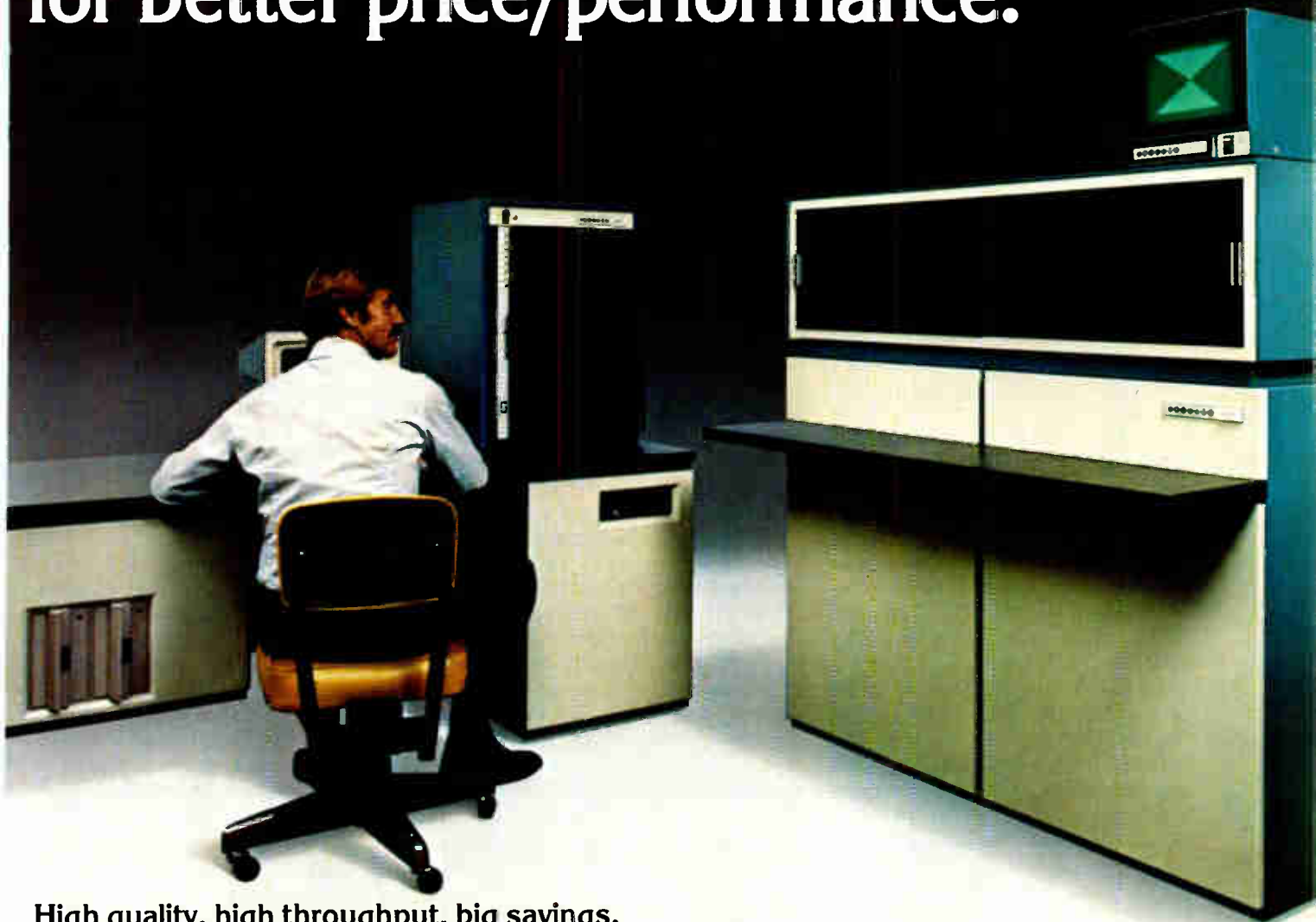

High quality, high throughput, big savings.

The performance of CalComp graphics COM measures up to the rest...for less. Compare our 80 lines/millimeter resolution, 16K x 16K addressable point matrix and 400,000 increments per second plotting speed. You get the high quality and high throughput you want at a price that can save you \$50,000 or more.

Whether your application is producing aperture cards, roll film or microfiche, CalComp graphics COM systems can meet your needs.

Plus features that are CalComp's alone.

Compare cameras. The CalComp Universal Camera saves you time and money. Our single camera can accommodate 16mm, 35mm and 105mm film. Prefocused lenses and universal film canisters allow you to change formats in minutes without lengthy set-up procedures.

Ease of operation can mean increased productivity for you. CalComp controller software performs extensive error checking before each job starts to assure the correct size film, lens and other operator-dependent set-ups correspond to job parameters.

Operator error is virtually eliminated so you save time and money by significantly reducing job re-runs.

CalComp compatibility with most systems.

CalComp graphics COM can be interfaced easily into your graphics operations. Data input is via magnetic tape—the same compact data format used by our pen plotters. And to facilitate conversion to CalComp COM, simulators are available to process Stromberg-DatagraphiX® SC4020 and SC4060 format tapes.

CalComp service...compares to no other.

With our unique one year warranty on parts and labor—plus the largest team of systems analysts and field service engineers in the industry—you know you're assured of prompt, quality product support.

Compare CalComp graphics COM with the rest. Learn how CalComp can give you quality, in-house graphics COM and increased productivity at significant cost savings. Contact your nearest CalComp sales office, or write: California Computer Products, Inc., 2411 West La Palma Avenue, Anaheim, CA 92801

CALCOMP
A Sanders Graphics Company
SANDERS

2411 West La Palma Avenue, Anaheim, CA 92801
(714) 821-2011 TWX 910-591-1154

Companies

Millennium goes on the offensive

Hit by loss of its biggest customer, maker of development systems goes to market with its own line

by Richard W. Comerford, Test, Measurement & Control Editor

What does a manufacturer of microprocessor development systems do when the customer that accounts for about 80% of sales decides to make its own? The answer for Millennium Systems Inc. is to hit the market with a new line.

The dilemma arose when the customer, Tektronix Inc., felt that it would have to build its own system [*Electronics*, Sept. 25, 1980, p. 33] to bring digital technology in house rather than depend on an outside supplier. That decision came after Millennium, which is in Cupertino, Calif., had been supplying the 8001/8002 Microprocessor Development Lab to be sold under the name of the big instrument maker from Beaverton, Ore., since 1977. The industry's knee-jerk reaction was, understandably, that for Millennium the day of judgment was at hand.

Yet when the agreement between the two companies formally expired on April 1, there was Millennium off and running on its own with a new development system series [*Electronics*, April 7, p. 178]. So far, the company has brought out two products in the line it calls 9500, a designation based on the Tektronix label for its new family: 8500.

One of the new products is the 9508, a stand-alone emulator for 8-bit machines such as the 8085 and 6800 types, among others. Designed for use with the other new machine, the 9520 software-development station, the 9508 does all the debugging, leaving the 9520 free to focus on such tasks as text editing, assembly, compilation, and simulation. And since the 9520 is a multitasking system, two persons can use it simultaneously—while one debugs a hard-

ware prototype, the other can be writing software. This brings the system cost down to about \$7,000 per user, well below the all-important \$10,000 level, plus the cost of the video display terminal.

Thought process. The conception and targeting of the 9500s represent some clear thinking under pressure by Millennium. In 1979, because of its association with Tektronix, the company found itself with an impressive base of development-system know-how. And though that union ended with Millennium entitled to use any emulator designs and cross assemblers developed by either firm through 1980—providing Millennium with an excellent support-software foundation—it left the California firm without a marketing presence in development systems.

But the situation was not totally

Family tree. Millennium's 9500 development system series takes advantage of the company's know-how gained from making such systems for Tektronix starting in 1977. The blocks in color above indicate products that will be introduced within a year.

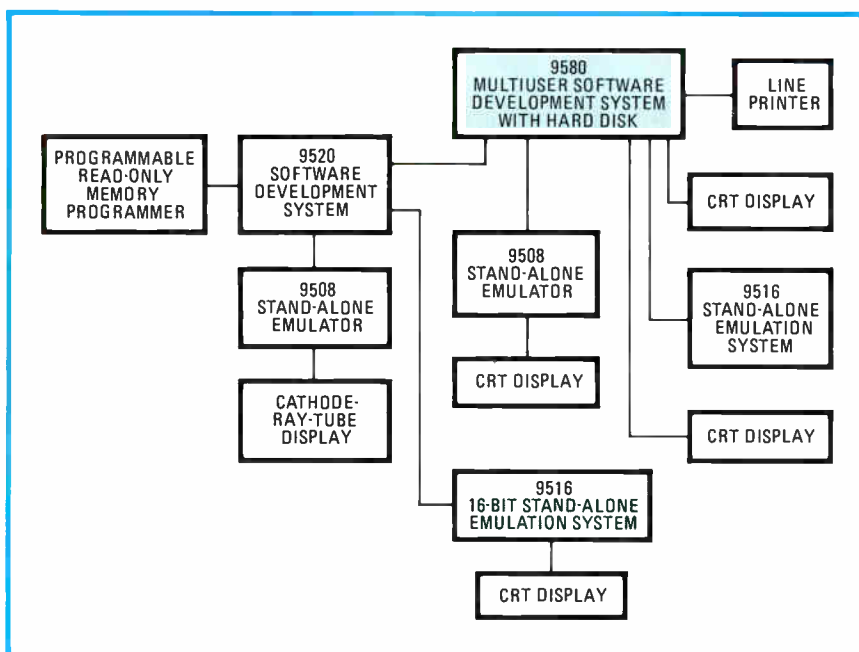

Logic Analysis System

The *PI-540* packs virtually every measurement function you'll need in a single, easy-to-use instrument.



Advanced Data Section

Up to 40 channels. Display data in hex, octal, decimal, binary and ASCII. Includes powerful qualification features, branch analysis, and 16 levels of triggering.



Disassembly Section

Dedicated μP probes with disassembly simplify software development tasks. *PI-540* can accommodate 3 resident disassemblers.

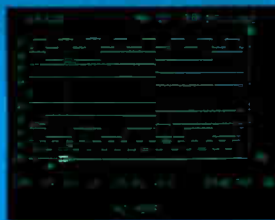

50 MHz Timing Section

Independent, 8-channel, 1000-word timing analyzer with 5 ns glitch capture. Also provides 5 state display formats.



Performance Monitoring

100 MHz counter/timer measures hardware and software execution times. Includes industry standard signature analyzer.

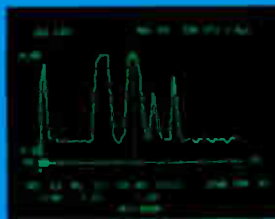

Waveform Recording Section

50 MHz and 1000 samples. Waveform can be linked to other analysis sections for tracing analog and digital interactions.



RS-232 Serial Testing

Model 70 probe converts *PI-540* into powerful serial communications analyzer. Receive, edit, and transmit messages at rates up to 19.2 K b.

Want a closer look? Call 800-538-9713 (outside California) or 408-263-2252. TWX: 910-338-0201

PARATRONICS INC.
2140 Bering Drive San Jose, California 95131
Leading the Way in Analysis Technology



The *PI-540* resides in the expandable System 5000 mainframe. RS-232 and IEEE-488 interfaces are available.

For additional information 180

For a demonstration: 274

Electrostatic discharges

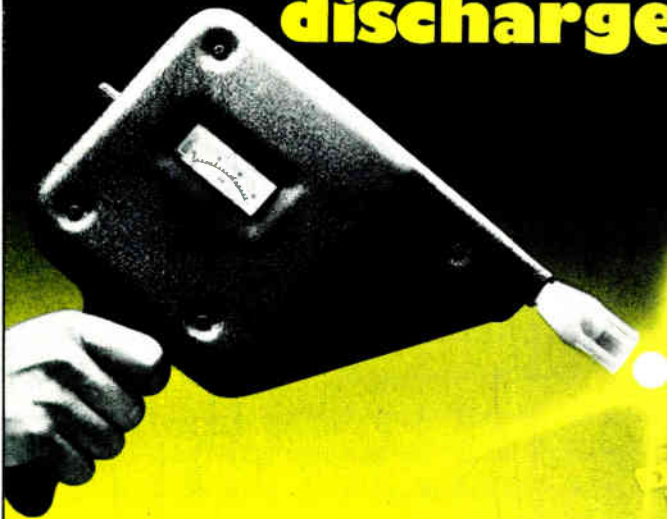

may cause malfunctioning and damage to computers, microprocessors, digital circuits, controllers and many other electronic devices. Testing with NSG 430 will insure that your equipment will be immune and still properly operating.

NSG 430 features:

- adjustable discharge voltage from 2–16.5 kV
- single shot and repetitive operation
- test according to latest standards
- high reliability and reproducible testing
- adjustable discharge distance

SCHAFFNER AG
CH-4708 Luterbach
Switzerland
Tel. 065 42 31 31/Telex 34491

SCHAFFNER EMC Inc.
377 Route 17
Hasbrouck Heights
New Jersey 07604
Tel. (201) 288-6860/Telex 134247

Trust the professionals

SCHAFFNER

Circle 112 on reader service card

The magazine you're reading now could be your own.

Drop off the routing list. Get your own fresh, unclipped copy mailed to your home or office. Turn to the subscription card in the back of the magazine. If somebody has beat you to it, write: Electronics, P.O. Box 430, Hightstown, N.J. 08520.

bleak. Millennium had, under its own name, built an extensive sales base as it carved out a reputation with its Microsystem Emulator. So it had not only a foot in the door with owners of those systems, but a body of real knowledge of debugging as well as of how to get a system from design to production.

As Dave West, business director for laboratory products, puts it, this represents a "flanking maneuver" for his company. "It gives us a path back into the laboratory through the add-on in-circuit emulation that can be used both with our own development system and with other currently available development systems."

Way to go. The separation of hardware debugging from software development in the 9500s also gives the user an economical path, a circumstance that is not lost on Millennium's marketers.

Item: In time for Wescon (to be held Sept. 15–17 in San Francisco), the company plans to have available the 9516, a stand-alone emulation system that will tie into the 9520 via an IEEE-488 port. Not only will that station support 16-bit processors such as the 68000, but it will also run the 9508's 8-bit emulators.

Item: With the 9520 already supporting two users, a large multiuser software-development system, the 9580, is being put together. It will work with hard disks to provide archival storage at a central point, and it will have a Unix-based operating system. The 9520 and 9580 will communicate over a high-speed link, an RS-422, for fast up- and downloading. Millennium now offers a C compiler as well as a Pascal compiler for its 9520.

Good directions. Thus, the company is chugging along on two tracks. As West sees it, Millennium is on a direct path back into development systems, a direction in which it was headed before it started making the systems for Tektronix. It is also taking a new approach with its add-on emulators for the end user. "In each case," says West, "we've leveraging our capabilities in in-circuit emulation and debug to give us a strong position in the 1980s." □

NATIONAL ANTHEM[®]

SEMICONDUCTOR NEWS FROM THE PRACTICAL WIZARDS OF SILICON VALLEY.

Where Data Acquisition technology is going.

NATIONAL'S BROAD LINE OF DEVICES LEADS IN PRICE/PERFORMANCE AND EASE OF USE.

The industry's most popular 8-bit A/Ds

The complete Data Conversion/Acquisition library

Practical analog I/O boards

More free literature from the National Archives

Get 12-bit DACs for less

Digitally programmable gain amps

Low-cost references for 12-bit systems

SPECIAL DATA CONVERSION/ACQUISITION ISSUE

Low-cost A/D solutions to Data Acquisition problems.

National's line of 8-bit A/D converters offer the best price/performance in the industry.

A lot of people in the semiconductor industry sell low-cost 8-bit A/D converters. But National was the first to offer the ADC0808, ADC0809, ADC0816 and ADC0817—a whole series of self-contained 8-bit A/Ds that combine superior performance and low unit cost. This combination has worked so well,

in fact, that two other suppliers have already second-sourced this industry standard series.

A/Ds that feature:

- $\pm 1/2$ LSB and ± 1 LSB total unadjusted error (max). This error term includes full scale and zero scale errors as well as the linearity error with no adjustment required. They are also guaranteed to have no missing codes.

- μ P compatibility, including latched TTL TRI-STATE® outputs and a multiplexer with latched control logic.
- 100 μ sec conversion time.
- 0V to 5V analog input range with a single 5V supply.
- 15mW power consumption.

Worlds ahead in Data Conversion/Acquisition technology.

National Semiconductor, the Practical Wizards of Silicon Valley, is the world's largest supplier of Data Conversion/Acquisition components. Over the last year, for example, they shipped over 5 million A/Ds—more than anyone else in the industry.

The key to their lead over the rest of the pack is their high volume production capabilities and extensively broad line, and their commitment to high performance at a low cost. With all of their transducers, amplifiers, filters, MUXs, sample and hold circuits, references, A/Ds and D/As, there's a National part

for every application.

In addition, they're the only supplier utilizing technologies of bipolar, CMOS, NMOS and hybrid along with thin-film resistors and laser trim.

This is just a glimpse into what they're up to—designing high technologies into practical high performance data acquisition components.

National, the dedicated leader in Data Conversion/Acquisition technology and components.

High performance means high versatility. The sum total of these and other performance features designed into these A/Ds comes down to ease and versatility of use.

Consider some of the interesting design ideas that the practical Wizards have come up with for their high performance A/Ds.

Analog Self-Testing. More and more digital systems perform a self-test. To take this concept one step further, National's 8-bit A/D converters can be used to encode the analog voltages in a system—power supply voltages, comparator set points, reference voltages, etc.

This way, the microprocessor can ensure that all of the components are operating properly.

A μ P-Compatible Comparator. At \$.45* per channel in 100 unit quantities, the ADC0809s serve ideally as cost-effective μ P-compatible comparators or even digital data acquisition components. Digital inputs can be connected to a channel to eliminate both an I/O port and the associated logic necessary to interface to a microprocessor.

The diagrams shown below illustrate two more ways to use these highly versatile components.

How to get a free sample. National Semiconductor, the leader in innovative, cost-effective Data Conversion/Acquisition products, now offers the best price/performance of any A/D available. In 100-piece lots, the ADC0809 (with 8-channel multiplexer) costs only \$3.60* and the ADC0817 (with 16-channel multiplexer) is a low \$7.95*

To receive a free sample of the popular ADC0809—plus data sheets, application notes and other useful information—simply check boxes 051 and 200 on this issue's National Archives coupon. Your business card or company letterhead must accompany a request for the sample to ensure delivery.

Once again, Practical Wizardry puts National way ahead of the rest of the industry.

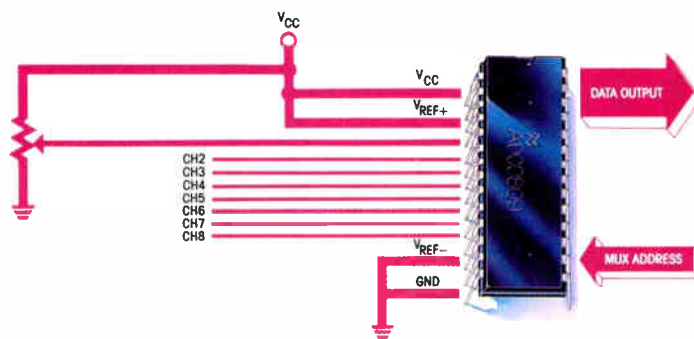

LOW-COST RATIOMETRIC A/D CONVERSION. NO ZERO OR FULL SCALE ADJUST IS REQUIRED. THESE ERROR TERMS ARE INCLUDED IN THE TOTAL ACCURACY SPECIFICATIONS.

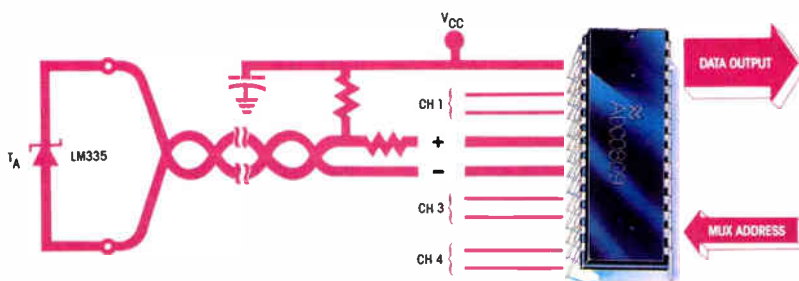

TEMPERATURE SENSING. THE COMBINATION OF THE LM335 AND THE A/D DIGITIZES TEMPERATURES EASILY AND ACCURATELY. 4-CHANNEL DIFFERENTIAL OPERATION IS CONTROLLED BY SOFTWARE.

*Prices shown are U.S. prices only. TRI-STATE is a registered trademark of National Semiconductor Corporation.

Low-cost precision references for 12-bit systems.

National Semiconductor, the leader in linear technology, is offering their LH0070 and LH0071 buffered voltage references to designers of precision 12-bit D/A and A/D systems.

The LH0070 has a 10.000V nominal output for BCD applications. The LH0071 provides a stable 10.240V reference for binary applications. These low-cost, totally self-

contained components also feature:

- 12.5V to 40V input voltage range
- $\pm 0.05\%$ output accuracy ($T_A = 25^\circ\text{C}$)
- $\pm 0.05\%$ /year long term stability
- $\pm 0.04\%$ output voltage change with temperature
- -55°C to $+125^\circ\text{C}$ operating temperature range
- $20\mu\text{V}$ peak-to-peak output noise voltage.

Both of these precision references are actively laser trimmed using ultra-stable thin film resistors. In fact, National actually guarantees the long term stability of the LH0070 and LH0071 for one full year.

Check box 071 on this issue's coupon for complete LH0070/71 information. 

Get Data Conversion/Acquisition input.



National's Data Conversion/Acquisition Data Book is a complete 958-page single-volume library of technical data and application information on the industry's broadest line of Data Conversion/Acquisition components and systems.

And each and every one of them combines state-of-the-art performance features in easy-to-use devices.

This \$7.00* product reference includes

National's standard-bearing A/D and D/A converters, analog-to-digital displays, voltage references, analog switches/multiplexers, S&H circuits, amps, resistor arrays, active filters, successive approximation registers and board-level systems.

To get a copy, check box 051 on the National Archives coupon. No technical library is complete without it. 

*U.S. price only

LH0084-The logical choice in instrumentation amps.

The LH0084 programmable gain instrumentation amps were designed specifically for data acquisition systems where settling time and input impedance are critical to the systems' integrity. As a result, the LH0084s settle to 0.1% in only $4\mu\text{sec}$ or less and offer 500pA input bias current and a typical input

impedance of $10^{11}\Omega$.

Gains for the LH0084 are set internally in two stages. The first stage is software programmable in highly accurate gain steps of 1, 2, 5, or 10. This stage, controlled by a 2-bit TTL-level input word, allows software to set gains dynamically within the system.

For additional flexibility, the second stage can be pin-strapped to gains of 1, 4, or 10. So it's easy to see why the LH0084 is truly the logical choice when it comes to instrumentation amps.

Check box number 032 on the coupon for complete information. 

Board level practicality for process control.

The BLC-8737—the quick and easy link between analog and digital.

National's MULTIBUS™ compatible BLC-8737 I/O board handles the complete analog conversion and scanning control for a data acquisition system. All data is converted with 12-bit resolution and a high $\pm 0.05\%$ accuracy.

Thanks to the BLC-8737's simplicity, the system software need only tell the board what gains it wants for each of the input channels: 16 single-ended (8 differential) that are easily expandable to 32 single-ended (16 differential).

And with two analog output channels available, the BLC-8737 serves as an ideal central supervisor for complex process control systems.

That's impressive capability for such an easy-to-use board.

For more information, check box 001 on this issue's coupon. 

MULTIBUS is a trademark of Intel Corporation.



The BLC-8715's onboard intelligence smooths out process control.

The BLC-8715 Analog Input Board was specifically designed for industrial data acquisition and process control systems. This new μP -based interface offloads all of the analog data pre-processing functions normally performed by the host CPU.

Based on National's proven BiFET™ technology, the 8-bit BLC-8715 performs highly accurate A/D conversion in a scant $8\mu\text{sec}$.

The BLC-8715 takes care of "front end" measurement and control functions for 16 analog processes plus 22 TTL-compatible functions.

Check box number 039 on this issue's coupon for additional information on the Practical Wizards' intelligent control board. 

BiFET is a trademark of National Semiconductor Corporation

10- and 12-bit CMOS DACs from National. Get the best for less.

National's DAC1218 12-bit binary multiplying D/A converters offer better performance than the AD7541 Series at about half the price.

The Practical Wizard's 10- and 12-bit CMOS DACs offer pin-compatibility plus significantly improved performance features over those of the nearest competition. Yet they cost up to 50% less.

Their DAC1218, for example, features both $\pm 1/2$ LSB linearity and monotonicity that are guaranteed across the entire temperature range. And so is its differential non-linearity ($\pm 1/2$ LSB max), making it a superior choice for closed loop systems.

But National's performance advantages don't stop there.

Rather than take the impractical "Best Straight Line" approach to linearity, the DAC1218 uses the "End Point" approach.

So instead of wasting valuable time fiddling with adjustments to obtain the specified linearity, all that's required with the DAC1218 is to set the zero and full-scale adjustments and the linearity spec is met automatically.

And to make adjustment even easier, the DAC1218's unadjusted gain error is guaranteed to -0.2% to 0.0% of full-scale.

Also, their unique digital input circuitry maintains TTL-compatible (1.4V) input

threshold voltages over the full 5V—15V operating supply voltage range.

For complete details on the DAC1218 and all of National's superior 10- and 12-bit DACs, check box 072 on the coupon below.

And get the best for less from the Practical Wizards of Silicon Valley.

DAC SUPERIOR REPLACEMENTS

AD7520	DAC1020
AD7521	DAC1220
AD7530	DAC1020
AD7531	DAC1220
AD7533	DAC1020
AD7541	DAC1218

Data Acquisition - A National perspective.

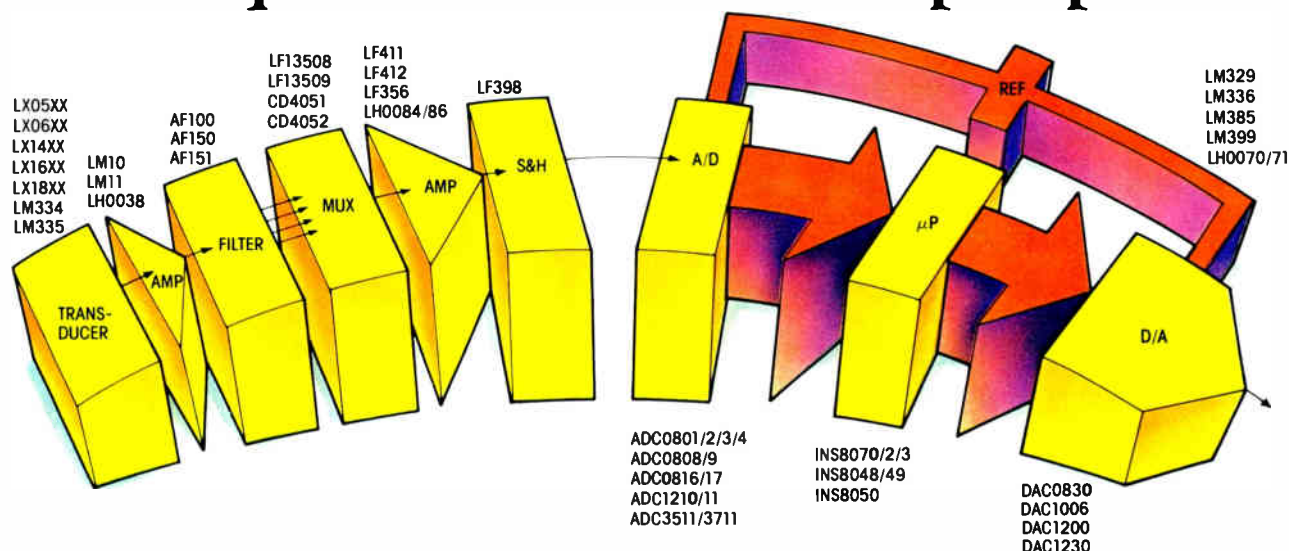

What's new from the National Archives?

- 001 BLC8737 Data Sheet
- 032 LH0084 Data Sheet
- 039 BLC8715 Data Sheet
- 051 Data Conversion/Acquisition Data Book (\$7.00)
- 071 LH0070/71 Data Sheets

- 072 CMOS DAC Data Sheets
- 073 Data Conversion/Acquisition Brochure
- 200 Free ADC0809 Sample (enclose your business card or letterhead to ensure delivery)

For desired information, mail coupon to:
National Semiconductor Corporation
2900 Semiconductor Drive
Mail Stop 16251
Santa Clara, CA 95051

Enclose check or money order based upon appropriate currency. Make checks payable to National Semiconductor. All prices shown are U.S. prices only. Add applicable state and local sales tax to your order. Allow 4-6 weeks for delivery. This coupon expires on September 30, 1981

In Europe, mail coupon to:
National Semiconductor GmbH
Industriestrasse 10
D-8080 Fürstfeldbruck
West Germany

NAME _____
TITLE _____ PHONE _____
COMPANY _____
ADDRESS _____
CITY _____ STATE _____ ZIP _____

 **National Semiconductor**
The Practical Wizards
of Silicon Valley

DAC 1

POSITIVE SPRAY DEVELOPING HAS JUST BEEN PERFECTED. AND HERE'S PROOF POSITIVE.

GCA has eliminated the negatives of positive spray developing with the Wafertrac™ Model 9110 Positive Spray Develop Module.

In fact, it produces exceptionally fine lines in a production environment with ± 0.05 micrometer uniformity across an entire 100mm wafer.

It's also the first positive spray develop module to offer high throughput because it's completely automated.

But most importantly, the Model 9110 eliminates all the previous drawbacks of positive spray developing, including floating crystals, salt buildup, misting, condensate drip, and temperature variations caused by the equipment.

As part of the total GCA Wafertrac wafer processing system, the Model 9110 makes it easy to maintain highly accurate control over your complete develop process. You'll also appreciate the fact that it can be quickly field retrofitted to any Wafertrac system ever built.

If you'd like more proof on how to perfect your wafer processing operation, send for our new Positive Develop application notes. Write: GCA Corporation, California Operations, 3570 Ryder Street, Santa Clara, CA 95050, (408) 743-6750. GCA is represented in the Far East by Sumisho Electronic Systems, Inc., Tokyo. Tel: 03-234-6211 and in Europe by GCA International, Circle 117 on reader service card

Kreuzlingen, Switzerland, Tel: 41-072-71-1585.

1. The high yield Wafertrac™ is a completely automatic, microprocessor-controlled wafer processing system. It gives you total process control, and its modularity lets you design your own system. It can perform a variety of wafer processes simultaneously.

2. Our Wafertrac™ Positive Develop Module incorporates low pressure spray nozzles and an open bowl design which eliminates many former limitations of positive spray develop.

3. 1.0µm to 2.0µm lines and spaces cleared by Positive Develop Process (1000x).

4. 1.5µm lines and spaces (10,000x).



GCA CORPORATION
IC Systems Group
Wafertrac Products

217 Humboldt Court
Sunnyvale, CA 94086
(408) 743-6700
TWX: 910-339-9211

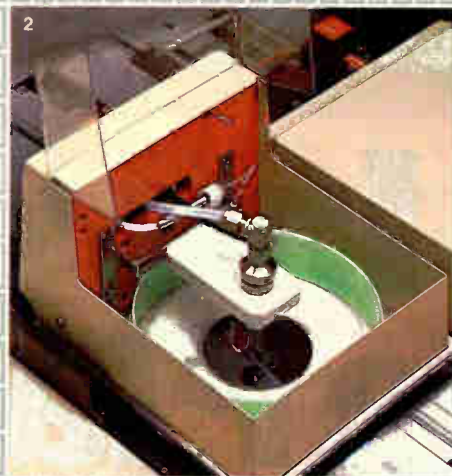
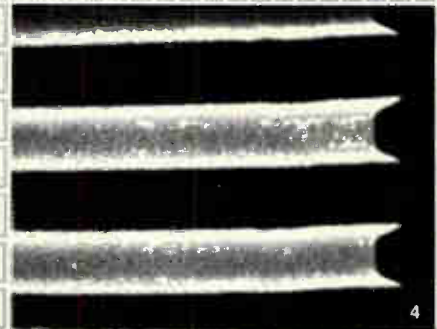
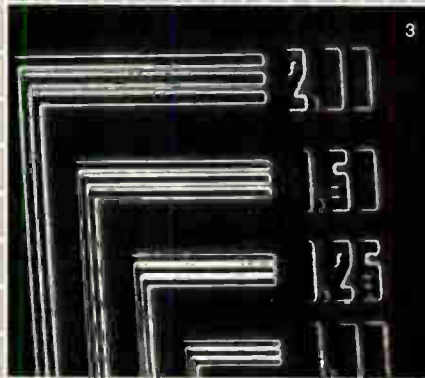
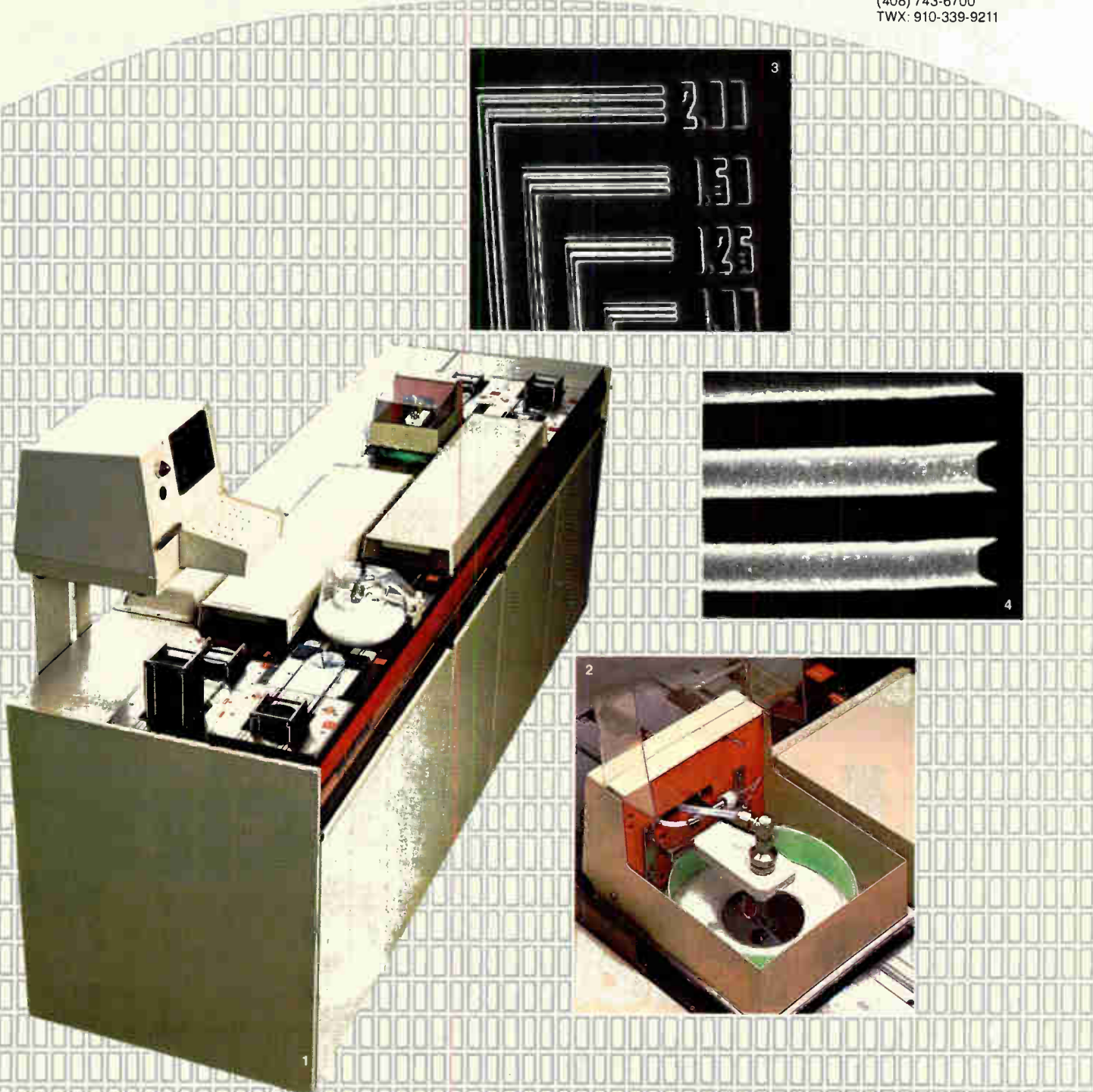



**The future
belongs to those who
reach for it fastest.**

To own the future, you must reach for it now.

Your company must find better ways to do what you're doing today to assure its survival. And you must find the best ways to do things tomorrow to assure its success.

With the aid of a Calma computer-aided design and manufacturing system, all manner of ways

to advance your firm are made possible.

Ways that will improve quality. Cut costs. Eliminate errors. Speed throughput. Boost productivity three times, eight times, even as much as 30 times.

That's why all kinds of manufacturing concerns throughout the world are using Calma computer-aided design and manufacturing

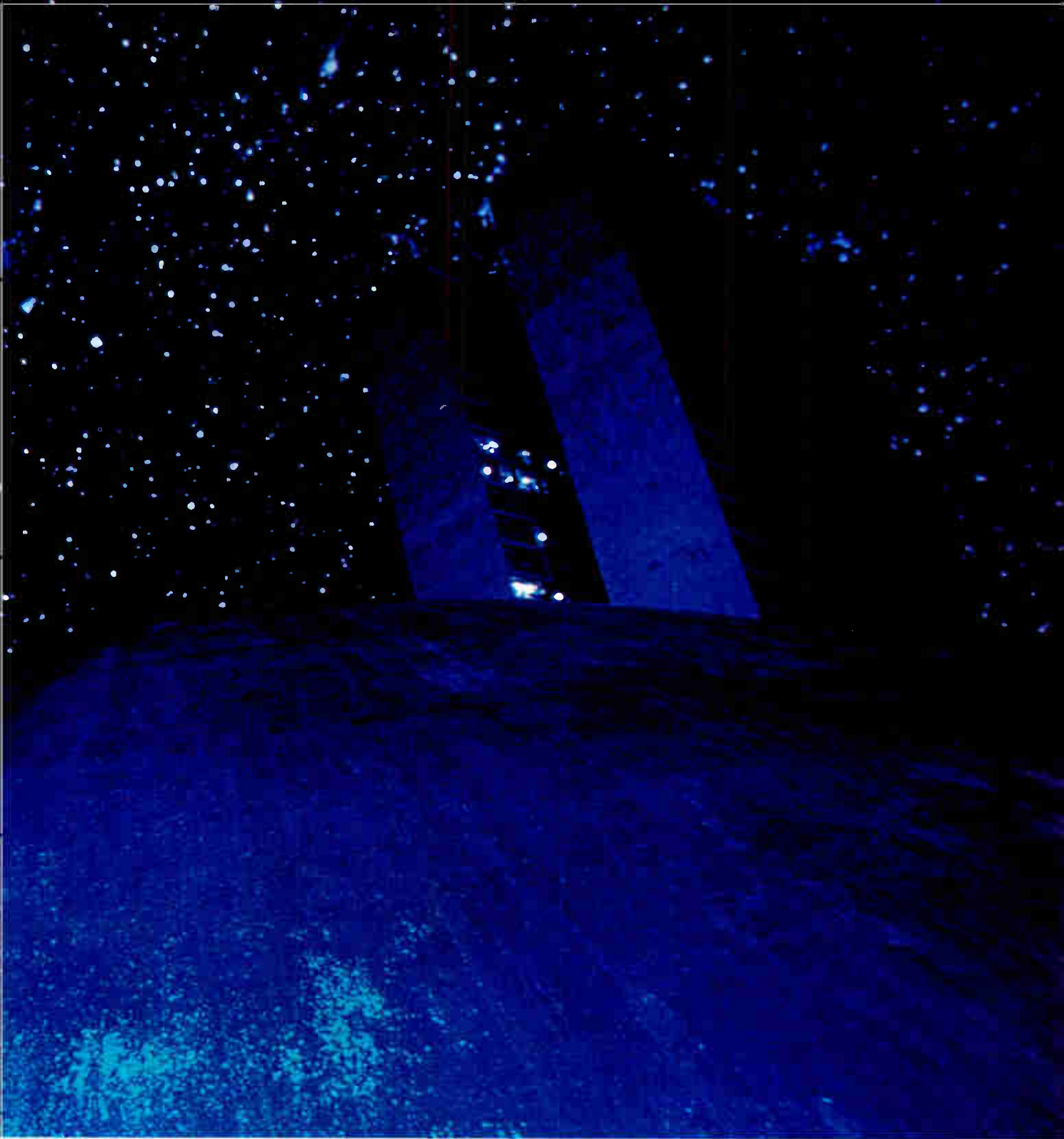

systems: to make significant advances in what they're making.

We're one of the leading suppliers of CAD/CAM systems. And we are the recognized technology leader, for we make the most advanced CAD/CAM systems available today.

We're committed to making even better CAD/CAM systems for the future.

As a General Electric company, we're the supplier with the strength and resources to do it, to assure the advances in technology and continuing service and support you need now, and must have tomorrow.

The future is there for the making. A Calma system could help make it yours. Please contact us, so we may show you how.



CALMA

Circle 121 on reader service card

World Radio History

For more information or an 11 x 14 print of this Pete Turner photograph, write or call us at 5155 Old Ironsides Drive, Santa Clara, CA 95050. (408) 727-0121.

“Fast A-D Conversion With 12-Bit Accuracy” That’s PMI’s Message About Its Incomparable Comparator, the CMP-05



© PMI 1981

“Another sandwich!” said the King.

“There’s nothing but hay left now,” the Messenger said, peeping into his bag.

“Hay, then,” the King murmured in a faint whisper. “There’s nothing like eating hay when you’re faint,” he told Alice.

“I should think throwing cold water over you would be better,” Alice suggested.

“I didn’t say there was nothing *better*,” the King replied. “I said there was nothing *like* it!”

In Linear Wonderland, many manufacturers are

always quick to let you know there is nothing *like* their product on the market, which often is fortunate for the customers since the product isn’t worth doing once, let alone twice. But in saying there is nothing *like* it, they hope you’ll think that means there is nothing *better* on the market.

PMI’s Messenger, the busiest little bunny in the Valley, has a real double whammy to deliver about PMI’s newest high-precision product: the CMP-05, a voltage comparator that is truly incomparable because it provides for the first time, the high accuracy, low

drift, and speedy response time needed for full 12-bit analog-to-digital conversion in the microsecond region.

This time PMI can say with certainty, there is nothing *like* it on the market and there is also nothing *better* on the market.

If you've been designing A-D converters, where you require 12-bit resolution you're already aware of the problems the CMP-05 can solve. Simply stated, the fastest way to obtain that performance is with a three-IC approach, with a DAC, a successive-approximation register, and a comparator. While there are 12-bit DACs available that can offer 200 or 250ns settling time to 1/2 LSB, the problem has been in the **comparators** trying to sort 12 bits at those speeds with sufficient accuracy. About the only way you can accomplish it is by externally nulling V_{OS} , which almost always causes further problems with V_{OS} tempco. The CMP-05 eliminates this problem.

Of course, if all you want is raw speed, fast comparators **are** available. Problem is, they are so fast they do sloppy work! None of them will convert to better than 9-bit accuracy.

If that doesn't put the message across, study the superb specs for the CMP-05, truly a high-speed precision comparator with latch circuit. It gives you low offset voltage (100 μ V), and speedy response (35ns with 5mV overdrive and 48ns with only 1.2mV overdrive). Moreover, in successive-approximation converters making 12 bits from a full-scale step input of 4mA at 10V, the total error contributed by the CMP-05 is typically less than 0.1 LSB and invariably less than 0.22 LSB.

You can truly have the CMP-05 however you want it, in a TO-99 or 8-pin hermetic minidip package, or in die form if you prefer. And from PMI you can also get all the other components you need to utilize it in any system design requiring high speed and excellent low-level analog signal resolution. That includes such applications as zero crossing detectors, logic threshold detectors and fiber-optics receivers, as well as in 12-bit successive approximation A-D converters.

If you're beginning to get the message now, just fill out the coupon and our Linear Wonderland Messenger will rush you a sample that will prove what we say is true. There is nothing *like* the CMP-05, and there is nothing *better* than the CMP-05.

If someone beat you to the coupon, write to us or circle #200 for literature.



Precision Monolithics, Incorporated

1500 Space Park Drive
Santa Clara, California 95050

(408) 246-9222 TWX: 910-338-0218 Cable: MONO

In Europe contact:

Precision Monolithics, Incorporated

c/o BOURNS AG

ZUGERSTRASSE 74, 6340 Baar, Switzerland

Phone: 042/33 33 33 Telex 78722

COMPARATOR SPEED VS ACCURACY (COMPETITIVE EVALUATION)

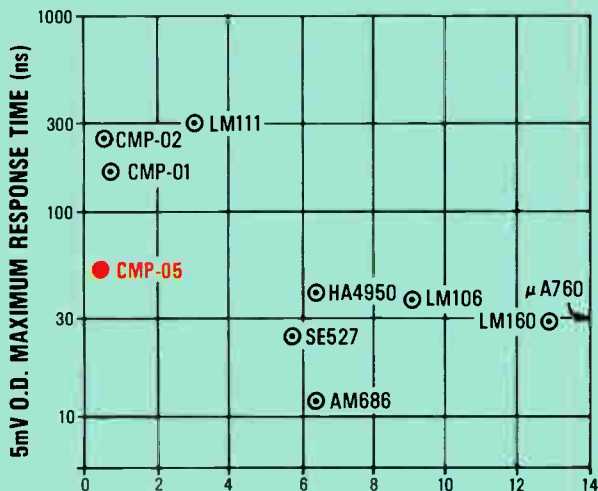

Please have your Linear Wonderland Messenger rush me a sample, proving that what you say is true.

CMP-05 Literature

Mail to: **Precision Monolithics, Inc.** 1525 Comstock Avenue,
Santa Clara, CA 95050

or **Precision Monolithics, Inc.** c/o BOURNS AG
Zugerstrasse 74, 6340 Baar, Switzerland

Name _____

Title _____

Company _____

Dept. _____

Address _____

Phone (_____) _____

What's TRW up to now?

A new breed.



The GP 1/4 dual rated general purpose metal film resistor for 1/4 W and 1/2 W applications.

A cost-technology breakthrough in general purpose resistors.

You've never seen a general purpose resistor like this one before ... because it's metal film ... not carbon. But, it's designed and manufactured to compete in the general purpose $\pm 5\%$ and $\pm 2\%$ markets.

You get metal film load life stability, TCR, VCR, very low current noise, and an attractive price. The unit is dual rated to handle both 1/4 W and 1/2 W applications.

And you get it from TRW/IRC, the original world-wide metal film supplier. With the technology and manufacturing process controlled right here in the U.S.

Consider it your domestic alternative, or use it simply because it's a better resistor at a very fair price.

For more information, contact TRW/IRC Resistors, an operation of TRW Electronic Components, 401 North Broad Street, Phila., Pa. 19108. Or call (215) 922-8900. TWX-710-670-2286.

TRW IRC RESISTORS

ANOTHER PRODUCT OF A COMPANY CALLED TRW

Circle 124 on reader service card

A SPECIAL REPORT

The drive for quality and reliability, Part 1

Propelled by aggressive competition and customer demand, equipment and component makers are pushing to upgrade their products

by Jerry Lyman, *Packaging & Production Editor*, and Alfred Rosenblatt, *Managing Editor, Technical*

□ A mammoth effort to improve the quality and reliability of its products is under way in the U.S. semiconductor industry. Often resulting in radical changes in the way companies operate, the effort seems well on the way toward the goal demanded by the industry's top customers—namely, quality so high and taken so for granted that incoming parts can move right to the assembly line to be built into equipment. Incoming inspections will become a thing of the past.

"We want to test the parts when they're already on the chassis," says Manuel Hunter, general manager of the engineering department of General Electric Co.'s Television Business division, Portsmouth, Va. "And we want quality levels measured in the parts-per-million range."

GE is not alone. Equipment makers generally are demanding better quality levels for their semiconductor suppliers. And they want the new, better levels fast.

But what, exactly, is meant by the two words that are now the battle cry of chip makers—and indeed of many other electronics firms as well? "Quality," explains Joseph L. Flood, director of reliability and quality assurance for Motorola Inc.'s Bipolar IC division in Mesa, Ariz., "is the measure of a component's compliance with specifications before it is assembled into equipment. Reliability, on the other hand, measures a component's performance over time under conditions in which the equipment will be used."

Achieving the higher quality now being called for is no mean task. It requires a multipronged approach geared to the idea that it is easier to produce quality parts by designing quality in from the beginning rather than by testing quality in later. It is an idea the Japanese have been promulgating for some time. The "brute force" screening and burn-in approach, used in the military arena, with its relatively short runs of technologically sophisticated devices, is definitely to be avoided.

But there is more to producing quality parts than merely deciding to add it at the design level. Companies



must also change their mode of operation. Quality is no longer the responsibility of the quality control manager alone. In fact, consciousness of the need for quality is being instilled at every level, beginning with top management (see "Quality begins at the top," p. 127) and working on down through middle managers to all types of engineers, production-line workers, sales people, and on out to even the branch sales offices, where care must be taken to ensure that orders are written up correctly.

Too often, companies have found, parts are returned not because they failed to meet their electrical specifications, but because of clerical error: the parts sent were not the ones ordered.

The customer, however, perceives these errors as poor quality as well.

Organizations also are experimenting with the ways they relate to their employees, trying to encourage suggestions for improvements and to pay greater heed to complaints. The Japanese idea of quality circles, in which workers discuss their work among themselves and with their supervisors, is being tried in the U.S. in myriad variations.

Manufacturers are taking pains as well to make their work environments more pleasant and to give employees, particularly on the production line, a better understanding of how what they do affects the final product.

Closer relationships

Increasingly, too, the semiconductor makers are finding that they must work closer than ever before with their customers. Relationships are taking on a new character of trust and helpfulness. Failure analyses, performed at expensive facilities installed by both semiconductor maker and customer, are supplying critical information for device designers on why parts failed.

To an extent, the semiconductor makers are reacting to the reputation for quality gained by the Japanese—not just in semiconductors, but in the consumer electron-

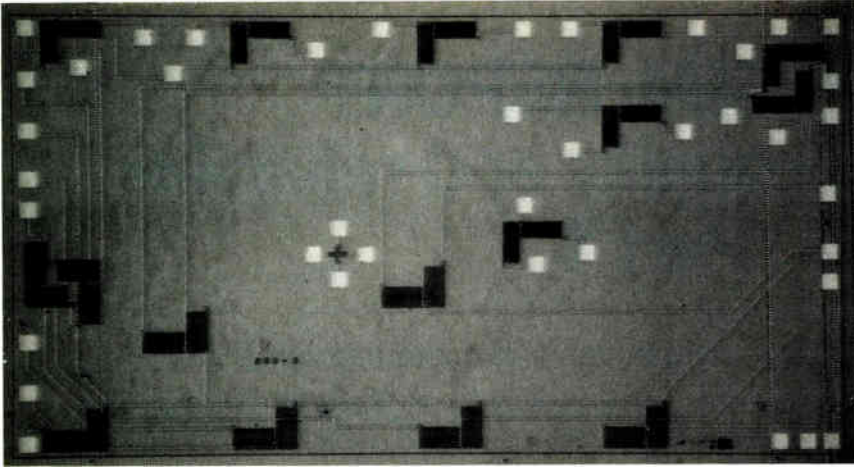

1. Silicon strain. Plastic packages tend to shrink as they cure, stressing their contents. Texas Instruments therefore employs this strain-gage chip to measure strain as a function of chip position. Diffused resistors (the black bars) in Wheatstone-bridge configurations are used as strain sensors. Measurements are taken on uncased and plastic packaged chips.

ics and automotive fields as well. They were particularly stung last year by the bombshell hurled at a quality-control seminar in Washington, D. C., sponsored by the Electronic Industries Association of Japan [*Electronics*, April 10, 1980, p. 81]. Tests of 4-K and 16-K random-access memories by Hewlett-Packard Co. showed that Japanese integrated circuits were "consistently better," said Richard W. Anderson, general manager of HP's Data Systems division in Cupertino, Calif. He termed the test data "a frightening set of statistics" for U. S. semiconductor makers. Such statistics and the inroads made by the Japanese on their customers have galvanized the industrywide efforts to meet and match the Japanese at their own quality game.

But U.S. IC firms are doing more than just hastening to catch up with the Japanese. In reacting to the demands of their customers, they have also come to realize what the Japanese began learning some 30 years ago—namely, that quality can be profitable.

The bottom line

That quality adds dollars to the bottom line becomes clearer when the definition of quality as "conformance to specifications" is fixed firmly in mind. If parts meet the specs set for them, then there are no bad parts to be thrown away, no parts to be reworked, none to be sent back by a customer. Productivity is raised. Moreover, there is no business lost because a customer, unhappy with the last shipment, goes to another supplier.

All these things—absent if the parts were made right the first time and conformed to spec—cost money. Eliminate them and the extra costs are eliminated. Hence quality can be profitable.

Another driving factor in the move to designing in quality is the development of very large-scale integrated circuits. Much harder to make than LSI, such parts run the risk of very low yields unless the design and production are done right the first time, says Jack E. Halter, senior vice president for the Bipolar Digital Products Group of Signetics Corp., Sunnyvale, Calif.

At present, quality assurance people at many electronics manufacturers concur that the quality of U. S.-built semiconductors has improved markedly over the past year or two. Hewlett-Packard's Anderson now places American suppliers of RAMs in positions No. 3 and 4

where they have nosed out two Japanese suppliers. He calls the gains "remarkable" (see "HP's Anderson calls quality competition a 'horse race,'" p. 128).

But semiconductor RAMs, which have borne the bulk of the invidious comparisons *vis-à-vis* the Japanese, still have a way to go, according to some major users.

"The best U. S. devices are about the equivalent of average Japanese products," says Ezra H. Sheffres, director of corporate quality assurance at Data General Corp. in Marlboro, Mass. "Good Japanese lots run at a rejection rate of about 0.03%, whereas a good U. S. lot shows about 0.3%—a factor of 10 worse. That's why the only RAMs we are not burning in are Japanese ones."

Some suppliers—in particular, several of the Japanese companies—have been able to meet reliability requirements with just their standard products, points out Roger Dunn, manager of LSI memory components engineering for Xerox Corp.'s Electronics division in El Segundo, Calif. (However, he declines to name them.) "Some American manufacturers have established special quality process flows, which they use to deliver better-quality products," he adds. Xerox's best 16-K RAMs are arriving with failure levels of less than 0.1% and "some are approaching 0.05%."

The pressure from VLSI

Many expect quality and reliability to become even greater issues in the VLSI marketplace. "That's where the Japanese are focusing their efforts," points out Tom S. Griffiths, vice president for quality assurance and reliability at National Semiconductor Corp.'s Semiconductor division, Santa Clara, Calif. "Customers are now speaking out for more 'bang for the buck,'" he adds. "We have to rise to the occasion to capture market share or someone else will."

Semiconductor makers are making great efforts to overcome the general perception in the marketplace that Japanese products are better. Accordingly, American Micro Devices Inc., Sunnyvale, Calif., for one, has launched a program that bears the Latin aphorism *secundus nulli*, which means that it plans to offer quality "second to none." Thus, as of April 1, AMD has been guaranteeing its customers an acceptable quality level (AQL) of 0.1% for MOS read-only memories and RAMs; 0.2% for bipolar logic and interface devices; and 0.3% for

Quality begins at the top

"Why are we doing it? Because quality is going to improve our profitability and improve our market share. It's not motherhood we're talking about, but the hard facts of what it takes to get quality improvement in all of our products." So says J. Fred Bucy, president and chief operating officer for Texas Instruments Inc., Dallas, concerning his company's commitment to a quality improvement program begun in December.

Bucy echoes sentiments heard from top executives throughout the integrated-circuit industry and from the highest echelons of semiconductor users. The theme is the same—without top-level endorsement, quality programs will not fly.

Alfred J. Stein, vice president and assistant general manager of Motorola Inc.'s Semiconductor Group in Mesa, Ariz., puts it in equally strong terms. "It's a matter of survival," he says, "a part of the equation of doing business and a key item in the semiconductor industry."

Claims that the quality of American products are declining "are not applicable to the U. S. semiconductor industry," comments Charles E. Sporck, president of National Semiconductor Corp., Santa Clara, Calif. On the contrary, he says, "the quality of U. S. semiconductor components has been improving at an outstanding rate." Today, there is a "massive reliability and quality improvement effort throughout the U. S. semiconductor industry that," he continues, "is top priority and operates across all levels of each company's organization."

To most semiconductor managers, the competitive

pressure for better quality has come from Japanese suppliers. As a result, Japanese quality levels are the targets in the cross hairs of American sights. It is certainly the driving force behind the program launched at Advanced Micro Devices Inc. of Santa Clara, Calif., by president and chairman W. Jerry Sanders III. "The program is a good way of saying, 'equal to the best,'" he states.

Others, however, maintain that top-level involvement in quality programs is in response to customer demand. Whatever the reason, it is difficult to dissociate the two factors. And in either case, top managers say, relations with customers have changed, for users anticipate competition over quality in their end products.

In contrast, the Japanese firms have always had a very close relationship with their customers, which are usually other parts of a larger, vertically integrated company, and that aspect does not get enough attention, according to TI's Bucy. "That's why we have made our customers aware of the program, so we can use their feedback."

Perhaps the dominant concern of industry top brass is the need to make their quality commitment stick—to instill the attitudes and values dubbed the "quality culture" into their employees. But will the next major upturn in the market subvert the quality culture? "You cannot afford to launch a major effort as we have done without taking it as a serious long-term change in business," answers Charles V. Prothro, chairman of Mostek Corp., Carrollton, Texas. "Employees will see right through that. And customers will see through it, too."

-Gerald M. Walker

linear devices, LSI logic, and other memories.

To achieve the desired quality, manufacturers are putting a greater emphasis on automation, computer control, and the collection of data all along the IC fabrication process. Furthermore, as another aspect of that effort, by the beginning of 1982 most semiconductor makers worldwide will measure quality in part failures per million (ppm) rather than in the current acceptable quality level, or AQL, measured in percent—partly because, in psychological terms, 200 ppm, say, sounds much worse than 0.02%. Pressures from large IC users, demands of VLSI and the U. S. government's Very High Speed Integrated Circuits (VHSIC) program, and the presence of a large and successful quality-conscious Japanese IC industry have brought this on. To reach those goals, the semiconductor industry is attacking the nitty-gritty aspects of technology, engineering, and manufacturing at every point in IC fabrication.

The six major parts in the IC fabrication process are design; wafer, or front-end processing; assembly; packaging; testing; and failure analysis. Major efforts are under way at each of these steps. Some, such as the use of electron-beam lithography, involve high technology; others, the introduction of automation; and still others, simple manufacturing improvements.

Perhaps the most important step in producing a quality IC is its initial design. Until fairly recently, many chip makers tried to achieve quality and reliability by testing them in. The attitude now, fostered in part by the example set by Japanese manufacturers, is that it is more cost-effective to do it right from the beginning. All

large semiconductor firms are now trying to tighten up the design tolerances of their large computer-aided design systems to make devices more uniform. They are creating IC software models that closely correlate with the finished product; designing in on-chip process and reliability monitors; and, for VLSI circuits, designing in on-chip testability.

Designing quality in

One example of a turn to CAD to raise IC quality is the First Time Design program recently instituted at General Instrument Corp., Hicksville, N. Y., as part of its overall Twelve Point Quality program, which covers all phases of IC design, manufacturing, testing, employee involvement, customer support, and reliability. The first element in the design program is greater use of advanced computer transient and logic modeling.

Andrew Sass, group director of business and technical research at GI, notes that "CAD tools have for a long time lagged the industry's capability for manufacturing circuits. Only recently have they become capable enough to handle the kinds of complex designs we are into."

"Now," he says, "instead of designing by the seat of our pants, we are in the process of checking our designs using logic, circuit, and device simulations and basically running our designs on a computer to a much greater extent than we did in the past." (Programs that check logic as well as masks have been developed, for example, by Phoenix Data Systems Inc., Troy, N. Y., for sale to the semiconductor makers [*Electronics*, Jan. 27, p. 42].)

Next year, GI's designers will check a design with a

HP's Anderson calls quality competition a 'horse race'

Richard W. Anderson, general manager of Hewlett-Packard Co.'s Computer Systems division, is the man who caused a stir among semiconductor companies with his revelations that Japanese-made 16-K dynamic random-access memories shipped to HP have been consistently superior in quality to those it receives from U. S. firms.

More recently, however, he reports that the differences are narrowing. Japanese suppliers still rate No. 1 and 2 in quality performance at the Santa Clara, Calif., division. However, the suppliers now ranked No. 3 and 4 are American. Suppliers No. 5 and 6 are Japanese, and supplier No. 7 is American. Thus two U. S. producers have passed the Japanese since Anderson's last report in November [*Electronics*, Nov. 6, 1980, p. 46].

"There has been no change in Japanese quality over all," Anderson remarks, "but there have been remarkable gains by U. S. memory makers. Their response has been admirable."

Although hard numbers are not yet available from Hewlett-Packard for 1981, here are Anderson's estimated figures on failures comparing January to June 1980 with July to December 1980. After 72 hours of burn-in at

125°C, in terms of failures per 10,000 parts:

- U. S. supplier A went from 60 to 35.
- U. S. supplier B, from 120 to 20.
- U. S. supplier C, from 110 to 50.
- Japanese supplier I, from 6 to 4.
- Japanese supplier II, level at 13.
- Japanese supplier III, level at 40.
- Japanese supplier IV, level at 40.

Anderson notes that the competition among the third- to seventh-ranked suppliers is now a "horse race" because of the gains by U. S. firms. Regarding the problems that American 16-K RAMs have evinced, Anderson comments, "Down deep in my stomach, I can't help but feel that the whole decision to go to off-shore assembly was in the long run a mistake because of its impact on quality." He notes that HP has a plant located one mile from his office, and "we do not get over there as often as we should to keep tabs on operations. What happens at the companies with assembly plants 7,000 miles away?"

While continuing to examine memories, Anderson is already zeroing in on another component with a big effect on end-product performance—logic arrays. **-G. M. W.**

software package that will permit them to reconstruct a logic diagram from the IC's layout. Since IC design proceeds from a logic or block diagram to a circuit layout to a mask layout, "it's like adding up a column of figures a second time, from the bottom, to see if you get the same answer both ways," Sass explains.

Among the other points in the CAD system are a routine that checks to see that design rules have not been violated and another that does the same for the guard bands—the operating parameters that characterize a device. In addition, all new circuits will be designed for ease of testing.

Under the First Time Design program, engineers will be rated and rewarded on how few design revisions their device goes through before it goes out the door. Like other semiconductor manufacturers, GI has noted a correlation between the number of design revisions and

outgoing quality: the fewer iterations, the better.

Many IC firms also are designing circuits with wider guard bands, giving process engineers a wider tolerance to work with. For example, widening resistor tolerances from $\pm 10\%$ to $\pm 15\%$ has been shown to increase the safety margin between design and processing by damping out the effects of process variables and thus results in better ICs.

Design standardization can be used to promote improved quality and reliability, as, for instance, Tokyo-based Hitachi Ltd. has found. A file of unit cells is maintained, and designers strive to use cells with a known history. This technique is applicable to memories, for example, because the same memory matrix can be used for memories with a bit organization of 1 K by 1, 2 K by 8, and 4 K by 4. In qualifying the design of new parts, reliability information on the cells used is consulted during the design review.

Like Motorola and others, Texas Instruments Inc. of Dallas has a thoroughly characterized design-rule set that can be employed to achieve designs having a wide tolerance. In addition, its Central Research Laboratories has devised a model for a charge-shared MOS field-effect transistor that has yielded a highly accurate prediction of VLSI MOS FET operation. MOS FET transfer characteristics have been computed with the aid of this software model to within 5% of actual device characteristics.

Previously, TI had experienced a large difference in parameters between MOS FET models and actual devices. One of the first ICs designed

2. Flying bonds. At Electronic Arrays, this computer-controlled machine, from parent Nippon Electric, wire-bonds dice to their lead frames faster and better than manual bonders.

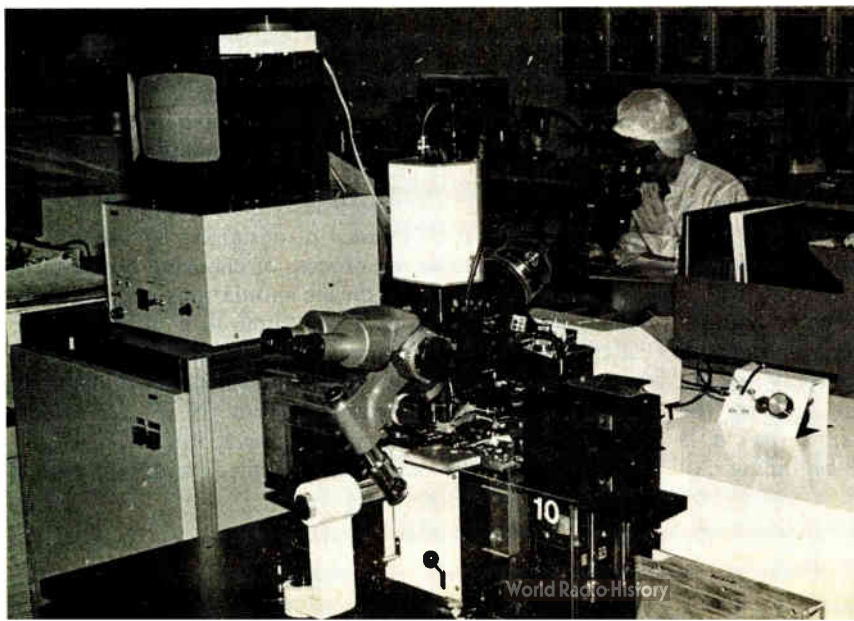

Analyzing failures with SEMs and TEMs

In their paper "Electron Microscopy and Failure Analysis," given in Orlando, Fla., Robert B. Marcus and Tan T. Sheng of Bell Laboratories, Murray Hill, N. J., have highlighted the many applications of the scanning electron microscope (SEM) and the transmission electron microscope (TEM) in analyzing integrated-circuit failures.

As line widths in ICs fall below 3 micrometers, the SEM is taking over from the optical microscope. With the even finer lines of very large-scale integration, high-resolution microscopy of vertical cross sections becomes an important need. Here, the TEM, with even higher resolution than the SEM, moves in. As the table shows, the TEM has a drawback—sample preparation is difficult and may take more than a day.

The authors point out that both types of microscope have important diagnostic uses in failure analysis other than that of providing images of surfaces and sections. For example, junctions can be delineated on cross-section slices and the delineated regions studied either in the scanning type using secondary-electron imaging or in the transmission type. Also, the crystalline phase of thin layers and small regions can be identified through the use of electron diffraction with the latter. Furthermore, X-ray-emission spectroscopy and electron-energy-loss spectroscopy can be performed by either tool to provide qualitative and quantitative chemical analyses.

The electron beam in an SEM may be employed as a probe in a variety of ways to locate leakage sites using the electron-beam-induced-current (EBIC) mode and to make quantitative and qualitative measurements of surface potential using the secondary-electron mode. Together, they are known as the voltage-contrast modes.

In practice, surfaces that differ by more than 1 volt can be distinguished by their secondary-electron images. In one case, a charge-coupled-device IC that had failed for unknown reasons was photographed (by means of secondary-electron imaging) with its surface aluminum electrodes held at +25 V. A single electrode was seen that was clearly at a more negative potential. An enlargement of the voltage-contrast image of the floating electrode at the image discontinuity (a) and a secondary-electron image at higher magnification at zero bias (b) showed that the cause of the failure was a break in the electrode caused by a surface scratch.

Although voltage-contrast images can often be obtained by applying a static bias to a circuit element, there are situations where that cannot easily be done or where it would be undesirable to do so. For example,

interior nodes of a circuit are often most easily biased through normal dynamic operation of the circuit. Also, simultaneous voltage-contrast imaging of a two-dimensional array of circuit elements over a large area during chip operation is more efficient than a serial study of those elements.

Voltage-contrast images of dynamically operating circuits can be taken either when the clock frequency is far lower than the line-scan frequency of the SEM, so that large areas of essentially static voltage contrast are seen on the screen at the same time, or when the clock frequency is an integral multiple of the line scan. The latter condition also requires that elements appear in striped contrast or the SEM's electron beam is strobed synchronously with the chip driving circuit so that the circuit elements under test will be visible only when they are expected to be in a particular state.

As the SEM beam raster-scans across the surface of a device structure, a variety of interactions occur that can provide useful information if properly detected. The minority carriers generated near a pn or a Schottky barrier junction produce a current as they sweep across the depletion zone after drifting to the region, and the current can be used to modulate the intensity of a synchronously sweeping cathode-ray tube.

This electron-beam-induced current is strongly modulated by defects or by local change in the ability of the beam to penetrate to the semiconductor. In the former case, defects can easily be "seen" in an EBIC image; in the latter case, minute holes in the silicon dioxide that permit the formulation of local regions of pn junctions (by impurity diffusion) can easily be detected. Other features can give rise to current-enhancement effects that produce a more intense signal at the site of the disturbance. —J. L.

COMPARING MICROSCOPY METHODS

Microscopy	Practical resolution limit	Sample preparation	Destructive
Optical (interference-contrast)	~1 μm lateral, ~50 \AA vertical	very easy; ~½ min.	no
Scanning electron (secondary-electron mode)	~100 \AA	easy; ~5 min.	can be
Transmission electron	~5 \AA	difficult; >1 day	yes

with this simulation was the TMS 7000, an 8-bit microprocessor containing over 20,000 transistors. The first prototype TMS 7000 was 98% functional, and the second worked completely. This close correlation between model and device allows the effects of process variations to be simulated exactly, which in turn permits tighter process monitoring.

Industrywide, the basis for most quality and reliability analyses is data gathered from outgoing testing by the IC manufacturer and from incoming testing and inspection by the user. However, these measurements—known, respectively, as concurrent and lagging measurements—are not the most helpful when it comes to raising quality.

What are needed, according to C. Morris Chang, named in December as TI's vice president for corporate quality assurance, are measurements at the wafer level that can be stored in a data base for monitoring quality trends and for predicting long-term reliability. Chang calls these measurements leading indicators. They consist of data collected from on-wafer sensors monitoring a multitude of wafer-processing, material, chemical, mechanical, optical, and electrical parameters.

TI has already started programs using leading indicators. Data from packaged parts that have been rejected at outgoing testing or have been returned from the field are being studied and correlated with the stored mea-

Japanese use U. S. burn-in services

Many Japanese integrated-circuit manufacturers do not like to talk about it, but burn-in is rapidly becoming a routine part of their processing, says Joe Lawrence, manager of engineering at Reliability Inc. in Houston.

"They like their image of high reliability, of course," comments Lawrence, who recently visited Japan. "They also enjoy their reputation for excellent processing techniques, but it is clear that they are beginning to depend more and more on burn-in to weed out the infant failures."

At least three Japanese semiconductor manufacturers have purchased burn-in and test equipment from Reliability. The firm has also burned in Japanese units at its Houston facility.

"On balance, I would say that they have higher-reliability parts compared with the average U. S.- or European-made devices," Lawrence says. "You could draw distribution curves of reliability and they would overlap, with the means of the Japanese companies being better than those of the others."

Processing is the Japanese key, he says. "It is the Japanese character to be very meticulous. In fact, it goes back to their culture," Lawrence explains. "Of course, we have good engineers in this country, but there is a tenden-

cy in the Western cultures to take more chances."

According to a study by his firm, the best place to look for improvements is in the manufacturing process. The second-best area is improvement of production equipment. Next is conducting more tests, and then conditioning and stress, such as burn-in.

"Obviously, you cannot put quality into a device just by testing," states John Redrupp, vice president and director of marketing at Reliability, which employs 500 workers worldwide. He says that "the Japanese have set a new standard as a result of their entrance into the U. S. market a couple of years ago."

Another factor in the recent quality blitz has been supply and demand. "Quality has generally been inversely proportional to the demand," he notes. "Demand goes up, quality goes down. Demand drops, quality rises." Manufacturers as well as users tend to cut corners when there is an IC shortage, he says. Test times are often abbreviated in an attempt to get the parts out of the door or make a larger profit in a seller's market.

To improve reliability, burn-in is a must, "because it causes latent failures to become actual failures," Lawrence points out.

-J. Robert Lineback

surements taken on the same wafer during fabrication. For instance, a large number of failures at incoming testing might be related back to a critical drift noted in measuring a particularly critical circuit voltage, or a large increase in field failures due to thermal drift might be related to a decline in oxide integrity measured on the wafer. In both cases, corrective action could then be taken at the front end.

Leading indicators are measured at test sites on the wafer. These sites—known variously as test patterns, test chips, test bars, plug bars, and test-element groups—have been designed onto semiconductor wafers for some time and are used worldwide today. They consist of chip-sized patterns, actual circuits, and/or components whose electrical output is measured when the wafer is probed.

Early test chips were either simple resistive patterns or discrete devices. Now they have evolved into complex multipurpose structures such as a large MOS modular test bar designed at TI. This unit has seven electrical outputs for monitoring wafer strain, alignment, transistor-channel inversion, metal continuity, humidity, charge spreading, polysilicon continuity, contact integrity, and polysilicon insulation resistance.

Bipolar test chips can be used to measure some 30 parameters ranging from oxide thickness and contact resistance to implant and diffusion doping. For MOS devices, Hitachi, for example, uses test devices that consist of active and parasitic MOS FETs, memory and shift register cells, and various contact-to-conductor structures. These test-element groups monitor electrical parameters such as threshold voltages, FET transconductance, leakage currents, output voltages, ohmic contact resistivity, and step coverage.

Generally, leading indicators are gathered from a test bar rather than a production chip. However, there are

exceptions. Motorola's MOS operation in Austin, Texas, for instance, redesigned its 16-K RAM after problems were discovered a year ago. It reworked the part to include on-chip stress pads (MOS capacitors), which are probed to check dielectric stress level at the wafer stage but are not connected to the final package's lead frame.

Packaged test chips

Design engineers at ITT Semiconductors Ltd., Footscray, Kent, England, perhaps Europe's largest memory maker, have expanded the use of test patterns to beyond the wafer level. ITT removes process-validation modules (test chips) from the wafer, packages them, and subjects them to thermal and electrical step stress and overstress in its initial qualification of a process. With the data gathered from this work, the maximum likely drifts in the various electrical and material parameters over an extended period of device operation (say, 10 or 20 years) can be predicted. The effect of these drifts on the performance of a particular memory can then be determined and suitable checks made to ensure that in the worst case a device will still have adequate operating margins at the end of its life.

Test chips can also be used to check the effects of the packaging process and the package itself on long-term reliability. For example, during fabrication, the shrinkage of a molded-plastic package can stress the silicon chip to its breaking point or cause piezoelectric effects. Moreover, the more stress applied to the chip during packaging and maintained thereafter, the more will its life be shortened.

One approach to this problem, tried by TI, Hitachi, and others, is to design test bars out of diffused silicon resistors—in effect, strain gages—capable of being probed at the wafer stage, with bonding pads for connecting the bar to a lead frame. Using the bars, the

3. Die attachment. This automatic machine, currently in use at both Electronic Arrays and NEC, continuously locates dice, picks them up, and places each one precisely in the center of its lead frame. An operator simply loads and unloads cassettes of lead frames.

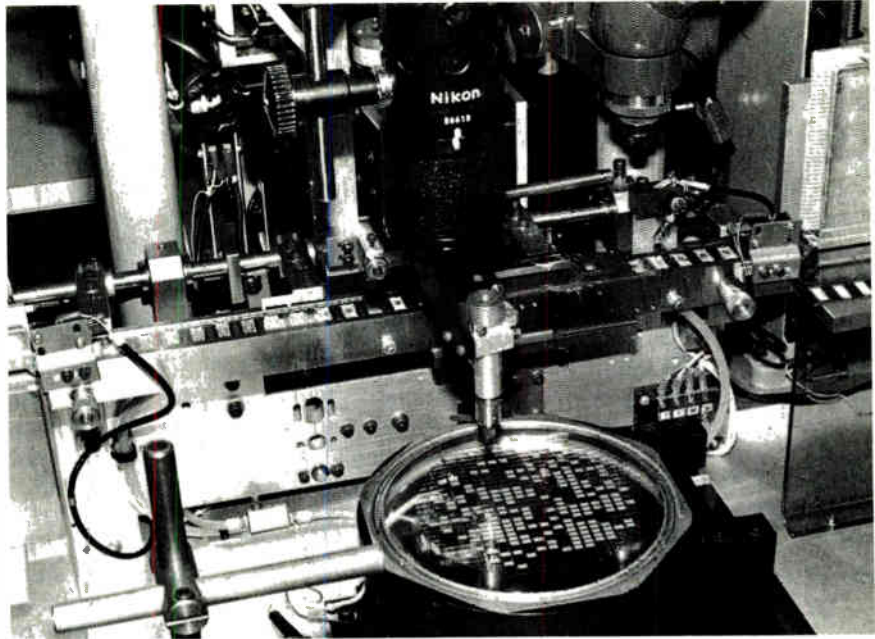

effects of stress on the chip caused by the molding and curing of the plastic can be monitored and an optimum molding compound selected.

One of TI's latest strain-gage test bars is shown in Fig. 1. Here a Wheatstone-bridge arrangement allows stress to be sensed in both the X and Y axes.

At the front end, automated processing, precision lithography, and process improvements are the three main thrusts being tried by manufacturers to improve quality and reliability in the 1980s.

The object of automated processing is to take the human element, with its inherent errors, breakage, and even contamination, out of processing and to substitute computer control and automatic handling equipment. Most firms are highly secretive about their facilities, but IBM, TI, Hewlett-Packard [*Electronics*, June 5, 1980, p. 151], and Toshiba all have revealed details of their automated lines.

International Business Machines Corp.'s Quick Turn Around Time (QTAT) line, at work at its General Technology division in East Fishkill, N. Y., consists of more than 100 automated tool subsystems grouped into eight sectors [*Electronics*, Jan. 27, 1981, p. 121]. The line, including electron-beam equipment used to personalize a master slice's circuitry, is controlled by a large distributed computer network.

In operation, wafers are moved on jets of air, in enclosed tracks, from one automated tool to another within a QTAT processing sector. The air tracks minimize friction and hence damage to the wafers. Filtered air within the air tracks and automated tools provide essential contamination control by limiting the airborne matter larger than 0.5 micrometer in size to fewer than 50 particles per cubic foot. Machines on the QTAT line perform photoresist application, baking, exposure, and development, as well as evaporation, sputtering, and etching, with many of the operations monitored by a central computer.

In another example, Toshiba Corp. in Kawasaki,

Japan, recently adapted an automated manufacturing system for its chip-making process that links microcomputer-controlled diffusion ovens, photolithography, and etching to a central microcomputer.

Zeroing in on lithography

Lithography, which exposes and develops ultradense line patterns on a resist-covered wafer, is one of the most critical steps in fabricating ICs. Any errors or defects in the mask details or mask-to-wafer alignment or any contamination of the wafer is carried right through the entire IC process and cannot be corrected. Obviously therefore, anything that will lessen errors at this step will have a great effect on chip quality and reliability.

Many firms are now attacking the quality problem in the lithography area with automated mask-inspection equipment. In such a machine—like the KLA 100, from the KLA Instrument Corp. in Santa Clara, Calif.—alternative die sites on a mask are compared for conformity as the mask is stepped past dual microscopes. Any deviation in detail represents a mask defect and is stored in a data base for retrieval later. Besides ensuring that masks meet specs, automated inspection allows the screening out of small defects right down to the micrometer range, increasing overall IC quality.

As Dean Toombs, manager of design and internal business at TI, points out, "Precision lithography should not only allow fine resolution but should also allow precise registration." A major problem for MOS circuits in yield and reliability is the ability to align and register successive mask levels. If a misalignment exposes gate oxide, a serious long-term reliability problem, like excess leakage, can occur under thermal stress. At present, only the scanning electron-beam lithography system that aligns at every chip site has the accuracy to surmount this problem, particularly with LSI and VLSI designs.

Process improvements, too, are helping the IC companies to achieve better yields. Most have now either partially or completely switched from wet to dry (plas-

ma) etching. Besides cutting down on contamination and uniformity variations, this technique permits finer lines.

Another new processing step being accepted industry-wide is the use of silicon nitride, which by nature is free of pinholes, as a passivation layer, rather than phosphosilicate glass (PSG). A layer of SiN₂ prevents contaminants from getting into the silicon. In addition, this type of passivation resists humidity better than PSG and so is suitable for chips housed in nonhermetically sealed plastic packages.

In Phoenix, Ariz., Motorola's Semiconductor Group has had several unusual front-end manufacturing programs. One is the use of a three-metal composite (copper-silicon-aluminum) to replace aluminum in order to correct a hillock problem over the last two years; these hillocks, where silicon pops through the metalization, occurred only when aluminum was used and caused field problems with electrical characteristics of multilevel devices. In addition, the three-metal composite makes possible higher current densities.

Motorola also pioneered another material innovation—substituting silicon nitride for oxide in capacitors. This substitution has two advantages: it prevents sodium contaminants from entering active areas, and it gives the capacitor a higher breakdown voltage.

Yet another material advance at Motorola is the use of polyimide for dielectric passivation and top covering. This material is self-leveling, which smooths out circuit layers so that line widths and interconnections can be reproduced better. Polyimide dielectrics have been used at Texas Instruments and in Japan as well. The material is also being employed as protection against alpha parti-

cles, which cause soft errors in memory chips.

"In the last two years, IC packaging problems have become far more significant," says Joseph Brauer, chief of the reliability branch of the U. S. Air Force's Rome Air Development Center, Rome, N. Y. "The increase in packaging problems on military ICs shows that chip makers are not paying enough attention to assembly and packaging. They have done a good job in improving the reliability of the chips; now they must do the same for the package."

Package failures

Brauer's engineers have seen package failures in military ICs that include poor seals, cracking of sealing glass, and corrosion of lead frames. Bob Thomas, chief of product evaluation at RADAC, says more attention should be paid to the compatibility of package materials with each other and they should be subjected to stringent thermal and mechanical tests. Quality must be kept up through the entire assembly and packaging sequence.

As in wafer processing, the key to raising quality in assembly and packaging is automation. Advanced Micro Devices, for instance, is pressing ahead with automated assembly techniques to improve yield. For example, with fully automatic bonders, the firm anticipates having wire-bond yields in excess of 99%, versus 97% to 98% with current semiautomatic techniques, which require an operator for alignment. "That might not sound like much of an improvement," says George M. Scalise, senior vice president and chief administrative officer at AMD, "but when you're talking about 1.5% of tens of millions of devices per year costing \$2 apiece on the

Willoughby wants commercial parts for the Navy

Ever since Willis J. Willoughby joined the U. S. Navy in 1975, he has been the subject of controversy among segments of the electronics industries, notably semiconductor makers, as well as among some of his counterparts in other services, particularly the Air Force. For, as deputy chief of naval material for reliability, maintainability, and quality assurance, Willoughby is trying to change the system by getting manufacturers to design reliability into products first and then have the user—the military's prime contractor—responsible for the reduced parts screening that will presumably result.

A product of the National Aeronautics and Space Administration and its lunar landing program, Willoughby is an advocate of reliability by design. Moreover, he favors reorientation of military specifications of standard parts to permit use of commercial parts that pass electrical verification at temperature extremes and loose-particle detection by random vibration (so-called PIND testing).

While agreeing that designed-in reliability is desirable, one Air Force critic, Joseph Brauer, chief of the reliability branch at the Rome Air Development Center in Rome, N. Y., disagrees sharply with some of Willoughby's other views. Brauer notes that the fact that budgets for acquisition and support (which includes testing) are separate and subject to pressure to hold costs down goes counter to the proposed additional cost of users' screening of commercial parts. This practice would also make the original-equipment manufacturer a supplier of microcircuits for the

life of its equipment—an undesirable situation. In addition, Brauer points out that the validity of PIND test results is highly questionable. Finally, he cites USAF data showing that nonstandard microcircuit spares bought by OEMs cost eight times more than Joint Army-Navy parts and cause a high rework rate.

Nevertheless, Willoughby persists. Defect rates of integrated circuits and transistors meeting military specifications are far too high, he says, and his approach to screening out faulty parts before they are built into modules and equipment has attracted much interest within the Department of Defense. He also has the support of the Navy, which is moving to install it within its major systems commands—Air, Sea, and Electronics.

In his effort to implement his program, Willoughby is disappointed by the semiconductor industry, which he finds "not very responsive at all." The reason is that the DOD's leverage is limited because it buys only 2% to 4% of the industry's output for mil-spec ICs, accounting for only 10% of the industry's dollar volume. With heavy financial obligations in other highly competitive markets, semiconductor makers find the military market "more trouble than it's worth."

Willoughby also is discouraged by "the lack of good engineering talent" within the Government, where the profit incentive does not exist. Industry has its own shortage of talented engineers, too, he notes, but "it is not as severe" as in Government.

-Ray Connolly

average, that's a lot of money you're banking."

"We couldn't stay competitive if we kept doing things with our old methods and equipment," says Michael R. McCoy, who was recently appointed to the new post of vice president of reliability and quality assurance at Electronic Arrays Inc., Mountain View, Calif., a subsidiary of Japan's Nippon Electric Co. Electronic Arrays has transferred some—but not all—of NEC's manufacturing methods to its facilities. One, for example, is at wafer probing, where dice are checked for electrical parameters. Rather than inking those dice that are out of spec, as is common, the company now follows NEC's practice of scratching them so that they cannot possibly be used later.

As for differences, McCoy says that NEC uses very few in-line quality-control inspections and relies heavily on automated equipment, but that EA is not so confident about them. It is therefore using a hybrid approach with a fair number of in-process inspections. It is planning, however, eventually to adopt NEC's approach.

It has, on the other hand, adapted much of NEC's automation equipment in transferring 16-K RAM production to the U. S. Included are: automatic wire bonders (Fig. 2); automatic die attachers (Fig. 3); and semi-automatic inspection systems for first (wafer), second (die), and third (before precapping) visual inspection. Previously, EA used manual bonders that were much slower. It had even attempted to use automatic bonders, but it could not make them perform satisfactorily and had to return them to the supplier. "The NEC bonder is the fastest available," McCoy states. "More importantly," he adds, "it has been in production for four years, and it is very reliable."

NEC is just one example of the high degree of automation in the assembly portion of its semiconductor manufacturing for which Japan has come to be noted.

Furthermore, Japanese assembly and packaging lines are run at a level of cleanliness approaching that of the front end. The same does not always apply to companies in the United States and Europe, which may rely on chip passivation for protection during assembly.

An example

Toshiba can serve as an example of the Japanese approach to automated assembly and packaging. There, one flow-through machine does all die bonding, wire bonding, molding, solder dipping, cutting and separation, and marking. This high-speed system has a big effect on reliability because it drastically reduces the number of necessary employees and machines, both of which increase the number of defects, and cuts time as well.

In its quest for quality, National Semiconductor, too, is increasing its use of automated assembly techniques. It is paying particular attention to tape automated bonding (TAB), a technique whereby specially bumped chips are automatically mass-bonded to special insulating tapes with IC patterns plated on [*Electronics*, Dec. 18, 1980, p. 100]. A hands-off method up to and including molding, it results in enormously more reliable bond leads. For example, National has mass-bonded 450 million ICs (small-scale integrated TTL) with TAB, with only 29 bonding failures. It is now in the process of expanding

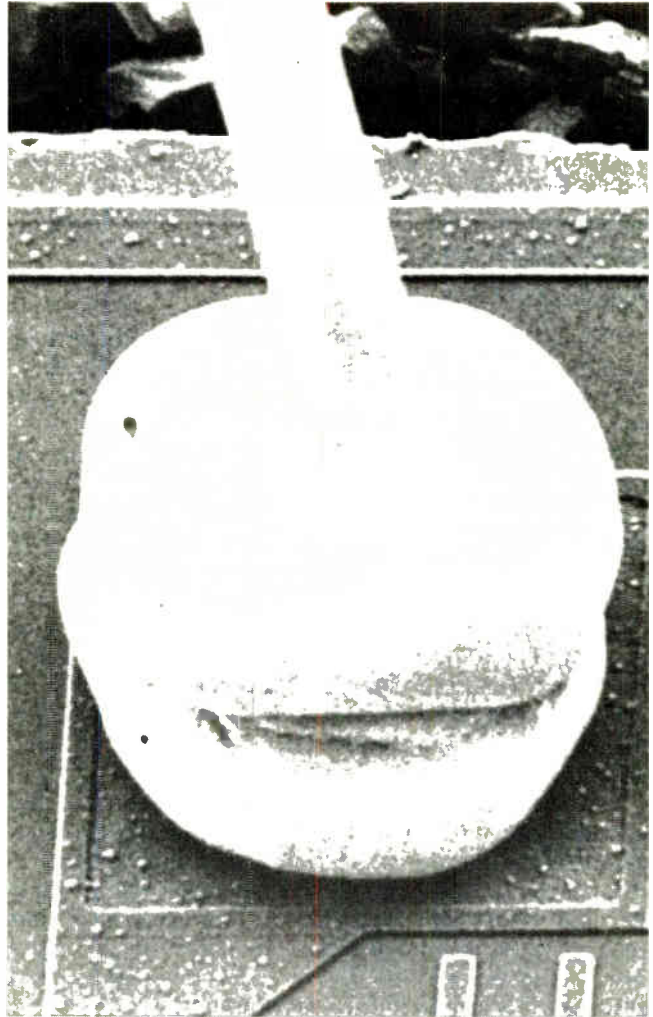

4. Double-bonded. An expanded view of an IC I/O pad shows a wire bonded to a previous bond pad. Although this IC passed electrical tests at Matsushita Electronic Corp., it was rejected because the company felt that with time it would be unreliable.

TAB to linear and interface ICs.

National is also trying to automate handling at the end of its complementary-MOS, linear, and bipolar logic lines, just as it does in its plating and dipping operations. In addition, it has gone through the production line and determined where materials containing chlorine can be removed. To reduce other contaminants that might later affect device reliability, National is looking to eliminate the tin plating of lead frames on the production line and instead use a preplated frame. Finally, it is trying to get away from solder dipping, which unnecessarily stresses parts internally.

Texas Instruments is one company looking into lead-frame problems. It has found that external silver leads on its standard full-silver lead frames are a potential long-term problem: if they are not stored in a sulphur-free environment, tarnish can form, affecting solderability. Consequently, a program is under way to convert TI's full silver lead frames into spot silver ones with solder-coated external leads.

TI also has developed a two-tone lead frame to eliminate the solder coat and the associated chemical pro-

cesses required to activate package leads prior to solder dipping or plating. Its fix is to selectively plate the lead frames for bonding and then solder the external leads. Thermosonic bonding takes place at 200°C, a low enough temperature to avoid solder melting.

Much of today's packaging failures occur in the popular low-cost plastic dual in-line package, or DIP. The causes are corrosion, package cracking, lead shorting, and circuit malfunction.

Plastic problems

Corrosion is caused by moisture and contaminants. It may be corrected by changing the mold compound or chip passivation material, the lead frame design, or one or more front-end steps.

Package cracks are caused by the lead frame and by mold compounds that stress the package. Strain-induced parametric shifting can result from stressing of the silicon by the mold compound. Cracks, too, can be corrected with an alternative mold material.

Since plastic packages are the most popular in the U. S., these problems are a major concern. For instance, at Motorola, 6 improved plastic materials are being evaluated. Texas Instruments has a major program in which 20 molding compounds are being evaluated for moisture performance, life-test performance, package cracks, chip strain, and contaminant levels.

One measure taken for the past several years to keep out moisture is the addition of a phosphosilicate glass coating over the aluminum interconnection layer. But that alone is insufficient; a good molding material must be used whose characteristics do not vary, and that requires close communication with plastic manufacturers. It also is necessary to store the molding material such that it is protected from moisture.

Hiroyuki Kumagaya, reliability and quality manager at Nippon Electric's IC division, for one, believes that moisture passes through the bulk of the plastic rather than along the lead frame, since corrosion occurs on the chip surface rather than on the leads. Therefore, surface passivation is important. Silicon nitride would provide even better humidity protection than PSG, but the chip surface may be damaged by the necessary plasma etching. This problem must be solved for even greater reliability, but at present NEC's customers are satisfied without a nitride coating.

Nitride passivation

For linear bipolar parts, at least, nitride passivation is a factor in another aspect of reliability—radiation hardening. Precision Monolithics Inc. in Santa Clara has been covering all its chips (linear ICs and digital-to-analog converters) with a silicon nitride overcoat for some time to protect the chips from contaminants and to extend the life of the chips in plastic packages. Because of comments from customers who noted that nitride-passivated units seemed to resist radiation, PMI decided to evaluate the nitride coating for radiation tolerance.

It manufactured a lot of PM-108 operational amplifiers with and without nitride passivation and submitted them to the Jet Propulsion Laboratory, Pasadena, Calif., for radiation testing. JPL's results showed that the

nitride-passivated op amps had three to five times the radiation tolerance of the unpassivated units, confirming the customers' comments.

Of course, eliminating or reducing failures means knowing why they occur. Failure analysis has gone from the simple procedures of the early days of IC fabrication, in which package lids were removed and semiconductors simply examined under a microscope, to a sophisticated measurement technology based on a battery of expensive and sophisticated tools such as scanning, transmission, and Auger electron microscopes and X-ray fluorescence analyzers. The results of failure analysis are fed back to design, front-end, and packaging and assembly stations, resulting in higher quality and better reliability.

Analyzing failures

At present, all U. S. and overseas companies have large failure analysis labs, as do many government agencies. Of all the American firms, Intel in particular has stressed quality improvement based on rigorous failure analysis, and it has done so for some time. That helps explain why, unlike many other U. S. semiconductor manufacturers, it is not jumping on the reliability and quality bandwagons that have recently been sent rolling.

"We've always been there," says Eugene J. Flath, vice president and assistant general manager of Intel's Components Group in Santa Clara, Calif. "We got there by driving from a totally different direction. We took the approach that if we're going to build a very high-speed device, for example, we don't want it in the hands of the customer if it doesn't work. Performance without reliability is nothing."

Thus the firm's emphasis is, and has been, on understanding the physical mechanisms that cause device failures and then designing the failures out by improving the technology and processes with which a device will be built. Typically, that is done no less than one year before a device is in production and available to customers.

Unlike quality, which can be built into a device with refinements in design, process control, manufacturing, assembly, and testing, "reliability is limited by the technology," explains Ron Smith, quality assurance manager at Intel's Memory Products division in Aloha, Ore. "It has latent defect limitation," he explains. "The design of a device can't make it defect-insensitive."

The company's failure analysis labs use some complex analytical instrumentation. For example, the Auger electron microscope shown in Fig. 6—manufactured by Physical Electronics Industries Inc. and costing approximately \$250,000—is used on ICs and their packages to detect surface defects or contamination in elements like silicon that might have been missed previously by a nondispersive electron microscope.

According to Smith, this investment in reliability engineering facilities and equipment is paying dividends. "On a per-chip basis, we have achieved the same reliability on each generation of product, from a 256-bit RAM on up, and that should include the next-generation 256-K RAM," he says. "What's more, the reliability figure of merit on a per-bit basis has seen orders of magnitude improvements." Overall, that figure for such memories, which are the vehicles Intel uses to debug a process

technology before applying it to electrically erasable programmable ROMs, microcomputers, and peripheral chips, in that order, "is approaching 0.1% failure per 1,000 hours."

Similarly, Intel boasts of some significant improvements in device quality. "In the 1973-74 period, we were shipping products with outgoing defective parts in the neighborhood of 0.6% to 1%. Now we are down to 0.1%, or at the 1,000-defects-per-million level, across the board in memory products," Smith states.

Of course, all major chip makers in the U.S., Japan, and Europe and most large IC users have extensive failure analysis facilities. TI's failure analysis flow is probably typical. It uses the scanning electron microscope in three modes—as an electron microscope, in the electron-beam-induced-current mode, and in the voltage-contrast mode (see "Analyzing failures with SEMs and TEMs," p. 129)—and like Intel, an Auger electron microscope for surface analysis. X-ray backscattering measurements are employed to look for contamination.

Often, analysis of apparently good semiconductors turns up surprising results. For instance, to ensure reliability, Japan's Matsushita Electronic Corp. also analyzes good devices, including opening and visually inspecting samples of each batch. It rejected one entire batch of a device, assembled by a semiconductor manufacturer's subcontractor in the Philippines, in which bonds were made on top unsuccessful bonds (Fig. 4), an inherently unreliable procedure.

Outgoing quality

Two of the biggest factors lowering outgoing IC quality levels do not result from technology, as Fig. 5 illustrates. This pie chart shows that a staggering 40% of all customer returns to TI's Digital Circuits division in Dallas are caused by clerical errors and another 25% by test correlation differences (differences between the vendor's and the user's test equipment and disagreements over test specifications). Actual out-of-spec electrical parts account for only about 15% of the returns.

To achieve the desired quality, all the major U. S. IC companies are in the midst of large programs to rid themselves of the first two types of error. At TI, for example, customer service teams have been assigned to monitor key aspects like customer's purchase orders, entry checks, entry time, and purchase order changes to eliminate errors.

The attack on correlation errors is proceeding along the same lines. For instance, Intel has a major program to cut this type of error. "The biggest obstacle to eliminating the lack of correlation," says Ron Smith, "is getting all parties involved to agree on a teamwork concept rather than taking the idea that it's not 'my' problem but 'yours.' It's really an industrywide issue that requires the customer and vendor working together."

Already, Intel's Memory Products division correlates test data with its memory systems operation, which essentially does no incoming inspection of memory devices. "We have identified correlation differences between our component tests and their system tests," Smith notes. That was done by "engineering the problem," he explains—that is, by backing off to a board-

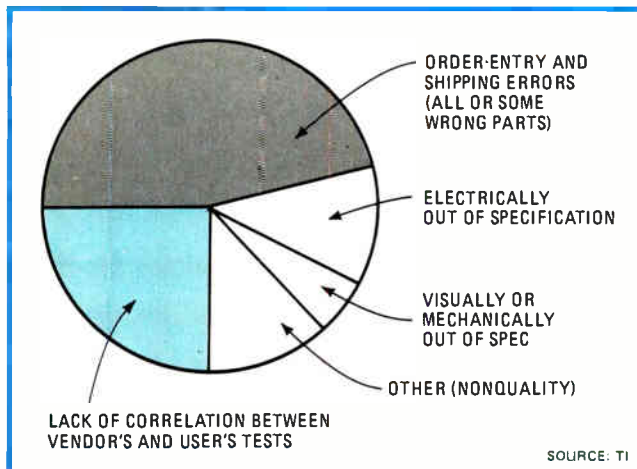

5. Unnecessary returns. A pie chart of customer returns for 1980 from TI's low-power Schottky department shows that the two largest causes of returns are lack of test correlation and clerical errors. All IC firms are working to reduce or eliminate these problems.

level test, running test patterns, and noting the different margins with respect to timing and voltage levels at various data points, then backtracking and duplicating the same procedure at the component test level.

"We need to resolve correlation issues with our customers as well," Smith continues. "If we can correlate our component tests with their system tests, the solution to improved quality can be achieved much quicker. There's no reason for the customer to 100% test incoming units. One of us, obviously, doesn't have to test them." Further, he notes, such can be the case if the customer and vendor build trust in each other.

At TI, test teams have been established specifically to deal with the correlation problem. For example, in one case involving the TMS 1000 microprocessor, a customer (a nonelectronics firm) was actually furnished functional test sets for his incoming lot acceptance, thus minimizing differences in their test results. In another TMS 1000 program, TI found that many of the customer's returned parts had failed from electrostatic discharges. In this case, TI actually educated the customer in proper handling procedures.

Eliminating discharge

TI's case history of customer returns caused by electrostatic discharge is by no means unique. For instance, many burn-in failures actually are due to electrostatic damage associated with the additional handling required by burn-in testing.

Steven Halperin, executive vice president of Analytical Chemical Laboratories, Elk Grove Village, Ill., points out that electrostatic-sensitive semiconductor devices are in danger at many areas—at the component manufacturer's test area and shipping facility, in transit, at the customer's incoming inspection and testing, at the customer's burn-in, on the assembly line, and finally in the field. Poor receiving control, poorly designed control procedures during production and testing, inadequate packaging, and lack of customer education are the root causes of electrostatic damage.

Halperin notes that, over all, the U. S. electronics

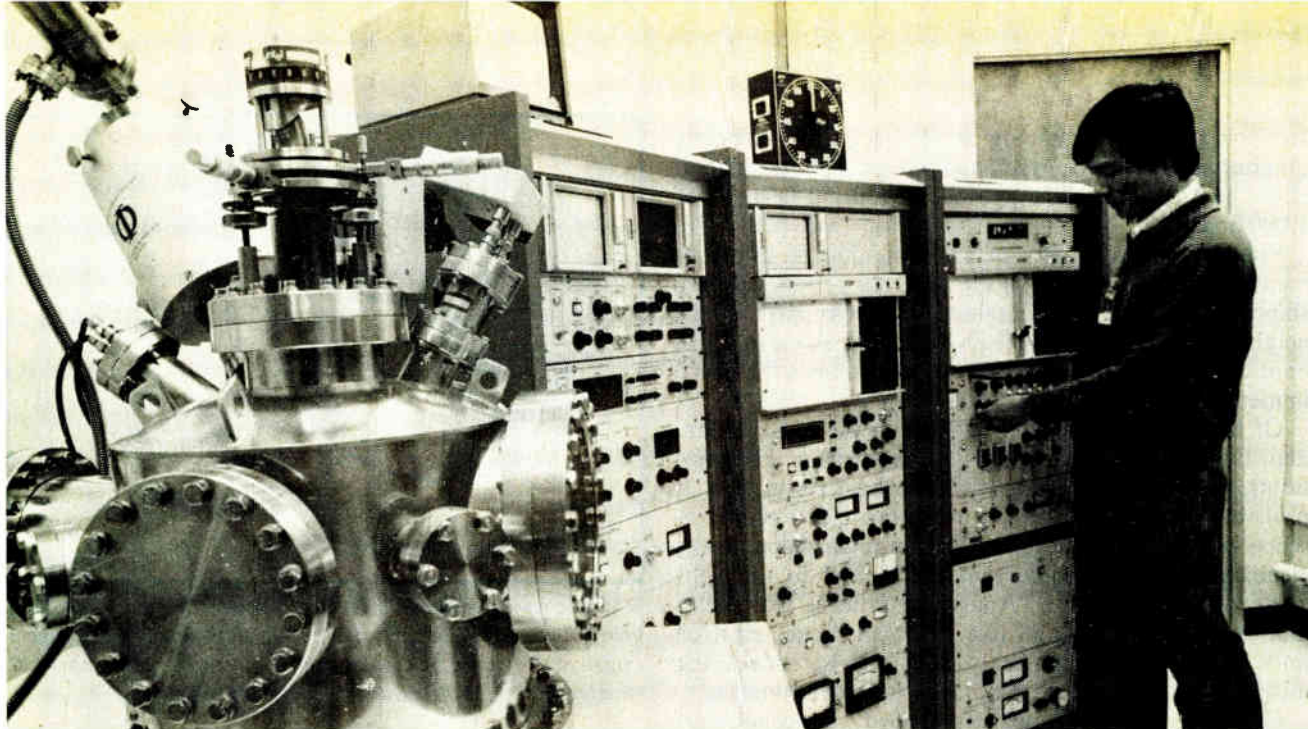

6. Trace detector. Intel uses this Auger electron spectrometer to detect trace elements on the surface of ICs and their packages. Its ultrahigh-vacuum system provides clean conditions for detecting concentrations as low as 1,000 ppm within the top few atomic layers.

industries are averaging losses amounting to 10% to 18% losses daily because of static. Over a year, that comes to a total of about \$10 billion worth of electronics lost, reworked, or serviced.

At the end of every test position in large IC manufacturing facilities are test handlers that sort out different grades of good devices, plus out-of-spec and failed devices. Formerly, the accuracy of the handlers was completely neglected, but now TI, National Semiconductor, and other firms are paying more attention to this simple task.

As W. T. Greer, operations manager of TI's low-power Schottky department in Dallas, points out, "Missorting of tested devices is a major cause of defect levels perceived by the customer. Commercial test handlers currently used by TI have missorted up to 1,000 ppm [equivalent to a 0.1% AQL]."

Because of this situation, TI has devised its own test handler. Designed to absolutely not missort, it will be in place by midyear.

National Semiconductor lowered its outgoing rejection rate for digital ICs to 0.1% in 1980, owing mostly to the use of automated assembly and bonding. However, according to Tom Griffiths, the firm's vice president for quality assurance and reliability, "we found that the device handlers would occasionally malfunction and not drop a part into the appropriate sorting bin after the device was tested. Now we have a sensor that shuts down the handler if the part doesn't make it into the appropriate bin."

Temperature testing

The Japanese have been temperature testing and burning in their ICs for some time, and that is one factor accounting for the high AQLs of these devices. In general, most U. S. firms were not following these procedures until recently. Now they are instituting programs to do the same thing for all digital parts.

For instance, one of the 12 points of General Instrument's quality program is testing at rated temperature. Here, 100% final testing will be done at the specified test temperature limit, and earlier, where technically feasible, the wafer will be probed at the same temperature.

At Intel's Special Products division in Santa Clara, approximately 10,000 devices per week are dynamically burned in to maximize the infant mortality rate. This test, which exercises the parts at elevated temperatures, typically accelerates oxide-breakdown failures. Often, potentially defective devices are also screened out by a cell stress test that raises the power supply and input voltages to much higher than normal levels and exercises the device with a standard pattern for a second or two. High-temperature bias testing similarly helps screen out potential defective parts.

A few U. S. companies like Mostek Corp. and Motorola have programs involving double testing. For instance, Carrollton, Texas-based Mostek has initiated what it calls a Q-flow on a small portion of its 4116 dynamic RAM process to produce the highest-quality parts regardless of cost. Robert B. Palmer, vice president of manufacturing, says that the Q-flow "has redundancy throughout. Everywhere you would do one burn-in, you'd now do two." Many of the Q-flow redundant tests will eventually be eliminated, he says, since the second test is often less stressful than the first.

Motorola's quality assurance staff continues to devise more rigorous screening and testing, too. One experimental program instituted for operational amplifiers and regulators doubles the screening for standard parts. After the usual 500-piece sample of a full lot has been subjected to tests at dc, ac, and three temperatures (-55° , $+25^{\circ}$, and $+70^{\circ}\text{C}$), half of the entire lot is screened at high temperature and half at dc; then a 500-piece sample from each half is run through all the dc, ac, and temperature tests. The result is a 50% reduction in defect density.

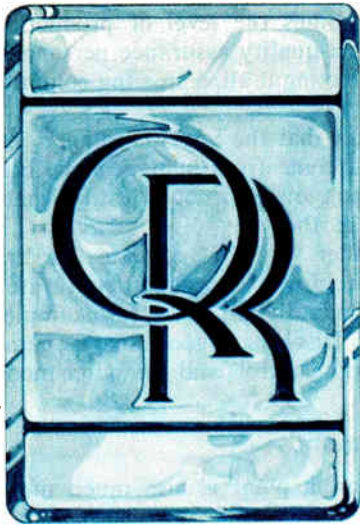

Part 2: Makers organize for quality

At every stage from design to delivery, component makers are reexamining their operations and reorganizing them for quality

An assortment of organizational structures is being tried to imbue the U. S. IC industry with the "build it right" precepts of the quality culture. Some, at companies like American Micro Devices and Fairchild Camera & Instrument Corp., are modeled on the Japanese quality-circle concept. Some are based on the work of Philip B. Crosby, whose book, "Quality Is Free," outlines the benefits to be gained by emphasizing quality in manufacturing operations, as well as presenting an organizational approach for achieving it. Other approaches, at the likes of Intel, RCA's Solid State division, GI's Microelectronics division, Harris Semiconductor, and Analog Devices, have been in place for so long, according to the companies, that they are taken for granted.

Texas Instruments, for one, has developed a matrix approach that attacks quality problems by bringing together people from different disciplines. Quality is achieved through a blend of a teamwork and individual incentives [*Electronics*, March 24, 1981, p. 95].

Different cultures require different approaches, points out TI's Morris Chang, whose operations in the Far East have implemented quality circles with great success. "We do not think quality and reliability are as much a part of our system and part of our [American] culture as we want them to be. I think that, typically, many Japanese companies have so far relied on a national characteristic. They have done good things with it. But I have a feeling that the direction we [at TI] are going in will leapfrog them."

Quality teamwork

TI's team network covers everything from technical and administrative areas to fostering an awareness of quality among workers at all levels. The plan also boosts quality incentives by offering higher pay for skilled workers in critical processing operations. In addition, the company began grading managers on quality performance—in many cases, 30% of a job review hinges on the ability to meet specific product-quality goals.

TI officials are pointing to the Digital Circuits division as having the most developed quality-team network in the corporation. The division, which inaugurated the program at TI in April 1980, maintains six functional

teams serving its seven profit-and-loss centers, called product customer centers (PCCs). The functional teams are: product and process design; front-end; assembly and packaging; testing; customer service (nonelectrical); and, for education and awareness programs, quality culture.

These teams consist of representatives from each of the division's PCCs, as well as quality assurance officials, says John S. Wiley, who is coordinating the division's program. "Those teams also include people from central organizations, like the company's test-equipment design group," he explains. "They normally meet once a month. Each team may have subgroups, which will meet more frequently on specific problems—they are also specialists. So you've got the top people from across the company on these teams."

Open up channels

Wiley says that the No. 1 purpose of the teams is to establish formal channels of communications among PCC operations: "PCC members communicate with each other and generally do things like find out what one group may be doing to solve quality problems. That keeps a PCC from going off and reinventing the wheel."

"Another function of these teams is to formulate policies for improvement," he adds. "Once they've kicked around a problem, they are then chartered to go and define what the plan is to solve it."

At Motorola's Semiconductor Group, top managers are also the force behind a quality program that not only is changing the physical look of the plants but also is trying to radically reorient workers' attitudes. The objective is an Americanized version of the Japanese approach to quality, of which the quality circle is only a fairly small part.

The technology of improving quality is not being downplayed by any means, but manager after manager at Motorola points out that technology is not the key issue, because most U. S. firms are the equals of the Japanese in that respect. It is in the contribution of people that Motorola has fallen behind, and that was not recognized until 1979. It showed in the high turnover, absenteeism, and lack of interest of its labor force. These problems translate into very high training costs, lost

production, and lower product quality. Motorola's management realized that they had to be addressed if the goals for 1980 were to be met.

"The quality issue permeates the entire Bipolar IC division," says Henri A. Jarrat, division vice president and general manager. The most important aspect is "our people, to whom," he admits, "we were not very attentive in the past."

Get them involved

What must be done, say Jarrat and Joe Flood, the division's director for reliability and quality assurance, is to change workers' attitudes, get them involved, give them a reason to want to do their best work. Breaking down the barriers that currently exist in order to get this involvement was, in the broadest sense, Motorola's goal.

Specifically, 20 months ago the Bipolar IC division began putting together a program based on three levels of teams in each product line. The most important is the lowest level, the direct-labor employees with similar jobs, who talk over their work, ask questions, belly-ache, and make suggestions for improvements. This is the level that must be instilled with the spirit of participation and

problem solving. Next comes the level of production supervisors, engineers, and quality assurance personnel; then, monitoring and directing it all, a steering committee.

Motorola officials admit that the impetus to keep the program going must still come from management. But results in quality and much lower turnover justify whatever it takes to forge ahead, they say.

Programs are also under way that educate workers about where they fit in the flow of a product from wafer fabrication to end use. Many did not know, for example, where their devices went. Displays of goods like General Motors cars with electronic controls and computer modules were brought in.

Improving the environment

The look of the Motorola plant is also much more pleasant than two years ago. Recruiters can start selling the same campuslike setting that Silicon Valley firms have, company officials claim. Instead of drab walls and a warehouse appearance, bright paint and large graphic presentations are splashed throughout.

Also aiding participation in improving quality is the

A view from an American in Japan

For Western manufacturers with plants in Japan, the lessons learned and the perspective gained from doing business there are indeed valuable. According to Jim Adams, president for the last four years of TI Asia Ltd. in Tokyo, Japanese manufacturers, including his organization, find it easier to achieve high-quality products than the average U. S.-based firm. There are a number of reasons for that, says Adams, who joined Texas Instruments Inc. in 1959 as a quality engineer before going to Japan in 1974 as operations manager for its Japanese subsidiary.

He cites the nature and dedication of the people to quality, as well as the high average level of education of production-line workers. New college graduates, for example, may be used initially as senior technicians and then as junior engineers, he points out, making for high-quality personnel in those positions and, eventually, engineers with plant experience. Moreover, a lower turnover in Japan than in the U. S. promotes higher average experience, also conducive to higher-quality output.

In addition, Adams says a quality discipline tends to be important in all functions, not only for persons responsible for quality control. Generally, there also is more testing all along the line and more rigid testing at that, he continues. Furthermore, Japanese manufacturers make extensive use of so-called leading indicators of semiconductor failure, and they tend to have more demanding customers.

Although many persons look for technical advantages to explain Japan's reported higher quality, Adams does not see it that way. Most of the reasons are strategic rather than technical. The emphasis on long-term rather than short-term results is important, too.

The Japanese are not doing anything that could not be done in the U. S., Adams says, but it may be easier for them to buy expensive production equipment. That is indicated by reports that the semiconductor industry's capital investment this year will be \$920 million, about 15% more than last year, despite a relatively flat total market. Japanese companies are using more domestically

produced equipment, but they still buy a significant amount of advanced American equipment such as direct step-on-wafer aligners from GCA Corp.

Adams observes that the Japanese tend to use very rigid criteria to place designs safely within product specifications. Also, they tend to be more conservative on product layouts, whereas in the U. S. the drive is to smaller chips with higher technology. In addition, when the Japanese second-source a product, they usually upgrade performance or add something extra, he notes.

A large proportion of the strong Japanese competitors are part of vertically integrated companies that are both manufacturer and user. Thus the manufacturer has not only a very good but also a very demanding—and communicative—customer, and this relationship tends to drive quality up. Feedback provides better understanding for both manufacturer and customer.

Adams says that people in Japan have looked for a number of years on quality improvements as a means of reducing cost. In general, he says, high yield and high quality tend to generate high reliability.

If, instead of screening out parts that do not measure up, a process is modified in order to meet specifications, higher yield, higher quality, and lower costs should result. Since higher yield tends to go along with higher quality, a situation exists in which the product engineer, manufacturing engineer, and quality engineer all have the same goal.

Adams notes that TI Japan, as it is called, has used the number of failures in 10⁹ device hours (FIT) for a good while to express reliability and that this measure works with quality levels expressed in parts per million rather than as acceptable quality levels (AQL) expressed as percentages. However, he says that the switch to ppm is primarily motivational.

Finally, he points out that he does not know any firm in the Japanese IC industry that tests only samples. All of them test 100% at least once.

-Charles Cohen

7. Guiding force. At Motorola's Bipolar IC division, vice president Henri A. Jarrat gave direction to a quality program aimed at a sweeping reorientation of the worker culture. Now, he says, "the quality issue permeates the division."



monthly competition between product groups. These are played up with trophies and awards.

To date, about 1,000 division people have gone through training and are at some stage of being phased into the programs. The goal is 2,000 by year-end, out of 3,300 in the division.

Major successes of a quality-awareness program in one of its wafer-fabrication areas, known as FAB II, encouraged Mostek to broaden its quality team program to involve employees on all levels, from the chairman's office on down to the line worker.

The initiative for the company to get its quality act together came from the top. As early as 1977, Mostek's founder and then-president, L. J. Sevin, identified the importance of quality in meeting Japanese competition. He also recognized the fact that upper- and middle-level managers had to be committed to the program for its success.

One Mostek executive remembers that when Sevin was at Texas Instruments during the 1960s, line managers made jokes about the zero defects program pushed by Government contractors. "There was little understanding of cooperation and the program was sabotaged," he reports. "L. J. told us that if he found anyone at Mostek undermining his quality program, that person was gone."

To speed up the process of introducing its quality program, Mostek last year sent 103 executives to an organization called the Quality College. Located in Winter Park, Fla., it is part of the services of Philip B. Crosby Associates Inc. Crosby, a consultant on introducing quality consciousness into organizations, says in "Quality Is Free" that it is profitable to do things right the first time, and his message is getting around (see "Quality pays," p. 140). At a total cost reaching about \$2,000 a student, it was expensive. But it was worth it to Mostek, which wanted to get its quality program off and running quickly.

Going to college

Bob Donnelly, Mostek's director of quality, notes that production managers were not the only Mostek officials to attend. Finance, design, and indeed all of the company's operations were represented.

In his view, "instead of some central productivity or quality group, it [the program] has got to be administered by each manager so that it will take off under his direction. Otherwise he will be waiting for someone to do it for him."

Asked why Mostek did not just require managers to read "Quality Is Free," Donnelly responds: "It's like reading a diet book and then putting it down. I'm not saying that you cannot be motivated by a book to improve quality, but we felt that it takes a little more to get a large program like ours off the ground."

Teaming up

Awareness teams, organized by operation areas and containing from 5 to 30 people, now meet once a week at Mostek to discuss ideas for higher quality. The teams are backed up by special engineering task forces, created on the spot to solve specific problems falling outside the awareness group's area. Once the problem is taken care of, the task force is dissolved.

The teams, though voluntary, now cover all operations in the corporation. Once a month, they view video-taped quality messages from top management that Mostek chairman Charles V. Prothro believes are essential for making management highly visible in the quality push. Such management visibility is one of Crosby's first rules for a successful program.

The quality-awareness drive on the FAB II line predated the Quality College program. Tony Jurvetson, then the line's manager and, as a result of its success, since promoted to general manager in charge of the fabrication area, read Crosby's book, bought several copies for his supervisors, and formed quality teams.

Initially, FAB II teams were primarily concerned with reduction of waste and reworks, says Jurvetson. "The team discussions were later expanded to cover reliability, and now anything that's bothering the employees can be discussed. Other things also began to happen. Turnover dropped because many felt they at least had a say in what happened to their work environment."

Money talks

However, the biggest selling point was the money saved because of the quality program. Donnelly says that the cost of quality can equal 25% of Mostek's total sales dollars. "Some are looked upon as good costs—like testing; others are negatives—like scrapped and reworked parts. Unless you do this parallel accounting system, you can never put things in their right perspective. We are just beginning to appreciate the value of it."



Motorola in Phoenix is one of a host of U.S. electronics organizations, semiconductor makers in particular, trying versions of the quality-circle

8. More spirit. For Motorola's Joseph L. Flood, the road to quality lay in changing workers' attitudes, getting them more involved, and giving them reasons for wanting to do their best work. The effort, he says, must be continuous.

Quality pays

Quality may be free, as Phil Crosby believes, but it is also paying off handsomely for him as clients beat a path to his door to hear his ideas. A self-styled "quality professional" for 28 years and the author of "Quality Is Free," Crosby says that his consulting group, Philip B. Crosby Associates, and the associated Quality College, both in Winter Park, Fla., have never been busier since their startup in mid-1979. Their charter is to consult on and teach quality for all kinds of businesses.

Crosby went out on his own after a 14-year stint as corporate vice president charged with instituting quality programs throughout ITT Corp. He is credited with the zero-defect concept applied in the 1960s at many electronics manufacturers, as well as the idea that quality is free once its cost is offset by the cost of making up for poor work.

Crosby now has some 70 organizations "in a lot of industries" as clients, half of them in the electronics field. Others, like Texas Instruments, Analog Devices, and Hewlett-Packard, have bought copies of his book—which is immensely readable—and are studying it avidly.

Things have changed since he got into the quality field. "The big difference now is that the senior management at many companies is taking charge of quality," he says. "Management is realizing that quality is too important to leave to the quality assurance people alone."

The important point to recognize is that quality is not "goodness and desirability" but performance that meets requirements, he continues. That is why he would say a Cadillac and a Mustang both can be thought of as quality products—if they each meet their own specifications.

"Traditionally, electronics companies have set quality levels as varying degrees," he says. "That is no longer acceptable, because you wind up with a lot of parts that are not so good. Companies should decide on specs and try to meet them. Management must establish requirements clearly."

Crosby blames management squarely for poor quality. "Until senior management stops supporting 'quality levels' and insists on getting things done right the first time, there will be no sincere corrective actions, only patchwork."

In the semiconductor field, the cost of solving quality-related problems can mount to as much as 50% of sales, he asserts. "That's why the best way to increase profitability is to increase quality and productivity."

At the Quality College course, which lasts several days and can cost more than \$1,000 per student, Crosby will start with top management and establish clearly in their minds the importance of quality and how its costs can be measured. In his book he outlines a 14-step quality-improvement program that goes from items like obtaining a commitment to quality, forming quality teams, and ways to measure quality to setting goals, recognizing those who meet the goals, and step No. 14, doing the whole thing all over again.

The typical program at a company takes anywhere from a year to 18 months to implement, according to Crosby. By that time, turnover and changing situations will have wiped out much of the education effort. "Repetition makes the program perpetual and thus part of the woodwork," he says. "If quality isn't ingrained in the organization, it will never happen."

-A. R.

approach [*Electronics*, Dec. 4, 1980, p. 95]. Some are introducing quality-circle ideas they found successful in their Far East operations. Almost all have adopted their own variations, and their own names, as they try to arrive at a system that meets their particular needs. Motorola's MOS operation in Austin, for example, has its Participating Management Program; National Semiconductor refers to its "circles concept" and "quest groups"; and Signetics and American Micro Devices rely on, yes, quality circles and quality teams.

Speak up

The aim of each program is to encourage employees to discuss among themselves and with supervisors problems they encounter in the workplace. Line workers—and managers and executives, too—are encouraged to take on greater responsibility for building quality into products. Education about the costs of nonquality is also important. So is mutual trust and loyalty between workers and the company. And management makes every effort to heed the suggestions of workers when it makes sense to do so.

"We want to let them know that management will either back their reasonable, rational solutions or give them a solid reason why it won't," explains D. C. McKenzie, director of corporate reliability and quality at Signetics. He also points out that the company provides its quality teams with training and tools for dealing with reliability problems. These include courses in statis-

tics and cause-and-effect analysis.

So far, the groups, ranging from a handful of people to 20 or 30 in number, are reported to be producing good results. Morale generally increases, and so does the quality of parts produced.

There are some companies, besides Texas Instruments, with experience in quality circles in the Far East that fear moving too fast in introducing quality circles to the U. S. "We're trying to understand the concept before proceeding," says Electronic Arrays' president, Charles Wood. Indeed, EA's parent, Nippon Electric, has encouraged its U. S. subsidiary to go slowly in implementing the circles. "We don't want to jump in too quickly, fail, and have to start all over again," Wood explains.

Recruiting aims higher

Attracting better-educated people is also receiving attention. Texas Instruments, for instance, has gone to the colleges for production-line workers. Students, majoring not only in technical subjects but also in liberal arts, are told of the company's quality push and of the importance it is placing on its wafer fabrication process.

Front-end workers, whose skills are regularly certified, must maintain low absenteeism and are paid an average of 10% more than employees in other operations. Productivity has climbed: based on parts per man-hours, throughput has increased 19% and yield has climbed 33% in the Digital Circuit division between the last quarter of 1979 and the end of 1980.

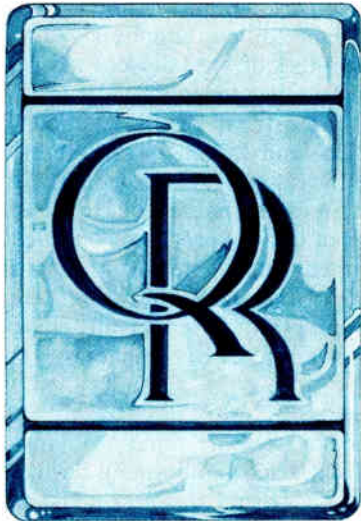

Part 3: Users push for quality

Meeting the upsurge in demand for quality calls for new and closer relationships with suppliers, equipment makers find

Equipment manufacturers became aware early on of the "cost of nonquality," as RCA Corp.'s Solid State division in Somerville, N. J., explains it to its employees. That is because an equipment maker's expenses are so much greater when a faulty part passes incoming inspection only to fail on a circuit board, in a chassis, or worst of all, in a customer's computer or automobile. Costs of repair or replacement go up dramatically as the part moves further along in the manufacturing cycle.

The concern for quality caught on first at equipment makers partly as a reaction to the example set by the Japanese. Certainly, a quality product helps a company compete. To that end, for example, the computer service group at Hewlett-Packard's Computer Support division, Cupertino, Calif., introduced its Guaranteed Uptime Service in December. They promise that if the computer system is not operating 99% of the time over a 24-hour day, seven days a week, the customer need not pay the service fee for that month.

Betting on quality

At the other end of the scale is a small company like IMS International Inc., a Carson City, Nev., maker of microcomputer boards. It had sales of \$8.5 million in 1980, and it expects to double that this year. IMS recently put itself on the line with a two-year warranty on all products, decidedly more impressive than the 90-day warranty usual in its business.

"We believe that if we use the best components available and insist on the highest possible standards for both engineering design and manufacturing, a two-year warranty is economically feasible," says Don Lehr, president and cofounder of the firm. From an installed base last year of almost 30,000 boards, only 116 were returned for repair or replacement—and some of these were found to be functioning properly, according to Lehr.

"In many companies, top management preaches quality, hangs up banners, and gives pep talks for the first 12 weeks of each quarter. But the pressures of meeting quarterly shipping quotas or earnings forecasts can cause this attitude to change during the final week," Lehr says. He believes that these shifts cause a tremendous amount of frustration and confusion for workers and avoids it.

Engineering design is another key element. For example, IMS uses sockets for ICs, although the popular belief is that sockets not only raise costs but decrease reliability as well. "There is a vast range of socket quality that is not obvious from skimming manufacturers' spec sheets," he says. IMS spends a lot of time choosing reliable sockets. As a result, stuffing errors can be corrected and defective ICs changed at the test station, eliminating a rework step. Also, field repairs are greatly simplified. Moreover, overall product reliability actually increases because ICs are not subjected to thermal stress during soldering, Lehr points out.

The company's design philosophy is to perfect a circuit and then use it wherever possible in its product line. Manufacturing people get to know boards very well when they see them year after year, Lehr says. And assemblers know that if everything is not just right, the job will be rejected.

As for ICs, "today nobody beats the Japanese when it comes to manufacturing memory products," IMS's cofounder, Al Fiegehen, believes. "Our failure rate on incoming test of C-MOS chips is less than 1 in 5,000. However, there's been a noticeable improvement in domestically manufactured C-MOS in the last six months. We've begun buying more of it."

Keeping track

Although, as Fiegehen points out, it is impractical for IMS to test extensively at the part level, it can follow its semiconductors closely. It knows the failure rates for each vendor's part at the board level. Each board is tested to the full temperature cycle and any failed component identified. If memory failure rates drop to 1 in 500 (from the usual 1 in 5,000), that is grounds for dropping the vendor, and this has occurred.

"I guess we have a luxury bigger companies don't have," says Fiegehen, smiling. "If something's not right, we stop everything and correct it."

Just how expensive poor quality can be was discovered a number of years ago—for example, by Hewlett-Packard. In the wake of an analysis of its operations, "we estimated that 25% of all floor space, one third of our manpower, and half of our inventory were needed

because of bad quality—that is, not doing things right the first time,” says Raymond M. Demere Jr., vice president for corporate manufacturing services in Palo Alto, Calif. This unnecessary overhead involved office workers, field sales personnel, and product development and manufacturing operations, among others. “We realized that we could free up a lot of assets if we all concentrated on doing things right the first time.”

Until recently, most managers viewed quality as a “housekeeping, rather than a strategic, activity. But they are beginning to change their minds,” notes HP’s corporate assurance manager, Paul Baird. “They are beginning to see that they can make tremendous strides in profitability if they improve quality.”

Baird is speaking, of course, not for HP managers alone but for the electronics industries in general. These industries are coming to realize that doing it right the first time saves money. That is not the only goad to top executives, however.

“I’ll be frank and tell you two reasons why we are demanding higher quality,” says James Cogan, vice president of computer systems at Datapoint Corp., San Antonio, Texas, a maker of small-business computer systems. “One, there is a lot more competition in [our] industry, and customer service and quality are becoming key sales techniques. People are looking for products that are going to work. Two, electronics customers like us are getting more knowledgeable about integrated circuits, and with that growing sophistication we are able to say, ‘We demand quality.’”

Another reason for the increasing desire for quality ICs is the shift to VLSI devices. “We can’t afford to put in the equipment necessary to test the very complex VLSI

circuits,” says General Electric’s Manuel Hunter “We will have to rely more and more on our suppliers. Complexity and growth in the number of VLSI devices we use will mandate essentially perfect components.”

In January, Hunter returned from visiting semiconductor companies in the U. S. and Japan. In every case, he says, he found that significant strides had been made in implementing programs to improve quality. He bases that judgment on the types of quality programs outlined by the semiconductor company managers and the data on the parts produced that they are collecting. He expected the good quality programs in effect in Japan. But he also likes what he saw at the U. S. companies.

How GE handles it

Though General Electric now sees the situation changing in the United States, frustration in obtaining devices was particularly keen at its Television Business division. “We made a swing to all our semiconductor vendors a couple of years ago and we told them we were serious: we want quality, we need it, we’re willing to pay extra to get it,” recalls the division’s manager of quality control, Fred Aaron. “‘Get with it,’ we said. ‘The Japanese are beating your socks off.’”

“The guys really didn’t act as if they had heard us. Typically, we might get a marketing guy to come in and tell us a lot of good things, but we never saw any action. Some guys just said, ‘Forget it,’”

According to Aaron, Japanese quality levels are even now 10 times better than U. S. levels and 15 times better than the European. He speaks of levels across the board for the range of active components the division uses. These parts include microprocessors, complex linear cir-

Tracking failures by the thousands

One of the more extensive systems for keeping track of failed components is operated by the Direction Générale des Télécommunications, the government agency that runs the French telephone network. A computer system analyzes hardware failures of transmission equipment and switching gear throughout the network. It spots, among other things, failure modes and substandard performance down to the component level. By comparing actual with predicted rates, the DGT gets an early warning on potential rashes of failures.

The system started up three years ago at the Lannion, Brittany, facility of the Centre National d’Etudes des Télécommunications, the research establishment of the DGT. It has since been turned over to the long-lines operating division and has proved so successful that the CNET is developing a second one just for switching gear. The initial system will then be used only for transmission equipment.

Code-named SADE (for *Système d’Analyse des Défaillances en Exploitation*), the existing system employs a Solar 16 minicomputer with disk storage of 200 megabytes, produced by the SEMS division of Thomson-CSF. It keeps tabs on 6,400 types of printed-circuit cards at 1,900 locations. These contain up to 2,000 different components used in 60,000 circuit-board part designations.

Raw data for SADE comes from out-of-order reports that DGT maintenance men or equipment suppliers file every time they make a repair. The reports identify every

piece of equipment, its location, the faulty circuit card, and the culprit components. Failed integrated circuits are shipped to the Lannion facility so that the causes of failures can be diagnosed.

SADE sifts and correlates the raw data in many ways exploiting some 60 programs to do so. It can total all the faults at a geographical location, for example, or all the failures for a component type throughout the system. It can even compare the performance of identical circuit cards made by different suppliers.

In some cases, the printouts trigger procedures painful for suppliers of below-par equipment. So far, the most startling example involved a simple bipolar circuit having a complexity of some 20 gates, used extensively in a digital transmission system. Approximately 3,000 of the packages failed within two months. The CNET traced the trouble to inordinately high phosphorus doping, which led to corrosion of the metalization layer because of humidity leakage into the plastic package. The fault, then, stemmed from the semiconductor maker’s process, meaning every one of the packages was a candidate for early failure.

The equipment maker in this instance had to replace 300,000 packages on 22,000 circuit boards, and the semiconductor vendor was struck off the DGT’s list of approved suppliers. But with the fault pinpointed, the supplier was able to alter the process and since has been returned to grace.

-Arthur Erikson

circuits for things like chroma control and intermediate-frequency strips, simple operational amplifiers, and frequency synthesizers.

Aaron continues, "As a TV set manufacturer, we came to recognize earlier than others that our Japanese competitors were winning on quality. We didn't make any progress until we recognized that."

Expensive solution

GE solved its quality semiconductor problem in two ways. First, it decided to test all incoming parts itself. "We got into testing everything ourselves and it was very expensive. We put money into things like burn-in ovens, automatic handling equipment that tested at high temperatures, temperature cycling. At the same time, we were also aging our completed product, the TV receiver. The testing itself was expensive: power costs kept going up, and we had to have an enormous inventory."

General Electric also moved toward Japanese and away from U. S. suppliers. "You hear about them dumping, but they're not. True, you may get a better price, but you get the quality edge to boot," Aaron says. "We try to get our engineering to design in the Japanese devices where we can, because from a manufacturing standpoint it's a lot cheaper."

He continues: "We ourselves have taken millions of dollars away from U. S. vendors. But we still do a lot of business with them because they have a lot of things we can't get anywhere else." He singles out items like control systems, where, he says, the U. S. and the Europeans tend to be more innovative. "But it's costing us. We're 100% testing them, and in some cases we're also paying for high-reliability testing. We don't 100% test any Japanese device."

For General Electric, its decision to obtain high-quality parts for its TV sets has had a striking effect. "We turned our image around and doubled our market share," asserts Aaron. "The sharper IC guys are picking up on this. We see even our problem suppliers getting a lot more serious."

Interestingly, he points out that GE often paid a premium for high-reliability screening by U. S. vendors, and "in many cases we still had to 100% test ourselves, because we weren't getting what we paid for." He also says that there is never a correlation problem between GE's and its Japanese suppliers' tests, although it does turn up with the American and European firms.

Measure up

GE also has a new way of dealing with its suppliers, Aaron says. "We're not even talking to these guys in terms of what their contract is. We're doing a comparative thing. We can measure them and say: 'Hey, I've got three suppliers, same product. Two of them are giving me 550 ppm; you're giving me 2,000 ppm. Why should we buy from you?' And if he says, 'But the contract says I only have to give you 3,000 ppm,' we say, 'So what? Look, you're way up here. Do you want to come along with us or don't you?'"

Aaron is encouraged by what he regards as a recently changed attitude on the part of U. S. semiconductor manufacturers to reach for quality. "We've got as much



9. Less overhead. Doing it right the first time was the way Raymond Demere Jr. predicted Hewlett-Packard could free up a lot of assets.

ingenuity and technology as anyplace else in the world," he says. "Once the [American] managers get turned on and understand that their performance is being measured on quality as well as on cost and quantity, they'll adjust. They'll figure out how to do it. They've got the talent. Quality just hasn't been perceived as a real issue until recently."

Also pleased by what he sees is Achille Pollino, director of the qualification and receiving department of Control Data Corp., the mainframe computer and peripherals manufacturer in Minneapolis: "In the past, I've always had to push the U. S. suppliers to establish aggressive goals [for quality]. But now, I don't have to push them anymore. They've all got very aggressive goals and they're telling me where they're going to be year by year in parts per million and how they're going to do it. They also have programs already set up. They're talking about being in the neighborhood of 20 ppm or less by 1985." Indeed, Pollino says that one U. S. semiconductor maker is talking in terms of a long-term goal of 1 ppm.

Control Data actually kicked off a zero-inspection program only on May 1. Directed by Pollino, it initially

Parts screening can be elaborate

The systems for screening incoming parts by high-volume semiconductor users are becoming elaborate. Such is the case at Japan's top maker of industrial measuring instruments, Yokogawa Electric Works Ltd. With sales in the hundreds of millions of dollars, the Tokyo firm buys about 10 million integrated circuits per year, including gate and logic circuits, read-only and random-access memories, microprocessors, and linear ICs. Buys from the U. S. fluctuate between 20% and 30% of its total.

All incoming components are inspected visually and mechanically, largely to make sure that no extraneous parts have found their way into the lot. After screening, the parts are electronically tested according to MIL-STD-105D. This procedure provides tables designating appropriate sampling rates based on lot size and quality standards for various functions. For parts categories with relatively many rejections, Yokogawa uses the "severe" chart, which essentially calls for higher sampling rates; for categories with normally very high quality, it uses the "loose" chart. For all others, it uses the "normal" chart.

Yokogawa also tests different part functions at different frequencies, depending on how critical the function is. For ICs, for example, its standard is a 0.1% failure rate for critical functions, 0.65% for lesser functions under dc tests, and 1.0% for lesser functions under ac tests. An example of a critical function is noise level in linear

devices. Any lot of linear ICs whose test samples show more than 0.1% failure is rejected.

Components for common usage are then logged into an inspection data file and sent to the warehouse. Those requiring especially high reliability—as for instrumentation destined for explosives plants, process control systems, or atomic power plants—are completely reinspected. In addition, they are subjected to various high-temperature or shock treatments or both, depending on their application, before being completed visually and, for a third time, electrically inspected.

About once a month, company officials meet separately with representatives of each supplier to review parts defects turned up by Yokogawa's screening and testing process. The maker subsequently examines each defective item and submits a report to Yokogawa. Hideyoshi Tsubota, manager of the incoming inspection group at Yokogawa's quality-control and administration department, volunteers that the defects sometimes are caused by poor handling at his firm.

"One reason we don't buy more from foreign suppliers is that regular information exchange is very difficult," Tsubota says. "Also, U. S. makers don't give us sufficient [failure] analyses. Japanese makers, on the other hand, are very detailed in their analysis."

**-Robert Neff,
McGraw-Hill World News**

involves only one of the 12 domestic divisions that Pollino's department services. Eventually it will be phased in for all divisions.

Using selected parts and vendors with a strong quality history, receiving inspection will be eliminated entirely. Instead, defective components are being analyzed for their modes of failure when detected on the manufacturing floor at the board-checkout, system-checkout, or product-testing level.

Down an order of magnitude

In 1981, the goal is 200 ppm for as many device lines as possible. By 1985, Pollino wants to move to 10 to 20 ppm. "We're phasing nicely into parts per million now, instead of using AQLs and lot acceptance as the performance criteria," he says. "We're not talking about how many lots are rejected or accepted, we're talking about how many bad devices you have in a million parts that you shipped me.

"In the past, when we did it on the lot basis, we might reject a lot that had 2% defective devices or it might have 50% defective parts. We're changing the way we're thinking, and I feel that that has been brought about by the Japanese."

In April, Control Data met with its two top vendors to learn what levels they were achieving on certain product lines. It will now verify the levels by testing 10,000 to 30,000 devices. If these tests show that the vendors are at the level of 200 ppm or less that they claim, CDC will forgo incoming tests on those devices unless certain agreed-to thresholds are reached. For example, if a device type is running at 200 ppm and it jumps to 1,000 ppm for a particular week, both the vendor and CDC will

take certain steps. (The 200-ppm goal refers to a part's meeting electrical specifications, not visual and mechanical specs, for which there is another ppm goal.)

"Maybe for the next two weeks the vendor is going to have to look at it more closely. If he's still at 1,000, then maybe he'll have to do more inspection until he finds out what the problem is and solves it," Pollino says. When necessary, receiving inspection on a device will be resumed until the problem is corrected.

Control Data will also do occasional audits. In these, two or three lots of a particular device will be pulled for 100% testing to see if the vendor is actually meeting the ppm commitment.

As the new system is phased in, the old one will continue in use for a number of device types. Correlation of CDC's test results with the vendors' for the ppm system will take time, and new devices will require receiving inspection until a quality history can be built up.

Learning from history

In some device lines where the confidence level is high enough in view of the history of a part, Control Data is already skipping electrical testing on some lots. When a device type passes the 0.1% AQL requirement for 20 lots in a row, CDC automatically goes to testing only every fifth lot on that particular device from that vendor. If the fifth lot fails, the company goes back to full testing until the part makes the level of 20 in a row without the failure of a lot again, according to Pollino.

With this approach, Control Data saved 31% in testing costs last year at one division alone, and "our quality didn't go down," Pollino boasts. "So quality is free, as Crosby says." Pollino estimates that the company skips

electrical testing on 15% to 20% of incoming lots.

CDC provides its vendors with monthly detailed reports on device defects based on its failure analysis. As for reliability data, Pollino says that CDC does not yet have a program in place to get much data on failures in the field. "That would be the next step. There's really such a wealth of information at the manufacturing floor level that we haven't tapped yet, and I really feel strongly that when we start looking at these devices and start feeding things back to suppliers, they're going to correct their processes and that's going to improve our reliability."

'Very, very close'

Already under way is the program at General Motors Corp.'s Delco Electronics division in Kokomo, Ind. which is "very, very close" to accepting its first active components under its so-called No Inspection Verification, or NIV, program, according to Bernard W. Pierce, general superintendent of vendor quality.

By the end of this year, Delco hopes that 20% to 30% of all purchased ICs will have been placed on NIV. Like CDC and numerous others, it is pushing for quality levels below 0.1% AQL, where the measure will be in ppm.

Once the AQL falls below 0.1%, the usual sampling techniques no longer apply. In fact, the numbers virtually dictate a no-inspection policy. Delco's Pierce explains: "The real crux of the situation is that we're trying to find on a percentage basis so few discrepant parts. Most of the things you do in receiving inspection degrade the lot and do damage to more parts than the number of ones that were already bad to begin with. How many parts do you have to inspect before you can find a failure rate of a couple of hundred ppm? A hell of a lot of parts.

"Once you get much below 0.1% AQL, the conventional statistical techniques don't hold anymore. So you've got to go to a program for watching how your staff goes down the line and how the end product works in the plant and then carefully monitor what happens in the field, because that's where the real money is."

Delco eventually wants fewer than 100 ppm for active components, says Robert B. Costello, Delco's director of materials management. For passive components, the ppm count should be less than 1.

Costello's target is the end of 1983 for eliminating receiving inspection on all procured ICs except for new device types for which the company has no history. This year, new device types might be as high as 50% of all ICs purchased, says Costello, since General Motors' new custom microprocessor chip set will be phased in heavily for model year 1982 cars [*Electronics*, Nov. 20, 1980, p. 113]. But even in a more representative year, as much as 30% of all ICs bought may typically be new devices that will require some incoming inspection even after the No Inspection Verification program is fully phased in.

Part way

Although the NIV concept has been in planning for a number of years, it was not until 1980 that the division actually began its first purchases of electronic devices—actually passive components—under the program. Now, four or five of Delco's six major merchant IC suppliers

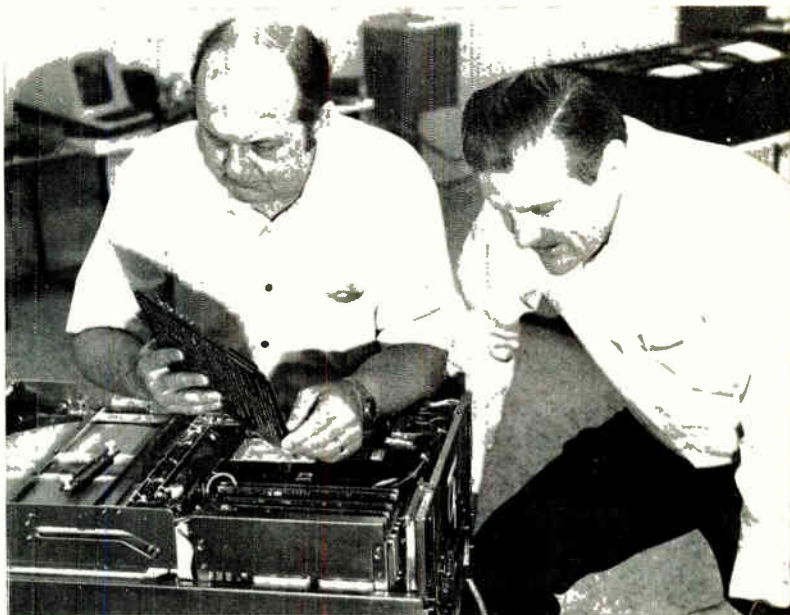

10. Advantage. At a small company like microcomputer maker IMS International, which offers a two-year equipment warranty, cofounders Al Fiegehen, right, and Don Lehr know they have a special luxury. "If something's not right, we stop everything and correct it."

are expected by the end of 1981 to be furnishing at least some parts under the NIV program.

Costello points out that Signetics has set up a special ppm line in South Korea. He also notes that the same concept of separate lines for the auto industry is in place at Texas Instruments.

However, there is trouble brewing for at least one member of Delco's supplier family. On the record, Costello will say only that for the 1982 model year one of the six vendors will be shipping substantially less to the division. (Delco began to issue purchase requirements in March 1981 for the 1982 model year and will begin receiving parts in late May or June.)

Less than adequate quality performance is not the total reason for cutting back on orders to the vendor. Costello says it has more to do with the company's failure to function as a team with Delco the way other vendors do. "We feel that it's sort of an antagonistic attitude; everything is a fight with them."

The deal at DEC

Further insight into the cooperation needed between user and supplier comes from Digital Equipment Corp., Maynard, Mass., as it presses to omit incoming testing and ship directly to stock. "There is no limit or goal as such for an ultimate AQL—it may be asymptotic, but we will still try to improve it." The computer maker has established a vendor test program that fosters close cooperation between it and its semiconductor suppliers. "Long before a DEC product is announced, we are heavily involved with the vendors who will supply the necessary ICs," points out Prakash Bhalerao, engineering business manager, who works at DEC's Westboro, Mass., operation. "We want no surprises."

Hence DEC does the usual thing: rejects designs with a history of problems and selects vendors with the best

11. Turn for the better. Achille Pollino of CDC does not have to push U. S. semiconductor makers as hard on quality as he used to. "They've all got very aggressive goals and they're telling me where they're going to be year to year in parts per million and how they're going to do it." He sees quality levels of 20 ppm or better by 1985.



manufacturing programs and those with the largest data bases. "Once we have selected a part—which really amounts to choosing a vendor as well—we begin the real process involved in the vendor test program," Bhalerao says. "First we establish a base line. We attempt to make sure that both DEC and the vendor use the same test equipment, test programs, and test conditions. We have gone to the length of supplying DEC-generated test programs to vendors for their use to be sure we are using the same yardstick.

"This alignment of hardware and software forms the first two parts of the vendor test program. The third may consist of DEC's obligating itself to purchases in sufficient quantities to guarantee the process and the product. That may at times encourage a vendor to continue producing a part not otherwise attractive to it.

"But far more importantly, we are able to get vendors to agree to notify us every time the smallest aspect of an IC's design or processing changes. Sometimes such changes force us to requalify a part from the beginning; sometimes the effort involved is less than that. But invariably, we know what is being delivered to us," Bhalerao says.

DEC tries in various ways to be helpful. "We give away test programs we may have generated ourselves, we try to help vendors understand unfamiliar pieces of test gear, we share data from our failure analysis and test labs—generally, we give a valued vendor any support we reasonably can," he continues. One example he cites is DEC's work with Texas Instruments, which uses different test equipment from DEC's. DEC took it upon itself to emulate TI's test gear and to share the emulation with the semiconductor vendor.

Close cooperation is especially needed when an equipment maker comes up with its own IC design. DEC now routinely designs a fairly large amount of custom LSI and VLSI devices. Naturally, it does not want to be the sole source for these ICs and therefore goes outside, designs in hand, to choose a supplier.

That may involve some frank conversation about just how things are done, and sometimes DEC and its vendor can get into areas that the vendor considers proprietary. But, according to Bhalerao, "we tell them everything about our processes, and we therefore expect them to be as open with us. Most firms are."

When parts fail, DEC collects data on the failure, analyzes it, and contacts the vendor, as well as DEC's own semiconductor manufacturing people, to see how serious the problem is in context. Often, its experts will evolve a solution. DEC will then try to help work through the problem if the vendor needs assistance. But for the semiconductor makers, relying on returns alone is an insufficient means of developing a data base, says Neill McCormack, manager of quality assurance and reliability for DEC's semiconductor manufacturing facility in Hudson, Mass. Measurements should be made on devices coming off every assembly line and charted to keep track of quality.

Making a family

It soon becomes apparent in conversations with managers concerned with boosting the quality of their products that relations with their vendors are key. Terms like "family," "trust," and "team" quickly emerge in conversation. Close cooperation, of the kind that exists in Japan among vertically integrated divisions of the same large company, is paramount, and that is especially needed when things go wrong.

Like others, Hewlett-Packard prefers to work closely with a small number of trusted vendors and offers a good reason for doing so. "You can't keep track of a lot of suppliers, but you can work closely with a small number and establish relationships where the suppliers are almost members of your own family," says HP's Paul Baird. Then, when a semiconductor manufacturer ships tested parts, "you can accept his evidence, rather than recreate it at incoming inspection when the parts arrive at your plant."

Cooperation as close as that means the semiconductor manufacturers are also playing a different—a more involved—role than before. “I’ve been screening ICs for over 10 years now, and my impression is that in the past, suppliers have not worked hard enough on reliability. Since the Japanese have begun to dig in, however, the U. S. companies have been much more willing to discuss reliability,” says Lee Ritchey, test engineering manager at Magnuson Computer Systems Inc., San Jose, Calif. “In past years, the attitude of some vendors has been, ‘you bought them, you eat them.’ That seems to have changed once they had the Japanese snapping at their heels.”

Attitudes to sharing

How do vendors regard the efforts of their customers to open communications and share information?

“It’s a darn good way of doing business,” declares Jeffrey R. Riskin, manager of product assurance at Analog Devices Semiconductor division in Wilmington, Mass. In this statement, he sums up the feeling of many other vendors.

Riskin is particularly pleased with the relationship being established with Hewlett-Packard, which was invited in March to Analog Devices’ plant to present its case for higher quality. “We’re attacking the problems together instead of attacking each other,” he explains. “HP has been very helpful to us. They came into our plant and sat down with our manufacturing, quality, advanced development, engineering people—everybody. They left a trail of business cards behind them and urged

us to call them with any problem.”

In effect, HP told Analog Devices: “We’ll tell you when you’re making mistakes. We will be glad to share what we have learned from the failure of your devices.” Riskin believes that that cannot do anything but help his organization perform better.

Furthermore, as they work more closely together, Riskin points out, the customer comes to a better understanding of the vendor’s concerns. “They realize what they’re asking for may not be a short-term solution. Both high quality and reduced price take a while. Costs will go down, but specs may also have to be reduced as well. That may just mean we’re both getting more realistic—a converter specified at 12 bits may really be better spec’ed at 11, given the price that’s desired.”

Typical of the great effort needed to feed back data on failed parts is that of B. N. (Mike) Svendsen, director of Sperry Univac’s semiconductor control facility in Minneapolis. Svendsen rides herd over centralized device procurement and quality control for Sperry Univac plants worldwide. About 100 million devices are purchased annually from the outside.

Feedback on failures

With today’s more complex devices, feedback from Sperry Univac plants—in terms of whether they are having problems during manufacturing or at board- and system-level testing—is much more critical than it used to be, Svendsen points out. With diodes and other less complex devices, it was relatively easy to determine what kinds of tests were necessary. But with the complex

12. Close. The first active components are soon to be accepted under Robert Costello’s No Inspection Verification program at GM’s Delco Electronics division. By the end of 1983, he hopes to eliminate receiving inspection on all procured ICs except for new device types with little or new history.



VLSI demands collaboration between IC and test makers

by Kenneth R. Willey

Data General Corp., Westboro, Mass.

Very large-scale integration issues nothing less than a mandate for test planning. For those faced with testing the new VLSI-packed boards, that means they must work more closely than ever before with automatic-test-equipment and VLSI makers. One hope is that efforts will be made to supply components specifications sufficient for the new parts to be modeled for testing. Along with that, there are other issues to consider.

Self-testing. Built-in, on-chip test systems are potentially a real leg up, and in fact it may not be possible in the future to get ATE gear to work on devices without it. But can manufacturers be made to agree on standard self-test methods so that ATE can be produced to make use of them?

CAD/CAM versus simulators. Computer-aided design systems, basically set up to help in the design of VLSI devices, do not concern themselves with testing problems; likewise, the computer-aided manufacturing portion of these systems does not deal with testing but instead with assembly. Test simulators, on the other hand, focus on testing but do not address assembly. Users of these combined systems are thus faced with a dilemma: either choose one system to do both CAD/CAM and test simulation or go to separate simulators, which requires duplicate modeling of devices. Somehow, the two sides should work together to smooth out some of the major differences.

Test models. Just how much testing is needed on a product that has gone through CAD? To test for every possible combination of faults would take days or months with even the most sophisticated testers. In light of that, the question then becomes: should a device be modeled for standard applications, with the hope that that will give a reasonable confidence level at the next test level, or should it be modeled for a specific application?

Also, some high-level languages are now available or under development for creating functional models of upcoming VLSI devices, but will the model's timing be the equivalent of the actual device?

High-speed functional testing. The maturing of CAD/CAM should eliminate the race conditions and timing-related faults that we now find with high-speed functional testing. But there are other questions: are we all speaking the same language when we talk about speed, or is a board manufacturer talking about the clock rate of the unit under test while a tester manufacturer is talking about data and pattern speed? And just how much testing is needed on a product that has gone through CAD?

New testers are very expensive—in the range of \$250,000 to \$800,000 per system. What percentage and what types of failures missed today by slower testers will be caught by these new testers? Is the answer to improve their timing resolution rather than going for full, at-speed functional testing?

Another concern with VLSI on a board is the problem of multiple faults within a test sequence. Either probing algorithms must become more sophisticated or testers will have to return to a single probe rather than use a clip, thereby increasing probing time significantly. The solution has been to use more patterns, which lengthens test time.

Controllability. Each VLSI device on a board must be controllable from an outside source, either by three-stating the outputs or by controlling the devices to produce the desired pattern to test the surrounding support circuitry. Otherwise, the devices must be removed when using ATE, or patterns must be "pumped" through the VLSI to test downstream logic.

There are many other topics to be dealt with, including the size and speed of pin electronics, the balance of analog and digital capabilities in the testers, ease of programming and interfacing, the application of automatic-learning modes and data-capturing techniques, tester modularity, signal termination, the cost of training and maintenance, and the use of IEEE-bus instruments. Test engineering groups and ATE manufacturers, as well as integrated-circuit designers, will have to work together as never before.

devices, "you could test forever and not hit the right thing" that might be important for system-level operation, he says.

Svendsen's program for achieving quality involves feeding back quality data to the vendors each month by device and assembly location. "That gives the vendor a comprehensive running report of how we feel about his products," he explains. Such ranking, including quality, delivery, and price—also done by other equipment makers—"puts pressure on the supplier to ship the best product he can as cost-effectively as he can," he notes.

Some recognize that keeping track of where failures occur in their equipment will be never-ending. Magnuson Computer is one. As Lee Ritchey explains, "We target a 2,000-hour mean time between failures for our

systems, each of which contains about 9,000 ICs." That works out to a requirement of 18 million IC-hours between failures, which is why, according to Ritchey, Magnuson "tracks its product forever." □

Contributing to this report were James B. Brinton, Boston; Wesley R. Iversen, Chicago; Bruce LeBoss and Martin Marshall, Palo Alto, Calif.; Larry Waller, Los Angeles; Terry Costlow, Costa Mesa, Calif.; J. Robert Lineback, Dallas; Ray Connolly, Washington, D. C.; Kevin Smith, London; Arthur Erikson, Paris; John Gosch, Frankfurt; Charles Cohen and Robert Neff, Tokyo; and Gerald M. Walker.

Reprints of this special report will be available for \$6 each. Write to Electronics Reprint Dept., P. O. Box 669, Hightstown, N. J. 08520. Copyright 1981, McGraw-Hill Inc.

Your IC fab line costs you more than \$500,000 a month in debt service, depreciation and overhead.

Unflat wafers don't carry their share of this cost. Get them out of the line.

Our new Flatgage™ scans a wafer — even a patterned wafer — in 20 seconds and tells you if it is flat enough to continue in your process.

There's a lot more. Write for technical data or call Tencor Instruments, 2426 Charleston Road, Mountain View, CA 94043. (415) 969-6767.



***FLAT IS BEAUTIFUL
ALSO ESSENTIAL***

Enhanced multiplier cuts parts count

by Guy Ciancaglini
Fellows Corp., Springfield, Vt.

The encoder-pulse-feedback multiplier circuit proposed by Frank Amthor [*Electronics*, Sept. 11, 1980, p. 139] and later simplified by Michael M. Butler [*Electronics*,

Nov. 20, 1980, p. 128] may be implemented in a higher-speed TTL version that costs less and has fewer parts.

Butler's circuit reduced the original four-latch outputs to three lines so an eight-channel analog-multiplexer can be used. But the price paid was a space-consuming exclusive-OR package.

The TTL design implements the multiplier's common edge detector with a 74379 quad D-latch connected as shown in Fig. 1a. Furthermore, the 74159 4-to-16-line decoder enables it to use all four latch outputs, eliminating the exclusive-OR package.

Another plus for the TTL design is its versatility, which

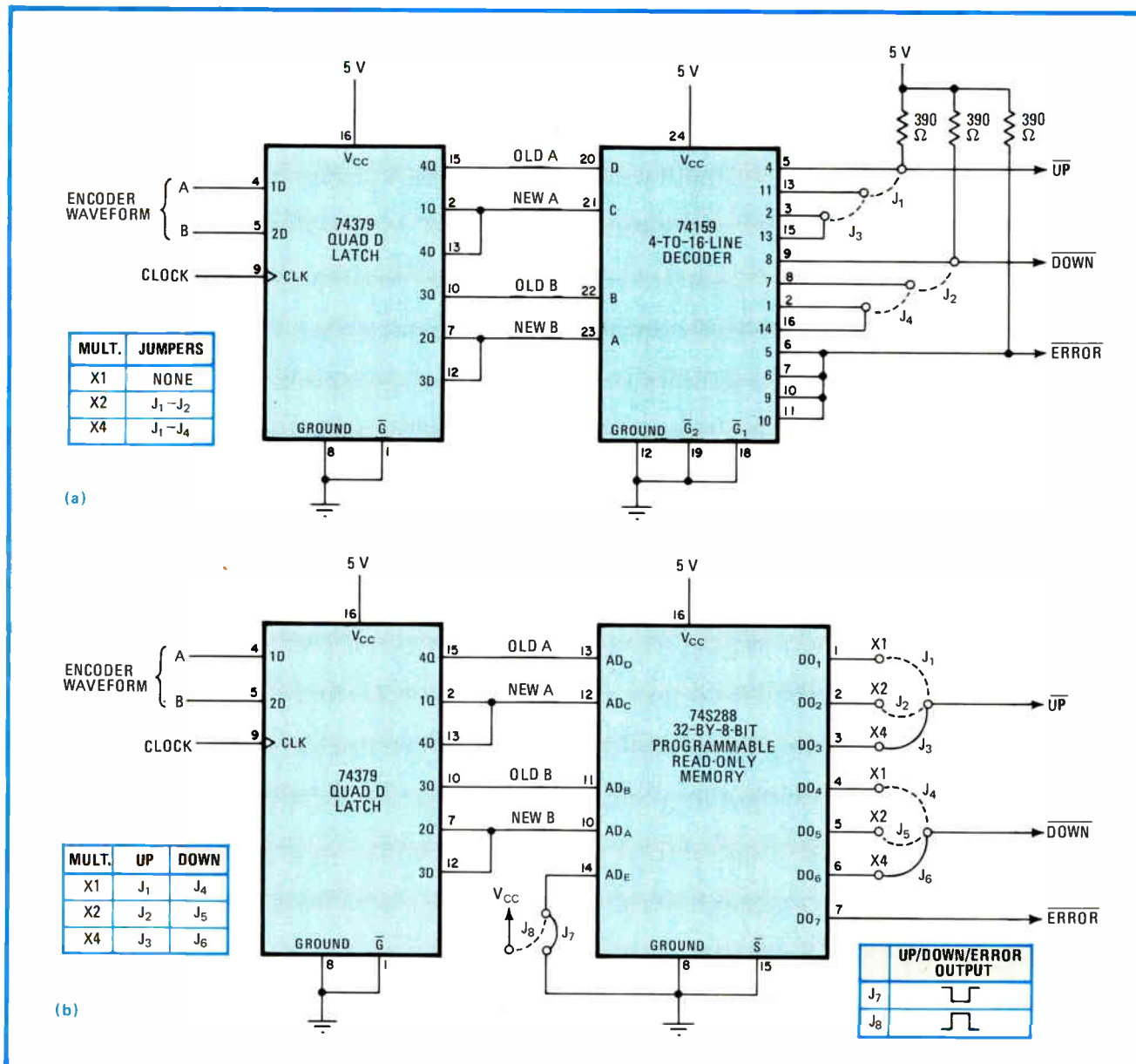

Two versions. The encoder feedback multiplier (a) uses transistor-transistor logic to save printed-circuit board space. The TTL PROM version (b) costs a bit more, handles positive or negative true logic, and needs even less board space. Both circuits are programmable.

TRUTH TABLE FOR ENCODER MULTIPLIER													
A	B	Latch output				NO.	Up*			Down*			Error*
		Old A	New A	Old B	New B		X1	X2	X4	X1	X2	X4	
0	0	0	0	0	0	0	1	1	1	1	1	1	1
0	↑	0	0	0	1	1	1	1	1	1	1	0	1
0	↓	0	0	1	0	2	1	1	0	1	1	1	1
0	1	0	0	1	1	3	1	1	1	1	1	1	1
↑	0	0	1	0	0	4	0	0	0	1	1	1	1
↑	↑	0	1	0	1	5	1	1	1	1	1	1	0
↑	↓	0	1	1	0	6	1	1	1	1	1	1	0
↑	1	0	1	1	1	7	1	1	1	1	0	0	1
↓	0	1	0	0	0	8	1	1	1	0	0	0	1
↓	↑	1	0	0	1	9	1	1	1	1	1	1	0
↓	↓	1	0	1	0	10	1	1	1	1	1	1	0
↓	1	1	0	1	1	11	1	0	0	1	1	1	1
1	0	1	1	0	0	12	1	1	1	1	1	1	1
1	↑	1	1	0	1	13	1	1	0	1	1	1	1
1	↓	1	1	1	0	14	1	1	1	1	1	0	1
1	1	1	1	1	1	15	1	1	1	1	1	1	1

*For PROM version: when address E is tied high, all output states are inverted.

it owes to the fact that the collector outputs of the decoder are now open and may be hooked together in a wired-OR configuration. By including four jumpers or a dual-in-line-packaged switch, these outputs may be selected for one, two, or four times the original encoder feedback (see table). Since the decoder has a slower propagation delay than the latch frequency, the latch clock rate is limited to at most 25 megahertz.

Use of a PROM programmer can save even more space,

but at a slightly higher cost. By replacing the decoder with a 32-by-8-bit TTL programmable read-only memory, the package is reduced in size and in pin count from 24 to 16 pins. The output pull-up resistors are also eliminated because of the PROM's three-state outputs. In this design variation, the $\times 1$, $\times 2$ and $\times 4$ outputs are on individual lines. By making use of the fifth address input to the PROM, the output polarity may be set to positive or negative true logic using jumpers (Fig. 1b). □

Power-fail detector uses chip's standby mode

by Jerry Winfield
Mostek Corp., Carrollton, Texas

As microprocessors are used more frequently for consumer and industrial applications, the need to preserve data and program status during power outages has become increasingly important. Until now, this function has been implemented with a small, outboard complementary-MOS random-access-memory battery-charging circuitry, power-fail circuitry, and a battery.

The MK3875, one of the MK387X family of single-chip microcomputers, simplifies the job of providing a battery backup system by incorporating 64 bytes of standby RAM and the battery-charging circuit onto the microprocessor chip. The only external components required are a battery and the power-fail circuit.

Figure 1 shows a simple, low-cost power-fail-detection circuit that can be designed with readily available parts. Figure 2 details the timing relationship between RESET and V_{cc} for enabling and disabling the standby RAM function. Simply stated, RESET must be low when V_{cc} is below its specified voltage, which is 4.75 volts for a 5%

part and 4.5 v for a 10% part.

The circuit shown in Fig. 1 detects power failures and resets the device automatically at power-on and manually during operation. The circuit monitors the unregulated voltage that feeds the V_{cc} regulator and compares this voltage against a voltage reference. When the voltage drops below the reference, the RESET line is pulled low. Hysteresis is designed into the comparator to prevent the oscillation caused by slow rise and fall times.

The trimming potentiometer, R_{11} , should be adjusted so the negative threshold voltage V_{th-} is greater than the minimum input voltage of the V_{cc} regulator. Adjusting the threshold voltage above the minimum will yield additional time before the RESET line goes low should the external interrupt be used for saving variables.

As mentioned earlier, the circuit also functions as a power-on or manual reset. The power-on reset is created by the addition of C_2 and D_1 , and the manual reset is created by the addition of R_2 and SW_1 .

The power-fail circuit can also be configured to generate an external interrupt to the MK3875 to save variables before the RESET line is activated. Adding capacitor C_3 allows time for executing the save routine before the RESET line is pulled low; the external interrupt should also be programmed as an active-high input.

The MK3875 was designed primarily for use with a small 3.6-v nickel-cadmium battery and will automatically supply a maximum charging current of 19 mA at

Memodyne Corporation, the data logging people, proudly introduce a brand new 20 column ALPHANUMERIC THERMAL PRINTER Model MAP-20S. **IN STOCK!**

- Simple 2 wire data input
- Isolated 20 mA current loop and RS232C interface
- Baud rates from 75 to 9600
- Internal/External Baud Clock
- 96 Character print set
- Print rate of 2 lines per second
- Internal self test program of all characters
- Programmable controls for:
Text or lister printing
Character size — normal or extended
Baud rate
- Complete with microprocessor electronics and AC power supply
- Small size measures 4.4" W x 2.75" H
- Fits in panel 4.5" W x 2.78" H
- Weighs 4.2 lbs.

Price \$725.00 each in single quantities.
Write for our complete 8 page color brochure.



Circle 152 on reader service card



85' High Time & Temperature Display, Birmingham, England

HIGH VISIBILITY DISPLAYS

They are crisp and clear close in...and can be legible up to a thousand feet away, even at wide viewing angles.

They cut energy consumption sharply...current is drawn only at the instant of change.

They can be used indoors and out...in temperatures as high as 75°C or as low as -40°C.

They are reliable, sturdy and virtually maintenance free...there are no bulbs or LED's to replace.

They are SIGNALEX ELECTROMAGNETIC READOUTS...available in sizes from 1½" to 24" high.

Signalex displays are used around the world...in industrial scales, truck weighing indicators, timers and a wide variety of applications. They can improve your product, too.

For more information on Signalex numeric and alphanumeric displays, contact: *The Staver Company, Inc., 51 Saxon Avenue, Bay Shore, N.Y., 11706 516-666-8000*

Copyright 1981

SIGNALEX
HIGH VISIBILITY DISPLAYS

Truck Weighing Indicator

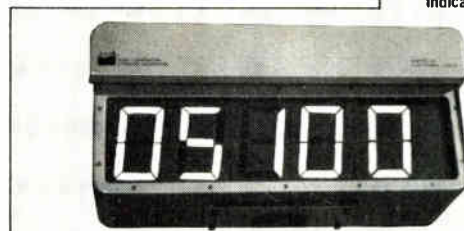

7 Segment Digital Display

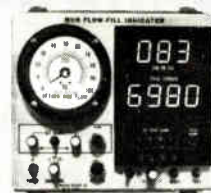

Oil Drill Monitor

Variable Speed Limit Sign



Prize Money Indicator

152 Circle 131 on reader service card

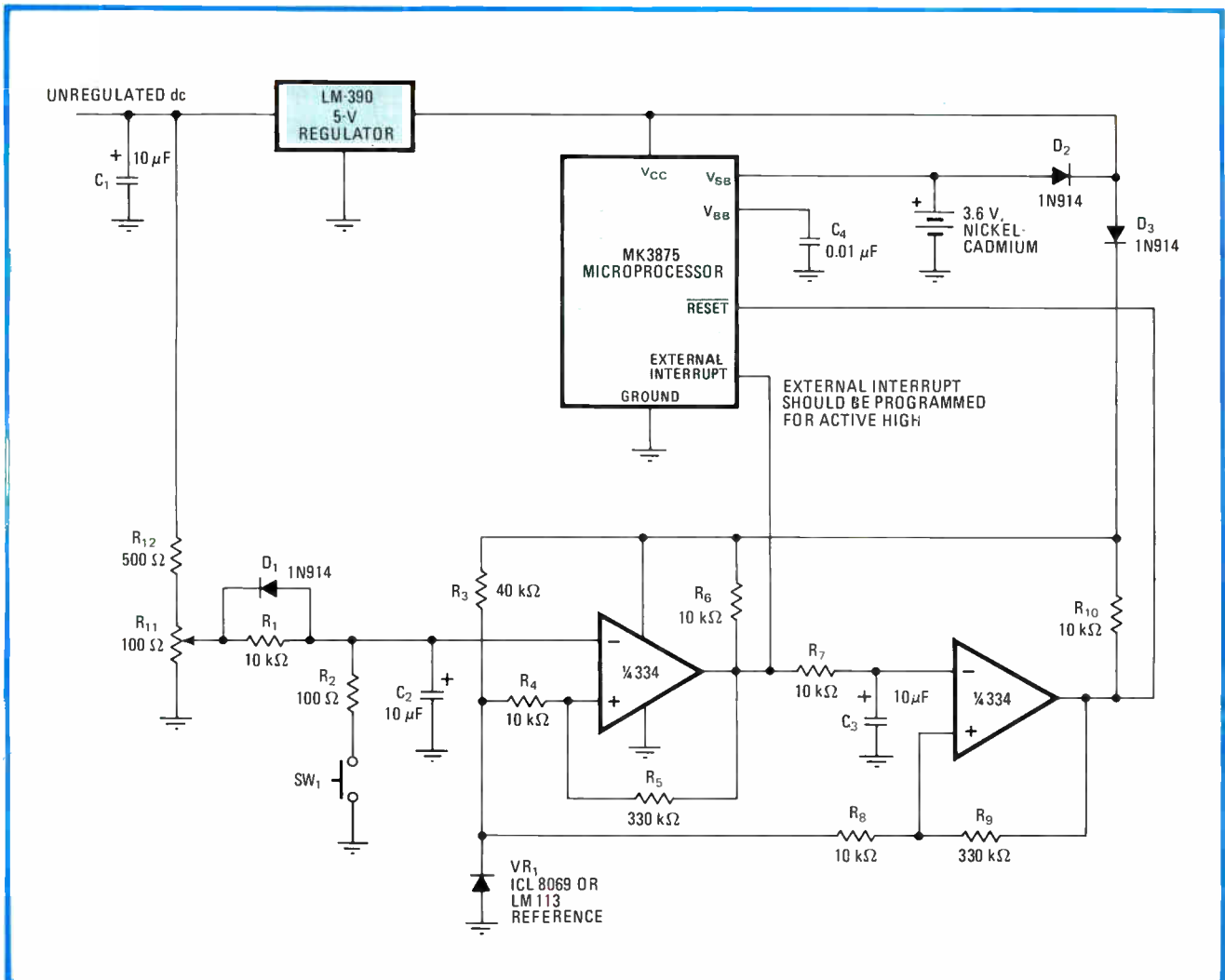

1. Please stand by. Though primarily for detecting power failures, this circuit also adds power-on and push-button reset functions to the MK3875 microcomputer, which has 64 bytes of standby RAM and a battery-charging circuit for implementing a standby power mode.

2. Wave goodbye. Where a save routine is needed to preserve critical data before power is lost, the external interrupt must be toggled before the reset line, during which time the routine is executed. The time allowed to save the data is determined by the value of C3.

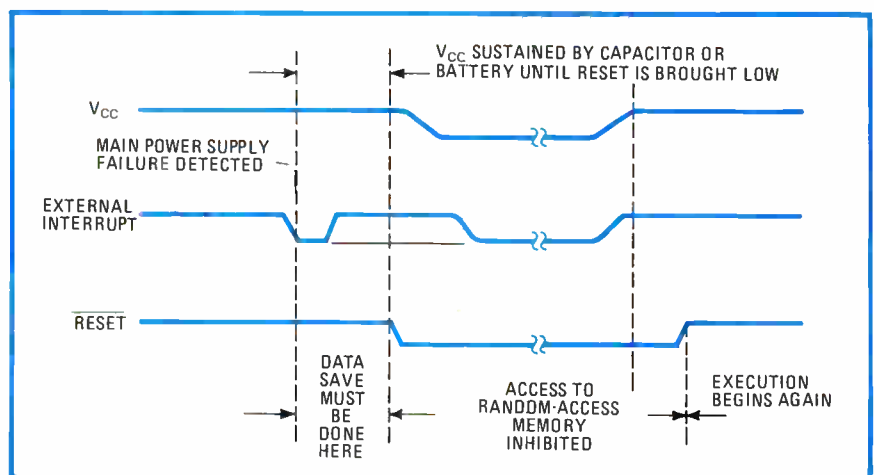

3.2 v and a minimum trickle charge of 0.8 mA at 3.8 v. The size of the battery will depend on the length of required standby time. (With a V_{cc} variation of 4.75 to 5.25 v, the standby current for the RAM will vary between 3.7 mA to 6 mA.)

Among those battery manufacturers whose small nick-

el-cadmium batteries could be used with the MK3875 are Varta, Yuasa, General Electric, Gould, Sanyo, and Panasonic. □

Designer's casebook is a regular feature in *Electronics*. We invite readers to submit original and unpublished circuit ideas and solutions to design problems. Explain briefly but thoroughly the circuit's operating principle and purpose. We'll pay \$75 for each item published.

**YOU ARE MISSING
A GOLDEN OPPORTUNITY!!**

**19th JEMIMA
INTERNATIONAL
EXHIBITION**

ELECTRIC MEASUREMENT & CONTROL INSTRUMENT-AUTOMATION EXHIBITION,
AND SEMINARS ON NEW TECHNOLOGY

**19th (Mon) — 23rd (Fri) Oct. 1981
Tokyo International Trade Center, Japan**

MAIN EXHIBITS

Indicating Meters
Electricity Meters
Test and Measuring Equipment
Process Measuring & Control Instruments
Monitoring Instruments for Environmental Quality
Nuclear Instruments
Electric Measuring Instruments for Medical Application

PARTICIPATING COUNTRIES

Austria, Denmark, Netherland, Switzerland, UK, U.S.A.,
W. Germany and Japan



JAPAN ELECTRIC MEASURING INSTRUMENTS MANUFACTURERS' ASSOCIATION

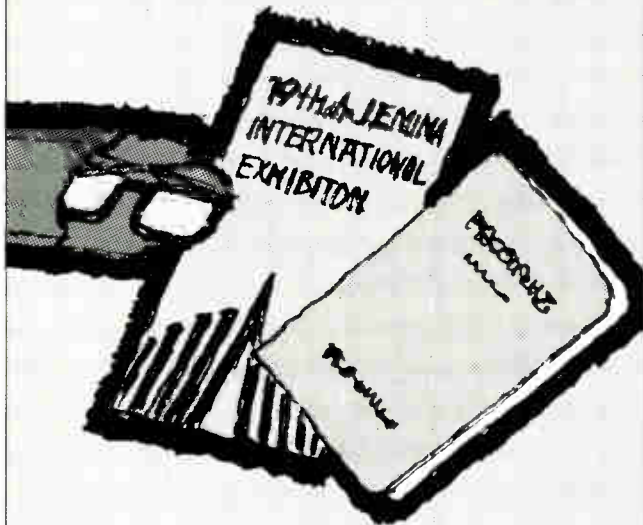

**HERE WE COME
TO PROMOTE BETTER UNDERSTANDING**

**OEM Systems Designers...
GET IT UP AND RUNNING
Microbench™ Development Software**

Complete development packages for:

- INTEL 8086/8088
8080/8085
8048/8748
- ZILOG Z8000 Z80
- MOTOROLA 6809 6800 to 6803

Includes:

- Cross Assembler • Linker
- Librarian • Downloader

Operates with DEC operating systems on:

- PDP-11 • LSI-11 • VAX

Also: FORTRAN—77 for the
INTEL 8086/8088

Cost effective with prices starting at only
\$1,695.

VIRTUAL SYSTEMS

1500 Newell Avenue, Suite 406
Walnut Creek, CA 94596
(415) 935-4944

The state of the art in microprocessor software

Circle 132 on reader service card

FREE! NEW!
(FOR LIMITED TIME ONLY)

Bishop Graphics

**PRINTED CIRCUIT
DRAFTING TECHNICAL
MANUAL & CATALOG 107** ^A \$7.50 Value!
(Includes Product Samples!)

Over 190 Pages Packed
With Time-Saving PC Design
Products, Tips & Techniques.

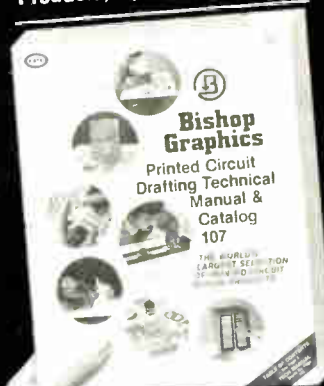

- NEW, expanded TECHNICAL MANUAL including "how to use" overlay drafting to create PC artwork masters
- OVER 20,000 PC DRAFTING SYMBOLS & TAPES... the world's largest selection
- NEW DIAZO drafting ACCUFILM®
- NEW Glass OPTO-SCALE™
- NEW Overlay Drafting System
- NEW DIP FEED-THRU patterns
- NEW SOLDER MASK patterns
- NEW TEMPLATES
- NEW "D" Subminiature CONNECTOR PATTERNS
- ... and much, much more!

Call or Write Your Local
Bishop Dealer Or Contact:

Bishop Graphics, Inc.
5388 STERLING CENTER DRIVE • P.O. BOX 5007
WESTLAKE VILLAGE, CA 91359 • (213) 991-2600
TELEX: 66-2400

EE-PROM goes to work updating remote software

Analog signals transmitted over telephone-line data links alter on-site memory for microsystem upgrading and maintenance

by Randy Battat and John F. Rizzo, Intel Corp., Santa Clara, Calif.

□ Microprocessor system software needs frequent revision, which is inconvenient, difficult, and costly. But because it combines the nonvolatility of ROM and the flexibility of random-access memory, an electrically erasable programmable read-only memory at the microprocessor site allows remote software changes to be made through a telephone-line data link, eliminating field service expenses.

As technology progresses, design and service costs are coming to determine—more than component costs—the cost of microprocessor systems (see “The cost of software service”). Intel’s 2816 EE-PROM not only solves the service problems, but it also makes existing designs more functional since they need only be updated, not replaced.

Memory requirements

In a remotely controlled EE-PROM, the memory must be nonvolatile, retaining data even when the host system is powered down. Furthermore, with today’s high-speed microprocessor systems such as the Intel 8086-2, the Zilog Z8000, and the Motorola MC68000, only fast memory devices can achieve full throughput. For example, a high-performance 8086-2 system with a zero time wait-state operation requires a memory-read access time of 250 nanoseconds.

Also, as software costs rise, high-level languages will often be used to reduce design time. These languages are memory-intensive, requiring high-density memory chips to effectively contain dedicated system programs without sacrificing printed-circuit board space.

Finally, a remote link-addressable EE-PROM must have read-mostly operation. Normally program memory and certain types of data memory are accessed in a read mode. At times, however, it is necessary to reload an entire program (as in the case of a software revision) or to reconfigure portions of data storage (when only certain parameters need to be changed). Then the ability to write into the memory in the circuit is essential.

The 2816 fills all these user requirements. It is nonvolatile, having greater than 20-year data retention. Its access time of 250 ns is compatible with today’s high-speed microcomputer systems. The chip is also electrically erasable on a per-byte or per-chip basis—a true read-mostly memory. It offers users 16,384 bits of storage organized as 2048 8-bit bytes.

The EE-PROM allows in-circuit erase and write, opera-

tions so it can be written into from many information sources. But because it is an excellent medium for storing nonvolatile programs and data, it is particularly suited to downline loading—in this case, in changing memory contents at remote sites via a data link.

The telephone is ideal for transferring information,

The cost of software service

Servicing a software change in a field application today averages about \$100 per hour. By 1985, assuming an inflation rate of 15%, these costs will approach \$200/h. A typical microprocessor system (2,000 in the field) requires a service time of 2 h. If each system needs to be updated a minimum of two times during the product’s life, the cost is at least \$400 per system. That means \$800,000 for the total retrofit. If a doubling of the cost of labor in the next five years is assumed, the new retrofitting cost comes to \$1.6 million.

By installing a remote-software serial link, software can be updated over telephone lines. Adding a 2816 EE-PROM and a remote link to the system will cost about \$50, a mere one sixteenth the 1985 service cost. Today, as seen in the figure, a 40% savings can result.

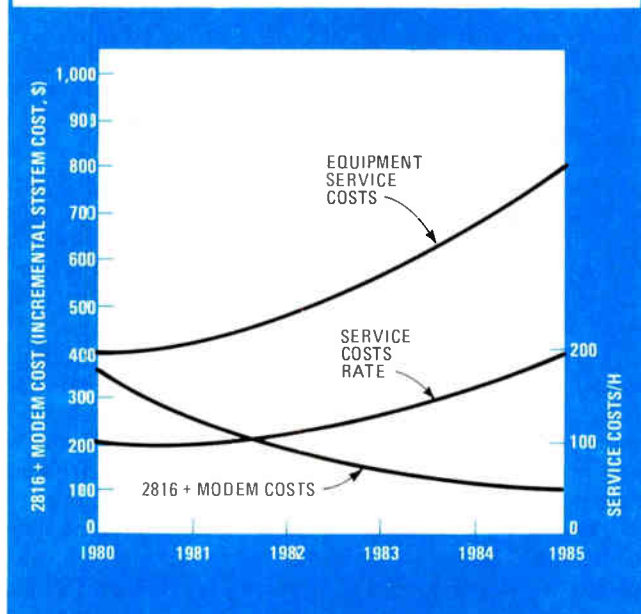

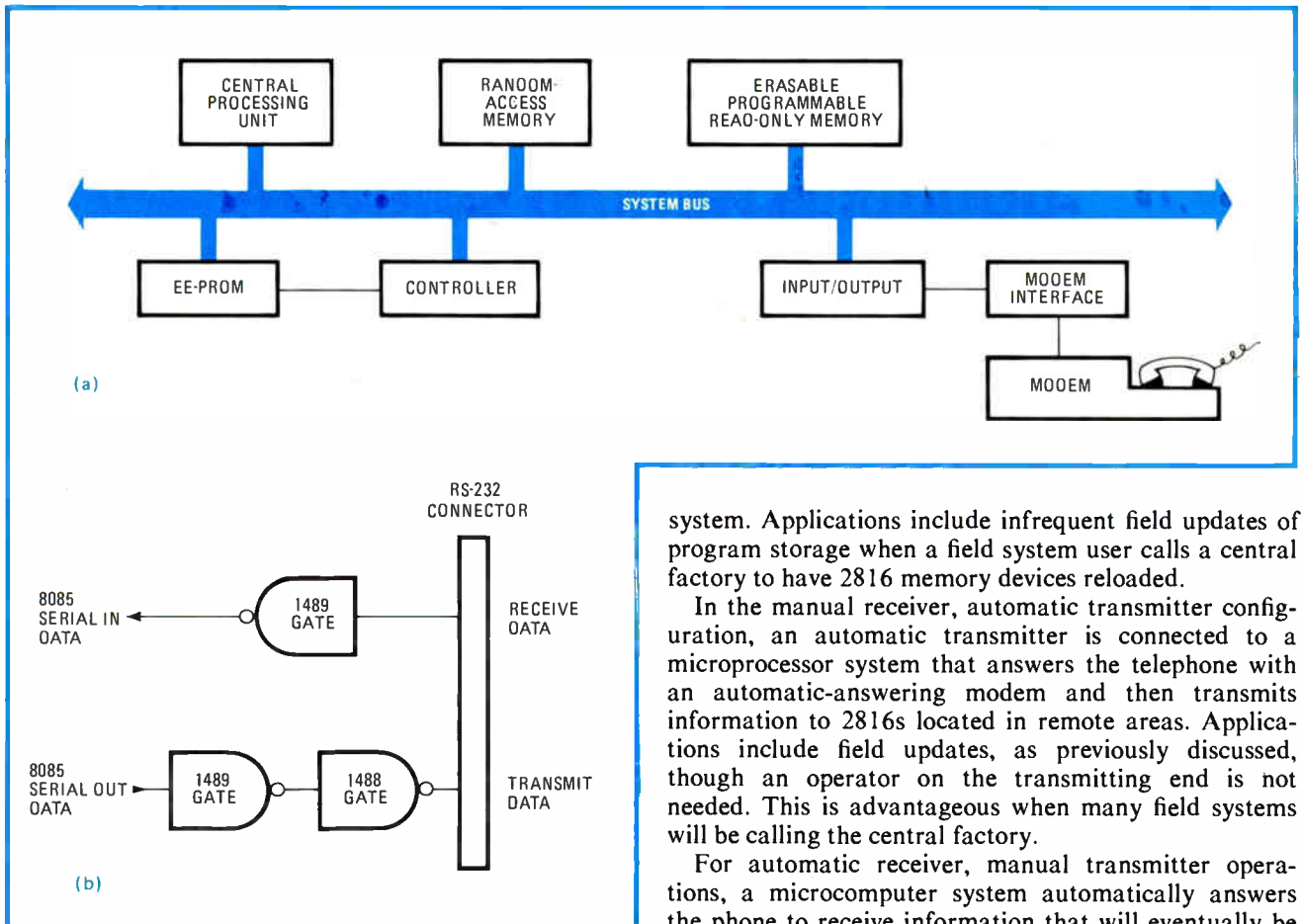

1. Easy downloading. A microprocessor at a remote site with an EE-PROM as a peripheral may have its software changed by means of a telephone data link (a). An acoustically coupled modem is required with an interface (b) that is simple to implement.

since it is readily available and requires no special interface. Using an acoustic coupler, serial binary data is converted into high- and low-frequency tones that are then transmitted over a worldwide link. Modems interface easily with microprocessors, and, in addition, the software overhead for such a downline-loading operation is minimal.

Mixing and matching

Programs downline-loaded into EE-PROMs find many applications in both large and small microcomputer systems. But regardless of size, all configurations require a modem to interface electrical signals from a host processor with the acoustically driven telephone. Automatic modems are usually dedicated to a specific telephone line and are completely operated by a host processor. Manual modems are usually portable, relying on an operator to place a telephone receiver in an acoustic-coupler cradle, thereby closing the communication loop. Both automatic and manual modems can be used in EE-PROM telephone communication systems in four possible configurations.

The first configuration uses a manual receiver, manual transmitter design—a cost-effective solution when telephone transmission is not performed often enough to warrant a dedicated telephone line and microprocessor

system. Applications include infrequent field updates of program storage when a field system user calls a central factory to have 2816 memory devices reloaded.

In the manual receiver, automatic transmitter configuration, an automatic transmitter is connected to a microprocessor system that answers the telephone with an automatic-answering modem and then transmits information to 2816s located in remote areas. Applications include field updates, as previously discussed, though an operator on the transmitting end is not needed. This is advantageous when many field systems will be calling the central factory.

For automatic receiver, manual transmitter operations, a microcomputer system automatically answers the phone to receive information that will eventually be loaded into EE-PROM devices. This configuration is used in unattended systems, where, for example, a processor controls remote communications switches or repeaters. If parameters need to be changed, the remote switching processor is telephoned and new parameters transmitted to the EE-PROM in the system. This application exploits the byte-erase feature of the 2816. Only those EE-PROM locations that contain parameters to be changed need be rewritten.

The last configuration, with automatic receiver and automatic transmitter, eliminates the operator. Here an automatic-dialing modem is used. A central computer could be requested to call many remote units to automatically update programs or data in the EE-PROM memory without human intervention.

The hardware elements of an automatic receiver and an automatic transmitter are the same, so describing a system with a manual receiver and an automatic transmitter can help explain all four configurations. Here the human operator on the receiving end initiates transmission by dialing the transmitter and placing a telephone receiver in an acoustic-coupler cradle. The transmitter answers the telephone and transmits data to the receiver. This data is eventually loaded into EE-PROMs.

The significant elements in this configuration are the modem and modem interface, the receiver central processing unit and associated software, and the 2816 and its controller (Fig. 1a). The receiver CPU is connected to a simple modem that converts serial binary data into acoustical tones. The standard Bell 103 modem or equiv-

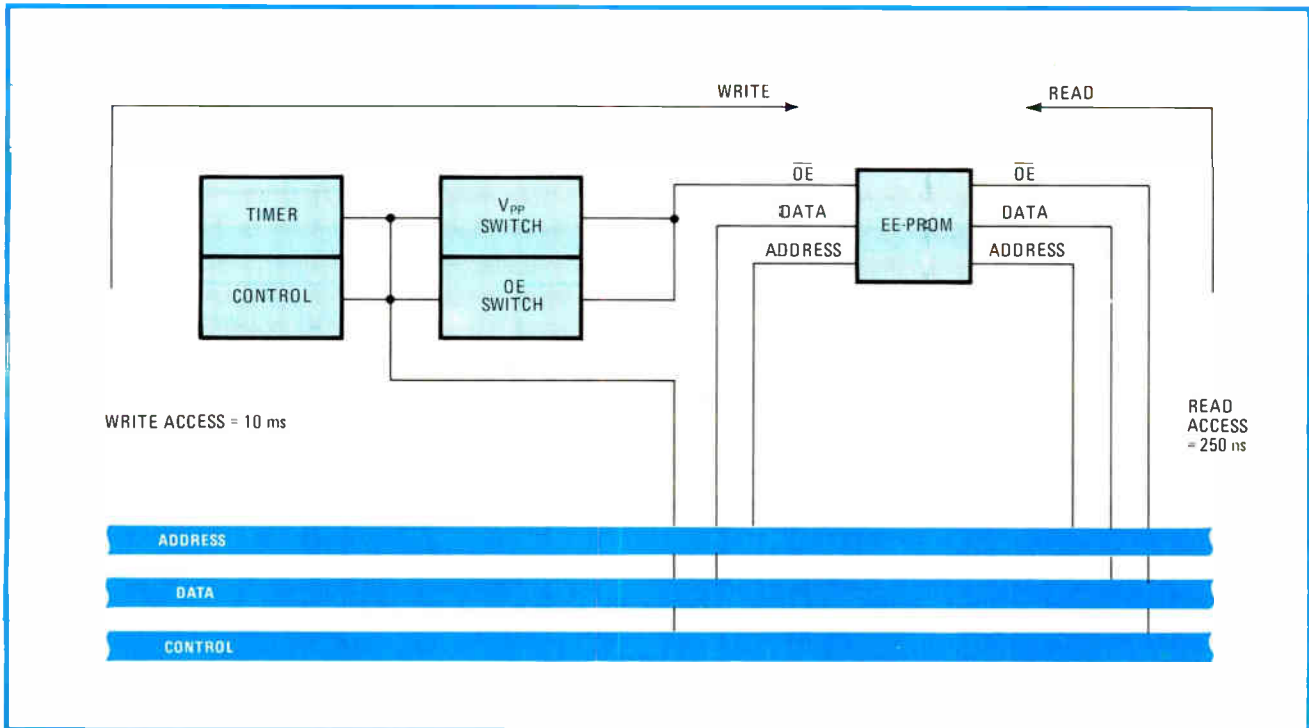

2. Controller. The circuit shown is typical of the several configurations that an EE-PROM may use to receive data. Here, the controller makes the 2816 resemble a slow-write random-access memory. Other configurations may be used depending on the data link's architecture.

alent provides a host system with serial input/output data and various status indicators (such as carrier-detect, which is active when a remote-modem carrier signal is detected). The hardware required is minimal—a standard modem can be readily purchased. An RS-232 interface is needed to interface 5-volt TTL signals from a CPU I/O port (or serial data line) with the ± 12 -V RS-232-compatible signals of the modem. Software handles the rest of the downline loading operation.

Figure 1b shows a simple modem interface. The MC1489 converts RS-232 levels into TTL levels, while the MC1488 converts TTL signals into RS-232. Here, serial data I/O lines can be passed directly to a universal asynchronous receiver transmitter (UART) for serial-parallel data conversion. If an 8085 processor is used, the serial I/O lines can be connected to the 8085's serial out-data (SOD) and serial in-data (SID) ports. Another option is to perform the serial-parallel conversion in software. The receiving CPU need only receive data bytes (possibly after a transmitter identification message is received) and program the EE-PROM.

The actual reception of data is simple. The processor first transmits an identifier message sent from the remote transmitter. This latter message may consist of a sequence of binary or ASCII data detailing the location of the transmitter, date and time of transmission, the number of bytes to be transmitted, and the address in EE-PROM of the data to be located. Next, the processor receives a data byte that may be immediately programmed into the 2816 or saved temporarily in RAM. If software performs serial-to-parallel data conversion, data received must be saved in RAM. The 2816 cannot be programmed as each byte is received, since the processor must devote most of its time to receiving data bits and

converting them into parallel form. However, if a UART circuit does the data conversion in hardware, data bytes may be saved in EE-PROM memory as soon as they are received.

In this process, if data is transmitted at 300 bits per second and if each character consists of 1 start bit, 8 data bits, 1 parity bit, and 1 stop bit, there will be 11 bits per character and a character will be received every 36.7 milliseconds. After every character a 2816 byte must be erased (10 ms) and written (10 ms), leaving 16.7 ms of free time until the next byte is received.

A typical controller

The final consideration in the downline load receiver is a 2816 controller circuit. Figure 2 shows a block diagram of a typical circuit. The read operation for the interface is identical to that for E-PROMs. To read data, chip enable (\overline{CE}) and output enable (\overline{OE}) are taken low after addresses are set up.

To write into the 2816, the host processor simply writes into memory. The controller circuit pulls the processor ready line low, stalling the CPU and stabilizing addresses and data for the 10-ms write interval while the programming pulse (V_{pp}) is active. With the controller, the 2816 resembles a slow-writing RAM except that it needs byte erase prior to writing.

The transmitter consists of a dedicated microcomputer connected to an automatic-answering modem, which is in turn attached to a telephone line. The transmit computer software loops while waiting for an incoming call. When a call is received the modem is signaled to answer the telephone. Information, in the form of data bytes, is received and transmitted in the same fashion as on the receiving end. Essentially, all the user's transmitter sta-

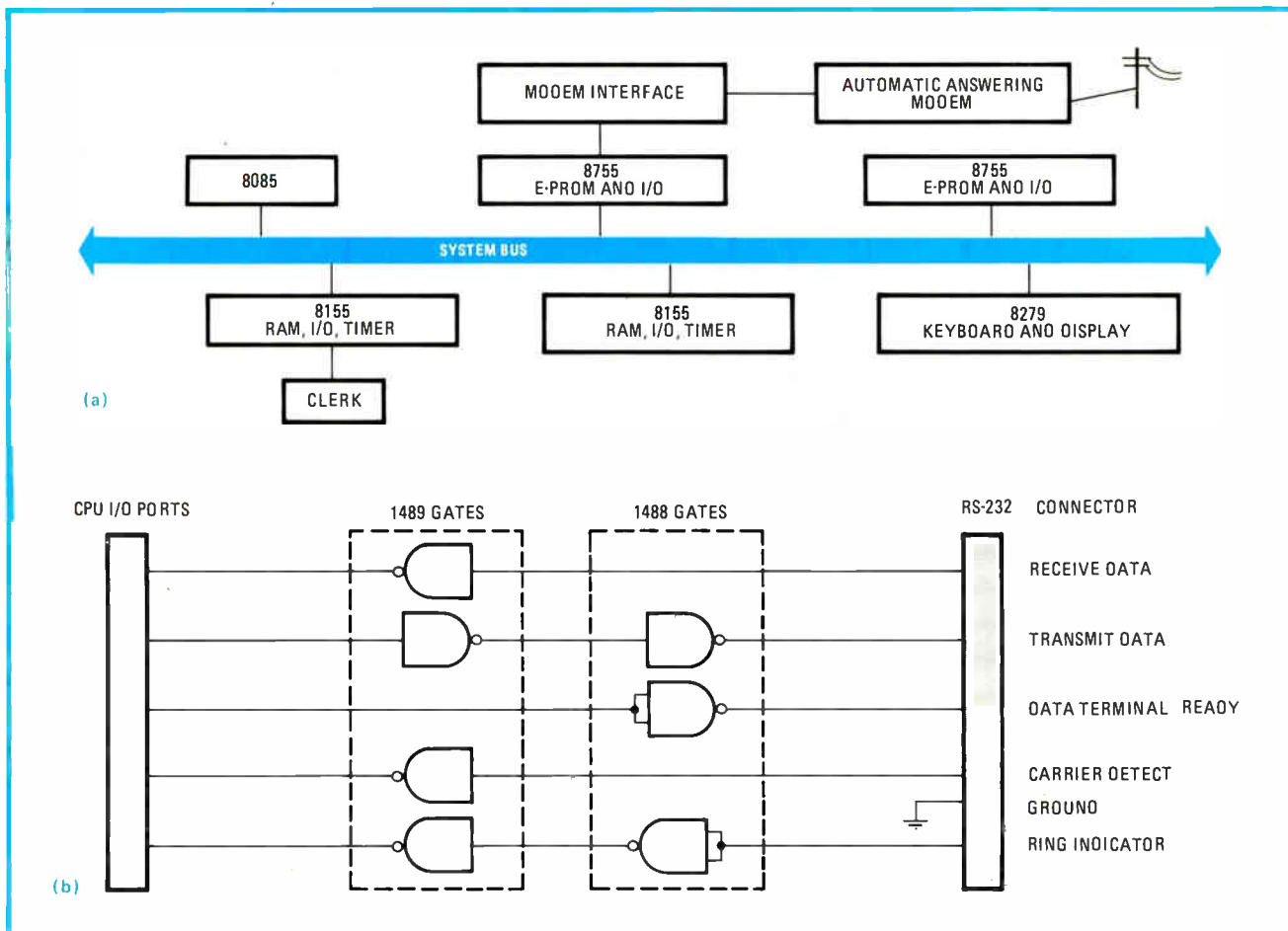

3. Base station. To transmit software changes to a remote-site EE-PROM, a base station (a) might use an 8085 microprocessor, with a keyboard display to help the user keep track of changes. Standard gates on the modem interface (b) furnish the required control signals.

tion must do is look for a remote-processor identification message, send its own identification message, transmit data serially, and hang up the telephone. Additional features may be implemented, such as a log of all calls received and their origins.

Figure 3a contains a block diagram of a transmitter base station system. An 8085 processor is used, with an additional 512 bytes of RAM and 4-K bytes of E-PROM. A modem interface is shown, in addition to a key pad and display for local-user operation and a real-time clock for logging date and time information.

In this design, the E-PROM memory contains information program storage and transmittal. This is the data that is to be transmitted to remote processor sites. Note that the data transmitting E-PROM could be replaced by an EE-PROM device to allow for frequent changes in transmission data without requiring the physical replacement of the transmit-data store. RAM is used to save logging information, temporary program data, and a character input buffer that stores received characters when a specific message is sought.

The key pad and display module enables a local base-station operator to interrogate the base station and reset date or time, or access a call log. The clock module is used to keep track of current date and time. Such data may be transmitted to remote processors or may be used locally as a part of the information logged pertaining to

each call received.

The modem interface for the base station is very similar to the receiver modem circuit. Figure 3b contains a circuit diagram of an automatic-answering modem interface. The circuit provides all signals and takes care of the ring indicator signals. The first is given by the host processor and tells the modem when to answer and hang up the phone. The second is active when the phone is ringing and is used to interrupt the processor.

A real circuit

A base station similar to the one described has been constructed at Intel. It is used to transmit information to remote 2816s for demonstration purposes. In this unit, the software has three operating modes. The first, the interactive mode, is the default, in which the processor displays the time of day while waiting to enter either the dial-in or local-user mode.

The dial-in mode is entered whenever a call is received. The processor answers the line, looks for a remote-processor identification message, and transmits its own identification header, followed by text data to be loaded into EE-PROM memory. The telephone is hung up as soon as transmission is completed and the inactive mode is entered. The local-user mode contains software implemented through the local keypad-display to allow a local user to reset. □

Looking for low profile, highly reliable PCB relays? Check Omron.

You'll want to look closely at our G2E relay. It's the world's smallest consumer relay, measuring 0.1 cubic inch. But don't let its small size fool you, it can switch 1A at 24 VDC or 0.3A at 120 VAC.

Our newest PCB relay additions, G2N and G2P, boast both high sensitivity and dielectric strength and are TTL compatible. In an IC styled 0.5" pitch PC rack-mountable package these relays are especially versatile.

If you're wondering about switching dry circuit loads, as low as 100 μ A 100 mV, the LZN and G2V series do it easily. In addition, LZN's multi-pole format and G2V's unique DIP package clearly give you a design advantage.

The G2L is suited for space saving applications. Flat-pack type for headroom space when mounted between PC boards and the vertical configuration for saving valuable PC board real estate. Not to mention the high power switching capability for both of 8A AC240/DC24.

Then there's our model G2U which features economy without sacrificing high performance. Its

sugar cube size of .85 inches high and switching capability of 5A loads makes it ideal for many applications.

And you don't have to worry about contamination from automatic soldering and cleaning. Most Omron PCB relays offer sealed construction.

So, even though Omron PCB relays have been proved worldwide through tested use, you don't have to check the world. Just check for the name of your nearest Omron distributor, by writing Omron Electronics, Inc., 650 Woodfield, Schaumburg, IL 60195. Or call (312) 843-7900.



For a universe of exceptionally reliable components.

Circle 159 on reader service card

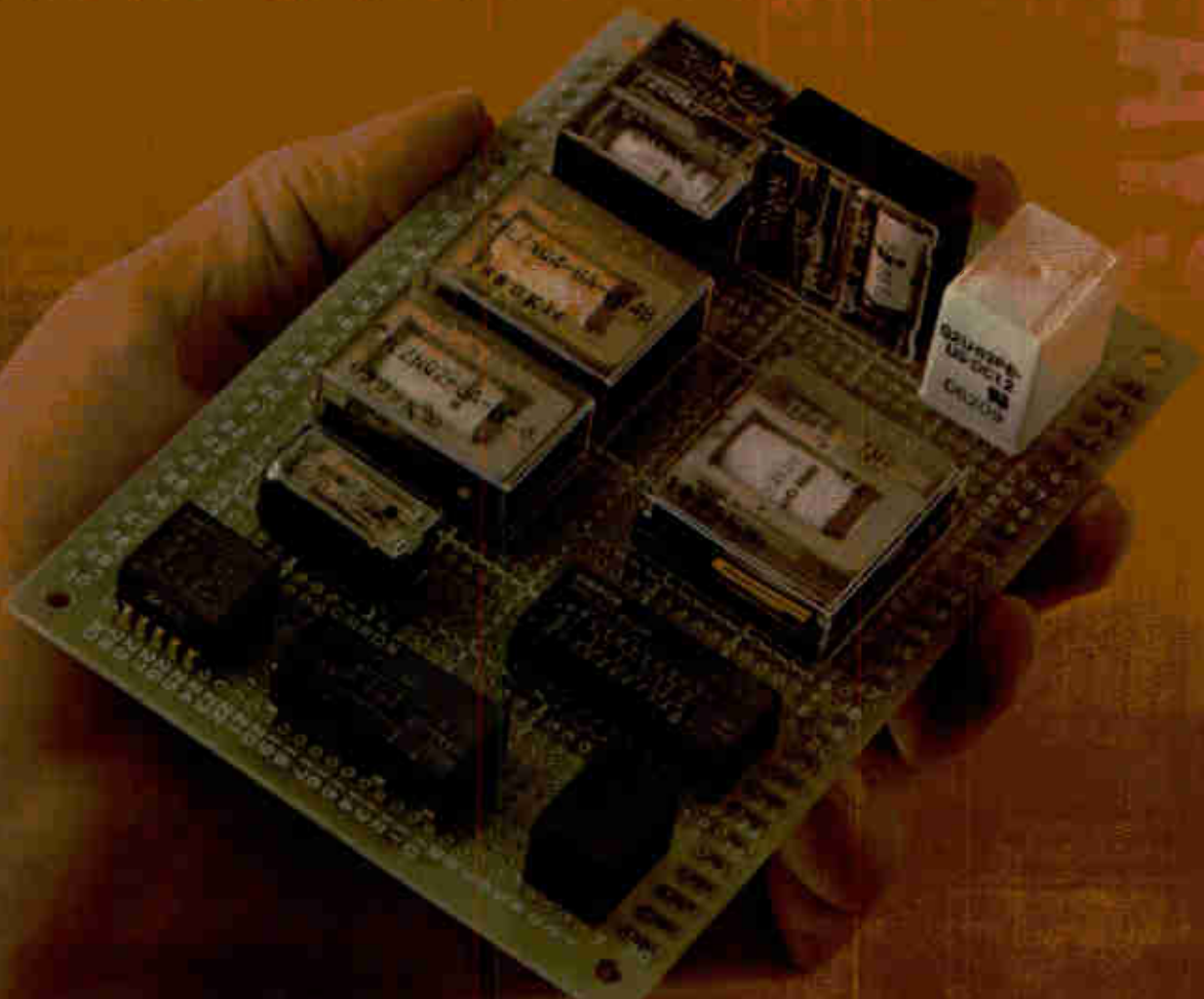

If you've been edgy about the quality of your PCB connectors, here's some good news:

The new Spectra-Strip™ IDC Card Edge connector is the one you've been waiting for.

Designed to the relevant portions of MIL-C-83503 and MIL-C-21097, the 807 Series is priced so that you can improve performance in even your most cost-sensitive systems.

With it, you can *reliably* terminate up to 60 wires at a time using our Twist 'N' Flat®, 3C® Color Coded and economical Spectra-Zip® cables. PCB contacts are bifurcated for reliability, you have a choice of three mounting configurations and covers are easily removable for

daisy-chaining (cover removal tool optional).

And maybe best of all, the Spectra-Strip 807 Card Edge connector is available off-the-shelf from your nearest Spectra-Strip distributor.

While you've got him on the line, you might want to ask about our other IDC connectors, flat cables and assemblies.

Then relax.

Spectra-Strip, 7100 Lampson Ave., Garden Grove, CA 92642, telephone (714) 892-3361 and 720 Sherman Ave., Hamden, CT 06514, telephone (203) 281-3200.

In Europe, Spectra-Strip, Ltd., Romsey, Hampshire, England, telephone (0794) 517575.

Advantedge

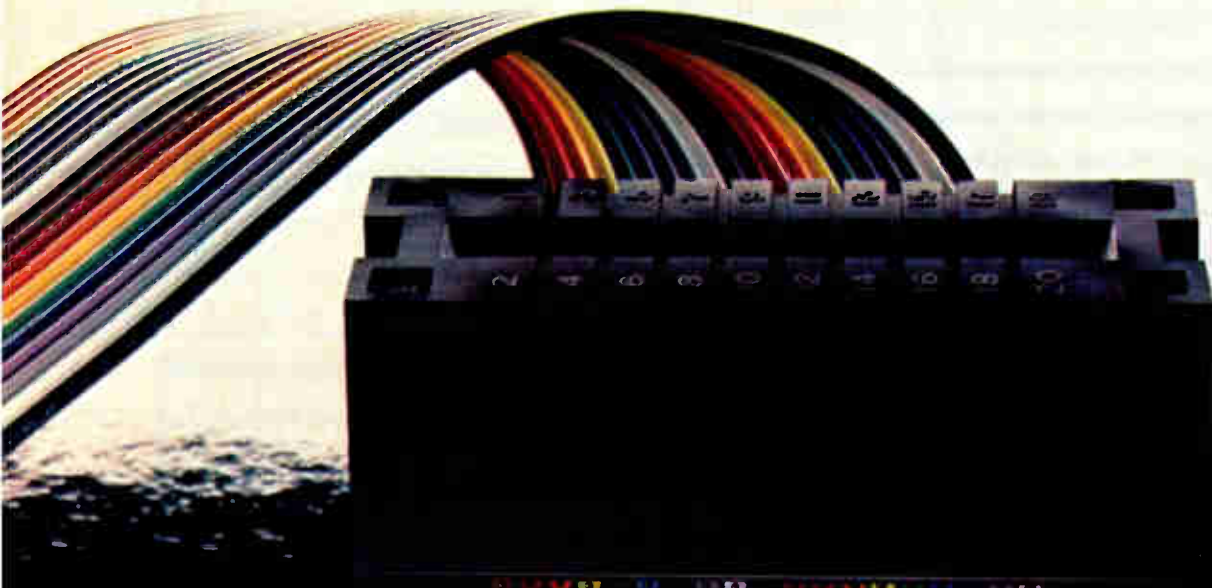

SPECTRA-STRIP

When you're down to the wire.

Special-purpose processor makes short work of host's I/O chores

An unusually smart controller with a dual-ported memory streamlines the link between the 68000 microprocessor and its input/output devices

by Mike F. Wiles and Sharon Lamb, *Motorola Inc., Austin, Texas*

□ An increasingly popular way of speeding up a computer system's throughput is to offload its input/output chores onto special peripheral controllers. In the case of a microsystem, the job has usually been given to general-purpose microprocessors because they can handle a wide variety of peripherals. However, they need a lot of extra circuitry to coordinate the timing between the host and the I/O devices as well as to provide the I/O ports themselves.

The Motorola MC68120 intelligent peripheral controller (IPC) is a special-purpose processor designed to handle these I/O chores with minimal additional circuitry. Built around the modular core of the MC6801 microcomputer, it interfaces with the MC68000 at the system level and with the MC6800 family of peripheral chips through a local bus. Its extremely powerful set of internal resources includes 2-K bytes of read-only memory, 128 bytes of dual-ported random-access memory, a maximum of 21 parallel I/O lines with two control lines, a three-function 16-bit timer, and a full-duplex serial communications interface. State-of-the-art high-performance MOS (H-MOS) technology packs all these resources onto a single piece of silicon (Fig. 1) in a 48-pin package that significantly reduces the system's total parts count and cost.

The IPC can operate in any one of three modes: single-chip, expanded nonmultiplexed, and expanded multiplexed (Fig. 2). In the single-chip mode, the number of I/O lines available to the peripheral controller is maximized at 21, including two handshake lines. This mode should be used for small systems employing only digital I/O

and not requiring off-chip memory. In the expanded nonmultiplexed mode, some of the I/O lines are traded off to generate a nonmultiplexed local bus, thus providing 256 bytes of external addresses that could be used for memory or 6800 family peripheral devices. The expanded multiplexed mode multiplexes the local bus, which can therefore address 64-K bytes of memory as well as numerous I/O devices from the 6800 family (given the addition of a TTL latch to demultiplex the bus).

Check the modes

The operating mode defines the memory map as well as the I/O configuration. The table shows the location of internal registers, on-chip dual-ported RAM, on-chip ROM, interrupt vectors for each mode, and available external memory space.

Compatibility between the 68000 and 6800 families is provided by a shared resource—the IPC's dual-ported RAM (Fig. 3). The system bus interface forms a data path, complete with handshake control, for the 68000 to the dual-ported RAM via the IPC's internal local bus. The dual-ported RAM in turn interfaces (again via the IPC's internal local bus) with the external local bus leading to the 6800 peripheral devices. (The IPC has access to both internal and external I/O and system resources.) Through the shared RAM, the two processors can transfer data and control messages to each other. Each may read the data from the same RAM location simultaneously, but they are not allowed to write data into the same location simultaneously, as that would

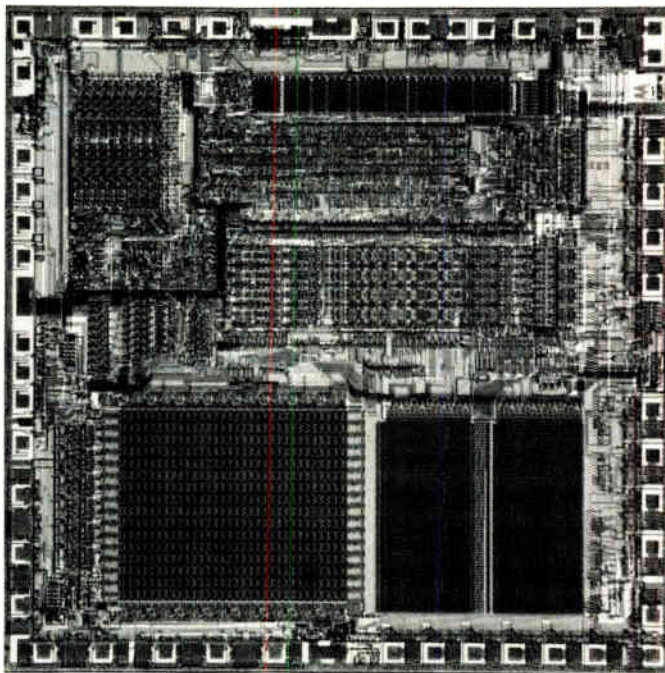

1. Modular die. The intelligent peripheral controller, or IPC, is built around the core of a 6801 microcomputer. It adds a dual-ported random-access memory (lower left) and semaphore registers.

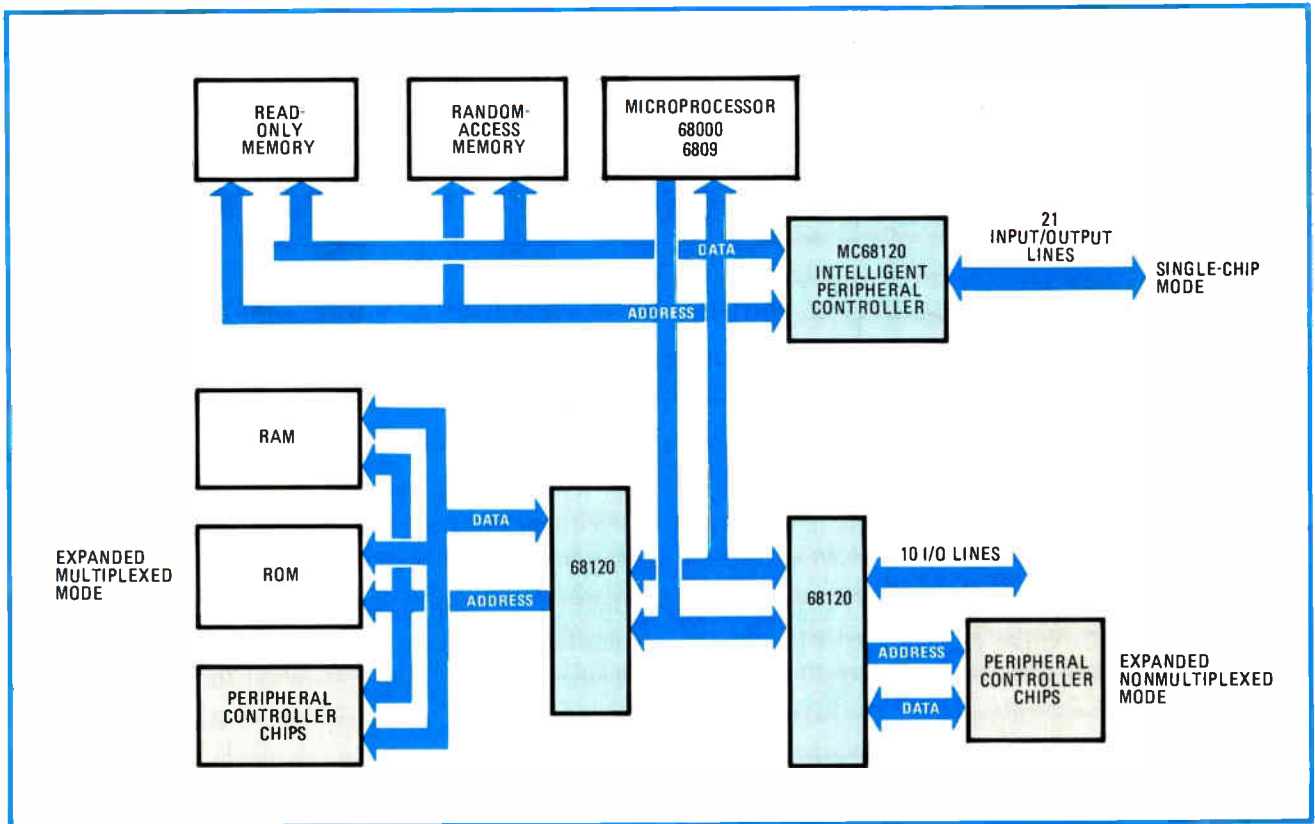

2. Distributed processing. The IPC can operate in three modes, all designed to offload from the host processor tasks involved in communicating with I/O devices. It serves as the intelligent interface between the host microprocessor and specialized I/O controllers.

cause undefined data to be written. This write action is therefore controlled by software with the aid of semaphore bits.

Semaphore bits are the perfect tool for controlling access to common resources. They are flags that signal when a resource is in use. A block of six semaphore registers is integrated into the IPC. They are accessible to the IPC on the local bus in the internal register map and to an external processor via the system bus.

The semaphore bits' roles

A semaphore bit is assigned by software to a specific resource. Before using that resource, the processors must check the semaphore for its availability. A zero (0) semaphore normally means the resource is available, a set (1) semaphore indicates the resource is busy, or unavailable. When the processor no longer needs the resource, it clears the semaphore by writing it to mark the resource as available once again.

Another bit in the semaphore register—the ownership bit—indicates whether it was the IPC or the external processor that last set the semaphore bit. An application program may need to know when the other processor has had access to a shared resource. It also may be desirable for the processor on the system bus to wait for the IPC to receive a message via dual-ported RAM before transmitting another message.

But the most important use of the semaphore bits is when both processors want a resource at the same time and simultaneously read the semaphore assigned to it. The IPC hardware controls the result of this contested

access of a semaphore by making one processor read it as saying the resource is available and the other processor read it as saying the resource is unavailable.

The system bus interface on the IPC works with either a synchronous processor like the 6809 or an asynchronous one like the 68000.

For synchronous processors the chip-select input to the IPC selects the RAM's internal semaphore register indicated by the address lines SA₀–SA₇ on the IPC. The data lines from the synchronous processor are directly connected to SD₀–SD₇ on the IPC with the read/write signal (S-R/W) controlling the direction of the data transfer. The data-transfer-acknowledge (\overline{DTACK}) pin is unused and tied low in a synchronous configuration, while the IPC's other pins supply peripheral interface, timing, and control functions.

Interfacing asynchronously

When the system bus interface is configured to operate in the asynchronous mode, the \overline{DTACK} signals when data is valid for a read cycle and when data has been received on a write cycle. This signal is sent asynchronously to the processor and allows the IPC to operate at an independent frequency. The \overline{DTACK} signal is generated as a response to a chip-select (\overline{CS}) signal indicating that the asynchronous master desires to read or write to the IPC. At the end of the cycle, when \overline{CS} is taken high, the \overline{DTACK} output will also be driven high and then put into a high-impedance state to allow an external pullup resistor to be used to wire-OR the \overline{DTACK} line.

The local bus of the IPC is pin-programmable into one

MEMORY MAPS FOR THE INTELLIGENT PERIPHERAL PROCESSOR'S MODES

Hexadecimal address	Mode 0: multiplexed test	Mode 1: multiplexed	Mode 2: multiplexed, no read-only memory	Mode 3: multiplexed MDOS-compatible ¹	Mode 4: single-chip test	Mode 5: non-multiplexed	Mode 6: multiplexed	Mode 7: single-chip
0000	internal registers	internal registers	internal registers	external memory	internal registers	internal registers	internal registers	internal registers
001F	external memory	external memory	external memory		unusable	unusable	external memory	unusable
0080	internal dual-ported random-access memory	internal dual-ported RAM	internal dual-ported RAM			internal dual-ported RAM	internal dual-ported RAM	internal dual-ported RAM
00FF	external memory	external memory	external memory	C000–C01F internal registers		0100–01FF external memory	external memory	unusable
BFF0	external vectors			C020–C07F external memory		unusable		
BFFF	external memory			C080–C0FF internal dual-ported RAM				
F800	internal read-only memory	internal ROM		external memory		internal ROM	internal ROM	internal ROM
FFFO		external vectors	external vectors	external vectors	XX80–XXFF internal dual-ported RAM	internal vectors	internal vectors	internal vectors
FFFF								

¹MDOS: Motorola Disk-Operating System

of the device's three basic operating modes—single-chip, expanded nonmultiplexed, or expanded multiplexed.

In the single-chip mode the local bus is all internal to the IPC and gives it access to on-chip resources only. This setup configures the ports for the maximum number of 21 I/O lines, plus two handshake lines—the input strobe (\overline{IS}) and output strobe (\overline{OS}).

In the expanded nonmultiplexed mode, some of the single-chip I/O lines become address and data lines, expanding the local bus to address 256 bytes externally at locations 0100_{16} through $01FF_{16}$ for additional I/O devices or memories. This local bus is directly compatible with all 6800 family peripherals. In this mode, one port provides eight data lines and another provides eight address lines, while a read/write (R/\overline{W}) output and an input/output-select (\overline{IOS}) line indicate that the local bus is active.

The local bus may also be configured in the expanded multiplexed mode. In this mode, the local address space is expanded to 64-K bytes, with one port providing eight of the lower address lines on the multiplexed bus while the upper address lines emerge from another. An address strobe must be supplied to the IPC for demultiplexing the address/data bus in this mode.

Modularity to the fore

The tested and accepted central processing unit of 6801 design is the IPC's computing module. The 8-bit processor's easily learned instruction set is an enhancement of the 6800's. Throughput is better since key instructions like load, store, push, pull, and branch now

require fewer cycles and hence execute faster. One new instruction provides 8-by-8-bit hardware multiplication; others perform 16-bit (double-accumulator) arithmetic, data transfers, and shifting. The double-accumulator instructions function with the same addressing modes as their single-byte counterparts.

The main difference from the 6800 is the concatenation of the A and B accumulators to form the 16-bit D accumulator. Several improvements ease indexing, among them being instructions that add an accumulator to the index register and that stack and unstack the index register.

As for its control lines, the IPC's processor includes clock inputs for system timing and a reset line for initializing the IPC to a known state and latching the mode from port 2. Also, the processor can be interrupted by either the maskable \overline{IRQ} line or another pin, which functions either as a nonmaskable interrupt (NMI) or halt line, as dictated by software.

Communicating serially

The IPC includes a full-duplex asynchronous serial-communications interface (SCI) for use with peripherals. The SCI operates in two basic formats: mark/space non-return-to-zero (NRZ) or biphasic. Software controls the bit rate generated within the IPC. The SCI also has an internal wake-up feature that makes it possible for the IPC to ignore the data on the serial interface until it receives a string of 10 consecutive 1s. This is particularly useful in a system of multiple IPCs since they can each ignore all data transfers on the serial bus until their

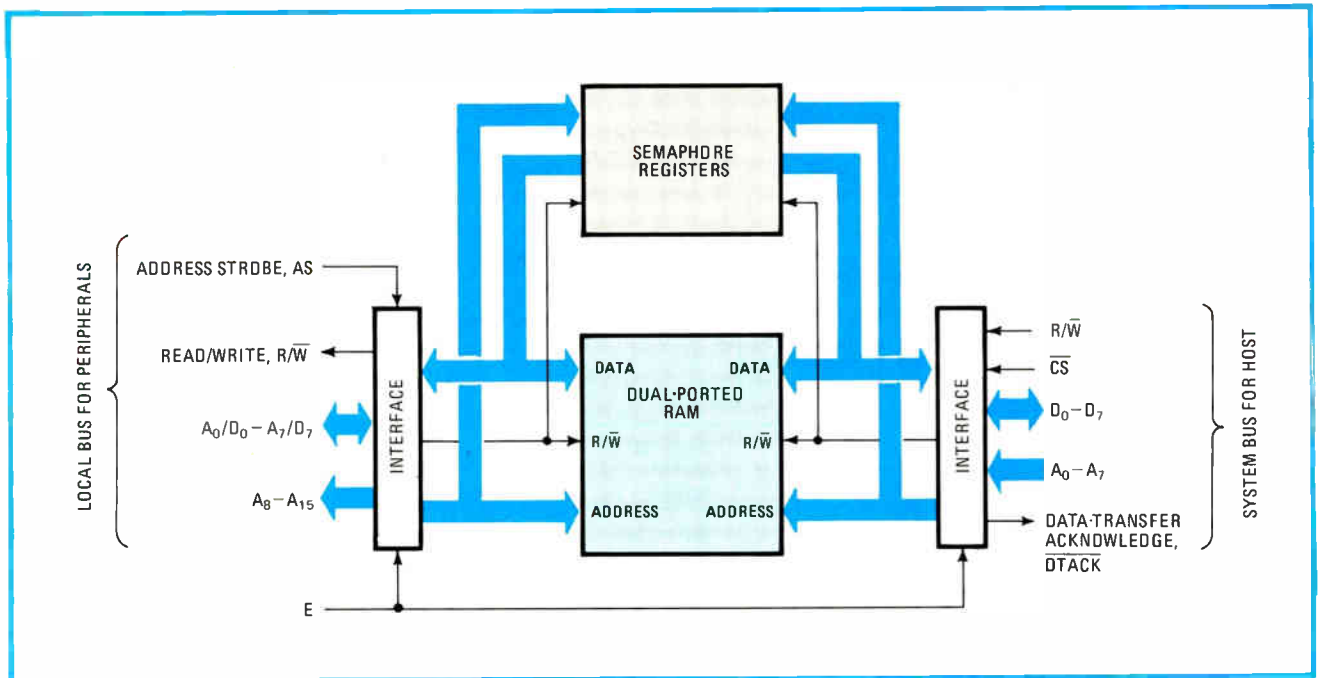

3. Dual-ported. Communication between the host processor and peripherals is mediated by the IPC's internal dual-ported RAM. Messages can be left in this RAM to direct the activities of peripheral control and semaphore registers prevent simultaneous access to the shared RAM.

wake-up code comes along. The basic data format used in the SCI is 1 start bit, 8 data bits, and 1 stop bit, which is used in both the NRZ and the biphase modes.

The serial communications interface contains six internal registers, two of which—the receive-data and the transmit-data shift register—are used only by the hardware and are not directly accessible by the internal processor. (Note that the internal bit-rate generator selects its clock from either the system clock or an external clock connected to a port 2 pin.) The rate-and-mode-control register controls the mode in which the SCI operates, either biphase or NRZ, as well as the bit rate for both the transmitter and receiver. The transmit/receive control and status register enables the transmitter and receiver, the wake-up function, and the automatic generation of interrupts. This register also reports the status of both the transmitter and the receiver. The receive-data register double-buffers data from the receiver shift register and is a read-only register.

The transmit-data register is the buffered input to the transmit shift register for the SCI and is a write-only register. The transmitter and receiver are interfaced to the outside through two pins on port 2.

Three timing functions

The IPC's programmable timer performs three functions for the user. It can generate a pulse-width-modulated output; it can measure a pulse-width-modulated input, and it can generate a periodic timer function using the overflow of its counter. In addition to the counter, the programmable timer includes an output-compare register, an input-capture register and a timer-control-and-status register.

The compare feature allows complete control of the voltage level of the timer's output independently of the period. It is used by writing a value into the output-

compare register on the internal bus. When the output-compare register matches the value in the free-running counter, a pulse is generated that sets the output-compare flag (OCF) and also clocks the output-level register, bringing the next value of the output to the output-level register. An enable-output-compare interrupt (EOCI) bit controls whether or not the output compare function also generates an interrupt. An overflow-detect register generates an active signal each time the 16-bit counter rolls over, thus setting the time overflow flag (TOF). If the enable-timer-overflow mask bit is clear, then an interrupt (OTOI) is also generated.

Edge detection

The edge-detect logic monitors an external input. If the appropriate edge is present as defined by the input-edge register, then this logic causes the value of the counter to be copied into the input-capture register, where it can be read by IPC and used to measure or adjust the input pulse width. The edge-detect logic also generates a signal that sets the input-capture flag, which may cause an interrupt when the enable-input-capture-interrupt (EICI) bit is set. The input-edge-detect-and-capture register is very useful when it is necessary to measure input pulse widths.

The modular architecture of the 68120 is an excellent foundation for future, more ambitious versions of the IPC. By taking advantage of progress in the scaled technology of H-MOS, it will be possible to integrate even more functions onto the IPC.

Candidates for this building-block approach are more RAM, more ROM, enhanced I/O functions, and possibly an erasable programmable ROM version. Also, standard software packages in the on-chip ROM could supply users with system building blocks like the 68122 clustered terminal controller. □



We don't claim leadership in microcomputer software. We earn it.

Every day. We think that supporting software is as important as developing it. Six years ago, we put BASIC on the first microprocessor based computer. Today, Microsoft BASIC is running on over 700,000 systems. Worldwide. Because we never stopped improving it. It's an everyday job at Microsoft.

Languages. BASIC for 8-bit microcomputers was our first language. Today we offer a full range of languages: BASIC, COBOL, FORTRAN and Pascal for both 8-bit and 16-bit microcomputers. Fully supported languages that meet industry standards. Plus enhancements we add to increase their utility. Languages that provide transportable applications software between microprocessors. Synergistic languages that provide feature-for-feature compatibility between 8-bit and 16-bit machines.

More than languages. In addition to languages, Microsoft has utility programs and end-user system software. Microsoft developed XENIX™, our implementation of UNIX® for 16-bit microcomputers. It isn't "UNIX-like." It's fully supported UNIX for the 16-bit world.

Partnership. When you put Microsoft products on your system, you enter an on-going partnership with some of the industry's foremost experts. We continually research hardware and software technology in an effort to develop new products, and, to improve our present products. And when those improvements are made, the updated products are

made available to our customers. That's a nice thing to know when you're developing systems.

Easy to OEM. Our royalty plan for licensing software allows you to add Microsoft software to your system with a very low initial investment, paying royalties on a when-sold basis. And if you're on a sensitive schedule, remember most of our products are available off the shelf. No waiting.

Questions? Call our OEM Accounts Manager. We'd like to show you why buying leading edge software is a lot less expensive than writing it. And remember, Microsoft is "One-stop Shopping" for your system software needs.

Microsystem specialists. Microsoft led the industry into the 8-bit world. Now, we're leading it into the 16-bit world. With fully supported and maintained software. The kind of software that gives our customers a lead on the competition. Today, people say we're the leading microcomputer software source. It's the kind of reputation people give you only when you earn it.

MICROSOFT

10800 N.E. 8th St., Suite 819
Bellevue, Washington 98004
(206) 455-8080 • TLX: 328945

Subroutine tests RAM nondestructively

by Steve Strom
Motorola Inc., Semiconductor Group, Phoenix, Ariz.

□ Nondestructive test patterns for random-access memories make it possible to check data on line even while executing programs. The RAM subroutine described here, which runs on the Motorola MC68000 16-bit microprocessor, tests a read/write memory of any length and requires only the starting and ending addresses of the storage block under scrutiny.

The program is said to be linear because the time required for the test goes up in a linear fashion as the number of locations increases. A linear pattern can never be as thorough as a higher-order test using, say, an N^2 pattern. But since the complexity of an N^2 pattern rises as the square of the input, testing time may become intolerably long. Quadrupling the size of the RAM increases the time for an N^2 test pattern by 16 but only by 4 for a linear pattern, possibly saving seconds to test a chip or minutes to test a larger system.

The test passes over memory three times. On the first pass, the subroutine calculates a checksum by exclusive-ORing each byte with data register D_0 . The final result is kept in another data register, D_2 .

In the second pass, another such checksum is taken, but the result is left in D_0 . Also on this pass, after each byte is read, it is complemented, read again, and compared with the complement to insure that each location can store its own complement. When the top of memory is reached, the checksum is compared with the one taken on the first pass.

The last phase of the test is identical to the second, except that the program begins at the top of memory; as before, its checksum is compared with that obtained on the first pass. In the end, every location has been returned to its original state. If a failure was encountered during the second pass, the test routine sets a flag but continues testing to search

NONDESTRUCTIVE RAM TEST SUBROUTINE

ENTRY REQUIREMENT:

A0 = BEGINNING ADDRESS OF RAM TO BE TESTED
A1 = ENDING ADDRESS + 1 OF RAM

RETURN CONDITIONS:

IF NO ERROR ENCOUNTERED--ZERO FLAG SET
IF ERROR ENCOUNTERED--ZERO FLAG NOT SET
& A2 = FAILED ADDRESS

TYPICAL CALLING ROUTINE:

```
LEA  RAMBEG, A0
LEA  RAMEND+1, A1
BSR  RAMTST
BNE  ERROR
```

```
RAMTST  MOVE.L  A0,A2      USE A2 AS A POINTER
        CLR.L  D7        USE D7 AS AN ERROR FLAG
        CLR.W  D0        USE D0 TO CALCULATE RAM CHECK SUM
EXOR    MOVE.W  (A2)+,D1  GET A BYTE FROM MEMORY
        EOR.W  D1,D0     EXCLUSIVE-OR IT TO 00
        CMP.L  A1,A2     SEE IF AT END OF MEMORY
        BNE.S  EXOR      CONTINUE UNTIL END OF MEMORY REACHED
        MOVE.W D0,D2     SAVE EXOR RESULT IN O2

        MOVE.L  A0,A2      GO BACK TO BEGINNING OF MEMORY
        CLR.W  D0        GET READY TO RECALCULATE CHECK SUM
LOOP1   MOVE.W  (A2),D1  GET A BYTE FROM MEMORY
        EOR.W  D1,D0     EXCLUSIVE-OR IT TO D0
        NOT.W  D1        COMPLEMENT THE DATA
        MOVE.W D1,(A2)   WRITE IT BACK TO MEMORY
        CMP.W  (A2)+,D1  SEE IF IT WAS STORED
        BEQ.S  PASS1     IF GOOD, THEN JUMP AROUND ERROR LOGGING
        TST.L  D7        SEE IF THERE WAS A PREVIOUS ERROR
        BNE.S  PASS1     IF SO, THEN JUMP AROUND ERROR LOGGING
        MOVE.L  A2,D7     RECORD FAILED ADDRESS
PASS1   CMP.L  A1,A2     SEE IF AT END OF MEMORY
        BNE.S  LOOP1    IF NOT, THEN STAY IN PASS1 LOOP
        CMP.W  D0,D2     SEE IF CHECK SUM CORRECT
        BEQ.S  END1     IF GOOD, THEN JUMP AROUND ERROR LOGGING
        TST.L  D7        SEE IF PREVIOUS ERROR ENCOUNTERED
        BNE.S  END1     IF SO, THEN JUMP AROUND ERROR LOGGING
        MOVE.L  A2,D7     SAVE FAILED ADDRESS

END1    CLR.W  D0        GET READY FOR NEXT CHECK SUM CALCULATION
LOOP2   MOVE.W  -(A2),D1  GET A BYTE FROM MEMORY
        NOT.W  D1        COMPLEMENT THE BYTE
        EOR.W  D1,D0     EXCLUSIVE-OR IT TO D0
        MOVE.W D1,(A2)   WRITE IT BACK TO MEMORY
        CMP.W  (A2),D1  SEE IF IT GOT THERE
        BEQ.S  PASS2     IF GOOD, THEN JUMP AROUND ERROR LOGGING
        TST.L  D7        SEE IF THERE WAS A PREVIOUS ERROR
        BNE.S  PASS2     IF SO, THEN JUMP AROUND ERROR LOGGING
        MOVE.L  A2,D7     RECORD FAILED ADDRESS
PASS2   CMP.L  A0,A2     SEE IF AT BEGINNING OF MEMORY
        BNE.S  LOOP2    IF NOT, THEN STAY IN PASS2 LOOP
        CMP.W  D0,D2     SEE IF CORRECT CHECK SUM
        BEQ.S  END2     IF SO, THEN END OF TEST
        TST.L  D7        SEE IF THERE WAS A PREVIOUS FAILURE
        BNE.S  END2     IF SO, THEN STOP HERE
        MOVE.L  A2,D7     SAVE FAILED ADDRESS

END2    MOVE.L  D7,A2     POINT A2 TO FAULTY ADDRESS
        TST.L  D7        SET CONDITION CODES
        RTS             RETURN TO CALLER
```

for any additional faults downstream.

The program sets a flag whenever a failure is encountered. Before returning to the calling program, the subroutine tests the error flag and sets condition codes accordingly. Pinpointing the faulty component usually requires additional, off-line diagnostics.

With minor modification, the routine could provide some diagnostic information. For example, it could store the address of each faulty location, as well as the data written into and read from the RAM. In fact, the program listing provided stores the first bad address in an error register. □

Calculator notes

HP-41C generates a pseudorandom sequence

by Ian Patterson, *Chemical Engineering Department, Ecole Polytechnique, Montreal, Quebec, Canada*

In much the same, time-honored way as a shift register whose output bit is exclusive-ORed with a selected bit in the register and fed back as input, this HP-41C program will generate a pseudorandom binary sequence that is useful for statistical communications analysis. This one provides a sequence ranging in length from $3(2^2 - 1)$ to $1,023(2^{10} - 1)$ bits.

The program is based upon determining the value of the register bit to be exclusive-ORed and fed back from the relationship:

$$n_r = \text{INT}(R/2^{l-n}) \text{ MOD } 2$$

where

l = the register length

n = the bit position of the bit to be exclusive-ORed in the feedback loop

R = the register value (the contents, decimal equivalent, of the register).

Only the register length and a seed (the initial value in the register) must be provided. The program is executed by keying XEQ PRBS. The user then responds to the prompt, "No. of bits?" with the register length (from 2 to 10), and then with the seed, which can be any positive integer. The feedback bit position, n , is calculated by subroutine 10 (LBL 10) in the program, using the method detailed by Davies¹.

Having the required information, the program then derives the sequence, with the calculator then generating a high tone when each stepped output bit is a 1 and a low tone for 0. The tone output may be suppressed and the

HP-41C PROGRAM FOR PSEUDO RANDOM BINARY SEQUENCE GENERATION							
Line	Code						
01	LBL ^T PRBS	30	8	60	*	90	^T BAD LENGTH
02	CF 10	31	-	51	RCL 02	91	AVIEW
03	^T NO. OF BITS?	32	x = 0?	62	2	92	GTO ^T PRBS
04	PROMPT	33	SF 10	53	/	93	LBL 08
05	STO 01	34	LBL 03	64	INT	94	RCL 02
06	2	35	FS? 10	65	+	95	4
07	RCL 01	36	GTO 08	66	STO 02	96	/
08	y ↑ x	37	RCL 02	67	RCL 04	97	INT
09	1	38	2	68	7	98	2
10	-	39	RCL 01	69	*	99	MOD
11	INT	40	RCL 03	70	TONE IND X	100	RCL 02
12	^T SEED?	41	-	71	RCL 04	101	8
13	PROMPT	42	y ↑ x	72	GTO 03	102	/
14	LBL 01	43	/	73	LBL 10	103	INT
15	x ≤ y?	44	INT	74	3481121110	104	2
16	GTO 02	45	2	75	RCL 01	105	MOD
17	2	46	MOD	76	1	106	+
18	/	47	LBL 04	77	-	107	RCL 02
19	INT	48	RCL 02	78	CHS	108	16
20	GTO 01	49	2	79	10 ↑ X	109	/
21	LBL 02	50	MOD	80	*	110	INT
22	x ≤ 0?	51	+	81	10	111	2
23	XEQ 10	52	2	82	/	112	MOD
24	STO 02	53	MOD	83	FRC	113	+
25	XEQ 10	54	STO 04	84	10	114	GTO 04
26	FIX 0	55	2	85	*	115	END
27	RCL 03	56	RCL 01	86	INT		
28	x = 0?	57	1	87	STO 03		
29	GTO 09	58	-	88	RTN		
		59	y ↑ x	89	LBL 09		

value displayed by deleting instructions 68 to 71 and substituting a pause (PSE) or STOP instruction in their place. □

References

W. D. T. Davies, "System identification for self-adaptive control," John Wiley & Sons, New York, 1970.

Counter-timer resolves 1 μs over extremely wide range

by M. Antonescu, *Ecole Polytechnique Fédérale de Lausanne, Lausanne, Switzerland*

Providing much greater resolution and range than even the circuit proposed by Pinchak [*Electronics*, Nov. 6,

1980, p. 130], this timer-counter delivers programmable markers for periods of 1 to 120×10^6 seconds in 1-microsecond steps. The duty cycle is also selectable over a range of ratios from $1:10^6$ to $10^6:1$.

As seen in the figure, the 8640B time standard from Suwa Seiko, which has a built-in quartz-crystal oscillator, can be programmed by means of switches S_1 and S_2 for any of 64 output periods in the 1-μs-to-120-s range. When used in the timing mode, this oscillator drives the Toshiba TC 5070P counter, which is similar to Intersil's ICM8240 but has six digits and can drive a common-



TEN THINGS TO DO WITH YOUR HANDS... while operating the SYSTEM 620 data acquisition system.

Today's technology demands more complex, more accurate measurements than ever before. But even with a high-performance system, you can't be sure of measurement accuracy until you've first calibrated and verified the performance of each transducer. At today's prices, the cost of these operations can be staggering if they are manual.

In our System 620, these pre-test adjustments are automated and brought on-line. That's what we mean by 'hands-off' operation.

Among the selection of sophisticated options for System 620 are computer-controlled system calibration, transducer calibration and automatic transducer balancing. With these features, there's no need to fiddle with zero pots, tweak balance controls or fumble with lengthy calibration procedures. In the world of hands-off data acquisition, you can take data immediately and with confidence.

Hands-off data acquisition is only one feature of the versatile System 620 that enables us to build a system to your exact requirements...custom systems from standard products.

We have a custom system for you. Ask us about it.

Call us on one of our toll-free lines: **(800) 423-7151**, outside California; in California, call us collect on **(213) 357-7151**.



700 South Myrtle Ave., Monrovia, CA 91016
TWX 910-585-1833



Neff. Custom Systems from Standard Products.

Circle 172 on reader service card

World Radio History

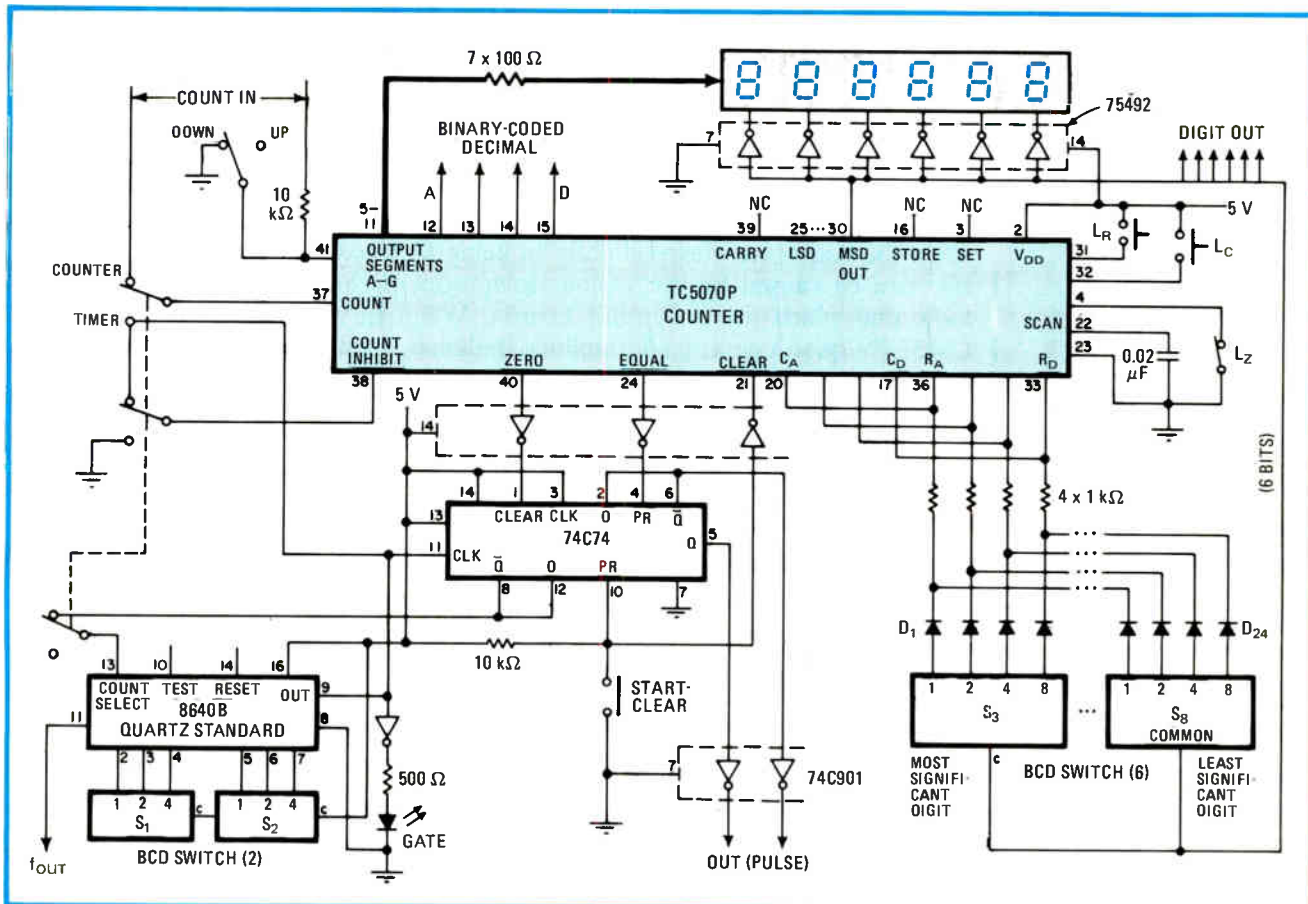

1. Show time. Start- and end-count numbers are loaded into a TC 5070P counter chip from switches S_3 – S_8 . For timing applications, another switch-selectable IC, the 8640B quartz standard, provides an accurate time base for marking precise intervals.

cathode light-emitting-diode display.

In the counter mode, switches S_3 through S_8 are used to set the start- and end-count numbers. Push-button switch L_C loads the counter with the start-count number, and switch L_R loads a register with the end-count number. When the latter is reached, the counter generates an “equal” signal that sets a flip-flop, and the setting is detected at the flip-flop’s output through a buffer. A second signal clears the flip-flop when the count passes through zero, and this event is detected at the same output buffer. Both up and down counting is possible.

When timing, the 5070 counter chip counts the timing pulses from the 8640 time standard. Again, the equal and zero counts are used to toggle a flip-flop, but in this use the action occurs over a specified time span, rather than a specified number of counts. The time span marked by the counter is adjustable, from a period of one clock pulse up to that of a million clock pulses, yielding a maximum period on the order of years.

Both normal and complementary outputs are generated along with a visual indication of the gate period from the LED labeled “gate.”

The timer has two modes, depending on the state of start/clear switch. Holding the switch on causes the counter to run continuously and reset itself every gate period, whereas a momentary depression of this switch

PROGRAMMING OF RATIO SWITCHES S_1 AND S_2

setting		0	1	2	3	4	5	6	7
S_1	pin 2	L	H	L	H	L	H	L	H
	pin 3	L	L	H	H	L	L	H	H
	pin 4	L	L	L	L	H	H	H	H
	ratio	1/1	1/10	1/2	1/3	1/4	1/5	1/6	1/12
Multiplier	S_2	1	10	10^2	10^3	10^4	10^5	10^6	10^7

cycles it through a single time period, stops the counter at the end, and displays the elapsed period.

For a gate time of 1 s, the time standard should be set for 2 s; that is, programming pins 3, 6, and 7 should be set high. The gate duration is the second half of the time period—in this example, 1 s—and is unaffected by the length of time the start/clear switch is closed.

The display output is multiplexed across the six seven-segment numerals. Switch settings are channeled to the display through a network of 24 diodes, providing a visual check of the setting.

Total current consumption with a fully lit display is about 40 milliamperes at 5 volts. With the display switched off, it falls to 7 or 8 mA. Overall accuracy is better than 10 parts per million.

Finally, an external clock can drive the time-standard chip so that special counting rates such as accelerated countdowns can be accommodated. □

Engineer’s notebook is a regular feature in *Electronics*. We invite readers to submit original design shortcuts, calculation aids, measurement and test techniques, and other ideas for saving engineering time or cost. We’ll pay \$75 for each item published.

Unstress that op amp

If the output of one of your dc amplifiers has drifted unaccountably, the cause could be mechanical stress transmitted to it through its pins by the board it is mounted on, warns Dale Hileman of Sphymetrics Inc., Woodland Hills, Calif. For instance, the IC's pins could have been bent when the board was flexed slightly in being fastened to a chassis. Flexing also can be caused by the various tolerances of the automatic insertion tools that place ICs on circuit boards. When he experimented with a LM324N quad operational amplifier, Hileman found **a change in the op amp's dc output that was equal to a 0.5-mV shift in its offset**—but he also found he could reduce the effect by 90% if he inserted the IC in a socket to minimize the mechanical coupling between it and the board.

All you need to know about venture capitalists

Venture capitalists financed Apple Computer, perhaps the most famous high-technology startup of recent years. Out from a garage, Apple has grown into one of the largest personal computer companies in the world. The founders of Apple were fortunate. **Engineers who are interested in forming their own company usually lack the necessary business expertise in starting a business and gathering the necessary capital.** They need to understand the relationship between the venture capitalist and the entrepreneur. One way to do this is by reading the fifth edition of the "Guide to Venture Capital Sources" just published by Capital Publishing Corp. The book includes 23 chapters on all aspects of venture funding and directories of money sources and small company underwriters. Contact Jane Koloski Morris at (617) 235-5405 for further information, or write to her at P.O. Box 348, Wellesley Hills, Mass. 02181.

Learn to implement the IEEE-488 interface bus

The popular IEEE-488 general-purpose interface bus can be implemented in several ways, none of which is simple. To help designers, Intel Corp. gives a four-day workshop on the subject. According to Ben Catanzaro, who teaches the course, **it is geared toward Intel's chips, but the discussion of interfaces, the bus itself, and its applications is of a general nature.** It's not just a theoretical workshop—participants will build a 488 bus talker-listener system. The cost is \$795 per person, which does not include hotel stay or meals. The next session starts Aug. 10 in San Francisco, although on-site workshops can be arranged. If you need to know more, write to Catanzaro at 1350 Bordeaux Dr., Sunnyvale, Calif., or call him at (408) 734-8102.

IEEE seeks people to devise memory-test language standard

The standards subcommittee of the Institute of Electrical and Electronics Engineers' Test Technology Committee is interested in finding people to help create a standard for a memory-test programming language. The language is expected to be based on Pascal. The overall effort will be carried out by two subgroups: a working group of five to eight people will prepare drafts of the standard and a larger group of up to two dozen people will review the drafts. **The working group will probably meet at least once a year at the Cherry Hill, N. J., test conference.** Individuals who wish to serve with either group or who would like to lead the working group should contact J. Reese Brown Jr., Burroughs Corp., 330 South Randolphville Rd., Piscataway, N. J. 08854.

-Harvey J. Hindin

Iskra - specialized and worldwide in electronics

Let us show how we can help you solve your problems



We develop, design, manufacture, supply, install and maintain

Communication equipment and systems
Computer and related equipment
Automation of traffic, power generation/distribution and industrial processes
Test and measuring equipment/instruments
Active and passive electronic components
Electromechanical devices, components and sub-assemblies
Electrical and electronic equipment for motor vehicles
Consumer products

Offered: licences, partnership, patents, joint venture, know how, co-production
Make your choice of these lines to get complete information and offers

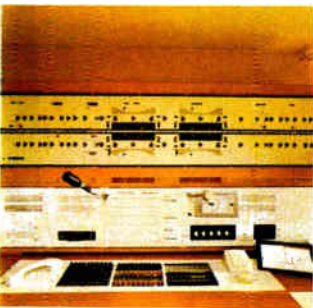

Facts about Iskra

30,000 employees

2000 research and development engineers

90 factories, research, marketing and other organizations; turnover \$ 1.316 billion last year

24 trading companies, representative offices and production plants in 18 countries
all over the world

In period 1976-1980, Iskra's export increased by 142% reaching \$ 145 million in 1980.

In 1981, the export is expected to be \$ 200 million and in the period 1981-1985
over \$ 1.5 billion.

Ask for a free copy of our brochure, Annual Report '80, catalogues, literature.

See us at the International Fairs in Paris, London, Birmingham, Hannover, Basel,
Leipzig, Munich, Köln, Milan, Moscow, Poznan, Budapest, Brno, Ljubljana, Zagreb,
Belgrade, Bagdad



For more information call or write

Iskra Commerce, Trg revolucije 3, 61001 Ljubljana, Yugoslavia, Telephone-International: + 38 61 324 261

Telex: 31 356 yu iskeyp, or contact our subsidiaries in Brussels, Paris, Gonesse Paris, Milan,

Barcelona, Solothurn (Switzerland), Coulsdon London, Syosset, N. Y., Stuttgart, Munich,

Manheim-Neckerau, Prague, Cairo, Tehran, Berlin, Warsaw, Bucaresti, Istanbul, Caracas, Moscow, Quito, Stockholm

Iskra

ZEBRA[®]

ELASTOMERIC MAKE ALL OTHER LCD

SANDWICHED BETWEEN LCD AND PC-BOARD CONNECTORS OUT-PERFORM CONVENTIONAL CONN

Tomorrow's microcircuit technology will require more numerous and tightly packed contact points. Conventional connectors will no longer be able to do the job in terms of size and performance. ZEBRA elastomeric connectors will—with a simple, cost effective connection between the contact pads of the printed circuit boards and the liquid crystal displays.

ZEBRA Elastomeric connectors provide these electrical and mechanical design advantages:

- Greatest design flexibility. Connections with any size LCD, flat or angle-mounted.
- High density interface between LCD and PC board connections.
- Flexible surface prevents damage to LCD and PC board contacts.
- Reduced assembly and disassembly costs. No heat or soldering required.
- Long-lasting contact integrity.
- Decreased assembly susceptibility to shock, vibration and environmental factors, such as moisture and corrosion.

✱ Call or write TECKNIT[®] for information on your LCD application and a free ZEBRA connector sample.

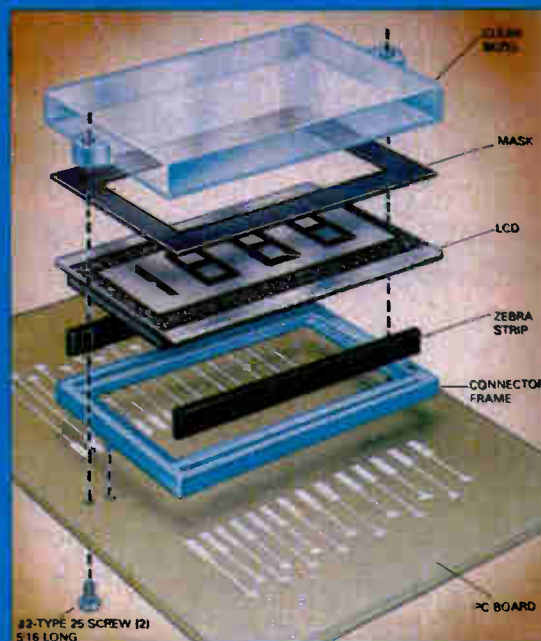

The ZEBRA elastomeric connector consists of alternating layers of conductive and non-conductive silicone rubber. It is made conductive by using carbon fillers. At least one conductive layer will connect opposing contact pads, and at least one insulating layer will separate adjacent pads. The ZEBRA elastomeric connector is available in an infinite number of sizes to meet design requirements.

CONNECTORS

CONNECTORS OBSOLETE

CONTACTS, VERSATILE **ZEBRA**[®] ELASTOMERIC CONNECTORS AS MICROCIRCUIT TECHNOLOGY ADVANCES.

DESIGN VERSATILITY MAKES ZEBRA CONNECTORS THE LOGICAL CHOICE FOR EVERY LCD APPLICATION.

FLUKE DMM



John Fluke Mfg. Co., Inc. chose to use ZEBRA elastomeric connectors for the latest model of their popular DMM. These connectors were used between the angle-mounted LCD terminal area and flex-cable interface to ensure survival in harsh environments, and to endure shock and vibration.

TOKHEIM MEMS II FUEL MONITOR SYSTEM



When Tokheim Corporation designed their new Modular Electronic Marketing System (MEMS I) for self-service gas stations, LCD's were chosen for better visibility and reduced power consumption. A connector that would provide reliable contact to the large-area LCD was required. Because conventional connectors presented assembly alignment and field service problems, Tokheim chose ZEBRA elastomeric connectors.

MILTON-BRADLEY VIDEO GAME

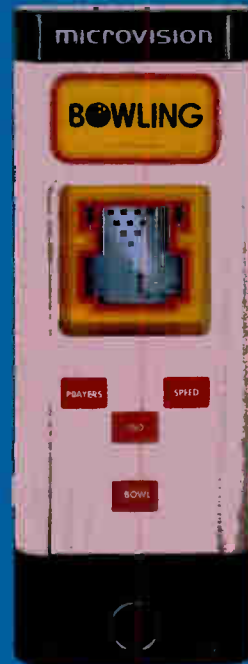

Milton-Bradley Co., required a high-density, right-angle connector for the LCD portion of the dot matrix display of their Microvision video game. The ZEBRA elastomeric connector versatility provided design flexibility for both parallel and right-angle connections to satisfy requirements of this large volume production application.



TECKNIT[®]

TECKNIT, Inc., 129 Dermody Street,
Cranford, NJ 07016 (201) 272-5500
TWX (710) 996-5951 TELEX 685 3079 TCKNT



ZEBRA[®]
THE NEW CONNECTOR
TECHNOLOGY

Circle 177 on reader service card



**The Gould family of test
and measurement instruments
keeps growing, and
so does its reputation.**



Our big family of test and measurement instruments is getting bigger every day. And any friend of one of the family knows what to expect from all the rest: rugged performance and reliability.

Our instruments are built to some of the toughest quality standards in the industry. Logic analyzers. Oscilloscopes. Fixed linear array recorders. Oscillographic recorders. Signal conditioners. Biophysical instruments. Digital multimeters. Analytical instruments.

Whatever your need, we can provide the right instrument to do the job. It's all in the family.

For more information, call or write Gould Inc., Instruments Division. Operations in Santa Clara, California; London, England; Paris, France; Frankfurt, Germany; and headquarters at 3631 Perkins Ave., Cleveland, Ohio 44114.



An Electrical/Electronics Company

Circle 233 on reader service card

The instruments that you available from the

Leader offers you more than 50 instruments that deliver better cost-performance than you ever thought possible.

Surprising fact: Leader's 50-MHz oscilloscope outperforms all competitors. Costing substantially less than the best selling competitive model, the LBO-517 is more sensitive, has a higher 20-kV accelerating potential for brighter displays, and permits simultaneous main and delayed time-base presentations. In fact, it has more features than any other 50-MHz oscilloscope at any price. In all, there are 12 Leader oscilloscopes... each offering more performance for less cost.

Surprising fact: Leader "easy-reading" frequency counters are preferred for many industrial applications. Built for continuous day-in, day-out use, Leader 80, 250, and 520-MHz frequency counters are production-line proven. All three units feature large, bright fluorescent digital displays for easy reading.

Surprising fact: Leader offers a big line-up of professional video and TV instruments. There are over 12 units in all. NTSC, PAL and SECAM sync and test signal generators, RF and IF alignment sweep/marker generators, CATV field strength meters... and more on the way.

Surprising fact: Leader audio instruments have a worldwide reputation for excellence. Design labs, production lines and service departments in over 80 countries rely on Leader audio instruments... frequency response recorders, speaker analyzers, precision sine and square-wave generators, distortion meters, attenuators, one and two-channel ac millivolt meters, FM stereo generators, wow, flutter, and drift meters. Over 17 off-the-shelf units.

Surprising fact: Leader general-purpose instruments grow ever more popular. VOM's, digital and FET multimeters, LCR bridges,

semiconductor testers and curve tracers, audio and RF generators, function generators... all feature human-engineered control layouts, up-to-date capabilities and sturdy, attractive enclosures. All offer optimum reliability at realistic costs.

Surprising fact: Additionally, over 100 other Leader instruments are available for production-test and special applications. Call or write for detailed information on these.

Surprising fact: Leader instruments are built to withstand extreme environments. Every unit is designed and tested for extremes of temperature, humidity, vibration and shock... and all production runs are tested to maintain Leader's high standards of environmental integrity.

Surprising fact: No waiting for Leader Instruments. Immediate deliveries from agents located around the world.

Consult the leader today. Get all the facts on the finest instrument line and the name of your local Leader agent.

LEADER

Leader Electronics Corporation
2-6-33 Tsunashima Higashi, Kohoku-ku
Yokohama, Japan Phone: (045) 541-2121
Telex: J47780 JPLEADER

In the U.S.A. contact:
Leader Instruments Corporation
380 Oser Avenue, Hauppauge, NY 11787 U.S.A.
Phone: (516) 231-6900
Telex: 510-227-9669 LEADER HAUP

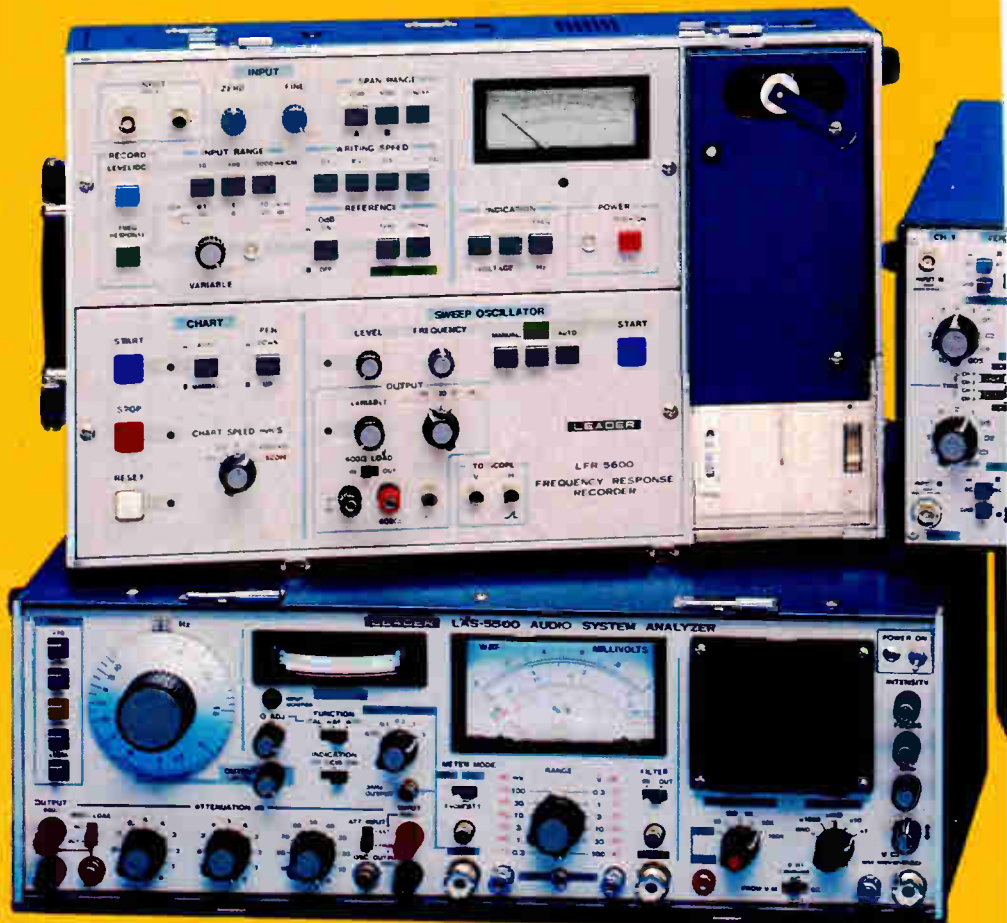

The SM-Relay from ITT: Hermetically sealed*

Key characteristics of the SM Relay:

- Extremely small dimensions:
15,7 x 12,8 x 9,5 mm
- Various rated voltages from
5, 12, 24 to 48 V
- Reliable switching from dry circuit
to 30 VA \Rightarrow
- Large voltage range:
3,55...100 V at 20 °C
- Wide ambient temperature range:
-40...+85 °C
- Outstanding component climatic category
40/085/56
- High shock resistance:
half-sine shock,
duration 11 ms: >15 g
- Superb vibration resistance:
sinusoidal vibration
between 10 and 500
Hz: >15 g
- Top mechanical endurance:
>2 x 10⁸ operations



- * Sealed in epoxy resin
- No problem with automatic wave soldering
- Best protection against flux
- Makes PC board cleaning an easy job
- Reliable performance even under unfavourable environmental conditions

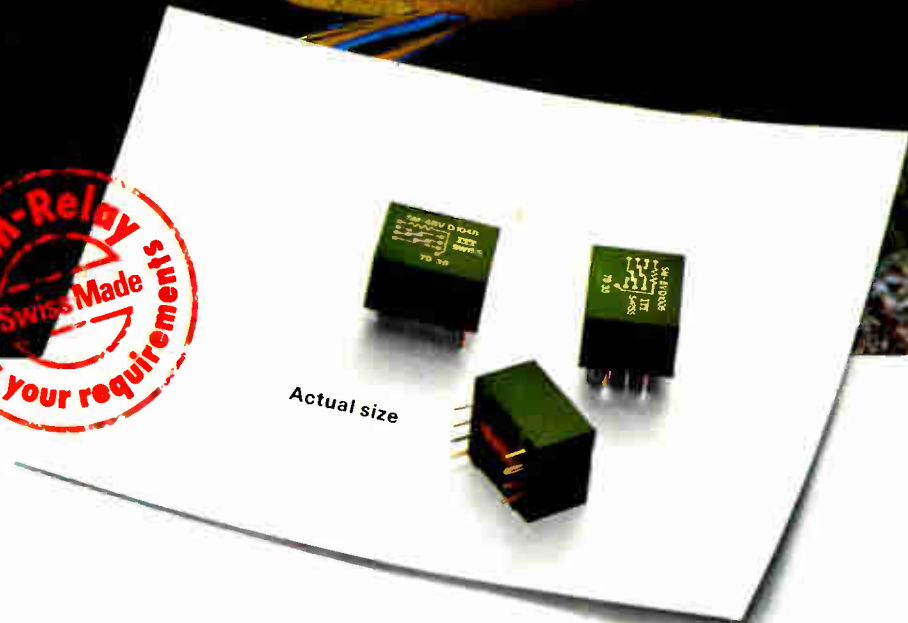

Ringel imperialfish
«Pomacanthus annularis»

Circle 235 on reader service card

ITT Components Group

Standard Telephon und Radio AG
Components Division
Brandschenkestrasse 178
CH-8027 Zurich
Tel. 01 201 42 55 - Telex 52 595

World Radio History

ITT
Components

Automatic unit troubleshoots systems

With probe plugged into microprocessor socket, tester generates address map of system, checks bus, RAM, ROM, and I/O

by Bruce LeBoss, San Francisco regional bureau manager

Whereas microprocessors are heightening the performance capabilities and shortening the hardware design cycles for many commercial, industrial, and consumer products, they are also adversely affecting the testing and repair of such microsystems. Conventional digital instruments require users to have a thorough understanding of the design and operation of microprocessor-based systems, as well as a goodly amount of software documentation. Now a new series of troubleshooting tools from John Fluke Manufacturing Co. automatically "learns" and rapidly tests microprocessor-based boards and systems.

The 9010A Micro System Troubleshooter "is the first piece of test equipment ever designed with a powerful algorithm to test the microprocessor bus and all bus-connected devices without any programming whatsoever," says Don Cassas, product manager for digital service products. It will automatically troubleshoot the entire kernel—power supply, clock, random-access and read-only memory, and input/output of the microsystem through the microprocessor socket, usually in less than five minutes, he claims. Results are shown on the instrument's 32-character, 14-segment alphanumeric display.

According to Cassas, the design of the 9010A includes algorithms that automatically examine and define all digital locations and functions of the microsystem kernel from a working board. Operating in the learn mode, the 9010S's algorithms find the major components in the microsystem's address space and establish the reference test parameters. For exam-

ple, if the 9010A reads back a signature that corresponds with the signal written to a given address, then the address range is categorized as a random-access memory. If the response is different from the stimulus routine, then the address range is categorized either as ROM or an I/O port, depending upon whether the range is greater or less than 64 bytes in length, respectively.

After identifying all of the microsystem's digital locations and functions, the 9010A generates a memory map for all of the devices found, as well as signatures for devices categorized as ROM. The data is stored in the 12-K bytes of dynamic RAM available to 9010A users for the day's work. Also, the data can be stored in the 9010A's minicassette

for permanent storage so that the learn procedure need only be performed once for a given system.

"Thus, the toughest and most time-consuming failures to troubleshoot, namely, those occurring in bus-connected devices outside of the microprocessor itself, may be found within minutes by a fast and totally self-generating test program, put to work literally the same day the instrument is received in a factory or field-service facility," Cassas states. Additional algorithms are available in the 9010A for working outside the kernel where peripheral devices reside, among them character generators, keyboards, readouts, and other types of electronic and electromechanical controls, he adds.

The Micro System Troubleshooter



When you have a static problem

Can you locate
and measure it?

Can you eliminate it?

Analytical Chemical Laboratories can provide the materials, instruments and consulting services to answer these questions.

Staticide™

... a unique topical anti-stat that eliminates static for long periods of time on any material. It is especially useful where non-conductive surfaces and continuous static generation occurs.

Staticide is an easily applied coating that is widely used to eliminate static on electronic components, subassemblies, equipment and environmental surfaces. Product packaging, production assembly and data processing areas can be rendered static-free with Staticide.

Staticide brand anti-stat complies with the electrostatic decay requirements of MIL-B-81705B and NFPA-56A. It is non-toxic, non-flammable, biodegradable, EPA registered, inexpensive and performance guaranteed.

Instrumentation

A full line of static measurement and detection devices, from hand-held types to continuous monitoring systems are produced.

Consulting

... Internationally recognized authorities in static control are available to analyze your problem and propose the best solutions.

Write or call for information on how Staticide can solve your static problems.

**Analytical
Chemical Laboratories**

1960 Devon Avenue
Elk Grove Village, IL 60007
312/981-9212

New products

uses a 6-MHz Zilog Z80A 8-bit microcomputer as the master controller for the basic monitoring program and to execute, for example, the preprogrammed tests. The 9010A also contains two Intel 8741 8-bit universal-peripheral-interface microcomputers for control of such functions as the instrument's tape drive and display. Six Intel 2764 64-K erasable programmable ROMs carry the system program.

Conventional digital troubleshooting instruments employ costly design techniques and hardware adapters to access test points of a unit under test, but the 9010A eliminates this requirement. The 9010A interface pod, which both simulates actions of the UUT's microprocessor and provides a window into the real-time operation of the microprocessor-based system, plugs directly into the microprocessor socket.

Each interface pod contains a microprocessor, the same as that in the UUT. Initially, Fluke will offer a family of pods to support popular 8-bit microprocessors, such as 8080, 8085, Z80, 6800, 6502, and 16-bit processors such as the 9900. The capability to support 32-bit microprocessor architectures in the future is built in.

The 9010A's keyboard initiates all functions and reduces complex operations to a single keystroke. The keyboard includes grouped troubleshooting key functions for automatic patterns and digital exercises. These range from simple read or write data operations to automatically generated patterns, such as walking 1s and 0s and digitally incrementing ramps. Also grouped are the mode controls that allow the operation to be repeated, looped, stopped, or continued as needed. A similar grouping of keys is provided for functional tests of RAM, ROM, and I/O

According to Cassas, "many of the problems that occur in microprocessor-based products result from bus, memory, and I/O failures" that are often difficult to identify and even harder to isolate. To ensure that these types of failures are quickly found, he says, the 9010A automatically tests these major system

components with a set of comprehensive test routines containing diagnostics for fault isolation. Testing begins automatically by pushing a single key that specifies the type of system component to be checked.

To illustrate, the bus test quickly verifies the electrical integrity of UUT control, address, and data buses, and a ROM test uses the stored addresses of all ROM elements categorized during the learn mode to compare signatures and verify correct operations. There are two RAM tests, one for quickly locating hard memory failures such as unreadable or unwritable bits and decoding errors, and a more extensive test to put the RAM through its paces to isolate pattern sensitivities or soft failures. An I/O test checks registers for correct read-write operations, and an auto-test button causes all tests to be run automatically.

Synchronized trigger. Among other key elements of the 9010A is its versatile troubleshooting probe, which counts transitions, takes signatures, shows logic levels, and injects states, as well as 1-kHz- or clock-synchronized bits. Another convenient item not found in other currently available microsystem testers is a clock-synchronized oscilloscope trigger, which makes possible jitter-free display of microprocessor-timed events.

Weighing 11 lb, the 9010A will be priced at \$3,795. The associated interface pods will cost \$695 for each 8-bit device, \$1,495 for each 16-bit microprocessor. Pre-introduction sales of the 9010A are such that initial deliveries are currently running at approximately 60 days after receipt of order. A model 9005A having fewer programming keys but with the same cassette tape drive and RS-232-C communications interface available in the 9010A will be available in the fall for \$3,495. It will be followed in the first quarter of 1982 by the 9020A, which will not have the cassette tape drive but an IEEE-488 interface for remote programming of the instrument.

John Fluke Manufacturing Co., P. O. Box C9090, Everett, Wash. 98206. Phone (206) 342-6300 [338]

The Texas Instruments News

256 Bits	NUMBER	ORGANIZATION	TYPICAL ADDRESS ACCESS TIME	TYPICAL POWER DISSIPATION
1K	TBP18S030	32 x 8	25 ns	400 mW
	TBP18SA030	256 x 4	35 ns	375 mW
2K	TBP24S10	256 x 8	45 ns	375 mW
	TBP24SA10	512 x 8	35 ns	500 mW
	TBP28L22	512 x 8	35 ns	475 mW
	TBP28LA22	512 x 8	40 ns	550 mW
4K	TBP28S42	1024 x 4	35 ns	625 mW
	TBP28SA42	1024 x 8	45 ns	275 mW
	TBP28S46	1024 x 8	65 ns	550 mW
	TBP28SA46	1024 x 8	35 ns	625 mW
	TBP24S41	1024 x 8	35 ns	625 mW
	TBP28S86-60	1024 x 8	45 ns	
	TBP28SA86-60	1024 x 8	35 ns	
	TBP28S86	1024 x 8	45 ns	
8K	TBP28SA86	2048 x 4	45 ns	
	TBP28L86	2048 x 4	45 ns	
	TBP24S81-55	2048 x 4	45 ns	
	TBP24SA81-55	2048 x 4	45 ns	
	TBP24S81			
	TBP24SA81			

A = Open Collector; L = Low Power

Best news in recent memory: New 8K PROMs. Plus fresh redesigns. The big family from Texas Instruments.

New 8K PROMs that are speedier, that save space and power. Redesigns that significantly improve system performance. TI, a major PROM supplier, gets your day started right.

Three 8K headliners

For outstanding speed, try these TI 8K PROMs: the TBP24S81-55 and TBP28S86-60. Typical address access time: 35 ns; max address access times: 55 ns and 60 ns, respectively.

To conserve space, TBP24S81-55 comes in a 300-mil wide, 18-pin package requiring 60% less board room than the industry-standard 600-mil wide, 24-pin package.

To save power, TI's TBP28L86 8K features typical power dissipation of only 275 mW — about 50% less than TI's standard high-speed PROMs — yet is one-third faster than similar devices currently on the market.

Five banner improvements

Redesigned lower-density PROMs now offer up to 20% faster max address access times and reductions of as much as 35% in power consumption. Included are TI's popular 1K; a low power 2K; two 512x8 4Ks; the 1024x8 24-pin 8K.

Extra! Easy programming

Programming problems are fewer,

costs lower with TI PROMs, since only one programming configuration is needed for all our devices from 1K through 8K.

More news in the making

On the way from TI: 16K PROM with a typical address access time of 35 ns, as well as Registered Output and Power-Down PROMs. For all the news about TI's big PROM family, call your TI distributor, or write Texas Instruments Incorporated, P. O. Box 225012, M/S 308, Dallas, Texas 75265.



14-ch with Video Cassette Tape

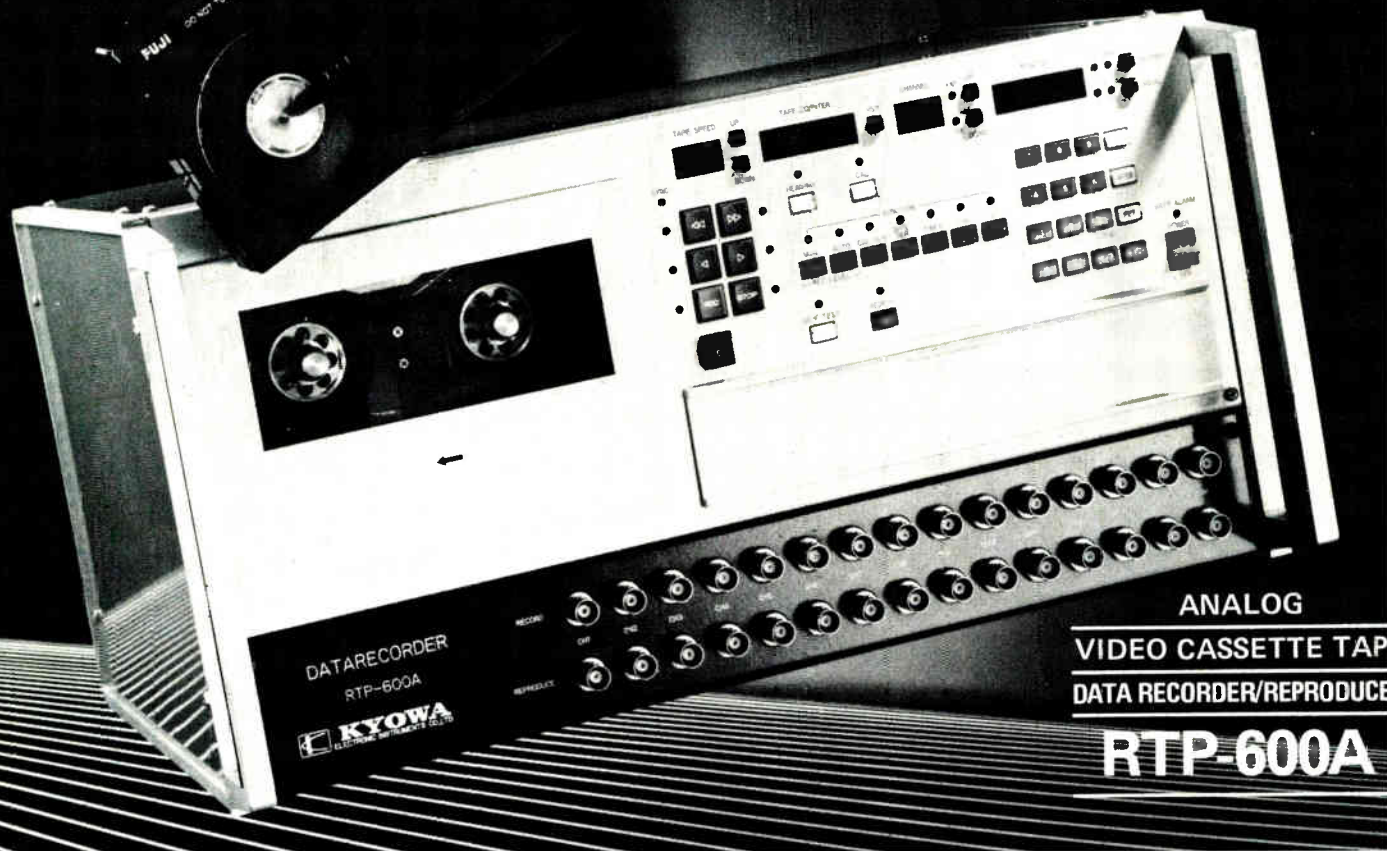

Can make a big difference in your measurement.

Working with a slim 1/2" wide Video Cassette Tape, this new instrumentation recorder weighs only 17 kgs (37.5 lbs), and lets you set up shop practically anywhere. Yet, it gives you a reel-to-reel recorder's SN ratio, linearity, drift, flutter and skew. With the head structure conforming with the ISO standards, it allows simultaneous monitoring of recording/reproduction. Uniquely high operability owes to the built-in microcomputer. The Auto Range function, for example. It needs no more than

10 seconds to automatically set the optimum recording level for all channels—through Amp-to-Amp operation, too. Another feature is the Self-testing capability, whereby it self-tests over ten items on its own hardware, including ROM and RAM, tape transport mechanism, power and amplifiers—all in 60 seconds preceding measurement. So, you are assured of a correct measurement every time. Once measurement starts, you command the recorder as easy as

with a desk-top computer. If you care for computer-aided data acquisition/analysis, the GP-IB interface is the answer. Vibration resistance? It clears $\pm 3G$ with a 40dB SN ratio and is rigidly tested in conformity with MIL STD-810C. Six tape speeds (1:32 time conversion) and 208 minutes of continuous recording. To convince yourself of the unique value of the recorder, contact your nearest Kyowa representative or Kyowa directly.

★ Argentina/Sirex Sociedad de Responsabilidad Limitada/393-4585 ★ Australia/Townson & Mercer (Distributors) Pty, Ltd./736-2088 ★ Austria/Vogel Industrie-Elektronik Ges.m.b.H./0222-948653 ★ Brasil/Panambra Industrial E Tecnica S.A./227-6722 ★ Canada/Associated Test Equipment Limited/416-497-2208 ★ Denmark/Instrutek A/S/455-611100 ★ Finland/Oy Honeywell AB/90-80101 ★ France/G.E.C. Components/(1)7906215 ★ Germany (Federal Rep.)/Piz-Gebiet 6/Messdata GmbH/06184 ★ Piz-Gebiet 4 U.5/Digilog Mess- und Datengeräte/826804 ★ Piz-Gebiet 8 U.1/Mantfred Dingeldein Ing.-Büro für elektronische Messtechnik/2658 ★ Piz-Gebiet 2 U.3/Voss Datentechnik GmbH/924003 ★ Greece/Neotech O.E./Esperou 19, Palaion Felliron, Athens/(01)9818432 ★ Holland/Depex B.V. Afd. Instrumentatie/030-763111 ★ India/The Industrial Gases Ltd./26.2920 ★ Israel/Import, Building & Trading Co., Ltd./829901 ★ Italy/E.C.T.A. S.a.s./2895978 ★ Korea/Kong Yeong Trading Co., Ltd./776-7631 ★ Mexico/Mecanismos Y Controles, S.A./515-25-86 ★ New Zealand/Smith-Biolab Ltd./483-039 ★ South Africa/Peter Jones Electronic Equipment (Pty) Ltd./37-7943 ★ Spain/Hisce Oficiena Tecnica/2505610 ★ Sweden/Atlas Copco ABEM Ab/08-7300804 ★ Switzerland/Traco Electronic AG/01-201-0711 ★ Taiwan/San Lien Development Co., Ltd./5610552 ★ United Kingdom/Graham & White Instruments Ltd./61110

★ Country/Representative/Phone

Whenever strain is measured, look to—

KYOWA

KYOWA ELECTRONIC INSTRUMENTS CO., LTD.

Address: 3-8, Toranomon 2-chome, Minato-ku, Tokyo, Japan

Phone: Tokyo 03-502-3551

Cable Address: KYOWASTRAINAGETOKYO

Telex: 222-3854 KYOWAT J

Circle 236 on reader service card

World Radio History

Design your own v.21 and v.23 modems with chip sets from Cermetek.

We offer two different types of modem chip sets for the European designer, both complete, and both with features that you can't get from any other supplier.

Our CCITTv.23 compatible 1200-baud modem is half-duplex—1200 bps on the forward channel and 75 on the reverse. We also make CCITTv.21 compatible 300-baud modem chip sets. You can get up to nine variations on these to fulfill your precise design requirements. And our modular design makes it easy for the first-time modem designer to integrate these functions into existing systems for typically one-third the cost of a packaged modem.

Because the v.21 and v.23 sets are integrated hybrid circuits, they take up less space than a separate modem unit or discrete designs. Maybe best of

all, they're field-proven. Cermetek has been selling modem chip sets in Europe for over five years. So we don't just give you chips—we give you a lot of design and engineering experience.

We're a reliable supplier. And a complete supplier as well. We'll give you engineering aid to guide you through the initial steps of system integration.

The modem chip set can add value to your products by offering your customers a more complete system with a resident

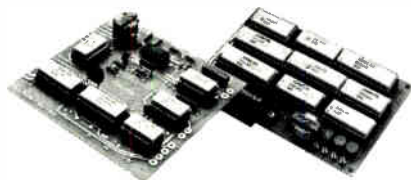

Cermetek
microelectronics

A subsidiary of Timeplex, Inc.

modem. To find out how, just write for one of our Evaluation Kits. Clip the coupon and send it to Cermetek Inc., 1308 Borregas Ave., Sunnyvale, CA 94086, USA. TWX 910-379-6931.

Please send me the: E/151981

- CCITTv.21 Modem Evaluation Kit for \$150 F.O.B. Sunnyvale, Calif.
- CCITTv.23 Modem Evaluation Kit for \$150 F.O.B. Sunnyvale, Calif.
- Data sheets and application notes on all Cermetek 300-baud modem chip sets.
- Data sheets and application notes on all Cermetek 1200-baud modem chip sets.
- Have local representative call.

Name _____

Title _____

Company _____

Address _____

City/Country _____

Phone() _____

Dealer inquiries invited

Analyzer fills debugging gap

Trigger trace analyzer can handle more complex software associated with new families of 16-bit microprocessors

by Bruce LeBoss, San Francisco regional bureau manager

As systems designers migrate from 8- to 16-bit microprocessors, they are quickly finding that most traditional hardware-software integration tools are incapable of debugging the significantly increased amounts of operating system code, among other more complex problems, associated with 16-bit prototype systems. To fill that gap, engineers at Tektronix Inc. have developed a trigger trace analyzer (TTA) that, they say, "gives the user the high-resolution debugging capability necessary for successful 16-bit design."

The new tool is specifically designed for 16-bit emulators, such as those for the Zilog Z8000, Intel 8086, and Motorola 68000 16-bit microprocessor families. It is an option for both the 8550 single-user Microcomputer Development Lab introduced by Tektronix last fall [*Electronics*, Nov. 6, 1980, p. 98] and for the 8540 integration unit, coming

later this year, that will provide hardware-software integration in conjunction with a host computer.

An enhancement of the real-time prototype analyzer option for the 8550 introduced last fall, the TTA has a trace acquisition memory 255 words deep by 62 bits wide that "allows us to bring virtually as many signals as we desire to the analysis process," according to Robert D. Hunter, microcomputer development products marketing manager. In all, it will accept 24 address, 16 data, and 14 emulator-dependent inputs from an emulator, as well as 8 inputs from probes tied to points outside the processor, "far more than was possible with the real-time prototype analyzer," he notes.

For triggering storage, the TTA provides four independent trigger recognition channels—twice as many as the analyzer. Each channel has a word recognizer, consisting of

a number of comparators, that can accept the full range of address, data, emulator-dependent, and external probe signals that can be stored, as well as one input from a separate BNC port. It can trigger on such signals singly or in various combinations. Further, each channel also has a 16-bit counter that can gate the output of the word recognizer, thus allowing the storage process to begin only after a number of trigger-word occurrences or a discrete period of time, if the user desires.

According to Hunter, the TTA has triggering capabilities for address and data comparators that include "equal to," "not equal to," "don't care," "ranging," and "range exclusion." The comparator on the external probe input can trigger "equal to" and "don't care," while the control signal comparator can trigger only "equal to." In addition to trace triggering, the TTA provides four external ports through which it can trigger other design tools such as logic analyzers and oscilloscopes.

Pick and choose. With an emphasis on operating in a real-time environment, the TTA features the ability to qualify storage in the acquisition trace memory. "The user can take off the bus only those things he really wants or all things if desired," Hunter says. For example, the user can look up all "stack writes" or "reads." "This helps the user to debug the more sophisticated software," he continues.

Furthermore, to accommodate newer very fast 16-bit microprocessors, the TTA has 125-ns (8-MHz) bus-cycle resolution both for the word recognizers and the acquisition trace memory. The maximum clock

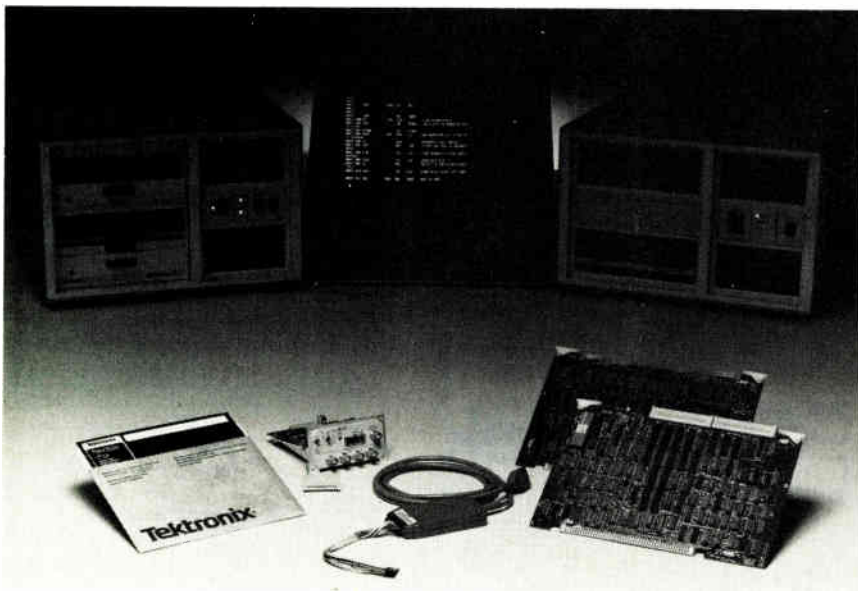

GRAYHILL KEYBOARDS: DIFFERENT STROKES FOR DIFFERENT FOLKS

SERIES 88 A short stroke sealed keyboard with excellent audible and tactile feedback. Colorful standard or custom-made graphics integrates this keyboard into your front panel. Coded outputs and low bounce characteristics easily mate with logic circuitry. Circle No. 191



SERIES 82 Long stroke high profile, wiping contacts. 1, 2, 3 and 6 button modules can be arranged for your specific needs. SPST to 4PST circuitry under each button; also available with coded outputs. Circle No. 192



SERIES 83-84-86 Short stroke standard 3x4 and 4x4 keyboard configurations. Choice of 1/2 inch or 3/4 inch button centers and post or flange mounting. Standard coded outputs—easily interfaces with logic circuitry. Excellent audible and tactile feedback. Circle No. 193



SYSTEM 87 Short stroke low profile, snap dome contact system provides tactile and audible feedback. Modular units—1 thru 6 buttons and 3x4 and 4x4 pads can provide any conceivable button arrangement. Circle No. 194



Your product is distinctive, and thus your keyboard needs are also likely to be unique. That's why Grayhill offers you four different keyboard families, with a host of options in each. We'll help you arrive at the keyboard solution that's most practical, attractive, and cost effective. Two of our four families—Series 83-84-86 and Series 88—are built around the popular 3 x 4 and 4 x 4 keyboard configuration; the other two—Series 82 and System 87—are modular, allowing you to create any unique keyboard arrangements.

Other features and options include:

- up to 3,000,000 operations per button
- standard or special coded outputs
- sealed or unsealed
- high or low profile
- short stroke or long stroke—dome or wiping contacts
- excellent audible and tactile feedback in dome contacts
- post, flange or PC mount
- 1/2", 11/16" or 3/4" button centers
- wide choice of legending modes
- color choices

For detailed information on Grayhill Keyboards, consult EEM, ask your local distributor, send for a copy of the Grayhill Keyboard Catalog or call us with your questions at (312) 354-1040.

Grayhill
INC

...the Difference Between Excellent and Adequate

561 Hillgrove Avenue • LaGrange, IL 60525 U.S.A.
Phone: 312/354-1040 • TWX: 910-683-1850

Available locally through these representatives

BELGIUM/LUXEMBOURG—Rodelco SA/VN Electronics B-1140 Brussels, Tel: (02) 2166338
DENMARK—E. V. Johansen Elektronik A-S DK-2200 Copenhagen N, Tel: (01) 83 90 22
FINLAND—OY Filinkenberg & Co. AB SF-00121 Helsinki 12, Tel: (0) 630 686
FRANCE—Radio Television Francaise F-92200 Neville-Sur-Seine, Tel: (01) 747-11-01
GERMANY—Data Modul GmbH D-8000 Munchen, 21, Tel: (089) 58-20-53
ISRAEL—Ropac Electronics Ltd. Tel Aviv 61180, Tel: (03) 477115
ITALY—Microelit s.r.l. -20148 Milano, Tel: (02) 46-90-444
JAPAN—Jepico Corp. Tokyo, Tel: 03 (354) 4661
NETHERLANDS—Rodelco BV Electronics 2280 AG Rijswijk, Tel: (070) 995750
NORWAY—Hans H. Schlive A/S Oslo-2, Tel: (02) 55 76 92
SPAIN—Unitronics SA Madrid, 13, Tel: (01) 242 52 04
SWEDEN—Bo Palmblad AB S-161 13 Bromma, Tel: (08) 252720
SWITZERLAND—Walter Blum Ltd. CH-8037 Zurich, Tel: (01) 42 23 42
UNITED KINGDOM—Highland Electronics, Ltd. Brighton BN1 1EJ Tel: (0273) 693688

HOW TO COPY THE MICROPOLIS 8" RIGID DISK DRIVE.

It's bound to happen sooner or later. Someone will decide to copy our 8" rigid disk drive. It happens to all industry-standard products.

So we're going to save someone the trouble and tell exactly how we built our 8" drive. But we're not worried. Because, frankly, we don't think anyone else will want to go to the trouble we did to give you such a product.

First of all, our family of 8" rigid disk drives (9 to 45 megabytes) comes with features you simply can't find in the competition's products. Such as our low-cost intelligent controller board, designed to allow swift integration into your existing system.

In addition to low power dissipation and fastest access time, we also included a Quartz-locked, direct-drive, brushless DC motor. We gave our rigid disk a braking mechanism, too. It extends the life of the disk by not allowing the head to act as the brake. That's a longer disk life for you, and a higher MTBF in the critical clean area. Next, we included our balanced rotary voice coil positioner, which, together with the closed-loop servo, absolutely protects against unexpected jolts, bumps, and shocks during write operations which might otherwise result in off-track writing.

We enclosed the heads, platters, and positioner assembly in a sealed clean area. No other drive has all active components outside the clean area, for easy access and maintenance. So we can offer the longest drive warranty in the business.

All this adds up to unprecedented quality, reliability, and stability. And our 8" rigid disk fits into the exact same space as an 8" floppy drive — they even use the same screw holes.

So if you want the best 8" rigid disk drive, call us. We deliver.
If you want to try and copy it, good luck. You'll need it.

MICROPOLIS™

21329 Nordhoff Street
Chatsworth, California 91311
213/709-3300 • Telex 651486

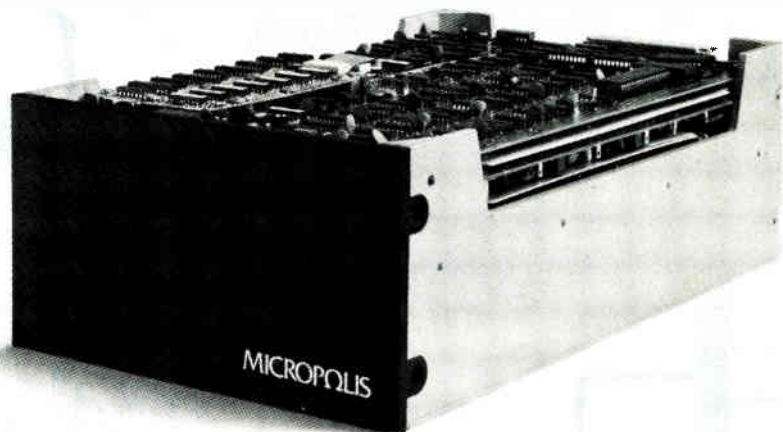

New products

rate for counting or timing, however, is 5 MHz (200 ns).

Up close. The TTA also improves the electrical interface to the prototype microsystem. To do this, Tektronix engineers designed the probe so that the hybrid circuits that provide active buffering are at the probe tip. "This allows us to get the TTA's electronics as close as possible to the prototype, so as to eliminate signal delays," Hunter says.

Among other features of the TTA are a microcomputer-specific user interface for 16-bit emulators; definition of an additional breakpoint for the emulator by each trigger; consecutive event detection; and sequential triggering detection.

Priced at \$4,150, the TTA will be available in October, as will the new Z8000 emulator, with probes for the Z8001A and Z8002A segmented and nonsegmented microprocessors, respectively. Compatible with TTA, the Z8000 emulator offers full-speed, completely transparent emulation of both the Z8001A and Z8002A at up to 6 MHz with no wait states," Hunter says. The full 48-megabyte addressing range—six 64-K-byte spaces for the Z8002A—is supported by the emulator.

Two break points. To simplify software debugging, two emulation breakpoints are contained in the Z8000 emulator, along with symbolic debugging. The emulator can disassemble instructions in both the segmented and nonsegmented modes as well as detect clock failures in the prototype microsystem.

Unlike other emulators that have a built-in trace analysis capability, the Z8000 emulator need not operate with the TTA. Thus, it has its own low-profile microprocessor probe. Among other important features are memory mapping and write protection, both with 4-K-byte resolution.

The Z8000 emulator will be priced at \$4,050, and the Z8001A and Z8002A probes will cost \$1,850 each. They can be ordered now for delivery in the fall when Tektronix will introduce emulators for the 8086 and 68000 16-bit processors.

Tektronix Inc., Box 500, Beaverton, Ore. 97077. Phone (505) 644-0161 [339]

CMOS analog I/O Microboards as low as \$99.

Six new 8-bit RCA Microboards offer you all of the advantages of CMOS with these features:

- A/Ds include 16 single-ended or 8 differential inputs.
- Temperature range from -40°C to +85°C.
- $\pm 2.5V$ for input and output signals on bipolar boards.
- 0 to +2.5V on unipolar boards.
- Operation from single +5V power supply. No external reference voltages required.

- Low power consumption (see table below).
- High noise immunity.
- Suitable for battery operation.

For more information on these boards or any of our extensive line of over 40 CMOS Microboards, contact any RCA Solid State sales office or appointed distributor.

Or contact RCA Solid State headquarters in Somerville, N.J. Brussels, Belgium. Hong Kong. Sao Paulo, Brazil.

Or call Microsystems Marketing toll-free (800) 526-3862.

Microboard	Type	Typical +5V current	Price (100+)*
CDP 18S658	A/D, unipolar	13 mA	\$99.
CDP 18S657	2 D/As, unipolar	9 mA	99.
CDP 18S654	A/D + 2 D/As, unipolar	15 mA	159.
CDP 18S648	A/D, bipolar	40 mA	129.
CDP 18S647	2 D/As, bipolar	22 mA	129.
CDP 18S644	A/D + 2 D/As, bipolar	50 mA	199.

*U.S. optional distributor resale

Another reason to
switch to CMOS.

RCA

Circle 273 on reader service card

12-bit d-a converter settles in 35 ns

High-speed digital-to-analog converter is compatible with emitter-coupled logic, uses only 15 chips

by Larry Waller, Los Angeles bureau manager

Burr-Brown Research Corp.'s first ultrafast digital-to-analog converter, the hybrid 12-bit DAC63, has a 35-ns typical settling time, 45 ns maximum. The unit's output is accurate to $\pm 0.012\%$ of full scale. The emitter-coupled-logic-compatible converter's highly integrated design cuts the active-chip count to less than 15, improving temperature and time stability. It comes in two versions, the DAC63CG and the DAC63BG.

Stephen R. Harward, data-conversion products marketing manager for this Tucson, Ariz., company attributes the converter's performance to a 12-bit switch chip and a thin-film-on-sapphire resistor network. Having all the current-switching transistors on one chip permits close thermal tracking and eliminates the possibility of thermal-tail settling problems.

Linearity is guaranteed to be within $\pm 1/2$ of the least significant bit over the specified temperature range

of -25° to $+85^{\circ}\text{C}$; that is, the converter's analog output will not vary by more than $\pm 1/2$ LSB for the CG version (± 1 LSB for the BG model) from an ideal straight line drawn between the end points. Gain drift is ± 30 ppm/ $^{\circ}\text{C}$ maximum. Bipolar offset drift is ± 10 ppm of full scale per $^{\circ}\text{C}$. For operation at its maximum conversion rate, the DAC63 should be used without an external operational amplifier. When so used, it may be connected for either bipolar voltage output or positive unipolar output and has a range of -0.5 to $+2.0$ v. To extend this range, an external operational amplifier must be used. A spare resistor on the sapphire ladder chip can be used with the external amplifier.

The converter addresses applications such as electronic countermeasures and driving displays that need speed and high accuracy. A major competitor in this market is the Analog Devices HDS1240E, which sells

for at least \$30 more than the contemplated Burr-Brown price. It and others have substantially higher chip counts than the DAC63.

Among the characteristics of the DAC63 (which comes in two models) is low glitch energy of 250 LSB-ns, making it useful where switching noise is troublesome. Other features include: adjustable logic threshold for ideal switching, internally bypassed supply lines to minimize settling time, and an internal feedback resistor for thermal tracking.

Specifications for the DAC63-CG's drift over a -25° -to- $+85^{\circ}\text{C}$ range are: total linearity error, $\pm 0.012\%$ of full scale; and total differential linearity error, $\pm 0.025\%$ of full scale. Another model, the DAC63BG, has a total linearity error of $\pm 0.025\%$ and total differential linearity error of $\pm 0.05\%$ of full scale. Power dissipation is 960 mW typical, 1,160 mW maximum. The housing is a 24-pin dual in-line bottom-brazed package.

Pricing of the DAC63BG starts at \$108 in quantities of 1 to 24; from 25 to 99, it is \$89; and 100 and up, \$83. The CG version costs slightly more. Sample quantities are off the shelf: 25 pieces take two to four weeks for delivery.

Harward says the speed, temperature stability, and price combine for a devastating entry in the high-speed d-a converter business. The firm is at present working on a military version, hermetically sealed, and having a -55° to $+125^{\circ}\text{C}$ temperature range.

Burr-Brown Research Corp., International Airport Industrial Park, P. O. Box 11400, Tucson, Ariz. 85734. Phone (602) 746-1111 [340]

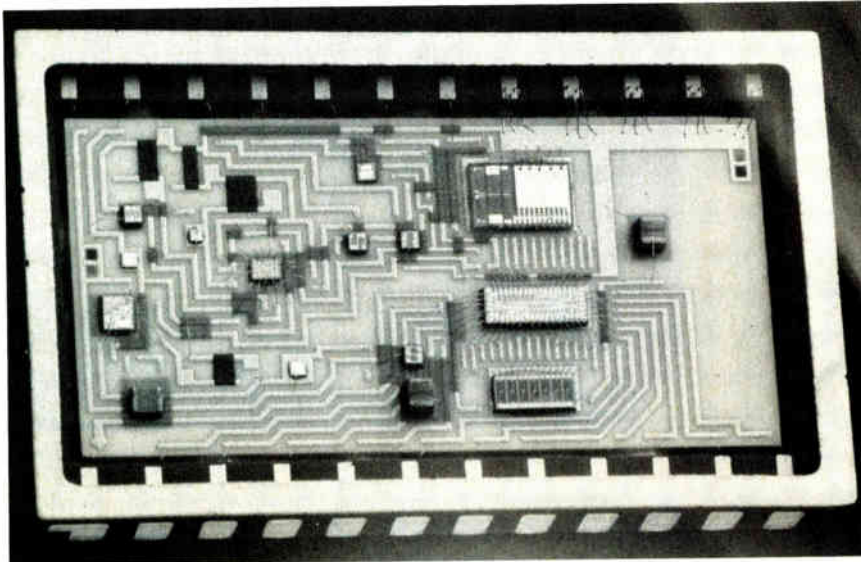

the right direction

Every year Italian electronics equipment makers use 300 million US \$ worth of components and subassemblies.

Their prime concerns are the quality and reliability of these parts, the technology behind them, delivery times, price, service, and customer back-up.

Dozens of such devices, or thousands, may go into a single piece of equipment, and the equipment manufacturer's success is obviously crucially dependent on his component makers.

ADELSY SpA chooses for its manufacturers only those components and subassemblies which are of advanced technology, of the highest quality, and of proven reliability.

From houses such as AMPHENOL, ARCO PLESSEY, CAMBION, C.ITOH, DATA GENERAL, GENERAL INSTRUMENT, GEN RAD, LITRONIX, NATIONAL SEMICONDUCTOR, NEOHM, RUBYCON, RYKIU, SILICONIX, TOSHIBA, UNION CARBIDE.

Computer-aided deliveries come direct from Adelsy's own stores, and the Company's highly qualified staff provide the consultancy and service which every customer has the right to expect.

Whether it's resistors - or microprocessors - or computers - Adelsy has a complete range at the right prices.

And a distribution and service network for components and subassemblies which is run by professionals.

 **ADELSY** spa
I CONSULENTI

MILANO 20153 Via Novara 570
tel. (02) 4524651/2/3/4/5 - telex: 332423 Adelsy I

Ancona - Bologna - Genova - Milano - Padova - Roma - Torino - Udine

Circle 238 on reader service card

**WE CAN'T GIVE YOU
ONE GOOD REASON TO
BUY THIS IC HANDLER,**



BUT WE CAN GIVE YOU FIFTY GOOD REASONS.

It's not any single feature that makes MCT the best-selling IC handler. It's a combination of many features.

In fact, MCT handling systems combine more reliability, versatility and efficiency than any other handler. That's what makes MCT the most cost-effective handler you can buy.

Take our "dead bug" handling approach for example. It significantly reduces jamming and downtime while allowing MCT handlers to handle the widest range of package types in the industry.

Or consider our superior contacts. They're made from gold-platinum for greater durability and better contact integrity.

And consider our efficient, human engineered design or our range of speeds up to 10,000 DPH.

Above all there's our professional service network — offering the most comprehensive installation, parts, service and training capabilities in the industry.

We could list at least fifty more reasons why MCT handling systems are the best you can buy. But we don't have room for them in this ad.

So, instead, we've put together a brochure that explains our reasons in depth. To get a copy just call (612) 482-5170, or write MCT today.



**THERE'S MORE
TO AN
MCT HANDLER**

MCT

Micro Component Technology, Inc.

P.O. Box 43013, St. Paul, Minn. 55164

• ENGLAND: Millhouse, Boundary Road, Buckingham Shire, Loudwater, High Wycombe, Tel: Bourne End 28231-5, Telex: 848798 • FRANCE: 32, Place De LaLoire, Sific 441,94593 RUNGIS Cedex, Tel: (Paris) 687 32 30, Telex: 842/26092 ITS-RUNG • WEST GERMANY: Lundsberger Strasse 439, Munich 60, Tel: (Munich) 089/71 44-021, Telex: 841/5212560 ITS D.

Circle 136 on reader service card

Clamping Ideas from Weckesser

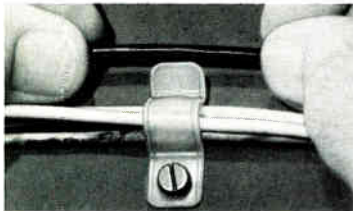

Nylon FLEX-CLIP

Slip wires in or out for changes or removal. Contour of clip plus spring-back flexibility of nylon provides easy assembly, yet holds bundles securely.

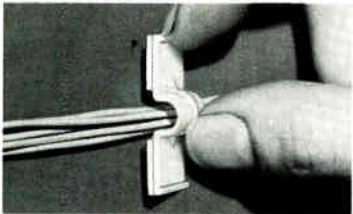

Nylon PRESS CLIP

Peel off... press and it's on to stay. Adhesive-back provides fastest way yet to install clips. Four sizes for bundles from 1/8" to 1/2" dia.

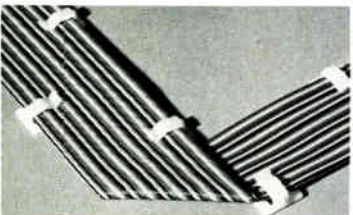

PRESS CLIP for flat cable

One size nylon clip for any width flat or ribbon cable. Used along edges, provides unlimited flexibility in mounting arrangements. Adhesive-back or screw mounting hole.

Write for catalogs.

Weckesser
COMPANY, Inc.

4444 W. Irving Park Road
Chicago, Illinois 60641 (312) 282-8626

New products

Microcomputers & systems

Faster 1802 is up in yield

Redesigned C-MOS processor
has lower price and
transparent enhancements

The first and most widely available all-complementary-MOS microprocessor, RCA's 1802, has had a face lift. The 1802A is a completely redesigned integrated circuit that is faster and more cost-effective than the 1802, while retaining plug-compatibility with the current model. The clock rate has been pushed from 2.5 to 3.2 MHz, and selected parts can easily achieve 5-MHz operation. The chip's design rules have been reduced by approximately 10% (from 6- μ m features) to bring the die area down from 41,652 to 33,971 mil². The 1802A is priced at \$3.98 each in lots of 1,000, a 40% price reduction from the 1802, which goes for \$6.50.

The large price drop (relative to

the die-area reduction) can be attributed to the increase in yields the 1802A enjoys. During the redesign, close attention was paid to adjusting critical timing paths and other close-tolerance features so it would be easier to manufacture the part.

Several user-transparent enhancements have also been implemented—for instance, a Schmitt trigger on the reset input makes it possible to use a simple RC network in the power-on/reset circuit. The drive capabilities of all the output transistors have been beefed up and the input buffers have been more carefully balanced, so circuit-board design with the microprocessor is less critical.

The undedicated register architecture of the 1802A is one of its attractions: the program counter, for instance, can be specified to be any of the 16 16-bit internal registers. An on-chip direct-memory-access address generator can reduce the parts count of an 1802A-based product, as can the use of RCA's custom read-only memories: mask-programmed address response makes chip-select circuitry unnecessary.

RCA Solid State Division, Route 202, Somerville, N. J. 08876 [371]

Entry price falls for HP 1000 computer system

The HP 1000 model 5 microsystem is the lowest-priced member of the HP 1000 computer family, costing under \$10,000, or 40% less than the previous entry-level family member. A model 5 combines the 1000 L series microcomputer, two 270-K-byte 5 1/4-in. floppy-disk drives, a cathode-ray tube, and a keyboard. It can use minicomputer-level software and a wide range of input/output interfaces and peripherals.

The system may be ordered with the 2621A terminal, the 2624 block-mode terminal with user-definable soft keys and form-generating set, or the 2626A multiple-workspace (split-screen) terminal. It supports two multiuser, multitasking real-time operating systems. One, the RTE-L, is a low-priced execute-only



operating system for computers with up to 64-K bytes of memory. The other, the RTE-XL, is an operating system for up to 512-K bytes of memory and includes full program-development capabilities. Languages available to the 1000 model 5

More than just another Spectrum Analyser.

Solartron
INSTRUMENTATION GROUP



The Solartron 1200 Signal Processor.

MEASUREMENT
Two channel, floating.
Autoranging: 10mV to 300V.
Resolution: 11 bits.
Windows: rectangular, flat-top, Hanning.
Integration, differentiation.
Engineering units.
Acoustic weightings.
Triggers, pre-triggers.
Synchronisation.

ANALYSIS
Resolution: 500 lines, 2mHz.
Bandwidth: 30kHz.
Linear, log, 1/3- and full octave.
Zoom: x2, x5. Expand: 4 decades.
Noise source: multi-sine, prbs, impulse.
Storage: analysis settings, data.
Auto- and cross-power and correlation.
Transfer function. Coherence.
Cepstrum. Synchronous spectrum.
Computed power and noise bandwidth.

DISPLAY
High resolution, 9-inch, raster scan.
Single: any function, waterfall, two functions overlaid.
Dual: two independent functions.
Bode, Nyquist, co-quad plots.
Full cursor control. Variable resolution.

INTERFACES
IEEE 488 and plotter output.

Quite a list – and all features are standard. No need for add-on options; this is how the 1200 gives you more. A product designed with the engineer in mind and which has unrivalled ability to take maximum advantage of dynamic measurements, whether in the time or frequency domain.

Brilliant ergonomic design enables simple operation. A minimum of main controls supplemented by 'soft-keys' guide you to just the settings you need.

The 1200 provides a capability which gives unrivalled analysis of dynamic performance.

No other unit can offer such features as standard and at such a realistic price.

Please phone and find out how the 1200 Signal Processor can benefit you.

SOLARTRON
Schlumberger

John Shave, Product Manager,
Solartron Electronic Group Ltd.,
Farnborough, Hampshire, England GU14 7PW.
Tel: Farnborough 44433 (STD 0252)
Cable: Solartron Farnborough, Hants.
Telex: 858245 Solfar G.

ARGENTINA Buenos Aires 362-7770. AUSTRALIA Sydney 439 3288. AUSTRIA Wien 835628.
BELGIUM Bruxelles 3847309. CHILE Santiago 82691.
DENMARK Hilerod 2955522. EGYPT Cairo 705 21.
FINLAND Helsinki 738265. FRANCE Villacoublay 946 9650.

GERMANY Munchen 854 3071. GREECE Pireaus 423471.
INDIA Bangalore 52321. ITALY Milano 366000.
JAPAN Tokyo 1790789. KOREA Seoul 566131. KUWAIT Safat 433526. MALAYSIA Kuala Lumpur 482226. MEXICO 536 09 10. NETHERLANDS Rijswijk 996 360. NORWAY

O-10 141290. PAKISTAN Karachi 514523. PORTUGAL Lisbon 370317. SINGAPORE 2927645. SOUTH AFRICA Johannesburg 220269. SWEDEN Landingo 7652855.
SWITZERLAND Zurich 528880. TAIWAN Taipei 3910822.
THAILAND Bangkok 251 9770. TURKEY Istanbul 8300303.
UAE Dubai 32229. USA Los Angeles 641 7137.

A FAST SOLUTION FROM ITT JENNINGS:

THE RJ2B. 30A, AT 2.5MHz, UP TO 10KV...AND 10 DAY DELIVERY.

Here's a reliable tool for your most demanding relay applications—a vacuum relay that offers high power capability in a small, rugged package. The RJ2B.

It will carry 30A at 2.5 MHz and withstand voltages up to 10KV. This lightweight relay (3 oz.) has a very low contact resistance, and is designed to outlast any conventional relay in applications such as antenna switching, antenna coupling, and pulse forming networks.

The RJ2B will operate at high altitudes, under pressure, at high temperature and vibration levels, and in many extreme environments. Because of the vacuum, its contacts are sealed for safe operation under volatile conditions.

Now the best part. It is available for quick delivery (10 days in most cases). Check with our applications department at 970 McLaughlin Avenue, San Jose, CA 95122, or call us at (408) 292-4025 and find out more about the RJ2B vacuum relay.

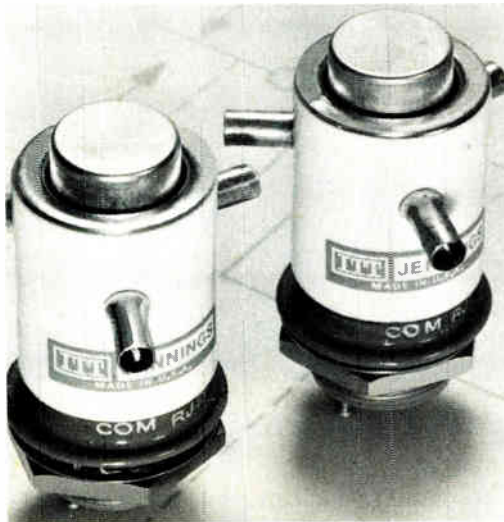

JENNINGS ITT

DIVISION OF INTERNATIONAL TELEPHONE AND TELEGRAPH CORPORATION

Circle 139 on reader service card



FIBER OPTICS VOCABULARY

The basic reference document on fiber optic and lightwave communications for those who design, develop, operate, use, manage, or manufacture communications or data processing equipment and components.

- 1400 entries, with
- index of terms
- inversions and cross-references

Order your copies today!

\$12.95 each, discounts of 10% on orders of more than 10.



Electronics Magazine Books
P.O. Box 669
Hightstown, NJ 08520
Tel. 609/448-1700, ext. 5494

New products

include HP Pascal, Fortran, assembler, and Basic.

HP's Distributed Systems Network software may link the computer to a local or global computer network, and Image/1000 provides efficient data-base management. Graphics peripherals are supported, as is Graphics/1000-II software.

Original-equipment-manufacturer and volume discounts are available; deliveries are in eight weeks.

Hewlett-Packard Co., Inquiries Manager, 1507 Page Mill Rd., Palo Alto, Calif. 94304 [374]

In-circuit unit emulates both Z8001 and Z8002

An in-circuit emulator for Z8001 and Z8002 16-bit microprocessors from Zilog is compatible with the firm's EZ-PRO modular development system. Like other emulators designed for the system, it runs at the microprocessor's full rated clock frequency and is transparent to the target system. A relocating macro-assembler, a linking editor, a debugger, and demonstration software are supplied with the \$1,995 emulator.

The EZ-PRO system supports over 30 8-bit microprocessors with \$995 emulators. A basic fixed-word-length system with printer, video terminal, and operating software sells for \$7,490. Bit-slice development systems start at about \$11,000.

American Automation, 14731 Franklin Ave., Tustin, Calif. 92680 [375]

32-K-byte magnetic-bubble subsystem fits 11-in.² module

A 32-K-byte magnetic-bubble memory subsystem highlights National Semiconductor's BLX family of board-level expansion modules. The module family is plug-compatible with Intel's SBX expansion modules; members of the family plug directly into any host board with this type of expansion bus and connector. The BLX-9252 bubble module is less than 11 in.² in area, offering incre-

Going out of the country for quality static RAMs?

You may not have to go out of town.

RAM's where you are. GTE Microcircuits Static RAM's are available off-the-shelf in both prototyping and production quantities from 78 distributor locations throughout the United States and Canada plus 22 more world wide. Which means that our RAM's are probably already where you are.

Quality. We're in a tough business. Claiming quality isn't enough. Delivering it is what we do. On time. To specification. In quantity. At competitive prices.

2114's. Some people call 2114's jellybeans. We call them our bread and butter. In fact, we make (1024 x 4) 2114 static RAM's in 23 separate speeds, power requirements and packages, including MIL-STD-883. All with



a single +5v supply.

Byte-wides for μ P's.

2K 3539's (256 x 8) and 8K 1024 x 8 static RAM's like our 8112's are ideal for microprocessor based systems development. To make development even easier, the GTE 8112 is pin-for-pin compatible with 2716 EPROM's and features a common I/O bus with our 8104's and 8114's.

Now, ROM's. The very things that make for quality in GTE static RAM's make for quality in ROM's. Our 2332's are here waiting for your final mask. Our 2316's and 2364's are on the way.

More than promises. When you go out of the country for static RAM's you get promises. When you go to your GTE distributor for static RAM's, you get static RAM's. Quality RAM's. In prototyping or production quantities. Now.

For additional information contact GTE Microcircuits, 2000 W. 14th St., Tempe, AZ 85281, U.S.A., or contact one of the following distributors:
AUSTRALIA: Ampec 818-1166. BELGIUM: Famatra C31-513251.
DENMARK: J. Henckel (03) 385791. ENGLAND: Thame 084-421-3146 or Dage Eurosem 44-01-868. FINLAND: Turion 90-377787/371151.
FRANCE: Alfmex 666 21 12. GERMANY: Dema 089-288018.
HONG KONG: Trans-Pearl 5-234367/5-226003. INDIA: Zenith 384214.
ITALY: Eltronic 313364. ISRAEL: R. N. Electronics (03) 471659.
JAPAN: Nissho (03) 544-8311. KOREA: Duk Sung 856-9764/854-5047.
NETHERLANDS: Famatra 076/133457. NORWAY: Henaco (02) 157550.
SPAIN: Semiconductores 218 09 60/ 218 02 17.
SOUTH AFRICA: S. Continental 48 0515. SWEDEN: AB Betoma 08-820280.
SWITZERLAND: Rotronic (01) 523411. TAIWAN: Hermes (020) 562-5851/511-4519.

GTE

Microcircuits

The Indicators With A Memory

Ferranti-Packard's memorizing indicators offer visibility, reliability and save energy too!

POPULAR FEATURES:

- Long life (100 million operations minimum)
- Zero power consumption
- Rugged construction
- Excellent visibility (light-reflecting disc)
- Choice of 5 fluorescent disc colors
- P.C.B. or Panel Mount

Ferranti-Packard indicators are ideal for Transient Recorders, Industrial Process Displays, Contact Status Indicators and Field Equipment.

Remember the indicators with a memory. Specify:



Ferranti-Packard Limited

Electronics Division
6030 Ambler Drive, Mississauga,
Ontario L4W 2P1 Canada
Telephone: (416) 624-3020
Telex: 06-961437

Circle 200 on reader service card

(617)272-0972

is a profitable number for semiconductor users and manufacturers for increased reliable yield. Keep device failures out of your product or system.

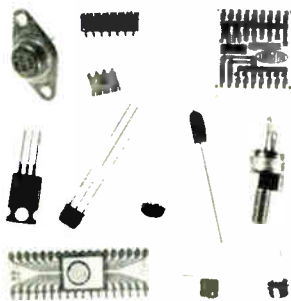

Complete testing and reporting from a pioneer in active component testing, and the largest facility in the northeastern United States for "turn key" semiconductor evaluation. Test as though your profit depended on it! It does! Find out quickly, easily with a test job.



Solid State Testing, Inc.

56 Middlesex Turnpike • Burlington, Massachusetts
(617) 272-0972 • TWX 710-332-1620

Pompton Plains, New Jersey

Palm Bay, Florida

200 Circle 141 on reader service card

New products

mental expansion of on-board non-volatile memory at a price of under \$1,000 in 100-unit lots.

The BLX-9252 dissipates less than 5 w. It can detect error bursts up to 12 bits long and can correct error bursts up to 3 bits long. A compatible 1-megabit BLX-9012 bubble-memory module is planned for release later this year.

Other BLX modules include the 281 speech synthesis module, the 321 analog-output module, the 331 fixed- or floating-point math module, the 332 floating-point math module, the 350 parallel input/output module, the 351 serial I/O module, and the 391 prototyping module.

National is also offering a BLC family of board-level computers. The BLC 86/12B is a 16-bit microcomputer board that is plug-compatible with Intel's SBC 86/12; the BLC 80/11A is likewise compatible with the SBC 80/10B; the BLC 80/116 is an 8-bit unit with 16-K bytes of random-access memory. All three have two BLX expansion connectors each. National Semiconductor, 2900 Semiconductor Dr., Santa Clara, Calif. 95051. Phone (408) 737-5312 [376]

8086-based boards carry up to 128-K bytes of RAM

The GPC 86 series of Multibus-compatible single-board computers is available with a 5-MHz or 8-MHz 8086 central processing unit and 0, 32-K, or 128-K bytes of on-board random-access memory. The microcomputers are software-compatible with Intel's SBC 86/12A and fully compatible with RS 86 and Debug 86 support packages from Microbar.

Each GPC 86 board has sockets that allow the user to plug in up to

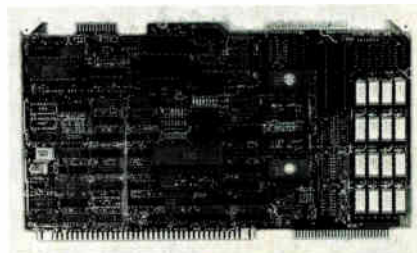

THIS NEW DATA I/O 6800 FAMILY TESTER CAN SAVE YOU A LOT MORE THAN IT COSTS.

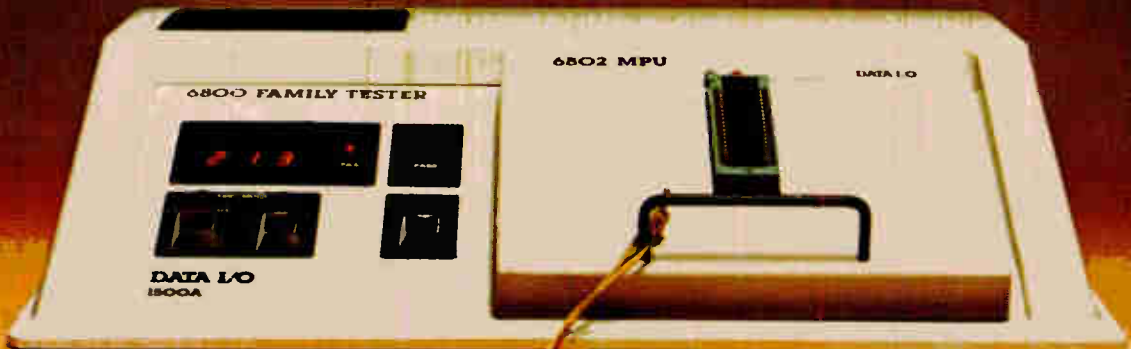

Reject bad devices before they get into your production line.

Everytime a faulty microprocessor or peripheral chip slips into one of your products it costs you profit in troubleshooting and replacement.

With the new Data I/O Model 1500A, you can set up a low-cost incoming inspection program to detect faulty 6800 family devices before they get loaded into boards.

Comprehensive testing detects problems in 6800, 68A00, 68B00, 6802, 6808, 6810, 6821 and 6850 devices.

The Data I/O 6800 family tester performs a full-functional test on devices under worst case load and supply voltages at real time speed in less than one second.

The test may reveal, for example, that the clock is inactive, or a line on the address bus is not working, or the internal RAM is defective.



Easy set-up and operation.

Simply plug the correct test adapter into the tester and you're ready to begin. No need to hire skilled personnel to write test programs, specify test vectors or parameters. It's all contained in a pre-written test sequence.

To operate, simply place the device in the socket and press the button. A green light identifies a functional part. A bad part triggers a three-digit code, which identifies the specific problem.

Reduce parts shortages and ease device returns. You don't have to reject an entire lot because of a few bad components

With the 6800 family tester you can quickly and efficiently screen all devices to make the best use of the components you have.

Most device vendors require proof of failure before they will accept rejects. The failure code provided by the 6800 family tester identifies the problem and will speed up the process of returning faulty parts.

Backed by Data I/O's commitment to quality and performance.

We've put the same care and engineering skill into the Model 1500A that we put into our entire range of PROM and logic device programmer products. The Model 1500A has been evaluated by device manufacturers and recognized as a viable test method. Each unit is backed by Data I/O's worldwide network of sales and service personnel.

Find out more about this remarkable new approach to testing by circling the reader service number or contacting Data I/O, P.O. Box 308, Issaquah, WA 98027. Phone 206/455-3990 or TOLL FREE 800/426-9016.

**DATA I/O
6800
FAMILY
TESTER**

World Radio History

SERVO FEEDBACK

Design it In — your way!



Waters built in servo-feedback elements simplify design and cut costs.

Why box yourself in with "packaged pots" — and linear-to-rotary conversions, and linkages, and costly housings, shafts and bearings you don't really need? Design your system *your way* — with our long-lasting, low-noise, custom-made feedback elements. We can supply squares, circles, strips — any geometric shape you need in linear and non-linear plastic elements. You'll save time. Cut costs. And chances are you'll improve performance.

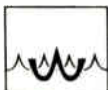

Send today for full information. Or call (617) 358-2777.

Waters Manufacturing, Inc.

Longfellow Center, Wayland, MA 01778 (617) 358-2777 • Telex 948-441

Circle 202 on reader service card

LET YOUR FINGERS DO THE TALKING...

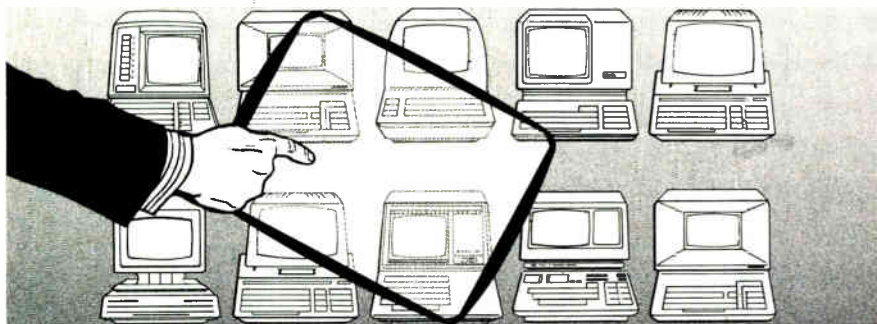

With the touch of a finger on the Elographics E270 Position Sensor, the coordinates of the touch point are transmitted to your terminal or computer for limitless menu and graphic applications. Replaces light pens and joy sticks. Opens new applications where finger touch simplifies a must.

The E270 is a transparent formfitting sensor mounting directly on CRT's. Utilizing modern continuous thin film coatings, the E270 gives high resolution coordinates. A variety of controller electronics is available to enable the OEM or system builder to interface easily to micros and minis.

- POINT MODE
- STREAM MODE
- MODELS TO FORMFIT VARIETY OF CRT'S
- RESOLUTION TO .003"
- HIGH RELIABILITY
- LOW PROFILE
- EASY TO INSTALL

The E270 offers a uniquely simple and flexible way to communicate with computer systems. Human engineered for all types of computer systems, from word processing to process control. Let Elographics solve your man-machine interface problems.

ELOGRAPHICS, inc.

1976 OAK RIDGE TURNPIKE OAK RIDGE, TENNESSEE 37830 (615) 482-4038

Circle 143 on reader service card

World Radio History

New products

32-K bytes of erasable programmable read-only memory using 64-K chips. A socket is also provided for an 8087 floating-point math processor. The microcomputers have 1 serial port and 24 parallel programmable input/output lines.

The GPC 86-8128 (the 8-MHz version with 128-K bytes of RAM) is priced at \$2,925 in single quantities. The 5-MHz, 32-K-byte GPC 86-532 is \$1,845; the GPC 86-832 and -5128 are \$2,095 and \$2,695, respectively. Delivery is from stock and takes up to 30 days.

Microbar Systems Inc., 1120 San Antonio Rd., Palo Alto, Calif. 94303. Phone (415) 964-2862 [377]

Disk controllers interface

Winchester and SMD drives

The SBC 215 and 220 are Multibus-compatible disk-drive controller boards for Winchester and SMD-type (storage module drive) disk storage, respectively. The SBC 215 interfaces up to four 8- or 14-in. industry-standard Winchester drives, which can range in capacity from 4.5 to 26.7 megabytes unformatted, for a total possible supported capacity of over 100 megabytes. By supporting up to four SMD-compatible drives, the 220 can interface from 12 megabytes to 2.4 gigabytes of storage.

Both controllers perform direct memory access using an 8089 input/output processor, both can address up to 1 megabyte of system memory, and both carry enough random-access memory to buffer one full data sector. A 32-bit Fire code is added to data fields to identify error bursts up to 32 bits long and correct those up to 11 bits long with on-board logic.

The SBC 215 is available in two models: the 215A for use with drives employing open-loop positioning of the heads and the 215B for use with closed-loop positioning. Both versions of the 215 cost \$2,000; the 220 sells for \$2,500.

Intel Corp., 5200 N. E. Elam Young Pkwy., Hillsboro, Ore. 97123 [378]

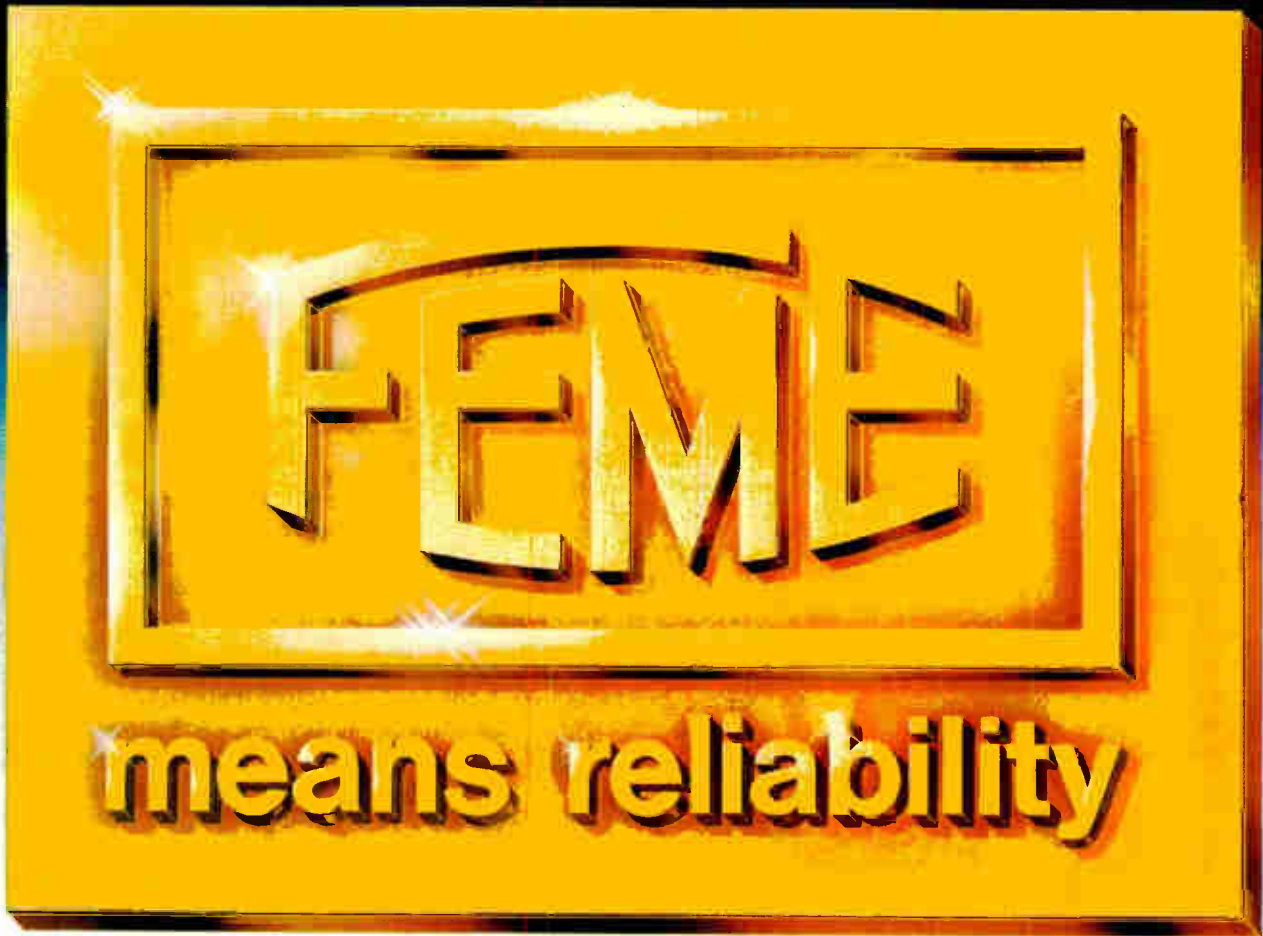

“FEME means reliability”
 an opinion that always accompanies us.
 It is not a simple slogan but a principle to which
 Feme conforms.
 Yesterday, today and tomorrow.
 The reliability arised from our design and
 manufacturing expertise, use of
 the latest technology, thorough quality
 assurance in production and finally
 technical customer service.

50 years of Feme production
 50 years of Feme reliability
 A gold plate to prove it.

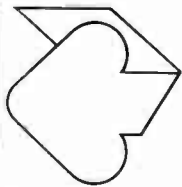
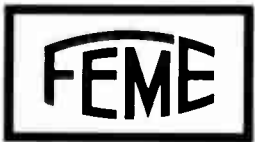

20149 Milano
 Viale Certosa, 1 - ITALY
 Tel. 390.021 - Telex 331217

New products

Instruments

Six-point probe reads resistivity

Meter measures wafer's sheet resistivity to 10^{11} Ω /square, takes leakage into account

As the semiconductor industry achieves thinner layers of deposited materials, the accurate measurement of a key parameter of those depositions, sheet resistivity, becomes more difficult. Layers less than 3,000 Å thick are common in integrated circuits, transistors, and solar cells; with these thin layers of material, it is hard to control the leakage of test current through the substrate.

Four-point probe meters, which have been used to determine sheet resistivity, cannot detect this leakage and incorporate it into the formulas used to determine sheet resistivity. Now, however, the leakage factor is taken into consideration by the model 101 six-point-probe meter developed by Four Dimensions Inc.

Although none of the four-point-probe meters on the market claims

to measure sheet resistivities above 5×10^5 Ω /square, model 101 claims a measurement range from 10^{-1} to 10^{11} Ω /square, with accuracies ranging from within $\pm 1\%$ at the low end to within $\pm 15\%$ at the high end. According to company president James T. C. Chen, this accuracy is made possible by the fifth and sixth probes, which detect that part of the test current leaking through the opposite-type substrate due to injection of minority carriers by the forwardly biased current probe.

In dealing with very thin layers, previous test probes may themselves have contributed to inaccuracies, because their 20-g or more probing force could cause the probe to penetrate the layer, resulting in the leakage of the test current through the substrate. Probes on model 101 are adjustable down to 10 g of probing force, which should help alleviate the leakage problem.

Point to point. A typical four-point-probe meter passes a known current between two of the points while the voltage between the other two points is measured. The six-point probe employs two probe heads. The first probe head has four linearly aligned electrodes in contact with the top surface of the semiconductor layer. Circuitry connected to



the first probe head performs the traditional four-point measurement. The second probe head is aligned with the first head on the opposite side of the wafer. Its two electrodes are in contact with the bottom surface of the substrate and help determine the magnitude of the leakage current. This setup also permits assessment of the quality of the pn junction between the thin layer and the substrate.

The probes can handle a maximum of 60 v during testing, with a potential probe input impedance of 10^{14} Ω at 30 picofarads. The potential probe bias current is a mere 0.01 picoamperes. Deliveries of the model 101 are in three months, and its price is \$8,200.

Four Dimensions Inc., box 3365, San Mateo, Calif. 94403. Phone (415) 574-0266 [351]

Rf voltmeter has rotating analog display

LCD usually stands for liquid-crystal display. In the case of Racal-Dana's 9303 radio-frequency millivoltmeter, however, it also stands for liquid-crystal d'Arsonval movement. The unique display on the very wideband (100 kHz to 2 GHz) instrument combines analog and digital readout.

For typical rf measurements on, say, a filter, an analog presentation has always been the quickest way of finding peak and null points. With the LCD display built by Racal's microelectronics center, measure-

ments can be manipulated digitally and still be presented in an analog format. The top part of the analog portion of the display gives 10% resolution and the lower, rotating part 1%. For absolute measurements, four digits to the right of the analog display provide direct digital readouts. The 9303 measures from 300 μ V to 3 v root mean square in nine ranges all told.

Since measurements can all be handled digitally, the microcomputer-based 9303 is actually two instruments in one: an rf millivoltmeter and a power-level meter. When the 9303's watts key is depressed, its microcomputer squares the rms voltage reading and divides it by whatever value is stored in the ohms reference memory; the unit powers up

with 50 Ω stored there, but that can be changed by a user for a particular application. Using the 50- Ω factor, the meter covers 18 pW to 180 mW in nine ranges.

The unit also combines features previously seen in the company's analog and digital meters. It uses the sampling technique introduced in the analog 9301A rf millivoltmeter to obtain high-frequency rms measurements and a patented noise-canceling circuit, which, by measuring



Now there's one source for the finest in semiconductor processing equipment.

Perkin-Elmer introduces its new Semiconductor Operations, your single-source for advanced semiconductor processing products and services. Under one umbrella Perkin-Elmer now offers systems for projection mask alignment, electron beam mask fabrication, deposition and etching, together with the analytic capabilities you need to optimize their performance in your application.

Practical mask generation at submicron line widths.

The one practical tool for generating masks below $1\mu\text{m}$ line widths is Perkin-Elmer's

MEBES*

it can also be used for writing directly on wafers. Line widths are uniform over the entire area and can be as fine as $0.5\mu\text{m}$. For reticle generation, MEBES* provides fast turnaround in addition to precise overlay.

The industry standard in projection mask alignment.

Using the performance-proven concept of 1:1 reflecting optics, Perkin-Elmer's Micralign® projection mask aligners have revolutionized the manufacture of integrated circuits. Wafers and smaller become possible without sacrificing production

of integrated with smaller geometries without sacrificing economies.

The best way to control deposition and etching.

Process flexibility, precision and cleanliness permit sophisticated chip designs to become practical products. Perkin-Elmer's 4400 family of plasma deposition and etching systems provides unique capabilities for the commercial fabrication of wafers of every degree of complexity. And, process pre-characterization matched to each system gives you a head start in reaching production yields.

For information,

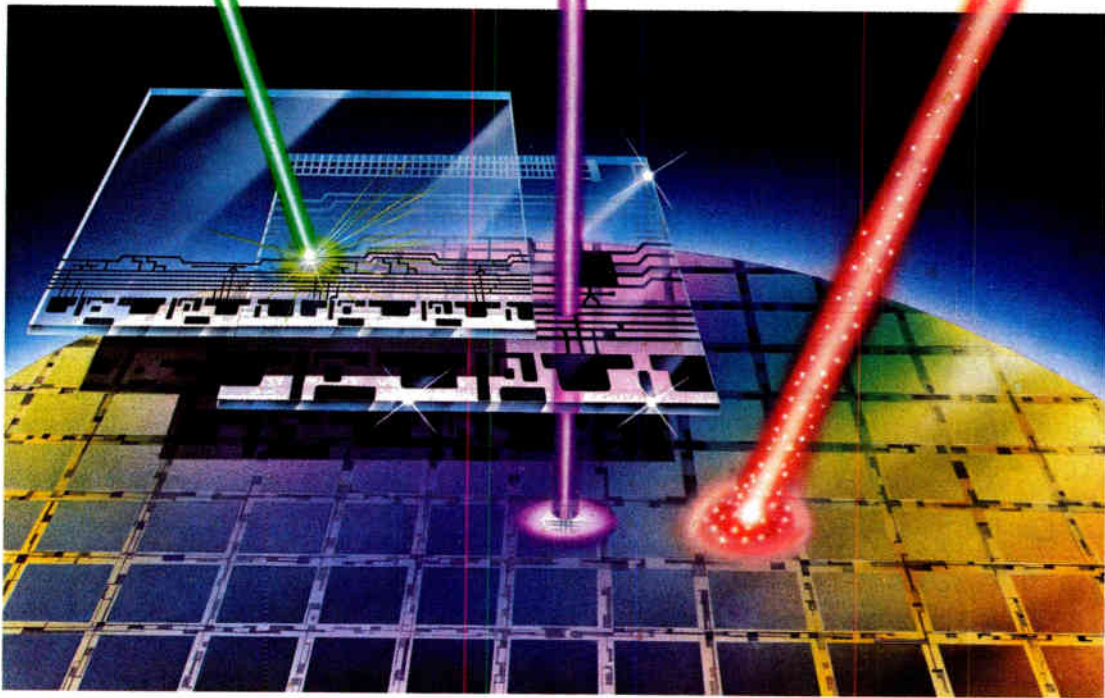

manufacturing electron-beam exposure system. Not only is it ideal for creating high-resolution masks,

A complete family of models ranging from the basic 100 Series to the state-of-the-art 500 Series meets every requirement.

write Perkin-Elmer, Semiconductor Operations, 50 Danbury Road, Wilton, Connecticut 06897.

PERKIN-ELMER

Responsive Technology

Circle 205 on reader service card

Continuing Education in
Engineering and the
College of Engineering
**University of
California, Berkeley**
announce an intensive short course

Analog MOS Integrated Circuit Design

September 21 - 22, 1981,
San Francisco Airport Hilton

For engineers in design, production,
marketing, planning and utilization.
Course faculty **Robert W. Brodersen**,
Paul R. Gray and **David A. Hodges**
of UC Berkeley will cover important
topics in the design of analog circuits
in NMOS and CMOS technology.

For details call (415) 642-4151 or
write to Continuing Education in
Engineering, Dept. HB-8, University
of California Extension, 2223 Fulton
St., Berkeley, CA 94720.

Circle 206 on reader service card

WHEN YOU NEED
DEC...

TERMINALS

- VT-100 • VT-103
- LA34 • LA120
- LA180

PDP 11/03

PDP 11/23

SYSTEMS

LSI/11 MODULES

Demand...Delivery
Demand...Discounts
Demand...UNITRONIX

UNITRONIX
CORPORATION

(201) 231-9400

197 Meister Ave.
Somerville, NJ 08876
TELEX: 833184

New products

internally generated noise between actual measurements, eliminates any measurement noise due to the instrument. Added to those functions are an IEEE-488 interface, so the rf meter can be part of a system, and automatic self-calibration, both of which have previously been seen in digital multimeters.

The calibration of the 9303's sampling tee heads—two can be connected to the instrument at once—is also automated. Using the internal 0-dBm calibration signal, each tee head can be calibrated and a correction factor stored that is automatically applied to each measurement made with that head. Each tee head also has a calibration curve for frequency printed on it that can be entered into the instrument.

In a system, the dual heads combine with the instrument's computing functions for sophisticated operation. A reading taken at one head can be stored and used as a reference for a reading taken at the other head. Gain or attenuation, for example, can be measured in this way and presented in decibels. Power ratio and percentage difference measurements can also be made in this way, or all three types of measurements can be made using manually entered measurements constants. A null function is also provided.

Input impedance of the unit is 50 Ω nominally and it has a voltage standing wave ratio of 1.1:1 up to 1 GHz and 4:1 to 2 GHz. Voltage and power accuracy at calibration frequency are $\pm(1\%$ of reading + 20 μ V) and $\pm(2\%$ of reading + 10 pW), respectively. Delivery takes 60 days, and the unit is priced at under \$3,000.

Racal-Dana Instruments Inc., 18912 Von Karman Ave., Irvine, Calif. 92715 [352]

Performance during power surges and sags tested

EMC Power is offering a power-line-disturbance generator-monitor that allows manufacturers to test equipment susceptibility to transient voltage sags and surges during

brownouts and power surges.

The one-year-old firm is targeting its Powerglitcher 1.2 at original-equipment manufacturers concerned about the performance of their products in a world of uncertain electrical energy supplies.

Powerglitcher 1.2—which costs \$2,500 and can be delivered within 12 to 15 weeks after orders are received—can be set up to produce voltage sags or surges of up to 70 V root mean square in 10-v increments for durations of 1 to 999 half cycles. The unit can apply single or repetitive sags or surges. It can also deliver up to 2 kVA continuously and as much as 4.5 kVA during maximum surges. Total dropouts to 0 V are also selectable. The phase angle at power turn-on to any of the 14 selectable voltages can be set from 1° to 360° with a 1° resolution.

Features include an external trigger to allow for use in semiautomated test sets, normalized outputs for externally monitoring current and voltage waveforms, and electronic fault-current protection.

Powerglitcher, which carries a two-year warranty, can monitor externally originated power-line voltage transients, as well as those it generates itself. The unit measures 6.5 by 16 by 12 in. and weighs less than 60 lb.

EMC Power, P. O. Box 2311, Garland, Texas 75041. Phone (214) 278-3133 [353]

Automatic unit counts frequency to 110 GHz

A new microwave counter makes possible automatic frequency measurement up to 110 GHz. EIP Microwave's model 548A can cover frequencies of 10 Hz to 110 GHz with accurate readout up to 12 digits at all frequencies in about a second when equipped with a \$3,700 internal option 06 frequency-extension module and an external model 590 frequency-extension cable kit, which costs \$200.

The counter uses an automated heterodyne technique in the down-conversion process. Without the op-

TURN ANY COMPUTER INTO A POWERFUL MEASUREMENT AND CONTROL SYSTEM.

MACSYM 20 OFFLOADS YOUR HOST AND ALSO STANDS ALONE.

MACSYM 20 is the measurement and control front end with a difference. Its superior intelligence frees up your host computer for other important tasks. And because it's programmable, MACSYM 20 can function on its own should your host go down.

MACSYM 20 CONNECTS DIRECTLY TO YOUR SENSORS.

Select the functions you need from our extensive family of I/O cards, and connect MACSYM 20 directly to the sensors. MACSYM 20 can accommodate up to 500 different I/O channels, and the signal conditioning is already done.

MACSYM 20 OPERATES IN HARSH ENVIRONMENTS.

MACSYM 20 can operate even in rugged environments because no movable mass storage devices are used. You have your choice of downline loading programs from your host computer into RAM memory on MACSYM 20, or burning the programs into PROM.



To get more information on MACSYM 20, simply fill out and return this coupon, or call your nearest Analog Devices office listed below.

MACSYM 20

I have an immediate need for intelligent I/O front ends.

- Please send more information.
- Please have a system specialist call.

Name _____

Title _____ Phone _____

Organization _____

Address _____

City _____

State _____ Zip _____

Send to: Bill Miller, Analog Devices, 4 Technology Center, Norwood, MA 02062

E-5

ETC.
LIMIT SWITCHES
4-20 mA
CONTROL VALVES
THERMOCOUPLES





Everything you need in

Circuit Board Terminals

- Stamped pins and receptacles in quantity in strips, on reels or loose.
- Your designs, competitive types, or our more cost-effective designs.
- In-house high-speed presses assure quality and reliable delivery at lowest possible cost.

PLUS

- Universal's automatic pin and terminal insertion machines and systems custom tooled to install them in your boards at rates up to 10,000/hour.

Call or write:



Universal Instruments Corporation
Box 825, Binghamton, New York 13902
Tel. 607/772/7522 TWX: 510/252/1990

Subsidiary of **DOVER CORPORATION**

Circle 208 on reader service card

BOLD LED INDICATORS



Quality LED indicators with refreshing bold appearance. The large dome or cylindrical shape allows the widest viewing angle possible without the necessity of a bezel hinderance. LED brightness is enhanced by use of a fresnel lens system. Mounting hardware provides a positive means of fastening. Your choice of red or green LED's or with a red LED flasher in either dome or cylindrical style housing. Flashers have built-in IC providing a light pulse about three times a second. These SLD Series feature a 5/16" mounting. Call or write Customer Service today for further details and ask for our new 164-page catalog.

AUGAT **ALCOLITE**[®]

ALCO ELECTRONIC PRODUCTS, INC.
1551 Osgood St., No. Andover Ma 01845 USA
Tel: (617) 685-4371 TWX: 710 342-0552
Canada: Kaytronics, 375 Norman St. Ville St. Pierre, Que. H8R 1A3
Europe: Augat France SA (Z.I. Sorilic) B.P. 440-CEDEX 94263 Fresnes, France

208 Circle 145 on reader service card

New products



tions, its range extends to 26.5 GHz. In order to get to 110 GHz, a second internal down-conversion stage is added.

This added stage, combined with remote sensor options ranging in price from \$500 to \$2,600, achieves 26.5-to-40-GHz, 40-to-60-GHz, 60-to-90-GHz, and 90-to-110-GHz measurements. Price of the basic 548A is \$6,300. Delivery is 16 weeks from receipt of order.

EIP Microwave Inc., 2731 N. First St., San Jose, Calif. 95134. Phone (408) 946-5700. [354]

Analyzer covers the 10-MHz-to-22-GHz range

The model 8569A spectrum analyzer from Hewlett-Packard covers the 10-MHz-to-22-GHz range and can be extended to 170 GHz with external mixers. Its frequency performance is achieved by an advanced mixer design that provides sensitivities of -113 dBm (at a 1-kHz bandwidth) for fundamental mixing and -95 dBm at 18 GHz; a frequency response of ± 3 dB to 18 GHz; an 80-dB dynamic range to 1.8 GHz; and a clean, stabilized local oscillator that allows close-in high-resolution measurements with 10 resolution bandwidths of 100 Hz to 3 MHz.

The spectrum analyzer has a microprocessor-controlled digital display system that provides two independent traces, each with 480-point horizontal and 800-point vertical resolution. The traces allow the user to store trace data and at the same time to monitor signal changes. A built-in HP input/output capability allows full read/write and sweep triggering and computer-aided data logging.

Electronics/May 19, 1981

Where in the World is Trio-Tech?



We're in 39 countries serving 545 companies with Environmental Test Equipment and Component Screening Services.

Since 1959, billions of electronic components have been tested by many cost-conscious companies using our Burn-in Systems, Hermeticity Testing Equipment and Centrifuges . . . and our complete Test Lab Screening Services.

Find out how a little testing can make a big difference in component reliability . . . and your reputation in the marketplace.

MAIL ME YOUR FREE BROCHURE

I want to know more about component testing and what it can do for me.

Name _____

Title _____

Company _____

Address _____

City _____

State _____ Zip _____

Phone () _____

TRIO-TECH INTERNATIONAL
2040 N. Lincoln St., Burbank, CA 91504



Environmental Test Equipment and Screening Services since 1959.

2040 N. Lincoln St., Burbank, CA 91504, (213) 846-9200

TLX 194811 (TTI INTL BUBK), Cable: TRIOCAL

Mountain View • Singapore • London • Manila

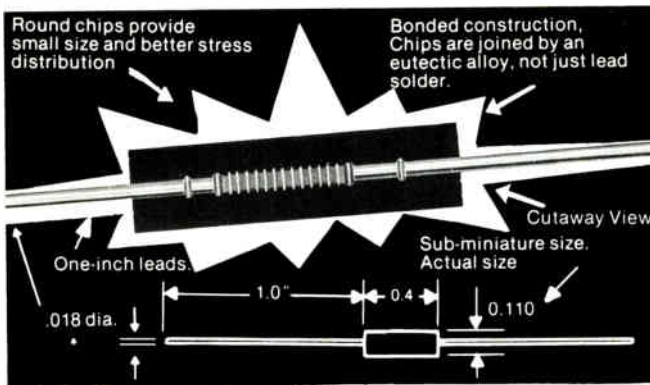

LOW COST MINIATURIZED SILICON RECTIFIER DIODES

Here's a line of inexpensive silicon rectifiers that features extra small, hexagonal cases and one inch leads to simplify construction into multipliers, assemblies and printed circuit boards.

The EDI "DL" Series is available from 3 to 15 KV, 25 mA, with fast 300 ns. recovery time.

Also available in DC series: 0.6" x 0.160" dia.

FREE SAMPLES

Write, outlining your OEM application for samples, full specification, and prices.

Buy from the specialists

edi electronic devices
21 Gray Oaks Ave., Yonkers, N.Y. 10710
(914) 965-4400, TWX710 560-0021

Circle 210 on reader service card

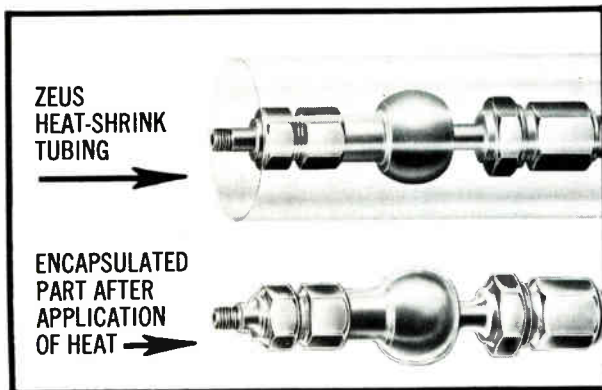

HEAT-SHRINK TUBING OF TEFLON*

Beats Hell, High Water and the Acid Test

Now your wires, cables, connectors, etc. can survive extremes of heat, (up to 500°F) corrosion, shock and moisture. A brief application of heat molds Zeus Heat-Shrink Tubing snugly around intricate shapes to form a skin-tight jacket, impervious to the worst kind of critical conditions. Provided in expanded state! Shrink ratios up to 4 to 1. Send for Data Sheet.

ZEUS INDUSTRIAL PRODUCTS, INC.

Foot of Thompson St., Raritan, NJ 08869
201-526-0800 (in NJ) • TWX 710-480-9346

Call Toll Free 800-526-3842

* DuPont's registered trademark for its fluoropolymer resins.

New products

The model 8569A is priced at \$26,500 in the U. S.

Hewlett-Packard Co., 1507 Page Mill Rd., Palo Alto, Calif. 94304 [355]

Parametric testing is done on VLSI wafer test patterns

Keithley Instruments has expanded its system 300 parametric test system to include the 300 parametric test series and the systems 323, 334, and 344. These testers analyze measurements on very large-scale integrated wafer-test patterns and are capable of handling up to four stations with up to 144 pins per station.

The system 323 is controlled by a PDP-11/23 computer from Digital Equipment Corp. The system includes the voltage and current forcing and measurement functions, as well as the capacitance measurements necessary for parametric testing. Prices start at \$60,000. The system 334, a TTL-based processor, includes a central processing unit, 128-K bytes of memory, floating-point processor, dual RL01 hard-disk drives, and a cathode-ray-tube console. Prices start at \$80,000. The system 344, which starts at \$100,000, is a low-power-Schottky TTL-based minicomputer using dual RL02 disk drives for 20.8 megabytes of mass storage.

Keithley Instruments Inc., 28775 Aurora Rd., Cleveland, Ohio 44139 [356]

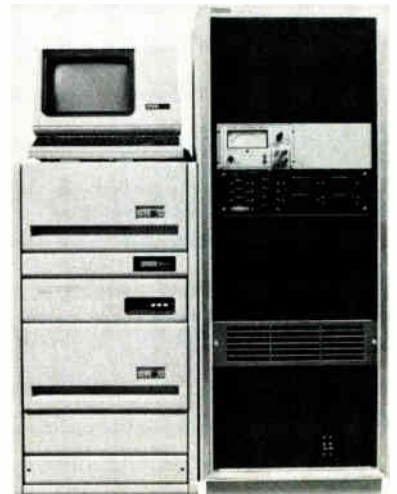

FLAWLESS?

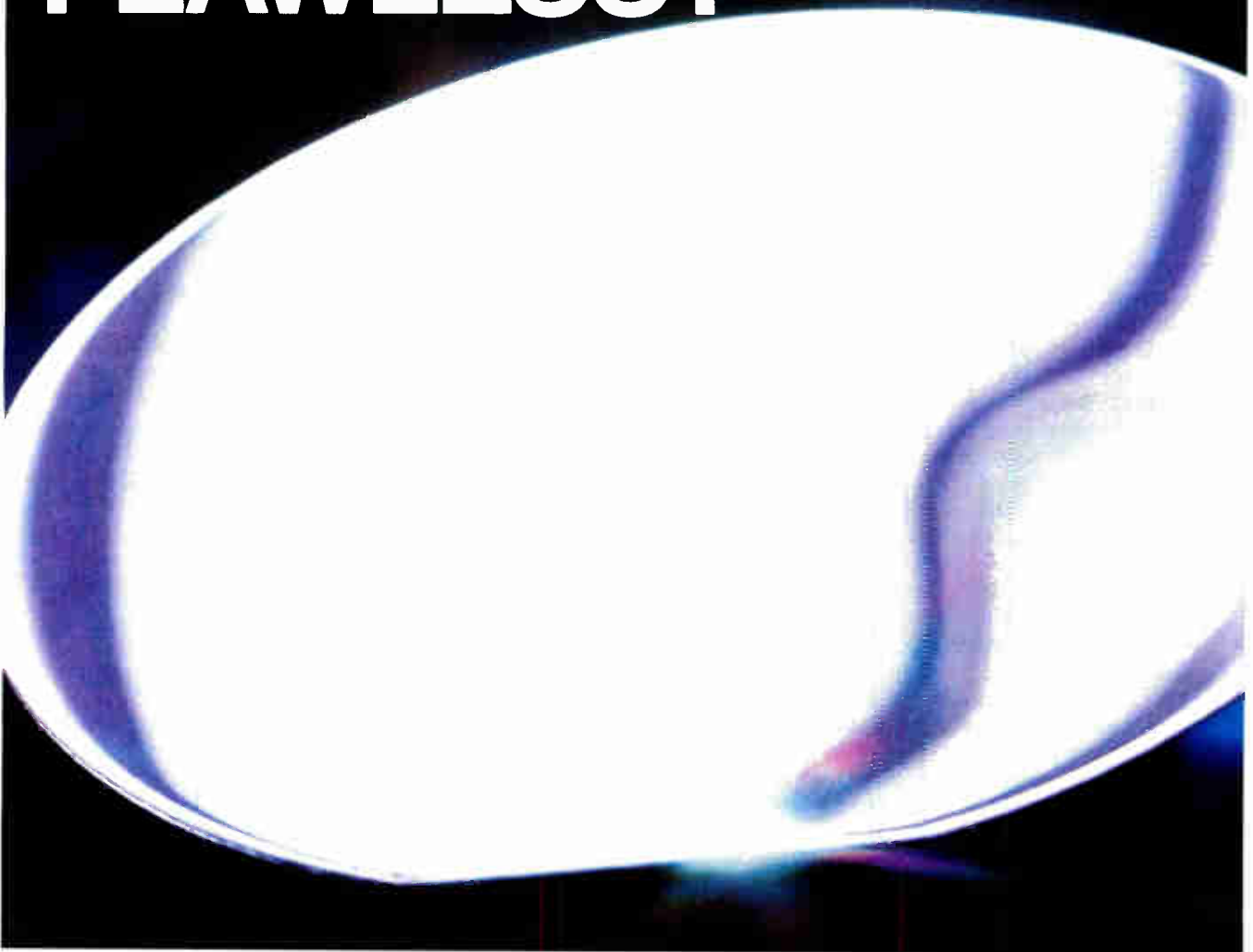

Announcing a Silicon Wafer Inspection System that can show you how reliable the human eye isn't.

- Automatic flaw detection capability down to one micron.
- Automatic sort for accept, reject, repolish, or reclean categories.
- On-line throughput capability up to 600 wafers per hour.
- High consistency and resolution of laser scanning technique assures the highest pass/no-pass reliability levels.

Put our Wafer Inspection System to the test. Bring your sample wafers for a test demonstration to Ford Aerospace & Communications Corporation booth no. 2284 at Semicon West May 19 through May 21. For more information and an appointment, call Mr. Jerry Alford, Process Control Products Operations, Charlotte, North Carolina. Telephone: (704) 394-8391.



Ford Aerospace & Communications Corporation

New products

Communications

Rf amplifier delivers 1,000 W

Solid-state amp uses
hybrid coupling to achieve
0.3-to-35-MHz bandwidth

The A-1000 from Electronic Navigation Industries is the first solid-state amplifier to offer a continuous-wave output of 1,000 W from 0.3 to 35 MHz. This hybrid-coupled class A amplifier evolved from the firm's less powerful A-500, says chief engineer Ron Sonkin, adding that it can handle amplitude-modulated, frequency-modulated, and single-sideband signals with equal ease. "It is unconditionally stable and protected against both overdrive and overload, so nonlinear loads won't cause any problems," he goes on.

The A-1000 produces 60 dB gain with a variation of only ± 1.5 dB over its bandwidth. At 800 W, all harmonics are more than 25 dB below the fundamental. Harmonics

are even lower at reduced power levels. With nominal input and output impedances of 50 Ω (using type N connectors), the amplifier is said to exhibit voltage standing-wave ratios of less than 1.5 and 4.5 at input and output, respectively. It does this while maintaining a noise figure of less than 12 dB.

The 370-lb unit owes its power and bandwidth to its hybrid coupling. The output from a group of its transistors is properly combined with respect to amplitude and phase by a group of passive devices (the hybrid couplers). The passive components are used, as the need arises, as either power combiners or dividers.

Says Lee Salmen, vice president of ENI, it is possible to couple A-1000s together and achieve higher-power outputs using an external hybrid. Possible applications for the solid-state amplifier, beyond replacing tube-type transmitters in wideband multifrequency communications systems (where ENI sees its largest potential market), include navigation beacons, over-the-horizon radar, jamming, and scientific areas such as in linear accelerators, fusion research, plasma work, spectroscopy, and radio-frequency heating.

The A-1000 is 52½ by 16¾ by 21½ in. It requires three-phase ac power at 208 to 230 V, drawing about 22 A per phase. Radio-frequency output voltage can be read on a front-panel meter, which is also calibrated in watts into a 50- Ω load.

The A-1000 is priced at \$17,500 and can be delivered in 90 days.

Electronic Navigation Industries Inc., 3000 Winton Rd. South, Rochester, N. Y. 14623. Phone (716) 473-6900 [401]

Receiver combines amp and photodiode in TO-5 format

The R1000 series of hybrid optical receivers integrates p-i-n photodiodes and transimpedance amplifiers in a compact TO-5 package to combine high speed and responsivity with low noise. They feature long-term stability and reliability, a dual power supply, and a high coupling

efficiency for fiber optics.

The R1000 series can be used in optical communications, radar, repeaters, pulse power monitors, light pens, video systems, remote sensing, and intrusion alarms. The units have an operating voltage range of -5 to -40 V (photodiode) and +5 to +15 V (amplifier), a current drain of 4 to 8 mA on positive supply, a dc offset voltage output of +1.2 to +1.7 V, ac output load of 50 Ω , a dc output load of 500 Ω , an output dynamic range of 80 dB, and a temperature range of 20° to +70°C.

The R1000s are available in SMA- and AMP-type fiber-optic receptacles. They range in price from \$85 to \$99 apiece, depending upon the desired series, in quantities of 10 to 99. A six-month warranty is provided. Delivery is from stock or takes up to four weeks.

Meret Inc., 1815-24th St., Santa Monica, Calif. 90404. Phone (213) 828-7496 [403]

Long, strong optical fiber loses 1.26 dB/km at 1.06 μm

An ITT-developed 12-km graded-index optical fiber drawn at a strength proof test level of 200,000 lb/in.² is believed to be the longest and strongest single strand of optical fiber available to date. It has a 35- μm core with a numerical aperture of 0.23, an average loss of 2.77 dB/km at 0.85 μm and 1.26 dB/km

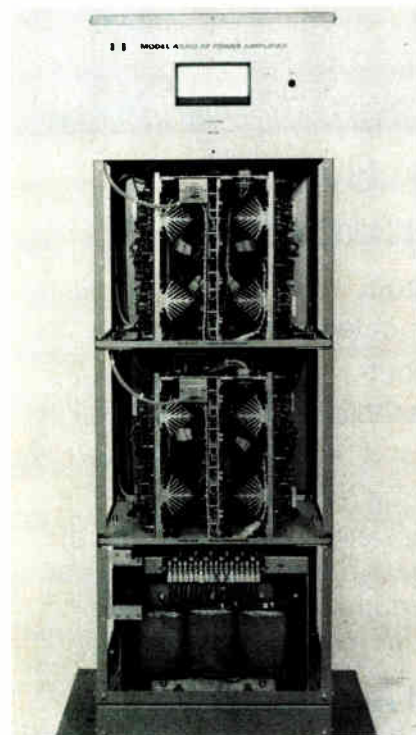

SUPERSWITCH

TO 3 POWER TRANSISTORS

PROGRESS IS YOUR CHOICE



YOU MAY DEPEND ON US, WE'RE NEVER FAR-AWAY...

THOMSON-CSF
COMPONENTS

THOMSON-CSF COMPONENTS CORPORATION

SEMICONDUCTOR DIVISION - P.O. BOX 1454 CANOGA PARK CALIFORNIA 91304 - 6660 VAREL AVENUE
CANOGA PARK CALIFORNIA 91303 USA . TEL. : (213) 887.1010 - TWX 910 494 1954 - TELEX 69 8481

BELGIUM
THOMSON S A
BRUXELLES (2) 648.64.85

THE NETHERLANDS
THOMSON S A,
RA s' GRAVENMOER (31) 231.76.00

BRAZIL
THOMSON CSF
COMPONENTES DO BRASIL
SAO PAULO (55 11) 543.79.38

FRANCE
THOMSON-CSF
DIVISION SEMI-CONDUCTEURS
COURBEVOIE (33) 1.788.50.01

WEST GERMANY
THOMSON CSF
BAUELEMENTE GmbH
MÜNCHEN (089) 7675.1

ITALY
THOMSON CSF
COMPONENTI
MILANO (2) 68.84.141
ROMA (06) 31.92.42.34

JAPAN
THOMSON CSF JAPAN K K
TOKYO (03) 264.6341

SINGAPORE
THOMSON CSF
COMPONENTS SEA
SINGAPORE 295 31 24

SPAIN
THOMSON CSF
COMPONENTES Y TUBOS
BARCELONA (3) 373 30 11
MADRID
T) 419.66.91/419.65.51

SWEDEN
THOMSON CSF
KOMPONENTER &
ELECTRONOR AB
STOCKHOLM (08) 22 58 15

SWITZERLAND
MODULATOR S A
BERN LIEBEFELD (031) 59 22 22

UNITED KINGDOM
THOMSON CSF
COMPONENTS AND MATERIALS LTD
BASINGSTOKE HANTS (0256) 29 155

World Radio History

Circle 213 on reader service card

HEADQUARTERS : 50, RUE JEAN-PIERRE TIMBALD, R.P. 5/92403 COURBEVOIE CEDEX - FRANCE - TEL. 33 (0) 788 50 01 - TWX 610540

New products

at 1.06 μm , and a dispersion of 0.4 ns/km. It will be used in the U. S. Army's integrated fiber-optic communications link program and provides full-duplex communication of video and control data over a single fiber for missile guidance.

International Telephone & Telegraph Corp., 7635 Plantation Rd., Roanoke, Va. 24019. Phone (703) 563-0371 [405]

Laser diode comes in a 14-pin hermetic package

The GO-DIP fiber-pigtailed laser diode has a 14-pin dual in-line hermetically sealed package that contains no organic materials. The standard fiber pigtail has a 50- μm core diameter, with a 0.2 numerical aperture. It has a laser-powered monitoring photodetector with a current rating of up to 300 μA and 1-mW maximum power. Its wavelength is 830 nm with a temperature coefficient of 0.3 nm/ $^{\circ}\text{C}$. It has an operating temperature of -40° to $+65^{\circ}\text{C}$, a storage temperature of -50° to $+80^{\circ}\text{C}$, and thermal resistance of $20^{\circ}\text{C}/\text{W}$ typical.

An optional thermoelectric cooler is available for the GO-DIP along with a 10- Ω thermistor for monitoring temperature.

The GO-DIP is priced at \$1,750. Delivery is from stock or takes up to six weeks. A limited warranty is provided.

General Optronics Corp., 3005 Hadley Rd., S. Plainfield, N. J. 07080. Phone (201) 753-6700 [404]

Receiver accepts inputs from dc to more than 40 Mb/s

Newly available from LeCroy Research Systems are the Fibercom FDR-13E digital fiber-optic receiver and the FDT-13E transmitter. The FDR-13E eliminates encoding-decoding circuitry for high performance. It accepts input data rates of dc to greater than 40 Mb/s (nonreturn to zero); includes optical input and electrical power connectors, de-

tectors, amplifiers, comparator, output buffering, and supply filtering; and does not require system-generated update signals. The receiver can be used in applications requiring high speed, good timing accuracy, low jitter, and perfect response to wide variations in duty cycle.

The FDT-13E digital transmitter accepts input data rates of dc to greater than 50 Mb/s (NRZ) and can transmit over distances as long as 2 km. It is a hybrid TTL-compatible unit with a true dc response and a temperature-compensated light-emitting diode. The transmitter operates over the temperature range of 0° to $+55^{\circ}\text{C}$, is housed in a shielded package, and requires a 5-v power supply.

The FDR-13E digital fiber-optic receiver is housed in a shielded, low-profile package and can be installed with any associated electronics on a printed-circuit board. It sells from stock at \$159 each in quantities of one to nine. The FDT-13E digital transmitter, available off the shelf in a shielded package, costs \$125 apiece in quantities of one to nine. LeCroy Research Systems Corp., 700 South Main St., Spring Valley, N. Y. 10977. Phone (914) 425-2000 [406]

Transmitter and receiver communicate over 3,000 m

The FI-6300 analog fiber-optic modules consist of transmitter (FI-6300T) and receiver (FI-6300R) that can be plugged into the FI-6000MF mainframe for power.

The FI-6300 link transmits high-quality analog signals over long distances of 3,000 meters with low signal degradation. It distributes studio-quality video signals through high electromagnetic-interference areas or where the small diameter of its optical-fiber cable is significant.

The analog fiber-optic modules have a signal input and output of 1.4 v peak to peak maximum, an impedance of 75 Ω , a -3-dB bandwidth of 10 Hz to 15 MHz, and front-panel indicators and test points to

allow monitoring of the link's performance. Delivery is in two months. Foundation Electronic Instruments Inc., 1794 Courtwood Crescent, Ottawa, Ont. K2C 2B5, Canada [408]

Cutting machine charges up for more than 600 splices

The fiber-optic fusion splicer model FW-303 is battery-powered and can splice 100- to 150- μm -diameter fibers (other ranges are available). It has an optical screen for easy viewing of the splicing operation, a V groove, two single-axis fiber positioners, and an integral crimping device for splice protection.

The FW-303's battery is rechargeable from 100 to 240 v ac, 50 to 60 Hz. More than 600 splices per charge can be achieved for the 125- μm fiber. It results in a splice loss of less than 0.25 dB.

The FW-303 costs \$8,800. Delivery will take 14 to 16 weeks. Orionics Inc., 34368 E. Frontage Rd., Bozeman, Mont. 59715. Phone (406) 586-8256 [409]

Data transmitter provides duplex or simplex operation

The ODT-A-100 is designed to be connected with RS-232-C standard data-processing equipment to provide full-duplex asynchronous data transmission at dc to 100 kb/s over distances of up to 5 km. This asynchronous optical data terminal may also be used for simplex operation as a transmitter or receiver.

The ODT-A-100 has a built-in system status indicator with a light-emitting-diode display for constant monitoring of optical link continuity and a built-in loopback testing capability to locate simple faults for easy maintenance. It may be either desk-top- or rack-mounted and withstands harsh physical environments. It is available for \$625. Delivery takes three to five weeks.

Phalo Corp., 530 Boston Turnpike, Shrewsbury, Mass. 01545 [410]

A new step forward in the field of power transistors for high speed switching.

A new generation of power transistors for higher efficiency, less base drive and higher current now increases the already extensive range of SUPERSWITCH transistors.

The main electrical characteristics of this series of Superswitch transistors are remarkable:

	$V_{CEO(sus)}$	$V_{CE(sat)}$ for $I_{C(sat)}/I_{B(sat)}$	
BUT 90	125 V	≤ 1.2 V	70 A / 7 A
BUT 91	200 V	≤ 1.2 V	40 A / 4 A
BUT 92	250 V	≤ 1.2 V	35 A / 3.5 A

The small voltage drop associated with the excellent switching performances at very high current levels (switching time t_f max is less than 300 ns for all three transistors of the series) enables minimizing the static and dynamic losses.

By utilizing the transistor at a lower collector current level, for example at the value for which the saturation voltage $V_{CE(sat)}$ is specified as less than 0.6 V, the losses can be reduced and the

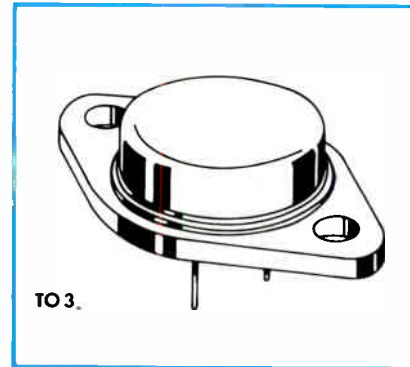

efficiency of the equipment considerably increased.

The BUT 90, BUT 91 and BUT 92 Superswitch transistors are thus suitable for all high-speed switching applications (DC-DC converters, speed-control circuits) where high efficiency at high switching frequencies and the reliability of the equipment are of prime importance.

Circle 214 on reader service card

TO 220 TRIACS: new series.

A new range of insulated and uninsulated triacs in TO 220 case is now available.

Particularly suited for applications such as phase control and static switching, this range includes 6, 8, 10, 12 A, types with V_{DWM} and V_{RWM} from 200 V to 700 V.

This original series: BTA06 to BTA12 (PRO ELECTRON registered) uses a glass passivated chip which ensures greater reliability and stability.

This series is characterized by its high level performances:

- $I_{GT} = 50$ mA for the standard types and 10 mA for the sensitive types,
- $dv/dt_{(c)} > 10$ V/ μ s,
- Insulation voltage = 2,5 kV(rms)/minute.

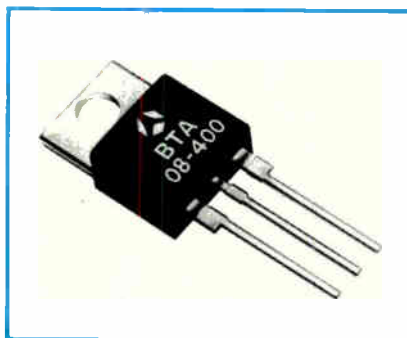

Circle 215 on reader service card

ESM 952: for safe switching from the 380 V mains.

The ESM 952, A is a new SUPER-SWITCH transistor encapsulated in a TO 3 case. That transistor permits switching a current of 12 A from the 380 V rectified mains without any switching aid network.

Main electrical characteristics:

	$V_{CEO(sus)}$
ESM 952	600
ESM 952 A	700
	$V_{CE(sat)}$ at $I_{C(sat)}$
ESM 952	$\leq 1,8$ V 12 A
ESM 952 A	$\leq 1,8$ V 12 A

The fall time measured on an inductive load at a current level of 12 A is about 150 ns which permits achieving a switching frequency of 50 kHz.

Glass passages for the connections have a diameter of 5 mm, thus complying with the European insulation standards.

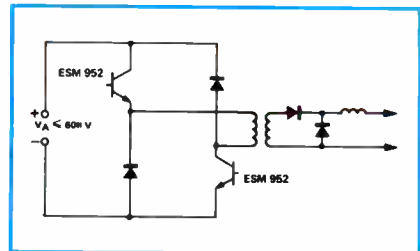

Example of utilization of SUPER-SWITCH transistor ESM 952 in a half-bridge asymmetrical converter.

Circle 216 on reader service card

CG 4447

New products

Computers & peripherals

Thermal recorder makes own grid

Unit prints waveforms, graphics, alphanumeric data on 2³/₄-in.-wide paper strip

A microprocessor-based thermal graphic recorder, the Versatek 60 from the Measurement and Control Systems division of Gulston Industries Inc., may be one of the most flexible strip-chart recording devices ever offered to original-equipment manufacturers. Product marketing manager John Olobri thinks its mix of features is unique.

The Versatek 60 strip-chart recorder offers a combination of digital and analog input, graphics, and real-time waveform display and can combine printing of graphics, waveforms, and alphanumeric. Printing of alphanumeric text can be done either parallel to or perpendicular with the edge of the paper strip.

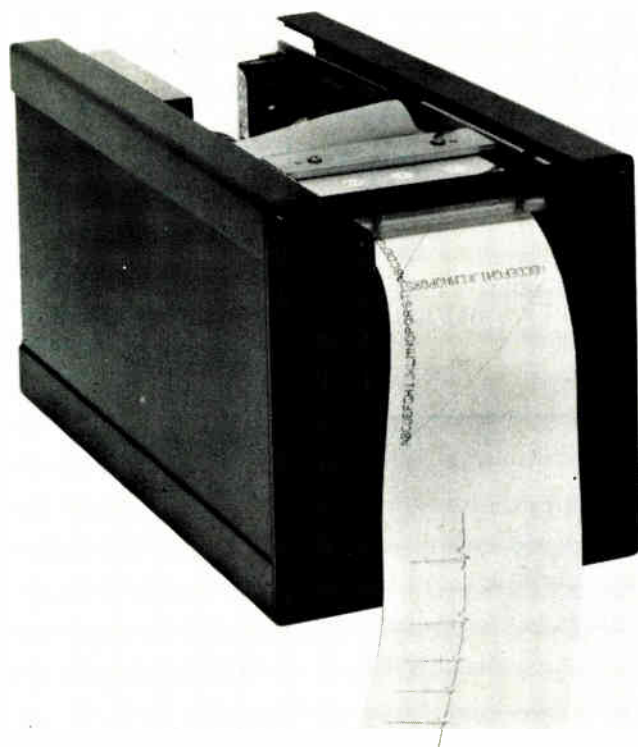

Users can select chart rates between 5 and 50 mm/s, and resolution of the unit's thermal print head is quite high—about 112 lines/in.

Olobri says the unit is primarily aimed at medical applications, with industrial uses a secondary target. He thus expects the model 60 to appear in next-generation electroencephalogram and electrocardiogram equipment, as well as in computer-based patient-monitoring systems.

Inputs. The unit accepts analog inputs of up to ± 250 mV full scale, passing them through a differential input stage to a 1.5-ms sample-and-hold network and thence to an 8-bit analog-to-digital converter. This port is expected to be used mostly for real-time waveform inputs.

Digital data and mode-control inputs enter through a 25-pin type D connector and are fed to a 128-K-byte random-access buffer memory. To save buffer space, the unit can be instructed to print a line when only its end points are specified.

The printer's intelligence is supplied by a Motorola 6802 8-bit microprocessor with its firmware stored in a 2732 32-K programmable read-only memory. Aside from com-

plex mechanical control and electro-mechanical timing functions, much of the 6802's task is translation of digital inputs, or digitized analog inputs, into firing instructions for the printhead drivers.

In operation, five mode-control lines determine how the data is to be presented. These lines allow selection of chart speed; they enable or disable the unit's grid-generation algorithm; they specify the alphanumeric format (along either margin or across the width of the strip); and they detail timing. For computer-based applications, these inputs can be varied under real-time software control. For simpler use, the mode-control line can be hardwired to fixed logic levels.

A unit like the Versatek 60 offers several advantages over presently available equipment, according to Olobri. Since it can generate its own grid references at the same time it records a waveform, there is no doubt as to the relative time and amplitude calibration of grid and waveform. In addition, he points out, plain paper is much cheaper than gridded stock.

Goodbye overshoot. When compared with the analog pen recorders that typically trace medical data, the thermal printer offers complete freedom from pen ballistics. Since its traces can be free from lag or overshoot, Olobri expects that the unit, with its high resolution, will more accurately reflect cardiac or encephalographic waveforms (for example) than pen-equipped systems. Olobri says the unit may offer from 20% to 25% greater accuracy and detail than analog recorders. Overall system accuracy is specified as within 1%, and linearity within 0.5%.

The alphanumeric font is the standard 64-character upper-case ASCII subset; the characters are 2.5 by 3.5 mm in a five-by-seven dot matrix. Alphanumeric inputs are byte-serial at TTL levels.

The unit includes its own switching power supply, operable with either 95 to 135 or 210 to 250 v ac. It uses 2³/₄-in.-wide strip paper and measures 6¹/₈ by 5³/₄ in. Price in single units is about \$1,200; delivery is

Unleashing the most powerful minicomputer ever designed.



Concept 32/87

Raw Power...

A minicomputer so far ahead of any other that the numbers speak for themselves:

Whetstone 1	3604 Whets(x1000)
Whetstone 2	2249 Whets(x1000)
Real-Time Simulation	22.4 Seconds

Serious about wanting the most powerful minicomputer available? Call SYSTEMS. We'll match our numbers against anyone's.

Systems Engineering Laboratories, Inc.
6901 W. Sunrise Blvd., Ft. Lauderdale, FL. 33313
(305) 587-2900, 1-800-327-9716

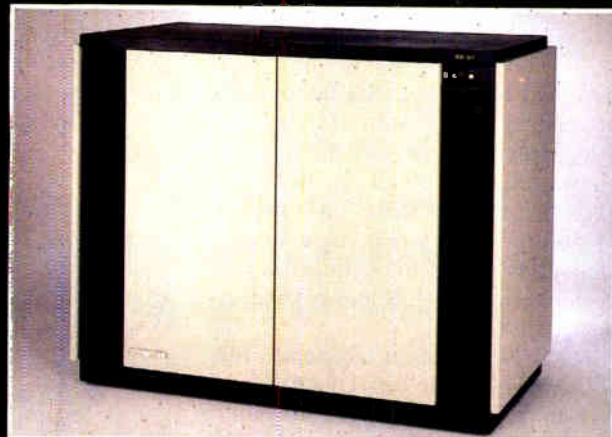

Argentina•Australia•Belgium•Canada•Colombia•England
France•Italy•Japan•Mexico•Sweden•Thailand•West Germany

Proven COMPUTER Performance

SYSTEMS

A Subsidiary of GOULD INC.

World Radio History

Circle 217 on reader service card

1981

New products

from stock to 60 days.

Gulton Industries Inc., Measurement and Control Systems Division, Gulton Industrial Park, East Greenwich, R. I. 02818 [361]

A raft of disk drives makes the NCC scene

Any doubts about the continued enthusiasm for fixed media were dispelled by the number of products introduced in conjunction with the recent National Computer Conference. Among those making the introductions were:

■ Control Data Corp., which announced last month an 8-in. fixed-disk drive, the Finch, aimed at mini-computer and microcomputer systems built by original-equipment manufacturers. The CDC 9410 drive provides either 8 or 24 megabytes of unformatted, fixed data-storage. Vying for spots ordinarily occupied by floppy-disk drives, the Finch is



designed to be mounted horizontally or vertically in the same space as an 8-in. flexible-disk drive. In OEM quantities, the 9410 is priced at \$1,295 for an 8-megabyte unit and \$1,560 for the 24-megabyte version. Deliveries are set to begin in June.

Control Data Corp., P. O. Box 0, Minneapolis, Minn. 55440 [364]

■ NEC Information Systems Inc., which has unveiled its D2200 family of 8-in. Winchester drives with up to 42.5 megabytes of storage and a 30-ms access time. The D2220 has a 25.5-megabyte capacity and is

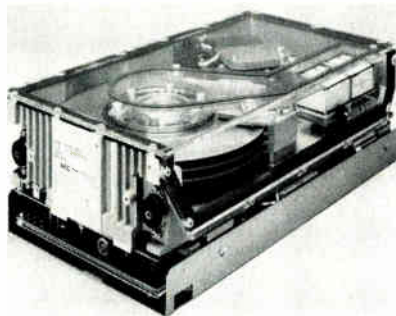

priced at \$2,365 each in orders of 100. The D2230 can store 42.5 megabytes and is priced at \$2,590 each in 100-unit quantities. Delivery is 60 days after receipt of order.

NEC Information Systems Inc., 5 Militia Dr., Lexington, Mass. 02173 [366]

■ Ampex Corp., which has added to its 14-in. Winchester line-up a series of rack-mountable units. The model 165 has a capacity of 165.9 megabytes and the model 330 one of 330.3 megabytes. These Capricorn units have an average access time of 30 ms and a data-transfer rate of 1.2 megabytes/s. The 165 costs \$5,900 and the 330 costs \$7,100 in OEM quantities. Shipments are scheduled to begin in September.

Ampex Corp., 401 Broadway, Redwood City, Calif. 94063 [365]

■ 3M, which has introduced six models of 8-in. Winchester disk drives with capacities of 10, 20, and 60 megabytes. The four in the 8400 series are 10- and 20-megabyte drives with and without data-handling electronics. The two in the 8500 series are both 60-megabyte drives, with and without data-handling capability and having an average access time of 29 ms. All six machines transfer data at a rate of 933 kilobytes/s. Unit prices to OEMs

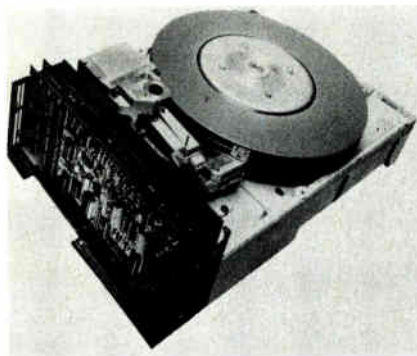

in quantities of 50 to 99 are \$1,695, \$1,925, and \$3,745 in ascending order of capacity.

3M Co., P. O. Box 3600, St. Paul, Minn. 55133. Phone (612) 733-9572 [367]

■ Kennedy Co., whose model 5380 80-megabyte 14-in. Winchester drive is compact, displacing only 1.69 ft³. Its average access time is 35 ms, and its data-transfer rate is 1.29 megabytes/s. The 5380 measures 7 by 19 by 22 in. In 100-unit quantities, the drives sell for \$4,320 each with delivery 30 to 60 days from receipt of order.

Kennedy Co., 1600 Shamrock Ave., Monrovia, Calif. 91016. Phone (213) 357-8831 [370]

Streaming tape drive backstops fixed media

The first in a family of streaming tape units is Control Data Corp.'s 92180 magnetic tape transport. Designed as a backup for medium-capacity fixed-disk drives and as a general-purpose tape transport for applications such as transaction data processing, the 92180 is a formatted, reel-to-reel transport that uses 1/2-in.-wide magnetic tape with a density of 1,600 b/in. Data is written in a nine-track phase-encoded format at a speed of 100 in./s in the streaming mode and 12.5 in./s in the start/stop mode. It uses a short 13-in. tape path with air bearings and distributed edge guides to control tape movement and for easy handling and threading. All guide rollers and mechanical tensioning arms have been eliminated from the design: only the head and a vacuum-assisted tape cleaner touch the tape's oxide surface. Its built-in diagnostics uses a two-digit display to read out the code numbers that tell the operator what is malfunctioning.

The 92180 magnetic tape transport is priced at \$2,760 in original-equipment-manufacturer quantities and production deliveries are due to start in the third quarter of this year. Control Data Corp., P. O. Box 0, Minneapolis, Minn. 55440. Phone (612) 853-4656 [368]

MCE THE EASY WAY TO YOUR OWN INTEGRATION

Your Full Service 4" IC House

SAVE IC DESIGN TIME AND COSTS WITH:

Uniray™

MCE's Universal semi-custom Array
(Mask programmable) IC concept

IF YOUR GOAL IS:

- PC Board Space Reduction Thru Higher Integration
- Low IC Design Cost
- Short IC Design Cycle
- Protection Against Design Being Copied by Competition
- Higher Reliability
- Tailored Packaging
- Complete IC Design Flexibility Including Changes
- Small to Large Production Quantities
- Computer-aided Design
- Your Own IC Design
- Semi-custom IC Design as an Easy Step to VLSI
- A Complete Set of IC Design Tools

THE Uniray™ CONCEPT IS FOR YOU!

MCE OFFERS A FULL COMPLEMENT OF Uniray™ DESIGN TOOLS:

- 21 Basic Semi-custom Arrays (Analog, Digital and Analog/Digital)
- Uniray™ Layout Worksheets for Easy IC Component Layout
- A Wide Selection of Uniray™ Kit Parts for Breadboarding and Evaluation
- UniDES (Universal Development and Evaluation System)
- UniDEL (Universal Design Library)

START YOUR Uniray™ AT ANY POINT IN YOUR DESIGN SEQUENCE.
CALL TODAY! CUSTOM IS OUR SERVICE, SERVICE IS OUR CUSTOM.

MCE  **MICRO-CIRCUIT**
ENGINEERING INC.

For U.S.A.

MCE
1111 Fairfield Drive
West Palm Beach
Florida 33407 U.S.A.
Telephone: (305) 845-2837
Telex: 513463 (MCE NPAB)

For International:

MCE
Pirckheimer Str. 124
D 8500 Nuernberg
Germany
Telephone: 0911-533993
Telex: 06-22748 (SVOLKD)

ASTRO-MED



New! AC-DC

DASH II RECORDER

- Take *anywhere* rugged design
- Rechargeable battery or line operate
- Position feed-back galvos . . . 99.5% accuracy
- DC — 125 Hz.
- Crisp, clear traces . . . low cost thermal paper
- Simple to operate . . . years of trouble free operation

This new Dash II may very well be the final word in portable/lab high speed recorders. With rechargeable batteries and built in charger, you can take it anywhere — land, sea or air, and use it for 4 to 5 hours. Then, you can continue to operate *while recharging* the batteries. Accuracy? The patented (U.S. #4,134,062) Pathfinder™ galvo is *position feedback* with better than 99.5% accuracy. High stylus pressure delivers crisp, clear traces on low cost thermal paper.



Get all the facts. Call or write



ASTRO-MED DIVISION
ATLAN-TOL INDUSTRIES, INC.
Atlan-tol Industrial Park/West Warwick, R.I. 02893
401-828-4000

Circle 220 on reader service card

New products

Packaging & production

Lasers mark wafers, DIPs

One system marks packages at 30,000/h; the other gives wafers unique codes

Two laser marking systems, one for marking silicon wafers and the other for integrated-circuit package marking, will be introduced at Semicon West by Lumonics Inc. The silicon wafer marker can give each a unique serial number; it uses characters selected from a spinning disk by a pulsed excimer gas laser. The package marking machine is intended for placing either belly brands or topside marks, giving the same code to each single or dual in-line package until the operator changes the code by

rearranging metal stencils.

The package marking system uses a pulsed carbon dioxide gas laser and has a stick-to-stick IC handler. Using a single pulse of light to produce a single multiple-character mark, it is very fast, marking at a rate of 30,000 packages per hour. Placement accuracy can be held to within ± 0.005 in., says the firm; the marks are very consistent. The system eliminates the setup and curing times associated with inking systems.

The wafer-marking system can code wafers at a rate of 600 per minute, producing solid-line characters that are very small (so as not to waste real estate) but easier to read than the dot-matrix characters produced by available laser wafer marking systems. Cratering and slag are also reduced, says Lumonics, cutting the potential for contamination of nearby devices on the wafer; penetration of the wafer is extremely shallow. Codes may be selected by a keyboard or via a computer link.

Pulses from the Lumonics-made excimer laser are 30 ns long at a single 308-nm wavelength; each pulse marks a single character. The beam has high uniformity over area. The system is easy to operate, requires little maintenance, and adapts without trouble to existing production-line equipment.

Lumonics claims its TE-290 pulsed excimer laser is suitable for other processing tasks and is engaged in a cooperative program with Mitel Semiconductor and the solid-state branch of Atomic Energy of Canada Ltd. to evaluate applications. An energy beam of about 1 j gives an interaction area of up to 1 cm², supplying energy densities typically needed for annealing dopant implantation damage. Other possible uses include annealing polysilicon to reduce resistivity, surface smoothing, backside gettering, and growing single-crystal silicon over oxide.

Lumonics Inc., 105 Schneider Rd., Kanata (Ottawa), Ontario, Canada K2K 1Y3 [391]

Burn-in tester exercises RAM

System can handle 18,000 memory chips and run 15 test patterns without an operator

As memory chips increase in density, the burden of testing them also increases. Thus more and more manufacturers may soon turn to burn-in test (BIT) systems as an economical way of ensuring quality and reliability. The process promises lower testing costs and decreased testing times by screening units during burn-in, and Reliability Inc. is coming to market with a system that not only does simultaneous burn-in and test but also places both processes under computer control.

Intercept, a BIT system capable of handling up to 18,000 memory devices at once, can be programmed to "automatically run 15 different test patterns without operator inter-

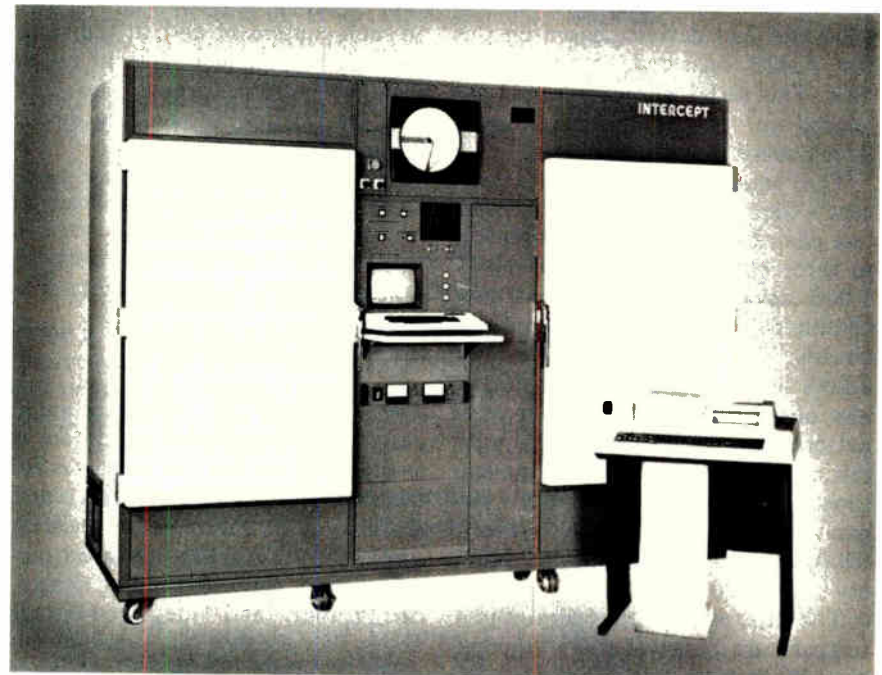

vention," says Joseph D. Lawrence Jr., engineering manager. The product uses a programming language the company terms "BIT-Basic" and an Intel 8080 microprocessor-based computer board to divide its burn-in

period into different test phases.

In each phase, the user has the option to program burn-in temperature, time, dc bias levels, and memory test patterns such as the Galpat and Galwrec N². The machine con-



ROEDERSTEIN specialized and worldwide in electronics

CAPACITORS

polyester, polycarbonate and polypropylene capacitors in foil/foil versions and metalized, aluminum-electrolyte capacitors, tantalum capacitors with liquid electrolyte, tantalum capacitors with solid semiconductor electrolyte, ceramic capacitors.

RESISTORS

carbon-film resistors, metal-film resistors, metal-oxide film resistors, precision wirewound resistors, potentiometers.

OTHER PRODUCTS

interference suppression devices, voltage multipliers, thick-film devices (thick-film hybrid circuits, resistor networks, high-valued resistors), semiconductors and micro-computer learning aids.

The range of application for ROEDERSTEIN components encompasses the whole entertainment electronics spectrum, household appliance and industrial electronics, communications, measuring and control, office equipment and computers, medical electronics, and the aerospace electronics sector. We can supply components that meet MIL, CECC and GfW specifications.

We will send you a condensed catalogue upon request. If you need specific information a detailed catalogue is available.

FIRMENGRUPPE ROEDERSTEIN

D-8300 LANDSHUT · FEDERAL REPUBLIC OF GERMANY · TELEX 0 58 335 (erola)

Software

Package brings Pascal to 8086

Cross compiler permits development of 8086 systems using PDP-11, ISO Pascal

A company developing microcomputer software typically has a mini-computer on site and is almost sure to have a microcomputer development system. If the development system is only slightly behind the state of the art, there is a software package from Intermetrics that could save users time and money.

Called PasPort, it is the first in a series of Pascal cross compilers that will permit software for a variety of microprocessors to be developed and pretested on timesharing minicomputers. It brings to bear the productivity advantage of a high-level language, the speed and power of mini-computer technology, and the division of programmer labor possible with timesharing. Software preparation is speeded without replacing what might otherwise be an outmoded development system.

The first release of PasPort supports the Intel 8086, uses the International Standards Organization's version of Pascal, and is designed for use on Digital Equipment Corp. PDP-11 minicomputers running under either Unix or DEC's RSX-11M operating system.

Intermetrics' basic approach is to develop, compile, and pretest software on a PDP-11, then transfer the software to a development system for final integration and test in a hardware environment. Ronald E. Kole, director of the company's Compiler Products division, says its approach is far more efficient and less costly than using available single-user systems for both software development and testing.

Kole notes that many older development systems support machine language only. This may have been

adequate for 8-bit microprocessors with their limited address space and consequently smaller average program size, but for 16-bit chips, for which larger programs will become common, the low-level language wastes time.

Kole says that as the 16-bit chips common today have entered use, software teams have become larger. He thinks PasPort can help offset this trend.

PasPort allows several programmers to work at the same time on parts of a single program, using the minicomputer's full complement of resources—file management, source control, and archives, plus high-capacity disks, high-speed printers, and other peripherals.

Programmers can use Pascal, share files and procedures, and reference stored programs or program modules left over from earlier work. Kole says these capabilities reduce both the number of programmers and the number of development systems needed for a project.

Internal affairs. With PasPort, microprocessor software can be interpreted in the host PDP-11 to trace program or logic errors, or compiled directly to produce a permanent, executable program on the host. At this point, it is possible to predict the success or failure of a programming effort before final integration and test on the development system, which, says Kole, can be brief.

PasPort also allows users to mix execution of Pascal programs in either interpretive or direct compilation modes and to interface either mode with assembler programs. Thus, users can select either for most efficient program storage or fastest execution, depending on need.

As another aid to efficiency, PasPort includes a profiler that keeps track of source line execution frequency. Also, the system produces notes of execution time for each source statement—useful data indicating which program paths have been tested, as well as which are most time-consuming and thus candidates for optimization.

Program transfer between the PDP-11 and the development system

usually takes place over an RS-232-C link. The software transferred can be in an intermediate form used by the host interpreter or in assembly source code. For program execution on the development system, PasPort supplies an 8086-resident run-time system for compiled Pascal programs, an 8086-resident interpreter for direct execution of PasPort's internal intermediate language format, and the ability to mix interpreted and direct (that is, machine language) execution modes in the same program.

The 8086 is only the first in what is expected to be a long list of PasPort-supported microprocessors. Intermetrics is taking aim at 16-bit chips first, but its general approach would appear to be useful for microprocessors using longer and shorter words as well.

The price is \$15,000; delivery is immediate.

Intermetrics Inc., 733 Concord Ave., Cambridge, Mass. 02136. Phone (617) 661-1840 [381]

Electronic mail, filing software runs on IBM machines

The InfoMail line of software for electronic mail and information management [*Electronics*, March 10, p.167], first introduced to service Digital Equipment Corp. VAX systems, can now also run on IBM equipment under the VM/CMS (Virtual Machine Conversational Monitor System) operating system at prices ranging from \$50,000 for the 4331 to \$70,000 for the 3033. In addition, users may now opt for InfoMail's new cursor-controlled display editor.

InfoMail is written in Ratfor, a structured high-level language that can be translated into Fortran, as has been done for the VAX version, and into PL/1, as for the IBM version. BBN offers InfoMail on its own C/70, a 20-bit minicomputer optimized to execute C code.

Bolt Beranek & Newman Inc., Information Management Corp., 68 Moulton St., Cambridge, Mass. 02238 [383]

NEW



1-SHOT IDC HARNESS TERMINATOR

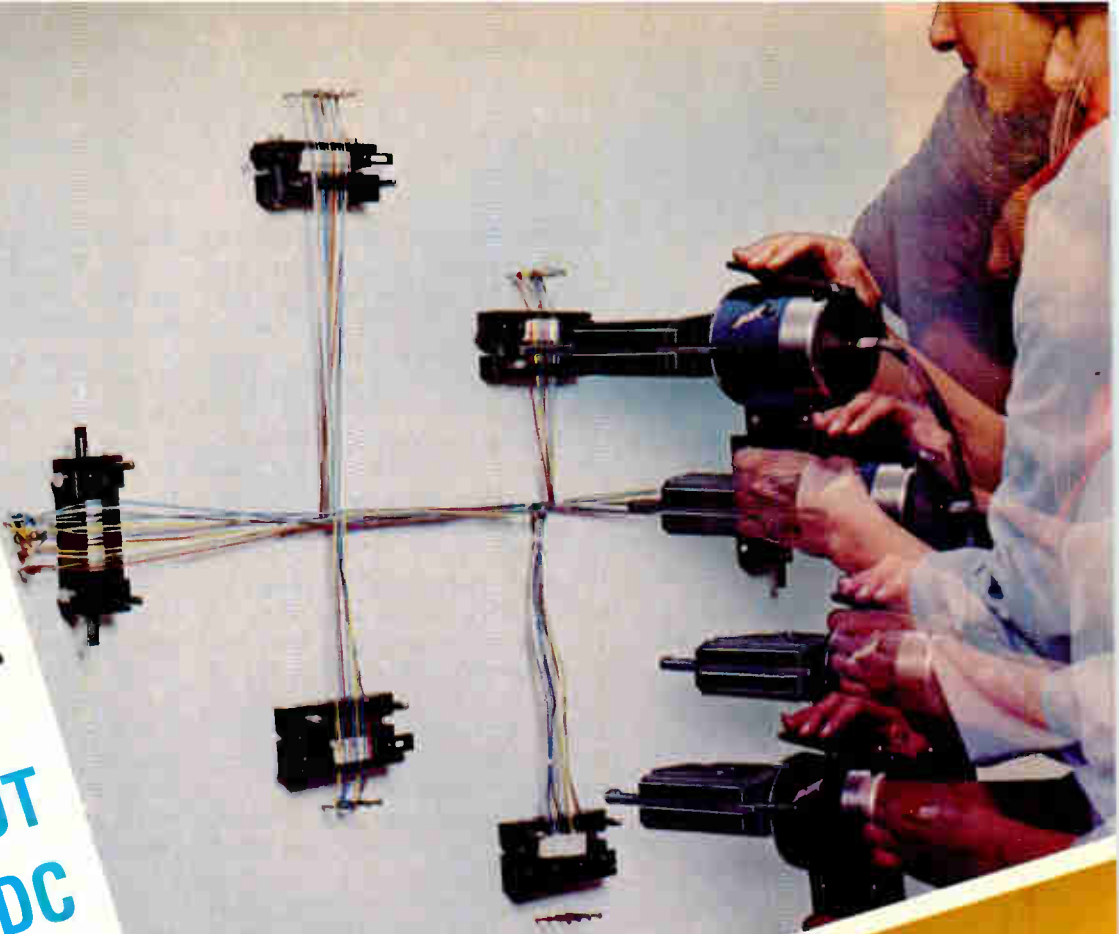

NEW JAGUAR IDC POWER CONNECTORS

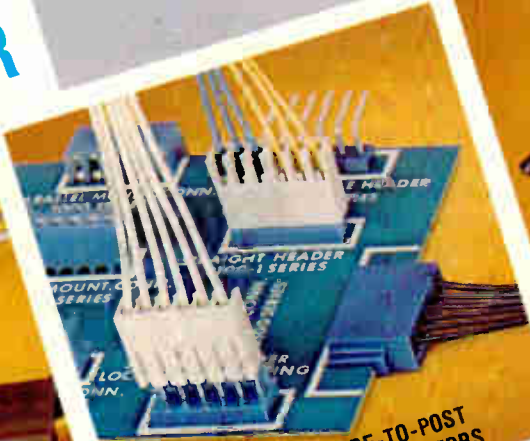

JAGUAR IDC WIRE-TO-POST
AND CARD EDGE CONNECTORS



JT-2 HAND GUN

One shot from our new Jaguar JT-2 hand gun automatically terminates 2 to 24 wires for super-fast harness construction. The air tool locks easily into IDC connector fixtures arranged to the harness shape . . . then trims and terminates the pre-positioned wires. This latest addition to our Jaguar interconnect system eliminates wire stripping, crimping and stuffing on small or large runs. The Jaguar system now has power connector and card edge configurations to provide mass termination IDC for all applications. Just circle the reader service number for details.



Methode Electronics, Inc.
INTERCONNECT PRODUCTS DIVISION
1700 Hick's Road
Rolling Meadows, IL 60008
(312) 392-3100 TWX: 910-887-0760



Products Newsletter

TI adds terminals using bubble memory

Texas Instruments Inc. is adding two more bubble-memory data terminals to its Silent 700 series: models 767 and 769. With the addition, the firm's Cypress, Texas, terminals and peripherals operation now offers 10 series members, four with bubble memory. **The new models are the first TI products to use the 3780 protocol**, which allows them to communicate with a number of other computer systems such as those manufactured by IBM Corp. The 767 and 769 will cost \$3,995 and \$4,295, respectively, in single quantities. The 767 will be available this summer; the 769, in the final quarter of the year. Both have data-entry validation for markets requiring error-checking capabilities and intelligent data-entry functions.

National starts turning out 800s

National Semiconductor Corp. of Santa Clara, Calif., has begun volume production of its NSC800 family of microprocessors and support circuits, manufactured with the firm's proprietary double-polysilicon complementary-MOS (P²C-MOS) process. **The NSC800 combines high performance with extremely low power requirements**—the central processing unit dissipates only 50 mW at 5 v when operating at 2.5 MHz—and executes the Z80 instruction set. The family includes the 2.5-MHz system-clock version, the NSC800, and two slower versions, the NSC800-2 (2 MHz) and the NSC800-1 (1 MHz). In 100-unit quantities, they cost \$134, \$114, and \$87 apiece, respectively. Delivery is from stock to eight weeks. Meanwhile, to complement this low-power family, National has also begun volume production on several new small- and medium-scale integrated devices, designated the MM74PCXX/82CXX series. Also fabricated with the P²C-MOS process, they dissipate microwatts of power while approaching low-power Schottky speeds.

12-bit C-MOS converter sports FIFO buffer

A 12-bit complementary-MOS digital-to-analog converter due soon from Analog Devices Inc. of Norwood, Mass., is said to be **the first to include an on-chip first-in, first-out buffer memory**. The AD7544 will interface directly with 16-bit microprocessors; its 12-bit-wide, 6-word-deep FIFO stack will accept data in parallel bursts, freeing the central processing unit for other tasks and protecting the converter from momentary CPU outages in process control applications. The device also is aimed at graphics applications, as well as uses in complex waveform generators and automatic test equipment. The 100-unit price should be between \$19.50 and \$26 per unit.

Price changes

- **National Semiconductor Corp. of Santa Clara, Calif.**, has reduced prices 22% on 15 of its medium-sized programmable array logic devices. Included are the DMPAL16L8, R8, R6, and R4. In addition, **the firm is now shipping samples of nine of its small versions of the PAL family**, which include both AND-OR and AND-OR-invert logic structures—the DMPAL10L8, 12L6, 14L4, 16L2, 10H8, 12H6, 14H4, 16H2, and 16C1. Currently, only commercial devices are available, at \$12 each in 100-piece lots, with military parts scheduled for midyear.
- **Datamedia Corp. of Pennsauken, N. J.**, has cut prices an average of 23% on single units of its entire series of terminals compatible with DEC's VT-100. **Affected are the models DT 80/1, 5, and 8**. The new prices range from \$1,695 to \$2,240.

“Nearly half of our subscribers are unduplicated. That’s impressive. But the other half is equally impressive.”

says our research director, Margery Sholes.

“We have approximately 47,500 paid subscribers who don’t read any of the other magazines in the field. But the interesting thing to me is that the other 48,800 subscribers, who receive one or more of the free magazines, continue to find it necessary to pay to read Electronics.”

Each of those 48,000 subscribers has the chance to compare Electronics with the free magazines received. Why do they keep on paying to read Electronics? The answer has to be our exclusive editorial. We have to provide information that



isn’t available anywhere else. Margery Sholes’ research helps us deliver on that objective.

“When we conduct our profile studies, we also get input from our readers on the type of editorial they need and expect from Electronics. We even ask our readers what specific subjects they’d like our editors to cover. This information helps us stay on target, providing the only magazine in the field worth paying for.”

Exclusively yours,

Margery D. Sholes



Exclusively yours,

Electronics Magazine

Educators flunk on innovation

■ The demand for apprentice engineers is high, and the schools are turning out more graduates to fill that growing need. But there may be a price to pay in terms of the quality of education these graduates are receiving and what they can expect from their careers.

According to the National Center for Educational Statistics, the estimated number of BSEE degrees awarded in 1979 was 12,890. There were 3,590 MS and 490 Ph.D. graduates the same year, for a total of 16,970, a 10.4% increase over 1978. However, while the number of BS degrees has been increasing sharply since 1977, the number of MS and Ph.D. degrees granted has been declining. This decline has been noted as a result of high starting salaries for new graduates. The trend also indicates that fewer EEs are entering academia.

The potential decline in academically trained educators, however, is not the only problem affecting EE education. According to M. E. Van Valkenburg, professor of electrical engineering at the University of Illinois in Urbana, "one negative to be faced is the growing reluctance of faculty to experiment, to offer new and different courses, and to change from what has become routine."

Van Valkenburg's observation is backed by a long career as an engineering educator at Massachusetts Institute of Technology, the University of Utah, and Princeton University. He also is a representative on the board of directors of the Accreditation Board for Engineering and Technology—the successor organization to the Engineer's Council for Professional Development—which is responsible for rating engineering curricula. As a result, he gets a good look at schools around the country. Although he is not happy with the decline in educational innovation, he notes that curriculum decertification is rare because programs never deteriorate that badly.

Part of the reason for the reluctance of faculty to experiment is a lack of motivation. Many reason

that all of their students are getting jobs, so why rock the boat? But Van Valkenburg points out, "many students claim that many old courses need revision and new technologies are not adequately covered. One of the reasons for this is the lead time needed to develop textbooks. In America, textbooks are almost a requirement for offering an undergraduate course," he notes.

Van Valkenburg says that increased faculty workloads are another factor in their reluctance to experiment. The increase is due to committee work, class size, and additional work educators must devote to research and making ends meet in an inflation-driven economy. Nevertheless, students complain that certain faculty members cannot be reached except when they are in class—often no more than 15 hours a week.

Other problems. There is also the problem of whether the student has learned the right material for today's technology. "The conflict between basic and applied work has been with us for 20 years or more," says Van Valkenburg. "But things are moving faster today," he is quick to add. "There is the digital revolution—integrated circuits, large-scale integration, and satellite communications among others. There are far

more demands than ever between the basic courses and the keep-up-to-date courses."

There is also the question of specialization. Some schools, according to Van Valkenburg, turn out nothing but "bit freaks," as they are known. Their knowledge of communications technology, analog and microwave techniques, and practical nondigital hardware is meager. One engineering manager said he had seen new grads who had no idea how to bias a discrete transistor on a breadboard.

What can be done about allocating course offerings? It is a difficult problem, Van Valkenburg notes. When all the courses required for engineering science and engineering design majors are taken into account, there remains little room in the student's schedule for electives. Some departments even usurp that space.

That means that some current high-technology material is not covered. Thus, for example, though "progress has been made in incorporating computers into the curriculum, microprocessor and very large-scale integration technologies have a long way to go" he says. "Offerings in the communications field and knowledge of statistics, probability, and the characteristics of the frequency spectrum leave much to be desired."

-Harvey J. Hindin

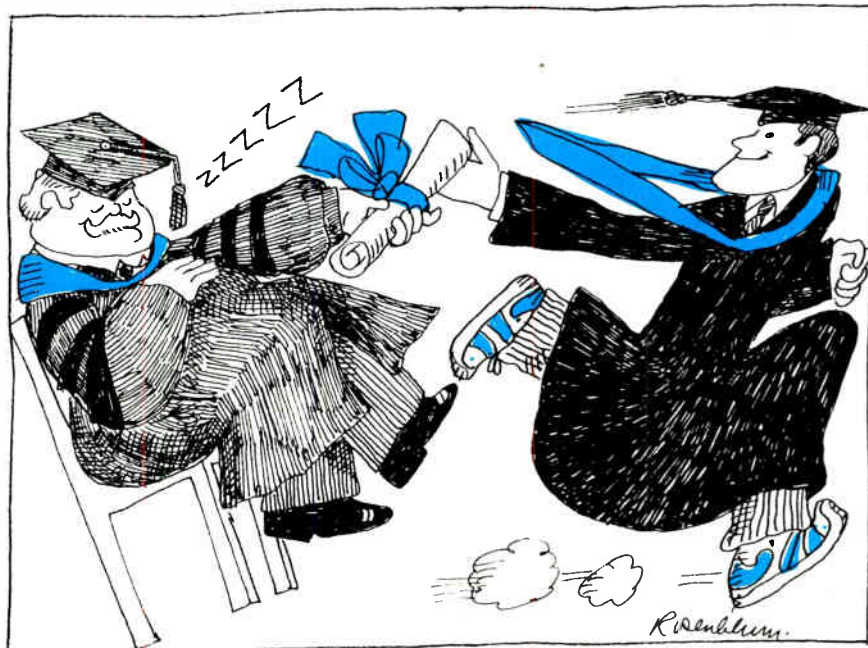

NORTHERN CALIFORNIA

The 'Good Life' for Engineers

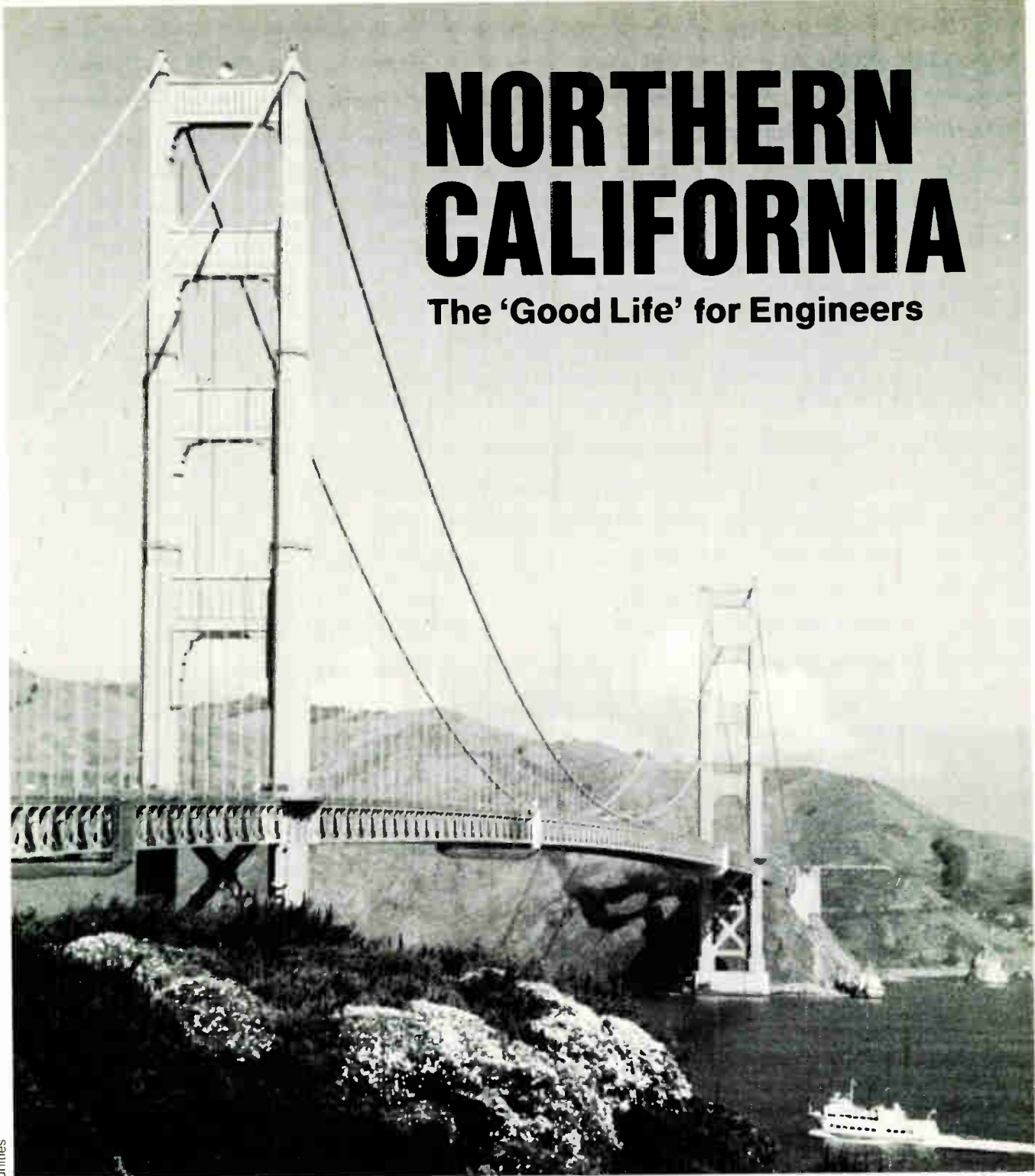

Advertisorial/Northern California Career Opportunities

High-technology engineers searching for the "good life" need look no farther than Northern California. Challenging jobs accompanied by high salaries are only part of the attraction. A relaxed lifestyle and a climate where snow is only found in nearby mountains also make the lure almost irresistible.

At last count, California's

electronics industry alone employed over 400,000 persons, with by far the largest percentage in the Santa Clara County/San Jose area, also known as "Silicon Valley." Along that 10-mile by 25-mile strip of land stretching along San Francisco Bay, and starting 45 miles south of San Francisco, hundreds of the nation's high-technology companies are

aggressively recruiting engineers from all disciplines. The heaviest emphasis is on electrical/electronics, computer science, data communications and aero-astronautical specializations.

In 1980, for instance, experts estimated that over 18,000 EE's were employed in Silicon Valley, with another 800 or so engineers working in the aerospace industry. By 1985, these

employment demographers project that more than 22,200 EE's will be employed in the area—more than 4,000 new jobs with rapidly expanding high-tech companies. Median family income in the San Jose area will reach \$34,000 in 1981, "the largest in the state," according to the United California Bank.

"When it comes to jobs for engineers it's a dream situation," comments the recruitment manager of a computing equipment company. A favorite story, only partly apocryphal, has it that engineers have been known to show up for work on Friday morning, receive an enticing offer from a rival firm down the street that afternoon, and report to a new job the following Monday.

Competition for engineers is so fierce, in fact, that some companies have taken to offering sign-up bonuses to new employees and such perks as three-day work weeks and attractive relocation benefits, which include everything from professional help locating housing to job-finding assistance for the new employee's spouse. Bonuses to employees who bring new engineers into a firm also are not uncommon.

The lure of well-paying jobs and the enticing California lifestyle has brought a squeeze in the availability of apartments and condominiums in Silicon Valley, and sent up the prices of homes to an average \$115,000.

There is assistance in a number of ways, though. Some companies compensate new employees for higher housing costs with "mortgage interest differential" payments. They work in this manner: If the interest rate on the engineer's old house, is, say, 8% and the new rate is 14%, a company might make up the 6% difference for three years, either based on the old mortgage balance or the new one. Home-finding counselors often sit down with new employees to help them work out their housing problems, sometimes taking over selling their old houses as well as locating new housing.

Another development: some high-technology firms are expanding elsewhere in Northern California. Several have chosen the Sacramento/Roseville area, about a two-hour drive north and west of Silicon Valley, and have begun building satellite manufacturing and R&D facilities there. Sacramento-area officials, by and large delighted, are

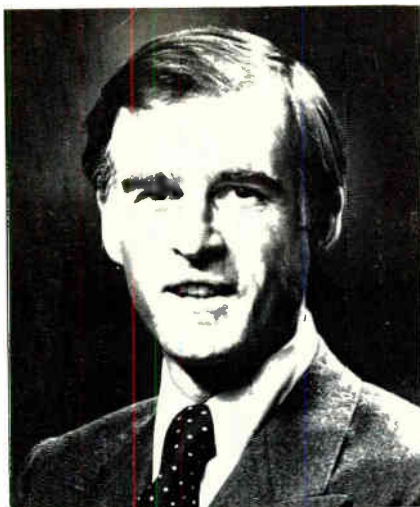

Governor Jerry Brown has proposed a \$12.6-million program to encourage engineers to train and work in California.

mapping plans "to pattern our community for a measured transition in growth." At last count, seven major high-tech companies and 15 smaller computer-oriented firms have built or are planning facilities in the state-capital region. The number of EE's employed in the three-county Sacramento/Roseville area is expected to jump from 1,600 in 1980 to well over 2,300 by 1985.

Land is available for building homes and businesses, housing is affordable (\$69,500 for an average home) and condominiums and multiple housing units are under construction or in the blueprint stage.

It could well be that the next decade will see more and more high-tech companies recruiting engineers to work north of Silicon Valley.

Wherever an engineer chooses to live and work in Northern California, the attractions are varied and in many cases unique. There's everything from small but delightful pleasures like riding San Francisco's cable cars for a modest 50¢ to elegant dining at Fisherman's Wharf; from skiing at Squaw Valley to backpacking in Yosemite National Park; from superlative sailing on San Francisco Bay to deep-sea fishing in the Pacific.

Cultural activities are also in abundance. The new San Francisco opera house, the San Jose center for the performing arts and Sacramento's famed Crocker art museum are only a sampling.

California boasts one of the nation's finest public educational systems and some of the finest private schools. The northern part of the state has an

impressive share. For engineers interested in continuing their education, many times paid for by their companies, there are such famed institutions as Stanford in Palo Alto and Cal State in Sacramento, two among many with programs tailored to meet their needs.

Education of engineers—present and future—is of prime concern to California Governor Jerry Brown, who recently proposed a two-part "Investment in Technology" program to the state legislature. It is designed to promote the continued growth of high-tech industries in the state. The aim of the program is to upgrade the educational opportunities for engineers "since it has been our experience engineers tend to locate in California when they are trained here," according to the governor. Training and retaining engineers in the state would thus encourage high-tech companies to locate and/or expand in California.

The first part of the governor's proposal would inject \$2.6-million into the University of California's engineering school budget, upgrading the already strong existing engineering facilities at Berkeley. A separate \$10-million matching grant fund would go for Microelectronic Innovations in Computer Research Operations (MICRO), a research program that would provide funds to any branch of the University of California for microelectronics study.

Recognizing that California is facing a "clear and present challenge as other states try to persuade companies to move outside California," Governor Brown's proposed program would go a long way toward maintaining California's lead in high-tech facilities and job opportunities.

Excellent salaries, challenging opportunities, an appealing lifestyle. All this and more is ready and waiting for you in Northern California.

If you are a recent graduate or a veteran engineer seeking an almost unlimited future, Northern California has much to offer. If you are an electrical/electronics, computer science, data communications or aerospace specialist, don't miss the advertisements on the following pages and elsewhere offering opportunities in the area. These are companies interested in you and your talents, now and in the future. —John Brand

BEGINNINGS

WITH NATIONAL SEMICONDUCTOR



If your new job is old hat, you didn't talk to National.

Maintaining leadership momentum in a highly competitive industry requires a continuing, objective review of the principles that have tempered that leadership position. So today's National Semiconductor is utilizing the knowledge and resources of the '80s with the same tomorrow-minded energy we started with years ago.

Each day at National begins with a powerful commitment to advanced technologies, new products and greater opportunities.

When you think 'semiconductor,' chances are you think National. As one of the world's largest manufacturers of semiconductor products, we offer the broadest product line in the industry. And that product line is growing faster than that of any other semiconductor manufacturer in the world. But today, National is much more than a well-known name in semiconductors.

For example, since the start of our Systems Division in 1972, we've created a fast-track edge in state-of-the-art systems development at every level of integration—from components and boards to advanced computer systems and development tools. Over the past 10 years, National has led information processing in eliminating ineffective, outdated MIS systems and has developed advanced systems for a faster-

paced industry. And in less than a year, engineering computing at National has grown 5-fold, reflecting our drive to position Computer-Aided Design at the leading edge of technology.

National's record sales last year approached the \$1 billion mark. And a sizable chunk of that went right back into Research & Development, with 1980 expenditures of \$80.19 million representing a 31.8% average yearly increase since 1974. That, of course, reflects our commitment to provide talented people with the resources they need to maintain technological momentum as well as on-going career challenge.

If your career direction is losing the vitality it used to have, begin the excitement again with National. Our hats are off to talented, aggressive engineers and other professionals looking for exceptional career opportunities at all levels of Semiconductor Design, Systems Development, Microcomputer Systems Design, Digital Logic Test, CAD/CAM, Reliability, Manufacturing, Mechanical & Industrial Engineering, Finance, Marketing, MIS and more.

Please send your résumé, in complete confidence, to Professional Staffing and Placement, National Semiconductor, Department 1-70-367, P.O. Box 60879, Sunnyvale, CA 94088. An affirmative action employer.

 **National
Semiconductor**

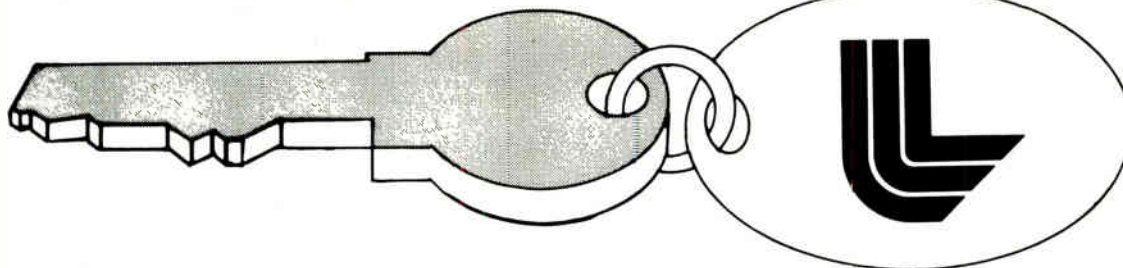

The Key To Professional Development Is High Technology

The Lawrence Livermore National Laboratory is an applied science R&D facility operated by the University of California for the U.S. Department of Energy, and is located in the San Francisco Bay Area. We have approximately 7,300 employees and are engaged in basic and applied research and development. Major programs at Livermore include National Defense R&D, Magnetic Fusion Energy, Laser Fusion, Laser Isotope Separation, Biomedical and Environmental Research and Energy and Resources Research.

ELECTRONICS ENGINEERS

Experience The Challenge Of Multi-Disciplinary R&D Teams

Computer Systems and Software Engineers

You will design and implement mini and micro-computer based systems for application in a variety of R&D areas. Typical applications include command, control and monitor of sophisticated test systems, computer network and inter-computer communication systems, data acquisition systems, machine tool control, measurement and characterization of machined surfaces and optical components of extreme preciseness, and data base management systems. Positions involve familiarity with DEC PDP-11 family of computers (LSI-11 thru VAX-11/780), high level (BASIC, FORTRAN, PASCAL) and assembly languages, digital logic system design and control system design. BS/MS in Electronics Engineering/Computer Science is required, with applicable experience preferred.

Design/Instrumentation Engineers

Engineers in these positions will develop and field a variety of analog and digital data acquisition, signal processing, and data transmission systems for high speed transient data. The systems may employ high speed integrated circuits, digitizers, microprocessors, fiber-optic data links and electro-optic sensors, and involve extensive control systems. BS/MS with applicable experience preferred.

- Extensive equipment, technical personnel and facilities support
- On-site advanced degree programs
- Competitive salaries

Electronic Project Engineers

Require senior engineers working directly as a part of a management team. The successful candidates will develop experience critical for future leadership positions while working closely with other engineers and scientists as a group responsible for all activities involved in field testing nuclear explosives. Positions require management and supervisory skill, familiarity with high-speed data acquisition systems, computerized command, control, and data transmission systems. Good communication skills are required. BS/MS in Electronics Engineering preferred, with applicable experience.

Pulse-Power/ Power-Conditioning Engineers

Engineers in these positions will design and develop high speed, high power systems and associated instrumentation for a major high-current linear accelerator project. The work will involve Marx generators, large capacitor banks, high-speed switching networks, magnetics, and sophisticated diagnostics systems. An MS in Electronics Engineering and applicable experience with high voltage pulse and/or charging systems is preferred; outstanding BS candidates will be considered.

- Three weeks' vacation
- Quick access to San Francisco Bay Area, ocean, mountains
- Informal work environment

Resumes may be sent in strict confidence to George Kumparak, Professional Employment Division, LAWRENCE LIVERMORE NATIONAL LABORATORY, P.O. Box 808, Dept. KET-051, Livermore, CA 94550. Or call Ed Lafranchi, Department Head, collect (415) 422-8373 for more information.

We are an equal opportunity employer m/f. U.S. citizenship required.

University of California

**Lawrence Livermore
National Laboratory**

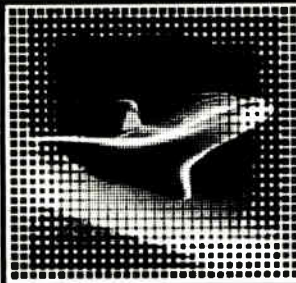

ENGINEERING & COMPUTER SCIENCE PROFESSIONALS

As the technological leader in the Santa Clara Valley . . .

Lockheed Missiles and Space Company has helped build many individual careers over the years by consistently providing outstanding professional and personal growth opportunities for our employees.

With us, you have a wider selection of interesting projects and challenging assignments. You have all the educational advantages offered in the Santa Clara Valley PLUS our extensive in-house educational programs (including the closed circuit television network from Stanford University!). And you have the advantage of working with the finest professionals in the industry.

If your background or interests are in these areas, we know we can offer you a world of opportunities you won't find anywhere else:

Systems Engineers
Microwave Engineers
Software Engineers
Systems Programmers
Reliability Engineers

RF Engineers
Systems Test Engineers
Digital Design Engineers
Manufacturing Engineers
Plus many others

For immediate consideration, or when you're ready to make a move, send your resume to: Professional Employment, Dept. 524-0684, P.O. Box 504, Sunnyvale, CA 94086. We are an equal opportunity affirmative action employer. Proof of U.S. Citizenship is required.

At Lockheed, technical excellence is a way of life.

 **Lockheed**
Missiles & Space Company

In sonics or phonics, why ELECTRONICS?

Because in these and hundreds of other fields, electronics applications are taking over. If your firm is looking for smart new electronics engineering graduates, you'll find them—and all other technical disciplines—through McGraw-Hill's **Graduating Engineer**.

Graduating Engineer is editorially planned to serve the career needs of soon-to-graduate engineers in civil, chemical, nuclear, industrial, electrical/electronic, aeronautical, mechanical, mining and petroleum fields, and computer sciences. Complimentary, all-request circulation puts your recruitment advertising

before a *guaranteed* 75,000 senior level engineering students in every major engineering school in the U.S.—over 500 institutions in all!

And a unique student resume forwarding plan, at no charge, supplies basic personnel information, as well as putting advertisers in touch with graduating engineers interested in *their* companies.

For full information on **Graduating Engineer**, call or write the Classified Representative at your nearest McGraw-Hill Regional Office. Or contact our telephone salesperson at (212) 997-2556.

GRADUATING ENGINEER

McGraw-Hill Publications Company, 1221 Avenue of the Americas, New York, N.Y. 10020





Would you hire an engineer who couldn't understand this magazine?

Of course not. ELECTRONICS is the technical publication for technical people. If they can't understand it, they can't receive it. That's why, when you're looking for qualified engineers, you should consider our Classified Section.

For only \$87.00 per inch your recruitment advertising will reach 90,000 pre-screened electronics engineers—as they're reading to combat job obsolescence, while they're thinking about their future and bettering themselves.

There's no charge for typesetting and free layout service is provided.

For more information call or write:

ELECTRONICS

Post Office Box 900
New York, N.Y. 10020
Phone: 212/997-2556

We want engineers who want to do engineering.

There's a lot of engineering to be done in both our Semiconductor and Systems groups. New technologies are stretching our minds. New products in telecommunications and industrial controls are stretching our people—our main resource—to the limit. We're growing fast, and need engineers who love engineering and want to grow with their discipline. You *can* at Intersil.

We pay well. We work hard, but in an informal atmosphere. Doors—and minds—are open. You can grow

at your own speed and in your own direction. Up the ladder into management or up the engineering ladder toward Staff Scientist, if you want to continue to do engineering.

Which we assume you do, since you've read this far.

Now: Action! Call one of our engineers who helps in personnel: (408) 996-5069. The current challenges are listed below. We're headquartered in Silicon Valley at 10710 N. Tantau, Cupertino, CA 95014.

Technology assignments open:

SENIOR DESIGN ENGINEERS

Microprocessors and Memory Devices

Senior Level Engineering responsibilities for the design and development of microprocessors, peripheral circuits, and memories using advanced CMOS and NMOS LSI technology.

BS/MSEE or BS/MSCS and three or more years experience.

SOFTWARE ENGINEERS

BS/MSEE, BS/MSCS or Math with one to three years experience in design, implementation, testing or maintenance of software for large, mini and microcomputers. We have projects ranging from systems programming to applications, particularly in communications.

The future's in process at

INTERASIL

ADVERTISERS

Send all new copy, film or changes to:

ELECTRONICS CLASSIFIED
ADVERTISING CENTER
POST OFFICE BOX 900
NEW YORK, NY 10020

1,000,000 TRANSISTORS ON A CHIP— AUTOMATICALLY

The opportunities are here.

The Integrated Circuit Laboratory of the Xerox Palo Alto Research Centers is making major contributions in advancing the state-of-the-art in VLSI technology. Our plans to couple VLSI technology development with the research programs in our computer, systems and materials laboratories provide a unique, ground floor opportunity to participate in fast interactive development of the technologies that will be applied to new systems concepts. We have the applications which require the use of one million transistors on a chip—and we need key contributors to assist in development of technologies that will be applied to Xerox Systems products.



The careers are here.

If you've been looking to make a more meaningful contribution to advanced technology, we'd like to talk to you about a career with Xerox. We're looking for creative individuals experienced in one or more of the following areas associated with advanced integrated circuit technologies:

- Characterization and operation of the latest processing equipment.
- Advanced development of NMOS/CMOS with dry processing, DSW, and new interconnect techniques.
- Circuit form evaluations, device design and simulation, and automated process characterization.

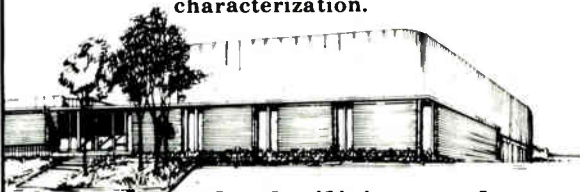

The facilities are here.

We are in the process of moving into our new, ultra-modern VLSI Laboratory. We can offer you a challenging research environment with attractive working conditions within our new lab in the Stanford Industrial Park located on the beautiful San Francisco Peninsula. The Xerox benefits package is of course one of the best in the industry and includes profit sharing and tuition aid, and you'll find our salaries very competitive.

Please send salary history and résumé to: Keith Clayton, Xerox Corporation, 3333 Coyote Hill Road, Palo Alto, CA 94304; (415) 494-4082.

An affirmative action employer.

XEROX

WHERE

DO YOU

FIT?

In today's job market, that is. One way to see if you're in demand is to check the employment opportunities contained in ELECTRONICS' Classified Section.

Another way to get a reading on your value is to place a blind (box number) Position Wanted ad there. The cost is low (only \$1.98 per line) and the results are often rewarding.

For more information call or write:

ELECTRONICS
Post Office Box 900
New York, N.Y. 10020
Phone: 212/997-3308

What will
intel put on a
chip next?

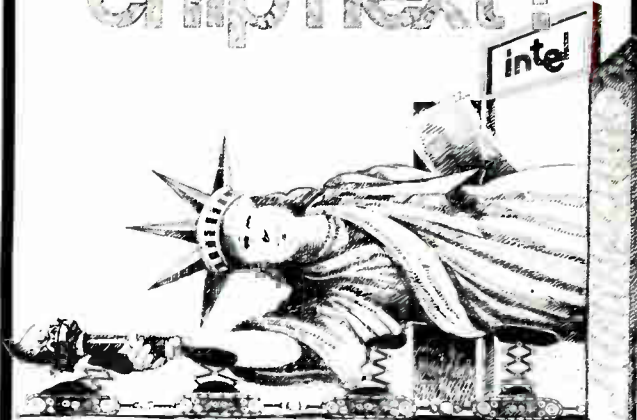

You can be sure it will be a bold and dramatic advance. At Intel, exciting ideas...new technological developments...programs of industry staggering magnitude...are a constant. In memories and microprocessors, we've created new industries and changed the way existing ones work. And our goals for the 80's are even more startling.

From our top-down matrix management structure to being supported by superior resources in terms of facilities, equipment and personnel... we're prepared to make a bold and dramatic impact on your career! The following are just a few of the management and engineering areas in which you can contribute:

- Application Engineering
- Software Development Engineering
- Product Marketing Engineering
- Diagnostic Programming
- Systems Hardware Development Engineering
- Product Engineering
- Test Engineering
- Project Management

Let's get together and talk; the least you can expect is a mind boggling view of what an aggressive high technology company can do when it has the freedom to venture beyond existing limits. Please send a letter or resume to:

Employment Department
2625 Walsh Avenue, SC4-211
Santa Clara, CA 95051

An equal opportunity employer m/f/h.

intel
WE ARE
THE FUTURE!

**CONTROLS AND INSTRUMENTATION
ENGINEERS AND DESIGNERS**

A top 100 E/A firm has immediate openings available in our control and instrumentation area for qualified and experienced Engineers and Designers. Applicants must be proficient in the selection and design of pneumatic and electronic instrumentation, and magnetic and solid state logic systems. Working knowledge and use of programmable controllers, micro processors, and computer process control systems would be extremely helpful. Our fast paced organization offers outstanding growth opportunities and advancement potential for those self-starting dedicated professionals interested in broadening their work experience. For interview appointment please submit resume and salary history in confidence to:

Director of Personnel
Samborn, Steketee, Otis & Evans, Inc.
1001 Madison Avenue
Toledo, Ohio 43624

An Equal Opportunity Employer M/F

Samborn
Steketee
Otis &
Evans Inc.

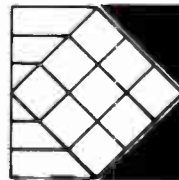

**ELECTRONIC ENGINEERS
WHERE DO YOU WANT TO LIVE?**

RCI is a search firm that assists high technology companies throughout the country in filling their technical employment needs. The following is a list of only some of the more critical types of individuals that some of our clients are seeking, as well as the geographic location of the position.

Microwave Engineers (Radar & EW)—FL, MD, TX, AZ, CA, CO, NJ

RF Communications Engineers—MD, IN, FL

Digital/Micro Processor Design—MA, MD, FL, CA, MN, CO, AZ, IN, NC, VA

Electro-Optics Engineers (Laser, IR)—MA, FL, CA, MN, TX

ATE—MA, NM, NY, CA, MN, IA, FL, NC

Real Time Software Development Engineers—
You tell us where you want to go

If you are interested in pursuing any of the above positions, send a resume or call collect.

Tony Ray

REGIONAL CONSULTANTS, INC.
Since 1969

213 West Ninth Street
Cincinnati, Ohio 45202

(513) 579-1513

NATIONWIDE TECHNICAL EXECUTIVE SEARCH

THE ADVANTAGES OF THE FUNCTIONAL GROUP:



Diversity of projects.
Varied technical challenge.

Involvement from concept through implementation.
Broad interaction and cooperation between software and hardware.

We've got it all at Harris Composition Systems in Melbourne, Florida.

We're pioneers in word processing. And the world's first and leading supplier of total word processing systems for use in the newspaper industry.

And we're now extending that "system-oriented" approach into the *office systems* field—integrating data processing, word processing,

electronic mail, advanced communications and networking. With an ambitious program representing the largest investment Harris Corporation has ever made to develop a new product.

That means the opportunity for personal participation and immediate contribution—across the board—in both newspaper word processing and office systems.

For experienced professionals with expertise in
 Real Time Software and Hardware/Firmware Development
 Digital Design
 Analog Design
 Applications Programming.

All supported by a billion dollar, Fortune 500 corporation. All in a modern, stimu-

lating work environment. All in beautiful, affordable Melbourne, Florida—on the shores of the deep blue Atlantic.

Send your resume and salary history to: **Daphne Cumberland, Composition Systems Division, Dept. EM, P.O. Box 2080, Melbourne, Florida 32901.** Or call COLLECT (305) 242-5321, in Florida. Outside Florida call 1-800-327-1493.

Share the advantages with us.

100% PURE OPPORTUNITY.



HARRIS
COMMUNICATION AND
INFORMATION PROCESSING

An Equal Opportunity Employer M/F/V/H.

Who will be first with the avionics of the 21st century?

It could be you and Hughes Radar Systems.

We pioneered pulse Doppler radar and built the first operational airborne programmable signal processor. Today, three out of the four front-line U.S. tactical aircraft have Hughes radars. We're leaders in synthetic aperture radar, in-weather reconnaissance and strike radar, high order language, antenna arrays and holographic displays. We're even building the rendezvous radar for the Space Shuttle.

And with computer-aided design, manufacturing, and testing of intelligent radar devices, the future is at Hughes.

In fact, Hughes is one of the nation's largest employers of electronic engineers and a major employer in virtually every other scientific, computer and technical discipline — with 1,500 projects and a backlog of over \$6 billion. Yet we're decentralized to give you the kinds of environments that stimulate innovation and promote recognition of your work.

Who will be first with the avionics of the future? It could be you and Hughes.

At Hughes Radar Systems, we'll introduce you to people, ideas and jobs that could change your world. And maybe ours.

Call (213) 647-4900, collect, or send resume to:

Engineering Employment
Hughes Radar Systems
P.O. Box 92426, Dept. E-5B
Los Angeles, CA 90009

Current openings:

Software Design/Analysis
Software Test Engineering
Systems Integration & Test
Computer-Aided Design &
Manufacturing
RF/Microwave Design
Digital Circuits Design & Test
Radar Systems Design
Large Scale Integration Design,
Development & Test
Production Process Engineering
Microprocessor Development/
Applications
Antenna Systems Design & Test
Reliability Engineering
Production Test Engineering
Industrial Engineering

It could be you and Hughes Radar Systems.

HUGHES

HUGHES AIRCRAFT COMPANY
RADAR SYSTEMS

Proof of U.S. Citizenship Required
Equal Opportunity Employer

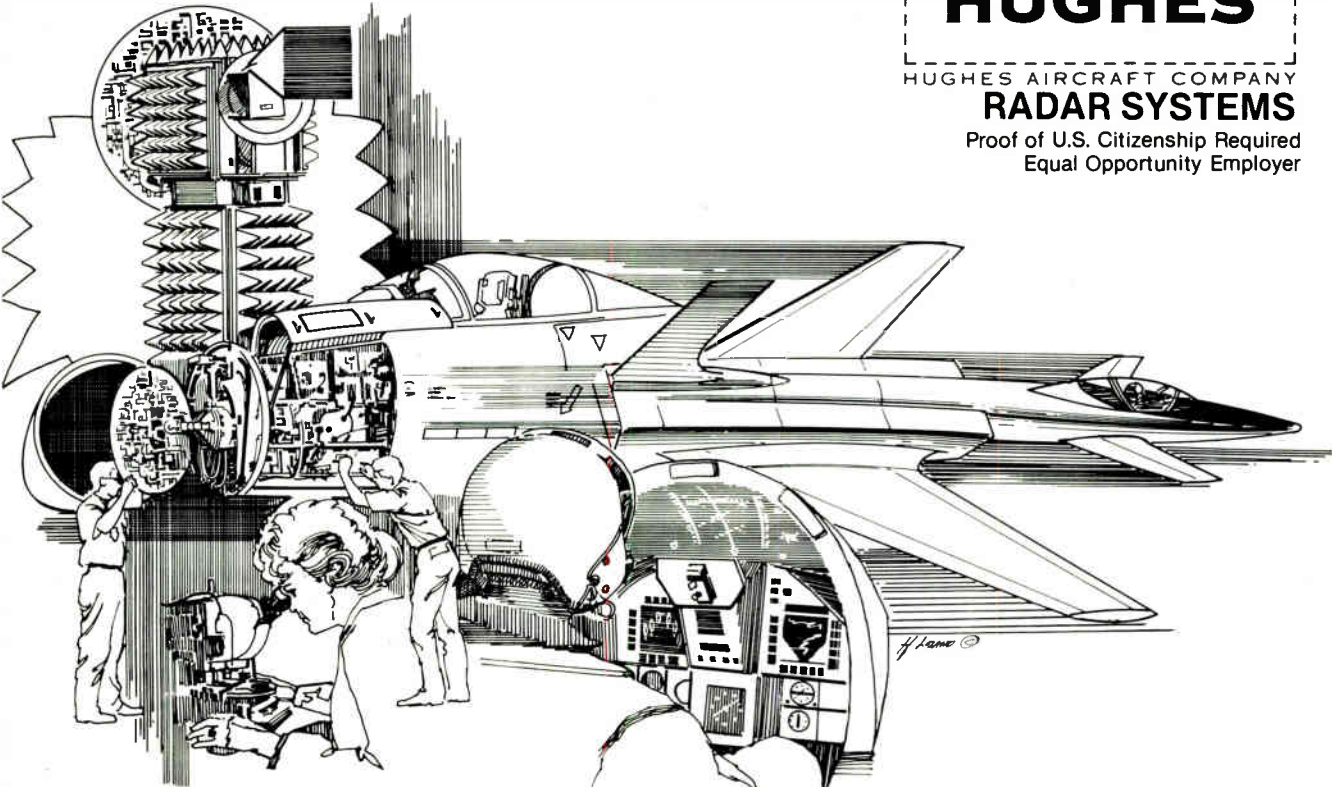

SOFTWARE ANALYSTS/ENGINEERS/TECHNICIANS/
TECHNICAL TRAINING SPECIALISTS

Move up by moving "Down Under."

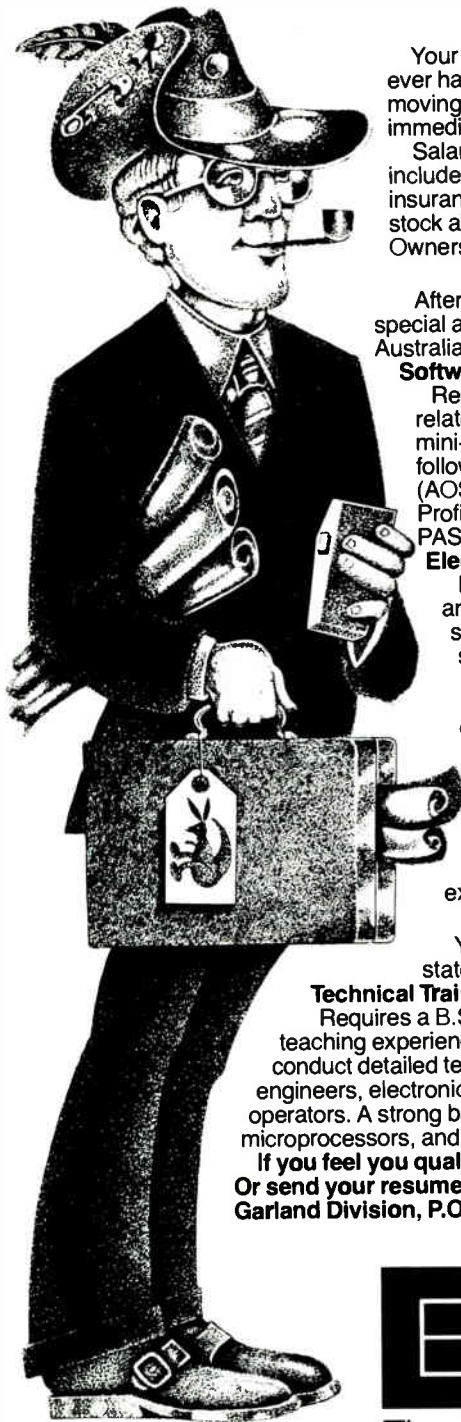

Your move to E-Systems will be the last move you'll ever have to make. We want to talk to you about moving your career to E-Systems ... and we have immediate assignments both in Australia and Dallas.

Salaries and allowances are excellent. Benefits include health, major medical, dental and life insurance programs. You'll also receive company stock at no cost through our Employee Stock Ownership Plan.

AUSTRALIA

After about one year of working to prepare for this special assignment, you and your family will travel to Australia for a seventeen-month tour.

Software Analysts

Requires a B.S. degree in Computer Science or related discipline and two or more years' mini-computer experience in one or more of the following systems: HP-21MX (RTE), DG-ECLIPSE (AOS, INFOS) and DEC-VAX 11/780 (VMS). Proficiency in Assembly Language, FORTRAN, or PASCAL is desirable.

Electronic Systems Maintenance Engineers

Requires a B.S.E.E. with three or more years of analog/digital circuit systems design, two years' systems equipment maintenance and hardware/software interface capability.

Senior Electronic Maintenance Technicians

Requires completion of a 2-year formal course or equivalent in electronic technology. Three years' current hands-on experience with a stable employment history in electronic R & D lab and/or electronic equipment maintenance and a thorough working knowledge of both analog and digital state-of-the-art circuitry. Current hands-on experience is a must.

DALLAS

You'll be working in a modern facility involved in state-of-the-art projects with top professionals.

Technical Training Specialists

Requires a B.S.E.E. or B.S.E.T. with a minimum of two years' teaching experience in Electronics. This individual will develop and conduct detailed technical and operational training courses for engineers, electronic technicians, and electronic equipment operators. A strong background in digital electronics, microprocessors, and electronic fundamentals desired.

If you feel you qualify, get in touch. Call COLLECT 214/272-0515. Or send your resume to: Professional Placement, E-Systems, Inc., Garland Division, P.O. Box 226118, Dept. AS29, Dallas, Texas 75266.



E-SYSTEMS

Garland Division

The problem solvers.

An equal opportunity employer M/F, H, V.
No agency calls please.

ENGINEERS

QC	Microprocessor
Analog	Digital
Hardware	Test
Software	Systems

INDUSTRIES

ATE	Tele/Data Communications
Controls	Defense Systems
Computers	Manufacturing
Satellite	Bio-Medical

Specialized Agency in Electronics looking for Engrs to work in CT, NY, NJ & PA. Salary increases in the range of 20% with all Fees Paid by Client Companies. Call or send resume for immed. consultation to: GILBERT LANE, 505 5th Ave, NYC 10017. Att: Robert D. Black, (212) 867-8100.

Engineers

• PROJECT • DESIGN
• DEVELOPMENT • EPD

\$20,000-\$50,000

Schneider, Hill & Spangler, Inc. is a specialist in the placement of electrical and electronic engineers throughout the USA. We offer advice on careers, resumes and interviews for a position that is right for you. Client companies assume all fees. For details call or send resume in strict confidence to William Jacobs, Consultant.

**Schneider
Hill &
Spangler, Inc.**



Western Savings Bank Building
Suite 710
Philadelphia, PA 19107
215-732-9550

POSITIONS VACANT

Engineers. All disciplines. EE/CS Entry to executive. Locations throughout U.S. All fee company paid. Send Resume to: F-O-R-T-U-N-E Personnel, Box 106, 3005 S. Michigan, South Bend, IN 46614, 219-291-7161.

Materials Scientist & Electromechanical Engineer. Positions open for MS or Ph.D.'s. Our company is engaged in the R&D of electrical components. Write to: Atadex Research 1081 Bristol Road, Mountainside, NJ 07092 Attn: Ray Klos.

Murkett Associates Qualified Reputable Management placement with national affiliates—fee paid. Box 527 Montgomery, AL 36101.

POSITIONS WANTED

BSEE, registered PE in Texas seeking challenging engineering management position with progressive company. 7 years experience with Bell Systems, extensive knowledge of data communications, telecommunication transmission engineering and micro processor application. Wish to remain in the Dallas, Texas area. PW-4192, Electronics.

Seek responsible challenging position in Europe. 18 years experience in micro computer / computer hardware/firmware/software / training / management. Fluent German. PW-4252, Electronics. Telephone 316 / 775-3348.

EMPLOYMENT SERVICES

Electronic engineering growth positions with clients located nationally. Our service is enhanced by the fact that I am an EE with 20 years in industry and over 10 years in placing professionals on an employer fee paid basis. Send your resume to Joe Torcassi, Director, J. Anthony & Associates, PO Drawer AD, Lynchburg, OH 45142. 513/364-2305.

• Adelys S.p.A.	193	Elographics, Inc.	202	Lifeboat	103
Advanced Micro Devices	10, 11	■ EMI Technology	62	Lumonics, Inc.	84
■ Alco Electronic Products (Sub. of Augat)	208	■ Entram Devices	5	Martin Marietta	223
American Microsystems, Inc.	47	■ Erie Technological Products	48	■ Memodyne Corporation	152
American Optical/Scientific Instruments	96	EVINCE INC.	147	• Memory Devices, Ltd.	45
• AMETEK INC.	14E	• FEME S.P.A.	203	□ Merak	88H
■ Amp Incorporated	18, 19	Ferranti Packard Ltd.	200	Method Electronics	228
Analog Devices	207	■ First Computer Corporation	15	Micro-Circuit Engineering, Inc.	219
Analytical Chemical Laboratories	184	John Fluke Mfg Co.	89	■ Micro Component Technology	194, 195
A.P. Products	85	Ford Aerospace	211	• Micropolis Corporation	190
Astro Med	220	GCA Corporation	117	Microsoft	169
‡ AVX	203	General Instrument Microelectronics	43	Minato Electronics, Inc.	7
Bausch & Lomb Scientific Optical Products	99	■ GenRad	90, 91	Mini-Circuits Laboratory	2
CEC Division/Bell & Howell Co.	107	Germanium Power Devices Co	70	‡ 3M Static Control Systems Department	68
‡ Bell Laboratories	190	Global Specialities Corporation	36	Mitel Corporation	100
Bishop Graphics	154	Gould Incorporated Electric Fuse Division	61	Mostek Corporation	27, 80
CalComp (Graphics)	109	• Gould Inc. Instrument Division	178, 179	• Murata Manufacturing Co., Ltd.	12E
Calma	120, 121	Gould Incorporated Instrument Div. SC Operations	30, 31	■ National Capacitor Supply Company	46
Cambion	87	■ Grayhill Incorporated	189	■ National Semiconductor	49-56, 113-116
• Cermatek	187	• GTE Microcircuits	199	National Semiconductor	234
■ Clairex Electronics	4th c	■ Hewlett Packard	1	□ Neohm	88D
Communications Transistor Corporation	118, 119	Houston Instrument	32	□ NEC-Italia	88E
Computer Products, Power Products Division	26	Inmos	78, 79	Neff Instrument Corporation	172
‡ Cortron Div. of Illinois Tool Works Inc.	182	Intel MSO	20, 21	Nippon Electric Company, Ltd.	22, 23
‡ Cts Corporation	199	Intel SPD	28, 29	Omron Electronics, Inc.	159
Data General	83	International Microcircuits Incorporated	41	■ Opto 22	3rd C
Data Instruments Inc	35	■ Iakra Commerce Marketing	175	‡ Panasonic	175
Data I/O Corporation	201	• ITT Capacitors	20E	Paratronics, Inc.	111
■ Data Translation	63	ITT Jennings	198	‡ P.E. Microcomputer	105
Decitek	57	• ITT Standard AG	182	Perkin-Elmer Semiconductor Operations	205
■ Delevan Division American Precision Industries	16	Japan Electric Measuring Instruments Mfrs.	154	• Philips Elcoma	18E, 19E
‡ Digital Equipment Corp. Microcomputer	180, 181	• Kyowa Electronic Products Co. Ltd.	186	■ Philips T&M	2E, 3E
■ Electronic Devices Incorporated	210	□ Lasi	88A	Pher International Corporation	13
■ Electronic Navigation Industries	6	■ Leader Instrument	180, 181	‡ Plessey Semiconductors	69

‡ Pro-Log	24A-B, 25	• Thomson CSF/DCM	1E
Precision Monolithics	122, 123	Thomson CSF/DSC	213, 215
Radiometer Electronics, U.S., Inc.	60	Thomson CSF/DTE	59
RCA Solid State	12, 58, 191	Trio-Tech International	209
Rockwell International	94, 95	‡ TRW Electric Components	186, 187
Ernst Roederstein GmbH	226	TRW/IRC Resistors	124
• Rohde & Schwarz	11E, 13E, 15E	US Instrument Rentals	108
‡ Rohm Corporation	193	U.S. Virgin Islands Industrial Devel Comm.	88
Schaffner	112	Unitronix Corporation	206
• Sfernice	4E, 5E	Universal Instruments	208
Shugart Associates	2nd C	University of California	206
• SIC/SAFCO	9E	• Vero Electronics Ltd.	67
• Siemens AG	6E, 16E	Virtual Systems, Inc.	154
‡ Siemens Corporation-Measurement Sys. Div.	45	Waters Manufacturing	202
Snap-on Tools Corporation	225	Watson Ind.	224
• Solartron Ltd. D.V.M. Division	197	■ Wavetek San Diego	64
Solid State Testing	200	Weckesser Company Incorporated	196
Spectra Strip	164	Western Digital	73
‡ Sprague Electric	67	Wilhelm Westermann	8
The Staver Co., Inc.	152	‡ Woven Electronics	197
Systems Engineering Labs	217	Xciton	86
Systron Donner	92, 93	Zendex Corporation	225
‡ Takeda Riken Industries Co. Ltd.	178, 179	■ Zeus Industrial Products, Inc.	210
Tandon Corporation	76, 77	Zilog	74, 75
Tanistor Electronics	107		
• TEAC Corporation	17E		
Tecknit (Technical Wire)	176, 177		
• Teledyne Philbrick	68		
■ Teledyne Relays	17		
Telesensory Systems, Inc.	87		
Tencor Instrument	149		
Texas Instruments Inc. (Digital Systems Div.)	9		
Texas Instruments Incorporated (Semiconductor)	185		
Textool Products/3M	14		

Classified and employment advertising

E-Systems, Garland Div.	242
Gilbert Lane	242
Harris Communication & Information Processing	240
Hughes Aircraft Co.	241
Intel	239
Intercil	237
Lawrence Livermore National Laboratory	235
Lockheed Missiles & Space Co.	236
Regional Consultants, Inc.	239
Samborn, Steketee, Otis & Evans Inc.	239
Schneider, Hills, Spangler	242
Xerox Corp.	238

- For more information of complete product line see advertisement in the latest Electronics Buyers Guide
- Advertisers in Electronics International
- ‡ Advertisers in Electronics domestic edition
- Advertisers in regional issue

Advertising Sales Staff

Advertising sales manager: Norman Rosen
3200 Wilshire Blvd., South Tower
Los Angeles Calif. 90010 [213] 487-1160

Market managers:

Components: William Boyle, Rochester, N.Y.
Computers & Peripherals: Frank Mitchell, Boston
Test & Measurement: Don Farris, San Francisco
Semiconductors: Norman Rosen, Los Angeles

Atlanta, Ga. 30309: Peter Stien
100 Colony Square, 1175 Peachtree St., N.E.
[404] 892-2868

Boston, Mass. 02118: Frank Mitchell
Paul F. McPherson, Jr.
607 Boylston St., [617] 262-1160

Cleveland, Ohio 44113: William J. Boyle
[716] 248-5620

Fort Lauderdale, Fla. 33306: Peter Stien
3000 N.E. 30th Place, Suite #400
[305] 563-9111

New York, N.Y. 10020

1221 Avenue of the Americas
John Gallie [212] 997-3616
Matthew T. Reseska [212] 997-3617

Philadelphia, Pa. 19102: Matthew T. Reseska
Three Parkway, [212] 997-3617

Pittsburgh, Pa. 15222: Matthew T. Reseska
4 Gateway Center, [212] 997-3617

Rochester, N.Y. 14534: William J. Boyle
Powder Mill Office Park, 1163 Pittsford-Victor Rd.,
Pittsford, N.Y. 14534 [716] 248-5620

Chicago, Ill. 60611

645 North Michigan Avenue
Jack Anderson [312] 751-3739
Robert M. Denmead [312] 751-3738

Southfield, Michigan 48075: Jack Anderson
4000 Town Center, Suite 770, Tower 2
[313] 352-9760

Dallas, Texas 75201: John J. Uphues
2001 Bryan Tower, Suite 1070
[214] 742-1747

Denver, Colo. 80203: Harry B. Doyle, Jr.
655 Broadway, Suite 325
[303] 825-6731

Houston, Texas 77040: John J. Uphues
7600 West Tidwell, Suite 500
[713] 462-0757

Los Angeles, Calif. 90010: Chuck Crowe
3200 Wilshire Blvd., South Tower
[213] 487-1160

Costa Mesa, Calif. 92626: Edward E. Callahan
3001 Red Hill Ave. Bldg. #1 Suite 222
[714] 557-6292

Palo Alto, Calif. 94303: Don Farris,
Larry Goldstein, Lauren Scott
1000 Elwell Court, [415] 968-0280

Paris: Michael Sales

17 Rue-Georges Bizet, 75116 Paris, France
Tel: 720-16-80

United Kingdom: Simon Smith
34 Dover Street, London W1
Tel: 01-493-1451

Scandinavia: Andrew Karnig and Assoc.
and Simon Smith
Kungsholmsgatan 10
112 27 Stockholm, Sweden

Tel: 08-5 1-68-70 Telex: 179-51

Milan: Ferruccio Silvera and A. Fabio Guarnieri
1 via Baracchini, Italy
Tel: 86-90-656

Brussels:

23 Chaussee de Wavre
Brussels 1040, Belgium
Tel: 513-73-95

Frankfurt/Main: Fritz Krusebecker
Liebigstrasse 27c, Germany
Tel: 72-01-81

Tokyo: Akio Saijo and Hirokazu Nakamura
McGraw-Hill Publications Overseas Corporation,
Kasumigaseki Building 2-5, 3-chome,
Kasumigaseki, Chiyoda-Ku, Tokyo, Japan
[581] 9811

Business Department

Thomas M. Egan
Production Director
[212] 997-3140

Carol Gallagher
Production Manager
[212] 997-2045

Betty Preis
Production Manager Domestic
[212] 997-2908

Thomas Kazich
Production Manager Related Products
[212] 997-2044

Karen Walpole
Production Assistant
[212] 997-2843

Frances Vallone
Reader Service Manager
[212] 997-6057

Electronics Buyers' Guide

H.T. Howland, General Manager
[212] 997-6642

Regina Hara, Directory Manager
[212] 997-2544

Classified and Employment Advertising

Gerry F. Moss, Manager
[212] 997-2897

Electronics Reader Service

For additional information on products advertised, new products or new literature, use these business reply cards.

Complete entire card.
Please print or type.

Circle the number on the Reader Service postcard that corresponds to the number at the bottom of the advertisement, new product item, or new literature in which you are interested.

To aid the manufacturer in filling your request, please answer the three questions.

All inquiries from outside the U.S. that cannot reach Electronics before the expiration date noted on the Reader Service postcard must be mailed directly to the manufacturer. The manufacturer assumes all responsibilities for responding to inquiries.

Subscriptions & Renewals

Fill in the subscription card adjoining this card. Electronics will bill you at the address indicated on the card.

Electronics May 19, 1981 This reader service card expires August 19, 1981

NAME _____ TITLE _____

PHONE (_____) _____ COMPANY _____

STREET ADDRESS (Company or home check one) _____

CITY _____ COUNTRY _____

Was This Magazine Personally Addressed to You? Yes No

Industry classification (check one):

- a Computer & Related Equipment
 b Communications Equipment & Systems
 c Navigation, Guidance or Control Systems
 d Aerospace, Underseas Ground Support
 e Test & Measuring Equipment
 f Consumer Products
 g Industrial Controls & Equipment
 h Components & Subassemblies

8 Source of Inquiry—All Other INT'L.

- j Independent R&D Organizations
 k Government

Your design function (check each letter that applies):

- x I do electronic design or development engineering work.
 y I supervise electronic design or development engineering work.
 z I set standards for, or evaluate electronic components, systems and materials.

Your principal job responsibility (check one)

- t Management
 v Engineering Management
 r Engineering

Estimate number of employees (at this location): 1. under 20 2. 20-99 3. 100-999 4. over 1000

1 16 31 46	61 76 91 106	121 136 151 166	181 196 211 226	241 256 271 348	363 378 393 408	423 438 453 468	483 498 703 718
2 17 32 47	62 77 92 107	122 137 152 167	182 197 212 227	242 257 272 349	364 379 394 409	424 439 454 469	484 499 704 719
3 18 33 48	63 78 93 108	123 138 153 168	183 198 213 228	243 258 273 350	365 380 395 410	425 440 455 470	485 500 705 720
4 19 34 49	64 79 94 109	124 139 154 169	184 199 214 229	244 259 274 351	366 381 396 411	426 441 456 471	486 501 706 900
5 20 35 50	65 80 95 110	125 140 155 170	185 200 215 230	245 260 275 352	367 382 397 412	427 442 457 472	487 502 707 901
6 21 36 51	66 81 96 111	126 141 156 171	186 201 216 231	246 261 338 353	368 383 398 413	428 443 458 473	488 503 708 902
7 22 37 52	67 82 97 112	127 142 157 172	187 202 217 232	247 262 339 354	369 384 399 414	429 444 459 474	489 504 709 951
8 23 38 53	68 83 98 113	128 143 158 173	188 203 218 233	248 263 340 355	370 385 400 415	430 445 460 475	490 505 710 952
9 24 39 54	69 84 99 114	129 144 159 174	189 204 219 234	249 264 341 356	371 386 401 416	431 446 461 476	491 506 711 953
10 25 40 55	70 85 100 115	130 145 160 175	190 205 220 235	250 265 342 357	372 387 402 417	432 447 462 477	492 507 712 954
11 26 41 56	71 86 101 116	131 146 161 176	191 206 221 236	251 266 343 358	373 388 403 418	433 448 463 478	493 508 713 956
12 27 42 57	72 87 102 117	132 147 162 177	192 207 222 237	252 267 344 359	374 389 404 419	434 449 464 479	494 509 714 957
13 28 43 58	73 88 103 118	133 148 163 178	193 208 223 238	253 268 345 360	375 390 405 420	435 450 465 480	495 510 715 958
14 29 44 59	74 89 104 119	134 149 164 179	194 209 224 239	254 269 346 361	376 391 406 421	436 451 466 481	496 701 716 959
15 30 45 60	75 90 105 120	135 150 165 180	195 210 225 240	255 270 347 362	377 392 407 422	437 452 467 482	497 702 717 960

Electronics May 19, 1981 This reader service card expires August 19, 1981

NAME _____ TITLE _____

PHONE (_____) _____ COMPANY _____

STREET ADDRESS (Company or home check one) _____

CITY _____ COUNTRY _____

Was This Magazine Personally Addressed to You? Yes No

Industry classification (check one):

- a Computer & Related Equipment
 b Communications Equipment & Systems
 c Navigation, Guidance or Control Systems
 d Aerospace, Underseas Ground Support
 e Test & Measuring Equipment
 f Consumer Products
 g Industrial Controls & Equipment
 h Components & Subassemblies

8 Source of Inquiry—All Other INT'L.

- j Independent R&D Organizations
 k Government

Your design function (check each letter that applies):

- x I do electronic design or development engineering work.
 y I supervise electronic design or development engineering work.
 z I set standards for, or evaluate electronic components, systems and materials.

Your principal job responsibility (check one)

- t Management
 v Engineering Management
 r Engineering

Estimate number of employees (at this location): 1. under 20 2. 20-99 3. 100-999 4. over 1000

1 16 31 46	61 76 91 106	121 136 151 166	181 196 211 226	241 256 271 348	363 378 393 408	423 438 453 468	483 498 703 718
2 17 32 47	62 77 92 107	122 137 152 167	182 197 212 227	242 257 272 349	364 379 394 409	424 439 454 469	484 499 704 719
3 18 33 48	63 78 93 108	123 138 153 168	183 198 213 228	243 258 273 350	365 380 395 410	425 440 455 470	485 500 705 720
4 19 34 49	64 79 94 109	124 139 154 169	184 199 214 229	244 259 274 351	366 381 396 411	426 441 456 471	486 501 706 900
5 20 35 50	65 80 95 110	125 140 155 170	185 200 215 230	245 260 275 352	367 382 397 412	427 442 457 472	487 502 707 901
6 21 36 51	66 81 96 111	126 141 156 171	186 201 216 231	246 261 338 353	368 383 398 413	428 443 458 473	488 503 708 902
7 22 37 52	67 82 97 112	127 142 157 172	187 202 217 232	247 262 339 354	369 384 399 414	429 444 459 474	489 504 709 951
8 23 38 53	68 83 98 113	128 143 158 173	188 203 218 233	248 263 340 355	370 385 400 415	430 445 460 475	490 505 710 952
9 24 39 54	69 84 99 114	129 144 159 174	189 204 219 234	249 264 341 356	371 386 401 416	431 446 461 476	491 506 711 953
10 25 40 55	70 85 100 115	130 145 160 175	190 205 220 235	250 265 342 357	372 387 402 417	432 447 462 477	492 507 712 954
11 26 41 56	71 86 101 116	131 146 161 176	191 206 221 236	251 266 343 358	373 388 403 418	433 448 463 478	493 508 713 956
12 27 42 57	72 87 102 117	132 147 162 177	192 207 222 237	252 267 344 359	374 389 404 419	434 449 464 479	494 509 714 957
13 28 43 58	73 88 103 118	133 148 163 178	193 208 223 238	253 268 345 360	375 390 405 420	435 450 465 480	495 510 715 958
14 29 44 59	74 89 104 119	134 149 164 179	194 209 224 239	254 269 346 361	376 391 406 421	436 451 466 481	496 701 716 959
15 30 45 60	75 90 105 120	135 150 165 180	195 210 225 240	255 270 347 362	377 392 407 422	437 452 467 482	497 702 717 960

Electronics Reader Service

If the cards below have already been used,
you may obtain the needed information
by writing directly to the manufacturer,
or by sending your name and address,
plus the Reader Service number and issue date,
to Electronics Reader Service Department,
P.O. Box No. 2530, Clinton, Iowa 52734, U.S.A.

Place correct airmail
postage here ... for
faster service.

Electronics

P.O. Box No. 2530
Clinton, Iowa 52735
U.S.A.

Place correct airmail
postage here ... for
faster service.

Electronics

P.O. Box No. 2530
Clinton, Iowa 52735
U.S.A.

PRINTED CIRCUIT SSRs

In Stock—At All Times—The Lowest Profile and Smallest Footprint Industry Standard SSRs

120 and 240 Volt Models

2, 3 and 4 Amp Ratings

UL Recognized and CSA Certified

Designed, Built and Tested for Reliability

Isn't this what you expect from Opto 22?

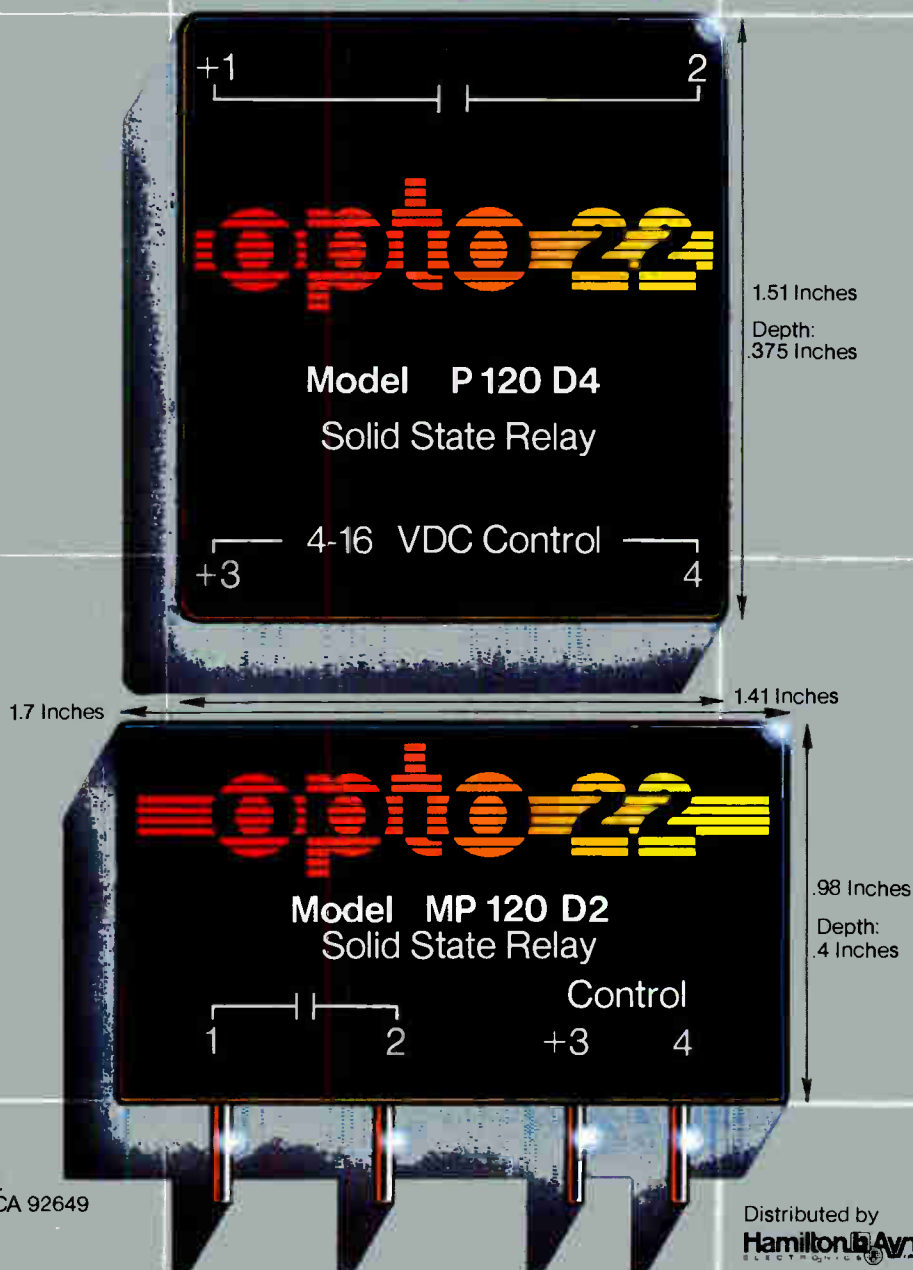

15461 Springdale St.
Huntington Beach, CA 92649
(714) 891-5861
Telex: 692386

Distributed by
Hamilton Avnet
ELECTRONICS

opto 22

Circle 901 on reader service card

World Radio History

SILICON OPTO CHIPS from Clairex



**PHOTOTRANSISTOR
CHIPS**

**PHOTOVOLTAIC
DIODE CHIPS**

**PHOTODARLINGTON
CHIPS**

**Now you can make your own hybrids,
arrays, solid-state relays and special sensors.**

The Clairex line of silicon photodetector chips consists of four photodiodes, five phototransistors and one photodarlington transistor. The diodes are intended for use in the

voltaic mode. The phototransistors are each available in two sensitivity ranges. All chips from Clairex have gold backings to facilitate ohmic bonding and are 100% tested before being

packaged in glass vials filled with Freon.

Call 914-664-6602 or write Clairex,[®] 560 South Third Avenue, Mount Vernon, New York 10550.

CLAIREX ELECTRONICS

A Division of Clairex Corporation

Circle 902 on reader service card