

APRIL 7, 1981

**THE PBX: CONTROLLING THE OFFICE OF THE FUTURE/139**

Carrying the Unix banner to major companies/ 108

Chip takes top-quality color graphics out of the luxury class/ 153

SIX DOLLARS A Mc GRAW-HILL PUBLICATION

International

# Electronics®



**MULTIFUNCTION CHIP  
REDUCES ANALOG INVENTORY**

## SIGNATURE ANALYSIS: A NEW AND EFFECTIVE METHOD OF TESTING MICROPROCESSOR-BASED BOARDS AT SPEED

If you're producing microprocessor-based products, you've probably found that board level testing is no trivial problem. That's because the complexity of the microprocessor (MPU) has introduced a number of new testing problems, especially when the boards must be tested at operating speeds.

### What are the new testing problems?

At-speed testing of dynamic devices creates five major problems: 1) Synchronizing most test systems with the MPU's fast on-board clock isn't possible; 2) The MPU's bi-directional bus makes fault isolation difficult; 3) Existing test systems often aren't fast enough to test today's dynamic memory devices thoroughly; 4) Most test systems cannot exercise the MPU's software — a must, and 5) Functional test development costs are increasing with device complexity. To solve these problems, Hewlett-Packard created new testing techniques.

### How HP developed Signature Analysis.

In 1977, as a means of reducing field service costs, HP developed a new method of testing dynamic devices. Called Signature Analysis (S/A) it is a data compression technique that reduces a complex data stream to a

series of unique four-digit hexadecimal signatures. Under test, the signature of each circuit node is compared to a stored value, making it easy to locate faulty nodes.

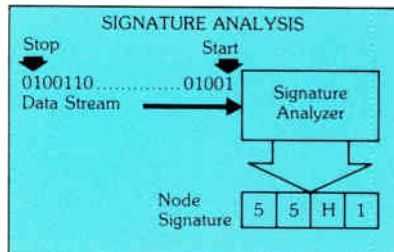

### Solving the five major problems.

Signature Analysis has made MPU board testing manageable by solving the testing problems outlined above. First, S/A can be synchronized with the MPU's on-board clock at rates up to 10 MHz. Second, interacting with the board under test, S/A can verify the data stream from a specific device on bi-directional buses. Third, the S/A technique is fast. It can locate speed-related faults in dynamic devices. Fourth, with S/A, the board under test is stimulated with a software test routine executed by the on-board MPU. With HP's 3060A, the test system can now supply this test routine to the MPU. No longer must S/A be designed into the board — unless you also plan to use S/A for field service testing.

Finally, S/A's stored go/no-go response approach is a cost-effective method for the testing of LSI devices.

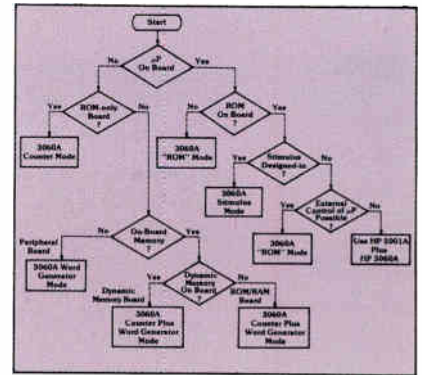

### You can put this new tool to work for you now.

Signature Analysis is part of the High Speed Digital Functional Test option to the proven HP 3060A Board Test System. This option is priced at \$12,000\* and can be added to 3060A's currently in service. The technique is complemented by the 3060A's programmable drivers, in-circuit program generator, and bed-of-nails visibility for automatic backtracing. Note, in the flow chart above, how the 3060A with this option provides flexibility in the selection of dynamic stimulus for board test applications.

### For additional information.

To receive complete details on the HP 3060A Board Test System and the High Speed Digital Functional Test option, write: Hewlett-Packard, 1507 Page Mill Road, Palo Alto, CA 94304. Or call the HP regional office nearest you: East (201) 264-5000, West (213) 970-7500, Midwest (312) 255-9800, South (404) 955-1500, Canada (416) 678-9430.

\*Domestic U.S.A. price only.

091/4

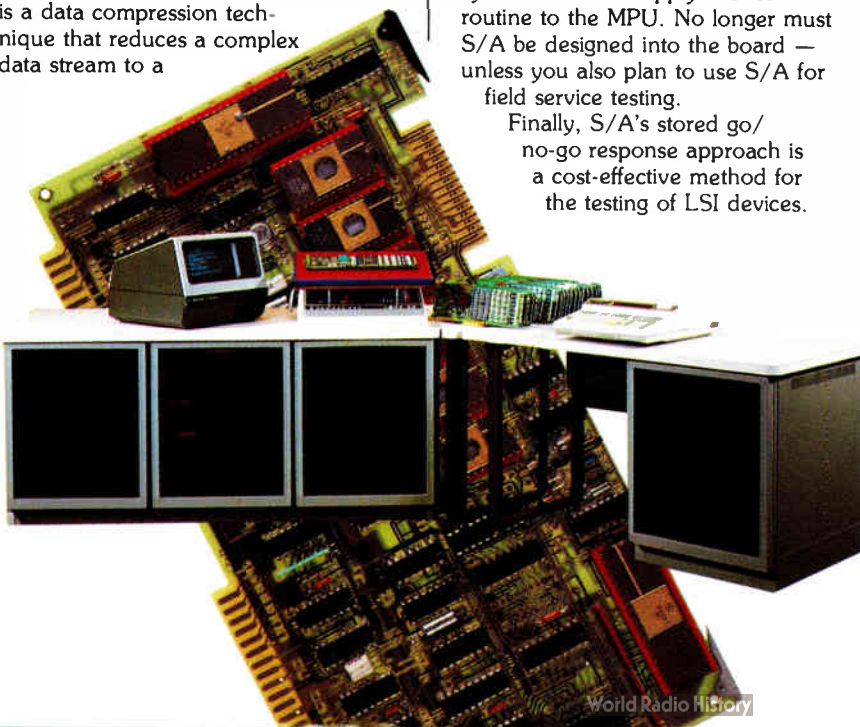

**HP Circuit Testers —  
The Right Decision**



Circle 900 on reader service card

# SURPRISE!

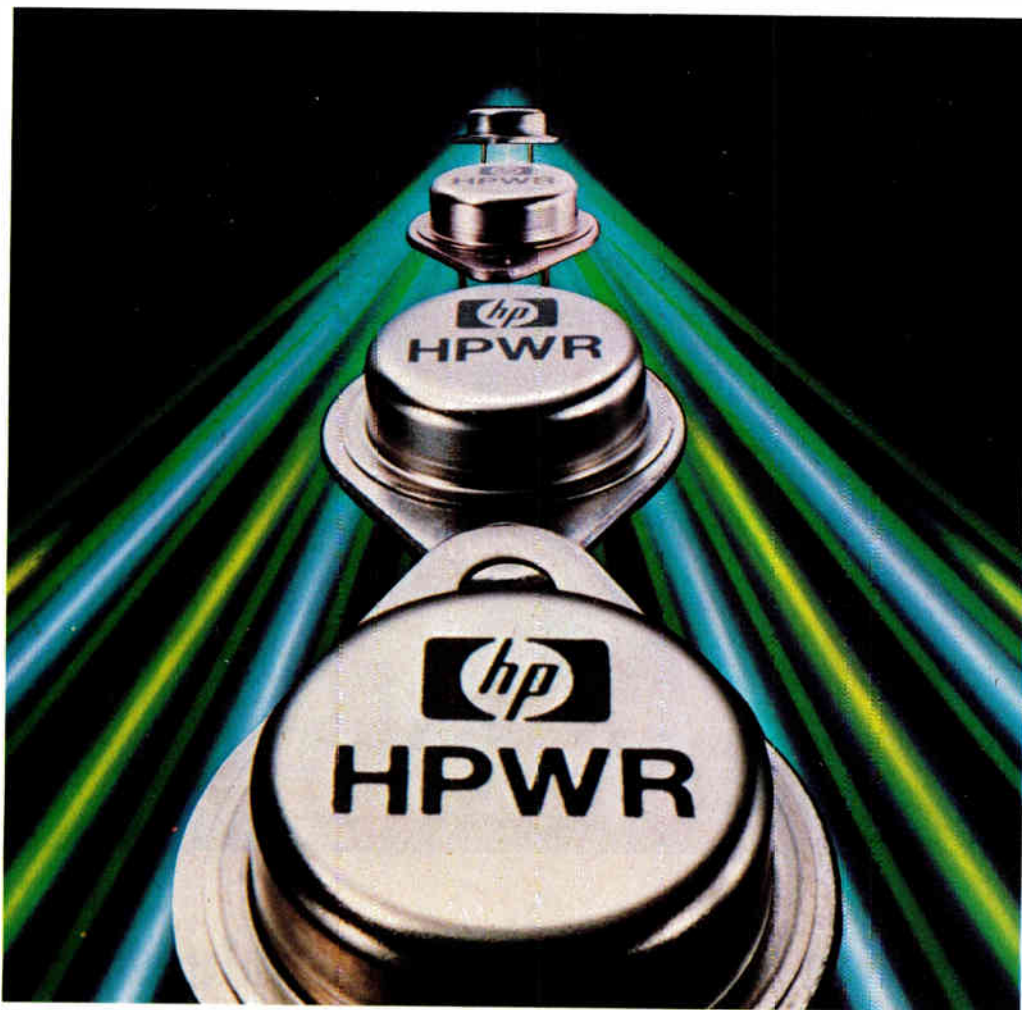

## Power MOS FET's are now available from HP

Look to HP for high quality, high performance and reliable Power MOS FET's. These FET's are ideal for off-line switching power supplies, inverter and converter circuits, motor drives and general industrial applications. HP MOS FET's are available now and feature: high breakdown voltage ( $V_{DSS}$ ), 450V minimum; low on resistance [ $R_{(ON)}$ ], 0.85 $\Omega$  maximum; and fast switching speed, 50 nanoseconds typical.

HP Power MOS FET's operate at high frequencies (200 kHz or more), with simple drive circuits. Switching losses are low and smaller components can be used, lowering system size and weight.

They're in stock right now at your local HP authorized distributor. In the U.S. contact Hall-Mark, Hamilton/Avnet, Pioneer Standard, Schweber, Wilshire or the Wyle Distribution Group (Liberty/Elmar). In Canada, call Hamilton/Avnet or Zentronics, Ltd.



**HEWLETT  
PACKARD**

05006B

# REMARKABLE

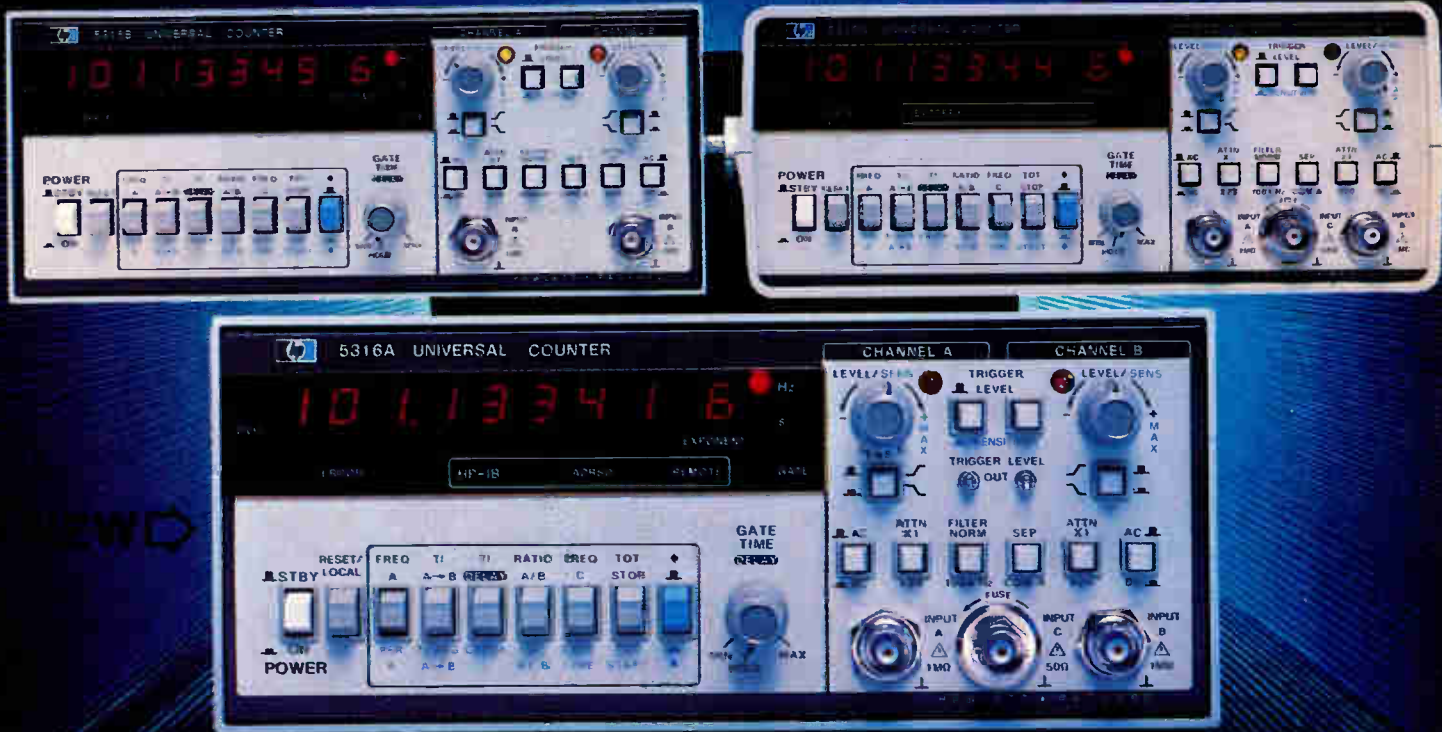

## Innovative design brings new values in universal counters for systems, bench and field use.

This is much more than just another family of 100 MHz universal counters. An innovative design using a micro-processor and HP's Multiple Register Counter IC give you remarkable performance and versatility for the money: 7 digits of frequency resolution per second; continuously variable gate times; dual-mode input conditioning that optimizes both frequency and time interval measurement; input filter and time interval delay for noisy inputs; very low RFI/EMC and excellent versatility when measuring frequency bursts.

Remarkably, at their low prices, these counters use the reciprocal measurement technique, which measures the input waveform's period and inverts

the result to display frequency. This gives you full resolution for all frequencies without the use of long gate times or phase-locked multipliers.

You get a full complement of universal counter measurements: frequency and frequency burst to 100 MHz (1 GHz optional), frequency ratio, time interval with resolution of 100 ns single shot and 10 ps averaged, period average and totalizing.

There are three models to select from. The new 5316A counter gives you full Hewlett-Packard Interface Bus (IEEE-488) capability including remote digital setting of trigger levels. It is metal-cased and rack mountable. And, at \$1500\* it is our lowest cost systems counter. The 5315B is similar to the 5316A, but without

HP-IB. It costs only \$1050\*. The HP 5315A portable version has a rugged polycarbonate case and carrying handle. It costs \$875\*. Options: battery pack (5315A only), \$225; \* 1 GHz C channel, \$250; \* Offset/Normalize Module (divides and/or adds numbers to Model 5315B or 5316A measurements), \$650; \* higher stability time base (TCXO), \$100\*.

All three of these counters have the quality you've come to expect from HP — at truly remarkable prices. For the full story just call your nearest HP sales office or write, Hewlett-Packard, 1507 Page Mill Road, Palo Alto, CA 94304.



Circle 2 on reader service card

\*Domestic U.S. prices only.

 **HEWLETT  
PACKARD**

World Radio History

## 121 Technical Articles

### SOLID STATE

**Multifunction chip plays many parts in analog design, 121**

### PACKAGING AND PRODUCTION

**Plastic packaging cuts the cost of rf power transistors, 130**

### COMMUNICATIONS

**Controlling the electronic office: PBXs make their move, 139**

### COMPUTERS AND PERIPHERALS

**Second group of IBM 4341 machines outdoes the first, 149**

### MICROSYSTEMS

**Display controller simplifies design of graphics terminals, 153**

DESIGNER'S CASEBOOK: 135

ENGINEER'S NOTEBOOK: 158

## 39 Electronics Review

SOFTWARE: Hands-off programming gains ground, 39

BUSINESS: Union activity astir in the West, 40

MICROSYSTEMS: New contenders enter the 4-bit microcomputer arena, 41

PACKAGING: Study applauds chips on tape, 42

COMPUTER-AIDED DESIGN: Modules analyze routing, heat factors, 44

INDUSTRIAL: Exxon drops complex ac motor drive, 46

COMMUNICATIONS: Capacitance switches 175-W space radio signal, 46

PERIPHERAL EQUIPMENT: Thin-film heads emerge from redesign, 57

SOLID STATE: Quick turnaround service is set for custom C-MOS, 62

## 69 Electronics International

BELGIUM: Portable scanner reads handwritten letters and figures, 81

GREAT BRITAIN: LSI to cut the price of adapters that turn TV sets into Prestel terminals, 82

FRANCE: Pilot office net uses message switching, 84

JAPAN: Robot moves by micrometers, 84

Amorphous silicon aids heat pipe, 86

NEW PRODUCTS INTERNATIONAL: 26E

## 97 Probing the News

INDUSTRIAL: Oil costs fuel power IC technology, 97

COMMUNICATIONS: Europeans test fast data link, 101

CONFERENCES: Display makers stick to CRTs, 104

SOFTWARE: Major firms join Unix parade, 108

## 171 New Products

IN THE SPOTLIGHT: Computer-aided design station aims at VLSI work, 171

Multitasking development system ups productivity, 178

Buffered acquisition system saves Q-bus time, 188

MICROCOMPUTERS & SYSTEMS: Serial input/output chip handles Bisync protocol, 191

Multiuser development systems cut design costs, 191

8-bit C-MOS microcomputer runs on 12 mW, 193

COMPUTERS & PERIPHERALS: DEC-compatible memory cards carry 256-K bytes, 198

Array processor fits on two Q-bus boards, 198

INSTRUMENTS: Digital scope stores 8-K bytes, 208

COMMUNICATIONS: 10-Mb/s fiber-optic link carries data 150 meters, 214

Microwave spectrum analyzer gains sensitivity, 214

PACKAGING & PRODUCTION: PROM programmer needs no personality modules, 220

MATERIALS: 224

## Departments

Highlights, 4

Publisher's letter, 6

Readers' comments, 8

News update, 12

People, 14

Editorial, 24

Meetings, 26

Electronics newsletter, 33

Washington newsletter, 65

International newsletter, 71

Engineer's newsletter, 162

Products newsletter, 227

Career outlook, 238

## Services

Reader service card, 37E

Employment

opportunities, 239

EDITOR-IN-CHIEF: Samuel Weber

MANAGING EDITORS  
*Technical:* Raymond P. Capece,  
Alfred Rosenblatt  
*News:* Gerald M. Walker  
*International:* Arthur Erikson

ASSISTANT MANAGING EDITORS:  
Howard Wolff, Margaret Eastman

SENIOR EDITORS: Ray Connolly, Bruce LeBoss

ART DIRECTOR: Fred Sklenar

ASSOCIATE EDITOR: Benjamin A. Mason

DEPARTMENT EDITORS  
*Aerospace/Military:* Ray Connolly  
*Careers:* Pamela Hamilton  
*Circuit Design:* Vincent Biancomano  
*Communications & Microwave:*  
Harvey J. Hindin  
*Computers & Peripherals:* Tom Manuel  
*Industrial/Consumer:* Gil Bassak  
*Microsystems & Software:* R. Colin Johnson  
*New Products:* Jeremy Young,  
Ana Bishop  
*Packaging & Production:* Jerry Lyman  
*Solid State:* John G. Posa  
*Test, Measurement & Control:*  
Richard W. Comerford

CHIEF COPY EDITOR: Margaret Eastman

COPY EDITORS: Mike Robinson,  
Charlotte Wiggers, David Kach

ART: Charles D. Ciatto, *Associate Director*  
Paula Piazza, *Assistant Director*

EDITORIAL ASSISTANT: Penny Reitman

EDITORIAL SECRETARIES: Patricia Randall,  
Dawn Ramsay, Janice Jung  
Christina Lindauer

REGIONAL EDITORS  
*Boston:* James B. Brinton,  
Linda Lowe (617) 262-1160  
*Chicago:* Wesley R. Iversen (312) 751-3806  
*Costa Mesa:* Terry Costlow (714) 557-6292  
*Dallas:* J. Robert Linöback (214) 742-1747  
*New York:* Pamela Hamilton (212) 997-2666  
*Los Angeles:* Larry Waller (213) 487-1160  
*Palo Alto:* Bruce LeBoss, *Manager*  
Martin Marshall, *Computers & Instruments*  
(415) 968-2712  
*Washington:* Ray Connolly (202) 624-7592  
*Frankfurt:* John Gosch 72-5566  
*London:* Kevin Smith 493-1451  
*Paris:* Arthur Erikson,  
Kenneth Dreyfack 720-20-70  
*Tokyo:* Charles Cohen,  
Robert Neff 581-9816

McGRAW-HILL WORLD NEWS  
Michael Johnson, *Editor*; James Smith, *Brussels*  
Jeff Ryser, *Milan*; Peter Hann, *Moscow*  
Robert Skole, *Stockholm*

PUBLISHER: Paul W. Reiss

GENERAL MANAGER, DIRECT MARKETING  
OPERATIONS: Horace T. Howland  
DIRECTOR OF CIRCULATION: Frederick J. Kostbar  
RESEARCH MANAGER: Margery D. Sholes  
PROMOTION MANAGER: Jane De Court  
MARKETING ADMINISTRATION MANAGER:  
Frances M. Vallone  
BOOKS & SPECIAL PROJECTS MANAGER:  
Janet Eyster

## Cover: Analog chip integrates discrete designs, 121

High-level integration has descended upon the linear world in the form of a general-purpose analog chip. Its powerful combination of features makes it a truly versatile building block suited to a wide variety of applications. Among them are sample-and-hold circuits, two-channel multiplexers, absolute-value amplifiers, and devices for implementing synchronous demodulation—a useful tool in critical applications in measurement, control, and instrumentation.

The cover photograph was taken by Art Director Fred Sklenar.

## High technology goes after the power, 97

The continually climbing cost of oil is only an additional motive for the move of digital electronics into power conversion devices. The upcoming Powercon 8 power electronics conference, to be held in Dallas, April 27–30, discloses important work going on, notably in two areas: MOS switches as well as combined MOS and bipolar devices to replace thyristors; and large-scale integrated circuits, usually microprocessor-based, for motor control.

## PBX makers seek to control the electronic office, 139

The office of the future is no longer so futuristic, and as it converges on present reality, the technical focus is shifting to the “central” question—that is, what will coordinate and control the various pieces of electronic office equipment. One prime contender for the role is the private branch exchange. This special report analyzes what is being done, and by whom, to incorporate a data-handling capability in these machines, which in their voice-only incarnation already take charge of telephone calls.

## Creating color graphics for CRT terminals, 153

As computers continue to proliferate and extend their roles, they demand ever greater sophistication of cathode-ray-tube displays, specifically in the form of high-quality color graphics. And just as large-scale integration has invaded the computer—processing and memory—so, too, it is now taking on the control of the CRT display. An LSI graphics display controller offers system designers an economical and effective way to incorporate these terminals even in small systems. Capable of addressing 256-K 16-bit words, it can create complex color images on a 2,048-by-2,048-dot matrix. And it is comfortable with almost any central processing unit.

## And in the next issue . . .

A preview of the National Computer Conference . . . raising programmers' productivity: a special report . . . a well-designed 64-K random-access memory . . . a 16-bit microprocessor that supports modular languages . . . a combined in-circuit and functional test system for large- and very large-scale integrated circuits.

April 7, 1981 Volume 54, Number 7  
105,481 copies of this issue printed

Electronics (ISSN 0013-5070). Published every other Tuesday except the issue of Monday, Nov. 30, by McGraw-Hill, Inc. Founder: James H. McGraw 1860-1948. Publication office 1221 Avenue of the Americas, N.Y., N.Y. 10020, second class postage paid at New York, N.Y. and additional mailing offices.

Executive, editorial, circulation and advertising addresses: Electronics, McGraw-Hill Building, 1221 Avenue of the Americas, New York, N.Y. 10020, Telephone (212) 997-1221, Teletype 12-7960 TWX 710-581-4879. Cable address: MCGRAW HILL NEW YORK.

Subscriptions limited to professional persons with active responsibility in electronics technology. No subscriptions accepted without complete identification of subscriber name, title or job function, company or organization, and product manufactured or services performed. Based on information supplied, the publisher reserves the right to reject non-qualified requests. Subscription rates: in the United States and possessions \$19 one year, \$32 two years, \$47 three years; company addressed and company libraries \$24 one year, \$42 two years, \$59 three years; Canada and Mexico \$20 one year, \$33 two years, \$48 three years; Europe \$50 one year, \$85 two years, \$115 three years; Japan, Israel and Brazil \$70 one year, \$115 two years, \$165 three years; Australia and New Zealand \$95 one year, \$170 two years, \$240 three years, including air freight; all other countries \$50 one year, \$85 two years, \$125 three years. Limited quota of subscriptions available at higher-than-basic rate for persons allied to field served. Check with publisher for these rates. Single copies: \$5.00. Please allow four to eight weeks for shipment.

Officers of McGraw-Hill Publications Company: Paul F. McPherson, President; Executive Vice Presidents: James E. Boddorf, Gene W. Simpson; Group Vice President: Daniel A. McMillan; Senior Vice President:

Editorial: Ralph R. Schulz; Vice Presidents: Kemp Anderson, Business Systems Development; Robert B. Doll, Circulation; James E. Hackett, Controller; Eric B. Herr, Planning and Development; H. John Sweger, Marketing.

Officers of the Corporation: Harold W. McGraw, Jr., President, Chief Executive Officer, and Chairman of the Board; Robert N. Landes, Senior Vice President and Secretary; Ralph J. Webb, Treasurer.

Title registered in U.S. Patent Office; Copyright © 1980 by McGraw-Hill, Inc. All rights reserved. The contents of this publication may not be reproduced in whole or in part without the consent of copyright owner. Where necessary, permission is granted by the copyright owner for libraries and others registered with the Copyright Clearance Center (CCC), 21 Congress Street, Salem, MA 01970, to photocopy any article (CCC) for the base fee of \$0.50 per copy of the article plus \$0.25 per page. Payment should be sent directly to the CCC. Copying done for other than personal or internal reference use without the express permission of McGraw-Hill is prohibited. Requests for special permission or bulk orders should be addressed to the publisher. ISSN 0013-5070/81\$0.50+.25.

Subscribers: The publisher, upon written request to our New York office from any subscriber, agrees to refund that part of the subscription price applying to copies not yet mailed. Please send change-of-address notices or complaints to Fulfillment Manager; subscription orders to Circulation Manager, Electronics, at address below. Change-of-address notices should provide old as well as new address, including zip codes. Attach address label from recent issue. Allow one month for change to become effective. Subscriber Service: call (609) 448-8110, 9 a. m. to 4 p. m. EST.

Postmaster: Please send form 3579 to Fulfillment Manager, Electronics, P.O. Box 430, Hightstown, N.J. 08520.

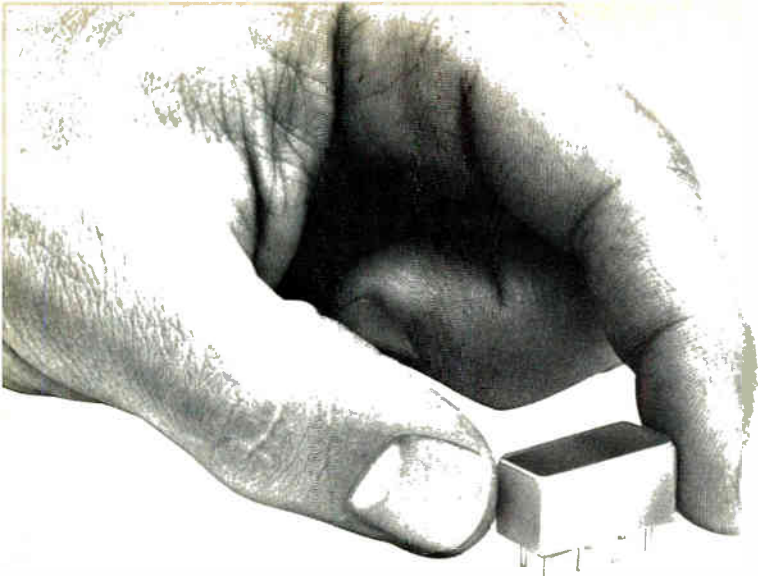

# the world's standard

## the world's only double-balanced mixer with a 3-year guarantee

The SRA-1 from Mini-Circuits only \$11<sup>95</sup> (1-49)

Our 3-year guarantee is still unique today... even though we have been offering it for the past five years.

Here is how we achieve it. The diodes are the most critical component in the mixer. So to start, we use an accelerated life screening test generally reserved only for space applications. The HTRB-screened Schottky diodes are subjected to a one-volt negative bias at 150° C for 168 hours, a stress designed to accelerate ageing and force time-related failures—thus screening out potentially unreliable diodes.

In addition, further stressing and testing are performed on the assembled unit.

Each completed SRA-1 experiences:

1. Burn-in for 96 hours at 100° C with 8 mA at 1 KHz.
2. Thermal shock.
3. Gross and fine leak tests (per MIL-STD 202).

Don't settle for an imitation. Specify Mini-Circuits' SRA-1, the only double-balanced mixers with a three-year guarantee. Immediate delivery, of course.

### SRA-1 SPECIFICATIONS

#### FREQUENCY RANGE (MHz)

LO 0.5-500  
 RF 0.5-500  
 IF DC-500

CONVERSION LOSS (dB)	TYP.	MAX.
1-250 MHz	5.5	7.0
0.5-500 MHz	6.5	8.5

ISOLATION (dB)		TYP.	MIN.
0.5-5 MHz	LO-RF	50	45
	LO-IF	45	35
5-250 MHz	LO-RF	45	30
	LO-IF	40	25
250-500 MHz	LO-RF	35	25
	LO-IF	30	20

MIN. ELECTRONIC ATTENUATION (20 mA) 3 dB Typ.

SIGNAL 1 dB COMPRESSION LEVEL +1 dBm

IMPEDANCE All Ports, 50 Ohms

LO POWER +7 dBm

## Mini-Circuits

A Division of Scientific Components Corp.  
 World's largest manufacturer of Double Balanced Mixers  
 2625 East 14th Street, Brooklyn, New York 11235 (212)769-0200  
 Domestic and International Telex 125460 International Telex 620156

Circle 5 on reader service card

# Never before...

## 200 watts of RF power with incredible versatility.

3200 L spans  
250 kHz to 150 MHz.



Now there's a completely solid state power amplifier that provides 200 watts of linear power over a frequency range from 250 kHz to 120 MHz. And at 175 watts, the range extends to 150 MHz.

Imagine the wide range of applications you can cover with this single Class A linear unit. All you need is any standard signal or sweep generator and you have the ultimate in linear power for RFI/EMI testing, NMR, RF Transmission, and general laboratory applications.

And, like all ENI power amplifiers, the 3200 L features unconditional stability, instantaneous failsafe provisions, and absolute protection from overloads and transients.

The 3200 L represents a breakthrough in RF power versatility and packaging. Never before has there been anything like it commercially available anywhere!

Contact us for a demonstration of the 3200 L and our complete catalog on the other amplifiers in our wide line. ENI, 3000 Winton Road South, Rochester, NY 14623. Call 716/473-6900, or Telex 97-8283 ENI ROC.

# ENI



The advanced  
design line of  
power amplifiers

## Publisher's letter

Unlike the digital world, which virtually revolves around the highly adaptable microprocessor, the analog world has lacked any such single-chip general-purpose building block." So say David L. Gillooly and Paul Henneuse of Precision Monolithics Inc., Santa Clara, Calif., in our cover article (p. 121) introducing the GAP-01, a general-purpose analog processor.

The GAP-01 is the kind of building block that can fit a wide range of applications, integrate discrete analog components, reduce board space, and be applied in either high or low volumes, the authors explain.

Does this development mark the return into the spotlight of the analog design engineer? Not exactly, says Gillooly, who is staff product market engineer for PMI.

"There's no way you can over-stress the importance of the digital microprocessor today," he observes, "but you don't need a microprocessor in all applications. Many things can be done linearly. Because of the success of microprocessors, we sometimes tend to forget that data are usually analog until we make them digital for processing."

Gillooly, by the way, has been in both camps. As an engineer at National Semiconductor Corp., he worked in the hybrid group developing high-performance analog parts. More recently at Biomation, his work was totally digital, dealing with the application of emitter-coupled-logic and TTL technologies.

Though Gillooly believes that digital designers do not appreciate all the techniques of analog design employed to make a device highly accurate, he says that analog designers do not appreciate fully the com-

plexity required in digital devices that are having to operate at ever-faster speeds.

To the communications community, private branch exchanges have always meant voice-only operation. Now it's time to take another look, because today PBXs capable of handling both voice and data are coming to market.

This development will be vital in the automated office, as communications editor Harvey Hindin points out in his special report on PBXs (p. 139). There are four contenders for controlling communications in the electronic office—central computers, local networks, the public telephone network as proposed in American Telephone & Telegraph Co.'s Advanced Communications Service, and voice-and-data PBXs.

"In these days of low-cost microprocessors, digital technology, and distributed processing, the PBX can handle data just as well as it handles voice," Harvey states. As evidence, in the last six months several companies have introduced private branch exchanges that do just that.

The *Electronics Index* for 1980 is about to come off the presses listing all of the stories and articles for the past year by subject and by author. If you want to receive an index, circle 370 on the Reader Service Card.

### Wanted: a Business Trends editor

A newly established department of the New York editorial staff of *Electronics* offers a unique opportunity for a skilled communicator interested in the business side of technology. We seek an experienced business journalist with a good statistical or market research background in the electronics field. An EE or an MBA in market research or an economics degree would be eminently desirable. Send your résumé to the Editor-in-Chief, *Electronics*, 1221 Avenue of the Americas, New York, N. Y. 10020.



# Four Filters in One

## Dual Channel Filter, Capable Of:

- Two independent low-pass channel filters
- Two high-pass channel filters
- Single channel band pass filter  
or
- Single channel band reject filter

... And all are tunable from 20 Hz to 2 MHz

The Model 3202 provides the flexibility essential for complex frequency or time domain measurements.

**Functions:** low-pass — direct coupled with low drift. High-pass — upper 3 dB at 10 MHz. Band-pass — continuously variable broad band or sharp null.

**Performance characteristics:** 24 dB per octave slope per channel; 80 dB maximum attenuation; 90 dB dynamic range (less than 100 microvolts hum and noise) eliminates costly pre-amplifier; 0 dB insertion loss; response characteristics — Butterworth or R-C (transient free).

For fast action, call: (617) 580-1660.

**KH KROHN-HITE CORPORATION**

Avon Industrial Park, Avon, MA 02322  
(617) 580-1660 TWX 710 345 0831

**Krohn-Hite...Benchmark of Quality in Instruments**

OVERSEAS SALES OFFICE: ARAB REPUBLIC OF EGYPT, Cairo, E.P.I. Co; ARGENTINA, Buenos Aires, COASIN S/A; AUSTRIA, Wien, UNIVERSAL ELECTRONIC IMPORT; AUSTRALIA, Chatswood, South Melbourne, Fortitude Valley Q, Auburn, Kidman Park, Cloverdale, WARBURTON FRANKI, LTD; BELGIUM, Brussels, C. N. ROOD s.a.; DENMARK, Naerum, SC METRIC A/S; ENGLAND, Reading Berks, KEITHLEY INSTRUMENTS, LTD; FINLAND, Helsinki, INTO/OY; FRANCE, Buc, M.B. ELECTRONIQUE; GERMANY, Munich, KEITHLEY INSTRUMENTS, GMBH; HOLLAND, Rijswijk, C. N. ROOD, b.v.; ISRAEL, Tel-Aviv, ARITMORE ENGINEERING CO, LTD; ITALY, Milan, Rome, VIANELLO S.P.A.; JAPAN, Tokyo, CHISHO CORP.; NEW ZEALAND, Lower Hutt, WARBURTON FRANKI LTD; NORWAY, Asker, TELEINSTRUMENT AB; PORTUGAL, Lisbon, MAGNETROM; SINGAPORE, Singapore, O'CONNOR'S (PTE), LTD; SOUTH AFRICA, Bramley, PROTEA P.N.I. (PTY), LTD; SPAIN, Barcelona, C.R. MARES, S.A.; SWEDEN, Vallingby, TELEINSTRUMENT AB; SWITZERLAND, Urdorf Zurich, MEGEX ELECTRONIC AG.

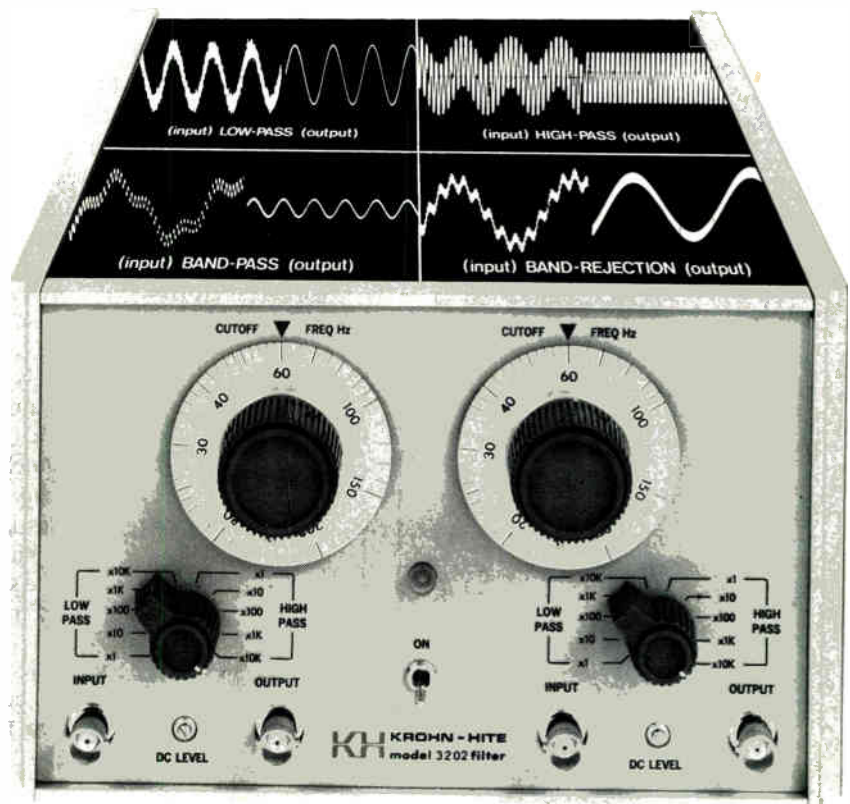

© Krohn-Hite Corporation 1981

Circle 228 on reader service card



## THIN-TRIM® & SEAL-TRIM® VARIABLE CAPACITORS

*Thin-Trim® capacitors are an advanced development in miniaturized variable capacitors for applications in circuits where size and performance are critical.*

*Seal-Trim® capacitors are Thin-Trim® capacitors encapsulated in a moisture-proof housing which eliminates dirt, dust, solder flux and atmospheric contamination.*

- Low Drift Rates
- High Q
- High Volumetric Efficiency
- Capacitance Ranges:  
.25-.7 pF to 20-100 pF in Three Sizes

**Electronic Accuracy  
Through  
Mechanical Precision**

**Manufacturing  
Corporation**

400 Rockaway Valley Road  
Boonton, New Jersey 07005  
201-334-2676  
TWX 710-987-8367

## Readers' comments

### The vote's real significance

**To the Editor:** President Leo Young's detailed explanation in the Readers' Comments section [Feb. 10, p. 8] of how the board of directors of the Institute of Electrical and Electronics Engineers approached the last election misses one important point.

Mr. Young states that the board made its decision based on the "meaning of the vote." However, the real meaning of the vote is that IEEE elections are of so little importance to most members that they don't bother to vote. In addition, the IEEE is of so little interest to most EEs that they see no real reason to join.

As an IEEE member, I feel the board should spend its time interpreting the meaning of this huge mandate for change.

Richard G. Wiley  
Syracuse, N. Y.

### Mixed-up couples

**To the Editor:** In "In memories, CMOS speeds up and redundancy catches on" [Feb. 24, p. 141], two technical points concerning fast random-access memories presented at the 1981 International Solid State Circuits Conference are explained inaccurately.

The description of the sense amplifier in Hitachi's 4-K Hi-C-MOS II static RAM states that the amplifier output  $\overline{OUT}$  is capacitively coupled to the input line DATA and that the complementary output, OUT, is coupled to DATA. The article claims that "the capacitors act as short circuits to the steep signal edges in the circuit." Therefore, "when the inputs change, the outputs will assume their correct polarities almost instantaneously."

In fact, the capacitors are connected in a positive-feedback configuration, with OUT coupled to DATA and  $\overline{OUT}$  coupled to  $\overline{DATA}$ . Their purpose is to boost the small signal swing on the DATA and  $\overline{DATA}$  input lines, not to "short out steep signal edges," which would tend to slow the sensing operation.

In addition, the article states that in its 16-K-by-1-bit static RAM, Texas Instruments Inc. has "column-line

sense amplifiers that replace the usual column decoders." Actually, Texas Instruments' part does employ column decoders to enable one of the 128 sense amps. These amplifiers replace large column-transfer transistors that exhibit high diffusion capacitance.

Mark Johnson  
Massachusetts Institute  
of Technology  
Laboratory for Computer Science  
Cambridge, Mass.

### Overlooked overflows

**To the Editor:** Concerning "Pulse-width meter displays values digitally" [Dec. 4, p. 162]: a decade counter will not always detect the overflow of a counting chain. If, for example, the chain overflows 10 times, the decade counter is reset to zero and retains no memory of the overflows. The last counter in the pulse-width meter should be replaced by a flip-flop that sets on the falling edge of the preceding counter output and stays set until it and the whole chain have been deliberately cleared.

Philip Bacon  
Gainesville, Fla.

### Corrections

*In "Two-chip pulse generator operates at 75 MHz" (March 24, p. 139), pins 6 and 11 of A<sub>1</sub> should connect through their respective 390-ohm resistors to pin 9, not to -5.2 volts. Pin 5 should connect to pin 9 as well, and neither of the two should connect to pin 8.*

*Analog Devices Inc.'s AD-ADC84/85 (March 24, p. 180) are, as their designation implies, analog-to-digital converters and not the other way around, as stated. The parts count for the converters is 13 integrated circuits and 6 capacitors, not 5 chips. The story gives maximum conversion times and linearity specifications. Differential linearity is  $\pm 1/2$  least significant bit, not "less than"  $\pm 1/2$  LSB. Offset errors should have read  $\pm 0.05\%$  for unipolar and  $\pm 0.1\%$  for bipolar operation. Finally, Analog Devices reports that 100-unit-lot prices for the models 84 and 85 are now \$75 and \$115 for 10-bit units, respectively, and \$85 and \$125 for 12-bit resolution.*

# Interested in higher performance software?

The Mark Williams Company announces **COHERENT™**, a state of the art, third generation operating system. **COHERENT** is a totally independent development of The Mark Williams Company. **COHERENT** contains a number of software innovations not available elsewhere, while maintaining compatibility with UNIX\*. The primary goal of **COHERENT** is to provide a friendly environment for program development. The intent is to provide the user with a wide range of software building blocks from which he can select programs and utilities to solve his problems in the most straightforward manner.

**COHERENT** and all of its associated software are written totally in the high-level programming language **C**. Using **C** as the primary implementation language yields a high degree of reliability, portability, and ease of modification with no noticeable performance penalty.

## Features

**COHERENT** provides **C** language source compatibility with programs written to run under Seventh Edition UNIX, enabling the large base of software written to run under UNIX (from numerous sources) to be available to the **COHERENT** user. The system design is based on a number of fundamental concepts. Central to this design is the unified structure of i/o with respect to ordinary files, external devices, and interprocess communication (pipes). At the same time, a great deal of attention has been paid to system performance so that the machine's resources are used in the most efficient way. The major features of **COHERENT** include:

- multiuser and multi-tasking facilities,
- running processes in foreground and background,
- compatible mechanisms for file, device, and interprocess i/o facilities,
- the shell command interpreter—modifiable for particular applications,
- distributed file system with tree-structured, hierarchical design,
- pipes and multiplexed channels for interprocess communication,
- asynchronous software interrupts,
- generalized segmentation (shared data, writeable instruction spaces),
- ability to lock processes in memory for real-time applications,
- fast swapping with swap storage cache,
- minimal interrupt lockout time for real-

\*UNIX is a trademark of Bell Labs

time applications.

- reliable power failure recovery facilities,
- fast disc accesses through disc buffer cache,
- loadable device drivers,
- process timing, profiling and debugging trace features.

## Software Tools

In addition to the standard commands for manipulating processes, files, and the like, in its initial release **COHERENT** will include the following major software components: **SHELL**, the command interpreter; **STDIO**, a portable, standard i/o library plus run-time support routines; **AS**, an assembler for the host machine; **CROSS**, a number of cross-assemblers for other machines with compatible object format with 'AS' above; **DB**, a symbolic debugger for **C**, Pascal, Fortran, and assembler; **ED**, a context-oriented text editor with regular expression patterns; **SED**, a stream editor (used in filters) fashioned after 'ED'; **GREP**, a pattern matching filter; **AWK**, a pattern scanning and processing language; **LEX**, a lexical analyzer generator; **YACC**, an advanced parser generator language; **NROFF**, an Nroff-compatible text formatter; **LEARN**, computer-aided instruction about computers; **DC**, a desk calculator; **QUOTA**, a package of accounting programs to control filespace and processor use; and **MAIL**, an electronic personal message system.

Of course, **COHERENT** will have an ever-expanding number of programming and language tools and basic commands in future releases.

## Language Support

The realm of language support is one of the major strengths of **COHERENT**. The following language processors will be supported initially:

- **C** a portable compiler for the language **C**, including stricter type enforcement in the manner of **LINT**.
- **FORTRAN** portable compiler supporting the full ANS Fortran 77 standard.
- **PASCAL** portable implementation of the complete ISO standard Pascal.

- **XYBASIC™** a state of the art Basic compiler with the interactive features of an interpreter.

The unified design philosophy underlying the implementation of these languages has contributed significantly to the ease of their portability. In particular, the existence of a generalized code generator is such that with a minimal effort (about one man-month) all of the above language processors can be made to run on a new machine. The net result is that the compilers running under **COHERENT** produce extremely tight code very closely rivaling that produced by an experienced assembler programmer. Finally, the unified coder and conformable calling sequences permit the intermixture of these languages in a single program.

## Operating System

In part because of the language portability discussed above, and in part because of a substantial effort in achieving a greater degree of machine-independence in the design and implementation of the **COHERENT** operating system, only a small effort need be invested to port the whole system to a new machine. Because of this, an investment in **COHERENT** software is not tied to a single processor. Applications can move with the entire system to a new processor with about two man months of effort.

The initial version of **COHERENT** is available for the Digital Equipment Corporation PDP-11 computers with memory-mapping, such as the PDP 11/34. Machines which will be supported in the coming months are the Intel 8086, Zilog Z8000, and Motorola 68000. Machines for which ports are being considered are the DEC VAX 11/780 and the IBM 370, among others.

Because **COHERENT** has been developed independently, the pricing is exceptionally attractive. Of course **COHERENT** is completely supported by its developer. To get more information about **COHERENT** contact us today.



1430 W. Wrightwood Ave., Chicago, IL 60614  
TEL: 312-472-6659 TWX: 910-221-1182

---

---

The International  
guarantees these ele  
parameters over the  
ture range: 0.1% on M  
0.2% on Bipolar Logi  
on Linear, LSI Log

---

---

INTL STD 1235

---

---

Standard of Quality  
Electrical AQLs on all  
operating tempera-  
OS RAMs & ROMs;  
& Interface; 0.3%  
& other memories.

---

---

We just changed the rules. We decided that what this business needed was a nice new set of AQLs. And here they are, effective April 1st. Talk to us about all the parts you can get with INT-STD-123 for free. We don't make them like they used to.

**Advanced Micro Devices** 

901 Thompson Place, Sunnyvale, CA 94086 • (408) 732-2400

# Now RCA Microboards go to extremes.

## RCA CMOS Microboards now operate from -40°C to +85°C.

- Extended temperature range on most boards, including:
  - all computer boards
  - memory boards
  - digital I/O
  - analog I/O
- Burned-in at 85°C for 72 hours.
- 100 percent function-tested before and after burn-in.
- **All this at no extra cost.**

The extended temperature range, combined with the low power consumption, high noise immunity and portability of CMOS, make these boards ideal for:

- Remote data acquisition

- Outdoor control systems
- Hostile industrial environments
- Environmental monitoring.

**Now RCA CMOS Microboards can run hot or cold for only \$99.\*** For a complete list and pricing of these Microboards contact any RCA Solid State sales office or appointed distributor.

Or contact RCA Solid State headquarters in Somerville, N.J. Brussels, Belgium. Sao Paulo, Brazil. Hong Kong. **Or call Microsystems Marketing toll-free (800) 526-3862.**

\* U.S. optional distributor resale. 100+ price. 604 Microboard computer.

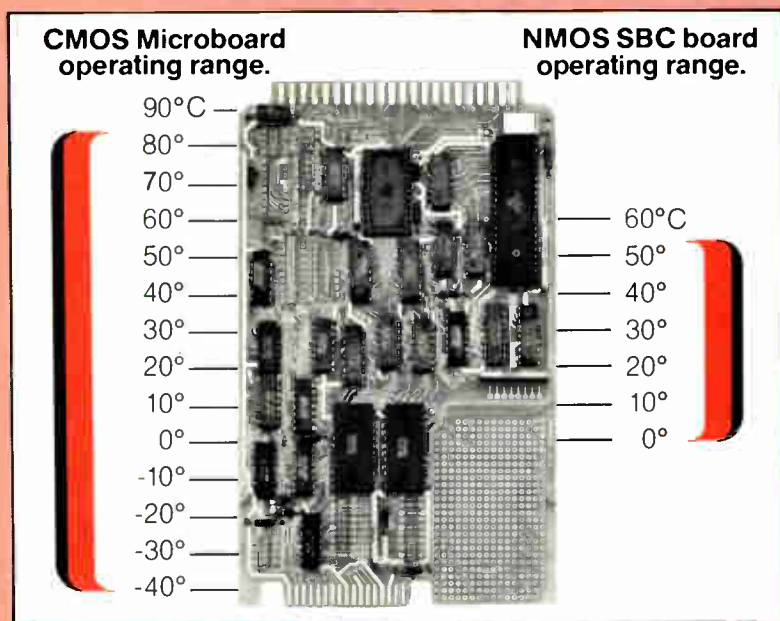

# RCA

**Another reason to  
switch to CMOS.**

## News update

■ It has been two years since International Business Machines Corp. sent price-performance shock waves through the plug-compatible manufacturing industry with the announcement of the 4300 series. In the wake of the announcement there were some questions and doubt about the future health of the plug-compatible industry [*Electronics*, Oct. 11, 1979, p. 89]. The Intel-National deal was expected to be only the first of many consolidations, and some failures among the new entrants were expected.

However, there was only a brief pause in earnings and sales growth among these companies, and neither failures nor any more mergers have happened. The industry has weathered the storm and is doing all right.

Most of the companies reported new highs in earnings and revenues at the end of 1980 and the first part of 1981, in spite of general price reductions. In 1980, for instance, the installed base of Amdahl Corp.'s 470 increased by more than 40%.

**Profits.** The National Advanced Systems operation of National Semiconductor Corp. achieved a solid profit in 1980 just one year after beginning direct sales. And last year Magnuson Computer Systems Inc. saw its first year of profitability since its incorporation in 1977, with a net income of \$2.5 million on revenues of \$27.8 million—a 160% increase over 1979 revenues.

All the major companies have introduced new systems with higher price-performance ratios in the past year. Amdahl announced its 580 series [*Electronics*, Dec. 4, p. 41]; National Advanced Systems announced its AS/9000 version of the Hitachi M-200H and then bracketed it below and above with the AS/9000N and the AS/9000DPC respectively. Hitachi Ltd. and Fujitsu Ltd. of Japan also just recently announced several new IBM-compatible models [*Electronics*, March 10, p. 77]. The companies competing directly with the 4300 series—Magnuson and IPL Systems Inc.—also have introduced new systems with price-performance ratios better than IBM's.

-Tom Manuel

# Cost-effective motor speed control

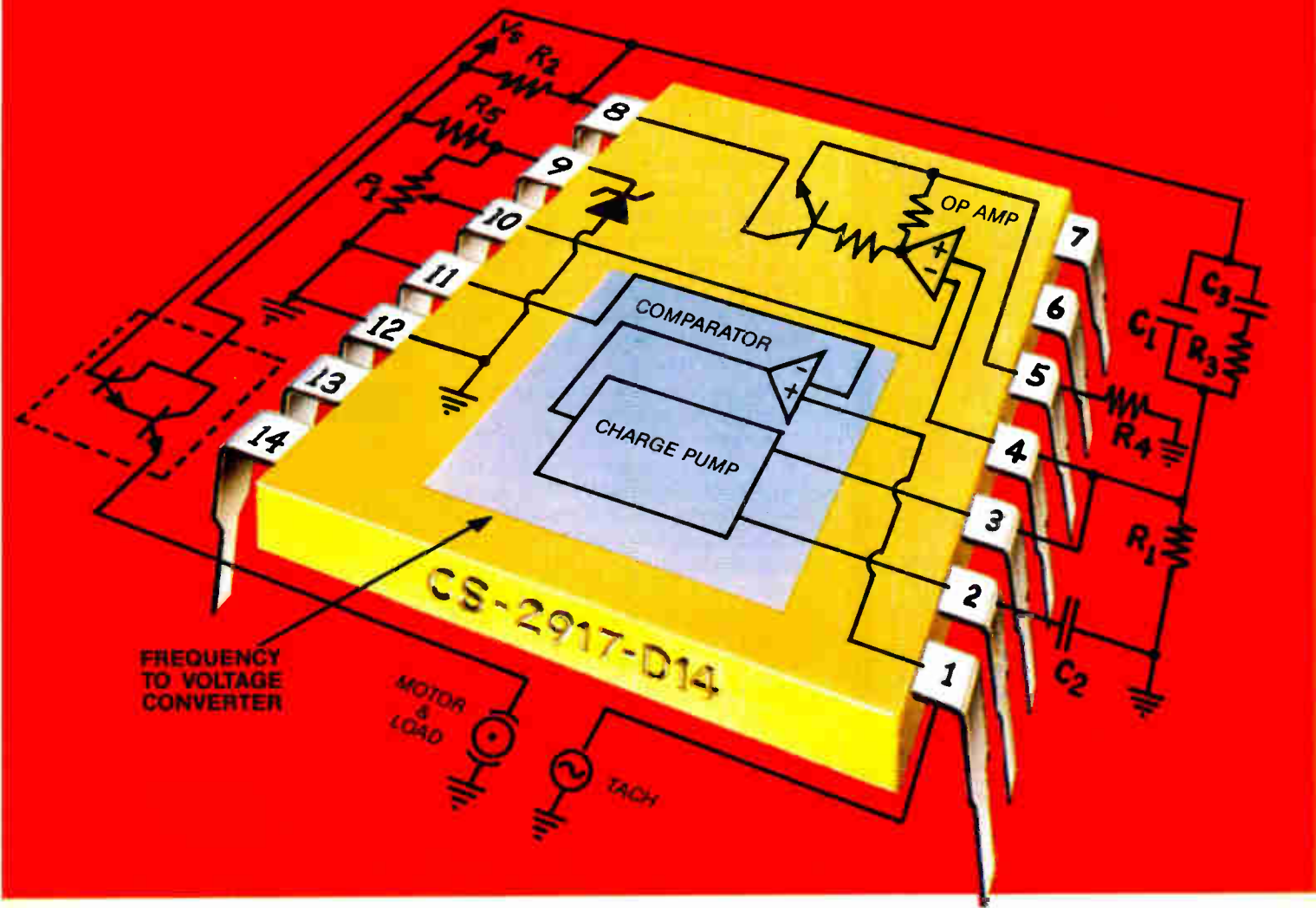

**PROBABLY** Cherry has a standard IC, in stock, to control the speed of your fractional horsepower motor. Precisely. With high resolution. At low cost.

**QUITE LIKELY** one of our three standard "families" of MSCs will do the job...in your application. Whether tape deck, floppy disc, turntable, appliance or vending machine. You name it, we'll control it. Accurately.

**IF NOT** Cherry will design an IC for your specific MSC application—economically.

**EITHER WAY** you get the advantage of our vast experience and expertise in.....



Actual Size

Choose from our three standard "families."

Cherry Part Number	CS-175	CS-140	CS-2907-17
Supply Voltage Range	4 to 9V	7 to 12V	6 to 28V
Lowest cost single MSC	X		
Dual MSC on one chip		X	
DC or AC drive with external thyristor	X	X	X
Six variations available			X

Or, we'll design you an affordable special.  
**FHP Motor Speed Control ICs.**

Phone or write today for MSC data sheets.

# CHERRY SEMICONDUCTOR

**CHERRY SEMICONDUCTOR CORPORATION** 2000 South County Trail, East Greenwich, RI 02818/ 401/885-3600

A wholly owned subsidiary of Cherry Electrical Products Corp., Waukegan, IL, U.S.A., 312 889 7700 • Worldwide affiliates and phone numbers: Cherry Mikroschalter GmbH, Auerbach, Germany, 09 843 181 • Cherry Electrical Products Ltd., Harpenden (Herts) England, (05827) 83100 • Chercro Brasil Industria E Comercio Ltda., Sao Paulo 55 (011) 248-4343 • Hirose Cherry Precision Co., Ltd., Kawasaki, Japan, 044 933 3511



## UNIQUE NEW DOUBLE DUTY DATA LINK

**New TRW Optron bi-directional design slashes costs of fiber optic data links!**

A unique new design allows TRW Optron to offer the only bi-directional fiber optic data link in the marketplace. And, it's inexpensive and immediately available!

A pair of transceivers and a length of Crofon 1040 cable form a fiber optic data link which through multiplexing can receive and transmit over a single fiber. This cost-saving design eliminates the need for two receivers, two transmitters and two lengths of cable. You save money, board space and assembly time.

Other cost reductions include the use of crimp-on brass ferrules to terminate the cable instead of sophisticated connectors. The housing is designed for snap-in mounting to PC boards and is flow solderable.



Each transceiver contains a gallium arsenide phosphide LED and a silicon PIN photodiode concentrically mounted in a clear plastic package. A raised ring molded in the package ensures proper alignment and firm seating of the ferrule terminated cable.

The data link is intended for distances to 10 meters and has a bandwidth of 1.5 MHz. When the LED is driven at 50 mA with a  $V_R = 12$  V through 3 meters of cable, photodiode output current is 200 nA minimum.

It is ideally suited for automotive, and board-to-board or chassis-to-chassis data transmission applications.

Detailed technical information and Application Note No. 106 relating to the OPB950 are available on request. Contact your nearest TRW Optron sales office or the factory at 1201 Tappan Circle, Carrollton, Texas 75006 USA. TWX 910-860-5958 • Tel 214/323-2200.

**TRW OPTRON**  
A DIVISION OF TRW INC.



## People

Wiles's expertise will guide VLSI Technology . . .

The chairman of one of Silicon Valley's newest startups, VLSI Technology Inc., hopes to prove that an ounce of prevention is worth a pound of cure. And having spent much of the last decade helping established but financially troubled firms get back on a growth curve, Q. T. Wiles knows about cures. Now, the 61-year-old management consultant plans to help new ventures before they get into trouble.

A native of Weeping Water, Neb., Wiles was graduated from the University of Nebraska with a bachelor's degree in mathematics and chemistry in 1940 and a master's in organic chemistry in 1941. After 10 years as a research chemist and applications engineer with Shell Development Co., he joined Goodall-Electric in Ogallala, Neb., where he rose to become president of the capacitor manufacturer. In 1960, Wiles sold his firm to TRW Inc. and spent the next 12 years in key marketing and management posts for that firm, the last as vice president and general manager of the TRW Electronic Components Group.

**On his own.** "When I left TRW, I had the idea I wanted to run my own company again," he recalls. So he immediately formed Q. T. Wiles & Associates, a manufacturers' representative firm that was recently sold to an employee group, and Q. T. Consultants Inc., a management consulting firm of which he is the sole employee. In this latter role, he has taken over four companies: linear integrated-circuit and converter products producer Redcor Corp. of Concord, Calif.; radio-frequency-interference filter manufacturer Corcom Inc. of Libertyville, Ill.; patient-monitoring equipment supplier Spacelabs Inc. of Chatsworth, Calif.; and telecommunications equipment producer Granger Associates of Santa Clara, Calif.

"The world started recognizing what I was doing when I came to Granger," says Wiles, who became chairman and chief executive officer



**Experience.** Q. T. Wiles's latest project is fledgling VLSI Technology.

last March. Since then, the firm has gone from an annual rate of under \$20 million to about \$33 million.

Wiles, who says he measures himself by financial success, lives with his wife in Palm Springs, Calif. He is also a limited partner in Hambrecht & Quest Co. of San Francisco, an investment banking firm that is one of six principal investors in Santa Clara-based VLSI Technology.

. . . as Balletto, as president, directs the design firm

Meanwhile, the daily business of running VLSI Technology is in the hands of Jack C. Balletto, who formed the new firm along with fellow Synertek Inc. cofounders Dan Floyd and Gunnar Wetlesen.

According to Balletto, a 40-year-old native of San Francisco who received his bachelor's degree in electrical engineering from the University of Santa Clara in 1962 and his master's from the same school in 1967, the Santa Clara, Calif., firm has a three-pronged charter: to provide original-equipment manufacturers with tools and training to design their own systems on a chip; to design circuits for customers with no or overloaded in-house capabilities; and to produce products that can be customized, such as mask-programmable read-only memories and gate arrays in high-density n-channel



# PDP-11<sup>®</sup> and LSI-11<sup>®</sup> TAPE and DISK CONTROLLERS

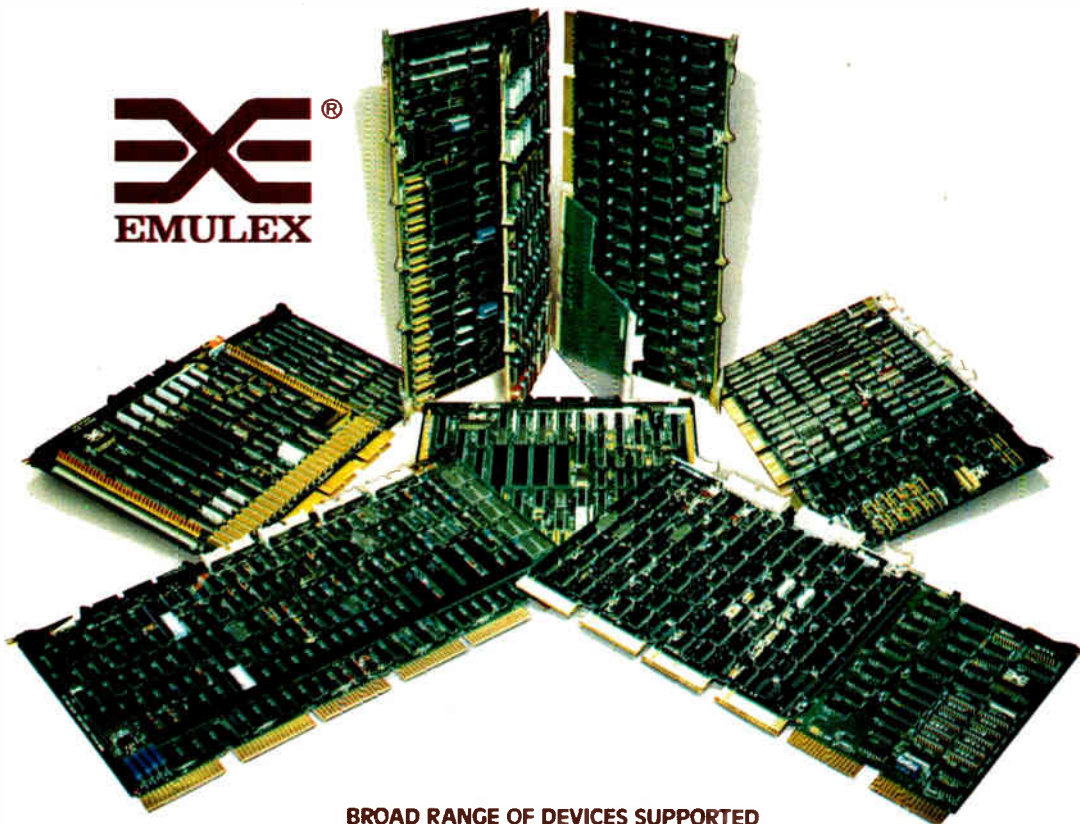

## AUTHORIZED EMULEX DISTRIBUTOR

First Computer Corporation, the world's leading DEC computer system integrator now distributes the complete spectrum of EMULEX Tape and Disk controllers for the PDP-11 and LSI-11 family of computers.

## HARDWARE/SOFTWARE TRANSPARENCY

These microprogrammed, emulating Tape and Disk Controllers are fully software transparent to both the PDP-11 hardware and software. The use of these controllers protects you from the impact of future versions of the operating system software. They are so compatible you can plug them into your system and be up and running the standard DEC diagnostics and operating systems in minutes.

## ADDED FEATURES

These controllers provide you with added features such as automatic self-testing, onboard pack formatting, and programmable bandwidth control at no additional cost.

® Registered trademark of Emulex Corporation  
® Registered trademark of Digital Equipment Corporation  
™ Trademark First Computer Corporation

## BROAD RANGE OF DEVICES SUPPORTED

It makes no difference which of the DEC PDP-11 or LSI-11 family you are using or which type of storage device is required for your application. We can support 59 different drives from 13 different manufacturers.

## HIGHEST QUALITY AND SUPER RELIABILITY

You can be assured of the quality and reliability of these Tape and Disk Controllers because First Computer Corporation specializes in PDP-11 and LSI-11 computer systems, components, and peripherals. Over the years our reputation was built on the quality and reliability of the products we sell. We continue to protect this reputation by selling only the very best.

## SUPER FAST SERVICE

Because we are the largest system integrator specializing in PDP-11 and LSI-11 systems, components, and peripherals, First Computer Corporation can satisfy most of your Tape and Disk Controller requirements directly from our stock.

## GUARANTEED SATISFACTION

Your satisfaction is fully guaranteed by First Computer Corporation. We believe in every product we sell. If for any reason these Tape and Disk Controllers do not meet your expectations, simply return them freight prepaid and insured, within 10 days of receipt and we will refund your money in full. First Computer Corporation backs each of these products with a full one year warranty.

## AUTHORIZED REPRESENTATIVES AND DEALERS

Authorized EMULEX Sales Representatives earn full commissions for orders filled by First Computer Corporation. Attractive Dealer discounts are available to all Authorized EMULEX Dealers.

## PRICE AND PERFORMANCE

You pay no more for First Computer Corporation service. Write or call today for our free EMULEX Buyer's Guide.



**First computer corporation**

corporate square / 825 north cass avenue / westmont, illinois 60559 / (312) 920-1050

TWX NUMBER 910-651-1916

CE3

**SOUTHERN REGION**  
Houston, TX (713) 960-1050

**WESTERN REGION**  
California (To be announced)

**NORTH CENTRAL REGION**  
Chicago, IL (312) 920-1050

Electronics / April 7, 1981

Circle 15 on reader service card 15

After 204 years of independence, are we more dependent than ever?



America fought long and hard for her independence. And in that war, some say the Kentucky long rifle was the gun that turned the tide in our favor.

Today we're fighting another kind of battle . . . one for economic freedom. Purchasing products manufactured in the U.S., like Wabash relays, can help end our dependence on foreign nations.

Wabash relays are 100% American made. Because we're closer, we can offer faster delivery and better service . . . plus quality and selection unsurpassed in the industry. Best of all, Wabash relays are priced competitively with those manufactured outside the U.S.

Make your declaration of independence, and get a better relay in the bargain. Give Wabash a call.

**Wabash Relay & Electronics**  
 First and Wabster Streets  
 Wabash, Indiana 46992  
 (219) 563-2191

**wabash**<sup>®</sup>  
 The Reed Relay Specialists

Circle 16 on reader service card

**People**



**Triple target.** Jack C. Balletto sheets VLSI Technology toward three-pronged goal.

MOS and complementary-MOS technologies. That charter is designed to take advantage of what he foresees as another revolution coming upon the industry, as happened with microprocessors 10 years ago.

**Experienced.** Balletto bases that prediction on broad experience. He joined Western Microwave Laboratories in 1965 as a senior design engineer and one year later joined the Philco-Ford Microelectronics division, where he became MOS marketing engineer. By early 1969, he was working as MOS product marketing manager for Fairchild Semiconductor. He left there in 1972 and in 1973 helped found Synertek.

As for the coming revolution, Balletto says, "As an industry, we transferred much of the microsystem's design burden to the customer, who previously had a collection of standard parts from which to design systems. Microprocessor complexity was at such a level that semiconductor makers had a problem defining standard products, aside from the general-purpose functions that went into a processor chip."

Similarly, he says, with very large-scale integrated circuits, "the definition and design of special-function chips will be even more horrendous than it was 10 years ago, and customers will have to get more involved in hardware and software designs. They will have to do these chips themselves." He expects that will be where the design tools and aids from his firm will come in. □

CUT OUT AND SAVE

# SELF-RETAINING RIBBED CAGE JACKS

Only From **CAMBION!**

Configuration	Jack Size	Cambion P/N	Recommended Mounting Hole Dia.	Length & Major Dia.
Copper Body	.025	450-3983	.055 ± .001 #54 Drill	O.A. length: .158 Major dia: .074
Brass Body	.030/ .032	450-3998	.071 ± .001 #48 Drill	O.A. length: .206 Major dia: .090
Copper Body (5-Leaf Contact)	.040	450-1800	.073 #49 Drill	Short profile O.A. length: .143 Major dia: .092
Brass Body	.040	450-3729	.076 ± .001 #48 Drill	O.A. length: .206 Major dia: .090
Brass Body	.040	450-3752	.076 ± .001 #48 Drill	O.A. length: .206 Major dia: .090

As a component mounting connector, Cambion's exclusive Self-retaining Ribbed Cage Jacks retain mounting position in PC boards during wave soldering operations. They can be utilized in .031, .062, .094, and .125 PC boards. Available in either gold, electrotin or gold cage/tin body finishes. Ask for evaluation samples today from over 100 Cambion distributors and get the 20-page CAGE JACK CATALOG now!

CAMBION

The Right Connection.

Cambridge Thermionic Corporation  
 445 Concord Avenue/Cambridge, MA 02238  
 Tel: (617) 491-5400. Telex: 92-1480. TWX: (710) 320-6399

16 Circle 229 on reader service card

# Did you know Mepco//Electra can replace that low power, ultra precision wire wound resistor in your circuit for about 35% less?

Advanced technology at a savings for you! And performance specs worth checking. Take a look! Our Ultra Precision Resistors have the following:

#### Electrical Specifications:

**power ratings:**  
1/20w 1/10w  
**resistance range:**  
100Ω to 301 KΩ  
**temperature coefficient:** Down to 5 PPM/°C  
**resistance tolerance:**  
± 1% to ± 0.025%  
**insulation resistance:**  
> 1000 MΩ  
**Johnson noise:** < -35 db  
**voltage coefficient:**  
≤ -0.1 PPM/V  
**thermal Em F:** < 2 μV/°C

#### Stability Specifications:

(test conditions per Mil-R-10509)  
**1000 hr. load life 85°:**  $\Delta R \pm 0.01\%$   
**Moisture resistance:**  $\Delta R \pm 0.04\%$   
**Temp. Cycle (-55°C to +165°C):**  $\Delta R \pm .005\%$   
**Low Temp. Operation:**  $\Delta R \pm 0.01\%$   
**Effects of Solder:**  $\Delta R \pm 0.01\%$   
**Short Time Overload:**  $\Delta R \pm 0.01\%$   
**Dielectric Withstanding Voltage:**  $\Delta R \pm 0.01\%$   
**Shock & Vibration:**  $\Delta R \pm 0.01\%$   
**1 Year Shelf Life:**  $\Delta R < 30$  PPM  
And precision matched sets are available with resistance ratio match tolerances to 0.02% and

**temperature coefficient tracking to 2 PPM/°C.** That's maximum performance at a minimum price! Think Mepco/Electra for all your ultra precision and matched set resistor needs. Need more details?

Call our Texas facility at (817) 325-7871 now.

**Mepco/Electra: your resistor/capacitor company with tomorrow's technology today.**



Corporate Headquarters  
Columbia Road  
Morristown, New Jersey 07960  
(201) 539-2000  
TWX: 710/986/7437



1/10W, ±0.25%,  
± 5PPM/°C,  
Wire Wound Resistor  
\$1.00

1/10W, ±0.25%,  
± 5PPM/°C,  
Metal Film Resistor  
\$.65

© Copyright, 1981 Mepco/Electra, Inc.

## Now you do!

Circle 17 on reader service card



# Intel's new E<sup>2</sup>PROM. We window, to open endless

**Intel introduces the 2816: the in-circuit Electrically Erasable 16K E<sup>2</sup>PROM that's both byte- and chip-erasable. Available in quantity today.**

For years, system flexibility has been limited by both ROMs and EPROMs. But no more. Now, Intel's 2816 E<sup>2</sup>PROM combines in-circuit alterability and non-volatility, providing functionality that will advance today's high-performance microprocessor designs. This makes the 2816 a natural to replace conventional ROMs and EPROMs as the standard storage medium for programs. And opens the doors to a whole new generation of non-volatile memory applications.

**For systems smart enough to learn from experience**

The 2816 E<sup>2</sup>PROM will revolutionize microprocessor system design. Now systems can be dynamically reconfigured—without human intervention. Consider the possibilities.

In industrial process control, equipment can be self-calibrating; machine tools, self-adjusting. In military and commercial aircraft, flight coordinates or radio frequencies can be changed remotely. In retail stores, point-of-sale terminals

can have pricing tables updated instantly. In harsh industrial and manufacturing environments, programmable robots can make use of self-diagnosing/self-correcting feedback loops. The

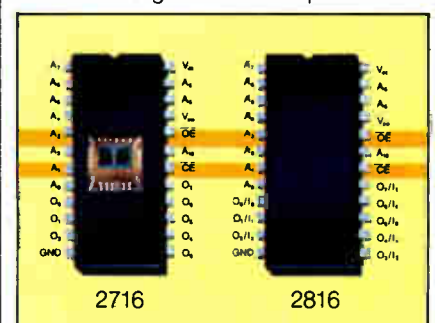

*Pin compatibility of Intel's 2716 and 2816*

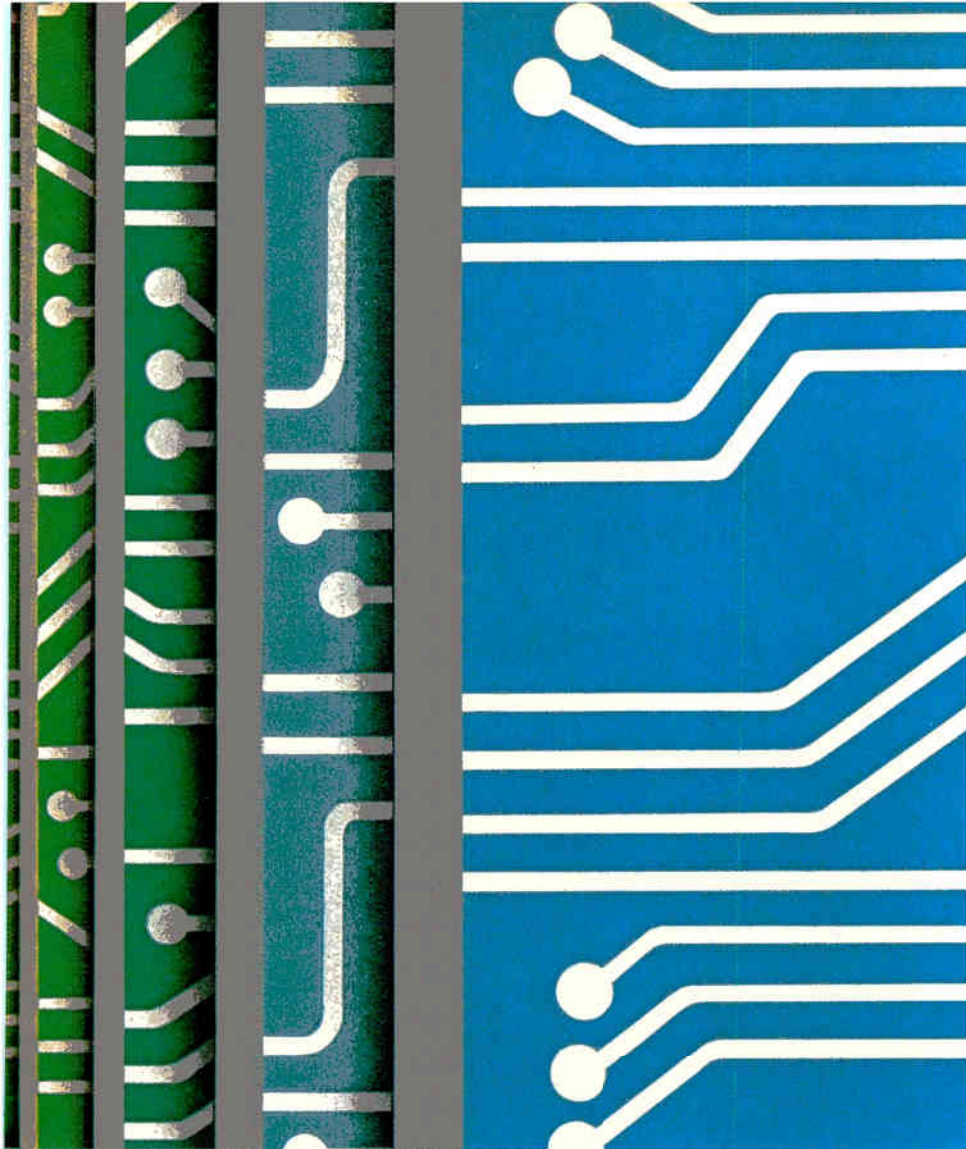

# closed the design doors.

potential for convenient, low-cost system reconfiguration is enormous, for both OEM and end-user alike.

## An exponential increase in design options

What are the E<sup>2</sup> advantages to designers? First, reprogramming flexibility. The 2816 can be reprogrammed electrically in the field, without interrupting in-service equipment operation. Or it can be reprogrammed remotely, via telecom or datacom links. Thus saving the labor and system downtime costs usually incurred with changing code in the field.

Second, the 2816 is both byte- and chip-erasable. Each byte can be rewritten up

to 10,000 times, leading to simpler, more flexible systems. And reprogramming is fast: a single-byte program edit takes only 20 ms.

Third, the 2816 has the same reliability and data integrity as all non-volatile Intel memories. This reliability is a result of the 2816's floating-gate tunnel oxide (Flotox) cell structure and ten years of Intel experience in EPROM manufacturing. And unlike some other non-volatile ROMs, the 2816 does not require data rewrite to insure integrity. It will retain its data for at least 20 years—regardless of read frequency—without refreshing. And this kind of reliability—coupled with improved performance—will make the 2816 the industry standard

for all program memories.

## A match for today's micros

The 2816 is pin-compatible with the Intel® 2716. So it gives you all the micro-processor-oriented features that have made the 2716 the industry standard among EPROMs.

The 2816 also has the industry's fastest standard access time: 250 ns. And its two-line control eliminates bus contention between address and data lines. Plus it's low power. Thus changing existing concepts of memory storage and enabling designers to take full advantage of powerful new micro-processor capabilities, like those of the 8088 and 8086.

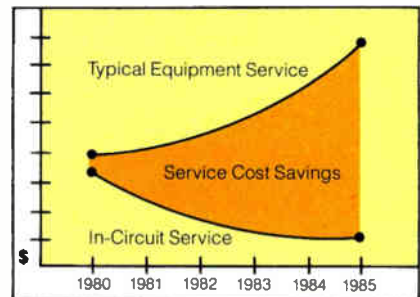

Typical software service costs

## Remote reconfigurability in the here and now

Although the 2816 offers revolutionary capabilities, it's also the practical choice for microprocessor designs in the here and now. It's manufactured by Intel's proven HMOS\*E process. So you know it will follow the classical learning curve of a mainstream semiconductor technology.

To help you get started designing-in 2816s today, Intel provides full applications support and documentation. For instrumentation and control applications, we've already incorporated the E<sup>2</sup>PROM on an iSBC 88/40™ single-board computer.

We've closed the window; now you can open totally new design doors, and watch the world beat a path to your products. The 2816 E<sup>2</sup>PROM is available from stock through your local Intel distributor or Intel sales office. Or for further information, contact Intel Corporation, 3065 Bowers Avenue, Santa Clara, CA 95051. Telephone (408) 987-8080.

\*HMOS is a patented Intel process.

Europe: Intel International, Brussels, Belgium.  
Japan: Intel Japan, Tokyo. United States and Canadian distributors: Alliance, Almac/Stroum, Arrow Electronics, Avnet Electronics, Component Specialties, Hamilton/Avnet, Hamilton/Electro Sales, Harvey, Industrial Components, Pioneer, L.A. Varah, Wyle Distribution Group, Zentronics.

**intel** delivers solutions

Circle 19 on reader service card

**Fast, automatic in-circuit test programming.**

Now the TROUBLESHOOTER 800™ gives you the industry's most automatic program generation software—so fast and accurate we call it THE PRODUCER.

In a matter of hours, THE PRODUCER can create complex test programs that might tie up other testers for days, even weeks.

And all it needs is a little help from a trained assembly

technician. Test engineers are freed for more cost-effective, high-level tasks.

**Friendly and forgiving software.**

Test programming is fast, easy and frustration-free, with simple step-by-step CRT prompting and built-in error safeguards.

Input list preparation is a simple process of entering component identification, then probing the device on the board with a DIP clip or single-conductor probe.

THE PRODUCER automatically learns the test node location for each pin or lead, and generates the shorts and continuities test for the entire board immediately.

When the input list is complete, THE PRODUCER does the rest: checks syntax, automatically computes proper guard points, and selects the appropriate test module for each analog and digital component from its vast internal library.

# ***Free test programmer in every box.***

*Meet THE PRODUCER,™ Zehntel's new program generator.  
It's like adding a skilled programmer to your test staff.*



Your completed test program is recorded automatically on a diskette and is ready for special fine-tuning and production testing.

**Free library updates.**

THE PRODUCER's library currently contains test elements for hundreds of popular analog and digital components. Library updates for new devices are supplied regularly, free of charge. Special or custom test templates

for your proprietary components are easy to develop and store in your library for future use.

**Cut your overhead costs.**

THE PRODUCER lets you spend less time programming and more time testing boards in production. That means you get your product to market faster and within budget.

Find out more about the industry's most production-minded

in-circuit tester—send for our TROUBLESHOOTER 800 brochure.

Write or call PLANTRONICS / Zehntel, 2625 Shadelands Drive, Walnut Creek, CA 94598, (415) 932-6900.



PLANTRONICS  
Zehntel

Circle 21 on reader service card



# TROUBLESHOOTER 800

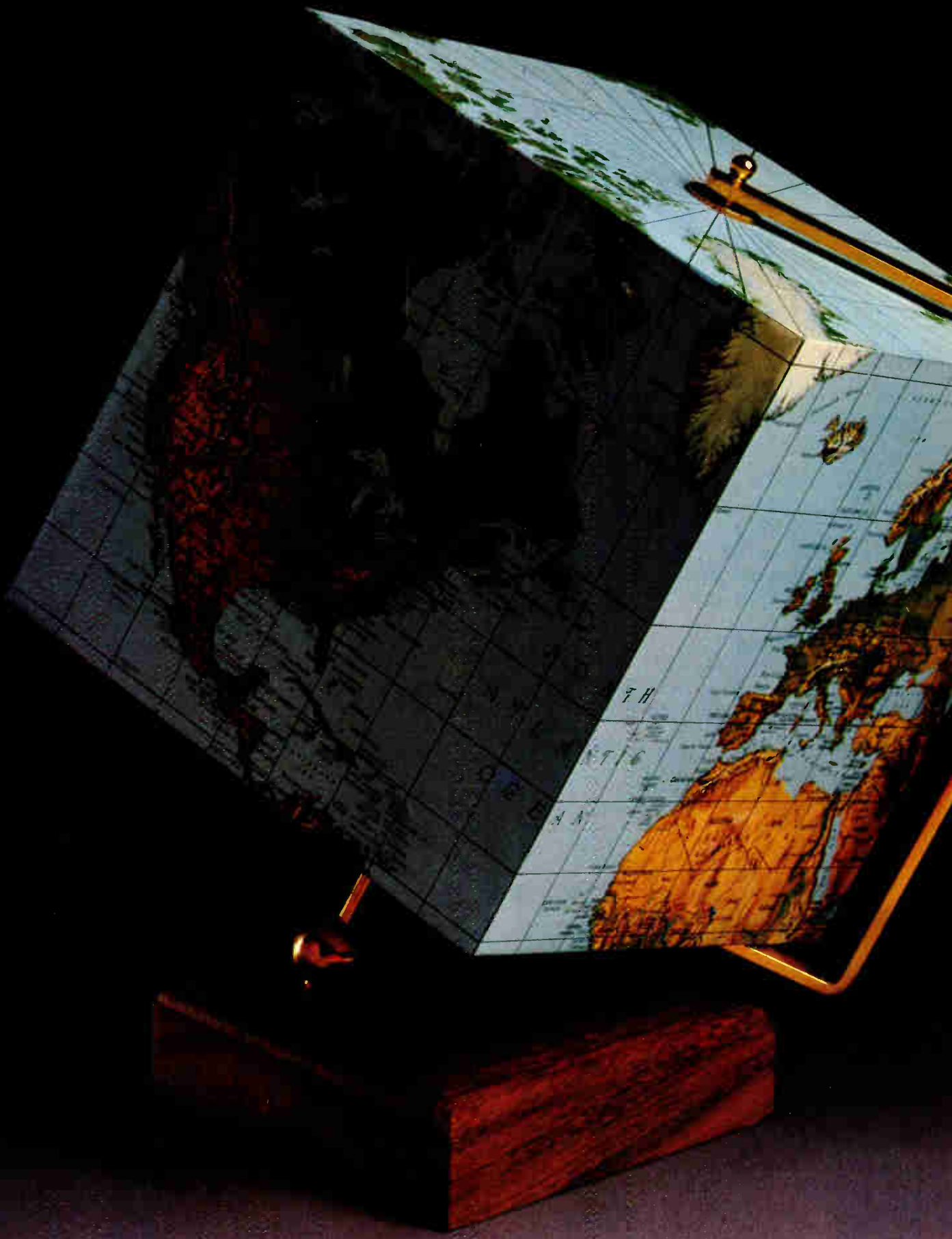



# When C. Columbus challenged the status quo, a surprising thing happened to our world.

Surprising things do happen when people challenge the status quo. And often, good things happen as a result.

HP would like to ask you to challenge the status quo . . . in oscilloscopes. You may discover some pleasant surprises, and displace some earlier disappointments too. Because, like the shape of the 15th century world, HP Oscilloscopes have changed . . . dramatically. Here's how:

**Triggering.** Today, HP Oscilloscopes offer excellent triggering on difficult signals because of HP advances in micro-circuit design. That also means triggering that's essentially unaffected by changes in trace position or temperature variation. Third channel trigger view, on many HP scopes, lets you see the fidelity of the triggering waveform, and also make timing measurements from it.

**Reliability.** You've told us you wanted improved reliability. We listened. The result is improved MTBF. Today, thousands of quality 1700 Series Oscilloscopes are delivering the reliable, day-to-day performance you expect from HP.

**Signal fidelity.** With most scopes, matching input impedances requires an external 50  $\Omega$  termination. On the HP 1700 Series, and our new fully programmable 1980 Oscilloscope Measurement System, switchable 50  $\Omega$  input terminations are built in to insure faithful reproduction of input signals.

**Value.** Put a 1700 Series Oscilloscope next to any comparable general-purpose scope of your choice

and compare the price/performance ratio for yourself. Because HP designs and builds the critical components, you get quality performance. Many HP scopes have Delta Time capability that provides fast time interval measurements while minimizing errors. The 1743A incorporates HP counter technology for precision and semi-automatic timing measurements. For viewing low-rep-rate signals and single-shot events, HP's 1741A, 1744A, and 1727A Storage Oscilloscopes, with fast writing, integrating, variable persistence operation, provide well-defined, easily viewed traces in applications which may otherwise result in annoying flicker, or require a viewing hood or camera. What's more, with HP's storage technology there is no transfer time or reduction of variable persistence writing speed, so you won't miss the signals you're after.

**See for yourself.** HP scopes have changed. And you owe it to yourself to challenge the status quo before you buy another general-purpose oscilloscope. But don't take our word for it. Call an HP Field Engineer for a hands-on demonstration of a new 1700 Series Oscilloscope. Then judge for yourself. Ask about the 1980 Oscilloscope Measure-

ment System, too. Find out how its fully programmable operation can help you deal with some of today's productivity problems.

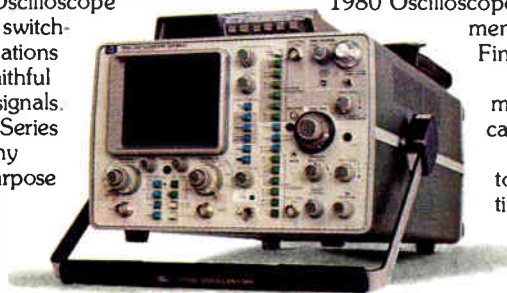

## Challenge the status quo and get a square-world mug. Free.

If you're considering the purchase of an oscilloscope, call an HP Field Engineer or use our coupon for a no-obligation demonstration. In return, we'll give you a distinctive square-world coffee mug.



I would like to challenge the status quo. Contact me for a no-obligation demo of an HP Oscilloscope. And yes, I want a square-world mug. E 4/7

NAME \_\_\_\_\_ TITLE \_\_\_\_\_

COMPANY \_\_\_\_\_

PHONE \_\_\_\_\_

ADDRESS \_\_\_\_\_

CITY/STATE \_\_\_\_\_

I initiate and/or approve oscilloscope purchases  Yes  No

Mail coupon to: Hewlett-Packard, P.O. Box 2197, Colorado Springs, CO 80901, Attn: Oscilloscope Marketing Manager. Offer expires June 30, 1981. Valid in U.S.A. and Canada only.

Circle 23 on reader service card

## Hurdling the productivity barrier

Experts as well as politicians have for years been seeking the key to increasing the productivity of the American industrial worker. Now, the Semiconductor Industry Association has made a survey showing that the semiconductor industry is not part of the problem of sluggish productivity, and in fact it may very well have the solution.

The SIA's figures indicate circuit makers know what they are doing. According to their figures, productivity (measured as value added per employee) increased at a compound rate of 22.7% per year from 1975 through 1979, the latest year for which those figures are complete. The report also shows that semiconductor sales per employee went up from \$18,300 in 1975 to \$29,000 in 1980, a compound annual increase of 12.3%. By comparison, growth in output per employee in the rest of the manufacturing sector from 1975 through 1979 has been about 9% and has actually been dropping slightly since 1978.

## More power to you

Power electronics, long considered a more staid, less glamorous field of engineering, is undergoing a resurgence of sorts, to judge by the rush to bring new energy-efficient machine controls and power-conversion devices and components to market. As infusions of digital microelectronics and advances in power semiconductors perk up the field (see p. 97), it is becoming apparent that electronic technology and the much older technology of electrical generation and transmission are destined to become partners in solving what may become one of the most significant problems facing the U. S.

Toward the end of this decade, this country's demand for electrical power will move beyond its generating capability. There are many complex reasons for this, none of which has anything to do with OPEC or oil or even technology. The fact is, the U. S. just has not been building enough generating capacity to meet the projected

The increase in real output per person for the entire U. S. economy in the same period has been a flat 5%.

What's behind the striking contrast? The semiconductor industry is making two major thrusts through the productivity barrier that the rest of American industry might profitably copy: a little more automation and process refinement.

The newer, more automated equipment being purchased by the circuit makers is costly, but it pays off in the long run—when fewer persons handle a product, it gets out the door more quickly and at a higher quality level. And when the manufacturing process itself becomes better and more efficient, there are fewer rejects to dilute the profit margin.

U. S. industry must start down the automation and process-refinement path. Taking the initial steps may be painful, but the alternative is oblivion.

demand. It takes 14 years to plan, build, certify, and get a nuclear power plant running, and even if that controversial source of energy were to become acceptable to everyone today, it is impossible to get enough new plants in operation soon enough to ward off the looming system overload. Although the conventional power plant takes less time to build, the economic roadblocks to financing them are formidable.

So, along about 1987, electric utilities will find peak demands pushing dangerously close to overload, and when that happens, they will simply take the only option available: cut the load. To do that without disrupting vital industrial and commercial activity, creating havoc in transportation, or inducing blackouts will require sophisticated sensing and control. This is an obvious role for electronics. The power-short era is not far away. Electronic technology must be ready to meet its challenge.

# NEW BIOMATION K500-D

## Introducing the world's fastest logic analyzer. Incomparable.

### 500 MHz for debugging mainframes and super-minis.

Now you can dramatically shorten the debug cycle in high-speed random and stored program logic design with our powerful new 500 MHz, 8-channel K500-D. With state-of-the-art 16-bit microprocessor control, 2K static RAM memory and GPIB interface for fully-automated operation, the K500-D is the industry's most advanced integrated test tool for the digital designer.

### Resolution to 2ns.

Clocking via internal time base, or with your superfast system clock, the K500-D gives you the best timing resolution available in a logic analyzer today. Glitches, transitions and other critical events can be

captured and sampled every two nanoseconds. You can even track a channel of analog activity at the same time for troubleshooting analog digital interface, or for high speed cause-and-effect relationships. Two trigger levels gives you precise data trapping.

### Advanced probe design.

Our probes were designed for high performance to cope with the speed and complexity of large systems, as well as complement the super high speed of the K500-D. Now, with 6-foot probes and hybrid buffering circuits in each probe tip, you can conveniently debug even the largest systems with minimum disturbance. With our unique scroll mode, you can probe hard-to-reach test points individually and build your timing diagram one channel at a time.

### Legendary ease-of-use.

Our new K500-D is even easier to use than our best-selling K100-D and that's saying something. Its status and data displays permit easy, flexible programming and data analysis. You can expand horizontally X10, X20, or X50, and specify the display format in binary, octal and/or ASCII.



### You owe it to yourself.

Any designer debugging mainframes or super-minis deserves full details on this revolutionary new logic analyzer. Write Gould, Inc., Bionation Division, 4600 Old Ironsides Drive, Santa Clara, CA 95050. Or call (408) 988-6800.



 **GOULD**  
An Electrical/Electronics Company  
Circle 25 on reader service card

## Meetings

**NCC '81—National Computer Conference and Personal Computing Festival**, American Federation of Information Processing Societies (P. O. Box 9658, 1815 N. Lynn St., Arlington, Va. 22209), McCormick Place, Chicago, May 4–7.

**PICA/81—12th Power Industry Computer Applications Conference**, IEEE Marriott Philadelphia, Philadelphia, May 5–8.

**AAMI 16th Annual Meeting and Exhibit**, Association for the Advancement of Medical Instrumentation (1901 N. Fort Myer Dr., Suite 602, Arlington, Va. 22209), Sheraton Washington Hotel, Washington, D. C., May 10–13.

**The European Consumer Electronics Show**, Industrial and Trade Fairs Ltd. (Radcliffe House, Blenheim Court, Solihull, West Midlands B91 2BG, England), Nuremberg, West Germany, May 10–13.

**34th Annual Conference**, Society of Photographic Scientists and Engineers (7003 Kilworth Lane, Springfield, Va. 22151), Grand Hyatt Hotel, New York, May 10–14.

**CICC '81—Custom Integrated Circuits Conference**, IEEE, Americana Hotel Rochester, Rochester, N.Y., May 11–13.

**31st ECC—Electronic Components Conference**, EIA and IEEE, Colony Square Hotel, Atlanta, May 11–13.

**Intermag 81—International Magnetics Conference**, IEEE *et al.*, Alpes-Congrès, Grenoble, France, May 12–15.

**Eighth Annual International Symposium on Computer Architecture**, Association for Computing Machinery and IEEE, Holiday Inn, Minneapolis, May 12–14.

**15th IEEE Photovoltaic Specialists Conference**, IEEE, Hyatt Orlando, Orlando, Fla., May 12–15.

**18th All Japan Optical Measuring**

**Instruments Fair**, Japan Optical Measuring Instruments Manufacturers' Association, (3-5-8 Shiba Koen, Minato-ku, Tokyo 105, Japan), Science Museum, Chiyoda-ku, Tokyo, May 13–15.

**56th Business Show**, Nippon Administrative Management Association (4-1-13 Sendagaya, Shibuya-ku, Tokyo 151, Japan), Tokyo International Fair Grounds, Chuo-ku, Tokyo, May 13–16.

**Computer Security Initiative Seminar**, National Bureau of Standards and Department of Defense (D. K. Branstad, A-265 Technology Building, NBS, Washington, D. C. 20234) NBS, Gaithersburg, Md., May 18–20.

**ISA Power Industry Division's National Symposium**, Instrument Society of America (67 Alexander Drive, P. O. Box 12277, Research Triangle Park, N. C. 27709), Hyatt Pittsburgh Hotel, Pittsburgh, Pa., May 18–20.

**1981 IEEE International Conference on Plasma Science**, IEEE, Sweeney Convention Center, Santa Fe, N. M., May 18–20.

**Automan 81—First European Automated Manufacturing Exhibition and Conference**, British Robot Association and IFS Conferences Ltd. (35–39 High St., Kempston, Bedford MK42 7BT, England), Exhibition Centre, Brighton, England, May 18–21.

**First European Conference on Cine-radiography with Protons or Particles**, L'Association Nationale de la Recherche Technique (ANRT, 109 Ave. Raymond Poincaré, 75116 Paris, France), Tour Olivier de Serres, Paris, May 19–21.

**Naecon 81—National Aerospace and Electronics Conference**, IEEE *et al.*, Dayton Convention Center, Dayton, Ohio, May 19–21.

**Semicon/West 1981**, Semiconductor Equipment and Materials Institute

Inc. (625 Ellis St., Suite 212, Mountain View, Calif. 94043), San Mateo Fairgrounds and Bay Meadows Race Track, San Mateo, Calif., May 19–21.

**Videotex '81**, Infomart (122 St. Patrick St., Toronto, Ont. M5T 2X8, Canada) and Online Conferences Ltd. (Argyle House, Northwood Hills, Middlesex HA6 1TS, England), Royal York Hotel, Toronto, May 20–22.

**Third European Conference on Hybrid Microelectronics**, International Society for Hybrid Microelectronics (Dr. Dreyfus-Alain, ISHM; 11 rue Hamelin, 75116 Paris, France), Palais des Papes, Avignon, France, May 20–22.

**Ninth World Congress of the International Measurement Confederation**, (VDI/VDE Gesellschaft Messund Regelungstechnik, Graf-Recke-Strasse 84, P. O. Box 1139, D-4000 Düsseldorf 1, West Germany), International Congress Center, West Berlin, May 24–28.

### Seminars

**High Technology Export Seminars**, EIA (2001 Eye St. N. W., Washington, D. C. 20006), Hyatt Riskeyes, Palo Alto, Calif., May 19; Marriott O'Hare Inn, Chicago, June 25; Boston, Dallas, and Los Angeles, dates to be announced.

**Telecommunications: Trends and Directions**, EIA (2001 Eye St. N. W., Washington, D. C. 20006), Dunfey's Hyannis Hotel, Hyannis, Mass., May 26–28.

**Advances in Software Technology**, IEEE and National Bureau of Standards, NBS, Gaithersburg, Md., May 28.

**Fiber Optic Communications and Sensor Applications for Military and Government Markets**, Kessler Marketing Intelligence (22 Farewell St., Newport, R. I. 02840), Sheraton-Islander Inn, Newport, R. I., May 28–29.

---

## LOW POWER TELECOM ICs

---

This telephone  
has a startling message  
for you.

# MOSTEK

---

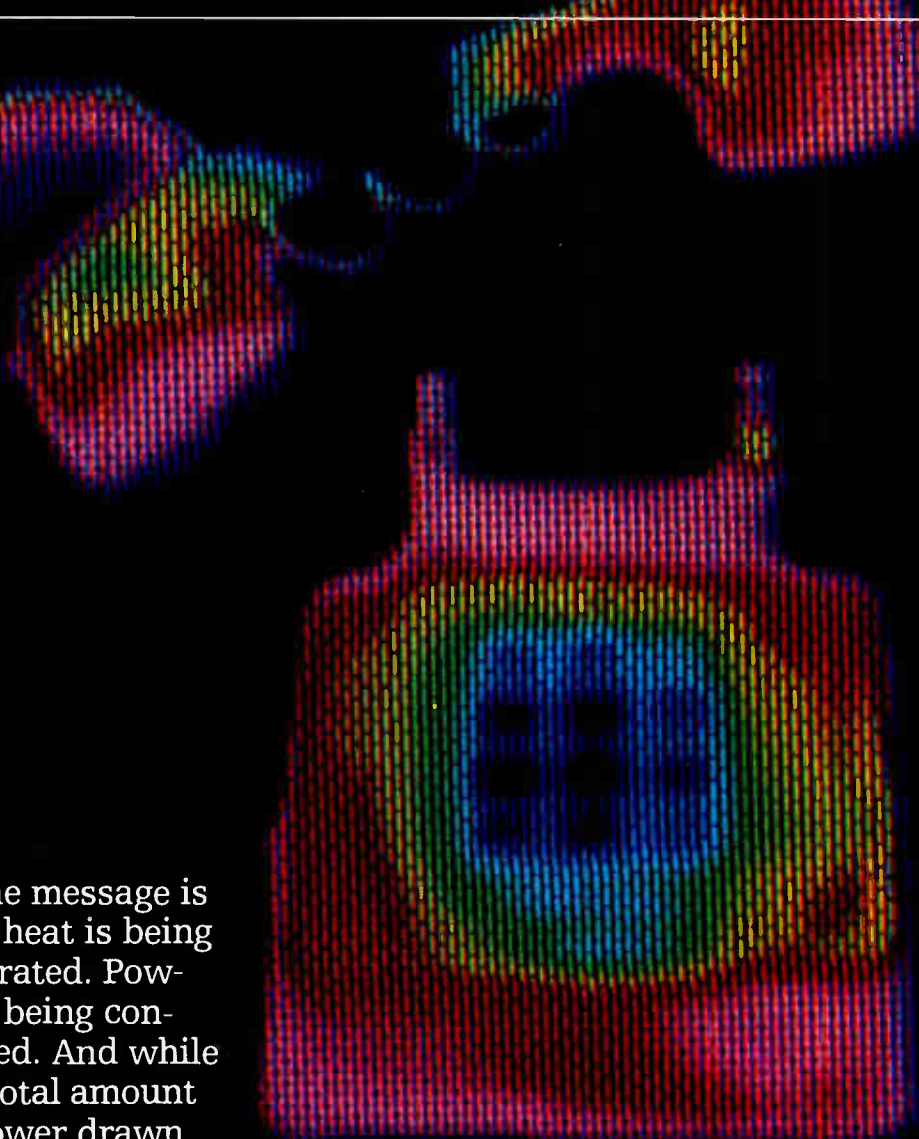

The message is that heat is being generated. Power is being consumed. And while the total amount of power drawn by telephone sets is a constant, how it is used is not. Our CMOS dialers use very little power for actual operation. Consequently, more power is available for other use. Such as powering a repository dialer. Or for data communications.

In systems such as remote switches, central

office switches, or PBXs that use thousands of CODECs and filters, power ratings and heat dissipation are critical. Which is why three out of five telecom majors chose the Mostek low power CODEC.

The point is that we know low power is criti-

cal to the telecommunications industry. Our circuits reflect it. Our broad product line incorporates it. Our track record proves it. And our extensive manufacturing capacity backs it up.

Hear the low power telecom message by calling or writing Mostek Corporation, 1215 West Crosby Road, Carrollton, Texas 75006; phone (214) 323-1000. In Europe, contact Mostek Brussels; phone 762.18.80.

# New powers of waveform analysis. From the

**(above right)** The Tektronix 468 portable digital storage oscilloscope becomes part of a powerful processing system when interfaced to the Tektronix 4052 Computer/Controller for analysis and processing.

**(above left)** Users can link the Tektronix 492P Spectrum Analyzer with the 4052 to compare accumulated displays over successive sweeps. Right at hand are high-speed analysis, plus permanent records via the Tektronix hard copiers.

**(far right)** The Tektronix 7854 Oscilloscope interfaces with the 4052 to apply high-speed floating point calculations and simultaneous display of high-resolution graphics and tabular data to the most complex analytical problems.

**(below left)** To state-of-the-art Tektronix GPIB waveform measurement instruments, you can add the analytical capabilities of the 19-inch 4054 computer/controller for problems requiring both speed and large data display; the fast 4052 for computationally intensive applications; or the economical, general-purpose 4051.

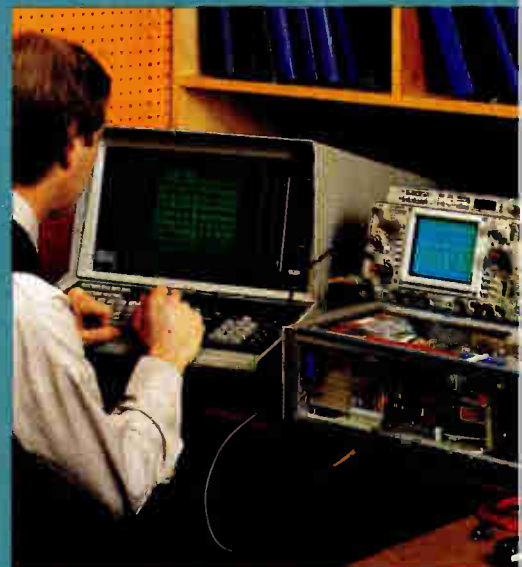

measurement expert.

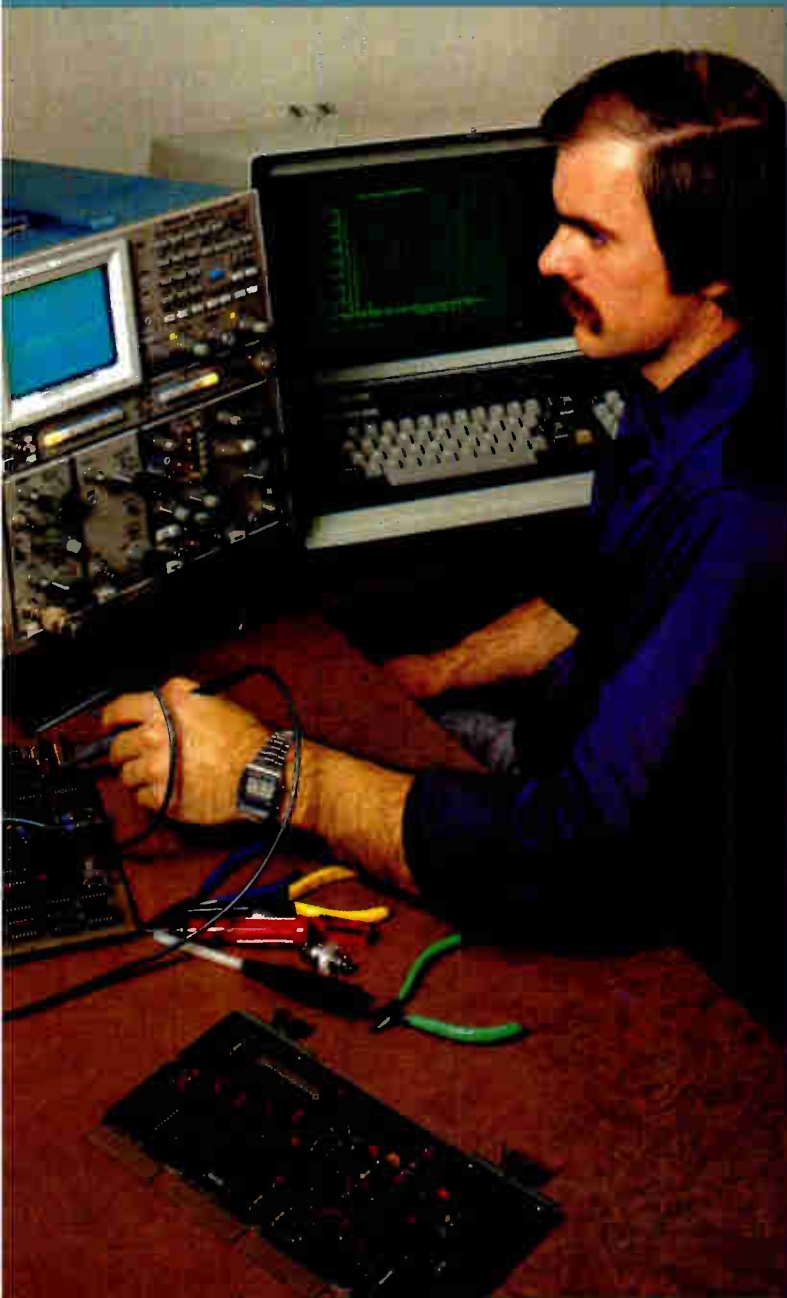

**Productivity in the  
Tektronix tradition: Graphic.  
Interactive. Easy. And fast.**

**Start with state-of-the-art GPIB instrumentation built on 35 years of Tektronix waveform measurement leadership.** Instruments like the fully programmable 492P Spectrum Analyzer. Our new 468 Oscilloscope. Or the extraordinary 400 MHz 7854 Oscilloscope. Each a huge productivity booster in its own right.

**Add the analytical power of high-speed processing and interactive graphics with Tektronix 4050 Series GPIB Computer/Controllers.** You can convert waveforms into any number of precise, storage tube graphics displays—like bode plots, log plots, histograms, Fast Fourier Transforms—so you can quickly analyze measurements.

**Result: you not only acquire data, but process, compare and literally draw conclusions with devices that are easy, even a pleasure to use.** There are no costly interface designs, difficult languages or complex procedures. Our GPIB codes and formats approach helps make our measurement instruments easy to interface and immediately compatible with each other, so engineers get results quickly no matter which devices are used.

**Let Tektronix take you from raw data to finished results—many times faster than by the methods you're using now.** For more information, contact your Tektronix Sales Engineer, or call toll-free, 1-800-547-1512 (in Oregon, 644-9051 collect).

**U.S.A., Asia, Australia, Central & South America, Japan**  
Tektronix, Inc.  
P.O. Box 1700  
Beaverton, OR 97075  
Phone: 800/547-1512  
Oregon only 800/644-9051  
Telex: 910-467-8708  
Cable: TEKTRONIX

**Canada**  
Tektronix Canada Inc.  
P.O. Box 6500  
Barrie, Ontario L4M 4V3  
Phone: 705/737-2700

**Europe, Africa, Middle East**  
Tektronix International, Inc.  
European Marketing Centre  
Postbox 827  
1180 AV Amstelveen  
The Netherlands  
Telex: 18312

**Tektronix®**  
COMMITTED TO EXCELLENCE

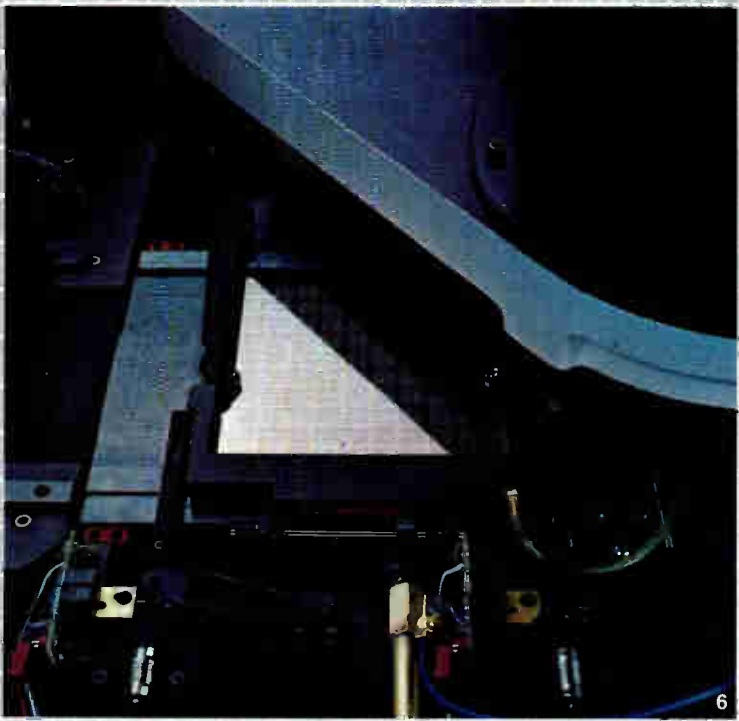
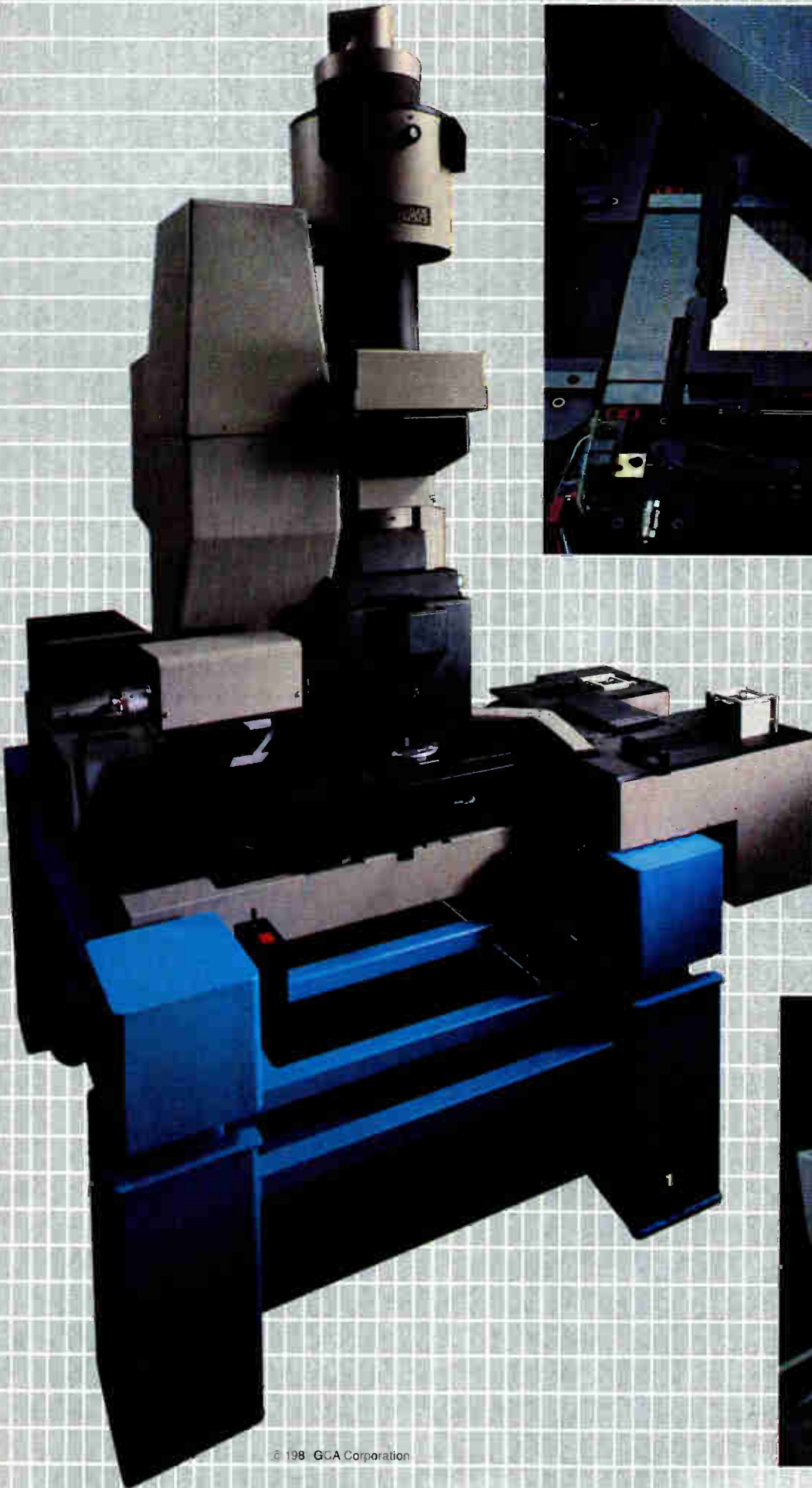

	.5	1.0	1.5	2.0	2.5	3.0	3.5	4.0	
.5	.	.	3	2	2	.	.	.	.5
1.0	.	.	.	.	.	.	1	.	1.0
1.5	.	.	.	.	.	.	.	.	1.5
2.0	1	.	.	.	.	.	.	.	2.0
2.5	.	.	.	.	.	.	.	.	2.5
3.0	.	.	.	.	.	.	.	.	3.0
3.5	.	.	4	.	.	.	.	.	3.5
4.0	.	.	.	.	1	.	.	.	4.0
.5	.	.	.	.	.	.	.	.	.5
1.0	1	.	.	.	.	1	.	.	1.0
1.5	.	.	.	.	.	.	2	.	1.5
2.0	.	.	.	.	.	.	.	.	2.0
2.5	.	.	.	.	.	.	.	.	2.5
3.0	.	.	.	.	.	.	.	.	3.0
3.5	.	.	.	.	.	.	.	.	3.5
4.0	.	2	.	2	.	.	.	1	4.0
	.5	1.0	1.5	2.0	2.5	3.0	3.5	4.0	





## INTRODUCING THE ONLY WAY TO CHANGE RETICLES WITHOUT CHANGING YIELDS.

Until now, there's only been one way to change reticles on a wafer stepper in a production environment. By hand. But once again, GCA is about to change the way the industry does things.

Introducing the 5510 ARC Automatic Reticle Changer—a production-oriented development that's part of the most successful microlithographic imaging system ever made—the 4800 DSW Wafer Stepper™ direct step on the wafer system.

The ARC has already proven itself in hundreds of hours of testing. But it doesn't just speed up DSW throughput. It keeps yield consistently high for maximum productivity, day in and day out.

The reason is simple. The ARC keeps operators out of the environmental chamber. And the particles of dust and dirt that go with them. It also has a number of other important features that dramatically reduce the contamination associated with manual operations.

And because the ARC can hold, change and align any one of up to ten industry standard 5" x 5" x 0.090" chrome reticles, you'll find it offers unparalleled flexibility as well.

Operation is automatic from start to finish. The software selects a reticle to be moved along a unique air-bearing track\*—untouched and uncontaminated.

A special bar code reader verifies proper circuit level sequence and correct orientation. The reticle is also inspected over its top and bottom surfaces for foreign particles by the ARC's laser scanner.\*

Positions of 5 micrometer and larger particles are instantly displayed on a video terminal or optional hard copy printout. Significantly contaminated reticles are rejected automatically but, if desired, the operator can make that decision instead. Either way, you don't have to worry about doing a production run using a reticle that can generate defects.

Just before exposure, the reticle is precisely aligned to the optical column. And the entire process for changing from one reticle to another, including alignment, takes one minute.

Another advantage is the ARC's set of Automatic Masking Aperture Blades that let you block off unwanted border areas.

In short, the Automatic Reticle Changer is much more reliable and significantly faster than manual methods. And it's just one of the industry firsts that are part of GCA's total DSW Wafer Stepper System.

So if you'd like to change for the better and be a step ahead in productivity, contact the industry leader for more facts at one of these addresses: GCA/Burlington Division, 209 Burlington Road, Bedford, MA 01730. Tel: (617) 275-5400. Sumisho Electronic Systems, Inc., Tokyo, Japan, Tel: 03-234-6211. GCA International, Kreuzlingen, Switzerland, Tel: 072-71-1585.

1. The DSW Wafer Stepper™ direct step on the wafer system.
2. The 5510 ARC Automatic Reticle Changer mounted on the DSW.
3. The cassette can hold up to 10 industry standard 5" x 5" x 0.090" chrome reticles.
4. The ARC in operation with protective covers removed.
5. A unique laser scanner inspects the entire reticle for foreign particles.
6. Each reticle is automatically aligned on the x,y, and  $\theta$  axis.
7. Locations of foreign particles are automatically displayed on a video terminal.



GCA CORPORATION  
Burlington Division

209 Burlington Rd.  
Bedford, Mass. 01730  
(617) 275-5400  
Telex: 95-1257

\*U.S. and Foreign Patents Applied For

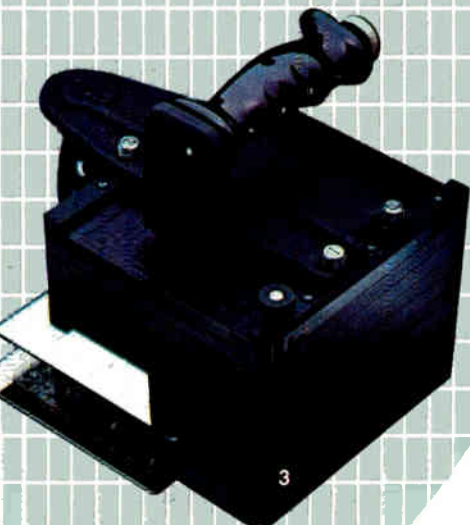
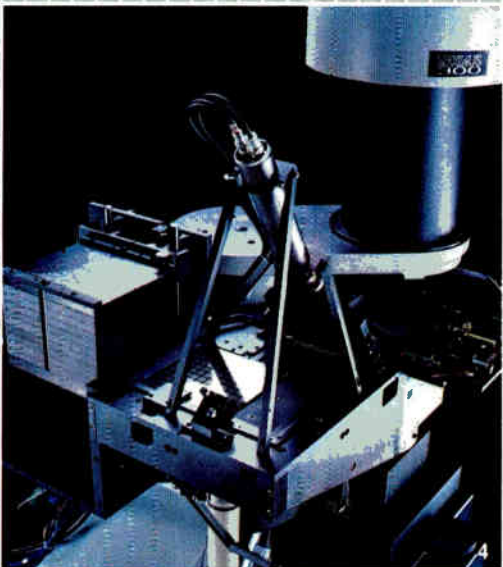
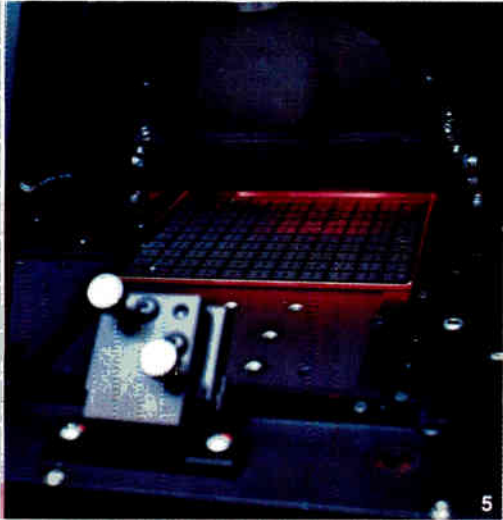

**A STEP  
AHEAD.**

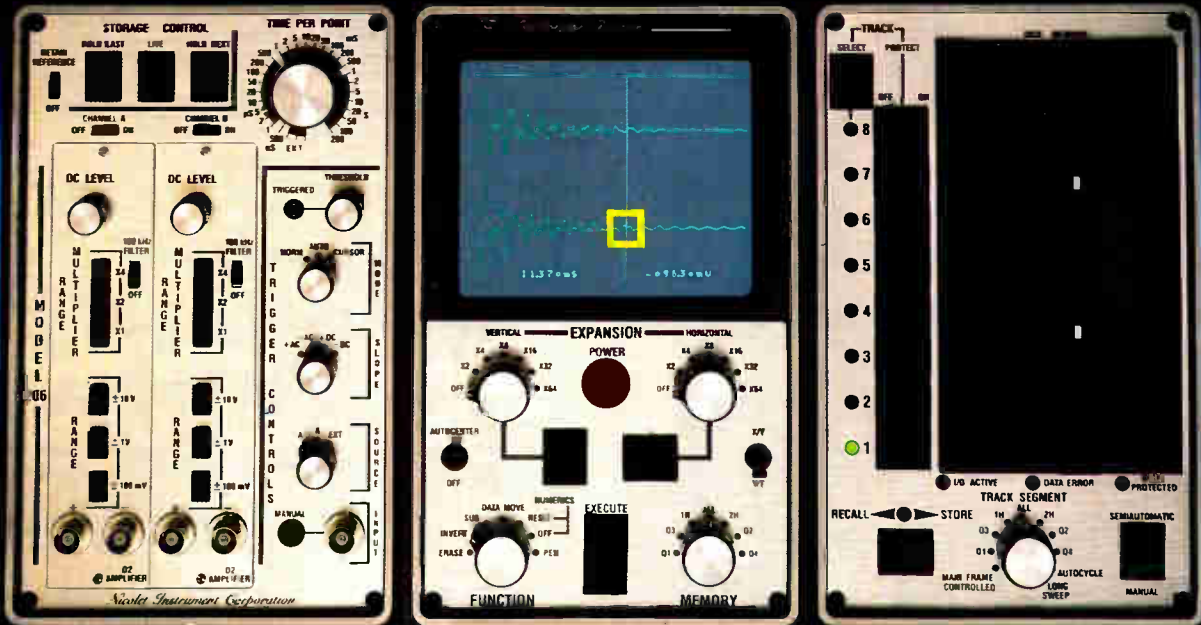

# See things you've never seen before.

Nicolet digital oscilloscopes offer you resolution, precision, dynamic range and transient capture capabilities unobtainable on analog oscilloscopes. *They are simple to operate and yet extremely versatile.*

Signals can be viewed live, continuously compared to a reference waveform or stored for detailed examination. Continuous, normal and pre-trigger operation are offered as standard and in all modes cursor-interactive time and voltage coordinates can be displayed concurrently with the signal. Stored waveforms can be displayed or plotted in XY or YT format, transferred to internal disk memory for permanent storage or output to other

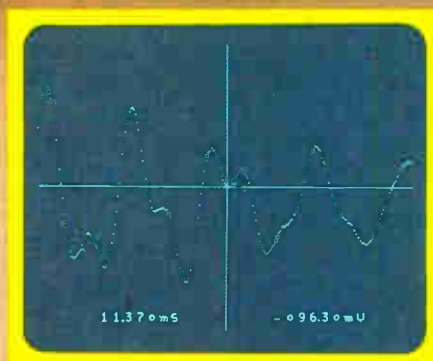

Expansion of selected area in above photo, for detailed analysis.



computing devices via industry standard interfaces.

In addition to offering you the performance you would expect from the industry leader, Nicolet digital oscilloscopes are extremely well proven with thousands in effective use throughout the world.

*Find out how Nicolet can help you solve problems and see things you've never seen before.*

For more information, simply circle the reader service card or call 608/271-3333. Or write: Nicolet Instrument Corporation, 5225 Verona Road, Madison, Wisconsin 53711.



**NICOLET  
INSTRUMENT  
CORPORATION**

OSCILLOSCOPE DIVISION

Sales and Service Offices Worldwide

# Digital Nicolet Oscilloscopes

Circle 32 on reader service card

## **Air Force wants laser-gyro-based avionic systems**

The Air Force's Aeronautical Systems division has awarded a \$2.7 million contract to McDonnell Douglas Corp. that could change the course of avionics development in the late 1980s. By early 1983, the St. Louis firm is to develop and test a laser inertial-reference system **that would replace the 30 to 40 mechanical gyros and accelerometers now used aboard fighter aircraft.** Instead, two black boxes would contain three laser-gyro and accelerometer systems and a digital computer patched into the aircraft's flight-control system. Air Force sources at Wright-Patterson Air Force Base in Ohio estimate that, although the purchase price for the new system would be about equal to that of current ones, the life cycle cost would be more than 20% lower, the mean time before failure about 10 times greater, and repairs 60% less. Honeywell Inc.'s Avionics division in Minneapolis will supply most of the hardware that McDonnell Douglas will test aboard its F-15 fighters.

## **Intel to show Ethernet-IIuk development tools**

To ensure that designers will be able to get their systems on Ethernet local networks quickly, Intel Corp. is working on a broad range of products aimed at satisfying the joint specifications published by it, Xerox Corp., and Digital Equipment Corp. Initially, the Santa Clara, Calif., firm will introduce development tools that permit users to gain hands-on experience with Ethernet. **They will be able to set up a network between development systems, write network applications programs, and evaluate the network as it relates to their data-communications needs.** A development system will be unveiled at next month's National Computer Conference in Chicago, along with board-level Ethernet controllers that plug into the firm's industry-standard single-board-computer (iSBC) chassis. Initially implemented in medium-scale integrated logic, these controllers permit users to quickly add Ethernet capability to prototype systems based on Intel's 8- and 16-bit central-processing-unit boards. Next year, component-level controllers are slated to be available for high-volume production needs. Intel will offer a very large-scale integrated Ethernet controller with an intelligent parallel interface for its iAPX microprocessors. This chip will be incorporated as well in later versions of the iSBC Ethernet controller.

## **Airline test market beckons**

A multimillion-dollar market for manufacturers of general-purpose test equipment could be opened by a soon-to-be-issued report to the airlines industry. Report 602, to appear next month, is from Aeronautical Research Inc. (Arinc), the research body established by and for the airlines. **It gives the airlines the option of using the IEEE-488 interface** to configure automated test systems for fleet maintenance. They now use custom equipment. Known informally as Airmate, the test equipment guidance report describes how systems may be configured and also recommends that Atlas be the test language if such systems are used.

## **Disk cache cuts access time to 4 ms**

Computer Automation Inc.'s Commercial Systems division has introduced a disk cache system that cuts disk access time to 4 ms from the 40 ms required by the firm's semiconductor version [*Electronics*, Sept. 11, 1980, p. 54]. **The disk cache stores often-used data in random-access memory as an interim buffer,** automatically retaining up to 2 megabytes for quick access. The controller, added to the semiconductor disk along with software alteration, is configured between the disk and the central process-

ing unit. The firm also upgraded its Syfa computer line at the Interface 81 show in Las Vegas, introducing the Syfa 2500, which doubles CPU memory to 512-K bytes and increases terminal ports to 64 from 48. A full configuration without peripherals costs about \$120,000.

## **TRW Optron enters Hall-effect arena**

TRW Optron, the Carrollton, Texas, electronic components operation of TRW Inc., will enter the Hall-effect market with the introduction of two products late in the second quarter. The optoelectronics unit plans to introduce a digital and a linear output part—both using hybrid thick-film technology. **At least one major U. S. auto manufacturer** plans to do business with the new operation.

## **Votrax aims text-to-speech device at hobbyists**

The Votrax division of Federal Screw Works in Troy, Mich., is putting its phoneme-based text-to-speech technology to work in a new peripheral device called Type-'n'-Talk that is aimed at the computer hobbyist and educational markets. Priced at \$345, the Type-'n'-Talk is designed to work with any computer equipped with an RS-232 port. Unlike the \$339 voice synthesizer device that Votrax supplies to Radio Shack on a private-label basis, however, it does not require phonetic programming; instead **the user may add speech to a program by simple typing in the words to be synthesized.** Though significantly less sophisticated than the \$15,000 CDS II text-to-speech development system announced recently by Votrax [*Electronics*, Feb. 10, p. 118], the Type-'n'-Talk employs the same SC-01 speech synthesis chip as well as a simplified version of the same proprietary text-to-speech algorithm. Also, look for Votrax to back up the new peripheral with the introduction at next month's National Computer Conference in Chicago of several new software packages incorporating speech that are designed for use with Type-'n'-Talk.

## **Prime to add dual-processor unit to supermini list**

A new challenger is scheduled to join the superminicomputer ranks next week when Prime Computer Inc. unveils its 32-bit Prime 850 dual-processor system. The 850 is said to incorporate two Prime 750 central processing units, **which can operate simultaneously on the same data in a scheme called multistreaming.** The result, says Prime, is throughput up to 50% better than that of Digital Equipment Corp.'s VAX-11/780. Running on Prime's Primos operating system, the 850 uses 1-megabyte memory boards containing 64-K random-access memories, the Natick, Mass., firm says. A typically configured system will cost about \$500,000.

## **Addenda**

After a year of operation under Chapter XI of the bankruptcy laws, R. C. Sanders Technology Systems Inc. says **it is back in business with nearly \$1.5 million in new backing and a new management team.** The Amherst, N. H., firm says it will soon give Diablo Systems Inc. of Haywood, Calif., nonexclusive manufacturing rights to its so-called infinite-matrix printing system. . . . Access Technology Inc. of Wellesley, Mass., a software publishing company, will offer **a self-teaching, user-friendly planning and analysis package called Supercomp** as its first product. . . . Data Precision Corp., Danvers, Mass., is showing this week at Electro its model 95, a 4½-digit multimeter that is accurate to within 0.03% and measures ac and dc current and voltage and **tests diode forward voltage directly.**

# TRY OUR ROMs, NOT YOUR PATIENCE.

EA averages 17-day turnaround on quality ROM prototypes.

Why wait 6 to 8 weeks for ROM samples? EA delivers in less than 4.

Our prices and specs are competitive, our quality is outstanding, and we average only 17 days from cycle verification to shipment of your samples. We also have the fastest turnaround in the industry from prototype to production run quantities—only 3 to 4 weeks.

EA's fast service and high quality are the result of years of experience dedicated to producing the industry's best ROMs. Our ultra-modern, fully automated assembly means faster, trouble-free ROM production. Our rigorous attention to quality control gives you ROMs that perform exactly to your specifications.

## 8K-64K ROMs.

Why wait? Call or write today for our new ROM Capabilities Brochure, showing why we're the premier 8K, 16K, 32K and 64K ROM manufacturer in the industry. Electronic Arrays, 550 East Middlefield Road, Mountain View, CA 94043, (408) 964-4321. In Philadelphia, call (215) 272-8830; in Chicago, (312) 858-8508.



**ELECTRONIC ARRAYS**  
A NEC Company

THE DIFFERENCE IS  
QUALITY

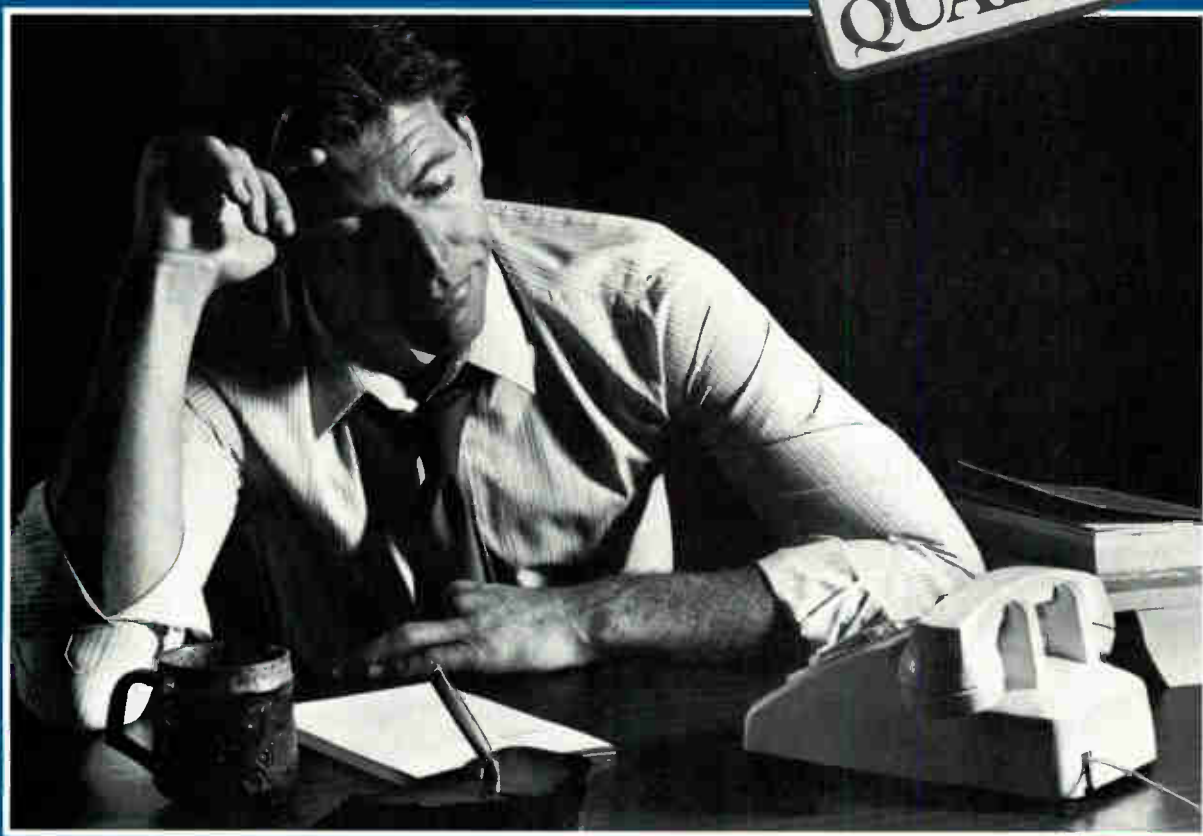

# Our Low-Density-PROM family tree is blossoming.

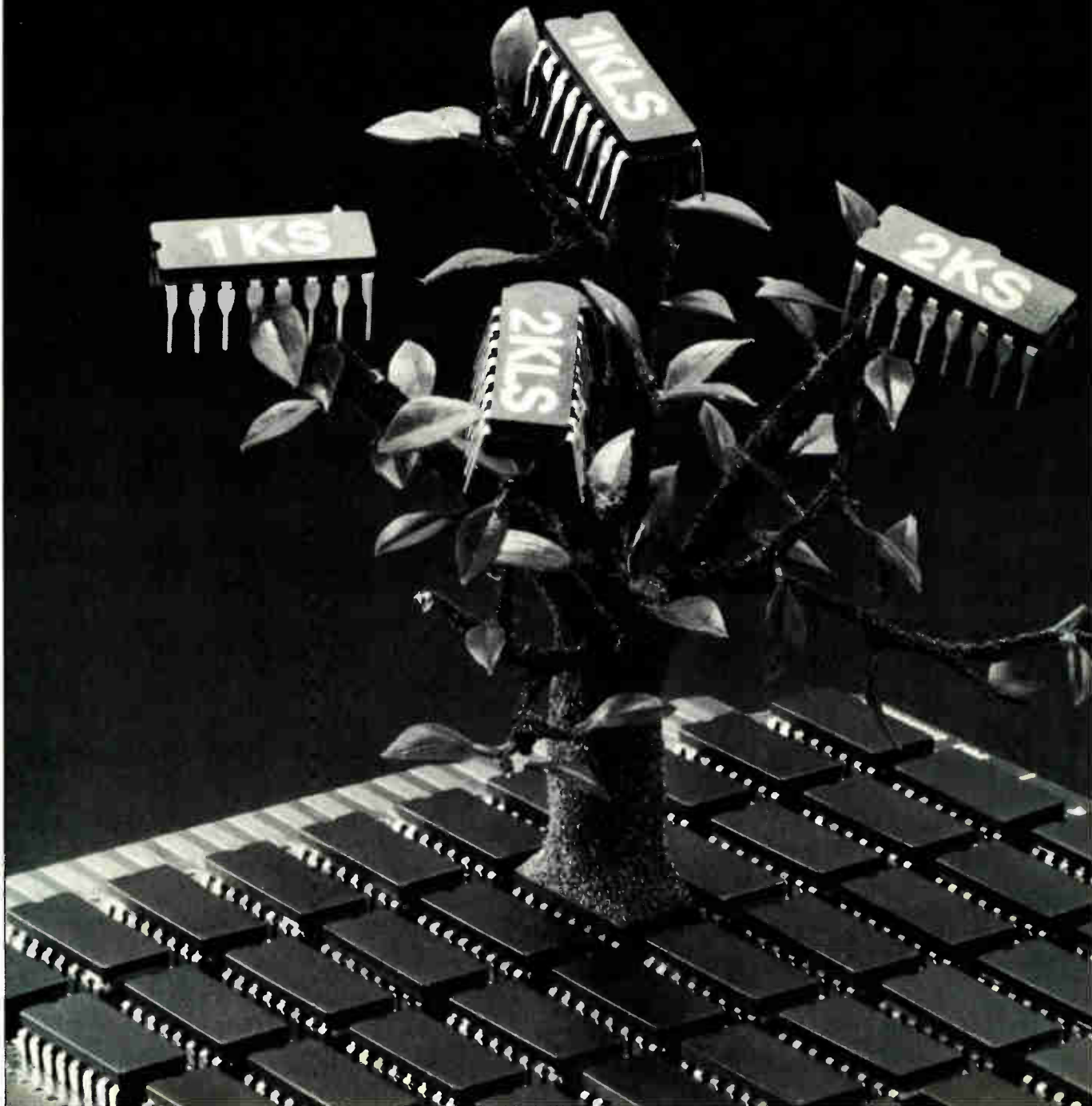

# New 1K and 2K Schottky PROMs offer 25% faster access times and 50% lower power dissipation.

We've said it often. Monolithic Memories is committed to producing low-density bipolar PROMs, in volume, as long as you need them.

Not only do we support low-density PROMs... now we've significantly improved them! With two new PROM families, both utilizing reliable titanium tungsten fuses and an advanced platinum silicide Schottky process which permits highest-speed designs over the entire operating temperature range of the device.

Available in 256-by-4 and 512-by-4 bit configurations, both the new "S" and "LS" families offer full Schottky clamping, your choice of open-collector or three-state outputs and 16-pin DIP packaging compatible with older 1K and 2K PROMs. And they're all in production, now.

## High speed Schottky PROMs.

The new commercial-grade 63S140/1 1024-bit PROMs and 63S240/1 2048-bit PROMs consume only 130 mA of supply current, about the same as older standard PROMs. But at that power level, they access in only 45 ns—a 25% improvement over older devices.

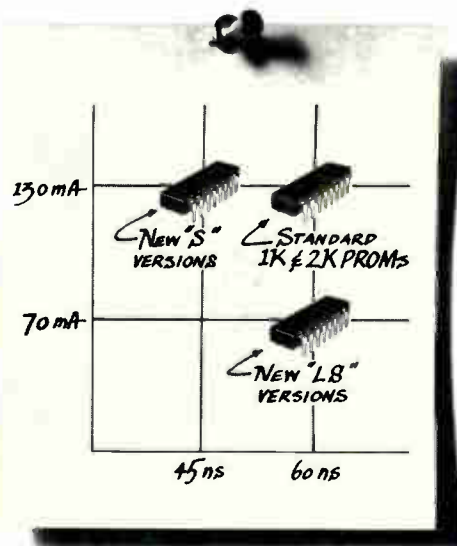

They are the fastest low-density PROMs anywhere.

This is the kind of switching speed currently in demand for high speed computers and real-time signal processing systems.

And at this speed it's even practical to use PROMs to replace random logic, with significant savings in board space and parts cost.

## Low power Schottky PROMs.

The supply current has been cut in half—to 70 mA—while maintaining the same switching speed at 60 ns. This makes our PROMs ideal for telecommunications, satellite and airborne applications.

## Available in military grades, too.

That's right. All the above come in mil-spec versions, with a 55 ns access time for the high-speed "S" version, and a 70 mA supply current for the "LS" PROM.

For full details contact our nearest Monolithic Memories stocking distributor or sales representative. Monolithic Memories, Inc., 1165 East Arques Ave., Sunnyvale, CA 94086.

### HOTLINE!

For express product information call toll-free:  
(800) 528-6050 Ext. 131.  
In Arizona: (800) 352-0458 Ext. 131.

**Monolithic Memories** 

# Now Shell produces Epoxy Novolac Resins in Europe.

If you've been buying epoxy novolac resins for high temperature applications we think you'd like to hear about a new development from Shell. Our latest epoxy resins for electrical and electronics use.

Produced in Rotterdam as an 80 per cent solution in MEK (Epikote 155-B-80) as well as in the 100 per cent plastic solid form

(Epikote 155) they can be easily delivered in drums all over Europe and in the case of Epikote 155-B-80 also in tank cars.

These resins join the proven Shell range of Epikote epoxy resins for use in printed circuit boards, moulding powders and machine coil insulation.

They are part of a series of new

developments by Shell to meet the constantly changing needs of the world's electrical and electronics industries.

Talk to your Shell company today. We'll be happy to tell you more about the latest developments in epoxy resins.

**Epikote**



**Shell Chemicals**

Circle 121 on reader service card



## Hands-off production of user software gaining ground

by R. Colin Johnson, Software Editor, and Terry Costlow, Costa Mesa bureau

Program generators do applications routines that draw on their repertoires of subroutines

The ultimate program-development tool would allow the user to describe a problem into a microphone and then automatically generate the needed program. The state of the art in software is moving in on this goal: a raft of automatic program generators is appearing to allow unskilled users to generate applications software by responding to a menu of questions.

Of course, such automatic program generators do not turn out just

any program. In fact, their repertoires vary considerably, and they are limited to the class of computers for which they were designed.

One of the most extensive of these program generators is Pro IV, which takes user answers to detailed specification forms and then performs the requested functions internally, in effect becoming the applications program. Other generators use an interactive menu on a terminal, and another output approach is to produce a program written in a high-level language.

**Linking routines.** Pro-IV, which originated at Data Technical Analysts Inc. in Honolulu and is marketed by Capro of Irvine, Calif., can turn out a number of different business applications programs. It con-

sists of 103 subroutines, written mostly in Fortran, and an executive routine that converts the data input from the specification sheets into the linkage among the subroutines that are necessary to perform the needed function.

**One offering.** General Automation, the only computer maker currently offering the package (under the name No-code) supplies it with a memory card for its line of 16-bit minicomputers for \$17,500. "In my opinion, nobody will program in five years using a conventional method. They'll be using No-code or a No-code technique," says Pete Papiro, marketing director for General Automation in Anaheim, Calif.

Similar but more limited business applications packages come for

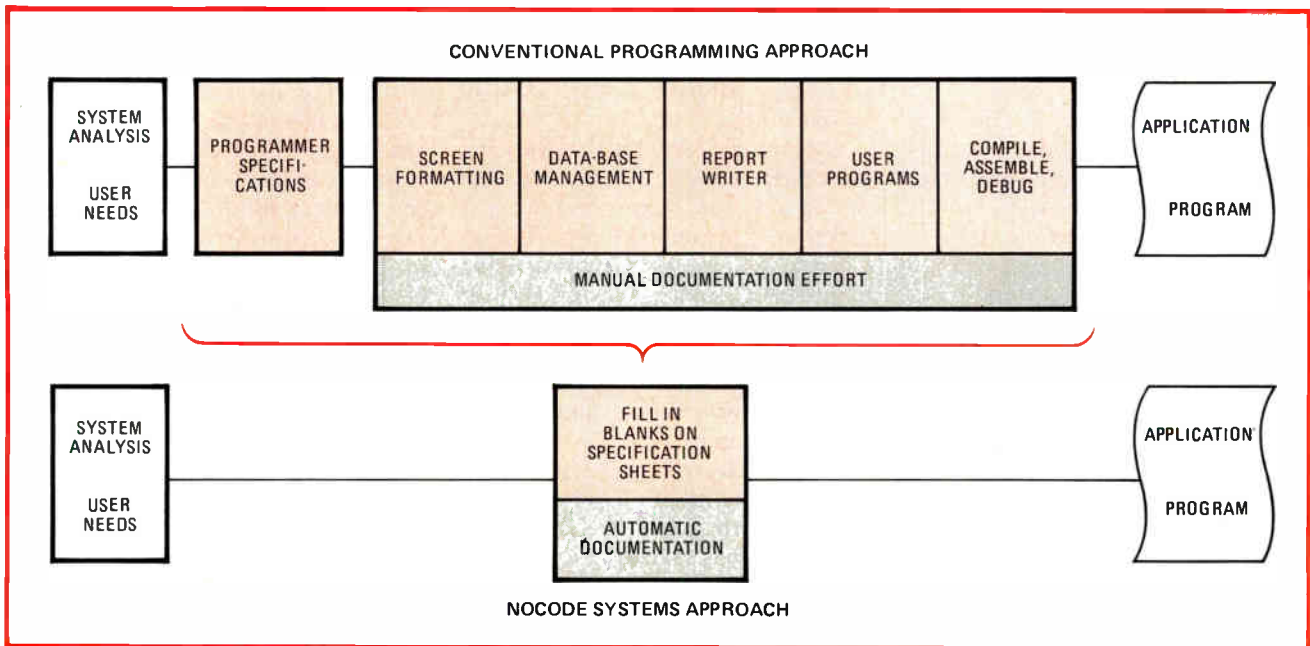

**No-hands programming.** Applications programs turned out by automatic program generators from various firms simplify software writing for users. General Automation's No-code produces applications programs as much as 10 times faster than manually generated programs.

systems based on 8-bit microprocessors and the CP/M operating system. Both the \$395 Configurable Business System from Lifeboat Associates in New York and Prism from Micro Applications Group in Van Nuys, Calif., use interactive terminal menus for their inputs and perform the functions internally.

**Another output.** The fundamental difference, however, is not input but output, and automatic program generators that provide an actual program may well have an edge. Their source code is available for optimization and for customization to the user's precise requirements. For large programming projects, it is always better to have the source code available, especially when new software must be integrated into an already existing system.

On the other hand, the program generators that perform all functions internally require minimal programming skill. Of course, since they become the applications program, they do require that the entire software system be resident in main memory whenever a function is run.

An example of the program output technique is Genasys, a program generator with extensive capabilities from Genasys International of Wellesley, Mass. It can generate programs gathered from specification forms or generated interactively in either Cobol or PL/1.

Available on lease, it runs on IBM mainframes, but under user control it can produce source code that is compatible with various target computers. It also turns out detailed documentation for its programs.

**More Cobol.** An all-interactive Cobol generator from David R. Black and Associates Inc. of Pittsburgh includes a special word processor for documenting programs in the same efficient manner in which they were generated. At least two other Cobol generators exist, one to be released next year by The Master Programmer Inc. in Santa Rosa, Calif., and the other, Jaspol, from Japan System Science Co.

Similar program generators are available in Basic. Among them is one called Pearl from CPU in Salem,

Ore., which allows a wide range of business applications to be generated for microprocessor-based computers running CP/M. Depending on the capabilities desired, the price can be as high as \$650.

Another program, aimed at database management, is Micro Applications Group's Magsam (for multi-keyed file-management system), costing \$145 or \$295 for CP/M-based systems. A complete business computer system from Point-4 Data Corp., Irvine, Calif., comes with a Basic automatic program generator at a base price of \$11,260.

Even as automatic program generation gets up to speed, the hands-off concept is spreading to maintenance

software. Next month The Master Programmer will introduce a program regenerator for IBM System 34 small-business computers.

From existing Cobol programs, it extracts from the data base all variable references that need changing. A companion screen-oriented editor allows nonprogrammers to order the changes simply.

For example, a single directive from the user to change from five- to nine-digit zip codes would automatically result in alterations to the statements controlling data storage, printing format, and screen layout and whatever other changes would have to be performed by hand. The package will sell for about \$9,300.

---

## Business

---

### Union activity astir on West Coast, with Phoenix seeing the greatest ferment

Union organizers in the western U.S., who gained a notable victory in the electronic industries early this year in San Diego, seem to be turning their sights on Phoenix. Continuing union efforts in the San Francisco area and other western regions are more restrained, but electronics company executives for the most part are paying close attention to what they perceive as the threat of unionization.

A petition filed with the National Labor Relations Board late last month sets the stage for a May 1 election at General Instrument Corp.'s Microelectronics division plant in Chandler, just south of Phoenix. Organizing activity has been on the upswing for months in the booming Phoenix area, observers say, which now counts some 50,000 electronics employees, not including those of fast-growing Tucson about 100 miles southeast.

The International Association of Machinists has taken the lead and is seeking to represent GI employees. Handbills from the International Brotherhood of Teamsters are showing up in parking lots, most recently at a small Motorola Inc. Semicon-

ductor Group facility, reports say.

In San Diego, the Communications Workers of America won a 294-to-245 victory on its first attempt to organize a two-year-old Sanyo facility. Sanyo contested the Jan. 9 election, but its appeals process ended last month when the firm did not file an exception with the NLRB. Company officials had no comment on the matter.

**Called unique.** Little union activity has followed the victory, which many feel is an isolated incident. They cite communication difficulties between Sanyo's Japanese management and its American work force, rivalry between management of refrigerator and stereo product lines (all under the same roof), and minimum pay scales as problems that let the union in. What's more, they think, Sanyo management did not realize the difference between in-house Japanese unions and gut-issue American unions until too late.

The victory has caused quite a stir in the expanding San Diego electronics community, which has little background in union relations. "Everybody's more aware of labor problems now. Personnel managers

have been discussing unions a great deal more," says one manager.

Communications Workers' vice president W. C. Demers, who heads the southern California district based in Los Angeles, feels the victory portends the future: "We're going to have a working relationship with the management so that whether they're American or Japanese companies, managers will see that the relationship works. [Sanyo] will be a model for the future, and firms will be coming to us instead of our going to them once they look at it."

**Mixed views.** Some nearby firms contest that view. "San Diego has never been a union community for industrial workers, and we've got a feeling that will continue," says a Cubic spokesman. On the other hand, "there's speculation about unions at all Japanese companies, and the communications gap makes us more susceptible," says Sam Takayama, administrative director at Fujitsu Microelectronics Inc. in San Diego.

The Sanyo decision also raised management hackles in Silicon Valley, where executives feared it would open the door to a new push. The most recent election there was at Raytheon Co.'s Semiconductor division in early 1980, which once again turned away unionization.

No new efforts have been noted, however, as the main union thrust continues to "try to exploit health and safety issues," as one official says. On this score, companies are putting effort into improving any less than desirable conditions and making it plain these are isolated and minor. The same jockeying goes on in the Pacific Northwest.

**Activity anticipated.** West Coast managers, who in the past have beaten back most organizing attempts by keeping wages and benefits moving ahead of union demands, are beginning to worry that a more persistent effort might lie ahead. With other heavily unionized businesses declining, union brass is known to be turning attention to greener pastures. "It would seem reasonable to assume more activity in a healthy industry," says one Los Angeles executive.

Further complicating any unified planning to meet such a challenge, if it comes, are the number of competing unions taking a crack at organizing. Besides the Machinists, Teamsters, and Communications Workers, the International Brotherhood of Electrical Workers and the United Auto Workers are active.

Also, such professional groups as Lockheed-California Co.'s Engineers and Scientists Guild are pushing hard

of late, even calling a nine-week strike that ended in January. The guild unsuccessfully sought an automatic cost of living rise but did obtain a three-year contract with guaranteed raises. In the most recent election in the Los Angeles area, printer manufacturer Dataproducts Corp. beat back a UAW attempt to organize a 200-worker fabrication plant by a 2-to-1 margin.

**-Larry Waller and Terry Costlow**

## Microsystems

### New contenders in 4-bit processor world cram many more functions on chip

The high-volume 4-bit microcomputer arena is getting two new contenders, both of which incorporate more functions on chip. To be formally announced at this week's Electro/81 show, the Texas Instruments Inc. TMS 2100 series and the American Microsystems Inc. S4200 are software-compatible with previous models from their respective makers.

Entrants into a crowded market-

place, the new parts aim at carving out their own niches with extra features. TI and AMI clearly see the 4-bit arena as continuing to be highly competitive, with new designs required to maintain market share.

**On-chip functions.** The TMS 2100 is software-compatible with the popular TMS 1000 line from the Dallas company, but it brings on chip such frequently used functions as an ana-

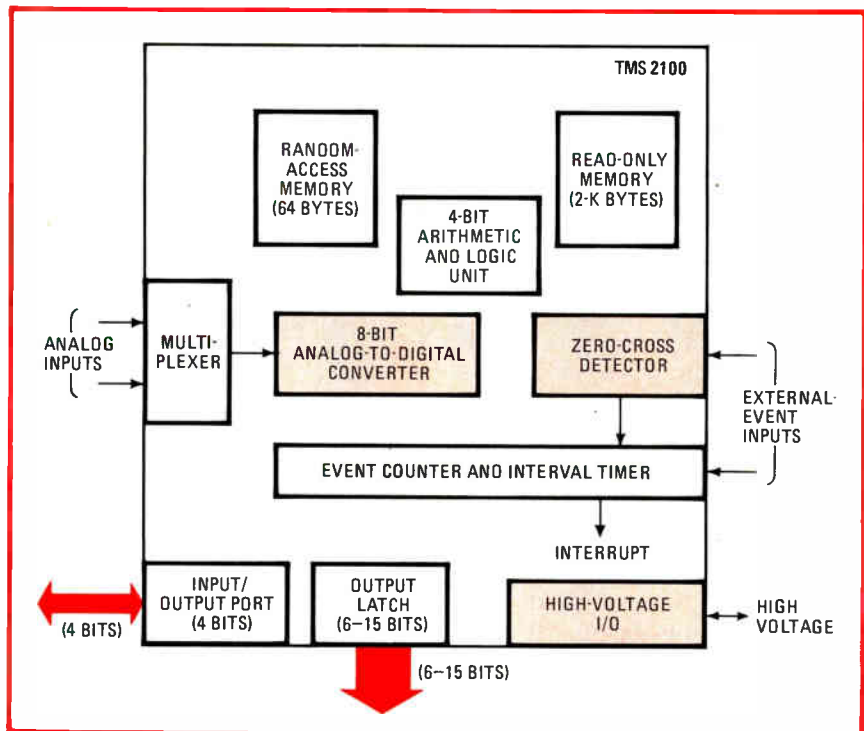

**Pack 'em in.** TI's new 4-bit microcomputer adds an a-d converter, a high-voltage I/O interface, and other circuitry (all tinted) to ease OEM hardware design.

log-to-digital converter and a high-voltage interface (see figure). Thus, the p-channel MOS part will simplify hardware design for the original-equipment manufacturer.

The 8-bit a-d converter uses a successive-approximation technique and comes in versions with one or two analog inputs. The high-voltage interface facilitates the connection to a liquid-crystal display. And a 32-term programmable logic array allows conversion like binary-coded-decimal data to seven-segment-display code to be performed in hardware.

Other design simplifiers include an on-chip zero-cross detector and an event counter and interval timer to directly count external events. Also, a programmable delayed interrupt feature helps handle time-outs for applications like debouncing switches and controlling the ac power line.

**C-MOS processor.** The S4200 [*Electronics*, March 24, p. 147] from AMI is essentially a complementary-MOS version of the Santa Clara, Calif., company's recently introduced S-2200. Among the features it adds is a software instruction that puts the unit on standby when not in use, thereby reducing power consumption to zero.

It will be fabricated in AMI's 5-micrometer C-MOS process, an easily shrinkable technology that the firm uses for codecs and other telecommunications chips. The S4200 will consume a mere 1 to 3 milliamperes, whereas the n-channel MOS S2200 consumes about 60 mA.

The C-MOS chip has both a low-power and a zero-power mode, says Peter M. Redford, AMI's senior design engineer. "Because C-MOS chips draw practically no current when the clock is turned off, the entire random-access memory can be preserved with power supplied either from a battery or a capacitor," he says.

The zero-power feature is activated either by a software instruction or by on-chip circuitry that detects power failures. The S2200 also has power-failure circuitry.

**-R. Colin Johnson and Bruce LeBoss**

## Packaging

### Study applauds chips on tape

In a head-to-head comparison of military-qualified thick-film hybrid circuits, a version built with tape-automated-bonded chips showed significantly higher yield than the identical circuit made with the conventional chip-and-wire assemblies. In a test for the U. S. Army, Honeywell Inc.'s Avionics division built 650 three-chip TAB hybrids and 150 chip-and-wire units and got an 84% yield for the TAB versions and 52.3% for the wire-bonded hybrids.

The yield improvement is due to the ease with which chips on tape may be electrically tested before hybrid assembly, says William Rodrigues de Miranda, who was staff engineer of microelectronics engineering during this study program at the St. Petersburg, Fla., division. Yield also improved because Honeywell Avionics was able to burn in chips while they were still on tape.

The study for the Army's Missile Command, Redstone Arsenal, Ala., focused on military hybrids. Honeywell determined that the break-even point at which TAB circuits cost less than chip-and-wire assemblies is 776 units—but the importance of TAB

technology for military hybrids with relatively short production runs is better yield.

For makers of integrated circuits, TAB packaging looks attractive for very large-scale integration [*Electronics*, Dec. 18, p. 100]—not only because of testability, but also because of the compact packaging of many-leaded ships. In fact, Honeywell Avionics used a 40-lead tape that Honeywell Information Systems and CII-Honeywell Bull are using for ICs in their computers.

**Cooperation.** The Avionics division drew upon the considerable resources of HIS and other Honeywell operations to build its hybrid. The circuit is a synchronous counter shift, and both the TAB version shown in the photograph and the wire-bonded version use standard Motorola low-power Schottky TTL medium-scale ICs.

Once the chips were bonded to continuous reels of tape, the division used a reel-to-reel tester to interface individual chips with a Fairchild 5000 automatic tester. The Honeywell adaptation of electrical testing is much cheaper than the usual probing of bare chips, and it is less prone to damage the ICs.

After testing, the tapes were cut into frames, which were mounted on 35-millimeter slide carriers. These holders serve a dual purpose: they can be used in outer-lead bonding to the substrate or in burn-in.

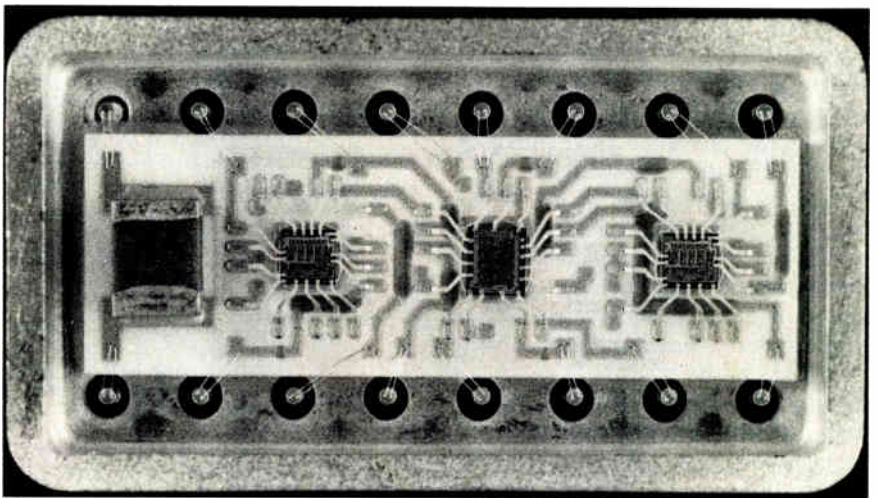

**Comparison test.** Honeywell Avionics built the identical hybrid circuit with TAB chips (shown) and with wire-bonded ICs. The TAB yield was 84%, versus 52% for the other.

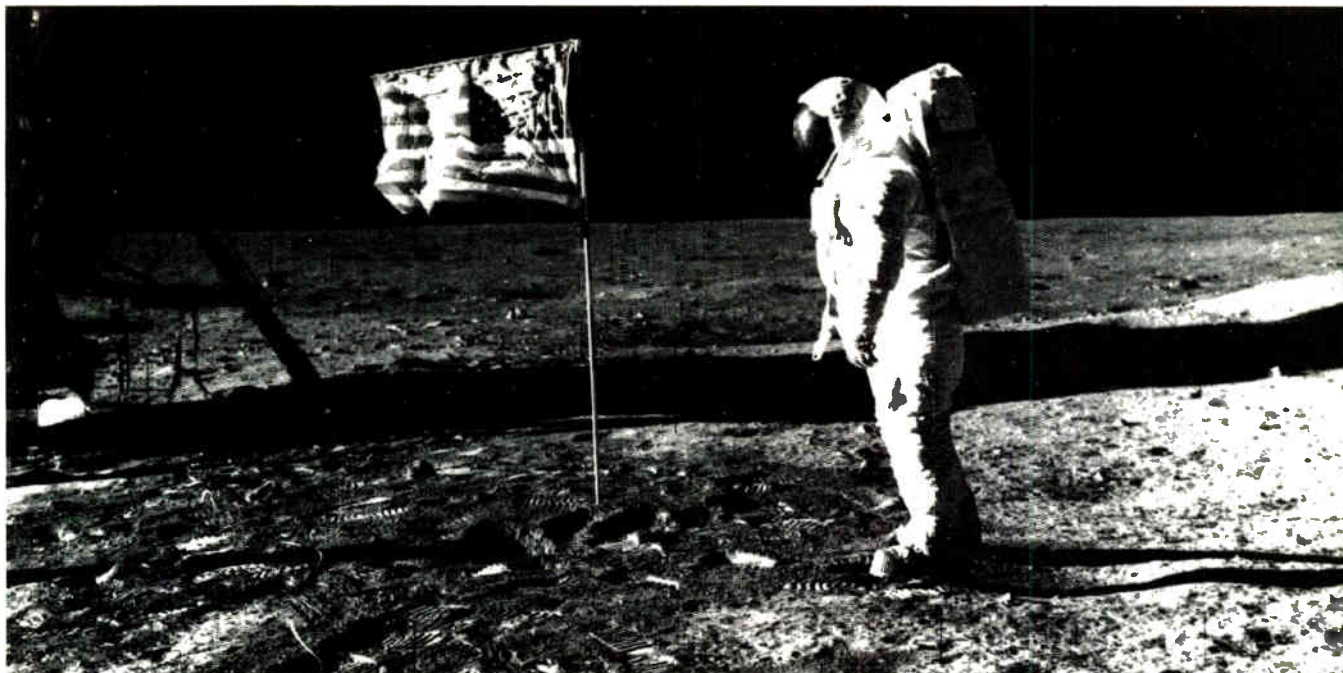

## When you're all alone, you have to have a reliable DC to DC power source.

Abbott military power supplies have been successfully used for twenty years in the most demanding environments known. Our experience includes such diverse applications as Apollo, F-111 and Trident programs.

Abbott power supplies have passed all of these tests with flying colors.

The reliability of Abbott's military power supplies is a fundamental objective of our management. Abbott's quality assurance begins with the basic electronic design, and is not just added in the final test.

Every one of our military power supplies is inspected at least forty-one times during its assembly. Each unit is electrically tested to ensure that its performance exceeds published specifications before it is encapsulated and hermetically sealed.

Abbott offers four models of DC to DC converters for your specific military application. The high performance Model C provides exceptional line and load regulation of 0.1% and peak to peak ripple of less than 50 millivolts. The CC dual output version is available in 20 output ranges with tracking accuracy of better than 1%. The Model B provides high reliability at less cost than the Model C. The single output BN and dual output BBN high efficiency switchers have a wide input range of 20 to 32 VDC. All units perform over the full military temperature range of  $-55^{\circ}\text{C}$  to  $100^{\circ}\text{C}$ . For more details on

MODEL	TYPICAL MTBF*	OUTPUT VOLTAGE RANGE	OUTPUT POWER RANGE (WATTS)
C	277,000	5-100	10-100
CC	176,000	$\pm 3 - \pm 30$	3-20
B	626,000	5-500	2-170
BN	112,000	5-48	25-100

\*Ground benign  $50^{\circ}\text{C}$  baseplate temperature per MIL-HDBK-217C

any of our power supplies, call or write for your free catalog today.

So wherever you plan to take your power supply, look to Abbott.

Because we've got one that will take you anywhere.

**abbott transistor**  
POWER SUPPLY DIVISION  
THE MILITARY POWER SUPPLY SOURCE

WESTERN OFFICES  
5200 W. Jefferson Blvd.  
Los Angeles, CA 90016  
(213) 936-8185  
Telex: 69-1398

EASTERN OFFICES  
1224 Anderson Avenue  
Fort Lee, NJ 07024  
(201) 224-6900  
Telex: 13-5332

Honeywell Avionics burned in 300 TAB chips at 125°C. When these ICs were assembled into hybrids, the yield jumped another 9% to 93%. Such a technique may replace burning in complete hybrids and so could reduce the amount of reworking.

To perform the burn-in check, the Avionics division devised a special fixture, a tray with 96 positions for the film carriers. The loaded tray is married to an interconnection board with spring-loaded pins that contact the TAB lead-frame pads.

**Burn-in.** The tray is immersed in an insulated tank containing a fluoro-carbon liquid stabilized at 125°C, and each chip is exercised electrically. After burn-in, the tray is disassembled and the ICs are tested.

In spite of the yield advantage, TAB hybrids may have a tough time in military applications. The problem is getting bumps built on top of ICs' aluminum interconnection pads to create a bonding surface resistant to the heat of the process.

Hybrid manufacturers typically do not order large numbers of ICs, and the chip makers show considerable reluctance in adding the bumps to such small portions of their production runs. Honeywell Avionics had the full company resources on which to draw, so it was able to procure its bumped chips without too much trouble.   
-Jerry Lyman

### Computer-aided design

## Modules analyze routing, heat factors

A computer-aided design setup for circuits that does testing and thermal analysis of a design before layout and can help build breadboard models afterward may sound too good to be true. Yet one such system has been in continual development at Bell Laboratories' Columbus, Ohio, facility since 1977.

Called Aides, for automated interactive design engineering system, it includes a number of advanced software modules that extend its capabilities during system definition and

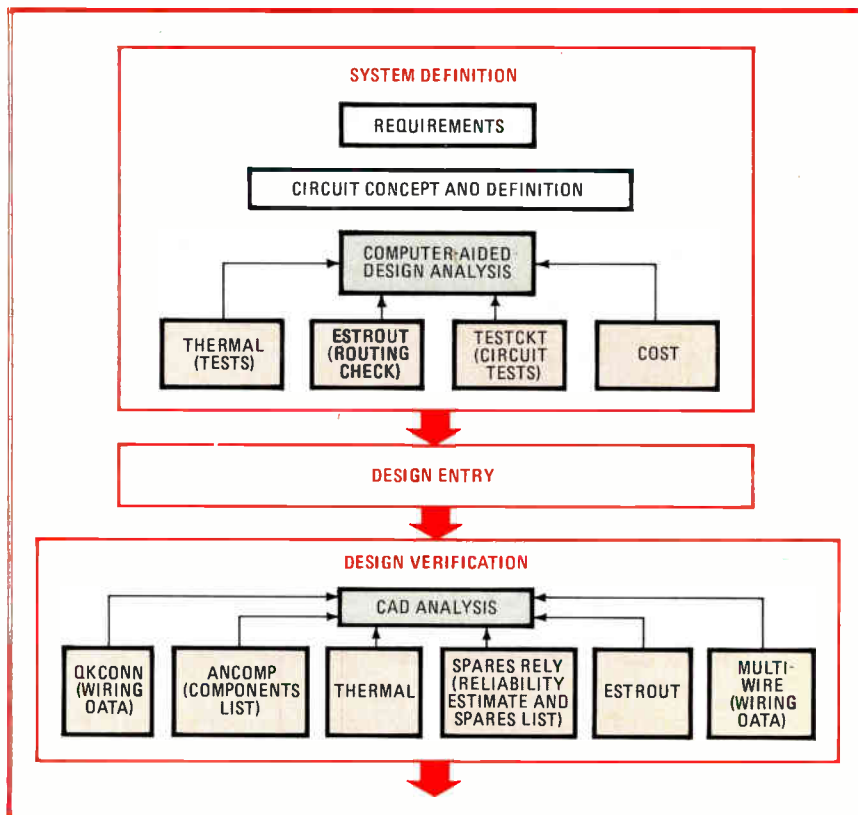

**Capable CAD.** Using an extensive series of modules, Bell Labs' Aides CAD system thoroughly analyzes circuit designs and even supplies the data for wiring breadboards.

design verification (see figure). It runs on an IBM 3033, occupying 1.25 megabytes of the machine's virtual memory, but its originators, among them the Advanced Design Technology group, say it could run on 32-bit minicomputers with large address spaces if some of its capabilities were pared down.

During system definition, a software module called Estrout investigates how well the proposed design may be routed on a particular type of circuit board and calculates the number of dual in-line packages or their equivalents that a given board can accommodate.

A second module, called Thermal, determines the effects of the given physical configuration on heat dissipation. The designer can learn the percentage of heat flowing through a board from its copper paths and off its component surfaces and can also find out the components' temperatures. Thus the effects of such changes as increased board spacing can be determined before layout.

A list of components can be generated using the Ancomp module. The Testckt module determines testing constraints, and the cost of the hardware necessary for adequate thermal design and packaging is estimated using the Cost module.

After design entry, the Estrout and Thermal modules come into play again during design verification. In fact, detailed component-level thermal analysis may be conducted where critical. The Ancomp module can review the final set of components. Another module, called Spares Rely, calculates the reliability and estimates the number of spare components required.

**Wiring data.** Now the designer refines his model and writes test changes. From the updated common design file where all changes have been stored, he builds a breadboard model using the Qkconn or Multi-wire modules, depending on the wiring method.

The data from these modules is available on paper tape to drive the

# ANNOUNCING SPECTRUM SERIES I

## A GIANT STEP FORWARD IN BENCHTOP IC TESTERS



DON'T LET THE SMALL SIZE FOOL YOU – SPECTRUM CAN CARRY AN INCREDIBLE TESTING LOAD!

Spectrum gives you AC and DC parametric/functional test capabilities in a low cost/high volume benchtop IC test system. It is the *only* benchtop that gives you the power to test static *and* dynamic devices. And that's not all:

- Tests all popular device families and fabrication technologies from 8 to 96 pins.
- Modular hardware and software lets you tailor the system to your needs and allows the system to grow to meet your changing test requirements.
- An optional IEEE-488 Bus allows Spectrum to operate with a host computer for multiple test station applications.
- The same highly trained field service and programming personnel that maintain Datatron's large test systems all over the world back-up Spectrum.

# IT DOESN'T HAVE TO BE BIG TO BE POWERFUL.....

The power to test microprocessors and dynamic memories under real world conditions doesn't have to carry a big price tag. Spectrum provides the same test capabilities as the big \$100K+ systems do in incoming inspection applications – at half the cost.

The Big News in Small Testers is

**SPECTRUM**  
SERIES I

**datatron, inc.** TEST SYSTEMS DIVISION

P.O. Box 11427, Santa Ana, CA. 92711 • (714) 544-9970 • TWX 910-595-1589  
INNOVATORS IN ATE TECHNOLOGY

For further information and a free brochure on Spectrum, call or mail coupon to:

Datatron, Inc./Test Systems Division  
P.O. Box 11427, Santa Ana, CA. 92711  
(714) 544-9970 • TWX 910-595-1589

NAME \_\_\_\_\_

COMPANY \_\_\_\_\_

ADDRESS \_\_\_\_\_

CITY \_\_\_\_\_ STATE \_\_\_\_\_ ZIP \_\_\_\_\_

TELEPHONE \_\_\_\_\_

## Electronics review

wiring machines. Once a prototype is built, the model can be functionally tested, necessary changes can be made to the design file, and a print-out may be transmitted to the drafting organization.

Like other CAD tools, Aides cuts back on errors and does so very early in the design process, he comments. By allowing the designer to make changes at every stage before the board is actually put together, it saves both time and money.

Although Aides started out as a text-oriented program to describe hardware, early users suggested there was little advantage to that. So it was turned into a graphics-oriented, schematic-entry setup.

Aides at present is being used by the designers of 12 different projects at the Columbus lab. Some of its modules, especially the one for thermal analysis, are in use at other Bell Labs locations.

-Ana Bishop

## Industrial

### Exxon drops complex ac motor drive

Even as Exxon Corp. postponed its plans for producing a digital speed-control for ac motors, General Electric Co. reaffirmed its commitment to these energy-conserving units. The GE offerings do not rely as heavily on exotic microelectronics as did the alternating current synthesizer that Exxon dropped—and that complexity appears to be the reason the ac synthesizer's promise withered.

In a seminar on its line late last month, GE officials were candid about where they thought Exxon went wrong with its system. "The whole thing was too complex," says James D. Johnson, manager of GE's ac drives project.

**Transformer options.** A key point is the power transformer. GE retains it for shifting voltage levels, but the Exxon design dropped it in favor of a bank of switching transistors that produce incremental changes in the output voltage, which is a simulated

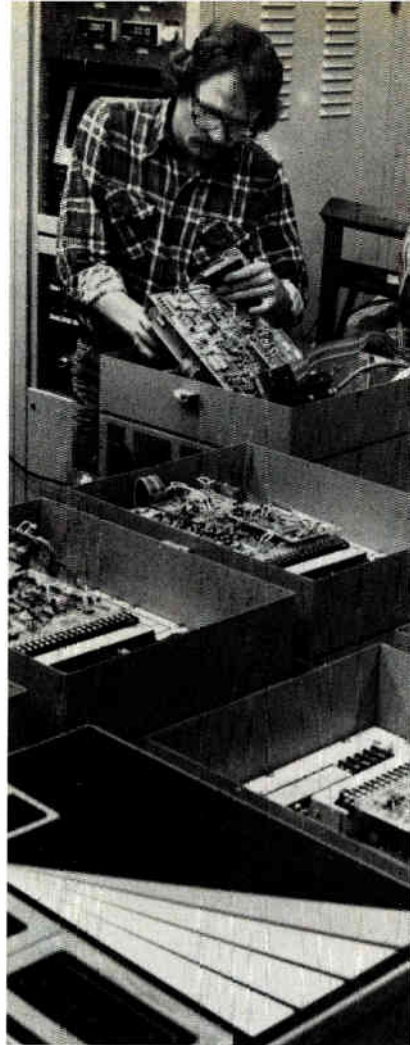

**From ac to dc.** GE's line of controllers electronically adjust the speed on ac motors according to the load, thereby saving the energy wasted with mechanical controls.

sine wave.

These power transistors, originally lauded as a low-power-loss substitute for the bulky transformer, eventually became the unit's Achilles heel. "After examining and demonstrating the [ac synthesizer] in a lab setting, we found that reliability and cost were such that the system could not compete in the marketplace," an Exxon spokesman says. The power transistors were a major source of trouble because they would fail in industrial environments, Exxon says.

Of the viability of the Exxon approach, James R. Olin, vice president and general manager of GE's industrial electronics systems division in Salem, Va., says, "Our people analyzed the patents and realized two years ago that it wasn't a practical thing. The [Exxon] people who were doing the job weren't familiar enough with the controls field."

However, solid-state circuitry is a major factor in the development of electronic controls to vary the speed of ac motors. The integrated circuits reduce the cost of an electronic drive. Though ac motor controls are still more expensive than dc motor controls, the ac motor is inherently more reliable and costs less than dc versions. In addition, an ac motor can be sealed against harsh industrial environments.

GE has big plans for its motor control line. A relatively low-voltage, low-power series covers motors ranging from 1 to 800 horsepower. There also are drives for larger motors, up to 20,000 hp.

As for Exxon, it says it plans to develop a simpler design for the ac motor-drive market, which GE, for one, expects to grow from \$70 million in 1980 to an estimated \$600 million by 1990.

-Gil Bassak

## Communications

### Capacitance switch handles 175-W signal

When the Columbia space shuttle goes aloft, it will be communicating continuously with the ground thanks to an S-band system dependent on a one-of-a-kind antenna switch. Capable of handling up to 175 watts peak power, the switch shifts the communications link among the shuttle's antennas at full transponder power—in other words, it is a hot switch.

"We had to have a hot switch for instantaneous and continuous [signal] coverage with overlapping beams," explains Thomas Pederson, program manager at TRW Inc.'s Defense and Space Systems Group for the S-band system, which will operate in the 1.7-to-3-gigahertz frequency band.

**Choices.** The standard switching method is a conventional contact switch, but this fails at typical operating power levels upwards of 10 w and so requires a substantial drop in output from high-power traveling-wave-tube transmitters. TRW also considered a computerized time-switched scheme, but rejected it for



# The Silent Commander.

IMMEDIATE  
DELIVERY

## 743 KSR

### Keyboard Send-Receive Data Terminal

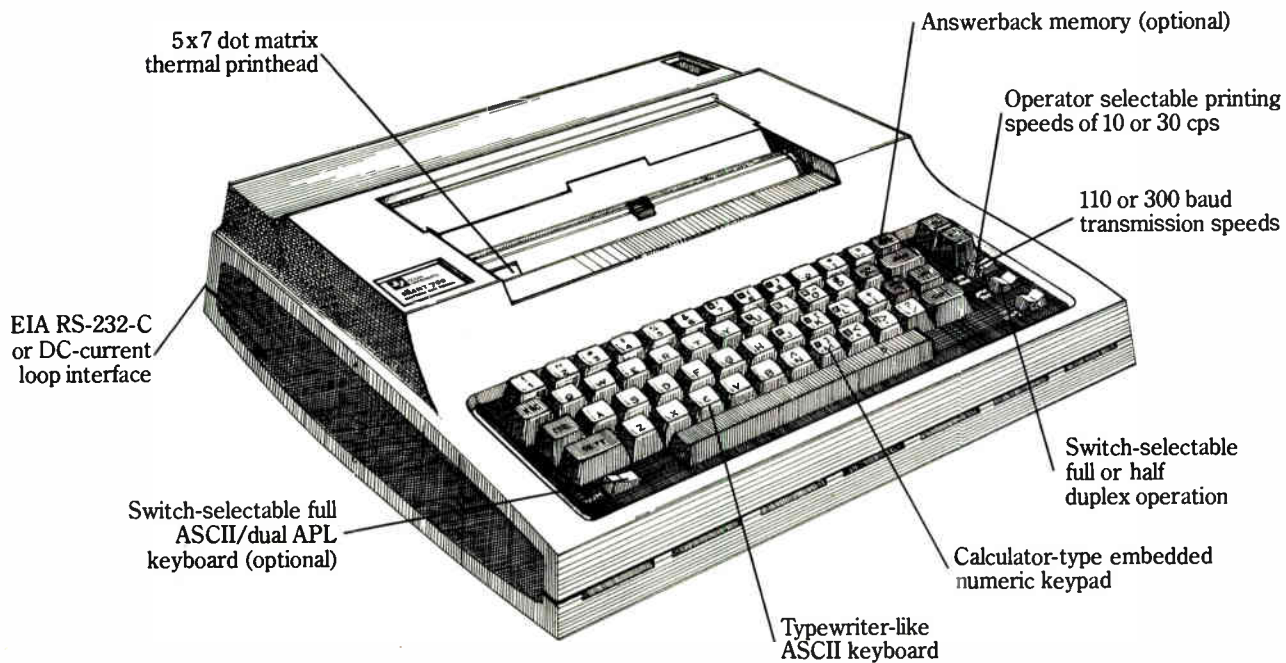

The Silent 700\* Model 743 KSR Data Terminal can help you take command of your data entry application needs today. The compact 743 offers a variety of easy-to-use standard features and options, and is an ideal input/output console. And with virtually silent thermal printing, the low-cost 743 leads the way for efficiency and reliability. The field-proven 743 is also available as a Receive-Only model. With either 743, you can depend on high-quality Silent 700 performance.

TI is dedicated to producing quality, innovative products like the 743 KSR Data Terminal. TI's hundreds of thousands of data terminals shipped worldwide are backed by the technology and reliability that come from 50 years of experience, and are supported by our worldwide organization of factory-trained sales and service representatives.

For more information on the 743 terminals, contact the TI sales office nearest you. In Europe, write Texas

Instruments, M/S 74, B.P.5, Ville-neuve-Loubet, 06270, France, or phone (93) 20 01 01. In Asia Pacific, write Texas Instruments Asia Ltd., 990 Bendeemer Rd., Singapore 1233. Telex RS 21399, or phone 2581122.



*We put computing  
within everyone's reach.*

\*Trademark of Texas Instruments Copyright © 1981, Texas Instruments Incorporated

TEXAS INSTRUMENTS  
INCORPORATED

**if**  
**magnetics**  
**is your**  
**field,**  
 it will pay  
 you to check  
 into the  
**F. W. Bell**  
 line of  
**Gaussmeters.**



**28 different meters.**  
**110 different standard probes.**  
**We've got a meter and probe**  
**for practically every magnetic**  
**measurement need.**

**Bell Gaussmeters provide:**

- 1** direct measurement of absolute field density.
  - 2** differential measurement of absolute field density.
  - 3** differential measurement of field density difference at two probe locations.
  - 4** incremental field measurements using an expanded scale.
  - 5** summation measurements.
- Accuracies from  $\pm 0.1\%$  FS.  
 Dynamic ranges from  
 0.1 Gauss FS ( $10^{-5}$  tesla) to  
 100,000 Gauss FS (10 tesla).

**For full technical information and**  
**application assistance,**  
**contact us today.**

**Fw** **BELL INC.**<sup>®</sup>  
 Subsidiary,  
 Magnetics & Electronics, Inc.

6120 Hanging Moss Rd. Orlando, FL 32807  
 Phone 305/678-6900 TWX: 810-853-3115

## Electronics review

### News briefs

#### IEEE announces annual honors list

The Institute of Electrical and Electronics Engineers has awarded this year's Medal of Honor to Sidney Darlington for his contributions to filtering the signal processing, as well as to pulse-compression radar. David Slepian of Bell Laboratories' Mathematics Research Center is the recipient of the Alexander Graham Bell Medal for his work in communications theory. C. Chapin Cutler, professor of applied physics at Stanford University, has been awarded the Edison Medal for his endeavors in microwave electronics, space communications, and the technology of communication systems.

James Hillier, a retired executive vice president and senior scientist at RCA Corp.'s research laboratories, has been presented with the Founders Medal for his work in electron microscopy and for developing a creative laboratory environment. The recipient of the Lamme Medal, George B. Litchford, president of Litchford Electronics Inc., has been honored for his aid in developing electronic systems for air navigation and air-traffic control. Ernest S. Kuh has been given the IEEE Education Medal for his leadership in engineering education as a professor in the University of California at Berkeley's Department of Electrical Engineering and Computer Sciences.

#### Toshiba unit to make Radio Shack's TRS-80 model I

Tokyo Electric Co., a Toshiba company, will be making the Radio Shack TRS-80 model I computer in line with an agreement reached with Tandy Corp., the Fort Worth, Texas, parent of Radio Shack. TEC will be making the computer for Japan only; the model I is now discontinued elsewhere. It will also sell other models of the TRS-80 line, and Tandy will continue to sell its computers through its Radio Shack operations in Japan. "The TEC agreement is an effort to expand the sales organization in the nation," says Jon Shirley, Tandy's vice president of merchandising for computer products. TEC has been known as a cash register manufacturer and has supplied undisclosed products to Tandy in the past.

#### TV camera has built-in VCR

A compact broadcast-quality color TV camera and video tape recorder system in one hand-held unit will be introduced by RCA Broadcast Systems at the National Association of Broadcasters' annual convention in Las Vegas next week. Called the Hawkeye, the 22-pound package uses the same half-inch video cassette as in consumer VHS video recorders and is intended, according to RCA, "to provide new flexibility in electronic news gathering, electronic field production, and other program production applications." The Hawkeye is a joint development of RCA Corp. and Matsushita Electric Industrial Co. RCA will disclose the price and delivery at the NAB meeting.

its uncertain reliability.

The Redondo Beach, Calif., group turned responsibility for the switch over to Teledyne Inc.'s Microwave division. It came up with a design that only faintly resembles a simple metal-to-metal contact switch.

From the first, the Mountain View, Calif., division concluded that the best approach would be a capacitance-coupling technique, which transmits power without metal-to-metal contact. However, a high-power capacitance switch had not been possible, says Richard Sun, a Teledyne engineer on the project, because the anodizing methods used to

apply the aluminum dielectric would have roughened the surface with air bubbles that would have decreased the device's dc voltage breakdown capacity—at least 500 volts in the space shuttle's antenna switch.

Teledyne solved the problem by pushing the anodizing process to the point where it becomes rather like the thick-film deposition found in semiconductor processing. The result is a mirror-like dielectric surface on facing aluminum plates, which have 0.1-square-inch contact areas.

Thus the 100-to-125-w signal can pass smoothly through a half-mil air gap between the contact areas. Net-

# NATIONAL ANTHEM<sup>®</sup>

SEMICONDUCTOR NEWS FROM THE PRACTICAL WIZARDS OF SILICON VALLEY.

## Look into National's P<sup>2</sup>CMOS<sup>™</sup> memories.

NATIONAL RAMs TAKE ADVANTAGE OF THE P<sup>2</sup>CMOS BENEFITS.

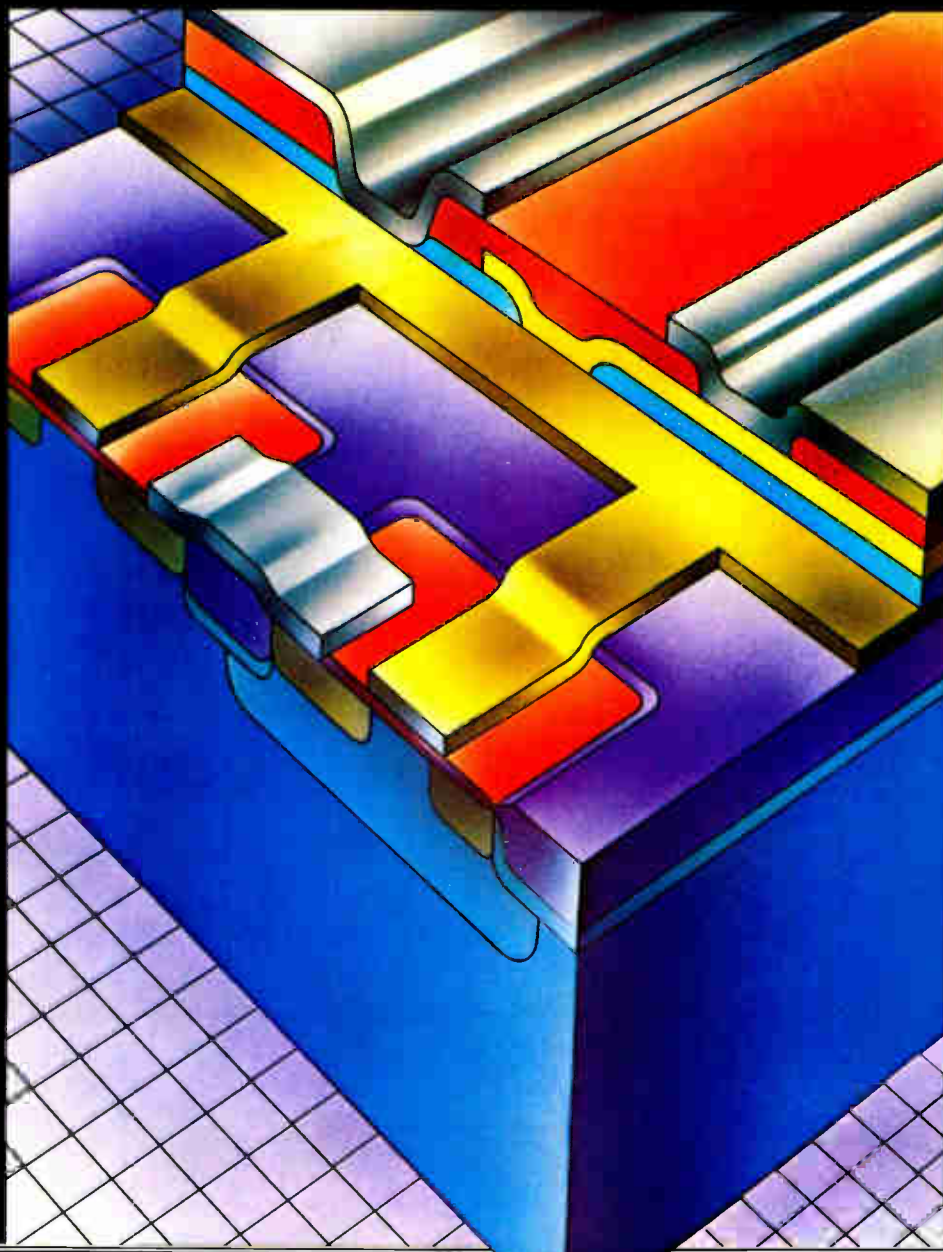

Field-programmable PALs<sup>™</sup>

Semiconductors speak

PARPLEX<sup>™</sup> with ISE<sup>™</sup> for  $\mu$ P emulation

Low cost bubble memory boards

CMOS logic population explosion

Fully armed for data acquisition

New adjustable voltage regulators

High-speed op amps

New 5V voltage regulator

Digitaltalker COPS Data Acquisition Logic Transistors Hybrids Linear Interface Bubble Memory  
RAMs/ROMs/PROMs Transducers Displays Custom Circuits Optoelectronics  
Memory Boards Microprocessors Development Systems Microcomputers Modules

## P<sup>2</sup>CMOS™: NMOS speeds at CMOS power.

National combines the features of existing technologies to give RAMs a boost.

P<sup>2</sup>CMOS, National's silicon-gate complementary-MOS process, has made possible a whole new generation of static RAMs.

By using less interconnect area and high density packing National is producing a family of P<sup>2</sup>CMOS static RAMs that offer an excellent speed-power product.

These high density RAMs employ two levels of polysilicon interconnect plus one level of metal interconnect and the result is NMOS speed at CMOS power.

And these RAMs take full advantage of P<sup>2</sup>CMOS: higher reliability, low power and heat dissipation, and improved immunity to system noise and alpha particles.

To make them easy to use, the line of P<sup>2</sup>CMOS RAMs all have industry-standard pinout and are fully TTL compatible. They also feature high output drive, on-chip address registers and, of course, TRI-STATE® outputs for easy memory expansion.

### Future generations of P<sup>2</sup>CMOS devices.

During the evolution of P<sup>2</sup>CMOS, plans were made for even denser, faster devices along the same continuum via scaling.

For data sheets and additional information check boxes 043 and 064 on the National Archives coupon.

Between their technical expertise, their high-quality RAMs and their unmatched volume production capacity, it's easy to see National is taking the RAM market head on. 

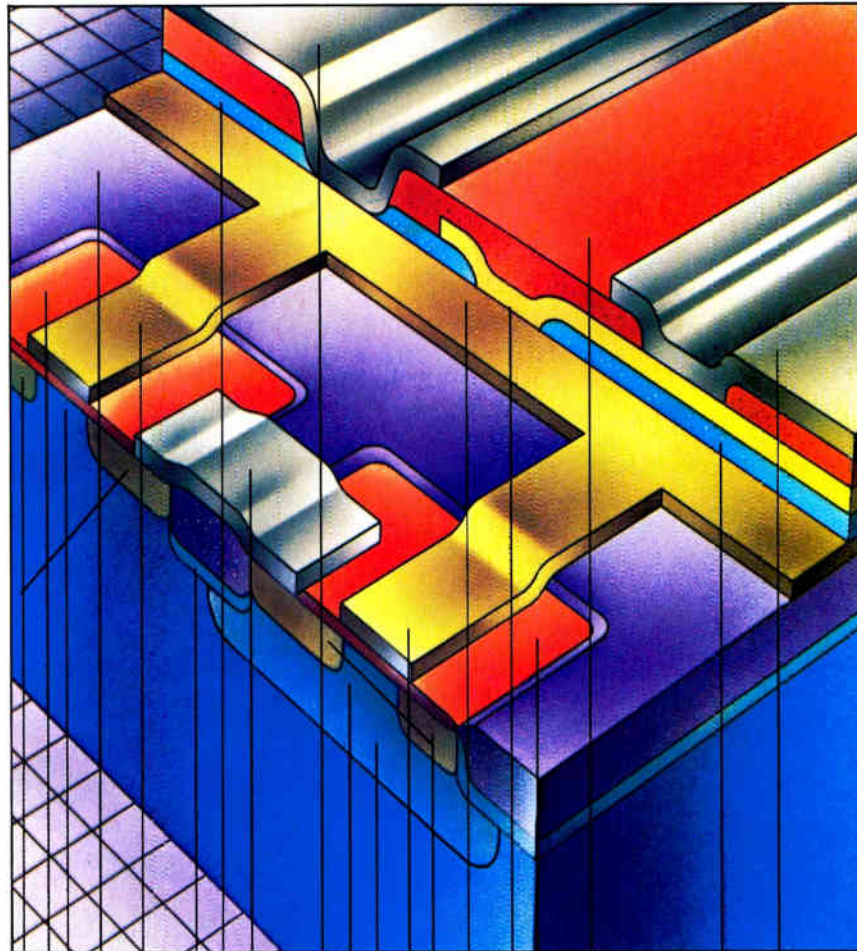

### P<sup>2</sup>CMOS STATIC RAM FAMILY

Part Number	T <sub>AA</sub> (ns)	Organization
NMC 6508	180-300	1K x 1
NMC 6518	180-300	1K x 1
NMC 6551	220-350	256 x 4
NMC 6552	220-350	256 x 4
NMC 6503	300-350	2K x 1
NMC 6504	300-350	4K x 1
NMC 6513	300-350	512 x 4
NMC 6514	300-350	1K x 4

P<sup>2</sup>CMOS and TRI-STATE are trademarks of National Semiconductor Corporation.

## The benefits of P<sup>2</sup>CMOS.

P<sup>2</sup>CMOS is National's new high-speed, low-power process. This double-poly, silicon-gate process evolved from existing high density NMOS technology.

A 50% reduction in the chip area between cells has been attained by using P-type wells, field oxidation and self-aligned ion implants.

The process is achieved with two levels of polysilicon interconnect and one level of metal interconnect, both oxide isolated by

selective field oxidation. Field surface doping extends the operating voltage and improves reliability without the usual CMOS guard rings.

The self-aligned gates are formed by a doped layer of polysilicon over a thin oxide layer. A second layer of polysilicon provides the interconnect, improving design flexibility and layout density.

In keeping ahead in volume production, National has expanded its fabrication facilities and their use of state-of-the-art tech-

niques for P<sup>2</sup>CMOS devices. Such as ion implantation, dry plasma processing and non-contact printing.

And soon, scaling will enable National to further reduce the chip area and improve performance for future generations of RAMs and other P<sup>2</sup>CMOS devices.

After all, that's what Practical Wizardry is all about. 

# Bubble memory bursts price barrier.

¼Mbit bubble memory boards for under \$1800\* available now from National.

National introduces the lowest priced ¼Mbit bubble memory board available – the BLC-9250. It's a non-volatile MULTIBUS™ and Series/80 compatible bubble memory board. And it's easily expandable to 1056K bytes with the BLC-9101 expansion board.

Suddenly, bubble memory becomes a cost-efficient choice for system design and life cycle enhancements. What's more, both the BLC-9250 ¼Mbit board and the BLC-9101 1Mbit expansion board are available in volume right now.

But low prices and availability are only part of the story.

**Smaller, faster and more reliable memories.** National's bubble memory subsystems use dense 16-pin memory modules designed to save board space. They have the smallest package and least number of pins for their density in bubble memory today.

In addition, they offer an average access time of 7ms and an average data rate of 75K bits per second.

The bubble devices on both boards employ Cr-Cu-Cr conductors which outperform others by a factor of 10 in reliability tests. And solid state design makes the memory impervious to dusty or harsh conditions.

The cost-efficiencies of National's bubble memory products are optimized by low profile board designs requiring only single card slots. That means that many products can be enhanced without the need to add an extra box to the system.

**National's family support.** Since both the BLC-9250 and BLC-9101 (and all Series/80 boards) are MULTIBUS-compatible, they interface with a wide variety of existing development systems. Including National's advanced STARPLEX™ development system with ISE™ (In-System Emulation) and CP/M operating system.

Additionally, both bubble memory boards use devices which employ swap gate, block-replicate, on-chip map loop and positive erasure for security applications.

For more information contact your local distributor or NSC sales rep and check box 065 in the National Archives coupon.

Now design engineers can look toward bubble memory as a cost-efficient alternative to conventional memories.

STARPLEX and ISE are trademarks of National Semiconductor Corporation.

MULTIBUS is a trademark of Intel Corporation.

\*Single-piece U.S. price only

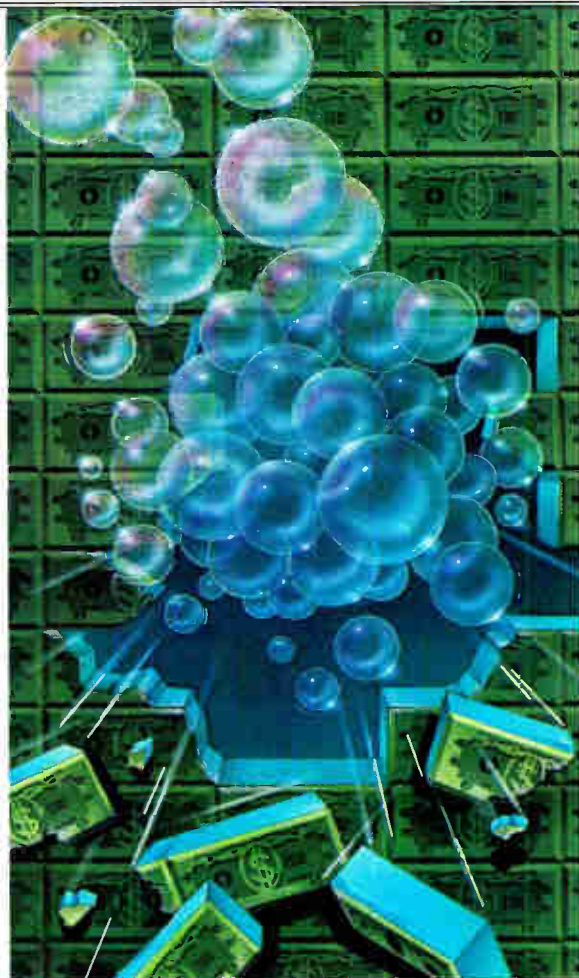

# Boost battery life.

Introducing the LM330 5V voltage regulator with 0.32V drop-out.

The new LM330 offers the lowest drop-out voltage of any fixed regulator on the market: 0.32V at 150mA. So instead of requiring 7.0V to operate (as do standard regulators), the LM330 provides a 5.0V output even when the input voltage dips as low as 5.32V.

As a result, the useful life of a battery is much longer, and system efficiency is significantly improved.

**National's better way.** To accomplish this feat, National's LM330 incorporates a pnp transistor enhanced by a deeper diffusion of the p-type material. This provides a higher current gain in the series-pass transistors.

Both the LM330 and its sister version, the LM2930 (designed primarily for automotive applications), feature this new pnp process.

**Efficiency plus.** Because the LM330 has a lower drop-out voltage, it runs cooler, and thus more reliably.

Since system designs using the LM330 won't need as much heat sinking the designer can now cut his costs to a minimum by using lower power/voltage components.

**Ultimate system protection.** This \$.70\* part protects other expensive devices by preventing both high voltages and negative voltages from getting through. The LM330

also offers protection against reverse battery, mirror image insertion, automotive load dump and input voltage transients.

And with National's 100% thermal limit burn-in offered as standard processing, incoming component test costs are significantly reduced.

National. Way out in front in linear technology.

For more information, check box numbers 053, 054 and 060 on the National Archives coupon.

\*U.S. price only

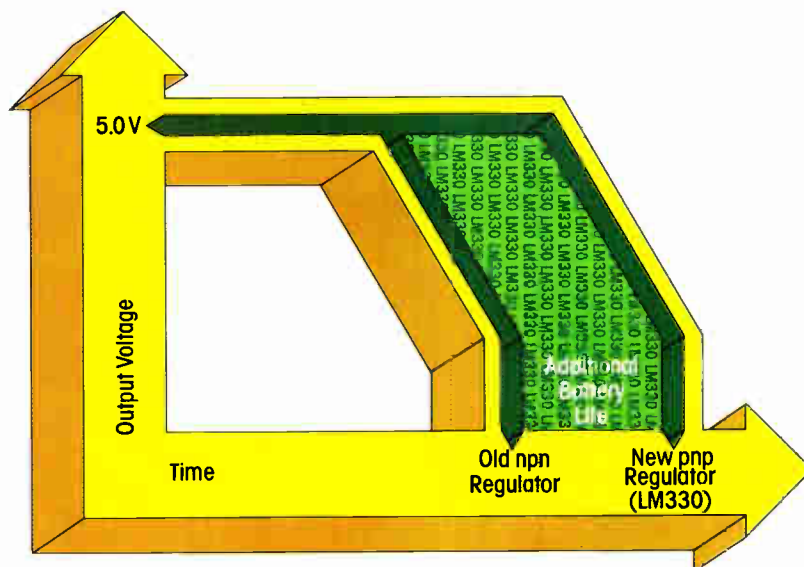

Battery Life

## DIGITAL TALKER™ - now your product can speak its mind.

National's unique DIGITAL TALKER Speech Synthesis chip set brings natural-sounding speech capability to virtually any product.

The Practical Wizards have come through with a versatile yet affordable application of an exciting technology.

Their new DIGITAL TALKER speech synthesis chip set brings truly life-like speech capability to a virtually unlimited array of products.

**The voice of things to come.** Since the speech produced by DIGITAL TALKER has incredibly human qualities, any product that uses it immediately takes on a distinct personality. Even that of a celebrity or a familiar company spokesman.

Toys, for example, can communicate with playful children's voices in any language. A TV set might take on parental authority. An automated bank teller can be bright and cheerful. An alarm or warning signal can sound a stern but calm explanation of a problem.

**Semiconductors speak.** DIGITAL TALKER's design versatility stems from its straightforward architecture. An independent Speech Processor Chip (SPC) translates digitized and compressed expressions stored in one or more standard ROMs (16K, 32K and/or 64K, depending on the size of the vocabulary).

Speech wave patterns are compressed in the time domain and stored in the ROM. This eliminates a great deal of the number-crunching required by other techniques in order to reconstruct the digitized words.

The result is a simpler, more straightforward SPC design. And that allows National to use proven technologies that are easily

producible in large volume by standard production processes.

The SPC also contains an internally programmable frequency generator and a variable gain D/A converter. Together they produce the intonation and inflection that make DIGITAL TALKER sound so incredibly realistic.

The result is that DIGITAL TALKER can reproduce any original voice in any spoken language - male or female, adult or child - both clearly and economically.

The SPC can directly address up to 256 expressions and 128K of ROM. Larger vocabularies may be obtained simply by cascading additional ROM.

**Simplicity of application.** Now, the ability to produce eloquent speech can be easily and inexpensively designed into a product using as few as two ICs (for simple switch-driven devices). For more sophisticated applications, the SPC is both COPS™ Family compatible and MICROBUS™ compatible.

This is where DIGITAL TALKER's true practicality really comes through. It requires few, if any, additional ICs for complete operation. And it functions equally well as either a stand-alone module or as a simple peripheral on a  $\mu$ P or microcontroller bus.

In fact, all it needs to begin speaking is a one-byte starting address and a "start" strobe. When the message is complete, it generates an interrupt.

The specially encoded customized

vocabularies stored in ROM are based on tape recorded messages submitted by the customer. National processes these messages and loads them into the necessary amount of ROM. This way, the end user gets the exact vocal fidelity he chooses.

So when it comes right down to it, the most difficult aspect of designing in DIGITAL TALKER is deciding on what it should say. Or who it should sound like.

**Have it speaking in 15 minutes.** DIGITAL TALKER is available for evaluative purposes in two forms.

The DT1000 (priced at \$495\*) is a totally self-contained board that - with just a speaker and a power supply - can rattle off any desired combination of 144 words.

For those who would rather build DIGITAL TALKER into their own evaluation designs, the Practical Wizards are also offering the DT1050 chip set (priced at \$85\*). The DT1050 consists of a 40-pin Speech Processor Chip and the same 144-word ROM library that comes with the DT1000.

To get more information on DIGITAL TALKER, just check box 066 on the National Archives coupon.

DIGITAL TALKER - the technology that speaks for itself.

\*U.S. prices only.

DIGITAL TALKER, MICROBUS and COPS are trademarks of National Semiconductor Corporation.

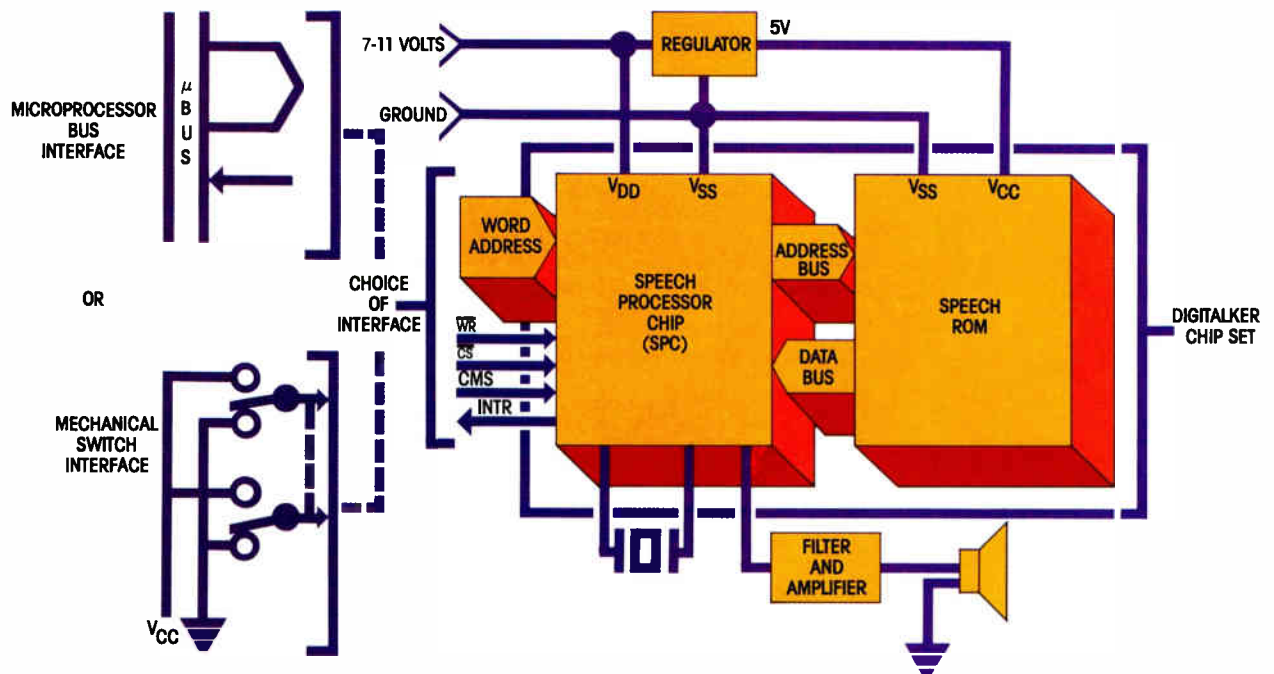

# PALs save money and space on tight TTL/SSI/MSI designs.

Immediate PAL™ design-in made feasible by steadily declining prices.

Now design engineers can benefit from both PAL price reductions as well as considerable savings in board space. National's technical expertise and volume production capabilities have allowed them to offer PALs at the lowest prices ever.

PALs (Programmable Array Logic) were designed to replace standard TTL logic. A single PAL can replace from 4 to 10 SSI/MSI packages.

At the higher levels of package replacement, PALs, in volume, are now cost-competitive with the SSI/MSI parts they replace.

At the lower replacement levels, PALs can be cost-justified if an entire PC board can be eliminated. This often happens when a few more logic functions are required than a single board can accommodate.

And PAL devices are fully field-programmable to provide the utmost in design flexibility and efficiency.

PAL's basic logic implementation is the familiar AND-OR array, where the AND array

is programmable and the OR array is fixed.

PAL's standard AND-OR logic and flexible I/O programming provides design and production efficiency unknown up to now. That's because logic modifications can be made more quickly and easily with PAL than with discrete random logic.

National is producing TTL-compatible PALs with the same time-tested technology used to manufacture PROMs. Their Titanium-Tungsten fuses have been proven reliable both through internal rel testing and three years of field use.

Program development and debugging on standard PALs is supported by National's STARPLEX™ development system.

And with 15 different PAL devices to choose from, logic design efficiency and reliability is truly maximized.

To obtain a PAL brochure simply check box 025 on this Anthem's coupon.

National – the inexpensive source for reliable PALs.

STARPLEX is a trademark of National Semiconductor Corporation

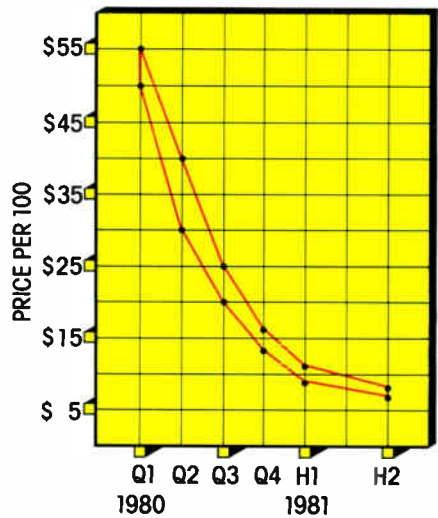

PAL PRICES CONTINUE DOWNWARD

PAL is a trademark of and used under license with Monolithic Memories, Inc.

# ISE™ has microprocessor emulation down cold.

STARPLEX™ with ISE – National's fully developed development system.

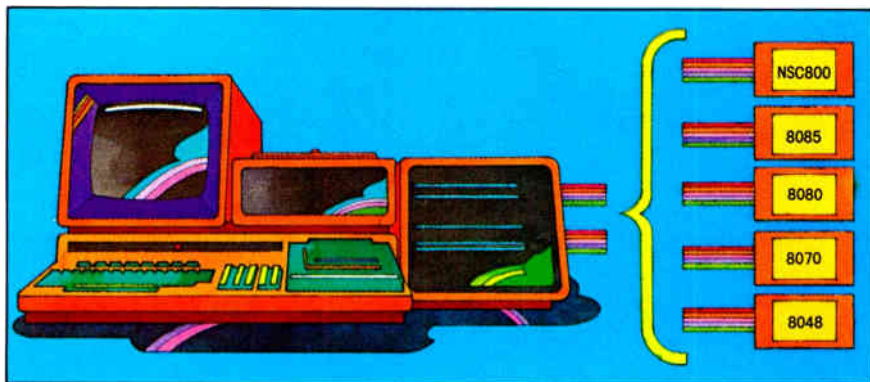

The Practical Wizards have created an easy-to-use development tool that helps design engineers do their entire job on the STARPLEX development system. It's called ISE (In-System Emulation).

With ISE, engineers can now develop, test, analyze and debug prototype software/hardware for 8080, 8048, 8049, 8050, 8070, Z80, COPS™ microcontrollers, NSC800 and 8085 microprocessors plus their Series/80 BLC boards.

ISE's powerful debugging capability allows simultaneous software and hardware

debugging of single or multiple processors for faster, more efficient system integration.

And since the symbol table is available during emulation, the same symbols are used in debugging that are used in writing the program being examined.

STARPLEX's symbolic debugging capability provides not only the usual breakpoint conditions, but also a "coast" command which allows you to continue executing a program after the breakpoint combination has been satisfied.

Also, with ISE's in-line assembler

and disassembler, programmers can modify object code and display it in assembly language without having to leave the debug and emulation environment. And without editing and re-assembly of the entire source program, thus eliminating many tedious manual steps.

National's easy-to-learn ISE software comes completely integrated into the STARPLEX system, including the unique Automatic Testing mode called "In-File." In-File implements a predefined sequence of tests. ISE can also record those results to show exactly how each part of the system performs during the tests.

When you get right down to it, National's STARPLEX with ISE offers features not available in any other development system on the market today. Yet it costs substantially less to own and operate than any system on the market.

For complete information on STARPLEX and ISE, check box 037 on the National Archives coupon.

The Practical Wizards have  $\mu$ P emulation down cold.

STARPLEX, ISE and COPS are trademarks of National Semiconductor Corporation.

## Fully armed for Mil/Aero data acquisition.

National's product breadth, performance and volume production add up to shorter lead times and lower system costs.

National Semiconductor is the broadest based Mil/Aero data acquisition supplier. No longer must design engineers fight with intermittent supply lines and long lead times for high performance parts. The big guns have arrived.

It's all part of a double-barrelled commitment to serve the total system needs of Mil/Aero DEs, the men and women who've been struggling to find a company that can equip them with everything they need for hi-rel data acquisition systems.

**Adding capacity cuts costs.** National brought two major resources to bear in their efforts: the broadest product line in the industry and sheer brute force.

Specifically, they've substantially increased their hi-rel production capacity and are strategically stockpiling inventories of components, every one totally compliant with MIL-STD-883 Class B processing.

So not only can National offer the full range of high performance data acquisition parts, they do it with shorter lead times and more attractive prices.

**System knowledge: the brains behind the brawn.** The third major resource that National has to offer is a complete understanding of data acquisition and process

control systems and environments. And they use every bit of this knowledge in designing the most practical and cost-effective components available.

More Mil/Aero DEs are turning to the Practical Wizards than ever before. Because

they know that National is fully armed for data acquisition.

For more information on their hi-rel data acquisition arsenal, check box number 062 on the National Archives coupon.

BIFET is a trademark of National Semiconductor Corporation.

### A SAMPLING OF THE NATIONAL ARSENAL

PART NUMBER	DESCRIPTION
LF198H/883	This monolithic sample and hold circuit used BIFET™ technology for very high DC accuracy (0.002%) and fast acquisition time (<10μs).
ADC0808CJ/883, ADC0816CJ/883	These low-cost 8-bit A/D converters offer high accuracy (±½ LSB max), low power (3mA max), a fast 100 μs, a fast conversion time and easy μP interfacing.
ADC1210HD/883	CMOS 12-bit A/D converter combining low power (210 mW max) with a 26μs conversion time.
LM131AH/883	This precision voltage-to-frequency converter combines low cost, guaranteed linearity (0.01% max) and excellent temperature stability (±50ppm/°C max).
DAC1285HD/883	A completely self-contained 12-bit accurate DAC with voltage out and reference.
LH0038D/883	A precision 12-bit accurate instrumentation amp with 100μV max offset voltage, 0.25μV/°C max offset drift and ultra-low input noise of 0.2μV p-p.
LH0091D/883	This low-cost true rms-to-DC converter features reading accuracies of 0.05% (trimmed) and 0.5% (untrimmed).
LM135H/883	This hi-rel linear IC temperature sensor offers low impedance and linear output to make interfacing to a readout or control circuitry especially easy.
LM199H/883	A precision temperature stabilized monolithic zener with temperature coefficients (.5ppm max) factor of ten better than high quality reference zeners.





# Adjustable voltage regulators: two new cost/performance alternatives.

The LM317L and LM350 fill out the industry's broadest line of adjustable voltage regulators.

In 1976 National developed the first 3-terminal adjustable voltage regulator. And now they've further strengthened their lead with the introduction of two new inexpensive versions of their time-proven adjustables.

The LM317L is a 100mA version of the well-known 1.5A LM317 now available in the low cost TO-92 plastic package.

Similarly, the LM350 is the 3 Amp adjustable regulator now in the popular TO-220 plastic package. So it extends the line of inexpensive plastic devices to 3 Amps.

**Better performance, lower costs.** Three terminal adjustable voltage regulators offer performance that's a factor of 10 better than fixed regulators. Line regulation, for example, is a low 0.01%/V and load regulation is a 0.1%.

Another advantage of adjustable regulators is the standardization they bring to any design.

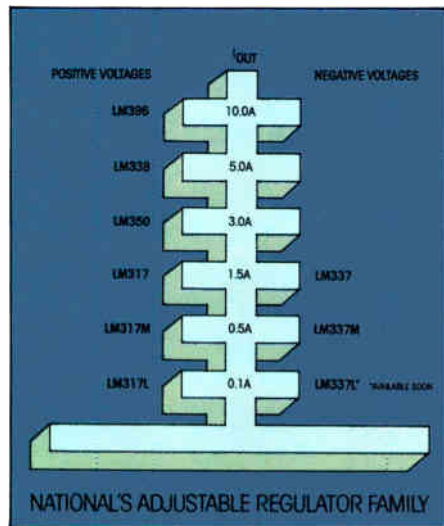

The output voltage is easily adjusted by two external resistors. This approach eliminates the expense and trouble of ordering and stocking many different fixed voltage regulators in low quantities.

**On-chip protection circuitry.** All of National's adjustable voltage regulators feature the same on-chip protection, including current limiting, thermal overload protection and safe area protection.

Additionally, thermal regulation, a new parameter guaranteed for both devices, gives the designer details on the effects of power dissipation caused by line and load changes on the regulator output.

For data sheets and other information on the LM317L and LM350, check boxes 055 and 056 on the National Archives coupon. 

# The LH0032 and LH0024 high-speed op amps- the best in the business.

State-of-the-art techniques go into the industry's only single-package versions of these popular high-speed op amps.

Ever since National began making their LH0024 and LH0032 high-speed op amps, they've been the industry favorites. And for good reason.

For starters, they use state-of-the-art thin and thick film technology in making the only single package versions of these op amps currently available.

Both the LH0024 and the FET-input LH0032 offer a very high slew rate (500V/ $\mu$ sec), a wide bandwidth (70MHz), low input offset voltage (2mV), a null offset with a single pot, and both are available in military and commercial temperature versions.

In addition, both are available in versions to meet military standard 883 level B specs. So not only are these op amps put through special testing and REL processing, they are also subject to National's own stringent REL and QA standards and procedures.

These low-priced op amps are ideally suited for a variety of high-speed applications.

Active filters, oscillators, comparators, summing amplifiers, sample and hold circuits, D/As and A/Ds, and many others.

Check the National Archives coupon

067 for data sheets and assorted application ideas and information. All free from the Practical Wizards of Silicon Valley. 

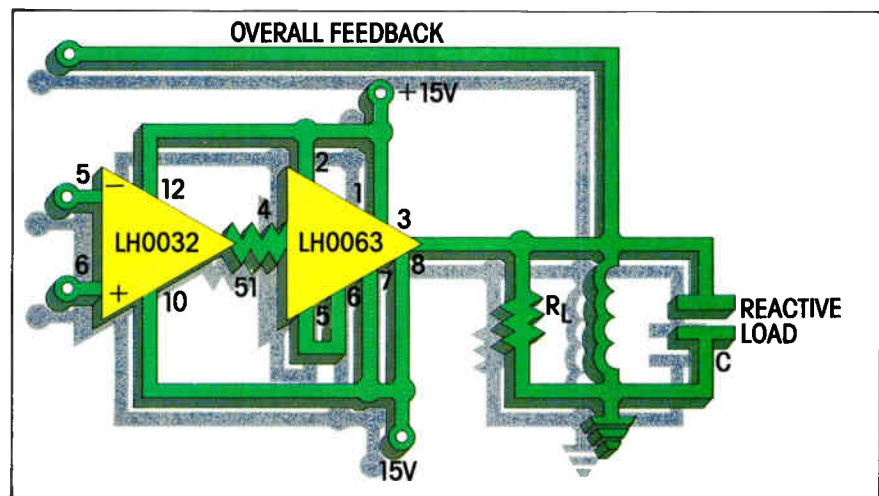

# The CMOS logic population explosion.

National's commitment to CMOS has made them the fastest growing supplier in the industry.

National first introduced the 74C Family back in 1972. And since that time, the Practical Wizards have been steadily reinforcing their commitment to these and other high quality, low power CMOS logic components, including the CD4000 Family.

As a result, National is the fastest growing CMOS logic supplier in the business.

**The advanced 74C900 Series.** In addition to offering pin-for-pin, function for function CMOS replacements for the most popular 7400 Series logic components, the Practical Wizards went one step further.

The expanding 74C900 Series offers carefully selected useful functions in powerful single-chip form. Including the National-designed industry standard A/Ds (ADC0808, ADC0816).

And the  $\mu$ P compatibility of many of the 74C devices stretches their versatility that much further, as in the case of National's TRI-STATE<sup>®</sup> octal buffers (MM74C240/244/941), octal latches (MM74C373) and octal D flip-flops (MM74C374).

**A commitment to innovation and practicality.** National's time-proven commitment to CMOS keeps on getting stronger as the years go by. They can already fill your CMOS needs for microprocessors, linear, Mil/Aero, MOS/LSI and additional memories.

To get the details on all of National's CMOS logic devices, check box number 061 on this issue's coupon.

## A/D converters.

ADC0808/09 (MM74C949/49-1):  $\mu$ P-compatible 8-bit A/Ds with 8-channel input analog mux.

ADC0816/17 (MM74C948/48-1):  $\mu$ P-compatible 8-bit A/Ds with 16-channel input analog mux.

ADC3511/3711 (MM74C937/38):  $3\frac{1}{2}$ -digit and  $3\frac{3}{4}$ -digit  $\mu$ P-compatible A/Ds. 12-bit successive approximation register.

## DVMs.

ADD3501/3701 (MM74C935/36):  $3\frac{1}{2}$ -digit and  $3\frac{3}{4}$ -digit DVMs with multiplexed 7-segment LED drives.

## LED display controllers.

MM74C911/12/17: 4-digit and 6-digit  $\mu$ P-compatible LED display controllers

MM74C956: Alphanumeric LED display controller (samples available soon from any NSC sales office).

## Keyboard encoders.

MM74C922/23: 16-key and 20-key keyboard encoders.

## LED/LCD direct drive counters.

MM74C925/26/27/28: 4-decade counters with multiplexed 7-segment LED drivers.

MM74C945/46/47: 4-decade up/down counters with direct drive 7-segment LCD drivers (samples available soon).

## Memories.

MM74C910: 256-bit static RAM.

MM74C920/21: 1024-bit (256 x 4) static silicon-gate RAM.

MM74C929/30: 1024-bit (1024 x 1) static silicon-gate RAM.

TRI-STATE is a registered trademark of National Semiconductor Corporation.

## What's new from the National Archives?

006  Special Functions Data Book (\$6.00)

025  PAL Brochure

029  INS8050 Data Sheet

036  Optoelectronic Handbook (\$3.00)

037  STARPLEX<sup>™</sup> and ISE<sup>™</sup> Information

043  1980 Memory Data Book (\$6.00)

044  1980 MOS Data Book (\$6.00)

051  Data Conversion/Acquisition Handbook (\$7.00)

052  Free Subscription to the Data Update

053  1980 Linear Data Book (\$9.00)

054  LM330 - 5.0V Fixed Regulator Data Sheet

055  LM317L Adjustable Regulator Data Sheet

056  LM350 Adjustable Regulator Data Sheet

060  1980 Voltage Regulator Handbook (\$6.00)

061  1981 CMOS Data Book (\$6.00)

062  1980 Reliability Handbook (\$12.50)

064  P<sup>2</sup>CMOS Memory Data Sheets

065  BLC-9250 & BLC-9101 Bubble Memory Data Sheets

066  DIGITALKER Data Sheets

067  LH0032 & LH0024 Op Amp Data Sheets

For desired information, mail coupon to:

**National Semiconductor Corporation**  
2900 Semiconductor Drive  
Mail Stop 16251  
Santa Clara, CA 95051

In Europe, mail coupon to:

**National Semiconductor GmbH**  
Industriestrasse 10  
D-8080 Fürstenfeldbruck  
West Germany

Enclose check or money order based upon appropriate currency. Make checks payable to National Semiconductor. All prices shown are U.S. prices only. Add applicable state and local sales tax to your order. Allow 4-6 weeks for delivery. This coupon expires on June 30, 1981.

NAME \_\_\_\_\_

TITLE \_\_\_\_\_ PHONE \_\_\_\_\_

COMPANY \_\_\_\_\_

ADDRESS \_\_\_\_\_

CITY \_\_\_\_\_ STATE \_\_\_\_\_ ZIP \_\_\_\_\_



**National Semiconductor**

The Practical Wizards  
of Silicon Valley

## Electronics review

works on either side match the signal with capacitance-coupling junctions and terminations.

A mark of confidence in the new switch is that it is the only part in the system without a spare. Units have been tested for more than 300,000 switching cycles, and their rating is a minimum of 500,000 cycles before performance deterioration. The maximum switching time is 25 milliseconds, and insertion loss at the switch is only 0.6 decibel.

The switch assembly shifts signals between two hemispherical coverage antennas and frequency-modulation transponders or between quadrant antennas and the S-band transponders. The system includes low-power S-band transponders that use only 10 to 15 w for ground links and a high-power unit that will link with the multipurpose tracking and data-relay satellite system, or TDRSS, for high-speed data dumping.

The TDRSS will operate in the 12- to 18-gigahertz K band. Ground stations will have a fixed narrow beam to focus on the satellite. "But the fast-moving shuttle must depend on a brute-force signal—hence the 175-w switch," says TRW's Pederson.

However, the first TDRSS will not go up until a later shuttle flight. In the meantime, the craft will use its S-band system to communicate with ground stations and with two other satellites.

-Larry Waller

## Peripheral equipment

### Thin-film heads emerge from redesign

Manufacturers of IBM-compatible computer peripherals and their suppliers are gearing up for volume production of read/write heads made with thin-film technology. A number of the designs have changed since they were first announced, however, as more has become known about the heads in IBM's new 3370, -75, and -80 disk drives.

In these new heads, a sputtered magnetic pattern, much as in thin-film semiconductor technology, re-

# The Fingerprinter™ It could change the way you look at your plasma process

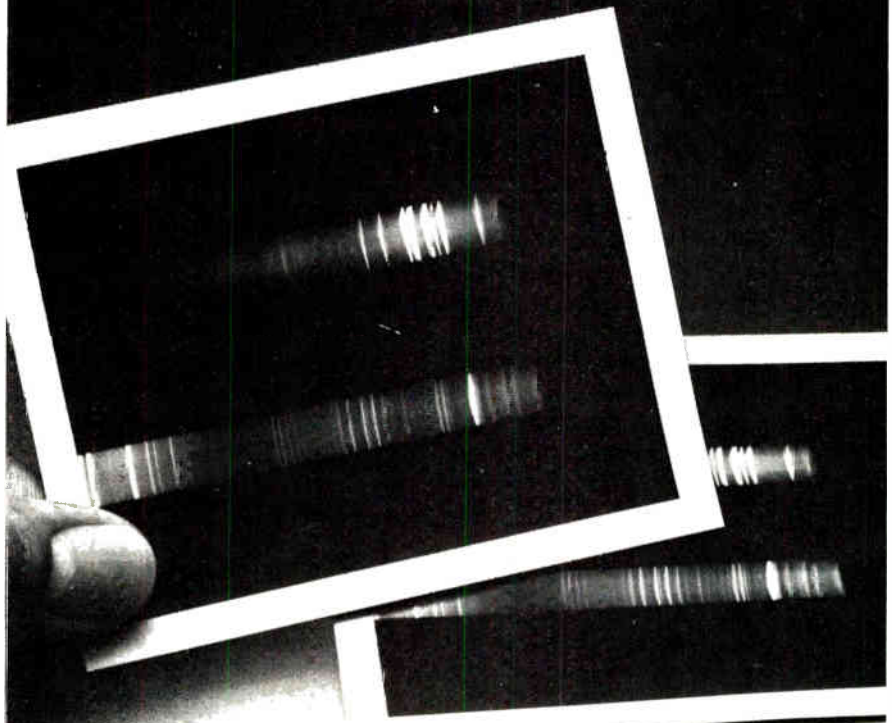

Take a look at the Fingerprinter. It's the first process gas spectrograph designed for plasma process control.

This is one process control tool that'll earn its place on your line. One technician can monitor the process, and analyze the vacuum system. Easily. Accurately. And fast.

The Fingerprinter is non-intrusive and non-contaminating, so it can be adapted to analyze both process parameters and contaminant levels.

Fingerprints, unique spectrographs on Polaroid® prints, can be interpreted by almost anyone. Each print also becomes a permanent record of the process.

The Fingerprinter lets you look at your plasma process from a

command point of view. Now you'll have the control to keep your system up to specs, do your own quality control checks, and fine tune your line.

Get a good look at the Fingerprinter by writing F.E.P., Front End Processes, at 2912 Blystone, Dallas, Texas 75220. Or call (214) 350-2482.

**Front End Processes — out front in semiconductor processing technology**





## This Ticket Printer Has The Guts To Stand Alone

Inside its free standing case, our PK-970 alphanumeric printer teams an advanced microprocessor-based controller and power supply, our long life dot matrix print head, and stepper motor that controls ticket advance, 6 lines to the inch or .110, and positioning until the message is complete. The result: a versatile standalone workhorse that can print both analog and digital data on the same card for special applications from lab to weigh station to manufacturing process control.

Print standard or enhanced characters on single-sheet cards or multi-part tickets, with or without ribbon mechanism. Program it for 30, 37 or 49 character line lengths and character density of 10, 12.4 or 16.5 characters/inch. And count on that integral controller to accept parallel, or serial data to meet your system's needs. For details write or call today.



### PRACTICAL AUTOMATION, INC.

Trap Falls Road, Shelton, Conn. 06484/Tel: (203) 929-5381

Circle 58 on reader service card

places wire coils, boosting read/write rates as much as 2½ times. Although many suppliers long ago launched development of thin-film heads [*Electronics*, Dec. 5, 1979, p. 51], they were hobbled by a lack of information on the IBM heads, and when technical data became available in February 1980, redesigns to match its performance were often necessary.

Anticipating IBM's course, some manufacturers began work on a multilayer helical design, each layer corresponding to a turn in the wire-coil head. Each layer can be as close to the head gap as any other, but there is not enough room for many layers—and this limits the head's responsiveness to the signal.

Other manufacturers opted for a spiral arrangement of the magnetic turns. This arrangement allows many adjacent turns in a single layer, but the further a turn is inside the spiral, the further it is from the gap, which decreases the signal level.

**Spiral for IBM.** The 3370's head is a spiral employing eight turns, many more than in the proposed helical designs. "The signals from IBM's 3370 were better than we expected, so we went to a redesign," says Joel Levine, director of marketing at Magnex Corp.

The San Jose, Calif., affiliate of Exxon Enterprises Inc. started with a four-turn, four-layer helical design, but it has evolved an approach that will be in production by June. It has two layers, with the four turns on the second layer interdigitized with the five on the first.

"Our head design will meet and probably exceed the performance of a typical IBM 3370 head," Levine claims. "Just the extra turn [nine versus eight] provides a minimum 11% signal improvement. There are some second-order improvements, such as shorter grooves that result in improved efficiency because the magnetic flux doesn't have to travel as far."

The Magnex approach does require more production processing, but "we're getting ourselves ready not only for the 14-inch disk market, but also for the 8- and 5¼-in. are-

## LARGEST RADAR INVENTORY IN THE WORLD

### SYSTEMS & SPARES

AN/ALT-6-7-8  
AN-APG-33  
AN/APG-51  
AN/APN-69  
AN/APN-102  
AN/APN-169  
AN/APQ-50  
AN/APQ-55  
AN/APS-20  
AN/APS-31A  
AN/APS-42-45  
AN/APS-64  
AN/ASB-4/9  
AN/CPS-6B  
AN/CPS-9  
AN/DPN-32  
AN/FPS-6-8  
AN/FPS-14-18  
AN/FPS-20-75  
AN/FRC-39  
AN/FRT-15  
AN/GPA-30  
AN/GPA-126  
AN/MPQ-4A-10  
AN/MPQ-29  
AN/MPS-19  
AN/MPX-7  
AN/MSO-1A  
AN/SPA-4A  
AN/SPA-8  
AN/SPN-5  
AN/SPS-5B  
AN/SPS-6C  
AN/SRW-4C  
AN/TPN-12/17  
AN/TPS-1D,E  
AN/TPS-10D  
AN/TPS-28  
AN/TPS-34B  
AN/TPS-37  
AN/TPX-21  
AN/UPA-25-35  
AN/UPX-4-6  
AN/UPX-14  
HIPAR  
MK-25  
Nike Ajax  
Nike Hercules  
SCR-584

### AUTOTRACK ANTENNA SCR-584 RADAR SYSTEM

360 deg AZ 210 deg EL. 1 mil. accuracy. Missile vel. accel. and slew rates. Amplidyne control. Handle up to 20 ft. dish. Compl. control chassis. ALSO in stock 10 cm. van mounted rad. system. Conical scan. PPI. 6 ft. dish. 300 pg. instr. bk. on radar, \$50.

### RF SOURCES

17-27 KHz 200 W CW  
125-450 KHz 4 KW CW  
2-30 MHz 3 KW CW  
4-21 MHz 40 KW CW  
24-350 MHz 100 W CW  
80-240 MHz 500 W 2-5 uS  
175-225 MHz 300 KW 1, 20 uS  
200-2000 MHz 40 W CW  
210-225 MHz 1 MW 5 uS  
385-575 MHz 1.5 KW CW  
400-700 MHz 1 KW .03 DC  
950-1500 MHz 1 KW .06 DC  
900-1040 MHz 5-10 KW .006 DC  
1.2-1.35 GHz 500 KW 2 uS  
1.5-9.0 GHz 150 W CW  
3.2-3.3 GHz 10 KW .002 DC  
2.7-2.9 GHz 1 MW 1 uS  
3.1-3.5 GHz 1 MW 1.3 uS  
2.7-2.9 GHz 5 MW 2-3 uS  
4.4-5.0 GHz 1 KW CW  
5.4-5.9 GHz 5 MW .001 DC  
6 GHz 1 MW 1 uS  
6.2-6.6 GHz 200 KW .37 uS  
8.5-11 GHz 200 W CW  
9.375 GHz 40 KW .5-1-2 uS  
8.5-9.6 GHz 250 KW .0013 DC  
15.5-17.5 GHz 135 KW .33-1-3 uS  
24 GHz 40 KW .15 uS  
35 GHz 50 KW .1 uS

### MODULATORS

25 KW 5.5 KV 4.5 A; .0025 DC  
144 KW 12 KV 12 A; .001 DC  
250 KW 16 KV 16 A; .002 DC  
405 KW 20 KV 20 A; 1 DC  
500 KW 22 KV 28 A; .001 DC  
1 MW 25 KV 40 A; .002 DC  
3 MW 50 KV 60 A; 30 uS  
10 MW 76 KV 135 A; .001 DC  
66 MW 160 KV 400 A; .00

### TRACKING SYSTEMS

K BAND MONOPULSE 40 KW E-34  
X BAND NIKE AJAX/HERCULES  
X BAND HI-RES MONOPULSE MOD IV  
X BAND GCA PAR II  
X BAND FIRE CONTROL 250 KW M-33  
X BAND MOBILE 40 KW AN/MPQ-29  
X BAND BEACON 100 W AN/DPN-62  
S BAND 250 KW AN/MPQ-10A  
S BAND 250 KW AN/MPS-9  
X BAND HAWK MPQ-34  
X BAND HAWK MPQ-33  
C BAND 1.5 MW MPS-19(C)  
S BAND 14' DISH PRELORT

### SEARCH SYSTEMS

KU BAND AIRBORNE 135 KW B-58  
X BAND WEATHER 250 KW AN/CPS-9  
X BAND WEATHER 40 KW AN/SPN-5  
X BAND 7 KW AN/TPS-21  
X BAND CW DOPPLER AN/PPS-9/12  
C BAND HGT FDR 1 MW TPS-37  
C BAND 285 KW AN/SPS-5B/D  
S BAND HGT FINDER 5 MW AN/FPS-6  
S BAND COHERENT 1 MW AN/FPS-18  
S BAND 1 MW NIKE AJAX/HERC  
L BAND 40' ANT 500 KW AN/FPS-75  
L BAND 500 KW AN/TPS-1D/GSS-1  
UHF 1 MW HELIHUT TPS-28

### C BAND TRACKER

Pwr: 1.5 MW Range: 250 miles  
Recv: paramp Display 5" "A" scopes,  
10' dish w/linear or circ. polarization.

### NIKE HERCULES SPARES/MAINTENANCE

Over 10,000 major components in stock w/repairs and overhaul facilities incl: SHOP 1 & 2 MAINTENANCE VANS.

SEND FOR FREE 24PAGE CATALOG



**Radio Research Instrument Co., Inc.**

2 Lake Avenue Ext., Danbury, CT 06810  
(203) 792-6666 • Telex 962444

# "Important development for STD Bus users: Total analog I/O capability from Data Translation."

Fred Molinari, President

Picture this.

A complete and comprehensive line of analog I/O for STD Bus microcomputers – the DT 2742 series. I/O that works with *any* STD Bus CPU. Including STD 8085, STD 8080A, STD 6800, STD 6809, and STD Z80.

We offer A/D boards for analog input, D/A boards for analog output, input channel expansion, DC-DC conversion, everything.

We can supply performance parameters sufficient to solve most any application problem.

In all, we stock more than 50 different boards.

And each includes a fully shielded DATA X II™ module which virtually eliminates ground loops and digitally-induced noise.

What's more, ours is the only line that provides user selectable interrupt structures.

In fact, we offer *two* kinds. Software polled and vectored interrupt. Both conform to the latest standards of the STD manufacturers group.

Good news, STD Bus users, we offer more than 50 analog I/O boards. Complete with two ways to handle interrupts. Our boards operate with any 8-bit STD Bus microcomputer, including STD 8080A, STD 8085, STD 6800, STD 6809, and STD Z80.

Now let's discuss accuracy.

If 12-bit resolution won't do, we can give you



14 bits. Or even 16 bits.

On top of all this, we promise to deliver your boards within five working days. Or about five times faster than the "competition." We think this enormous assortment of analog I/O and our five-day delivery are just what the industry needs – so tell all your friends.

Data Translation cannot be overexposed.

For more information write Data Translation, 100 Locke Drive, Marlboro, Massachusetts 01752. Or call (617) 481-3700. TELEX 951646. In Europe: Data Translation Ltd., Rockwell House, 430 Bath Road, Slough, Berkshire/England SL1 6BB (06286) 3412. TELEX: 849862.

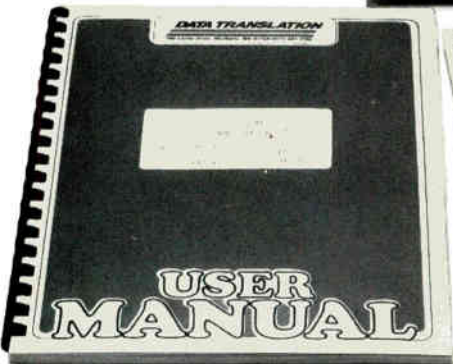

# DATA TRANSLATION

INTERNATIONAL SALES OFFICES: ARGENTINA, Buenos Aires 93 2557; AUSTRALIA, N.S.W. (02) 818 1166; BELGIUM, Brussels 02-352135; CANADA, Toronto 416-625-1907; DENMARK, Copenhagen (01) 83 34 00; ENGLAND, Stockport 061-442-9768; Slough 06286-3412; FINLAND, Helsinki 90 377787; FRANCE, Meudon La Foret 6306839; GERMANY, Puchheim (089) 80 1602; INDIA, Bombay 231040; ISRAEL, Ramat Hasharon 03-237959; ITALY, Milano 34.93.041; JAPAN, Tokyo (03) 244-1111, (03) 437-5471; NETHERLANDS, Rijswijk 070-996360; NEW ZEALAND, Wellington 693-008; NORWAY, Oslo (02) 229850; PORTUGAL, Lisboa 545313; SPAIN, Barcelona (93) 301 7850; SWEDEN, Vallingby 08 38 00 65; SWITZERLAND, Zurich 01/7241410.

DATA X II is a trademark of Data Translation Inc.

# LET YOUR FINGERS DO THE TALKING...

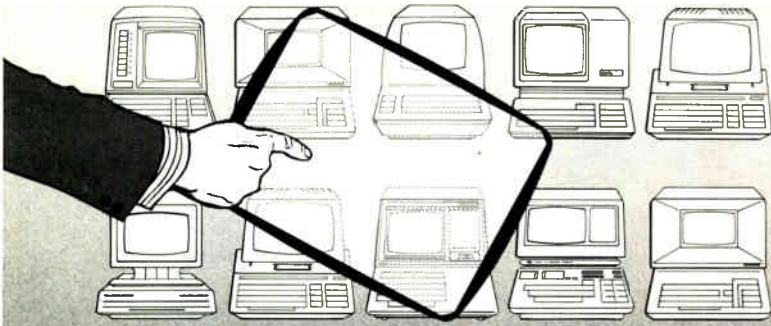

With the touch of a finger on the Elographics E270 Position Sensor, the coordinates of the touch point are transmitted to your terminal or computer for limitless menu and graphic applications. Replaces light pens and joy sticks. Opens new applications where finger touch simplicity is a must.

The E270 is a transparent formfitting sensor mounting directly on CRT's. Utilizing modern continuous thin film coatings, the E270 gives high resolution coordinates. A variety of controller electronics is available to enable the OEM or system builder to interface easily to micros and minis.

- POINT MODE
- STREAM MODE
- MODELS TO FORMFIT VARIETY OF CRT's
- RESOLUTION TO .003"
- HIGH RELIABILITY
- LOW PROFILE
- EASY TO INSTALL

The E270 offers a uniquely simple and flexible way to communicate with computer systems. Human engineered for all types of computer systems, from word processing to process control. Let Elographics solve your man-machine interface problems.

**ELOGRAPHICS, inc.**

1976 OAK RIDGE TURNPIKE OAK RIDGE, TENNESSEE 37830 (615) 482-4038

Circle 60 on reader service card

## DTMF-MODEMS

*You are looking at the world's most complete line of DTMF receivers.*

SSL's unparalleled performance in reliability, precision and competitive pricing have all come together to bring you the smallest and most advanced DTMF receivers available

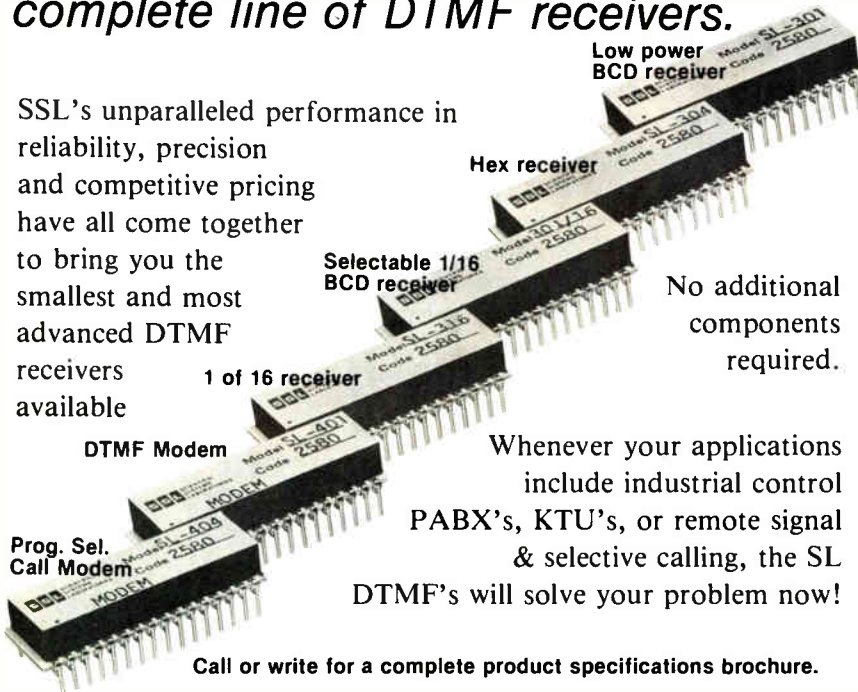

No additional components required.

Whenever your applications include industrial control PABX's, KTU's, or remote signal & selective calling, the SL DTMF's will solve your problem now!

Call or write for a complete product specifications brochure.

**SSL** SCIENTIFIC SYSTEMS LABORATORIES

2031 E. Cerritos, Suite J, Anaheim, CA 92806  
(714) 776-5003

60 Circle 236 on reader service card

## Electronics review

nas," Levine says. The smaller disks, although spinning at the same rate, have fewer flux changes per second and therefore less signal, and "the additional turn will boost the signal backup," he says.

Also adopting a hybrid approach is Storage Technology Corp., Louisville, Colo. "We have gone with a 10-turn, 2-layer design," says Joseph J. Curry, vice president and general manager of the Microtechnology division.

Storage Technology's thin-film head has five turns on one layer right above the five turns on another. "This also gives us a natural central tap if we want it," Curry says. "We felt this approach to be the optimum structure when trading off increased head efficiency against complexities in manufacturing."

Another company that went from a helical design to a spiral type is Applied Magnetics Corp.'s Magnetic Head division in Goleta, Calif., which plans to be in volume production by December. Memorex Corp. of Santa Clara, Calif., hedged its bets by working on several head designs. When information on the 3370's head surfaced, it reworked a 10-turn spiral design into an 8-turn model. The revised version is scheduled for pilot production at the rate of 100,000 heads a quarter by December.

ICs too. Memorex also developed an integrated circuit for the read/write electronics with a 50-megahertz bandwidth said to exceed the 3370 in performance and, in fact, to reach the 3380's level. Also, industry sources say that a consortium of six other manufacturers—Magnex, Applied Magnetics, Storage Technology, Information Magnetics, Siemens, and Digital Equipment Corp.—are working with the custom house Silicon Systems Inc. of Tustin, Calif., on read/write and servo-amplifier ICs that all six firms can use.

"Several customers did come to us to develop a thin-film read/write IC for the 3370, -75, and -80 markets," acknowledges Alan H. Portnoy, director of marketing for Silicon Systems. "We expect to be beginning

# Books of special interest to our readers

## Applying Microprocessors

Reprinted from *Electronics*, completes the EE's transition from the old methods of electronic design to microprocessor engineering. Pub. 1977, 191 pp. Order #R-701, \$9.95

## Basics of Data Communications

This compilation of essential articles from *Data Communications* magazine includes chapters on terminals, acoustic couplers and modems, communications processors, networking, channel performance, data link controls, network diagnostics, interfaces, and regulations and policy. Pub. 1976, 303 pp. Order #R-603, \$12.95

## Circuits for Electronics Engineers

Almost 350 circuits arranged by 51 of the most useful functions for designers. Taken from the popular "Designer's Casebook" of *Electronics*, these circuits have been designed by engineers for the achievement of specific engineering objectives. Pub. 1977, 396 pp. Order #R-711, \$15.95

## Design Techniques for Electronics Engineers

Expert guidance at every point in the development of an engineering project—making measurements, interpreting data, making calculations, choosing materials, controlling environment, laying out and purchasing components, and interconnecting them swiftly and accurately. Nearly 300 articles from *Electronics*' "Engineer's Notebook." Pub. 1977, 370 pp. Order #R-726, \$15.95

## Microelectronics Interconnection and Packaging

Up-to-date articles from *Electronics* include sections on lithography and processing for integrated circuits, thick- and thin-film hybrids, printed-circuit-board technology, automatic wiring technology, IC packages and connectors, environmental factors affecting interconnections and packages, computer-aided design, and automatic testing. Pub. 1980, 320 pp. Order #R-927, \$12.95

## FREE

Brochure describes *Electronics*' editorial reprints, services, books. For free copy, check the coupon in this ad or circle #275 on the reader service card.

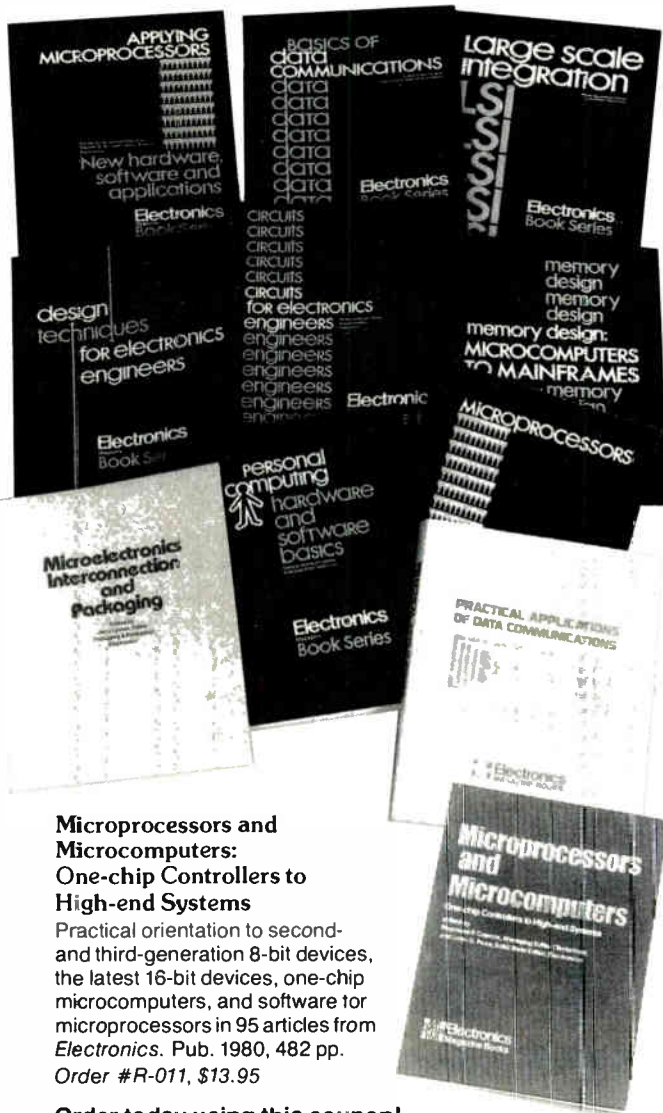

## Microprocessors and Microcomputers: One-chip Controllers to High-end Systems

Practical orientation to second- and third-generation 8-bit devices, the latest 16-bit devices, one-chip microcomputers, and software for microprocessors in 95 articles from *Electronics*. Pub. 1980, 482 pp. Order #R-011, \$13.95

## Order today using this coupon!

Electronics Magazine Books  
P.O. Box 669  
Hightstown, NJ 08520  
Tel. (609) 448-1700, ext. 5494



Order #	Qty.	Price
R- _____	_____	\$ _____
R- _____	_____	\$ _____
R- _____	_____	\$ _____
R- _____	_____	\$ _____
R- _____	_____	\$ _____
Total		\$ _____

Name \_\_\_\_\_

Title \_\_\_\_\_

Company \_\_\_\_\_

Street/P.O. address \_\_\_\_\_

City/state/zip \_\_\_\_\_

Payment enclosed (payment must accompany orders under \$25)

Bill my company (or attach company Purchase Order)  Bill me

Send a free copy of the *Electronics* Editorial Reprints brochure.

Ten-day money-back guarantee applies on all books. EL

## Large Scale Integration

As published in *Electronics*, covers the entire range of design applications in sections on bipolar LSI, MOS LSI, new devices, system design, computer-aided design, testing, and applications. Pub. 1976, 208 pp. Order #R-602, \$9.95

## Memory Design: Microcomputers to Mainframes

The technology, devices, and applications that link memory components and system design. How to apply the new technology to meet specific design goals. Edited from the pages of *Electronics*. Pub. 1978, 180 pp. Order #R-732, \$12.95

## Microprocessors

The basic book on microprocessor technology for the design engineer. Published in 1975, articles are drawn from *Electronics*. 150 pp. Order #R-520, \$8.95

## Personal Computing: Hardware and Software Basics

More than 50 articles from leading publications give you up-to-date information on personal computing hardware, software, theory, and applications. Pub. 1979, 266 pp. Order #R-903, \$11.95

## Practical Applications of Data Communications: A User's Guide

Articles from *Data Communications* magazine cover architecture and protocols, data-link performance, distributed data processing, software, data security, testing and diagnostics, communications processors, and digitized-voice and data-plus-voice. Pub. 1980, 424 pp. Order #R-005, \$13.95

# FREE! YOUR PERSONAL COPY OF

## NEWARK CATALOG 105

ALL NEW FOR 1981!

Your first and finest reference book for electronic components

- 756 pages!
- 190 product lines including many new listings

ALL PRODUCTS LISTED ARE STOCKED!

Featuring

WRITE OR CALL TODAY FOR YOUR COPY

### HAMLIN: LCD's and RELAYS

Hamlin offers a complete line of reed, solid state and mercury wet relays to satisfy your switching requirements. Standard and custom large area displays from the nation's leading supplier of liquid crystal displays.

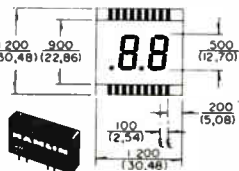

## NEWARK ELECTRONICS

500 N. PULASKI • CHICAGO, IL 60624  
PHONE (312) 638-4411 • TELEX 25-3218

Circle 62 on reader service card

## Instrumentation Amplifiers



### Transducer Signal Conditioning

Precision differential amplifier and transducer conditioners for use with thermocouples, load cells, strain gages, pressure transducers, and other low-level sources.

**Features:** Gains from 0.01 to 5000. 100 KHz bandwidth. 300 Volt common mode. 2 microvolt stability. 0.01% gain accuracy. Transducer excitation and calibration.

**Options:** Switchable filter, 6 poles Butterworth or Bessel. Programmable gain. Voltage and resistance calibration. Overload detection. Output multiplexer. Gain and bandwidth readout. Galvanometer and tape outputs.



... the signal conditioning specialists

**PACIFIC PRECISION INSTRUMENTS**

1040 SHARY COURT  
CONCORD, CA 94518  
(415) 827-9010

## Electronics review

deliveries to some of the development partners by mid-1981." The IC is for use with non-center-tapped designs similar to those in the 3370, he adds.

-Bruce LeBoss

## Solid state

### Quick turnaround set for custom C-MOS

A gap perceived is a gap filled: thus it ideally goes in the semiconductor industry, as in most others. The gap filler this time is the fast fabrication of custom complementary-MOS integrated circuits.

"Most custom designs have less than a 50% chance of entering mass production," points out Gary P. Kennedy, marketing director for Comdial Semiconductor Inc., Sunnyvale, Calif. Consequently, a semiconductor chip designer could find it difficult to interest a wafer fabricator, whose eye is often on long production runs.

The answer. Enter Comdial, which specializes in short runs. It promises prototype 10-wafer quantities in a C-MOS silicon-gate process in as few as 10 working days, rather than the weeks it often takes, at \$1,000 per finished wafer. Comdial also offers ceramic and Cerdip packaging, as well as advanced design-engineering assistance.

"Volume" production runs for the company, which introduced an n-channel silicon-gate process last fall, are limited to 125 3-inch wafers per design per customer per month. Capability to handle 4-in. wafers will be in place shortly, according to Kennedy.

To handle larger orders, Kennedy passes the job on to the nearby Synertek, a division of Honeywell Inc., Santa Clara, Calif., with which Comdial has a close relationship. For example, the two are coordinating a high-performance MOS process, which will be made available in the fourth quarter. And an n-channel Isoplanar process is in the offing and should be ready during the second quarter.

-Alfred Rosenblatt



# The new 1981 IC Master.

## One book. Two volumes. Five Updates.

The newly revised 1981 IC Master is bigger and better than ever. Now expanded to two full volumes, it includes all of the latest information on over 50,000 ICs and microcomputer boards from 150 different manufacturers, worldwide. Survey the entire industry—at a glance. There's no need to spend hours or days searching through dozens of separate manufacturer's catalogs and data sheets for the most current information.

All you need is the IC Master.

IC Master solves problems in seconds.

Need to know who makes a 16K Dynamic RAM with an access time of 300ns or faster? Or, a D/A converter with 12 bits resolution,  $2\pm$  LBS linearity error and 24 mW power dissipation? Or, quad comparators with .8 offset voltage, 100 nA bias current and 25 nA offset current?

You'll find the answers in the 1981 IC Master.

IC Master's easy-to-use functional index system is divided into eight time-saving Master Selection Guides—Digital, Interface, Linear, Memory, Microprocessor, Microcomputer Board—and two brand new sections on Custom ICs and Microprocessor Development Systems.

The Master Selection Guides enable you to quickly find the products which are most appropriate to fulfill your major requirements—and then provides data for them.

Within each category, products are classified by type and key parameters. Locating exactly what you need is a snap.

AUSTRALIA A J Distributors PTY LTD, Tel. 269 1244. AUSTRIA LBG GMBH (0222) 92 46 74. BELGIUM Rampe Gauloise la, Tel. 02 478 4847. CANADA Future Electronics, Inc., Tel. (514) 731-7441. DENMARK Advanced Elektronik, Tel. 01 194433. ENGLAND Paterson & Partner, Ltd., Tel. 0799 22612 or J. B. Tratsart Ltd., Tel. 02514-3334. FRANCE Alphatronic (1) 791-44-44. HOLLAND Manudax-Nederland B.V., Tel. 04139 1252. HONG KONG CONMOS Products Ltd., Tel. 3-697241-5. INDIA Radio & Craft Publication, Tel. 277147. ISRAEL Sharon Industrial Agencies, Tel. 03-481667. ITALY Jackson Italiana Editrice SRL, Tel. (02) 680054. JAPAN Asahi Glass Company, Ltd., Tel. (03) 287-2821-7 or Overseas Data Service Co., Ltd., Tel. (03) 400-7090 or Tokyo Information Communication Corp., Tel. 379-2561. KOREA Leewood International, Inc., Tel. 778-5831. NORWAY Ingenioertorlaggt A/S, Tel. (02) 11-51-70. SOUTH AFRICA Desatron (PTY) Ltd., Tel. (011) 836-3851. SPAIN Sagitron, Tel. 275 4824. SWEDEN Naxab, Tel. 08/985140. SWITZERLAND W. Stolz AG, Tel. 056840151. UNITED STATES United Technical Publications, Inc., Tel. (408) 248-8044. WEST GERMANY Astronic GMBH, Tel. (089) 30 4011.

Need an alternate source?

To make your job even easier, the IC Master includes the industry's most comprehensive Alternate Source Directory listing over 40,000 direct replacement parts —plus a Part Number Index, Part Number Guide, Application Note Directory, Military Parts Directory and more.

Five free Updates keep you current throughout the year.

As complete as the 1981 IC Master is, we publish the IC Update magazine to help keep it that way.

Five times in 1981, you'll receive a copy of IC Update listing all new products, application notes, and alternate sources that have been introduced since the publication of the current IC Master. Each issue is cumulative. And there's even an index on discontinued parts.

Order your 1981 IC Master today.

The new 1981 IC Master is ready now. To order, simply contact your local international distributor listed below. Or return the coupon.

- Sounds great! But first I need more information.  
 It's just what I need. Send me an order form.

Name (Please Print) \_\_\_\_\_  
Title \_\_\_\_\_  
Company \_\_\_\_\_  
Address \_\_\_\_\_  
City/State/Zip \_\_\_\_\_  
Country \_\_\_\_\_  
Telephone \_\_\_\_\_

The 1981 IC Master is available throughout the world from major electronic component distributors and technical book dealers.

Mail to: United Technical Publications, Inc., ATT: D. Renoud, 645 Stewart Avenue, Garden City, NY 11530.

IC Master/IC Updates, UTP,  
A subsidiary of Hearst Business Communications, Inc.  
1333 Lawrence Expressway, Suite 101  
Santa Clara, CA 95051 (408) 248-8044/TWX: 910-338-0272

Circle 124 on reader service card

# System-tailored VFC's ...to 10 MHz

These VFC's meet the tougher requirements of newer instrumentation systems... providing true price/performance breakthroughs... through innovative circuitry.

For instance, 1 MHz systems can be upgraded with minimal redesign to operate at 2 MHz... for two-fold improvement in resolution/sample performance... *at considerable cost saving.*

A family of 10, 5, and 2 MHz models is offered, with guaranteed non-linearities as low as  $\pm 0.02\%$  and gain temperature drifts as low as  $\pm 15$  PPM/ $^{\circ}\text{C}$ .

These designs are available in both industrial and full military versions.

## The performance hybrids

DMC... the acknowledged leader in voltage-to-frequency conversion... invites you to send for complete design data.

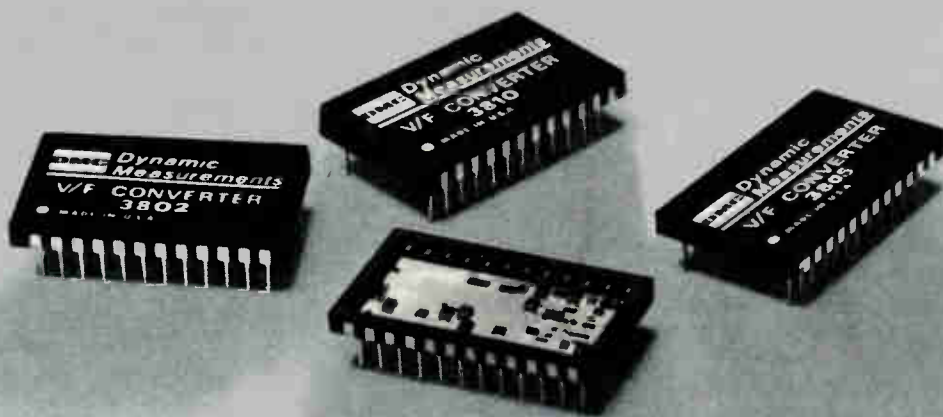

**Dynamic Measurements Corp.**

6 Lowell Ave., Winchester, MA 01890. (617) 729-7870. TWX (710) 348-6596

Call our toll free number 800-225-1151.

Circle 64 on reader service card

## **Darpa seeks 40% space-laser rise . . .**

Development of space-based lasers to detect and destroy enemy satellites and missiles is budgeted by the Defense Advance Research Projects Agency (Darpa) for \$98 million in fiscal 1982, **accounting for nearly 15% of the \$655 million Darpa request** and a jump of nearly 40% from this year. Agency director Robert R. Fossum has identified for Congress the key segments of Darpa's demonstration effort in its "space laser triad" as Alpha, which uses high-efficiency infrared lasers; Lode, a large-optics demonstration experiment for controlling aperture beams; and Talon Gold, a system now in development for target acquisition, tracking, and pointing for high-energy laser systems. Two California companies, Lockheed Missiles & Space Co. of Palo Alto and Rockwell International Corp. in Downey, are competing for the Talon Gold prime-development contract scheduled for award in the fall.

## **. . . with Talon Gold tests to use shuttle**

The Air Force will conduct initial flight tests of Talon Gold brassboard hardware against space targets with high-altitude aircraft, probably U-2s. These will carry **"a low-power laser pointing experiment that utilizes a scaled acquisition, tracking, and pointing payload,"** Darpa director Fossum reports. Later tests of more advanced systems will be conducted aboard the space shuttle. Precision tracking by Talon Gold's laser radar was initially developed with Darpa funds at the Massachusetts Institute of Technology's Lincoln Laboratory, Lexington, Mass., using a ground-based system to track satellites with "enhanced signatures."

## **Millicom plans appeal if FCC adopts rules**

If the Federal Communications Commission, in its imminent ruling on broadband cellular radiotelephones, accepts its staff's recommendation to automatically reserve half of the 40 MHz allocated to wire-line telephone companies, Millicom Inc. of New York is ready to go to the U. S. Court of Appeals. At the least, **Millicom wants a postponement of the vote until the FCC returns to its full strength of seven presidentially appointed commissioners,** rather than a decision now by only five members, including an acting chairman. The FCC has not acted on Millicom's application, filed almost a year ago [*Electronics*, June 19, 1980, p. 61], to demonstrate in the Raleigh-Durham, N. C., area a portable, lightweight system it is designing in cooperation with IBM Corp., Harris Corp., and E. F. Johnson Co. Millicom says production costs of its unit would be \$350 in quantity, compared with \$900 for American Telephone & Telegraph Co.'s, and argues that the basic monthly user fee would be \$60 versus AT&T's \$80. To automatically assign one license in a two-carrier cellular market to the local telephone company "would be blatantly anticompetitive," the Justice Department has told the FCC.

## **Plan for Intelsat 6 doubles capacity**

Proposals for a new international communications satellite series to be known as Intelsat 6 are being sought by the Washington-based International Telecommunications Satellite Organization. Capable of simultaneously handling 40,000 telephone calls plus two TV channels, the new series **will more than double the capacity of any previous international satellite,** according to the 105-nation consortium. The initial award for 5 to 8 satellites in March 1982, with options to increase the total to 16, will call for a base-line design permitting frequency reuse of up to six times in the 6-/4-GHz band and two times in the 14-/11-GHz band. Also sought is

incorporation of satellite-switched time-division multiple access for the digital system. For its second purchase, Intelsat wants satellite lifetimes raised to 10 years from 7, intersatellite links, a second-generation maritime communications subsystem, experimental gear for 30-/20-GHz operations, and improved facilities for provision of domestic leased services. The first launch of an Intelsat 6 is expected in 1986.

## **EIA defers China telecom show**

The Electronic Industries Association has **postponed for one year its telecommunications equipment show and seminar in China** because of that country's economic downturn and resultant political uncertainties. The EIA Communications division, cosponsor of China Comm '81 with the National Council of U. S.-China Trade, reportedly could take up to a \$50,000 loss on the show's deferral, a term being read in some quarters as a euphemism for "doomed." Formerly scheduled for next Nov. 3-13 in the Beijing exhibit center, the show was expected to draw up to 100,000 qualified registrants [*Electronics*, Oct. 23, 1980, p. 57].

## **Air Force seeks radar upgrade**

The Air Force wants to add electronic counter-countermeasures to two Raytheon Co. AN/GPN-22(V) precision approach radars known as Hi-Par. Designed for high-density air traffic control at a fixed base, **the radars will be upgraded to perform in an electronic countermeasures environment.** A draft proposal request expected in May from the Air Force Electronic Systems division, Hanscom Air Force Base, Mass., will call for the winning contractor to develop the hardware and software and use it to modify two Hi-Par systems supplied by the Air Force, to be subsequently tested at Eglin Air Force Base, Fla. The 42-month award will require that the package not degrade the radar's performance or reliability.

## **Northern Telecom closes SBS deal**

Northern Telecom Inc., Nashville, Tenn., has picked up more than \$30 million in new business with an award from newly operational Satellite Business Systems, McLean, Va., for 20 DMS-250 digital multiplex switches. Deliveries of the DMS-250, a stored-program-controlled system with a 30,000-trunk capacity, will begin in early 1982, says SBS. **The company expects the switches to significantly cut the cost of customer access to SBS** by permitting more efficient use of telephone company trunk lines from satellite earth stations.

## **Satellites sought to sub for ELF**

The Navy now wants first to substitute an upgraded version of its communications relay aircraft known as Tacamo (take charge and move out) until it can get a preferred extremely high-frequency satellite series to communicate with its fleet of submarine missile launchers. **The satellites would replace the controversial and long-delayed extremely low-frequency shore-based system, known as ELF,** which has been dropped. Initially called Sanguine and contracted to GTE's Sylvania Electronic System division at Waltham, Mass., ELF "would have been a prime target for a nuclear warhead, and of course, no state wanted it," explains a Navy source. "Moreover, its message rate was relatively slow—so slow it could have been taken out before it completed a missile launch message."

# WE COVER THE BASES IN HI-PERFORMANCE AM-FM.

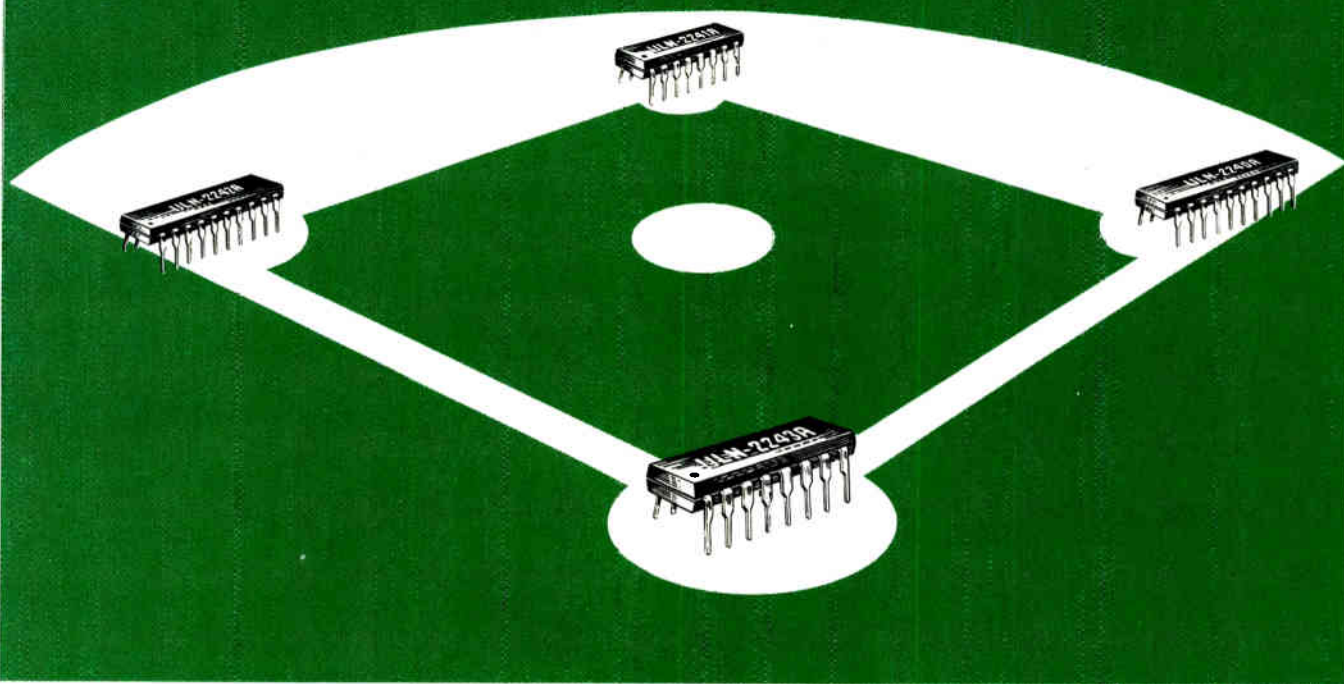

## Four new additions to Sprague's IC line-up are ideal for automotive and home entertainment products.

**At First Base:** ULN-2240A AM/FM Signal Processing System features signal level muting and deviation muting for use in high quality Dolby® receivers.

**At Second Base:** ULN-2241A AM/FM Signal Processing System provides excellent performance while holding down total system cost. All FM/IF functions and all AM functions are performed by this *one-chip* receiver with minimum external parts count.

**At Third Base:** ULN-2242A Signal Processing System affords level muting, AFC output, and advanced circuit design without performance trade-offs.

**At Home Plate:** ULN-2243A Mixer/IF for FM radio applications, includes AGC detector for MOSFET R-F stage. It can be used with an inexpensive ceramic filter coupling and is capable of handling an extremely wide range of input signal levels.

Sprague World Trade Corp. — 3, Chemin de Tavernay, 1218 Geneva, Switzerland Tel. (022) 98 40 21  
Sprague France S.A.R.L. — 2 ave. Aristide Briand, F-92220 Bagneux, France Tel. 6 55 19 19  
Sprague Electric (U.K.) Ltd. — Salbrook Road, Salfords Redhill, Surrey RH1 5DZ, England Tel. Horley 5666  
Sprague Elektronik GmbH — Darmstädter Landstr. 119-125, 6000 Frankfurt/Main 70, Germany Tel. 0611-6055-1  
Sprague Benelux — B.P. 104, B-9600 Ronse, Belgium Tel. 055-21 53 02  
Sprague Italiana S.p.A. — Via G. de Castro 4, I-20144 Milano, Italy Tel. (02) 498 78 91  
Intelko AB — Sandsborgsvägen 55, S-12233 Enskede, Sweden Tel. 08-49 25 05  
Semicaps — Gammel Kongevej 148, 5 DK-1850 Copenhagen, Denmark Tel. 01-221510  
Field Oy — Veneentekijäntie 18, SF-00210 Helsinki, Finland Tel. 90-69 22 577  
Racom Electronics Co. Ltd. — P.O. Box 21120, IL-Tel Aviv, Israel Tel. 03-45 31 51  
Bianchi S.A. — Apartado 220, E-San-Sebastian, Spain Tel. 943 36 20 45



a subsidiary of **GK Technologies**

# Fujitsu's FCN-700 Series Flat Cable Connectors

## Every connector in our complete lineup is fully perfected and field proven.

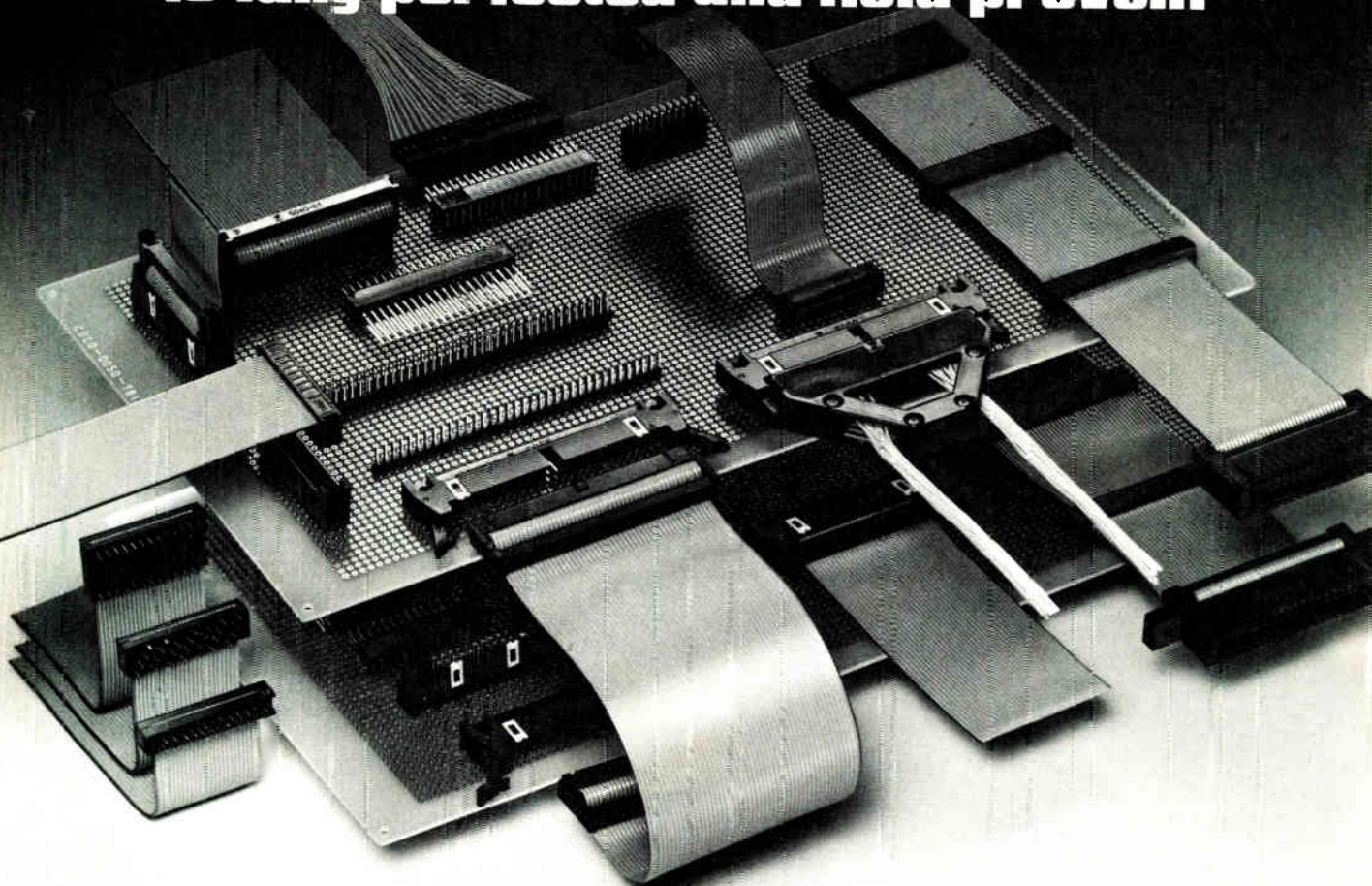

Fujitsu now offers the most complete lineup of flat cable connectors, each with fully perfected features, for all your interconnection and mass termination needs. Here is a sampling of the major features which guarantee that the connectors you choose will give you a perfect connection, superior cost performance and long life reliability.

### Snap-action locking system

Fujitsu's exclusive mechanism snap-locks into a solid connection which prevents the cable from jarring loose under shock or vibration. And to eject the cable, the snap-action release gives a quick, clean disengagement to save time and struggle.

### U-shape contacts

The gold-over-nickel finish U-shape design maintains a gas-tight, firm connection and is field proven to be highly reliable for continuous, long-term use.

### Solvent-resistant PBT resin

The FCN-700 Series uses UL-approved PBT resin, which has a strong resistance to trichloroethylene and trichloroethane, to eliminate the cleaning problems presented by conventional thermoplastic insulators.

### Exclusive node-slot mating

Fujitsu developed node-slot mating on its headers and socket connectors for even easier identification. And it offers an additional clip-slot design and one-sided, two-sided and sideless configurations which increase your selection and further guard against improper installation.

The complete lineup is here. All with fully perfected features. Contact your nearest Fujitsu distributor for full details.

#### European Distributors

AUSTRIA	FRANCE	ITALY	NETHERLANDS	SWITZERLAND	UNITED KINGDOM	WEST GERMANY
ELBATX GMBH A-1235 Wien, Breitenfurterstr. 381 Phone: (0222) 88 56 11 Telex: T3 3128	ERN rue de Fourny, Z.A. de Buc B.P. ND. 4, 78530 Buc Phone 956-00-11 Telex: 698627 F	C.S.E. 20146 Milano, Via Arzaga, 16 Phone: 4150992/ 4159260 Telex: 311590	BODAMER INTER- NATIONAL B.V. Havenstraat BA, Postbus 125B, 1500 AG Zaandam Phone: 075-351521 Telex: 19069	ELBATX AG CH-5430 Wetzigen, Alb. Zwysigsstrasse 2B Phone: 056-265641 Telex: 55239	TEMPATRON LTD. 6 Portman Road, Bottlefarm Estate, Reading RG3 1JQ Phone Reading (0734) 59616* Telex: 84773Z	COMTEC GMBH Südl. Auffahrtsallee 56 D-8000 München 19 Phone: (089) 178 1941 Telex: 0528435 comtc D

Head Office (Component Marketing Division): 18 Mori Bldg., 3-13, Toranomon 2-chome, Minato-ku, Tokyo 105, Japan  
Phone: 03-502-0161 Telex: 2224361 FJ TOR J

Paris Office: Porte No. 207, 1 Voie, Felix, Eboue 94021 Creteil Cedex, France Phone: 01-377-0355 Telex: 212544

Circle 127 on reader service card

World Radio History



April 7, 1981

# Electronics

## International®

Hand-sized scanner reads  
handwriting: page 81

Part of the French office automation project called Kayak, this work station is already being shown to potential manufacturers: page 84

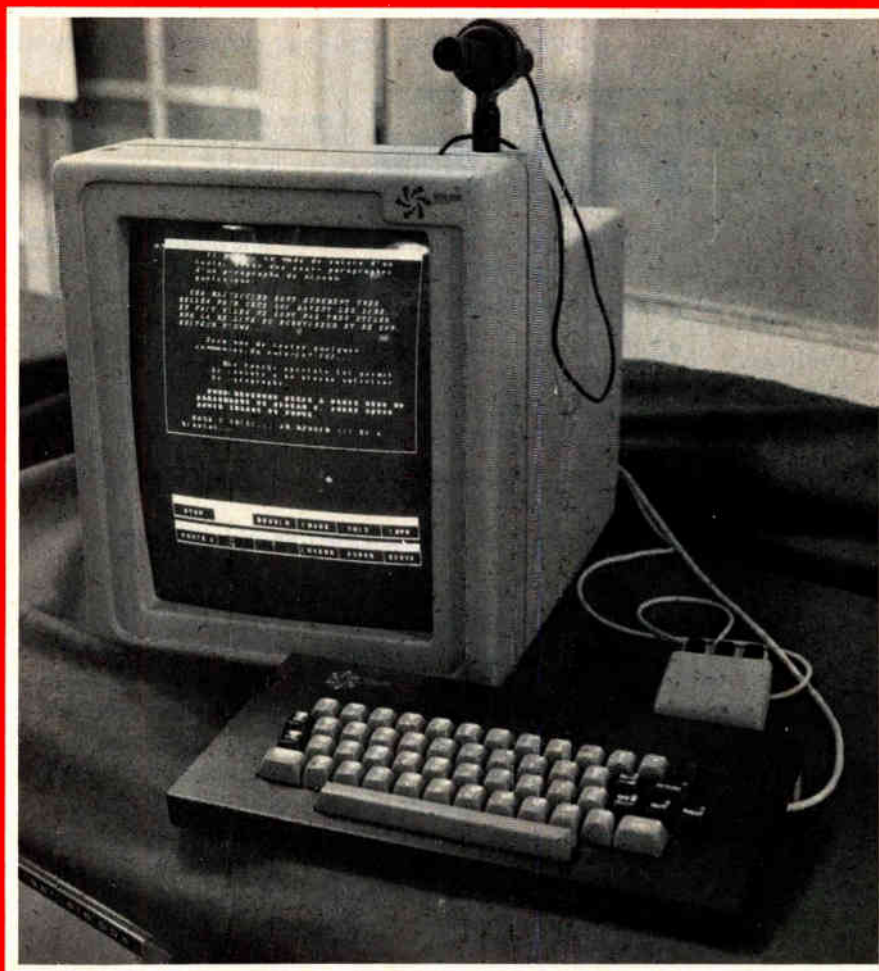

### **Joggers to check their pulse for \$70**

For between \$67 and \$78, joggers will soon be able to check their pulse with a package of electronics no bigger than a cigarette pack. The Jogger's Friend, as it is called, is gripped in the palm of one hand and touched to show the pulse rate on a liquid-crystal display. To be marketed later this year by Weybridge, Surrey-based Pulse Time UK Ltd., it incorporates a dedicated microprocessor chip developed for it by the University of Edinburgh's Wolfson Microelectronics Unit. **A wristwatch version is under development**, but the company is also licensing its pulse-sensing and -measurement technology, and one Swiss company is planning a mid-April launch of a wristwatch version. Such a product appeared on the U. S. market four years ago [*Electronics*, April 28, 1977, p. 32], but Pulse Time claims that it proved too expensive at \$500 and used an inconvenient pulse-sensing transducer.

### **Phone handles voice, data concurrently**

A digital telephone set developed jointly by Berlin-based AEG-Telefunken and its affiliate Telefonbau und Normalzeit GmbH in Frankfurt, is one of the main attractions at these two firms' stands at the April 1-8 Industrial Fair in Hanover, West Germany. Subscribers can make phone calls with the set while **simultaneously using it for viewdata and other digital data-based services**. Called Digon, the new phone is undergoing field tests in West Berlin. The set incorporates an analog-to-digital converter that changes the speech signals into a pulse-code-modulated digital signal transmitted to the exchange system at 64 kb/s. Multiplexing devices in the set and at the exchange add bit streams of other data services to the line for a total bit rate of at most 96 kb/s.

### **Fujitsu makes first 32-K bipolar PROM**

The world's first 32-K Schottky TTL programmable read-only memory has a typical access time of 45 ns, with maximum access times of 65 ns and 80 ns available now and 55 ns to come. Fujitsu Ltd.'s engineers say that test circuits and terminals on the byte-wide memory enable them to test and guarantee all devices' specifications before shipment. The current pulses used to program the memory short-circuit a vertical diode by what Fujitsu calls the diffused eutectic aluminum process, or DEAP [*Electronics*, Oct. 23, 1980, p. 141]. The smallness of the diode and the efficient use of shallow-V-groove isolation between cells and also between peripheral circuits **enable engineers to shrink memory cell size to 14 by 18  $\mu\text{m}$**  (0.55 by 0.71 mils) and the chip to 4.6 by 5.8 mm (181 by 228 mils).

### **PBX makers to maintain UK units**

Having applied intense pressure, manufacturers of private branch exchanges will be allowed to maintain as well as supply the equipment when the post office act relaxing British Telecom's monopoly becomes law later this year. Both overseas and UK companies had feared that British Telecom would limit market growth for lack of the resources to adequately maintain the increased variety of private digital exchanges that would become available under liberalization. But suppliers will still have to contend with a new licensing authority whose nature has yet to be finalized. In another move, which could also help to boost the telecommunications sector, the state corporation appears to have won its fight with the government to **raise an extra \$472 million of private sector funds** to maintain its investment program.



# Teamwork.

You and our new *PI-600* logic analyzers —  
the most powerful analysis team around.



#### *PI-616* 100 MHz Analyzer

16 channels. Choice of timing or 5 state displays. Collects up to 2000 samples. Has 5 ns glitch memory.

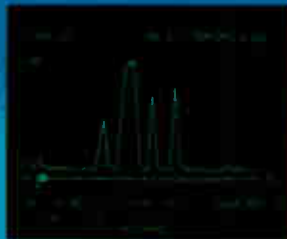

#### Waveform Recording

50 MHz and 1000 samples. Use this plug-in option in our *PI-616* to capture and analyze the analog signals in your system.



#### *PI-648* Advanced State Analyzer

48 channels plus 8 qualifiers. Mixed format display capability. Has data search mode and 16 levels of triggering.



#### Mnemonic Display

Use our 8-bit and 16-bit dedicated  $\mu$ P probes, plus the *PI-648*'s dis-assembly software, to simplify the analysis of complex programs.



#### Additional Capabilities: I/O and Stacking

RS-232 standard; IEEE-488 optional. Single cable mates *PI-616* and *PI-648* for 64-channel operation.



#### Performance Monitoring

100 MHz counter/timer plus industry-standard signature analyzer. Use this plug-in option in either *PI-600* analyzer to measure hardware/software performance.

Want a closer look? Call 800-538-9713 (outside California) or 408-263-2252 (California) for a demonstration or an evaluation unit. TWX: 910-338-0201.

**PARATRONICS INC.**  
2140 Bering Drive San Jose, California 95131

*Leading the Way In Analysis Technology*



# Introducing digital

PLUG-INS

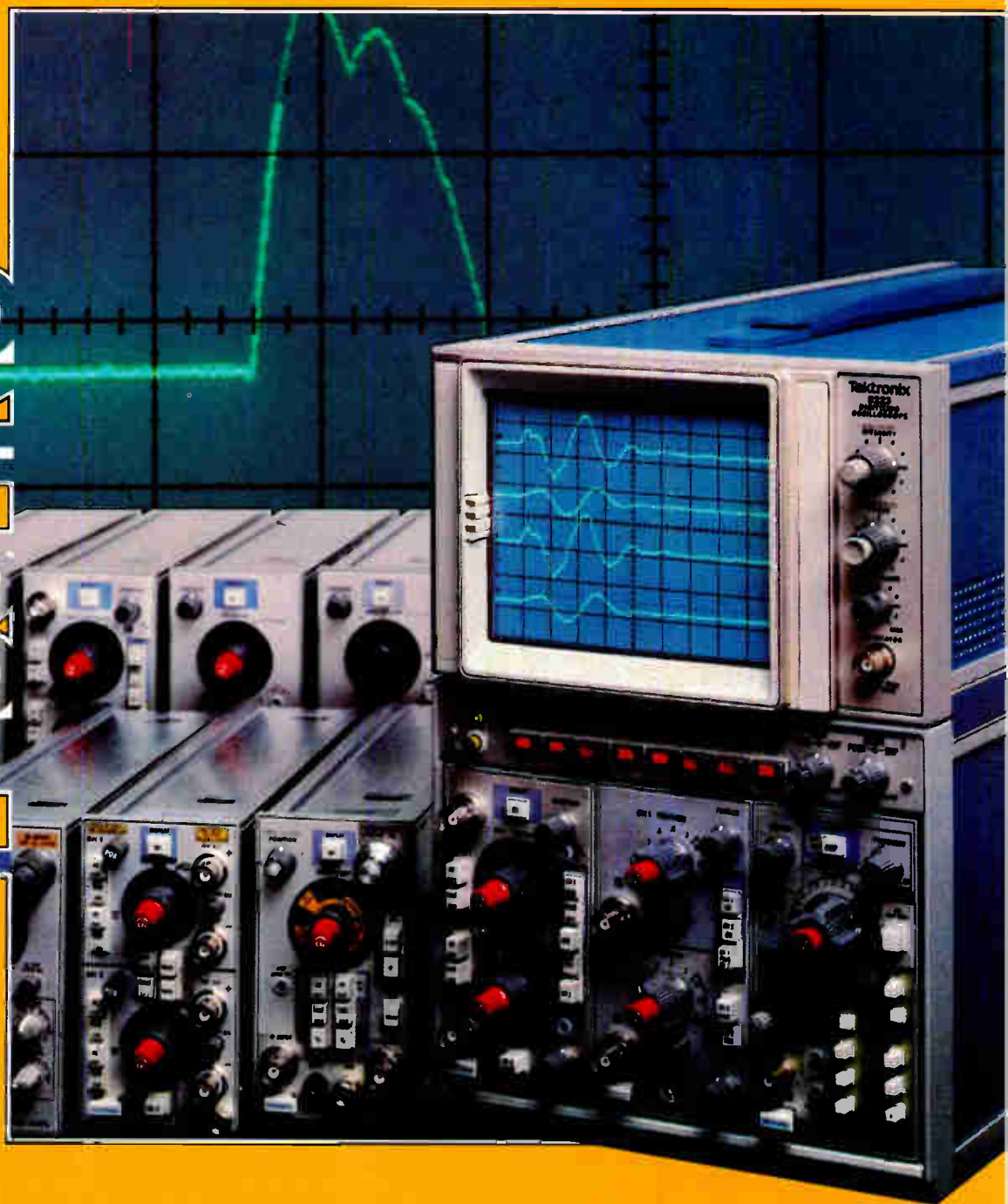

# storage with plug-in flexibility— a new 5000-Series Scope.

## Tektronix 5223

If you're faced with trying to view elusive transient events, or slow repetitive signals found in many transducer applications, Tektronix' new 5223 Oscilloscope can meet your measurement needs. It combines digital storage with the measurement flexibility of a wide range of interchangeable 5000-Series Plug-ins. Just consider what these features can do for you.

### Digital Storage

At the touch of a button, waveforms are sampled at up to a 1 MHz rate and stored with 10 bit vertical resolution in 1K of memory for each vertical compartment in use.

### Pre-trigger

With the continuously variable pre-trigger of the 5B25N Time Base, it is now easy to see what occurred prior to your trigger event. And because this part of the display is intensified, you can identify it immediately and simplify your documentation. In addition, if you are not sure of the slope of your single-shot signal, the bi-slope trigger mode will alleviate the guess work.

### Equivalent Time Sampling

Repetitive signals to 10 MHz, including those at low repetition rates, can be easily digitized and displayed for flicker-free viewing. You can expand and reposition these stored signals for detailed analysis, or output them for further processing.

### X-Y Mode

With the simple push of a button, stored signals up to 10 MHz can be displayed in the X-Y mode. For repetitive signals both X-Y and Y-T can be displayed simultaneously.



The 5223 will interface with a GPIB controller, such as the Tektronix 4050 Series shown here.

### GPIB Interface

Using the 5223's optional GPIB interface, you can integrate waveform acquisition with an intelligent terminal. Once transferred by a GPIB compatible controller, the digitized waveforms can be both processed and stored for later recall. Because the 5223 is both a "talker" and a "listener," reference signals can easily be input for comparison or review.

### 10 MHz Real Time

In addition to digital storage, the 5223 offers you complete conventional 10 MHz oscilloscope capabilities, including signals out... on a large, high resolution CRT that gives an exceptionally bright, crisp display.

### And more...

With the new 5223, both real time and stored signals can be displayed simultaneously... and, for your slowly changing events, the roll mode provides a continuously updated display similar to a strip chart recorder. Furthermore, permanent documentation with your X-Y plotter is produced at the touch of a button via the analog memory output. Plus, an external clock input allows you to synchronize digitizing with other instruments.

The 5223 makes our 5000-Series a digital proposition... with plug-in and GPIB flexibility.

For more information, call your local Tek Sales Engineer or fill in the coupon below and mail it to the appropriate address.

U.S.A.  
Tektronix, Inc.  
P.O. Box 1700  
Beaverton, OR 97075  
Phone: 800/547-512  
Oregon only 800/644-9051  
503/644-0161  
Telex: 910-467-8708  
Cable: TEKTRONIX

Africa, Europe,  
Middle East  
Tektronix International, Inc.  
European Marketing Centre  
Postbox 827  
1180 AV Amstelveen  
The Netherlands  
Telex: 18312

Asia, Australia, Canada, Central &  
South America, Japan  
Tektronix, Inc.  
Americas/Pacific  
P.O. Box 1700  
Beaverton, OR 97075  
Telex: 910-467-8708  
Cable: TEKTRONIX

**Tektronix**  
COMMITTED TO EXCELLENCE

**Yes, I'm interested in the new 5223.**

Name \_\_\_\_\_

Title \_\_\_\_\_

Company's name \_\_\_\_\_

Address \_\_\_\_\_

Phone (\_\_\_\_) \_\_\_\_\_ ext \_\_\_\_\_



Please send me additional information

Please have a Sales Engineer call me

# PIN-COMPATIBLE MICROPROCESSOR MEMORIES

Planning for the future. It's no longer a design luxury. It's a competitive necessity. Multiple redesigns. Quantum leaps in density upgrades. Countless new product introductions. These are the everyday realities that confirm the need for planning. In fact, in today's fast-paced marketplace, it's almost axiomatic: If you want to outpace your competition, plan for tomorrow before you start designing today.

A contradiction in terms? Not if you use BYTEWYDE memories from Mostek. These pin-compatible n-word X 8 RAMs, ROMs and EPROMs provide unprecedented flexibility. Flexibility to design a state-of-the-art array that's easily upgraded. Flexibility that eliminates the need for "guesswork" partitioning between program and memory storage capacity. Flexibility to lay out a more compact board that requires only one socket type. Flexibility that makes the inevitable change fast, simple and efficient. In a thought, flexibility to plot a well-defined course farther down the product life cycle road.

## NEW LANDMARKS.

Now there are even more choices to get you there in record time. Our new 16K MK4802 is the highest density static RAM you can get. Within the BYTEWYDE family, it's a double density upgrade from the MK4118A 1K X 8 static RAM.

Our new MK37000 is equally impressive. This 8K X 8 ROM features fast access — 250ns (max); low active power — 220mW (max); and just 35mW (typ) standby. Prototyping is easy.

## BYTEWYDE MEMORIES

TYPE	PART NO.	ORGAN.	ACCESS(ns)
ROM	MK34000	2K x 8	350
	MK37000	8K x 8	250/300
RAM	MK4118A	1K x 8	120/150/200/250
	MK4801A	1K x 8	70/90
	MK4802	2K x 8	120/200
EPROM	MK2716	2K x 8	300/350/390/450
	MK2764*	8K x 8	450

Circle 77 on reader service card

\* MK2764 will be available 2Q, 1981 + Contact Mostek Military for complete details.

MOSTEK® and BYTEWYDE are trademarks of Mostek Corporation © 1981 Mostek Corporation

World Radio History

The BYTEWYDE track:  
Designed to take you  
the distance.

MOSTEK.

Just use our EPROM equivalent, our new  
8K X 8 MK2764. Mask generation? It's quick  
and efficient as well.

Together, these memories significantly  
expand the BYTEWYDE family  
into state-of-the-art density levels.

Their common pinout with other  
BYTEWYDE RAMs, ROMs and  
EPROMs means you can  
interchange all three  
types without jumper-  
ing. And plan for up-  
grades as dense  
as 32K X 8.

All with the same 28-pin  
JEDEC-approved pinout. Most  
BYTEWYDE memories\* are  
also available in military ver-  
sions designated "MKB" with  
full MIL-STD 883 Class B  
processing.

#### CLEAR-CUT DIRECTIONS.

Before you start up your next  
memory design, or rethink an  
existing one, take a hard look at  
the components you plan to use.  
Can they be easily interchanged  
with other types? Or upgraded  
through several generations  
without redesign? If not, you  
owe it to your future to investi-  
gate the straightforward course  
in memory design: The BYTE-  
WYDE track. Just write Mostek,  
1215 W. Crosby Rd., Carrollton,  
Texas 75006, (214) 323-6000.

In Europe, contact Mostek  
Brussels at 762.18.80.

# Multi-chip R6500: the system thruput edge.

In the 8-bit price range, the third-generation R6500 microprocessor family is a cost-performance leader. Pipeline architecture provides direct, simultaneous processing. Thirteen address modes provide direct memory access. I/O devices with on-chip functions minimize CPU work. The third-generation R6500 family gives higher thruput and faster execution with minimal chip systems.

Further, R6500 peripheral devices are system oriented. They include CRT, communications, display, printer and other interfaces, all with on-chip intelligence to eliminate TTL add-ons. Plus, there's a variety of

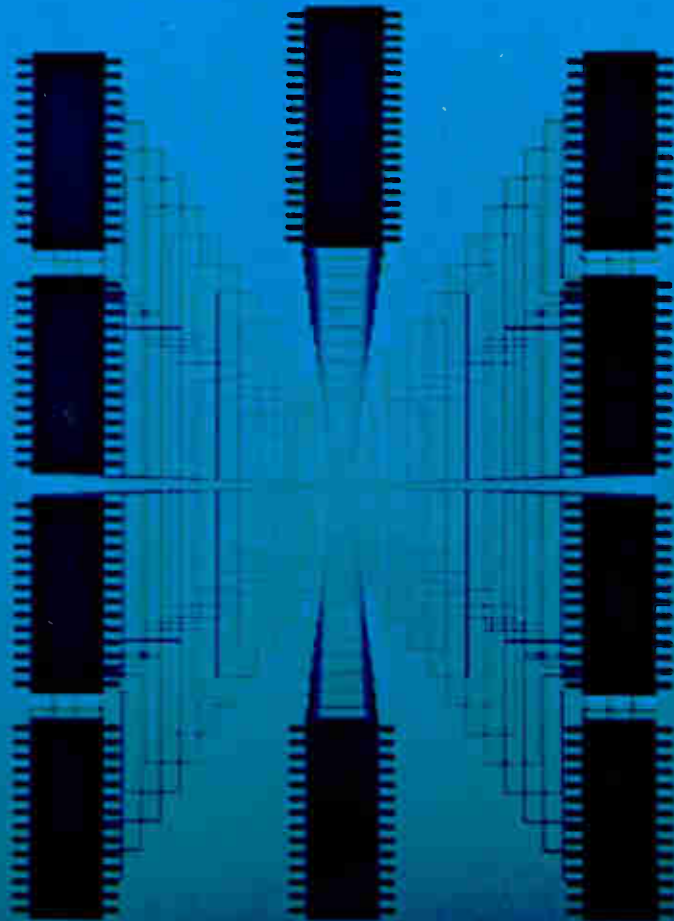

RAM-ROM-Timer-I/O devices. And, ten R6500 CPU options enhance the economics and board space of your system.

## **Rockwell. Your systems source.**

You can evaluate the thruput of an R6500 system by purchasing an AIM 65 microcomputer for a few hundred dollars. For full-up design, Rockwell has SYSTEM 65, a surprisingly low-cost development system.

Call Rockwell International toll free at 800-854-8099 (within California, 800-422-4230).

Or write:

Rockwell International,  
Electronic Devices  
Division, RC55, P.O.  
Box 3669, Anaheim,  
CA 92803.



where science gets down to business

Circle 78 on reader service card

# R6500

# Now! One-chip microcomputers offer R6500 performance.

Presenting the Rockwell R6500/1 series: single-chip, 8-bit microcomputers and microcontrollers that are software compatible with the R6500 family, provide fast execution speed and may be interfaced readily with all R6500 I/O and memory devices.

R6500/1 features include 1.5K to 3K bytes of ROM, 64 to 192 bytes of RAM, 23 to 56 I/O ports, multiple use counter/timers, serial communication port, bit manipulation, expansion bus, multiple bus interface, directly executable RAM with low power standby, and multiple interrupts.

## **Rockwell. Your systems source.**

To facilitate system and program development, Rockwell supports the R6500/1 series with emulator devices and interface

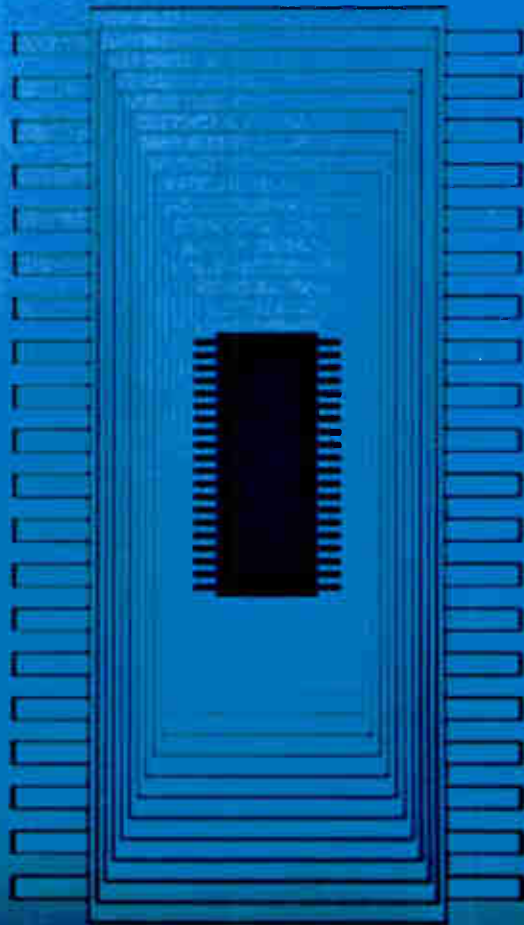

lines to external memory, plus evaluation modules. One R6500/1 even is available as a back-pack emulator that accepts PROMs or ROMs in an on-chip socket. Additionally, the SYSTEM 65 microcomputer development system with R6500/1 personality module supports full-up hardware and program development, as well as in-circuit user simulation. Call Rockwell International toll free at 800-854-8099 (within California, 800-422-4230). Or write: Rockwell International, Electronic Devices Division, RC55, P.O. Box 3669, Anaheim, CA 92803.



**Rockwell  
International**

where science gets down to business

Circle 79 on reader service card

# R6500/1



## OUR CONTACTS GIVE YOU MORE RELIABLE INFORMATION.

In the world of electronic data processing, a bad contact is often the same as no contact. And that means information is lost. So when you're connecting a PC board to a backplane or assembling I/O connections, check into the ITT Cannon Electric ADAPTA-CON connector series.

The ADAPTA-CON line is our most versatile packaging concept. Whenever you need a large number of contacts in a specific connector length, ADAPTA-CON gives you high density, high reliability two-piece connectors in a wide variety of crimp or solder type, high or low insertion force, all-plastic designs. Which means you can handle increased capacities with greater reliability. Plus you get Cannon quality with fast delivery at very competitive prices.

For immediate information refer to our pages in EEM. For literature, the name of your local ITT Cannon distributor or other information contact Rectangular Division Marketing Manager, ITT Cannon Electric, a Division of International Telephone and Telegraph Corporation, 10550 Talbert Avenue, Fountain Valley, CA 92708. (714) 964-7400. In Europe, contact ITT Cannon Electric, Avenue Louise 250, B-1050 Brussels, Belgium. Phone: 02/640.36.00.

**CANNON ITT**

You can always connect with Cannon.



# FRENCH COMPONENTS GO HIGH TECH

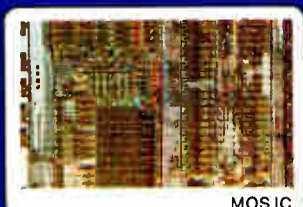

MOS IC

**DISPLAY CONTROL**



Decoding bipolar IC

**DECODING**



F.O. Connector

**FIBER-OPTIC CONNECTION**



videotex terminal



Laser diode

**OPTICAL COMMUNICATIONS**



Intelsat V TWT

**SATELLITE COMMUNICATIONS**



consumer facsimile transceiver

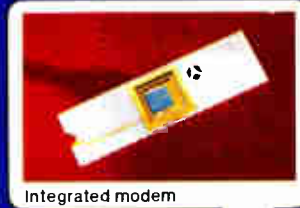

Integrated modem

**MODEMS**



GaAs FET

**TRANSMISSION**



home directory terminal

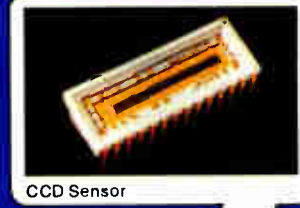

CCD Sensor

**IMAGE SENSING**

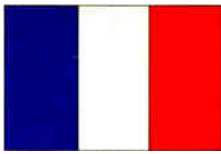

# FRENCH COMPONENTS: A BRIGHT FUTURE

Integrated circuits flourish in a climate of technological innovation

The French components industry is ramping up for a future that will bring rapid expansion in opportunities for new integrated circuits, advances in IC technology, and a new interest in exports. The industry had a total 1980 pretax turnover of 1.1 billion francs (see the table) and employed 54,000 persons.

Although there was a notable slowdown in some sectors, sales of ICs are booming—boosted by the increased activity in the telecommunications and data-processing areas. Last year's turnover for discrete semiconductors was up only 14% over 1979, but IC sales jumped 46%, a positive trend numerous industry observers predict will continue.

"The current 'crisis' in sales of some active and passive components is a worldwide one and not limited to France," says Bernard Levi, director of research and development for Thomson-CSF's components and electronics group. "But the IC area is untouched by this crisis and we are optimistic." The

*This special section on the French components industry was written and coordinated by Joel Stratte-McClure, a Paris-based writer who has covered French technical subjects for a variety of international publications.*

The French Electronic Components Industry - A Ten Year View												
Pre-Tax Turnover in Millions of French Francs												
Electronic Components	1971	1972	1973	1974	1975	1976	1977	1978	1979	1980*	plus over	1979
Electronic Tubes	654	783	810	916	945	1,119	1,227	1,456	1,593	1,815		+14%
Discrete Semiconductors	451	559	801	1,124	838	1,001	1,098	1,211	1,403	1,600		+14%
Integrated Circuits	106	142	245	346	276	406	548	727	890	1,300		+46%
Total Semiconductors	557	701	1,046	1,470	1,114	1,407	1,646	1,938	2,293	2,900		+26%
Total Active Components	1,211	1,484	1,856	2,386	2,059	2,526	2,873	3,394	3,886	4,715		+21%
Total Passive Components	1,749	2,104	2,751	3,402	3,292	3,780	4,118	4,760	5,476	6,400		+17%
Total Components	2,960	3,588	4,607	5,788	5,351	6,306	6,991	8,154	9,362	11,115		+19%

\*Estimates

reason for the bustling activity in the IC sector is due to the maturation of a government-devised components plan, which has spawned an industry now coming of age and with much promise for the future.

## Components plan makes the difference

On May 23, 1977, the French government decided to allocate between 800 million and 1 billion francs (at 1980 values) during 1978 through 1982 to create a commercially competitive IC industrial base and expand research facilities for advanced IC technologies. The plan was meant to establish, initially through technology transfers and joint ventures with U.S. firms, an industry capable of designing and producing the latest and best products.

The government's goal is to boost domestic output to equal

the country's components requirements by 1985, and participants in French industry believe it is on target (See the second part of this report, "Industry leaders plan for a future of high technology"). Foreign firms at that time may still have about half of the domestic market, but French companies are expected to export an equal amount of their production.

The French have their work cut out for them. France represents only 4% of the world components market and 17% of the European market. While the general consensus among French government officials and industrial executives is that the country now has the required technology, it remains to be seen during the next two years whether it can successfully penetrate foreign markets.

On the domestic front,

# The ENERTEC challenge: quality, capability, performance



Logic analyzer

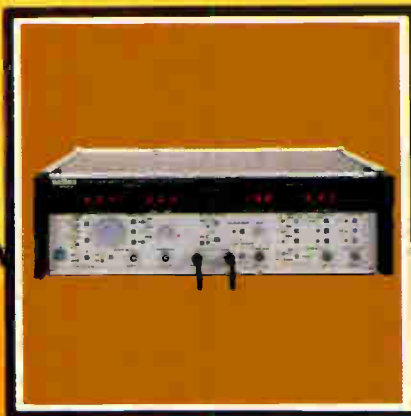

Jitter generator



Frequency meter



Oscilloscope

**ENERTEC**  
**Schlumberger**  
12, PLACE DES ÉTATS-UNIS  
B.P. 620 - 92542 MONTROUGE CEDEX  
TEL. (1) 657.11.23 - TÉLEX 204376  
FRANCE

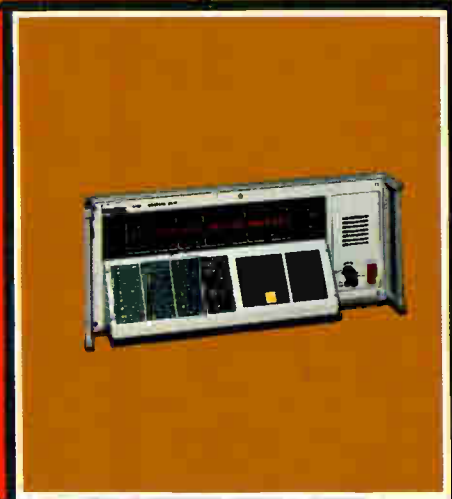

Measuring receiver



Magnetic tape recorder

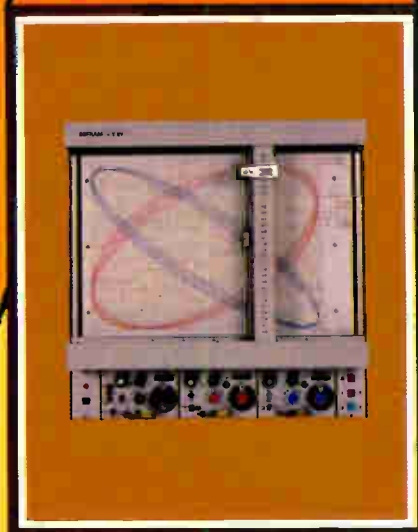
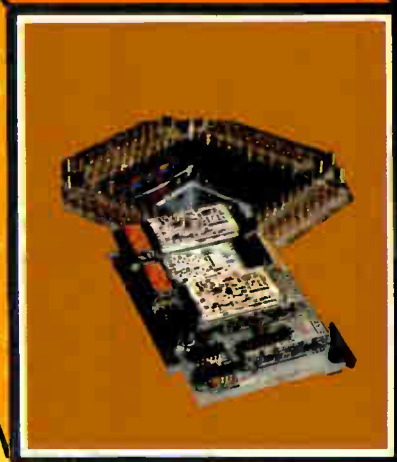
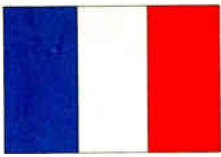

Chart recorder



Automatic testing equipment



however, the components makers have an attractive incentive and a captive market for a full range of ICs and other components. Since 1976, the French government has invested over 1.3 billion francs to improve the domestic telecommunications network—primarily by substantially increasing the number of subscriber lines and by introducing digital time division multiplexing (TDM) switching techniques and pulse-code modulation (PCM) transmission networks. In addition, the country has developed a national datapacket transmission network and has formulated the *télématique* program that will have a big impact.

### **Télématique a key to growth**

Telecommunications and *télématique* are important words in the components industry these days. The prime reason is that they represent a potentially important market for so many companies from microelectronic parts to display elements to subsystems.

Basically the *télématique* program marries the capabilities of telecommunications and data processing (known as *informatique* in French). And so this concept incorporates telephones, television, facsimile machines, computer terminals and other related media into an integrated network that permits data, voice, and written information to be speedily transferred over the telephone network.

"There is an extremely important relationship between the goals of the *télématique*



Products created for *télématique* will require a wide range of components, such as these RTC—La Radiotechnique Compélec parts for videotex terminals.

program and the future of the French components industry," says Michel Camus, director of the Norbert Segard Microelectronics Center of the government's Centre National d'Etudes des Télécommunications (CNET). "The evolution of more rapid, less energy-consuming ICs will dictate the success of *télématique* products."

### **New products mean new components**

Component manufacturers in France have already contributed to the increased use of chips in the transmission functions. Now they are positioning themselves to produce specially designed circuits for the *télématique* program—such as new switched-capacitor filter ICs for coder-decoder chips and placing codec and filter, as well as peripheral

functions, on the same chip.

In addition, purchasers of components are also gearing up for new products in the *télématique* field (left). "The *télématique* program will affect all traditional suppliers of measuring and testing equipment besides the producers of the major products," says Jacques Brault, director of Enertec's Instrument Division. "Transmission of data, text, and videotex requires a better quality of transmission than voice and hence a better quality of testing equipment throughout the system."

It is the French government's intention that *télématique* products will be introduced on a mass scale in France—both in the office and in the home. This plan could provide the large market required for cost-effective production runs of new ICs and other components.

In the office, *télématique* products will require the full range of components necessary to manufacture subsystems, which include facsimile transceivers, word processing machines, and large-capacity data storage like digital optical memories.

Numerous French companies, notably office equipment and telecommunications manufacturers, are developing fully integrated offices combining a private automated branch exchange, telephone switches, and a local data network that can handle voice and data communications simultaneously. "The idea is ultimately to wed telephones, word processing units, computers, facsimiles, and other equipment into a common

# POWERFUL IC'S

# TEA 1001 SP

## SWITCHMODE REGULATOR

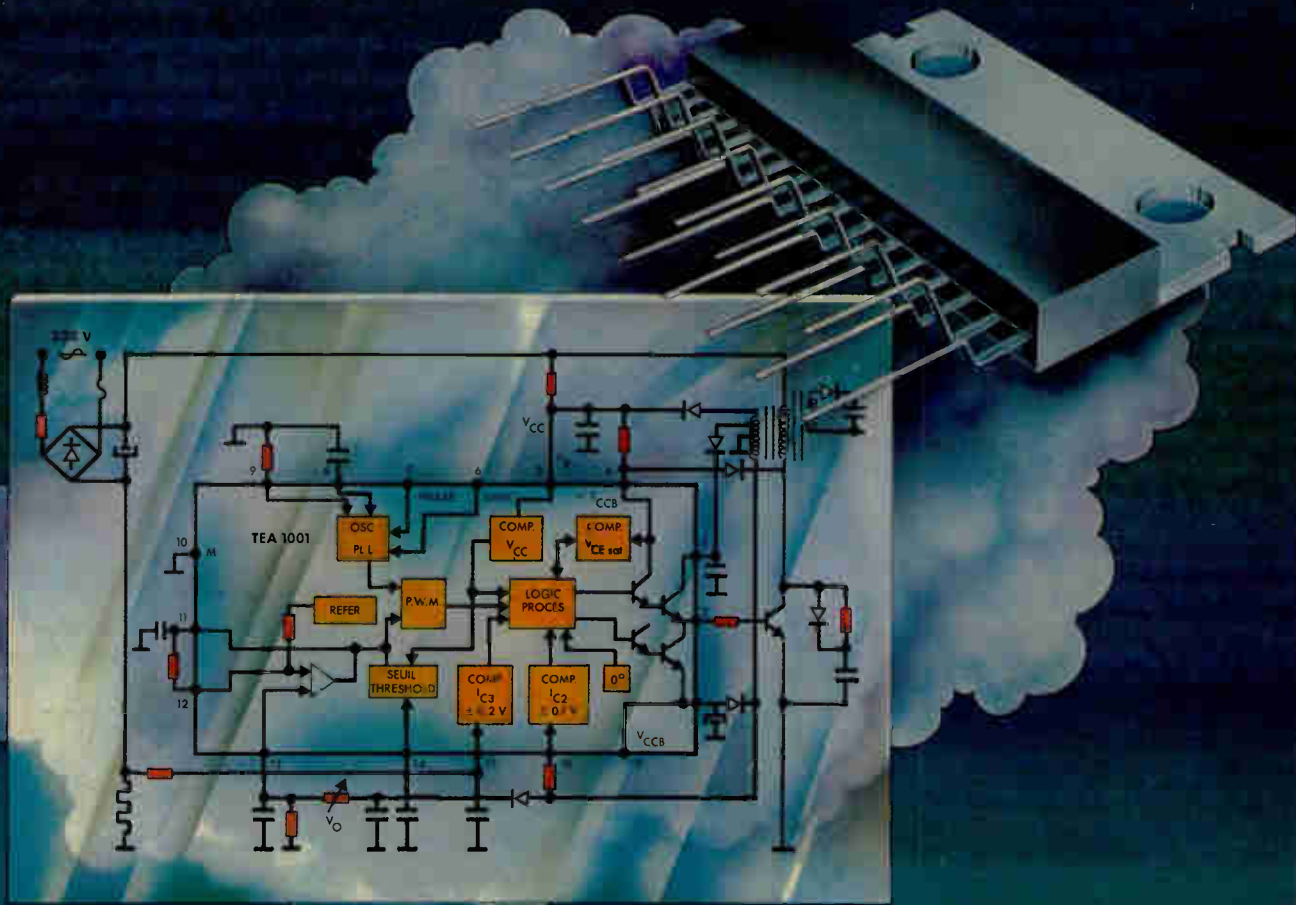

Fully optimized control circuit for minimal parts count :

- Very high drive current :  $\pm 3A$
- Switching frequency up to 50 kHz

YOU MAY DEPEND ON US, WE'RE NEVER FAR-AWAY...

**THOMSON-CSF**  
COMPONENTS

### THOMSON-CSF DIVISION SEMICONDUCTEURS

50, RUE JEAN-PIERRE TIMBAUD - B.P.5 - 92403 COURBEVOIE FRANCE - TEL : 33 (1) 788.50.01 - TELEX 610560

**BELGIUM**  
THOMSON S A  
BRUXELLES 32 26 48 64 85

**BRAZIL**  
THOMSON CSF  
COMPONENTES DO BRASIL  
SAO PAULO 55 11 543.79 38

**WEST GERMANY**  
THOMSON CSF  
BAUELEMENTE GmbH  
MUNCHEN 089 7675.1

**ITALY**  
THOMSON CSF  
COMPONENTI  
MILANO 21 68.84.141  
ROMA 06 31 92 42 34

**JAPAN**  
THOMSON CSF JAPAN K K.  
TOKIO 03 264 6341

**THE NETHERLANDS**  
THOMSON CSF  
KOMPONENTEN  
RA s GRAVENMOER  
31 16 23 17 600

**SINGAPORE**  
THOMSON-CSF  
COMPONENTS -EA  
SINGAPORE 295 31.24

**SPAIN**  
THOMSON CSF  
COMPONENTES Y TUBOS  
BARCELONA 3 373 30 11  
MADRID 11 419 66 91/419.65 51

**SWEDEN**  
THOMSON CSF KOMPONENTER  
& ELECTRONOR AB  
STOCKHOLM 081 22 58 15

**SWITZERLAND**  
MODULATOR S A  
BERN LIEBEFELD 031 59 22 22

**UNITED KINGDOM**  
THOMSON CSF  
COMPONENTS AND MATERIAL LTD  
DANESHILL  
BASINGSTOKE HANTS 0256 29 155

**USA**  
THOMSON CSF  
COMPONENTS  
CORPORATION CANOGA PARK  
CALIFORNIA 213 887 1010

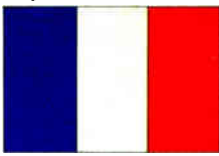

channel," says Alain Le Bihan, vice president of telecommunications and télématique development at Thomson-CSF.

### Coming: A new kind of phone directory

In the home, consumers will soon begin receiving free alphanumeric terminals to replace the telephone book. Ultimately they will have access to a unidirectional teletext system, a compatible interactive videotex system, a low-cost facsimile, and similar services.

"The key to télématique is mass markets and the corresponding low cost of products and components," says Jean-Victor Le Ridant, head of the components division of the Direction Général de Télécommunications' industrial and international affairs division (DAII). "Many télématique products will require specially designed ICs which will give French firms and research laboratories an opportunity to develop new technologies. In addition, they will have a large local market which should bring production costs down to an internationally competitive level."

The French government actively encourages its domestic telecommunications companies to buy from local sources. So it is likely that many IC and other component manufacturers will greatly benefit from télématique activity.

### The French IC companies progress

The French components plan led to the designation of five major companies to tackle the

future of integrated circuits in France. A look at their progress to date indicates they believe they are well-positioned to supply the necessary components for the télématique era.

□ Thomson-CSF's semiconductor division, which is receiving 100 million francs as part of the plan, has increased its activity in bipolar ICs to include

microprocessor market in 1985. In addition, "we will be able to produce every type of MOS component for télématique products (below) and will have our own designs ready for manufacture in the next few years," he says.

□ Eurotechnique, a joint venture between St.-Gobain-Pont-à-Mousson (51%) and National

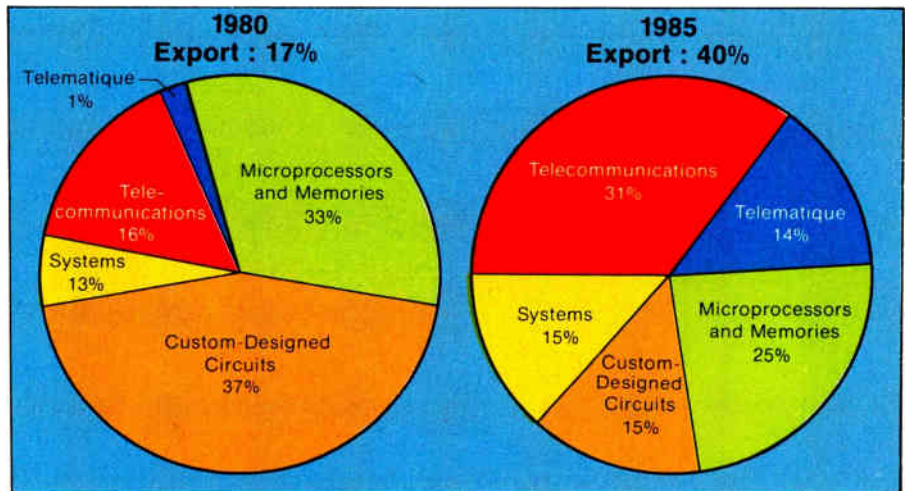

both analog and digital circuits. "Turnover increased by over 30% last year largely due to the plan, and we are broadening our product line to obtain a substantial slice of the télématique business from within our company and from other producers," says division vice president George Grunberg.

□ EFCIS, 65% owned by Thomson-CSF and 35% by the French Atomic Energy Commission (CEA), is making substantial headway in the production of various MOS technologies. Also, EFCIS president Paul Mirat says the company's second-source agreement with Motorola for its 6800 and 68000 microprocessors will give EFCIS 30% of Europe's

EFCIS, the MOS IC firm, is projecting a substantial increase in its telecommunications and télématique activity, in addition to a healthy boost in exports.

Semiconductor Corp. (49%), is two years old this month and is producing 4-K static and 16-K dynamic n-channel MOS memories. It will begin manufacturing 32-K erasable programmable read-only memories and XMOS technology later this year, and production of high-speed complementary-MOS very large-scale ICs is slated for June, 1982. Next year, the company will also begin producing a codec filter for the full range of TDM switching exchanges, and company president François Grandpierre

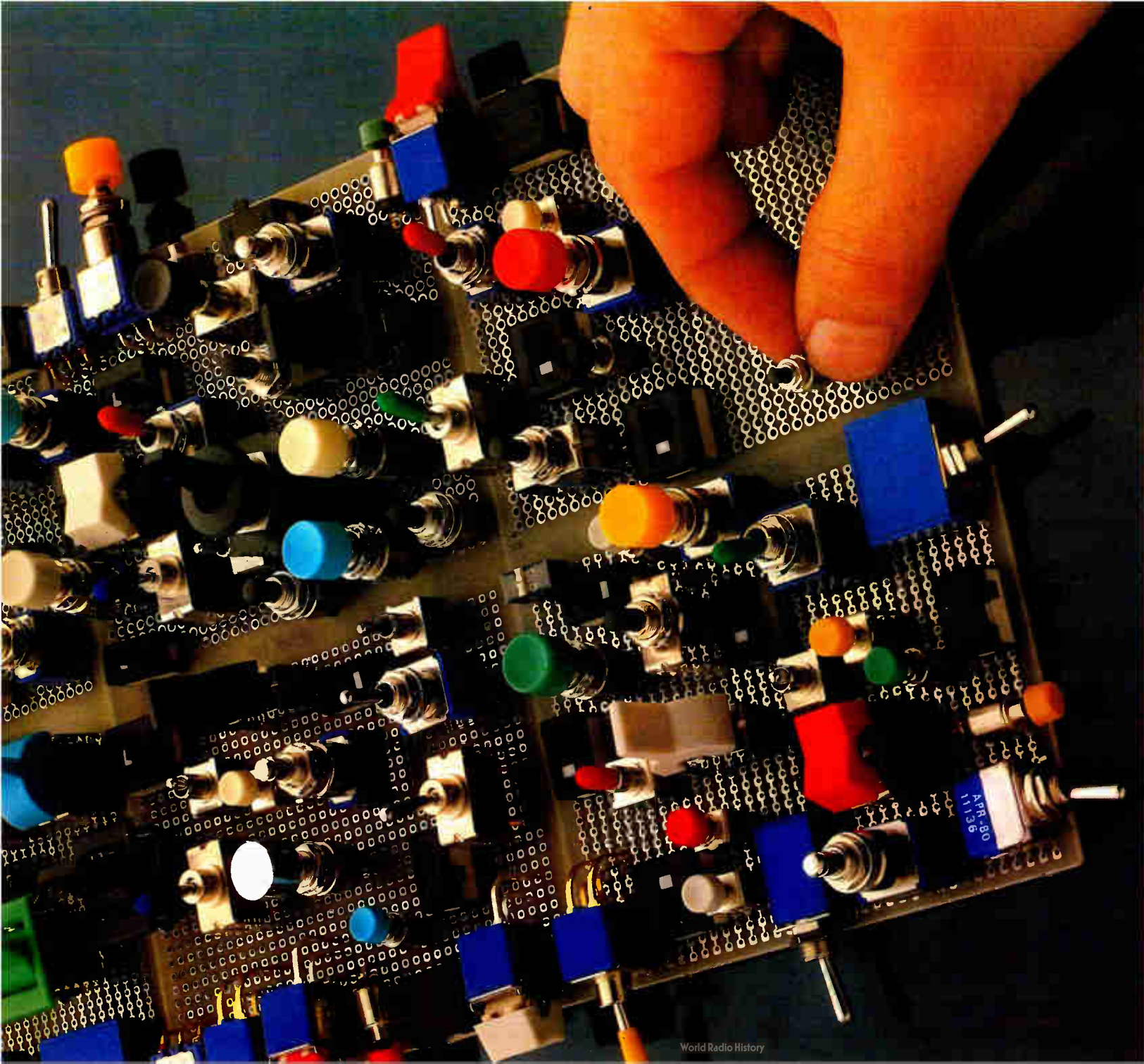

# Pick yours.

There is always space in a printed circuit for an APEM switch, even on the most densely packed boards, whether it needs a toggle, paddle, rocker, slide or pushbutton actuator, either with straight or right angle terminals. APEM switches feature: sealed for flow soldering, resistant against thermal shocks, resistant against solvent cleaning, low current level contacts.

All good reasons why you should select APEM switches for your printed circuit requirements.

**APEM** BP 1 - 82300 Causssade - France  
Tél. (63) 93.14.98 TX 520713

**An infinite variety for printed circuits.**

Circle 141 on reader service card

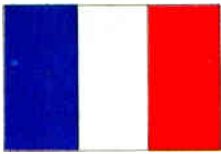

predicts exports "will account for 60% of our sales in 1982."

□ Matra-Harris

Semiconducteurs, a joint venture between Matra (51%) and Harris Corporation

(49%) produced its first C-MOS 4-K RAM last December.

Company chairman Pierre Fougere expects sales to increase to over 700 million francs in 1986 with "substantial emphasis on custom-designed circuits for the télématique program."

□ The Philips subsidiary, RTC—La Radiotechnique Compélec, agrees that the French plan has been a success to date and resulted in substantial progress in their production of rapid bipolar circuits. In addition, "we are well positioned to produce high-quality displays for terminals required for the télématique program," says the head of the company's product department, L.-Jacques Foret.

### The future looks bright

Each of the companies briefly profiled above, as well as other French component manufacturers, extol the possibilities of the télématique program and believe it is a fundamental aspect of their development during the 1980s. It will allow low-cost high-volume production, provide a captive domestic market for many manufacturers, and lead to the development of new designs and products for export.

"France now has a competitive IC industry that should be exporting 50% of its production by 1985," says Alain Crémieux, head of the interministerial

mission for electronic components at the government's Direction des Industries Electroniques et de l'Informatique (DIELI). "The telecommunications and télématique activity will be fundamental to their growth. Today telecommunications represents about 25% of all components activity. In 1985, the computer and telecommunications sectors—or télématique in its broadest form—will represent 60% of the industry's total turnover."

The French components plan, besides producing a competitive French industry, also allowed American companies—primarily Harris and National—to obtain a slice of the French market, which otherwise might have been closed to them. This "two-way street," as Eurotechnique president François Grandpierre calls it, will continue.

What remains to be seen for French IC producers, of course, is whether they can translate their evolving technological expertise into commercial benefits. "The télématique program provides us with an enormous market for numerous components," says Thomson-CSF's Georges Grunberg.

Adds Matra's Fougere, "Télématique is important and we are involved in numerous programs, but we can't let it dominate our thinking. If we sell over 30% of our ICs to Matra, we're making a mistake. Our future technologies must be salable in other markets."

In addition, the French must have, on a governmental and industrial basis, the inspiration to develop their own technologies in

the future and not simply be subcontractors to American expertise. There is unanimous agreement, in fact, that during the next three years this independence and technical advancement will be the major emphasis within the industry.

### R&D getting a good base

For one, the components plan has created a research and development structure which should allow the design and manufacture of advanced ICs and other components. Although the French plan failed to create the equivalent of a Silicon Valley (Matra-Harris Semiconducteurs is in Nantes, Eurotechnique is near Marseille, EFCIS is in Grenoble, for example) it has still established a committed R&D base.

Four government ministries (industry, PTT, defense, and research) are involved with the plan. The new CNET microelectronics laboratory devoted to the development of rapid high-density IC technology has opened in Grenoble. Also, there is a close collaboration between universities, the government and industries regarding R&D planning.

"The plan will have been a failure if we don't concentrate on strengthening our technological know-how during the future," says Thomson-CSF's Grunberg. Adds the CNET's Michel Camus, "French industry *will* begin designing their own circuits and the telematique program *will* lead to technical breakthroughs in components which will put us ahead in numerous areas in the future." □



# visualisation

## les tubes monochromes

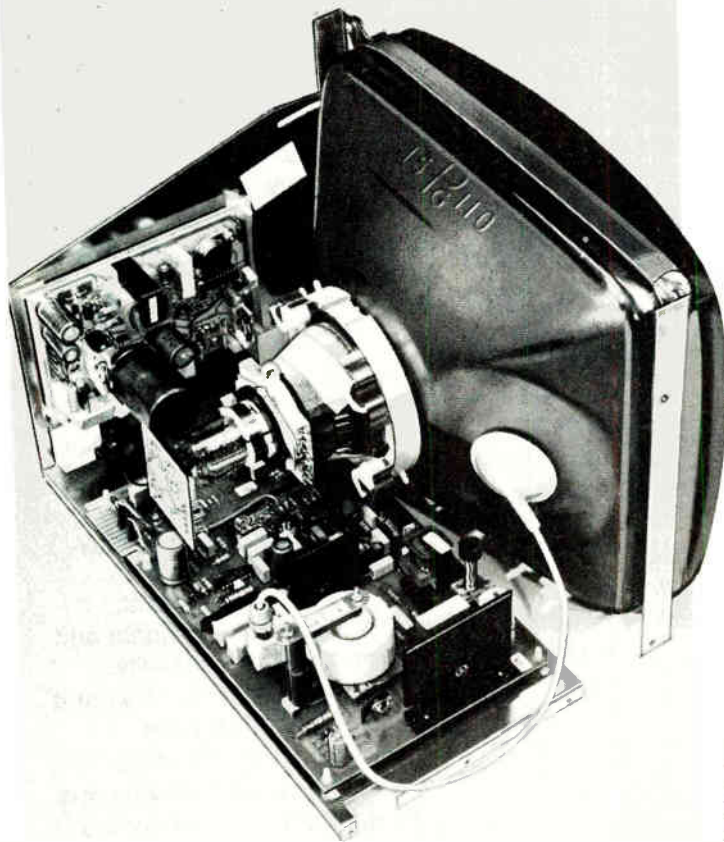

De la télévision en circuit fermé jusqu'aux moniteurs pour traitement de textes, graphismes et fac-simile.

Nouveaux tubes haute et très haute résolution 1500 et 2000 lignes.

Quatre familles complémentaires de tubes moniteurs :

- 24 et 31 cm - 90° col 20 mm
- 31 et 38 cm - 110° col 28,6 mm
- 17, 24 et 31 cm - 90° col 28,6 mm
- 38 cm - 70° col 36 mm

## les circuits intégrés

Pour vos applications videotext norme ANTIOPE

- démodulateur VIP
- démultiplexeur CDA
- gestion de mémoire GMA
- générateur de synchronisation ATIC
- générateur de caractères AROM (version 40 et 80 caractères)
- famille microordinateurs 8048/8049/8400
- synchronisation TDA 2593, 2576 A
- déviator de trame TDA 2654
- ampli vidéo RVB TDA 3501
- commande d'alimentation à découpage: TEA 1039/40

## et tous les composants associés

Composants de col, composants bobinés, semiconducteurs discrets, résistances, condensateurs, circuits imprimés.

Je désire recevoir

- la visite d'un ingénieur conseil
- votre catalogue

M. \_\_\_\_\_

Fonction \_\_\_\_\_

Société \_\_\_\_\_

Adresse \_\_\_\_\_

\_\_\_\_\_  
Ville \_\_\_\_\_

Tél. : \_\_\_\_\_

545 E

*Afin que vous puissiez innover*



130, AVENUE LEDRU-ROLLIN - 75540 PARIS CEDEX 11 - TEL (1) 355.44.99 - TELEX : 680.495 F

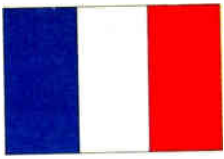

# FRENCH COMPONENTS: THE INSIDERS' VIEW

Industry leaders plan for a future of high technology

For the insiders' view of the French components industry, the place to turn is to the leaders of companies that are making the future happen. A series of interviews with these men focused on three areas: their opinions of the government's aid to their industry, the effects of the push in telecommunications and *télématique*, and company directions in research and development.

## Question

How do you gauge the progress of the French components plan to establish a competitive integrated circuits industry, and what is your evaluation of the future?

## Answers

**Paul Mirat**, President-Director General, EFCIS: "We are well on our way towards one of our major goals: to supply 30% of Europe's microprocessor requirements and export 40% of our total production by 1985. Our turnover will increase from 35 million francs in 1978 to 250 million francs this year, and we have increased our employment from 180 to 700 persons during the same period. If the bottom line is any indication, the plan has been a success.

"All of our products are geared towards the future, and we are expecting to sign second-source agreements for some of them this year. The primary benefits of our



Paul Mirat, President-Director General, EFCIS

progress to date are that we can control our products, control our technology, and control our commercial development."

**Jean-Claude Asscher**, chairman, Tekelec: "It's too early to categorically say that the French plan has been a success, and it won't be clear until the end of the year whether IC prices will be internationally competitive. If they are, then the large investment in technology and production facilities will have paid off. If not, the government is going to have to create a *very* expansive internal market."

**Jacques Eldin**, technical director, Alcatel group: "We have always had some reservations about the government IC plan. We're not sure some of the systems manufacturers involved

should have gone into large-scale component production, and it is not clear that current links with U.S. companies will involve permanent access to advancing IC technology.

"However, the plan has worked to the degree that production facilities have been established—now let's see how the prices compare. Our own future? We will produce hybrid circuits and some strategic components for our own use and take shares in U.S.-based companies which provide us with permanent access to updated technology."

**Bernard Levi**, director research and development, Thomson-CSF Components and Electron Tubes group: "The government has given us what it promised, and it remains convinced that the IC sector is the most important components area in the future. I believe we have a global approach to the market and, despite our late start and comparatively low production levels, we can increase production and decrease costs at a rapid rate."

**François Grandpierre**, President, Eurotechnique: "We have respected the cost estimates of the plan: there has been no problem with the transfer of technology by our American partner; and we are currently manufacturing three products. An additional family of

memories and microprocessors will be launched before July.

"Our future is to have long-term access to products and technology developed by National Semiconductor in addition to developing our own line of technology, both in conjunction with National and with the research arm of the French PTT. Our relationship with National will be, we hope, an example of the necessary two-way street which is required in this industry."

**Georges Grunberg**, Vice-President, Semiconductor Division, Thomson-CSF: "French industry certainly needed a logical IC plan to achieve both government and corporate goals in sales and exports. The plan definitely boosted our investment and industrial commitment, and the accumulative annual growth in this division has increased by over 30%—largely due to the IC plan.

"It has enabled us to develop our own sophisticated technologies and produce a good catalogue of products in the area of bipolar ICs. We will need another five-year plan to secure our position as technical leaders and further establish ourselves in the market. We've created the technical expertise; now we must export it."

**Pierre Fougere**, chairman of Matra-Harris Semiconducteurs and head of Matra's components division: "We've begun producing a 4-K RAM and will begin production of a newly-designed 1-K RAM and 16-K RAM before the end of the year. We started the plan in August 1979 and produced our first wafer in December 1980—that's an aggressive program and we expect our turnover to increase from 14 million francs in 1980 to 700 million francs in 1986.

"Our future will be to expand the Harris C-MOS catalogue. They've allowed us to start with a good existing technology, but we

are not subcontractors. We will develop our own processes and technologies in three areas: microprocessors and peripherals, specific circuits for telecommunications, and microcomputers for the automotive industry."

#### Question

What influence have government expenditures in the telecommunications and télématique sectors had on the French components industry?

#### Answers

**Paul Mirat** of EFCIS: "The components we are manufacturing for the



Pierre Fougere, chairman of Matra-Harris Semiconducteurs and director of Matra's Components division

telecommunications industry are the most important aspect of our production. We are involved in most important telecommunications and télématique projects and attempt to manufacture everything required in this field. The entire company philosophy, in conjunction with other Thomson-CSF affiliates, is to produce all components for complete systems in all sectors of telecommunications and télématique."

**Pierre Fougere** of Matra's components division: "We work very closely with other Matra divisions and expect to produce components for three major areas in télématique: the new

telephone sets, which will go into production in 1983; facsimiles, which are extremely important in terms of ICs; and the electronic directory."

**Michel Camus**, director of the Norbert Segard Microelectronics Center, CNET: "There is an extremely important relationship between telecommunications and components in France today. Microelectronics and ICs are a fundamental and critical technology for the future of telecommunications and télématique. As we move towards large integrated systems, much more equipment will consist of components—and if we are going to improve the overall performance, we must have more rapid, less energy-consuming components."

**Georges Grunberg** of Thomson's semiconductor division: "Télématique has led and will continue to lead the development of custom-designed circuits, as well as large-quantity production of standard products. Naturally it is our hope that the components used for the new products will become standards throughout the world."

**François Grandpierre** of Eurotechnique: "Télématique will be the backbone of our activity for the next 15 years and provides an exceptional base for our future. We are looking forward to supplying components for future generations of two basic telecommunications items: the telephone set and the electronic directory. We hope that Olivetti and CII-Honeywell Bull, two companies with financial relationships with our parent company St.-Gobain-Pont-à-Mousson, will find our components economically attractive and provide us with additional applications."

**L.-Jacques Foret**, head of the product department, R.T.C.-La Radiotechnique Compélec: "We have a firm background

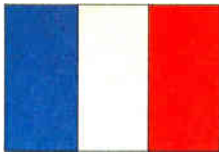

producing numerous components that will be required for products in the télématique area—particularly displays and keyboards for the inexpensive terminals which will be produced in large quantities. Obviously we plan to adapt this experience to future programs, and we believe we have the capabilities to produce economic, high-quality displays for the electronic directory. In addition, tubes will play an important part in the audio and video aspects of télématique and we are determining which direction to move in these areas."

**Jean-Claude Asscher** of Tekelec: "Télématique has given French manufacturers a substantial head start on competitors from other countries and has enabled us to purchase components used in a wide range of new products: test and simulation equipment for data transmission, tele-diagnostic equipment, test equipment for TDM switching and PCM transmission, to name a few. It has provided us with a great head start when it comes to software and design."

**Jacques Brault**, director of the instrument department, Enertec: "Télématique, particularly data and video transmission, requires much more sophisticated measuring equipment, especially because of the increased use of digital techniques. A substantial amount of our current development is due to the French government's progress in telecommunications—new measuring equipment for Antiope, for example."

#### Question

What are your priorities in

research and development for the future?



Georges Grunberg, Vice President of Thomson-CSF Semiconductor division

#### Answers

**Michel Camus** of CNET: "Our priorities in Grenoble are primarily in two areas: silicon microelectronics and optoelectronics. Naturally other CNET laboratories are working on intelligent terminals and networks, optical and satellite communications systems, computer and microprocessor assistance to all network functions, and new communications concepts."

"We will use our technological base to design new integrated circuits that are more rapid and consume less energy. We expect to develop our own C-MOS process with 2-micrometer minimum features in 1983 and to rival the Americans in terms of design. We have 150 employees in R&D today and will have 230 next January. We will also concentrate on analysis and synthesis of speech and advanced generations of memory circuits."

**Georges Grunberg** of

Thomson's Semiconductor division: "In digital circuitry, we are planning to enter the memory activity arena, especially PROMs. What we are determining now is our capacity to be competitive with these products. We will also increase our strength in analog circuits in terms of offset drift, higher voltages and higher frequencies."

**Francois Grandpierre** of Eurotechnique: "In 1985 we will have 700 employees with 200 of them working in R&D. We will concentrate on products that can be produced in large series for the European market in the fields of telecommunications, computers, and automobiles. Our engineers will pool their resources with CNET, which will provide us with an opportunity to quickly industrialize new technologies."

**Jacques Eldin** of Alcatel: "In the components field we will be working very closely with CNET in the area of optoelectronics with the goal of being an important European manufacturer in this field. Our association with American firms should also allow us to develop new components for télématique-oriented products."

**Jacques Brault** of Enertec: "We will continue to develop testing and measuring equipment that is capable of simultaneously working with analog and digital networks."

**Bernard Vautrin**, marketing manager for electro-optical devices, Thomson-CSF Electron Tube division: "A priority will be surface area sensors for videophones and other applications. We are investigating flat-panel displays, which may ultimately replace CRTS." □

# A FULL RANGE... ONE NAME!

THOMSON CSF



THOMSON CSF

THOMSON CSF

THOMSON CSF  
ELECTRON TUBES  
AND MATERIALS LTD

 **THOMSON-CSF**  
COMPOSANTS

**THOMSON-CSF** DIVISION TUBES ELECTRONIQUES  
38 RUE VAUTHIER - B.P. 305 - 92102 BOULOGNE BILLANCOURT CEDEX - FRANCE  
TEL (33 1) 60 4 81 75

**USA**  
CLIFTON NJ  
THOMSON CSF  
ELECTRON TUBES  
TEL (201) 779 10 04

**BRAZIL**  
SAO PAULO  
THOMSON CSF  
COMPONENTES DO  
BRASIL LTDA  
TEL (11) 542 4722

**GERMANY**  
MUNICH  
THOMSON CSF GMBH  
TEL (89) 75 10 84

**UNITED KINGDOM**  
BASINGSTOKE  
THOMSON CSF  
COMPONENTS  
AND MATERIALS LTD  
TEL (256) 29 155

**SWEDEN**  
STOCKHOLM  
THOMSON CSF  
COMPONENTER &  
ELEKTRONIK AB  
TEL (8) 22 58 15

**JAPAN**  
TOKYO  
THOMSON CSF  
JAPAN K.K.  
TEL (3) 264 63 46

**ITALY**  
ROMA  
THOMSON CSF  
COMPONENTI  
TEL (6) 638 14 58

**SPAIN**  
MADRID  
THOMSON CSF  
COMPONENTES Y  
TUBOS S.A.  
TEL (1) 419 88 42

# RCK

niGRO CER®

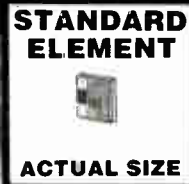

If ultra precision resistors concern you, have a look at the different lines of products already manufactured with our technology.

**INCREASING OHMIC VALUES**

**RCK02** 0,5W at 70°C  
0,33W at 125°C  
1Ω... 200 kΩ  
± 0,005% ... ± 1%

**RCK04** 1W at 70°C  
0,6W at 125°C  
2Ω... 400 kΩ  
± 0,005% ... ± 1%

**RCK05** 1,2W at 70°C  
0,9W at 125°C  
3Ω... 600 kΩ  
± 0,005% ... ± 1%

**RCK06** 1,5W at 70°C  
1,2W at 125°C  
4Ω... 800 kΩ  
± 0,005% ... ± 1%

**INCREASING POWER**

**S118**

**RTK 3**

**ULTRA PRECISION HERMETIC SEAL**

**RHK**



# A VERY HIGH PRECISION RESISTIVE ELEMENT WITH ULTIMATE POSSIBILITIES

The design and technology of very high precision resistors have progressed considerably in recent years.

- Nowadays, users frequently need from a resistor such performances as :
- initial tolerance of 0.005%
  - temperature coefficients less than 1 ppm/C
  - 2000 hours' load life stability at Pn 125°C better than 0.002%.
  - rise time of a few nano seconds.

SFERNICE in France and its subsidiary in the United States, RESISTOR RESEARCH CORPORATION are among the few manufacturing companies that have made their first priorities the development of an industrial process that fulfills these needs.

This original and complex process, known as "Nicrocer®", permits series manufacture of a standard element.

## The standard element

The basic element consists of a square chip, 0.2" x 0.2" x 0.025" (5,4 x 5,4 x 0,635 mm) in size, made of a ceramic substrate to which a thin resistive foil (100 microinches thick/2,5 micrometers) is bonded.

This foil is then treated by a proprietary manufacturing process that trims it up to the very true ohmic value specified by the customer.

Two flexible ribbons welded to the foil provide the necessary electrical connections.

Because it is a fine metal foil, the resistor has the specific electrical stability of solid metal.

Special thermal treatment and bonding technology combine to give these resistors extremely low thermal coefficients, associated with excellent reproducibility.

Our etching process permits line width down to 3 micrometers to a tolerance of 1 micron. It is then possible to achieve :

- ohmic values to a precision of better than 10<sup>-5</sup>
- extremely short rise times required for rapid electronics (planar structure, self-inductance cancelled out between two conductors).

The requirement of very good thermal conductivity dictates the choice of alumina as a substrate.

The flexible ribbons insulate the resistive element from the mechanical and thermal strengths arising when the user solders the assembly.

A wide range of very high-precision and extremely stable products has been developed from this resistive element.

If you do not find your exact requirement in this range, we will be glad to help you personally, either in our European plant or our U.S. subsidiary, to develop a high-precision product that answers your needs.

For further information, please contact :

**worldwide SFERNICE 115-121, bd de la Madeleine**  
**except B.P. 17 - 06021 Nice Cedex FRANCE**  
**U.S.A. : Tél. (93) 87.58.90 + 470261**

**in U.S.A. : RESISTOR RESEARCH Corporation**  
**11515 Sunset Hills Blvd**  
**Reston, Virginia 22090**  
**Tel. (703) 435-2000 TWX 710-831-0344**



V at 70°C  
at 200 k Ω  
,01% ... ± 1%

without heat sink / at 25°C  
V on heat sink  
... 600 k Ω  
,01% ... ± 1%  
metic seal > 10<sup>-7</sup> Atm.



o ± 0,001%  
metic seal better than  
Atm.  
ility better than 5.10<sup>-6</sup>/year



## NETWORKS

**RE** series 20 - 30 - 40

**DIL**

- Network R/2R
- Kelvin Varley Divider
- All special requirement

## CUSTOMERISATION (Method Numbers)

- sets of resistors
- TC Tracking
- Tolerance matching
- All customer specification

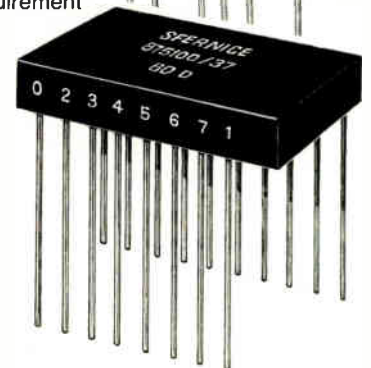

# SFERNICE

**SOCIETE FRANÇAISE DE L'ELECTRO-RESISTANCE**

117, BOULEVARD DE LA MADELEINE

06021 NICE CEDEX - FRANCE

TEL. (93) 87.58.90 - TELEX 470 261

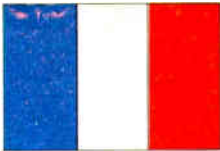

# NEW PRODUCTS

## Processor Card is Building Block

The EFCIS EFS-MPU2 is a processor module built around the EFCIS EF6809 8-bit microprocessor. It is a basic building block for any system in industrial or data-processing applications. The module offers a 1 K-byte RAM and the possibility of a 2- or 4 K-byte EPROM.

The RS-232-C asynchronous, serial communications bus can

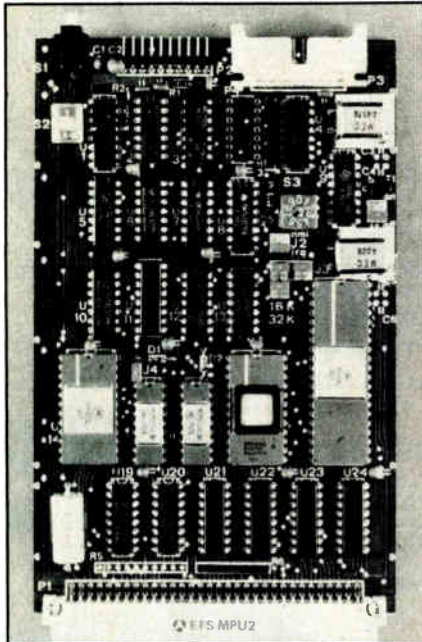

be run at 110 to 9,600 baud. A real-time clock driven by a 4-MHz crystal generates a signal every 10 ms, enabling the implementation of applications that require timing.

EFCIS, 45 ave. de l'Europe, 78140 Velizy-Villacoubaly, France. [341]

## Resistor Nets Have Four Configurations

The Microelectronics division of

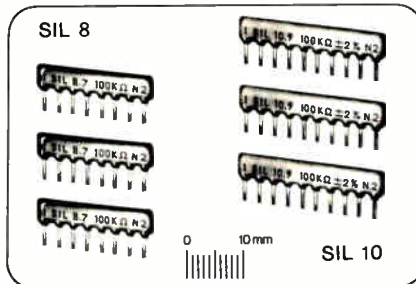

SFERNICE has announced a new range of high-volume single in-line resistor networks. There are four different configurations: the SIL 8-7, an eight-pin package with seven resistors, the No. 1 pin being common; the SIL 8-4, an eight-pin package with four individual resistors; the SIL 10-9, a 10-pin package with nine resistors, the No. 2 pin being common; and the SIL 10-5; a 10-pin package with five individual resistors. The ohmic value ranges from 10Ω to 1 MΩ is manufactured in the E 12 resistance series with ±2% or 2Ω resistance tolerance.

SFERNICE, 59 rue Gutenberg, 75737 Paris Cedex 15, France. [342]

## Test Gear Checks Antiope Data

Enertec's Instrument division has developed a range of equipment to test and measure

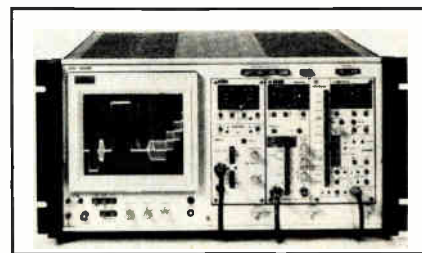

signals of the Didon system of data broadcasting in Antiope, the French direct one-way videotex. The 5547 verifies the

transmission of the correct signal over the network and is capable of recognizing the Didon lines on a video signal.

Digital information, which permits the measurement of two consecutive lines, is indicated on Enertec's 5376 Mesure Didon equipment. Enertec's 5500 R uses a cathode-ray tube to show analog measurements.

Enertec, Instruments Division, 5 rue Daguerre, 42030 St. Etienne, France. [343]

## Synthesizers Boost Performance

The Adret 7100 A and B synthesized generators have been upgraded into the 7100 D version, which features improved spectral purity within the 100-KHz-to-1.3-GHz frequency range with 1-Hz resolution, high-quality modulation characteristics

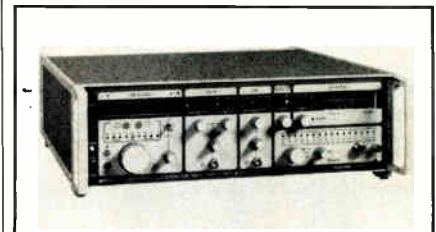

compatible with stereo modulation, wide-output-level dynamic range (160 dBm) by -1 dB steps with improved accuracy, and AM, FM, PM, oM modulation capabilities.

The 7100 D model has an audio generator, continuously tunable within the 10-Hz-to-100-KHz range, which can be used for internal modulation and external purposes simultaneously.

Adret Electronique, 12 ave. Valdimir Komanov, 78192 Trappes, France. [344]



# logic analyzer 7600

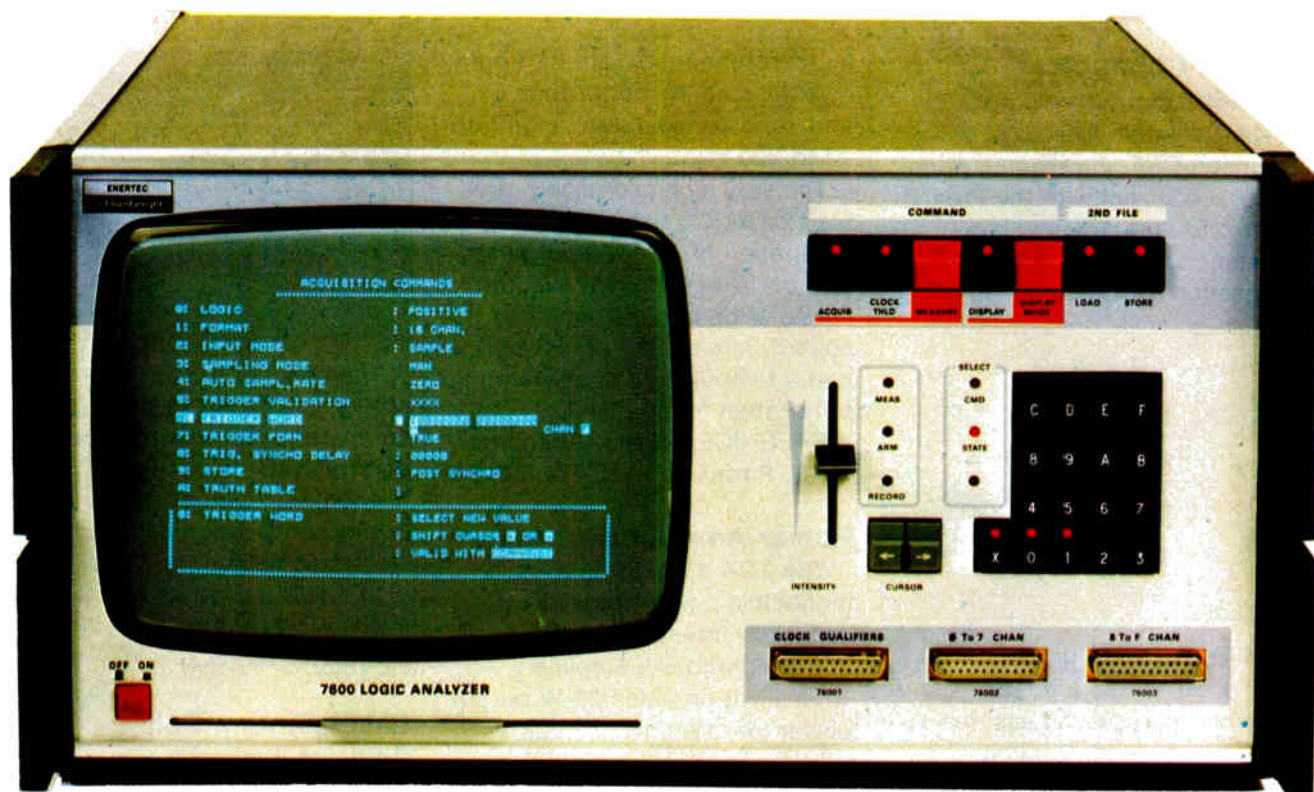

**high performance, ease use, economic  
you want them all, we offer them all**

#### simple operation

large 23 cm screen  
interactive control  
command recall and display  
non-volatile memories for  
using program

#### advanced performance

16 or 32 channels - 100 MHz  
6 qualifiers  
dual 4096-bit memories

#### 4 display modes

levels : normal, expanded or  
mixed scale  
time interval measurement  
trigger point-on preselected  
cursor position.

states : binary, hexadecimal,  
octal or ASCII codes with  
comparison mode.

graph : binary values  
of the stored words,

being plotted against time  
(using on A/D and D/A conver-  
ter and on microprocessor  
systems).

map : normal or  
expanded scale.

#### programming

RS 232 interface card  
(input/output) and IEC GP-IB  
(fully programmable).



ENERTEC  
DÉPARTEMENT INSTRUMENTS  
5, RUE DAGUËRRE 42030 ST ETIENNE CEDEX FRANCE  
TÉL (77) 25 22 64 TELEX ENIST A 330696 F



# NEW PRODUCTS

 (Continued)

## Optical Connectors are Waterproof

The Socapex division of Thomson-CSF, in research done under a contract with the French Atomic Energy Agency, has developed waterproof, low-congestion six-optical-channel

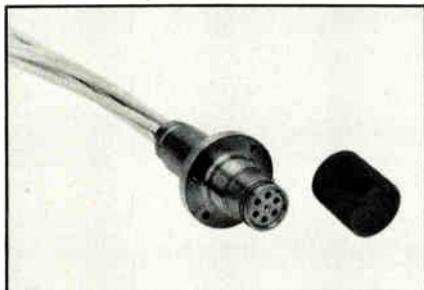

connectors with a graded index fiber of 50 to 125  $\mu\text{m}$ . The technology employed assures 150 bars waterproof insulation. Unpaired, the connectors can support a 150-bar pressure, avoiding any light penetration into the cable. The optical loss is below 1 dB per connection, recurring no more than 100 trials.

Socapex, 10 bis quai Leon Blum, B.P. 32, 92151 Suresnes, France. [345]

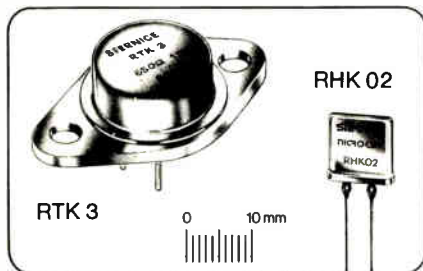

## Power Resistor Models Extend Range

SFERNICE is introducing two new models to complete its extensive range of ultra-precision power resistors. The ultra-precision type RHK 02 has a tolerance reaching 0.001%, a

temperature coefficient of 1 ppm, a yearly stability better than 5 ppm, and ohmic value range from  $1\Omega$  to 200 k $\Omega$ .

The very high precision power resistor RTK 3 has a power dissipation of 3 W without heat sink or 10 W with heat sink, an ohmic value range from  $3\Omega$  to 600 k $\Omega$ , a tolerance of  $\pm 0.01\%$ , and a temperature coefficient better than 5 ppm.

SFERNICE, 59 rue Gutenberg, 75737 Paris Cedex 15, France. [346]

## Power Amp Aims at Audio

The TDA 1103 SP is a monolithic power amplifier especially intended for use as an audio high-fidelity amplifier. Typically it provides 20-W output power ( $d = 1\%$ ) at  $V_{CC} = 28\text{ V}$ ,  $R_L$

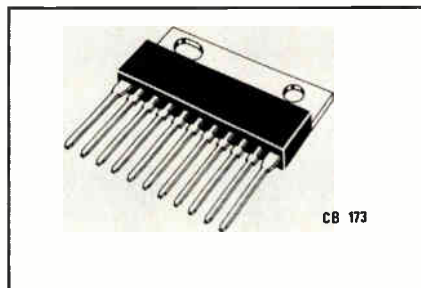

$= 4\Omega$ . It is supplied in a special case featuring very low thermal resistance.

Thomson-CSF, Semiconductor Division, 50 rue J. P. Timbaud, B.P. 5, 92403 Courbevoie, France. [347]

## Connector System Suits Many Needs

SOURIAU's 8609 connector system uses common mountings for all types of connector and contact arrangement. The standardization of different components results in minimum mechanical part costs and a multisource component supply.

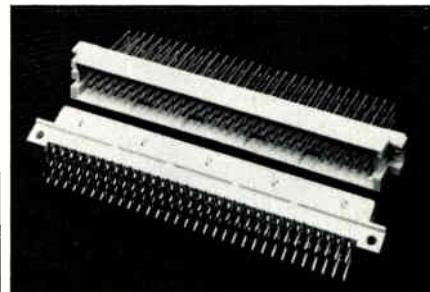

The concept of the 8609 system enables it to be applied in computers, instrumentation, control systems, telecommunications, and other professional, electrical, and electronic fields.

SOURIAU, 9-13 rue du Général Gallieni, 92103 Boulogne-Billancourt, France. [348]

## Laser Diodes Suit 0.84- $\mu\text{m}$ Lines

Thomson-CSF has developed a series of laser-diode optical heads for 0.84- $\mu\text{m}$  communications. They feature 1, 2 or 3 mW of optical power and are available either with a pig-tail or connector output.



Thomson-CSF, Microwave Components Division, 101 blvd. Murate, 75781 Paris Cedex 16, France. [349]

## Graphics Display ICs Write Fast

EFCIS has developed two high-resolution graphics display

# BE A BOTTICELLI AT 1 $\mu$ s/PIXEL... NOW



WITH  
**THOMSON-EFCIS  
EF 9365 TRUE GRAPHIC  
DISPLAY PROCESSOR**

High resolution (512 x 512),  
high speed, low cost, ease of  
use, evaluation boards: the first  
available MOS one-chip intelligent  
color graphic co-processor.

ASK US NOW...  
AND STAY AHEAD



**THOMSON-CSF**  
COMPONENTS

**EFCIS** 45, AVENUE DE L'EUROPE - 78140 VELIZY - TEL. (3) 946.97.19 - TELEX 698 866 F

**BELGIUM**  
THOMSON S.A.  
BRUXELLES (2) 648.64.85

**BRASIL**  
THOMSON-CSF  
COMPONENTES DO BRASIL  
SAO PAULO (55.11) 542.47.22.

**WEST GERMANY**  
THOMSON-CSF BAUELEMENTE  
MÜNCHEN (089) 76.751

**ITALY**  
THOMSON-CSF  
COMPONENTI  
MILANO (2) 68.84.141.

**JAPAN**  
THOMSON-CSF JAPAN K.K.  
TOKYO (03) 264.63.41.

**NETHERLANDS**  
THOMSON S.A.  
RA s GRAVENMOER  
(016) 23.17.600

**SINGAPORE**  
THOMSON-CSF SEA  
SINGAPORE 295.31.24.

**SPAIN**  
THOMSON-CSF  
COMPONENTES Y TUBOS  
MADRID (1) 419.65.51.

**SWEDEN**  
THOMSON-CSF  
COMP & ELECTRONÖR AB,  
STOCKHOLM (08) 22.58.15.

**UNITED KINGDOM**  
THOMSON-CSF  
COMPONENTS  
& MATERIALS  
BASINGSTOKE (0256) 29.155.

**USA**  
THOMSON-CSF  
COMPONENTS CORP.  
CANOGA PARK, Ca  
(213) 887.10.10.

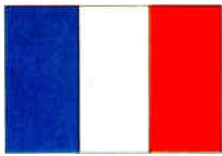

# NEW PRODUCTS

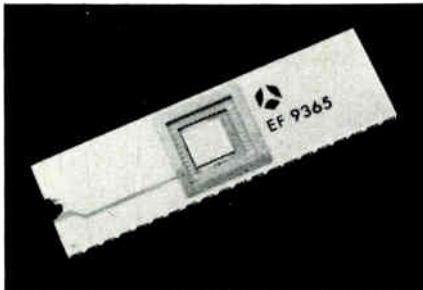
 (Continued)

processors with high-end capabilities. The EF9365 and EF9366 are programmed through any 8-bit microprocessor and allow different resolutions in black and white or in color.

The parts include all the necessary logic required to perform a complete interface to raster-scan displays, as well as two hardwired display processors, a vector generator and a character generator. This unique feature allows an ultra-fast screen writing speed at almost no microprocessor cost.

EFCIS, 45 ave. de l'Europe, 78140 Velizy-Villacoublay, France. [350]

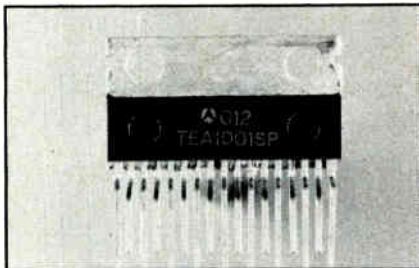

## Chips Aid Power-Transistor Switching

Thomson-CSF's Semiconductor Division has designed two advanced circuits for driving an external power transistor in a manner that improves both switching characteristics and reliability. The UAA 4001 DP and TEA 1001 SP are intended for switch-mode power-supply control.

Thomson-CSF, Semiconductor Division, 50 rue J.P. Timbaud, B.P. 5, 92403 Courbevoie, France. [381]

## 140-Mb Test Gear is First in Line

Enertec's Instrument Division, in collaboration with the DAll and the CNET, has developed equipment to measure and analyse transmission at 140 Mb/s. The 7700 *Generateur/Mesureur de Gigue* 140 Mbit/s is the precursor of



additional equipment being developed for 34- and 52-Mb/s transmission rates.

Enertec, Instruments Division, 5 rue Daguerre, 42030 St. Etienne, France. [382]

## Synthesizer Packs in Features

Adret Electronique's synthesized generator, the 7200 A, provides a number of improved features at a moderate cost including outstanding



spectral purity generation within the 10-Hz-to-1.3-GHz range with 1-Hz resolution; high dynamic

output range, from + 20 dBm to - 140 dBm with automatic output level correction.

Adret Electronique, 12 ave. Vladimir Komanov, 78192 Trappes, France. [383]

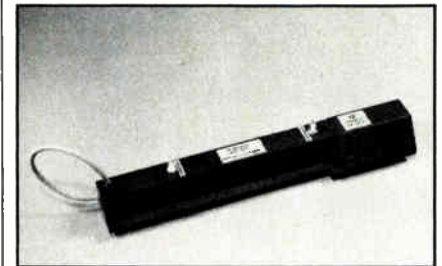

## TWTs Suit Small Earth Stations

For small satellite communication earth stations, Thomson-CSF now offers two broadband helix travelling-wave tubes, the TH 3641 and TH 3642. Both operate in the 6-GHz uplink band and deliver a minimum saturated output power of 75 and 150 W respectively. The tubes have high gain, over 25% efficiency at full power, and are designed for average operating lives of over 15,000 hours. Their development is supported by the French PTT.

Thomson-CSF, Electron Tube Division, 38 rue Vauthier, 92100 Boulogne-Billancourt, France. [384]

## Small Trimmer Keeps Performance

The latest edition to the SFERNICE family of single-turn trimmers is the front-adjust model TX, which may be interchanged with the most popular pin style of front adjust  $\frac{3}{8}$ -in. single turn. The TX also is smaller (8.2 by 7 mm compared with 9.52 by 9.52 mm). It provides equipment manufacturers with

# THE UTMOST IN PERFORMANCE

After 500 pcs sold, now comes the upgraded version **7100 D.**

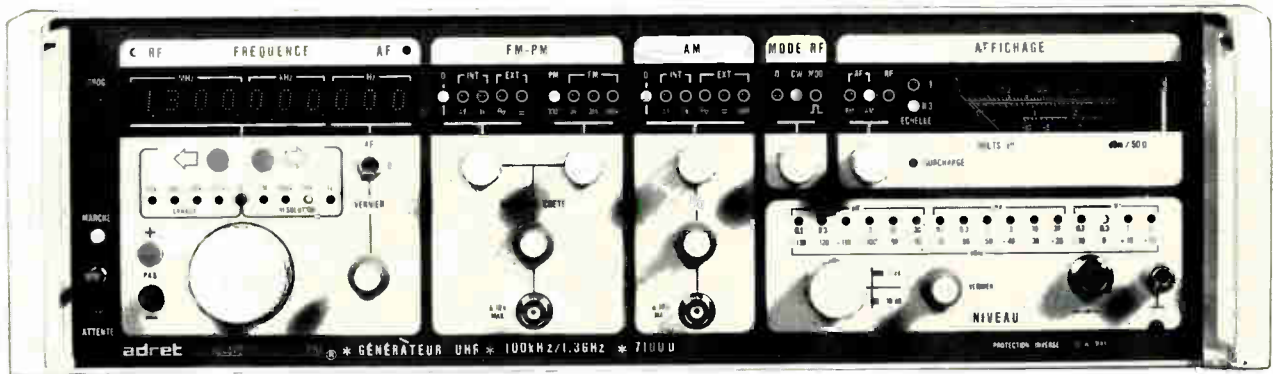

**AT WHAT A PRICE ?  
ASK US  
YOU'LL BE  
SURPRISED**

- Built-in AF generator : 10 Hz - 100 kHz
- Enhanced spectral purity : 136 dB/Hz at 10 kHz fm carrier
- Very low incidental FM : less than 1 Hz (CCITT)
- Multiple modulation : AM, FM, PM, PULSE from DC to 100 kHz
- Extended frequency range : 100 kHz to 1.3 GHz
- 1 Hz resolution throughout the range
- All functions fully IEEE 488 programmable



ADRET ELECTRONIQUE 12, Av. Vladimir Komarov ● BP 33 78192 Trappes Cedex ● France ● Tél : (3) 051.29.72 ● Télex ADREL 697821 F  
Foreign representatives : W. GERMANY : Rohde und Schwarz, Cologne ● UK : Racal Instruments, Windsor ● ITALY : Electronucleonica, Milano ● SPAIN : Telco, Madrid ● THE NETHERLANDS : Rood, Rijswijk ● BELGIUM : Sait, Brussels ● SWITZERLAND : Roschi Tel, Bern ● SWEDEN : Teleinstrument Vallingby ● NORWAY : Morgenstjerne, Oslo ● DENMARK : Tage Olsen, Ballerup ● FINLAND : Orbis Oy, Helsinki ● GREECE : Scientific Enterprises, Athens ● EASTERN COUNTRIES : RST, Vienna, Austria ●

Circle 147 on reader service card

# THE MOST VERSATILE (though affordable) DC STANDARD you've been looking for :



## ADRET 103 : VOLTAGE AND CURRENT, ADRET 104 VOLTAGE ONLY

- DC Volts : 1  $\mu$ V to 110 V
- DC currents : 1 nA to 110 mA (103 only)
- Accuracy class :  $1.10^{-5}$
- Selectable polarity
- Guarded output
- High compliance Volt/vs current : up to 110 volts (103 only)
- Output inhibit
- Short circuit protection
- 20 memorable complete configuration settings (103 only)
- Very low internal resistance :  $< 1.10^{-3}$  ohms
- Digital sweep between set limits
- Step by step increment/decrement
- Fully IEEE 488 programmable (103 : Std - 104 : option)
- BCD programmable (104 only)



ADRET ELECTRONIQUE 12, Av. Vladimir Komarov ● BP 33 78192 Trappes Cedex ● France ● Tél : (3) 051.29.72 ● Télex ADREL 697821 F  
Foreign representatives : W. GERMANY : Rohde und Schwarz, Cologne ● UK : Racal Instruments, Windsor ● ITALY : Electronucleonica, Milano ● SPAIN : Telco, Madrid ● THE NETHERLANDS : Rood, Rijswijk ● BELGIUM : Sait, Brussels ● SWITZERLAND : Roschi Tel, Bern ● SWEDEN : Teleinstrument Vallingby ● NORWAY : Morgenstjerne, Oslo ● DENMARK : Tage Olsen, Ballerup ● FINLAND : Orbis Oy, Helsinki ● GREECE : Scientific Enterprises, Athens ● EASTERN COUNTRIES : RST, Vienna, Austria ●



# NEW PRODUCTS

 (Continued)

miniaturization of components without sacrificing cost effectiveness or performance.

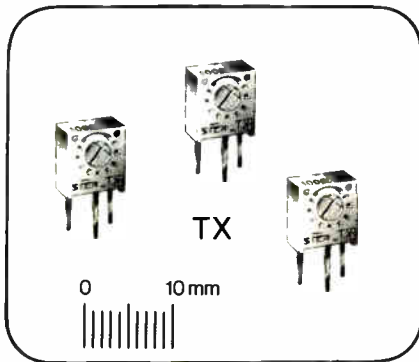

The TX offers 0.75 W at 40°C power dissipation and a CRV that is typically 1% of nominal resistance achieved by using a multifinger wiper. The temperature range of -25°C to +125°C, coupled with an excellent temperature coefficient, allows the units to be employed for a variety of applications.

SFERNICE, 59 rue Gutenberg, 75737 Paris Cedex 15, France. [385]

## Thermal Vidicon Saves Power

Thomson-CSF now offers a Pyricon (pyroelectric-target

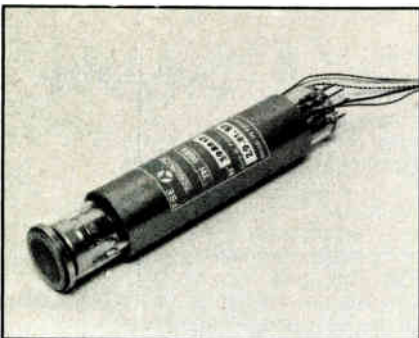

vidicon) with electrostatic focusing, the TH 9868, whose deflection field is produced by a printed circuit wrapped around the tube. This combination of electrostatic focusing and

magnetic deflection greatly reduces the power consumed, while permitting the thermal TV camera to be much smaller and lighter. The performance of the market-standard TH 9851 Pyricon is conserved.

Thomson-CSF, Electron Tube Division, 38 rue Vauthier, 92100 Boulogne-Billancourt, France. [386]

## PC Cards Use Forced Local Insertion Contacts

Forced local insertion of contacts, particularly applied to the implementation of harnesses,

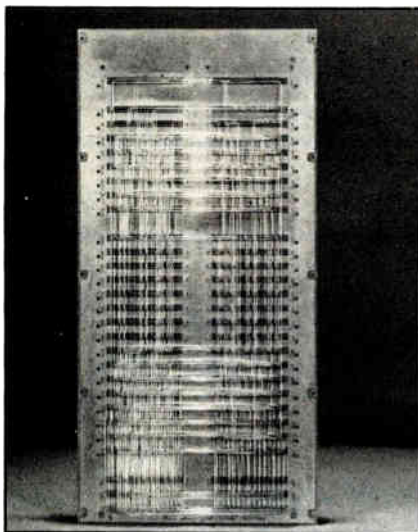

consists of using printed-circuit cards with metalized through-holes. Contacts are forced into through-holes to obtain solderless electrical connections.

Contacts are sequentially inserted either manually or automatically with a programmable machine, pitch being to DIN standard (32, 64, 96 contacts in three rows). Following insertion, the pins are coated with an insulator for full protection and self-alignment. Each pin can be individually removed and bonding is made on

contact tails provided for wrapped connection.

Socapex, 10 bis quai Leon Blum, B.P. 32, 92151 Suresnes, France. [387]

## IC Acts like Interactive Terminal

The SAA 5070 is a complex microprocessor-peripheral integrated circuit in n-channel MOS technology intended for use in wired data-communication systems. In a 40-pin package, it performs most of the hardware functions of an interactive terminal including an autodialing circuit, a 1200-baud demodulator and asynchronous receiver, and a 75/1200-baud modulator and asynchronous transmitter.

The device includes a tape interface circuit suitable for the recording of character codes of pages of text on an audio cassette recorder as well as an IBUS receiver and receiver/transmitter on separate ports enabling the software recoding of IBUS transmissions.

In addition, there are two general input/output ports, which may be used as an interface to a nonvolatile memory that can store telephone numbers for automated dialing and user passwords. The second port could be used for display control.

The SAA 5070 has been partitioned for flexibility of use. For example, an external modem can be used in conjunction with the internal asynchronous receiver and transmitter, or the internal modem can be used independently of the internal receiver and transmitter.

RTC-La Radiotechnique Compélec, 130 ave. Ledru-Rollin, 75540 Paris, France. [388]

## GaAs Schottky diodes



Among its wide range of semiconductors and passive devices, the Microwave Components Division of THOMSON-CSF offers a series of GaAs Schottky diodes for mixer applications. They feature a very high cut-off frequency and a low noise figure. Organometallic epitaxy and passivation with silicon dioxide are used to produce these components.

THOMSON-CSF  
Division Composants Microonde  
101, Bd Murat - 75781 PARIS CEDEX 16 - FRANCE

## Multilayer hybrid circuits with copper conductors

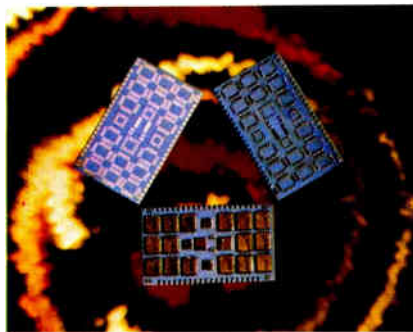

Now in mass-production, a new line of circuits featuring:

- increased propagation speed, reduced impedance and coupling capacity.
- higher reliability through the suppression of intermetallic components (gold - tin) in the tin-process silk screening
- repairability of circuits including a large number of LSI in chip carrier.
- lower cost as compared with circuits using gold or gold-platinum conductors.

THOMSON-CSF  
Département Circuits Hybrides  
Domaine de Corbeville - B.P. 10 -  
92401 ORSAY - FRANCE

## NEWS

### Manual magnetic Card reader



Designed to read track ISO 2 ABA according to the ISO 3554 standard.

- Advantages:
- reduced size
  - only one voltage supply
  - low power consumption
  - wide speed range
  - reliability
  - low cost

- Applications:
- access controls
  - parking
  - security systems
  - flexi-timekeeping
  - personnel identification
  - banks
  - sales tills

- Other products:- Ferrinox<sup>®</sup> soft ferrite parts
- digital magnetic heads
  - magnetic viewer devices

LCC  
Magnetic Products Department  
36, Av. Galliéni - Tour Galliéni 2  
93170 BAGNOLET - FRANCE

 **THOMSON-CSF**  
COMPONENTS

## Minicad

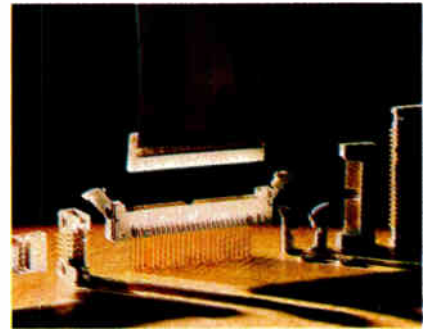

Insulation connectors for flat cables: 10, 20, 26, 34, 40, 50 connections in less than 30 seconds.

SOCAPEX's wide range of connectors - coaxial, round, for printed circuits, optical fibers - meets most requirements in all fields of Professional and Industrial Electronics, Aeronautics and Telecommunications.

SOCAPEX  
10 bis, quai Léon Blum - B.P. 32  
92151 SURESNES - FRANCE

## TCXO Temperature compensated crystal oscillators

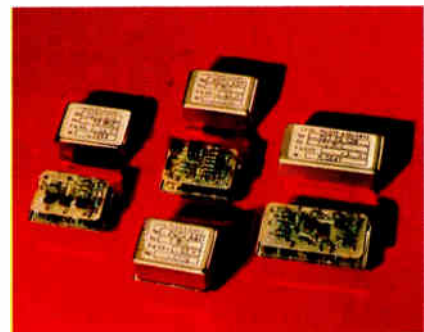

A temperature compensated frequency source consists of a crystal-controlled oscillator whose frequency shift, in a given temperature range, is compensated by means of a thermosensitive network adapted to each oscillator. The frequency stability obtained lies in the range  $10^{-6}$  -  $10^{-7}$ .

The main advantages of these oscillators are: ● small size ● low power consumption ● instantaneous starting.

Frequency range: 4 - 170 MHz  
Temperature range: the frequency shift of the oscillator may be compensated in the range -55°C to +105°C

CEPE  
101, rue du Président-Roosevelt - B.P. 74  
78501 SARTROUVILLE CEDEX - FRANCE

# 5218 oscilloscope 200 MHz - 3 traces - 1 ns/div

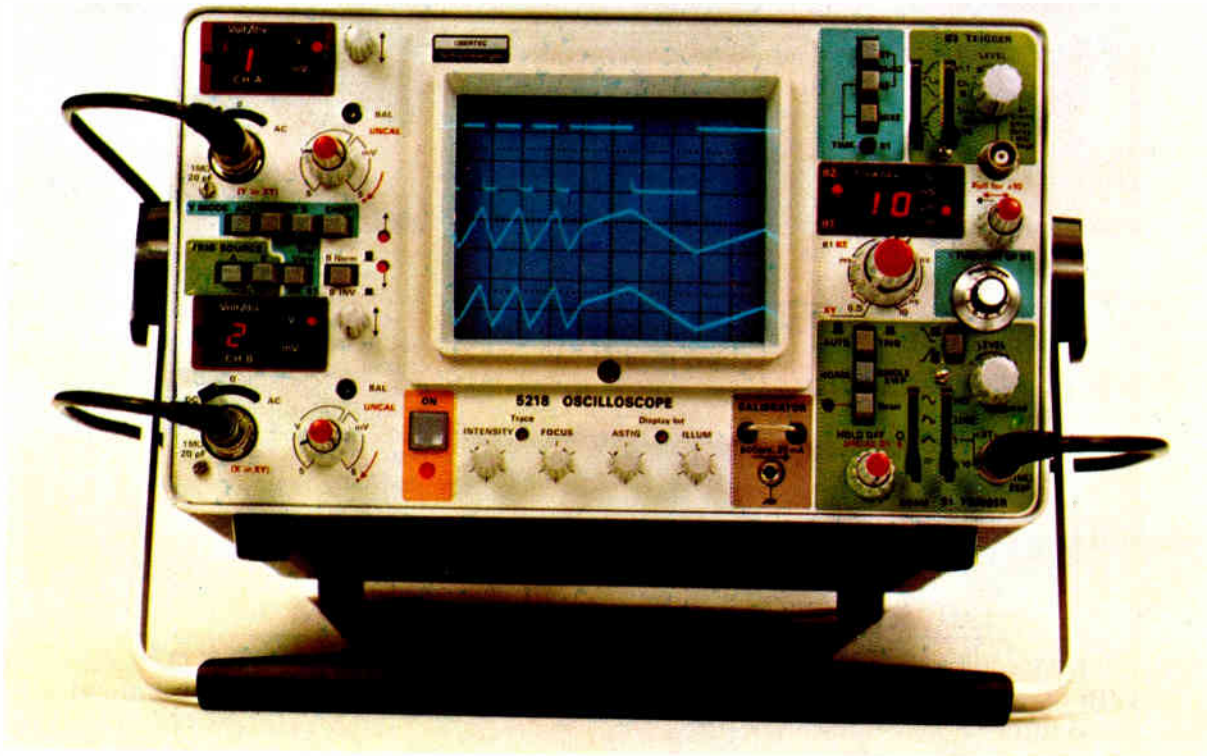

## digital readout of sensitivities and sweep rates

### Wide application

The 5218 enables to display simultaneously 3 traces : channel A and B signals and external trigger signal.  
General purpose oscilloscope well suited to complex measurement problems in a wide range of applications.

### Convenience and ease of use

It has several features which enable it to be used without risk of error :

- digital display of true vertical amplifier deflection factors (with or without probe) and horizontal sweep rates
- liberal use of pilot lamps, for : time base triggered

single sweep in use (flashing lamp)  
verniers uncalibrated  
spot off-screen.

### Optional

Add-on multimeter for direct readout of current, voltage, resistance, frequency and time.



ENERTEC  
DÉPARTEMENT INSTRUMENTS  
5, RUE DAGUERRE 42030 ST ETIENNE CEDEX FRANCE  
TÉL (77) 25 22 64 TELEX ENIST A 330696 F



## Portable scanner reads handwritten letters and figures

by Douglas Glucroft, McGraw-Hill World News

Three specialized chips and a microprocessor create a unit that could sell for a tenth the usual price

A startlingly low-cost optical-character-recognition system intended for use in a hand-sized scanner can recognize a full range of letters and numbers, sometimes even when handwritten. Developed in Belgium, it should reach the industrial prototype stage within a couple of months and could sell for only \$2,000 or so once production reaches 10,000 a year, possibly by 1983.

According to the future manufacturer, SAIT Electronics SA of Brussels, the large-scale integration of much of the circuitry, together with the use of a standard microprocessor and only one printed-circuit board, is responsible for the expected low price of the Readicon One system, as it will be called. Scanners having comparable abilities currently sell for upwards of \$20,000.

The portable scanner will read about 100 characters per second, detecting upper and lower cases and spaces between words. It will be equipped with a reading wand, its single most expensive element, plus a 16-character video display and a cassette for data storage. The result of four years of research conducted jointly by SAIT and the Université Catholique de Louvain, Louvain-la-Neuve, Belgium, the scanner was discussed today in Paris at the International Conference on New Trends in Integrated Circuits by the university's director of microelectronics,

Paul Jespers, and SAIT engineer Christian Jusseret.

According to Jespers, the scanner could be used in hospitals or warehouses or "anywhere you have labels." But though it can read more than, say, bank checks or postal codes, he says it still imposes some conditions on its users. For example, the characters would have to be written without breaks—an O would have to be closed—and each letter must be separate from the other. And, as Jusseret explained, certain kinds of ink or paper might render the letters unreadable by the unit.

The system uses three large-scale integrated circuits besides a microprocessor: a photosensing chip, a preprocessing chip that refines the photosensor's images, and a detection circuit that converts each refined image into a unique series of vectors for classification as a specific letter or number by the processor.

The photosensing chip is an array of 64 by 24 photodiodes. The signals

it senses are fed to an equal number of binary decision circuits, which read them as either black or white. Then the preprocessing chip cleans up any poorly defined images by eliminating random dots and filling in white spaces surrounded by black areas. The results resemble the stylized characters printed on bank checks for scanner identification.

Unusual. But the system's most distinctive feature is to be found on the detection chip. Some other optical scanners simply match images with patterns in their processor's memory. However, increasing the repertoire of recognizable images by increasing the number of patterns in the memory slows a system down. So the Belgian engineers chose to develop what they call a features extraction method, which analyzes each letter topologically.

The software developed for this purpose reads not only OCR-B, the optical-character-recognition type style most popular in Europe, but

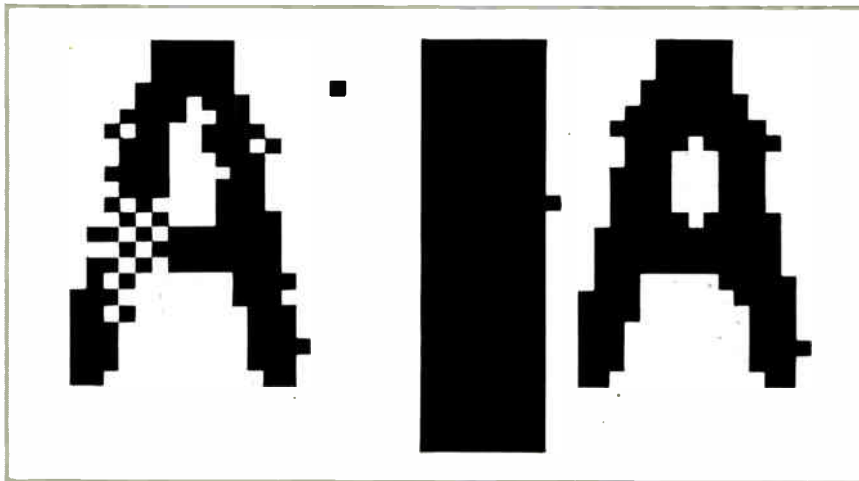

**Four steps.** The image (left) from the OCR scanner's photosensing chip is cleaned up (right) by the preprocessing chip for analysis by the third chip and classification by the processor.

also similar type. A reference table for variant image configurations in the third chip allows some deviation from OCR-B and could additionally be adapted to special needs.

The software first detects the edges of the images. In this search mode, a detection window finds the letter's edge and then traces counterclockwise along its edge. Next, the image is skeletonized through a peeling process that systematically removes dots, thinning an image's lines and eventually reducing it to a series of microvectors. The software then consolidates sets of consecutive microvectors into macrovectors.

Finally the microprocessor attempts to classify the macrovectors. If it succeeds, its output will be an image on the display screen; otherwise, it will reject the vectors as unrecognizable because it has found no such configuration in the lookup table. This lookup table, says Jusseret, may in the future give the Readican One even more versatility, for it could be programmed to recognize entirely different fonts.

On the prototype SAIT is completing, a Motorola 68B00 microprocessor is being used, and the longest time necessary to execute a program is 8 milliseconds.

not big business by our standards yet." Indeed, one of the first adapter makers in the market, Pye Labgear Ltd., is disenchanted with the lack of early growth and is pulling out.

Peter Bacon, Mullard Ltd.'s marketing manager for consumer integrated circuits, reckons the viewdata market is something like one to two years behind the teletext market. If so, the long-term prospects are encouraging; Mullard—widely recognized as the dominant supplier of teletext decoders—took two years to sell its first 2 million decoders worldwide but will sell its next million within six months.

### Great Britain

## LSI to cut the price of adapters that turn ordinary TV sets into Prestel terminals

Thanks to a new generation of chip sets, adapters that plug into the telephone line and the TV antenna socket and so turn a television set into a Prestel terminal are about to slash the entry price for viewdata usage. In contrast to around \$1,600 for a full-feature TV set with a built-in teletext and viewdata decoder, they cost \$400 apiece.

The hope is that the lower viewdata entry ticket will help to stimulate the market. At least four comparatively unknown UK companies—Radofin Ltd., Tangerine Ltd., Oracle Ltd., and Ayr Viewdata

Ltd.—are counting on it and have jumped on the viewdata bandwagon with low-cost adapters.

But it is by no means clear how far or how fast the bandwagon will roll. Official estimates from Britain's National Economic Development Office put UK sales for 1981 at 40,000 business and 6,000 residential Prestel decoders, compared with an installed base of around 8,000 today. Ken Scott, a director of London-based Radofin Ltd., believes the figure is realistic and is talking about a 30% to 40% share with his \$433 adapter. Ayr Viewdata Ltd.'s managing director, Harry Thomas, sees big opportunities overseas and is readying both Scandinavian and U.S. versions of his \$360 adapter. He boasts that production at his Ayr, Scotland, company could reach \$8.5 million by next March.

**Reservations.** But one big chip manufacturer cautions, "The adapter manufacturers have no idea how many they are going to sell. The viewdata market is definitely showing signs of moving, but it's certainly

**The suppliers.** The viewdata module, though, is relatively more complex and hence more expensive. Heading the field in the supply of these chips sets to the adapter manufacturers are Mullard and General Instrument Microelectronics Ltd., though Texas Instruments Ltd. and Marconi Electronic Devices Ltd. (formerly GEC Semiconductors Ltd.) are also in the market. The two contenders adopted somewhat different strategies in reducing their viewdata chip sets.

The starting point for Mullard's fourth generation of viewdata modules is its teletext decoder board, used to receive broadcast text information services and now in volume production. To equip this module for viewdata as well as teletext, Mullard adds an Intel 8049 microprocessor controller, together with a new large-scale IC called Lucy (a corruption of line-coupling-unit asynchronous receiver-transmitter) that interfaces the module with the external world [*Electronics*, May 22, 1980, p. 64]. The previous, third-generation system needed upwards of 16 standard ICs to perform the functions now integrated into a single Lucy chip of some 12,000-transistor complexity (see photo).

But Lucy, produced at Mullard's Southampton plant, contains features over and above those called for in the viewdata specifications. A standard viewdata terminal receives frames of data down the line at 1,200 bits per second in response to keyed commands transmitted at up

**Lucy.** Mullard's viewdata chip set hinges on a chip called Lucy that includes a telephone autodialer, a modem, a UART, and an interface to a memory that identifies the terminal.

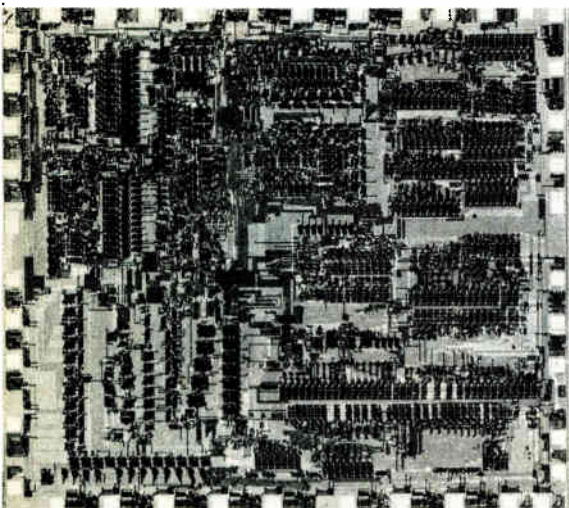

# Data Instruments Pressure Transducers



## You Can Rely On.

High reliability pressure transducers from Data Instruments are making work smoother for industrial, construction, and farm vehicles. As vital systems — hydraulics, oil pressure, and manifold air — are pounded, stressed, vibrated, and contaminated, our rugged pressure transducers guard reliability. The unique stainless steel case-diaphragm protects the transducer from hostile environments.

Rugged enough to be the best in the worst situations — this is the pressure transducer for your demanding application.

We've been working under pressure for more than twenty years providing transducers you can install and forget. Remember Data Instruments for the "forgettable" pressure transducers... the rugged ones you can rely on.

If you have a demanding application, call us for the solution at 617-861-7450.

**WE WORK BEST UNDER PRESSURE**

 **DATA INSTRUMENTS INC.**  
4 Hartwell Place, Lexington, Mass. 02173  
617-861-7450 TWX 710-326-0672

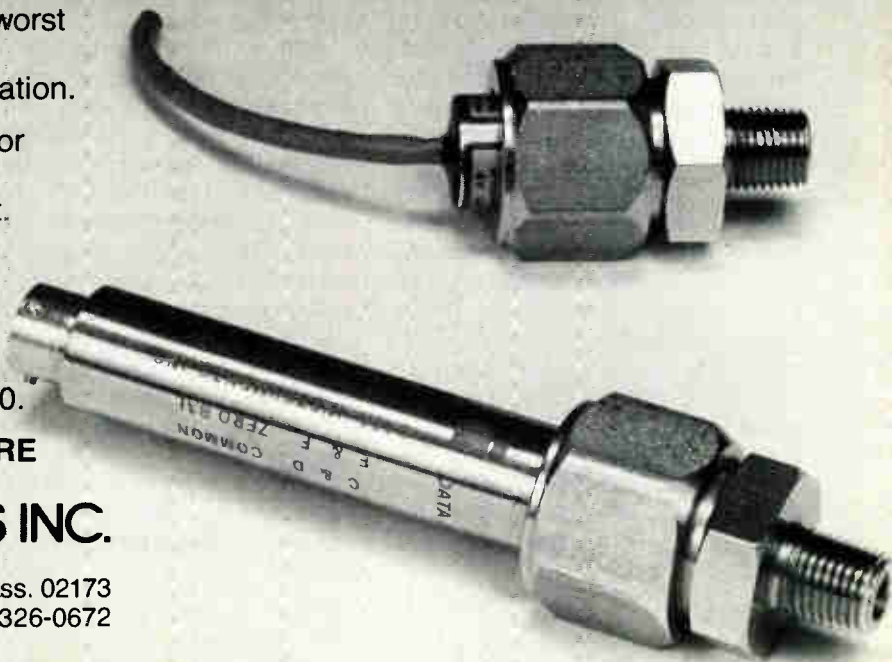

to 75 b/s: Lucy both transmits and receives at 1,200 b/s. The facility can be used both to transmit messages between local Prestel terminals and to dump data into a local store.

A plus. General Instrument, in contrast, was a late entrant into the teletext and viewdata market and so had the advantage of starting with a clean slate. It has basically three chips, all made at its plant in Glenrothes, Scotland: its own PIC 1650 8-bit microcomputer, a video generator chip, and a data-acquisition chip. A standard universal asynchronous receiver-transmitter is also needed, as are two 4-K static random-access memories for page storage. Many of the functions handled in hardware on the Mullard chip set become software routines in GI's module—a technique that cuts chip counts to the bone but, according to critics, leaves little spare microcomputer capacity. Consequently, it is probably the most highly integrated version available—a factor in its selection for use with Plessey's viewdata telephone [*Electronics*, Dec. 4, 1980, p. 84].

-Kevin Smith

### France

## Pilot office net uses message switching

Nearly halfway into their ambitious five-year Kayak office-automation pilot project, researchers at the French National Institute for Data Processing and Automation see a good chance that the architecture, software, and hardware they have worked out will start turning up in commercial systems around 1985. They already have installed a pilot system operating at the institute's headquarters. More important, they have begun showing the system design, local network, and a prototype work station to potential users and equipment manufacturers to speed the passage from the laboratory to the marketplace.

"We chose electronic messaging as the heart of our architecture," explains Najah Naffah, director of

the project. "All automation services—electronic mail, filing, database access, whatever—are treated as messages." In other words, the system relays all information in a standard format.

Naffah and his co-workers at the Institut National de Recherche en Informatique et Automatique (INRIA), located in the Paris suburb of Le Chesnay, divide his message system into four functional modules: one for system control, one to get messages in, one to store and route them, and one to get them out.

To implement this architecture, INRIA prescribes what it calls a user agent, which formats outgoing messages and receives incoming ones. To fulfill the storage and routing functions, a name service finds the address and an address service sends the data on its way. A user agent can be integrated within a single piece of equipment—a terminal or mainframe, for example—or shared by several elements in the system; name and message services may be either centralized within a single processor or distributed among several.

In their pilot setup, a mainframe (a DPS-68 from CII-Honeywell Bull with a Multics program) provides both name and message services to the user agents integrated into half a dozen office automation terminals, or *buroviseurs*, developed specifically for the project. All communication is handled by the local network, Danube, which was also developed as part of Kayak.

**Ethernet-like.** Danube uses a single coaxial cable as a serial bus, much like Xerox Corp.'s Ethernet, and can handle 1 megabit per second. The *buroviseur* contains two modules to interface with the network. An adapter board handles the mechanism implementing a carrier-sense multiple-access system with collision detection (CSMA-CD). It also formats and unformats messages for the standard High-level Data Link Control (HDLC) protocol. A network coupler handles higher-level protocols.

The INRIA team is working with two such couplers. One is built around a Zilog Z80 microprocessor

and converts inputs and outputs into the form standardized under the CCITT V. 24 document. The second employs an Intel 8088 microprocessor and creates a direct interface between the Danube network and Intel's version of the IEEE-696 S-100 bus, which is used within the *buroviseur* work station.

This station gives users access to all of the system's office automation services. But as the first prototypes became available only at the beginning of this year, the INRIA team has so far used them only for a relatively simple in-house electronic mail application. Plans are to link the in-house *buroviseurs* with terminals at two other French research centers via Transpac, the French public packet-switching network.

**Shades of gray.** Because they feel no terminal can gain wide acceptance if its cost exceeds \$2,000 or so, the INRIA researchers chose a high-resolution black and white cathode-ray tube rather than a color CRT for the *buroviseur*. Intel's iSBC 86/12 single-board computer is the central processing unit.

In order to facilitate graphic design as well as cursor movement, the *buroviseur* is equipped with a two-dimensional sensing device, called the Mouse and developed at the Ecole Polytechnique in Lausanne in Switzerland. The device has a steel ball inserted in its underside. As it is moved across a flat surface, a pair of photosensors register impulses from the ball along the X and Y axes.

-Kenneth Dreyfack

### Japan

## Robot moves by micrometers

A robot recently developed by Nippon Electric Co. for in-house use handles objects with such precision that it could herald far greater automation of electronic components assembly. Described in detail for the first time in late March, the ARMS-D (for advanced robot manufacturing system—developmental) operates at

# "Designing our own LSI circuits makes a lot of sense. But finding a flexible manufacturer is driving us crazy."



Unlike most other MOS companies, AMI has the flexibility to work the way that's best for you — and your circuit design.

For starters, we can offer you 14 variations of the three major process technologies: the very mature P-channel, state-of-the-art N-channel and CMOS. So when the time comes for you to choose a process, we don't have to play favorites. Instead, we can help make sure you get the one that best fits your application.

Our flexibility also makes it easy for you to interface with us. We'll take on your job at any stage of development and we can work from pattern generator tapes, data base tapes or working plates. If you want, you can develop your own test vectors or complete test programs. Or we'll do it for you.

And we'll give you components at any stage of manufacturing: wafers, dies, untested assemblies or completely tested units.

What's more, our own in-house capability is large and diverse enough to handle all phases of your job without subcontracting.

## WE'RE JUST THE RIGHT SIZE.

AMI is big enough to provide everything you require. But you'll find us small enough to be responsive to your special needs. In fact, we have the industry's only group organized exclusively to handle customer designed projects. One of these highly trained specialists will be directly accountable to you for the quality of the service you receive in development and production. And for making sure all your circuits — no matter how many or what kind — go through quickly and efficiently.

Which means if you have questions, you know exactly who to go to for quick answers.

## WE'VE GOT THE EXPERIENCE.

AMI has been manufacturing customer designed circuits since 1974, with over 750 jobs under our belt. That's more than anybody else in the business.

And these circuits will continue to be a big part of what we do in the future. Because, unlike most other manufacturers, we are fully committed to manufacturing LSI circuits for companies that design their own.

There are lots of other reasons to choose AMI as your semiconductor expert. If you'd like to hear them, send in the coupon and one of our product marketing engineers will get in touch with you right away.

It's the easiest way for you to find out just how flexible a MOS manufacturer can be.

Name \_\_\_\_\_ Title \_\_\_\_\_

Company \_\_\_\_\_ Mailstop \_\_\_\_\_

Address \_\_\_\_\_

City \_\_\_\_\_ State \_\_\_\_\_ Zip \_\_\_\_\_

Phone (\_\_\_\_) \_\_\_\_\_ Ext. \_\_\_\_\_

Send to: American Microsystems, Inc.,  
Customer Tooling Marketing,  
3800 Homestead Road,  
EL-4 Santa Clara, CA 95051.

**AMI**  
AMERICAN MICROSYSTEMS, INC.

MINIATURE AND LIGHTWEIGHT  
**MICROFAN**  
**MF-406**

**0.36W**

**1<sup>3</sup>/<sub>4</sub> OZ** (50grams)

**1<sup>5</sup>/<sub>8</sub>" × 1<sup>3</sup>/<sub>8</sub>"** (41mm × 35mm)

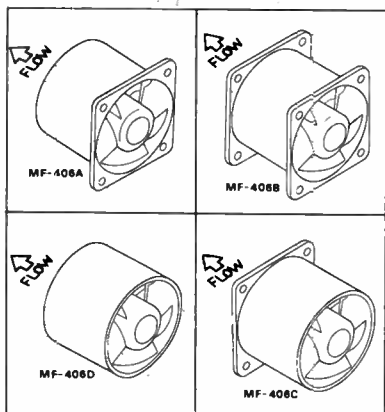
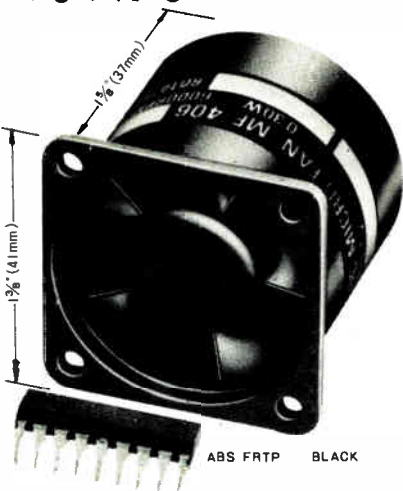

**PERFORMANCE CURVE**

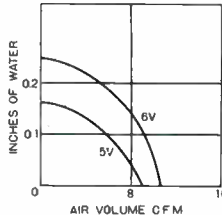

**FEATURES:**

Employing low-noise, precision coreless motor, it blows strongly but calmly nevertheless it costs inexpensively.

**RATINGS:**

DC5V-6V/80mA/6,000rpm/15°-120°/0.36W/  
 8.5C.F.M./1.7" Aq(4mm Aq)/1.8oz(50grams)

**WHERE TO USE**

Applicable to local cooling and ventilation for communication equipment, auto-control device, power supply, computer, broadcasting equipment, measuring equipment, portable electric equipment and industrial equipment.



**NIPPON BLOWER**

**NIPPON BLOWER CO., LTD.**

3-5-13 Soto-Kanda, Chiyoda-ku, Tokyo 101 Japan  
 Phone: (03)251-3511

Tokyo Japan

**Electronics International**

micrometer-level tolerances. NEC has been using more than a dozen since last year and plans to start marketing the unit in about two years as its first commercial robot.

The ARMS-D gets its silent and almost vibrationless motion from two moving-coil linear motors that use magnetic force to drive its two or three arms. NEC claims this is the first use of linear motors in industrial robots. They move the arms at up to 450 millimeters a second along two horizontal, mutually perpendicular axes, 700 and 270 mm long. The movement up and down along the rotating 200-mm-long vertical axis is powered by a pulse stepping motor at rates of up to 250 mm/s.

Each of the robot's hands can grasp and move up to 2 kilograms. High-resolution optical and pressure sensors on each hand relay information about its position to a controller based on an NEC8085 microcomputer. It then directs placement precisely to within  $\pm 4 \mu\text{m}$  ( $\pm 0.16 \text{ mil}$ ), as against the  $\pm 25$  to  $\pm 50 \mu\text{m}$  ( $\pm 1$  to  $\pm 2 \text{ mils}$ ) of the highest-precision robots available today [*Electronics*, Oct. 25, 1979, p. 86]. NEC engineers say they could also equip the ARMS-D with pattern recognition.

**Variety.** With this new breed of robot, the company hopes it will become more economical to produce small quantities of many kinds of products. It also looks for advantages robots have given other industries, such as better product uniformity, easier adjustment to design changes, and manpower reduction.

"It can halve the work force," claims Shigeru Katayama, general manager of NEC's production automation development laboratory. At subsidiary Nippon Electric Tohoku Ltd. in Iwate prefecture, 10 ARMS-D-equipped parts-packaging machines are doing the work of about 30 workers in two shifts. The machines automatically cap switches and seal them with a laser welder. In another plant NEC is using the robot to place such parts as transistors and diodes on hybrid integrated circuits. Katayama says the process requires only a fifth as many workers as conventional machines would need.

NEC is also using the ARMS-D to inspect and select parts. One arm pulls stainless steel strips one at a time from a magazine and places them on an inspection pad for automatic measurement. The other arm picks up the inspected strips, placing good parts in one receptacle and rejected ones in another. "Two simultaneously moving arms shorten the operating time," Katayama explains. Although all of the robots now have two arms, Katayama insists that adding a third is easy.

**More jobs.** By the time it has introduced at least 200 of the robots into its own factories three years from now, NEC plans many other jobs for them. These include assembly of printed-circuit boards and terminals and wire bonding. Katayama says the robot is better for wire bonding than conventional machines because it can be doing other tasks at the same time.

With commercialization still two years away, no price has been set yet for the ARMS-D. As of now, Katayama indicates that it costs more than the best robots on the market, partly because of the low production volume.

-Robert Neff,

McGraw-Hill World News

**Amorphous silicon  
 aids heat pipe**

Amorphous silicon is in the news again—this time in the form of solar cells mounted on the heat-collecting fin of a heat pipe housed in an evacuated glass cylinder. The unit both heats a working fluid that raises the temperature of the water in an external heat exchanger and produces the electricity needed to pump it to its point of use. Yet the device occupies the same space as a conventional heat pipe—one without solar cells on its fin—and costs only 50% more to make, according to its developers at Sanyo Electric Co.'s central research laboratory.

Being tightly coupled thermally to the copper pipe, the solar cells normally operate at 90°C or above. Yet their efficiency falls only to 3.75% at

If you're looking for a sweeper in the 2.5 GHz range, the obvious choices are Wavetek's Model 2002A and HP's 8620C mainframe with an 86222B plug-in. But just look at the chart: the Model 2002A is a lot more instrument for about half the price. The only way your choice could be more clear would be if the HP instrument didn't exist. But then what could we compare our Model 2002A against? Wavetek Indiana, Inc., P.O. Box 190, 5808 Churchman, Beech Grove, IN 46107. Toll-free 800-428-4424; in Indiana, (317) 787-3332. TWX (810) 341-3226.

	Wavetek Model 2002A including Harmonic Markers	HP 8620C Mainframe with 86222B plug-in
Price	\$4600	Plug-in + Mainframe - Total \$5750 + \$2850 = \$8600
Convenience	Single, stand-alone unit	Two detachable units, mainframe & RF plug-in
Frequency Range	1 MHz to 2.5 GHz	10 MHz to 2.4 GHz
Non-harmonics at 13 dBm	None detectable (0.5 to 2.5 GHz) >35 dBc (1 to 500 MHz)	> 30 dBc (0.01 to 2.3 GHz) > 25 dBc (2.3 to 2.4 GHz)
Calibrated Output Level Meter	Standard	Not available
Step Attenuator	Standard	Optional at \$400
Harmonic Markers	1, 10, 50 and 100 MHz (plus single frequency markers)	1, 10 and 50 MHz
Marker Range	1 MHz to 2.5 GHz	10 and 50 MHz markers to 2.4 GHz 1 MHz marker to 1.0 GHz
Marker Width	Adjustable from 15 kHz to 400 kHz	Fixed, Minimum width is 150 kHz
Marker Size	Adjustable	Fixed

Circle #87 for literature  
Circle #239 for demonstration

**WAVETEK®**

**Compare  
our 2.5 GHz sweeper  
with its closest  
competitor.**



(The competition costs more  
and does less;  
we think that puts it  
out of the picture.)

# Our new, slower, cheaper array processor.

Our new MSP-3X is only about half as fast as our MSP-3. But at \$4950 its price is also less than half that of any other array processor on the market.

"Slower," of course, is relative: MSP-3X lets your PDP-11 computer perform arithmetic and signal analyses 20 to 50 times faster than it can alone. A 1024-point real Fast Fourier Transform in 14.3 milliseconds, for example. That's plenty of speed for most analyses of vibration, sonar, communications, radar, medical image, and dozens of other kinds of data.

And you needn't sacrifice convenience, either. Operation is simple and reliable, based on straightforward execution of an extensive library of functions, accessed through Fortran calls. And MSP-3X's two hex boards simply plug into your PDP-11.

All in all, MSP-3X is a most intelligent trade-off. Write us for detailed specifications.

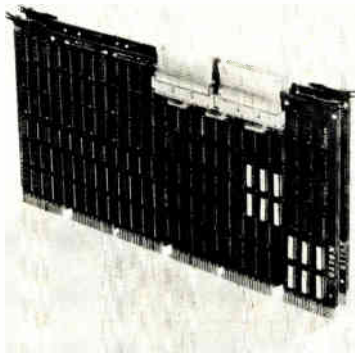

**MSP-3X array processor**

**Computer Design & Applications, Inc.**

377 Elliot Street  
Newton, MA 02164 (617) 964-4320

Circle 88 on reader service card

**Check**

- Transistors
- Capacitors
- Diodes
- IC's

**CONTROLLED HEATING**  
... where it counts  
**THERMO-PROBE**

Heat any integrated circuit or electronic component to its rated temperature with a heat probe. Accuracy  $\pm 3^{\circ}\text{C}$  or better. Or check the component's temperature with a thermo-couple probe. Model 810 Thermo-Probe does both. Reads out directly in  $^{\circ}\text{C}$  and  $^{\circ}\text{F}$  on a large  $4\frac{1}{2}$ -inch meter.

**MTI MICRO-TECHNICAL INDUSTRIES**

23112 "C" Alcalde  
Laguna Hills, Calif. 92653  
(714) 855-4326  
TWX (910) 595-1745

88 Circle 240 on reader service card

**NEED SERVICE  
ON YOUR  
SUBSCRIPTION  
TO ...**

Electronics

*Do you want to change  
your address?  
Have you missed an  
issue?  
Was your copy damaged?*

**CALL  
(609) 448-8110\***

**FOR IMMEDIATE  
HELP**

\*9 a.m.-4 p.m. EST

## Electronics international

that temperature from 5% at  $30^{\circ}\text{C}$ . The company hopes to have a commercial version of the Amorton heat pipe collector, as it is called, available next spring.

**P-i-n principle.** In essence the solar cells are 6,000-angstrom-thick p-i-n diodes that absorb energy selectively at the wavelengths needed to generate electricity while passing most of the remainder on to the heat pipe. Plasma deposition on a stainless steel substrate forms successive layers of phosphorus-doped n-type amorphous silicon about 500 Å thick, undoped amorphous silicon of much greater thickness, and boron-doped p-type amorphous silicon carbide several hundred angstroms thick. A transparent conductive electrode that doubles as an antireflective coating and a current-collection layer of finger-shaped metal complete the devices.

Sanyo researcher Yukinori Kuwano says that amorphous cells need the undoped, intrinsic layer for good efficiency. A depletion layer extends most of the way through the middle, intrinsic layer from the upper, silicon carbide layer, which gives a heterojunction with a band gap of about 1.7 electronvolts. That figure yields both good sensitivity at the short wavelength end of the visible spectrum and good performance at elevated temperatures.

The electrical output of a heat pipe in a glass cylinder 0.08 meter in diameter and 2.5 m long (roughly 3 inches by 8 feet) is about 6.9 watts at  $30^{\circ}\text{C}$  and about 5.2 w at  $90^{\circ}\text{C}$ . In both cases the operating voltage is 0.55 v, but the operating current falls from 12.5 amperes at the lower temperature to 9.5 A at the higher temperature.

According to the manufacturer, only about 10% to 20% of the electrical power is needed to pump the hot water generated by the heat pipe's working fluid, and the 80% to 90% surplus can be used for other applications. Though the new device heats less water than do Sanyo's commercial heat-only pipes, its ability to generate electricity as well will in many cases more than compensate for that defect.

-Charles Cohen

Electronics / April 7, 1981



# Zero in on hardware problems by software analysis.

Now...digital fault finding and analysis in a single compact instrument.

Digital fault finding requires both a logic analyzer and an oscilloscope. But before Philips combined both in a single instrument, designers and service technicians were forced to use two awkward and expensive instruments.

Today all they need is one PM3540. It's unique.

Our logic scope gives you an exact match between the two worlds of state and timing. Faster. And for less money. In addition, since the scope is "time correct" with the analyzer, trigger conditions are in perfect sync.

It's the ideal instrument for introduction into the digital world, because it's so easy to learn.

And old-timers at digital design or troubleshooting will appreciate its versatility, and wonder how they ever got along without it.

For more information contact the Philips organisation in your country or write to:

Philips Industries,  
Test & Measuring Instruments,  
Dept. TQ III-4, 5600 MD Eindhoven,  
The Netherlands.



## From Philips, of course.



Test & Measuring  
Instruments

# PHILIPS

Circle 150 on reader service card

# Eurocard line graduates to 16-bit processing

by Arthur Erikson, Managing Editor, International

68000-based card plugs into EFCIS-backed G-64 bus; system offerings include box with 5 $\frac{1}{4}$ -in. Winchester drive

Gespac SA started out two years ago with a straightforward strategy for success—to put “more on a Eurocard.” The small Geneva-based company has since gone to market with some 40 microcomputer modules based on the 6800 and 6809 8-bit microprocessors of Motorola Inc.’s Semiconductor Group and the Z80 of Zilog Inc. At the early-April

Salon International des Composants Electroniques in Paris, Gespac will reaffirm its strategy with a new family of Eurocards built around Motorola’s 16-bit 68000. “This is the first computer module using the 68000 microprocessor available on a 160-by-100-mm standard board,” maintains Marc Marinello, Gespac’s founder.

Gespac has packed onto the module, called the GESMPU-4, the processor itself and all the required buffers, decoders, clocks, and logic needed to interface it with a bus. With the board, Marinello points out, system designers can take advantage of the powerful instruction set of the 68000 for process control as well as for data-processing applications.

“Because of our standard G-64 bus,” he explains, “the 16-bit processor will work with any of our 8-bit interface cards.” They provide functions like double RS-232-C serial interfaces, double parallel interfaces, printer interfaces, opto-isolated input channels (32 on a card), 16-

channel 12-bit data acquisition, and a quartet of analog output channels.

The new 16-bit family includes a couple of memory modules matched to the speed of the processor. One, the GESMEM-2, can provide up to 32-K bytes of random-access memory and erasable programmable read-only memory. The other, the GESRAM-4, has sockets for up to 128-K bytes of dynamic RAM in 64-K packages. There also is an 8-K-byte monitor to test programs, with the usual debugging commands.

**Prefab.** Marinello is convinced the 68000 cards will catch on solidly as 16-bit processors gain ground in the marketplace. “The Euroboards are a sort of prefabrication for microcomputer systems,” he says. “You can cut design time by as much as half by working with the cards rather than circuit packages.” Equally important, he says, is the development system the company has devised to go with its cards. It is built around Gespac cards, and thus the application can be wrung out directly in the system without any emulation of the processor.

Also, the price is right, Marinello feels. The basic 68000 board, bought singly, sells for roughly 1,500 Swiss francs (about \$800); the RAM-E-PROM card costs some 400 Swiss francs (about \$210) singly.

At the moment, Gespac is turning out some 500 cards—mostly 8-bit versions—monthly and expects to bound up to 1,000 per month by May. These numbers do not truly reflect the market force of Gespac’s cards. The company has a powerful ally in its second source in France, the MOS house of Thomson-CSF. “With EFCIS [Société pour l’Etude

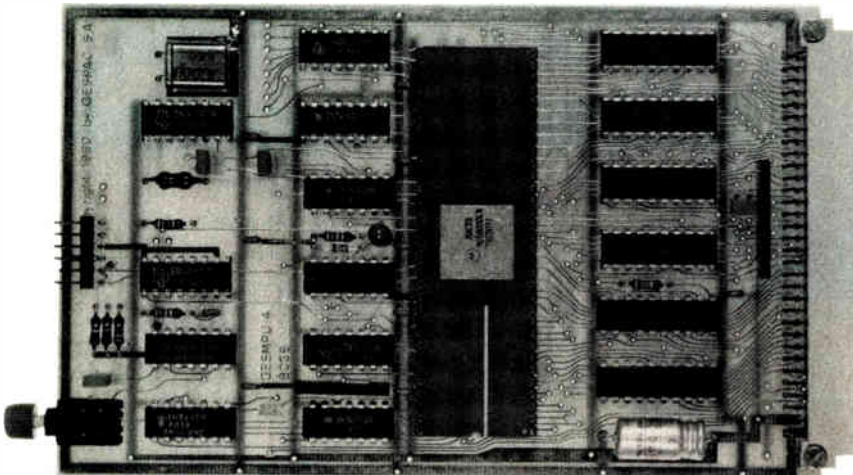
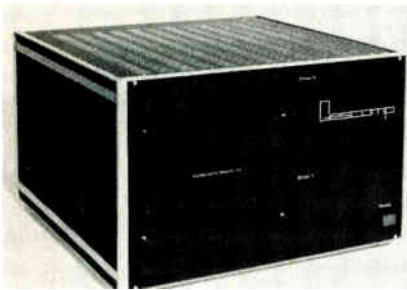

# Test receiver ESH 3

## 10 kHz to 30 MHz

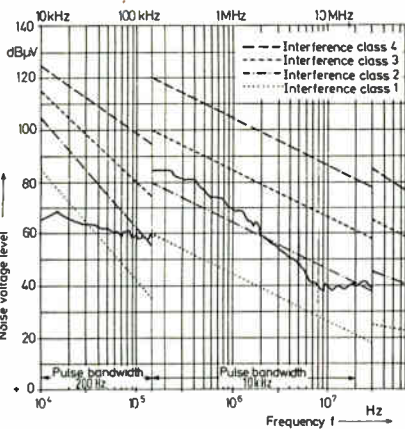
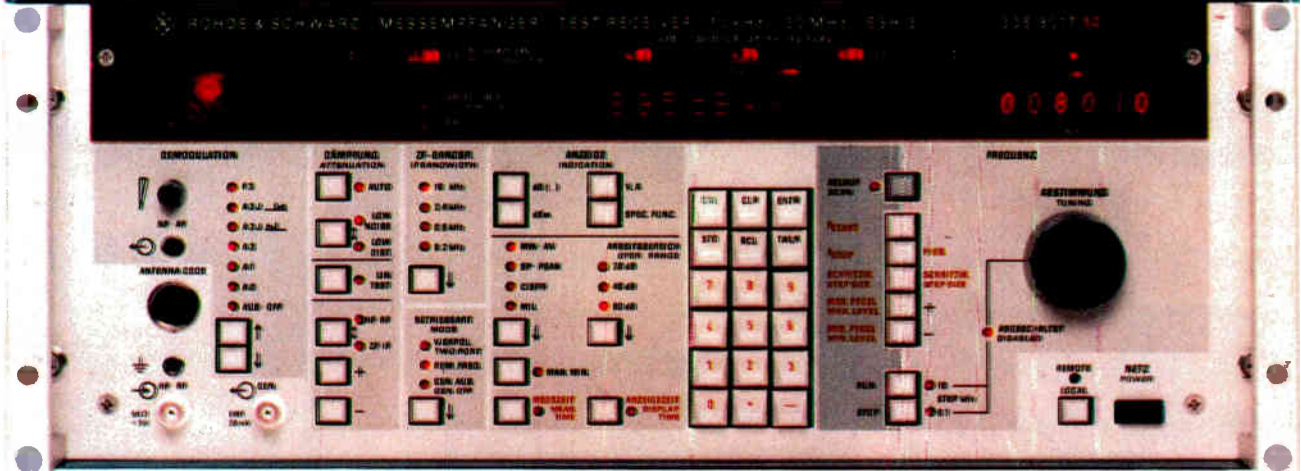
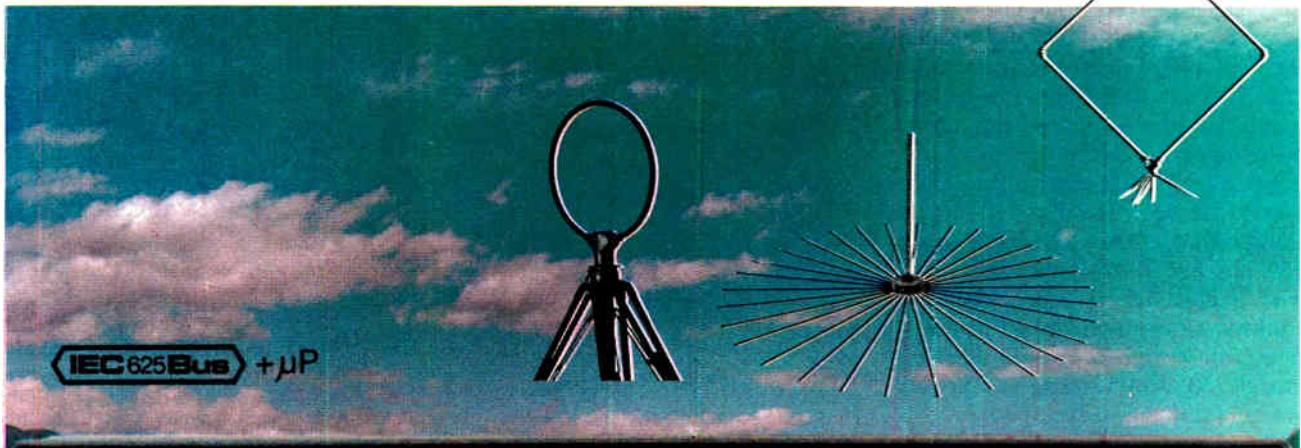

**System-compatible** (IEC/IEEE 488 bus), **precise** and versatile – a true test receiver of the 80s, for wanted signals and interference (CISPR, MIL, VDE, VG).

**The ESH 3 can store** nine complete device settings, **drive** five frequency-band recorders, printers, XYT recorders, **scan** any five frequency bands.

### The ESH 3 can measure

- voltage: dB ( $\mu$ V), dBm,  $\mu$ V to V
- current: dB ( $\mu$ A),  $\mu$ A to A
- broadband noise: dB ( $\mu$ V/MHz), ( $\mu$ V to kV)/MHz, dB ( $\mu$ V/m/MHz), ( $\mu$ V to kV)/m/MHz
- field strength: dB ( $\mu$ V/m to V/m) and extra parameters like
- modulation depth
- FM deviation
- frequency offset

### Precision

Error of level indication: <1 dB  
(for field strength: <2 dB)

### Accessories

Test antennas, probes, artificial mains network

Ask for more information about

**Test receiver ESH 3**

**Accessories ESH 2/3-Z**

Hanover Fair: Hall 12

Salon Paris: Hall 32

NAB Las Vegas: Stand 1110

Measurement of broadband noise (peak value), recorded with ESH 3 and XY recorder

**Rohde & Schwarz GmbH & Co. KG**  
Postfach 80 14 69  
D-8000 München 80  
Federal Republic of Germany

Telex 523 703 (rus d)  
Phone internat. +(4989) 4129-1  
Independent concern  
(established 1933)  
represented in 80 countries



**ROHDE & SCHWARZ**

Electronic measurements · Broadcasting  
Radio communications · Radiomonitoring

## New products international

et la Fabrication de Circuits Intégrés Spéciaux] backing the G-64 bus," Marinello reasons, "it could become the unofficial standard for Europe."

In addition to Euroboards, Gespac builds a range of microcomputers—based on its bread-and-butter products, of course. There will be innovation in these areas as well at the Composants show. The new model 760 has a 5¼-in. Winchester drive with a capacity of 5 megabytes in addition to the 1-megabyte-capacity floppy-disk drive of the existing model 750. Any of Gespac's processor modules can be specified.

Gespac SA, 378 Route de Bernex, CH-1233 Geneva, Switzerland [441]

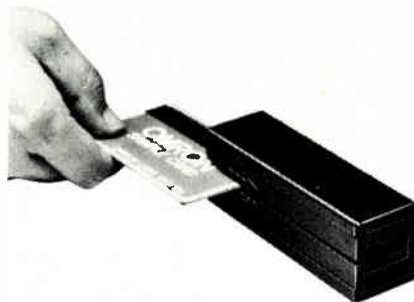

The manual magnetic-card reader has a temperature range of  $-10^{\circ}$  to  $+55^{\circ}\text{C}$  and a card-speed range of 10 to 150 cm/s. It is used for automatic tellers and point-of-sale systems. Omron Europe GmbH (OEG), 2000 Hamburg 76, Hamburger Strasse 11, West Germany [444]

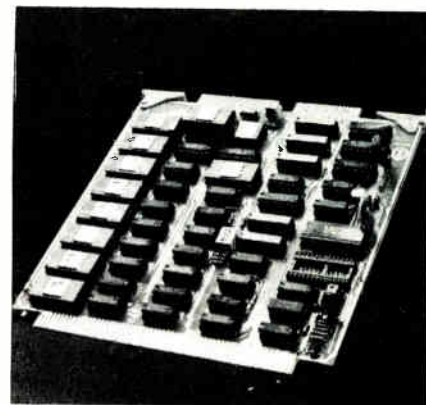

The SCB-MCB speech-synthesis board plugs into a Zilog MCZ bus. Its parallel input/output interface is for digital process-control applications; it also has an RS-232-C port. Multitech International Corp., 977 Min Shen E. Road, Taipei 105, Taiwan, Republic of China [447]



The 14D-10 oscilloscope has a 2-mV sensitivity over its full bandwidth of 10 MHz, is accurate to within  $\pm 3\%$  and operates from 210 to 250 V or 104 to 125 V on 48/60 Hz, ac supplies. Scopex Instruments Ltd., Pixmore Industrial Estate, Pixmore Avenue, Letchworth, Herts. SG6 1JJ, England [442]

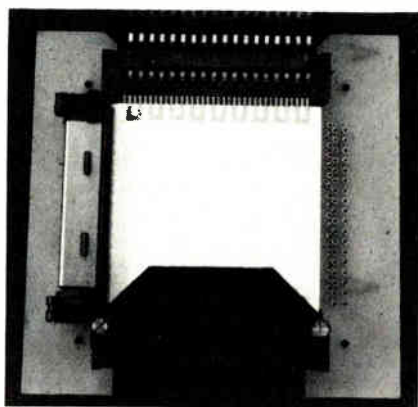

This modular connector is for 1- to 4-in. ceramic substrates at ½-in. pitch. It features a zero insertion force rating and is available with two types of heat sinks. Socapex, a Thomson-CSF subsidiary, 10 Bis Quai Leon Blum, B. P. 32, 92151 Suresnes Cedex, France [445]



The PM 2502 analog multimeter has 32 ranges covering dc voltages from 100 mV to 1,000 V full-scale, ac voltages from 1 to 600 V, dc and ac currents from 100  $\mu\text{A}$  to 10 A, and resistance from  $1\Omega$  to 10 M $\Omega$ . Pye Unicam Ltd., York Street, Cambridge CB1 2PX, England [448]

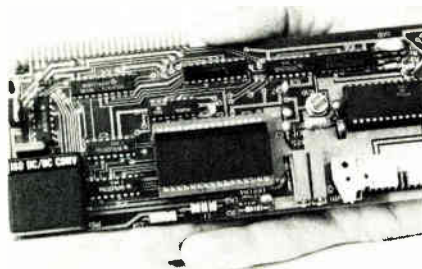

This 16-channel digital input/output card offers a 12-bit resolution over link-selectable input levels up to  $\pm 10\text{V}$ . It features a typical conversion rate of 25  $\mu\text{s}$  and nonlinearity of better than  $\pm 0.025\%$ . MC Computers Ltd., Park Street, Newbury, Berkshire RG13 1EA, England [443]

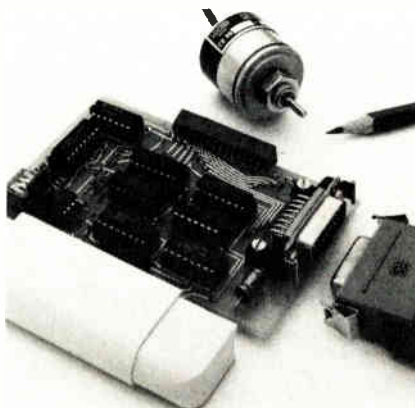

The CO30C Absolute Optical Shaft Encoder is used with a specially designed Pet interface to communicate with mechanical systems in the field of position control and mechanical data logging. Cetriconic Ltd., Hoddesdon Road, Stanstead Abbots, Ware, Herts. SG12 8EJ, England [446]



Model RD28 Programmer-Simulator simulates a single-supply n-channel MOS erasable programmable read-only memory. It features 2-K bytes of static random-access memory, 11 modes of operation, and an access time of 250 ns. Data R. D., 21 rue Florian, 26000 Valence, France [449]

# Testing transceivers in **service** and **production**

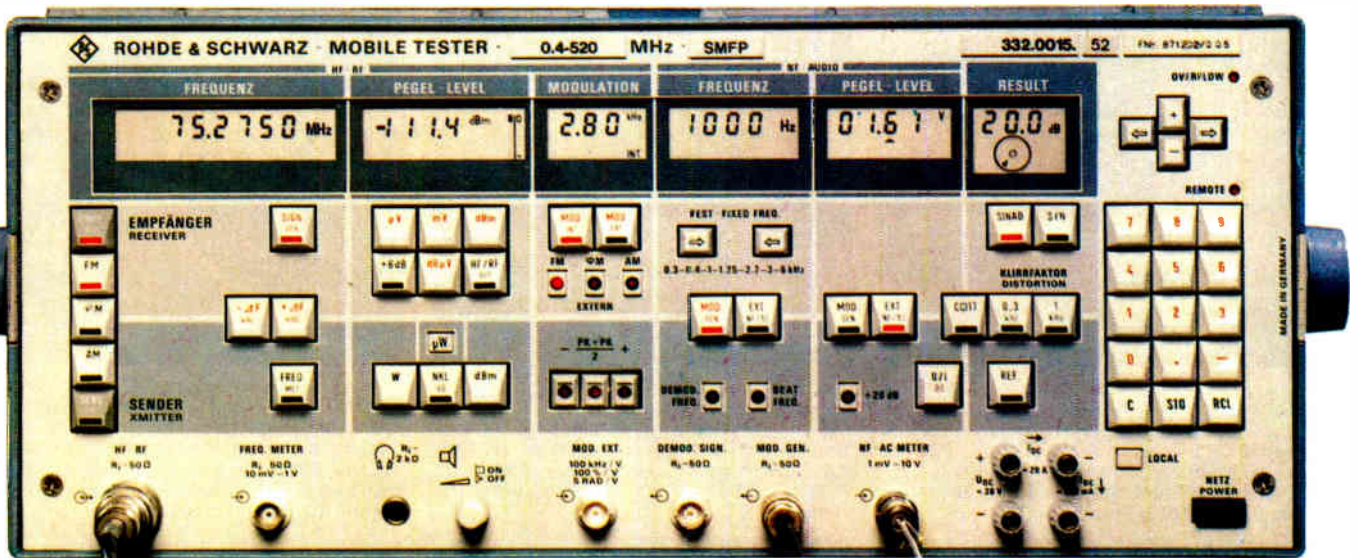

Press the PTT button of the transceiver and that's enough, the SMFS/SMFP does the rest – it automatically measures all the basic parameters in transmit and receive modes and shows the results really clearly.

**SMFS/SMFP – the compact testers for mobile and stationary use, for manual or computer-aided operation.**

**Mobile tester SMFS (left)**  
0.4 to 520 (1000) MHz

- Portable tester for indoor/outdoor servicing, production and lab use
- Simple,  $\mu$ P-aided operation with automatic switching between complete transmit/receive tests: measurement of distortion, S/N, SINAD; search routines (e.g. for sensitivity) at the push of a button
- Much shorter testing times, no more operator errors
- Compact, and can be battery-powered in mobile use
- Options: for adjacent-channel power measurement and extension to 1 GHz

**Mobile tester SMFP (right)**  
same as SMFS, plus:

- All measurements computer-controlled (e.g. with our process controller PPC)
- Easy-as-can-be programming with optimized Basic routines
- Flexible program generation for servicing, production and quality assurance – also with hardcopy printout of test results
- Complete control of the test item with built-in relay switches and TTL control lines

**Ask for the data sheet**  
**Transceiver testers SMFS/SMFP**

Hanover Fair: Hall 12  
Salon Paris: Hall 32  
NAB Las Vegas: Stand 1110

Rohde & Schwarz GmbH & Co. KG  
Postfach 80 14 69  
D-8000 München 80  
Federal Republic of Germany

Telex 523 703 (rus d)  
Phone internat. +(4989) 4129-1  
Independent concern  
(established 1933)  
represented in 80 countries



**ROHDE & SCHWARZ**

Electronic measurements · Broadcasting  
Radio communications and monitoring

Circle 152 on reader service card

## New products international

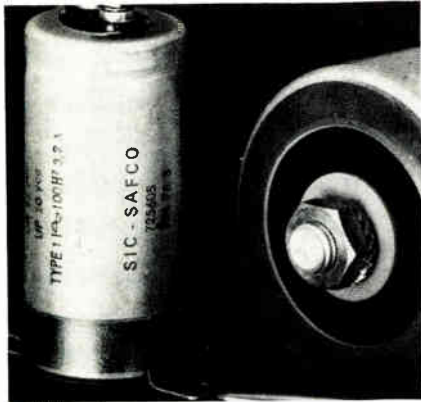

The FELSIC 125 FRS capacitor has a low equivalent series resistance permitting high ripple current at higher frequencies,  $\pm 30\%$  capacitance, and ranges from 220 to 150,000  $\mu\text{F}$  and 16 to 250 V. Cetronic Ltd., Hoddesdon Road, Stanstead Abbots, Ware, Herts. SG 12 8EJ, England [451]

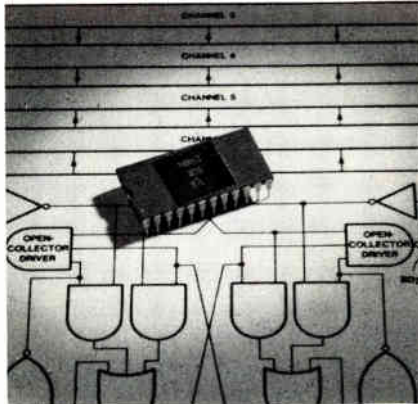

The 8X41 Signetics asynchronous bidirectional bus extender and repeater (Saber) has eight independent data channels. It can transfer data without external logic. NV Philips Gloeilampenfabrieken, Elcoma Division, P. O. Box 523, 5600 AM Eindhoven, The Netherlands [454]

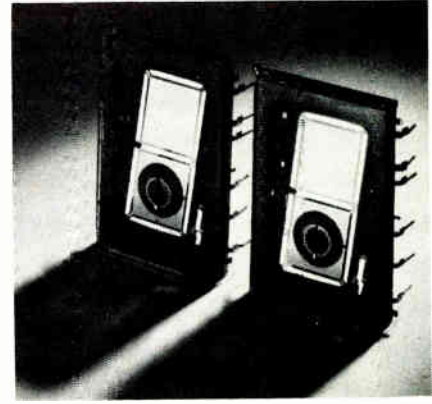

The ZM1560 indicator tube, for pinball machines and numerical-control equipment, has a 1-in.-high character and dual in-line tinned pins for printed-circuit board mounting. NV Philips Gloeilampenfabrieken, Elcoma Division, P. O. Box 523, 5600 AM Eindhoven, The Netherlands [457]



The PIP 85 data-acquisition and -control system, based on a Hewlett-Packard HP-85F microcomputer, combines computing capability with industrial-standard measurement and control facilities. Micro Consultants Ltd., Kenley House, Kenley Lane, Kenley, Surrey CR2 5YR, England [452]

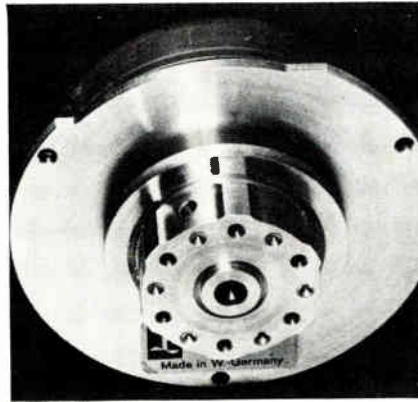

The GAE 53.10 motor, for use in 5.25-in. Winchester hard-disk drives, utilizes Hall-effect technology for excellent speed stability, very fast acceleration, and low component count. Papst-Motoren KG, Postfach 35, D-7742, St. Georgen/Schwarzwald, West Germany [455]

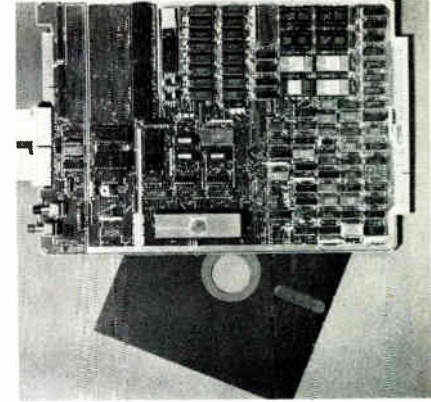

The EMEX 68KDM board aids in the design and evaluation of the EF 68000 processor. It provides two serial RS-232 ports for communication between the module and a terminal or host computer. Thomson-EGCIS MOS Integrated Circuits, B. P. 217-38019, Grenoble, France [458]



The Laporte 36 water-cooled wafer-polishing machine polishes silicon, germanium, gallium arsenide, and other semiconductor wafers. It is for mass production and processes wafers at a high rate. Shibayama Kikai Co., Ishibashi Bldg., 3-4-7 Konan, Minato-ku, Tokyo 108, Japan [453]



The MAX-100 frequency counter has a range of 5 Hz to over 100 MHz and an eight-digit display. It operates from alkaline or rechargeable batteries or from a 7.5- to 10-V dc supply. Continental Specialties Corp., Shire Hill Industrial Estate, Saffron Walden, Essex CB11 3AQ, England [456]

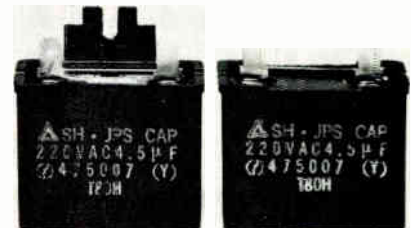

These dry-type metalized capacitors, for lighting ballasts, motor operation, and other ac applications, have a self-protecting ability for safe operation. Maximum rated voltage is 250 V ac and maximum capacitance is 10  $\mu\text{F}$ . Matsushita Industrial Equipment Co., 3-1-1 Inazu-cho, Toyonaka 561, Japan [459]

# Modulation Analyzer FAM

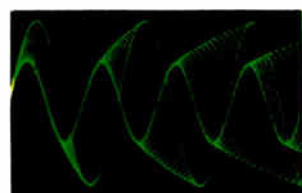

AM + FM

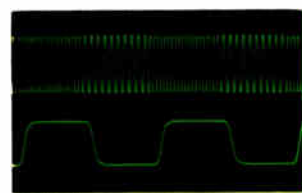

FSK



STEREO

**All-round modulation analysis, manually or automatically, in the carrier-frequency range 55 kHz to 1.36 GHz**

**Special features:**

Residual FM < 1 Hz (CCITT weighted)  
Residual AM < 0.01 % (CCITT weighted)  
– thus superior for spurious-modulation measurements

Excellent amplitude and phase linearity with stereo crosstalk attenuation of > 50 dB, distortion < 0.1 %

IEC-bus interface for use in automatic test systems

Compact design (12 kg) and low power needs

Easy to operate, ergonomic styling

The FAM is five instruments in one:

- modulation meter
- RF counter
- AF counter
- distortion meter
- psophometer

Versatile AF evaluation facilities:

- AF-level measurement
- weighting filters CCIR and CCITT
- distortion measurement

Indication of measured results by:

- three digital displays, one quasi-analog display

Ask for more information  
**Modulation analyzer FAM**

Hanover Fair: Hall 12  
Salon Paris: Hall 32  
NAB Las Vegas: Stand 1110

**Rohde & Schwarz GmbH & Co. KG**  
Postfach 80 14 69  
D-8000 München 80  
Federal Republic of Germany

Telex 523 703 (rus d)  
Phone internat. +(4989) 4129-1  
Independent concern  
(established 1933)  
represented in 80 countries



**ROHDE & SCHWARZ**

Electronic measurements · Broadcasting  
Radio communications and monitoring

**SIEMENS**

# Why don't you assemble pc boards from below as well?



To assemble pc boards exclusively from above is a thing of the past. To assemble from below, too, only depends in fact on the temperature resistance of the components to be used – no problem for Siemens ceramic multilayer capacitors.

If the chip has already been sintered at 1200 °C in the course of manufacture, subsequent flow soldering is the equivalent of taking a warm footbath after a steaming hot shower. Prior to soldering, the components are

fixed to the underside of the pc board using an appropriate adhesive. The advantages of this technology are higher packing density, lower self-inductance, and greater reliability.

These ceramic multilayer capacitors for automatic equipment of pc boards are only one example from our range of types. We produce chips and caps from 1 pF to 4.7  $\mu$ F, in four ceramic materials as taped and magazine-loadable versions for automatic assembly.

For detailed information, please write to us at Siemens AG, Components Group, Infoservice, Postfach 156, D-8510 Fürth, quoting "Ceramic multilayer capacitors".

## Ceramic multilayer capacitors from Siemens

Circle 154 on reader service card



## New products international



The TR 6824 is a hand-held digital multimeter that has a 4½-digit display, and a temperature-measuring function ranging from -50° to +800°C. The instrument offers a 10 µV resolution. Takeda Riken Industry Co., 1-32-1 Asahi-cho, Nerima-ku, Tokyo 176, Japan [460]

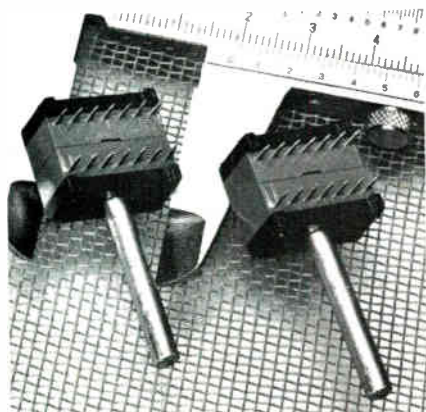

The LP series are fully enclosed rotary switches mountable on printed-circuit boards. They are 10 mm high and 18 mm wide, have 2 to 12 positions, and are sealed against atmospheric contaminants, fluxes, and solvents. Oak Europe, Vulcan Road North, Norwich NR6 6AH, England [461]

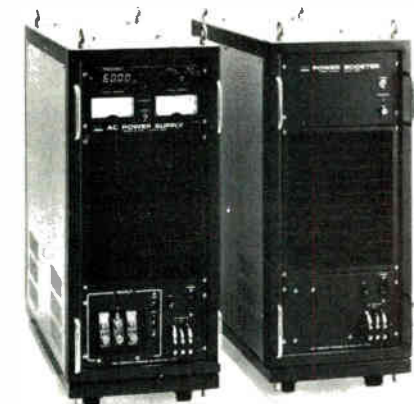

This regulated ac power supply system consists of the master unit EA-2100 and the power booster EA-2010. The system has a maximum output of 10 kVA and 2, 4, 6, 8, and 10 kVA ac power supplies. NF Circuit Design Block Co., 6-3-20 Higashi, Amigima, Kohoku-ku, Yokohama 223, Japan [462]

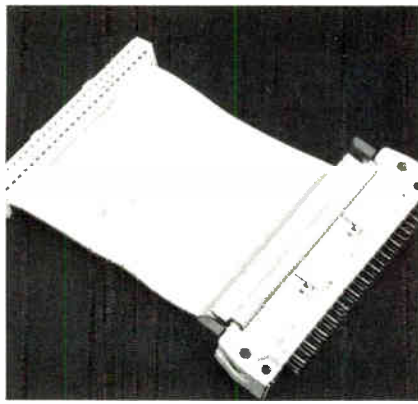

The 8603 connector connects printed-circuit boards to ribbon cables. It has an insulation-displacement female plug for ribbon cable and a male receptacle with straight and angled spalls or wrapped-wire terminations. Souriau, 9-13, rue de Général Gallieni, 92103 Boulogne-Bill./Cedex, France [463]

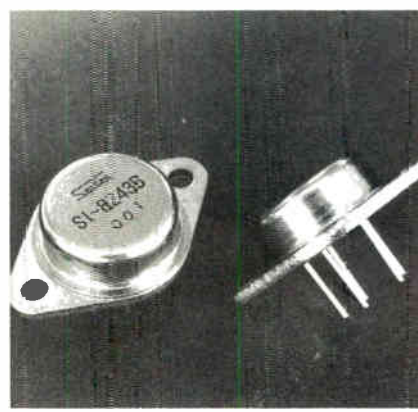

The SI-8000B series of switching regulators, built in TO-3 packages, have an output current of 3 A (1.5 A without a heat sink) and output voltages of 4, 12, 15, or 24 V. A dc input-voltage rating of 55 V is available. Sanken Electric Co., 1-22-8 Nishi Ikebukuro, Toshima-ku, Tokyo 171, Japan [464]

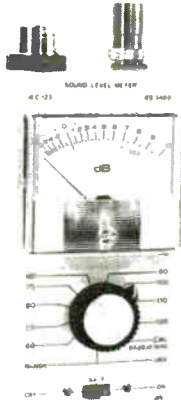

The CRL 2.2 A sound-level meter has a frequency range of 10 Hz to 12.5 kHz. Its microphone is in its acoustic-calibration chain; a 94-dB, 1-kHz signal generated internally ensures correct calibration. Cirrus Research Ltd., 1-2 York Place, Scarborough, North Yorks. YO11 2NP, England [465]

## MINI DIP SWITCH & PC MOUNTABLE SWITCH

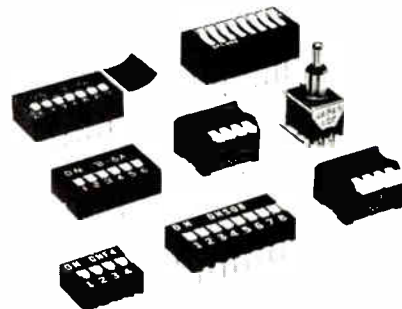

Choice of 2,4,5,6,7,8,9 and 10 poles

Slide: B-2,4,5,6,7,8,9,10A

(Tape sealed is available)

DNS04,06,08-GF

(Tin alloy plated is available)

DNF4,6,8

(Light touch version)

Piano: DNP4,8 DNT4,8 DNP1

Rocker: SPC002,4,5,6,7,8,10

Transfer: NP2,4 B-AX (2,4,6,8,10)

PC mountable switch: UT series

### Representatives

**ALFRED NEYE-ENATECHNIK GMBH**  
2085 Hamburg, Schillerstr. 14, W. Germany Phone: 04106/612-1

**COMESA**  
34, Rue Jacquart-93500 Pantin, France Phone: 844-87-39

**DOTT. ING. GIUSEPPE DE MICO S.P.A.**  
Via Vittoria Veneto, 8, 20060-Cassina De' Pecchi, Milano, Italy  
Phone: (02) 95.20.551

**INOTEC A/S**  
Marielundvej 46 A DK-2730 Herlev, Denmark Phone: (02) 948033

**MEMOTEC AG**  
CH-4932 Lozwill, Switzerland Phone: 063 28 11 22

**NORISWITCH AB**  
Banvagen 17, S-181 62 Ludingö, Sweden Phone: 08-766 54 10

**P. CARO AND ASSOCIATES LTD.**  
2347 Coventry Road, Sheldon, Birmingham B26 3LS,  
United Kingdom Phone: 021-742-1328

**SAEN**  
Apartado 50 San Cugat Del Valles (Barcelona)

Phone: (93) 674 10 12

**TELEREX NEDERLAND B. V.** (Holland Netherland Luxemburg  
Belgium) P.O. Box 180 5680 AD Best, Netherland  
Phone: 04498-4295

**TELEREX N. V.**  
Kouwenbergdreef, 6 2230 Schilde, Belgium Phone: 031/83.33.50.

**CHEMICO TRADING COMPANY**

RM. 1102, New Seoul Bldg., No. 62-7, 2-ka, Chungmu-ro,

Chungku, Seoul, Korea Phone: (02) 777-5768

**KARIN ELECTRONIC SUPPLIES CO. LTD.**

RM. 100 1-2 Chow Sang Sang Bldg., 229 Nathan Road, Tsimshatsui,

Kowloon, Hong Kong Phone: 3-668338 (695321).

**ELECTRONICS TRADING COMPANY (PTE) LTD.**

No. 66 & 66-A (6km) Upper Serangoon Road Singapore 1334

Republic of Singapore Phone: 285 2911

**XENITEK PTY LIMITED**

P.O. Box 128 658 Pittwater Road, Brookvale, N.S.W., Australia

Phone: 934 4311

**H. KOPP AND CO. (PTY) LTD.**

P.O. Box 2944 Johannesburg 2000, South Africa Phone: 23-6511

**TELSYS LTD.**

12 Kehilat Venetsia Street Tel Aviv, Israel Phone: 482126-7-8

**INDUSTRIAS ELECTRICAS "NAZA" S. R. L.**

Uruguay 267-1870 Avellaneda, Buenos Aires, Argentina

Phone: 204-5914

# JEPICO

**JEPICO CORPORATION**  
Overseas marketing section

Shinjuku Dai-Ichi Seimei Bldg., P.O. Box 5016  
Shinjuku-ku, Tokyo 160, Japan  
Telex: 2323167 JEPICO J

# The biographies of 5,240 of your colleagues...

## Profiles the Top Management of Major Electronics Firms throughout the World —and more

This is the only reference devoted solely to biographies of the most influential people in electronics: corporate executives... technical managers... designers and developers of important products and processes... government and military officials... academics... editors and publishers... securities analysts... directors of trade and professional groups... and consultants.

### McGraw-Hill's **Leaders in Electronics**

Prepared by the Staff of Electronics  
651 pages

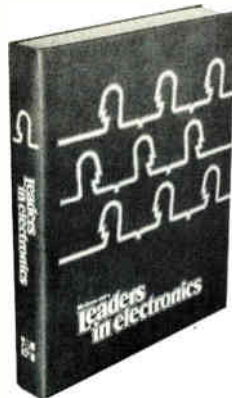

#### As easy to read as any professional publication in electronics

With LEADERS IN ELECTRONICS on your bookshelf, you no longer have to search through many different sources for biographical data on your colleagues. What's more, you don't have to strain your eyes reading minuscule type, nor do you have to waste valuable time trying to decipher seemingly endless paragraphs of abbreviations. Boldface type spotlights the various information categories so that you can scan entries rapidly to pinpoint what you need.

#### Unique convenience feature... Index of biographees by affiliation

A special 80-page index lists individual organizations alphabetically, complete with the names and titles of top employees. By looking up the names in the general biography listing, you can get a complete profile of the organization's top management in a matter of minutes. Plus an easy-access listing of independent consultants in every electronics specialty.

#### Electronics Magazine Books

P.O. Box 669, Hightstown, NJ 08520

Send me \_\_\_\_\_ copies of *Leaders in Electronics* @ \$39.50 plus applicable sales tax. McGraw-Hill pays regular shipping and handling charges on pre-paid orders.

I must be fully satisfied or you will refund full payment if the book is returned after ten-day trial examination.

Payment enclosed     Bill firm     Bill me  
Charge to my credit card:     American Express  
 Diners Club     Visa     Master Charge

Acct. No. \_\_\_\_\_ Date Exp. \_\_\_\_\_

On Master Charge only,  
first numbers above name \_\_\_\_\_

Name \_\_\_\_\_

Company \_\_\_\_\_

Street \_\_\_\_\_

City \_\_\_\_\_ State \_\_\_\_\_ Zip \_\_\_\_\_

Signature \_\_\_\_\_

### New products international

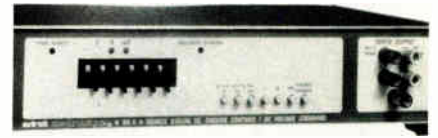

The voltage-current standard Adret 103, for measurement and calibration applications in the avionics and automotive industries, has a current range of 1 to 100 mA dc and a voltage range of 1 to 100 V. Adret Electronique, 12 Ave. Vladimir-Komarov, 78190 Trappes, France [466].



This automatic aluminum wet-etching system has an accurate end-point detection function and a wafer throughput of 300 wafers/h, processing 4- to 5-in. wafers. It is easy to operate and avoids producing radiation damage. Sigma Corp., 1-3-15 Komagome, Toshima-ku, Tokyo 170, Japan [467].

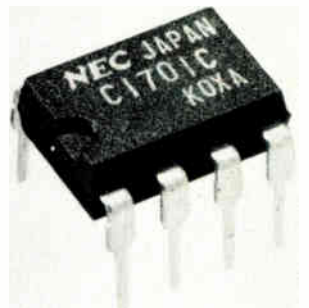

The  $\mu$ PC1701C symmetrical-burst-control integrated circuit is designed for triggering a triac at zero voltage points to avoid radio-frequency interference. High-current triacs can be switched by its output—200 mA minimum. Nippon Electric Co., 5-33-1 Shiba, Minato-ku, Tokyo 108, Japan [468].



The SFERNICE clinometer provides solutions to weight and position measurement problems. It has an electrical travel from 10° to 350°, an essentially infinite resolution, and a rotational life-expectancy of more than 20 million cycles. SFERNICE, B. P. 17, 06021 Nice Cedex, France [469]



The DATAX SP 9600 FAST modem uses automatic equalizers on large-scale integrated chips for a high response time of 15 ms. It can be applied to the public switched telephone network. Nippon Electric Co., Tokuei Bldg., 5-33-7 Shiba, Minato-ku, Tokyo 108, Japan [470]



The Series S 200 watertight switches are for printed-circuit boards. They are available with such options as single- and double-pole configurations, three lever lengths, and straight- or right-angle- pc terminals, eliminating hand-soldering. APEM, B. P. 1-82300 Caussade, France [471]

# Lamb<sup>®</sup> pm motors are designed for high performance applications

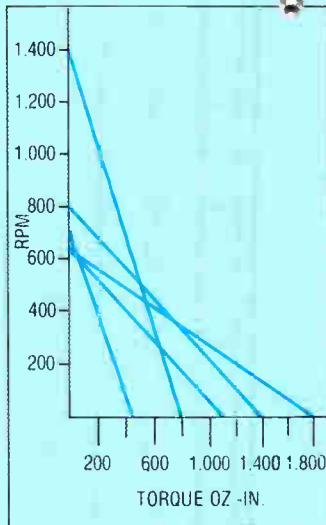

## High torque in small frame size saves space and weight.

These 4" diameter pm motors are for high-performance, variable-speed applications, particularly those requiring a repeatable, straight line speed/torque curve. Features include ball bearings, ceramic magnets, Class F insula-

tion, dc and rectified ac excitation, rapid two-lead reversibility, stable commutation for long brush life and high current capability.

The motors are available in standard 5", 6", 7", 8" and 9" lengths and can meet requirements for continuous rated torque to 540 oz.-in. and peak torque to 2400 oz.-in. with speeds to 2000 rpm. Component recognized by U.L. Inc., the motors are widely used in data processing peripherals, reproduction equipment, machine tools and similar applications.

The design of the motor, coupled with Lamb Electric's manufacturing capabilities, make these motors a very economical power package for mid- and high-range production requirements.

For additional details, contact AMETEK, Lamb Electric Division, 627 Lake Street, Kent, Ohio 44240. Telephone (216) 673-3451.

**AMETEK**  
LAMB ELECTRIC DIVISION

# THE DOUBLE PROTECTION! THE CITEL P98C SURGE-ARRESTER



Protection against short and long overvoltages. The P98C is short-circuited in the only case of long overvoltages:

- easy detection of the surge-arrester to be changed
  - no excessive and long heating so no risk for your holders and P.C. boards
  - your line being grounded, your electronic equipment remains protected after destruction of the surge-arrester.
- The P98C as all the CITEL surge-arresters, does not use any radioactive element, and is not sensitive to obscurity.

## CITEL

8 AV. JEAN-JAURÈS 92130 ISSY-LES-MOULINEAUX (FRANCE)  
TEL. (33.1) 645.70.45 - TÉLEX 203360.

G. N. CONSEILS

Circle 157 on reader service card

## Data Communications Books.

### McGraw-Hill's Compilation of Data Communications Standards

Presents all 89 user-relevant data communications standards promulgated by CCITT, ISO, ANSI, EIA, and U.S. FTSC. Also includes descriptions of the standards organizations, plus relational charts of similar interfacing standards produced by different groups. Edited by Harold C. Folts and Harry R. Karp. 1133 pp., clothbound, \$165.

### Data Communications Procurement Manual

The most authoritative and current information you need to turn data communications procurement into a smoothly running, cost-effective operation. Includes sample solicitation clauses and forms, specification checklists on 38 devices, and 8 useful appendixes. By Gilbert Held. 150 pp., clothbound, \$24.50

### Practical Applications of Data Communications: A User's Guide

Articles from *Data Communications* magazine cover architecture and protocols, data-link performance, distributed data processing, software, data security, testing and diagnostics, communication processors, and digitized-voice and data-plus-voice. 424 pp., paperback, \$13.95



### Basics of Data Communications

This compilation of essential articles from *Data Communications* magazine includes chapters on terminals, acoustic couplers and modems, communications processors,

networking, channel performance, data-link controls, network diagnostics, interfaces, and regulations and policy. 303 pp., paperback, \$12.95

#### Order today, using this coupon!

##### Electronics Magazine Books

P. O. Box 669  
Hightstown, NJ 08520  
Tel. (609) 448-1700, ext. 5494

Please send me...

\_\_\_\_\_ copies of *Data Communications Standards* @ \$165.

\_\_\_\_\_ copies of *Data Communications Procurement Manual* @ \$24.50

\_\_\_\_\_ copies of *Practical Applications of Data Communications* @ \$13.95

\_\_\_\_\_ copies of *Basics of Data Communications* @ \$12.95

Payment enclosed (payment must accompany orders under \$25)  Bill me  Bill my company Ten-day money-back guarantee applies on all books. EL



Name \_\_\_\_\_

Title \_\_\_\_\_

Company \_\_\_\_\_

Street/P.O. address \_\_\_\_\_

City/state/zip \_\_\_\_\_

**When you want  
technology,  
performance,  
ease of use,  
growth,  
and  
availability...**

# ZILOG makes it



## The leader in micro technology

At Zilog, our record of achievement in both R&D and manufacturing speaks for itself: our Z80<sup>™</sup> is the industry standard for 8-bit CPUs, the processor

in the development of the 16-bit CPU with our Z8000<sup>™</sup>; the Z8<sup>™</sup> is the most versatile single-chip microcomputer available today; our Z8132 RAM combines efficiency and reliability for maximum economy. And, our products are backed by a complete family of sophisticated peripheral chips.

## Superior performance gives you a competitive edge.

Zilog's reputation is directly related to our superior performance. From CPUs to peripheral chips, we have a complete family of products that are backed by a complete family of sophisticated peripheral chips.

As new family members have been introduced, has continually increased in capability and performance. As a result, Zilog gives you the performance that can make your products more competitive than ever before.

## Total support makes it all easy.

Zilog backs you up with total product support including software, hardware, and technical assistance. Our Z8000<sup>™</sup> is the industry standard for 16-bit CPUs, the processor

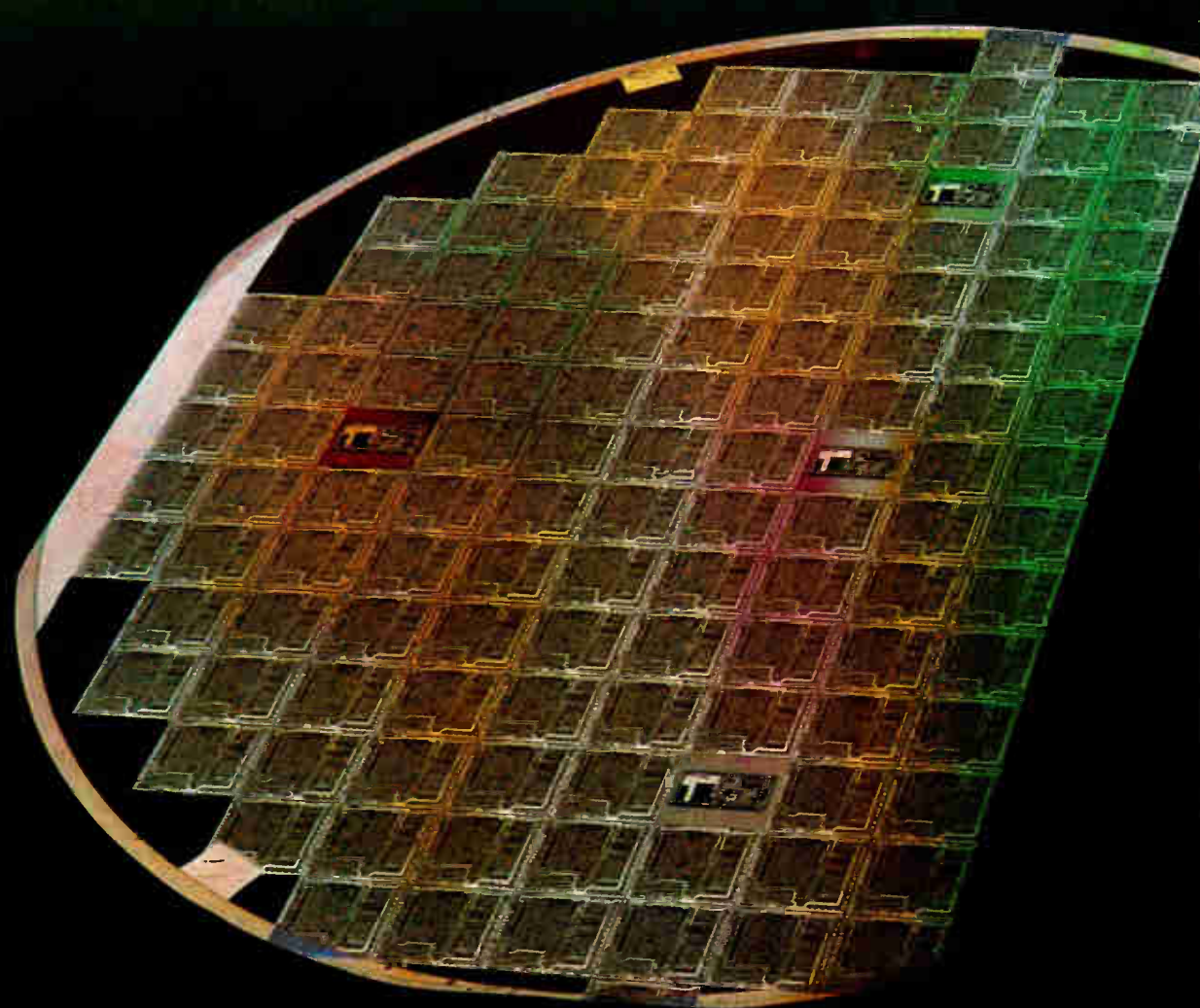

# happen for you!



real-time software like ZRTS. In other words, the kind of total support that maximizes programmer and design engineer productivity. And minimizes your time to market.

## Growth without obsolescence.

Who Zilog, your investment today is protected for the future. Our component families offer ranges of performance from 2.5 MHz right on up through to MHz. Performance upgrades can be made while maintaining hardware and software compatibility. We team ahead with leading product manufacturers to provide the most current and available

maximum return on your development investment both today and tomorrow.

## It's all available right now!

Thanks to significant progress along the learning curve, Zilog consistently produces high yields per wafer. Products are available in industrial, commercial and military versions. And with the opening of new production facilities, we've got the capacity and volume to meet your schedule. Call the products and support you need. Call your local Zilog sales office today. You'll find that Zilog can make it happen for you right now!

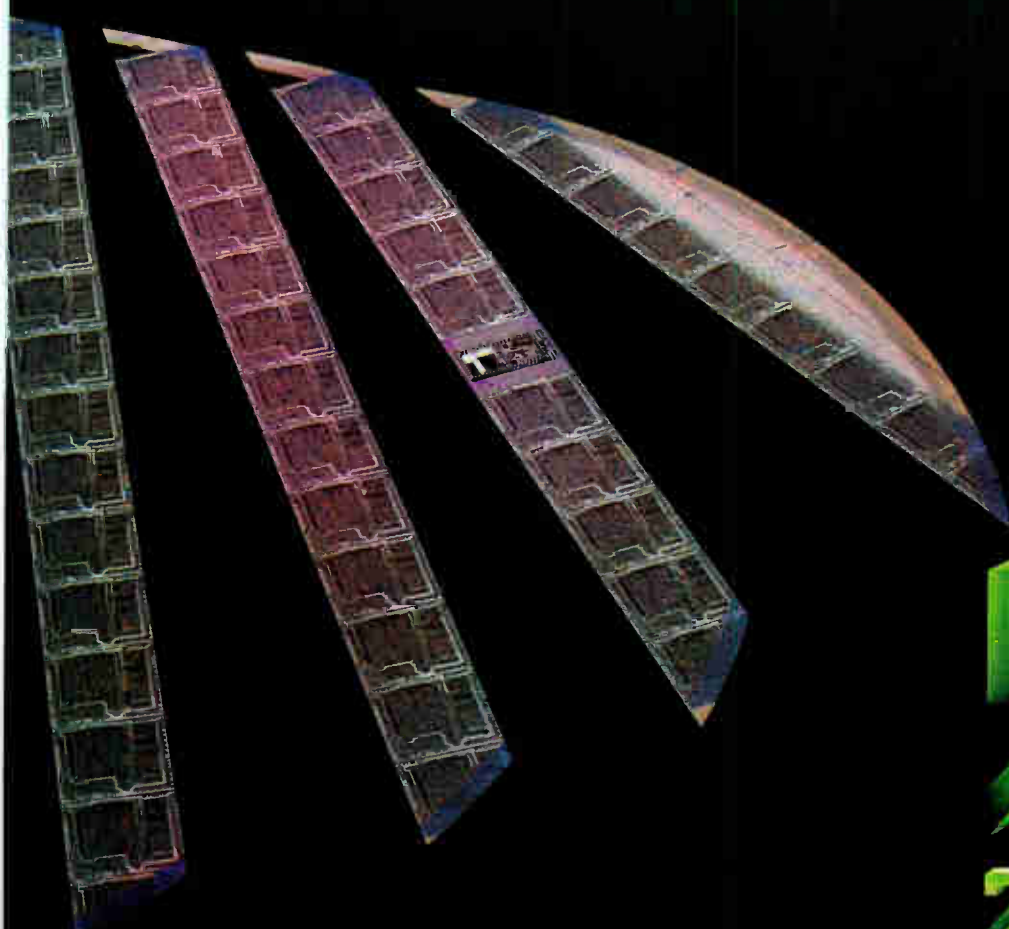

Circle 91 on reader service card

ENTER Y FOR SYSTEM HELP  
ML1040 -- SELECT  
PX, LC, VN, DG, DI, TC, TI

HELP:  
ML2040 -- T  
SELECT YO  
CODE SE

PX PR  
LC LC  
VN VN  
DG DG  
DI DI  
TC TC  
TI TI

NR --  
PX1010





# Announcing a new way to manage the unmanageable: Processed engineering information, at your fingertips, with TECH-NET.<sup>TM</sup>

Information Handling Services originated *processed* information — engineering data that's already cataloged, collated, cross-indexed and cross-referenced for you.

And now, we've made this unique technical data base even easier for you to access with TECH-NET, a new, on-line, interactive search service.

For one thing, it gives you a complete, electronic index with full, automatic cross-referencing to over 24,000 industrial vendor catalogs, 91 % of the world's most commonly-used industry codes and standards, and to the most comprehensive collection of Military Specifications and government documents in the world. What's more, TECH-NET leads you directly to this information not in minutes or hours, but in seconds. And it makes you instantly aware of important related data you may not know existed, or could have inadvertently missed.



## **A more productive solution — VSMF<sup>®</sup> subscriber or not.**

If you currently subscribe to an Information Handling Services VSMF service, you'll find that TECH-NET can help you work more efficiently — and more productively — by speeding you to the information you need.

But even if you are not a VSMF subscriber, TECH-NET still represents a more cost-effective solution. Because you can use it to identify the information you need, then obtain the exact documents required in hard copy form via a new, low-cost service called Documents-on-Request.

So if you've always thought that *processed* information was too expensive, given the size of your company, think again.

## **8,000,000-plus pages of data and over 1,000 people.**

Here at Information Handling Services, we've been collecting and distributing engineering data for over 20 years. In fact, our data base now incorporates more than 8,000,000 pages of technical information. Every page of which has been reviewed by a qualified engineer who has coded this data for you to ensure fast access and easy retrieval. For that matter, we currently have over 1,100 employees — worldwide — at work constantly to increase, improve and update this data base just to make sure the information you need is both complete and current.

## **Experience *processed* information firsthand.**

See for yourself what *processed* information can mean to your productivity. Call or write today for a no-obligation demonstration — in your office — of our powerful, new TECH-NET solution. Or for more details, simply call or write: Information Handling Services, Dept. 481, 15 Inverness Way East, Englewood, Colorado 80150, attn. Susan Michals, or call 800-525-7052, ext. 328.

***Processed* information for increased productivity.**



**Information Handling Services**

An Indian Head Company

©1981, Information Handling Services

1/03

DESIGN

PROCESSING

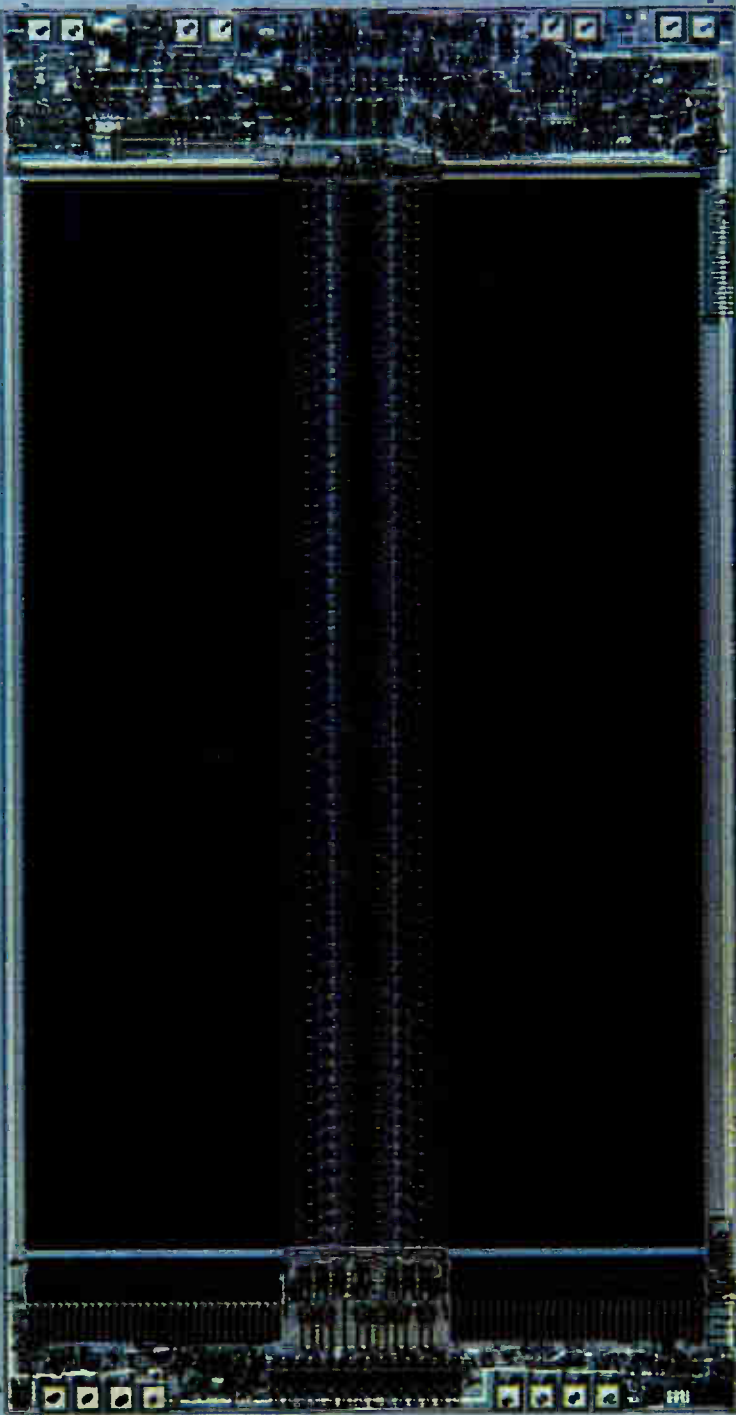

MATERIALS

TESTING

*from design to test  
and everything in between...  
a commitment to dynamic RAM  
state-of-the-art...*

# TMS4164 from Texas Instruments.

## Advancing the systems approach to 64K technology.

Using diverse resources and production-proven experience, TI developed a 64K dynamic RAM supported by a broad base of technical innovations — at all levels.

There's a systems approach to the advancement of 64K technology that assures our customers that TMS4164 is superior in design — and equally superior in the use of materials, processing and testing techniques.

Because improvements in one technology drive improvements in all the others, it's the shared learning experience between all TI semiconductor technologies that has brought TMS4164 to the leading edge of the state-of-the-art — and beyond.

### Design

Our unique grounded substrate design totally eliminates the need for a substrate bias generator — and its less effective method of establishing a negative voltage to control injected electrons. Enhanced noise immunity, greater tolerance to negative undershoot, wider operating margins and firmer transistor parameters are just a few of the breakthroughs TI has achieved with the grounded substrate technology.

Of course, there's much more to the design story, too — like our advanced 256-cycle, 4-ms refresh

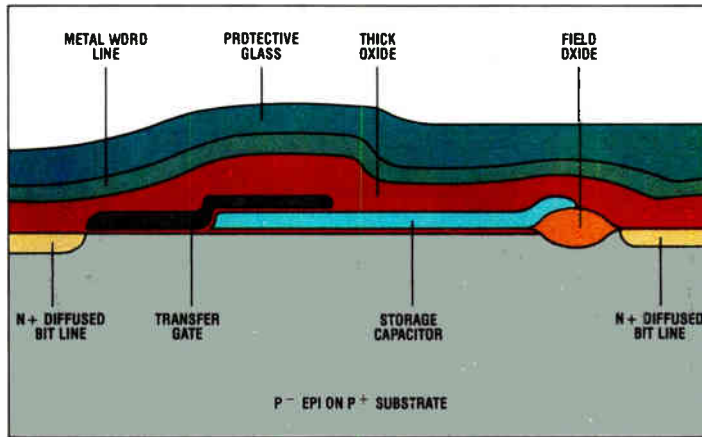

*Fabricating the TMS4164 cell on epitaxial silicon virtually eliminates substrate noise.*

architecture, low-power dissipation and fast cycle time.

### Materials

Innovations are also incorporated into TI's use of materials. By depositing a thin, closely controlled layer of highly resistive P<sup>-</sup> silicon onto a low resistivity P<sup>+</sup> substrate, we have virtually eliminated peripheral noise in the TMS4164.

The low resistivity substrate damps out capacitive coupling typically caused by clock bus line activation. Other benefits of this epitaxial (epi) layer are reduced algorithm sensitivity and immunity to address voltage bump. And, epi sets the stage for the future — the not-too-distant future of 256K devices — and the challenge of VLSI.

### Processing

Processing advances in TI's TMS4164 mark major technology turns in high-performance DRAM production. TI has unequalled ex-

perience in the development of key equipment, like our own dry plasma reactors, and use of advanced low-temperature processing techniques. Our processing capability means device consistency, uniformity and reliability. And satisfied customers.

### Testing

For consistently superior system performance, every 64K

DRAM is tested well beyond device specification. TI's meticulous attention to equipment accuracy and exhaustive algorithm testing result in high incoming quality. And, our own Test Data Management (TDM) system uses TI's 990 minicomputer to statistically track transistor parameters and other performance characteristics for constant process improvement.

Thanks to this kind of real-time process feedback, TI can assure every TMS4164 user of a more uniform product — and, built-in quality.

For the inside story on TI's TMS4164 64K dynamic RAM, and our leading edge systems approach, call your nearest TI field sales office, or write to Texas Instruments Incorporated, P.O. Box 1443, M/S 6955, Houston, Texas 77001.



# THERE'S A BIG NEW NAME ON THIS BOARD WALK.

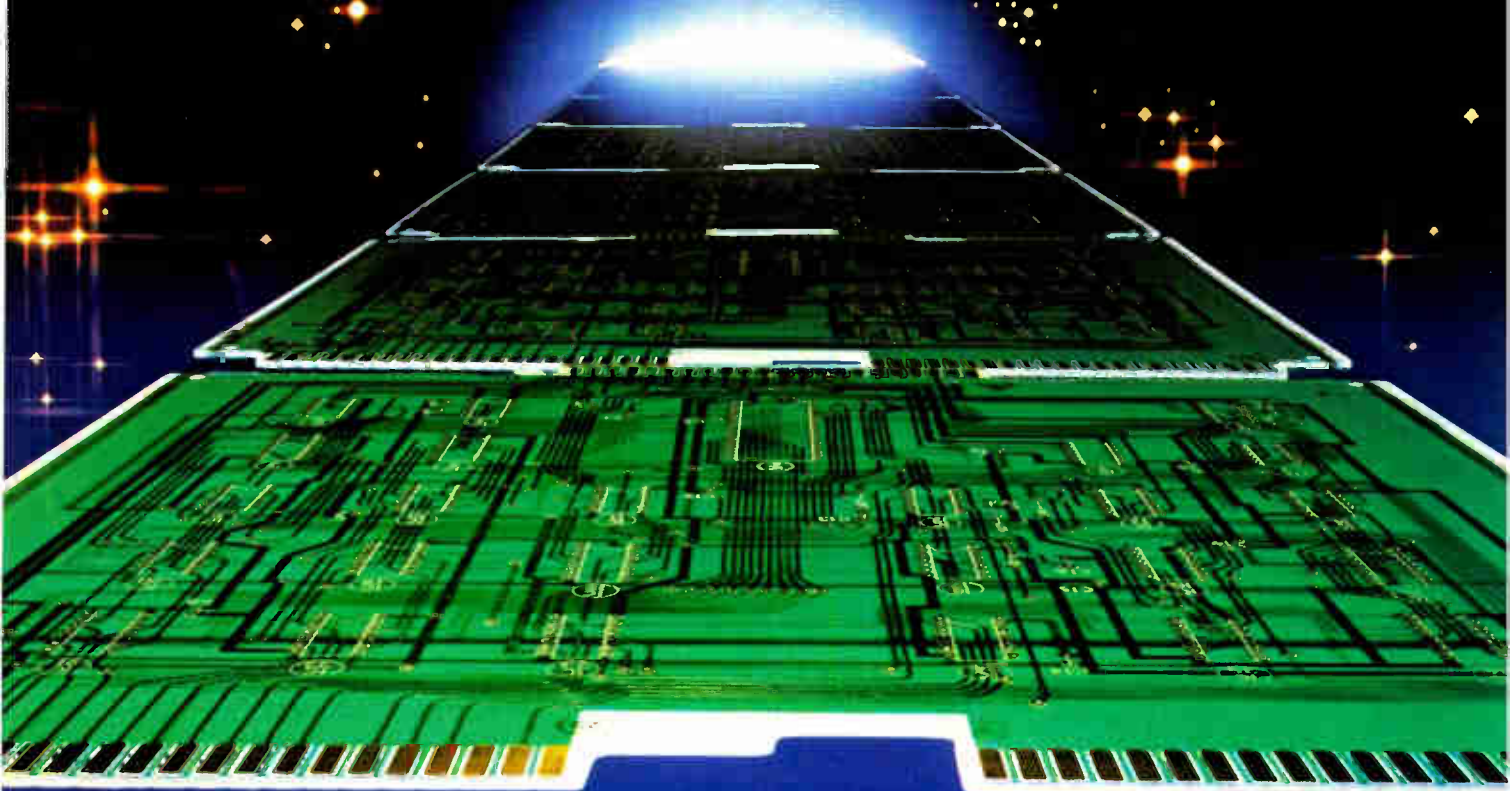

## TERADYNE COMES TO BARE BOARD TESTING, WITH THE N221.

With the new N221 Bare Board Test System, Teradyne introduces a combination of performance and flexibility unheard of till now. And worldwide support and service only a major testing company can provide.

Microprocessor-based, the N221 economically handles boards of any size or density. With solid-state switching for fast, accurate detection of shorts, opens, and leakage paths between lands caused by contamination or solder slivers.

Test electronics expand up to 64k points. For testing at one station, or multiplexing as many as four test stations to a shared system controller.

N221 software ensures versatility in operation and programming. For

Circle 96 on reader service card

example, you can easily get diagnostics either in your own product nomenclature, x-y coordinates, or N221-assigned points.

Depending on your board types, choose the N221 with integrated vacuum fixturing and interchangeable test heads. Or opt for a flexible interface to an in-house or commercial vacuum or pneumatic bed-of-nails fixture.

The N221 Bare Board Test System from Teradyne. The big new name in bare board testing.

Teradyne manufactures a complete line of automatic test equipment for electronic components and subassemblies. For information on the N221 or any other product, contact Teradyne, 183 Essex Street, Boston, MA 02111.

# TERADYNE

## Oil prices fuel power IC work

Conference spotlights emerging importance of power electronics  
as computer technology begins to make inroads

by Gil Bassak, Industrial/Consumer Editor

**Pushed by soaring** oil costs, the development of increasingly efficient power conversion devices is gaining momentum. Designers of power supplies, power inverters, motor drives, and high-voltage systems are turning to fast MOS switches, large-scale integrated control circuits, and computer-aided design to achieve maximum efficiency for minimum long-term cost.

This trend is apparent in the sessions scheduled for Powercon 8, an annual power electronics conference to be held this year on April 27-30 in Dallas. It is striking because for many years the area of power electronics has been overshadowed by dazzling strides in digital microelectronics. Now, with electricity costs rising and silicon chip costs dropping, the two disciplines are joining forces to boost the efficiency of high-powered equipment.

"Not long ago the average efficiency of power-conversion equipment was 50%," notes Ronald I. Birdsall, Powercon's chairman, "now it's 80% or 90%." "We have the technology to design with high-efficiency techniques," adds Birdsall, who is also president of Power Concepts Inc., a Ventura, Calif., consulting firm.

"At this conference we're noticing a number of applications of computer technology creeping into the program, mostly for analysis and measurement. We even see computer technology creeping into the controllers themselves," he continues.

**Small and efficient.** A sampling of the Powercon program reveals several directions emerging in the application of microelectronics to power conversion equipment design. Sever-

al manufacturers have introduced MOS switches to take advantage of the high switching rate and low power requirements of MOS. In some cases, they are integrated on the same substrate with bipolar devices at the output to handle higher steady-state currents.

One noteworthy example of the thrust to marry MOS and bipolar characteristics will be presented at Powercon by Intersil Inc.'s Nathan Zommer and James Meador. The

**MOSAic.** High-voltage D-MOS device allows simultaneous fabrication of on-chip analog and digital signal-conditioning circuitry.

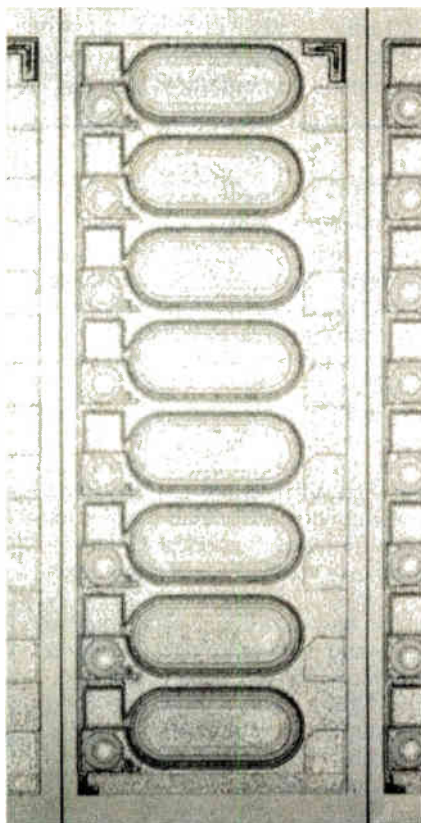

Cupertino, Calif., semiconductor house, which was recently acquired by General Electric Co., will unveil its Bipmos technology underlying a single integrated bipolar and MOS circuit. "It's a new technology and a new device category," remarks Zommer, who heads Intersil's power MOS operations. "We are discussing all kinds of configurations of bipolar-MOS in order to achieve a very powerful switch that is easy to drive."

Honeywell Inc.'s Solid State division in Minneapolis is one of those investigating MOS as a technology to replace the broad category of thyristor devices controlling ac power. "Compared with a thyristor, our device can survive large transients without burning out or staying on," says Honeywell's Mark Hartranft, an applications engineer. "You can also put control and interface circuitry on the silicon." Honeywell, however, is not planning to release its switch commercially but will use it in house.

**Speed, too.** The drive to use MOS in place of bipolar devices and thyristors is not just based on the low power needs or the durability of MOS during transients. Its faster switching capability also makes it an attractive choice for the latest power conversion equipment designs, which use high-frequency switching to reduce weight, size, and losses. By cranking the switching frequency past the 60-hertz line, in some cases up to 200 kilohertz, the magnetic components used for transforming and filtering become smaller, lighter, and less wasteful.

In addition, good voltage regulation is easier to achieve with MOS than with linear power devices. That

is because the bandwidth, which is a function of the switching frequency, is higher, so that the system can respond to load surges more quickly without large capacitors. A paper from Bell Laboratories on this subject will be presented, entitled "An Efficient and Conceptual New High Frequency UPS [uninterruptible power supply] Technique."

A great deal of attention is being drawn to speed controls for ac motors, which is reflected in a separate Powercon session devoted to the subject. The rising interest again stems from the increase in energy costs. Typically, ac motors run at a speed fixed by the line frequency; speed is changed mechanically, with the excess power dissipated and lost as heat. Solid-state frequency synthesizers, however, have made it cost-efficient to conserve excess power and to vary the motor speed from an adjustable-frequency, high-power driver instead.

**Digital control.** At the core of such a driver is a digital control circuit, usually a microprocessor but sometimes a custom digital controller, which is used to process control and error inputs and regulate motor speed. Such digital motor control is explored at Powercon by Silicon

General Inc. of Garden Grove, Calif., and is the basis for the session called "Simplifying High-Efficiency Motor Drive Systems with a New Family of PWM [pulse-width-modulation] Integrated Circuits."

Signetics Corp. of Sunnyvale, Calif., will balance the program with a discussion of a dedicated LSI device that uses an analog input to control dc motors. "Using Microprocessors in the Design of Motor Control Power Systems" will cover applications of the Signetics 5522 dc motor controller. Lester J. Hadley, an applications engineer at Signetics, will present the 5522 controller as a building block for a velocity and position servomotor that uses a step voltage input for commands.

Aside from a range of papers, Powercon will feature workshops and exhibits that, Birdsall says, represent "an explosion of new ways people are working out to convert power efficiently." With the cost of energy showing no promise of dropping and the Government placing a premium on energy efficiency in determining contract awards, there is very little chance that the explosion will die away quickly.

**Revolution due.** Summing up the picture, Zommer of Intersil predicts that "the 1980s will be the era when we will see the revolution of power conversion equipment. It now pays to

put a little brains into any motor or power conversion device. You get a very healthy payback."

Zommer expects the present push in motor controls to extend from separate boxes sitting between lines and motor to more integrated packages housed within each motor. "The motor of the future will have the mechanics of today's motor, but with a black box attached. The motor will not see the ac line, but instead see a drive functions tailored for each application, making it small and more efficient."

**Showing wares.** As at most conferences, some manufacturers are taking the opportunity at Powercon to introduce products. For example, Supertex Inc., the Sunnyvale, Calif., affiliate of Exxon Enterprises Inc., has developed a power MOS field-effect transistor with very high input impedance and good drive characteristics. The SuperFET, as it is called, is a 500-volt device whose on resistance is 0.3 ohm or less, with a current-handling capacity that is upwards of 20 amperes. The structure of the device combines the best aspects of bipolar technology with a variation of standard vertical double-diffused MOS (D-MOS) technology.

With much of the development of power devices stressing improvements in power-handling semiconductors, Amperex Electronics Corp. of Slatersville, R. I., will show an expanded line of gate-turnoff (GTO) thyristors. Such components are fast three-terminal, four-layer pnpn devices that can operate at frequencies of up to about 50 kHz with a low gate current.

For Thermal Associates Inc. of Stoneham, Mass., the target is the market for motor control, industrial heat control, and dc power supplies. It will introduce a line of clampless, springless semiconductor power modules. Unlike discrete devices, they can hold multiple units—thyristors, diodes, and transistors—all internally connected. The parts are epoxy-mounted under pressure, rather than clamped or soldered, making mounting a simple matter of normal studs and bolts. The modules are isolated to 1,200 v ac. □

### Power to the designers

Powercon, an annual meeting for power conversion engineers, is the result of one man's desire to further the work in his field. As a designer himself, Ronald I. Birdsall wanted to "put a conference together so that we could interest universities and power designers in doing rigorously correct designs." He feels that power conversion engineering is a multidisciplinary field and that "the people doing this work have been almost underqualified for the job. They'd know some area but not all of it."

Apparently Birdsall's idea has gone over well with his colleagues, for the number of participants has increased every year and "registration in 1981 is running almost 50% ahead of last year"; he predicts that more than 3,000 people will visit the show this year in Dallas. Part of this interest in Powercon on the part of engineers in the field is probably due to Birdsall's fervor for keeping the sessions practical. "We stay away from knowledge for knowledge's sake," says Birdsall, who is interested only in that body of information that "will enhance the technology."

But there have been problems. Birdsall has had to ask a Federal court to halt a former associate from using his name and a Powercon-like title for a competitive event, now called International Motorcon '81. And power engineering has not been too attractive a field. "A few years ago no one knew what a power engineer was," remarks Birdsall. Now, he claims, "there is a great demand because of the energy crunch," noting that research and development is picking up to include higher-power areas.



# The Single-board Computer System for the Man Who Doesn't Have Time to Build His Own\*



## \* Or can't afford to

So-called "single-board" computers are a long way from being single-board computer *systems*. Analyze what it really takes to make one: CPU board, memory boards, I/O boards, rack-mount, software development system, and weeks (sometimes months) of construction, programming, and debugging.

Now consider the BASIC CONTROLLER™: one board. Period. CPU, RAM, EPROM sockets, video generator, keyboard and cassette interfaces, 24 hour clock, serial and parallel ports, a multitude of "real-world" I/O's — even an EPROM programmer — are all included. And our built-in ZIBL™ (Z80 Industrial BASIC language) interpreter will reduce your programming time to hours, instead of weeks. So you can concentrate on your application, not hardware and software. If your needs are less than 200 *systems* per year, you really can't afford to use anything but a BASIC CONTROLLER™.

# DYNABYTE

115 Independence Dr., Menlo Park, CA 94025 (415) 329-8021

Circle 100 on reader service card

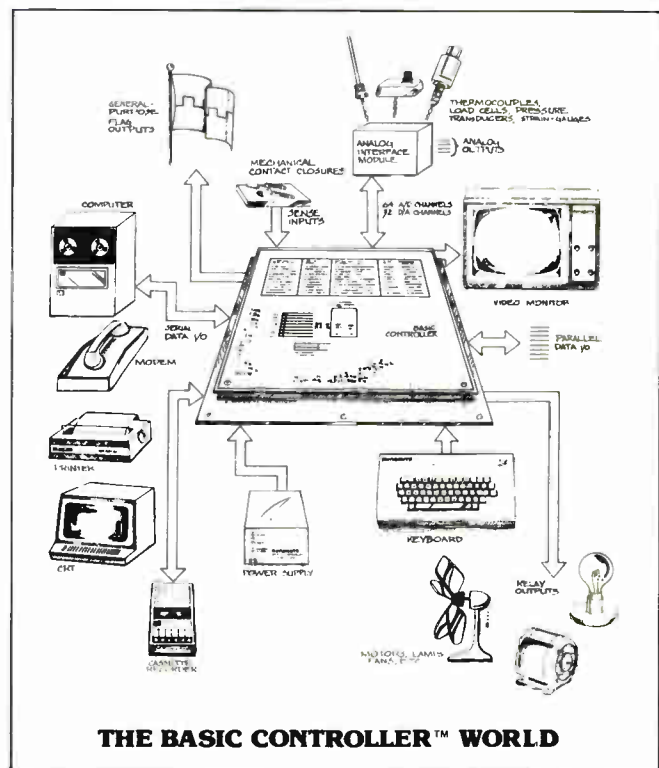

THE BASIC CONTROLLER™ WORLD



Communications

# Europeans test fast data link

West Germans start year-long trial of Telex-compatible Teletex service that links directly to typewriters

by John Gosch, Frankfurt bureau manager

European communications officials are paying close attention to trials in West Germany of a new text-communication service that combines the speed of digital data transmission and the convenience of printing messages out on electronic typewriters or word processors. The service is called Teletex, and its potential as an electronic mail medium is immediately apparent.

High on the list of its advantages is transmission speed. At 2,400 bits per second, the information on a standard-size page containing 1,500 characters can be transmitted in less than 10 seconds—20 to 30 times faster than possible with ordinary Telex. Another boon is Teletex's compatibility with Telex, enabling subscribers participating in West Germany's test to communicate with the 1.2 million Telex terminals worldwide and vice versa. Code, pro-

tol, and rate converters in the networks make this possible.

Unlike Telex, Teletex transmits both upper- and lower-case letters, as well as symbols and accents. Text is sent in high-quality page form and is reproduced at the terminal in the same format and layout in which it was sent.

**Getting there.** In preparing materials for Teletex, the message is simultaneously typed out on paper and entered into the memory of a storage typewriter or word processor. After editing, it is transmitted in coded form via Telex and other data networks to the memory of similar equipment at the destination. During transmissions and memory write-in or readout, the equipment can be

**Data center.** In tomorrow's business office, such systems as Teletex, at right, will speed the delivery of mail and messages.

used for its normal operator functions.

For the West German test, which will last a year, domestic transmission will be over the Integrated Text and Data network, a synchronous digital network developed by Siemens AG. Though labeled a trial, the West German system has been nationwide from its start on March 10. When it becomes a regulated service, costs will be low—about 13 cents to send a two-page letter anywhere in the country during the day; at night it will be a nickel. That comes to 10 times less than Telex and 20 times less than Telefax facsimile services.

Facilitating Teletex communications on a worldwide basis will be the standard that the Consultative Committee on International Telephony and Telegraphy recommended last year. Besides equipment compatibili-



## Probing the news

ty, the committee has specified a transmission error rate of  $10^{-8}$ , or one error per 100 million characters. Also required is that memory-to-memory transmissions as well as text transfer into nonvolatile memories be fully automatic.

The handling of transmission on a typical Teletex terminal is straightforward. First, the operator types the call number of the addressee and the text to be sent into memory, usually a mini-diskette. At the same time the text is typed out on paper it can be called up on a cathode-ray-tube display for editing and correction. When a button is pushed, or automatically at a preselected time, the connection to the receiving terminal is established.

Next, protocols are exchanged between the terminals—also automatically—to determine what kind of keyboards are used and whether the receiving memory is ready to accept the text. If it is, the contents of the sender's memory are transmitted to the receiver's. There, the addressee is automatically alerted by a few printed words. The text is then automatically printed out, shown on the CRT screen, or kept in the memory for reproduction at a later time. A typical mini-diskette can store up to 80,000 characters.

**Other tests.** Hailed as a means for worldwide electronic correspondence, Teletex will also be put to the test in Sweden and Austria next year. The Swedish telecommunications administration, Televerket, plans to test Teletex terminals this fall and deliver them to subscribers in early 1982. In France, the government telecommunications agency, Direction Générale des Télécommunications, expects to see the first Teletex units available in early 1983. The new service will use the regular switched telephone network or the digital data net now going in.

In Britain, the enthusiasm over Teletex that communications executives showed last year has waned. The reason is that because of problems with Britain's existing Telex network, a full version of Teletex service adhering to international standards may not be ready before



**Sending the word.** Electronic typewriters or word processors can be used for Teletex. This word processor from Siemens was developed specifically for the new technique.

1983. A limited service, however, may be offered before then. For it, Britain is likely to use the public switched phone network with 1,200-baud full-duplex modems.

Meanwhile, other European countries are taking a hard look at Teletex. Belgium, Denmark, Italy, the Netherlands, and Norway plan to start the service. By 1985, postal authorities in Bonn expect nearly all of Western Europe to have Teletex. Eastern European countries, as well as Australia, Japan, South Africa, Canada, and the United States, are also showing interest.

Industry experts see a big potential for Teletex. The West German post office predicts that the number of terminals in that country alone will rise to 40,000 by 1985 and to about 130,000 by 1990, an estimate close to the numbers projected by Siemens. Says Hans-Dieter Grösser,

deputy director in Siemens' section of communications terminals, "In principle, all of the two and a half million office typewriters now in use in West Germany are candidates for eventual replacement by Teletex terminals."

The Bonn government is impressed by the load that a service like Teletex can handle. A government-sponsored study shows that more than half of the 10 billion letters mailed annually in the nation can be electronically transported. One third of these contain graphic material or pictures and so lend themselves to facsimile, or Telefax, techniques. The other two thirds, or well over 3 billion mailings, are candidates for Teletex transmission. To handle that, postal authorities predict, there will be 40,000 terminals in West Germany by 1985 and about 130,000 by 1990. □

# Metallized stacked-film capacitors from a NEW prime source: Sprague.

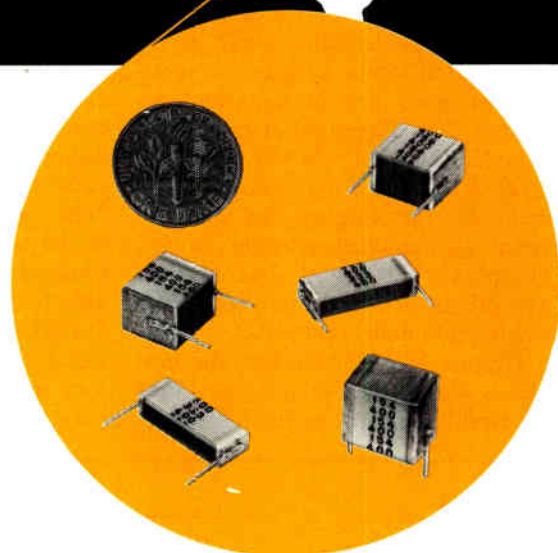

## Type 451P standard design now available for automotive, EDP, telecommunication, TV, instrumentation, and industrial control.

There are good reasons for using metallized polyester stacked-film capacitors: high volumetric efficiency, low self-inductance, and high voltage stress capability—plus great suitability for printed wiring boards. Small base dimensions and unencapsulated construction keep size to a minimum,

while insulating plates provide mechanical protection. Type 451P capacitors are available with capacitance values ranging from .001  $\mu\text{F}$  to 2.2  $\mu\text{F}$  and with voltage ratings of 100, 250, and 400 WVDC. Capacitance tolerance of  $\pm 10\%$  is standard . . .  $\pm 5\%$  can be ordered at a modest premium.

Sprague World Trade Corp.—3, Chemin de Tavernay, 1218 Geneva, Switzerland. Tel. (022) 98 40 21  
 Sprague France S.A.R.L.—2 ave. Aristide Briand, F-92220 Bagneux, France. Tel. 6 55 19 19  
 Sprague Electric (U.K.) Ltd.—Salbrook Road, Salfords Redhill, Surrey RH1 5DZ, England. Tel. Horley 5666  
 Sprague Elektronik GmbH—Darmstädter Landstr. 119-125, 6000 Frankfurt/Main 70, Germany. Tel. 0611-6055-1  
 Sprague Benelux—B.P. 104, B-9600 Ronse, Belgium. Tel. 055-21 53 02  
 Sprague Italiana S.p.A.—Via G. de Castro 4, I-20144 Milano, Italy. Tel. (02) 498 78 91  
 Interelko AB—Sandsborgsvagen 55, S-12233 Enskede, Sweden. Tel. 08-49 25 05  
 Semicons—Gammel Kongevej 148, 5 DK-1850 Copenhagen, Denmark. Tel. 01-221510  
 Field Oy—Veneentekijantie 18, SF-00210 Helsinki, Finland. Tel. 90-69 22 577  
 Racom Electronics Co. Ltd.—P.O. Box 21120, IL-Tel Aviv, Israel. Tel. 03-45 31 51  
 Bianchi S.A.—Apartado 220, E-San-Sebastian, Spain. Tel. 943 36 20 45

4SP 0110 R1 V2



a subsidiary of **GK Technologies**  
Incorporated

Conferences

# Display makers stick with CRTs

Information display seminar emphasizes their adaptation for specialized uses in business and home systems

by Ana Bishop, Assistant New Products Editor

The use of displays in an information-processing environment remains the strongest influence on their technological development. This trend is evidenced by the more than 60 technical presentations scheduled for the Society for Information Display's International Seminar and Symposium to be held April 27–May 1 in New York.

In fact, scientists in the U. S. are responding so strongly to the need to adapt existing technology for such uses that the 1981 meeting will attest to a shift of the main activity in technological innovation from the U. S. toward Japan, and, secondarily, Europe. Although scientists from Finland, Germany, Switzerland, and France will make presentations at the 16-session symposium at the Grand Hyatt Hotel, Japan rates second after the U. S. with presentations from some 16 organizations. England runs third with about 10.

"In the past, the U. S. originated ideas for the technological development of information displays, but now it seems to be more interested in the adaptation of already existing technology to suit particular applications," says program chairman Andras I. Lakatos, who is manager

of thin-film devices at the Xerox Research Center in Webster, N. Y. This concern with improvements is confirmed by the fact that at two of the sessions about cathode-ray tubes, all nine papers are from U. S. companies.

**New uses.** CRTs remain one of the most active fields of endeavor; 30% of all the presentations will be on CRT-related topics. One of the more innovative will be a presentation covering a 2-in. diagonal flat-panel CRT from Sinclair Ltd., Cambridge, England, that sports a depth of only 0.75 inch. In the display, an electron beam is launched parallel to the phosphor. Horizontal and vertical deflections are accomplished by a single set of deflection plates.

Despite such innovation, the emphasis will be on developing new uses for traditional CRT technology. Says

Lakatos, "Finally, we are truly tailoring CRTs for specific applications rather than using the old picture tube." He points out that the emphasis on applications now directed toward CRTs will eventually move on to the newer technologies, such as plasma, electroluminescent, and liquid-crystal and other passive displays.

In fact, LCDs are already coming on strong. Lakatos says, "The number and variety of papers on LCDs indicates that the technology is expanding strongly." He calls this "one of the technologically most active areas." As evidence of this, those attending the meetings will be able to hear about improvements in a pocket-sized liquid-crystal television from Hitachi Research Laboratory in Yokohama, Japan. The display uses a quad-matrix liquid-crystal panel with 640 terminals connected by two flexible printed circuits to its driver—a set of large-scale integrated circuits on two pc boards. With batteries, the TV weighs about 480 grams.

"Most of what we will see will be evolutionary rather than revolutionary in nature," he adds. For example, Lohja Corp.'s Electronics division in Espoo,

## The human factor

SID 81 will dedicate one of its 16 sessions to human factors that must be considered when designing a display system. The first paper on that subject, from Lockheed Missiles and Space Co. in Sunnyvale, Calif., examines the needs of operators at facilities from which electric utility companies control the generation of power. In the study, researchers conclude that operators would be able to make more effective decisions if, instead of seeing discrete status indicators or digital information on their wall-mounted displays, they were able to view information in a graphic manner—through a display of trends, derived values, or predictive information, rather than data applicable to an isolated, immediate situation only. Also concerned with the viewing of cathode-ray-tube displays, a paper from NHK Japan Broadcasting Corp., Japan, describes how edge transitions between staircase-waveform steps can be emphasized by adding a signal similar to the secondary differential waveform to create a sharper image.

Several of the papers at the session concern displays in cockpits. One of those, on a wearable head-up display, discusses its use as a pilot's display and a speech-reader by the deaf. A virtual image from a fiber-optics generator is viewed by means of a tiny concave collimating mirror mounted directly in front of the pupil of the eye without blocking vision. The paper comes from the Bell Helicopter division of Textron Inc., Ft. Worth, Texas.

### XR-30

4 speeds 7 channels plus one memo-announce channel



Two new data recorders using 1/2-inch videocassettes, the XR-30 and the XR-50, combine 7- and 14-track recording capability and open reel performance with the convenience of a cassette recorder. They're light, compact and ideal for field work—both have DC operated power supplies. The XR-50 provides 14 channels of recording flexibility, while the XR-30 provides 7 channels plus one memo-announce channel. Four switchable speeds range from 7-1/2 ips to 15/16 ips, and wide-band FM recording is standard, permitting high frequency data recording. Any channel can be

modified for direct recording by simply popping in an optional DR amplifier board.

Tape posit on is indicated by a highly accurate digital linear counter, and such parameters as time-base error, jitter and dynamic skew can be further improved by switching in the Tape Servo mode.

An optional AC power supply is available for lab use, so whether your applications are in the field or in the lab, if you'd like cassette convenience, open reel performance and multitrack capability, you really should take a closer look at TEAC's XR-30 and XR-50.

# An important new data recorder development from TEAC

## The convenience of a cassette recorder with the performance of open reel machines is now a reality.

**XR-50**  
4-speeds  
14 channels

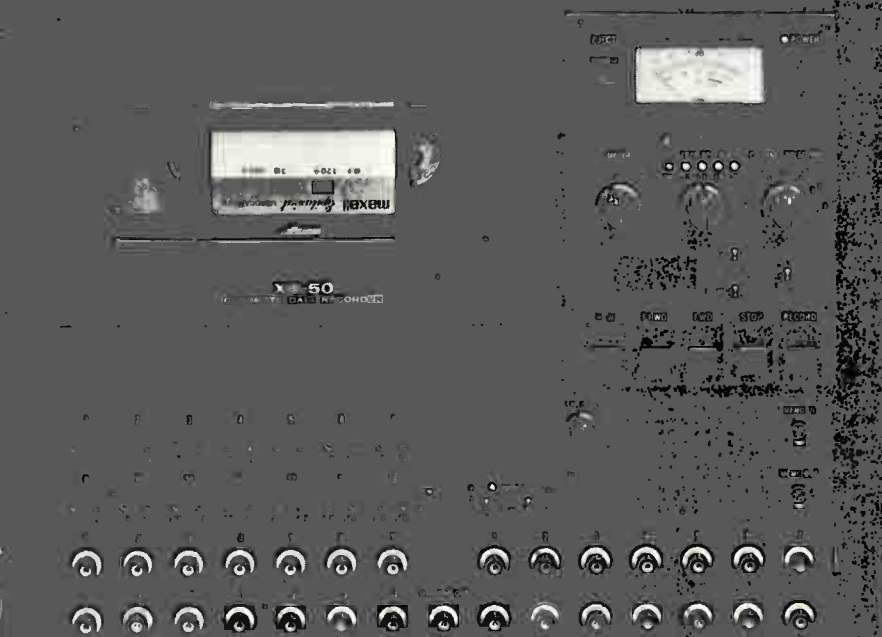





# TEAC

TEAC CORPORATION: 3-7-3 Naka-cho, Musashino, Tokyo, Japan Tel: (0422) 53-1111

- U.S.A. B.J. Wolfe Enterprise Inc., Tel: (213) 877-5518 • Canada R.H. Nichols Co., Ltd., Tel: (416) 661-3190 • Hongkong Dah Chong Hong Ltd., Tel: 5-261111, 5-226258
- Australia Jacoby Mitchell Pty. Ltd., Tel: (02) 26 2675 • South Africa Mayfair Sales (Pty) Ltd., Tel: (011) 29-2921 • Belgium & Luxemburg Simac Electronics, Tel: 02-219.24.53
- Denmark Danbit, Tel: (03) 141515 • France Tekelec Airtronic S.A. Tel: (1) 534-75-35 • United Kingdom International Recorders Ltd., Tel: 04427 5959 • Holland Simac Electronics B.V., Tel: 40-533725 • Italy A.E.S.S.E. S.P.A., Tel: 54 64.741-2-3 • Spain Atai Ingenieros S.A., Tel: 733 0562, 733 3700 • Sweden teleinstrument ab, Tel: 08-380 370
- West Germany nbn Elektronik GmbH, Tel: 08152/390

**CONCORD**  
ELECTRONICS CORPORATION

30 GREAT JONES ST., NEW YORK, N.Y. 10012  
(212) 777-6571 • TWX 710-581-4930

 GOLD PLATED P.C. JACKS	 SHORTING PLUGS
 INSULATED TIP PLUGS	 90° NYLON P.C. JACKS
 HEXAGONAL BINDING POSTS	 HANDLES
 INSULATED BANANA JACKS	 DUAL BANANA PLUGS
 BANANA PLUGS	 SOLDER TERMINALS
 DUAL BINDING POSTS	 TEFLON TERMINALS & TEST JACKS
 P.C. PINS	 SPACERS & STANDOFFS
 FLUTED BINDING POSTS	 P.C. JACKS
 PANEL JACKS	 P.C. TEFLON JACKS

**FOR OFF THE SHELF ELECTRONIC COMPONENTS CALL (212) 777-6571**

### Probing the news

Finland, has an atomic-layer-epitaxy panel that is now free of the defects that had been present when the technique was described earlier. The new approach is analogous to the molecular or atomic techniques used to make lasers, and the Finns have developed a redundancy configuration to avoid failures.

**Fatigue factor.** This year's symposium has one session and a panel discussion dedicated to human factors, a topic that was not covered in last year's meeting. This interest is partially due to the increasing prevalence of CRTs in the office, where their use in text editing and graphics generation creates fatigue—though apparently not when used at home for recreation. Recognizing in its advance program literature that "raster-scan displays of the type used in word processing and data entry have come under intense scrutiny" and that "some believe that these displays can cause headaches, eyestrain, and even cataracts," SID has decided to examine all sides of the issue at a panel discussion.

In another departure from last year, SID will run two sessions (instead of one) on hard copy, including such impact and nonimpact printing methods as thermal ink jet, electrophotographic, electrostatic, wire matrix, and thermal ink transfer. The last, covered by a paper from Oki Electric Industry Co. Ltd., Japan, uses solid ink formed continuously on a platen roller that, when exposed to the heat generated by a thermal head, transfers to plain paper. By expanding its coverage of printers, SID hopes "to recognize the marriage between printers and displays in the presence of the personal microcomputer," says Lakatos.

**Talking heads.** One of the more unusual presentations, a talking head display, will come from the Massachusetts Institute of Technology in Cambridge, Mass. It involves a three-dimensional surface in the shape of a person's face on which facial expressions are imaged in real time. The purpose of the display is to accurately represent the nuances of face-to-face conversation in teleconferencing.

# The NEW Electronics Buyers' Guide is now available!

Completely new listings of catalogs, new phone numbers, new addresses, new manufacturers, sales reps, and distributors! The total market in a book—four directories in one!



**The only book of its kind in the field.**

**If you haven't got it, you're not in the market.**

**To insure prompt delivery enclose your check with the coupon now.**

Yes, please send me \_\_\_\_\_ copies of 1980 EBG.

I've enclosed \$30 per copy delivered in USA or Canada. Address: EBG, 1221 Avenue of the Americas, New York, N.Y. 10020.

I've enclosed \$52 for air delivery elsewhere. Address: EBG, Shoppenhangers Road, Maidenhead, Berkshire S16, 2Q1 England.

Name \_\_\_\_\_

Company \_\_\_\_\_

Street \_\_\_\_\_

City \_\_\_\_\_

State \_\_\_\_\_ Zip \_\_\_\_\_ Country \_\_\_\_\_

# Type MS Non-Inductive Power Film Resistors from CADDOCK optimize high-speed power switching:



## 1. Caddock's "Non-Inductive Design" can improve rise and fall times to minimize losses in power switching circuits.

To keep the inductance to an absolute minimum, the special serpentine pattern provides for neighboring lines to carry the current in opposite directions to achieve maximum cancellation of flux fields over the entire length of the resistor.



The result is a truly non-inductive resistor that is about as inductive as a straight piece of wire the length of the resistor body.

This makes it possible for engineers to design new circuit configurations with superior non-inductive performance.

## 2. Extended-life stability that is typically better than 0.05% per 1000 hours.

Extended load-life tests at full power have demonstrated typical stability better than 0.05% per 1000 hours.

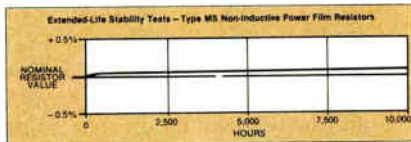

Detailed stability data is included in the "Reliability Test Summary - Caddock Report #1" which is available on request.

## 3. Higher voltage and power ratings extend the maximum 'critical' resistance value.

Caddock's Micronox® film resistor technology permits single-resistor voltage ratings as high as 6000 volts to be combined with power ratings of 12.5 watts at +25°C. This combination of power and voltage provides a 'critical' resistance value of 2.88 Megohms - more than 10 times higher than can be achieved with wire-wound construction.

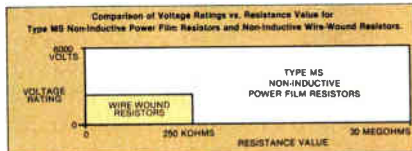

The higher voltage rating of Type MS resistors also overcomes the resistance value limits imposed on wire-wounds by the minimum wire size and spacing.

## 4. The special construction of Micronox® resistors assures high performance through harsh environments.

Type MS Power Film Resistors are produced by firing high-stability Micronox® resistance films directly onto a solid ceramic core - in air - at +1400°F to achieve a structure with these special performance advantages:



- Operating temperatures as high as +275°C.
- Repeatable temperature characteristics that include a TC of only 50 PPM/°C.
- Verified reliability through environmental extremes encountered in both 'down-hole' oil exploration and deep-space instrumentation equipment.

## 5. The family of Type MS Power Film Resistors includes 14 models with single-resistor values to 30 Megohms.

To overcome the construction and cost limitations inherent in wire-wound resistors, Caddock Micronox® film resistor technology gives circuit designers a *practical* balance between performance, value, size and cost, as the specifications for the Model MS 313 demonstrate:



- Non-inductive performance.
- 12.5 watt power rating.
- Resistance values from 50 ohms to 30 Megohms.
- Resistance tolerances from  $\pm 1.0\%$  to  $\pm 0.1\%$ .
- Maximum operating voltage of 6000 volts.
- Unit prices below \$2.50 on 1000-lot orders for any value between 100 ohms and 200 Kohms.

## 6. Overloads of 5-times rated power for 5 seconds and 20-times rated power momentary are standard on all models.

After repeated power overload tests that apply 5-times rated power for 5 seconds, Type MS resistors have demonstrated stability typically better than 0.1%

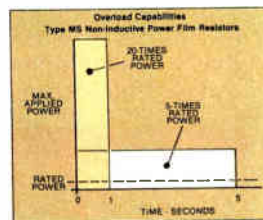

For even higher overload situations, Type MS resistors can be subjected to 20-times the rated power for one second.

Caddock's advanced film resistor technology is the source of these outstanding advantages - advantages that are matched by an 18-year record of outstanding 'in-circuit' reliability.

Discover how easily these problem-solving resistors can improve the performance and reliability of your equipment, too. For your copy of the latest edition of the Caddock 20 page General Catalog, and specific technical data on any of the more than 150 models of the 13 standard types of Caddock High Performance Film Resistors, just call or write to -

Caddock Electronics, Inc., 1717 Chicago Avenue, Riverside, California 92507 • Phone (714) 788-1700 • TWX: 910-332-6108

# CADDOCK

HIGH PERFORMANCE FILM RESISTORS

Software

# Major firms join Unix parade

Transparent versions of operating system make it available for computers ranging from mainframes down to microsystems

by R. Colin Johnson, *Microsystems & Software Editor*

**Devotees of Unix**, the operating system whose responsiveness has been compared to that of a well-tuned sports car, are adding to their number almost daily. This rapid expansion of the user base of Unix, developed at Bell Laboratories and licensed by Western Electric Co., has been spurred by the emergence of user-transparent versions made for computers ranging in size from the likes of IBM System 370 mainframes down to Z80-based 8-bit microcomputer systems.

Item: Texas Instruments Inc., Dallas, long known for its comprehensive software development system, is planning to implement Unix through a subcontract with a third-party software house.

Item: Lifeboat Associates, a leading 8-bit software publisher in New York, has just signed an exclusive marketing contract with Microsoft for end-user sales of its 16-bit Xenix-11 adaptation for PDP-11s.

Item: Intel Corp.'s Ada compiler

for the iAPX 432 [*Electronics*, Feb. 24, p. 119] is written in Pascal on a VAX-11/780 under Unix. (When asked why Unix was used when the final compiler release will be under VMS, Nicole Allegre, Ada program manager for the Santa Clara, Calif., company, responds, "The programmers just really wanted to use it.")

**Obeys orders.** Those programmers at Intel are not alone. Their counterparts across the country have been taken by Unix's responsive software-development environment. Also, the language in which the original Unix is written, C, is one of the most respected of the structured languages extant [*Electronics*, May 8, 1980, p. 129].

Since Unix was developed on Digital Equipment Corp. machines, it has been widely used on PDP-11 minicomputers for some time. However, now that Western Electric allows systems with only a few users to pay a special per-user royalty fee, it has become economical for com-

mercial software houses to configure Unix for even inexpensive systems. An increasing number of original-equipment manufacturers and commercial software houses should start offering Unix for various other computer systems.

Unix is in fact making a strong bid to become a standard among operating systems for the new wave of 16-bit microsystems, though it faces stiff competition from the entrenched operating system family from Digital Research, Pacific Grove, Calif. When that company's 16-bit implementation of its MP/M becomes available, it will include many of the facilities that make Unix so desirable—plus CP/NET, which allows both 16- and 8-bit microsystems to share expensive peripherals. OEMs can look forward to a rich selection of system-level software packages from which to choose. Even the 8-bit microsystems are acquiring Unix-like capabilities without having to sacrifice CP/M capability.

**Drawbacks.** Unix is not without its critics. They say that the system cannot be used easily by clerical personnel and cite difficult operations, like rebuilding the linked list that describes the hierarchical file structure after a system crash. Some say that Unix does not provide adequate file-protection systems to make it completely trustworthy in commercial uses.

Such criticism stems from Unix's initial target: cooperative multiprogrammer software projects in which most of the users were professional computer specialists. That is why many of the facilities provided by it are specifically aimed at efficient

UNIX AND UNIX-LIKE OPERATING SYSTEMS

Processor or computer	Company	Name	Bell Laboratories' version	Original implementation
Z8000	Zilog Microsoft	Zeus Xenix	✓ ✓	
Z80	Cromemco Morrow Designs	Cromix μNIX		✓ ✓
LSI-11 and PDP-11	Whitesmiths Microsoft Mark Williams Co.	Idris Xenix-11 Coherent	✓	✓ ✓
6809 68000	Tech System Consultants	Uniflex		✓
C/70	BBN Computer	Unix	✓	
470	Amdahl	UTS	✓	
All Perkin-Elmer 32-bit Machines	Wollongong Group	Unix	✓	

Source: *Electronics*



# 4K CMOS RAMs

NOW Available From  
Solid State Scientific.  
The SCM5114 Family.

**The fast, non-clocked RAM.** The fully static SCM5114 4K CMOS memory from Solid State Scientific is the industry's popular replacement for the NMOS 2114 RAM due to its high density and low power requirements. The SCM5114 has true TTL compatibility and has equal access and cycle times.

**Advancing performance. Cutting costs.** Solid State Scientific has achieved higher density and improved performance through its high-density CMOS (HCMOS) process. This new process produces a family of memories with four times the density in the same space. The advantages are less power, high reliability, fast access times, low warranty costs, reduction in labor, less expensive power supplies and fewer sockets. With this capability as much as a 75% savings can be achieved in parts and other related expenses.

## SCM5114 Operating Characteristics

Device Type	Access Time $t_A$ (Max.)	Standby Current $I_{CCSB}$ @ 5V (max.)	Data Retention Voltage
SCM5114-1	200 ns	50 $\mu$ A	2.0V
SCM5114-3	300 ns	50 $\mu$ A	2.0V
SCM5114-5	300 ns	400 $\mu$ A	2.0V
SCM5114-8	450 ns	800 $\mu$ A	4.5V

**Need more information?** Call your local Solid State Scientific representative for further information on the SCM5114 family. You can contact us for your local representative at (215) 855-8400 or write Solid State Scientific, Inc., Montgomeryville, PA 18936.



# Solid State Scientific

World Radio History

Circle 109 on reader service card

# **SCIENCE/SCOPE**

An antenna built to extremely close tolerances is a key element of a military weather satellite that will use a microwave sensor to gather vital data about clouds, rain, wind speed, soil moisture, and sea ice. The dish, cast in a mold that was machined to an accuracy of 0.4 mils from a single 1500-pound block of steel, consists of 20 layers of high-performance graphite fabric and an epoxy resin. Coating it is a vacuum-deposited layer of aluminum 0.0002 inch thick. The antenna is designed to an accuracy of less than 1 mil and will operate over temperatures ranging from -120°F to 180°F. It will detect radiation in four frequency bands: 19, 22, 37, and 85 GHz. Hughes built the antenna for the Defense Meteorological Satellite Program under a U.S. Air Force contract.

Tactical cruise missiles can be guided to a target, despite electronic jamming, using signals from navigation satellites. Flight tests over nine months demonstrated extremely accurate midcourse guidance of a Navstar Global Positioning System (GPS) missile guidance system, which was mounted in a pod beneath an F-4 fighter. The system even flew over a simulated high-power jammer without breaking its tracking lock. Tests were conducted by Hughes for the U.S. Air Force.

An optical chip the size of a stick of chewing gum can do the job of conventional electronics equipment the size of a two-drawer file cabinet in analyzing and identifying microwave frequencies. The chip is called an optical planar waveguide and is part of a larger device known as an integrated optical spectrum analyzer (IOSA). The IOSA uses a beam from a tiny semiconductor laser to separate a broadband microwave signal into as many as 100 individual frequencies. A key feature of the planar waveguide is two concave lenses ground into the chip's surface. The first lens collimates the laser light so it travels correctly through the microwave acoustic signal, which bends the beam. The second lens focuses the bent beam into one or more of 100 charge-coupled detectors. Hughes developed the IOSA for the U.S. Air Force for microwave signal processing.

Hughes is seeking engineers to develop advanced systems and components for such weather and communications satellites as GOES E and F, Anik C, Anik D, GMS II, SBS, Westar IV/V, Palapa B, and Telstar III, plus the Galileo Jupiter Probe. Immediate openings exist in advanced communications, scientific and engineering programming, systems test and evaluation, microwave and RF design, power system design, spacecraft alignment, reliability, and quality assurance. Please send your resume to Tom W. Royston, Dept. SE, Hughes Space & Communications Group, P.O. Box 92919, Los Angeles, CA 90009. Equal opportunity employer.

A new atomic clock being developed for navigation satellites will perform better than previous devices. The clock, which incorporates a hydrogen maser, will use a new microwave cavity design to provide a compact and lightweight package, and new electronic techniques to maintain long-term stability. The clock can provide precise navigation information to military forces because it is stable to one second in 3 million years. The differences in the time when signals from four satellites arrive at one location can be used to calculate that position to within a few yards. Hughes is developing the clock under a U.S. Navy contract.

*Creating a new world with electronics*

**HUGHES**

HUGHES AIRCRAFT COMPANY  
CULVER CITY, CALIFORNIA 90230

# Next Time You Travel On Business, Don't Let Important Things Wait.

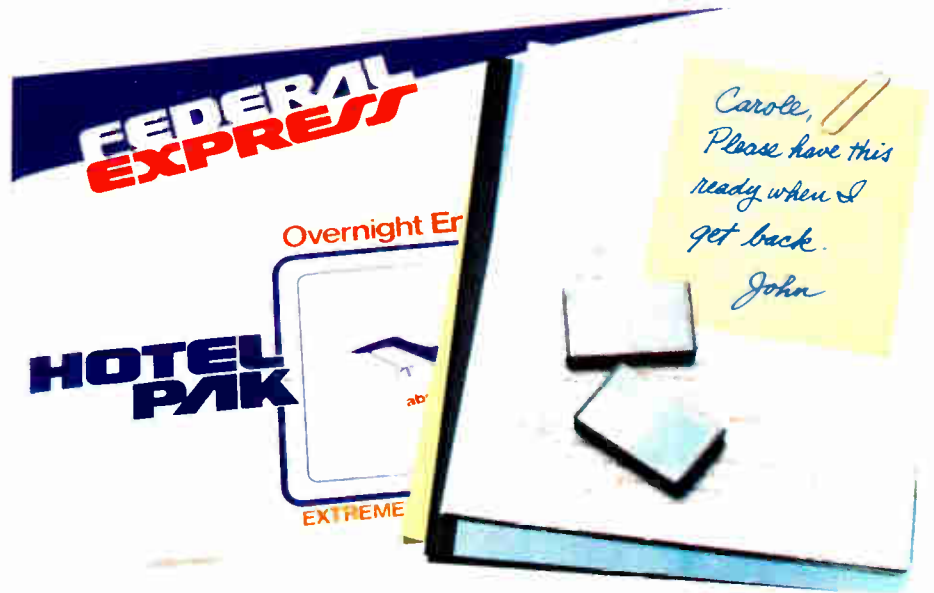

INTRODUCING THE ONLY OVERNIGHT DELIVERY SERVICE RIGHT FROM YOUR HOTEL:

## FEDERAL EXPRESS HOTEL PAK<sup>SM</sup>

You're away on business for a few days. You come back with a pile of crucial stuff. Work you took with you, or picked up out of town. Now it has to be finished—fast. Your secretary goes crazy, or goes elsewhere. And you wonder why it has to be this way. It doesn't.

Now when you're away from the office, you're really not. You can send important items back from your hotel, overnight.\* Or on to another office, overnight. Or to any of 13,000\* U.S. places, overnight.

Think of what that means. You'll never have to put off an important trip. Or come back before you should. Because any work needed back at the office gets back overnight, in a Hotel Pak.

There's never been a convenience like Hotel Pak, ever. You can send anything from contracts to computer parts, briefs to blueprints, samples to securities. It's inexpensive. You can charge it to your room or credit card. And it's as easy as sending out your laundry. Once you use Hotel Pak, business travel will never be the same again. Thank goodness.

How Hotel Pak works and where to find it is all in a kit that's yours for the asking. Mail the coupon now. Or call 800 238-5355. In Tennessee, 800 542-5171.

### FEDERAL EXPRESS

When it absolutely, positively has to be there overnight

\*Monday through Friday. Saturday delivery by special request only and at an additional service charge. Areas served, delivery times, and liability subject to limitations in the Federal Express Service Guide. ©1981 Federal Express Corporation.

### Free Travel Alarm Clock Offer.



Here's how sure we are that Hotel Pak will make a productive, profitable difference in your business trips. Try Hotel Pak just once and we'll send you, absolutely free, this beautiful quartz travel alarm. It sells for \$20. To get it, send your

copy of a validated Hotel Pak receipt and your business card to

**FEDERAL EXPRESS Clock Offer**  
Box 727, Dept. 250-022, Memphis, TN 38194

Offer limited to one clock per customer. Offer expires June 1, 1981. Allow 6 to 8 weeks for delivery. Supplies are limited. Void where taxed, prohibited or otherwise restricted. Federal Express reserves the right to substitute equal value clocks depending upon availability.

**Hotel Pak is available at participating locations of** Hilton, Hyatt, Marriott, Radisson, Sheraton, Westin Hotels, as well as at Americana, Brock, Doubletree, G.E. Springer, Helmsley, Host International, Howard Johnson's, and Stouffer Hotels.

### Free Hotel Pak Travel Kit.

**FEDERAL EXPRESS Free Hotel Pak Travel Kit**  
Box 727, Dept. 250-022, Memphis, TN 38194

**It's about time, Federal.** Please rush your Hotel Pak Travel Kit containing a Hotel Pak brochure, envelope, airbill, and directory of participating hotels.

NAME \_\_\_\_\_

TITLE \_\_\_\_\_

COMPANY \_\_\_\_\_

ADDRESS \_\_\_\_\_

CITY \_\_\_\_\_

STATE \_\_\_\_\_ ZIP \_\_\_\_\_

EL

program development. On the other hand, Unix is probably best known for its document-preparation and -management functions, which are often used by nonprogrammers. And with the addition of a good screen-oriented editor, like Zilog's visual editor, Unix offers a wide avenue of capability for professionals and non-programmers alike.

**New version.** One of the latest Unix versions is the Zeus adaptation by Zilog Inc. Cupertino, Calif., for its Z-Lab software development system using the Z8000 [*Electronics*, March 24, p. 120]. And to be released next month to selected OEMs is the Z8000 version called Xenix from Microsoft in Bellevue, Wash. [*Electronics*, March 24, p. 34]. Among the first of the OEMs is Codata of Sunnyvale, which is working on a floppy- and hard-disk-based microsystem that makes use of a Multibus-compatible central processing unit. Later this year, the 8086 version of Xenix is to be delivered to Altos Computer Systems of Santa Clara for its single-board 8086-based microsystem.

After that, Microsoft plans to release a 68000 version (as does Whitesmiths Ltd. of New York in an original implementation), with an eye to the iAPX-432 and the 16000 in an attempt to establish Xenix as the standard version of Unix for 16-bit microsystems. Not only is Microsoft dedicated to marketing Unix, but it is also dedicated to using it: all product development programming in its Consumer Products division is done in C on a PDP-11/70 under Unix and then transported to the target microsystem.

The first computer to which the operating system was transferred from the one on which it was developed was the Interdata 8/32. The Wollongon Group of Palo Alto, Calif., now offers Unix for the 8/32, as well as for the rest of Perkin-Elmer's 32-bit minicomputers (Perkin-Elmer having bought Interdata).

**The same.** In the Wollongon offering, a supreme attempt has been made to make this implementation virtually identical to the original as it appears to the user, in the interest

# VACTEC

INFRARED  
OPTICAL  
SWITCHES,  
LED'S, DETECTORS

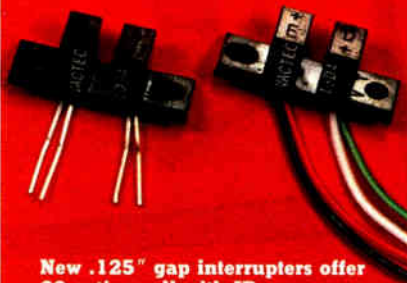

New .125" gap interrupters offer 22 options all with IR transmitting seamless plastic housing. No seams or openings to collect dust

Some options are:

- .005" or .010" internal apertures
- completely sealed units
- can be immersed in cleaning solvents
- various sensitivities
- flying leads

Write for bulletins on VTL10D, VTL11D, VTL12D, VTL13D series.



OR ASSEMBLE YOUR OWN switch from a pair of clear thin line packaged GaAs emitters, phototransistors or photodarlington with integral molded lens. 12 detector types—4 emitter types as well as matched pairs available.

Write for bulletins on VTM-712, VTE-712, and VTT-712 series.

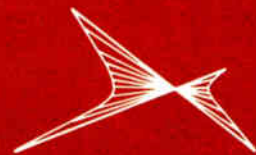

**VACTEC, INC.**

10900 Page Blvd.  
St. Louis, MO 63132  
(314) 423-4900  
TWX 910-764-0811

## Probing the news

of program portability and of preserving a common command language across Unix systems.

Unix is also available from Amdahl Corp. for its IBM 370 look-alike, the 470 mainframe, and even for a computer that is specially optimized for the C language—the C/70—from BBN Computer Corp. [*Electronics*, Nov. 6, 1980, p. 46]. These, like the others, are licensed by Western Electric.

However, before the licensing procedures were changed to accommodate small systems, several software developers began work on Unix look-alikes. These user-transparent, yet original, implementation projects are now coming to fruition.

One that has been around for more than a year is Whitesmiths' Idris [*Electronics*, March 24, 1981, p. 125]. Some of the newer ones are aiming at the 8-bit market to maintain compatibility with current software bases. Two, for Z80-based microsystems using the S-100 bus, come from Morrow Designs of Richmond, Calif., and Cromemco Inc. of Mountain View, Calif., respectively.

**Subtasks.** Morrow Designs' version, called  $\mu$ NIX, runs CP/M as one task within its multiuser environment, thereby maintaining compatibility with CP/M software while gaining the conveniences of a user-transparent Unix. The emphasis throughout has been on compatibility and portability;  $\mu$ NIX is written entirely in Whitesmiths' C, which is not supplied with the package. Cromemco's version runs the CDOS operating system as a subtask and maintains compatibility with that already extensive software base, including its new C compiler.

There is even a version, from Technical System Consultants Inc., for Southwest Technical Products Corp.'s 6809-based 128-K-byte microsystem. Called Uniflex, it is written entirely in assembly language and includes most of Unix's features; it supports both floppies and a 20-megabyte hard disk. The West Lafayette, Ind., firm will add a 68000 version soon and is looking to Ada, Pascal, and C for future high-level language projects. □



The use of our large experience in the electronic industry for know-how, engineering, licences, technology, studies, design, manufacturer's marks, complete assembling lines, technical assistance, training of the staff, services, would certainly give you a complete satisfaction.

High qualified specialists of a large experience are ready to answer accurately your most exigent demands just contact them!

Ask for technical data and any other informations on the following address:

**ELECTRONUM**  
EXPORT — IMPORT  
Specialized Foreign  
Trade Company  
**70317 Bucharest-Romania**  
11-15, Olari Street  
P.O.B.: 34-36  
Telex: 11547, 11584



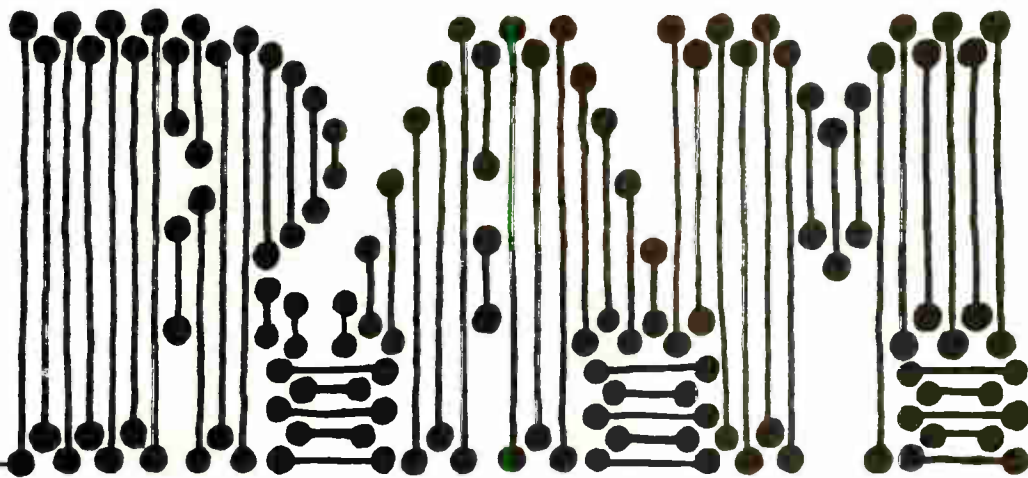

## ALTERNATIVE PROCESSING METHOD FOR INDUSTRY AND ELECTRONICS



Lith development is not always strictly necessary, for example in industry or in electronics, when carrying out the preparatory photographic work. Or when using an exposure system producing needle-sharp results, for instance on the high-quality Copyline HDU films by means of a photo plotter.

In these cases you may use the R.A.M. method (Rapid Access Metal-hydroquinone processing). From dry to dry in 90 seconds. A welcome gain of time! High transport speed and therefore a large throughput. With R.A.M. no need for replenishment! Your solutions will remain stable for a long time.

Our assortment is truly complete: small, medium and large processors, films and papers for every conceivable application, processing solutions, accessories, etc.

Ask for more information on the Rapid Access Metal method.

AGFA-GEVAERT N.V.  
B-2510 Mortsel-Belgium

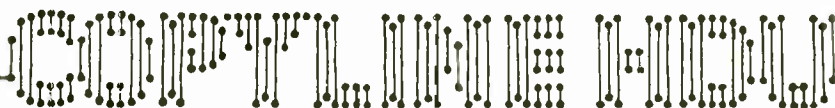

**AGFA-GEVAERT - your go-ahead partner!**

## How HP-IB helped AVCO/Lycoming slash engine test time 50%...

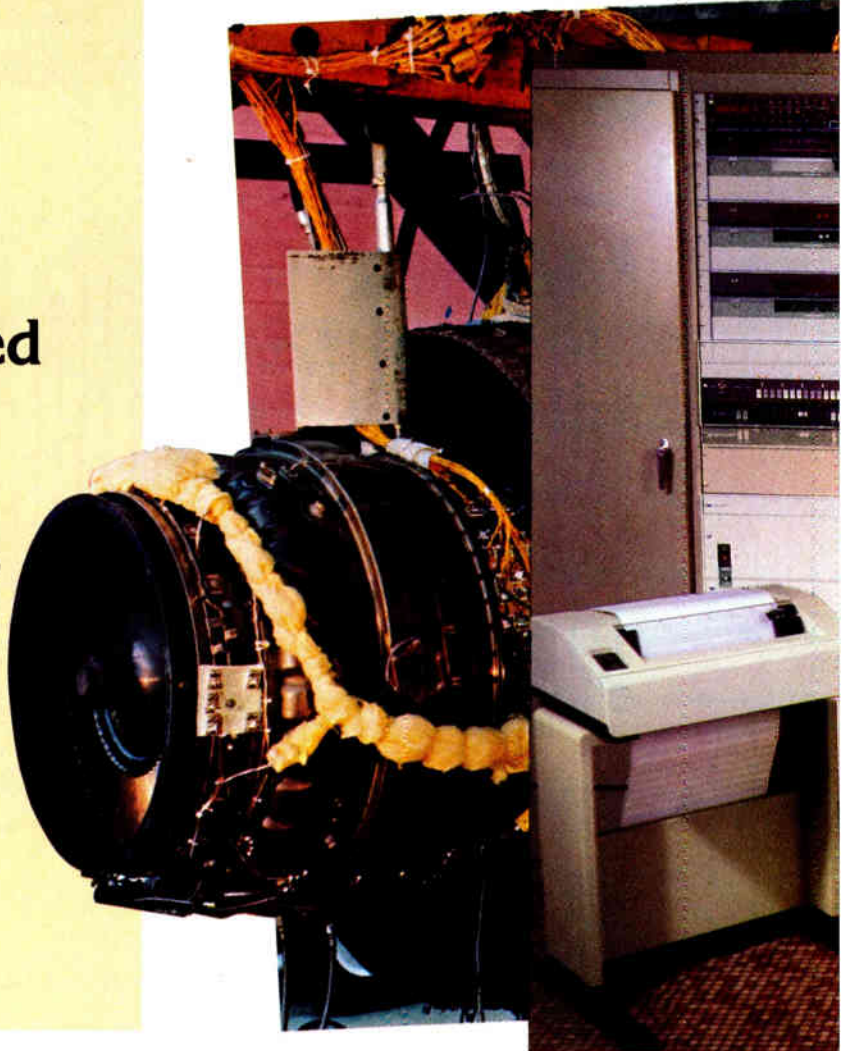

AVCO's Lycoming Division, in Stratford, Connecticut, has long been known for the production of tough, dependable gas turbine engines for commercial aircraft and the military. Given the nature of its prime customers, this reliability must not only be designed in; it must be tested and proved at every stage of development. Thus, real time test data acquisition and analysis are critical to the company.



Edward Twarog, Lycoming's Manager of Electronics and Instrumentation, recommended the use of an HP-IB (Hewlett-Packard Interface Bus) system for developmental testing, because "this system is twice as fast as our previous data acquisition system, yet can be handled by a single engineer and one technician vs. the engineer and two technicians previously required.

Just as important, the combination of HP 1000 computers and HP-IB instruments not only gives us the performance data we need; it gives it to us in engineering units that allow instant reaction, and, therefore, real time decision-making."

### 408 variables in 20 seconds.

Lycoming's HP-IB system is a closed-loop configuration. An HP 1000E is used to start the engine under test and operate it at various predetermined speeds. A total of 408 different variables can be monitored by HP instruments, which then feed this data back to the 1000 for data reduction and analysis. All told, these 408 variables — including pneumatic pressure, hydraulic pressure, temperature, speed, flow, position, vibration and torque/thrust — are acquired in 20 seconds.

"This system," Twarog reports, "not only gives us the accuracy we need but improves measurement sensitivity, and provides complete repeatability, since all engine and test parameters can be stored on tape or disc. This system will even give us an audible warning if something goes wrong with the test, or the test will be automatically shut down before any damage occurs."

### Serving many masters.

Twarog also reports that Lycoming's HP-IB system must be flexible enough to serve many engineers. In any given week, engineers from Lycoming's Design, Performance, Dynamics, Stress and Heat Transfer Groups may all be using the system working in any of AVCO's seven engine test cells on this distributed system. "We like the fact that a test engineer can perform his initialization on magnetic cassettes, load this data to the host HP 1000E, then download it to a satellite 1000E and suddenly, the system is doing exactly what he wants it to do — with no starting from scratch each time. This provides us with a very cost-effective solution to our needs."

### One-stop shopping.

Lycoming chose the HP 1000Es to drive this automatic data acquisition system for two other important reasons. "We went to HP," Twarog explains, "because it's an instrumentation house. We felt they understood our needs and objectives better than any mainframe manufacturer. This also permitted us to enjoy 'one-stop shopping,' with a single manufacturer supplying both the computers and the test instruments.

"Second, in our case, we found the HP products just connected and worked. In addition to the two HP Satellite 1000Es and 1000E Host and two HP 5 Megabyte hard discs,



with no sacrifice  
in configuration  
flexibility or  
start-up time.

our data acquisition system also includes an HP 3455A Digital Voltmeter, three 3495A Multiplex Scanners, and two HP 2240A Measurement and Control Processors. HP-IB makes these instruments so easy to configure, we've just never had a problem."

**What to look for in system design.**

When you design and build instrument systems, make sure you get more than plug compatibility. HP, as a manufacturer of instruments and computers, offers you much more to help you achieve a working measurement solution in a minimum of time. That includes comprehensive documentation, training courses, applications information, systems engineering support, and on-site service.

Find out how an HP-IB system might solve your test and measurement needs. Simply write for our free brochure, "Do your own system design in weeks, instead of months." Hewlett-Packard, 1507 Page Mill Road, Palo Alto, CA 94304. Or call the HP regional office nearest you:  
East (201) 265-5000,  
West (213) 970-7500,  
Midwest (312) 255-9800,  
South (404) 955-1500,  
Canada (416) 678-9430.



**HP-IB: Not just a  
standard, but a  
decade of experience.**



**HEWLETT  
PACKARD**

08017

# The Wizards of ALPS

Carbon resistive element and silver conductive track are printed on phenolic board and fired, allowing greater control over thickness and uniformity.

Dual variable resistor formed — using same casing, rotor, and phenolic board — by simply printing four tracks instead of two on phenolic board, and ...

...replacing the single contact with two

Portion of contact which actually touches carbon resistive element is divided into three "fingers" to ensure reliable electrical contact.

"Springs" molded into plastic rotor maintain precise, constant pressure of rotor against casing, for smooth turning action.

Standard rotors are produced in a wide range of sizes at the shaft end — to accommodate knobs, or to act as knobs themselves.

Precision punching technique produces exceptionally smooth surface on inside of casing, enhanced by special lubricant developed by Alps.

Precision molding technique produces exceptionally smooth surface on rotor, for smooth turning action.

K16 SERIES

Shown here are our 16mm single shaft single and dual rotary standard pots. In addition we offer 16mm multi-unit pots, and 12mm standard and double-shaft pots,

**plus:**

detent and mini-detent type rotary pots; metal glaze, solid, carbon film, and metal glaze/carbon film trimmer pots; and seven series of slide pots.

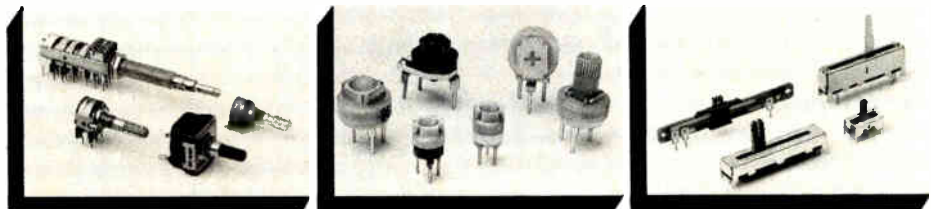

**ALPS ELECTRIC (U.S.A.) INC.**, 100 N. Centre Ave., Rockville Centre, NY 11570 / 516-766-3636 / TLX (23) 014-4508



# make rotary variable resistors that turn with velvety smoothness, and are far more reliable than others costing a good deal more.

That lovely smooth action is the result, first, of precision molding and punching techniques that create a rotor and a casing with exceptionally smooth surfaces to slide against each other; second, a secret lubricant; and third, (a particularly brilliant piece of wizardry), a springiness molded into the rotor that keeps it pressing against the casing with exactly the proper pressure.

The reliability comes, first, from the fact that we, unlike other people, print the carbon resistive element on the phenolic board, and then fire it. This lets us closely control its thickness. We can also print several hundred at the same time, test them all, and only punch out the good ones for use in resistors. The second source of reliability is the multi-fingered contact. The third is simplicity: only seven parts are used in the single resistor, eleven in the dual. (We've detailed all of this for you on the opposite page, together with an explanation of how our Wizards have contrived to put a single or a dual unit in the same casing.)

The fourth source of reliability is the total in-house control we exercise over every part of everything we make. That control actually starts with the selection of the basic raw materials. We do all our own tooling, punching, stamping, and molding; and we design a special machine to make every part, and to

assemble the finished product. And our demanding QC wizards keep the number of failures to an incredibly low number per million.

Alps may not be a familiar name to you, but it's a very familiar and highly respected name to OEM design engineers in all other parts of the world. Now in our 33rd year, we've long been known as one of Japan's most innovative manufacturers, and our nine factories

produce a tremendous variety of electro-mechanical and electronic components, from television tuners to variable capacitors and key switches, from digital impact printers to cassette mechanisms.

You'll certainly want to know more about us, about our rotary, as well as slide, variable resistors and trimpots, and about our other products. To make it easy for you to do so, we've provided a coupon which we invite you to fill out and mail today.



Call me to discuss my application

My parameters are:  
\_\_\_\_\_

My project volume is:  
\_\_\_\_\_

Send literature on:

Variable Resistors:

- Rotary    Slide    Trimpots
- Tact Switches
- Keyboard Switches
- Push Switches
- Slide Switches
- Flex Switches
- Rotary Switches
- Power Switches
- Lever Switches

My application is

Now    6 months    Future

Name \_\_\_\_\_

Co. \_\_\_\_\_

Dept. \_\_\_\_\_

Tel. \_\_\_\_\_

Address \_\_\_\_\_

City \_\_\_\_\_

State \_\_\_\_\_ Zip \_\_\_\_\_

**ALPS ELECTRIC  
(U.S.A.) INC.**  
100 N. Centre Avenue,  
Rockville Centre, NY 11570  
516-766-3636



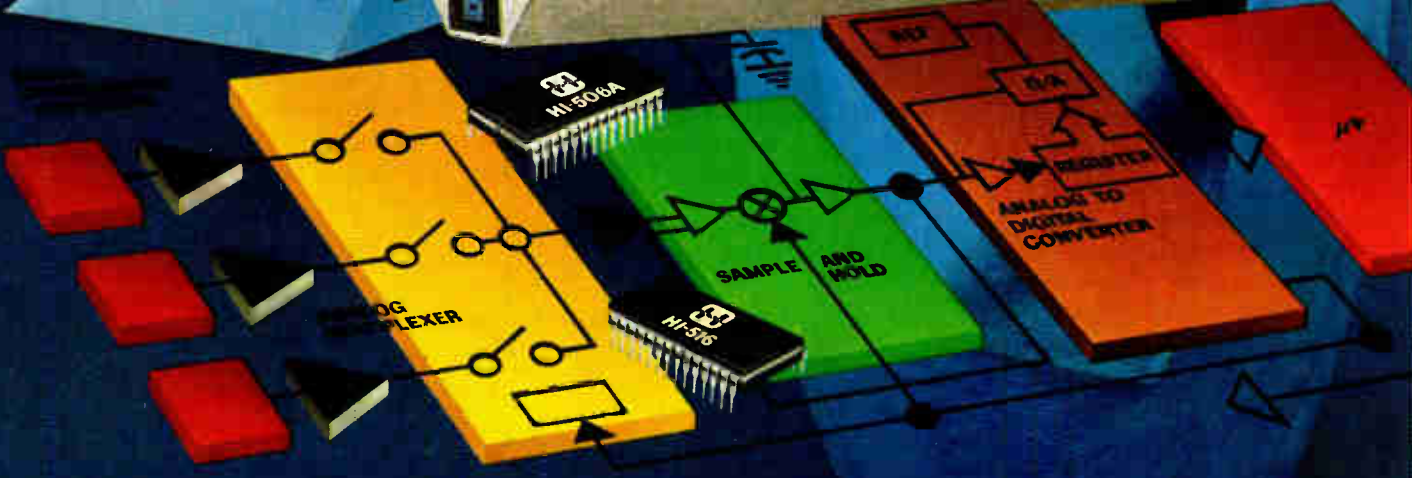
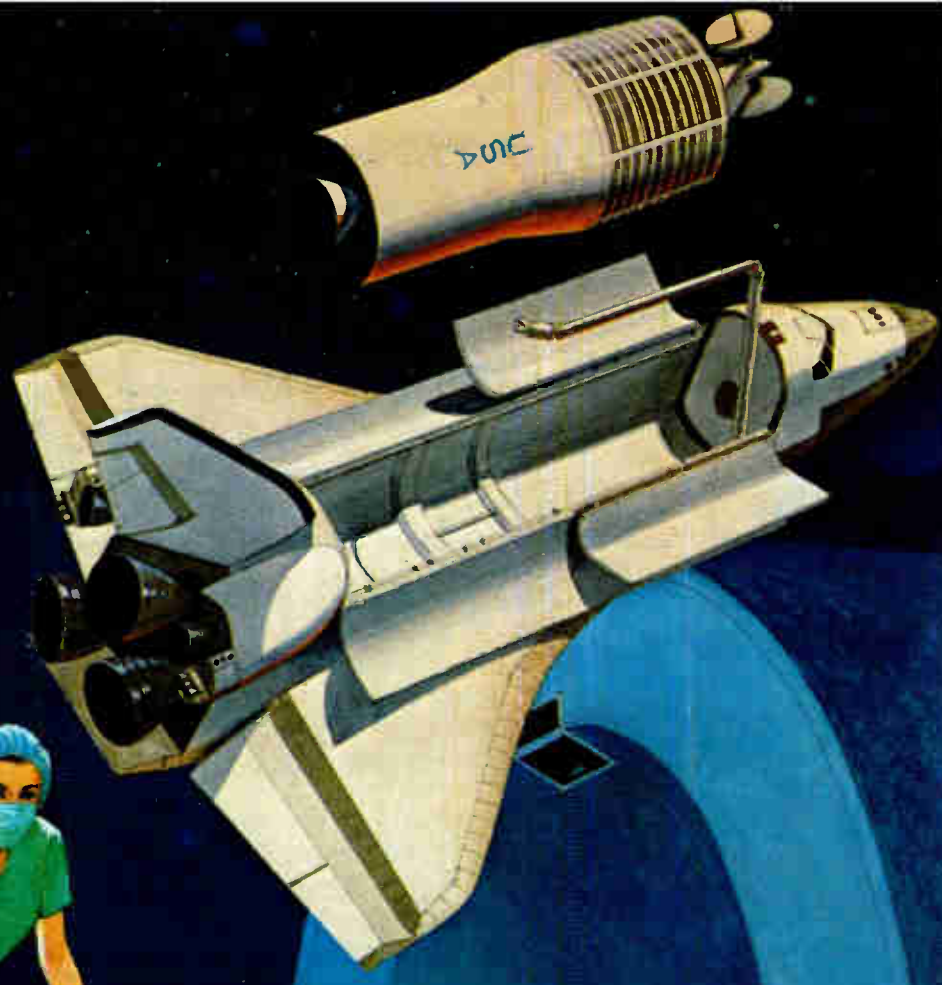

Harris Technology at Work

# Harris mux technology delivers max system performance.

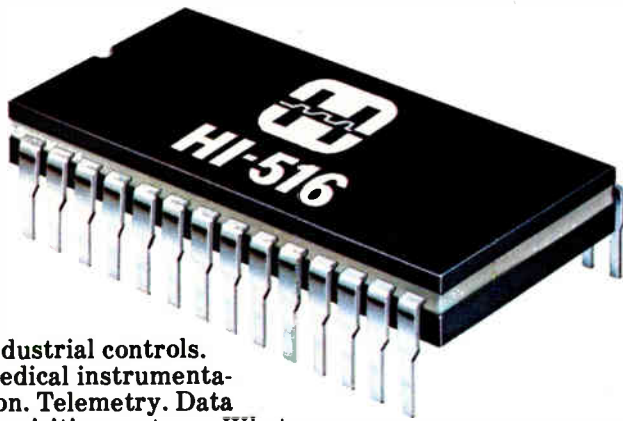

Industrial controls. Medical instrumentation. Telemetry. Data acquisition systems. Whatever the application, systems designers look to Harris Semiconductor for the industry's most advanced family of analog multiplexers. All feature Harris' unique Dielectric Isolation (DI) processing. And that means outstanding performance and reliability.

**Ultra-High Speed.** Looking for unprecedented speed? The HI-516 and HI-518 are prime examples. How about 600 ns settling to 0.01% accuracy! And these two speedsters can be configured under logic control for 16-channel or 8-channel differential (HI-516), or 8-channel or 4-channel (HI-518) operation, for maximum flexibility:

## HI-516/518

- Single/Dual Operation — 16/8 Ch.
- Mode Programmable
- Fast Access Time — 100 ns
- Fast Settling Time — 600 ns (.01%)
- Low Leakage — 35 pA
- Low Charge Injection — 0.3 pC
- High Off Isolation — 80 dB

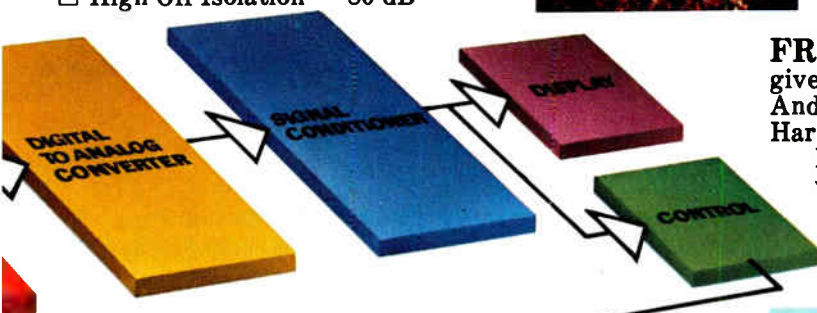
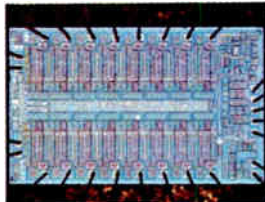

## HI-524 — WORLD'S FIRST VIDEO MUX!

- 4 Video Channels
- High Input B.W. — 20 MHz
- Fast Access Time — 150 ns
- High Off Isolation — 72 dB (5 MHz)

**Low Cost — Low Power.** Popular Harris multiplexers like the HI-506/507 and HI-508/509 include 16-channel and 8-channel differential versions that are TTL, DTL and CMOS compatible:

## HI-506/507/508/509

- 16 and 8-Channel Versions
- Access Time — 300 ns
- Off Isolation — 75 dB
- Low Power Dissipation — 4mW/Ch.
- Low Cost — 63 cents/channel (1K qty)

**Input Protected — Low Power.** Overvoltage protection? Take a look at the Harris HI-500A Series. These clever muxs withstand loss of power supply voltages and overvoltages up to 20 volts without faulting the output or any input channels. This feature gives you another competitive edge in system reliability:

## HI-506A/507A/508A/509A

- 16 and 8-Channel Versions
- Access Time — 300 ns
- Analog Input O.V. Protected
- Low Power Dissipation — 0.5 mW/Ch.

**Optimum Quality.** Choose from five HI-500 Series quality grades to complement your application needs:

**Commercial/Industrial** (0°C to +70°C)

1. Standard, Dash 5 code
2. High-Reliability, Dash 7 code

**Military** (-55°C to +125°C)

3. Standard, Dash 2 code
4. MIL-STD-883B, Dash 8 code

**High-Temperature** (0°C to +200°C)

5. Standard, Dash 1 code

**FREE WALL CHART!** Harris multiplexers give you max performance. At competitive prices. And off-the-shelf delivery. For more examples of Harris technology at work, request your copy of the Harris Linear and Data Acquisition Products wall chart.

Use the Harris Hot Line, or write to:  
**Harris Semiconductor Products Division,**  
Box 883, Melbourne, Florida 32901.

**ON THE HORIZON**  
Exciting Harris Semiconductor Product  
Now in Development

HI-529 Low-Level Multiplexer

**HARRIS HOT LINE!**  
1-800-528-6050, Ext. 455

In Arizona: 1-800-352-0458, Ext. 455

Call toll-free (except Hawaii & Alaska) for phone number of your nearby Harris sales office, authorized distributor or expedited literature service. Or check your IC MASTER for complete product listing and specifications.

*Harris Technology*  
...Your Competitive Edge



**HARRIS**  
SEMICONDUCTOR  
PRODUCTS DIVISION  
A DIVISION OF HARRIS CORPORATION



# Our new 208 A/B is adaptable to either dial-up or dedicated use. What's your line?

■ Converts from dial-up to dedicated lines with only three straps ■ Bell-compatible ■ Smallest, lightest 4800 bps modem anywhere ■ 10W max power requirement ■ Adaptable to two- or four-wire private circuits ■ Front panel control permits switched network voice communication via standard telephone ■ Built entirely from standard, commercially available parts ■ Compatible dialer available now ■ Modular back panel accepts standard telephone jacks.

For full technical details, contact Universal Data Systems, 5000 Bradford Drive, Huntsville, AL 35805. Phone: 205/837-8100. Telex: 810-726-2100.

"Confidence in Communications"

## Universal Data Systems



Member  
IDCMA

DISTRICT OFFICES: Birmingham, AL 201/322-0025 • Blue Bell, PA, 215/643-2336 • Atlanta, 404/998-2715 • Chicago, 312/441-7450 • Dallas, 214-355-0428 • Santa Ana, 714/712-4819 • Sunnyvale, 408/738-0433 • Boston, 617/875-8868.

See us at NCC: Booth 5301-5304

Created by Dayner/Hall, Inc., Winter Park, Florida

Circle 120 on reader service card

# Multifunction chip plays many parts in analog design

Containing TTL-gated transconductance amplifiers, a buffer, and a comparator, the device cuts the components count of data-conversion and control systems

by David L. Gillooly and Paul Henneuse, *Precision Monolithics Inc., Santa Clara, Calif.*

□ Unlike the digital world, which virtually revolves around the highly adaptable microprocessor, the analog world has lacked any such single-chip general-purpose building block. True, specific, widely used analog functions, including regulators, multipliers, data converters, filters, and waveform generators, have been implemented as integrated circuits. But low-volume applications are still served by discrete designs and do not share in the benefits integration brings to any design: high performance, space savings, simplified system design and checkout, increased reliability, and lower cost.

The first of these higher-level integrated solutions is the GAP-01, so named because it is a general-purpose analog processor. It combines in an 18-pin dual in-line package two differential-input transconductance amplifiers, a pair of low-glitch current-mode switches controlled by TTL signals, an output voltage-buffer amplifier, and a precision comparator—all on an 8,600-

square-mil (5.55-square-millimeter) chip (Fig. 1a). This combination of functions (Fig. 1a) will prove a powerful blend, simplifying the implementation of such otherwise complex circuits as selectable-gain multiplexers, dual-input sample-and-hold amplifiers, absolute-value amplifiers, and synchronous demodulators.

The GAP-01 is a precision device whose elements offer high performance in their own right (see table). Offset-voltage and charge-transfer errors are adjusted by the zener-zap technique—selectively shorting zener diodes across resistors. An external capacitor provides loop compensation and doubles as a hold, or memory, capacitor when the GAP-01 is employed as a sample-and-hold amplifier. The response is overdamped for an external compensation capacitor of 500 picofarads, and settling time is adequate for most low-frequency signal-processing applications.

Sample-and-hold applications were strongly in mind

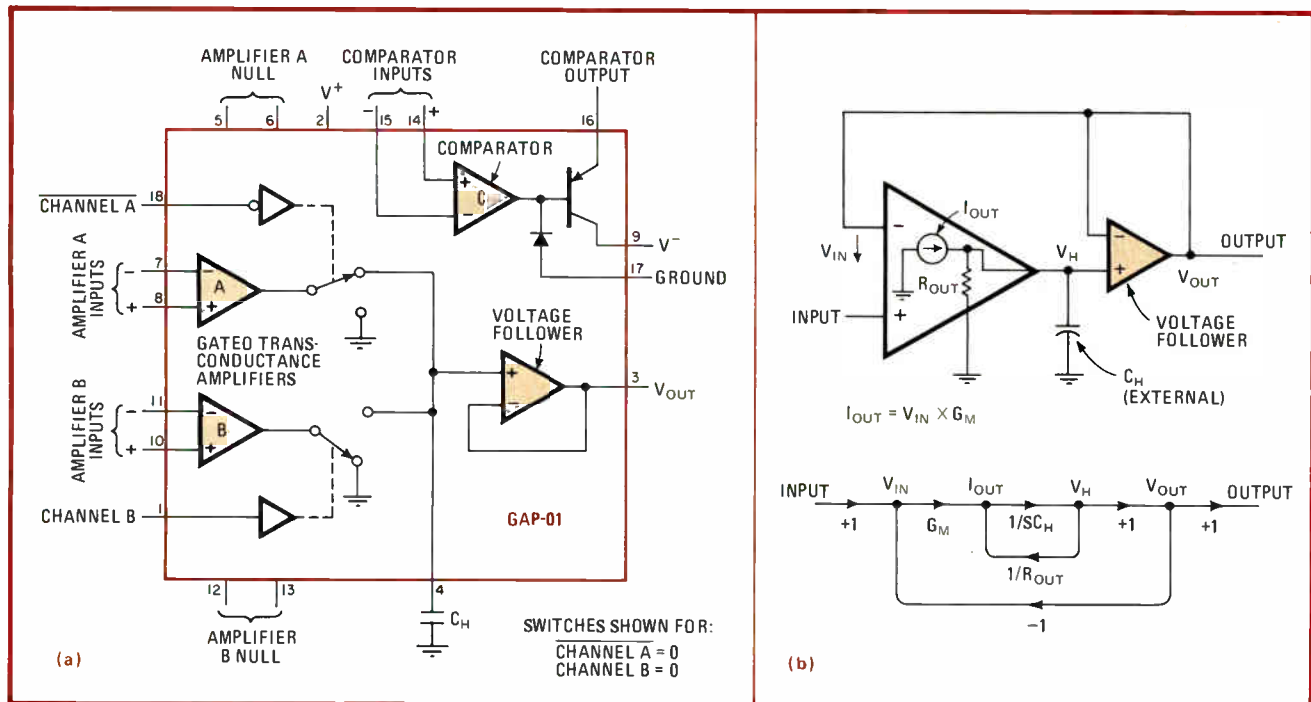

1. Gap filler. One of the first multifunction analog integrated circuits, the GAP-01 (a) combines low-glitch switches, transconductance amplifiers, and a comparator in an 18-pin dual in-line package. Its transfer function is readily figured from the flow diagrams (b).

ELECTRICAL SPECIFICATIONS FOR THE GAP-01 MULTIFUNCTION ANALOG CHIP	
<b>Transconductance Amplifier</b>	<b>Typical</b>
Input offset voltage	3.0 mV
Input bias current	150 nA
Input offset current	50 nA
Common-mode rejection ratio	80 dB
Input voltage range	±11.5 V
Gain	85 dB
Feedthrough attenuation (switches open)	80 dB
<b>Comparator</b>	
Input offset voltage	3.0 mV
Input bias current	1.0 μA
Input offset current	300 nA
Input voltage range	±12.0 V
Differential input voltage range	±24 V
Response time	200 ns
Low output voltage ( $I_{sink} = 5.0$ mA)	0.4 V
<b>Switch</b>	
Aperture time	75 ns
On switching time	50 ns
Off switching time	50 ns
Charge transfer	1 pC
<b>Miscellaneous</b>	
Slew rate $C_H = 1,000$ pF	0.5 V/μs
$C_H = 500$ pF	1.0 V/μs
Settling time to 0.1% (20-V step)	60 μs
Transconductance	1.0 μA/mV
Droop rate ( $C_H = 1,000$ pF)	0.1 mV/ms
Power supply current	5.0 mA
Note: supply = ±15 V, ambient temperature = 25°C	

when the GAP-01 was designed. The current-steering circuits that handle all internal switching do so in 50 nanoseconds or less and with minimal charge transfer into the external loop-compensation capacitor. The charge transferred is typically less than 1 picocoulomb and remains constant over a 20-volt input-signal range. In fact, most ICs designed specifically as dedicated, high-performance sample-and-hold amplifiers have larger and less constant charge-transfer errors.

The output voltage follower in the GAP-01 is also useful in sample-and-hold applications. Its field-effect-transistor input was chosen to minimize droop-rate error. What's more, a bias-current-cancellation circuit maintains the FET input bias current at less than 10 nanoamperes at 125°C—a noteworthy characteristic, in view of the fact that FET gate currents normally tend to double for every 10°C rise in temperature.

### A comparator, too

The inclusion of a precision comparator on chip increases the GAP-01's versatility and cost-effectiveness in nonlinear and data-conversion applications. With a low 3.0 millivolts of offset error, a 200-ns response time, and a 24-v differential input capability, the comparator's performance is far above average. The output-high voltage level is set by an external resistive divider between the voltage supply,  $V_{CC}$ , and ground, with  $V_{OH} = V_{CC} (1 + R_1/R_2)$ , where  $R_1$  ties the output to  $V_{CC}$  and

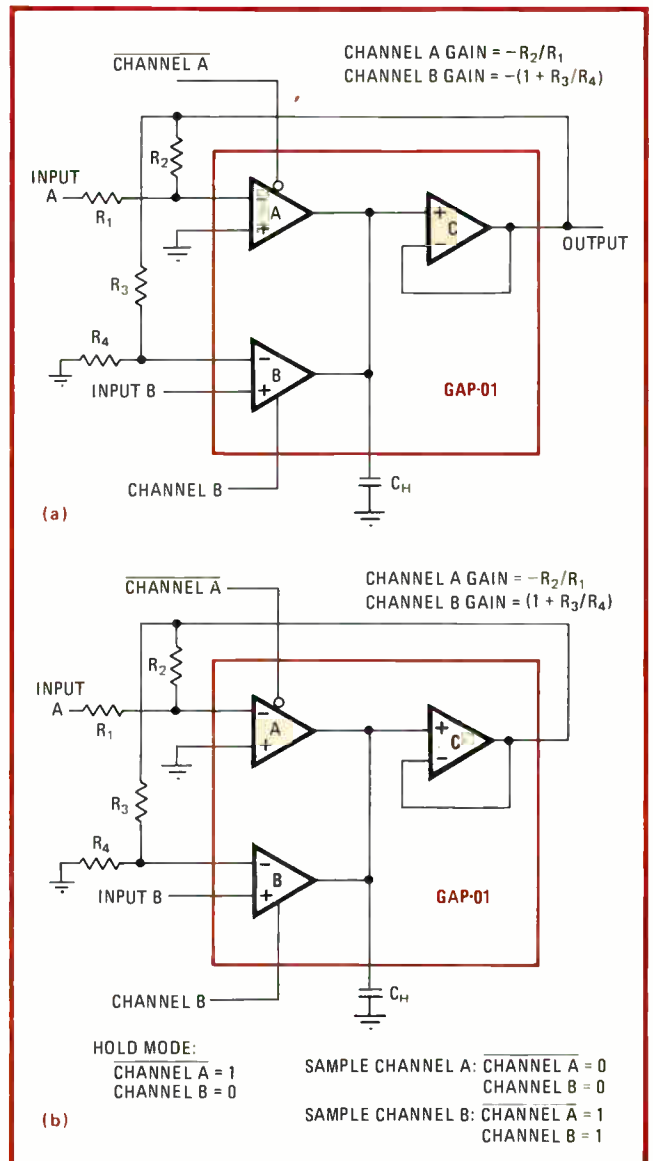

**2. Simple functions.** The GAP-01 requires few external components to build a two-channel amplifier with programmable gain and polarity (a) or a two-channel sample-and-hold amplifier (b). The latter performs especially well thanks to a low droop-rate error.

$R_2$  ties it to ground. This scheme not only maximizes noise immunity but also permits the device to be interfaced with any logic family—including TTL, diode-transistor logic, and complementary-MOS up to +15 V.

Both transconductance amplifier outputs are gated by current-mode switches into the voltage-follower output stage, thus providing two digitally selectable signal paths through the device. Gain through each of the two channels may differ in both sign and magnitude depending on the external feedback chosen. The unity-gain transfer characteristic of the GAP-01 follows directly from the signal-flow illustration of Fig. 1b:

$$V_{out} = 1/[1 + 1/(G_M R_O) + s(C_H/G_M)] \\ \approx 1/[1 + s(C_H/G_M)]$$

where  $R_O$  is the output impedance of the transconductance amplifier, approximately 20 megohms;  $C_H$  is the

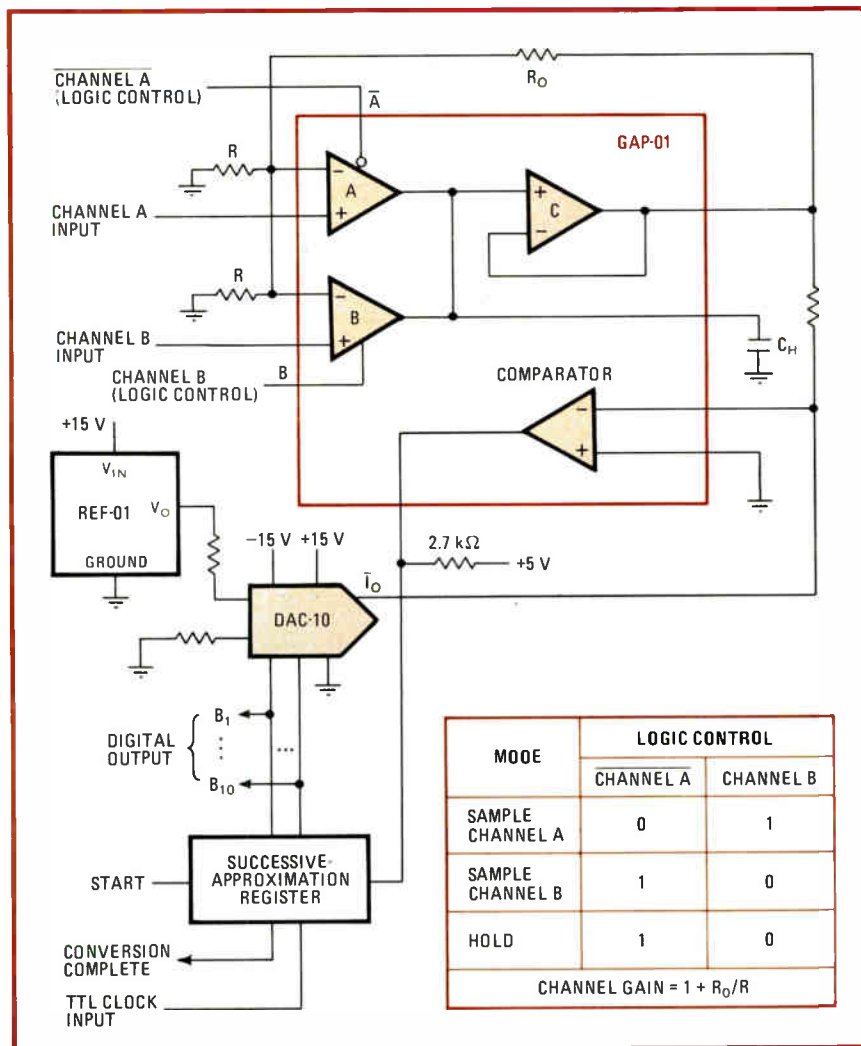

**3. Conversion made easy.** The addition of a reference, a digital-to-analog converter, and a register to the GAP-01's functions makes possible a simple, two-channel analog-to-digital converter. The table shows the TTL inputs required for operation.

value of the external compensation, or hold, capacitor, usually from 500 to 1,000 pF; and  $G_M$  is the amplifier's transconductance, which is approximately 1 microampere per millivolt.

Several applications exploit this ability to select the signal path through the GAP-01. As a two-channel multiplexer or analog switch (Fig. 2a), the device can take advantage of its high input impedance for switching high-impedance signals. Gain through the multiplexer is also possible. As another example, the device operates as a sample-and-hold amplifier (Fig. 2b), placed in its hold mode when both input amplifiers are unselected. With the on-board comparator, a two-channel successive-approximation analog-to-digital conversion system can easily be constructed (Fig. 3).

### Absolute value

Perhaps not so obvious is the GAP-01's ability to serve as an absolute-value amplifier—a circuit function usually realized by discrete designs. An absolute-value amplifier, or full-wave rectifier, is commonly implemented by summing the output of a half-wave rectifier and its input. The technique generally requires five matched resistors, two diodes, and two operational amplifiers. In contrast, implementation with the GAP-01

requires only two matched resistors (Fig. 4a).

Here, the two transconductance input amplifiers allow a selectable signal path gain of +1 or -1. A zero-crossing detector, made with the on-chip comparator, monitors the input signal polarity and selects the proper signal path. The resulting full-wave-rectified signal (Fig. 4b) may be presented as a positive or negative polarity by switching the comparator inputs. The polarity switching may also be put under digital control by exclusive-ORing the comparator output with a polarity-selection signal. Output polarity selection in conventional designs would require a programmable-gain operational amplifier or a physical reversing of the diodes.

The GAP-01 is well suited to use with low signal levels. The fast, low-glitch current-mode switches distort the waveform very little when the signal path is selected by the zero-crossing detector—a direct result of the internal switches' low charge transfer.

Combining the absolute-value amplifier with a sign-magnitude digital-to-analog converter results in a four-quadrant multiplying d-a converter (Fig. 5).

Maybe the most sophisticated function of the GAP-01 is synchronous demodulation. Another function usually realized at the component level, synchronous demodulation is a powerful tool that is useful in many critical

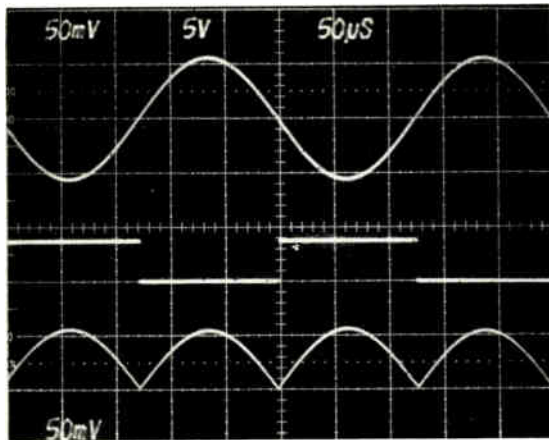
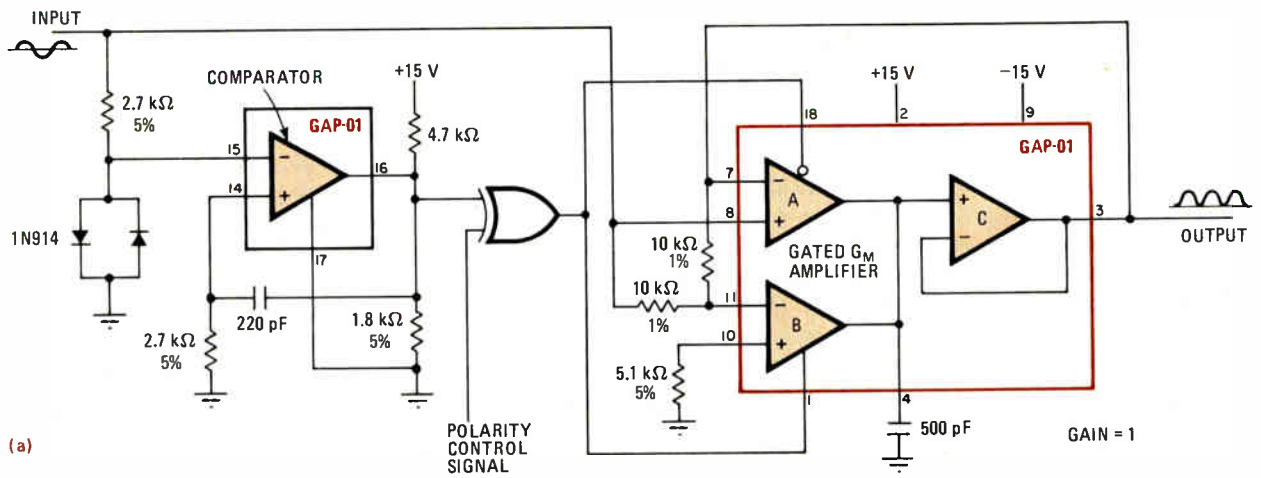

**4. Full wave.** An unobvious application of the GAP-01 is as an absolute-value amplifier requiring only two matched resistors (a). The full-wave-rectified signal (bottom trace in photograph) may be presented as positive or negative by switching comparator inputs.

applications in measurement, control systems, and instrumentation (see "Synchronous demodulation explained," p. 125). Here, three specific applications of it will be described.

One of these applications of the GAP-01 is in position-detection systems employing linear variable differential transformers (LVDTs). The LVDT relies on a movable magnetic core to determine the coupling between a primary winding and two secondary windings such that the device produces an ac output proportional to the movement of its magnetic core. Since the identical secondary windings are wired in a series-opposing fashion, the LVDT theoretically produces no net output voltage when

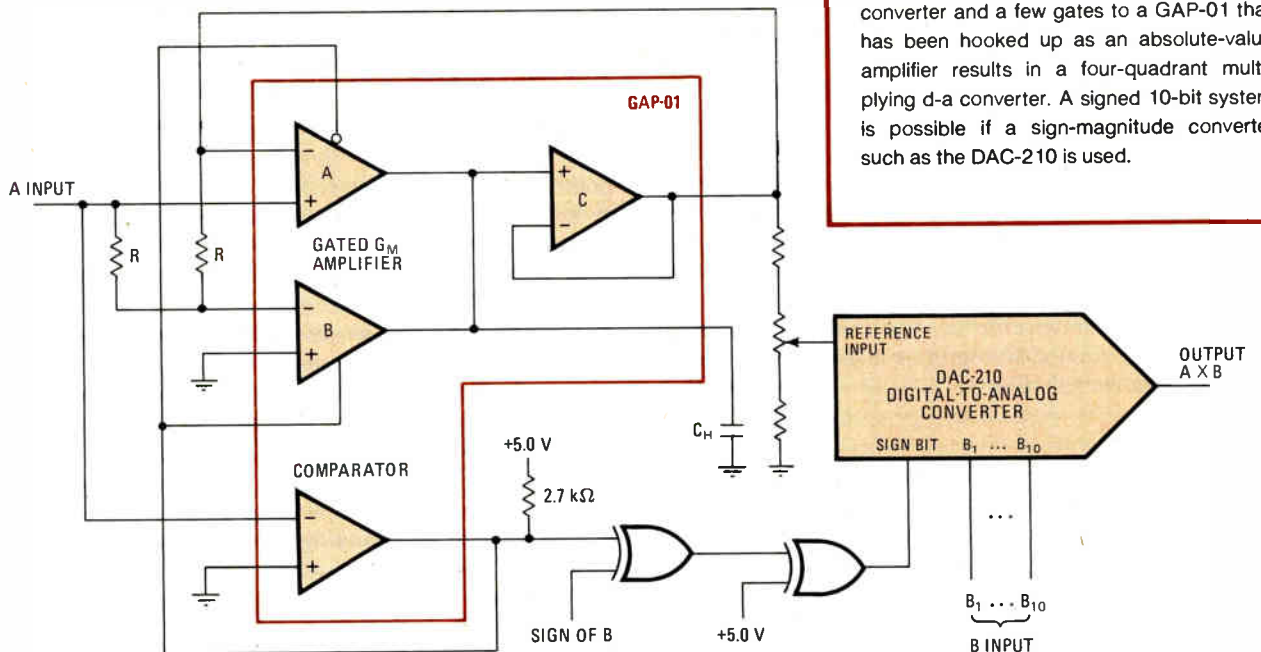

**5. All quadrants.** Adding a digital-to-analog converter and a few gates to a GAP-01 that has been hooked up as an absolute-value amplifier results in a four-quadrant multiplying d-a converter. A signed 10-bit system is possible if a sign-magnitude converter such as the DAC-210 is used.



## Synchronous demodulation explained

Modulation imposes an information-bearing signal on a carrier signal in a predictable way. In instrumentation and measurement systems where transducer signals have fundamental frequency components at or near dc, modulation can be used to great advantage. It can place the signal information on a high-frequency carrier wave well above common low-frequency disturbances such as 1/f noise and power-line interference. Signal information can thus be amplified and extracted from a region of minimum noise after modulation.

A synchronous demodulator (or phase-sensitive detector) extracts the information in the best of ways: only those signals in synchronization with the carrier frequency are detected—which means that all random or nonsynchronous interfering signals are rejected.

As shown in (a), a mixer performs the actual signal demodulation. After filtering, a dc signal is left that contains the magnitude and phase information (relative to the carrier) produced by the transducer. Demodulation is theoretically equivalent to passing the modulated transducer signal through a gating switch that toggles in phase with the carrier reference signal. Input signals synchronized with the carrier reference signal are half-wave-rectified—for a 0° phase shift, positive-wave rectification occurs, whereas for a 180° phase shift, the negative peaks are rectified. The trick is to use two gating switches and to

sum alternate input signal cycles with positive and negative gain in order to obtain a full-wave-rectified result, as illustrated in (b).

Since the full-wave demodulator's lowest frequency component is twice the carrier frequency, much greater bandwidth is possible than with half-wave demodulation. Also, the amount of filtering needed to extract the dc signal that is proportional to the transducer signal is far less than with half-wave demodulation (c).

Full-wave synchronous demodulation is readily described mathematically. Consider a sinusoidal input signal in phase with a carrier signal. Let the carrier signal equal  $V_c \cos \omega_c t$  and the modulated input signal equal  $V_{pk} \cos \omega_c t$ , where  $V_{pk}$  is the information-carrying signal. Since the full-wave synchronous demodulator multiplies the input signal by +1 when the carrier signal exceeds zero and by -1 when it is less than zero, a full-wave, positively rectified signal results. The output can be represented by a Fourier series:

$$V_o = V_{pk} \left[ \frac{2}{\pi} - \frac{4}{\pi} \left( \frac{1}{4} \cos 2\omega_c t - \frac{1}{3.5} \cos 4\omega_c t \dots \right) \right]$$

After passing through a low-pass filter, the signal will have all its ac terms eliminated from it or reduced. The low-pass filter output will equal the Fourier series average value and thus be proportional to input signal  $V_o = 2V_{pk}/\pi$ . The synchronous demodulator also performs a full-wave rectification if the input signal and carrier signal are 180° out of phase. The demodulator output is, however, negatively full-wave-rectified. Being below ground, it has an average value of  $V_o = -2V_{pk}/\pi$ . As before, the first ac ripple term is at twice the carrier frequency. A high carrier frequency ensures that the ac frequency components will be attenuated by relatively simple low-pass filtering circuits.

Nonideal transducer behavior will often produce quadrature signals, which are 90° out of phase with respect to the carrier. As shown in (d), a synchronous demodulator's full-wave rectification averages quadrature signals to zero after low-pass filtering.

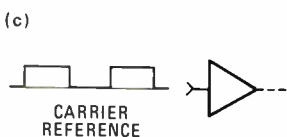
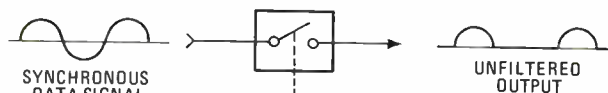
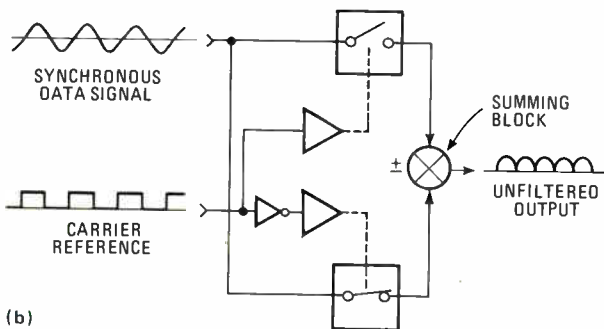
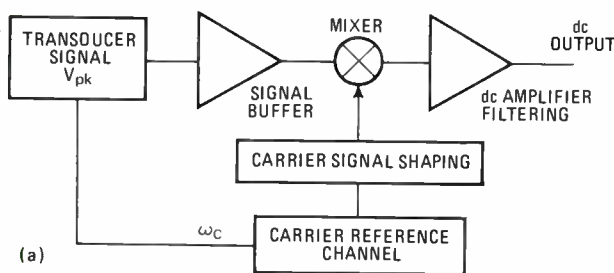

its core is in the null, or center, position.

The ac LVDT signal must be converted into a dc signal for control and readout purposes; however, its limited accuracy and large linearity error at low signal levels rule out straightforward diode-rectification schemes. Simple full-wave bridge-rectification circuits lack the polarity information necessary to determine whether the core is above or below the null position. Complex rectification schemes that provide polarity information require matched diodes and significantly attenuate the LVDT signal, further complicating the signal-processing process.

Either a synchronous demodulation or some other phase-sensitive rectification scheme is needed to eliminate rectification problems while simultaneously exhibiting excellent linearity for both small- and large-amplitude signals.

LVDT errors also result from small quadrature (out-of-phase) signal components caused by capacitive feed-through and other nonideal transformer properties that prevent a zero-amplitude output signal when the core is at null. Synchronous-demodulation techniques supply a true zero output by automatically averaging the quadra-

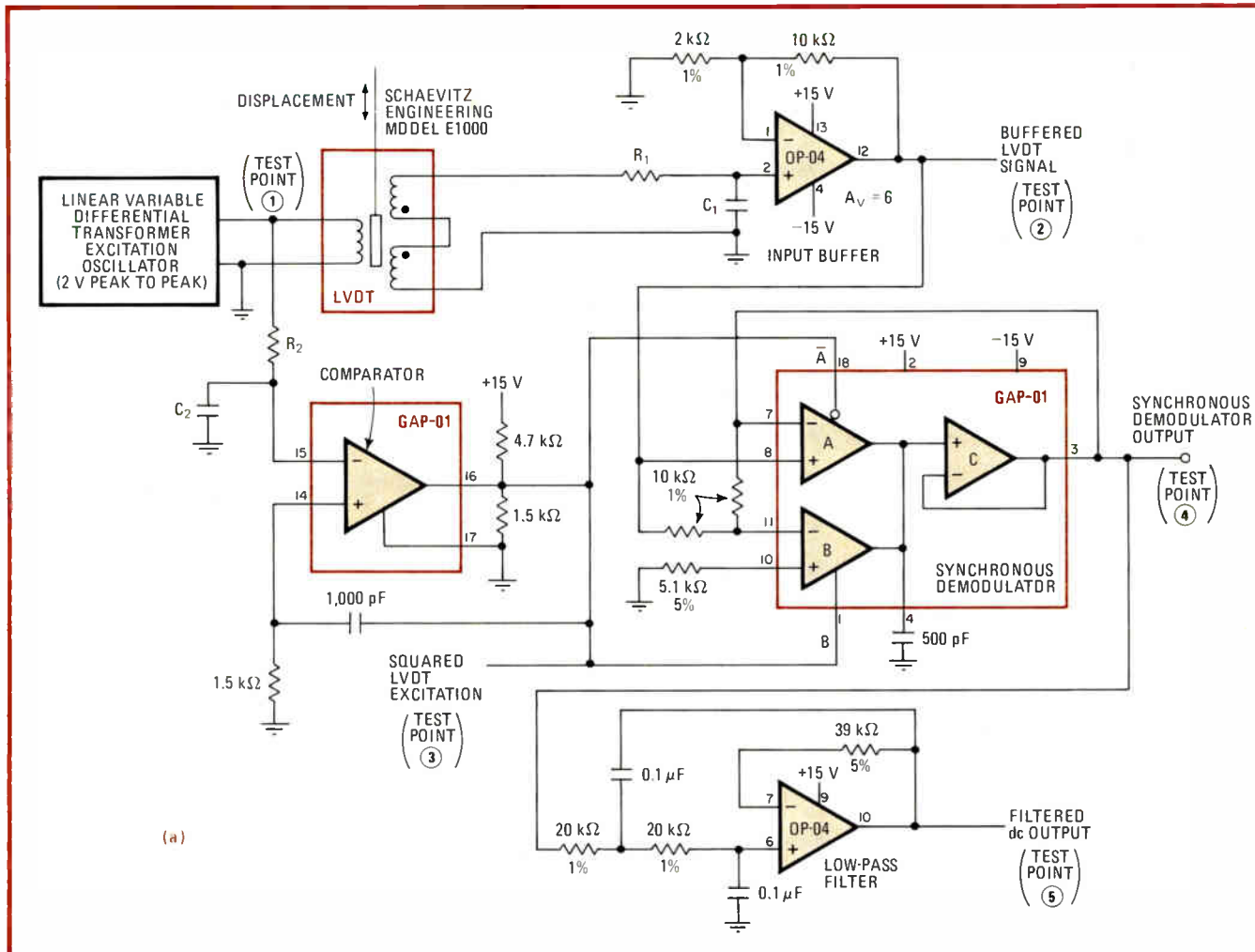

**6. LVDT application.** Using the GAP-01 for synchronous demodulation extracts a dc voltage proportional to the displacement of a linear variable differential transformer (a). The traces (b) show, from top to bottom, the excitation, its buffered output, and the signal after

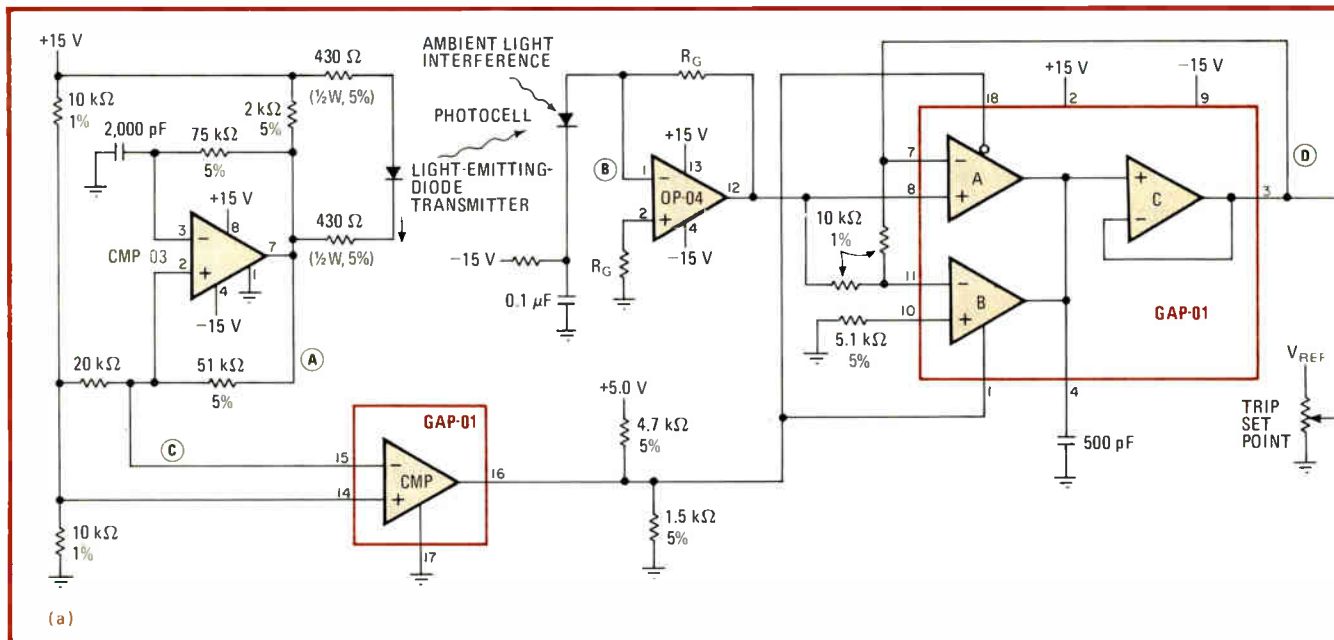

**7. Photodetector.** This photoelectric-control setup is immune to ambient-light interference. Waveforms at various points in the circuit are at right. The transmitter signal, A, is at the detector, as is background noise apparent in B. Switches in the GAP-01 change its gain from +1 to

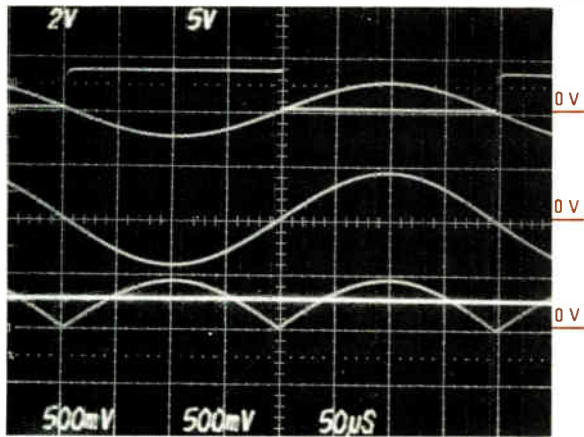

(b)

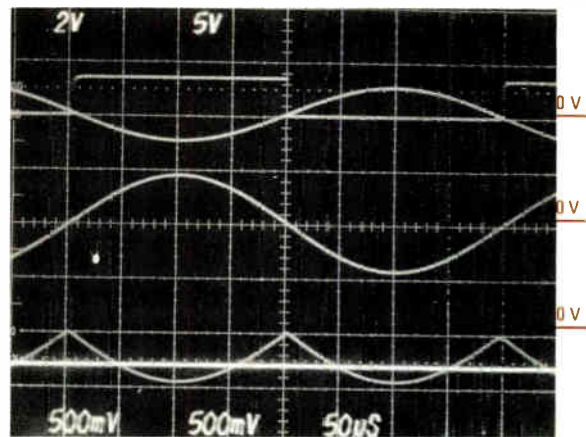

(c)

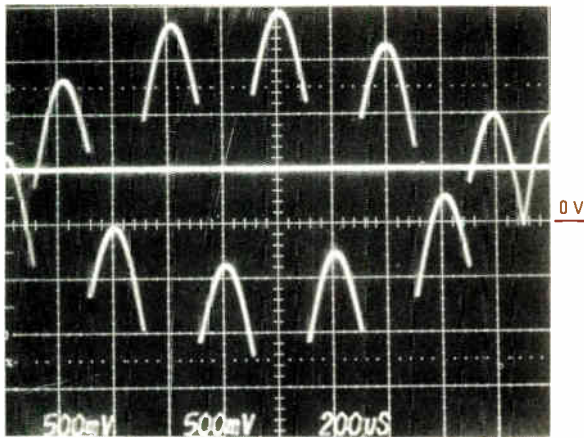

(d)

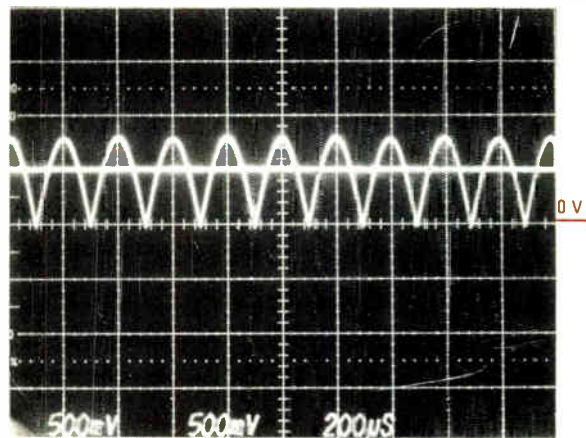

(e)

demodulation (along with the dc output). For a displacement to the other side of null, the waveforms are correspondingly inverted (c). In (d), a 120-hertz interference signal is added to the LVDT; its dc output (500 mV) is just as clean and accurate as that with no noise (e).

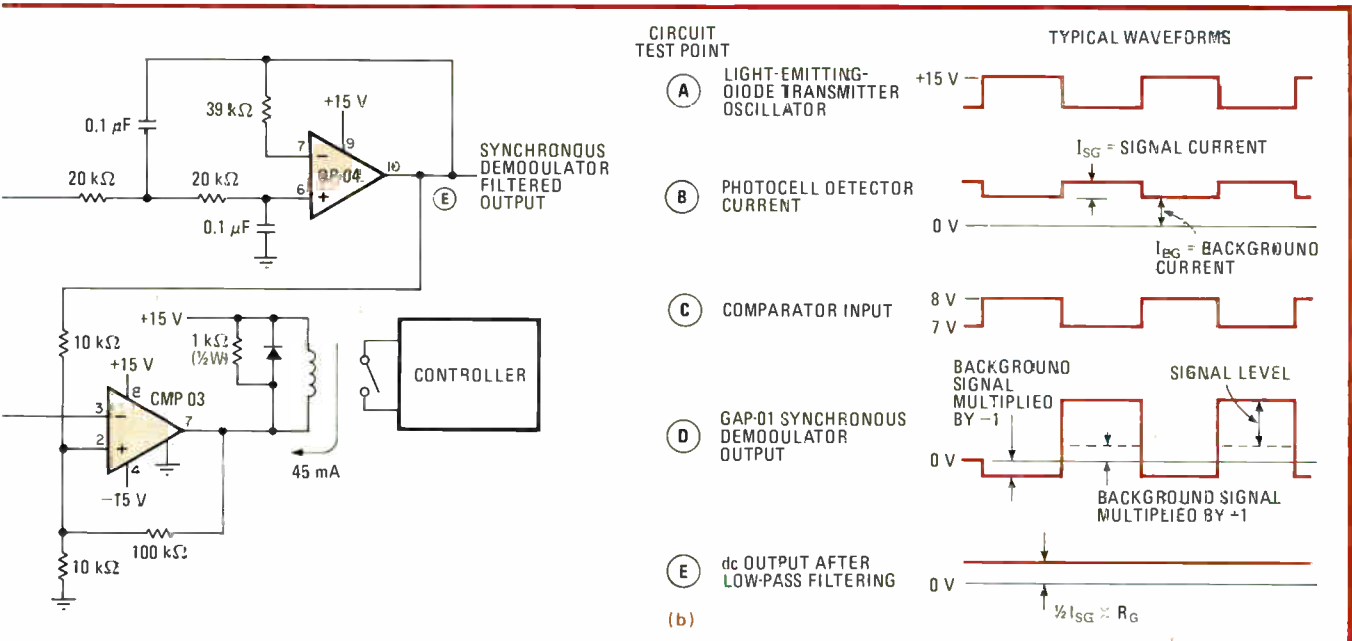

-1 with each logic pulse in C. At the demodulator output, D, the background signal is alternately multiplied by +1 and -1; consequently, all background and noise signals average to zero. Then low-pass filtering leaves a dc output proportional to the transmitter current:  $V = \frac{1}{2} I_{SG} R_G$ .

**8. No strain.** Yet another application of the GAP-01 to synchronous demodulation serves strain gages. Pairing the versatile part with an instrumentation amplifier, this circuit relies on polarity-switching of the power source that drives the strain-gage bridge.

ture distortion components to zero. In fact, all signals—noise, ground-loops, ac-line interference, and so on—that are not synchronized to the LVDT excitation signal are averaged to zero.

Figure 6a shows a complete LVDT signal-conditioning block that uses the GAP-01 as a synchronous demodulator. One half of a dual operational amplifier buffers the LVDT signal and presents a constant impedance to the secondary windings of the transformer. The remaining op amp is used in a low-pass active filter to remove high-frequency components from the GAP-01 output. A pure dc signal that is proportional to the core position remains after filtering. The uncommitted comparator in the GAP-01 converts the sinusoidal LVDT excitation into a synchronizing TTL signal that controls the signal paths.

The photographs of Figs. 6b and 6c show circuit waveform for the core position on either side of null. Note that the dc output of the GAP-01 clearly tracks the phase reversal of the ac signals, indicating the LVDT core has passed through the null position. Synchronous demodulation preserves both the direction and the magnitude information contained in the LVDT signal.

That synchronous demodulation will reject signals not synchronized with the LVDT excitation is demonstrated in Fig. 6d, which shows nonsynchronous interference signal distorting the LVDT output. The dc output in Fig. 6e provided by the GAP-01 is identical to that in the photograph of Fig. 6b, where the interfering signal was not present. Synchronous demodulation extracts the desired information even in the presence of an extremely large interference signal.

### Modulated light

Photoelectric control systems, which find many industrial control applications, can be improved by using synchronous demodulation techniques. Often the photoelectric systems are on-off controllers that detect an object's presence or absence in a light path. On-off control applications include counting, filling, and security surveillance. Other systems require a continuously variable light source be monitored and measured for control purposes. Among these analog, or proportional-control, applications are intensity control, hue control, color differentiation, and exposure timing.

Maximum system accuracy and reliability are possible only if potential error sources are eliminated or controlled. Changes in the ambient light can falsely trigger on-off photoelectric systems or produce erroneous readings in proportioned-control systems. Detectors are also susceptible to spurious signals from nearby light sources directed at other photodetectors. In addition, photodetectors are plagued by dark currents that generate a dc output in the absence of light. The dark current will vary from device to device and with temperature changes as well. At the system level, where a transimpedance dc amplifier has to be used to convert the photodetector current into a voltage, amplifier bias-current and offset-

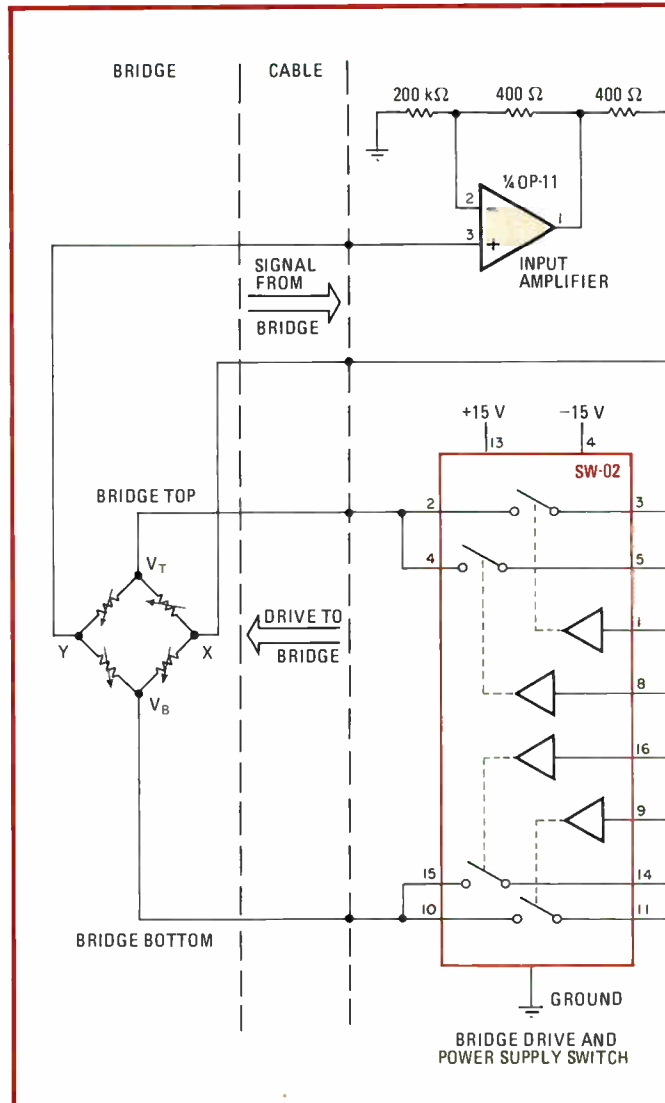

voltage errors will degrade system sensitivity and reliability at low signal levels.

The answer lies in modulating the transmitted light source and synchronously demodulating the received signal to eliminate the error sources. Figure 7 shows a typical modulated-light control system and the accompanying waveforms. The waveform at test point D illustrates how background noise and dc error terms—ambient light, dark currents, and transimpedance amplifier offset voltage and bias current—are averaged to zero by the GAP-01 synchronous demodulation process. The filtered dc output varies only with the received light intensity; an additional comparator can power a relay to drive a controller.

Since the system will reject any nonsynchronous signal, transmit-and-receive pairs operating at unrelated carrier frequencies may therefore be in physical proximity without any mutual interference. Edge-detecting and -positioning applications could use that feature.

A strain-gage bridge, used for measuring pressure or weight, can be powered by a constant unipolar power source. But by polarity-switching the power source, the synchronous-demodulation technique can readily extract

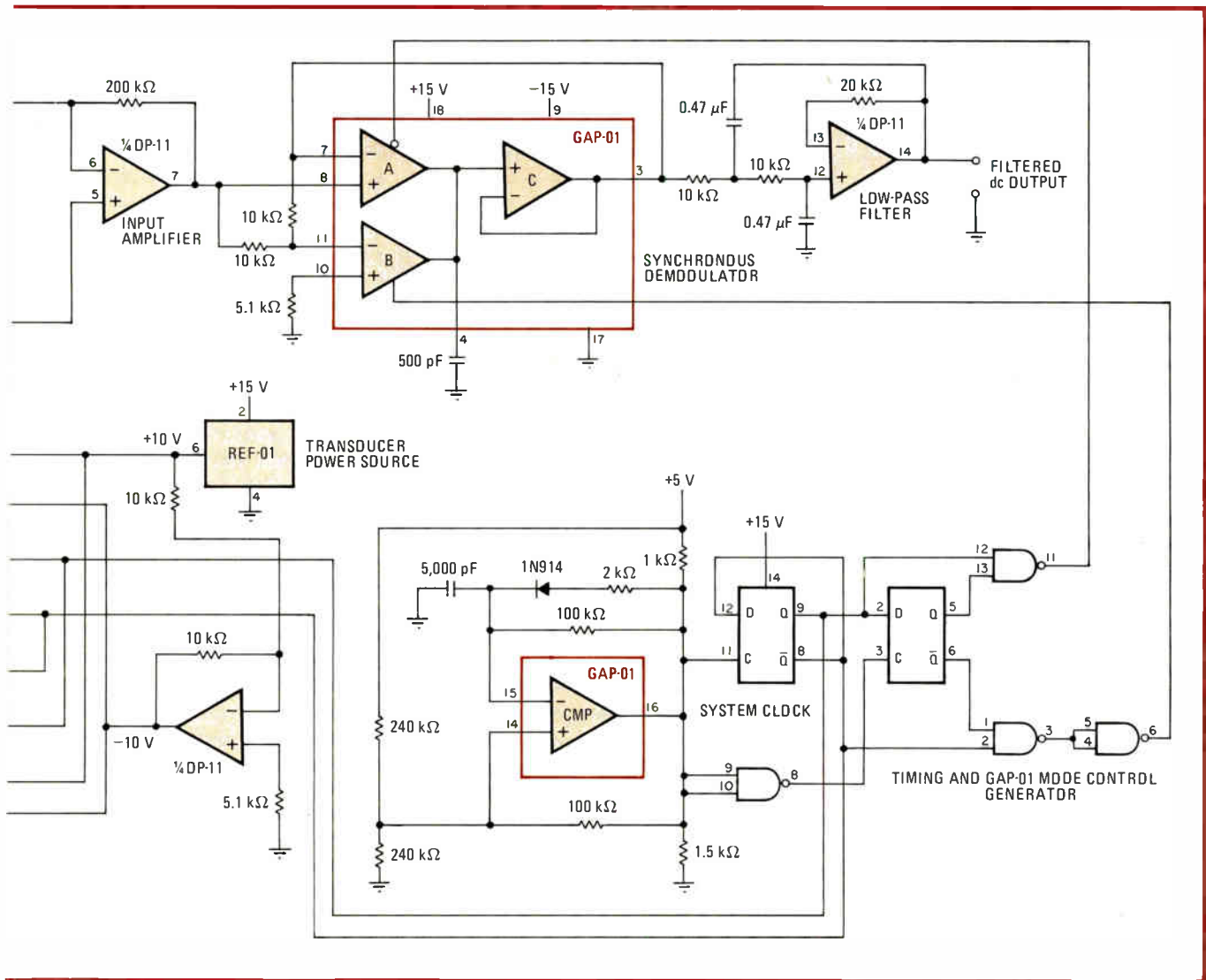

the gage's low-level output signal with great accuracy. Such a high-performance signal-conditioning subsystem is shown in Fig. 8. The only requirement, of course, is that the transducer be capable of accepting the switching in polarity of its power source.

### Switching the polarity

The supply switching rate becomes the modulation's carrier frequency. Switching the supply polarity causes the transducer output signal to change polarity as well—but noise, dc offsets, and common-mode errors from the signal-conditioning circuitry are not switched in polarity. Synchronous demodulation uses that fact to reject the error signals.

The GAP-01's comparator generates the system carrier frequency. The digital timing circuitry provides a system clock of 50% duty cycle, which guarantees that error sources will average to zero after the synchronously demodulated output is filtered.

The switched transducer output feeds a conventional dual instrumentation amplifier whose dc input specifications are not critical. The signal is then synchronously gated through the GAP-01. The device's internal trans-

conductance amplifier A is set for a gain of +1, while amplifier B is set for -1. The system rectifies the transducer output, producing a signal whose dc component corresponds directly to the strain gage's desired output and whose ac component comprises offset, noise, and common-mode error signals.

When the transducer supply voltages are switched, both input transconductance amplifiers are disabled. The GAP-01 thus operates as a sample-and-hold device in its hold mode. As a result, no noise or glitches associated with the switching have any effect on its output voltage.

After low-pass filtering, only the transducer output signal remains. The complete system nulls instrumentation-amplifier gain-stage errors, 60-hertz line interference, and thermoelectric voltages. Problems plaguing conventional op-amp systems—including "popcorn" noise, 1/f noise, and commutation noise in chopper-based systems—are eliminated using the GAP-01. □

### Bibliography

Edward E. Hecceg, "Handbook of Measurement and Control," Schaevitz Engineering, Camden, N. J. 1976.  
 Darold Wobschall, "Circuit Design for Electronic Instrumentation," McGraw-Hill Inc., New York, 1979.

# Plastic packaging cuts the cost of rf power transistors

Wraparound metalization scheme minimizes parasitics, reduces material costs, and increases gain for high-frequency, high-power bipolar transistors

by Mark Burkett and Jim Groenke, *Communications Transistor Corp., San Carlos, Calif.*

□ Radio-frequency transistors of up to 30 watts continuous wave with frequencies as high as 500 megahertz can now be housed in relatively inexpensive packaging. By including a wraparound metalization scheme to prevent unwanted parasitics, packaging techniques traditionally limited to low-frequency transistors can be adapted to high-frequency, high-power silicon parts. As a result, material costs can be reduced and assembly and testing procedures automated to such an extent that rf power transistors may be produced at as little as half their previous cost.

Rf transistors have historically been packaged in metal-ceramic strip-line cases (at right in Fig. 1). Due to their low parasitic-impedance and high thermal-dissipation characteristics, such packages have been ideal for transistors operating at 30 MHz or more and at power levels of 10 w or more. But they have also cost more than plastic packages. The material and assembly costs for metal-ceramic strip-line packages are quite high—relatively large amounts of gold and beryllium oxide are required, and assembly involves high-temperature silver brazing, for which costly tooling is needed to hold components in close alignment.

These basic costs have been compounded by the absence of automated assembly and testing procedures for handling metal-ceramic strip-line packages. Compared with integrated circuits and discrete small-signal low-frequency transistors, production volumes for rf power transistors have tended to be very low. As a result, assembly and testing for rf power transistors have remained essentially manual—hence time-consuming and labor-intensive—leading to higher costs.

## Wraparound metalization does the trick

The popular TO-220 plastic package costs about one fifth as much as a typical metal-ceramic strip-line package used for rf power transistors. In addition, because of its widespread use, it is highly compatible with existing automatic assembly and test equipment and has the potential for high production volume and hence for low device costs.

However, using a plastic TO-220 plastic package for rf power transistors posed major problems. In a standard package, the long wire leads that connect a power-transistor chip to its carrier cause unwanted parasitic capacitances and inductances at high frequencies. To tap the economies of standard packaging offered by TO-220 plastic cases, a more uniform packaging and chip interconnection technique with minimal parasitics had to be developed.

By employing a wraparound metalization scheme where metal surrounds the usual beryllium oxide ceramic substrate (Fig. 2a), Communications Transistor Corp. designers came up with a standard assembly and packaging method that does away with the negative effects of long bonding leads. Furthermore, less ceramic material is used than in a conventional strip-line rf power transistor, making possible

**1. Packaging.** Radio-frequency power transistors typically require metal-ceramic strip-line packages (right). Using a new metalization scheme, they can now be packaged in low-cost plastic TO-220 cases (left).

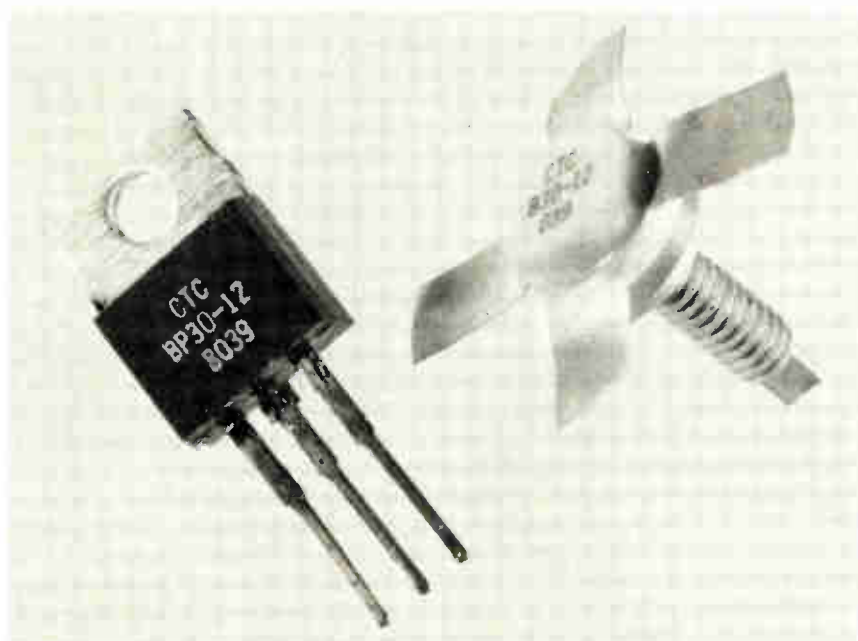

175-MHz transistors with 30-w power levels, at half the cost [*Electronics*, Aug. 28, 1980, p. 42].

A ceramic die-carrier electrically isolates the rf power transistor's collector from the TO-220's header and facilitates electrical connection to the package's flange and lead frame (Fig. 2b). Beryllium oxide was chosen for the same reasons it is used in traditional rf power strip-line transistors—namely, its excellent electrical-insulation characteristics and thermal conductivity.

The 0.025-inch-thick beryllium oxide carrier is gold-plated and has metalized areas for die attachments and wire bonding. Compared with a conventional 0.06-inch-thick carrier, the 0.025-in.-thick carrier is much smaller in volume, resulting in material-cost savings for both the ceramic content and the gold platings and metalizations. The reduced thickness also leads to improved thermal dissipation between the die and heat sink to which the transistor is attached.

### Metalized layer reduces parasitics

The rf transistor die is mounted on a large metalized island near the center of the beryllium oxide ceramic substrate. Several 2-mil-diameter aluminum wires are then bonded between the die's emitter bonding pads and the front and rear edges of the substrate's metalization layer. This gold-plated layer minimizes parasitic inductance effects in the rf transistor and envelops the transistor's substrate on both the front and rear surfaces. Bonded 2-mil-diameter aluminum wires are also used to connect the pad on the die base with the metalization strip, and 10-mil-diameter aluminum wires are employed in connecting the collector and base to the TO-220 lead frame. The substrate's backside is then eutectically soldered to the TO-220 flange in order to complete the emitter connection.

Bringing out the die's emitter lead through a wrap-around metalization pattern minimizes the length of the emitter lead and yields excellent grounding and minimal common-lead inductance characteristics—essential ingredients for good common-emitter gain when a device is operating at high frequencies.

### Better gain

Figure 3 compares the gain of a 12.5-volt 175-MHz 30-w rf transistor in a TO-220 plastic package (model BP30-12) with that of a 12.5-v rf transistor packaged in a traditional metal-ceramic strip-line case (model B30-12). Note the 0.5 decibel of additional gain for the plastic device, caused by the lower common-lead inductance and thermal resistance in the plastic device. The measured junction thermal coefficient for the BP30-12 is 2.0°C per watt compared to 2.7°C/w for the strip-line device. Figure 4 illustrates the typical gains possible with 50- as well as 470-MHz TO-220 rf transistors.

The fact that the TO-220 is a plastic package might lead potential users to suspect that rf transistors in such cases might have lower reliability levels than in strip-line packages. However, initial accelerated lifetime tests performed on rf transistors mounted in TO-220 plastic packages have shown the major limitation on transistor lifetime to be electromigration of the die metalization, a phenomenon equally limiting for traditional

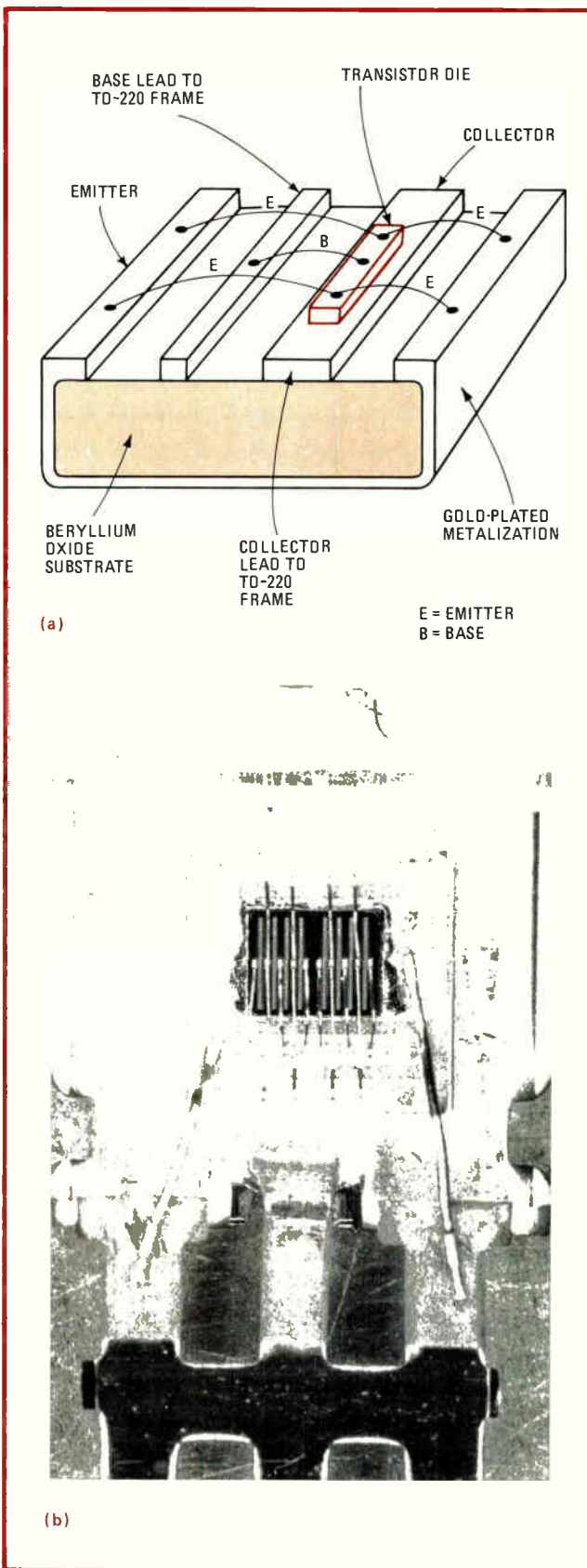

**2. Wraparound.** A metalized layer wrapped around the usual beryllium oxide ceramic substrate of an rf power transistor (a) allows shorter emitter-lead lengths, which reduces parasitics and permits packaging in a standard plastic TO-220 case (b).

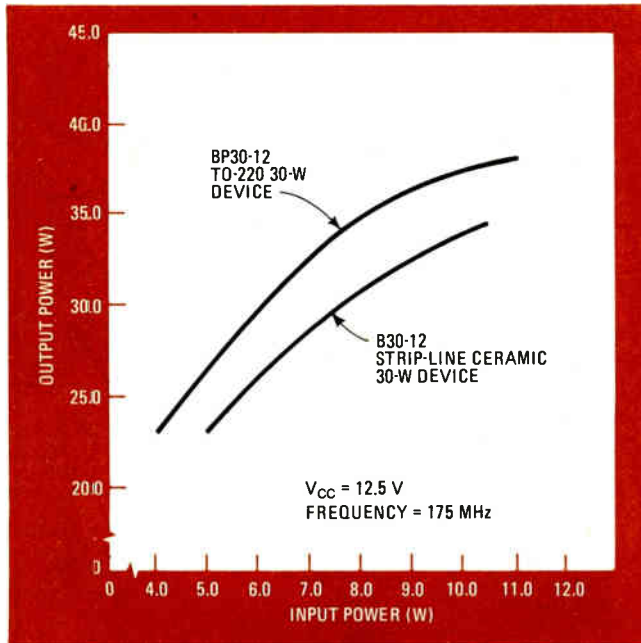

**3. Comparison.** A plastic-packaged 175-MHz 30-W transistor has about 0.5 decibel more gain (top curve) than the same device packaged in a standard metal-ceramic strip-line case (bottom curve). Both devices operate from 12.5-V supplies.

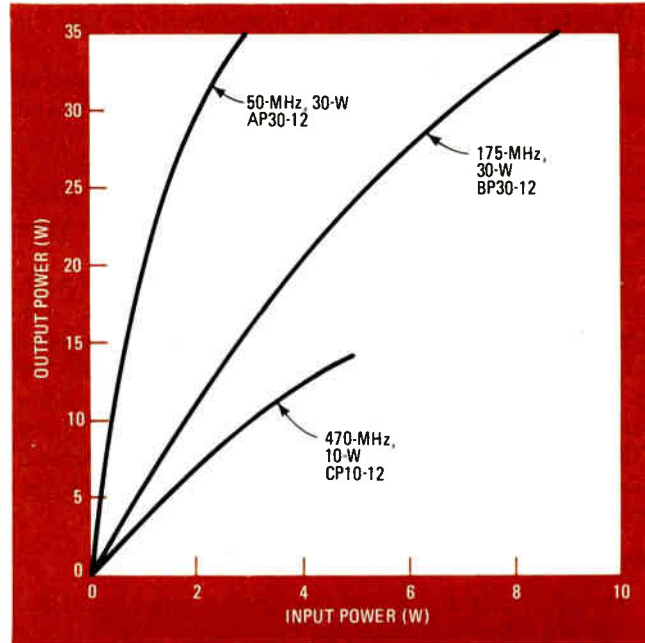

**4. Gain.** Three different rf power transistors packaged in plastic TO-220 cases show impressive gain figures at different frequencies. Starting from left to right, the curves are for 50-MHz 30-W, 175-MHz 30-W, and 470 MHz 10-W devices. All operate from 12.5 V dc.

strip-line-packaged rf transistors.

Common failures due to the separation of bonds and bond wires are essentially eliminated in the plastic-cased TO-220 rf transistors with the application of a conformal coating over the die and bond wires prior to encapsulation. When cured, the conformal coating remains pliable enough to allow the bond wires to flex during power cycling without developing abnormal shear forces at the bond sites. Since the wraparound design minimizes wire lengths, total wire movement during power cycling is kept to a minimum.

Although there are many suitable encapsulation materials on the market, a copolymer of silicone and epoxy was found to be most useful in the packaging process. Such a material combines most of the advantages of both epoxies and silicones, exhibiting good physical strength and moisture resistance, low ionic content, and excellent molding characteristics.

### Broad range of devices

A wide range of plastic-packaged rf power transistors is being made available in TO-220 cases. These include the AP15-12 and AP30-12 15- and 30-w 50-MHz devices; the BP8-12, BP15-12, and BP30-12 8-, 15-, and 30-w 175-MHz devices; and the CP5-12, CP10-12, and CP20-12 5-, 10-, and 20-w 470-MHz devices, in minimum gains ranging from 4.6 to 12 dB. All operate at up to 12.5 V dc; some, such as the AP30-12 and BP30-12, are also available in reverse-pinout configurations for push-pull-balanced operations.

Current applications for the transistors include land-mobile radios, aircraft communications, consumer appliances, and industrial rf heating. Devices now under development (including some MOS transistors) are the BAP40-28 and BAP80-28 136-MHz, 40- and 80-w peak

(50% duty cycle), 28-v dc transistors with approximate minimum gains of 11 and 10 dB respectively, which are both aimed at amplitude-modulation communications applications.

### Circuit-design compatibility

The process of designing rf amplifier circuits with high-power TO-220 plastic devices is virtually the same as for metal-ceramic strip-line devices. The same consideration should be given to device selection, adequate heatsinking, and grounding techniques.

Other design factors should include:

- Total device power dissipation at least twice the desired rf power output for maximum reliability.
- Device ratings at least 1.2 times the required minimum power output of the system. This 20% margin is usually sufficient to compensate for filter and general circuit losses associated with the normal variations of circuit components.
- An efficient heat sink large enough to dissipate the thermal energy developed. Although the TO-220 package exhibits a better junction thermal coefficient than a comparable copper-ceramic stud device, a thin layer of silicon as a thermal compound is recommended for best thermal conductivity to the heat sink.
- Minimal common-lead inductance to maintain gain and bandwidth. This can be accomplished by using wraparound foil grounds or plated-through holes that conduct from the top side of the circuit board to the ground-planed bottom side near matching capacitors. Because of the high inductance of the center lead, the TO-220 package must be rf-grounded by means of the flange. It is therefore important that matched components be so placed that the shortest ground return path is the one to the flange. □



## .5 ppm/°C Gain Error Tempco minimizes your DAC error budget.

### DAC accuracies up to 0.0008%.

MPS's plug-in replacement DAC's have improved temperature characteristics. We've made them for 10 years.

#### MPS DAC's Have Superior Gain Error Tempco!

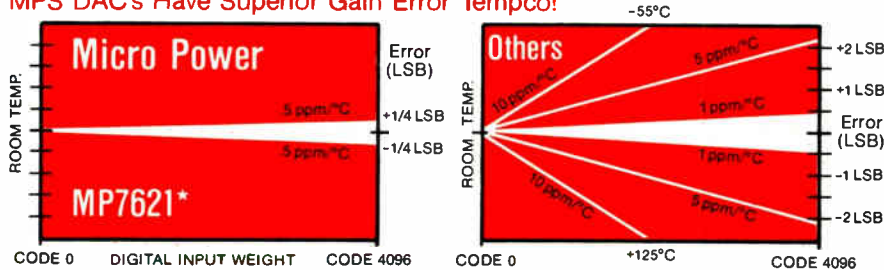

\*Note: Error plot for 12-bit system; errors shown from ideal value with calibration at 25°C only.

MPS also has the high speed, high precision op amps and precision voltage references for your DAC system.

All parts are immediately available with MIL-STD-883B processing, as well as standard can, plastic, and ceramic packaging. All parts available in die form.

For complete details, sample parts, catalogs, and prices, call your local rep/distributor, or send coupon, or call MPS Marketing direct: ask for Bob Smith, (408) 727-5350, ext. 278.

#### MPS Second Sources AD, PMI & Hybrid Systems.

MPS PART #	DESCRIPTION	FOR	MPS PART #	DESCRIPTION	FOR
MP5520/ DAC-01	6-bit DAC	DAC01	MP7533	10-bit DAC	AD7533
MP5560/ DAC-100	10-bit DAC	DAC100	MP7541	12-bit DAC	AD7541
MP561	10-bit DAC	AD561	MP7621	12-bit DAC	AD7541
MP562	12-bit DAC	AD562	MP7622	12-bit DAC μP comp.	HS3120
MP7520	10-bit DAC	AD7520	MP3140	14-bit monolithic DAC	HS3140
MP7521	12-bit DAC	AD7521	MP9331-16	16-bit MDAC μP comp.	DAC9331-16
MP7522	10-bit DAC	AD7522	MP9377-16	16-bit MDAC w/ref. & op amp	DAC9377-16
MP7523	8-bit DAC	AD7523	MP370-18	18-bit MDAC μP comp.	DAC370-18
MP7524	8-bit DAC	AD7524	MP377-18	18-bit MDAC w/ref. & op amp	DAC377-18
MP7530	10-bit DAC	AD7530			
MP7531	12-bit DAC	AD7531			

#### Samples and Data Available.

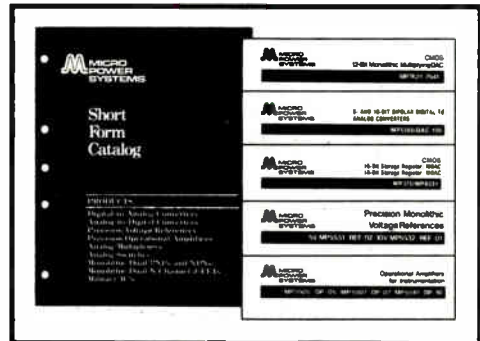

U.S. REPS.: AL: R.W. Mitscher Co. (205) 883-0506; CA: Los Angeles: Select Electronics Ltd. (714) 739-8891; CA: San Diego: The Df Rep Co. (714) 292-9001; CA: Palo Alto: Nor-Cal Assoc. (415) 961-8121; Canada: Ontario: R.F.O. Ltd. (416) 626-1445, (613) 226-6610; Canada, Quebec: (514) 694-5724; Canada, Vancouver: Conit Electronics (604) 324-0505; CO: Delta Sales Assoc. (303) 741-0646; FL: Dyne-A-Mark (305) 831-2097, (813) 441-4702, (305) 771-6501; GA: R.W. Mitscher Co. (404) 923-3239; IL: John Kennaugh & Assoc. (312) 980-7570; IN: Valentine & Assoc. (317) 888-2260, (219) 291-3863; IA: REP Assoc. Corp. (319) 393-0231; MD: Stemler Assoc. (301) 944-8262; MA: Dynamic Sales (617) 272-5676; MI: Lowell Wendt Mktg. Co. (313) 553-9800; MN: Peterson-Snater Elect. (612) 884-3483; NJ: Stemler Assoc. (609) 966-4070; Upstate NY: R.W. Mitscher Co. (716) 633-7970, (315) 637-6561; (315) 458-1321; (716) 586-4012, (716) 381-9115, (914) 679-6151; NY: Hartsdale: Spectrum Sales (914) 997-1166; NC: R.W. Mitscher Co. (919) 828-0575; OH: K.W. Elect. Sales (513) 890-2150, (216) 491-9177, (614) 888-0483; OK: The Cunningham Co. (918) 492-0390; OR: Electronic Component Sales (503) 245-2342; PA: K.W. Electronic Sales (412) 487-4300; PA: Stemler Assoc. (215) 322-9633; SC: R.W. Mitscher Co. (803) 772-1907; TN: R.W. Mitscher Co. (615) 282-6240; TX: The Cunningham Co. (512) 459-8947, (214) 233-4303, (713) 461-4197; VA: Stemler Assoc. (703) 548-7818; WA: Electronic Component Sales (206) 232-9301.

U.S. DISTRIBUTORS: AZ: Kachina Elect. Dist. (602) 269-6201; CA: Ryno Electronics (714) 292-6022; VSI Electronics (714) 557-7131, (408) 734-5470; CO: Integrated Elect. (303) 534-6121; FL: Time Elect. (305) 974-4800; IL: GBL/Goold Elect. (312) 593-3220; IN: Star-Tronics Dist. (317) 844-0102; MD: Whitney Dist. (301) 944-8080; MA: Zeus Components, Inc. (617) 273-0750; Aved Electronics, Inc. (617) 245-7406; MI: Star-Tronics Dist. (313) 477-7586; MN: The Joel Co. (612) 545-5669; MO: Olive Elect. (314) 426-4500; NY: Zeus Components, Inc. (914) 592-4120; OH: Argent (513) 836-8633; REH Elect., Inc. (216) 248-1636; OK: Quality Components (918) 664-8812; PA: Time Mid-Atlantic (215) 622-2500; Star-Tronics Dist. Co. (412) 372-3340; CA/M/RPC Indust. Elect. (412) 782-3770; TX: Quality Components (512) 838-0551, (214) 387-4949, (713) 772-7100; WA: Bomber's Elect. Sales (206) 941-0518; WI: Taylor Electric (414) 241-4321.

INTERNATIONAL DISTRIBUTORS: Australia: Ampex Elect. (02) 818-1166; Austria: Burisch (0222) 387638; Belgium: SA Sotronic NV (02) 7361007; Denmark: Adv. Elect. of Denmark (01) 194433; England: Pronto Elect. Sys. (01) 599 3041/2; Finland: Turion Oy 90 377 787; France: A 2 M (1) 955-32-49; Radio Television Francaise 747-11-01; Holland: Tekelec-Airtronic 079-310100; India: MJ Exports Pvt. Ltd., Bombay 230644; Israel: STG International Ltd. (03) 248231; Japan: Kaigai Elect. 586-0471; Norway: Eltron A/S 02-152051; South Africa: S.C. Devices (011) 789-2400; Spain: Diode Espana 217 26 19 - 217 26 52, 424 86 55 - 423 65 83, 455 36 86; Sweden: Saticco AB 46 8 83 02 80; Switzerland: Anatec AG (042) 367633; Taiwan: Strong Elect. (02) 521-8826; W. Germany: Kontron Elektronik (089) 31901-377, Tekelec-Airtronic (089) 594621.

3100 Alfred Street  
Santa Clara, CA 95050  
(408) 727-5350

To: Micro Power Systems, 3100 Alfred St., Santa Clara, CA 95050

- Send DAC Data Sheets       Send Short Form Catalog  
 Send Op Amp Data Sheets       Send Volt. Reference Data Sheets

E 4781

Application: \_\_\_\_\_

Name \_\_\_\_\_

Title \_\_\_\_\_

Company \_\_\_\_\_

Address \_\_\_\_\_

City \_\_\_\_\_ State \_\_\_\_\_ Zip \_\_\_\_\_

Circle 133 on reader service card

## Milliampere current source is voltage-controlled

by William J. Mundl  
Concordia University, Department of Psychology, Montreal, Canada

The constant small positive or negative current produced by this voltage-controlled source is useful for a variety of low-level measurements. As the current also has a virtually linear relationship with the input voltage, it may be modulated as desired by a given input waveform or, still more usefully, be put under microprocessor control to create an automated test system.

As seen in (a), incoming signals in the range of 0 to 10 volts are buffered by the LM358 micropower operational amplifier  $A_1$  and then introduced to  $A_2$ , which with transistor  $Q_1$  makes the current-monitoring feedback

circuit. For a given input voltage,  $A_2$  amplifies and inverts  $Q_1$ 's emitter-to-base voltage variations, so that any increase or decrease in current due to temperature or load variations is counteracted. As a result, the current will rise linearly from zero to  $I_{max}$ , where  $I_{max}$  is determined by resistor  $R$ , with the variation of  $I$  for a given  $V_{in}$  being about 2%. In this circuit, the maximum attainable value of  $I_{max}$  is approximately 4 milliamperes, obtained with a 1.5-kilohm load impedance.

Calibration of the circuit is simple. Potentiometer  $R_1$  need only be adjusted to null the output current for  $V_{in} = 0$ . For convenience in setting the output current, an oscilloscope can be placed across a 1-k $\Omega$  resistor.

The layout for this circuit's counterpart, a negative current sink, is similar, as shown in (b).  $Q_1$  becomes an npn transistor, the supply potential on the circuit is reversed, and an inverting stage is added at the input.

Although the circuit is relatively insensitive to variations in the supply voltage, use of a regulated power supply of the simple series type is recommended.  $\square$

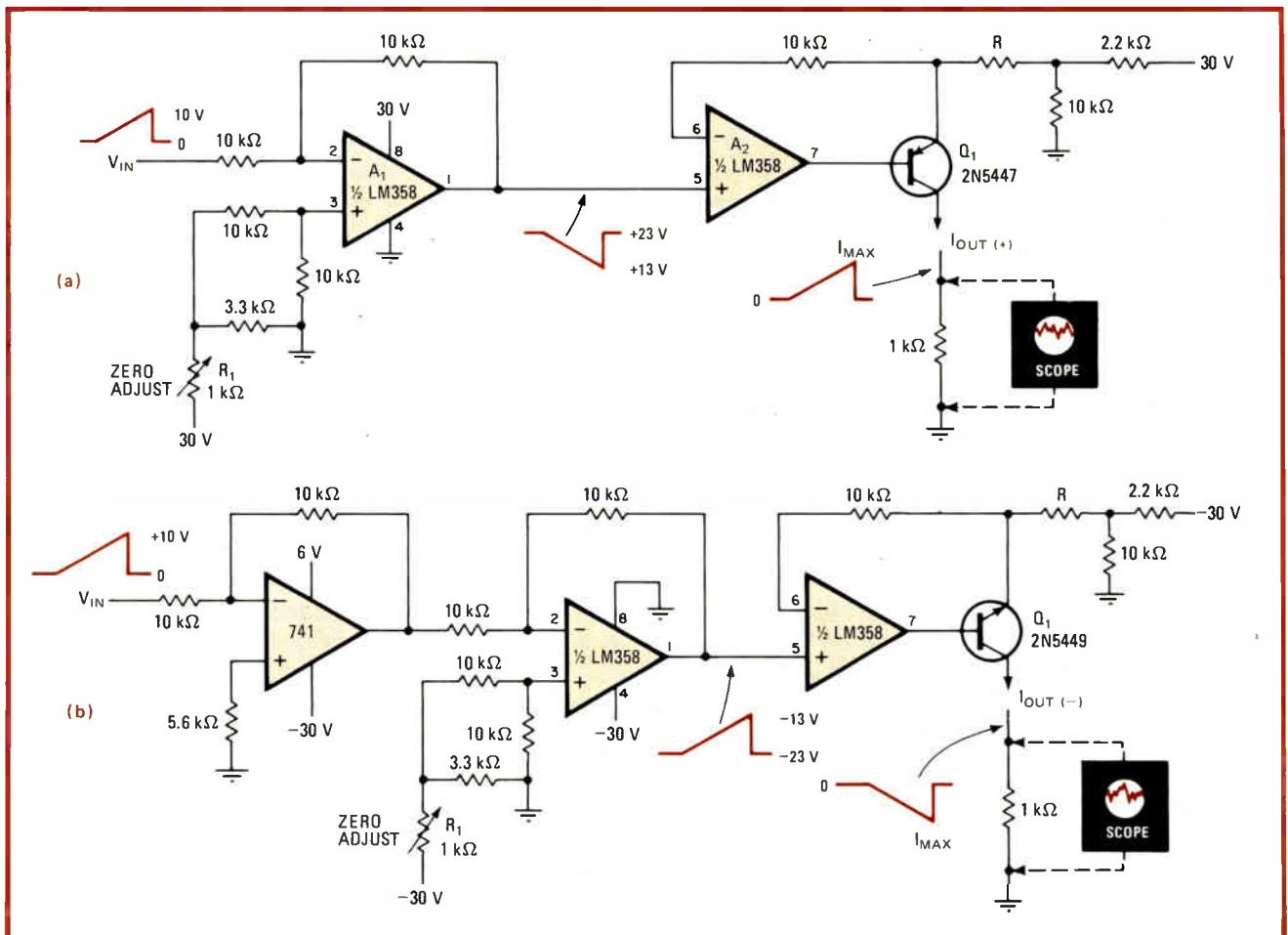

**Milliampere magnitudes.** The circuit's input voltage sets its constant output current to within 5% of the desired value, adjustable from 0 to 4 mA if  $R = 1.5$  k $\Omega$ . Its linear response makes it attractive for microprocessor-based (automated) tests and measurements. The positive source in (a) or negative sink in (b) is simply calibrated by means of resistor  $R_1$  and an oscilloscope monitor.

# Extending the range of a low-cost op amp

by Bob Darling  
 Department of Physics and Astronomy, Rutgers University, Piscataway, N. J.

Low-cost operational amplifiers often have limited power-supply and common-mode voltage ranges. This is the case with the recently introduced ICL7650CPD from Intersil Inc., a device with otherwise very good specifications that sells for under \$3 in 100-piece quantities. The 7650 has a typical offset voltage of under 1 microvolt, drift of only a few nanovolts per degree Celsius, bias current in the low picoampere range, and a bandwidth of 2.5 megahertz.

However, its applicability is limited because its maximum supply voltage of 18 volts and its common-mode voltage range  $V^-$  to  $V^+ - 2.7$  v yields a maximum allowable common-mode input of about 15 v. The circuit in (a) greatly extends the common-mode range in the follower mode.

The idea is to bootstrap the power supply of the 7650, limit the supply voltage on the integrated circuit with a zener diode, and float the complete package on a current source or another floating voltage source.

The 7650 has a maximum rated supply current of 4

**Ranging out.** Bootstrapping the power supply, as well as limiting the supply voltage with a zener, helps extend the common-mode range of the inexpensive ICL7650 operational amplifier (a). Minimum parts version (b) of the extender circuit uses a commercially available 2:1 current mirror and a selected ITE4391 as the booster FET.

milliamperes, so a current source capable of 5 mA was chosen. Transistors  $Q_2$  and  $Q_3$  (2N6718) provide a current mirror yielding the 5 mA current source. The 1N5242 zener diode limits the supply voltage to 12 v dc, and the 1N5228—a 3.9-v zener diode—plus the gate-source voltage of the ITE4393 field-effect transistor is used to provide the greater-than-4-v bootstrap voltage needed for  $V^+$  of the IC.

Bias for the 1N5228 comes through a 100-kilohm resistor, and the 10-k $\Omega$ , 150-picofarad filter stabilizes the circuit against high-frequency oscillations. Because the FET has a gate-source breakdown voltage ( $BV_{GSS}$ ) of more than 60 v, the circuit has a common-mode range of -29 v to +25 v. In addition, the circuit can follow a 40-v peak-to-peak signal of over 20 kilohertz into a 50-k $\Omega$  load.

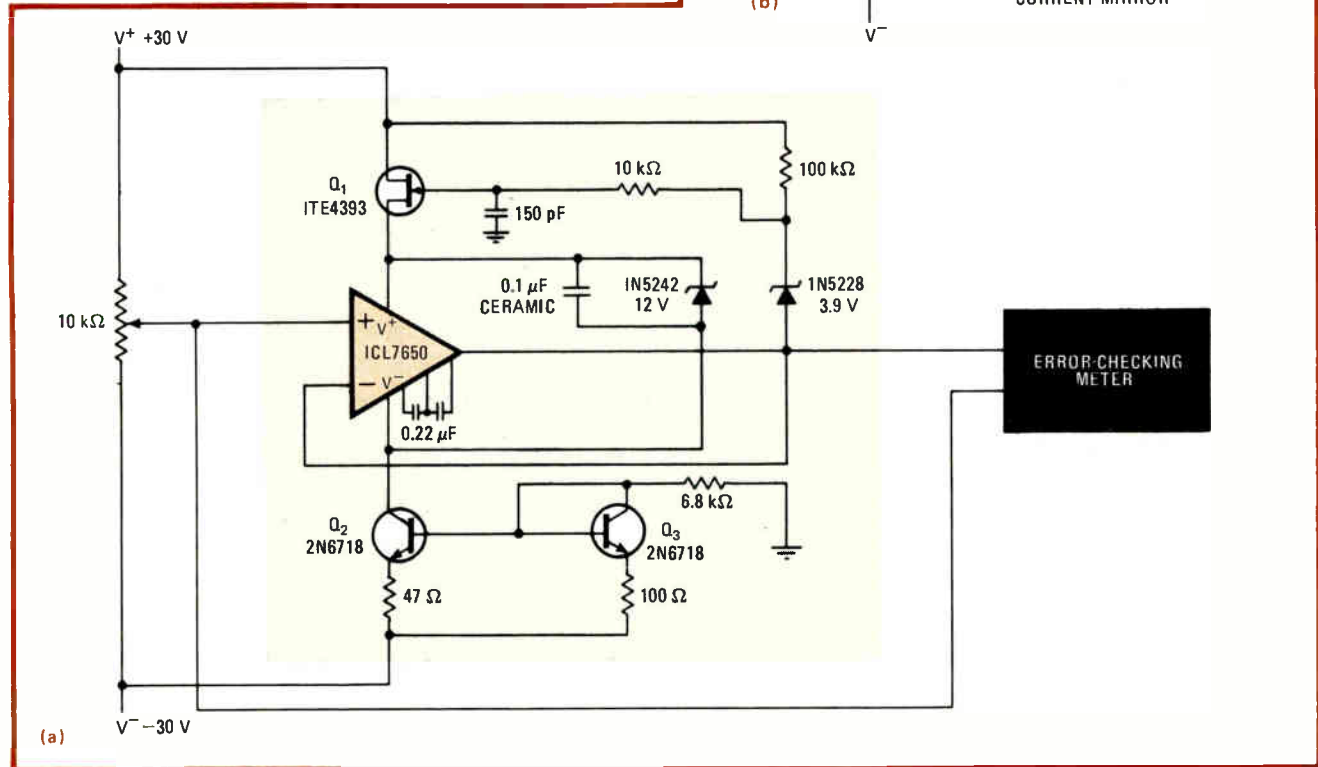
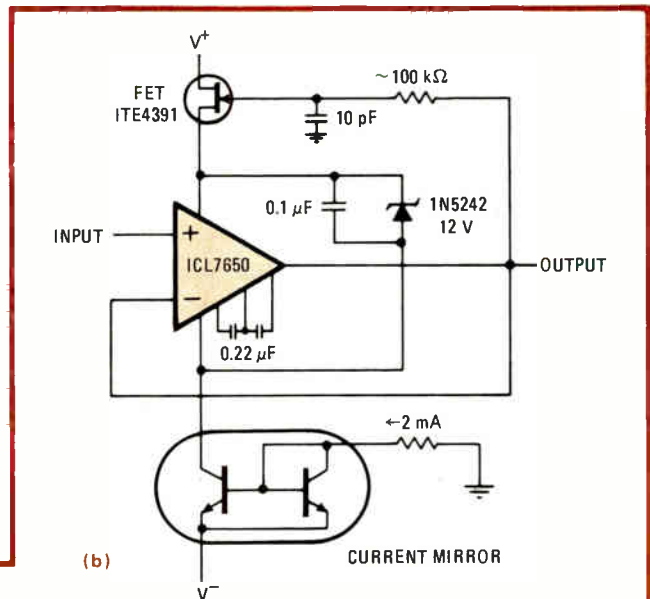

## DIGITAL PANEL METERS

**PM-35U \$39\*** (1-9) \$29 (100%)



Lowest priced quality 3 1/2 digit DPM available • Bright 3 LEDs • Differential Inputs • Bipolar • Auto Zero • Rotomatic • Dimmer/Ampl • Programmable Decimals • 200mV 2V 20V 200V 1200V rms • Edge connector or direct solder tab connections • TC 100 ppm typ, 200 max • 5V DC Pwr

**PM-35A \$49\*** (1-9) \$37 (100%)



Popular, general purpose 3 1/2 digit instrument. More than 20,000 units have been installed throughout the world in thousands of different applications, attesting to the meter's reliability • Differential Inputs • Programmable Current & Dimmer Capability • Rotomatic • 200mV 2V 20V 200V 1200V inputs • Scaling in Engineering Units with Offsets • Lamp Test • Low TC 50 ppm Typ • Auto Zero • Bipolar • Programmable Decimals • 5V DC Pwr

**PM-35AR \$74\*** (1-9) \$62 (100%)



World's Smallest Size Lowest Priced Autoranging DPM. Has all the features of the PM-35A except Rotomatic ohms measurement • Autorange between 200mV-2V, 2V-20V, 20V-200V, 200V-1200V • 1000 mV input on 200mV-2V range 10 mV on others • Auto Switching Decimals • Programmable to Display Engineering Units • 5V DC Pwr

**PM-3.5 \$59\*** (1-9) \$50 (100%)



Very fast update rate available • 3 1/2 digit • Single ended input • MUX BCD Available • Sample & Hold • Leading Zero Blanking • 0.01% Rtg Accuracy • 0001 volt resolution • Rotomatic • Bright 3 LEDs • 5V DC Pwr

**PM-45 \$79\*** (1-9) \$67 (100%)



Popular economical 4 1/2 Digit DPM • Single ended input • MUX BCD Available • Sample & Hold • Leading Zero Blanking • 0.01% Rtg Accuracy • 0001 volt resolution • Rotomatic • Bright 3 LEDs • 5V DC Pwr

**PM-35D \$59\*** (1-9) \$38 (100%)



Super Bright, 54° LED's • 20mA Drive Per Segment • Hi-Rel Design for Long MTBF • Accuracy  $\pm$  (0.05% reading + 1 digit) • Sample Hold Feature • Ideal Replacement for Low Drive capability single chip DPM's • The PM-35D is a full feature 3 1/2 Digit Instrumentation DPM • Full Differential Inputs • Bipolar • Auto Zero • Rotomatic • 4/20 mA • Ohmmeter/Ammeter • Programmable Decimals • Scaling in Engineering Units with Offsets • Low TC • Lamp Test • Sample Hold •  $\pm$  12V DC  $\pm$  5mA Power Output from Internal DC to DC Converter • 5V DC Pwr

**PM-45D \$100\*** (1-9) \$88 (100%)



Ultra Stable, Super Accurate Top of the Line 4 1/2 Digit Instrument • Accuracy  $\pm$  (0.01% reading + 1 digit) • Differential Input • 10 Micro Volt Resolution • 200K Hz Quartz Crystal Clock for 120dB 50/80 Hz Normal Mode Noise Rejection • 80 dB Common Mode Rejection at DC. The PM-45D Represents the ultimate in miniature Hi-Rel DPM Design featuring very bright 4 LEDs • 4/20mA Inputs • Ohmmeter/Ammeter/Rotomatic • Programmable Decimals • Scaling in Engineering Units with Offsets • 7 to -3V Common Mode Voltage • Sample and Hold • Usable at 10 to 100mV to display 10 to 20,000 Counts • Internal Attenuator for 2V, 20V, 200V, 1200V rms • Lamp Test • Overrange Output • Busy Output • Clock Output • 5V DC Pwr

\*PRICES FOR THE USA ONLY

## TEMPERATURE METERS

**TM-150/150F \$55\*** (1-9) \$47 (100%)

**TM-150R/150RF \$59** (1-9) \$50 (100%)



Low cost direct reading temperature meters 3 LED • 5V DC Pwr • TM-150 and TM-150F are configured for voltage and current sensing and are factory preset to display °C and °F with popular IC transducers such as HSC LM-135, LM235, LM335 or Analog Devices AD590 sensors • TM-150R and TM-150RF are configured for resistance sensing with a precision 1uA to 10mA current source and are factory preset to display °C and °F with platinum 100 ohm RTD sensors • Two programmable decimal positions • Auto polarity

**TM-150X \$75\*** (1-9) \$64 (100%)

**TM-150XR \$79\*** (1-9) \$67 (100%)

**TM-150XAC \$79** (1-9) \$67 (100%)

**TM-150XACR \$83\*** (1-9) \$71 (100%)



Low cost low power direct reading temperature meter • High contrast 48° LCD display • Operates with most popular RTD and voltage or current output transducers/probes • The TM-150X 5VDC Pwr and TM-150XAC 115VAC Pwr are configured for voltage and current sensing and are factory preset to display °C with HSC LM135, LM235, LM335 or Analog Devices AD590 sensors • The TM-150XR 5VDC Pwr and TM-150XACR 115VAC Pwr are configured for resistance sensing with a precision 1uA to 10mA current source and are factory preset to display °C with Platinum 100 ohm RTD sensors • Programmable °C and °F • Descriptors and two programmable decimal positions • Measurements from -185° to +600°C, Accuracies to 0.1°C are possible depending on sensor/probe selected • Auto polarity

**TM-150XF \$75\*** (1-9) \$64 (100%)

**TM-150XRF \$79\*** (1-9) \$67 (100%)

**TM-150XACF \$79\*** (1-9) \$67 (100%)

**TM-150XACRF \$83\*** (1-9) \$71 (100%)



**RV-C8 \$49\*** (1-9) \$41 (100%)

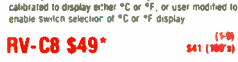

Identical features to the TM-150X, TM-150XR, TM-150XAC, TM-150XACR but factory preset to display °F • Any of the TM-150 Series may be user modified and calibrated to display either °C or °F, or user modified to enable switch selector of °C or °F display

**RV-C8 \$49\*** (1-9) \$41 (100%)

Accuracies of  $\pm$ 1°C between -50°C and +125°C with inexpensive interchangeable Curve-8 NTC Thermistors are possible with the RV-C8 Converter. Standard Output is 1.5mV/°C ( $\pm$ 1mV/0.1°C). Power Supply is 5V DC. The RV-C8 is designed for panel mounting usually in association with a DPM and/or AM-20S controller. Thermistor inputs are normally provided through a rear edge connector. A front mounting terminal jack may be user retrofitted. Accurate calibration of the RV-C8 requires only two precision resistors • Many types of inexpensive Curve-8 Thermistors are available from Sencor/Western Thermistor, Oceanside, CA 92054 TEL (714) 433-4848

## TEMPERATURE PROBES

For user convenience, Texmate offers a broad line of temperature transducers/probes, and accessories that can be ordered with your meter, including an All-Temp probe designed especially for the semiconductor industry to measure hydrofluoric etchant baths.

**Texmate's Popular Low Profile 1" x 2 1/2" DPM Cases For Twin Mounting or multiple arrays order your OPMs in cases to suit your panel layout.**

- End Mount Case**  
Two End Mount Cases enable simple Twin mounting in single cutout.
- Center Mount Case**  
Any number of center mount cases may be fitted between end mount cases for multiple arrays.
- Flat Bezel Case**  
Has complementary styling to multiple mounting cases.
- Slit Line Case**  
Standard Texmate case with attractive malle finish engraved with all orders unless otherwise specified.

## AC POWERED DPM'S

THE REPLACER SERIES OF 3 1/2 AND 4 1/2 DIGIT .56" LED DISPLAY METERS DESIGNED TO FIT MOST OTHER MANUFACTURER'S CUT-OUTS INCLUDING DIN/NEMA STANDARDS.

**RP-35U \$49\*** (1-9) \$42 (100%)



World's lowest priced 115/230VAC line operated DPM • 3 1/2 Digits • 56° Standard Red LEDs • True Differential Inputs • 200mV to 1200V FS • Rotomatic • Ohms • Current • Bipolar • Auto Zero • Programmable Decimals • TC 100ppm typ

**RP-35A \$59\*** (1-9) \$56 (100%)

Extremely versatile full feature 3 1/2 digit 115/230VAC line operated DPM • Differential Inputs • Customer Programmable Current and Ohmmeter Capability • Rotomatic • 4/20mA • Scaling in Engineering Units with Offset • DC Outputs Available • Display Test • Low TC 60 ppm Typ • Auto Zero • Bipolar • Programmable Decimals

**RP-35AR \$85\*** (1-9) \$73 (100%)

World's lowest cost autoranging AC PWR DPM • Has all the features of the RP-35A except Rotomatic ohms measurement • Autorange between any two ranges from 200mV-2V to 200V-1200V • Auto Switching Selectable Decimals

**RP-35AA \$71\*** (1-9) \$61 (100%)



High display drive capability DPM • MUX .56" LED display • 200mV to 1200V FS • High CMV • Scaling in engineering units with offset • 60PPM TC • Bipolar • Rotomatic • Ohms • 4/20mA • Display Test • Autozero • 115/230VAC Pwr

**RP-35UU \$65\*** (1-9) \$56 (100%)

Utility version of RP-35AA • Same High Brightness Display but uses single sided PCB • Selectable TC non switchable decimal points

**RP-35DD \$97\*** (1-9) \$87 (100%)

**RP-45DD \$125\*** (1-9) \$100 (100%)



RP-35000 3 1/2 digit and RP-45000 4 1/2 digit are top of the line 115/230VAC line instrumentation DPMs • High normal mode noise rejection at 50/60 Hz of 120dB with internal 200K Hz quartz clock • Scaling in engineering units with offset • 4/20mA • Rotomatic • Ideal for load cell measurements • 200 to 200MA ohmmeter capability • 10 microvolt resolution on RP-45000 • Provision for plug-in signal conditioning modules including an RMS converter, Peakhold, and a  $\times$ 10/ $\div$ 100 amplifier

**RP-35000BCD \$127\*** (1-9) \$107 (100%)

**RP-45000BCD \$160\*** (1-9) \$137 (100%)

All the same features as RP-35000 and RP-45000 but with buffered Hi-Rela parallel BCD output. Note: Parallel BCD output board is also available for field retrofit of previously purchased RP-35000/45000 meters

**RP-3500AC \$122\*** (1-9) \$104 (100%)



Measures AC input signals with autzero • Frequency range of 40Hz to 1KHz • Average reading, calibrated in RMS • 20mV to 2000V to 1200V FS •  $\pm$ 1.0% Rtg • 1 Digit accuracy • 2.5 readings/sec • 56° LED display • Programmable decimals • 60 PPM TC • 115/230VAC Pwr

**RP-350D \$79\*** (1-9) \$67 (100%)

**RP-450D \$95\*** (1-9) \$81 (100%)



RP-3500 3 1/2 digit and RP-4500 4 1/2 digit are low cost 115/230VAC line operated DPMs • Single-ended inputs • MUX BCD • Remote control sampler/hold feature • Display blanking • Leading zero blanking • Autorange outputs • Display test • Autorange • Bipolar • Flashing overload • 2V FS to 1200V

**RP-3500BCD \$109\*** (1-9) \$93 (100%)

**RP-4500BCD \$130\*** (1-9) \$111 (100%)

All the same features as RP-3500 and RP-4500 but with buffered Tri-state parallel BCD output. Note: Parallel BCD output board is also available for field retrofit of previously purchased RP-3500/4500 meters

## NEW PRODUCT

2-WIRE PROCESS DPM'S POWERED DIRECTLY FROM THE SIGNAL CURRENT LOOP

**CM-35X \$75** (1-9) \$64 (100%)



Powered by a 20mA signal loop power • No external power source required • Transmits 4 to 20mA input into 0 to 1999 digital display • May be user scaled to any required engineering unit • Programmable extra digit for use as 0.1% or as °C or °F descriptor • 48° LCD display • Bipolar • 5C PPM TC • Programmable decimals • Safe for hazardous areas • Available in stackable cases, as shown

**CM-35XHC \$79\*** (1-9) \$67 (100%)

Identical features to the CM-35X but configured for operation from 10 to 25mA signal loop current

**ANALOG METERS**

**AM-20 \$49\*** (1-9) \$41 (100%)

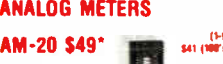

Rugged Versatile Solid State Analog DPM • Accuracy  $\pm$  2% of Full Scale • 10 Meg  $\Omega$  Input Impedance • User Programmable for Bargraph Display • Moving Dot Display • Moving Proportional Brightness • 4 Dot (slinky) Display • 0-4V FS to 0-200V FS Input • 4/20 mA Input • Offset Capability • Bipolar Center Zero Null Meter • Unipolar Center Zero with expanding Bar or intersecting Bars • Selectable LED Scale Points • Flashing Overrange • Overrange Alarm Output • 5V DC Pwr Bar Mode • 4V to 24V DC Pwr Dot Mode

**AM-20S \$65\*** (1-9) \$56 (100%)

Solid State Dual or Single Set Point Controller • Set Point Accuracy  $\pm$  3% • 20 Selectable Set Points • Two Optoisolated Relay or Alarm Drivers • Max Off Voltage 30V • Max on current 200 mA • 5V DC Pwr Bar Mode • 4V to 24V DC Pwr Dot Mode

**SECOND SOURCE DPM'S**

SHORT DEPTH CASES TO FIT DATEL AND IMC PANEL CUTOUTS

**DM-3100L \$49\*** (1-9) \$42 (100%)



Low cost short depth DPM • 1.05% Rtg • 1 Digit accuracy • Differential input • 56° LED display • Autozero • 200mV to 1200V FS • Auto Polarity • 5VDC Pwr • Rotomatic • Current • Ohms • Programmable decimals

**DM-310DX \$65\*** (1-9) \$56 (100%)



Identical features as DM-3100L but with low power 0.5° LCD display • Battery Pwr or 5VDC Pwr

**DM-4100L \$85\*** (1-9) \$72 (100%)



Low cost general purpose 4 1/2 digit DPM • (0.1% Rtg • 1 Digit accuracy • 100 microvolt resolution • 56° LED display • Autozero • 2V to 1200V FS • Auto Polarity • 5VDC Pwr • Sample/hold • Rotomatic • Ohms • Programmable decimals • MUX BCD output available

## NEW PRODUCT

**PM-45X \$150\*** (1-9) \$129 (100%)

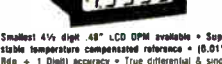

Smallest 4 1/2 digit .48" LCD DPM available • Super stable temperature compensated reference • (0.01% Rtg • 1 Digit accuracy • True differential & single ended inputs • 1000Hz quartz crystal controlled clock for 120dB 50/60Hz MUX • 80dB CMR • 200mV to 1200VFS • 4/20mA • Ohms • Current • Rotomatic • Programmable decimals • Scaling in engineering units with offset capability • Overrange/underage output • Busy Output • Clock output • Ramp/hold • MUX BCD output • Ultra low power requirements 3-5mA at  $\times$  4.5V to  $\times$  5VDC (<25mW)

**PM-45XBCD \$180** (1-9) \$153 (100%)

All the same features as the PM-45X but with an internally mounted buffered Tri-state parallel BCD output

**PM-45XU \$97** (1-9) \$87 (100%)

Low cost utility version of the PM-45X. Has all the same low power features of the PM-45X except a standard TC reference and has detailed specifications • Accuracy (0.015% Rtg • 2 Digits)

**PM-45XUBCD \$127** (1-9) \$108 (100%)

All the same features as the PM-45XU but with an internally mounted buffered Tri-state parallel BCD output

## NEW PRODUCT

**REMOTE DISPLAYS .48" LCD**



**RD-45XMUX4 \$49** (1-9) \$42 (100%)

Accepts standard 4 wire BCD Data inputs with 2u sec min spacing between digit scan/digit drive outputs • Positive or negative logic; Polarity sign and 5 selectable decimal positions • Overrange indication • 26 pin Ribbon cable edge connector input • 3V to +6V operation at 2-3mA

**RD-45XMUX4I \$49** (1-9) \$47 (100%)

All the same features as the RD-45XMUX4 but designed to operate with internal A/D converters where the Digit scan output overlaps and a STROBE signal identifies the data for each Digit

**RD-45XMUX7 \$54** (1-9) \$48 (100%)

Accepts multiplexed 7 segment inputs • Common Anode or Common Cathode • Negative or Positive Logic • Requires 7u sec min spacing between Digit scan/Drive Drive outputs • Polarity sign • Overrange indication • 5 decimals • 3V to +6V DC operation at 2-3 mA

## ENERGY MISER LOW POWER DIGITAL PANEL METERS

Incorporating TEXMATE'S Proprietary Hi-Rel Hi-Contrast 0.48" LCD Displays

**PM-35X \$65\*** (1-9) \$62 (100%)

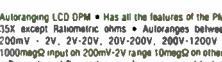

Versatile 3 1/2 digit low pwr LCD meter • Wide operating voltage range capability 3.5V to 50VDC @ 4/15mA • Differential inputs • Programmable current & Ohmmeter capability • Rotomatic • 200mV 2V 20V 200V 1200V inputs • Scaling in Engineering units with offset • Lamp test • Auto zero • Bipolar • Programmable decimals • 8 selectable Function Descriptors

**PM-35XAR \$81\*** (1-9) \$68 (100%)

Autoranging LCD DPM • Has all the features of the PM-35X except Rotomatic ohms • Autorange between 200mV • 2V • 20V • 200V • 1200V • 1000uA input on 200mV-2V range 10mV on others • Decimals and Descriptors can be programmed to Auto Switch • 3.5V to 50V DC pwr

**PM-35XAC \$69\*** (1-9) \$64 (100%)

The World's smallest 115/230V AC Line Operated DPM. Fully isolated with internal transformer.

**PM-35XACR \$85\*** (1-9) \$73 (100%)

All the same features as the PM-35X but with AC Pwr • Can also operate from DC Voltages of 9V DC to 50V DC

**PM-35XACAR \$85\*** (1-9) \$73 (100%)

Auto ranging version of PM-35X AC has all the features of the PM-35X AR but operates from 115/230VAC power

**TEXMATE INC**  
348 SOUTH CEDROS AVENUE, SOLANA BEACH, CA 92075  
TWX-910-322-1738  
Telephone (714) 481-7177

- AUSTRALIA: SYDNEY (02) 782-9222; MELBOURNE (03) 329-8873 • AUSTRIA: VIENNA 02-22-305-325 • CANADA: TORONTO (416) 661-3193; MONTREAL (514) 337-0425; EDMONTON (403) 432-7746; OTTAWA (613) 238-7077 • FRANCE (11) 575-53-53 • GERMANY: DARMSTADT 041 06/612-1; HANOVER 05 11/88 606; DUESSELDORF 011/66 61 45; DUNKERSTADT 061 51/26 64 46; STUTTGART 07 11/73 63 57; MUNICH 089-47 3023 • SPAIN: BARCELONA (93) 692-35-19 • SWEDEN: STOCKHOLM 08-776 10 15 • SWITZERLAND: ZURICH 01-645660 • TAIWAN: TAIPEI 592-3509/591-9651 • UNITED KINGDOM: RADLETT (09276) 4844

↑ RIP OUT THIS PAGE FOR REFERENCE ↓

A minimum parts version of the first circuit is shown in (b). The current source is a 2:1 current mirror (from Texas Instruments), and the booster FET is a selected ITE4391 with a gate-source breakdown voltage ( $BV_{GSS}$ ) greater than 60 v dc and a drain current greater than 5 mA when the gate-source voltage is equal to  $-3$  v. The

100-k $\Omega$  and 10-pF stabilizing network is adjustable for maximum frequency response.

This type of circuit can be used to more than 100 v by substituting bipolar transistors or high-voltage FETs. And it can be built to be fully floating by replacing the current source with a pnp amplifier or p-channel FET  $\square$

## Integrator improves 555 pulse-width modulator

by Larry Korba  
Ottawa, Ont., Canada

In one method of providing linear pulse-width modulation with the 555 timer, a current source charges a timing capacitor, creating a ramp signal that drives the modulation input of the 555. Unfortunately, the circuit offers only a limited dynamic range of pulse widths and is highly sensitive to temperature. A better way is to use a resettable integrator as the timing element.

Charging with a constant current source (a) at best yields a 2:1 dynamic range for a supply of 5 volts—the linear operating range for voltage-to-pulse-width conversion is approximately 2.1 to 4.1 v, and the timing capacitor is totally discharged every timing cycle. Furthermore, the circuit requires temperature compensation to eliminate any timing fluctuation due to the temperature sensitivity of  $Q_1$ , since the base-emitter voltage varies at the relatively high rate of  $-5$  millivolts per  $^{\circ}\text{C}$ . And, to add to the circuit's woes,  $I_{cbo}$  varies with temperature as well.

The resettable integrator (b) made up of  $A_2$ ,  $Q_1$ , C, and R applies a trigger pulse to the 555, causing  $Q_1$  to turn off. Integrator  $A_2$  then ramps up until the voltage level at the modulation input of the timer equals that at pin 5. When that happens,  $Q_1$  is turned on again, resetting the integrator and turning off the 555.

The voltage applied to the integrator,  $V_c$ , is set to 2.1 v. This makes the shortest linearly modulated pulse width equal to the trigger pulse width—2 microseconds. With the timing values shown, the maximum pulse width is 6 milliseconds, producing a dynamic range of more than 3,000:1 over the linear operating region.

The active components affecting the timing circuit are  $A_2$ ,  $Q_1$ ,  $A_1$ , and  $V_{cc}$ . Since the average temperature coefficient for the offset voltage of  $A_2$  is a very low 5 microvolts/ $^{\circ}\text{C}$  (affecting the timing by only 2.5 parts per million/ $^{\circ}\text{C}$ ), the circuit's almost negligible adverse temperature effects are largely due to the variation with temperature of the off current of  $Q_1$ ,  $I_{dss}$ .  $I_{dss}$  doubles every  $10^{\circ}\text{C}$ ; for the 2N4360, it is about 10 nanoamperes at room temperature.

It is important to note that for both circuits, the effects of  $V_{cc}$  and the 555 on timing stability are the same. As a bonus, however, the new circuit provides a linear ramp output that can be loaded fairly heavily without seriously affecting circuit timing.  $\square$

Engineer's notebook is a regular feature in *Electronics*. We invite readers to submit original design shortcuts, calculation aids, measurement and test techniques, and other ideas for saving engineering time or cost. We'll pay \$75 for each item published.

**Old style, new style.** In the most common method of linear pulse-width modulation using the 555 timer integrated circuit (a), the timing elements are current source Q, and capacitor C. The sensitivity of the pulse characteristics to circuit parameters leaves much to be desired. When a resettable integrator is used to time the modulator (b), circuit sensitivities are reduced greatly. As a bonus, pin 6 provides a ramp output with significant drive capability.

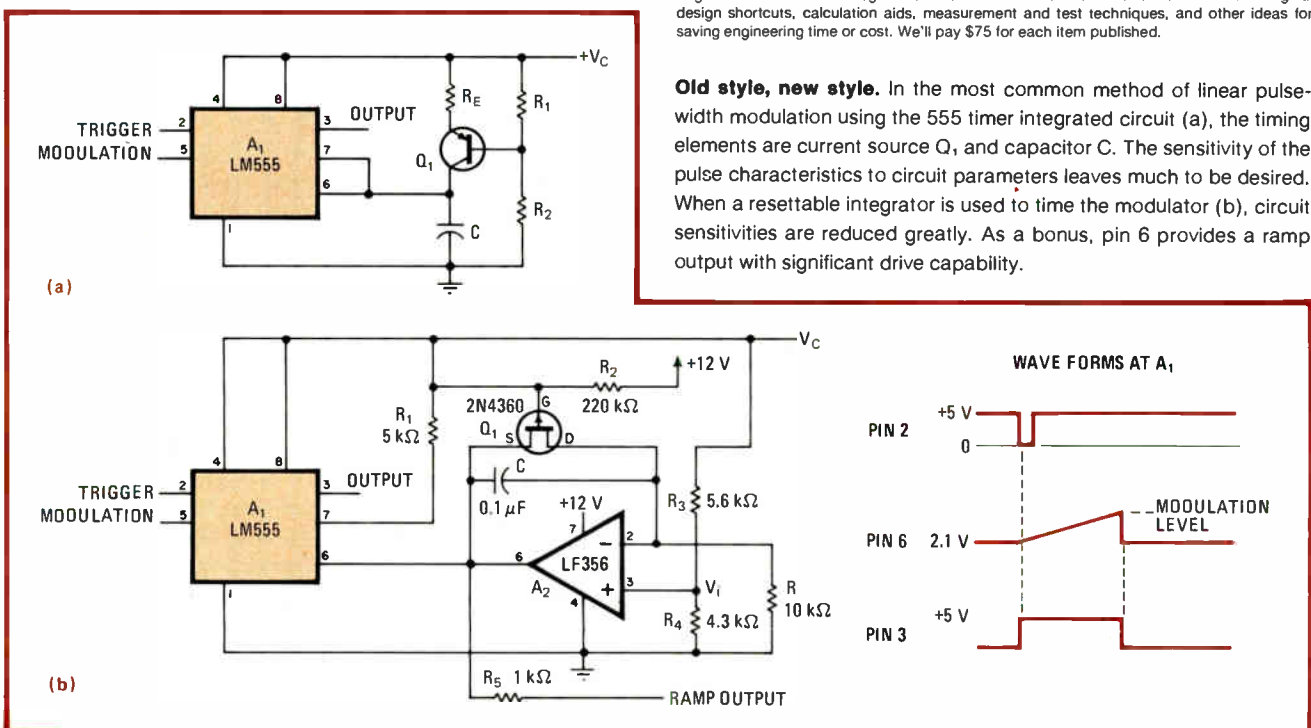

# Precise splice optical fibre

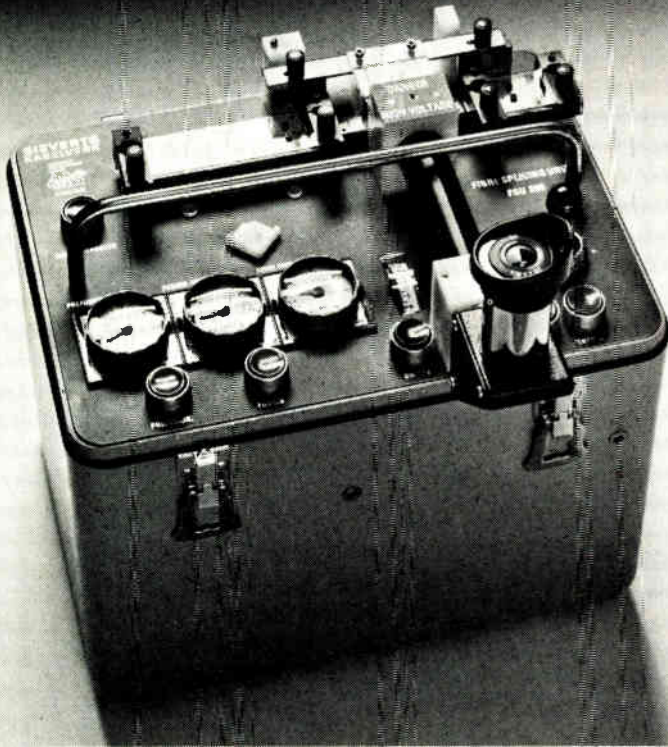

You can now get clean, precise, fast splicing of optical glass fibres with LM Ericsson's FSU 800. It's a portable, compact splicer for both MCVD and DC fibres with diameter from 100 to 400  $\mu\text{m}$  without need to change set-up. For handling the wide range of diameters welding arc current is adjustable and timer controlled. The FSU 800 provides a splice that is so neat that its loss is negligible, which means less amplification demand. Fibre is fed automatically during welding, with automatic alignment of fibres radially and simple joy-stick manipulation axially. The unit is equipped with a 20 $\times$  microscope and fitted for attachment for video screen monitoring. The FSU 800 is supplied complete with 1,5 m mains voltage cable, and packed in rugged carrying case.

**LM ERICSSON**   
**TELEMATERIEL AB**

Components Department  
 Box 401, S-135 24 Tyresö, Sweden  
 Telex 109 20 LMSBO S

Circle 138 on reader service card

# Circuits. Circuits. Circuits!

## Electronic Circuits Notebook.

344 pp., illus.

Some 268 proved-in-action circuits are gathered here for the first time in a single, easy-access resource that meets the highest standards of performance, cost reduction, and reliability. From amplifiers to voltage regulators... from data conversion to phase lock loops... you'll find the most needed, most reliable solutions to a vast range of circuitry challenges.

## Circuits for Electronics Engineers.

396 pp., illus.

More than 340 circuits from all over the world are arranged here by 51 of the most important functions designers use to implement their systems, including amplifiers, detectors, memory circuits, integrators, and much more. Complete with component values, circuit diagrams, waveshapes where applicable, and clear explanations of operations and applications.

## Design Techniques for Electronics Engineers.

370 pp., illus.

The best of *Electronics'* popular "Engineer's Notebook," this is an indispensable storehouse of solutions to numerous frequently encountered design problems. You'll find a host of proven techniques to help you make measurements, interpret data, make calculations, choose materials, control environment, lay out and purchase components, and more!

Don't forget the other valuable Electronics Magazine Books on the coupon below.

### Electronics Magazine Books

P.O. Box 669, Hightstown, NJ 08520  
 (609) 448-1700, ext. 5494

No. of Copies	Title	Price
_____	Electronic Circuits Notebook	\$14.95
_____	Circuits for Electronics Engineers	\$15.95
_____	Design Techniques for Electronics Engineers	\$15.95
_____	Microprocessors and Microcomputers:	
_____	One-chip Controllers to High-end Systems	\$13.95
_____	Microelectronics Interconnection and Packaging	\$12.95

If after my 10-day free-trial examination I am not fully satisfied I understand that my payment will be refunded. Payment must accompany orders under \$25.

Discounts of 10% on orders of more than 10 books.

Payment enclosed     Bill firm     Bill me  
 Charge to my credit card:  
 American Express     Diners Club     Visa     Master Card\*  
 Acct. No. \_\_\_\_\_ Date Exp. \_\_\_\_\_

\* On Master Card only, first numbers above name \_\_\_\_\_

Name \_\_\_\_\_ Title \_\_\_\_\_

Company \_\_\_\_\_

Street \_\_\_\_\_

City \_\_\_\_\_ State \_\_\_\_\_ Zip \_\_\_\_\_

Signature \_\_\_\_\_ ELH

# Controlling the electronic office: PBXs make their move

Once capable of voice only, private branch exchanges  
are being designed to handle data as well

by Harvey J. Hindin, *Communications & Microwave Editor*

□ The newest generation of office workers has a communications problem. The data-generating and -receiving machines now showing up among the typewriters and copiers need a means to interact. Years ago, this task was handled by computer firms like IBM and Digital Equipment Corp. with proprietary local networks that really spoke only to their own gear. More recently, firms like Xerox and Zilog introduced their respective Ethernet and Z-Net local networks to do the job. Today, some dozen manufacturers of private branch exchanges—those in-the-office voice-routing and -switching machines—are adding data-handling capabilities to their products. That means a 56- or 64-kilobit-per-second data rate, which, the makers say, is more than enough for typical offices.

The goal of this work—by Datapoint, InteCom, Mitel, Northern Telecom, Rolm, and others—is to control the voice and data flow in the office of the future (see “The debate over how to control the data flow,” p. 140). Several products have been introduced in the past few months, and several are about to be introduced.

On the one hand, firms like Rolm are updating their voice-only PBXs. That is possible because distributed architecture and digital technology make the use of add-on printed-circuit boards cost-effective. Also, layered software makes additional programming no big chore.

## Starting fresh

On the other hand, newcomers to the PBX industry like InteCom and Lexar have of necessity had to develop totally new PBXs. Like the others, these are geared in large part to voice—voice is after all 80% to 90% of the traffic in typical offices. But unlike its competitors, InteCom's unit is unusual in that it uses packet switching for communication among its internal parts.

Still in the wings but promised for the PBXs that are available and for those yet to appear are protocol and format translators. These software-controlled modules permit almost any type of data-generating or -receiving equipment to be connected to the PBX. For now, most machines are content to handle only the commonly used RS-232-C protocol.

As with large voice-only systems, calls for routed through the PBX's interfaces to commercial communications networks. These include AT&T's Long Lines, RCA's

Globecom, Tymshare's Tymnet packet-switching network, and Satellite Business Systems' earth satellite.

Manufacturers have concluded that the best way to ensure a share of the PBX market for themselves is to bring their own particular capabilities to bear. Thus Mitel is depending on its semiconductor know-how to develop special-purpose chips to make its forthcoming SX-2000 unique. For its part, Datapoint has opted for a PBX designed to interact with its Arcnet local network.

Still unknown is the approach to be taken by IBM and AT&T, who are expected to introduce new products in the next year or so. Japan, too, is notably absent from the market, but various products are available or about to be made available from Europe.

## Stating their case

Although none of the present machines has protocol converters, PBX manufacturers insist that their products can do the best job of controlling the office of the future. They quote several facts to support their views. For one, since the voice PBX has been in offices for years, the wiring—which can accommodate the newer machines—is already in place. Furthermore, the voice PBX in its pulse-code-modulation digital implementation already has built-in hardware and software for dealing with data. That means, for example, that no costly modems are necessary, since there are no analog-to-digital conversions to be made.

With or without protocol translators, the new voice- and data-handling PBXs will make major changes in the architecture and capabilities of office data-communications equipment. Most important is the fact that users will now have a work station at their desks, whereas older PBXs were designed only for telephones. The work station's phone will be digital, with a built-in codec so that the cost and flexibility benefits of an end-to-end digital PBX can be realized. Furthermore, the work station will have a keyboard and a cathode-ray-tube screen so that data can be simultaneously entered and displayed. And, of course, the screen will display a data call received from another party.

Set up less than two years ago, Exxon Enterprises Inc.'s InteCom Inc. of Dallas has just come out with its initial offering, which the company says is a voice- and data-handling system that is “able to perform both format conversion and protocol translation so that normally

## The debate over how to control the data flow

With communicating word processors, intelligent copiers, and other equipment appearing on the market emerging as the forerunners of the office of the future, a fight is in the making over how to control and coordinate the information flow from all this gear. Some manufacturers of private branch exchanges like Rolm Corp. have been beating the drum for PBX control of data flow for some years now and the PBX does have certain advantages.

For example, the fact that the PBX already has lines flowing to it from every important location in an office is particularly important to engineers at Nippon Telegraph & Telephone Public Corp. in Tokyo. This already-existing wiring, they say, is one of the reasons that the PBX will beat out its contenders in Japan for the controller of the office of the future.

The competition says that the PBX is not a sensible candidate for controller because of price. The current cost of about \$900 per installed line (strongly dependent on the number of lines and the features of the PBX) may well be up to \$1,200 or more per line when the necessary software and hardware are added to enable data to be handled. Therefore some firms, like Infotron Systems Corp., Cherry Hill, N. J., have said that it is more economical to have a separate data PBX for data communications.

This view is strongly contested by many experts, including Jean-Jacques Duby, director of switching systems at IBM Europe in La Gaude, France, who says that such an approach would "cost an arm and a leg." "You would be better having a PBX with both digital and analog ports for the data and voice," he believes.

As far as the data rate is concerned, PBXs can handle 56 or 64 kilobits per second. That figure pales in comparison to the megabit rates of local networks, but the PBX people say that their data rates are enough for all but special applications and that coaxial-cable-based local networks—another contender for the office-of-the-future controller—cannot readily handle voice.

As if local networks were not enough competition, PBXs must also contend with the view that the central public telephone networks should provide the intelligence needed to keep everything in order. American Telephone & Telegraph Co.'s much delayed Advanced Communications Service is an example of this approach, as is NTT's under-study network to do much the same thing in Japan. In contrast, British Telecom, the telecommunications authority of the British government, is studying setting up interfaces for protocol translation on users' premises so that the national telephone network or local loops can be tapped by diverse office gear.

AT&T is also known to be covering its bases by developing a voice- and data-handling PBX at its Denver, Colo., facility (jointly shared by Western Electric, Bell Laboratories, and AT&T). Project Antelope, as it is known, is so hush-hush that AT&T—ever fearful of preannouncement—will not even admit to the name.

IBM Corp., for its part, has a faction that believes that word processing, electronic mail, and the like, should be handled by a computer—no doubt based on the company's Systems Network Architecture. Still, like AT&T, IBM covers its bases as best it can. It is said to be working on a

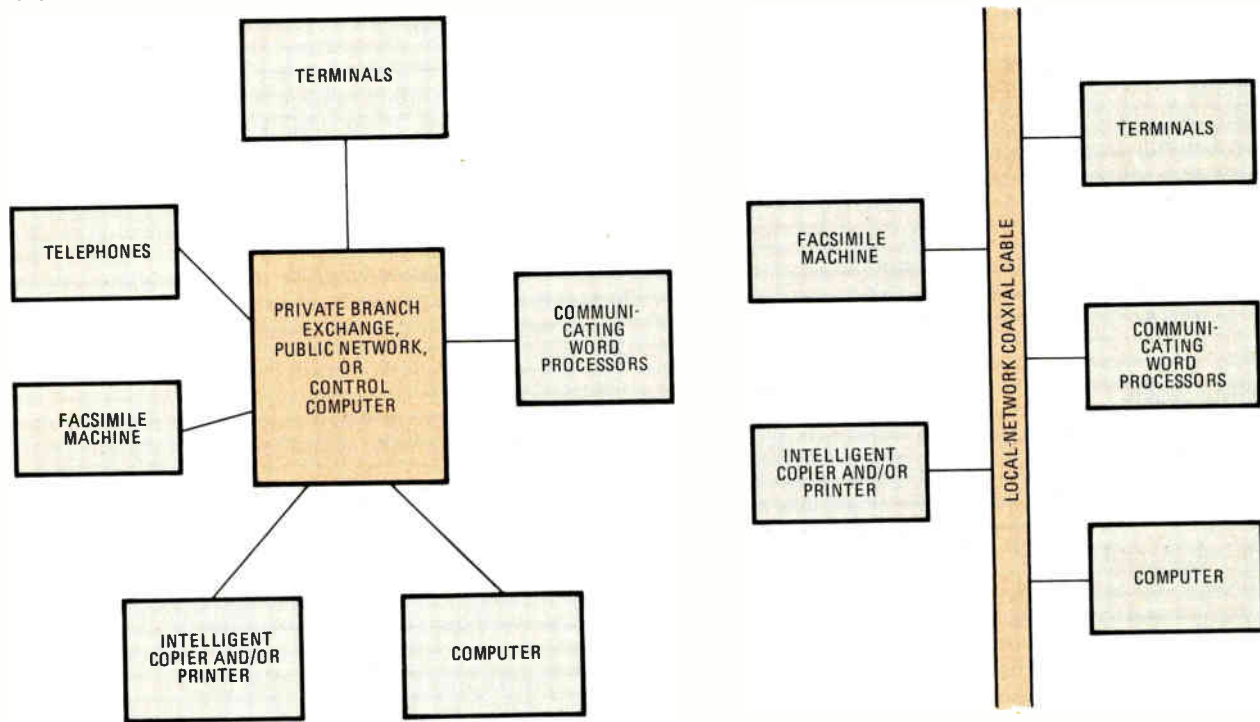

incompatible data-generating and -receiving equipment can communicate." The ability to act as a universal switching device makes the IBX/S40 unique in its field; however, the first model, to be shipped this year, is said not to have the capability installed, although there is

provision for it to be added in the future (Fig. 1).

According to the company, a user of its machine can initiate or receive data calls that are asynchronous or synchronous at rates of up to 56 kb/s, a common speed for the latest PBXs. Simultaneously, he can also initiate



PBX for the North American market based on the model 1750 voice and data PBX it has been selling in Europe for two years.

It remains to be seen if PBXs will win the day. However, some experts have already decided. Kenneth G. Bosomworth, president of International Resource Development Inc. in Norfolk, Conn., says that "on the basis of current market trends, the PBX is the winner." His view applies to the shorter term and smaller offices. Says Celeste Hynes, another IRD researcher, "The PBX is providing the most acceptable stepping stone to local networking and may continue to be a viable option for small companies during the 1980s. It is a natural, low-risk bridge to networking, with gear for effective integration of voice and data communications available from several PBX manufacturers."

Still Hynes does not see it all rosy for PBXs. She notes that "it is limited in its data speed, is liable to a catastrophic failure that could cut down the entire communications system, and relies on the concept that the telephone will continue to be the vehicle for individual communications."

Indeed, the telephone may be replaced by the keyboard; coaxial cable has a much greater bandwidth than a PBX; and a local network's distributed work stations, if they fail, cause only graceful rather than abrupt network collapse. Still, the consensus among industry observers is that there will be a place for all these approaches over the long term. They say that each will carve out a niche for itself depending on complex questions of cost-effectiveness and on vendor salesmanship.

or receive an ordinary voice call.

Thomas H. Aschenbrenner, the firm's vice president of marketing, will not say anything about which protocols and formats will be implemented or how that will be done. However, it is clear, industry observers say, that if the IBX/S40 is really a universal switching device, for both intra- and inter-facility use, it will be a formidable contender for the automated-office controller.

### Internal packet switching

Like other offerings, the IBX/S40 depends on a PCM-based time-domain-multiplexed design (see "PBX technology: an evolution," p. 143). It is set up as a distributed architecture network both for reliability—no catastrophic failure—and to serve users at far-flung sites (Fig. 2). The switching partitions (sections of the PBX that actually connect one transmission line to another) and the master control unit communicate by means of packet switching—an internal approach not seen elsewhere. The reason for this method, one industry theory has it, is to make it easy to use packet technology as the basis for the protocol and format translators that will be at users' terminals. Such easily programmed interfaces are one way to make sure that a user can hook up whatever he wants to the PBX. And packet signals from the interface would easily activate the switching partitions, which, as mentioned, communicate with the central control by the same method.

To do all this fancy switching, the PBX switching partition employs cross-point arrays controlled by redun-

dant 32-bit central processors with a memory capacity of 4 megabytes. These processors coordinate the work of as many as 16 distributed switching partitions. Each of these is, in turn, provided with a Z80 microprocessor and 64-k bytes of memory to handle 256 wideband (128 kb/s) interface ports, for a system total of 4,096 voice or data inputs. The partitions can be linked to the master control over distances of a mile or more, if necessary, by means of laser-driven fiber-optic cable, about which there are no details.

At a user's work station, voice and data are digitally encoded by means of separate instruments—the company calls integrated terminal equipment. At present, these InteCom-manufactured telephones contain RS-232-C and RS-449 interfaces for data. They multiplex up to 56 kb/s of data and digitized voice over twisted pairs connected to the switching partition. The RS-449 capability is unique and awaits the expected increased use of this very new protocol.

### Not universal

Whereas InteCom's is a stand-alone device, Datapoint Corp.'s much-anticipated voice- and data-handling PBX (project Evergreen), finally unveiled last week, is designed to interact with Arcnet (Fig. 3). Arcnet is a coaxial-cable system that hooks up all of Datapoint's data-communication equipment.

According to the San Antonio, Texas-based firm's vice president and group executive of the Office Systems group, Dan Hosage, the Information Switching Exchange, or ISX, as it is called, can handle up to 20,000 voice and data hookups. But more important than the sheer size of the machine is the fact, acknowledged by Hosage, that the product is not universal. He says that it is "no catchall for everybody's equipment." Explaining, he points out that "at least 75% of what could be hooked up in an office can be accommodated by our PBX and Arcnet as it exists."

This means that, unlike the situation for the InteCom machine, there are no plans at present for protocol or format translators. Says Hosage: "There is a connection at the PBX's combination voice and data telephone known as the Infoset 2. This set has a 24-character alphanumeric display, a standard 12-button numeric pad, and 20 function keys and will accommodate our office data-communication equipment and most RS-232-C-governed equipment, but RS-449 and other rules are not taken care of." The latter is no problem, he says, "because the PBX not only hooks into Arcnet, it builds on it to use all the data-communications facilities existing in the network."

To accomplish this "building" in a wholly digital operating mode, Infoset 2 (Fig. 4) has a codec built into it, although, like other PBX offerings, it can handle analog phone connections. The codec is not a custom chip, and, Hosage says, neither is any of the others in the system like the microprocessors, random-access memories, or subscriber-line interface chips. Most PBX manufacturers have taken the standard-parts approach for economy, although Mitel is developing several codecs and switching matrixes for its yet-to-appear SX-2000.

The Datapoint PBX makes use of a distributed archi-

ecture much like that of the InteCom exchange. To do this, each of the Infosets is connected by means of simple twisted-pair wiring into remote switching units. Up to 350 user terminals can be tied into one of these units, and up to 50 remote switching units can be hooked together into the central control unit.

It is in this last stage of connection that the distributed architecture really becomes important. The company has chosen to allow for several different transmission techniques between the remote switches and the central control. Which one is chosen depends on the desired error rate, the traffic load, the cost, and the distance. Thus, not only is coaxial cable available, but also fiber-optic cable and Datapoint's infrared link. These systems can operate at the standard AT&T T-1 carrier rate of 1.54 megabits per second, whereas the individual user's voice and data terminals can carry a combined digital traffic of up to 56 kb/s.

All the system intelligence is based on Z8000 16-bit microprocessors, with more than 8 megabytes of RAM used to keep tabs on who is sending messages to whom, to monitor and control the system, and to switch lines. For reliability, the system adopts what Hosage calls "hot standby" of all strategic elements such as microprocessors. "We have enough stuff on board to take care of all system configurations reliably," he says confidently. He goes on to explain that reliability is not based on a dual-system concept but rather on redundant components and circuit boards.

### A clever upgrading

A completely new approach to a voice- and data-handling PBX was not necessary for Santa Clara, Calif.-based Rolm Corp., which has been saying since it brought its all-digital voice PBX (known as a CBX) to market that it would be upgradable for data handling.

The company has just introduced an add-on data-communications feature with data rates of up to 19,200 bits per second. Unlike InteCom, Rolm does not claim that its machine will be suitable for all data-generating and -receiving terminals. It is content with asynchronous RS-232-C machines only, since they, the company says, are the machines most commonly seen in the office. Moreover, Rolm says that a data rate of 19,200 b/s is more than enough for most office data machines.

Rolm is able to include a data capability in its PBX to the user's telephone by simply plugging in a hardware interface and some pc boards to route the data through the PBX's central control. To keep tabs on this equipment, Rolm includes some additional software (Fig. 5).

Like most other PBXs, the Rolm system can hook up many more pieces of equipment than can simultaneously use the system. In fact, usage statistics show that the system starts to overload internally at about 150 completed simultaneous voice calls. PBX manufacturers just do not expect all users to be on the line at one time and have devised complicated statistical procedures to design a system for a predetermined working capacity.

### 'Submultiplexing' the calls

Because of the large demand it anticipates, Rolm wanted to be able to handle many thousands of data calls—the exact number depends on their data rates—without interfering with voice service. Adding to its problem was the fact that company information had it that the average data call is a half hour (versus six minutes for the average phone call).

What Rolm came up with is a clever trick it calls submultiplexing. In this approach, a data call—which typically uses far less than the 96,000 b/s that a voice line furnishes—is sent out over only a part of a voice line's capacity; thus many simultaneous data calls are

**1. Translates protocols.** InteCom's IBX/S40 promises the user the capability of attaching modules to any and all of his data-generating or -receiving equipment so that they may communicate without thought of protocols, codes, or formats.

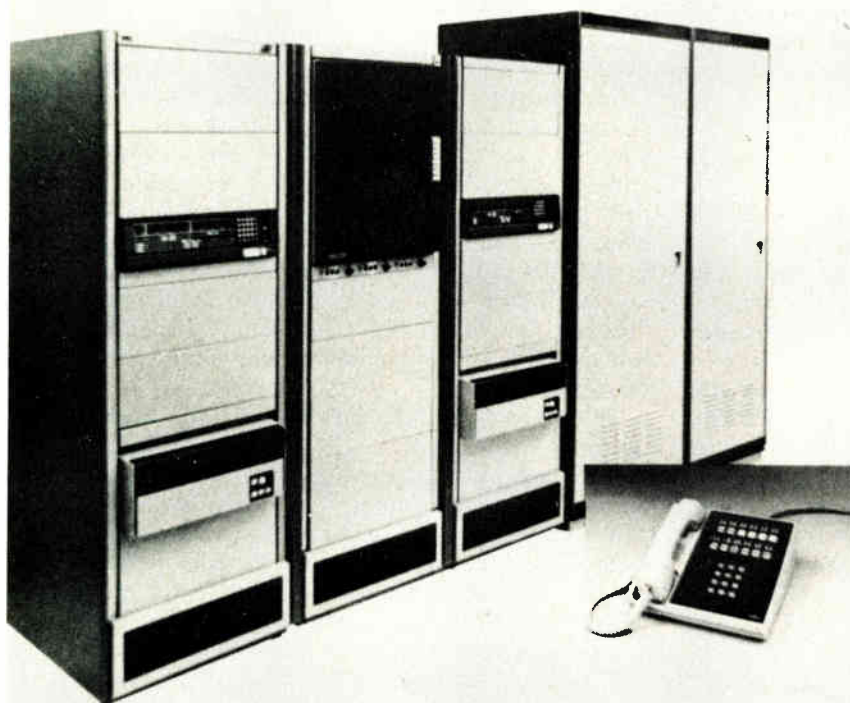

## PBX technology: an evolution

Private branch exchanges employ the same technology found in the larger switching systems in telephone company facilities. The oldest of these, introduced some 100 years ago, and still found at some sites, is known as the step-by-step or Strowger process. This electromechanical approach calls for switching in a sequential, stage-by-stage procedure coincident with the reception of individual electrical impulses as each digit is dialed.

Step-by-step systems are operated under direct control. That means that the switching process control is integral with the switching action and occurs in unison with each dialed digit. No special segment of the switch mechanism is called into action. In contrast, common control, not seen until the 1940s, separates the control and switching functions. A common control system oversees all the functions related to the establishment of a path through the internal switching network. It is then free to handle another call. By design, a small amount of common control is shared on a demand basis.

Common control was originally conceived for the electromechanical switches that opened and closed appropriate transmission lines. It was then extended to the quasi-electronic reed relays that followed in the development of switch technology and finally to the integrated circuits that do the job today. A common control system, regardless of whether it is made up of relays or ICs, uses a

grid, or coordinate array, of what is known as cross-point switches to establish the physical paths for transmission through the switching network.

Until recently, both Strowger and cross-point switches employed only space-division-multiplexing techniques. In this scheme, a particular physical connection is dedicated to only one conversation or data transmission between a single pair of terminals. In contrast, the newer technique of time-division multiplexing does not switch physical path connections but only slices and recombines information—either voice or data—in a controlled sequence over a common connection.

Each voice or data terminal in a TDM switching system is connected to a common transmission line by means of a switch that is gated, or activated, to an on condition at a specified time. The switch simply samples each terminal's signal momentarily. These samples are carefully timed, combined with those of other conversations, and transmitted over the common transmission line in what is known as pulse-amplitude modulation. In contrast, the latest TDM PBXs convert voice into a digital signal immediately by means of pulse-code modulation. In this approach, a series of constant-amplitude pulses (bits) is generated by a code wherein the on-off sequence or coding of the pulses indicates the amplitude of the analog information to be transmitted.

shared on one voice line. In contrast with other approaches a data call, at whatever rate, usually takes up an entire voice line. Rolm's method, it says, is unique in the PBX industry and depends on the time-slot properties of a PCM machine.

Normally, the stand-alone analog telephone that the Rolm PBX connects to transmits information in two directions using a single pair of wires. These two-wire signals are converted into unidirectional signals in the PBX's hybrid circuit. Then the PBX's codec samples the analog signal, converts it into a digital representation and stores the result until commanded by the system microprocessor to transmit it to the appropriate TDM transmission time slot.

Of the 384 time slots in the PBX, two are required for each voice conversation (one in each direction), and some are used for command and status signals, audible tone transmission, and the like. When the data-communications hardware and software are added, each voice conversation time slot is further divided into many more slots that are still long enough in time and adequate in data-handling capability to manage a number of simultaneous data calls at different data rates.

### Using the full slot

The only restriction on this technique is that the maximum data rate for one call of 19,200 b/s (set by other parts of the PBX) not be exceeded. Thus it is possible, for example, to transmit, on one PBX internal voice connection, the data calls of 40 users at 2,400 b/s or 5 data calls at 19,200 b/s. In either case, the full time slot is carrying 96,000 b/s, which is what it was designed to do. Of course, it is not necessary to use the full data

capacity of the voice line at any one time.

Whereas Rolm's submultiplexing technique will soon allow users of that company's all-digital PBX to handle asynchronous data at rates of up to 19,200 b/s, purchasers of the SL-1 stored-program-control PBX from Northern Telecom Systems Inc., Richardson, Texas, have been able to accommodate asynchronous 9,600-b/s data for more than a year now. As with Rolm's approach, microprocessor-controlled equipment is required for the phone—which Northern calls an add-on data module—and line cards for the PBX central control. But according to Arnold J. Murphy, project manager for the SL-1 at Bell Canada's Hull, Quebec, facility (Northern Telecom is a subsidiary of Northern Telecom Ltd. in Montreal, which in turn is a subsidiary of Bell Canada, and therefore has close working relationships with Canadian telephone organizations), "the data function is software-independent and requires no change to the installed SL-1's operating software."

Thus each data call is handled directly by a digital voice line of the PBX. For systems with enough of the modular, readily expandable PBX subsystems to handle all their voice and data traffic, there is no need for dividing the voice time slot into further segments or other procedures. Indeed, for the market as it sees it as now constituted, Northern Telecom has sold thousands of its SL-1s, and, says Peter Cassidy, director of product management at Richardson, "the add-on module seems to be keeping its customers happy because it and the SL-1 have enough capacity to meet their needs."

However, the company will not discuss what is happening at its affiliated research and development divisions in the U. S. and Canada to meet future needs—

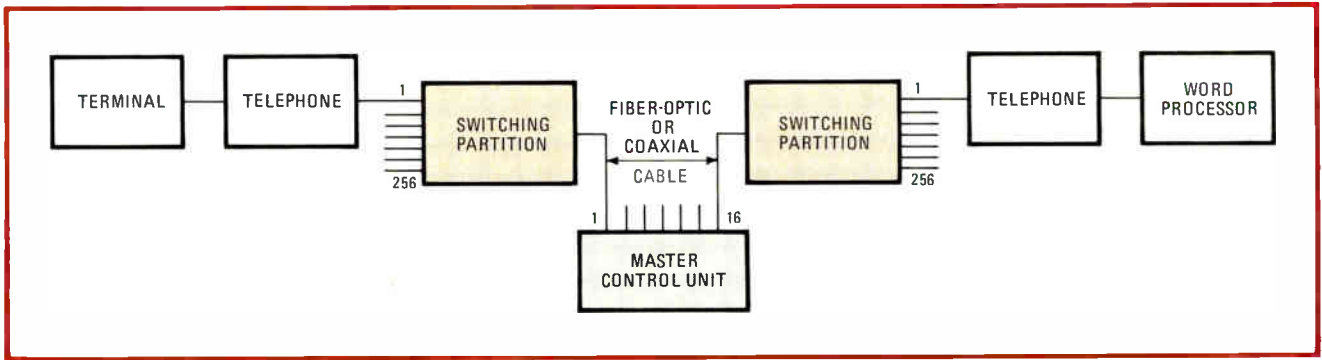

**2. Distributed architecture.** The IBX/S40 separates its component parts so that far-flung office equipment may communicate easily. The switching partitions may even communicate with the InteCom system's master control over public networks or microwave or infrared links.

faster data phones, the accommodation of other than asynchronous RS-232-C data, the handling of greater quantities of data calls—although the work is going on.

Mitel Inc., a Kanata, Ont., firm, will take what its president, Michael Cowpland, calls the “next logical step” in its all-digital product line sometime at the end of 1981 or the beginning of 1982 when it introduces the voice- and data-handling SX-2000. This yet-to-be completed machine will handle up to 10,000 users, so many that the company has decided to address the problem of voice- and data-line availability by using special chips from its in-house semiconductor operation. These will be designed with the company's Iso-C-MOS process, which combines the low power-handling capability of complementary-MOS with the speed of TTL. The key chip in this endeavor is a cross-point array that provides more than 65,000 switching connections on one large-scale integrated circuit.

### Ready for work

But fancy LSI is not all that is needed. Nor is the machine's modular hardware and layered software the whole story. The SX-2000 also will depend on what the company calls its Special Set Type Two. This is a desktop work station with a voice and data terminal built in. It also has an ASCII keyboard, an RS-232-C data-input port, a 7-inch CRT display, software-controlled keys for special applications, and a handset.

The work station connects to the SX-2000 through twisted pairs. This exchange is under the control of 16-bit microprocessors operating in duplicated structures for reliability. The PBX's stored program control—which implements the layered software—operates the control processor (which runs the show), the system memory, and a message-handling system. The memory uses magnetic-bubble devices instead of the silicon-based RAMs employed in most systems to furnish the voice and data lines with the many megabytes needed for routing, control, and administration. For its part, the message handler takes care of the digital processing of all calls between the SX-2000 and the Type Two terminals.

Mitel's PBX will handle data, but it is clear that the company, like others in the PBX business, believes that voice is going to be the dominant medium in the office for a long time. It has therefore taken great pains to make all the parts of its system modular so that they may be expanded as users' needs increase. Cost-

effectiveness is the name of the game here, for it is known that users will not buy expensive data-handling features that they will not need right away.

This conservative approach to PBX design is followed by most suppliers. For example, Rockwell International Corp.'s Wescom operation in Downers Grove, Ill., says that its new 580 series of PBXs, which now handles voice only, has a “digital architecture designed to accommodate combined voice- and data-switching features through the addition of new digital termination modules and related control software.” But it is too early for Wescom to say specifically what capabilities will be available.

The same philosophy is followed by Stromberg-Carlson Corp. According to George M. Dellinger, manager of private-network planning for the Tampa, Fla., firm, its not-yet-available PBX will operate at an internal 64-kb/s data speed and will handle both synchronous and asynchronous data. Like most other systems, it will be able to interface with the specialized common carrier network.

Dellinger says that it is “not yet product announcement time” for Stromberg-Carlson. Similarly, for the American operations of various Japanese companies like Oki, Hitachi, and Nippon Electric, it is not that time either. These firms would not release any information about what they plan to do in the U.S. voice and data PBX market, although they claim to be looking into the matter. The situation in Japan (discussed below), which precludes the rapid introduction of such PBXs in that country, is the major cause of this delay.

### More distributed architecture

Lexar Inc. of Los Angeles (just sold by Citicorp to United Technologies Corp.) is a small research and development firm working on a digital PBX called an LBX. It depends on a-d conversion in the user's telephone so that it can be an all-digital system from end to end. As such, there is a codec right in the handset. Lexar will furnish the handsets and says that a proprietary chip will multiplex both voice and data onto the digital highway to the PBX. Like other large PBXs, Lexar's offering will be designed with redundant circuits and access the specialized common carriers, as well as the nationwide telephone network. The company says its architecture will be distributed, but just what capabilities it will have is unknown. As currently planned, the PBX's telephones

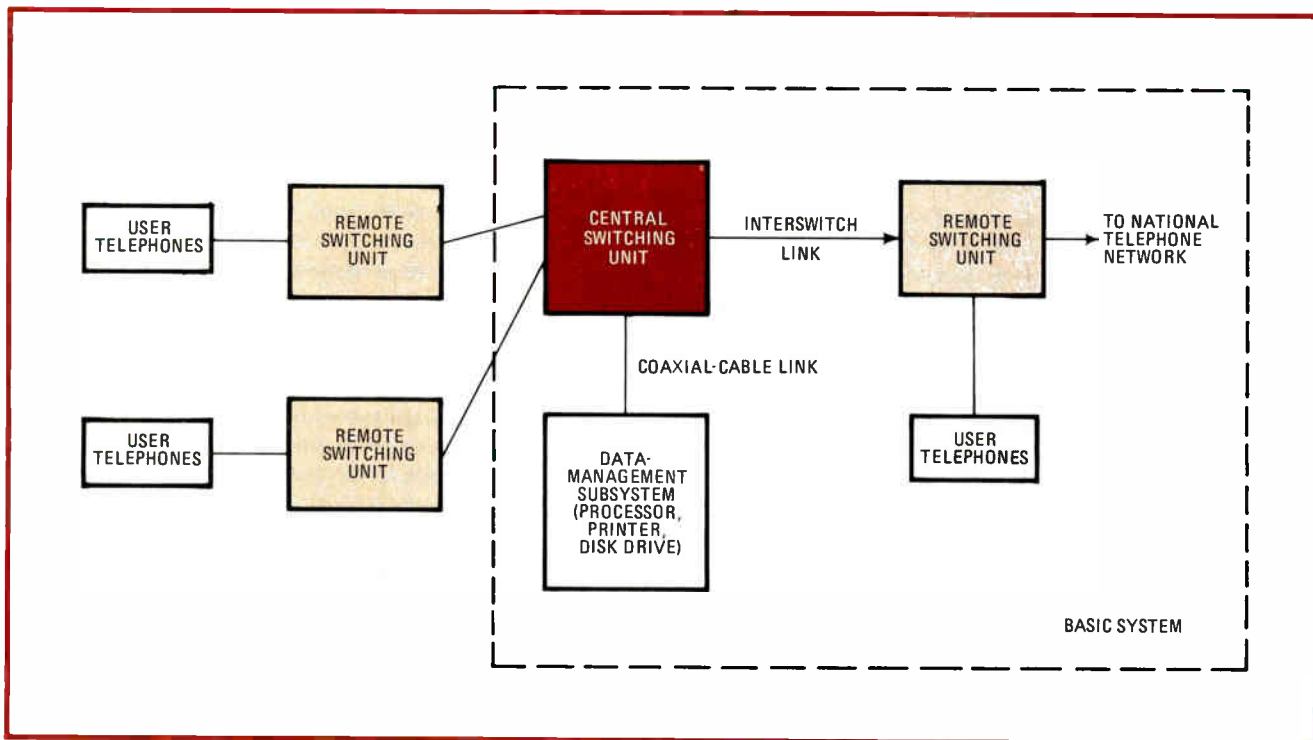

**3. Fits right in.** A typical Datapoint ISX configuration consists of a central switching unit (CSU), a remote switching unit (RSU), and a data-management subsystem. An initial RSU, which handles 256 stations, can fit in the same cabinet with the CSU.

will handle data alternately with voice at speeds of up to 56 kb/s and simultaneously with voice at 9,600 b/s. All that will be controlled by 768-K bytes of RAM.

What giant International Business Machines Corp. does in the PBX market will, at least in the long term, help determine the market direction. Consequently, it is significant that the company does not believe that the latest technology is needed to do the voice- and data-handling job. In fact, for Jean-Jacques Duby, director of switching systems at IBM Europe, the particular PBX technology adopted is not of prime importance. "You must differentiate between the function and the technology—you can use analog technology to switch both voice and data," he says.

Just as other firms in Europe, Japan, and U. S. note about their space-division-multiplexed PBXs, IBM underlines the fact that its model 1750 can switch data efficiently if it has to, although this feature has not been much called for in Europe. Space-division multiplexing is so efficient, says Duby, that "there is very little difference between space- and time-division switching so far as functions are concerned"; the switch is simply transparent to the user.

### Up to the task

"In the beginning of the PBX business, the technology was based on space-division switching, and ultimately it will be based on time division. On this, there is little argument. But as long as most of the public network is analog," says Duby, "I don't see much advantage in going digital." Clearly, sometime in the 1990s, when most public networks will be digital, the change will have to occur. But, Duby continues, the problem for PBX manufacturers is that "the change will not occur simul-

taneously in all countries" and "that is going to be a tough nut." However, he is quick to add, IBM does have a time-division switch in the form of SBS's satellite communications controller.

Some industry observers say that such talk is telephone company philosophy. They point out the fact that the U. S.'s AT&T (which like ITT in the U. S. will say nothing about future voice and data PBX products) has hardly led the turn to digital technology and Western Electric has lost much PBX market share. Will IBM end up the same way? they ask.

IBM's latest voice- and data-handling PBX was introduced in 1979 from the company's development laboratory in La Gaude, France. It is sold only in Europe and can handle 100 outside and 760 inside lines. Its architecture is based on a pair of processors, one for control and management and one for the actual switching, which are then doubled for reliability. The 1750's switching processor operates at 440,000 instructions per second. For speed-comparison lovers, it is important to note that those are specialized switching language instructions and hardly comparable to conventional computer-program instructions.

Duby would not say when IBM plans to introduce its first TDM PBX. However, rumor has it that work is going on apace in La Gaude and at an undisclosed location in the United States.

Some IBM watchers tend to see each bit of news from the company as part of some master plan for conquest of the world office market. No doubt the company wishes that it could do so good a job. For example, it has just applied to the Federal Communications Commission for authorization to connect its 1750 PBX to the U. S. telephone network. An IBM spokesman says that the FCC



**4. On the desk.** Datapoint's Infoset 2 uses a combination of standard and programmable feature buttons and a 24-character alphanumeric display. An RS-232-compatible data terminal can be attached.

others are working along the same lines. The company's Z80-controlled machines use pulse-amplitude modulation (like AT&T's Dimension PBX) and its larger, minicomputer-controlled machines use PCM. The minis are an in-house design (because the company could not buy what it wanted) and are based on bit-slice processors. According to Paul Denis, the firm's director of telecommunications, PCM is used for the larger units because PAM signals are more prone to the potential interference problems in such machines.

"The switch was conceived with digital inputs and outputs," says Denis, "so that performing functions such as voice storage and forwarding, mailboxing, and code conversion are basically straightforward problems." However, he says that though the PBX can provide these services

and they have been tested, they have not been incorporated into the system itself. Thus the familiar refrain about the evolutionary growth of PBX data services is heard again.

"We are now proposing to our customers direct digital access and some code modifications," Denis says, adding that the PBX has been successfully tested with a 54-kb/s data channel linked into a digital public switching exchange. A 9.6-kb/s synchronous terminal hooked to the PBX has also been successfully tested.

#### On the Continent

Other French companies like the telephone divisions of Thomson-CSF and CIT-Alcatel offer voice PBXs only. They are designed to handle data but have not yet done so except for a few experiments. They are capable, their backers say, of servicing message, electronic mail, facsimile, and other functions the PBX office controller must perform. In fact, Thomson-CSF claims that its 8080-controlled P-40 PBX will ultimately have modules to convert protocols. These modules would require more PBX intelligence as an add-on feature.

**Across the channel**

In the UK, Plessey Telecommunications & Office Systems Ltd. licenses Rolm's digital CBX and GEC Telecommunications Ltd. does the same for Northern Telecom's SL-1, but other voice- and data-handling PBXs still await development in England. British manufacturers have not directly addressed the voice and data PBX, because they are approaching the automated office in stages. For example, GEC and Plessey will announce business terminals this year that can hook up with PBXs, and Plessey has already introduced a telephone that has some viewdata functions. As Plessey sees it, according to

application was made for internal use of the 1750 at a small number of locations as part of a voice-communications upgrading. Maybe that is all there is to it, and maybe not. It may indeed be that this is the first step in introducing a 1750 or 1750-like product in the U. S.

Meanwhile, in West Germany potential manufacturers of similar gear have frustrating regulatory problems to contend with. They are somewhat similar to those faced by the Japanese.

managing director Desmond Pitcher, "the PBX will evolve from its voice-switching role and acquire a complete message-handling capability with store-and-forward facilities provided by add-ons." Explaining further, he says that "that would likely take the form of a separate self-contained microprocessor-controlled store-and-forward unit with a data link to the PBX."

Not to be outdone by its rivals, Nexos Ltd., the London-based electronic office-equipment firm founded by the National Enterprise Board, is building its market effort for the electronic office on a multiprocessor originally designed by an Exxon subsidiary, Delphi Communications Corp. in Los Angeles. A huge machine, suitable only for the largest of users, the Delta multiprocessor, as it is known, operates at a maximum speed of 120 Mb/s and, to the pleasure of its managers at Nexos, can hook up to either PBXs or local networks. So whichever emerges as the office-of-the-future controller is of no matter as far as they are concerned. They will be able to shuttle data from either of these into the national or international communications network with no problem. In fact, reports have it that Delta can also act as a voice and data PBX or local network directly.

### Whither Japan?

Yesterday's technology, tomorrow's technology, economics and politics somewhat like West Germany's—those are the roadblocks that, so far, prevent the adoption of even voice-handling, let alone combined voice-and data-handling, digital private branch exchanges on Japan's switched telephone network. At present, Nippon Telegraph & Telephone Public Corp., the government-formed monopoly that is in charge of such matters, will not even consider the "type approval" required for use of the digital PBX. NTT's plant engineering bureau says that the schedule calls for standards to be formulated and approved by the Ministry of Posts and Telecommunications by the end of August 1981. Curiously, not only do present standards make no mention of space-division or time-division technology, they do not even address the choice of analog or digital techniques. All that is of concern is end-to-end system specifications. Physical implementation is another matter.

Whether the August approval date will be met is unknown and it already represents one postponement from March 1981. But approval time is not the only concern. Yesterday's technology is involved because Japanese standards for the nation's telephone lines specify performance,

**5. Three extra pieces.** The addition of circuit cards to the central controller, an interface to the user's telephone (shown), and controlling software turns the Rolm PBX into a voice- and data-handling machine.

not to the point where the PBX connects, but through the acoustic input and output of the telephone set. As a result, a PBX is allowed a transmission loss of only 2 decibels. However, to prevent singing (audible oscillations) in the four-wire PCM portion of a digital PBX when a telephone is disconnected by its hook switch, a loss of 6 dB is usually needed. The new standard, when it appears, must address this and other electrical design-budget problems.

Other factors for NTT engineers to worry about are those that could reduce telephone line quality. They include quantization noise from the coding-decoding process performed by the PBX's codecs and echoes and other distortion at the PBX's hybrid circuit, which provides the transition needed from a two-wire phone to a four-wire exchange. NTT engineers admit that similar coding-decoding problems are in the telephone transmission network as it exists now, but they quickly point out that the additional coding-decoding processes in one or two PBXs at the ends of the line might push the degradation past the acceptable limits.

What's more, the conservative Japanese agonize over compatibility with tomorrow's technology. For example, the CCITT recommendations for integrated telephone services on digital networks call for 64,000-b/s transmission that is transparent to the user. But the PCM technology adopted by the U.S.'s Bell System in its standard T-1 service and in Japan for many exchanges uses the least significant bit of the digital transmission for signaling. This bit of information keeps track of the telephone's operational status. Its loss is no particular problem for relatively low-fidelity voice but cannot be tolerated for data, as the transmission error rate would be unacceptable. Therefore the government will probably



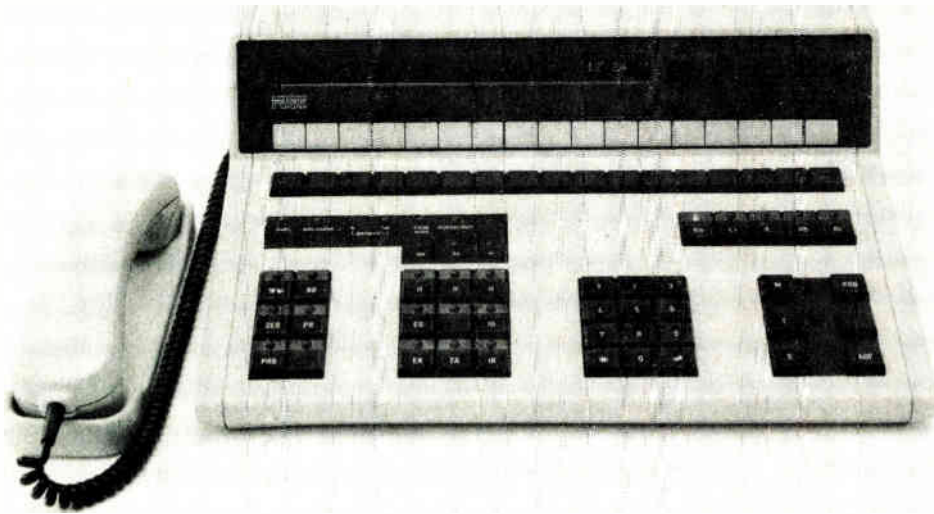

**6. Ready for data** The model 8818 private branch exchange, from West Germany's Nixdorf Computer, is designed to handle voice now and data when necessary. The operator console shown here has an alphanumeric display.

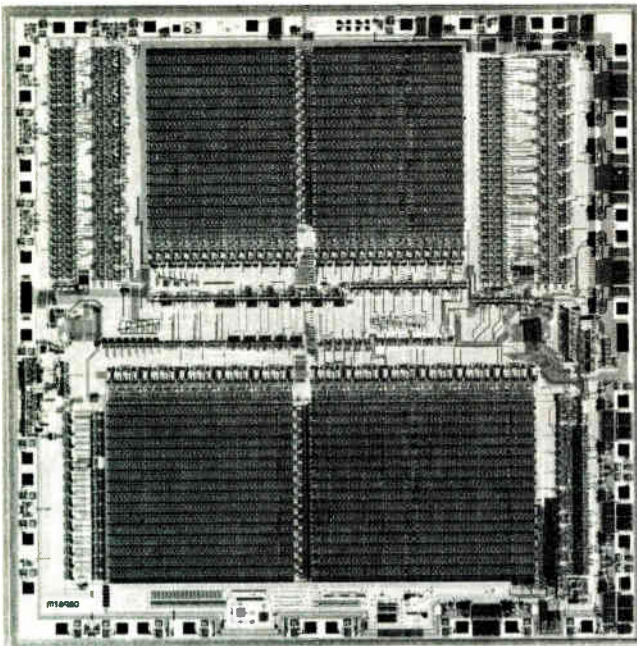

**7. Biggest ever.** Mitel's MT8980 digital switching chip has 36,500 transistors configured to form 65,526 digital cross-points. It is a critical component in the firm's SX-2000 PBX and is made using Mitel's Iso-C-MOS technology for low power and high speed.

include some restriction on the use of this bit for signaling in its standard.

LSI is at the heart of what can be done with modern digital PBXs. A case in point is Mitel's SX-2000. It will enjoy the benefits of what company president Cowpland calls the "world's most powerful and versatile digital telecommunications switching chip." Designated the MT8980 or, for short, the DX, the chip has 36,500 transistors implemented in Mitel's Iso-C-MOS process on an approximately 270-mil-square (6.9-millimeter-square) piece of silicon (Fig. 7). Operating under microprocessor control, the chip furnishes 65,536 digital cross-points—more than that of any other chip.

The MT8980 is designed to implement the common

control in the SX-2000, although it will also be sold as a separate product. To perform that chore, the chip links M "vertical" by N "horizontal" terminals or lines. In fact, any vertical terminal or line may be connected with any horizontal one by common control activation of the appropriate cross-point switching element in the array.

Mitel is also developing a codec to handle the analog-to-digital and digital-to-analog conversions that the SX-2000 requires. This Iso-C-MOS device is designed to use but 15 milliwatts in the active state and has all the on-board filters it needs.

Inexpensive chips containing both codec and filter were of concern to Mitel for its new PBX, and they are a prime concern for other contenders for the office-of-the-future controllers as well. For IBM Europe's Duby, the cost of the integrated codec plus filter is the "key factor in determining the economies of switching over to digital PBXs."

IBM Europe is not alone in France in its concern for the availability of such an IC. Jeumont-Schneider's range of all-digital TDM PBXs also awaits the ideal codec. Says telecommunications director Denis, "New PBX developments are based on single-channel codecs, but our present systems use a multichannel, or shared, codec approach." He adds, "The inexpensive integrated codec and filter has been promised for some time, but it is not ready today. It will be tomorrow."

Japan's Hitachi Ltd. will soon incorporate a dedicated IC in its HDX digital exchange (an export item usable as a PBX) for line balancing. This is part of the so-called Borsht functions—an acronym for battery-feed, two-to-four-wire conversion, ringing, test, and other tasks—performed by subscriber-line interface circuits. For now, 6800 microprocessor. Fully integrated SLICs that performed by dedicated chips, whereas the line balancing is taken care of by software control with a Motorola 68000 microprocessor. Fully integrated SLICs that perform all the Borsht functions are in various stages of development worldwide. □

Contributing to this report were John Gosch in Frankfurt, Kevin Smith in London, Arthur Erikson and Kenneth Dreyfack in Paris, and Charles Cohen in Tokyo.



# Second group of IBM 4341 machines outdoes the first

Smaller logic chips and faster, larger cache memory account for the improvement

by H. Cordero and J. B. Chambers  
*International Business Machines Corp.,  
System Products Division, Endicott, N. Y.*

□ Scheduled for first delivery this quarter, the IBM 4341 model group 2 processors have throughputs up to 80% larger than the first 4341 systems, now called the model group 1. They also have twice as much main memory as their predecessors.

Their increase in performance is due mainly to their use of smaller and hence faster logic chips, which reduces the base cycle time of the processor from 150 to 120 nanoseconds. But an important contribution is also made by the cache memory, which is twice as large as in the earlier machines and also has a wider data path between it and main memory. Its increased parallelism reduces the read cycle time from 225 to 120 ns.

Other improvements in the group 2 machines include more efficient power supplies, an optional color console, and new microcode that enhances the operating system. In addition, two of the group 2 machines' six block-multiplexed data channels can transfer data at the rate of 3 million characters per second and can therefore plug into IBM's recently announced 3380 thin-film-head 2.52-billion-byte disk drives.

A size reduction of the 704-circuit gate array, or master-slice logic chip, is the cornerstone of the improvements in the group 2 machines. All the processors in the 4300 series, as well as the IBM System/38, use the basic 704-circuit gate-array design produced by IBM's General Technology division at its facility in East Fishkill, N. Y. [*Electronics*, March 15, 1979, p. 105]. Using a similar technology to that of the other 4300 series processors, the chip has nevertheless been reduced from 4.6 to 3.7 millimeters square (Fig. 1). This 35% or so shrinkage in area reduces circuit delay from 3 to 2.1 ns by decreasing stray capacitance and resistor values.

The new chip maintains the same voltage levels, circuit counts, drive capability, and number of signal pins as the previous chips. These similarities made it possible for the computer designers to convert to it quickly and

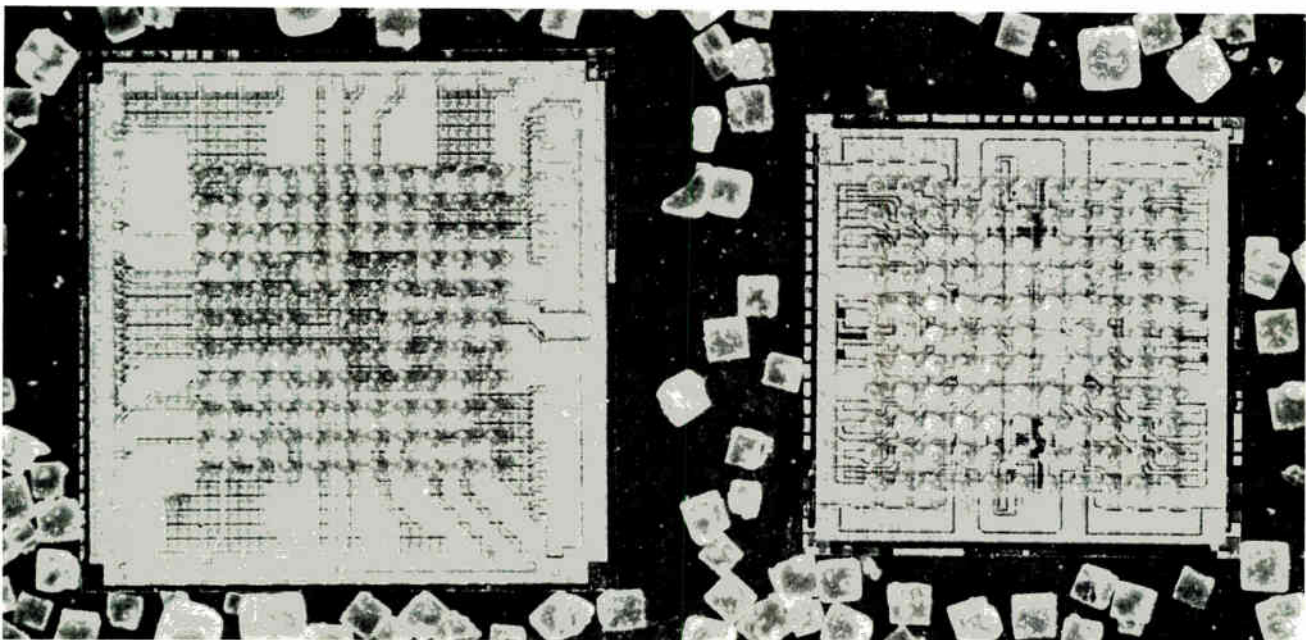

**1. Incredible shrinking chip.** The newly developed large-scale integrated logic chips used in the 4341 model group 2 are smaller and faster than those used initially in the 4341 model group 1 processors. The "rocks" in the photograph are table salt crystals.

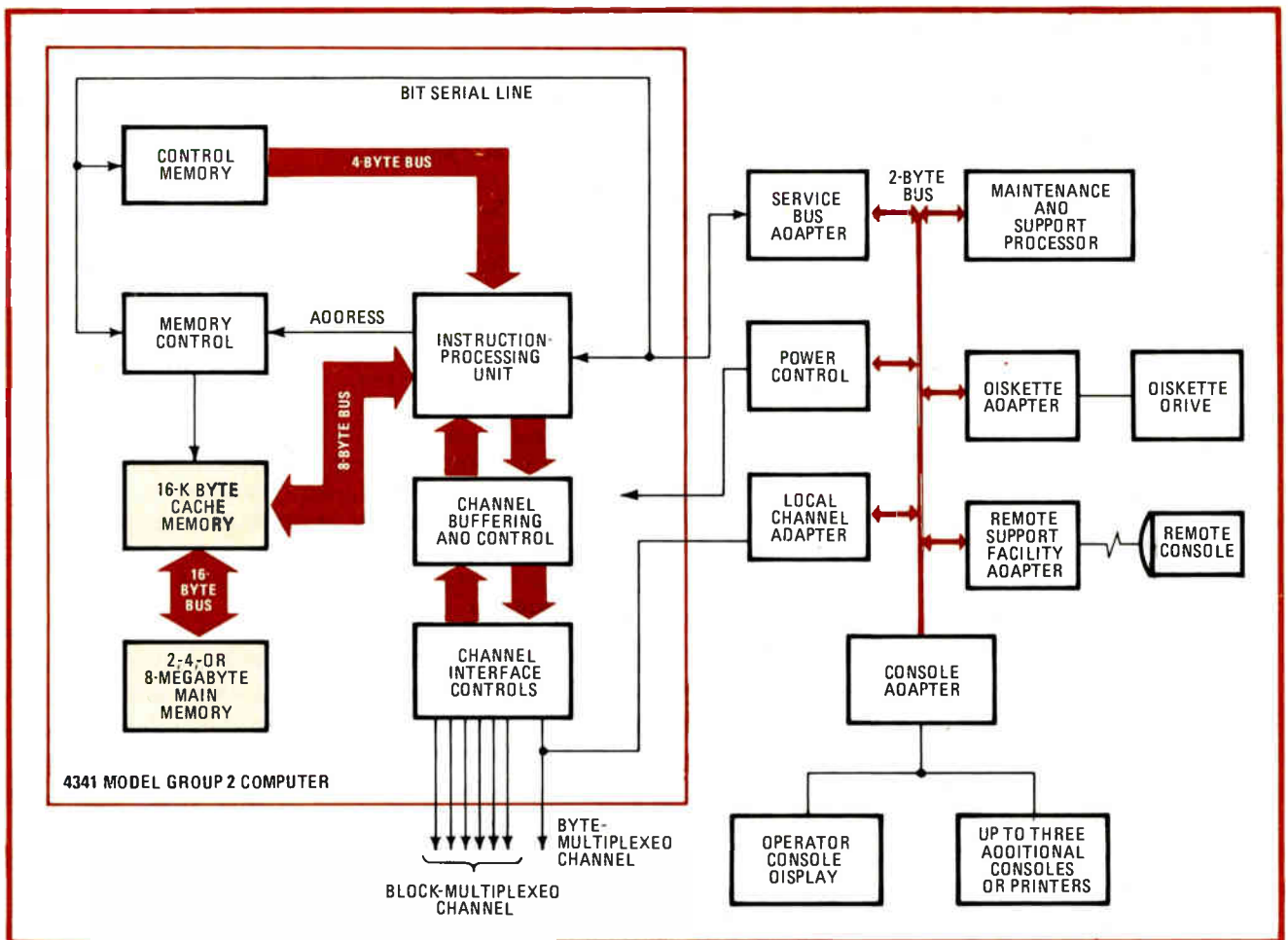

**2. The big bus.** The bus between the cache memory and the main memory in the new processors has been doubled in width from 8 to 16 bytes. The cache memory has also been doubled from 8- to 16-K bytes, and the main memory can now be expanded to 8 megabytes.

easily and with a high level of confidence.

Both the new and the old chips use a master-slice fabrication process that yields a wafer containing an array of identical elementary components. The final fabrication steps complete the interconnection of the elements to tailor the chip for its specific application.

The second notable addition to the group 2 processor's throughput derives from the speed with which it can access main memory. The alterations to the cache memory are responsible for this particular improvement. They involve the ability to load it faster and an increase in its speed, as well as the doubling of its capacity from 8 to 16 kilobytes.

### The cache contribution

The cache is a set of high-speed memory arrays that hold the data currently in most frequent use by programs. This data consists of copies of small chunks of data from main memory but can be accessed much faster from the cache than from the main memory. The data held in the cache changes as the programs execute. In the group 2 machines, hardware updates it and keeps track of the changes.

The group 2 cache memory can be loaded faster than the one in the group 1 machines because the width of the path between it and the main memory has been doubled

to 16 bytes, to enable them to exchange data faster (Fig. 2). Its speed was increased by its use of the faster logic chips, as well as by modifications of its circuit design.

Its larger size increases the probability that the data required by a program is resident in the cache and available at the high cache speeds. This likelihood reduces the number of accesses that have to be made to the slower main memory, with the overall effect that the storage subsystem appears faster to the program.

### Congruence classes

The group 2 cache memory holds 256 separate 64-byte blocks of data from various addresses in main memory. Its addressing hardware divides all the main memory addresses into 32 sets, called congruence classes. For each congruence class, there are therefore eight 64-byte entries in the cache that can store that corresponding main memory data. When data from a given congruence class is needed from the cache, all eight elements are read in parallel and the cache directory selects the correct one from the output register (Fig. 3). If a program wants data that is not in the cache, the least recently used element in the data's congruence class is replaced with the new data.

For the first time, a color console is available as an option with the group 1 as well as the group 2 processors.

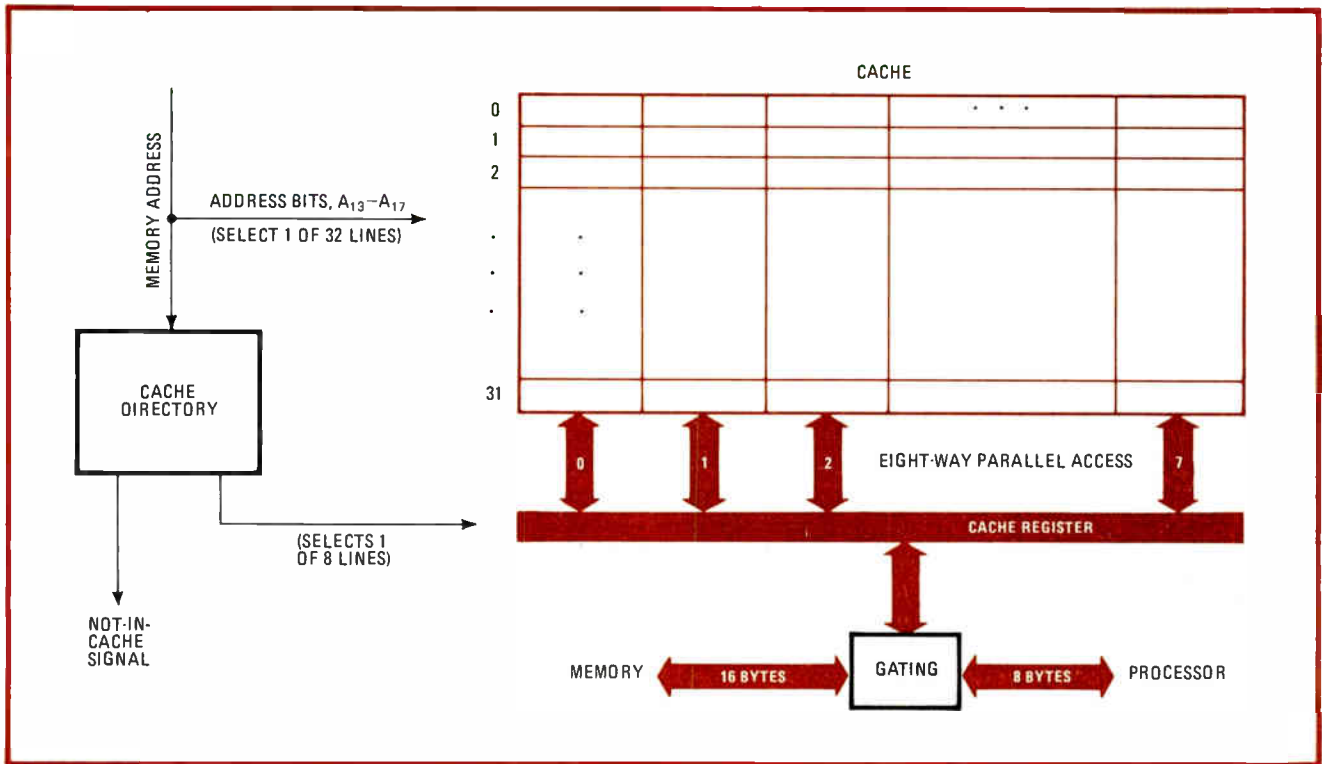

**3. Parallel cache flow.** On a read operation the cache is accessed in eight parallel operations while the address is being looked up in the cache directory. If the address is found in the directory, the correct one of the eight outputs is sent to the processor.

Consisting of the IBM 3279 color display and 3287 color printer, it aids the operator's understanding of what is going on in the system by displaying the console messages in four colors—red, green, white, and blue.

The same software that generates the messages for the monochrome console can be used for the color console. The only change is that two control fields are used slightly differently. One of them controls the intensity attribute, which in the monochrome console brightens selected fields. The other field controls the protect attribute, which determines whether or not a given data field can be used for input to the console. The console programs use the four combinations of the two fields to

select one of the four colors available for each display item (see table).

The color display is a high-resolution cathode-ray tube. Thanks to a unique adjustment capability, the system operator can adjust the tube's color convergence without the aid of a service engineer. The microcode in the display controller places cross-hatched patterns in 13 different positions on the screen, and the operator brings them into alignment by manipulating the cursor control buttons on the console (Fig. 4). The result is a digital adjustment of the color guns, which is automatically stored in the console memory as the new setting.

The new power supplies in the group 2 processors

**4. Converging colors.** One of the patterns that occurs when the color convergence is badly out of alignment is shown in (a). In (b) all 13 convergence patterns have been correctly aligned by the system operator and the colors displayed will be true.

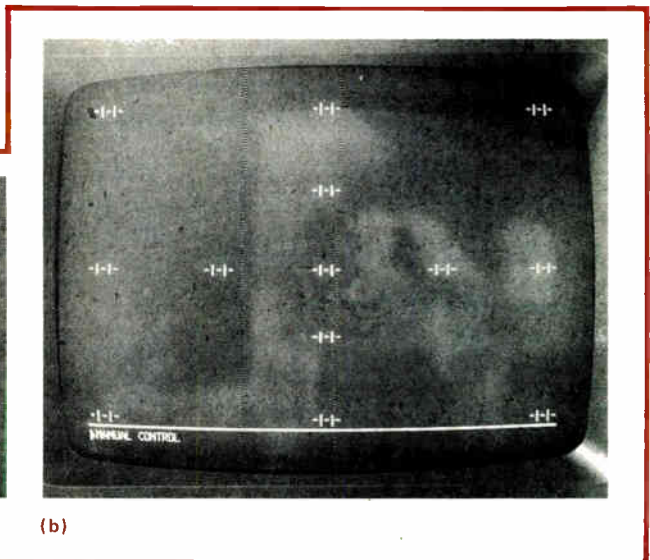
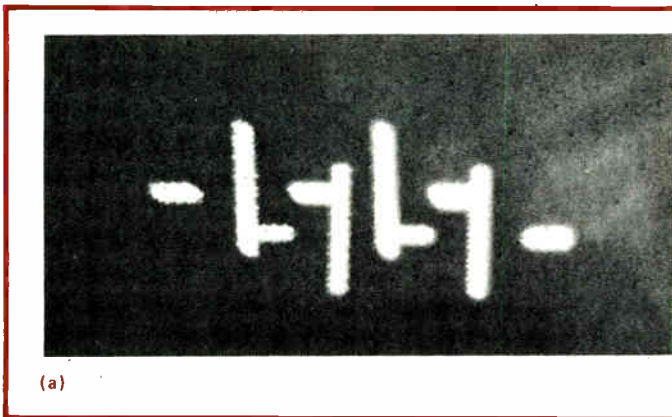

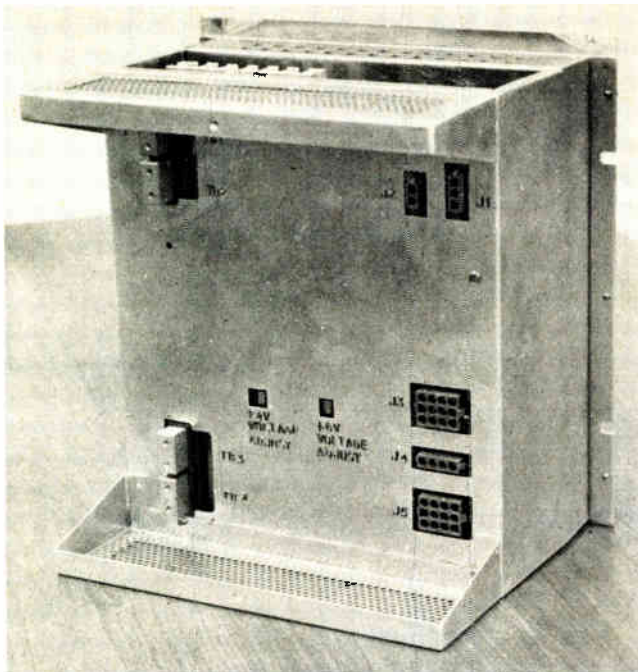

**5. Modular power.** The power supply units for the group 2 processors are small and light enough to be easily removed and replaced by customer engineers. A new design based on semiconductor switches enables them to use smaller transformers and capacitors.

employ a switching regulator design that is more efficient electrically and occupies less volume per watt than the supplies used in the group 1 machines. They achieve power conversion efficiencies of 61%, as against 38% in the group 1 supplies.

In the new design the 60-hertz input power is rectified, filtered, and distributed to individual regulators for each voltage required. Each regulator uses semiconductor switches to chop the voltage up into a 30-kilohertz frequency. This frequency is then transformed, rectified, and filtered to get the voltage level needed. To regulate the output voltage, a feedback mechanism from the output controls the switched pulse width. The high frequency of the semiconductor switches made it possible to use smaller, less expensive transformers and filter capacitors, around which a modular unit could be designed (Fig. 5).

Such a design reduces most field repair to a matter of identifying an incorrect voltage level and replacing the corresponding regulator assembly. To help identify a failing unit, sensors are built in throughout the machine to catch voltage and current conditions outside specifications. These conditions are recorded and time-stamped as part of the overall machine error-logging process.

### The microcode assist

Support of the OS/VS2 MVS (Multiple Virtual Storage) operating system—the one most commonly used on the largest IBM computers—has been added to the group 1 systems since their introduction. This is provided through a microcode feature called ECPS:MVS that enhances the operating system in the areas of lock management, integrity, tracing, interrupt handling, and real storage management.

CONTROL FIELD COMBINATIONS FOR  
CONSOLE DISPLAY COLOR SELECTION

Protect attribute	Intensity attribute	Color
off	no	green
off	yes	red
on	no	blue
on	yes	white

The microcode assists are a way to tailor the machine to the software system that uses it. Before designing the microcode, measurements are made to find the frequency with which various functions of the system software are used. Those that are heavily used are candidates for microcoded assistance. The machine is then modified by the microcode in such a way as to take over these functions from the software.

Since the microcode is much faster than operating software at performing these functions, the computer system is left with more time for running application programs. The technique of microcode assist has been proven to be an extremely productive approach—it reduces operating system overhead by more than 70% in some cases.

The group 2 processors have additional microcode to help MVS run under VM/370 (Virtual Machine/370). This operating system is a software system that runs on an IBM 370, 4300 or 3000 series computer and makes the single, real computer appear as multiple machines to other software. These are called virtual machines. A program runs on a virtual machine as if it were running on a dedicated computer; it has no knowledge of the other virtual machines or of VM/370.

Among the tasks that VM/370 must perform in order to create this virtual machine environment is the allocation of the resources of the system such as input/output devices, memory, and processing power. The four VM/370 functions on which the new microcode assist concentrates are privileged instruction simulation, real memory management, channel program translation, and virtual machine dispatching.

### Inherited assets

The advantages inherent in the earlier models of the 4341 are retained in the group 2 processors—the reduction in computing costs, the reliability and serviceability, and the highly effective procedures for capturing error information and running automatic analysis programs to identify failing components. Moreover, the separate maintenance subsystem includes the Remote Support Facility, a teleprocessing connection over which the service specialist can control the machine remotely. With this maintenance facility, a high level of expertise can be concentrated on particularly complex problems without the usual travel delays and costs.

In addition, the group 1 machines can be upgraded to the higher-performance group 2 level at the customer's site. A conversion package is available that contains the higher-speed logic, the larger cache memory, and two new power supplies. The proper microcode, diagnostics, and documentation are also provided. The physical size and appearance of the system will remain unchanged. □

# Display controller simplifies design of sophisticated graphics terminals

Dedicated chip makes high-density color displays with alphanumeric and figure-drawing capabilities an economical proposition

by Jeffrey L. Wise and Henryk Szejnwald  
*NEC Microcomputers Inc., Wellesley, Mass.*

□ The ongoing computerization of society brings with it the need for ever more sophisticated cathode-ray-tube displays. But lagging display controller technology has kept the price of high-resolution color graphics terminals high. Now, market demand has reached the threshold at which large-scale integration of the circuitry in these devices becomes economical and so will bring the terminals within reach of even small-system users.

The  $\mu$ PD7220 graphics display controller, or GDC, promises to lower the cost of color graphics significantly. This dedicated LSI chip can handle a display memory as large as 256-K 16-bit words—the equivalent of over 4 million picture elements (pixels). It can draw lines, arcs, circles, and rectangles at a rate of less than 800 nanoseconds per pixel.

Previous controller solutions have had some serious drawbacks. Medium-scale integrated controllers are fast

**1. Living color.** The  $\mu$ PD7220 graphics display controller can create complex color images on a 2,048-by-2,048 dot matrix and can address 256-K 16-bit words. In its graphics mode, they can be red, green, and blue overlay planes. The GDC can also draw figures like circles without processor intervention.

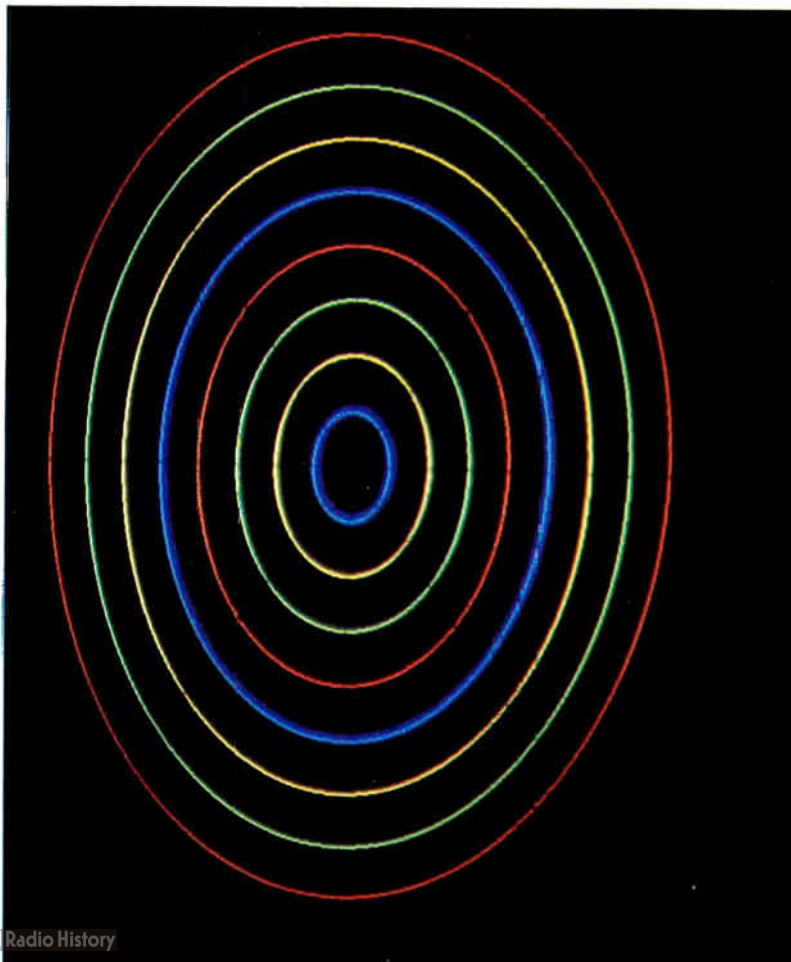
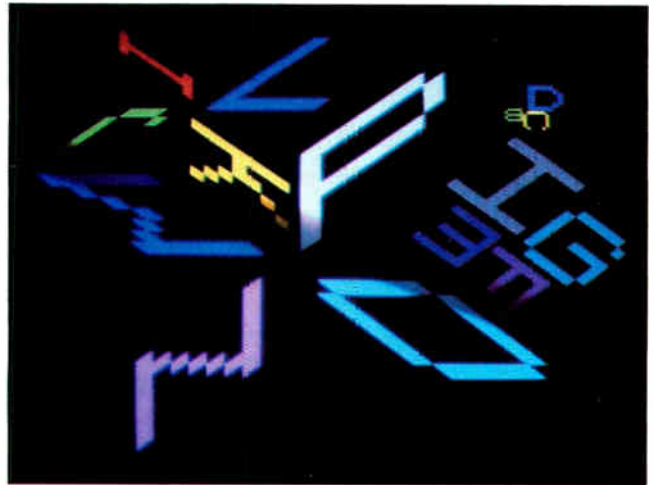
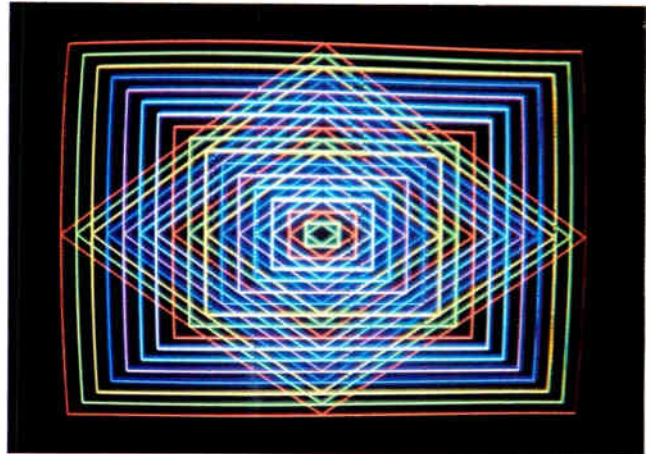

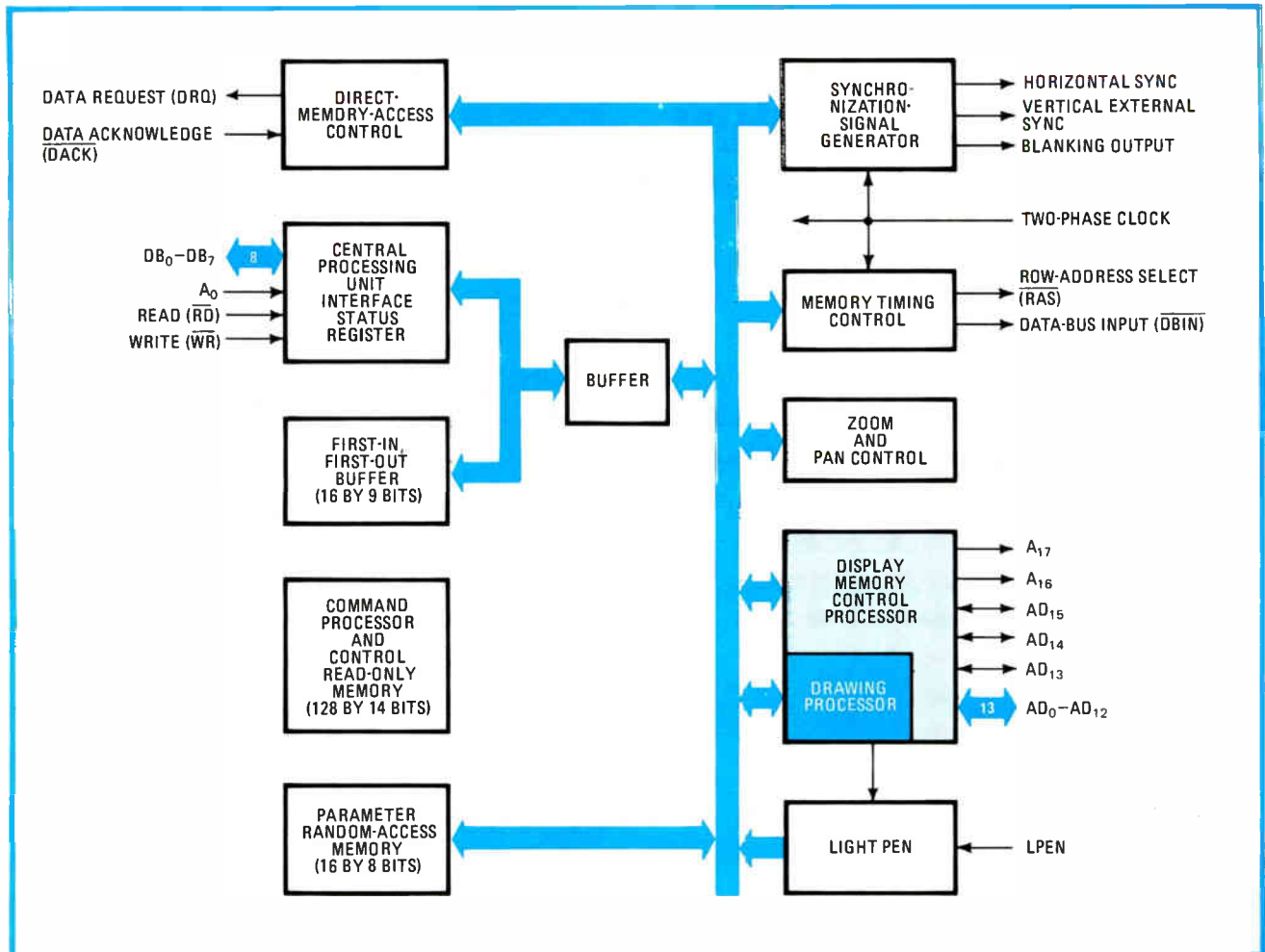

**2. System on a chip.** Inside the graphics display controller, elements are connected by means of an on-chip data bus. The small buffer permits independent transfers to take place through the first-in, first-out memory. The drawing processor constructs geometric objects.

and often adequate, but they consume considerable power and occupy significant board space. Controllers based on bipolar bit-slice processors have also been effective but require lengthy design work and are difficult to upgrade. The MOS microprocessor display controller offers lower package count and lower cost but is too slow to be considered a high-performance solution.

The GDC, however, fabricated with a 3-micrometer n-channel MOS process using over 13,000 transistors, simultaneously meets performance and cost requirements of sophisticated yet high-volume graphics terminals. It isolates the display memory from the microprocessor, freeing the processor to handle higher-level graphics calculations and communications with the terminal user and the host processor. It can work with almost any central processing unit to form a basis for a powerful computer graphics system with character capability at very low cost.

### Flexible formats

How effective a graphics system is depends largely on the flexibility of the system's display controller. The GDC can control thousands of alphanumeric characters or graphics figures comprising millions of dots. These bit-mapped figures can be drawn so quickly that complex

images can be created in one 16.7-millisecond video-frame period. Up to four character-display or two graphics-display areas may be horizontally split and scrolled independently, with little local processor overhead.

The display memory is often larger than the display area, so as to make possible double-buffered display frames, multiple-frame movies and panning and the use of lower-cost video circuitry and monitors. Zoom magnification factors of 1 to 16 may be selected under program control, and a light-pen detection circuit is included. The GDC facilitates the strobe generation for dynamic random-access memories, which it refreshes, even during high zoom magnification.

For graphics, the GDC's display memory can be organized as 2,048 pixels by 2,048 lines, or as 1,024 pixels by 1,024 lines with four bit planes per location, or in just about any other combination. Data can be moved from the display memory to the screen in 16-bit words in a minimum cycle of under 400 ns. Optionally, two 16-bit words can be moved simultaneously for a video pixel rate of 80 megahertz.

Allowing for RS-343 blanking, this rate yields a 60-hertz noninterlaced display of 1,024 pixels by 792 lines, for a 4:3 display aspect ratio. A 2:1 interlaced display of 1,024 by 1,024 dots with red, green, blue, and overlay

planes is comfortably within the GDC's speed and addressing capability (Fig. 1).

In the controller's character mode, a word of display memory stores a character code and attribute bits. Up to 100 rows of characters can be displayed, each with a maximum of 32 lines. There can be up to 256 characters per row.

With a 7-by-10-dot area suitable for a 5-by-7-dot character and noninterlaced video, 40 rows of 80 characters can be displayed at 60 Hz without interlacing and over 20 such screens can be stored in display memory. With an 80-by-24-character format, up to 34 screens can be buffered.

Multiple GDCs may be synchronized in one system to expand display memory depth while maintaining its height and width. Two GDCs, for example, allow either alphanumeric superimposed over graphics or else more bit planes per pixel. For the fastest drawing speed, each plane can have its own GDC. True color is possible using several GDCs for display memories of up to 2,048 by 2,048 pixels.

### Other innovations

Besides high resolution, the GDC introduces two outstanding features: the capability to process display-memory data in a single read-modify-write cycle and to draw graphics figures.

During a read-modify-write cycle, the controller reads the desired word from display memory, modifies the bit or bits, and writes the modified word back into memory. Its mask and pattern registers make possible multibit and multifield modifications and automatically dotted lines. The GDC's modification operations include set, clear, invert, and replace with a pattern.

Its graphics figure-drawing speed—for lines, arcs, circles, and rectangles at less than 800 ns per pixel—means that 20,000 pixels may be updated in one refresh period. Once the parameters are loaded into the controller and the drawing is initiated, no further attention is needed from the local processor. Parameters for the next figure can be prepared while the graphics controller calculates the addresses and draws the present figure using back-to-back read-modify-write cycles.

### Local intelligence

An intelligent graphics display terminal can be built by adding a general-purpose microprocessor and possibly local mass storage. Graphics input devices, such as light pens, joysticks, trackballs, and tablets, should be handled locally by the microprocessor to achieve the fastest response times.

The terminal's microprocessor can maintain a vector-list representation of the objects to be displayed in order to effect rotation, scaling translation, and clipping of the objects. Communication with the host computer is required only to transfer high-level information such as vector list changes and viewpoint.

The graphics display controller significantly reduces the terminal processor's overhead by handling many of the most time-consuming tasks. It receives its commands through a first-in, first-out buffer to maximize the system's efficiency. Direct access to the display memory is

TABLE 1: DISPLAY CONTROLLER REGISTERS

Address line 0	Read mode		Write mode
	Read status register	Bit definitions	
0	0	Data ready	Write parameter into first-in, first-out buffer
	1	FIFO full	
	2	FIFO empty	
	3	Drawing in progress	
	4	Execute direct memory access	
	5	Vertical synchronization	
	6	Horizontal synchronization	
	7	Light pen detected	
1	Read FIFO		Write command into FIFO

under the control of the GDC and proceeds at a rate of up to 1.25 million bytes per second. Figure 2 is a simplified block diagram of the GDC.

As shown in Table 1, the low-order address line,  $A_0$ , and the read-write line permit parameters and commands to be entered into the controller and status information, cursor position, and display-memory data to be extracted from it. Note the additional buffer isolating the CPU interface and the FIFO from the rest of the GDC to allow independent transfers between the FIFO and the terminal processor.

In the FIFO's read mode, data goes from the GDC to the CPU, so that it can read video memory, the position of the cursor, and the light-pen status. In the write mode, the CPU can send commands—each with a number of parameter bytes—asynchronously to the GDC until the FIFO is full.

Two bits in the status register reflect the FIFO's status as full or empty. It can be written into by the processor and responses can be taken from it, but not concurrently. The status register in the CPU interface may, however, be read independently of the buffer.

All 18 of the controller commands are listed in Table 2. These commands have been broken down into five basic categories: video control, display control, drawing control, data read, and direct-memory-access (DMA) control.

The two-phase clock in Fig. 2 has twice the display memory's word-access rate. This frequency is the basis of all timing in the GDC and can range from 0.5 to over 5 MHz. Any additional timing signals, like those needed for dynamic memories, can be easily generated from the clock with a shift register.

The GDC operates in one of three modes. The first, a full graphics mode, uses all 256-K words of memory and 16 data bits via the time-division-multiplexed display-memory interface pins. Another mode combines graphics and coded characters on the screen simultaneously; 16 of the lines are used for address and the other 2 control an external line counter to switch external circuitry between

TABLE 2: A SUMMARY OF DISPLAY CONTROLLER COMMANDS

Mnemonic	Operation(s)
<b>Video control commands</b>	
RESET	resets the graphics display controller to its idle state and specifies the video display format
VSYNC	selects master or slave video synchronization mode
CCHAR	specifies the cursor and character row heights
<b>Display control commands</b>	
START	starts the display scanning process
ZOOM	specifies zoom factors for the display and graphics characters writing
CURS	sets the position of the cursor in display memory
PRAM	defines starting addresses and lengths of the display areas and specifies the 8 bytes for the graphics characters
PITCH	specifies the width of the X dimension of display memory
<b>Drawing control commands</b>	
WDAT	writes data words or bytes into display memory
MASK	sets the mask register contents
FIGS	specifies the parameters for the drawing processor
FIGD	draws the figure as specified above
GCHRD	draws the graphics character into display memory
<b>Read data commands</b>	
RDAT	reads data words or bytes from display memory
CURD	reads the cursor position
LPRD	reads the light pen address
<b>Direct-memory-access control commands</b>	
DMAR	requests a DMA read transfer
DMAW	requests a DMA write transfer

graphics and character display. The third mode displays coded characters only and eliminates the need for an external line counter. Here 13 address and data lines control a display memory of up to 8-K words and the 13 bits per word are used for the character code and its attributes.

**Different uses for lines**

The GDC's interface with its memory uses TDM address and data lines. In addition, depending on the display mode, these lines are also used in other ways. In the graphics mode, all 18 pins supply address values, whereas the two character modes use either 13 or 16 lines respectively, for addressing. In any case, the address of the display memory is available early in the cycle for latching so that the rest of the memory cycle can use the lines for data. In the graphics mode, 16 of the lines are used for the data bus; in the character modes, 5 lines are used to indicate cursor position, line count, blink timing, and mode-switching information.

The parameter RAM holds 16 predefined variables. These variables are loaded through the CPU interface and referred to by other elements of the GDC as needed.

The drawing processor works with the parameter RAM and the display memory controller to compute the position of each pixel in graphics figures. Drawing can proceed uninterrupted while the next drawing command and parameters are loaded into the FIFO buffer.

The GDC has an unusually flexible video-raster for-

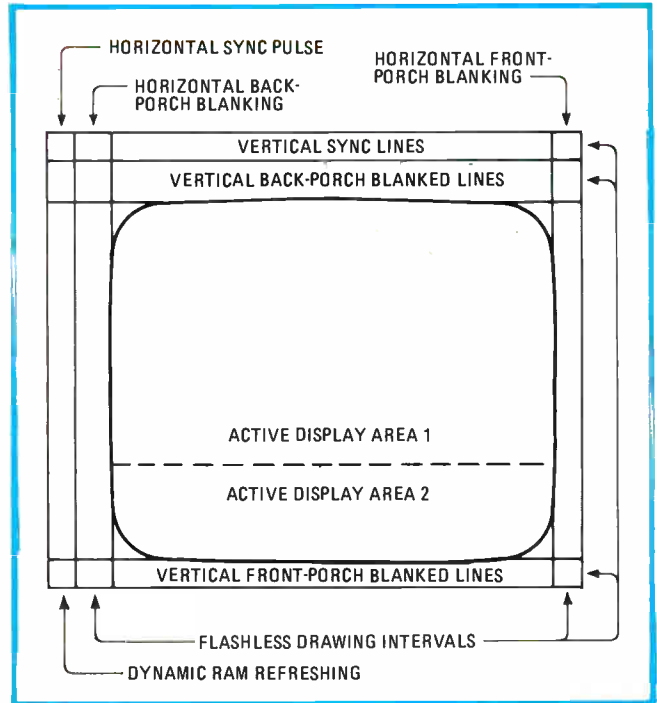

3. Partitioning. The screen can be partitioned into four horizontal display fields, and each can be scrolled up and down independently. Drawing can be done at any time, but the display will not be disturbed if it is done during retracing periods.

mat. It supplies separate horizontal and vertical synchronization signals, and the number of display blanking lines and words of active display per line can be any even number from 2 to 256.

With a two-clock-cycle word, the horizontal front- and back-porch widths can be adjusted to up to 64 word periods, and the width of the horizontal synchronization pulse can range up to 32 words (Fig. 3). These same ranges apply to the vertical synchronization periods, but in terms of lines. In addition to noninterlaced video, both interlaced and repeat-field-interlaced video formats are available.

Display size may be set equal to or less than display memory size. Logic circuitry automatically takes the starting address from the parameter RAM in the controller and scans the number of words required for the line. The GDC then automatically inserts a horizontal sync pulse before going to the next line.

The count through the display memory continues from where it left off until the end of the field, when the starting address is again referred to. If the display area is partitioned, multiple starting addresses are stored in the GDC with their line counts. They are used no matter where they are in display memory (Fig. 4). The starting addresses can be individually modified to achieve the independent scrolling mentioned earlier.

**Figure drawing**

The drawing processor can calculate the word and dot addresses of the pixels in a figure in parallel with—and at the same speed as—the display-memory writing process. Patterns for various dotted, dashed, and solid figures are loaded into a pattern register by the terminal



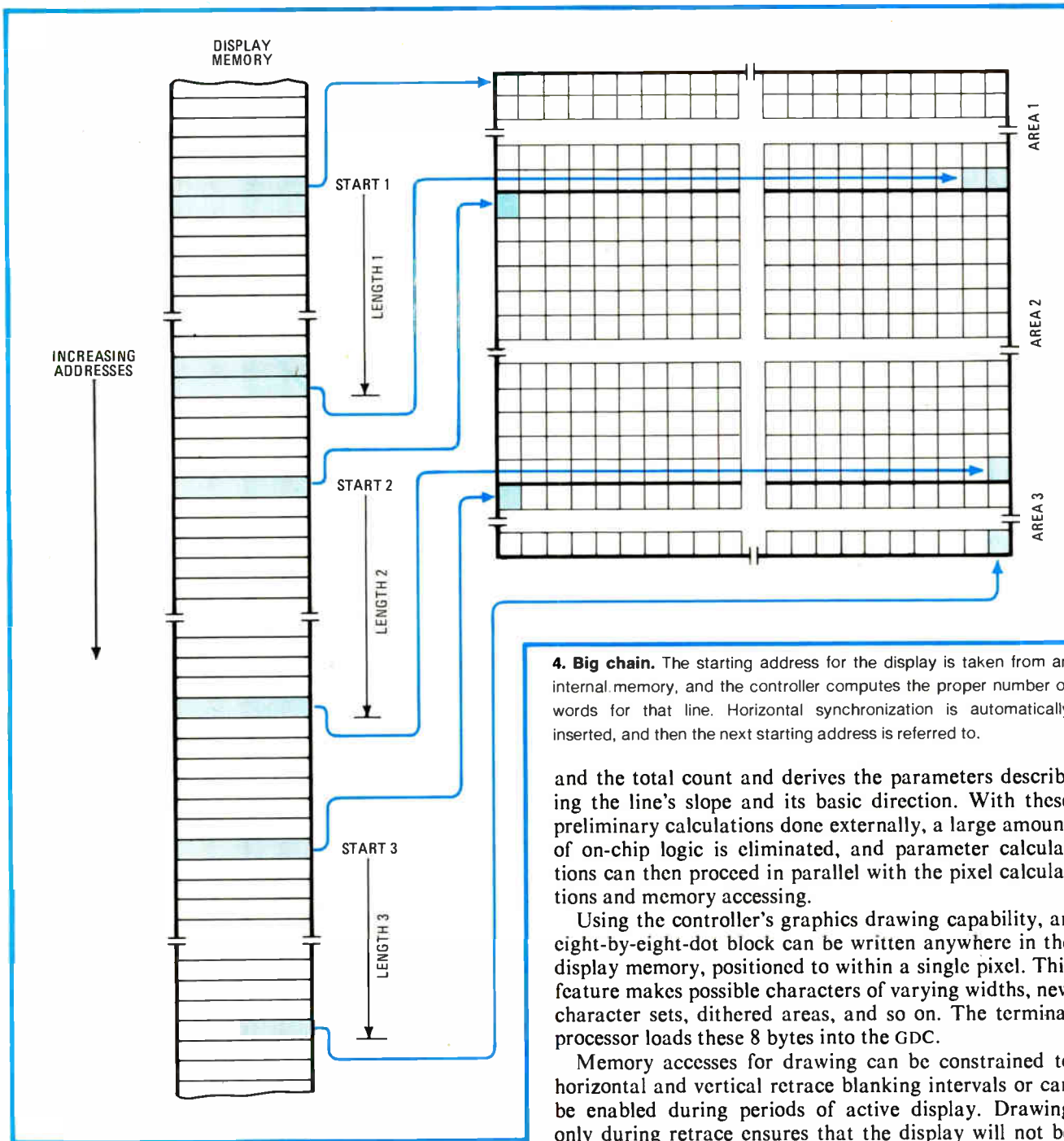

**4. Big chain.** The starting address for the display is taken from an internal memory, and the controller computes the proper number of words for that line. Horizontal synchronization is automatically inserted, and then the next starting address is referred to.

and the total count and derives the parameters describing the line's slope and its basic direction. With these preliminary calculations done externally, a large amount of on-chip logic is eliminated, and parameter calculations can then proceed in parallel with the pixel calculations and memory accessing.

Using the controller's graphics drawing capability, an eight-by-eight-dot block can be written anywhere in the display memory, positioned to within a single pixel. This feature makes possible characters of varying widths, new character sets, dithered areas, and so on. The terminal processor loads these 8 bytes into the GDC.

Memory accesses for drawing can be constrained to horizontal and vertical retrace blanking intervals or can be enabled during periods of active display. Drawing only during retrace ensures that the display will not be disturbed by intermittent flashes. However, for the fastest drawing speeds, the read-modify-write drawing cycles can be enabled at any point on the screen. The blanking signal from the GDC is asserted during such cycles to minimize display disturbances.

#### Direct access to display memory

The 7220's DMA-read and -write functions are useful in two basic situations. In the first, the GDC generates a graphics picture or receives video data—from a camera, a scanner, or other video source—that needs to be moved into its video display memory. In the second, it writes graphic figures into display memory that need to be sent out to a printer, microfilm, disk, or tape. □

processor, and the decision to modify a pixel of a figure is based upon the contents of this register.

A 16-bit mask register in the drawing processor selects the bits of the word for modification. Although this register is used automatically during drawing of the figures, it is also possible to load it with all logic 1s to write all 16 pixels of a word in one memory cycle in order to fill any area rapidly. In the character mode, the mask register can select the bits of the character or the attribute codes that are to be modified.

Parameters can be loaded into the GDC to draw lines, arcs, circles, or rectangles. With line drawing, for example, the microcomputer supplies the initial pixel address

## Chip changes the colors of light-emitting diodes

by Marvin Burke  
Novato, Calif.

A light-emitting diode that changes color as a function of the input voltage is useful for instrumentation and equipment displays, since both the presence of the light and the color convey information. A simplification of the circuit by Smithline,<sup>1</sup> this design needs no separate frequency generator and requires only a single supply voltage in the range of 5 to 16 volts.

As shown in Fig. 1a, the new design needs only one integrated circuit, six resistors, a capacitor, and a bicolor LED. Operational amplifier  $A_1$ , part of the quad LM324 package, interfaces with some external voltage source such as a voltage follower. Its output is the input,  $V_i$ , to  $A_2$ . For its part,  $A_2$  is set up to act as a voltage-controlled pulse-width-modulation oscillator. The duty cycle of its output pulse varies exponentially with  $V_i$ , as a percentage of  $B$ , the supply voltage. As seen in Fig. 1b, the ratio of  $A_2$ 's pulse-width high level to its pulse-width low ( $PW_H/PW_L$ ) follows the exponent of  $V_i$  linearly over two decades. That is more than enough to get a full

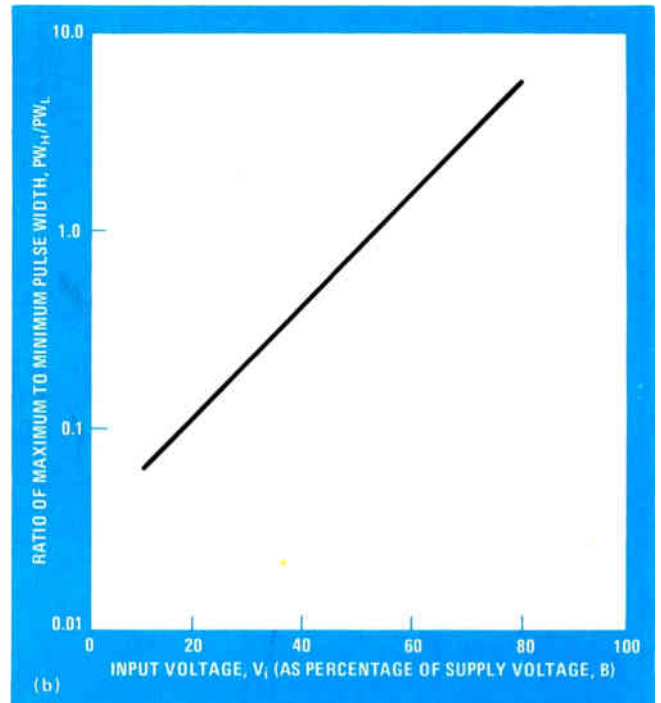

**1. Multicolored outputs.** Just one integrated circuit is required to construct a voltage-controlled multicolor light-emitting-diode display (a). Pulse-width modulation of  $A_2$ 's output by means of input voltage  $V_i$  (b) is the key to obtaining any LED output color from green to red.

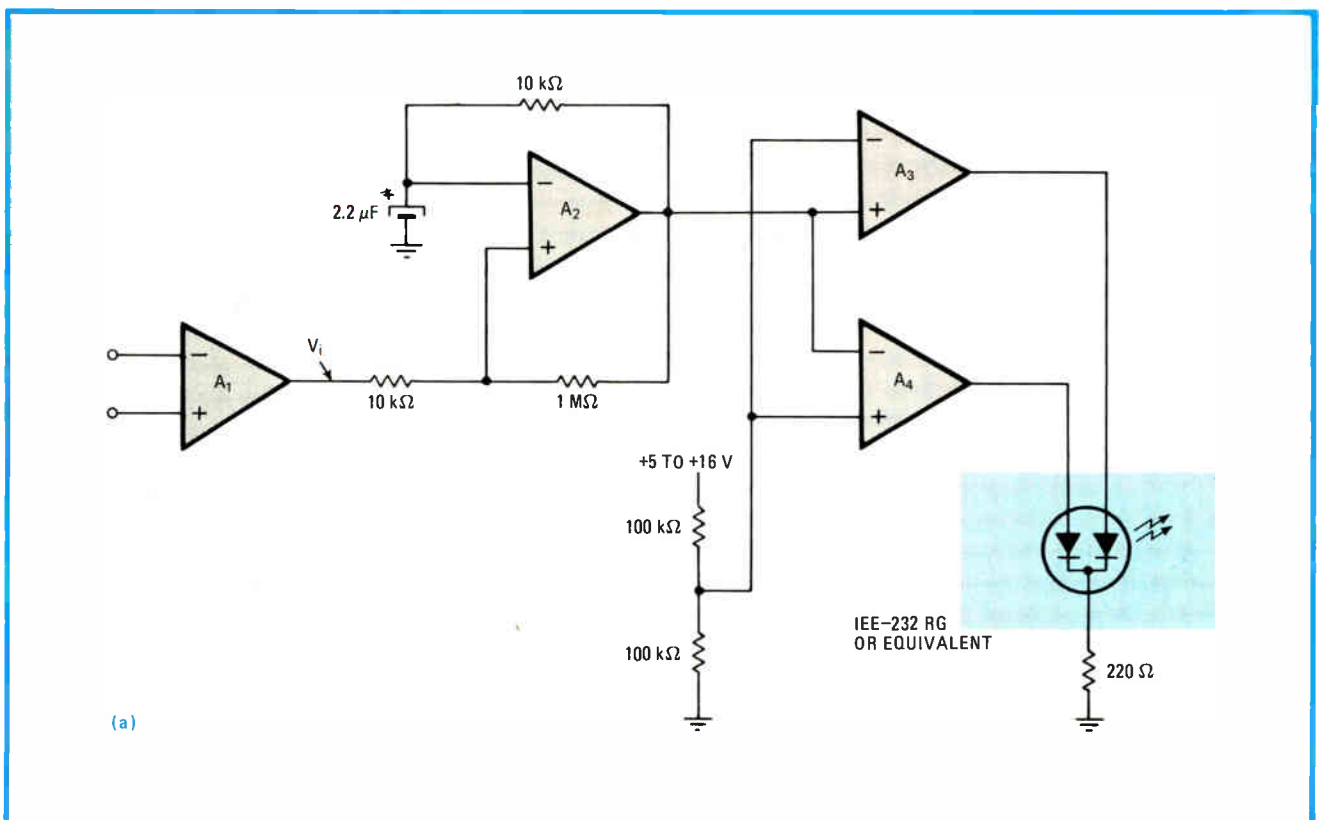

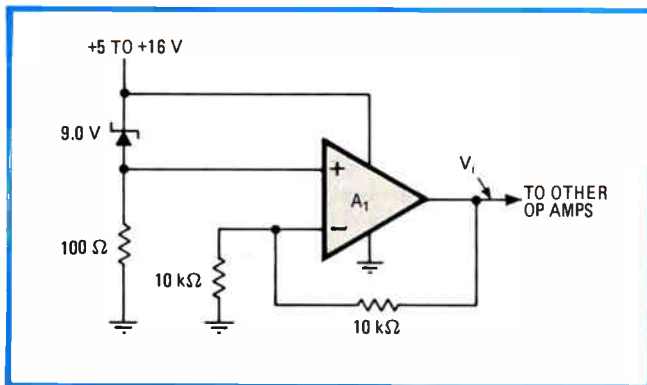

B	$V_i$	$V_i/B$	$PW_H/PW_L$	COLOR
13.0	8.0	0.62	2.00	GREEN
12.5	7.0	0.56	1.25	GREEN/YELLOW
12.0	6.0	0.50	1.00	YELLOW
11.5	5.0	0.43	0.60	ORANGE
11.0	4.0	0.36	0.40	RED

**2. Watcher.** The LED color modulator can monitor the supply voltage of a music synthesizer. Here, op amp  $A_1$  replaces part of the same number in Fig. 1. The table shows yellow for the normal voltage (12 V), green for the high one, and red for the low one.

range of color output from the LED. The output of  $A_2$  is fed to  $A_3$  and  $A_4$ , which act as noninverting and inverting buffers, respectively, for  $A_2$ 's pulse.

The buffers power the bicolor LED so that when the green LED is on, the red one is off, and vice versa. Since the overall color perceived is dependent on the relative power through each LED (provided they are flashing quickly enough for blending to occur), it depends strictly on the ratio of  $PW_H$  to  $PW_L$ . Thus,  $V_i$ , which determines  $PW_H/PW_L$ , is ultimately in control of the color. The color mix for a given range of  $V_i$  may be modified by

placing separate resistors in the red and green leads of the LED and adjusting the ratio of the resistors until the desired effect is achieved.

A direct application of the technique is shown in Fig. 2. Here,  $A_1$  is set up to monitor a synthesizer's supply voltage. With the parameters shown in the table, colors shift from green for high voltage to red for low voltage, keeping a close tab on the supply. □

#### References

1. Leonard M. Smithline, "Dual light-emitting diode synthesizes polychromatic light," *Electronics*, Aug. 16, 1979, p. 130.

## Fiber-optic transmitter measures high voltages safely

by Larry Berkbigger and Greg Dallum  
Lawrence Livermore Laboratory, Livermore, Calif.

In many industrial as well as research applications, there is a routine need to make accurate, high-voltage measurements in the region of 10 kilovolts or more. But unless sufficient isolation is provided between such a high voltage and the person measuring it, he (or she) will be in extreme danger.

This transmitter circuit converts a high voltage into an optical pulse train whose frequency corresponds to the voltage, providing a safe means of measuring high dc or low-frequency ac voltages. Since all power for the circuit comes from the measured source, faults cannot be conducted either through an ac power line or through the optical fiber that transmits the output pulse train.

The transmitter is basically a relaxation oscillator consisting of an oscillator circuit, an output-pulse-duration timer, a load and matching circuit, and a compensation network. In the oscillator circuit, capacitors  $C_1$  and  $C_2$  are charged to about 100 volts through  $R_1$  at a rate proportional to the input voltage,  $V_{in}$ . When  $V_a$  reaches

the value of the reference voltage  $V_g$  (see figure), the programmable unijunction transistor (PUT) fires and turns on the silicon controlled rectifier.  $C_1$  and  $C_2$  are thus discharged through the load, which also turns on the pulse-duration timer.

After about 8 microseconds, the output pulse turns itself off, which forces the SCR's biasing current to zero and switches it off. For high input voltages, where an 8- $\mu$ s discharge time would cause significant errors in the measurement being made, the compensation circuit shortens the charging time.

The circuit shown is optimized for a maximum  $V_{in}$  of 30 kv and its output frequency is 0.2 hertz per volt  $\pm$  1% over the span of 6 kv to 30 kv; other ranges will require a number of component changes. The 8- $\mu$ s output pulse is approximately half sinusoidal, with a peak power of 500 microwatts.

With inputs below 6 kv, the transmitter has two problems. First, it loses accuracy as  $V_{in}$  approaches the peak charge voltage of the capacitors,  $C_1$  and  $C_2$ —the circuit has a typical error of  $\pm$  2% with a 1-kv input. Second, the transmitter has a poor response time at low  $V_{in}$ ; the output frequency is low, placing a burden on a frequency-to-voltage receiver.

The circuit is calibrated by first adjusting  $C_1$  to provide a 2-kilohertz output with an input of 10 kv; at that input level, the compensation network has little effect. The compensation network is then calibrated by



# HAVE THE CORRECT SOCKET FOR YOUR BURN-IN APPLICATION!

## WORLD FAMOUS "HI-RISE" SOCKET

### WELCON SERIES 603

Our "Hi-Rise" socket is *the* reliability standard of the industry. Its unique contact design results in an insertion force of only 10 grams/pin... good for thousands of duty cycles. And the high side construction easily accepts I/Cs with splayed leads. It's available in all pin outs on .400", .450", .500" and .700" pin centers, in a wide variety of materials and platings to cover burn-in requirements to 200°C.



## SELECT PLATE "MID-RISE" SOCKET

### WELCON SERIES 613

You can save both board space and money with our new "Mid-Rise"! It has 25% less bulk and the cost advantage of select gold plating. With its low profile, insertion force of 20 grams/pin, side-to-side stackability, excellent under-socket clearance for resistors, and tin plated contact tails, you'll find this socket hard to beat. It's available in all sizes from 14 to 40 pins on .300" and .600" pin row centers.



## SPECIAL "ISOLATION" SOCKET

### WELCON SERIES 614

V-groove contacts on the "614" provide for vertical mounting of isolation resistors—the socketed I/C device can then be completely isolated from all others in the system, resulting in a higher quality burn-in. The contact design allows for easy flexing of the soldered assembly even under extreme temperature cycling! Specify this socket when you need both electrical isolation and proven dependability!



### FREE 1981 CATALOG

Details on all 22 families of "ZIF" sockets, burn-in/test sockets, production sockets, screw machine sockets and flatpack, quad pack, TO-5, and DIP contactors and carriers. Write, or call 219/287-5941.

# Welcon™

SOCKETS  
CONTACTORS  
CARRIERS  
CONNECTORS

\* WELLS ELECTRONICS, INC., 1701 S. MAIN ST., SOUTH BEND, IND. 46613 U.S.A.



Circle 160 on reader service card

World Radio History

**High tension.** Basically a high-voltage-to-frequency converter, this circuit safely measures voltages in the range of 1 to 30 kV. The output signal, which can be sent a distance of 20 yards or more over a fiber-optic link, is a TTL pulse train whose frequency is 0.2 Hz per measured volt. Above 1 kV, accuracy is to within 2%, and the circuit is powered only by the voltage that it is measuring.

adjusting  $C_3$  so that the output is 4.8 kHz with a 24-kv input. One iteration may be required in order to balance the system. □

Engineer's notebook is a regular feature in *Electronics*. We invite readers to submit original design shortcuts, calculation aids, measurement and test techniques, and other ideas for saving engineering time or cost. We'll pay \$75 for each item published.

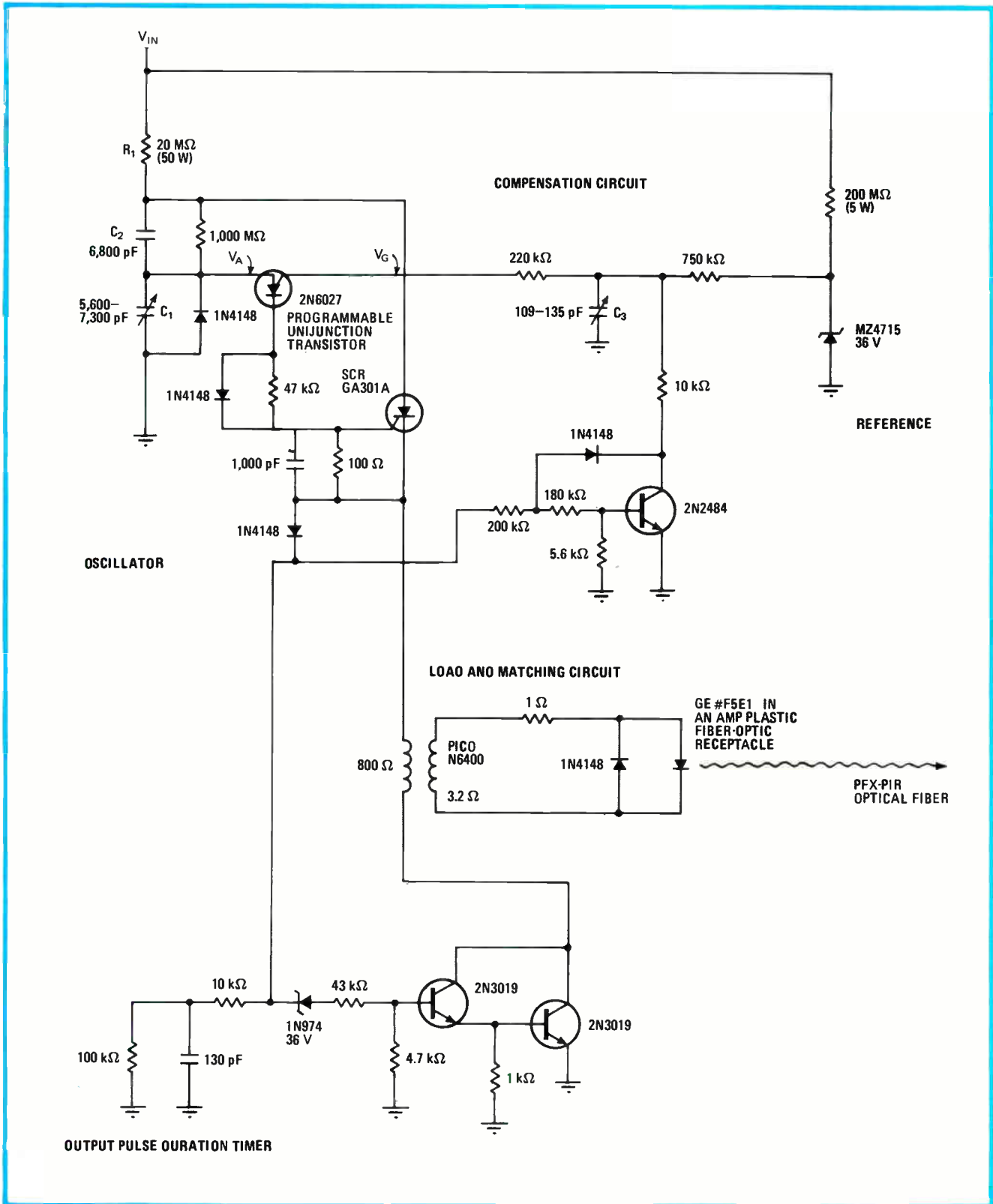

## **EIA standardizes connection to public telephones**

The Electronic Industries Association's new standard, RS-470, establishes technical criteria for connection to the U. S. public telephone network. Although the document is written around conventional carbon-transmitter telephones, its specifications are **valuable as a guide to designers of new all-electronic instruments as well.** According to O. J. Gussella Jr. of GTE Service Corp., who headed the committee that wrote the standard, it is designed to be used in conjunction with existing standard RS-464 for private-branch-exchange systems. A third standard on push-button phone systems will be released later this year. Copies of RS-470 are available at \$23 each from the Standard Sales Office, Electronic Industries Association, 2001 Eye Street N. W., Washington, D. C. 20006.

## **Pulse sampling cuts tunnel diode's power**

A simple tunnel-diode oscillator circuit can function as a sensitive transducer that will measure temperature and pressure over a wide temperature range. That much is well-known, but National Bureau of Standards physicist Craig Van DeGriff has gone one step further. Faced with the fact that at low ambient temperatures the power dissipation from the diode's own operation causes self-heating that destroys the measurement being made, Van DeGriff has devised a **scheme to sample the sensor diode with pulses as short as 1/30 second.** "This spreads the energy dissipated over a relatively long time and causes only a minor loss in precision," he says. Van DeGriff, who works at the NBS's Gaithersburg, Md., facility, has written a paper about his device. He can be reached at (301) 921-2753.

## **NBS will calibrate 30- and 60-MHz noise-signal generators**

Recognizing that precise calibration is a necessity to keep noise-signal generators accurate, the National Bureau of Standards has set up an arrangement so that private companies, Government agencies, and other organizations that wish to calibrate their 30- and 60-MHz units to the primary national standard may send them to its Electromagnetic Fields division in Boulder, Colo. The two frequencies are in common use as intermediate frequencies to help amplify incoming signals in a variety of radio-wave receivers. The new service is **accurate to within 1.5% and has a noise-temperature calibration range of 75 to 15,000 K.** It accepts GR 900, APC 7, precision type N, or SMA connectors. The calibration fee for a single noise generator at one frequency is \$855. For additional information, contact David F. Wait at 4085 Radio Building, National Bureau of Standards, Boulder, Colo. 80303, or call (303) 497-3610.

## **Learn about telecom chips**

Large-scale integrated circuits have been adopted by the telecommunications industry in great numbers in the last few years. Still, the chip folks have problems understanding the needs of the telecommunications business, and the telecom people sometimes make impossible demands of the chip manufacturers. To address this problem, the 1981 symposium of the Institute of Electrical and Electronics Engineers' Circuits and Systems Society is offering a one-day course, "Integrated Circuits for Telecommunications." According to P. M. Lin, professor at the School of Electrical Engineering at Purdue University, **the course will deal with the practical aspects of IC performance, external interfacing, and internal algorithms.** Particular devices covered will be codecs, anti-aliasing filters, interface circuits, and tone detectors. Write to Lin at Purdue, West Lafayette, Ind. 47907, or call him at (316) 493-3806 for details. **-Harvey J. Hindin**

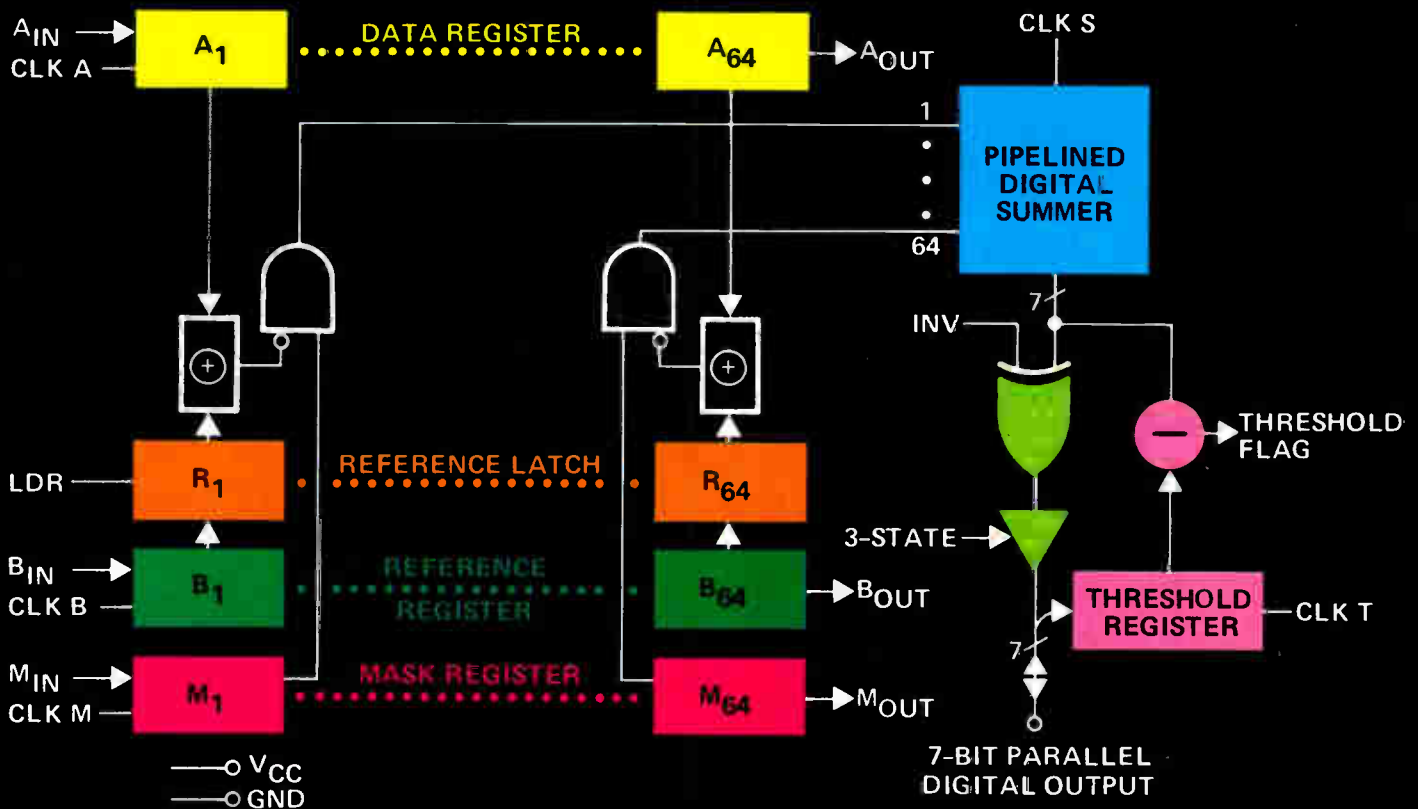

## Now! A 64-bit, 20 MHz All Digital Correlator. (On a single chip.)

Our TDC1023J correlator chip gives you the ability to detect a desired signal in the presence of other signals or noise. It can recognize and compare signal patterns. It may be used to measure time delays through various mediums such as materials, the body, RF paths, electronic circuits. It's ideal for the digital design engineer working in these areas:

- Convolution
- Error detection and correction
- Noise reduction in communications
- Pattern and image recognition
- Signal synchronization
- Signature analysis

And just take a look at these key features:

- Separate buffer register—speeds processing, reduces external components
- Threshold register—enables flag at preset correlation level
- Mask register—permits adjustable compare lengths
- 20 MHz correlation rate

- +5V supply; TTL compatible
- 24 pin ceramic DIP package
- Only \$85 in 100's

Prices quoted are U.S. prices.

**For complete information on our all new digital correlator, call your nearest TRW International Sales office and ask for our new 32 page brochure, "Correlation — a powerful technique for digital signal processing."**

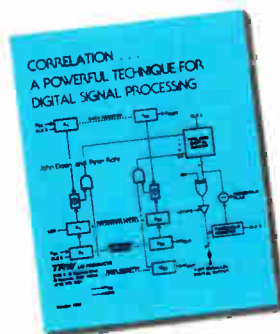

**ARGENTINA**, Buenos Aires 304132

**AUSTRALIA**, Moorabbin 5559566

**AUSTRIA**, See Germany

**BELGIUM**, See France

**BRAZIL**, Sao Paulo 2409211

**DENMARK**, Herlev 842000

**FINLAND**, Helsinki 6926022

**FRANCE**, Paris 7581111

**GERMANY**, Munich 7146065

**HONG KONG**, Kowloon 3856199

**ISRAEL**, Tel Aviv 444572

**ITALY**, Monza 360021

**JAPAN**, Tokyo 4615121

**NETHERLANDS**, Den Haag 210101

**NEW ZEALAND**, Wellington 851279

**NORWAY**, Oslo 786210

**SOUTH AFRICA**, Capetown 21-215350

**SPAIN**, Madrid 2425204

**SWEDEN**, Vallingby, Stockholm 8635040

**SWITZERLAND**, Zurich 429900

**TAIWAN**, Taipei 7512062

**UNITED KINGDOM**, London 9025941

TRW keeps you ahead in digital signal processing

**TRW LSI PRODUCTS**

An Electronic Components Division of TRW Inc.

# INTRODUCING THE \$324\* WE DO-IT-FOR-YOU WINCHESTER CONTROLLER.

Until now if you needed an inexpensive Winchester controller board, you were in big trouble.

They didn't exist.

Then we designed 5 chips that take the place of about 75 on an ST500/SA1000 interface. Which means it's now possible to fit a complete controller on one 6" x 9" board with about 40 chips instead of 150.

**BIG ON RELIABILITY.** Our WD1000 board gives you everything you need in a Winchester controller. Features like: a choice of 128, 256 or 512 byte buffers; a 5 MBITS/SEC transfer rate; control for up to 4 drives; control for up to 8 R/W heads and much more. All for about one-third the price of previously available controllers. The WD1000 is just \$324 in quantities of 250.

So suddenly you have greater design flexibility and the opportunity to create a system that's more reliable, less expensive and programs just like a floppy.

**BIG JUMP ON THE MARKET.** The WD1000 can save you up to 50% on your complete Winchester system and months of development time. Now's your chance to get a better product on the market, fast enough to make it very profitable.

For more information, including specifications on the WD1000 board, call (714) 557-3550 or mail in our coupon today.

With our boards, it won't be long before you're in the chips.

\*Quantity 250.

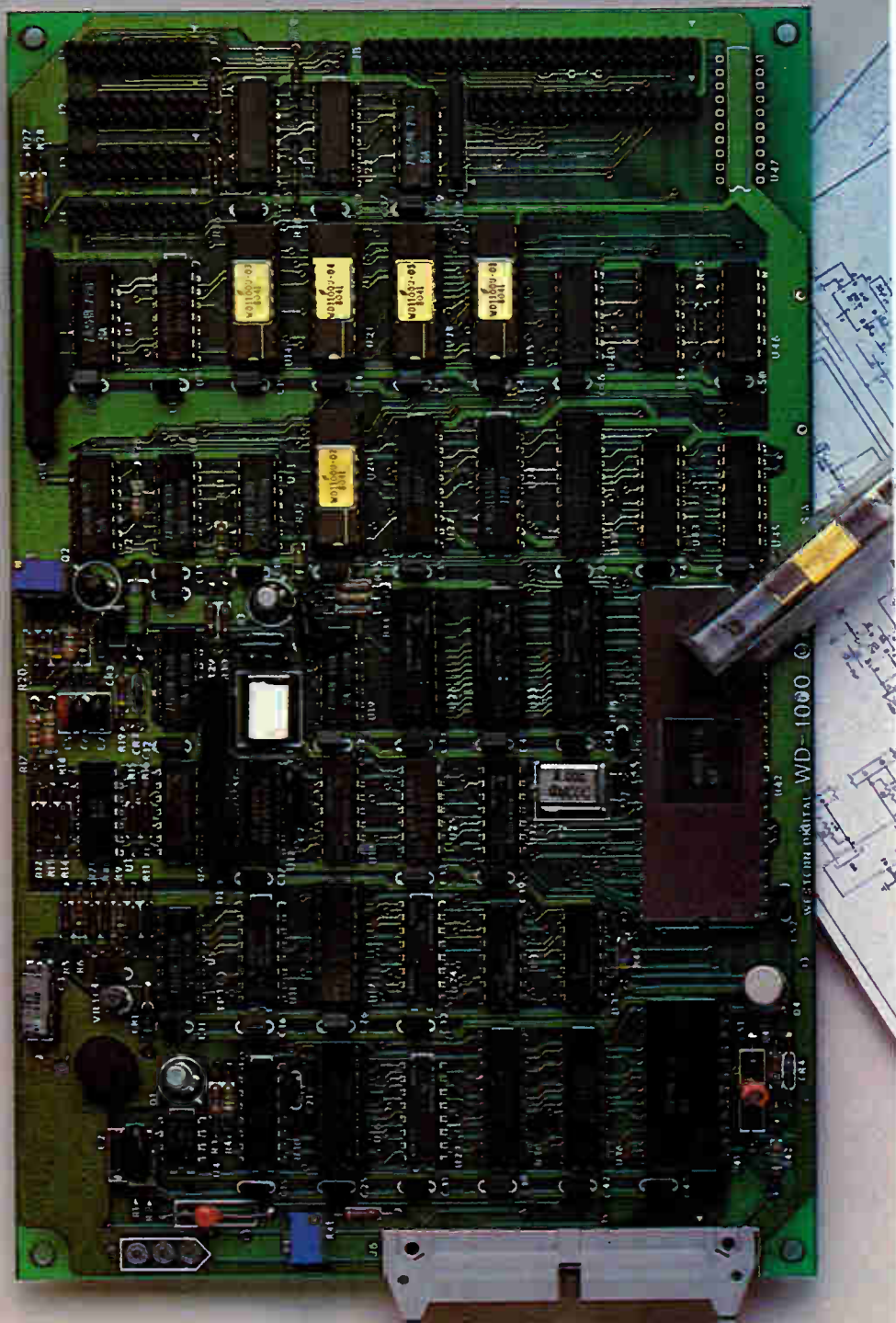

**WESTERN DIGITAL**  
CORPORATION

**REGIONAL SALES OFFICES:** Newport Beach, CA (714) 851-1221; Santa Clara, CA (408) 727-1777; Des Plaines, IL (312) 635-6090; Marblehead, MA (617) 631-6466; and Morden Surrey, U.K. 01-542-1036.



# INTRODUCING THE \$48\* OEM DO-IT-YOURSELF WINCHESTER CONTROLLER.

Until now Winchester controllers had to be big, complex and very expensive.

**SMALL WONDER.** We've taken 75 discrete components from the usual Winchester controller and replaced them with 5 MSI chips (address mark detector, CRC generator/checker, MFM generator, serial/parallel converter, parallel/serial converter) that can fit on a single board. And cost \$48 per set.

Think what that means to you.

**SMALL PACKAGE.** An ST500/SA1000 interface for your system that's small, inexpensive, a lot less complicated and very reliable.

When you order the WD1100 5-chip set, we include complete instructions on how to design your controller board to make it work the way you want it too.

So not only will you save cold hard cash and months of development time, you'll be able to design a more compact, more reliable product. And get it into production while it's still new and exciting.

For more information, including specifications on the WD1100 chip set, call (714) 557-3550 or mail in our coupon today.

And it won't be long before you're in the chips.

Yes, I'm interested in saving money on my next Winchester controller.

Call me.     Send literature

NAME \_\_\_\_\_ TITLE \_\_\_\_\_

COMPANY \_\_\_\_\_

ADDRESS \_\_\_\_\_

CITY \_\_\_\_\_ STATE \_\_\_\_\_ ZIP \_\_\_\_\_

TELEPHONE: \_\_\_\_\_

Mail to: Western Digital Corporation  
3128 Red Hill Ave.  
P.O. Box 2180  
Newport Beach, CA 92663  
Telephone: (714) 557-3550

Circle 165 on reader service card

---

# examine...

## a worldwide perspective.

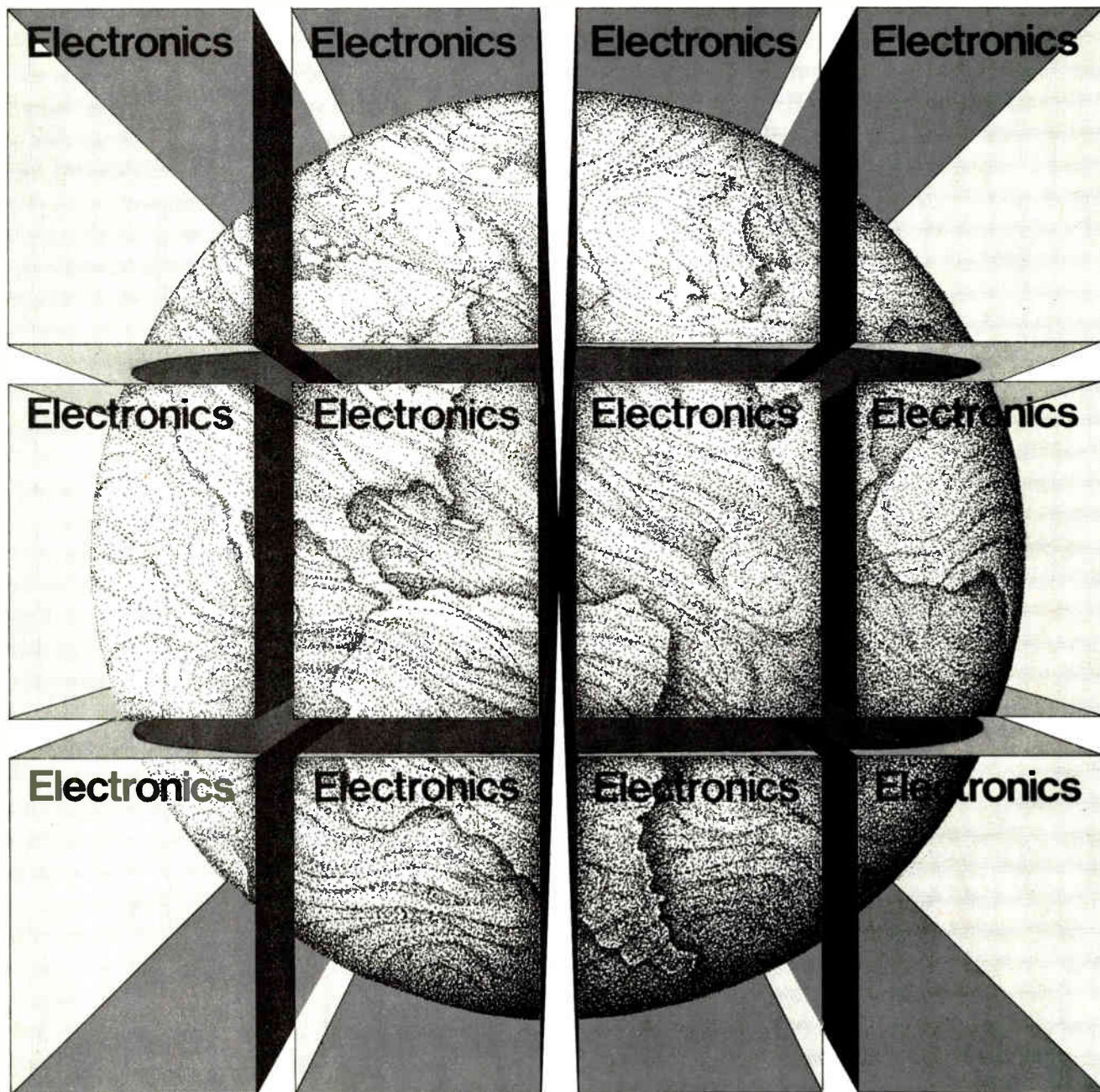

---

Wherever you are in this world, whatever your specialty...ELECTRONICS magazine's exclusive worldwide, international coverage of electronic technology and business guarantees that our subscribers are the first to know precisely what's happening...when it's happening...regardless of where it's happening.

From San Francisco to Tokyo, Moscow to Tel Aviv, only ELECTRONICS covers the fast-paced changes taking place in today's world of electronic technology. Our overseas editors don't travel to where the news is breaking, they live and work there. They examine and interpret every significant technological and business development on the international electronics scene to make sure our subscribers not only keep pace...but keep on top.

You owe it to yourself and to your career to find out why nearly 100,000 of your professional colleagues in 127 different countries explore the world of Electronics on a regular basis. Devote one hour of your reading time every two weeks and we'll broaden your dimensions in ways that no one else can. We'll keep you current on what's going on in the technology.

To start your subscription to ELECTRONICS send in the subscription card found in this magazine. Or, write directly to Subscription Department, ELECTRONICS, McGraw-Hill, 1221 Avenue of the Americas, New York, N.Y. 10020.

# Electronics Magazine



# There are two ways to look at $\mu$ P-based systems.

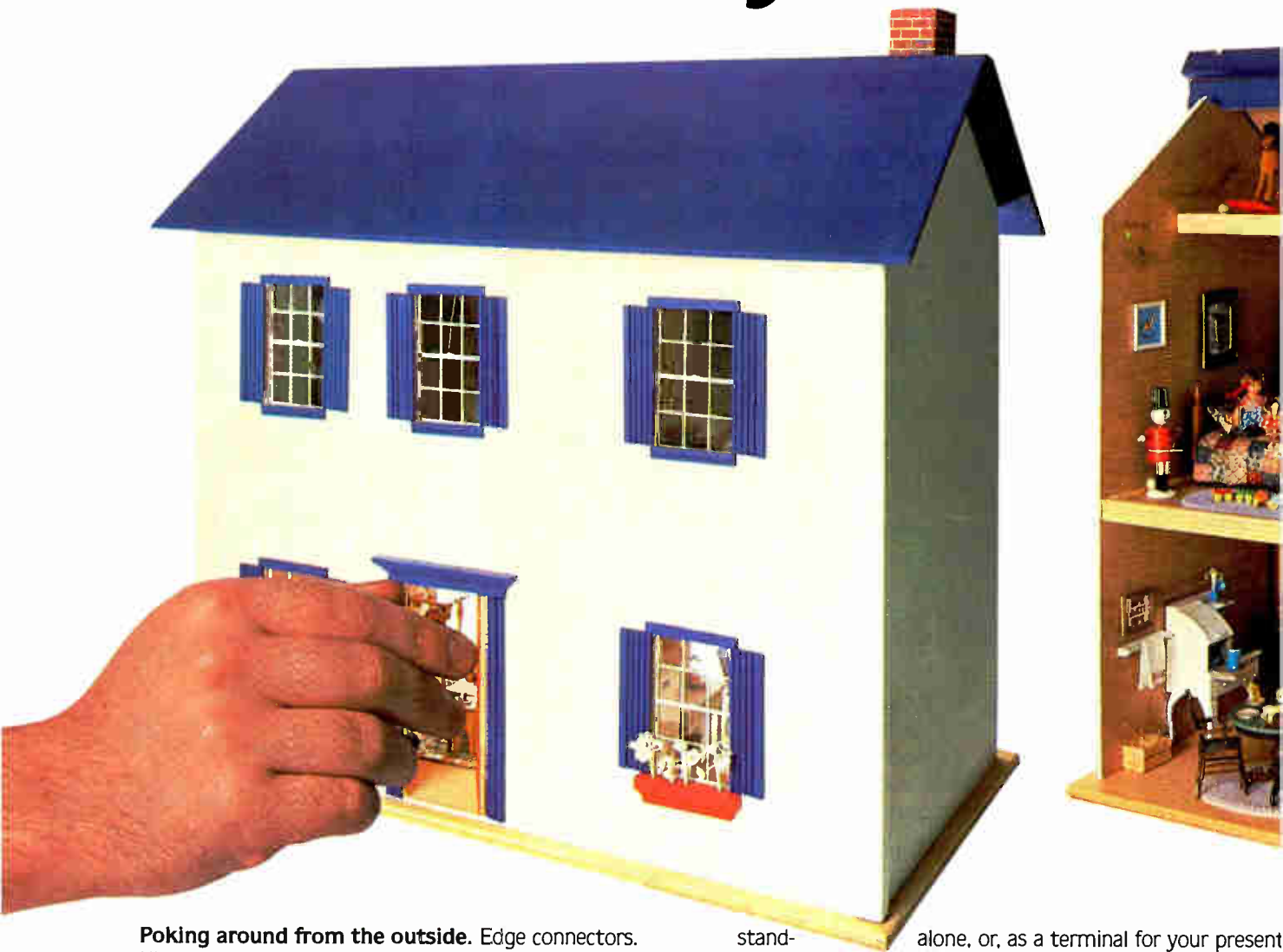

**Poking around from the outside.** Edge connectors. Kludged systems. Kludged system integration. Wait states. Unwieldy software integration. All, because from the outside you have to look at  $\mu$ P-based systems a piece at a time. Compared to Millennium's in-circuit emulation technology, poking around from the outside is slow. It's also unwieldy. Worse yet, it's expensive.

**Looking around from the inside.** In-circuit emulation is a window into the system. A big window. By simply plugging a  $\mu$ P emulator into the  $\mu$ P socket of the system under test, you can exercise every board in the system.

**Transparent instruments.** Millennium makes a family of products which utilize in-circuit emulation to speed up microprocessor-based systems development and testing. The  $\mu$ SE Micro-System Emulator, which can be used

stand-alone, or, as a terminal for your present minicomputer or dedicated development system, offers you multiuser ICE. That means you can develop hardware and software concurrently on the same development

system. And, integrate on the same system. All, transparent to the system under development.

**The ICE\* test.** Millennium combines ICE with signature analysis in the  $\mu$ SA MicroSystem Analyzer. In board test, it gives you GO/NO-GO just like other systems. Unlike other systems,  $\mu$ SA tests at the full speed of the microprocessor. And, in conjunction with a host computer,  $\mu$ SA can lead you right down the fault tree to the faulty node. That means it's an ideal tool in the factory, depot or field. And Millennium's FASTPROBE™ software allows even low-skill field employees to perform

\*ICE is a trademark of Intel Corporation



## IN-CIRCUIT EMULATION VERSUS WHATEVER YOU'RE USING NOW

# 2



complicated fault isolation. Bye-bye board float.

**All  $\mu$ P's are not created equal.** For that reason, Millennium supports 25 separate microprocessors and microcomputers. Buy the basic system and add  $\mu$ P emulators as you need them. And each optional  $\mu$ P Emulator comes in a package with its own warranted cross software.

**Try before you buy.** If you'd like to liberate your dedicated microprocessor development system, add development terminals to your mini, or, put ICE and signature analysis to work in your test operation, call us. There are two ways to look at  $\mu$ P-based systems. From the inside. From the outside. Look at yours. See ours. Then, make up your own mind.

## MILLENNIUM

Call for information or a demonstration:

(800) 538-9320 Toll Free

(800) 662-9231 In California

Millennium Systems, Inc., 19050 Pruneridge Ave., Cupertino, CA 95014

Millennium Systems is a subsidiary of American Microsystems, Inc.

Demonstration: Circle Reader Service Number

Information: Circle Reader Service Number

The inherent controllability and observability of a system determines the nature and degree of control which can be exercised over it. This principle, drawn from control systems theory, applies to the control and observation of microprocessors and VLSI components during system development, and is a major contributing factor to the rate at which system debug can proceed. The increase in functional complexity of these components makes control and observation much more difficult. Instrumentation designed to aid in controlling and observing prototype systems must, therefore, become more sophisticated and more "friendly."

Of all the tools available to the system designer, in-circuit emulation (ICE) is the only one which allows him to control the system under development. All others, such as logic analyzers and oscilloscopes, are merely passive monitors.

The degree of control and observation provided by an ICE unit is relatively easy to judge: register and memory display capabilities, number and complexity of breakpoints, width and depth of trace memory, data modification capability, and execution control capability. There is another factor, however, which must be considered. It is transparency, or the lack of intrusion on system performance. An ideal ICE would be totally transparent; i.e. the system under development would perform as if the ICE were not present. But the Uncertainty

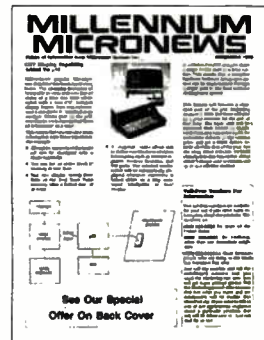

Principle states that the act of measurement will exert some effect on the event being measured (an oscilloscope probe, for example, will load a signal).

Loading such as that introduced by an oscilloscope probe is usually of no concern, but some ICE loading can be serious. One example is the insertion of "wait states." Individual instructions may execute at real-time speeds, but programs do not. Another example is the inability of some emulators to support all of the operating modes of the target microprocessor. Such ICE limitations, if present, will affect the system designer's control over his prototype, and will seriously limit observability.

Millennium is committed to the effectiveness of  $\mu$ P-based system design through in-circuit emulation. By incorporating increased transparency, controllability and observability into our development systems, we continuously maintain this commitment.

Circle 169 on reader service card

# A New Page has been Added to 100MHz Oscilloscope History!

**NEW**

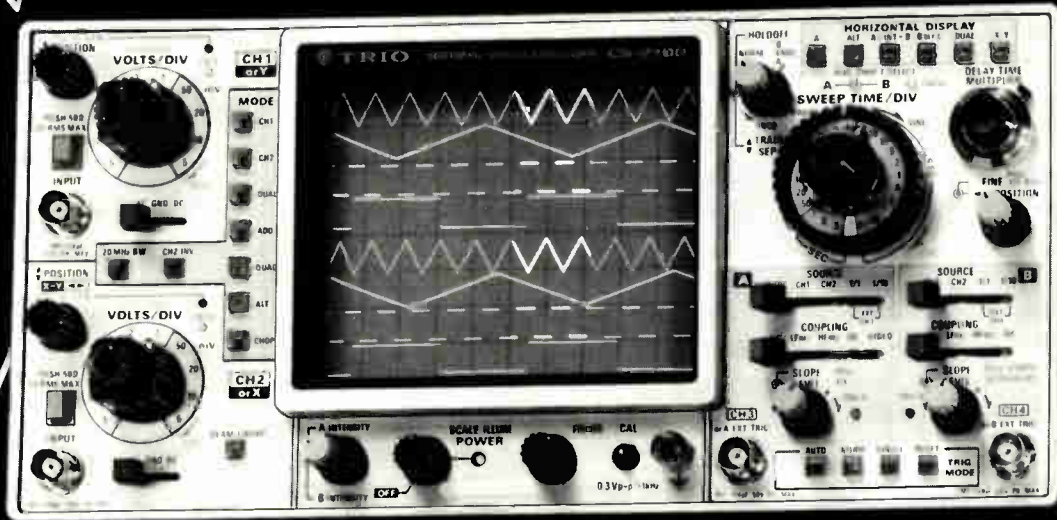

## 4 Channel 8 Trace Display

100MHz 4 Channel Oscilloscope

# CS-2100

Trio, known throughout the world for its responsiveness to the tough demands of oscilloscope users, has developed a 100MHz scope that is destined to change your thinking about 100MHz oscilloscopes.

The compact, 100MHz CS-2100 offers 4 Channel/8 Trace display capability to solve even your trickiest display problems. The CS-2100 is the successful culmination of a development effort which sought to provide all the high frequency response and sensitivity demanded by today's state-of-the-art circuitry as well as a variety of features such as delayed, alternate and dual sweep display. The result of this effort is a full-feature 100MHz scope with designed-in solutions to your toughest problems.

- Up to 1 mV/DIV sensitivity usable all the way to 100MHz.
- Sweep times to 2ns/DIV with x10 magnification for easy viewing of the fastest signals.
- Unique 4 Channel/8 Trace display.
- Indispensable Delayed Sweep feature allows simultaneous viewing of the delayed sweep and the main sweep.
- Completely independent A and B Sweeps for easy viewing of signals of widely different frequencies.
- 50Ω input impedance is selectable for observing fast pulses or signals on 50Ω lines without the need for bothersome terminations.
- Independently adjustable main and delayed sweep intensity.
- 16kV of accelerating potential and Auto-focus for a clear bright display.
- Electronic switching and panel set-up memory.
- Compact 28.4cm(W) x 13.8cm(H) x 40.0cm(D) package weighs only 7.4kg for true portability.
- Power saving circuit requires only 56W and needs no cooling fan.

**TRIO-KENWOOD CORPORATION**

Producer of world-renowned KENWOOD brand audio equipment.

TEST INSTRUMENT DIV.: SHIONOGI SHIBUYA BLDG., 17-5, 2-CHOME, SHIBUYA, SHIBUYA-KU, TOKYO 150, JAPAN  
CABLE: TRIOINSTRUMENT TOKYO TELEX: 242-3446 TRITES

Circle 132 on reader service card

# CAD station aims at VLSI design

Intended for a designer working on a silicon subdivision, dual-8086 unit lowers per-station cost of CAD efforts

by Martin Marshall, West Coast Computers & Instruments Editor

Many facets of building computer-aided design systems and software for very large-scale integration are still in embryonic stages [*Electronics*, July 31, 1980, p. 73], but most integrated-circuit design houses agree upon the need for lower-priced design stations that are compatible with large computers. Although the major CAD system manufacturers seem to be focusing on the highly profitable mechanical design market, a well-financed startup company, Avera Corp., has developed a state-of-the-art CAD system expressly tailored to VLSI design.

Dubbed the Avera IC Designer, the system is among the first 8086-based systems to reach the marketplace. Its operating software also represents a major effort, incorporating over 200,000 lines of Pascal code in its development. At \$39,250 for a complete basic station, it significantly undercuts the per-station cost of its larger-system competitors.

The IC Designer is built around two 16-bit 8086 processors, with the processors arbitrating through multitasking operating software. One processor is used to interpret commands and the other to support graphics. The main processor has 64-K bytes of random-access memory, and the graphics processor has 64-K bytes of RAM plus an additional 64-K-byte bit map. The main storage RAM has parity checking, but the bit-map RAM does not. The basic system also has two double-density 8-in. floppy-disk drives capable of storing a half megabyte each, and in July a 10-megabyte 8-in. Winchester disk option will be offered as an alternative to one of the floppy disks.

The system has a standard key-

board with 12 extra control keys including arrow keys for text editing and 14 so-called soft keys that—with a shift control—can be used for up to 26 user-programmable functions. The primary graphics input device is a “mouse,” which the user rolls along any surface to move a cursor on the cathode-ray-tube display. A \$2,000 optional data tablet can also be used for graphics input.

The 564-by-832-pixel CRT display is oriented vertically, with a 9-by-12-in. viewing area and 24 on-screen function boxes that respond to the cursor control. The graphics area contains 512 by 512 pixels. The display unit also has a two-digit light-emitting-diode display for indicating self-diagnostic codes and a speaker that can be used to acknowledge a command input.

The control and storage module contains a 10-slot Multibus cage with cards double the height of standard Multibus cards. This card cage contains the processor boards, the video-controller card, a diskette-con-

troller board, a bit-map board, and an input/output board, as well as room for an optional magnetic-tape-interface board and empty slots for the user's own Multibus-format boards. The basic system has two RS-232-C ports, with options for two more like them and a magnetic-tape-interface port.

Upon this hardware base Avera has built a great deal of software functions. The commands have been organized into five groups—control, editing, manipulation, status, and viewing; this organization eliminates the need to display all commands simultaneously. Once a command category is selected, the commands within that group are displayed. The user can string together, or concatenate, functions, as well as demand the syntax of a given command. Using the mouse or data tablet, he can also draw symbols representing the commands much as one draws symbolic commands on available Applicon systems.

The system uses a recursive data



# For increased profits when you expand...

## Texas, Corpus Christi, and Corpus Christi's Industrial Technology Park!



### A Winning Combination

#### In Corpus Christi:

- High labor productivity  
(like getting every 4th worker free)
- Large labor pool/unskilled and skilled
- Industrial revenue bonds
- Favorable government at all levels
- Right-to-work and no state income tax
- Clean air, light traffic, mild winters

#### At the Park:

- 150 acre park, 5 acre tracts
- Limited to research & development and light manufacturing
- Protective covenants
- Access to 5,000,000 marketplace plus Mexico
- Quick access to major airlines, rail lines and interregional highways.

Increase your profits . . . expand to the Corpus Christi Industrial Technology Park and enjoy a great climate for year-round living.

Please send me more information on Corpus Christi and the Industrial Technology Park.

Name \_\_\_\_\_

Title \_\_\_\_\_

Company \_\_\_\_\_

Street \_\_\_\_\_

City \_\_\_\_\_ State \_\_\_\_\_

Zip code \_\_\_\_\_ Telephone \_\_\_\_\_

Brodie Allen, Director  
Corpus Christi Industrial Commission  
P. O. Box 640, Dept. E-41  
Corpus Christi, Texas 78403 (512) 883-5571

Circle 172 on reader service card

### Keeping you ahead of the pack...

You (and we) are in a quick-moving business. News breaks frequently. Change is the name of the game. Awareness is the way to win.

Give us one hour of your time every two weeks and we will keep you aware of what's going on around you and around the changing world of electronics technology.

**Keep ahead of the pack. Send in one of the subscription cards in this issue.**

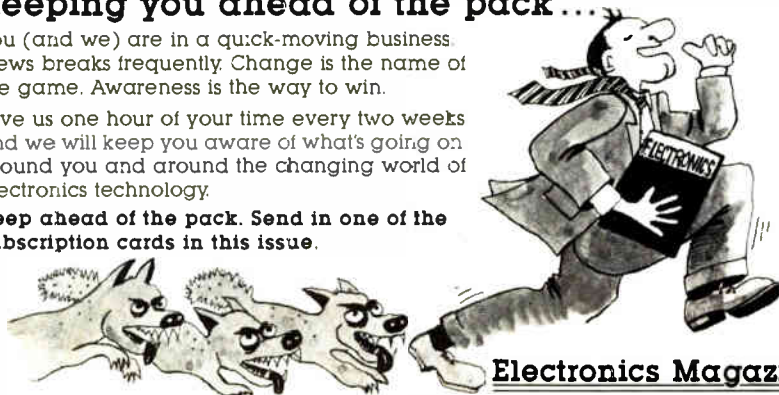

**Electronics Magazine**

### New products

structure, plus Avera's own intermediate data structure for external communication, which lends itself to design partitioning and uploading to a larger computer such as a Digital Equipment Corp. VAX machine, a Prime computer, and, later, IBM mainframes using the Binary Synchronous format.

President Mike Dickens points out that Avera's intermediate data format is acceptable to NCA Corp. of Sunnyvale, Calif., for input to its layout-checking programs and that if the market demands, Avera will also develop an output in Caltech intermediate format. Data in the IC Designer can also be formatted so that it can be directly read by other major graphics systems like those of Calma and Applicon.

**Uploading.** The 1-megabyte capacity available on diskettes represents storage for a drawing with about 1,000 transistors in it. "Usually, a designer should be able to put one month's worth of work onto a single diskette," notes Dickens. The theory behind the IC Designer is that a user will be working on a partitioned piece of a VLSI design and will probably only have to offload his work to a larger computer once a day. That larger computer will then take on the chore of simulation and design-rule checking and feed its results back to the designer.

The IC Designer can display an IC design in either symbolic or detailed representation or in a mixture of both. It has a zoom feature similar to that of the Applicon 860 systems, and like the Applicon system, it can manipulate only data within the viewing window. The system can also save a window so that the user can come back to a prior representation if he is unsatisfied with his changes. The total table size available for storing a drawing is 64-K points in the X direction and 64-K points in the Y direction. That corresponds to a 16-bit data base, but the Avera system can also register offsets to a 32-bit data structure.

Deliveries are in 30 to 60 days.  
Avera Corp., 340 El Pueblo Dr., Scotts Valley, Calif. 95066. Phone (408) 438-1401 [338]



# WHO MAKES THE ONLY VMOS POWER OP AMPS?

 **TELEDYNE PHILBRICK**

Call them high speed op amps with more muscle than previously available or power op amps with more speed than previously thought possible, but Teledyne Philbrick's 1460 and 1461 are still the first and only op amps with VMOS FET output stages. SOA restrictions and secondary breakdown problems are no longer a concern. The 1461 has a FET input, a guaranteed  $\pm 30V$ ,  $\pm 600mA$  output, an incredible  $1200V/\mu\text{sec}$  slew rate, and an astonishing  $1\text{GHz GBW}$  product ( $15\text{MHz}$  operating bandwidth). The 1460 has a guaranteed  $\pm 30V$ ,  $\pm 150mA$  output, a  $300V/\mu\text{sec}$  slew rate, and a  $1\text{GHz GBW}$  product. Teledyne Philbrick is a leading manufacturer of precision, high speed and high power op amps for both military and commercial applications. We also manufacture extremely fast A/D-D/A converters, V/F-F/V converters and S/H amplifiers.



 **TELEDYNE PHILBRICK**

Get YOUR hands on the latest specs for Teledyne Philbrick VMOS power op amps!

Send me data sheets     Have a local representative call

My application is: \_\_\_\_\_

Name \_\_\_\_\_ Title \_\_\_\_\_

Company \_\_\_\_\_ Tel. \_\_\_\_\_

Address \_\_\_\_\_ M/S \_\_\_\_\_

City \_\_\_\_\_ State \_\_\_\_\_ Zip \_\_\_\_\_

 **TELEDYNE PHILBRICK:** Allied Drive @ Route 128, Dedham, MA 02026  
Tel: (617) 329-1600

EI (B)



*Insert card,  
select  
transaction*

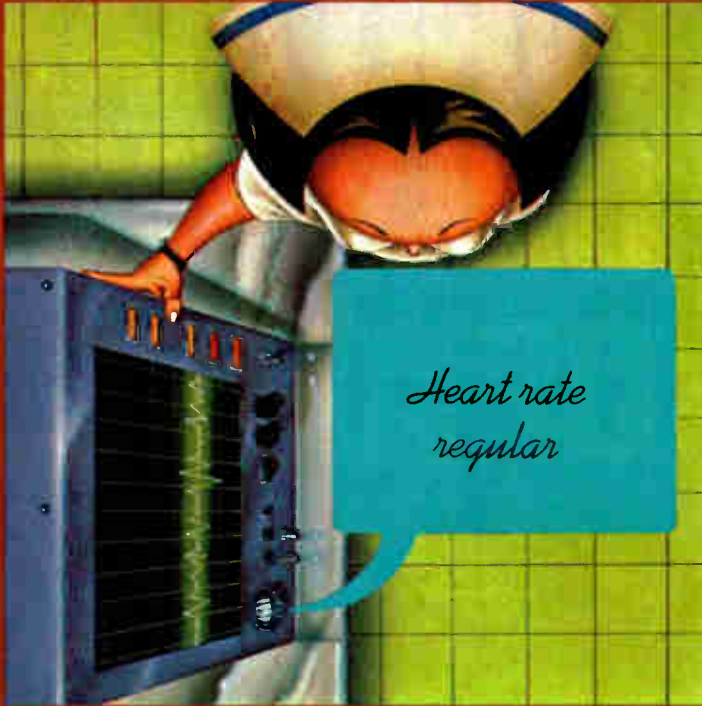

*Heart rate  
regular*



*Branch office  
data transmission  
complete*



*Good game!  
Play  
again!*



**TMS5200**

*Products that talk.  
The man-machine interface  
will never be the same.*

# Let's talk about speech capability. Voice synthesis products. From Texas Instruments.

The bright promise of products that think came closer to fulfillment in the 70s. The trend for the 80s is clear: Products that "talk."

Whether it's appliances, automotive consoles, transaction terminals, office systems, telecommunications, robotics or electronic toys and games, no other area of technology will have more impact during this decade.

Speech synthesis technology — pioneered by TI — portends a whole new generation of voice-prompting products. Products that will change the way you live and learn and work.

So, if you're designing new products with speech applications, talk to TI — the *only* total capability supplier with the experience and production-proven know-how to assure you of reliable speech products and services.

## Let's talk technology

TI offers several methods of vocabulary analysis, dependent on your volume, versatility of application and voice quality desired. TI's Linear Predictive Coding (LPC) technique provides the highest quality speech reproduction because it's the only technique devised that models itself after the human vocal tract.

Define your vocabulary, consider your volume requirements, cost and development time, then talk to TI about your application.

## Let's talk products

Choose from the industry's broadest, most cost-effective line of speech products. A growing line of integrated circuits, evaluation kits, OEM boards and a capability for the design and development of complete custom modules incorporating microprocessors, display and interface functions. A good example of our commitment to this technology: ROMs made especially for speech applications.

TI's LSI Voice Synthesis processors (VSP) and Voice Synthesis memories (VSM) are in volume production, now.

The TMS5200 single chip VSP produces high quality speech at a very low data rate (1200 bps), easily interfacing with 8 and 16-bit microprocessors. The on-chip FIFO buffer allows speech data to be stored in either the host microprocessor system, or off-line on bubble memory or floppy disk. Also, speech data may be stored in a custom ROM, such as the 128K-bit TMS6100. You can use TI VSPs with TMS6100 Series VSMs for storage of up to 3,000 words of speech.

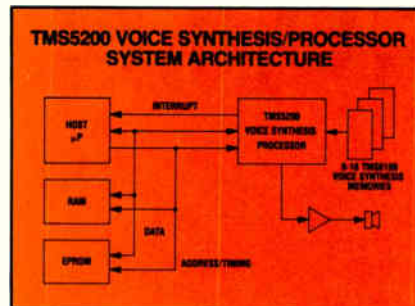

The TMS5100 single chip VSP produces high-quality speech at data rates of 1200 bps and interfaces with 4-bit microprocessors. TMS5100 VSP directly addresses up to 16 TMS6100 VS memories for up to 30 minutes of speech.

For evaluation of TI's voice synthesis capabilities for 4, 8 and 16-bit microprocessors, complete speech evaluation kits are available for TMS5100 and TMS5200.

So, what are we talking about? We're talking about quality, flexibility, cost/performance effectiveness and right now delivery — only from the voice synthesis leader — only from Texas Instruments.

There's more. We're also talking about custom modules and boards. Like the TM990/306 speech module without standard vocabulary for applications using customer-specified words and shipped without EPROMs, allowing users to install Solid State Speech\* vocabularies developed specifically for their own applications.

For high-volume applications, user-developed vocabularies can be implemented on mask-programmed ROMs.

The benefits of the custom module approach are both time and cost related. TI's experience in the design and production of electronic modules means quick cycle times, substantial savings, and, of course, getting your product to market faster.

## Let's talk support

Like the development of production vocabularies at any of TI's Regional Technology Centers. Custom vocabularies can be synthesized at the RTCs at low cost with quick turnaround (so quick in some cases that you can walk out the door with your program) and delivered on EPROMs for use with either TI's TM990/306 speech board or TMS5000 Series VS processors.

And like tapping the resources of TI's word library where natural sounding speech is pre-recorded and readily available for specialized vocabularies.

And like an intensive one-day RTC seminar covering TI's Solid State Speech technology and its applications, including acoustics, phonetics, waveform analysis and LPC. Systems architectures as well as hardware and software design techniques and a demonstration of several speech products round out the day.

And like the Design Service assistance rendered by the RTCs for the application of cost-effective, state-of-the-art technologies to your specific product and program needs.

## Let's talk now

About a total systems solution capability for voice synthesis technology. About low-cost, high-quality, quick turnaround Solid State Speech applications for your products.

Talk to your nearest TI field sales office, or write to Texas Instruments Incorporated, P.O. Box 225012, M/S 308, Dallas, Texas 75265.



\*Solid State Speech is a trademark of Texas Instruments Incorporated.

# TEXAS INSTRUMENTS

ARGENTINA 748-1141 • AUSTRALIA (02) 887-1122 • BELGIE/BELGIQUE (02) 720.80.00 • BRASIL 518423 • DEUTSCHLAND 08161/801 • FRANCE (3) 946 97 12 • ITALIA (0746) 69034  
JAPAN 03-498-2111 • MEXICO 567-9200 • NEDERLAND 020-473391 • SCHWEIZ/SUISSE 01 740 22 20 • SVERIGE (08) 23.54.80 • UNITED KINGDOM (0234) 67466

# The New Microprocessor-Based Scalar Network Analyzer System.

## Running it is as simple as A, B, C, D, E, F!



# It's a Wiltron.

You're going to make accurate automated microwave measurements far easier with Wiltron's new Series 5600 Automated Scalar Network Analyzer System over the 10 MHz to 40 GHz range. And you're going to make them for less.

In truth, you're going to discover the most accurate and easiest way ever offered to measure return loss, transmission loss or gain and power automatically. You're going to use a powerful new system featuring distributed microprocessor technology and state-of-the-art microwave design.

## Only Three Elements to the System

Each system consists of the Model 560 Scalar Network Analyzer, a 6600 Series Programmable Sweep Generator and the Model 85 Controller. Connect the SWR Autotester and Detector supplied, plug-in the factory pre-programmed cartridge and the system is ready to go.

## 40 dB Directivity

Wiltron's 5600 Series offers 40 dB directivity over a 10 MHz to 18 GHz continuous sweep range. Dynamic range is 66 dB with -50 dBm sensitivity. The system offers 82 dB programmable attenuation in 0.1 dB steps. ROM-corrected frequencies are accurate to  $\pm 10$  MHz from 10 MHz to 18 GHz. Six models span the 10 MHz to 40 GHz range.

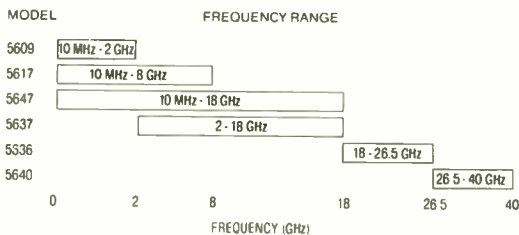

A key part of the system is the new Series 6600 Programmable Sweep Generator. This sweeper uses fundamental oscillators to avoid substantial errors generated by the harmonic products of multiplier type oscillators. The result, broadband coverage with the lowest harmonic content (-40 dBc, 2-18.6 GHz), low residual FM and greater stability.

A pre-processor chip separately scans front panel controls and interfaces directly with the main processor. Response speed is never a problem. All interfaces with the bus are internal, eliminating the need for an external interface box. For user convenience, up to 99 test set-ups can be stored in the control cartridge for future use.

## On The Air Moments After You Get It.

Simply plug-in the preprogrammed cartridge and enter a few simple inputs.

## It's as Simple as A, B, C, D, E, F!

### A. System Setup

- 1) Date.
- 2) Type of measurement to be made.



### B. Frequency Selection

- 1) Frequency range limits.
- 2) Frequency step size or number of test points.

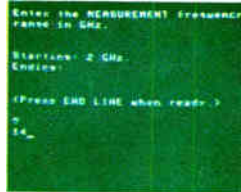

### C. Calibration

- 1) DUT identification. Select 1) Averaging of open/short residuals.
- 2) Storing of normalized residuals.

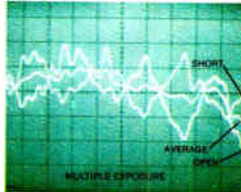

### D. CRT display of DUT characteristics

- 1) Select marker frequencies and amplitude limits.
- 2) If necessary, adjust DUT.
- 3) If not, continue.



### E. Measurement

- 1) Press key to start automatic measurement sequence.



### F. Hard-copy output

- 1) Plotted curves.
- 2) Tabular data.

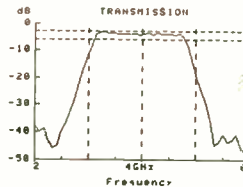

## Make Your Own Comparison Soon

For a demonstration and/or our new brochure, phone Walt Baxter, (415) 969-6500 or write Wiltron, 825 E. Middlefield Road, Mountain View, CA 94043.



# Development system is multitasking

One- or two-user system improves productivity;  
8086 and Z8000 support will join current roster for 8-bit chips

by Bruce LeBoss, San Francisco regional bureau manager

Millennium Systems Inc. is not widely associated with the small group of experienced manufacturers of development system products. But the firm fits into that category by virtue of having designed and produced the 8001/8002 microprocessor development labs sold under the Tektronix name. With the ending of that accord this week and, more importantly, the subsequent introduction of a new family of development systems, Millennium intends to make its own name known in the field.

The 9500 family was designed to increase the productivity of designers of 8- and 16-bit microprocessor-based systems, according to David G. West, Millennium's business director for laboratory products. The family, the first members of which will be unveiled at Electro/81 in New York this week, improves engineering productivity through multitasking and uses stand-alone instru-

ments and stations to distribute hardware debugging and software development tasks, he states.

The 9520 software development system is controlled by a Z80A running under the MP/M operating system. With this multiuser version of the popular CP/M disk-based operating system, a single user can initiate several tasks and thus greatly increase his or her productivity. For example, West notes, a user can be editing a source-code file while the printer is producing another file or while a program is being compiled. The multitasking capability of the MP/M operating system, he adds, can also be exploited by having two users working at the 9520 simultaneously.

The system can be used with the 9508 microsystem emulator and an 8-bit debugging station with trace analysis capability that Millennium also will introduce at Electro/81, as well as with two stand-alone units

that the firm intends to unveil in the fall—a multiuser system that supports up to eight users and an 8- and 16-bit microprocessor emulation system. “The debug functions are offloaded onto the emulation stations, allowing the 9520 to focus on software development tasks,” such as text editing, assembly, compilation, and simulation, says West.

In a single enclosure, the 9520 houses two double-density floppy-disk drives, a regulated switching power supply, and a single board containing 64-K bytes of memory (48-K bytes of which are available to the user), the 6-MHz Z80A, four serial ports (three RS-232-C and one high-speed RS-422) and one IEEE-488 port. An additional 48-K bytes of memory, necessary when the 9520 is configured for two users, is available on a separate board for \$1,500. The two disk drives in the 9520 store 1 megabyte.

**Reliability.** All memory parity is selectable under software control, and at power-up, a built-in system confidence check exercises the major functional elements of the system—memory, input/output ports, and the floppy-disk drives and their controller, among others—and indicates go/no-go conditions through light-emitting-diode displays. Additional diskette-based diagnostics let the user check out the system more completely, isolating any faults down to a replacement-module level.

The 9520 also has a screen-oriented text editor that can format text as well as execute word-processing tasks. It is compatible with all programs that have been written for CP/M and has a user-configurable driver that operates many cathode-

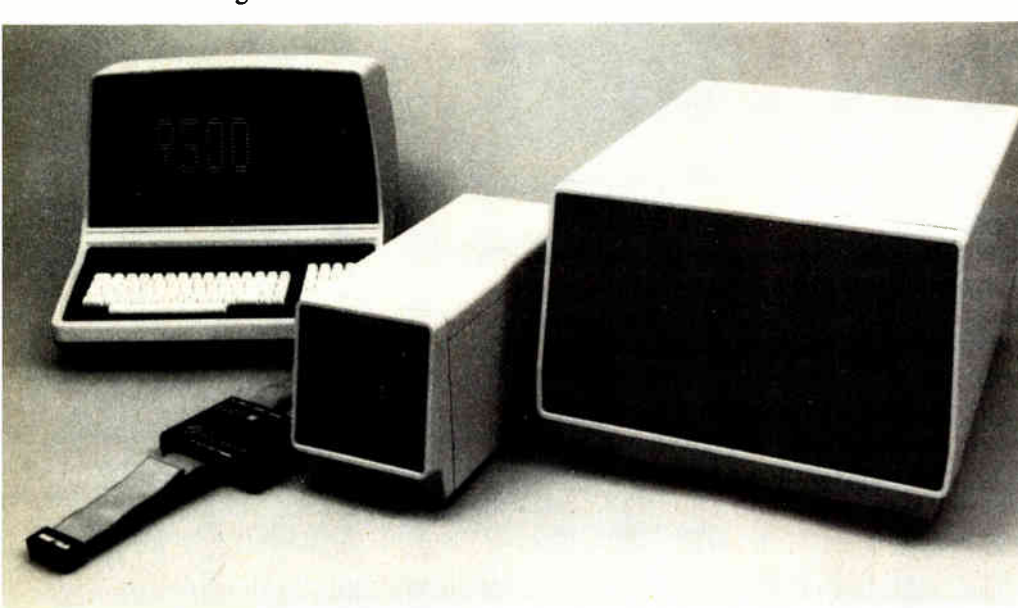

# POWER SWITCH SOLID STATE AC RELAYS

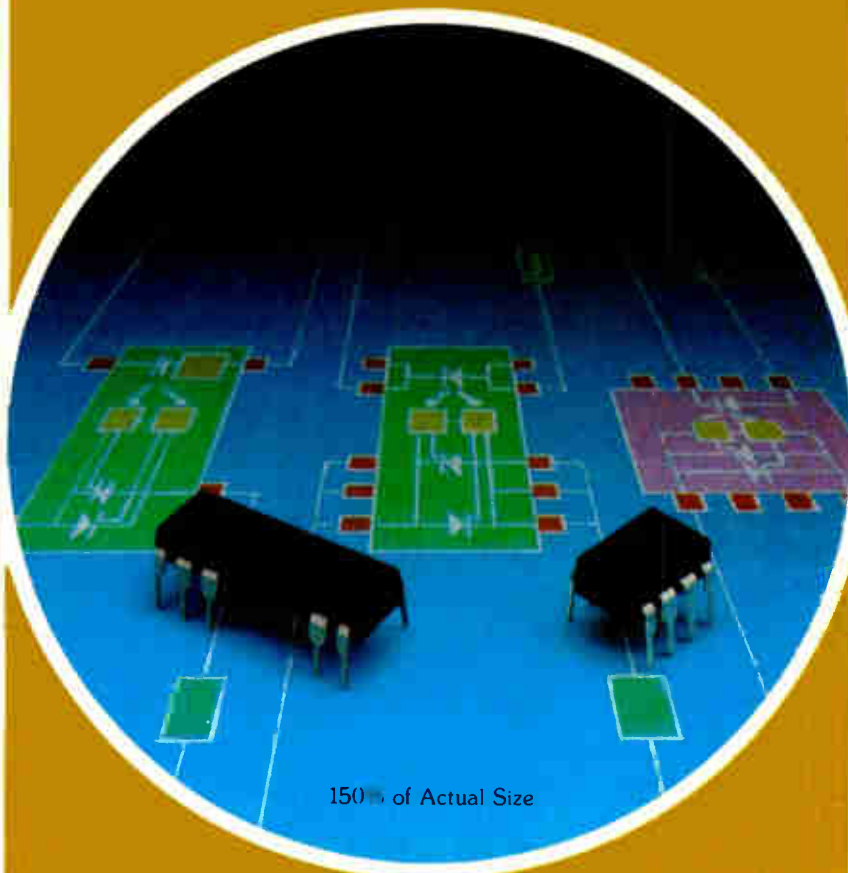

## FOR DIRECT OPERATION FROM LOW-LEVEL TTL/CMOS LOGIC CIRCUITS

Power Switch, a subsidiary of Elec-Trol, Inc. now offers two series of solid-state AC relays—an SA Series rated at 0.7-amp that comes in an 8-lead DIP package and a 1-amp SB Series provided in a standard 16-lead DIP package. Both Series employ identical construction, but the SB Series offers higher continuous-current capability and is available in several footprints for new and existing designs.

These subminiature, optically-coupled, solid-state AC relays are interchangeable with the Power Interface SK and SP Series units, and they perform the same functions as the Teledyne 642 Series. They are suitable for activating AC loads directly from the commands developed by TTL/CMOS logic and microprocessors while maintaining a high degree of isolation between the low and high-level circuits.

For more information, use the reader service card or contact your local distributor, representative, or the factory direct.

Power Switch, a subsidiary of Elec-Trol, Inc., 26477 N. Golden Valley Road, Saugus, CA 91350, (213) 788-7292, (805) 252-8330. TELEX: 18-1151.

**POWER//SWITCH**  
ELEC-TROL, INC.

Circle 178 on reader service card

# ELEC-TROL DIP RELAYS

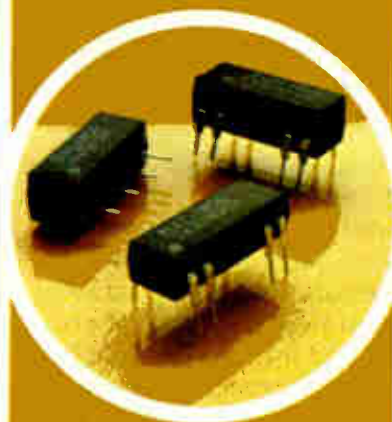

## 140 STANDARD MODELS

Elec-Trol now offers one of the broadest lines of DIP Reed Relays available, 140 different standard models. You can select 1A, 2A, 1B, and 1C dry reed contacts with either 3-watt or 10-watt ratings or 1A mercury-wetted with 50-watt rating. All of them are available with or without clamping diodes and with a choice of 5, 6, 12, or 24 VDC coils. For off-the-shelf delivery or to ask about samples, contact your Elec-Trol representative.

## INTERNATIONAL REPRESENTATIVES

**ARGENTINA** BUENOS AIRES

YEL S.R.L. +6 2211

**AUSTRALIA** NORTH BRIGHTON

Total Electronics 596 2549

**BELGIUM** KLEES ELECTRONICS B.V.

Amsterdam, The Netherlands 020 160511

**BRAZIL** SAO PAULO

Serion LTDA, 223 5415 222 1183

**DENMARK** COPENHAGEN

A Fredslund Pedersen 01 194500

**EASTERN EUROPE** ELTRANS

Vienna, Austria (0222) 24 71 37

**FINLAND** HELSINKI

Tahink Oy (90) 354188

**GERMANY** NORDERSTEDT

Weiler Passive Bauelemente KG (040) 5223031

**ISRAEL** TEL AVIV

G.E.T.S. Ltd (03) 330604

**ITALY** MILANO

Spectral Ind srl 68 87 951 2 3 68 44382

**JAPAN** YOKOHAMA

Iland Elec Trol, Inc (045) 572 8186

**NETHERLANDS** AMSTERDAM

Klees Electronics B.V. 020 160511

**NORWAY** OSLO

Talonic A/S 46-2211

**SPAIN** MADRID

Sagtron I 2754824 2766954

**SOUTH AFRICA** PRETORIA

E.B.E. (PTY) Ltd 4692216

**SWEDEN** SPANGA (STOCKHOLM)

TH's Elektronik AB, Stockholm 760 01 90

**SWITZERLAND** WALLISELLEN (ZURICH)

Sivoend A.G. 01 830 3161

**U.K.** MAIDSTONE KENT

Electrautom Ltd. (0622) 673131

**ELEC-TROL**

Circle 244 on reader service card

# Just published... your headstart on electronics demand worldwide!

Focus on the outlook for almost 200 electronics products! In 13 countries including the U.S., Japan, and all of Western Europe! Results of an authoritative, worldwide research effort! Packed into easy-to-use tables and on-target analyses!

*Electronics'* highly respected 23rd annual market forecast has now been expanded to provide an in-depth look at the current and future demand for electronics products in the United States, Western Europe, and Japan—including 23 additional pages of market-estimate and growth-rate tables.

More helpful and reliable than ever before, the 55-page report offers invaluable guidance on the outlook for some 200 electronic products by such categories as...

components • communications equipment • industrial electronics • test and measuring equipment • semiconductors • data-processing systems, peripherals, and office equipment • and consumer electronics

**Far-ranging research findings not available elsewhere are brought together here for immediate access to...**

- compound annual U.S. growth rates for 1979-1984
- U.S. report research methodology and response ranges • economic analyses and outlook for the U.S., Western Europe, and Japan
- Product-by-product, country-by-country market

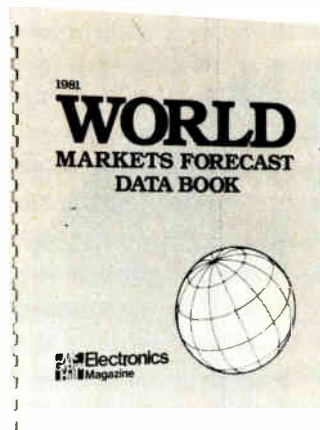

## Electronics' 1981 World Markets Forecast Data Book

by the Editors of *Electronics*

estimates for Belgium, Denmark, France, Italy, Netherlands, Norway, Spain, Sweden, Switzerland, United Kingdom, and West Germany

Emphasis throughout is on the key factors influencing product price and consumption volume in the coming years, including: rapid technological change, intense competition, high costs of research and development, high and rising costs of production and distribution, and changes in the volume of sales.

Some 40 *Electronics* editors stationed worldwide worked together to analyze hundreds of questionnaires and conduct follow-up interviews.

**The results belong in the hands of everyone serious about the emerging technical, financial, and planning outlook for the electronics market.**

**Among the vast range of most-needed information found here are**

U.S. market estimates and growth rates for...

- semiconductors and 15 other categories of components
- consumer electronics • 10 sections of industrial and commercial equipment... plus Federal procurement projections!

Western Europe 1979-1981 consumption of...

- 66 components • 100 types of electronic equipment... all spelled out product by product, country by country!

Japan/Western Europe demand for...

- 86 equipment products • 54 separate components... all in one easy-to-compare table!

Order today for immediate delivery!

Electronics Magazine Books  
1221 Ave. of the Americas, 42nd Fl.  
New York, NY 10020 USA



Name \_\_\_\_\_ Title \_\_\_\_\_

Company \_\_\_\_\_

Address \_\_\_\_\_

City \_\_\_\_\_

State/Country \_\_\_\_\_ Zip (U.S.) \_\_\_\_\_

EL1

Send me \_\_\_\_\_ copy (copies) of *Electronics'* 1981 World Markets Forecast Data Book (606724-6) at \$125 each, plus local sales tax in U.S. (Price includes first-class mail in North America, air shipment elsewhere.) I understand that full payment must accompany this order.



**If you  
need  
service  
on your  
subscription  
to ...**

**Electronics**

*Do you want to  
change your  
address?*

*Have you missed  
an issue?*

*Was your copy  
damaged?*

**Please call your  
representative**

**(609) 448-8110\***  
For immediate help

\*9 a.m.—4 p.m. EST



## New products

ray-tube terminals, such as the external CRT terminal that Millennium will be making available for approximately \$1,200.

In keeping with the now-ended accord, both Tektronix and Millennium have the rights to all of the emulators and cross assemblers developed by either firm through 1980. Thus, Millennium will offer a wide range of macroassemblers, including newly developed ones. These generate relocatable code that can be linked by a linking loader and bound to an address or code generated by the C or Pascal compilers developed for the 9520. These compilers generate object code for the target microprocessors and, West says, "provide excellent vehicles for program development."

**Processor support.** Initially, Millennium will offer macroassemblers for Intel's 8080, 8085, and 8048/9, as well as other 8-bit microprocessors, such as Zilog's Z80 and Motorola's 6800, 6801, 6802, and 6809. One 8-bit macroassembler will come with the basic 9520, with additional macroassemblers available for \$1,000 each. Macroassemblers for Intel's 8086 and Zilog's Z8000 16-bit microprocessors will be available in six months at \$1,500 each. Software drivers for printers can be had now.

The 9520 is priced at \$8,000. Optional hardware includes a \$1,500 programmer for programmable read-only memories in most n-channel MOS and complementary-MOS PROM families.

Priced at under \$6,000 (\$3,995 for the stand-alone instrument and \$1,995 for an emulator, such as that for the 8085), the 9508 emulator does not carry the overhead of 16- and 32-bit support found in similar units, West states. However, the 8-bit emulators from the 9508, he notes, may be used in the firm's upcoming 16-bit microprocessor emulation system planned for introduction in the fall. Availability of the 9508, as well as the 9520, is 60 days after receipt of order.

Millennium Systems Inc., 19050 Pruneridge Ave., Cupertino, Calif. 95014. Phone (408) 996-9109 [339]

## MARKEM MARKING TECHNOLOGY

**Your partner  
in productivity.**

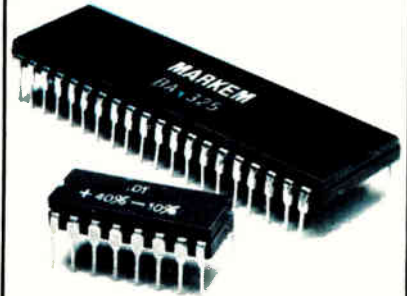

### DIP Printing Systems

MARKEM'S Model 521 singulated DIP print/cure system was designed totally around the productivity idea.

That's why the 521 is designed for one operator. Its L-shaped work area is compact, just 2' x 2'.

That's why the 521 can handle up to 25 tubes of DIP's at one time.

That's why the 521 has special product control features which minimize damage to ceramic packages.

That's why there are few transfer points—and there's easy access to printing elements, the conveyor belt, tubes in magazine, and inking adjustments.

The 521 DIP printer is built for reliable, sustained operations and consistent throughput. And it is available with in-line UV curing.

See us at Semicon West  
Booth 1045

Get the whole productivity story. Call Roger Langley in Keene at (603) 352-1130.

**MARKEM**

150 Congress St., Keene, NH 03431

# GENRAD ANNOUN

This is the VLSI test system designers and test engineers have been anxiously awaiting. The VLSI test system that makes every other product on the market today look antiquated by comparison. The VLSI test system that's going to change forever the way VLSI testing is done.

This is the GenRad GR16.

**A VLSI device tester that will define the state-of-the-art for years to come.**

The GR16 starts out where other testers leave off. It can test VLSI

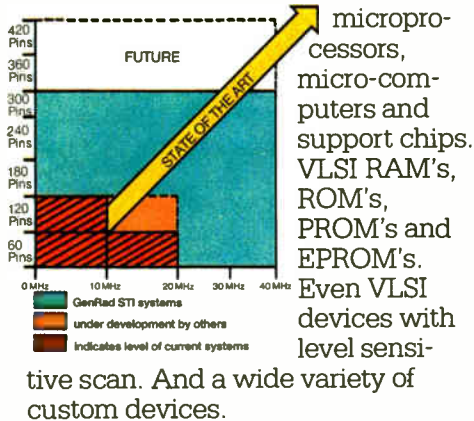

It's as productive in production tests as it is in engineering characterization. And, here's the amazing news: the GR16 can routinely take on devices up to 144 pins at test rates of up to 40 MHz. With a level resolution of 14 bits and timing accuracy of less than a nanosecond.

The GR16 has parallel test capability. It has honest-to-goodness *auto cal*. It uses PASCAL. And there's host computer networking capability, too.

**A company that's been a leader in testing for 65 years.**

Before we go any further, though, you may be interested to know



*First signal generator.*

the character of the company behind this new machine. This is

GenRad we're talking about. The people who pioneered the first standard signal generator. The first megohm bridge. The first electronic stroboscope. The first commercial computer-based logic board test system. A world-wide company with sales of over \$150 million and with more levels of support (even regional centers) than anyone else in the industry. A company that is the acknowledged technology leader in printed circuit board testing with more functional test systems installed than any other company.

**An elite design group.**

Who designed the GR16? An elite group of ATE experts with a *carte blanche* to explore the very limits of VLSI testing. A team that is, today, the very best in VLSI testing and, who are, according to the degree of your interest and your ability to buy, available to you for advanced planning and analysis of your VLSI device testing requirements as they apply to automatic test systems. Perhaps you should make a note to call them.

**A "start-from-scratch" attitude yields a totally new design.**

"The design," you're saying. "Get to the design."

O.K. The GR16 is a totally new design based on dual bus architecture. The advantages?



*The GR16. A product so new it's years ahead of its time.*

There are several. Like a test rate of 40 MHz, which, combined with a 2 MHz instruction rate, mean incredibly high throughput. Plus field-expandable pin count to help make sure the GR16 meets your needs for the future.

As you might expect, with these features the GR16 has an



extraordinary capacity for speeding up your time to market and cutting your cost to test VLSI devices.

# ES:VLSI TESTING.

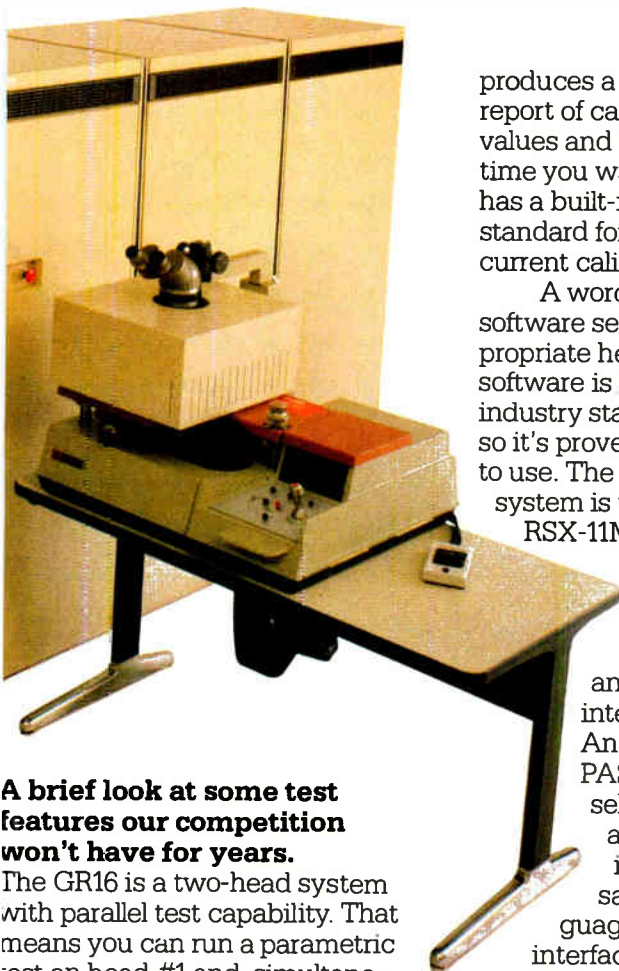

## A brief look at some test features our competition won't have for years.

The GR16 is a two-head system with parallel test capability. That means you can run a parametric test on head #1 and, simultaneously, run either a parametric or functional test on head #2. As you can imagine, dual heads operating in parallel can increase throughput by up to 100%.

The timing control unit has 16 phase generators, each of which has 16 values, selectable in real time. 125 ps resolution, high stability, and autocalibration provide sub-nanosecond timing precision. And the GR16 allows you to switch, on-the-fly, between algorithmic and functional test patterns and all input, output pin states. In addition, all pins are truly universal with complete access to timing and test pattern resources which lets you test the most complex VLSI components.

And the GR16 has true *auto cal*. With a program that automatically calibrates the system and

produces a summary report of calibration values and limits. Any time you want. It also has a built-in transfer standard for voltage/current calibration.

A word about software seems appropriate here. The software is based on industry standards, so it's proven and easy to use. The operating system is unmodified RSX-11M from DEC including file management,

memory management and utilities. There's a user interface operating system. And our test language is PASCAL; highly-structured, self-documenting and becoming a universal test language. The user interface is menu driven so you get direction and guidance all along the way.

And, for people who want networking, there's GRnet,™ which uses very high speed data links to GenRad's host computers, to distribute the computing tasks and maximize throughput.

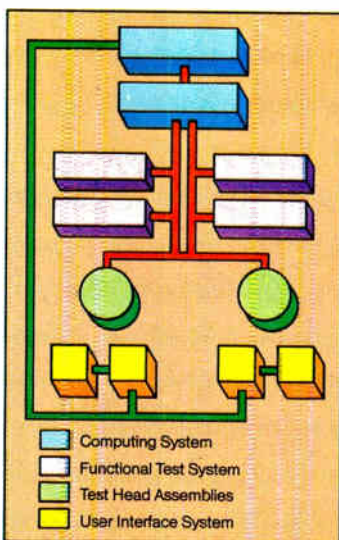

GR16's four main hardware segments.

## A measure of our acceptance.

We should also mention in passing that the response to our first VLSI test system has been fantastic. It even surprised us.

Some very large companies, here and abroad, have been inquiring about our product (despite the fact we've tried to keep it as quiet as possible). And we're pleased to say we've already sold our very first system.

## A chance for you to see for yourself.

By now you're probably wishing you could see the revolutionary GR16 in action. You can. We've created a special videotape presentation of the GR16 to show to prime prospects. If you'd like your own private screening, just ask.



After all, isn't that just the kind of advanced idea you'd expect from the company that's the best in test?

**GenRad**  
THE BEST IN TEST

If you're really eager for a screening or more information, give us a call at (408) 946-6960. Ask for Jim Healy. Or send this coupon to: GenRad STI, 510 Cottonwood Drive, Milpitas, CA 95035.

- I'd like a "private screening" of your videotape.
- Send me more information.
- Send a sales representative.

Name \_\_\_\_\_ Title \_\_\_\_\_

Company \_\_\_\_\_ Telephone \_\_\_\_\_

Address \_\_\_\_\_

City \_\_\_\_\_

State \_\_\_\_\_ Zip \_\_\_\_\_

Circle 183 on reader service card

**See us at SEMICON WEST '81**  
May 19-21, Booth 2168-2178  
Bay Meadows Racetrack  
at San Mateo County  
Fairgrounds

# More ends to end more problems. From your flat cable connector source.

Six new Amphenol® flat ribbon cable connector combinations. Six more ways to design your end connection in electronic packaging using economical Flat Ribbon Cable (FRC) connectors. Sockets and headers with 3-amp rating, DIP plugs, PCB solder, Card-Edge, and Micro Ribbon® connectors join our 1-amp sockets and headers (FRC2) to offer you a complete range of flat ribbon cable connectors. And if you need discrete wiring with FRC headers, we have that too. And all come with our commitment to advanced technology and high quality.

For complete information, technical data, dimensions, and prices, contact your nearest Amphenol North America sales office or distributor.

## Amphenol 57F Micro Ribbon Connectors.

Intermate with our standard solder and Micro-Pierce® connectors as well as other industry-standard Micro Ribbon® type connectors. Use standard 0.050" pitch cable for our 0.085" contact spacing.

## Amphenol FRCE PCB Solder Connectors.

Staggered four-row spacing meets standard spacing requirements. Easy, permanent transition between boards. Standoffs protect connector during flow soldering. Sturdy molded locking components.

**Amphenol 225F Card-Edge Connectors.**

Available with or without mounting ears. Separate strain relief lessens strain on connection, makes for easier unplugging of connector from card edges.

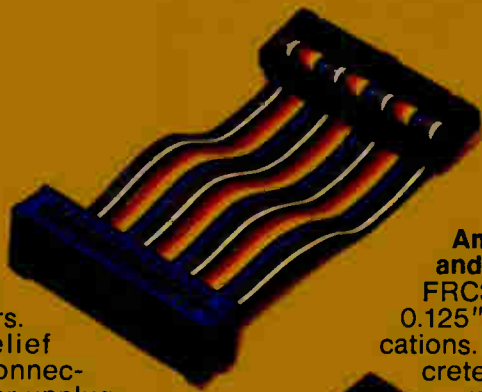

**Amphenol FRC3 and HU Connectors.**  
FRC3 accepts 24 AWG FRC on 0.125" centers for 3-amp applications. HU Series combines discrete wiring (AWG 22-26, 4-amp rating) with FRC technology. Both provide physical polarization to prevent mismatching.

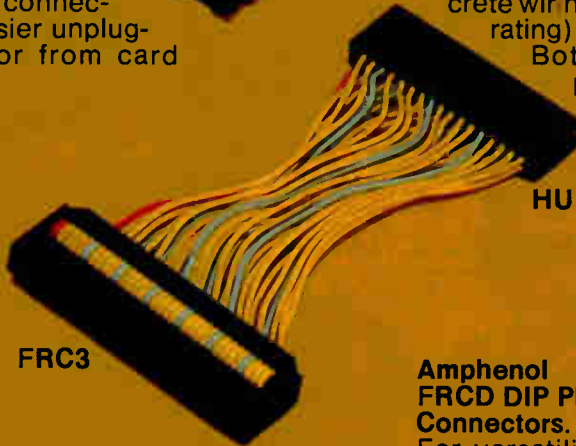

**Amphenol FRCD DIP Plug Connectors.**  
For versatility in inter-board connections, IC socket testing, and microprocessor applications. Standoffs protect during flow soldering.

**BUNKER RAMO**

**AMPHENOL NORTH AMERICA**

A Division of Bunker Ramo Corporation

See us at  
**ELECTRO/81**  
Booth 3811-17  
April 7-9

Amphenol North America Division Headquarters: Oak Brook, Illinois 60521

Sales Offices: Atlanta (404) 394-6298 • Boston (617) 475-7055 • Chicago (312) 986-2330 • Dallas (214) 343-8420 • Dayton (513) 294-0461  
Denver (303) 934-2355 • Greensboro (919) 292-9273 • Houston (713) 444-4096 • Indianapolis (317) 842-3245 • Kansas City (816) 737-3937  
Knoxville (615) 690-6765 • Los Angeles (213) 649-5015 • Minneapolis (612) 835-4595 • New York (516) 364-2270 • Orlando (305) 647-5504  
Philadelphia (215) 732-1427 • Phoenix (602) 265-3227 • St. Louis (314) 569-2277 • San Diego (714) 272-5451 • San Francisco (408) 732-8990  
Seattle (206) 455-2525 • Syracuse (315) 455-5786 • Washington, DC (703) 524-8700  
Canada: Montreal (514) 482-5520 • Toronto (416) 291-4401 • Vancouver (604) 278-7636 • International: Oak Brook, Illinois TELEX 206-054

**Distributors:**

**ALABAMA**  
Hall-Mark Electronics Corp.  
Huntsville  
(205) 837-8700

**ARIZONA**  
Catec Electronics  
Phoenix  
(602) 272-7951  
Wyle Distribution Group  
Phoenix  
(602) 249-2232

**CALIFORNIA**  
Catec Electronics  
South Gate  
(213) 773-6521  
Kierulff Electronics  
Los Angeles  
(213) 725-0325  
Wyle Distribution Group  
El Segundo  
(213) 322-8100  
Catec Moltronics  
San Diego  
(714) 278-5020  
Kierulff Electronics  
San Diego  
(714) 278-2112  
Wyle Distribution Group  
San Diego  
(714) 565-9171  
Catec Moltronics  
San Jose  
(408) 263-7373  
Bell Industries  
Sunnyvale  
(408) 734-8570

**WESTERN ELECTROMOTIVE**  
Santa Clara  
(408) 727-7411  
Wyle Distribution Group  
Santa Clara  
(408) 727-2500  
Schweber Electronics  
Irvine  
(714) 556-3880

**COLORADO**  
Newark Electronics  
Denver  
(303) 757-3351  
Wyle Distribution Group  
Thornton  
(303) 457-9953

**CONNECTICUT**  
Connector Company  
New Haven  
(203) 624-0127  
Wilshire Electronics  
Wallingford  
(203) 265-3822

**FLORIDA**  
Arrow Electronics  
Palm Bay  
(305) 725-1480  
Kierulff Electronics  
St. Petersburg  
(813) 576-1966  
Schweber Electronics  
Hollywood  
(305) 921-0301

**GEORGIA**  
Arrow Electronics  
Norcross  
(404) 449-8252

**ILLINOIS**  
Bell Industries  
Chicago  
(312) 982-9210  
Newark Electronics  
Chicago  
(312) 638-4411  
Ohm/Electronics, Inc.  
Palatine  
(312) 359-5500  
Schweber Electronics  
Elk Grove Village  
(312) 364-3750  
Klaus Radio, Inc.  
Peoria  
(309) 691-4840

**INDIANA**  
Graham Electronic  
Supply  
Indianapolis  
(317) 634-9202  
Genesis Electronics  
South Bend  
(219) 287-2911

**KANSAS**  
Wichita Aircraft  
Wichita  
(316) 838-1421

**MARYLAND**  
Arrow Electronics  
Baltimore  
(301) 247-5200  
Hall-Mark Electronics  
Baltimore  
(301) 796-9300  
Pioneer Electronics  
Gaithersburg  
(301) 948-0710

**MASSACHUSETTS**  
Kierulff Electronics  
Billerica  
(617) 935-5134  
Schweber Electronics  
Bedford  
(617) 275-5100  
Wilshire Electronics  
Burlington  
(617) 272-8200  
Industrial Components Corp.  
N. Wilbraham  
(413) 596-3854  
Gerber Electronics  
Norwood  
(617) 769-6000

**MICHIGAN**  
RS Electronics  
Livonia  
(313) 525-1155  
Wedemeyer Electronic  
Supply  
Ann Arbor  
(313) 665-8611

**MINNESOTA**  
Arrow Electronics  
Edina  
(612) 830-1800  
Newark Electronics  
Minneapolis  
(612) 331-6350

**MISSOURI**  
Walters Radio Supply, Inc.  
Kansas City  
(816) 531-7015  
Olive Industrial  
Electronics, Inc.  
St. Louis  
(314) 426-4500

**NEW JERSEY**  
Schweber Electronics  
Fairfield  
(201) 227-7880  
Wilshire Electronics  
Clifton  
(201) 340-1900  
Radio Electric Service Co.  
Pennsauken  
(215) 925-6900

**NEW YORK**  
Harvey Electronics, Inc.  
Binghamton  
(607) 748-8211  
Genesee Radio  
Parts Co., Inc.  
Buffalo  
(716) 873-9661

Summit Distributors  
Buffalo  
(716) 884-3450  
Arrow Electronics  
Farmingdale  
(516) 231-1030  
Progress Electronics Co.  
Plainview  
(516) 433-1700

Schweber Electronics  
Westbury  
(516) 334-7474  
Simcona Electronics Corp.  
Rochester  
(716) 328-3230

**NORTH CAROLINA**  
Arrow Electronics  
Winston-Salem  
(919) 725-8711

**OHIO**  
Schuster Electric Co.  
Cincinnati  
(513) 489-1400  
Pioneer Electronics  
Cleveland  
(216) 587-3600  
Schweber Electronics  
Beachwood  
(216) 464-2970  
Pioneer Electronics  
Dayton  
(513) 236-9900

**OKLAHOMA**  
Electro Enterprises  
Oklahoma City  
(405) 478-1752

**OREGON**  
Bell Industries  
Lake Oswego  
(503) 241-4115

**PENNSYLVANIA**  
Almo Electronics Corp.  
Philadelphia  
(215) 698-4000  
Pyltron Industrial, Inc.  
Montgomeryville  
(215) 643-2850  
CAM/IPC Industries  
Pittsburgh  
(412) 792-3770

**TENNESSEE**  
Electra Distribution Co.  
Nashville  
(615) 329-3971

**TEXAS**  
Hamilton/Avnet  
Electronics  
Irving  
(214) 659-4111

**Sterling Electronics**  
Dallas  
(214) 243-1600  
Texas Instrument Supply Co.  
Richardson  
(214) 238-6821  
Allied Electronics  
Ft. Worth  
(817) 336-5401  
Sterling Electronics  
Houston  
(713) 627-9800  
Hall-Mark Electronics  
Dallas  
(214) 343-5000

**UTAH**  
Diplomat  
Salt Lake City  
(801) 486-4134  
Standard Supply Co.  
Salt Lake City  
(801) 486-3371

**WASHINGTON**  
Bell Industries  
Bellevue  
(206) 747-1515  
Wyle Distribution Group  
Seattle  
(206) 453-8300

**WISCONSIN**  
Electronic Expeditors, Inc.  
Milwaukee  
(414) 228-8100

**CANADA:**  
Distributors in major cities

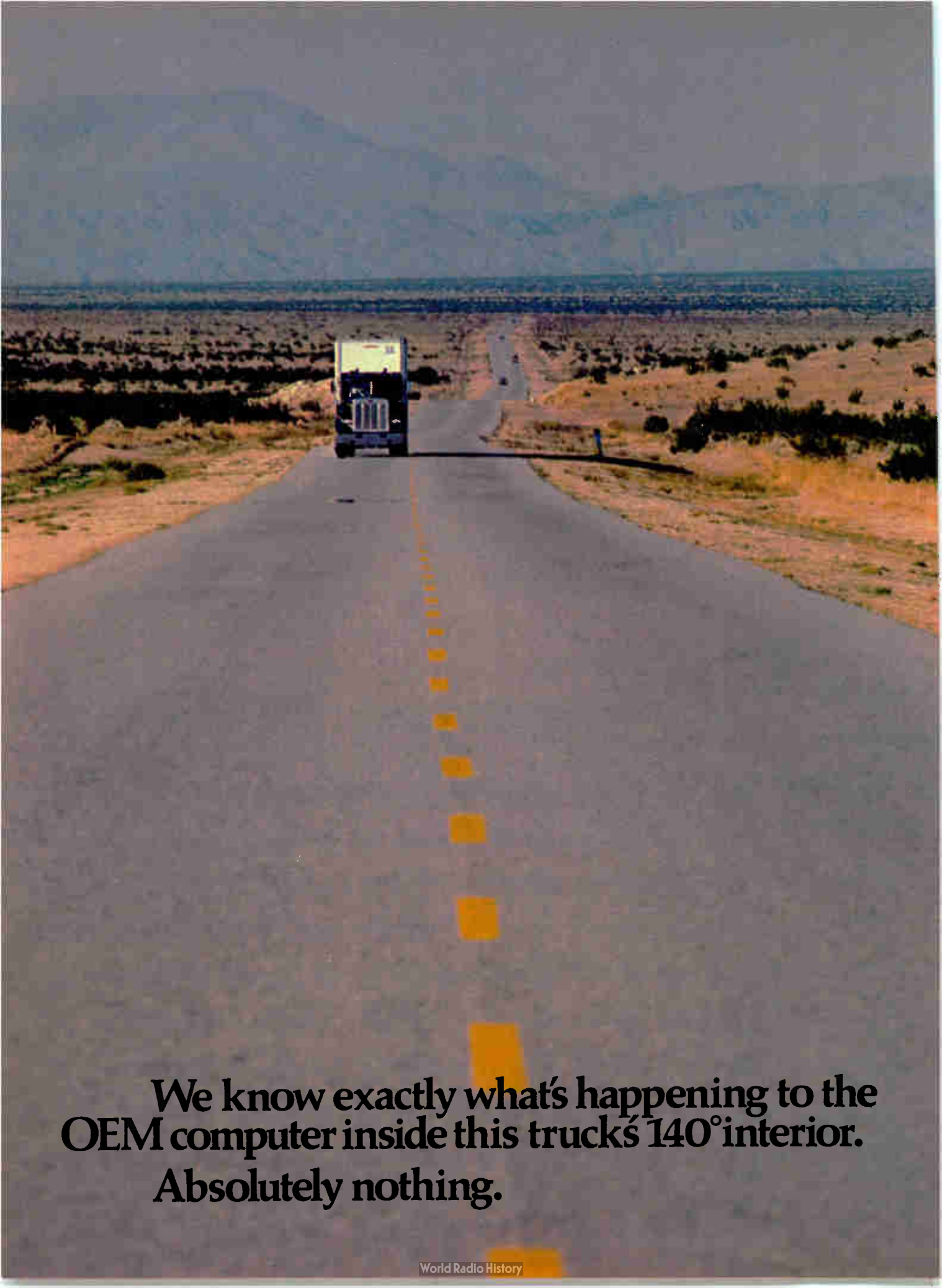

**We know exactly what's happening to the  
OEM computer inside this truck's 140° interior.  
Absolutely nothing.**



All computer manufacturers are concerned about how their products cope with heat while they're running.

At Digital, we also take a good hard look at how computers react to heat even before you turn them on.

Because we know you may have to ship product anywhere in the world, often under less than ideal conditions. And for a computer, high storage temperatures can be just as bad as high operating temperatures. So we test for both.

Our storage temperature testing is just part of the most comprehensive physical and mechanical test program in the industry. A program that subjects our products to drop forces up to 40Gs. Vibration forces far greater than those encountered on the average factory floor. Heat, humidity, static electricity, electromagnetic and RF interference.

At Digital, our approach has always been to give OEMs more than just great product. Just as important are the extra quality features, the extra testing that can make your design and marketing job easier. The software compatibility that can take you from micros to 32-bit large-scale computers, from one generation to the next. The worldwide service capability that can be tailored exactly to the way you run your business. It's an approach designed to help you meet a wide range of computer strategies.

You probably already know a lot about Digital performance. To find out the rest, send for our new brochure, "The Thinking Behind the Industry's Largest Selling Line of OEM Computers."

Digital Equipment Corporation,  
(PK3/M-86), Maynard, MA 01754. (617)  
493-6253. In Europe: 12 av. des Morgines,  
1213 Petit-Lancy/Geneva. Tel. 93 33 11. In  
Canada: Digital Equipment of Canada, Ltd.  
**We build a lot more than performance  
into an OEM computer.**

**digital**

Circle 187 on reader service card

# Acquisition system saves Q-bus time

250-kHz, 12-bit data-acquisition system has optional dual-port, two-block buffer memory card to offload overworked host bus

by James Brinton, Boston Bureau Manager

High-speed data-acquisition systems sometimes can tax Q-bus-based computers of Digital Equipment Corp.'s LSI-11 series. Now, however, Data Translation is introducing a pair of DEC-compatible circuit boards that form a 250-kHz buffered and programmable data-acquisition system. DT spokesmen say that the system can handle about twice the number of Q-bus equivalent transactions with about half the usual Q-bus overhead.

The system consists of the DT3362 50- to 250-kHz data-acquisition system (DAS) and the DT3369 dual-port random-access memory and control board. The DAS can also be used alone where Q-bus overload is not a consideration, or where only a few channels per second are accessed.

The DT3362 DAS is intended for 12-bit conversion of high-level (up to 10-V) analog data at an accuracy to

within 1/2 least significant bit. In its minimal configuration, it accepts either 16 single-ended or 8 differential inputs, but there is an on-board expansion option that can service up to 64 single-ended or 32 differential input lines.

The DT3362 uses the recently introduced DT5722 pipelined data-acquisition module [*Electronics*, Feb. 24, p. 230], but adds much in programmability and on-board control. For example, gain is optionally programmable (to 1, 2, 4, or 8), and triggering is either controlled by program or occurs in response to external interrupts. Four independent 256-byte channel- and gain-selection files are maintained in on-board RAM, giving the user flexibility in selecting the sequence and number of channels, sampling timing, and setting the gain of each channel.

Three data-conversion schemes are available: burst, semiburst, and single-conversion. Similarly, there are four data-transfer modes; interrupt-driven, programmed input/output, standard Q-bus direct-memory-access, and external-port DMA. The latter is for use with the DT3369.

With its 250-kHz throughput and software-controlled addressing and gain, the DT3362 can be "a little too hot" for some Q-bus applications, DT spokesmen point out. Using a standard DMA approach, data must move over the Q-bus twice, from the DAS to main memory and from main memory to bulk storage. Using the DT3369 in tandem with the DT3362 DAS, conversion and throughput rates of 250 kHz can be maintained without disabling the Q-bus.

The DT3369 dual-port RAM card is installed between the Q-bus and

the DT3362's external DMA port. Like the DT3362, the 3369 fits a standard DEC quad-sized board and includes a dual-port DMA controller, DMA channel chaining, or dual buffering, for continuous data transfer, and either 32-K or 128-K bytes of MOS dynamic RAM with on-board refreshing. The 3369's operation is also pipelined—while the current address is being used, the next has been latched and the following address is being decoded.

**Port control.** The 3369's external port is controlled by an on-board address controller (OAC) or by an external address generator, such as a Q-bus peripheral. Since the Q-bus has the lowest port-access priority, the control format the user selects will influence port-access time and attainable throughput. The OAC permits the 3369 to be set up as dual buffers; DT calls this channel chaining. The 3362 fills half of the buffer storage while the other half puts out data to the Q-bus for a full 250-kHz transfer rate.

The 3362's inputs must be ordered as single-ended or differential. The price for the 50-kHz version is \$2,395 in either case. High-speed conversion and throughput (250 kHz) is a \$1,100 option. Programmable gain adds another \$175; the addition of an on-board 32/64-channel capability adds only \$200. DAS delivery takes five days.

The DT3369 can be ordered with either of two memories; the 16-K-word version is priced at \$1,675 and a unit with 64-K words at \$2,775. Deliveries of the 3369 will begin in mid-June.

Data Translation Inc., 100 Locke Dr., Marlboro, Mass. 01752 [340]

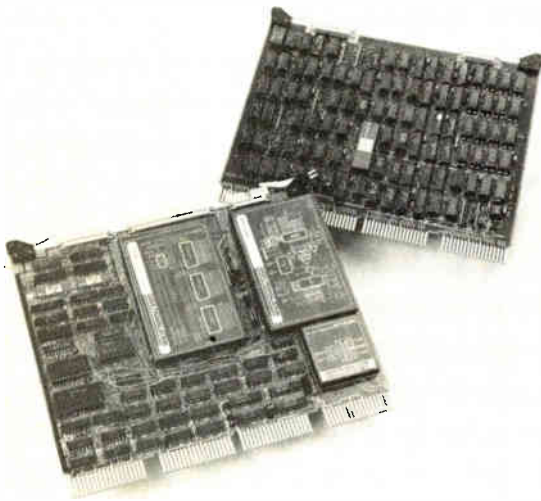



# JOIN OUR DATA BANK. WE'LL KEEP ON BRINGING YOU THE LATEST NEWS.

If you need further proof that we eat, drink and sleep capacitors at ITT, then here it is. Straight from our bulldog's mouth.

Fill in the coupon to apply for our brand new ITT Capacitor Handbook. It's completely free.

It's a fat, well produced, well indexed source of information on all our capacitor technologies to date. About as vital a fixture on your desk as your phone in fact.

But that's not all. So that you can keep on keeping up to the minute we'll also enrol you in our Data Bank.

This entitles you to regular news bulletins on the state of the art, the introduction of new technologies, additions to capacitor ranges, our distributor network and much much more.

The Handbook for now. The Data Bank for the future. It's a package deal no engineer should be without. So fill in your name, company and address below.

It's not so much a coupon. More a passport to tomorrow.

## ITT CAPACITORS

South Denes, Great Yarmouth,  
Norfolk NR30 3PX.



ITT Components Group, Capacitors,  
South Denes, Great Yarmouth,  
Norfolk NR30 3PX.

Components **ITT**

Name ..... Job Title .....

Company .....

Address .....

..... Tel: .....

# Oak puts control in Membrane Touch Panels

Now you can get membrane switching for your product with all the associated electronics you need built in. All to your exact specifications, schedule, and budget. It's called EPS (Electronics Packaged Systems) and it's available now from Oak Switch Systems Inc.

Oak engineers will design, build, test and manufacture a complete membrane switch-controller subsystem—including full microcomputer control if you choose—all custom tailored to suit you and your product. We'll work from either detailed schematics or simply your functional requirements.

The payoff with EPS? A capability of individual graphic layouts combined with custom

firmware that provides the aesthetic touch; truly coordinated switch/controller design; the cost/performance advantages of membrane switching; and the natural efficiency and savings of using a single manufacturer.

EPS delivers the performance, reliability, and durability that make Oak the leader in membrane switch technology. TIP™ membrane switching

panels have emerged as the clear cost/reliability choice for most electronic applications. Now the added dimension of fully integrated control electronics in one package gives you the edge you've been looking for.

Call or write to learn how it can work for you. You can't afford not to call Oak!



**OAK** Switch Systems Inc.

An Oak Technology Company

P.O. Box 517 • Crystal Lake, Illinois 60014  
Phone: 815-459-5000 • TWX 910-634-3353 • TELEX 72-2447

For further information circle #190

To have a salesman call circle #245

## New products

Microcomputers & systems

### Serial I/O chip handles Bisync

IC's two full-duplex channels can operate under several communications protocols

Intel has developed a successor to the popular model 8251 universal synchronous/asynchronous receiver-transmitter chip. The new chip, called the 8274 multiprotocol serial controller, combines the functions of two chips. Having two full-duplex channels, it can replace two 8251s in multichannel applications. The 8274 also goes beyond the 8251 to offer compatibility with IBM's byte-serial Binary Synchronous Communications (Bisync) protocol. This feature is added to the chip's ability to handle asynchronous protocols, as well as bit-synchronous protocols such as the Synchronous and High-level

Data Link Control procedures.

The 8274 is directly compatible with Intel's 8- and 16-bit microprocessor and microcomputer families, including the 8080/8085, MCS-48, MCS-85, and iAPX families. The 8274's operating configuration is initialized and controlled by a straightforward selection of optional bits in a small set of instructions. Asynchronous protocols can be programmed for 5- to 8-bit characters; odd, even, or no parity; 1, 1.5, or 2 stop bits; and the detection of framing, overrun, and parity errors.

In the bit-synchronous mode, the device is compatible with SDLC and HDLC, with features including flag generation and recognition, 8-bit-address recognition, automatic zero-bit insertion, automatic cyclic-redundancy-check generation and correction, and compatibility with CCITT X.25 standards. Its byte-serial operation is compatible Bisync. Its features include one or two sync characters, internal or external character synchronization, and automatic CRC generation and correction. The general programmable func-

tions available on the 8274 include clock-rate multiples up to 64 K times a basic clock rate, combinations of polled, wait, interrupt, and direct-memory-access modes, and assignments of channels to transmitters and receivers.

The 8274 offers an 880-kb/s data rate in its standard version. In a selected version, the 8274-2, a full 1-Mb/s data rate is offered. The chip is packaged in a 40-pin dual in-line package and is fabricated in the firm's high-performance MOS, or H-MOS, technology. For multichannel applications, the 8274 may be connected in a daisy chain, with channel priorities determined by each device's position in the chain. Alternatively, the priorities may be dynamically controlled with Intel's standard priority controllers.

The price of the 8274 is \$30.30 in quantities of 100, compared with a \$5.60 price for the 8251 in similar lots. Sample quantities of the chip are available now, with volume deliveries to begin in June.

Intel Corp., 2625 Walsh Ave., Santa Clara, Calif. 95051. Phone (408) 987-8080 [371]

### Systems cut design cost

Development systems for 9900-based microcomputers unite teams of two to eight

Three hard-disk-based systems support development work using 9900 family microprocessors and TM 990 series microcomputer modules and involving teams of designers varying in size from one to eight. The three systems all have the same central processing unit, a 990 TTL-based minicomputer; they differ in the amount of main memory and hard-disk capacity supplied. The largest, designated the TMAM9040, can bring per-user costs below \$10,000. The four-to-eight-user 9040 has a base price of \$72,900; the two-user 9010 starts at \$37,700.

The multitasking capability of each system includes compilation, assembly, debugging, editing, printing, and multiple-processor emulation. The Multi-AMPL systems, as the maker calls them, use the AMPL high-level debugging and test procedure language, whose integer and Boolean math increase the user's efficiency. The recently updated language controls the emulation of target applications, the setting of breakpoints, defining of data- or address-comparison events and data and address tracing and allows direct target-system memory and input/output manipulation. Fortran and Microprocessor Pascal (for the 9900 family) are also offered.

**Emulation stations.** Standard systems include the CPU; a dual hard-disk drive, part of whose capacity is fixed; and one to four 1,920-character, 12-in.-diagonal video display terminals with keyboards. AMPL stations can be added to support simultaneous emulation and logic-state

trace analysis. Programmers for programmable read-only memory and line printers for the system are optional as well.

The price of the most basic 9010

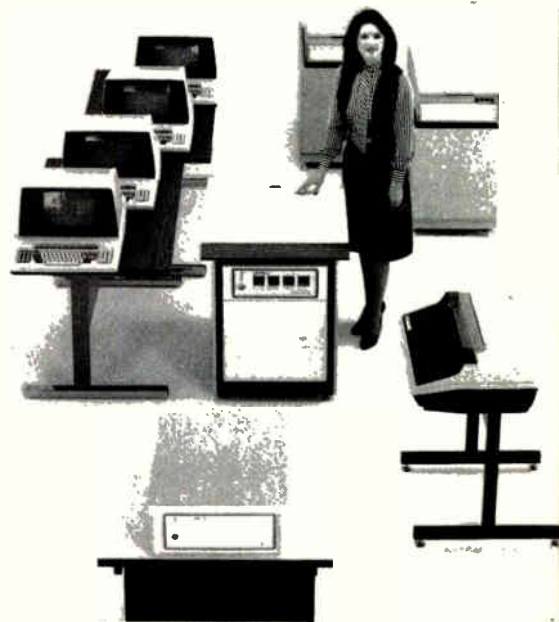

# Going out of the country for quality static RAMs?

## You may not have to go out of town.

**RAM's where you are.** GTE Microcircuits Static RAM's are available off-the-shelf in both prototyping and production quantities from 78 distributor locations throughout the United States and Canada plus 22 more world wide. Which means that our RAM's are probably already where you are.

**Quality.** We're in a tough business. Claiming quality isn't enough. Delivering it is what we do. On time. To specification. In quantity. At competitive prices.

**2114's.** Some people call 2114's jellybeans. We call them our bread and butter. In fact, we make (1024 x 4) 2114' static RAM's in 23 separate speeds, power requirements and packages, including MIL-STD-883. All with

a single +5v supply.

### Byte-wides for $\mu P$ 's

2K 3539's (256 x 8) and 4K 74024 x 8) static RAM's like our 8112's are ideal for microprocessor-based systems development. To make development even easier, the GTE 8112 is pin-for-pin compatible with 2716 EPROM's and features a common I/O bus with our 8104's and 8114's.

**Now, ROM's.** The very things that make for quality in GTE static RAM's make for quality in ROM's. Our 2332's are here waiting for your final mask. Our 2316's and 2364's are on the way.

**More than promises.** When you go out of the country for static RAM's you get promises. When you go to your GTE distributor for static RAM's, you get static RAM's. Quality RAM's. In prototyping or production quantities. Now.

For additional information contact GTE Microcircuits, 2000 W. 14th St., Tempe, AZ 85017, U.S.A., or contact one of the following distributors:  
AUSTRALIA: Ampec 818-1166. BELGIUM: Famatra 031-513251  
DENMARK: J. Henckel (03) 385791. ENGLAND: Thame 084-421-3146 or Dage Eurosem 44-01-868. FINLAND: Turion 90-377787/371151.  
FRANCE: Almex 666 21 12. GERMANY: Dema 089-288018.  
HONG KONG: Trans-Pearl 5-234367/5-226003. INDIA: Zenith 384214.  
ITALY: Eltronic 313364. ISRAEL: R. N. Electronics (03) 471659.  
JAPAN: Nissho (03) 544-8311. KOREA: Duk Sung 856-9764/854-5047.  
NETHERLANDS: Famatra 076/133457. NORWAY: Henaco (02) 157550.  
SPAIN: Semiconductores 218 09 60/ 218 02 17.  
SOUTH AFRICA: S. Continental 48-0515. SWEDEN: AB Betoma 08-820280.  
SWITZERLAND: Rotronic (01) 523411. TAIWAN: Hermes (020) 562-5851/511-4519.



**Microcircuits**

Circle 249 on reader service card

World Radio History

## New products

two-user system covers a 256-K-byte main memory, a 9.4-megabyte disk drive (4.7 megabytes of which are removable), one VDT. AMPL, Multi-Amplus interactive disk-system software, an interactive screen editor, a 9900 family macroassembler, link-editor and PROM programming utilities, and diagnostic software. This system can support one AMPL emulation station without performance

degradation. A second VDT and 9.4 megabytes of disk capacity can be added.

The \$48,250 price of the mid-range 9020 two-to-four-user system covers a second 9.4-megabyte drive and two VDTs. The four-to-eight-user 9040 comes with a 320-K-byte main memory, two 44.7-megabyte (formatted) hard-disk drives, and four VDTs. It will support up to four

debugging and emulation stations.

The Microprocessor Pascal option includes compiler, interpreter, and run-time support. From a series called Component Software are available a file manager and a multi-tasking executive called Realtime Executive that supports the TI family products.

Texas Instruments Inc., P. O. Box 225012, M/S 308, Dallas, Texas 75265 [372]

## Microcomputer runs on 12 mW

1.1-MHz C-MOS version of 8-bit device aims at portable consumer markets

Built with complementary-MOS technology, General Instrument's PIC 16C55 is a reduced-power version of the firm's PIC 1655A 8-bit microcomputer. The C-MOS version dissipates a maximum of 12 mW at a 1.1-MHz clock rate. In contrast, the n-channel MOS unit has a maximum dissipation rating of 1 W.

The new version, like the old, contains 32 8-bit registers, a read-only

memory capable of storing a user's program consisting of 512 12-bit words, a real-time clock counter, a two-level stack, and a self-contained oscillator. Both microcomputers also have eight latched bidirectional input/output lines.

The 28-pin 16C55 requires a 2.5-to-6-v power supply and can operate using an external time base of 50 kHz to 1.1 MHz, for a minimum instruction cycle time of 4.5  $\mu$ s. The n-MOS version's minimum instruction cycle time is 4.0  $\mu$ s, and a 0.2- to 1.0-MHz external time base may be used in conjunction with it.

"A fast C-MOS part won't find its way into the low-end consumer market for hand-held electronic games. It's too expensive for that," notes Ken Greenburg, GI microprocessor product manager. He sees markets

for the 16C55 in small appliances, where a large power supply would be both costly and unwieldy; as a frequency-synthesis tuning device for car and mobile radios; and in portable consumer products such as alarm clocks where speech synthesis will be used.

"There are a lot of applications where the couple of extra dollars the user spends on the processors will be offset by the savings in power supplies," Greenburg says.

The PIC 16C55's price in quantities of 500,000 is less than \$4.25 each, with deliveries to begin in June. In contrast, the older PIC 1655A sells for under \$1.55 each in similar quantities.

General Instrument Corp., Microelectronics Division, 600 West John St., Hicksville, N. Y. 11802. Phone (516) 733-3107 [373]

Multibus 512-K-byte memory has memory management unit

The MEGA-4 Multibus-compatible memory card, with up to 512-K bytes of read/write memory and a memory management unit, supports byte-wide and word-wide data transfer to satisfy the large memory requirements of 8-bit (8085, Z80A) and 16-bit (8086) microcomputer systems. The memory card also contains distributed refresh and full-parity-generation and -checking circuitry, as well as an advance-acknowledge signal as a jumper option. The memory's worst-case access time is 625 ns and its cycle time is 725 ns.

The MMU in the MEGA-4 consists

of two identical banks of 128 address-translation registers that specify the mapping of the 64 physical memory segments into the 128 logical memory segments in the 1-megabyte Multibus address space. The MMU gives 8086-based systems the same segmented addressing found in Z8000 systems.

The MEGA-4 is available in 32-, 64-, 128-, 256- and 512-K-byte configurations populated with either 16-

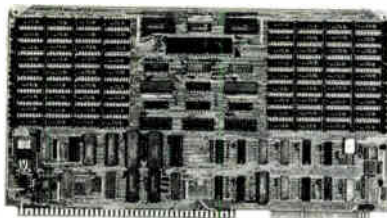

K or 64-K random-access memories. Prices range from \$680 for the 32-K-byte version to \$5,775 for the 512-K-byte unit, but discounts are available for original-equipment manufacturers. Delivery takes two to four weeks.

Matrox Electronic Systems Ltd., 5800 Andover Ave., T. M. R., Quebec H4T 1H4, Canada. Phone (514) 735-1182 [380]

64-K-byte static RAM operates on S-100 bus

A 64-K-byte, fully static random-access memory board is claimed by its manufacturer to be the highest-density static RAM offered for the S-100 bus (IEEE-696 standard) on a 5-in. board. Among the advantages

With the Series 100 X-Y recorders

# You only pay for the features you need

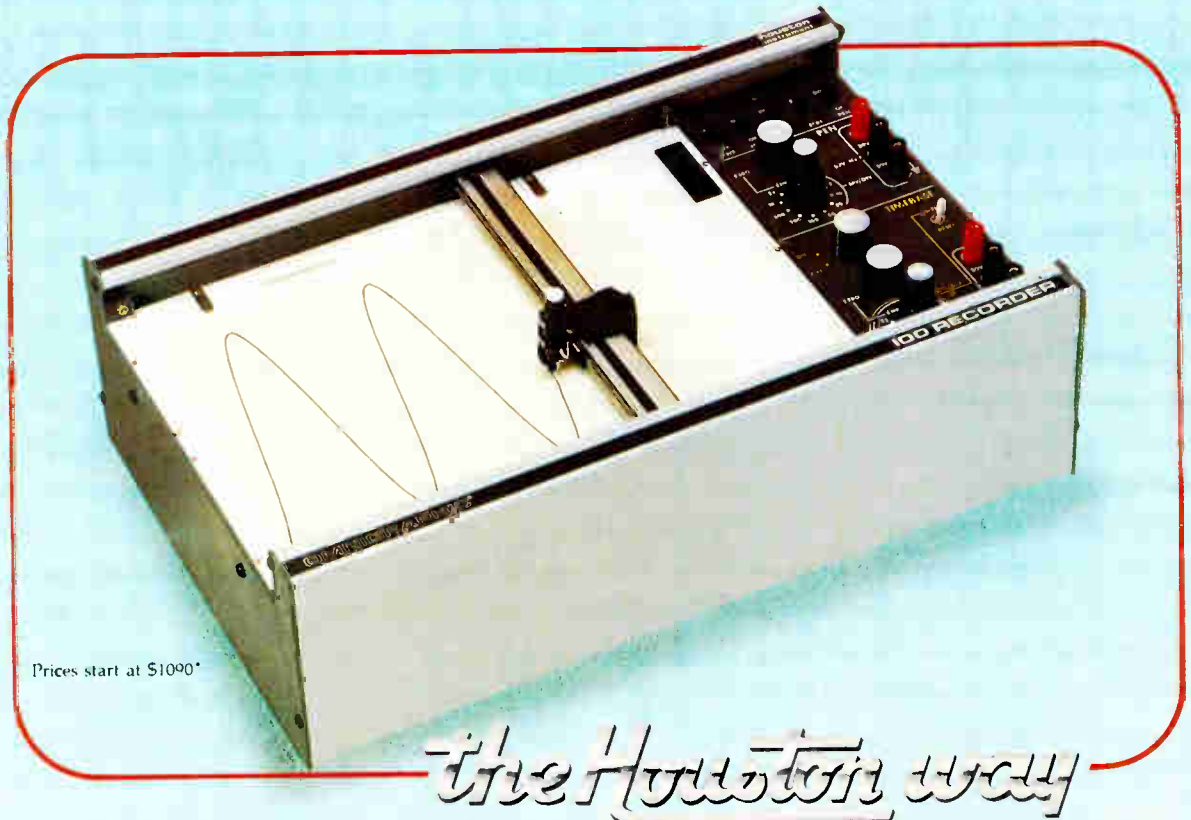

Prices start at \$1090\*

*The Houston Way*

With some X-Y recorders you wind up paying for features you'll never need. Not when you record the Houston Way. The Omnigraphic® Series 100's user configurable design lets you tailor the recorder to specifically meet your requirements — lab or field, production or process, OEM or dedicated.



The self-contained mainframe can serve as a stand alone recorder or act as the basic building block for your particular recorder configuration. Add your choice of options and the recorder is tailored to your application.

The Series 100 utilizes Houston Instrument's patented capacitance feedback transducer. It replaces the old slidewires and potentiometers and their inherent problems of wear, electrical noise and glitches. The result is longer recorder life and enhanced accuracy.



The Series 100 records on 8½" x 11" (DIN A4) paper and displays  $Y=f(X)$  or  $Y=f(T)$ . The linear bearing supported pen bar assures alignment for the lifetime of the recorder. All electrical and mechanical components are easily accessible by simply removing four screws on the bottom panel.

And we haven't forgotten the OEM. We'll work with you to make any necessary mechanical and circuit modifications, and deliver the recorders in your color and with your logo.

Get in touch with Houston Instrument today. We'll show you the way to configure an X-Y recorder that's exactly suited to your application . . . the Houston Way.

Contact Houston Instrument, One Houston Square, Austin, Texas 78753. (512) 837-2820. For rush literature requests and sales office information, outside Texas call toll free 1-800-531-5205. For technical information ask for operator #2. In Europe contact Houston Instrument, Rochesterlaan 6, 8240 Gistel, Belgium. Phone 059/27-74-45.

**houston instrument**

GRAPHICS DIVISION OF

**BAUSCH & LOMB**



\* U.S. suggested retail price. OEM prices available.  
® Registered trademark of Houston Instrument.  
UL Listed

Circle #114 for literature  
Circle #247 to have a representative call  
World Radio History

## New products

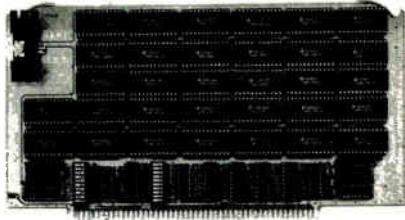

the RAM 17 offers over its dynamic counterparts are the guarantee that the RAM 17 will run with 6-MHz Z80s and 10-MHz 8086s and 8088s, less than 2 W of power dissipation, freedom from alpha-particle soft-bit errors, and direct-memory-access operation. The board offers 24-bit addressing to allow up to 16 megabytes of system memory. It uses 2-K-by-8-bit static RAM chips that are pin-compatible with 2716-type erasable programmable read-only memories, and up to 32 K of E-PROM can be intermixed with the RAM if desired.

Single-quantity and end-user prices for the RAM 17 are \$1,095 for a kit, \$1,395 for an assembled and tested version, and \$1,595 for a certified system with a high-reliability program. The RAM is also available in a 48-K configuration. Delivery is from stock but may take up to 30 days.

CompuPro, Division of Godbout Electronics, P. O. Box 2355, Oakland Airport, Calif. 94614 [374]

### \$9,500 2-megabyte RAM for Unibus replaces disk storage

An inexpensive large-capacity random-access memory for Digital Equipment Corp.'s Unibus systems has built-in self-diagnosis and self-maintenance features. Called Nuram, the memory offers from 2 to 8 megabytes of rack-mountable auxiliary memory that emulates DEC's RS04 fixed-head disk subsystem. A multidevice controller called Hexacon interfaces the RAM with Unibus systems. It simultaneously controls up to four 67-megabyte disks and up to four half-inch magnetic tapes in addition to controlling Nuram.

With 16 spare RAMs per mega-

byte, the memory can substitute a good RAM for a failing one, yet do so transparently to the system in operation. The manufacturer offers a 24-hour spare-replacement program for Nuram at a cost of \$10 per half-megabyte memory board per year.

Deliveries of Nuram will begin early this summer and production quantities will be available by September. In single quantities, it is priced at \$9,500 per 2-megabyte increment. Hexacon costs between \$3,000 and \$6,500 depending on which devices it must control.

National Semiconductor Corp., 2900 Semiconductor Dr., Santa Clara, Calif. 95051. Phone (408) 737-5000 [375]

### Programmable real-time clock runs on STD bus

The time-keeping functions of a real-time clock are available now for STD-bus users with the 200-1 programmable interrupt generator. The unit utilizes a single-digit binary-coded decimal data format to provide clock-time data in the form of years, months, days, hours, minutes, and seconds. The unit has a programmable alarm-clock function that generates interrupts when the set time is reached. Interrupts can be set at intervals from 8  $\mu$ s through 512 s in 64 ranges that can be selected by a host processor. The clock's functions are backed by a battery for a minimum of three years. The card itself is compatible with STD-bus processor cards that use 8085, Z80, and 6800 processors. The 200-1 is available off the shelf, for \$315 each for one to nine cards.

Enlode Inc., 1728 Kingsley Ave., Orange Park, Fla. Phone (904) 264-4405 [376]

### PDP-8-software-compatible microcomputer costs \$815

At a cost nearly half that of a comparable PDP-8, the PCM-12 microcomputer system offers 100% software compatibility with the entire Digital Equipment Corp. PDP-8

# Not everything costs less in Georgia. It just seems that way.

Sourdough bread, seedless grapes, iceberg lettuce and perhaps even Boston baked beans may cost more in Georgia than in some other parts of the country. But when you consider living costs, real estate, labor and the cost-intensive aspects of production in the electronics industry, Georgia looks mighty good. Recreational advantages, minimum pollution, receptive state and local governments are also major pluses. And now with the advent of the Advanced Technology Development Center at Georgia Institute of Technology, the state offers educational opportunities available in few other parts of the nation. If you are considering expansion or relocation of your electronics business, write today for your free copy of "Cost Data on Industrial Buildings in Georgia." This booklet contains 62 pages of costs, specifications and photographs of 32 recently constructed plants.

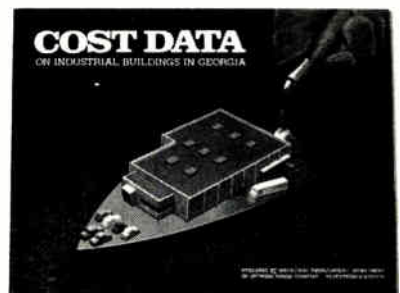

Not listed on reader service card

WRITE FOR YOUR FREE COPY

Joseph H. Inglis, Manager  
INDUSTRIAL DEVELOPMENT  
DEPARTMENT

Georgia Power

Box 4545EE, Atlanta, GA 30302

## New products

family of minicomputers, as well as with DEC's new VT-78 DECstation equipment. The new system is primarily aimed at manufacturers who build PDP-8s into their own original equipment and who have made substantial investments in developing proprietary support software for their machines.

The PCM-12 employs a binary instruction set, so that all DEC- and user-written PDP-8 software can be used directly on the microcomputer without modification. The unit's clock speed is 4 MHz and its memory capacity is 64-K words. Packaged in an aluminum cabinet, the PCM-12 offers a card cage that can accommodate 18 cards. It includes a heavy-duty linear power supply. Bootstraps for both single-density and double-density floppy disks, hard disks, tape, and paper tape can be activated by push buttons on the microcomputer's front panel.

The PCM-12 is priced at \$815 in quantities of 10 units. Plug-in modules offering such features as memory options, input/output, disk controllers, analog-to-digital and digital-to-analog converters, and printer interfaces cost between \$200 and \$300. Delivery takes 30 days.

Pacific Ciber/Metrix Inc., 6800 Sierra Court, Dublin, Calif. 94566. [377]

### 32-K-byte dynamic RAM

has direct memory access

A dual-ported 32-K-random-access memory board allows direct memory access without interrupting the central processing unit. Thus the host computer can work at speeds otherwise unattainable when operating in a video input/output, disk-through-DMA-port, or multiuser timesharing environment. The RAM's ports can be selected by software. One port can be dedicated to video I/O or to disk systems while the CPU continues to function with other memory.

The board features two independent 16-K-byte banks addressable on 16-K-byte boundaries, or 16-, 32-, 48- or 64-K-byte banks can be sel-

ected by software. The RAM offers transparent refreshing, S-100 and IEEE-488 compatibility, and low power consumption (7 W maximum). The dual-ported RAM is compatible with 8080, 8085, and 4-MHz Z80 CPUs without wait states. It sells for \$579 in the U. S.

B&G Computer Applications, 206 Brookside St., Bryan, Texas 77801 [378]

### 256-K-byte memory board is LSI-11-compatible

A 256-K-byte memory card that can be installed into any quad backplane wired for the LSI-11 Q bus is electrically and mechanically compatible with the LSI-11, PDP-11/03, and LSI-11/23 microcomputer systems. The memory printed-circuit board will operate with or in place of the Digital Equipment Corp. MSV11-D and MSV11-E series semiconductor memory cards.

Memory capacity for the new board, designated model NS23Q, ranges from a minimum of 16 K by 16 bits without parity to a maximum of 128 K by 18 bits with parity. The starting address of the 128-K-by-18-bit dynamic n-channel MOS random-access memory can be assigned anywhere within the LSI-11/23 128-K-word address space in 4-K increments. The unit also has an optional 22-bit addressing capability installed at no additional cost to extend the card's use to within a 2-megaword address range.

The NS23Q offers a read access time of 180 ns, a read cycle time of 490 ns, a write access time of 80 ns per byte, a write cycle time of 390 ns, and a read-modify-write access time of 700 ns per byte with a RMW cycle time of 1,000 ns. Features include internal or optional external refresh and optional on-board parity generation and checking. In the 128-K-byte version, each card is priced at \$1,400. The 256-K-byte fully populated version is \$2,250. Delivery takes 30 days.

National Semiconductor, Memory Systems Division, 2900 Semiconductor Dr., Santa Clara, Calif. 95051. [379]

# TRW OPTRON

- ARGENTINA**, Buenos Aires, Tlf: 54.01.49-1735  
NUCLEX
- AUSTRALIA**, Melbourne, Tlf: 61.03.96-5076  
TOTAL ELECTRONICS
- AUSTRALIA**, N. S. W., Tlf: 61.45.428-3500  
TOTAL ELECTRONICS
- AUSTRIA**, Vienna, Tlf: 43.222-829451  
TRANSISTOR VERTRIEB GmbH
- BELGIUM**, Brussels, Tlf: 32.2.7361007  
SOTRONIC S.A.
- DENMARK**, Charlottenlund, Tlf: 45.1-640099  
DANSK KOMPONENT IMPORT
- ENGLAND**, Bedford, Tlf: 44.234-64948  
TRW OPTRON
- ENGLAND**, Reading, Tlf: 44.734-864411  
NORBAIN ELECTRO-OPTICS LTD.
- FINLAND**, Helsinki, Tlf: 358.0-801-2133  
HILVONEN TECHNICAL PRODUCTS OY
- FRANCE**, S. Seine, Tlf: 33.3.980.41.40  
COMPOSANTS ET PRODUITS  
ELECTRONIQUES
- GERMANY**, Berlin, Tlf: 49.030-6845088  
AKTIV-ELECTRONIC
- GERMANY**, Hamburg, Tlf: 49.040-5404046  
GETRONIC
- GERMANY**, Munich, Tlf: 49.89-7146065  
TRW ELEK. BAUELEMENTE VERTRIEBS  
GmbH
- GERMANY**, Seefeld, Tlf: 49.8152-7774  
ULTRATRONIK
- GERMANY**, Stuttgart, Tlf: 49.711-724844  
DITRONIC
- HONG KONG**, Kowloon, Tlf: 852.3-856199  
TEKTRON ELECTRONICS (HK) LTD.
- INDIA**, Ghaziabad, U. P., Tlf: 2979  
GHAZIABAD ELECTRONICS (P) LTD.
- ISRAEL**, Tel-Aviv, Tlf: 972.03.444572  
TALVITON ELECTRONICS LTD.
- ITALY**, Milan, Tlf: 39.2.653.131  
DOTT. ING. GIUSEPPE DEMICO
- JAPAN**, Tokyo, Tlf: 81.03.461-5121  
NIHON TEKSEL CO., LTD.
- KOREA**, Seoul  
NEWKAYA CORPORATION
- NETHERLANDS**, The Hague, Tlf: 31.70.210101  
KONING EN HARTMAN, N.V.
- NEW ZEALAND**, Auckland, Tlf: 64.09.493-029  
PROFESSIONAL ELECTRONICS LTD.
- NORWAY**, Oslo, Tlf: 47.02.106050  
H. C. A. MELBYE
- PORTUGAL**, Lisbon, Tlf: 351.19-545313  
DITRAM LDA
- SOUTH AFRICA**, Dunswart, Tlf: 27.892-1001  
ALLIED ELECTRIC (PTY) LTD.
- SWEDEN**, Hagersten, Tlf: 46.8.7440300  
MARTINSSON & CO. INSTRUMENT AB
- SWITZERLAND**, Zurich, Tlf: 41.63.281122  
MEMOTEC AG
- TAIWAN**, Taipei, Tlf: 86.2-751-2062  
SEA UNION ENGINEERING
- YUGOSLAVIA**, Trieste, Italy,  
Tlf: 38-040-827-395  
ELTRADE, S. P. A.



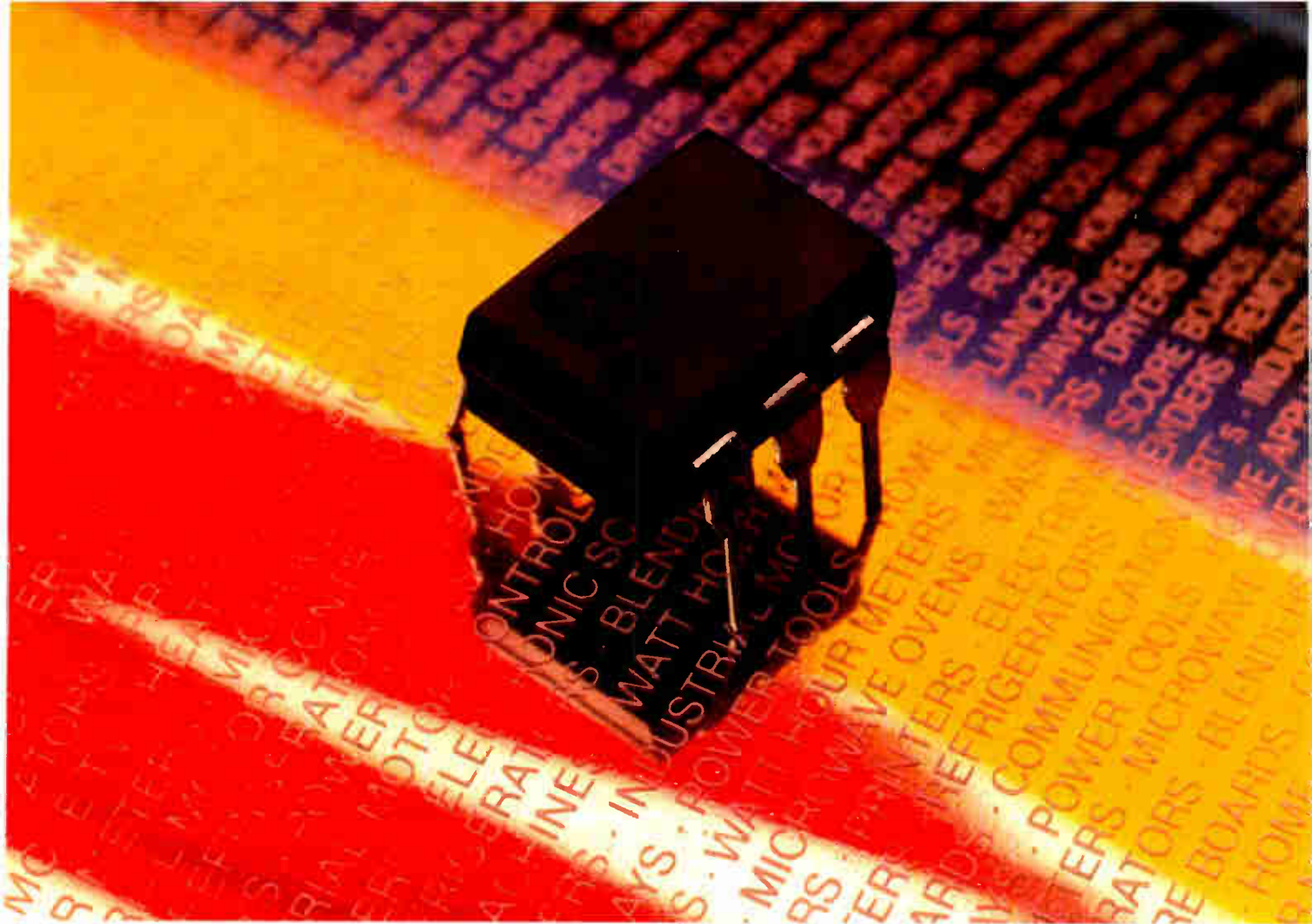

## Free! Your own brand new optically coupled isolator with triac driver output from TRW Optron.

You already know what it does; with as little as 10mADC in the coupler's input, it gives you logic control capability and electrical isolation for 120 VAC appliances and equipment.

What you *didn't* know until now is that you no longer have only one source for these popular optocouplers. TRW Optron has just jumped into the opto triac driver business with both feet. Our OPI3009, OPI3010, and OPI3011 are directly interchangeable with *their* MOC3009,

MOC3010, and MOC3011.

Naturally, you can look for the same kind of quality, reliability, and availability you already expect from an industry leader.

Write now for your free TRW Optron-quality opto triac driver. Check it out. And, keep your eyes on TRW Optron. In the near future, you will see the OPI3020, OPI3021 series for 240 VAC applications and the OPI3030, OPI3031 series with zero crossing networks included on-chip.

Yes! I'd like to test a TRW Optron triac driver. Send one free with Application Bulletin #110 and data sheet.

Name \_\_\_\_\_

Company \_\_\_\_\_

Div/Dept \_\_\_\_\_

Mail Code \_\_\_\_\_

Address \_\_\_\_\_

City \_\_\_\_\_

State \_\_\_\_\_

Zip \_\_\_\_\_

**TRW Optron**  
1201 Tappan Circle  
Carrollton, Texas 75006 USA  
Phone 214-323-2200

E-4

# TRW OPTRON

An Electronic Components Division of TRW Inc.

Circle 248 on reader service card

## New products

Computers & peripherals

### 256-K-byte cards fit DEC machines

64-K or 32-K RAM chips are used in dual-width card; VAX card holds 1 megabyte

The standard versions of two memory cards from Motorola both carry 256-K bytes for a price of \$2,450 each in lots of less than 10. Both cards plug into Digital Equipment Corp. computer systems—the LSI-11/32 and the VAX-11/750.

The MMS1132 card is fully populated with MCM6665L 64-K random-access memories in the standard 256-K-byte version, which includes parity. Depopulated versions

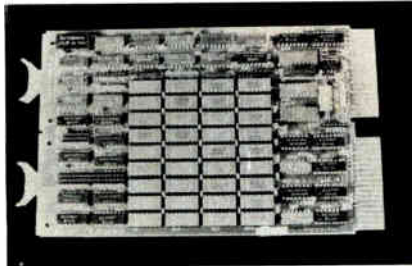

are also available, such as a 128-K-byte card using 32-K MCM6633L RAMs. The dual-width (8.94-by-5.19-in.) board is particularly suited to systems with advance memory management units with up to 22 address lines, says the firm. The MMS1132 has a typical read access time of 250 ns, operating in systems with cycle times as low as 500 ns.

The MMS750 is a hexadecimally-board populated with MCM4116 16-K RAMs in its standard version, but can also be ordered with 6665L 64-K RAMs for a total of

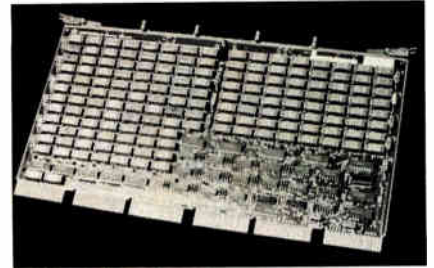

1 megabyte on the board. This version is priced at \$9,450 in lots of less than 10. The VAX-11/750's memory controller generates the address, data, error-correction codes, and refresh signals that operate the MMS750 memory board, so access and cycle times of the memory are as that controller dictates.

Both boards will be available two to four weeks after receipt of order, says Motorola, which plans to show the cards at Electro/81.

Motorola Inc., Memory Systems, 3501 Ed Bluestein Blvd., Austin, Texas 78721 [361]

### Array processor fits on two boards

Low-cost number cruncher performs pipelined operations, shares memory with LSI-11

Possibly the smallest, least costly array processor yet, the MNK-02 is aimed at microcomputer-based applications. Its maker, the year-old Sky Computer Inc., has designed the system so that the entire floating-point array processor fits on two circuit boards that plug directly into the backplane of a Digital Equipment Corp. LSI-11 microcomputer. The MNK-02's price is compact, too, at \$5,900 for a single unit and \$3,990 each in 100-unit lots.

Thus, for a price comparable with that of a microprocessor, users can get what Sky calls a Micro Number Cruncher capable of digital filtering; post-processing; and threshold, minimum-maximum, and fast Fourier processing. The unit does everything expected of a floating-point proces-

sor, such as integer-to-floating-point conversion (and the reverse) and vector, scalar, and matrix computations on both real and complex numbers.

The speed of an array processor is one of its most important features, and the MNK-02 is fast. A one-dimensional, 1,024-bit, complex fast Fourier transform takes about 50 ms—not Cray speed, but as much as 50 to 100 times the speed at which its host microcomputer would do the job. A real floating-point addition takes 1.1  $\mu$ s. Floating-point multiplication requires 1  $\mu$ s—6  $\mu$ s if complex—and complex division takes about 10  $\mu$ s.

The MNK-02 is designed somewhat differently from other inboard (and outboard) array processors. For example, the unit's hardware and software is said to be "tightly coupled" to the host; the microcomputer's instruction set is extended to include vector, matrix, and compound mathematical instructions. Sky provides support software to link host and array processor, although the unit takes advantage of DEC's RT-11 operating system and will soon add RSX-11M compatibility.

Little additional support is needed for the MNK-02. Its software package includes a vector subroutine library, two interface device drivers, and a Fortran test program. The rest of the unit's instructions are micro-coded in read-only memory and thus are not accessible to the user. However, custom instruction sets will be available to bulk purchasers.

**More windows.** As a part of the tight coupling and to save money, the MNK-02 shares its host's memory. Compared with an array processor that has more memory, the data and instruction transfers between the array processor and the microcomputer's main memory on the Q-bus are more frequent; but they are shorter in duration and enable the host to use the bus for other tasks in the time windows left over on a more continuous basis. The MNK-02 operates independently of the host for relatively short periods, generating an interrupt when finished. Data can flow between micro- and array-processor at the full speed of DEC's Q-bus—up to 500 kb/s. Installation is easy—largely just a matter of inserting the boards.

The MNK-02's arithmetic and

# The quickest distortion measurements for the most critical applications.

**The AA 501 Distortion Analyzer and SG 505 Oscillator measure harmonic distortion, level, and intermodulation distortion. Automatically.**

This pair of TM 500 Plug-ins makes distortion measurement truly automatic to save you both time and money. For production testing, the AA 501's automatic speed provides substantial labor reduction with no loss in accuracy. Together, the AA 501 and SG 505 have the lowest harmonic distortion plus noise (THD+N) rating in the entire industry: 0.0025%.

The SG 505 Oscillator outputs a sine wave with the lowest residual distortion on today's market (.0008%). The AA 501 Distortion Analyzer uses digital processing to lock in on test signals, set levels and adjust the notch filter for nulling. All measurements, including dB levels are precalculated and then displayed on an LED readout.



In addition to level and harmonic distortion measurements, the AA 501 measures intermodulation distortion to three standards: SMPTE, DIN and CCIF difference tone. Automatically selected.

The AA 501 and SG 505 are both TM 500 Plug-ins that can be installed in any of five mainframes, including rackmount, bench and portable. They can also be separated and still used as a team, even though miles apart. Or configured with over 40 other TM 500 Plug-ins currently available.

To find out more about the AA 501 Distortion Analyzer and SG 505 Oscillator, contact:

U.S.A., Asia, Australia, Central & South America, Japan Tektronix, Inc., P.O. Box 1700, Beaverton, OR 97075, Phone: 800/547-1512, Oregon only 800/644-9051, Telex: 910-467-8708, Cable: TEKTRONIX.  
Europe, Africa, Middle East Tektronix International, Inc., European Marketing Centre, Postbox 827, 1180 AV Amstelveen, The Netherlands, Telex: 18312.  
Canada Tektronix Canada Inc., P.O. Box 6500, Barrie, Ontario L4M 4V3, Phone: 705/737-2700.

**Tektronix**  
COMMITTED TO EXCELLENCE



## New products

logic unit is pipelined. This feature aids vector operations since data can flow through the ALU with arithmetic operations overlapping each other rather than each awaiting the end of a prior operation. The ALU is implemented in 7-MHz bipolar logic arrays.

To keep bus interrupts to a minimum, the MNK-02's data and command memory stores up to 15 outstanding commands; it also provides working space for up to 64 floating-point numbers—operands or result vectors. The unit offers a choice of 32- or 48-bit precision and 20- or 24-bit addressing, has floating-point and integer format conversion built into it, and uses 16-bit-wide internal data paths.

Delivery is specified as 90 days after receipt of order.

Sky Computer Inc., P. O. Box 1006, North Chelmsford, Mass. 01863 [362]

### Speech recognition system sells for under \$2,500

An isolated-word speech recognition and development system, the Auricle I is available for less than \$2,500. The manufacturer hopes that at this low price the 3-by-12-by-13-in. unit will permit makers of computer terminals and control systems to familiarize themselves with speech recognition and to develop interface hardware and software for designing speech recognition into their products. By the end of 1981, the firm will make available a compatible printed-circuit-board version of the speech-recognition module for less than \$500 in volume quantities.

Both the Auricle I and the p-board version recognize a 40-word vocabulary (expandable to 128 words) with accuracy above 99%. The Auricle I development system receives individual spoken words or phrases under 1.2 s in duration, analyzes their energy content with a spectrum analyzer, and compares them with patterns of vocabulary words entered into memory by the user in a single training session. Close correlation between input and



a stored word determines recognition.

The front end of the unit is the equivalent of a 16-channel bandpass filter. The user says each vocabulary word three times to enter it and then sets a threshold at which the system differentiates between similar-sounding words. The higher the threshold, the more distinct the differences between the words in memory must be before the unit will acknowledge recognition. Background noise is canceled automatically.

Data compression is by binary-feature extraction, which reduces each word to a 512-bit matrix—4 bytes for each of the 16 channels. Dynamic time warping increases recognition accuracy, which is controlled by a Z80 microprocessor.

The Auricle I includes a power supply and noise-canceling microphone and weighs 7 lb. Response time is 350 ms. Its output is serial ASCII code that is compatible with terminals operating on the RS-232-C communications interface. RS-232-C connection is standard on the Auricle I, and IEEE-488 connection is available as an option. Data rate is selectable from 330 b/s to 19.2 kb/s. The unit costs \$2,480 per system.

Auricle Inc., 20823 Stevens Creek Blvd., Cupertino, Calif. 95014 [363]

### Alphanumeric printer puts out high-resolution graphics

An 80-column thermal printer, the Sprinter 80, offers a printing speed selectable between two and four lines per second and high-resolution graphics capability for \$595. At this low price, the Sprinter 80 can serve as a peripheral to any of the personal

computers. In fact, the manufacturer, Alphacom Inc., offers optional interfaces for most of the popular microcomputers, such as the Apple II, TRS-80, Mattel Intellivision, and Atari 400 and 800 models, in addition to the standard Centronics parallel and RS-232 interfaces included with the printer.

The five-by-eight-dot matrix printer has a 560-by-n matrix that allows it to print 240 full 80-character lines per minute, so 280-dot-wide cathode-ray-tube hard-copy printouts are possible in less than 15 s. A slower version of the printer, the Sprinter S80 operates at 80 characters per second but offers even better resolution in a single pass. Varying

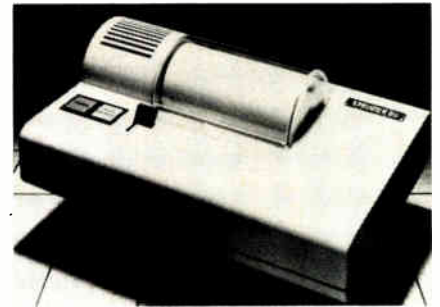

the length of time a single dot is exposed to the heated element gives four shades of gray per dot. The printer's output is of nearly photographic quality.

With a switch, the user can select between the parallel or serial interfaces as well as between the character or graphics modes. There are eight selectable data rates of 110 to 9,600 b/s, and the units print the 96-character ASCII set. The Sprinter 80 can feed paper in roll or fan-fold form and can print right side up, upside down, or sideways in a variety of print sizes. Information that is normally printed on a full-sized 132-column printer can be printed out sideways.

Using the same thermal-printing, thick-film-printhead technology controlled by a microprocessor, the firm offers 40- and 20-column printers priced at \$350 and \$175, respectively. The printing mechanism is manufactured by Olivetti; Alphacom adds all the necessary electronics.

The Sprinter 80 measures 16 by

# DURABLE



## Bendix Tri-Start

For the dependable performance demanded by MIL-C-38999. And then some!

Bendix-designed and DOD-preferred, our high performance Series III Tri-Start connector meets the challenges of new technology. Challenges that depend on Tri-Start's ability to:

- withstand vibration (60G peak at temperatures up to 200°C)
- suppress electrolytic erosion
- provide superior EMI shielding
- resist corrosion (by withstanding 500-hour salt spray)

A new breed in connector capability, the general duty MIL-C-38999 Series III Tri-Start eliminates lock-wiring, couples in a 360° turn of the coupling nut, and intermounts with standard MS connectors. Tough and dependable, Bendix Tri-Start is available in a variety of shell styles and service classes, including class K firewall. Insert arrangements cover contact sizes 12 through 22D.

For complete information, call 607-563-5323 or write The Bendix Corporation, Electrical Components Division, Sidney, N.Y. 13838.

**We speak connectors.**

**Bendix**



# isra tech '81

ISRAEL  
TECHNOLOGY WEEK  
JERUSALEM,  
NOVEMBER 9-12, 1981

SECURITY & SAFETY PRODUCTS  
BUILDING SUPPLIES  
AVIATION  
ELECTRONICS  
AUTOMOTIVE EQUIPMENT  
TECHNICAL PLASTICS  
INDUSTRIAL MACHINERY & SUPPLIES

Hundreds  
of Israeli  
manufacturers  
interested in  
representation  
and distribution,  
displaying the most  
advanced technology  
and new products at

ISRATECH  
81

For further information  
contact your nearest Israeli Commercial  
Representative or the ISRATECH '81  
Organizing Committee, P.O.B. 29732,  
Tel Aviv 68125, Israel, Telex: 35613 IL

## New products

9.5 by 5 in. It can be delivered, even  
in large quantities, in 30 days.

Alphacom Inc., 3031 Tisch Way, San Jose,  
Calif. 95128. Phone (408) 249-2152 [369]

\$399 dot-matrix printer  
uses single print hammer

The GP-80M impact printer uses a  
single, rugged print hammer rather  
than seven or more individual sole-  
noids and print wires to produce a  
five-by-seven-dot-matrix pattern.  
The small 80-column device prints  
both graphics and alphanumerics  
and sells for \$399 in single quantities  
and for \$250 in lots of 1,000 for  
original-equipment manufacturers.

The character or graphics image  
produced by the GP-80M is created  
by the hammer striking in rapid suc-  
cession as the print head advances  
across the paper in front of a rotat-  
ing platen with protruding splines.  
For uniformity, the hammer is close-  
ly aligned with the splines. The  
printer offers the ASCII upper- and  
lower-case character sets, consumes  
12 w, and has a Centronics parallel  
interface. Optional interfaces in-  
clude those for most popular person-  
al computers, TTL, 20-mA current  
loop, and IEEE-488. The standard  
version has full graphics capability  
with resolution of better than 60  
dots/in.

The GP-80M measures 5 by 12.9  
in. It is manufactured by Seikosha, a  
company of the Seiko group and is  
imported exclusively by Axiom in  
the U.S. Delivery is 30 days from  
the receipt of an order.

Axiom Corp., 1014 Griswold Ave., San Fer-  
nando, Calif. 91340. Phone (213) 365-9521  
[364]

\$575 graphics printer offers  
7-by-7- or 14-by-7-dot matrix

The model DIP-84G graphics print-  
er features both a 7-by-7- and a 14-  
by-7-dot matrix and six character  
sizes for \$575 in quantities of 100. It  
prints at 100 characters/s bidirec-  
tionally and has a variable line den-

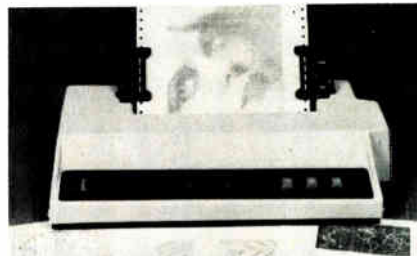

sity. The dot-addressable graphic  
capability can provide plotting,  
printing from cathode-ray-tube  
graphics, drawing, and printing of  
symbols. The printer can also pro-  
duce the full 96-character ASCII set,  
upper- and lower-case, at a column  
width of 40, 48, 66, 80, 96, or 132  
characters per line.

Complete with electronics, the  
DIP-84G interfaces directly with  
mini- and micro-computers. It mea-  
sures 17 by 9.75 by 6.5 in. and can  
be delivered within one week.

DIP Inc., 745 Atlantic Ave., Boston, Mass.  
02111. Phone (617) 482-4214 [365]

10 1/2-in. hard-disk drive  
stores 473 megabytes

The M2351 Eagle is a 10.5-in. Win-  
chester disk drive that offers 473  
megabytes of storage capacity, an  
18-ms average access time, and a  
standard storage-module drive  
(SMD) interface. Designed for origi-  
nal-equipment manufacturers, the  
drive, called Midi-Winchester by its  
manufacturer, offers a data-transfer  
rate of 1,859 kilobytes/s, like the  
IBM 3370 and 3375 drives. The  
10.5-in. diameter of the media  
should provide more efficient storage  
space than smaller, 8-in. models  
(300 megabytes/ft<sup>3</sup>) yet build up  
less heat in operation than the 14-in.  
variety, says the maker. Track densi-

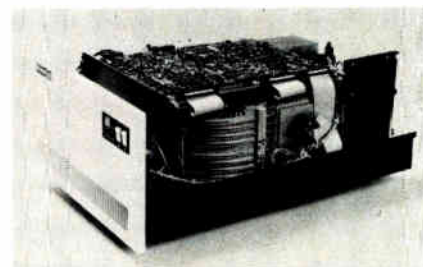

# HP-33C, 34C, & 38C with Continuous Memory. They're ready when you are.

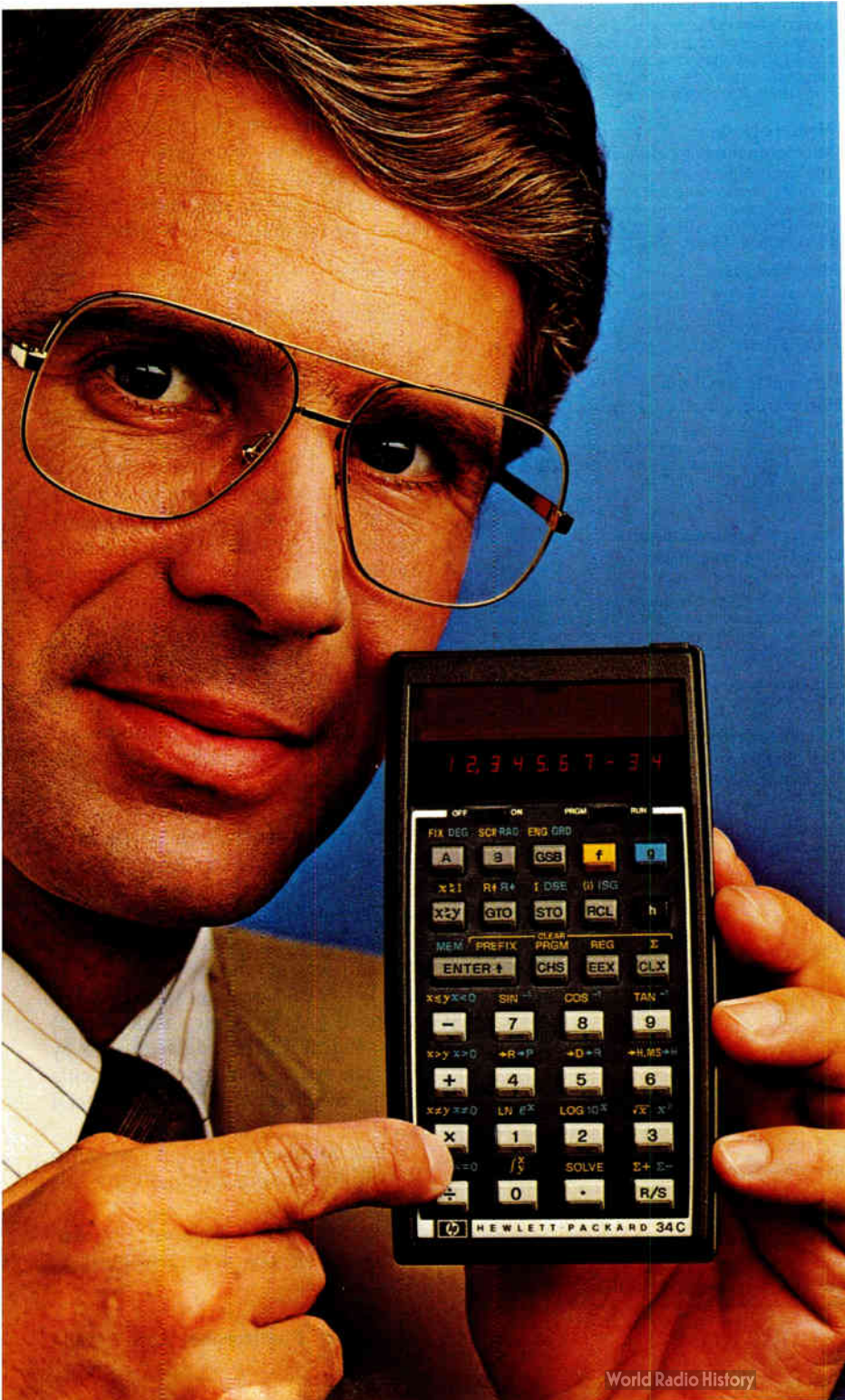

These advanced programmable calculators from Hewlett-Packard retain your data and programs even after they've been turned off. Just think how much more quickly and easily you'll be able to solve your business or scientific problems.

But these remarkable calculators do more than just remember. Consider the HP-34C, for instance. It provides up to 210 program lines. Up to 3 keystroke instructions are automatically merged into one program line, expanding memory to the equivalent of 370 program lines. And editing is a snap. The HP-34C's editing features let you review your programs and insert or delete instructions as needed. The HP-34C also has two special function keys, Solve and Integrate, to determine the roots of an equation or compute the definite integrals of a function.

Hewlett-Packard supports the HP-33C, 34C and 38C with the most comprehensive instruction manuals and software solutions to problems for science, engineering and business applications.

Visit a Hewlett-Packard dealer now and experience the advantages of Continuous Memory in one of these outstanding calculators.

- HP-33C Programmable Scientific with Continuous Memory. *New low price* \$90\*
- HP-34C Advanced Programmable Scientific with Continuous Memory \$150\*
- HP-38C Advanced Financial Programmable with Continuous Memory \$150\*

For details and the address of your nearest HP dealer, CALL TOLL-FREE 800-547-3400, Department 214K, except from Hawaii or Alaska. In Oregon, call 758-1010. Or write to Hewlett-Packard, 1000 N.E. Circle Blvd., Corvallis, OR 97330, Dept. 214K.

\*Suggested retail price excluding applicable state and local taxes—Continental U.S.A., Alaska and Hawaii. Display photographed separately to simulate typical appearance. 610/13



Circle 203 on reader service card

# Books of special interest to our readers

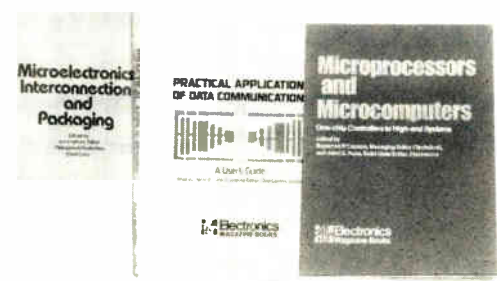
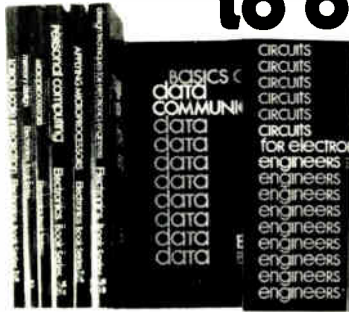

### Applying Microprocessors

Reprinted from *Electronics*, completes the EE's transition from the old methods of electronic design to microprocessor engineering. Pub. 1977. 191 pp. Order #R-701, \$9.95

### Basics of Data Communications

This compilation of essential articles from *Data Communications* magazine includes chapters on terminals, acoustic couplers and modems, communications processors, networking, channel performance, data link controls, network diagnostics, interfaces, and regulations and policy. Pub. 1976. 303 pp. Order #R-503, \$12.95

### Circuits for Electronics Engineers

Almost 350 circuits arranged by 51 of the most useful functions for designers. Taken from the popular "Designer's Casebook" of *Electronics*, these circuits have been designed by engineers for the achievement of specific engineering objectives. Pub. 1977. 396 pp. Order #R-711, \$15.95

### Design Techniques for Electronics Engineers

Expert guidance at every point in the development of an engineering project—making measurements, interpreting data, making calculations, choosing materials, controlling environment, laying out and purchasing components, and interconnecting them swiftly and accurately. Nearly 300 articles from *Electronics*' "Engineer's Notebook." Pub. 1977. 370 pp. Order #R-726, \$15.95

### Microelectronics Interconnection and Packaging

Up-to-date articles from *Electronics* include sections on lithography and processing for integrated circuits, thick- and thin-film hybrids, printed-circuit-board technology, automatic wiring technology, IC packages and connectors, environmental factors affecting interconnections and packages, computer-aided design, and automatic testing. Pub. 1980. 320 pp. Order #R-927, \$12.95

### Large Scale Integration

As published in *Electronics*, covers the entire range of design applications in sections on bipolar LSI, MOS LSI, new devices, system design, computer-aided design, testing, and applications. Pub. 1976. 208 pp. Order #R-602, \$9.95

### Memory Design: Microcomputers to Mainframes

The technology, devices, and applications that link memory components and system design. How to apply the new technology to meet specific design goals. Edited from the pages of *Electronics*. Pub. 1978. 180 pp. Order #R-732, \$12.95

### Microprocessors

The basic book on microprocessor technology for the design engineer. Published in 1975, articles are drawn from *Electronics*. 150 pp. Order #R-520, \$8.95

### Personal Computing: Hardware and Software Basics

More than 50 articles from leading publications give you up-to-date information on personal computing hardware, software, theory, and applications. Pub. 1979. 266 pp. Order #R-903, \$11.95

### Practical Applications of Data Communications: A User's Guide

Articles from *Data Communications* magazine cover architecture and protocols, data-link performance, distributed data processing, software, data security, testing and diagnostics, communications processors, and digitized-voice and data-plus-voice. Pub. 1980. 424 pp. Order #R-005, \$13.95

### Microprocessors and Microcomputers: One-chip Controllers to High-end Systems

Practical orientation to second- and third-generation 8-bit devices, the latest 16-bit devices, one-chip microcomputers, and software for microprocessors in 95 articles from *Electronics*. Pub. 1980. 482 pp. Order #R-011, \$13.95

## New products

ty is 880 tracks/in. on the M2351 and recording density is 2,790 b/in. using a modified-frequency-modulation encoding format.

Maximum access time is 35 ms utilizing a samarium-cobalt rotary actuator. The head-disk assembly (HDA) is a sealed aluminum module that contains six platters, 20 magnetic read/write heads, one servo head, a spindle assembly, and a dc spindle-drive motor and rotary voice-coil actuator.

The complete disk drive, with one HDA and power supply, weighs slightly over 100 lbs and mounts in a standard 19-in.-wide rack. In lots of 100, it sells for \$8,500 apiece.

Fujitsu America Inc., 2945 Oakmead Village Court, Santa Clara, Calif. 95051 [366]

## LSI controller and Z8 team up in \$650 CRT terminal

In single quantities, the Viewpoint cathode-ray-tube terminal is priced at \$650, and the manufacturer says that its pricing structure in original-equipment-manufacturing quantities will be 30% below any currently available terminal. The terminal contains all its logic circuits on a single 6.5-by-8-in. card whose major component is the firm's own large-scale-integrated video controller circuit. The LSI chip contains the equivalent of 148 individual ICs and is the size of a postage stamp. The terminal also uses a Zilog Z8 microprocessor.

Among its user-friendly features are a keyboard similar to that of the popular IBM Selectric typewriter. A coiled cable like those used with telephone handsets attaches it to the CRT so it can be moved about easily. The 12-in. CRT screen displays 1,920 standard ASCII characters in 24 lines. It tilts to the angle desired by the user. An optional glare filter cuts down on reflections from overhead lights.

The company expects to ship 30,000 Viewpoint terminals by the end of this year.

Applied Digital Data Systems Inc., 100 Marcus Blvd., Hauppauge, N. Y. 11787 [368]

### Order today using this coupon!

Electronics Magazine Books  
P.O. Box 669  
Hightstown, NJ 08520  
Tel. (609) 448-1700, ext. 5494



Order #	Qty.	Price
R- _____	_____	\$ _____
R- _____	_____	\$ _____
R- _____	_____	\$ _____
R- _____	_____	\$ _____
R- _____	_____	\$ _____
Total		\$ _____

Name \_\_\_\_\_

Title \_\_\_\_\_

Company \_\_\_\_\_

Street/P.O. address \_\_\_\_\_

City/state/zip \_\_\_\_\_

Payment enclosed (payment must accompany orders under \$25)

Bill my company (or attach company Purchase Order)

Bill me  Send a free copy of the *Electronics* Editorial Reprints brochure.

Ten-day money-back guarantee applies on all books.



# EAROM

## the word erasable memory.

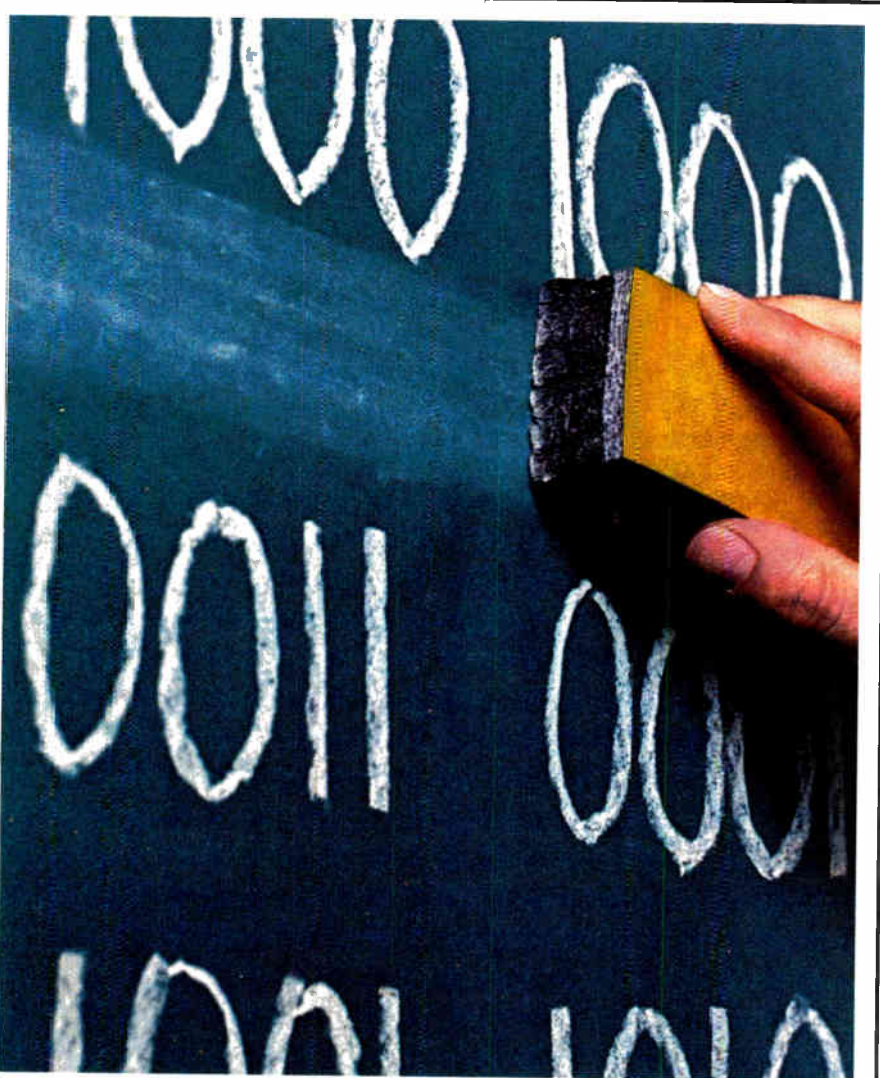

**Whenever you want to record data, retain it, or change it in system...that's when you will want to consider General Instrument EAROM.**

Electrically Alterable Read Only Memories give you the application ease of a RAM, the non-volatility of a ROM...plus electrical erasability, word alterability and in-system reprogrammability. That adds up to an unmatched memory capability...enough for you to provide in-circuit programming and reprogramming control without data loss in power outages.

Unlike other non-volatile memory devices, General Instrument EAROMs provide word erasability. This feature permits select changing of data in system without the time consuming need to erase and rewrite everything each time a change is required.

Our EAROMs, available in many configurations, are being used in control, measuring, recording, metering, and tuning applications, to name but a few.

General Instrument has already shipped over 6-million EAROM devices. That's why we say our EAROMs are: A reality for today, rather than a promise for tomorrow.

For more information, write to: General Instrument Micro-electronics Ltd., Regency House, 1-4 Warwick Street, London W1R 5WB, London, or call 01-439-1891.



**We help you compete.<sup>®</sup>**

# GENERAL INSTRUMENT

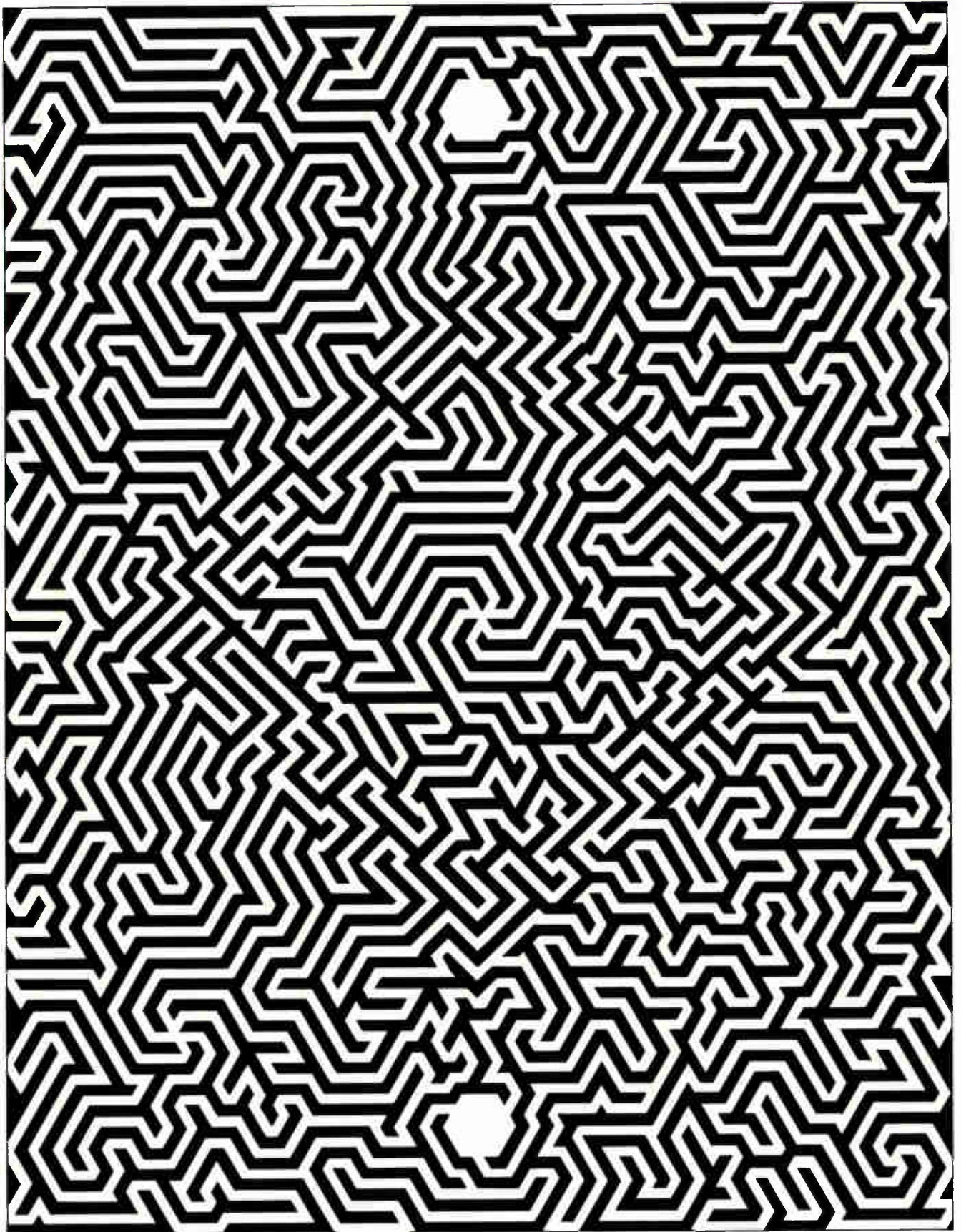

**Test #2.** Start in the hexagon near the bottom, and work your way to the hexagon near the top, without retracing your path. If you feel really confident, use a pen.

# WE'RE HERE TO TEST YOUR CIRCUITS. AGAIN.

Why do more people buy GenRad functional test systems than any other brand? Solving our maze will give you the answer.

It's a fact, you know. More test engineers choose GenRad functional test systems than any other.

The reason? A GenRad system can reduce the time to test and cost to test printed circuit boards better than other functional test systems.

How? Well, when you realize that troubleshooting a circuit board is a lot like solving a maze, you're already headed in the right direction.

## You Need a Systematic Approach.

What's the real trick to getting through a maze as fast as possible? Not wasting time going down dead-end paths. And, that's exactly the advantage a GenRad functional test system offers.



Wouldn't it be great to solve our maze a chunk at a time?

It systematically keeps you on the most direct route through the entire process: From program preparation, and verification, to diagnosing the precise fault.

## The First Step: Interactive Program Prep.

Our software gives you a clear advantage over any other system for program prep. You see, from the start, we made sure that it was well defined and perfectly integrated with the system hardware. But even more important, we've kept right on enhancing it over the years.

In fact, we've just introduced our latest version: CAPS X. It's the product of 15 man-years of development. And unquestionably the most dramatic improvement we've made.

Okay, but what does CAPS X really do for you? Well, for one thing it has Incremental Simulation, which

lets you write a program in small chunks and test each one on the spot. It's like being able to solve our maze one section at a time, eliminating every false path before you move on. (Imagine what a help that would be!)

We also have a terrific Fault Simulator, which allows you to evaluate your test program for typical PC board faults, using software. So, you don't have to wait until you're on the test floor to find out how good or how bad your program is. And nobody has a larger library of functionally modelled IC's than we do. Over 2000 SSI and MSI and over 100 LSI devices.

But let's assume that you've finished your test program. (You're near the end of the maze, right?) But the draftsman goofed drawing the schematic, and you're up against a wall. What now?

With a GenRad functional test system, you don't have to worry. It has Nodal Verification. It'll pick up every inaccuracy that might result from external forces, such as schematic errors, fixturing errors, or even noise "glitches." So when you turn your test program over to production, you know there won't be any hangups.

programming, it eliminates probing devices on the bus that haven't been enabled. And saves a technician the frustration of probing hundreds of irrelevant pins. (If you've gone down a few dead-end paths in our maze, you know what we mean.)



The business end of our DRM module.

Our hardware also has a new enhancement. It's called the Diagnostic Resolution Module (DRM II, actually). And it can test as many as 40 different paths simultaneously. So while other test systems may leave you with a lot of wandering around to do as you get near the fault, our DRM will tell you, not only which node is bad, but what's wrong with it.

## A Final Test of Your Abilities. And a Good Indication of Ours.

Have you solved our maze? Great. We'll send you a wall-sized version, if you write us on your letterhead or enclose your business card.

But what about the next puzzle we throw at you? And what about your next board design? And the next? And the next?

We'd like you to know we're prepared to help. And if we can answer

any more questions about how a GenRad functional test system can reduce your cost to test and time to test, just call or write.

They don't call us the Best in Test for nothing, you know.

You can reach us at 300 Baker Avenue, Concord, Massachusetts 01742. Telephone: (617) 369-4400.



The 1796 Functional Test System.

## The Second Step: Pinpoint Diagnostics.

Our CAPS X software has some new twists that make diagnosing faults faster and more precise. Things like Dual Threshold Probing, Continuity Checking, and Pulse Discrimination.

But, by far the most impressive feature is our Conditional Connectivity Probing. Without additional pro-

 **GenRad**  
THE BEST IN TEST.

Circle 207 on reader service card

Instruments

## Digital scope stores 8-K bytes

Dual-channel unit samples at 10 MHz, detects peaks, has post-storage expansion

A generous 8-k bytes of event storage together with refinements such as split-trace display, peak detection, and post-storage expansion are the selling points of Gould Instruments division's OS4040 digital storage scope. Its basic 10-MHz sampling rate rounds out Gould's digital storage scope line, which had previously extended to 2 MHz on the OS4020.

Like other storage scopes in the Gould line, the OS4040 can be operated as a conventional real-time oscilloscope with a 25-MHz bandwidth before it is switched into the storage mode. Product manager Dick Parish stresses the new scope's storage capacity, which at 8-k bytes can be used to capture and store fast waveforms accurately at full sampling rate or as very slow events occurring over an extended period.

Within the memory, 5-k bytes are allocated to display memory and 3-k bytes to pretrigger memory. In the refresh mode, digitized waveforms stored in the pretrigger memory can be transferred to the display memory

in 10% steps up to a maximum of 60% of the display by push-button selection. In the roll mode, the entire display can be used to display pre-trigger information.

Another feature of the dual-channel storage scope is a split-screen facility whereby up to four sequentially triggered events can be displayed on separate traces. This single-channel multisweep mode allows comparison and analysis of up to three stored traces and one real-time trace. Alternatively, in the dual-channel mode, two stored and two real-time traces can be compared.

**Peak enveloper.** One other addition is a peak-detection facility that prevents very fast signals from being missed when the instrument is operated at low sweep rates (below 50  $\mu\text{s}/\text{cm}$ ). Ambiguous operation known as aliasing, which can occur in any digital sampling instrument, is prevented by the scope's display of an envelope of the waveform that gives the maximum excursions during the measurement period.

The OS4040 incorporates switched expansion in the X direction, permitting waveform details to be analyzed at up to 20 $\times$  expansion in the storage mode and 10 $\times$  in the normal mode. A further 2.5 $\times$  variable expansion is available to display finer details.

Comprehensive trigger controls allow stable triggering of even the most complex input waveforms, and a dual-slope feature ensures that transients of either polarity will trig-

ger the oscilloscope if they exceed a predetermined level. The stability of trigger operation results from the use of a sophisticated wideband trigger circuit that enhances operation in the normal mode.

Options available on the OS4040 include an analog output unit suitable for use with X-Y or strip-chart recorders and a parallel digital output suitable for direct interface to the input/output port of a microprocessor or data-handling system.

Gould Instruments Division, 7 Roebuck Rd., Hainault, Ilford, Essex IG6 3UE, England [351]

Gould Inc., 10 Gould Center, Rolling Meadows, Ill. 60008 [352]

## Digital unit logs data on fluorescent display and paper

Designed as a process monitor and test instrument, the Digital Data Logger is intended to serve as an alternative to the standard strip-chart recorder, accelerating the analysis of results in automatic data monitoring. The machine shows data on a bright vacuum fluorescent display and records it on standard 2 $\frac{1}{4}$ -in. paper tape. It features analog-to-digital conversion and programmable data-capturing intervals. A real-time clock helps document data with the day, hour, and minute of the recording. The instrument also features programmable high and low set points for an audible alarm when incoming data exceeds those values.

Applications for the Digital Data Logger include the measurement

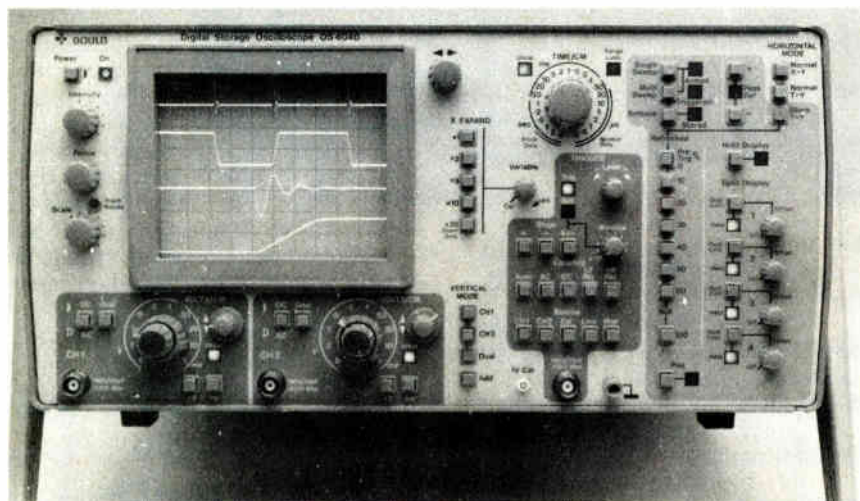

# LINEAR



Linear goes leadless ...

## Leadership linear products. Now in leadless chip carrier packages. From Texas Instruments.

Op amps, comparators, regulators, drivers and receivers — all these popular linear products are available right now in LCCCs (Leadless Ceramic Chip Carriers).

### Increased package densities

One-sixth the surface area, one-twelfth the weight of conventional DIPs, TI's

square-shaped, 100-mil thin, single-layer JEDEC standard type "C" LCCC features contacts with 50-mil center spacing.

TI is currently offering linear chip functions in the 20-pin (contact) LCCC package. The device types include TI's very popular TL064 low power and TL074 low noise quad BIFET op amps.

### Military processing

Linear devices in LCCCs can be processed to MIL-STD-883B Level B requirements with 100% testing, burn-in and AC/DC characterized.

### Future designs — now

Since chip carriers reduce overall system costs they can be designed in cost-effectively, now. Forward-looking designers are looking at chip carriers for future designs as well as for projects in the early design stages.

### Call for fast delivery

For more information about microcomputer functions in chip carrier packages, watch for our next ad. For details, pricing and availability, or to order linear functions in chip carriers, call (915) 685-6711, or write to Texas Instruments Incorporated, P.O. Box 225012, M/S 308, Dallas, Texas 75265.



### POPULAR DEVICE TYPES AVAILABLE NOW

LINE CIRCUITS		OP AMPS		COMPARATORS	SWITCHING REGULATORS
SN55110FC	SN55183FC	LM101FC	TL088MFC	LM111FC	SG1524FC
SN55113FC	SN55188FC	LM124FC	TL288MFC	LM139FC	
SN55114FC	SN55189AFC	TL064MFC	UA741MFC	TL514MFC	SPECIAL FUNCTIONS
SN55115FC	DS7831FC	TL071MFC	UA747MFC		
SN55138FC	DS7832FC	TL072MFC		<b>CORE MEMORY</b>	SE555FC SE556FC TL441MFC UA723MFC
SN55182FC		TL074MFC		SN55325FC	
				SN55326FC	
				SN55327FC	

©1981 Texas Instruments Incorporated

# TEXAS INSTRUMENTS

829271

ARGENTINA 748-1141 • AUSTRALIA (02) 887-1122 • BELGIE/BELGIQUE (02) 720.80.00 • BRASIL 518423 • DEUTSCHLAND 08161/801 • FRANCE (3) 946 97 12 • ITALIA (0746) 69034  
JAPAN 03-498-2111 • MEXICO 567-9200 • NEDERLAND 020-473391 • SCHWEIZ/SUISSE 01 740 22 20 • SVERIGE (08) 23.54.80 • UNITED KINGDOM (0234) 67466

World Radio History

Circle 126 on reader service card

# ASTRO-MED

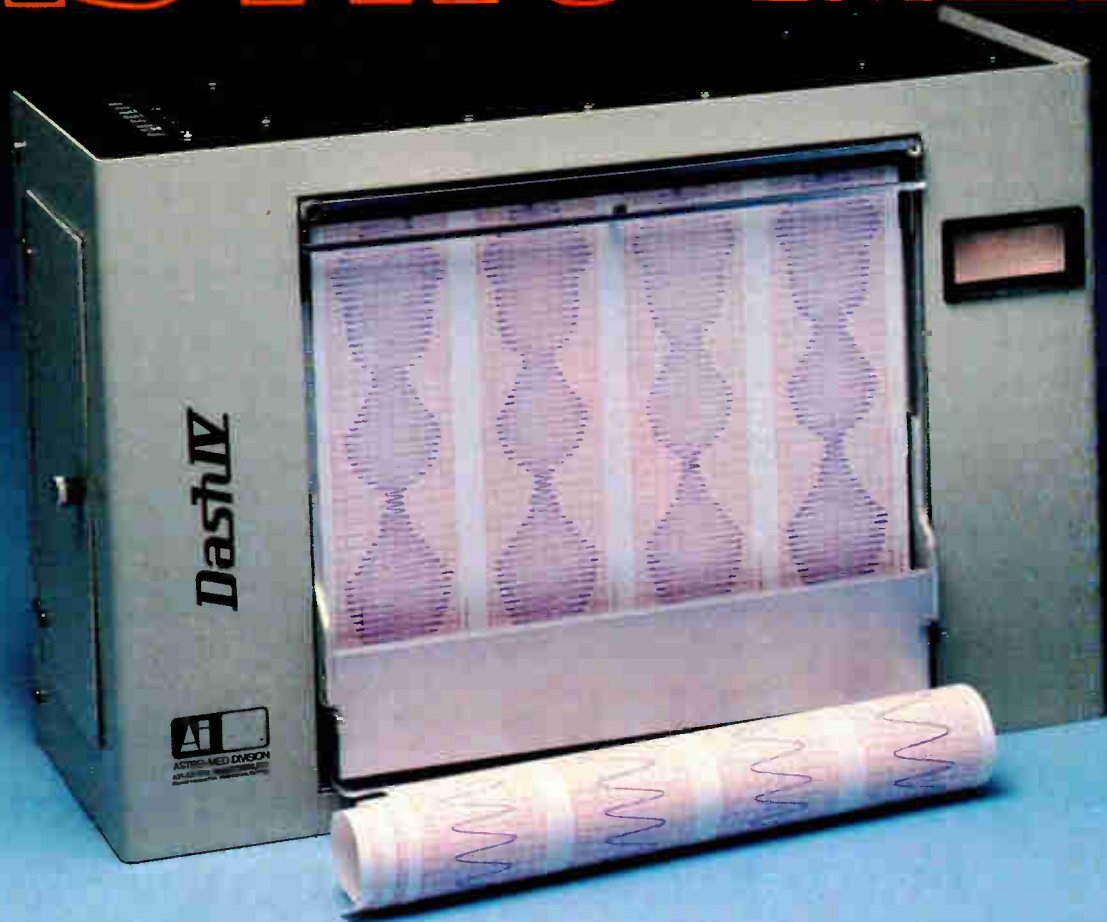

## FOUR CHANNEL GRAPHIC RECORDER

with exclusive  
*AUTOMATIC TIME and DATE PRINTING*

The Dash IV is a highly advanced Recorder with position feedback galvanometers for recording data from DC to well over 100 Hz inklessly. It has four 50 mm wide analog channels along with automatic time and date printing. Time is continuously displayed on front panel LED along with hard copy printing of time and date right on the chart as you record!

*Telephone, telex, or write for complete details.*

### All of these special features are Standard!

- Automatic Digital Printing of Time & Date.
- Pathfinder™ Position Feedback Galvanometers.
- Multi-Speed Chart Drive with 8 speeds from 5 mm/min to 100 mm/sec.
- Cartridge Chart Load System — low cost thermal paper via easy-load cartridge.
- Compact & Complete — lightweight & rugged for lab or field (115 or 230 VAC, 60-50 or 400 Hz).



ASTRO-MED DIVISION  
ATLAN-TOL INDUSTRIES, INC.  
Atlan-tol Industrial Park/West Warwick, R.I. 02893  
(401) 828-4000/TWX No. 710-382-6409

Circle 210 on reader service card

## New products

and monitoring of processes that involve electric current, pH, temperature, or conductivity. The price of the instrument is \$399.

Electronic Controls Design, 13626 S. Freeman Rd., Mulino, Ore. 97042. Phone (503) 829-9108 [354]

### Ac amplitude, frequency standard has GPIB control

The model 4500 sine-wave amplitude and frequency standard is a fully programmable unit that can be controlled via the IEEE-488 bus or by serial (ASCII) or parallel format. All functions can also be controlled manually; the standard's memory continuously stores new program commands while the instrument is in the manual mode.

The instrument's frequency is variable from 10 Hz to 110 kHz and resolved to 0.01% in four ranges. The accuracy of the frequency in the worst case is to within 0.001% and has a 24-hour stability of to within 0.0005%. The amplitude is also programmable from 100  $\mu$ V root mean square to 100 V rms in six ranges resolved to 1 ppm (0.0001%). The output's amplitude accuracy is to within 0.04% of the setting and remains stable to within  $\pm 0.005\%$  for 24 hours.

The instrument will deliver a load current of up to 50 mA by way of four-wire remote sensing. There also is an auxiliary square-wave output that is compatible with TTL or complementary-MOS logic.

The 20-lb unit is 19 by 14.2 in. and costs \$4,995. It is on display at Electro/81.

Electronic Development Corp., 11 Hamlin St., Boston, Mass. 02127. Phone (617) 268-9696 [353]

### Portable data-line monitor performs real-time analysis

For use in the designing and diagnostic testing of data-communications systems and peripherals, the model VP-3680A portable data-line

monitoring oscilloscope is able to translate, analyze, and display frame- and packet-level data links or simulate system hardware and software components in real time. For packet-switching networks, the scope takes the data contained in a packet header, translates it into mnemonic format, and displays it on a high-resolution 8-in. cathode-ray tube, according to the CCITT X.25 protocol. Easy to operate, the unit can provide selective traces and program triggers. Hard copies are possible through a video-printer interface.



The 14-kg on-line monitor has a standard RS-232-C interface, and accessories are available for other interfaces. The list price starts at \$25,000. Delivery will begin in the second half of the year.

Matsushita Communication Industrial Co., MTC Division, 2446 Watson Ct., Palo Alto, Calif. 94303. Phone R. P. Raskowitz at (415) 856-0300 [355]

### DMMs take rms readings from 20 Hz to 2 kHz

Three broadband digital multimeters to be introduced at Electro/81 read true root-mean-square current, voltage, and power. The model 240 is a portable battery-powered unit that has a clamp-on current input, autoranging, and the ability to read power factor directly in situations where wave shapes are highly non-sinusoidal. Accuracies to within 1% are possible for inputs of 20 and 2,000 Hz. The unit handles currents of 2 to 200 A and voltages of 20 to 500 V. Full-scale power outputs are from 200 W to 200 kW. It sells for \$725.

The model 259 is a dc-coupled

meter with both ac and dc transfer-standard and direct-measurement capabilities. As a transfer standard, it allows comparisons to within 0.1% between dc and ac inputs from dc to 20 kHz. As a direct-measuring instrument for ac or dc inputs below 20 kHz, the basic accuracy is to within 0.05% of reading  $\pm 0.1\%$  of the range. It costs \$2,145.

The model 260 extends the measurement capability of these multimeters to 1 MHz. It comes with both fixed and selectable ranges of current, voltage, and power and sells for \$500 to \$2,500, depending on the accuracy, the type of output, and the number of ranges required. Some of the meters have optical isolation for remote operation and IEEE-488 bus compatibility. Delivery on any of the three takes 30 to 60 days.

Clarke-Hess Communication Research Corp., 156 Fifth Ave., New York, N.Y. 10010. Phone (212) 255-2940 [356]

### \$2,100 X-Y recorder reaches slewing speed of 60 cm/s

Costing only \$2,100, a medium-performance X-Y recorder, the 3052, offers features often found in more-expensive, high-performance units, such as a slewing speed of 60 cm/s. Top acceleration is 3,800 cm/s<sup>2</sup> in the X direction and 2,100 cm/s<sup>2</sup> in the Y. A felt-tip pen mechanism that prevents skipping ensures writing quality.

In addition, the 3052 offers as standard several features usually found only as optional add-ons in most mid-range recorders, says the maker. These include switchable input filtering, preamplifier-polarity reversal without manual lead switching, electronic signal limiters, remote-control cycling, and easy access for calibration. Hardware is provided for rack mounting. The standard time-base module for the recorder is a \$250 option for making strip-chart plots. Delivery of the instruments takes 60 days from receipt of an order.

Gould Inc., Instruments Division, 3631 Perkins Ave., Cleveland, Ohio 44114 [357]

# Chemicals for high technology

Epoxy Resins and Curing Agents  
FREON® Cleaning Solvents  
Flux Removers  
Epoxy Stripper  
Release Agents  
Conformal Spray Coatings  
Epoxy Diluents and Additives  
Epoxy Kits  
Aerosol Cleaners

You know us for our high purity aerosol cleaners, used to assure system reliability. We also offer a wide range of other chemicals for the changing needs of the electronic industry. In fact, Miller-Stephenson offers over 300 products in a variety of convenient containers.

All of these specialty chemicals are produced under careful quality control and many of them exceed military and government specifications. We believe the purer our product, the better the performance of your product.

For specifications, write Miller-Stephenson Chemical, Danbury, Conn. 06810 or call (203) 743-4447.

*25 years of keeping pace with technology*



**miller-stephenson  
chemical co., inc.**

TORONTO • LOS ANGELES • CHICAGO • DANBURY



FREON is Du Pont's registered trademark for its fluorocarbon compounds.  
EPON is a registered trademark of Shell Chemical Company.

Circle 212 on reader service card





# Color is Coming!

## For high performance CRT displays

Yes. Right here in America we are working hard on developing deflection yokes for industrial/commercial and military color CRT display applications where quality and performance are more important than mass production.

Color displays are many times more complex than monochromatic displays because of the critical interface between CRT, yoke and circuitry. And quality displays are too demanding for conventional color TV type yokes.

For several years Syntronic Instruments, Inc. has been working with major international manufacturers of full-color shadow mask tubes to develop high performance color yokes.

With a unique blend of teamwork between display designer, CRT designer and our experienced deflection yoke engineers we are meeting the challenge of high brightness, high resolution, high speed and pure, accurate, full color. Typical areas of

development are high speed graphic terminals, flight simulators and cockpit displays.

Syntronic is ready to team up with your display engineers to develop a high performance color yoke for your application.

Call Dave Brown at 312-543-6444 for more information.



**See us at  
Booth 610  
SID '81**



**Precision yokes for exacting displays**

Syntronic Instruments, Inc. 100 Industrial Road, Addison, IL 60101 312-543-6444

Communications

## Fiber-optic link sends data 150 m

---

Interchangeable parts of 10-Mb/s link come assembled or separately for custom use

---

The CL10 fiber-optic data-link system from Augat is a complete line from which users can select several preassembled combinations or opt for individual components for customized configurations. Using a low-cost, flame-retardant fiber-optic cable, the CL10 system has a data-rate capability of dc to at least of 10 Mb/s (14 Mb/s is typical) over distances of up to 150 meters.

"Our system parts are interchangeable, so a user whose needs don't call for a complete transmitter, say, can buy emitter or driver assemblies separately," says Robert A. Wey, Augat's manager of fiber optics technology. He says the CL10 system will aim at original-equipment manufacturers of data-communications links and of industrial and process-control networks.

The CL10's TTL-compatible transmitter includes a built-in optical connector and uses an emitter that yields 38  $\mu\text{W}$  when coupled to the fiber. Also available separately is an

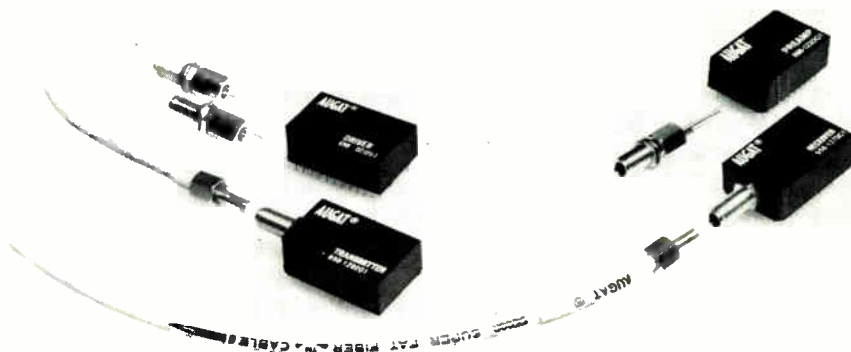

emitter for shorter distances—up to 50 meters—providing 12  $\mu\text{W}$  coupled to the fiber. Both emitter assemblies operate at an 880-nm wavelength. A driver assembly operates in the shunt mode and uses a single +5-v power supply.

**Light power.** The CL10 receiver, or detector and preamplifier together, respond to 2.5  $\mu\text{W}$  of light power at the input, yielding a bit-error rate of less than  $10^{-9}$ . The preamplifier is TTL-compatible; the detector includes a photodetector and a temperature-reference diode.

The system uses a single-fiber cable manufactured by Siecor Optical Cables Inc. in Hickory, N.C. The Siecor 155 cable contains a large-core, all-glass fiber with a numerical aperture of 0.4 [*Electronics*, Nov. 8, 1979, p. 274]. The highly flexible, 3.8-mm-diameter cable

meets Underwriters Laboratories standards for flame retardation, according to technology manager Wey. "So as well as transmitting data reliably and safely in noise- and electricity-filled environments, the cable can make connections throughout a building without the need for protective conduits."

The maximum optical attenuation of the cable is 37 dB/km. The cable comes preterminated with Augat 123 connectors and operates from  $-30^{\circ}$  to  $+70^{\circ}\text{C}$  with less than 2 dB/km of additional attenuation.

The top price for a preassembled CL10 data-link package is \$148 in 100-unit lots; the system's cable assembly costs \$1.65 per meter. Delivery is from stock.

Augat Inc., 33 Perry Ave., P. O. Box 779, Attleboro, Mass. 02703. Phone (617) 222-2202 [401]

---

## Microwave unit gains sensitivity

---

Spectrum analyzer performs digital averaging, has cleaner local-oscillator signal

---

Although most progress in measuring microwave signals is incremental, Hewlett-Packard's model 8569A is a collection of these increments that represents a new generation for HP's second-most sophisticated mi-

crowave spectrum analyzer. It is most likely to compete with the Tektronix model 492 with programmable option 123 or with the Eaton/Ailtech model 757. At \$26,500, the 8569A costs significantly less than HP's most sophisticated analyzer, the \$55,000 8566A. It also has a number of advantages over its closest predecessor, the 8565A.

As on other HP 8560 family members, the three knobs of the 8569A enable its user to tune to a signal, decrease the frequency span, and set an amplitude level with successive adjustments. Its list of advantages

over the 8565A includes a built-in IEEE-488 interface and software by means of which the analyzer can drive a plotter directly, without taking up the IEEE-488 controller's time. The 8569A has also an added digital display and two digital traces. The alphanumeric instructions, displays of parameter settings, and user prompts are above the graticule on the cathode-ray tube. The analyzer also offers a newly developed optional set of comb generators that extend to 22 GHz. Frequencies of up to 170 GHz can be reached through the use of external mixers.

Thanks to the microprocessor em-

# High density digital recording with fingertip control of data rate and density.

With Honeywell's new HD-96, you can instantly program data rate and packing density at the touch of a thumbwheel, and record or reproduce high density digital data *without recalibration*.

Other major features of our new High Density Digital Magnetic Tape Recorder include:

- Automatic equalization
- Tape speed continuously variable from 1-7/8 to 240 ips
- Programmable data rates from 26 kbps to 160 Mbps
- Data processor clock tracking for bit rate control during reproduce

The advanced features of the HD-96, combined with the proven tape handling of Honeywell's Model Ninety-Six transport, 3,000-hour ferrite heads, built-in self-test, low-cost error correction, complete track format flexibility from 4 to 28 tracks, remote control, and auxiliary analog data channels, now provide a new and superior approach to high density digital recording.

To answer your questions on how Honeywell can meet your requirements, call Charlie Castle or Leighton Meeks, (303) 773-4700, or write Honeywell Test Instruments Division, Box 5227, Denver, Colorado 80217.

## WE'LL SHOW YOU A BETTER WAY



# Honeywell

Circle 215 on reader service card

## New products

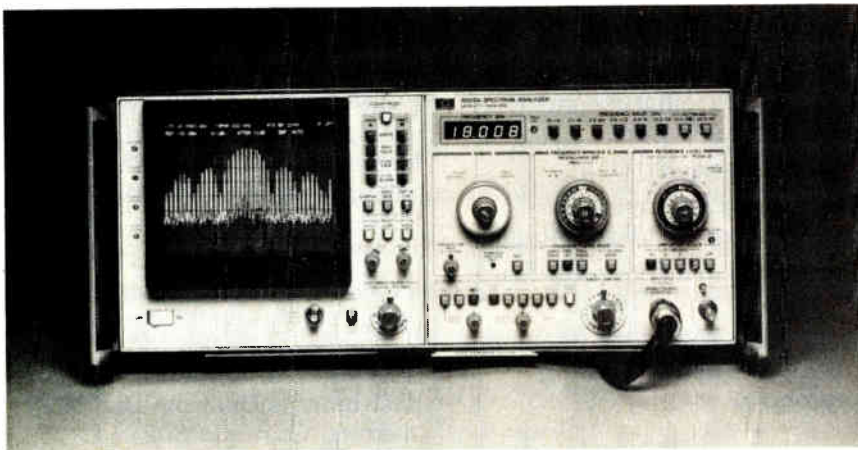

bedded in it, not to mention the digital display and storage of trace information, the analyzer can average display signals digitally. This digital averaging can make as much as an 8-dB difference in extracting some signals from their surrounding noise. The analyzer can also perform digital averaging on a difference of traces (A minus B). Some of this averaging had been done previously by using video averaging techniques, but digital averaging has the advantage of not slowing down the sweep speed—a drawback of video filters.

**Low noise.** The 8569A contains a tracking generator that can handle frequencies of up to 1.5 GHz. Its resolution for each trace is 480 points horizontally and 800 points vertically. Its sensitivity at 18 GHz of  $-95$  dBm is a 12-to-15-dB improvement upon the 8565A over that bandwidth. A contributing factor to this is that the local oscillators used in the 8569A are 5 dB cleaner than those used in the 8565A. For fundamental mixing the 8569A achieves sensitivities of  $-113$  dBm using a 1-kHz bandwidth.

The frequency response is within  $\pm 3$  dB over the dynamic range up to 1.8 GHz. In the preselected bands, from 1.7 to 22 GHz, dynamic range exceeds 100 dBm. The 3-MHz analog bandwidth of the analyzer itself, which is an improvement over the 300-kHz analog bandwidth of the 8565A, allows for pulses of greater bandwidth, which result in better signal-to-noise ratios.

The digitization of the trace-memory data allows the reentry of a ref-

erence waveform from the IEEE-488 controller. This is useful in charting the history of a system and in tweaking it back to a previous standard. In data-logging applications, it is helpful that the 8569A can store and redisplay control settings along with the trace data. When fed back into the analyzer, control setting information can also be displayed in the form of knob-setting and key-pressing instructions.

The 8560A has a maximum hold feature that lets the user see the drift of a signal. It also has automatic sweep-time control and displays an "uncalibrated" warning to the user if the sweep is too fast. In addition, it can display limit parameters as shaded regions, indicate that a trace update is not complete, and warn the user of invalid settings. First deliveries of the 8569A will be in April.

Hewlett-Packard, 1501 Page Mill Rd., Palo Alto, Calif. 94304. Phone (415) 857-1501 [351]

### I-f chip recovers audio in narrowband fm receivers

The MC3359 low-power fm intermediate-frequency circuit handles narrowband fm signals with the aid of an external 455-kHz ceramic filter. It includes an oscillator, mixer, limiting amplifier, automatic frequency control, quadrature detector, squelch, scan control, active filters, and mute switch.

The unit has the high gain and low power consumption needed for nar-

rowband fm receivers and transceivers found in voice communications and energy-management and replaces many discrete components normally used in similar systems, thereby reducing overall costs. Typical audio-output voltage of the circuit is 700 mV, current drain remains low at 3.0 mA (typical) from a 6.0-v dc power supply, and sensitivity is 2.0  $\mu$ V (typical) for a  $-3$ -dB input-limiting switch.

Available in an 18-pin plastic dual in-line package, the integrated circuit is priced at \$2.25 in 100 to 999 quantities and is available immediately from stock.

Motorola Semiconductor Products Inc., P. O. Box 20912, Phoenix, Ariz. 85036 [403]

### Fiber-optic STD bus card has high noise immunity

The model STD-211 card, with a single duplex-channel fiber-optic serial input/output port, transmits data in electrically noisy environments over the STD bus. The top of the card has separate transmit and receive fiber-optic connectors that are compatible with a wide variety of optical fibers. Fiber-optic cables up to 2.4 km in length with mating connectors are available from the manufacturer.

The STD-211 operates at programmable bit rates of from 75 b/s to 38 kb/s. It can be used in systems with separate mating fiber-optic transmitters and receivers or with a second serial fiber-optic card. The unit meets all mechanical and electrical standards for the STD bus; is compatible with Z80, 8080, and 6800 systems; and operates on a  $+5$ -v and  $\pm 12$ -to- $18$ -v power supply. It has a 450-ns access time (250 ns optional) and is software-programmable for from 5 to 8 bits of resolution per character.

Available in a kit containing two 10-m fiber-optic cards and two cables and user documentation, the STD-211 sells for \$2,495.

IGC Intermagnetics General Corp., P. O. Box 566, Guilderland, N. Y. 12084. Phone (518) 456-5456 [404]

# Mallory tantalum capacitors earn top MIL reliability ratings.

In solid tantalums, Mallory is now qualified to provide Level S, the highest reliability rating, for styles CSR 13 and CSR 91. Level S, under MIL-C-39003, means a life failure rate of only 0.001% per 1,000 hours. Here is our current QPL line-up in solids:

MIL Style	Mallory Type	Life Failure Rates
CSR13	TER	M, P, R, S
CSR23	TXE	M, P, R
CSR33	TXR	M, P
CSR91	TNR	M, P, R, S

In wet slug tantalums, we have become the first source qualified at Level R, under MIL-C-39006, for style CLR69 — the extended capacity range wet tantalum, which makes our wet QPL list look like this:

MIL Style	Mallory Type	Life Failure Rates
CLR10	XTM-XTK	L, M, P
CLR14	XTL-XTH	L, M, P
CLR17	XTV	L, M, P
CLR65	TLX	L, M, P, R
CLR69	TXX	L, M, P, R

They're all available from authorized Mallory Distributors. Send for our latest QPL bulletins. Mallory Capacitor Division, Mallory Components Group, P.O. Box 372, Indianapolis, Indiana 46206. (317) 636-5353.

# MALLORY

ELECTRICAL / ELECTRONIC GROUP

## EMHART

# "Pascal-1 helps our customers meet complex, real-time needs."

Don Cutler, Chief Systems Engineer,  
Electro Scientific Industries, Inc. (ESI), Portland, Oregon

More than 125,000 microcircuit resistors per hour can be adjusted by ESI's PDP-11/04 controlled laser trimming systems. The Pascal-1 compiler has given ESI fast, precise control since 1976. ESI's Don Cutler says, "Pascal-1 offers two big advantages—real-time performance and real problem-solving power."



**Left:** Pascal-1 controls ESI's laser trimming system. The laser repairs semiconductor memory chips, replacing faulty cells with alternates.

**Below:** ESI dominates the industry in the computer-controlled laser adjustment of microcircuits. Pascal-1 programming flexibility gives ESI access to many different markets.



## Precise control in milliseconds.

Controlling a laser beam 4 to 8 microns in diameter, the ESI system moves the laser beam positioner at accelerations up to 3.5 G's, directs a trim cut, and decides where to go next, fast enough to trim 35 resistors per second. The Pascal-1 programs directly control all aspects of the trimming system. Some ESI customers use the laser trimmer to adjust the circuits of such devices as air flow transducers, audio filters,

and heart pacers, with the microcircuit activated to simulate operation. Pascal-1 handles these processes with speed and precision.

## Easy-to-follow programming.

Writing correct code is easy because of the logical structure and clarity of

the language. ESI engineers save design and debugging time by writing control software in Pascal-1. ESI's customers also apply Pascal-1 to their own specialized production processes.

## Free case study.

Read why ESI, one of Oregon Software's 1700 customers, chose Pascal-1. Order your free copy of this eight-page case study by calling Oregon Software collect at (503) 226-7760 or by using the reader service card.

# Oregon Software

2340 Southwest Canyon Road  
Portland, Oregon 97201  
(503) 226-7760 • TWX 910-454-4779

**DISTRIBUTORS:** Australia: Network Computer Services, Sydney/Tel: 290-3677 England: Real Time Products, London/Tel: 01-588-0667 Holland: N.H.C.S., B.V., Haarlem/Tel: 023-234951 Japan: Rikei Corporation, Tokyo/Tel: 345-1411 West Germany: AC Copy, Aachen/Tel: 0241-506096 West Germany: Periphore Computer Systems GmbH, Munchen/Tel: 089-681021

# Surprise!

The most powerful computer on a chip—a Hewlett-Packard development. Capable of processing 32 bits simultaneously, this 450,000 transistor chip is faster and more powerful than many mainframes.

# No Surprise!

Because at Hewlett-Packard performance is measured by results.

You can help create products that will be tomorrow's breakthroughs. Take the first step by contacting any of the HP Divisions listed below.

HP's new miracle chip.

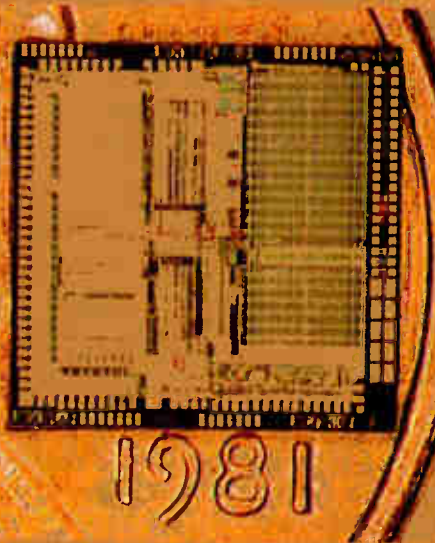

### Colorado Springs Division's

IC facility designs and manufactures many solid state devices including high frequency analog ICs, high complexity digital bipolar ICs, and thick film and hybrid microcircuits. We're looking for the following people to contribute to our development and production of high-speed, high-complexity bipolar processes:

BIPOLAR IC PROCESS ENGINEERS  
THICK FILM HYBRID PROCESS ENGINEERS

Send your resume in confidence to:  
Hewlett-Packard Company, 1900 Garden of the Gods Rd., Colorado Springs, CO 80901.

### Desktop Computer Division is in

Fort Collins, Colorado, just 65 miles north of Denver, in the shadow of the Front Range of the Rocky Mountains. Our in-house IC facility designs and manufactures N-Channel (NMOS) processors, ROM and LSI random logic chips and various thin film products including thermal print heads and hybrid circuits. We're looking for:

IC PROCESS ENGINEERS  
IC DESIGNERS  
MECHANICAL ENGINEERS  
ELECTRICAL ENGINEERS

Send your resume in confidence to Gale Hamelwright, Desktop Computer Division, Dept. 20, Hewlett-Packard Company, 3400 East Harmony Road, Fort Collins, CO 80525.

### Cupertino Integrated Circuit

**Operation** currently manufactures its ICs in CMOS-SOS technology. We produce more than twenty different products, including microprocessors, memories and interface circuits. We are also currently installing a state-of-the-art IC processing facility for bulk NMOS technology geared for the production of random logic and memory circuits for HP computer systems and peripherals. We are looking for:

TEST ENGINEERS  
PROCESS ENGINEERS  
DESIGN ENGINEERS  
FACILITIES ENGINEERS  
PRODUCT ENGINEERS  
TECHNICIANS

Send resume in confidence to Eileen Collins, Hewlett-Packard Company, 10900 Wolfe Rd., Cupertino, CA 95014.

**HP Laboratories** (the corporate research division) has contributed to the success of Hewlett-Packard through early, state-of-the-art work in solid state materials, devices, circuit design, and applications. This contribution continues with our current work on LSI and VLSI. We work in all of the technologies used by HP, which includes Bipolar, CMOS, NMOS, and GaAs, as well as others. We're looking for engineers to work in:

IC DESIGN  
DEVICE PHYSICS RESEARCH  
SEMICONDUCTOR PROCESSING RESEARCH

Send your resume in confidence to Brent G. Thompson, Dept. 900, Hewlett-Packard Laboratories, 3500 Deer Creek Road, Palo Alto, CA 94304.

**Corvallis Division** is located in the scenic Willamette Valley just 50 miles from the Pacific Coast and the Cascade Mountains. Help us to develop and support advanced LSI, VLSI and thin film technologies to include:

CMOS/NMOS PROCESSING  
CIRCUIT DESIGN  
CAA/CAD  
TESTING SYSTEMS AND METHODOLOGY

Send your resume in confidence to Hewlett-Packard Company, Dept. 1210-CRI, 1000 NE Circle Blvd., Corvallis, OR 97330.

### Loveland Instrument Division,

located in Loveland, Colorado, resides in a semi-rural setting within easy reach of major cultural and educational activities. The technologies range from high-speed LSI chips to precision analog processing chips utilizing NMOS, CMOS, bipolar and JFET technologies. Additional processes include thin film LSI resistor network chips produced on sapphire wafers, multi-chip hybrid processes, and advanced efforts in CAA/CAD and testing technologies. We're looking for:

BS/MS ELECTRICAL ENGINEERS  
BS/MS MECHANICAL ENGINEERS  
MS MATERIALS SCIENCE

Send your resume in confidence to Hewlett-Packard Company, Loveland Instrument Division, Professional Employment Manager, Box 301, Loveland, CO 80537.

### Microwave Semiconductor

**Division's** major products include power MOS transistors, RF and microwave Schottky diodes, bipolar transistors, GaAs Fets, and integrated components based on these devices. We presently have openings for engineers in the following technical areas:

BIPOLAR DEVICE/PROCESS DEVELOPMENT  
POWER MOS DEVICE/PROCESS PROJECT MANAGEMENT  
MICROWAVE DIODE PROCESS/DEVICE DEVELOPMENT  
SEMICONDUCTOR DEVICE PACKAGING AND ASSEMBLY DESIGN

Candidates should have an MS or Phd in relevant disciplines. Send your resume in confidence to Shelly M. Okuno, Hewlett-Packard Company, 350 West Trimble Rd., San Jose, CA 95131.



## HEWLETT PACKARD

We are an equal opportunity/affirmative action employer.

Packaging & production

## Unit's ROM stores personality data

Programmer handles most types of programmable chips, needs no personality hardware

Although it is not the first system to utilize software techniques to program semiconductor memories, Citel Inc.'s system 37 appears to be the most versatile. Unlike competitive offerings, most of which rely on expensive and cumbersome personality modules, the system 37 is not limited to programmable read-only memories and erasable PROMs. The "nearly universal" system, as its developers describe it, can be used for virtually all programmable semiconductor devices.

The system 37 consists of a central controller, which also programs n-channel MOS E-PROMs, and four expansion modules. These peripheral units extend the programming capability to electrically erasable PROMs (both floating-gate and metal-nitride-oxide-semiconductor types), PROMs, programmable logic devices, and even programmable microprocessors and input/output devices,

whether fabricated in n-MOS, complementary-MOS, or bipolar technologies. There is no need to calibrate the programming system, once it has been "factory-tuned."

Based on an 8-bit 8080 microprocessor, the central controller houses 8-K by 8 bits of static random-access buffer memory (expandable to 16-K or 32-K bytes), a large dot-matrix alphanumeric display, a keyboard for entering commands and data, an RS-232-C serial interface with modem handshaking capability, and a 16-bit bidirectional parallel interface. It can program n-MOS E-PROMs from 4-K (512 by 8 bits) through 256-K (32-K by 8 bits) in size, selectable by a thumbwheel switch for any industry-standard 24- or 28-pin configuration. "The personality information for the different device types is coded in software, thus making personality hardware obsolete," states Ron D. Wilfong, who is in charge of engineering and development at the new Sunnyvale, Calif., manufacturer.

The internal software in the programming system provides complete memory editing capability, seven checksums, a self-test provision that is exercised automatically on power-up, remote control, 16 communications formats (12 standard and 4 custom), and "an upgrade path for programming advanced devices," Wilfong says. In the self-test mode,

the display shows the results of the keyboard and standard (IEEE) memory tests, as well as selected data rates (from 50 to 4,800 b/s), parity, the number of stop bits, word length, translation format, and device type. The display will read out more than 40 concise and clear messages after each command is entered, "eliminating time-consuming searches through manuals for error codes" and, Wilfong says, keeping the operator constantly aware of the status of the programmer.

**Remotely controllable.** According to Wilfong, the optional (\$185) remote-control feature lets any keyboard function be entered in the system 37 via its RS-232-C link. The 16-bit parallel interface is used for communicating with the system's expansion modules or with a custom user interface. "The extensive remote-control capabilities make the system 37 ideal for interfacing with computers and microprocessor development systems," he continues.

The four peripheral units include: the CP37-1, for programmable array logic and field-programmable logic arrays; the CP37-2, for EE-PROMs, C-MOS E-PROMs, and programmable microprocessors and I/O devices; the CP37-3, for programming all types of bipolar PROMs; and the CP37-4, used for gang programming of as many as 16 n-MOS E-PROMs.

"These modules have been designed to use all of the features of the central controller while containing personality data for the appropriate devices within the expansion modules. This architecture," says Wilfong, "allows an upgrade path for future devices that requires simply changing a ROM chip in the module without modifying the main unit in any way."

Citel has developed a fifth peripheral unit, designated the CP37-5, which is a stand-alone universal master/slave version of the CP37-4 gang programmer. This unit does not communicate with the system 37, but simply duplicates a master E-PROM on up to 16 E-PROMs. It has no buffer memory or editing capability and is intended for high-volume applications.





# Introducing MYCRON 2000

## MYCRON High Level Bus Interface

(multi-drop, high speed, parallel)

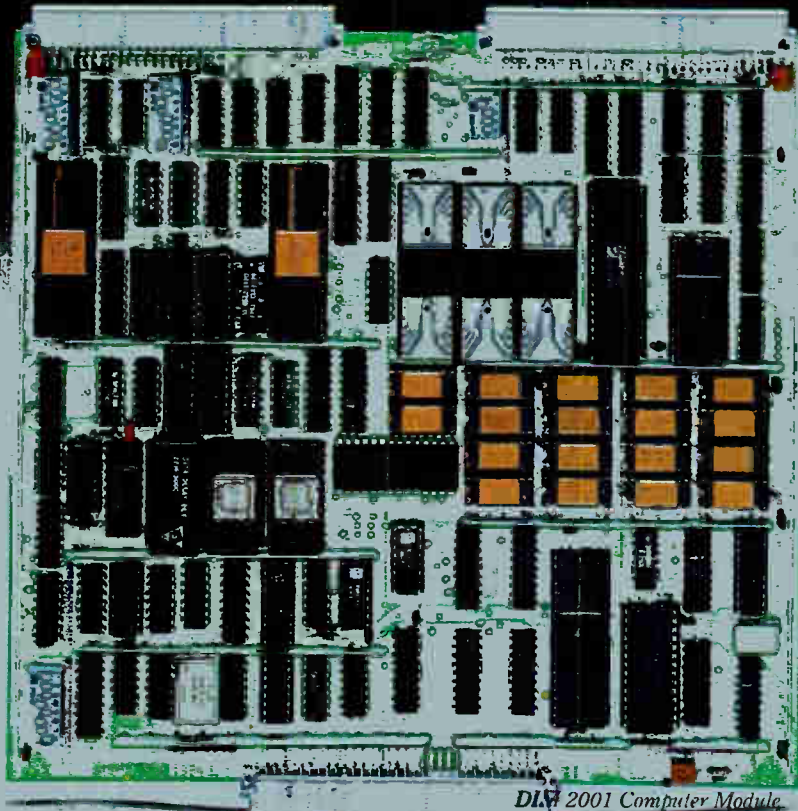

DMA  
Controller

Floppy Disk  
Controller

8 KByte  
EPROM

Local Bus  
Extension  
(for more I/O  
and Memory  
up to 1 MByte)

User  
definable  
8 Bit Switch

System Status  
LED-array

4 Channel  
Counter/Timer

Zilog PIO

6 Channel USART  
(Zilog SIO)

8086 CPU

8 Level Interrupt  
(Intel 8259)

*DIM 2001 Computer Module*

In 1974 MYCRON offered you the world's first complete 8080 microcomputer on one board. Now we introduce a set of 16-bit modules with the power of a minicomputer. A flexible multiprocessor configuration is obtained with the Dual Bus System: A Local Bus plus an Integrated High Level Bus.

Hardware and supporting software available within 90 days:

- DIM 2001 CPU Module (max. 128 KByte RAM)
- DIM 2010 Memory Module (max. 512 KByte ECC RAM)
- MP/M<sup>®</sup> Operating System with Debugger and Utilities
- QEDIT Editor
- PASCAL and PL/MYCRO Compilers

- MYCRON File System
- IBM 3780 for Remote Job Entry

Modules available later this year:

- DIM 2002 8 Channel Communications Module
- DIM 2003 Heavy Duty Processor Module
- PL/1<sup>®</sup> Compiler
- IBM 3270 for On-Line Communication

These modules are a part of MYCRON 2000 Multiprocessor Computer System. For detailed information, contact: A/S MYCRON, P.O.Box 6199, Etterstad, N-Oslo 6, Norway. Telex: 18384 n.

# MYCRON

Innovation in Computer Business

Price examples ex. works (delivery 60-120 days ARO): DIM 2001 CPU qty. 5 \$ 5600, qty. 20 \$ 4700. DIM 2010 512 KB RAM qty. 5 \$ 7200, qty. 20 \$ 6390.

Ⓢ The trademark of Digital Research Corporation.

Note: MP/M and PL/1 will not be delivered as separate software modules.

Circle 221 on reader service card

---

## New products

---

Priced at \$2,590, the basic system 37 is 30% to 40% less expensive than most E-PROM programmers, some of which have one half or one fourth the buffer memory. A complete system with three expansion modules—the CP37-1 (\$1,295), CP37-2 (\$1,480), and CP37-3 (\$1,665)—costs \$7,030, or “one fourth to one half the cost of competitive programming systems that are capable of handling far fewer devices,” Wilfong claims. Both the CP37-4 and the CP37-5 gang-programmer expansion modules are priced at \$1,850 each.

With the exception of the bipolar PROM module, which will be available in the fourth quarter of 1981, delivery on all units is 4 to 10 weeks after receipt of order. Citel also will make available a full line of accessories that include a paper-tape reader, ultraviolet-light eraser, modem, and cathode-ray-tube terminal, among others.

Citel Inc., 392 Potrero Ave., Sunnyvale, Calif. 94086. Phone (408) 738-4773 [391]

---

### Evaporators recover gold from plating baths

The GoldMiner evaporative recovery units help printed circuit and connector manufacturers recover and recycle precious-metal plating baths by consolidating gold-plating rinse waters and thus reducing shipping and refining costs. Designed for installation on line with the plating process, the unit operates automatically with fail-safe shutdown.

The evaporator units employ a horizontal boiler with a 3-to-6-in. static and dynamic head and a large surface-area-to-volume ratio, resulting in a gentle boiling action with low vapor velocities that minimize or eliminate entrainment losses of metal, foaming, and fouling. They are available in 2-, 6-, or 10-gal/hr capacities and can be run with electricity, low-pressure steam, or high-pressure hot-water heating systems.

The main body of the evaporator is made of chemical-resistant Pyrex borosilicate glass, facilitating control of the concentration and volume of

the recovered bath. Prices start at \$15,000, and deliveries will begin in late summer or early fall.

Corning Process Systems, Chemical Recovery Systems Dept., Corning Glass Works, MP-21-4, Corning, N. Y. 14830. Phone (607) 974-9000 [393]

---

### Breadboarding kit sockets accept 8 to 40 conductors

An expanded Scotchflex breadboard system can accommodate several standard microprocessor boards and simplifies the fabrication of plugs and connectors for sockets that accept from 8 to 40 conductors. The system has 24 24-contact plug strips and 16 24-contact solder strips that can be snapped off into any size configuration and dual sockets in 16- to 40-pin sizes.

The sockets use an S-shaped beryllium-copper contact for a reliable connection between a dual in-line package and the U-shaped contact. A standard breadboard tool is available to furnish the exact number of strips needed and to insert two wires in any one U contact.

The standard expanded system sells for \$80. Optional kits are available with a microprocessor board for either an SBC-8010, the Motorola M6800, the Zilog Z80, or their equivalents. Prices range from \$110 to \$138, depending on the board supplied. Additional 24-contact strips, in small quantities, are 60¢ each; sockets in small quantities are 6¢ to 7¢ per contact.

3M Co., P. O. Box 33600, St. Paul, Minn. 55133. Phone (612) 733-9214 [394]

---

### Particle counter examines 1- $\mu$ m contaminants in liquids

With the MCM-1100 on-line ultrasonic particle counter, liquid contaminants of 1  $\mu$ m or less can be counted automatically in deionized water, acids, solvents, and photoresists. The counter also continuously examines liquids while in use in the fabrication area. It can be used as a

diagnostic tool, as an incoming inspection device, and as a continuous purity monitor.

The MCM-1100 employs one or more transducers mounted in the wall of the process piping. Ultrasonic waves are transmitted directly into the liquid and the reflected signals indicate the presence and size of particles. The instrument can discriminate between particles and bubbles.

The pulser and analyzer unit has a digital display and analog output. Its console can be either centrally located to monitor 1 to 6 points or mobile to monitor any number of permanently mounted transducers. Base price is \$2,350; with a high-power option, the MCM-1100 sells for \$3,650. Deliveries take two weeks or more.

Micro Pure Systems Inc., 14 Cedar Swamp Rd., Smithfield, R. I. 02917. Phone (401) 232-2550 [395]

---

### Photoresist developer has temperature controller

The model 950 positive-resist developer controls the temperature of developing and rinsing solutions. The temperature may be set from 23° to 50°C  $\pm$  1°C. Dependable operation is ensured by simple wafer transport and microprocessor control.

The model 950 has a 13-in.-wide process chamber that is twice the volume of any competitive spray-develop systems, says its maker, and provides splash-back-free processing and safe, clean operation. It is constructed of polypropylene, which is compatible with all types of aqueous-based developers and includes the company's Centri-Chuck, which holds wafers securely in place without a vacuum. This construction permits complete rinsing and drying of both the top and bottom surface of the wafer. The system can accommodate 3-to-5-in.-diameter wafers and has a diagnostic system that allows easy maintenance.

The 950 is priced at \$25,000; delivery is in six to eight weeks.

APT Inc., 3310 Victor Court, Santa Clara, Calif. 95050. Phone (408) 988-7595 [396]

---



# ULTRA-PURE SIGNAL. ULTRA-WIDE RANGE. THE 1618 MICROWAVE SYNTHESIZER. FROM SYSTRON DONNER.

## **Frequency range 50MHz to 18GHz.**

The Systron Donner Model 1618 synthesizes fundamental frequencies from 2 to 18GHz. And a simple option extends that range down to 50MHz.

Resolution over the full range is 1kHz. And with external input, it goes as low as 1Hz.

## **Signal harmonics better than 50dB below the carrier.**

The 1618 Microwave Synthesizer provides substantially greater spectral purity than its closest competitor. Internal filtering insures harmonics better than 50dB below carrier in the standard 2 to 18GHz range, and 40dB below carrier from 0.05 to 2GHz. Non-harmonic spurious levels are better than 50dB down throughout the entire range.

## **Synthesizer and all options fit in one instrument.**

The 1618 provides you with one totally self-contained instrument package, measuring 5¼" x 16" x 22". All eight options may be accommodated with no increase in size. And the 1618's use of plug-in modules and off-the-shelf components makes servicing simple.

## **Optional internal pulse modulator.**

A PM option permits very high speed pulse amplitude modulation: 20ns rise/fall time. And typical on/off ratios are 80dB, 2 to 18GHz.

The 1618 also lets you select combined modulation modes for very complex outputs, in manual or remote operation.

## **AM depth to 90%.**

Set amplitude modulation depths to 90% at rates up to 100kHz with a simple front-panel control.

For FM applications, modulate the r.f. output at rates of 50kHz to 1MHz, with peak deviation greater than 1MHz.

Control r.f. output levels by an output step attenuator, with 10dB steps, and by a multi-turn level vernier. The calibrated output level is directly displayed in four digits, with 0.1dB resolution.

## **IEEE-488 interface is standard. Simple, flexible programming.**

This interface provides you with remote control of all basic front panel functions. And 1618 programming combines flexibility with a logical, simple entry format. During remote control five LED annunciators

display operating status and modes. Clearly, the 1618 leads the field in range and purity. Find out more. Call us or send in the coupon. We'll rush you complete product literature—along with a list of our representatives in your area.

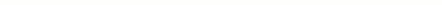

**SYSTRON DONNER**  
**INSTRUMENT DIVISION/MS1**

E4781

2727 Systron Drive, Concord, CA 94518  
Phone: (415) 676-5000  
TWX: 910-481-9479

Dear Systron Donner,  
It sounds like the 1618 Microwave Synthesizer has the range and purity I need. Send me a brochure right away.

Name \_\_\_\_\_

Title \_\_\_\_\_

Company \_\_\_\_\_

Address \_\_\_\_\_

City/State/Zip \_\_\_\_\_

Phone \_\_\_\_\_

*Product specifications subject to change without notice.*

**SYSTRON  
DONNER**  
Member THORN EMI Group

1981  
**WORLD**  
MARKETS FORECAST  
DATA BOOK

Electronics  
Magazine



**... that belongs in the hands of everyone serious about the technical, financial, and planning outlook for electronics.**

*Electronics'* highly respected 23rd annual World Markets Forecast has been expanded to provide an in-depth look at current and future demand for some 200 component and equipment products in the USA, Western Europe, and Japan—including 23 additional pages of market-estimate and growth-rate tables.

**Includes information not published elsewhere ...**

- 1979-84 compound U.S. growth rates
- U.S. report research methodology
- economic analyses for U.S., Western Europe, and Japan
- Product-by-product markets for 11 Western Europe countries

Delivery is immediate (air shipment outside N.A.) for the *Electronics 1981 World Markets Forecast Data Book*. \$125 must accompany your order to:  
Electronics Magazine Books  
42nd Fl.  
1221 Ave. of the Americas  
New York, NY 10020 USA.

## New products/materials

**A two-component epoxy, EPO-TEK 353ND** bonds optical fibers, metals, glass, ceramics, and plastics. It is designed to operate at temperatures of  $-50^{\circ}$  to  $200^{\circ}\text{C}$  continuously or at a maximum of  $400^{\circ}\text{C}$  for several hours. It features a pot life of 4 h, a refractive index of 1.560, and resistance to solvents, chemicals, and moisture. The manufacturer says the epoxy exhibits good handling characteristics and excellent wicking into fiber-optic bundles. It will cure in 1 min. at  $150^{\circ}\text{C}$  or in 1.5 h at  $60^{\circ}\text{C}$  or with a heat gun in 4 to 5 min. When it is fully cured, the epoxy turns a dark red.

EPO-TEK 353ND epoxy is recommended for medical instrumentation applications because autoclaving conditions will not degrade its physical characteristics. It can be applied by brushing, dipping, or pouring or by commercial dispensing equipment. An 8-oz trial kit is available from stock. Preweighed, 4-g packs are also available priced at \$2 per pack, with a minimum order of 25 packs.

Epoxy Technology Inc., 14 Fortune Dr., P. O. Box 567, Billerica, Mass. 01821. Phone (617) 667-3805 [476]

**An alumina-based adhesive, Ceramabond 503** adheres to dense alumina or beryllia ceramic, graphite, quartz, and glass and is used to coat porous refractories or insulation boards to prevent flaking.

Available as a premixed paste, Ceramabond 503 can be automatically applied using a syringe dispenser or a brush or spatula. It will cure at  $250^{\circ}\text{F}$  when dried, making it suitable for use at temperatures of up to  $3,000^{\circ}\text{F}$ .

Ceramabond 503 single-component adhesive is available from stock at \$37.50 per pint, \$52.50 per quart,



and \$142 per gallon and in 10-gallon lots.

Aremco Products Inc., P. O. Box 429, Ossining, N. Y. 10562. Phone (914) 762-0685 [477]

**Solder masks** for printed-circuit boards, models PCM-100, with a smooth matte finish, and PCM-101, with a semigloss finish, are designed to be used in automatic screening equipment and provide a tough solvent-resistant coating. Their solder-wave performance characteristics protect pc boards from solder bridging and hostile environments.

The PCM-100 and -101 masks can be cured in 4 to 5 seconds under an ultraviolet light source. They save production time and energy over the conventional oven-cure systems, says the manufacturer. They are available in gallons.

3M, P. O. Box 33600, St. Paul, Minn. 55133. Phone (612) 733-9214 [478]

**A two-part epoxy, TRA-BOND 2116** is for high-vacuum end-use applications and for securing electronic components to printed-circuit boards. Adhering to most metals, glass, ceramics, and rigid plastics, it has good mechanical, structural, and electrical properties and a high resistance to a wide variety of organ-

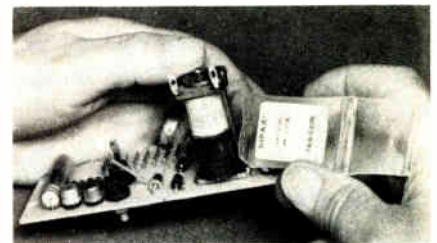

ic and inorganic compounds.

TRA-BOND 2116 mixes to form a smooth thixotropic paste that will stay on vertical surfaces. It cures overnight at room temperature or in a few hours at high temperatures.

The epoxy is available for immediate shipment from stock in a range of predispensed Bipax package sizes. The Bipax packages make the resin easy to mix, convenient to store, and safe to use.

TRA-CON Inc., Resin Systems Division, 55 North St., Medford, Mass. 02155 [479]

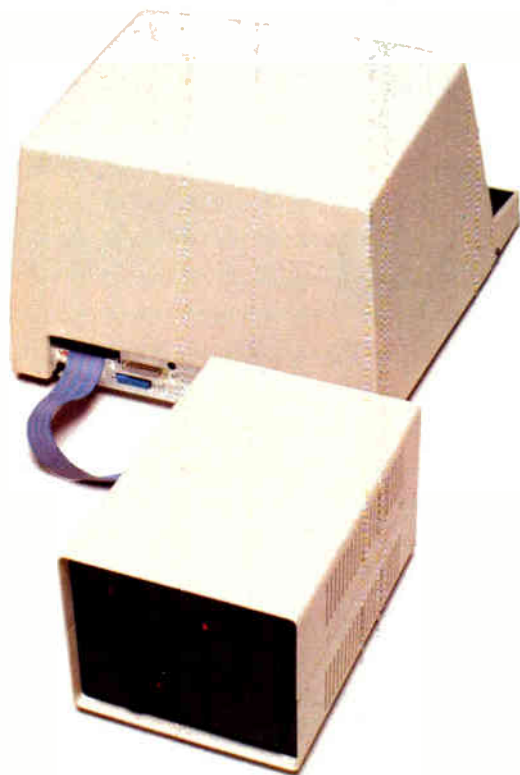

## **“And in conclusion, I’ll only use my exceptional powers for the good of mankind.”**

“That’s a vow all we Vector 3005s make. And it’s not one we make lightly.

“After all, being the only product on the market with a Vector 3 terminal, a 5¼” floppy, and a 5¼” Winchester rigid disk drive that provides 5 megabytes of storage is quite a responsibility. It used to take 20 floppies to give you that kind of capacity.

“Our powers don’t stop there, however. Each 3005 also comes with a 32-bit error-correcting code — the first time sophisticated IBM-style technology has been available on a small business system. This lets us detect and correct errors, and almost completely eliminates data loss on disks due to dirt, wear, or damage.

“All this makes us pretty awesome, all right. But there’s more. When coupled with Vector’s MEMORITE III and EXECUPLAN software packages, we give you a 30,000 word dictionary, the ability to create your own phrase library, a teaching manual right on the screen, pass word security, plus a host of other word processing capabilities as well as financial planning, forecasting and basic accounting.

“And we’re reliable. Our powers won’t diminish, our abilities won’t fade, and dedication to mankind won’t weaken.

“For more information and your nearest dealer, call Vector at 800-423-5857. In California, call 800-382-3367. Or write to them at 31364 Via Colinas, Westlake Village, CA 91362.

“Thank you all for coming today. And I hope we’ll have the chance to do business together in the future.”

**VECTOR**  
VECTOR GRAPHIC INC.

**COMPUTERS FOR THE ADVANCEMENT OF SOCIETY.**

# No price premium for our multi-channel couplers



**Litronix duals and quads will save you space, assembly and money.**

Not everyone needs a multi-channel coupler.

But if you're designing equipment where compactness is essential, multi-channel couplers will save you precious board space.

So here's the latest news.

Litronix duals and quads are now priced competitively with single channel couplers.

This means you can squeeze a two-channel coupler in the space normally required for one. Or four channels in the space required for two. And not pay a premium.

Assembly costs also drop. And your parts count, too.

Isn't it nice to discover that without upping the price, two can now live as compactly as one.

For further information on the most complete line of single and multi-channel couplers available, contact Litronix,

19000 Homestead Road, Cupertino, CA, U.S.A. 95014.  
 (408) 257-7910. Litronix England, 35 Bury Mead Road,  
 Hitchin Herts SG5 1RT, England. 462-56-322. Litronix GMBH  
 Schoenblick 25, 8068 Pfaffenhofen, West Germany. 844-14-02

Part #	No. of Channels	Current transfer ratio %	Breakdown voltage Peak AC	BVceo @ 1mA (v)min	1000 piece price*	Price per Channel*
IL-1	1	20	2500	30	.63	.63
IL-74	1	12.5	1500	20	.55	.55
ILD-1	2	20	2500	30	1.26	.63
ILD-74	2	12.5	1500	20	1.10	.55
ILQ-1	4	20	2500	30	2.52	.63
ILQ-74	4	12.5	1500	20	2.20	.55

\* U.S. prices

U.S. Distributors: Advent, Almac-Strom, Arrow, Component Specialties, Gerber, Hamilton Avnet, Harvey, Kirkman, Lionex, Marshall, Moltronics, Pioneer-Standard, Summit and Zeus. Canadian Distributors: C.M. Peterson, Electro Sonic, Future, Hamilton Avnet and L.A. Varah.

**Litronix** A Sierens Company

Circle 226 on reader service card

## **Intel readies sample of one-chip codec and filter**

Late in the second quarter of this year, Intel Corp. will introduce its first single-chip codec and filter for customer sampling. The high-performance MOS device, designed to handle both fixed and variable data rates, has a not-often-seen bonus in the form of a **50- or 60-Hz band-reject filter on board to minimize the effects of electrical noise** at those frequencies, which are common spurious signals in telephony systems. The 2914 features an on-chip voltage reference and both  $\mu$ - and A-law operation for the European and North American markets, respectively. The Santa Clara, Calif., company says the 2914's low price will serve as a tradeoff for a less-than-spectacular 175-mW power consumption in the active mode. The chip will be available in a 20-pin package for synchronous operation and a 24-pin package with what is known as an 8-bit loop-back test capability for the asynchronous mode. Intel expects to go into full production in the first quarter of 1982.

## **Low-cost fiber-optic connectors transmit data at 10 Mb/s**

At Electro/81, Amp Inc., Harrisburg, Pa., is displaying a fiber-optic connection system targeted at the low end of the data-transmission market. The Optimate system is characterized by **10-Mb/s data rates, with cable runs in the 10-to-30-m range**. The connector components are expected to cost about 25 cents each, and splices somewhat less. The system will be compatible with 1,000- $\mu$ m all-plastic fibers with a 2.2-mm-outer-diameter jacket such as the Eska SH 4001 and DuPont Crofon types and with the coming low-cost TO-47 and TO-92 emitter-detector packages, as well as with light-emitting diodes and detectors from Motorola and Spectronics.

## **Data I/O moves into signature analysis arena**

Having established itself as the leading supplier of memory programming systems, Data I/O Corp. is **planning to make its presence felt in the digital troubleshooting instrumentation arena**. The Bellevue, Wash.-based firm is understood to be developing a portable instrument, slated for introduction around the fall, that will use a variation of the signature analysis techniques pioneered by Hewlett-Packard Co.

## **Master logic will second-source Iso-C-MOS ULAs**

Master Logic Corp. of Sunnyvale, Calif., will second-source the line of **oxide-isolated complementary-MOS uncommitted logic arrays** developed by Semi Processes Inc. of nearby Santa Clara with Mitel's Iso-C-MOS process. Master Logic will also supply the masks and design services, as well as packaged and tested devices. The initial accord covers the 1,000-gate SP7010 and the 544-gate SP7005, but it will soon be expanded to cover ULAs with both lower and higher gate complexities.

## **One-pass matrix printer offers multipass quality**

Watch for Integral Data Systems Inc., Natick, Mass., to display a prototype of a 132-column, high-resolution dot-matrix printer at its booth at the National Computer Conference. Instead of a 9-wire (or hammer) print head, the new unit has **18 wires staggered in a zigzag pattern** to produce print quality about equal to that of multipass dot-matrix printers with the 150-character/second speed of the original Paper Tiger model. The higher print quality derives from the slight overlap of each hammer's impact site.

# Meet the HP Series 80: Hewlett-Packard's new one-on-one computing systems for professionals.

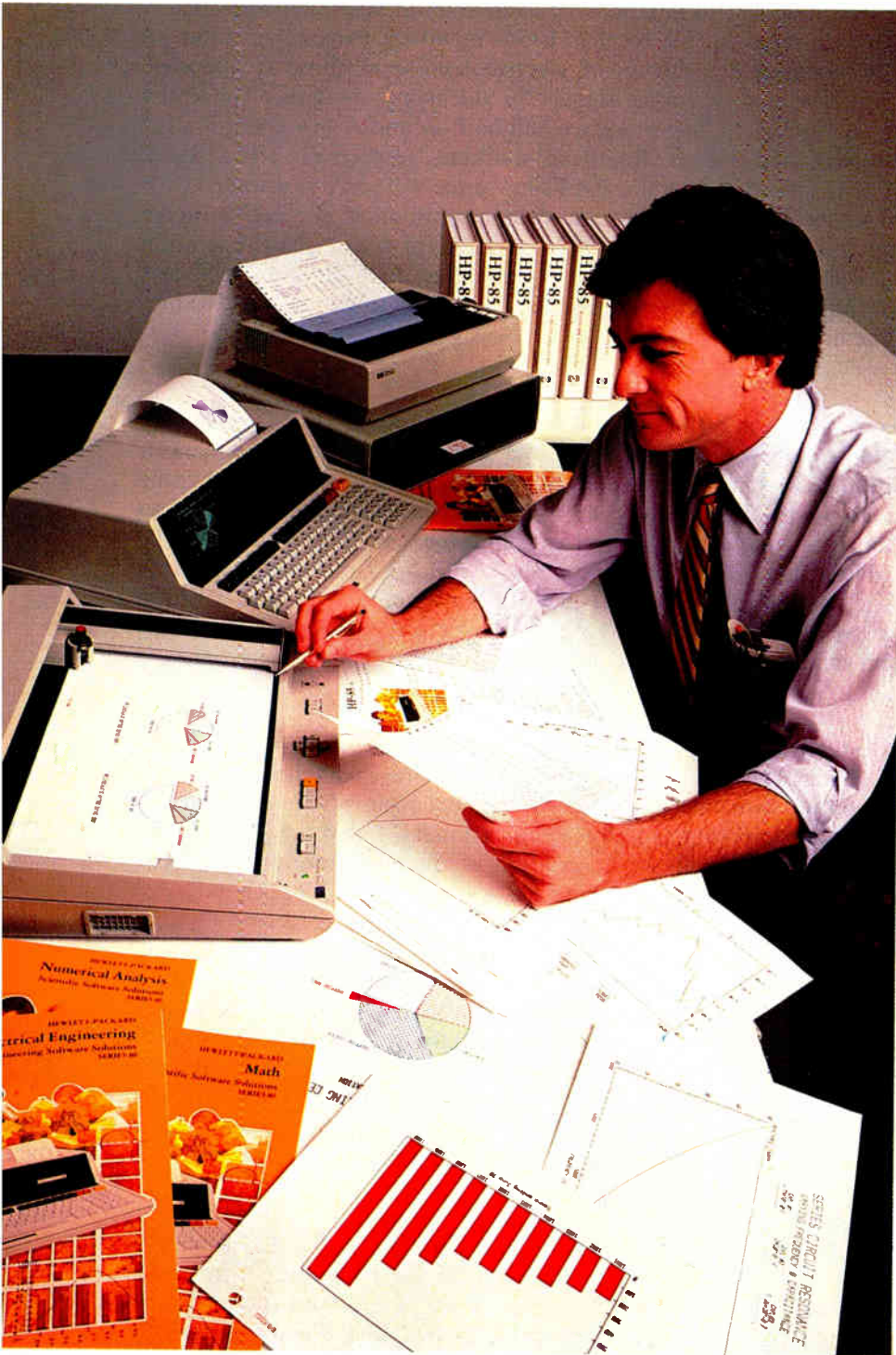

**Together, you can analyze technical problems and evaluate solutions. Rapidly and accurately.**

HP Series 80 personal computing systems provide the technical solutions you require. Quickly! Easily! Inexpensively! Analysis techniques that were formerly difficult and often impossible, become part of your everyday work routine. You can evaluate functional behavior, select variable alternatives, perform cost analysis... and more... all with greater accuracy and using more variables than you thought possible.

## **SERIES 80, VISICALC™ PLUS AND YOU**

HP's VisiCalc™ PLUS is a major new software tool. It's an electronic worksheet that instantly recalculates results as you change the variables. You ask the *what-if* questions and immediately see their effects on your solution. No programming is necessary... you can become proficient with VisiCalc™ PLUS in a few hours... and then watch your horizons broaden. VisiCalc™ PLUS features many powerful functions including statistical analysis tools and the entire HP Series 80 BASIC math set. Plus graphics! Create professional presentations with curve-fitting plots, stacked or clustered bar-graphs, exploded pie-charts and line graphs, all in up to four colors, on paper or transparencies.

## **ONLY FROM HEWLETT-PACKARD**

HP Series 80 personal computing systems are part of a forty-year tradition of electronic products built to uncompromising standards of excellence. Additionally, HP Series 80 products are serviced by HP technicians and on-site service contracts are now available. We urge you to judge for yourself with a hands-on, one-on-one demonstration at your HP dealer. For locations, call TOLL-FREE 800-547-3400, Dept. 283A, except Alaska/Hawaii. In Oregon call 758-1010. Or write Hewlett-Packard, Corvallis, Oregon 97330, Dept. 283A.

611/04

HP Series 80 Personal Computers for Professionals: HP-85 (\$3250\*) and HP-83 (\$2250\*) specifications: 16K RAM expands to 32K, 32K ROM expands to 80K; CRT with integrated graphics; (HP-85 only; built-in thermal printer, cassette tape unit); Software includes VisiCalc™ PLUS, Information Management, Graphics Presentations, Surveying, Data Communications (Spring '81), Statistics, Regression Analysis, Math, Linear Programming, Waveform & Circuit Analysis, BASIC Training. HP peripherals include floppy discs, printers and plotters.

VisiCalc is a trademark of Personal Software, Inc. \*Suggested retail price excluding applicable state and local taxes—Continental U.S.A., Alaska & Hawaii.

Circle 227 on reader service card



**HEWLETT  
PACKARD**





**TECHNOLOGY:**  
**AMERICA'S COMPETITIVE EDGE.**

Westinghouse addresses the vital role of technology in industry.

# Technology is the key to the world marketplace.

## If we want to maintain America's competitive edge, we must make better use of present technologies, and encourage new ones.

Most of the firms and countries which have achieved conspicuous success in this world have done so because they possessed some special advantage. They had an edge over their competitors. In recent decades, America's competitive edge has been its technology. Our ability to originate and apply innovative scientific and engineering ideas earned us a commanding lead in the world marketplace.

### **Things have changed**

Unfortunately, that lead has dwindled. America's share of the world's manufactured goods market has eroded over the past 20 years, lost to foreign manufacturers. Not only have they captured part of what had been our share of the world market, but they are now successfully penetrating our own domestic markets.

### **What happened?**

A look at a few statistics helps reveal some of the reasons for our reversals. Take patents. The number of domestic patent applications by Americans has been flat for several years. In contrast, the number of those filed here by foreign countries has been rising every year. In 1978, almost 37 percent of the patents granted went to foreign applicants. Or take the percentage of our Gross National Product going into industrial R&D. Over the past two decades, it has dropped precipitously.

### **What is needed**

Fortunately, today Westinghouse and other corporations already have technologies which can help America maintain its technological leadership. And these same corporations are hard at work on tech-

nologies which can expand America's leadership. The problem lies in implementing those technologies. Because, while the development of new technologies costs a large amount of money, turning them into commercial realities requires far more.

### **A national commitment**

Something else is needed: a united effort by industry, labor and government. Obviously, management should make a greater R&D effort to refine today's technologies, and develop new ones for tomorrow. Employees must realize that their cooperation is vital if America is to remain the most productive nation in the world. And our elected officials need to re-establish a sound economic foundation, because that is basic to all social progress. In particular, tax laws and monetary policy must be structured to allow industry to accumulate capital needed to apply available technologies, and invest in the development of still more advanced ones.

### **The Westinghouse role**

At Westinghouse, we believe technology is vital to our nation, our customers, and our own progress. We're supporting that belief by ambitious R&D programs, by building and modernizing existing facilities, and by introducing innovative methods to improve both our own quality and productivity and that of our customers. Today's proven Westinghouse technologies are focused on key areas such as productivity, services, energy, and America's national security. These existing technologies, together with the ones we are developing for the future, represent our efforts to help maintain this nation's competitive edge. On the following pages are some examples.

### U.S. Industrial R&D Spending

Outlays as percent of Gross National Product

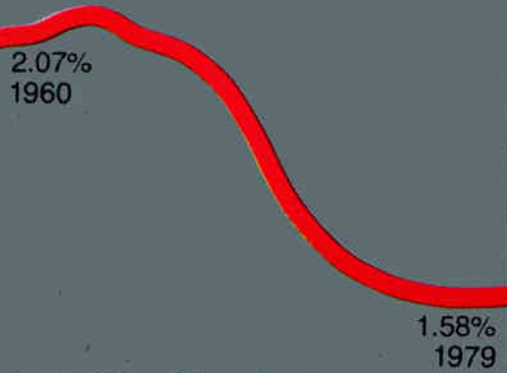

Source: National Science Foundation

### U.S. Patents

Number of applications filed: Inventions

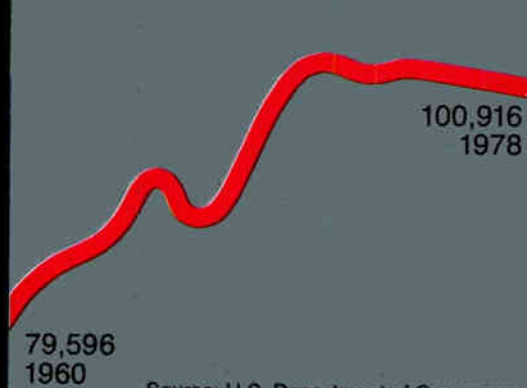

Source: U.S. Department of Commerce

### U.S. Exports

Percent share manufactured goods from 15 major countries excluding exports to U.S.



Source: U.S. Department of Commerce

In the next five years, Westinghouse plans to invest:

**\$1 Billion on R&D and \$2 Billion applying current technologies in:**

- Modernization of existing plants and equipment
- Construction of new plants
- Productivity and quality improvement projects

---

## WESTINGHOUSE TECHNOLOGY APPLIED TO ENERGY

---

### Someday, Westinghouse technology will provide economical electricity from the sun, and clean gas from coal.

The fact that silicon photovoltaic cells can turn sunlight into electric current has been known for some time. The problem is the high cost involved. Westinghouse has invented a new dendritic web process that significantly reduces the cost of producing such cells. As a result, the U.S. Department of Energy's economic cost target now appears achievable. Westinghouse is working with the two largest electrical utilities in California to provide demonstration photovoltaic modules this year.

#### Advanced energy technologies

Westinghouse is involved in the advanced energy technologies that may play a role in this nation's energy future. For example, on the horizon are promising technologies like iron-nickel, and iron-air high power batteries. Also showing promise are fuel cells that chemically produce electricity. But until solar and other energy technologies become a reality, this nation will depend upon coal and nuclear power for its electricity. Westinghouse is focusing much of its effort on these two areas.

#### Clean gas from coal

Westinghouse has pioneered in coal gasification technology. Over the last decade we have developed a process to turn coal into a clean gas for power generation, and for industrial or synthetic natural gas applications. The process has the advantage that it can use virtually any type of coal, soft coal or hard coal. The environmental impact is minimal, regardless of the coal's moisture, sulphur, or ash content. With continued technical progress, Westinghouse coal gasification systems can be in commercial operation by the mid-1980's.

#### Nuclear technology

Nuclear power remains an economical and safe way of producing electricity. Westinghouse leads in the application of nuclear technology to generate electricity. And we are developing an advanced nuclear plant able to make more fuel than it uses.



A segment of silicon ribbon from the Westinghouse dendritic web process

---

## WESTINGHOUSE TECHNOLOGY APPLIED TO SECURITY

---

### Today, Westinghouse Airborne Radar is one of our first lines of defense around the world.

It's called AWACS, an airborne warning and control system which provides long-range surveillance in an area at least 20 times greater than any surface-based system. It's already in use by our Air Force, and has been adopted by NATO. Just one AWACS radar mounted on a military version of the Boeing 707 flying at 30,000 feet can provide early warning of enemy attacks in an airspace of more than three million cubic miles. The information it helps give to military commanders multiplies the effectiveness of our air defense systems.

#### New safety for pilots

Another Westinghouse system protects aircraft crews from fast-closing missiles and enemy aircraft. It's called our Tail Warning Radar and it

provides the pilot with accurate warnings to take evasive maneuvers. It also automatically triggers appropriate countermeasures. It's able to do all this in a split second, and with a phenomenally low false alarm rate.

Radar, of course, has many applications in commercial aviation, and its importance grows as the skies become more crowded. Thirty-six Westinghouse Air Traffic Control surveillance radars are now serving

the FAA, the Switzerland Federal Air Office, and the Canadian Department of National Defense. The FAA uses the radars in some of the nation's most heavily traveled areas. So, nearly all domestic commercial flights come under the surveillance of a Westinghouse radar at some point during their flight.

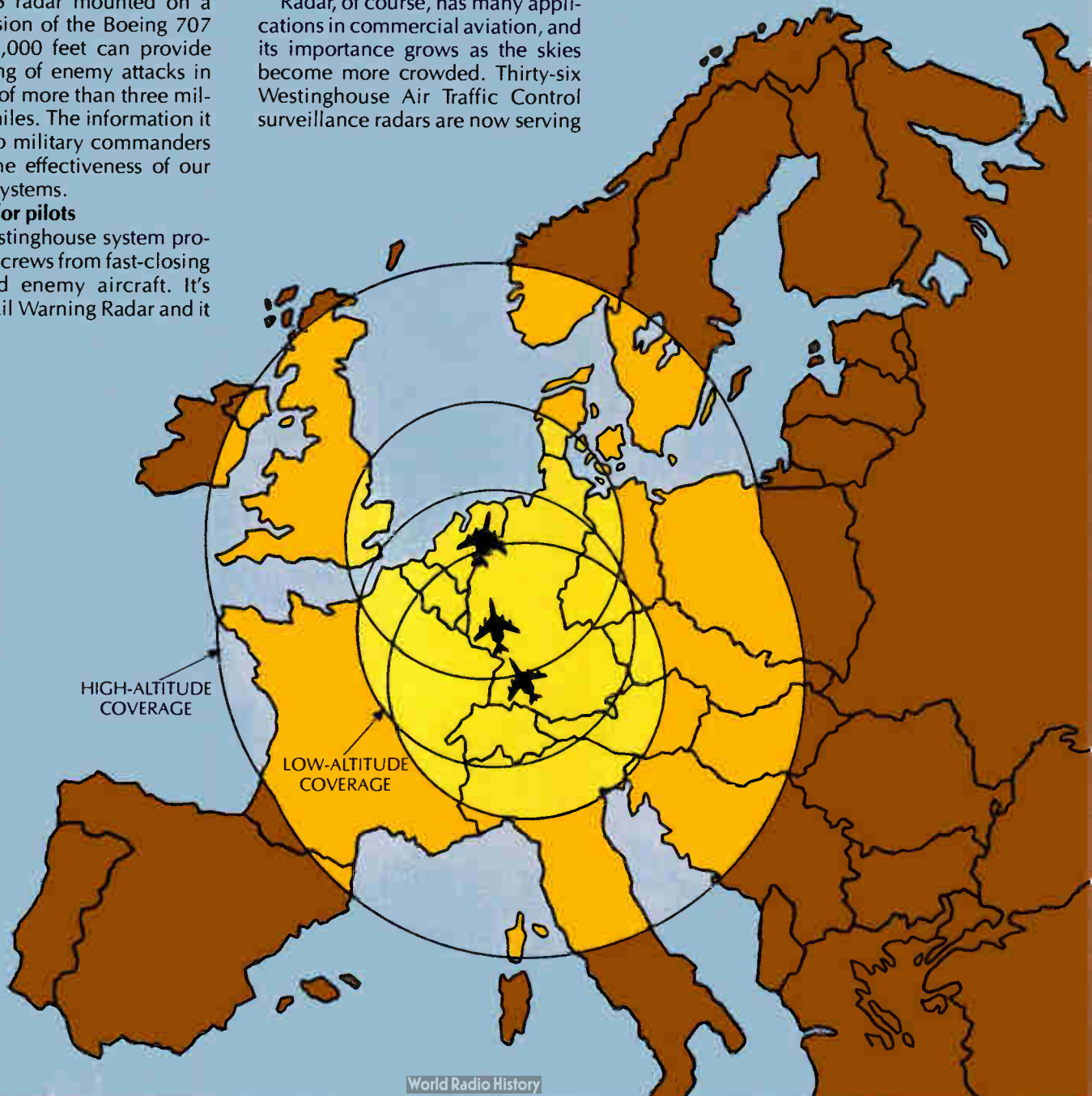

---

**WESTINGHOUSE**  
**TECHNOLOGY APPLIED TO**  
**PRODUCTIVITY**

---

# How Westinghouse product can increase industrial

*How to increase output per hour...  
How to eliminate waste...  
How to cut energy costs...  
Westinghouse has developed products  
and systems able to provide  
a wide variety of industries  
with effective answers.  
Here are several of special interest.*

## **The Westinghouse Numa-Logic® Control System**

The Westinghouse Numa-Logic solid-state programmable controller uses microprocessor technology to provide more reliable operation for electrical control applications. It can economically replace as few as eight relays. It also has the capability to control the hundreds of sequences required by sophisticated, automated processes. The Westinghouse Numa-Logic system is being used in the machine tool, materials handling, textile, paper, steel-making and other industries to reduce downtime, give quick start-ups, and increase operational efficiency.

## **Factory computer systems**

Also making major contributions to increased productivity are Westinghouse factory computer systems. They are capable of operating as many as 100 different machine tools simultaneously. They can also provide real time status and performance monitoring at four levels: maintenance, shop supervisor, middle and upper management. In application after application, downtime has been sharply reduced, and actual machine time has been increased up to 55 percent.

## **Power electronics**

Solid-state static VAR generators are a key solution for utility and industrial system line problems because they provide system stability and improve power flow capability. Planning studies at a major utility concluded that 10 transmission lines with static VAR generators could deliver the power ordinarily requiring 16 lines. When it comes to industrial applications such as steel-making, VAR generators can improve the efficiency of power usage by improving the power factor and providing faster arc furnace melt times. One steel producer's productivity increased sufficiently to pay back the nearly \$2 million cost of the static VAR generator in 15 months.

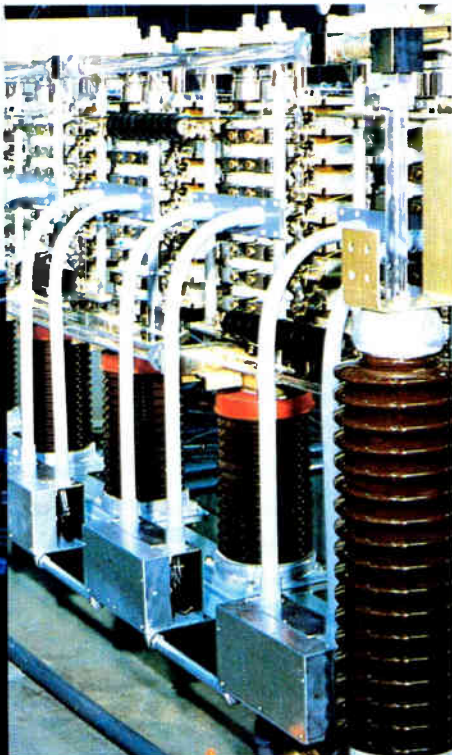
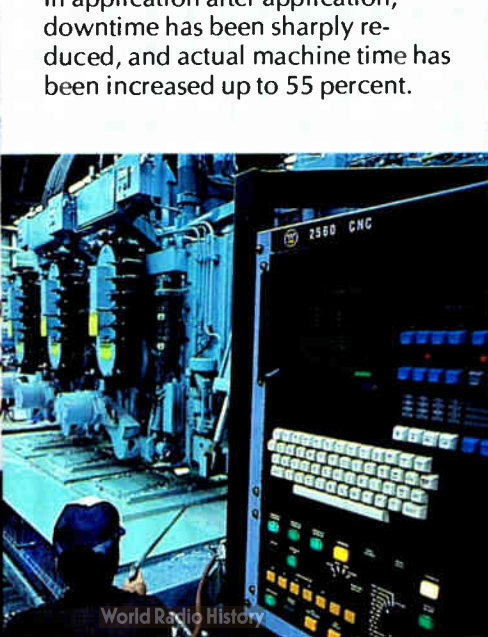
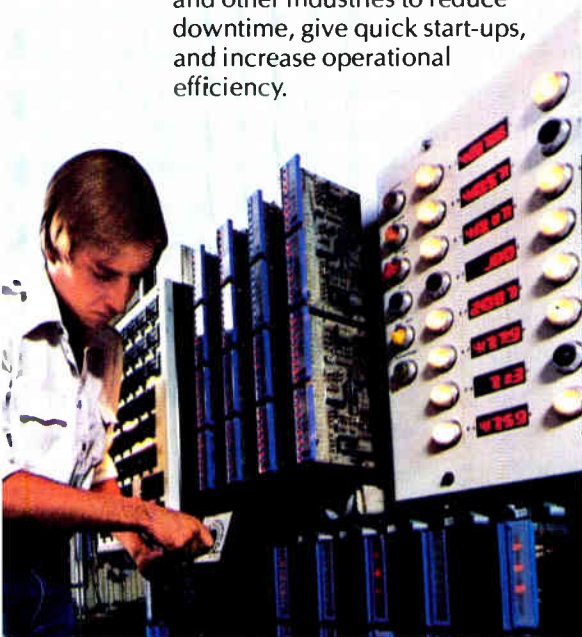

# and service technologies productivity today.

## Applied Plasma Systems

Because of the skyrocketing costs of fossil fuels used to supply process heat or chemical reactions, many firms are searching for alternatives. The Westinghouse Applied Plasma Systems can efficiently fire high temperature industrial processes, and serve as a central heating device for a myriad of applications such as chemical processes, metals treating, and combustion replacement. This technology is already providing an efficient answer for blast furnaces and direct reduction iron-making processes. It uses a high temperature gas stream to transmit heat. Studies on the upgrading of existing blast furnace facilities demonstrate up to an 80 percent increase in the capacity of the facilities through the application of Applied Plasma Systems.

*How to minimize downtime... As machines grow more complex, keeping them running takes specialists. To help you maximize productivity, Westinghouse can provide the same technological expertise in services as it does in products.*

## A remarkable worldwide service network

Because Westinghouse engineers, tests, and builds complex products and systems, we have the special skills, trained personnel, and necessary tools to maintain such equipment best; or to repair it in the least amount of time. Available to help you with either maintenance or repair are hundreds of trained Westinghouse field service engineers and specialist mechanics who use the most sophisticated on-site testing and repair equipment. And backing them up is a vast network of repair facilities.

Whether Westinghouse built it or not, we can service and repair almost anything from escalators and elevators, to steam turbines and nuclear power plants. Westinghouse can do an operation analysis and recommend an upgrading program, we can train your operators and service personnel, or we can do continuous monitoring of various operations. Whatever is needed.

Experience has taught us that a regularly planned and scheduled maintenance program greatly increases uptime and saves money. Westinghouse is equipped to provide programmed maintenance on a plant-wide basis. During scheduled shutdowns, a crew of Westinghouse field engineers and technicians can move in to do a complete analysis and top-to-bottom overhaul of your entire facilities.





- **Technology is America's competitive edge.**
- **To retain that competitive edge, we must make better use of the technologies we already have, and actively encourage the development of new ones.**
- **Westinghouse believes technology is vital to our nation, our customers, and our own growth.**
- **Westinghouse has technologies that increase manufacturing productivity, help meet our energy needs, and contribute to our national security.**

Six Gateway Center—Dept. 10  
Pittsburgh, PA 15222



**Westinghouse**

*A powerful part of your life.*



**“By the time we get out of this traffic, my 6-month auto policy will be up for renewal.**

**And they may raise my rate, too!”**

**“6 months? Next time, call GEICO and get a 12-month policy.”**

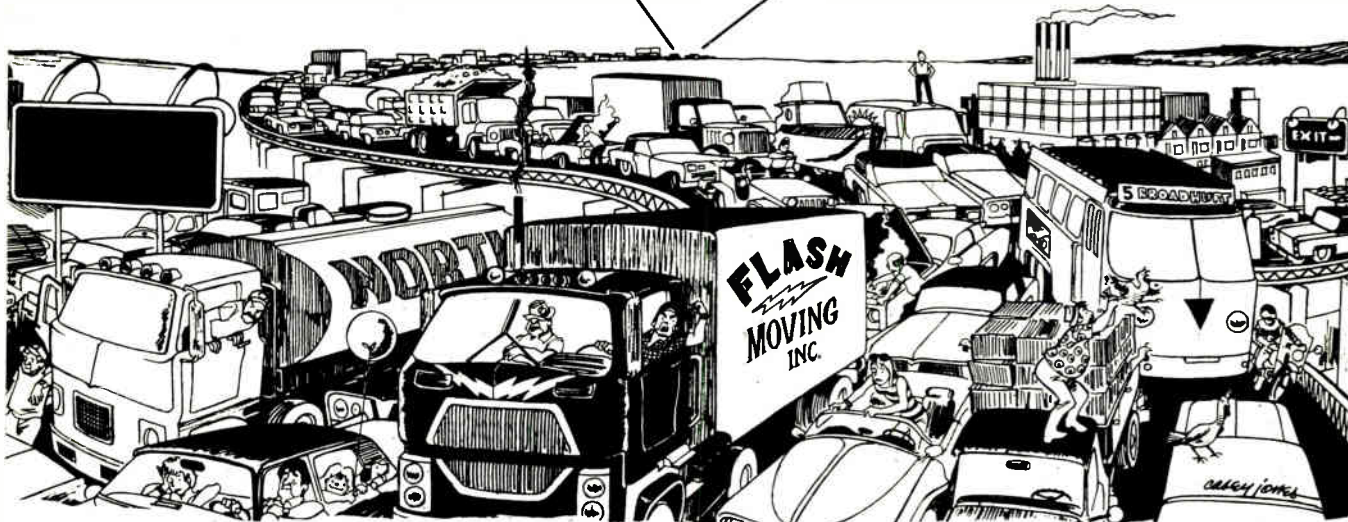

Unlike most companies, GEICO still offers the 12-month auto policy... a full year's coverage at a low rate. With a choice of convenient payment plans to fit your budget. Up to 9 payments if you wish.

And this is possible because GEICO tries to insure only good drivers. Good drivers are the best inflation-fighters around. You have fewer accidents. You cost us less. So you are one reason we can afford to charge you less.

“Good” doesn't mean “perfect.” Even good drivers may occasionally have an accident. That doesn't necessarily bar you from GEICO...or from being renewed once you're a GEICO policyholder.

If you call, you'll talk directly to a GEICO sales insurance counselor, not a salesman. So there's no pressure. And no extra sales expense to inflate the cost.

GEICO has been saving money for good drivers since 1936. Today, nearly 1,500,000 people are satisfied GEICO policyholders. And that makes GEICO the 5th largest of the more than 1,000 stock companies insuring autos in the U.S.

GEICO has fast and efficient claim service with toll-free and collect-call telephone numbers throughout the U.S. So if you have to report an accident or loss, you can call our claim adjusters immediately. We also have

over 3,500 claim representatives countrywide to assist in handling your claim if necessary.

**NOTE:** While you're checking GEICO, why not find out about our rates for homeowner/renter and boatowner coverage. And—even if you do not meet GEICO's auto policy standards—you may still obtain the same quality auto coverage and service from our affiliate, Criterion Insurance Company, at somewhat higher rates. Criterion operates in the District of Columbia and every state except Massachusetts, New Jersey and South Carolina.

# GEICO

Where good drivers get the low rates they deserve.

Call toll-free **800-841-3000** (8 a.m.-9 a.m. East Coast Time)  
In Georgia call toll-free 800-342-2800 or mail coupon. No obligation. No salesman will call.

Send to: GEICO & Affiliates, Consumer Information Services, GEICO Center, Macon, GA 31295

Name \_\_\_\_\_

Address \_\_\_\_\_ Apt. = \_\_\_\_\_

City \_\_\_\_\_ State \_\_\_\_\_ Zip \_\_\_\_\_

Employer \_\_\_\_\_ = Yrs. \_\_\_\_\_

Govt. or Military Grade \_\_\_\_\_ Have you previously been insured with GEICO?  Yes  No

Location of car if different from address above:

Car = 1: City \_\_\_\_\_ State \_\_\_\_\_

Car = 2: City \_\_\_\_\_ State \_\_\_\_\_

Car = 3: City \_\_\_\_\_ State \_\_\_\_\_

Name of current insurance co. \_\_\_\_\_ Month / Year Current Policy Expires \_\_\_\_\_

List all drivers	M or F	Relation	Age	Marital Status	Occupation	Yrs. lic.	Driver Training		% of Use of Cars			Accidents in Past 5 Years*		Violations in Past 3 Years		License Suspension <sup>o</sup>	Days per week driven to work or parking area	One way driving distance	Is car used in business (except to /from job)?	
							Yes	No	= 1	= 2	= 3	Yes	No	Yes	No					Yes
		SELF																		

If student away at school, how many miles to school?  
\_\_\_\_\_ miles.

	CAR 1	CAR 2	CAR 3
Year & Make			
Model (Nova, Granada, etc.)			
Body type: 2 / 4 dr. sdn, hardtop, sta. wag			
No. of cylinders			
Est. Annual Mileage			

If "yes" explain \_\_\_\_\_

<sup>o</sup>For accidents, violations, or license suspension, give dates and complete details, including cost of damages, on a separate sheet.  
Check for information on  Homeowners / Renter's Insurance  Boatowner's Insurance

GEICO and Affiliates, Corporate Headquarters: Washington, D.C. 20076

Not available in New Jersey or Massachusetts. 684

## ENGINEERS

Quality Control Industrial  
Maintenance/Instrumentation

## DESIGN

Analog Digital  
Software Micro Processing  
Test Equipment Instrumentation

Salary ranges are \$20-60,000<sup>1</sup> per year. Our firm is associated with a leading network & all costs are paid by client companies including interviewing, fees, relocation & free resume service. Call Dan Wheeler at 1-317-899-1777 or send resume to: TWT & Associates Inc., 3724 N. Mitthoefer Rd., Indianapolis, Indiana 46236

### POSITIONS VACANT

**Engineers. All disciplines. EE/CS** Entry to executive. Locations throughout U.S. All fee company paid. Send Resume to: F-O-R-T-U-N-E Personnel, Box 106, 3005 S. Michigan, South Bend, IN 46614, 219-291-7161.

**Electrical Engineer/Senior** Development Engineer for research and development on electronic circuits for laboratory instruments. Requires knowledge in digital electronics. Requires MSEE degree. No experience necessary. \$22,200 per year. Harrop Laboratories, 3470 East 5th Ave., Columbus, OH 43219. EOE.

**Materials Scientist & Electromechanical Engineer.** Positions open for MS or Ph.D.'s. Our company is engaged in the R&D of electrical components. Write to: Atadex Research 1081 Bristol Road, Mountainside, NJ 07092 Attn: Ray Klos.

**Electronic Engineers—Sunbelt/Southwest.** Opportunities in Design Software, Digital/Analog, Microprocessing. Personalized representation. Employer fee paid. J. Gifford Inc., 5310 East 31st Street, #225 Tulsa, Oklahoma 74135. (918) 665-2626.

### FACULTY POSITIONS VACANT

**Combination Physics/Electronic** Instructor to teach in a community college physics program including both transfer and technical physics as well as introductory technical electronics courses — to join 1 electronics and 2 physics teachers. Tenure track. Master's required. 2-3 years teaching or related field experience required. Starts August 20, 1981. \$13,688-\$30,768 ('80-'81 schedule) Contact: David Schultz, Vice President, Academic Services, Lincoln Land Community College, Springfield, IL 62708. EOE.

### POSITIONS WANTED

**Design Engineer (u P Hardware/Software, TTL, ECL, CMOS).** Prefer small mid-size company Northwest to Northeast. Reply to PW-4042, Electronics.

**Electrical Engineer — experienced hardware/software designer** seeks part time engineering jobs in East/South SF bay area. 415-455-9519.

## Career outlook

### Bay State predicts job increases

■ The growth of high-technology jobs in Massachusetts will continue at a rate of 20% or more per year through 1983, according to a recent survey undertaken by the Massachusetts High Technology Council. The number of jobs for electrical and electronics engineers will increase at a projected annually compounded rate of 22% over the same period, and slots for computer scientists and mathematicians will reach 25% per annum. Technician, assembly, and production jobs will increase at a rate of about 21%. Mechanical engineers, chemists, and physicists will be needed, too, but the projected growth rates for these job categories are somewhat lower at 15%, 19%, and 19%, respectively.

With over 100 member and 35 associate member companies, the MHTC accounts for more than 100,000 employees in Massachusetts. Sixty-one of the member companies participated in the human resource needs survey; and these companies represented approximately 85% of those people employed by council members. The MHTC itself includes nearly 50% of the total high-technology industry in the Bay State.

To satisfy their rapid growth in personnel needs, many companies are now looking directly to colleges and universities, says Howard Foley, president of the council. "There's a more mature attitude on the part of many high-technology companies.

They are now doing more recruiting on college campuses—here, and farther away—as opposed to using a *de facto* pirating strategy as they have done in the past. Most have found that such a strategy fails on an intermediate to long-term basis, anyway," he observes.

The trend toward campus recruitment was well represented in the results of the survey. The responding companies intend to hire 32% of their technical professionals directly from colleges or universities. For the remainder, the firms expect 18% of their new employees to come with one to three years of high-technology industry experience; 24% with three to five years; 21% with more than five years; and 5% with experience outside high technology.

"Companies are becoming far more articulate about their manpower needs," notes Foley. "They are coming to the colleges and universities with far larger numbers of the type of people they need, and they can specify the area for which they need them. The schools can therefore respond to these requests in a more effective way."

More than three out of four of the firms that answered the survey preferred recruiting in Massachusetts over anywhere else in the country. Moreover, "the companies are revising their support plans in terms of money and equipment for the schools," says Foley. "It's part of a whole council effort to provide more regional support for the schools in Massachusetts." -Pamela Hamilton

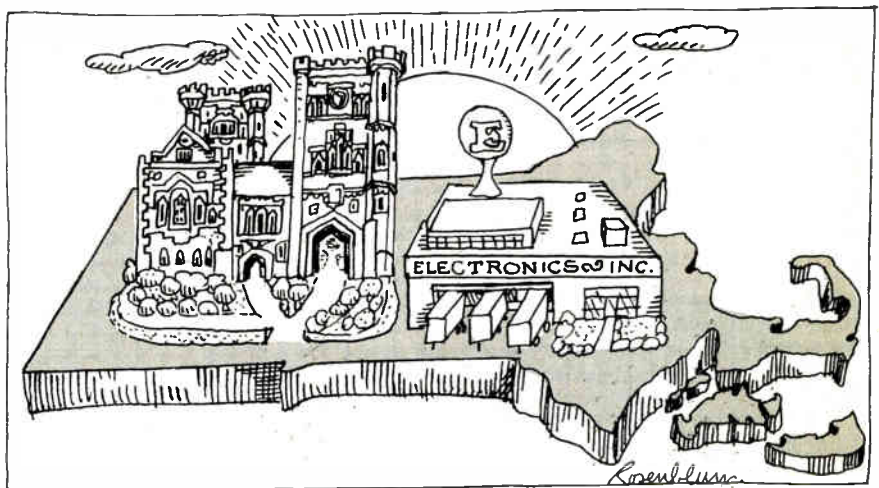



# GTE & PHOENIX... a winning team

GTE Automatic Electric Laboratories has been a leader in the telecommunications industry since 1892, and our future never looked better!

In this exciting and rapidly changing industry, GTE is meeting the challenges and opportunities of the future by developing advanced digital telecommunications systems today. Our new design and development laboratory in Phoenix will help us maintain our edge in advanced systems design technology.

If you're looking for technical challenge, growth opportunity and would like to be a part of our rapidly growing organization...if you're looking for the quality of life offered in this vibrant, emerging technological center, make the move to GTE & Phoenix.

A degree in Electrical Engineering, Computer Science, Computer Engineering or related field and experience in any of the following areas will qualify you for a position with our winning team.

- OPERATING SYSTEM SOFTWARE**
- ON-LINE RECOVERY AND DIAGNOSTIC SOFTWARE**
- DEVELOPMENT SUPPORT SOFTWARE**
- CALL PROCESSING AND ADMINISTRATIVE SOFTWARE**
- TEST UTILITY SOFTWARE**
- SYSTEMS TEST AND CONTROL**

Send your resume in complete confidence today. GTE Automatic Electric Laboratories, Manager of Manpower, Dept. EM0407, 11226 N. 23rd Avenue, Phoenix, AZ 85029.

**GTE Automatic Electric Laboratories**



**Research and  
Development**

An Equal Opportunity Employer M/F/H



*Opportunities  
Deep in the Heart  
of Technology*

**Tracor Aerospace**, an operating group of Tracor, Inc., is an international company performing research and development, engineering, manufacturing and worldwide marketing. We are a leader in many fields, including electronic countermeasures, navigation systems and teleprinters. Our steady growth has created these exciting career opportunities in our facility in Austin, where you can enjoy life as you achieve your career goals.

**SOFTWARE ENGINEERS:** BSEE, BSCS with assembly language programming and microprocessor software development experience.

**POWER SUPPLY ENGINEER:** BSEE with experience in transformer specifications and the design of switching regulations and power supplies for use in extreme environmental conditions.

**E/O ENGINEERING SPECIALIST:** Experience in state-of-the-art sensors, computer simulation of E/O weapon systems and vehicle E/O signature evaluation. Technical degree.

**RF DESIGN ENGINEERS:** BSEE with experience in the design and development of communications frequency transmitters for military applications. Knowledge of ECM, RF jammers, radar design and/or RF antenna design preferred.

If you desire challenge plus an excellent opportunity for career advancement, we invite you to join our growing team of professionals. For immediate consideration, please send your resume to: **Larry Powell, Tracor, Inc., Dept. E-47, 6500 Tracor Lane, Austin, Texas 78721.** Give us an opportunity to tell you more about **AUSTIN & TRACOR AEROSPACE--THE RIGHT PLACE AT THE RIGHT TIME.**

We are an equal opportunity employer, m/f.

## COMMUNICATIONS ENGINEER

Bernard Johnson Incorporated, a Houston based architectural/engineering firm in the ENR Top 100, has an immediate opening for a Communications Engineer. Position requires BSEE with 5+ years experience in systems design of radio communications systems to include VHF/UHF radio coverage analysis and intermodulation product determinations. Experience with microwave, teleprocessing or satellite systems beneficial but not required. P.E. with project management experience preferred.

Send resume in confidence to:

### BERNARD JOHNSON INCORPORATED

Architects—Engineers—Planners  
5050 Westheimer, Houston, Texas 77056  
Attn: David C. Blaschke  
An Equal Opportunity Employer M/F

## Engineers

- Design
- Development
- Project
- Software

**\$20,000-\$50,000**

Riddick Associates Engineering Division specializes in placement of electrical and electronics engineers with top companies in the Southeast and throughout the U.S. We provide advice on careers, resumes and interviews for a position tailored to your skills. Client companies pay all fees. For details call or send resume in strict confidence to Phil Riddick, President.

### Riddick

#### Associates, Ltd.

9 Koger Executive Center  
Norfolk, VA 23502  
Area 804-461-3994

#### SOUTH & SOUTHWEST POSITIONS

Engineering and Management positions throughout the South, Southwest and U.S. Employers pay all fees. Send resume or call Bob Hogue, P.E. (513) 658-3525.

### SouthWest Technical

P.O. Box 33070,  
San Antonio, Texas 78233

**DESIGN ENGINEERS to \$38K.** Central Penna. & nationwide. Design connectors / terminals, microprocessors, controls. Reply in confidence to Z. A. Gonglewski, MECK ASSOC. PERSONNEL, 1517 Cedar Cliff, Camp Hill, PA 17011 (717/761-4777).



**NATIONAL PERSONNEL CONSULTANTS**

## ENGINEERS \$20,000-\$60,000

Nationwide fee-paid opportunities in aerospace, defense electronics, weapon systems, microwave, communication systems.

- DIGITAL & ANALOG
- MICROPROCESSOR
- MARKETING
- CONTROL

Call collect or send resume to Glenn English, President

### GLENN ENGLISH AGENCY

7840 Mission Center Court  
San Diego, CA 92108  
(714) 291-9220

## S.W. & SUNBELT

- System EE's
- Design EE's
- Product EE's
- Software
- Design ME's
- Communications

**\$20,000 to \$50,000**  
100% Fee Paid

Specializing in placing technical people with data acquisition and peripheral equipment manufacturers located across southern U.S. Send complete resume, salary history and geographic preferences to:

### J. Robert Thompson Companies, Inc.

Management & Employment Consultants  
2200 West Loop South, Suite 800  
Houston, Texas 77027 713/627-1940

**CALL IN  
YOUR  
CLASSIFIED ADS  
212/997-2556**

## Diva G. Garcia

PERSONNEL CONSULTANTS

Choice engineering positions (Overseas and Domestic) in:

**ELECTRONICS/ELECTRICAL/Data Process/Systems Analysts/Sr. Programmers/Craft Superintendents (urgent)**

Send resume to:

Diva G. Garcia  
Personnel Consultants Consultants  
Professional Division  
One Allen Center, Suite 3045  
Houston TX 77002

713/757-0088

Many Bilingual Positions



**NOW: INCREASE YOUR SALES IN EUROPE**  
**TRONOMECHANICAL COMPONENTS**  
**GERMAN SALES MANAGER OFFERS:**  
Well-organized MARKETING & SALES OFFICE for the Common Market with experience in marketing & sales of electronic/mechanical components.  
Complete O.E.M. Customer Service.  
For more information please contact:  
**Hans Janssen, Prielmaystr. 19, D-8011 Pöding/Munich, Western Germany. Phone D 8121-82616**

# COMMUNICATIONS ENGINEERS

**More job challenge, more vacation and up to 40 percent more pay. Aramco offers them all to the highly motivated, self-starting communications professionals we need now for major projects in Saudi Arabia.**

Aramco needs outstanding people on the energy frontier in Saudi Arabia. We're offering outstanding incentives to get them: up to 40 percent pay premium, 40 days' vacation every year, and a chance to work on vast and challenging projects with the world's largest oil-producing company.

Among our major projects is an enormous communications system which interlinks our vast network of operations in Saudi Arabia. You'd have to look hard to find a system quite like it anywhere.

If you have the qualifications, we have the following openings in which you could expand your communications career.

## **Radio Engineers**

Your areas of responsibility will include system engineering, design, operational support for all our HF, VHF, UHF radio systems. You'll work on a team responsible for major additions to our HF radio, mobile radio, paging, radio-telephone, marine and IMTS systems.

*Requirements:* a BSEE, plus at least 10 years' experience in radio communications engineering.

## **Radio/Microwave Engineers**

You will oversee engineering studies, design and development phases

of projects and facilities; implement modifications on existing systems and facilities.

*Requirements:* a BSEE or equivalent, 7 years in some or all of the following: microwave, telephone, mobile radio, analogue-digital, communications and control systems.

## **Senior Projects Engineer— Radio/Microwave**

You will supervise design and material procurement; provide work direction for engineers and direct design and project management contractors. Also responsible for engineering aspects of new systems design, system additions, and modifications.

*Requirements:* a BSEE or equivalent. Minimum 12 years in systems engineering, with planning on major communications projects.

## **Unsurpassed compensation and benefits**

The Aramco salary is competitive and a cost-of-living differential increases it even further. Aramco people in Saudi Arabia receive a tax-protected premium for overseas employment which can amount to up to 40 percent of the base salary.

Money aside, Aramco offers an outstanding combination of benefits, including the long vaca-

tion, comfortable housing, abundant recreation, and an excellent American-style school system for the children.

## **Extra overseas bonus and new voluntary "bachelor" status for married employees**

Newly hired employees for Saudi Arabia also receive a one-time, lump-sum, fully tax-protected Overseas Employment Bonus of up to \$5,000.

And now all of the attractive compensation and benefits are available for married employees who may want to work overseas on a temporary "bachelor" status for the first year. This program includes three free repatriation trips by air during this one-year period, and the option to request family status at three conversion dates during that same year.

**Interested?** Call our 24-hour line any day: (713) 750-6965. If you wish, call toll-free: (800) 231-7577, ext. 6965 between 7 A.M. and 5 P.M., Monday-Friday, Central Time.

If you prefer, send your résumé in full confidence, or write for more information to: Aramco Services Company, Dept. ELT0407 NB04A, 1100 Milam Bldg., Houston, Texas 77002.

**CHALLENGE BY CHOICE**

# ARAMCO

SERVICES COMPANY

# Who will be first with the avionics of the 21st century?

It could be you and Hughes Radar Systems.

We pioneered pulse Doppler radar and built the first operational airborne programmable signal processor. Today, three out of the four front-line U.S. tactical aircraft have Hughes radars. We're leaders in synthetic aperture radar, in-weather reconnaissance and strike radar, high order language, antenna arrays and holographic displays. We're even building the rendezvous radar for the Space Shuttle.

And with computer-aided design, manufacturing, and testing of intelligent radar devices, the future is at Hughes.

In fact, Hughes is one of the nation's largest employers of electronic engineers and a major employer in virtually every other scientific, computer and technical discipline — with 1,500 projects and a backlog of over \$5 billion. Yet we're decentralized to give you the kinds of environments that stimulate innovation and promote recognition of your work.

Who will be first with the avionics of the future? It could be you and Hughes.

At Hughes Radar Systems, we'll introduce you to people, ideas and jobs that could change your world. And maybe ours.

Call (213) 647-4900, collect, or send resume to:

Engineering Employment  
Hughes Radar Systems  
P.O. Box 92426, Dept. E-4A  
Los Angeles, CA 90009

Current openings:

- Software Design/Analysis
- Software Test Engineering
- Systems Integration & Test
- Computer-Aided Design & Manufacturing
- RF/Microwave Design
- Digital Circuits Design & Test
- Radar Systems Design
- Large Scale Integration Design, Development & Test
- Production Process Engineering
- Microprocessor Development/ Applications
- Antenna Systems Design & Test
- Reliability Engineering
- Production Test Engineering
- Industrial Engineering

## It could be you and Hughes Radar Systems.

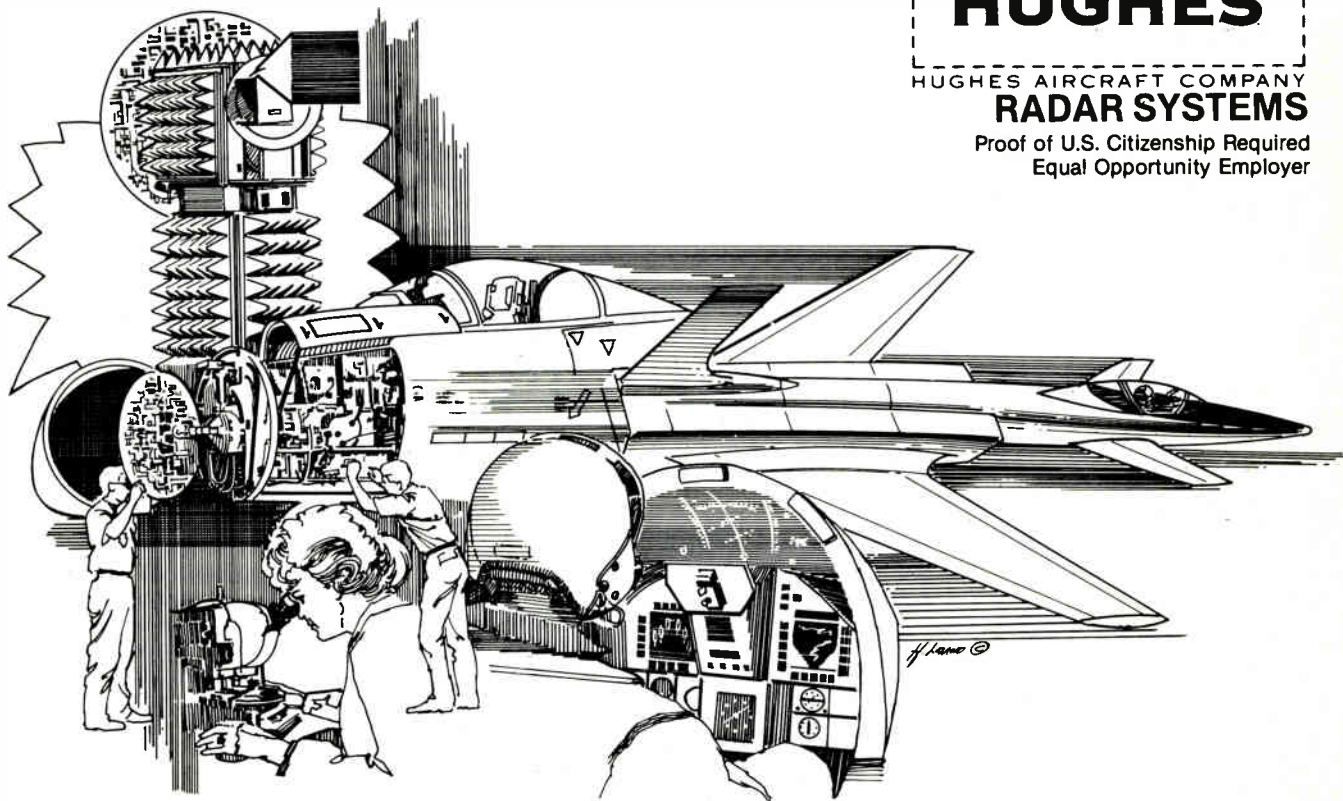

### HUGHES

HUGHES AIRCRAFT COMPANY  
**RADAR SYSTEMS**

Proof of U.S. Citizenship Required  
Equal Opportunity Employer

• Abbott Transistors Labs	43	• Efcis	19E	Information Handling Services	92, 93
‡ Acme Electric	38	Elec-Trol, Inc.	179	Intel Special Products Division	18, 19
□ Adalsey	88E-D, E	Electronic Arrays	35	Israel Export Institute	202
• Adret Electronique	21E	■ Electronic Navigation Industries	3C, 6	■ ITT Cannon Electric	80
Advanced Micro Devices	10, 11	Electronum	112	• ITT Capacitors	189
• Afga Gevaert	113	Elographics, Inc.	60	• Jepico Company, Ltd.	33E
Alps	116, 117	• Enertec Schlumberger Montrouge	3E	■ Johanson Manufacturing Corporation	8
American Microsystems, Inc.	85	• Enertec Schlumberger Saint Etienne	17E, 24E	‡ Kontron Electronics, Inc.	61
• Ametek, Inc.	35E	LM Ericsson Telematerial AB	138	■ Krohn-Hite Corporation	7
■ Amphenol North America	184, 185	□ ESCO	88E-A	Litronix	226
• A.P.E.M.	7E	Federal Express Corporation	111	Mallory Capacitor Company	217
Astro Med	210	FEP, Inc.	57	Markem	181
■ F.W. Bell, Inc.	48	■ First Computer Corporation	15	• Memory Devices, Ltd.	61
‡ Bell Laboratories	189	John Fluke Manufacturing Company	99	Mepco/Electra	17
■ Bendix Electrical Components Division	201	• Fujitsu Limited	68	Micro Power Systems	133
Caddock Electronics, Inc.	107	GCA Burlington	30, 31	■ Micro Technical Industries	88
Cambion	16	Geico Company	237	Millennium	168, 169
■ Cherry Electrical Products	13	‡ General Electric Instrument Rental	170	■ Miller-Stephenson Chemical Company, Inc.	212
• Citel	36E	General Instrument Microelectronics	205	■ Mini-Circuits Laboratory	5
Computer Design & Applications	88	■ GenRad	182, 183, 206, 207	Monolithics Memories	36, 37
■ Concord Electronics	106	Georgia Power Company	195	Mostek Corporation	27, 76, 77
Corpus Christi Industrial Commission	172	• Giers Schlumberger	70	‡ Murata Corporation of America	173
Data Instruments, Inc.	83	Gould Inc., Instrument Div., SC Operations	25	Mycron	221
■ Data Translation	59	■ GTE Microcircuits	192	■ National Semiconductor	49-56
Datatron, Inc.	45	Hamilton / Avnet Electronics	4C	Newark Electronics	62
Digital Equipment Corporation	186, 187	Harris Semiconductor	118, 119	Nicolet Instrument Corporation	32
Dynabyte	100	■ Hewlett-Packard	2C, 1, 2, 22, 23, 114, 115, 203, 219, 228	Nippon Blower Company, Ltd.	86
Dynamic Measurements	64	■ Honeywell Test Instrument Division	215	Oak Industries	190
‡ Eastman Kodak Company	105	Houston Instrument	194	Oregon Software	218
‡ Eaton Corporation, Cutler Hammer	192	Hughes Aircraft	110	Pacific Precision Instruments	62

<input type="checkbox"/>	Panduit	88E-B, C	Texas Instruments, Inc. (Semiconductor)	94, 95, 174, 175, 209
	Paratronics, Inc.	73	Texmate, Inc.	136
* ■	Philips T & M	25E	Thomson Components News	23E
	Plantronics Zehntel	20, 21	Thomson CSF/DSC	5E
	Practical Automation	58	Thomson CSF Div. D.T.E.	13E
■	Radio Research Instrument Company	58	Trio Test Instrument Division	170
<input type="checkbox"/>	Radiohm	88E-F	TRW/LSI Products	163
	RCA Solid State	12	TRW Optron	14, 196, 197
	Rockwell International	78, 79	US Instrument Rentals	70
*	Rohde & Schwarz	27E, 29E, 31E	United Technical Publications	63
*	RTC	9E	Universal Data Systems	120
	Scientific Systems Laboratories	60	Vactec, Inc.	112
‡	Semiconductor Equipment & Materials Institute	63	Vector Graphics	225
‡	Seminar Development Corporation	69	Wabash Relay & Electronics	16
*	Sfernice	14E, 15E	Wavetek Indiana	87
*	Shell	38	Westinghouse	229-236
*	Siemens AG	32E	Wells Electronics	160
‡	Siemens Corporation	113	Western Digital	164, 165
	Solid State Scientific	109	Mark Williams Company	9
‡	Souriau, Inc.	180	Wiltron	176, 177
<input type="checkbox"/>	Spezial-Electronic KG	88E-A, D	Zilog	89-91
	Sprague Electric	67, 103		
■	Syntronic Instruments, Inc.	213		
	Syston Donner	223		
‡	Takeda Riken Industry Company, Ltd.	166, 167		
*	TEAC Corporation	105		
	Tektronix	28, 29, 74, 75, 199		
*	Teledyne Philbrick	173		
	Teradyne, Inc.	96		
	Texas Instruments, Inc. (Digital Systems)	47		

#### Classified and employment advertising

Aramco Services Co.	241
Bernard Johnson	240
Garcia, Dora G. Personnel Consultants	240
Glenn English Agency	240
GTE Automatic Electric Labs	237
Hans Janssen	240
Hughes Aircraft Co.	242
National Personnel Consultants	240
Riddick Associates Ltd.	240
Southwest Technical	240
Thompson, J. Robert	240
Tracor, Inc.	240
TWT & Assoc.	238

- For more information of complete product line see advertisement in the latest Electronics Buyer Guide
- \* Advertisers in Electronics International
- ‡ Advertisers in Electronics domestic edition
- Advertisers in regional issue

#### Advertising Sales Staff

**Advertising sales manager:** Norman Rosen  
3200 Wilshire Blvd., South Tower  
Los Angeles Calif. 90010 [213] 487-1160

#### Market managers:

*Components:* William Boyle, Rochester, N.Y.  
*Computers & Peripherals:* Frank Mitchell, Boston  
*Test & Measurement:* Don Farris, San Francisco  
*Semiconductors:* Norman Rosen, Los Angeles

**Atlanta, Ga. 30309:** Peter Stien  
100 Colony Square, 1175 Peachtree St., N.E.  
[404] 892-2868  
**Boston, Mass. 02118:** Frank Mitchell  
Paul F. McPherson, Jr.  
607 Boylston St., [617] 262-1160  
**Cleveland, Ohio 44113:** William J. Boyle  
[716] 248-5620  
**Fort Lauderdale, Fla. 33306:** Peter Stien  
3000 N.E. 30th Place, Suite #400  
[305] 563-9111  
**New York, N.Y. 10020**  
1221 Avenue of the Americas  
John Gallie [212] 997-3616  
Matthew T. Reseska [212] 997-3617  
**Philadelphia, Pa. 19102:** Matthew T. Reseska  
Three Parkway, [212] 997-3617  
**Pittsburgh, Pa. 15222:** Matthew T. Reseska  
4 Gateway Center, [212] 997-3617  
**Rochester, N.Y. 14534:** William J. Boyle  
Powder Mill Office Park, 1163 Pittsford-Victor Rd.,  
Pittsford, N.Y. 14534 [716] 248-5620  
**Chicago, Ill. 60611**  
645 North Michigan Avenue  
Jack Anderson [312] 751-3739  
Robert M. Denmead [312] 751-3738  
**Southfield, Michigan 48075:** Jack Anderson  
4000-Town Center, Suite 770, Tower 2  
[313] 352-9760

**Dallas, Texas 75201:** John J. Uphues  
2001 Bryan Tower, Suite 1070  
[214] 742-1747  
**Denver, Colo. 80203:** Harry B. Doyle, Jr.  
655 Broadway, Suite 325  
[303] 825-6731  
**Houston, Texas 77040:** John J. Uphues  
7600 West Tidwell, Suite 500  
[713] 462-0757  
**Los Angeles, Calif. 90010:** Chuck Crowe  
3200 Wilshire Blvd., South Tower  
[213] 487-1160  
**Costa Mesa, Calif. 92626:** Edward E. Callahan  
3001 Red Hill Ave. Bldg. #1 Suite 222  
[714] 557-6292  
**San Francisco, Calif. 94111:** Don Farris,  
Larry Goldstein, Lauren Scott  
425 Battery Street, [415] 362-4600

**Paris:** Michael Sales  
17 Rue-Georges Bizet, 75116 Paris, France  
Tel: 720-16-80  
**United Kingdom:** Simon Smith  
34 Dover Street, London W1  
Tel: 01-493-1451  
**Scandinavia:** Andrew Karnig and Assoc.  
and Simon Smith  
Kungsholmsgatan 10  
112 27 Stockholm, Sweden  
Tel: 08-51-68-70 Telex: 179-51  
**Milan:** Ferruccio Silvera and A. Fabio Guarneri  
1 via Baracchini, Italy  
Tel: 86-90-656  
**Brussels:**  
23 Chaussee de Wavre  
Brussels 1040, Belgium  
Tel: 513-73-95  
**Frankfurt/Main:** Fritz Krusebecker  
Liebigstrasse 27c, Germany  
Tel: 72-01-81  
**Tokyo:** Akio Saijo and Hirokazu Nakamura  
McGraw-Hill Publications Overseas Corporation,  
Kasumigaseki Building 2-5, 3-chome,  
Kasumigaseki, Chiyoda-Ku, Tokyo, Japan  
[581] 9811

#### Business Department

**Thomas M. Egan**  
Production Director  
[212] 997-3140  
**Carol Gallagher**  
Production Manager  
[212] 997-2045

**Betty Preis**  
Production Manager Domestic  
[212] 997-2908

**Thomas Kazich**  
Production Manager Related Products  
[212] 997-2044

**Karen Walpole**  
Production Assistant  
[212] 997-2843

**Frances Vallone**  
Reader Service Manager  
[212] 997-6057

#### Electronics Buyers' Guide

**H.T. Howland**, General Manager  
[212] 997-6642  
**Regina Hera**, Directory Manager  
[212] 997-2544

#### Classified and Employment Advertising

**Gerry F. Moss**, Manager  
[212] 997-2897



# Electronics

## Reader Service

For additional information on products advertised, new products or new literature, use these business reply cards.

Complete entire card. Please print or type. Circle the number on the Reader Service postcard that corresponds to the number at the bottom of the advertisement, new product item, or new literature in which you are interested. To aid the manufacturer in filling your request, please answer the three questions.

All inquiries from outside the U.S. that cannot reach Electronics before the expiration date noted on the Reader Service postcard must be mailed directly to the manufacturer. The manufacturer assumes all responsibilities for responding to inquiries.

**Subscriptions & Renewals**  
Fill in the subscription card adjoining this card. Electronics will bill you at the address indicated on the card.

**Electronics** April 7, 1981 This reader service card expires July 7, 1981

NAME \_\_\_\_\_ TITLE \_\_\_\_\_

PHONE ( \_\_\_\_\_ ) \_\_\_\_\_ COMPANY \_\_\_\_\_

STREET ADDRESS (Company  or home  check one) \_\_\_\_\_

CITY \_\_\_\_\_ COUNTRY \_\_\_\_\_

Was This Magazine Personally Addressed to You?  Yes  No

**Industry classification** (check one):

- a Computer & Related Equipment  
 b Communications Equipment & Systems  
 c Navigation, Guidance or Control Systems  
 d Aerospace, Underseas Ground Support  
 e Test & Measuring Equipment  
 f Consumer Products  
 g Industrial Controls & Equipment  
 h Components & Subassemblies  
 j Independent R&D Organizations  
 k Government  
 8 Source of Inquiry—All Other INT'L.

**Your design function** (check each letter that applies):

- x I do electronic design or development engineering work.  
 y I supervise electronic design or development engineering work.  
 z I set standards for, or evaluate electronic components, systems and materials.  
 r Engineering  
**Your principal job responsibility** (check one)  
 t Management  
 v Engineering Management

**Estimate number of employees** (at this location): 1.  under 20 2.  20-99 3.  100-999 4.  over 1000

1 16 31 46	61 76 91 106	121 136 151 166	181 196 211 226	241 256 271 348	363 378 393 408	423 438 453 468	483 498 703 718
2 17 32 47	62 77 92 107	122 137 152 167	182 197 212 227	242 257 272 349	364 379 394 409	424 439 454 469	484 499 704 719
3 18 33 48	63 78 93 108	123 138 153 168	183 198 213 228	243 258 273 350	365 380 395 410	425 440 455 470	485 500 705 720
4 19 34 49	64 79 94 109	124 139 154 169	184 199 214 229	244 259 274 351	366 381 396 411	426 441 456 471	486 501 706 900
5 20 35 50	65 80 95 110	125 140 155 170	185 200 215 230	245 260 275 352	367 382 397 412	427 442 457 472	487 502 707 901
6 21 36 51	66 81 96 111	126 141 156 171	186 201 216 231	246 261 338 353	368 383 398 413	428 443 458 473	488 503 708 902
7 22 37 52	67 82 97 112	127 142 157 172	187 202 217 232	247 262 339 354	369 384 399 414	429 444 459 474	489 504 709 951
8 23 38 53	68 83 98 113	128 143 158 173	188 203 218 233	248 263 340 355	370 385 400 415	430 445 460 475	490 505 710 952
9 24 39 54	69 84 99 114	129 144 159 174	189 204 219 234	249 264 341 356	371 386 401 416	431 446 461 476	491 506 711 953
10 25 40 55	70 85 100 115	130 145 160 175	190 205 220 235	250 265 342 357	372 387 402 417	432 447 462 477	492 507 712 954
11 26 41 56	71 86 101 116	131 146 161 176	191 206 221 236	251 266 343 358	373 388 403 418	433 448 463 478	493 508 713 956
12 27 42 57	72 87 102 117	132 147 162 177	192 207 222 237	252 267 344 359	374 389 404 419	434 449 464 479	494 509 714 957
13 28 43 58	73 88 103 118	133 148 163 178	193 208 223 238	253 268 345 360	375 390 405 420	435 450 465 480	495 510 715 958
14 29 44 59	74 89 104 119	134 149 164 179	194 209 224 239	254 269 346 361	376 391 406 421	436 451 466 481	496 701 716 959
15 30 45 60	75 90 105 120	135 150 165 180	195 210 225 240	255 270 347 362	377 392 407 422	437 452 467 482	497 702 717 960

**Electronics** April 7, 1981 This reader service card expires July 7, 1981

NAME \_\_\_\_\_ TITLE \_\_\_\_\_

PHONE ( \_\_\_\_\_ ) \_\_\_\_\_ COMPANY \_\_\_\_\_

STREET ADDRESS (Company  or home  check one) \_\_\_\_\_

CITY \_\_\_\_\_ COUNTRY \_\_\_\_\_

Was This Magazine Personally Addressed to You?  Yes  No

**Industry classification** (check one):

- a Computer & Related Equipment  
 b Communications Equipment & Systems  
 c Navigation, Guidance or Control Systems  
 d Aerospace, Underseas Ground Support  
 e Test & Measuring Equipment  
 f Consumer Products  
 g Industrial Controls & Equipment  
 h Components & Subassemblies  
 j Independent R&D Organizations  
 k Government  
 8 Source of Inquiry—All Other INT'L.

**Your design function** (check each letter that applies):

- x I do electronic design or development engineering work.  
 y I supervise electronic design or development engineering work.  
 z I set standards for, or evaluate electronic components, systems and materials.  
 r Engineering  
**Your principal job responsibility** (check one)  
 t Management  
 v Engineering Management

**Estimate number of employees** (at this location): 1.  under 20 2.  20-99 3.  100-999 4.  over 1000

1 16 31 46	61 76 91 106	121 136 151 166	181 196 211 226	241 256 271 348	363 378 393 408	423 438 453 468	483 498 703 718
2 17 32 47	62 77 92 107	122 137 152 167	182 197 212 227	242 257 272 349	364 379 394 409	424 439 454 469	484 499 704 719
3 18 33 48	63 78 93 108	123 138 153 168	183 198 213 228	243 258 273 350	365 380 395 410	425 440 455 470	485 500 705 720
4 19 34 49	64 79 94 109	124 139 154 169	184 199 214 229	244 259 274 351	366 381 396 411	426 441 456 471	486 501 706 900
5 20 35 50	65 80 95 110	125 140 155 170	185 200 215 230	245 260 275 352	367 382 397 412	427 442 457 472	487 502 707 901
6 21 36 51	66 81 96 111	126 141 156 171	186 201 216 231	246 261 338 353	368 383 398 413	428 443 458 473	488 503 708 902
7 22 37 52	67 82 97 112	127 142 157 172	187 202 217 232	247 262 339 354	369 384 399 414	429 444 459 474	489 504 709 951
8 23 38 53	68 83 98 113	128 143 158 173	188 203 218 233	248 263 340 355	370 385 400 415	430 445 460 475	490 505 710 952
9 24 39 54	69 84 99 114	129 144 159 174	189 204 219 234	249 264 341 356	371 386 401 416	431 446 461 476	491 506 711 953
10 25 40 55	70 85 100 115	130 145 160 175	190 205 220 235	250 265 342 357	372 387 402 417	432 447 462 477	492 507 712 954
11 26 41 56	71 86 101 116	131 146 161 176	191 206 221 236	251 266 343 358	373 388 403 418	433 448 463 478	493 508 713 956
12 27 42 57	72 87 102 117	132 147 162 177	192 207 222 237	252 267 344 359	374 389 404 419	434 449 464 479	494 509 714 957
13 28 43 58	73 88 103 118	133 148 163 178	193 208 223 238	253 268 345 360	375 390 405 420	435 450 465 480	495 510 715 958
14 29 44 59	74 89 104 119	134 149 164 179	194 209 224 239	254 269 346 361	376 391 406 421	436 451 466 481	496 701 716 959
15 30 45 60	75 90 105 120	135 150 165 180	195 210 225 240	255 270 347 362	377 392 407 422	437 452 467 482	497 702 717 960

# Electronics Reader Service

If the cards below have already been used,  
you may obtain the needed information  
by writing directly to the manufacturer,  
or by sending your name and address,  
plus the Reader Service number and issue date,  
to Electronics Reader Service Department,  
P.O. Box No. 2530, Clinton, Iowa 52734, U.S.A.

Place correct airmail  
postage here ... for  
faster service.

## Electronics

P.O. Box No. 2530  
Clinton, Iowa 52735  
U.S.A.

Place correct airmail  
postage here ... for  
faster service.

## Electronics

P.O. Box No. 2530  
Clinton, Iowa 52735  
U.S.A.

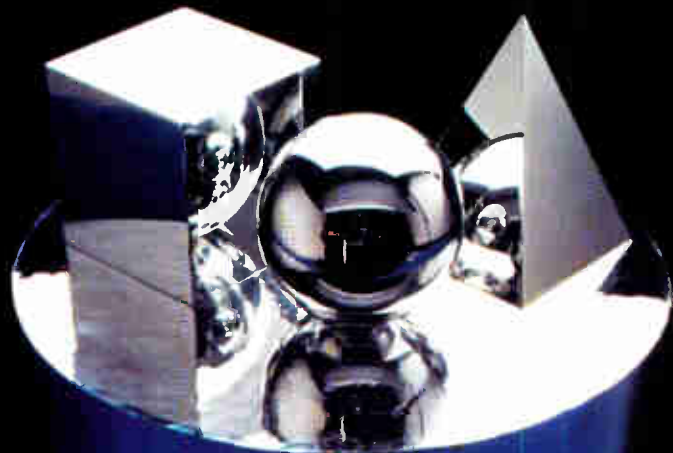

Wherever you need  
**100 Watts of RF power**  
from 10kHz to 400MHz...



# ENI has it covered.

Imagine the tremendous versatility you could enjoy with the extremely wide coverage of just these two broadband power amplifiers.

The **ENI 5100L** spans the frequency range of 1.5 to 400 MHz with a Class A linear output rating of 100 Watts and a flat 50 dB gain. And it will deliver 200 Watts from 1.5 to 200 MHz.

The **ENI 2100L** covers the range from 10 kHz to 12 MHz with a Class A linear output of more than 100 Watts. And it, too, can deliver 200 Watts over much of its useful frequency range.



Both units are solid state. Both units are unbelievably rugged. Unconditionally stable. Will not oscillate for any conditions of load or source imped-

ance. And will withstand all mismatched loads including short and open circuits.

Now there's no need to buy a whole expensive spread of individual units. With just these two portable amplifiers, you can work on an almost infinite range of applications. If it's 100 Watts... ENI has it covered!

For more information, a demonstration, or a full line catalog, please contact us at ENI, 3000 Winton Road South, Rochester, NY 14623. Call 716/473-6900, or telex 97-8283 ENI ROC.

## ENI

The advanced design line of RF power amplifiers

ENI products available through ENI Power Systems, Ltd., 23 Old Park Road, Hitchin, Hertfordshire, England SG52JS, Tel: Hitchin 51711, TELEX 825153  
ENI UK G. And: **AUSTRALIA:** Elmeasco Instruments Pty Ltd., Concord N.S.W. Australia, Tel: 939-7944 **BELGIUM:** Regulation-Mesure S.P.R.L., 1150 Brussels,  
Belgium, Tel: 771.20.20 **DENMARK:** Instrutek, 8700 Horsens, Tel: 05-611100 **EGYPT:** Electronic Precision Instrument Co., P.O. Box 1262, Cairo, Arab Republic  
of Egypt, Tel: 860819 **FRANCE:** Comsatec, 92300 Levallois-Perret, France, Tel: 758.59.10 **GERMANY, AUSTRIA:** Konttron Elektronik GmbH, 8057  
Eching/Munich 1, Germany, Tel: 89-3188-1 **ISRAEL:** RDT Electronics Engineering Ltd., Tel Aviv 61210, Israel, Tel: 483211-5 **ITALY:** Vianello S.p.A., I-20121 Milano,  
Italy, Tel: 34.52.071 **JAPAN:** Astech Corporation, Shinjuku-ku, Tokyo 160, Japan, Tel: Tokyo 343-0601 **NETHERLANDS:** Koning en Hartman Elektrotechniek  
B.V., The Hague 2040, Netherlands, Tel: 70-678380 **SOUTH AFRICA:** Associated Electronics (Pty), Ltd., Johannesburg, South Africa, Tel: 724-5396  
**SWEDEN:** Saven AB, S-18500 Vaxholm, Sweden, Tel: 0764/31580 **SWITZERLAND:** Kontron Electronic AG, 8048 Zurich, Switzerland, Tel: 01 62 82 82  
**UNITED KINGDOM:** Dale Electronics, Ltd., Frimley Green, Camberley, Surrey, England, Tel: Deepcut (02516) 5094

Circle 250 on reader service card

# Objective:

## Enhanced 64K RAM Performance.

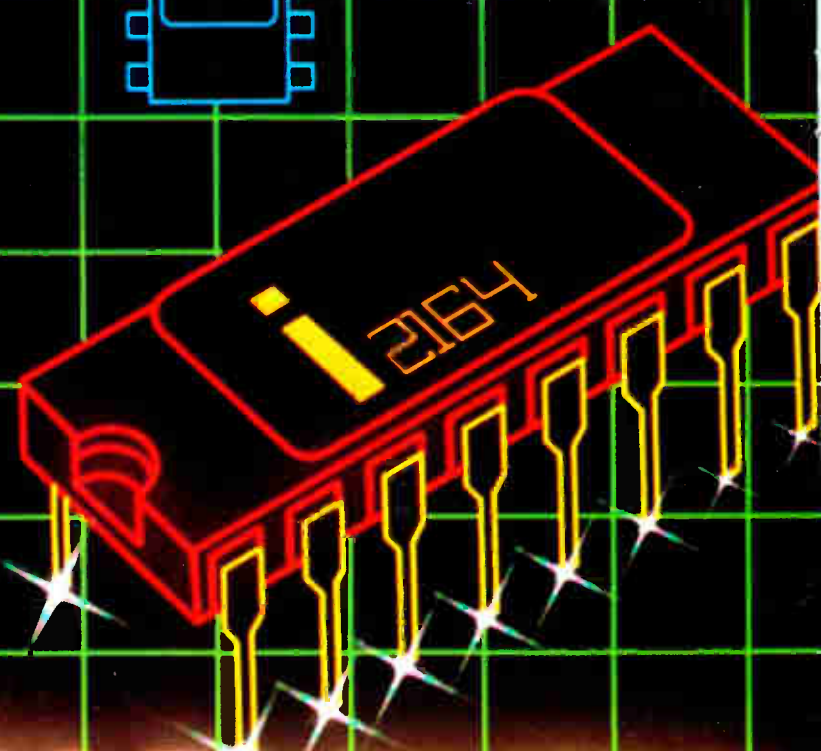
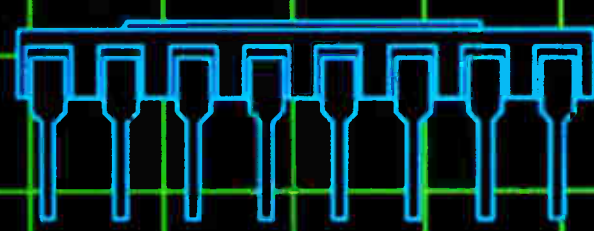
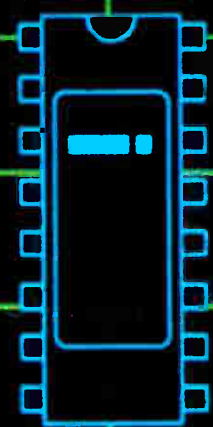

# Solution:

## Intel's HMOS Technology.

In 1977, Intel's patented high-performance HMOS process brought about a new era in the design of memories and microprocessors. Today, Intel takes HMOS a step further in their new 2164 group of 5-volt-only 64K dynamic RAMS — now in stock at Hamilton/Avnet. The result is a marked increase in performance and higher levels of integration. Plus, the four-row, four-column

redundant design contributes to a higher yield of error-free devices and consequently greater availability.

The 2164 is configured in a 64Kx1 organization and is packaged in the industry standard ceramic 16-pin DIP pinout. Available with access times of 150 ns, 200 ns, and 250 ns, the 2164 also allows users to upgrade from Intel's 2118  $\pm 5V$ , 16K RAM.

Look to Intel to deliver innovative solutions to price/performance objectives. And look to Hamilton/Avnet to make these solutions readily available to you. Like the 2164, now in stock and ready for immediate delivery from any of our 42 locations.



# INTEL® from HAMILTON/AVNET

World's largest local distributor with 42 locations stocking the world's finest lines of electronic components



**SOUTHERN CALIFORNIA**  
Avnet, L.A. (213) 558-2345  
Avnet, D.C. (714) 754-6111  
Hamilton, L.A. (213) 558-2121  
Hamilton, O.C. (714) 641-4100

**SOUTHWEST**  
San Diego (714) 571-7510  
Phoenix (502) 275-7851

**NORTHWEST**  
San Francisco (408) 743-3355  
Portland (503) 635-8831  
Seattle (206) 453-5844

**ROCKY MOUNTAIN**  
Salt Lake City (801) 972-2800  
Denver (303) 779-9998  
Albuquerque (505) 765-1500

**NORTH CENTRAL**  
Chicago (312) 678-6310  
Minneapolis (612) 941-3801  
Milwaukee (414) 784-4510

**SOUTH CENTRAL**  
Dallas (214) 659-4111  
Houston (713) 780-1771  
Austin (512) 837-8911

**MID CENTRAL**  
Kansas City (913) 888-8900  
St. Louis (314) 344-1200

**GREAT LAKES**  
Cleveland (216) 831-3500  
Dayton (513) 433-0610  
Detroit (313) 522-4700  
Indianapolis (317) 844-9333

**NORTHEAST**  
Boston (617) 273-7500  
Syracuse (315) 437-2641  
Rochester (716) 475-9130

**METROPOLITAN**  
Long Island (516) 454-6060  
Connecticut (203) 797-2800  
N. New Jersey (201) 575-3390

**MID ATLANTIC**  
Baltimore (301) 995-3500  
S. New Jersey (609) 424-0100  
Raleigh (919) 829-8030

**CANADA**  
Toronto (416) 677-7432  
Montreal (514) 331-6443  
Ottawa (613) 226-1700

**SOUTHEAST CENTRAL**  
Atlanta (404) 447-7507  
Huntsville (205) 837-7210

**SOUTHEAST**  
St. Petersburg (813) 576-3930  
Miami (305) 971-2900

**INTERNATIONAL**  
Telex 66-4329  
Telephone (213) 558-2441

**JAPAN**  
Tokyo (03) 662-9911  
Osaka (06) 533-5855

Circle 902 on reader service card  
World Radio History