

OCTOBER 9, 1980

STANDARD TESTERS FOR FIBER OPTICS AWAIT MARKET SURGE/91

Large-scale integration lightens the rf design load/ 148

Fiber-optic receivers start to integrate/ 155



FOUR DOLLARS A McGRAW-HILL PUBLICATION

Electronics®

SHRINKING A MAINFRAME CPU INTO SILICON

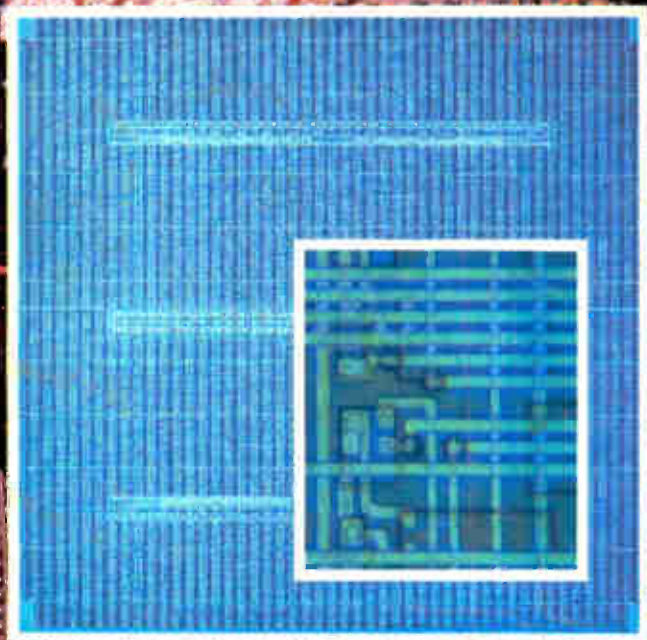

07A7K

147A 080324 44CAZ MAY82
CS OSBORNE, JR
PERIPHICON
BOX 324
BEAVERTON, OR

HOW DEPENDENT SHOULD YOU BE ON THE ATE SUPPLIER?

Automatic board test equipment can provide a powerful solution to today's testing needs. But choosing the right system can be a complex and bewildering task, because of all the non-hardware factors to be assessed.

Purchase alternatives.

One factor is the question of system responsibility. At one end of this spectrum is a turnkey system. Here the ATE manufacturer assumes total responsibility and the user is dependent upon the supplier for hardware, software and system implementation. At the other end is the do-it-yourself system tailored to your exact application, in which case the user is almost self-sufficient. Other alternatives also exist. So how can you choose the right one?

Some helpful criteria.

The three most important criteria are: your environment, departmental resources, and the system supplier.

Production environment is critical. How high is the PC board volume? Are the boards extremely complex? How many new products are anticipated? For example, if you have fairly simple boards and few requirements for changes, a turnkey solution may be your answer. But for highly complex boards and a stream of new products, you may wish to keep expansion and revision control in-house. What about departmental resources? Do you have the technical people to assemble and program a do-it-yourself system?

Finally, the

system supplier should be evaluated. Does the company have knowledge of your business and applications engineers familiar with your needs? Will service and support personnel be available when and where you need them?

The concept of shared responsibility.

HP's answer is shared responsibility . . . a concept that minimizes both start-up difficulty and your dependence upon outside suppliers (see chart below).

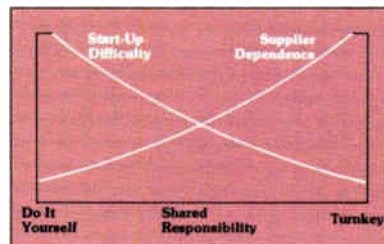

When you choose the HP 3060A Board Test System, you get a system designed to put you on the road to independence. Here's why:

First, you get two weeks of intensive training in system use and software development. Second, HP supplies the software aids that take the mystery out of programming. Non-technical people can easily program in-circuit tests by entering node numbers plus parts values and tolerances. HP's In-circuit

Program Generator (IPG) does the rest, selecting appropriate test methods, determining uncertainty, generating the test program and more.

Then, your technical people can easily master BTL (Board Test Language), using commands such as the one shown, to

program functional tests. Because they know the circuit best, testing becomes more thorough and more meaningful.

Third, you get reliable hardware that's ready to operate. Most systems are up and running the same day they're installed. And because the system is HP-IB compatible, you can modify and expand its capability right in your facility without a major software investment.

If you have problems, HP doesn't desert you. Our specialists are available to help. And with the self-diagnostics built into the system, you'll be up and running again quickly.

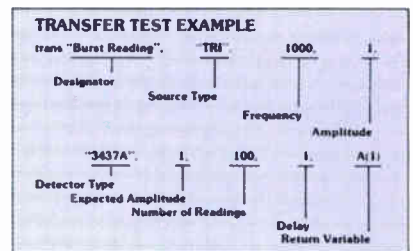

Supplier independence.

The net result is greater independence. With the HP 3060A, you learn to solve your own problems. That means faster response to changing needs. Direct control over expenses. And, generally, lower overall cost of ownership.

For additional information.

There are numerous other reasons to consider the HP 3060A (\$85,000* for standard operating system). To get complete details, write: Hewlett-Packard, 1507 Page Mill Road, Palo Alto, CA 94304. Or call your nearest regional sales office: East (201) 265-5000, West (213) 970-7500, Midwest (312) 255-9800, South (404) 955-1500, Canada (416) 678-9430.

*Domestic USA price only.

0801-45

HP Circuit Testers —
The Right Decision

 HEWLETT
PACKARD



SURPRISE!

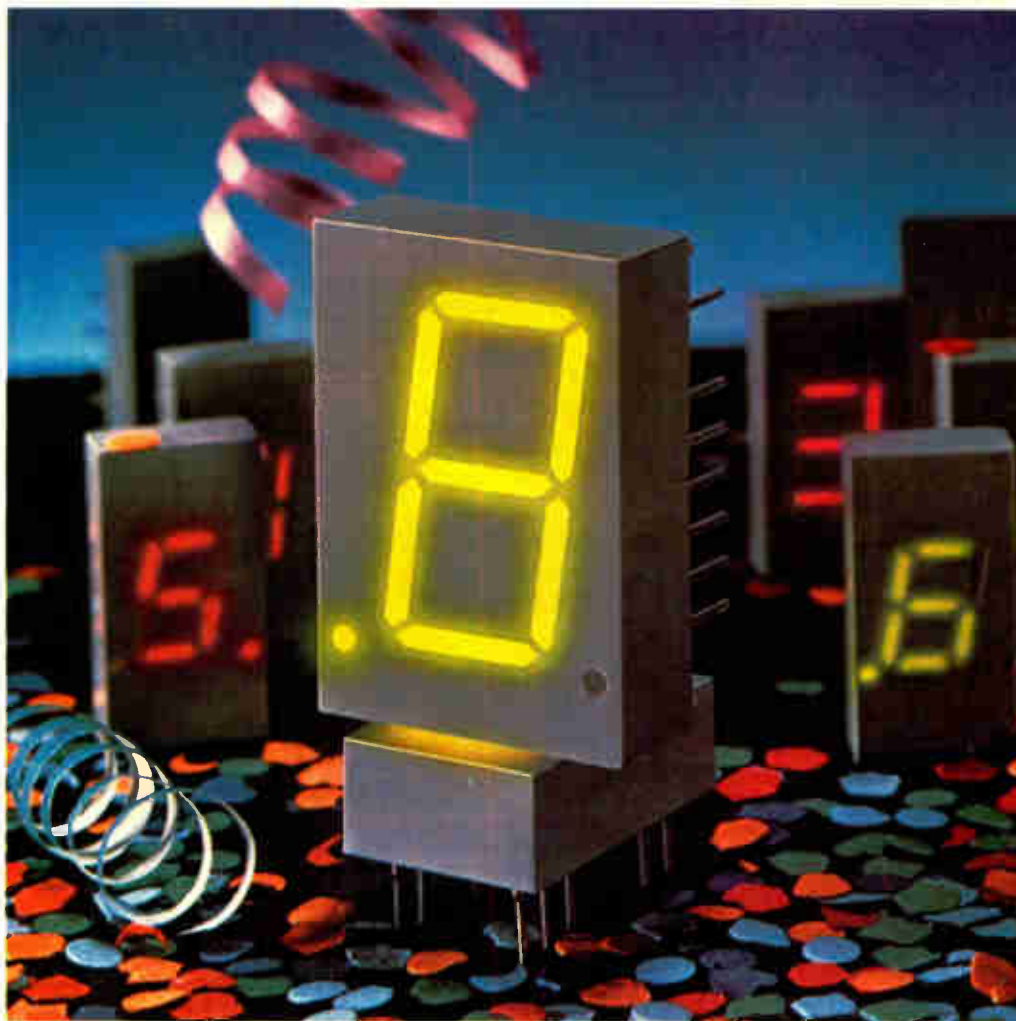

HP's New Display is a Big Yellow Show Off.

Yellow joins High Efficiency Red in HP's popular 20mm (0.8") high displays. Both can be viewed clearly from as far away as 10 metres. They show off well too, with excellent readability in bright ambient conditions because of their gray body color and untinted segments. This is HP's family of HDSP-3900 Series of red displays and HDSP-4200 Series of yellow.

IC compatible, they're ideal for electronic instrumentation, point-of-sale terminals, TV's weighing scales, digital clocks, and other applications where you need a big, easy-to-read display. And power requirements are low since they utilize a chip made from GaAsP on a transparent GaP substrate.

Units are priced at \$2.55* in quantities of 1000.

For immediate delivery, call any authorized HP components distributor. In the U.S. contact Hall-Mark, Hamilton/Avnet, Pioneer Standard, Schweber, Wilshire or the Wyle Distribution Group (Liberty/Elmar). In Canada, call Hamilton/Avnet or Zentronics, Ltd.



**HEWLETT
PACKARD**

Available from stock.

HI-REL MIXERS with a 3-year guarantee!

\$8.95 SRA-1
from (500 qty)



Hi Rel

Five years ago, Mini-Circuits offered a two-year guarantee for its industry-standard SRA-1 hermetically sealed Double-Balanced Mixer. . . now used worldwide for a variety of military and industrial applications.

The two-year guarantee was made possible by the use of an accelerated-life screening test for diodes generally reserved only for space applications. The HTRB-screened Schottky diodes are subjected to a one-volt negative bias at 150°C for 168 hours, a stress designed to accelerate ageing and force time-related failures — thus screening out potentially unreliable diodes.

Mini-Circuits is proud to offer a three-year guarantee for the SRA-1 achieved by further stressing and testing the assembled unit. Each completed SRA-1 experiences:

1. Burn-in for 96 hours at 100°C with 8 mA at 1 KHz.
2. Thermal shock.
3. Gross and fine leak tests (per MIL-STD 202).

And the three-year guarantee SRA-1 is still only \$8.95! Of course, the additional testing adds to our cost, but our continuing commitment is to offer performance and reliability unmatched for off-the-shelf Double-Balanced Mixers.

So, for space or rugged industrial applications, ensure highest system reliability by specifying SRA-1 mixers, the only Doubled-Balanced Mixers with a three-year guarantee. . . from Mini-Circuits where low price goes hand in hand with unmatched quality.

Model **SRA-1**

Freq. range (MHz)

LO.....0.5-500
RF.....0.5-500
IF.....DC-500

Conversion loss (dB)

	Typ.	Max.
1-250 MHz.....	5.5	7.0
0.5-500 MHz.....	6.5	8.5

Isolation (dB)

	Typ.	Max.
0.5-5 MHz.....LO-RF	50	45
LO-IF	45	35
5-250 MHz.....LO-RF	45	30
LO-IF	40	25
250-500 MHz.....LO-RF	35	25
LO-IF	30	20

Min. Electronic Attenuation (20 mA) 3 dB Typ.

Signal, 1 dB Compression Level + 1 dBm

Impedance All Ports, 50 Ohms

LO Power + 7 dBm

World's largest manufacturer of Double-Balanced Mixers

 **Mini-Circuits**

2625 East 14th Street Brooklyn, New York 11235 (212) 769-0200
Domestic and International Telex 125460 International Telex 620156

139 Technical Articles

COMPUTERS

The System/370 processor chip: a triumph of automated design, 139

Implementing the architecture, 140

Wiring the chip, 144

Shortening long path delays, 146

COMPONENTS

Adding to PLL chips' functions speeds rf synthesizer design, 148

COMMUNICATIONS

Integration is on the way for fiber-optic receivers, 155

COMPONENTS

High linearity and video speed come together in a-d converters, 167

MICROSYSTEMS

Single-chip computer aims at multiprocessing, 172

DESIGNER'S CASEBOOK: 162

ENGINEER'S NOTEBOOK: 176

39 Electronics Review

MEMORIES: ROM cells hold 2 data bits each, 39

MICROSYSTEMS: Mini makers face another challenge from a chip maker, 39

SOLID STATE: Superconductivity reported at room temperature, 41

COMMUNICATIONS: IC makers ready codec-filter combinations, 41

COMPUTERS: Already there is competition for the newest IBM 4341, 42

PACKAGING: Elastomers cushion prototype reworks, 44

PRODUCTION: Laser-based system inspects printed-circuit boards, 44

BUSINESS SYSTEMS: Fujitsu quietly tests U. S. office-computer waters at Wescon, 46

SHOWS: Wescon encore set at Anaheim, 46

NEWS BRIEFS: 48

65 Electronics International

JAPAN: The power is with a 16-bit silicon-on-sapphire microprocessor, 75

FRANCE: Gallium arsenide to yield 5-GHz divider, 76

GREAT BRITAIN: Adaptive echo canceler helps modem run at 9,600 b/s on noisy phone lines, 78

AROUND THE WORLD: 80

WEST GERMANY: Siemens aiming to sell more ICs abroad, 82

91 Probing the News

TEST EQUIPMENT: Instrument makers see market in fiber optics, 91

MILITARY: Military purchases to slow, 95

COMPONENTS: European components outlook dim, 100

MILITARY: NATO dollars are flowing, 104

189 New Products

IN THE SPOTLIGHT: Storage oscilloscope samples at 50 megahertz, 189

Microcomputer has 32-K ROM on chip, 194

16-K MOS ROM accesses in 80 ns, 202

MICROCOMPUTERS & SYSTEMS: C-MOS version of 8048 draws 10 mA at 6 MHz, 206

SEMICONDUCTORS: Small PROMs access in 45 ns, 217

DATA ACQUISITION: Hybrid 18-bit d-a converter contains reference, 228

MATERIALS: Semiconductor-processing chemicals become 1,000 times purer, 240

Departments

Highlights, 4

Publisher's letter, 6

Readers' comments, 8

News update, 12

People, 14

Editorial, 24

Meetings, 26

Electronics newsletter, 33

Washington newsletter, 57

Washington commentary, 58

International newsletter, 65

Engineer's newsletter, 180

Products newsletter, 249

Career outlook, 258

Services

Reprints available, 8

Employment opportunities, 262

Reader service card, 283

EDITOR-IN-CHIEF: Samuel Weber

MANAGING EDITORS

Technical: Raymond P. Capece,
Alfred Rosenblatt
News: Gerald M. Walker
International: Arthur Erikson

ASSISTANT MANAGING EDITORS: Howard Wolff,
Margaret Eastman

SENIOR EDITOR: Ray Connolly

ART DIRECTOR: Fred Sklenar

ASSOCIATE EDITOR: Benjamin A. Mason

DEPARTMENT EDITORS

Aerospace/Military: Ray Connolly
Circuit Design: Vincent Biancomano
Communications & Microwave:
Harvey J. Hindin
Components: Roger Allan
Computers & Peripherals: Tom Manuel
Industrial/Consumer: Gil Bassak
Microsystems & Software: R. Colin Johnson
Test, Measurement & Control:
Richard W. Comerford
New Products: Jeremy Young
Ana Bishop
Packaging & Production: Jerry Lyman
Solid State: John G. Posa

CHIEF COPY EDITOR: Margaret Eastman

COPY EDITORS: Mike Robinson,
Charlotte Wiggers

ART: Charles D. Ciatto, *Associate Director*
Paula Piazza, *Assistant Director*

EDITORIAL SECRETARIES: Maryann Tusa,
Alan Kleinberger, Dawn Ramsay, Christina Lindauer

REGIONAL EDITORS

New York: Pamela Hamilton (212) 997-2666
Boston: James B. Brinton,
Linda Lowe (617) 262-1160
Chicago: David Cook (312) 751-3805
Dallas: Wesley R. Iversen (214) 742-1747
Los Angeles: Larry Waller (213) 487-1160
Palo Alto: Bruce LeBoss, *Manager*
Martin Marshall, *Computers & Instruments*
(415) 968-2712
Washington: Ray Connolly (202) 624-7592
Frankfurt: John Gosch 72-5566
London: Kevin Smith 493-1451
Paris: Arthur Erikson,
Kenneth Dreyfack 720-20-70
Tokyo: Charles Cohen 581-9816

McGRAW-HILL WORLD NEWS

Editor: Michael Johnson
Brussels: James Smith
Milan: Jeff Ryser

Moscow: Peter Hann
Stockholm: Robert Skole
Tokyo: Robert Neff

PUBLISHER: Paul W. Reiss

GENERAL MANAGER, DIRECT MARKETING
OPERATIONS: Horace T. Howland

CIRCULATION MANAGER: Herbert A. Hunter

RESEARCH MANAGER: Margery D. Sholes

PROMOTION MANAGER: Jane De Court

MARKETING ADMINISTRATION MANAGER:
Frances M. Vallone

BOOKS & SPECIAL PROJECTS MANAGER:
Janet Eyley

SERVICE REVENUE SPECIALIST:
Penny Reitman

Computer-aided design reduces mainframe CPU to a chip, 139

Realizing very large-scale integration is no sure thing. To find out if its automatic gate-placement and -wiring system is up to the task, IBM went about fitting the central processing unit of the System/370 mainframe computer on a single chip. Three articles reveal, respectively, how the architecture was implemented (p. 140), how the gates and wiring were placed (p. 144), and how long path delays were shortened (p. 146).

The cover design is by Art Director Fred Sklenar, the photographs by courtesy of IBM Corp.

Market for fiber-optic measurement instruments is aborning, 91

With agreement on how to characterize fiber-optic links drawing near, instruments to specify the link's components—fibers, sources (transmitters), and detectors (receivers)—will soon be forthcoming. One indication that fiber-optic measurement is a field whose time is approaching is the Symposium on Optical Fiber Measurements. The first meeting devoted to the topic, it is being organized by the National Bureau of Standards in cooperation with the Optical Society of America and the Institute of Electrical and Electronics Engineers.

Enlarging PLL chips' functions eases synthesizer design, 148

By putting more phase-locked-loop control functions on chip, a complementary-MOS family offers designers noteworthy performance while cutting power consumption, cost, and space, as well as design time. The chips each contain one or two programmable divide-by-N counters; for those with two, dual-modulus prescaling can be used.

Integrated fiber-optic receivers, too, are in the offing, 155

Fiber-optic communications has emerged as a major technology, but slower to develop have been the monolithic optical receivers needed to make fiber-optic systems a commercial reality on a large scale. A few hybrid products are available, much work is being done around the world, and within five years many receiver components will be made in chip form. This special report looks at what is out and what is coming.

One-chip computer enlists as multiprocessor, 172

Ready to take on multiprocessing assignments is a series of 8-bit single-chip computers that include the control logic required to resolve the inherent problem of bus contention. What's more, special 16-bit instructions suit the parts for word-processing chores as well.

And in the next issue . . .

Electronics' annual technology update . . . the 1980 achievement award.

October 9, 1980 Volume 53, Number 22 102,499 copies of this issue printed

Electronics (ISSN 0013-5070). Published every other Thursday by McGraw-Hill, Inc. Founder: James H. McGraw 1860-1948. Publication office 1221 Avenue of the Americas, N.Y., N.Y. 10020; second class postage paid at New York, N.Y., and additional mailing offices.

Executive, editorial, circulation and advertising addresses: Electronics, McGraw-Hill Building, 1221 Avenue of the Americas, New York, N.Y. 10020. Telephone (212) 997-1221. Teletype 12-7950 TWX 710-581-4879. Cable address: MCGRAW HILL NEW YORK

Subscriptions limited to professional persons with active responsibility in electronics technology. No subscriptions accepted without complete identification of subscriber name, title or job function, company or organization, and product manufactured or services performed. Based on information supplied, the publisher reserves the right to reject non-qualified requests. Subscription rates: in the United States and possessions \$18 one year, \$31 two years, \$46 three years; company addressed and company libraries \$23 one year, \$41 two years, \$58 three years; APO/FPO addressed \$35 one year only; Canada and Mexico \$19 one year, \$32 two years, \$47 three years; Europe \$50 one year, \$85 two years, \$115 three years; Japan, Israel and Brazil \$70 one year, \$115 two years, \$165 three years; Australia and New Zealand \$95 one year, \$170 two years, \$240 three years, including air freight; all other countries \$50 one year, \$85 two years, \$125 three years. Limited quota of subscriptions available at higher-than-basic rate for persons allied to field served. Check with publisher for these rates. Single copies: \$4.00; special Anniversary issue: \$9.00 each. Please allow four to eight weeks for shipment.

Officers of McGraw-Hill Publications Company: Paul F. McPherson, President; Executive Vice Presidents: James E. Boddorf, Gene W. Simpson, Group Vice President; Daniel A. McMullan, Senior Vice President; Editorial: Ralph R. Schutz; Vice Presidents: Kemp Anderson, Business

Systems Development; Stephen C. Croft, Manufacturing; Robert B. Doll, Circulation; James E. Hackett, Controller; William H. Hammond, Communications; Eric B. Herr, Planning and Development; John W. Patten, Sales; Edward E. Schirmer, International

Officers of the Corporation: Harold W. McGraw, Jr., President, Chief Executive Officer, and Chairman of the Board, Robert N. Landes, Senior Vice President and Secretary; Ralph J. Webb, Treasurer

Title registered in U.S. Patent Office, Copyright © 1980 by McGraw-Hill, Inc. All rights reserved. The contents of this publication may not be reproduced in whole or in part without the consent of copyright owner.

Where necessary, permission is granted by the copyright owner for libraries and others registered with the Copyright Clearance Center (CCC), P.O. Box 8891, Boston, MA 02114, to photocopy any article herein for the base fee of \$0.50 per copy of the article plus \$0.25 per page. Payment should be sent directly to the CCC. Copying done for other than personal or internal reference use without the express permission of McGraw-Hill is prohibited. Requests for special permission or bulk orders should be addressed to the publisher ISSN 0013-5070/80\$0.50+\$0.25.

Subscribers: The publisher, upon written request to our New York office from any subscriber, agrees to refund that part of the subscription price applying to copies not yet mailed. Please send change-of-address notices or complaints to Fulfillment Manager, subscription orders to Circulation Manager, Electronics, at address below. Change-of-address notices should provide old as well as new address, including zip codes. Attach address label from recent issue. Allow one month for change to become effective. Subscriber Service: call (609) 448-8110, 9 a.m. to 4 p.m. EST.

Postmaster: Please send form 3579 to Fulfillment Manager, Electronics, P.O. Box 430, Hightstown, N.J. 08520

FRONTLINE

WHEREVER THE FRONT... THE EMERSON NAME IS ON THE LINE.

It's been that way since 1940.
That's the reason we build a variety
of defense and industrial systems
of frontline quality...of frontline
reliability, including:



- Ship and aircraft gun mounts
- Aircraft radar
- Anechoic chambers
- Communications systems
- Anti-intrusion detection systems
- Antenna feed systems
- Electronic warfare systems
- Anti-submarine warfare systems
- Automatic test equipment
- Air defense systems
- Anti-tank weapons systems



ELECTRONICS & SPACE



For product information,
please contact:
Floyd C. Raynard
V.P. Marketing



Government & Defense Group
Emerson Electric Co.
8100 W. Florissant Ave.
St. Louis, Missouri 63136
(314) 553-2000 TELEX 44-869

For career opportunities,
please call:
(800) 325-0783



Wide Band, Precision CURRENT MONITOR TRANSFORMER

With a Pearson current monitor and an oscilloscope, you can measure pulse or ac currents from milliamperes to kiloamperes, in any conductor or beam of charged particles, at any voltage level up to a million volts, at frequencies up to 35 MHz or down to 1 Hz.

The monitor is physically isolated from the circuit. It is a current transformer capable of highly precise measurement of pulse amplitude and waveshape. The one shown above, for example, offers pulse-amplitude accuracy of + 1%, -0% (typical of all Pearson current monitors), 10 nanosecond rise time, and droop of only 0.5% per millisecond. Three db bandwidth is 1 Hz to 35 MHz.

Whether you wish to measure current in a conductor, an electron device or a particle accelerator, it is likely that one of our off-the-shelf models (ranging from 1/2" to 10 3/4" ID) will do the job. Contact us and we will send you engineering data.

PEARSON ELECTRONICS, INC.

4007 TRANSPORT ST. / PALO ALTO, CA 94303
TELEPHONE (415) 494-6444 / TELEX 171 412

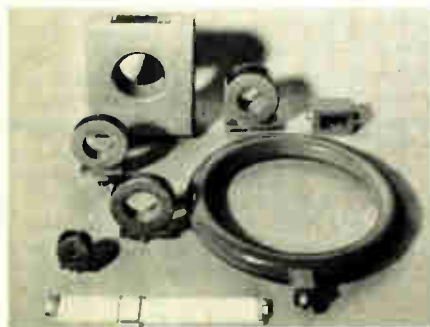

6 Circle 6 on reader service card

How far can computer-aided design, testing, and wiring procedures for gate arrays be pushed? Is it possible to put the 5,000-plus circuits of an IBM System/370 data flow on a chip? In 1978 an engineering team organized informally at International Business Machine Corp.'s Data Systems division in East Fishkill, N. Y., set out on an experiment to answer those questions.

Fascinated by the challenge, the group, representing diverse backgrounds and talents, pushed gate array design to new levels of density and complexity. It took just nine months to encode the 370 processor's logic design, automatically place and wire the logic gates, and generate verified test patterns.

A description of this project appears in the three-article cover series from IBM starting on page 139. The experiment more or less coalesced around author Claud Davis, senior engineering manager for advanced systems at East Fishkill.

As the systems expert on the team, 56-year-old Davis brought some 31 years' experience in design work on some of IBM's large computers, including the System/360. In a sense, he personifies the progress of computational power from large machines filling a room to a slice of silicon. Thinking back, Davis observes, "It's strange to realize that we can build on one chip more computing power than any machine we could make in the mid-'50s."

Equally challenged by the audacity of the project was Allan Dansky, advisory engineer in advanced applications. At 42, Dansky remembers designing chips with five circuits for the 370/145. "We've increased bipolar circuit capacity a thousandfold in 13 years," he notes. "Without computer-aided design, it could not have been done."

To Michael Feuer (pronounced "foyer"), who was responsible for the automatic placement and wiring, the project proved that the gate array has a vital place in very large-scale integration. Thirty-eight-year-old Feuer, senior engineering manager for VLSI physical design, points out that there is still a great deal

more potential in the gate array.

Everyone on the project was impressed by the team work and dedication involved. In part it was the fact that the IBM 370 was the benchmark.

"No question about it, we were self-motivated. It was something special," Feuer recalls.

For fiber-optic communications to spread its hair-thin web over the world, it will become necessary to integrate the components in the systems. Of the major parts that make up a fiber-optic system, the receiver is a natural for integration.

But there are real problems to overcome. With this thought in mind, communications editor Harvey Hindin prepared the special report on fiber-optic receivers (p. 155).

Basically, the way to make p-i-n diodes for these systems is incompatible with silicon technology as we know it today, Harvey points out. Moreover, the avalanche photodiode, an alternative, is even harder to integrate and requires several hundred volts to operate. "Nevertheless," he observes, "all concerned agree that present hybrid receivers will be replaced by ones with much greater degrees of integration over the next few years."

This trend underscores the progress of fiber-optic communications from interesting concept to trial applications to operating systems. Development has been especially animated in Western Europe and Japan, so that the information from our overseas bureaus was particularly important for this report.

Considering the interest in integrating receivers, Harvey was surprised to note that, with a few exceptions, the large semiconductor houses are not addressing this market. That situation will probably change as the dollar's value begins to grow, he predicts.

Angle accuracy to .02 degrees

Our Model 6500 digital phasemeter measures typically to .02° accuracy. The broad bandwidth extending from 3 Hz to 5 MHz coupled with the wide voltage range from 10 mV to 120 V makes it ideal for numerous applications. Here's a 0-360° continuous non-ambiguous display with resolution to .01°. This unit requires no "extras" and is priced for only \$2400. Going through a phase? Contact The WAVEMAKERS® at (617) 580-1660, or any of the offices listed.

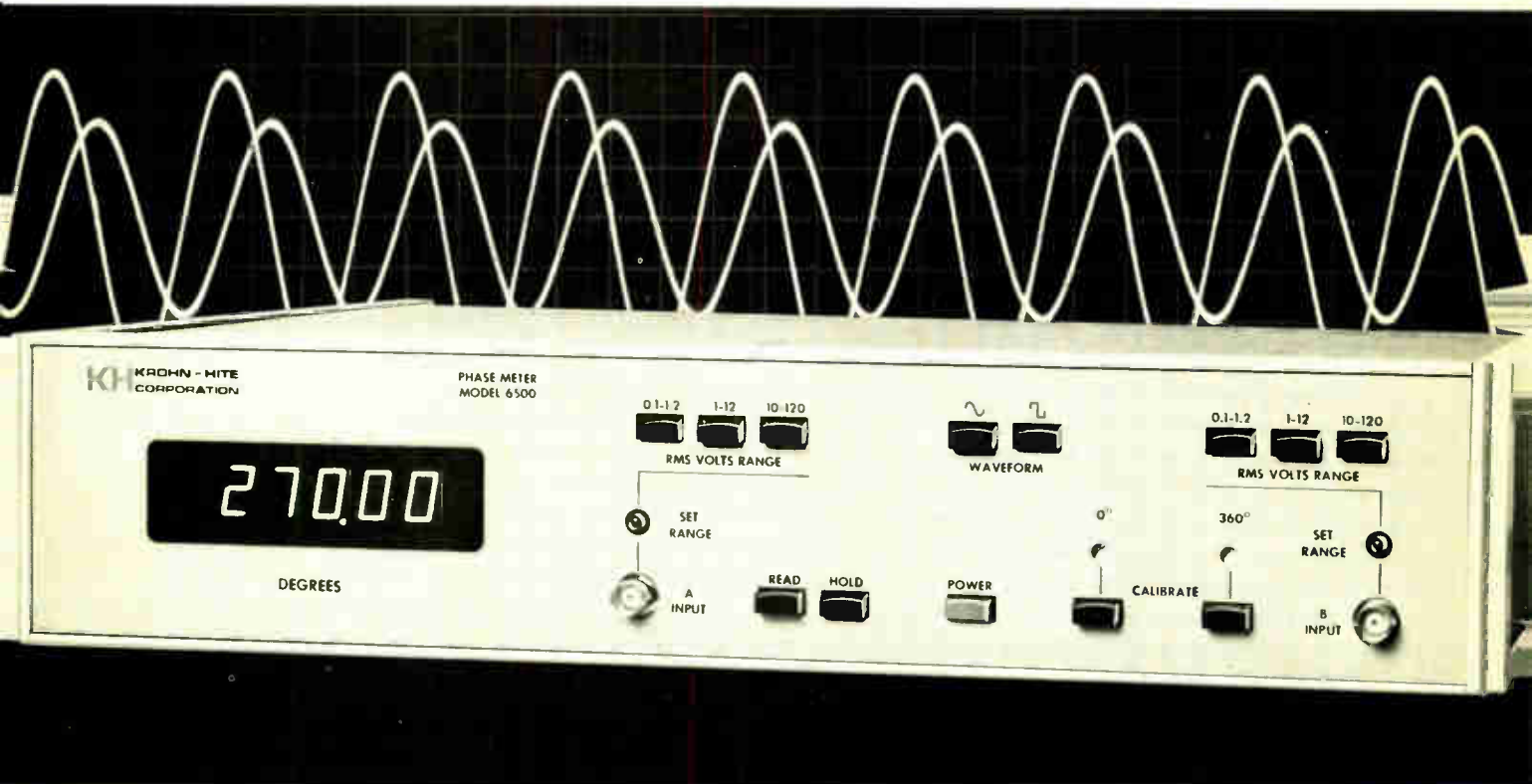

**KH KROHN-HITE
CORPORATION**

Avon Industrial Park, Avon, Mass. 02322 • (617) 580-1660, TWX 710-345-0831

AL, Huntsville (205)534-9771; AZ, Phoenix (602)279-1531; CA, Inglewood (213)674-6850, San Jose (408)292-3220; CO, Denver (303)773-1218; CT, Canton Center (203)693-0719; FL, Orlando (305)859-7450, Sunrise (305)742-2115; GA, Atlanta (404)455-1206; HI, Honolulu (808)941-1574; IL, Chicago (312)283-0713; IN, Carmel (317)844-0114; KS, Overland Park (913)649-6996; LA, Gretna (504)387-3975; MD, Towson (301)321-1411; MA, Chelmsford (617)256-9061; MI, Detroit (313)961-3042; MN, Minneapolis (612)835-4818; MO, St. Louis (314)569-1406; NM, Albuquerque (505)255-2330; NJ, Cherry Hill (609)482-0059, Englewood (201)871-3916; NY, Rochester (716)473-5720, Saratoga Springs (518)584-6519, Syracuse (315)437-6666; NC, Burlington (919)227-3639; OH, Chesterland (216)729-2222, Dayton (513)294-2476; OK, Jenks (918)299-2636; OR, Portland (503)297-2248; PA, Pittsburgh (412)261-2604; SC, Greenville (803)271-8543; TX, Dallas (214)661-0400, Houston (713)688-1431; UT, Salt Lake City (801)466-8729; VA, Falls Church (703)573-8787; WA, Bellevue (206)454-3400; WI, Milwaukee (414)545-8400; CANADA, Montreal, Quebec (514)744-5829, Ottawa, Ontario (613)725-1931, Toronto, Ontario (416)625-0600, Calgary, Alberta (403)276-7567.

Circle 7 on reader service card

Stretch your IEEE-488 Bus to 300 Meters... 28 Instruments.

IEEE-488

National Instrument's new high speed GPIB-100 bus extender system adds flexibility to your IEEE-488 instrumentation bus. Increases the distance between instruments up to 300 meters and raises the capacity of the bus from 15 to 28 instruments. You can now implement test and measurement systems with either single or multiple controllers in a distant location at the rate of 250 kbytes per second at 150 meters. And when the extenders are connected in series, instru-



ments can be located at multiple stations throughout your facility.

The system consists of two GPIB-100 units and an interconnecting cable. Fourteen GPIB-compatible instruments can be connected to

each unit. The system supports all GPIB functions. The system front panel has indicator lamps so you can see the status of the bus at a glance.

For more information on the GPIB-100 system, and the complete line of National's GPIB accessories call or write:



8900 Shoal Creek Blvd. Building A-117 Austin, Texas 78758 • (512) 454-3526

Circle 12 on reader service card

FREE

Brochure describes Electronics editorial reprints, services, books...

- More than 70 article reprints in 15 subject categories
- Handy wall charts
- Custom-made reprint services
- Books especially for **Electronics'** readers
- Convenient postage-paid order cards

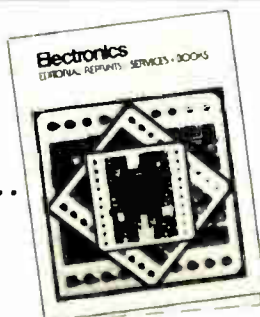

For your free copy, circle #275 on the reader service card.

Readers' comments

Not this engineer

To the Editor: I write in response to Andrew Grove's "Finding tomorrow's engineers today" [Aug. 14, p. 32].

I do not intend to proselytize for the engineering profession for these reasons:

(1) Predictions of demand are notoriously unreliable. In July 1962, the Engineering Manpower Commission stated that the supply of engineering graduates for each of the next 10 years would be at least 11,000 short of the most conservative estimates of need. In February 1971, an estimated 10,000 engineers, scientists, and supporting professional workers were out of work in Massachusetts alone! Senator Brooke even announced a plan to retrain 2,000 engineers and scientists for work in urban programs.

(2) For better or worse, a person's place in this society depends as much on power as on ability. Electrical engineers have no power. We have virtually no unions and our "professional organization" is controlled by the industries that employ us. Consequently, engineering labor is a commodity. Although demand is now high, the equilibrium total income for an engineer (as for anyone whose labor is a commodity) is equal to the subsistence income plus the cost of his or her education.

George Caplan
Newton, Mass.

Corrections

In "Transformerless inverter cuts photovoltaic system losses" (Aug. 14), total harmonic content should be slightly over 11%, instead of slightly over 5% as given on page 124. On page 126 the 256-bit read-only memory in the figure should have a 5-bit, not an 8-bit, address line.

The price for the initial offering in Tektronix 8500 series (Sept. 25, p. 33) should be under \$15,000.

Some numbers were jumbled in "Intel and NEC heat up the race in 64-K RAMs" (Sept. 25, p. 39). Intel Corp.'s 64-K RAM is the 2164, not the 4164. Mostek Corp's device is the MK4164, rather than the 4146.

Interested in higher performance software?

The Mark Williams Company announces **COHERENT**,™ a state of the art, third generation operating system. The design of **COHERENT** begins with the basic technology of the highly-acclaimed Western Electric UNIX operating system. From this starting point, it goes on to include further substantial software innovation. The primary goal of **COHERENT** is to provide a friendly environment for program development. The intent is to provide the user with a wide range of software building blocks from which he can select programs and utilities to solve his problems in the most straightforward manner.

COHERENT and all of its associated software are written totally in the high-level programming language **C**. Using **C** as the primary implementation language yields a high degree of reliability, portability, and ease of modification with no noticeable performance penalty.

Features

COHERENT provides **C** language source compatibility with programs written to run under Seventh Edition UNIX, enabling the large base of existing UNIX software (from numerous sources) to be available to the **COHERENT** user. The system design is based on a number of fundamental concepts. Central to this design is the unified structure of i/o with respect to ordinary files, external devices, and interprocess communication (pipes). At the same time, a great deal of attention has been paid to system performance so that the machine's resources are used in the most efficient way. The major features of **COHERENT** include:

- multiuser and multi-tasking facilities,
- running processes in foreground and background,
- compatible mechanisms for file, device, and interprocess i/o facilities,
- the shell command interpreter—modifiable for particular applications,
- distributed file system with tree-structured, hierarchical design,
- pipes and multiplexed channels for interprocess communication,
- asynchronous software interrupts,
- generalized segmentation (shared data, writeable instruction spaces),
- ability to lock processes in memory for real-time applications.
- fast swapping with swap storage cache,
- minimal interrupt lockout time for real-

time applications,

- reliable power failure recovery facilities,
- fast disc accesses through disc buffer cache,
- loadable device drivers,
- process timing, profiling and debugging trace features.

Software Tools

In addition to the standard commands for manipulating processes, files, and the like, in its initial release **COHERENT** will include the following major software components: **SHELL**, the command interpreter; **STDIO**, a portable, standard i/o library plus run-time support routines; **AS**, an assembler for the host machine; **CROSS**, a number of cross-assemblers for other machines with compatible object format with 'AS' above; **DB**, a symbolic debugger for **C**, Pascal, Fortran, and assembler; **ED**, a context-oriented text editor with regular expression patterns; **SED**, a stream editor (used in filters) fashioned after 'ED'; **GREP**, a pattern matching filter; **AWK**, a pattern scanning and processing language; **LEX**, a lexical analyzer generator; **YACC**, an advanced parser generator language; **NROFF**, an Nroff-compatible text formatter; **LEARN**, computer-aided instruction about computers; **DC**, a desk calculator; **QUOTA**, a package of accounting programs to control filespace and processor use; and **MAIL**, an electronic personal message system.

Of course, **COHERENT** will have an ever-expanding number of programming and language tools and basic commands in future releases.

Language Support

The realm of language support is one of the major strengths of **COHERENT**. The following language processors will be supported initially:

- **C** a portable compiler for the language **C**, including stricter type enforcement in the manner of **LINT**.
- **FORTRAN** portable compiler supporting the full ANS Fortran 77 standard.
- **PASCAL** portable implementation of the complete ISO standard Pascal.

- **XYBASIC**™ a state of the art Basic compiler with the interactive features of an interpreter.

The unified design philosophy underlying the implementation of these languages has contributed significantly to the ease of their portability. In particular, the existence of a generalized code generator is such that with a minimal effort (about one man-month) all of the above language processors can be made to run on a new machine. The net result is that the compilers running under **COHERENT** produce extremely tight code very closely rivaling that produced by an experienced assembler programmer. Finally, the unified coder and conformable calling sequences permit the intermixture of these languages in a single program.

Operating System

In part because of the language portability discussed above, and in part because of a substantial effort in achieving a greater degree of machine-independence in the design and implementation of the **COHERENT** operating system, only a small effort need be invested to port the whole system to a new machine. Because of this, an investment in **COHERENT** software is not tied to a single processor. Applications can move with the entire system to a new processor with about two man months of effort.

The initial version of **COHERENT** is available for the Digital Equipment Corporation PDP-11 computers with memory-mapping, such as the PDP 11/34. Machines which will be supported in the coming months are the Intel 8086, Zilog Z8000, and Motorola 68000. Machines for which ports are being considered are the DEC VAX 11/780 and the IBM 370, among others.

Because **COHERENT** has been developed independently, the pricing is exceptionally attractive. Of course **COHERENT** is completely supported by its developer. To get more information about **COHERENT** contact us today.



1430 W Wrightwood Ave. Chicago, IL 60614
TEL 312-472-6659 TWX: 910-221-1182



**DON'T LET DRIVING
YOUR MEMORY
DRIVE YOU CRAZY.**

You're trying to drive a large, high-performance memory array using 16K or 64K RAMs. And it's driving you nuts.

What with the undershoot, the skew problems, the large number of packages, the boss expecting a faster system than last year's — what's a designer to do?

Introducing the Am2964B: The Simple Solution.

Now Advanced Micro Devices has a bipolar dynamic memory controller for use with 16K and 64K RAMs. It's easy to use. It's flexible. And it takes care of all your RAS, CAS and address problems on one chip.

The Am2964B replaces about a dozen high-speed, high-power Schottky parts. And it not only does the job faster, it uses less power.

But what about the interface to the RAM? We thought you'd never ask.

Meet our Am2965/66 RAM drivers.

The faster you drive your memory, the faster your system. And that's where our new Am2965/66 come in. Together with our Am2964B, they achieve maximum performance and completely eliminate undershoot.

The speed is specified up to 500 pf. Min's and max's, too.

And if you need to upgrade your system, no problem. Our new RAM drivers have the same pin-outs as the S240 and 244, so it's easy to convert your existing system.

The Am2964B and Am2965/66 are the newest members of AMD's dynamic memory support family — the family that makes implementing dynamic RAM systems easier, cheaper, simpler, faster. Like all our parts, they're MIL-STD-883 for free, the highest quality parts you can buy.

Don't let driving your memory drive you up a wall. Send for all the facts on AMD's Dynamic Memory Support Family.

Bipolar LSI: The Simple Solution.

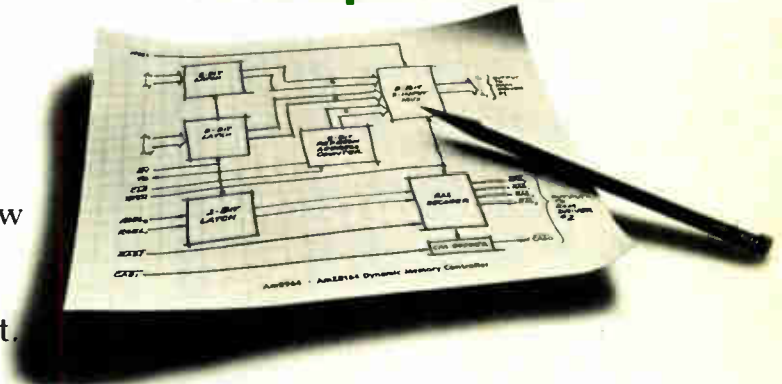

Advanced Micro Devices

901 Thompson Place, Sunnyvale, CA 94086 · (408) 732-2400
Right, from the start.

The Pascal Software Tool

OMSI PASCAL V1.2™

The value of Pascal in computer software design is becoming widely recognized. And our new V1.2 version contains significant enhancements in ease of operation and reliability. Consider the V1.2 Symbolic Debugger.

Pascal debugging should be performed in Pascal, not with assembler listings and memory maps. Our Debugger knows your data names and structures. Values are accepted and displayed in Pascal notation, including scalars, sets, arrays, records, and pointers.

Complete interactive control displays your original source lines, including embedded comments. Breakpoints give statement numbers and procedure names, rather than octal addresses. The Debugger can show the program execution history, including all stacked procedure calls. Should fatal errors occur, they are intercepted by the Debugger instead of ending your testing.

For more information on our approach, ask for the complete OMSI Pascal V1.2 Product Description.

Oregon Software

2340 S.W. Canyon Road • Portland, Oregon 97201
(503) 226-7760 • TWX 910-464-4779

INTERNATIONAL DISTRIBUTORS

Australia: Sydney
Network Computer Services 211-2322

Canada: Vancouver
Valley Software (604) 291-0651

England: London
Real Time Products 01-588-0667

Japan: Tokyo
Rikei Corporation 03-345-1411

W. Germany: Aachen
AC Copy 241/50-60-96

W. Germany: Munich
PCS 089/68-10-21

Circle 8 on reader service card

NEW 1980 Electronics Buyers' Guide

The only book of its kind in the field. If you haven't got it, you're not in the market.

To insure prompt delivery enclose your check with this coupon.

Yes, please send me _____ copies of 1980 EBG.

I've enclosed \$30 per copy delivered in USA or Canada. Address: EBG, 1221 Avenue of the Americas, New York, N.Y. 10020.

I've enclosed \$52 for air delivery elsewhere. Address: EBG, Shoppenhangers Road, Maidenhead, Berkshire S16, 2Q1 England.

Name _____

Company _____

Street _____

City _____

State _____

Zip _____

Country _____

News update

■ The MIT microchannel spatial light modulator will start moving towards commercialization with the signing of a licensing agreement between the Massachusetts Institute of Technology and Japan-based Hamamatsu Corp. in the next few months. Hamamatsu, which has built four MSLM units for development work at MIT, plans to approach manufacturers of scientific instrumentation with evaluation samples in about two years, says J. Ralph Eno, executive vice president of U. S. operations in Middlesex, N. J.

"Like the laser in its infancy, the MSLM is an answer looking for the right questions," says Eno. MIT researchers in Cambridge, Mass., developed the unit to speed data flow into and out of optical computers [*Electronics*, June 7, 1979, p. 41], but now foresee a number of other uses.

The MSLM is a kind of phase modulator, converting incoming images into coherent light images. Incoming light strikes a photocathode, which gives up electrons. Amplified by a microchannel plate and accelerated by an accelerator planar grid, the electrons charge an electro-optic plate, changing its refractive index. When a coherent laser beam illuminates the plate, these refractive changes induce phase changes in the laser's wave front, creating a visible readout of the original image.

Smart sensor. Its real-time, image-processing abilities suggest smart-sensor applications, says team leader Cardinal Warde, assistant professor of electrical engineering and computer science. It may also make possible reception in low visibility in wireless optical communications systems, he adds.

The MIT team has made the MSLM perform a variety of sophisticated image-processing functions, says Warde. These include contrast reversal and digitization of images.

Improved materials and design will increase the MSLM's processing speed—currently 20 hertz for full modulation—and will push its spectral sensitivity further into the near-infrared, Warde believes. He reports image-storage times of up to two months.

-Linda Lowe

HIGH SPEED ENTRY?

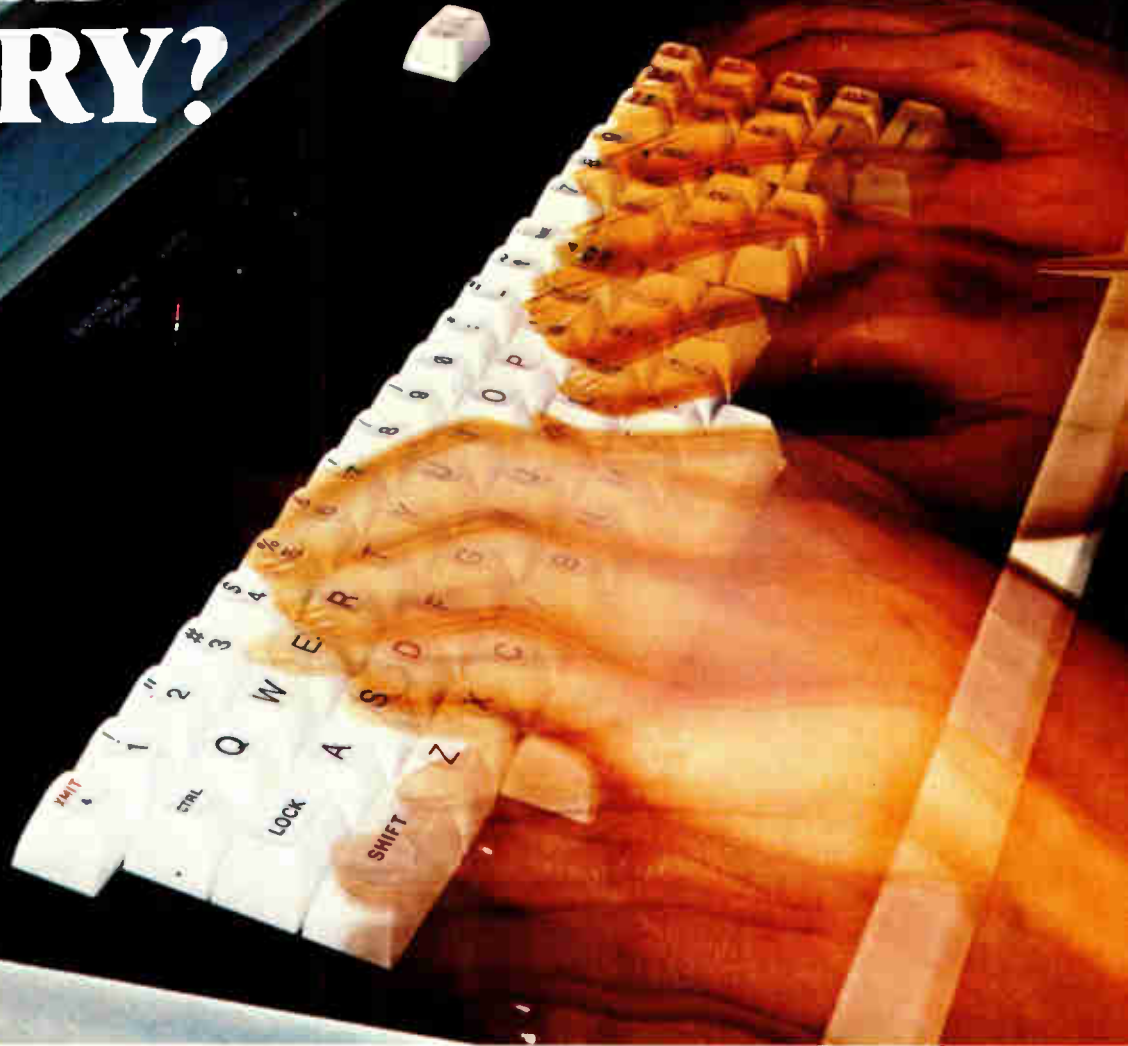

The fastest fingers can't outrun Cherry's new solid state keyboard

Word processing... phototypesetting... key-to-disc... no application exceeds the capability of this Cherry keyboard. Scan time externally adjustable to as little as 1.1 milliseconds accumulated total (entire keyboard). Burst rate speed is 1000 characters per second.

Capacitive design delivers error-free operation... long life dependability.

No chance for false signals. A unique noise immunity circuit tests continuously for valid key depressions. Elec-

tronic hysteresis circuit eliminates "teasing." Reliable contactless design gives long, trouble-free service life.

Custom designs for your specific application, do-it-yourself options and user assignable keys on standard models add surprising versatility at affordable price.

Put solid state reliability to work in your data entry operation.

Call or write Cherry today for your free copy of our 36 page keyboard catalog and the "How To" book of detailed application data.

Circle 13 on reader service card



SOLID STATE KEYBOARDS

CHERRY ELECTRICAL PRODUCTS CORP. 3608 Sunset Avenue, Waukegan, IL 60085 • 312/689-7612 • TWX: 910/235-1572

Our worldwide affiliates and phone numbers: Cherry Semiconductor Corp., Cranston, RI, U.S.A., 401/463-6000 • Cherry Mikroschalter GmbH, Auerbach, Germany, (09643) 18-1 • Cherry Electrical Products Ltd., Harpenden (Herts) England, 058-27-63100 • Chercos Brasil Industria E Comercio Ltda., Sao Paulo, Brazil, 55 11 246 4343 • Hirose Cherry Precision Co., Ltd., Kawasaki, Japan, (044) 933-3511



TRIAC DRIVER OPTOCOUPERS

Now, you have a choice!

This new TRW Optron series of optically coupled isolators features triac driver output in a standard six pin dual in-line plastic package.

The OPI3009, OPI3010 and OPI3011 are directly interchangeable with Motorola types MOC3009, MOC3010 and MOC3011.

Each device consists of a gallium arsenide infrared emitting diode optically coupled to a photosensitive silicon bilateral switch which functions like a triac.

The OPI3009, OPI3010 and OPI3011 are designed for threshold trigger currents of 30 mA, 15 mA and 10 mA, respectively, to latch the outputs. These trigger currents are design parameters over a temperature range of 0 to +70°C with expected operation of 50,000 hours minimum. The series can be used to control any power triac requiring a gate current of up to 100 mA.

A major application for triac drivers is to interface between the electronic controls of a home appliance and the power triacs which control solenoids, power supplies, motors, or heating elements. An added advantage is complete electrical isolation between the controls and the 120 VAC load.

New triac driver optocouplers are immediately available from your nearest TRW Optron authorized distributor or the factory direct. Applications Note No. 110 on the triac driver series and information on upcoming 240 VAC versions, the OPI3020 and OPI3021, are available from TRW Optron, 1201 Tappan Circle, Carrollton, Texas 75006 U.S.A. TWX 910-860-5958 • Tel 214/323-2200.

TRW OPTRON
A DIVISION OF TRW INC.



People

Raphael wants to make
modem design easier

"Two areas that are seeing the most technology innovations are microprocessors, and telecommunications and data communications. The second area is a consequence of the first," believes Howard A. Raphael. That helps explain why the former group director of microprocessor operations at National Semiconductor Corp. recently joined Cermetek Microelectronics Inc., the Sunnyvale, Calif., hybrid circuits manufacturer, as president.

The 34-year-old Raphael expects that as more equipment incorporates microprocessors, making them more intelligent and decentralized, "there will be an increasing need for data-communications capability." What's more, he continues, "the most widely available vehicle for data communications is the telephone." Thus it is clear why Raphael is excited about his new role at Cermetek, where he intends to focus the firm's hybrid microcircuits technology on supplying equipment designers with modem chips and modules that perform complete modem functions in the low-speed (300-to-1,200-bits-per-second) Bell-compatible market.

"We are looking to put modem design capability into the hands of first-time modem designers—that is, microprocessor, digital, and telecommunications engineers," states Raphael. By taking advantage of such modem modules and standard leased lines, "much equipment can be linked into a hassle-free network."

Raphael hopes that by offering components implementing the RS-232-C serial interface, among others, Cermetek not only will reduce systems cost but also, he says, "get digital designers to think beyond RS-232-C. Most just haven't dealt with analog functions before. Thus, by integrating those functions into our modem module—a digital product—we make them invisible to the digital designer."

By capitalizing on the microprocessor's acceptance and breaking new ground in other areas, Raphael



Think analog. Cermetek's Raphael wants digital designers to think beyond RS-232-C.

expects Cermetek's volume (currently estimated at about \$5 million) to grow an average of 50% annually over the next five years.

A native of New York City, Raphael holds a bachelor's degree in electrical engineering from the Rochester (N. Y.) Institute of Technology. Upon graduating in 1969, he joined Singer Business Machines Co. as an associate engineer and left five years later as its manager of process development. Prior to joining National Semiconductor in 1977, he was manager of low-end microcomputers at Intel Corp.

Bumb sees backup memory
as key to disk growth

Few would dispute that the magnetic storage media market—disks, tape, cartridges, and the like—has expanded at a dazzling 30% to 40% annual clip for several years—but can it continue? In the opinion of a 28-year veteran of the business, Frank C. Bumb, "it's still one of the most exciting growth areas, and there's a lot of gold to be mined."

Bumb stepped in as president this summer at Kennedy Co., a Monrovia, Calif., firm whose products pretty well cover the field. He takes over operating responsibility from founder Charles J. Kennedy, who remains as chairman. Acquired by Allegheny Ludlum Industries Inc. of Pittsburgh

PDP-11[®] and LSI-11[®] TAPE and DISK CONTROLLERS

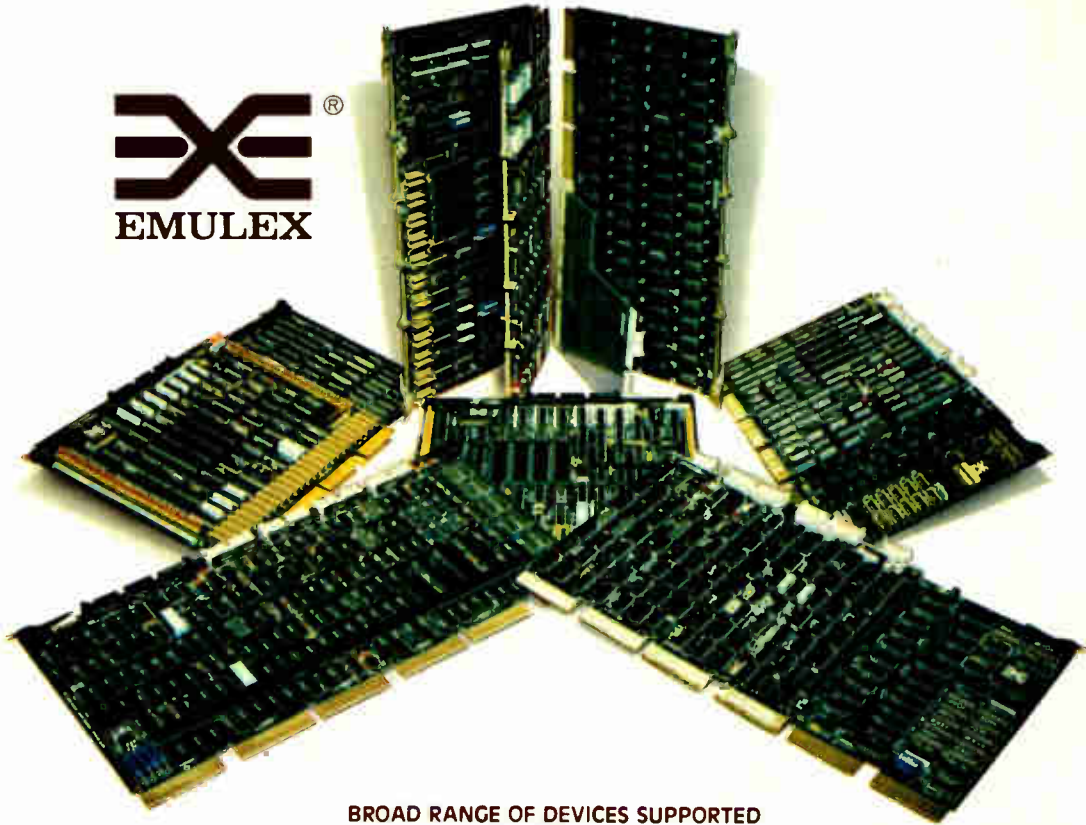

AUTHORIZED EMULEX DISTRIBUTOR

First Computer Corporation, the world's leading DEC computer system integrator now distributes the complete spectrum of EMULEX Tape and Disk controllers for the PDP-11 and LSI-11 family of computers.

HARDWARE / SOFTWARE TRANSPARENCY

These microprogrammed, emulating Tape and Disk Controllers are fully software transparent to both the PDP-11 hardware and software. The use of these controllers protects you from the impact of future versions of the operating system software. They are so compatible you can plug them into your system and be up and running the standard DEC diagnostics and operating systems in minutes.

ADDED FEATURES

These controllers provide you with added features such as automatic self-testing, onboard pack formatting, and programmable bandwidth control at no additional cost.

BROAD RANGE OF DEVICES SUPPORTED

It makes no difference which of the DEC PDP-11 or LSI-11 family you are using or which type of storage device is required for your application. We can support 59 different drives from 13 different manufacturers.

HIGHEST QUALITY AND SUPER RELIABILITY

You can be assured of the quality and reliability of these Tape and Disk Controllers because First Computer Corporation specializes in PDP-11 and LSI-11 computer systems, components, and peripherals. Over the years our reputation was built on the quality and reliability of the products we sell. We continue to protect this reputation by selling only the very best.

SUPER FAST SERVICE

Because we are the largest system integrator specializing in PDP-11 and LSI-11 systems, components, and peripherals, First Computer Corporation can satisfy most of your Tape and Disk Controller requirements directly from our stock.

GUARANTEED SATISFACTION

Your satisfaction is fully guaranteed by First Computer Corporation. We believe in every product we sell. If for any reason these Tape and Disk Controllers do not meet your expectations, simply return them freight prepaid and insured, within 10 days of receipt and we will refund your money in full. First Computer Corporation backs each of these products with a full one year warranty.

AUTHORIZED REPRESENTATIVES AND DEALERS

Authorized EMULEX Sales Representatives earn full commissions for orders filled by First Computer Corporation. Attractive Dealer discounts are available to all Authorized EMULEX Dealers.

PRICE AND PERFORMANCE

You pay no more for First Computer Corporation service. Write or call today for our free EMULEX Buyer's Guide.

® Registered trademark of Emulex Corporation

® Registered trademark of Digital Equipment Corporation

™ Trademark First Computer Corporation

CE3



computer corporation

corporate square / 825 north cass avenue / westmont, illinois 60559 / (312) 920-1050

TWX NUMBER 910-651-1916

You don't mess around with the Logic Timing Recorder.



Eliminate the mess of writing, erasing and re-writing your timing charts until they're perfect. The Logic Timing Recorder is an innovative and timesaving device for charting logic timing. It's an ingenious plastic board with 320 slides arranged in eight horizontal rows. These slides can be moved vertically between two click-stop positions to represent the logic state in your circuitry.

Look how easy it is to use the Logic Timing Recorder:



1. Move the sliders between the logical '1' and '0' levels according to your signals. You can represent a maximum of eight signals simultaneously.



2. You can easily reproduce the Logic Timing Recorder on your office copy machine. If it is necessary to identify the signal names near each row, you can write them on a piece of detachable, self-sticking paper or tape.



3. A neat copy of your final timing chart is now ready for presentation, or for your permanent files.

Durable ABS Plastic - 11-3/4" x 8-1/4" x 1/4"
Part Number 923758 Model No. LTR 320
\$44.95



A P PRODUCTS
INCORPORATED
1359 West Jackson Street
Painesville, Ohio 44077
(216) 354-2101
TWX: B10-425-2250

In Europe, contact A P PRODUCTS GmbH
Baemlesweg 21 • D-7031 Weil 1 • W. Germany

Call Toll Free 800-321-9668 for the name of the distributor nearest you. In Ohio, call collect (216) 354-2101

Circle 16 on reader service card

People



Still digging. Frank Bumb says there is much gold to mine in magnetic media hills.

in 1979, the company this year should see its sales approach \$45 million.

Spurring such a pace is, of course, the ravenous demand for microcomputer memory. In the hottest market segment, Winchester drives, Bumb notes that "disk suppliers can't service the market today." Projected disk drive sales by independent manufacturers for 1981, of units having up to a 200-megabyte capacity, are nearly \$185 million. "And this product didn't exist five years ago."

But disks are only part of it, since a clear-cut solution to the so-called backup question is still to be found. Disks must have a separate backup memory to take over in case of failure, "but the problem is a matter of price and access speed," explains the Kennedy president. The backup should not be as expensive as the disk, but it must be reliable and fairly fast. Kennedy's approach is to offer a single package, with either its 14- or 8-inch Winchester drive backed by a model 6809 tape "streamer" transport of its own or a model 640 cartridge drive. Bumb says Kennedy is the only firm selling its own package of disk drive and backup.

A graduate of the California Institute of Technology in adjacent Pasadena, Bumb held his previous job in that town as well, where he was president and general manager of Bell & Howell Co.'s Tape Products division. □

The magazine you're reading now could be your own.

Drop off the routing list. Get your own fresh, unclipped copy mailed to your home or office. Turn to the subscription card in the back of the magazine. If somebody has beat you to it, write: Electronics, P.O. Box 430, Hightstown, N.J. 08520.

HP-41C. The calculator that changes with your needs.

AVAILABLE
NOW AT YOUR
HP DEALER

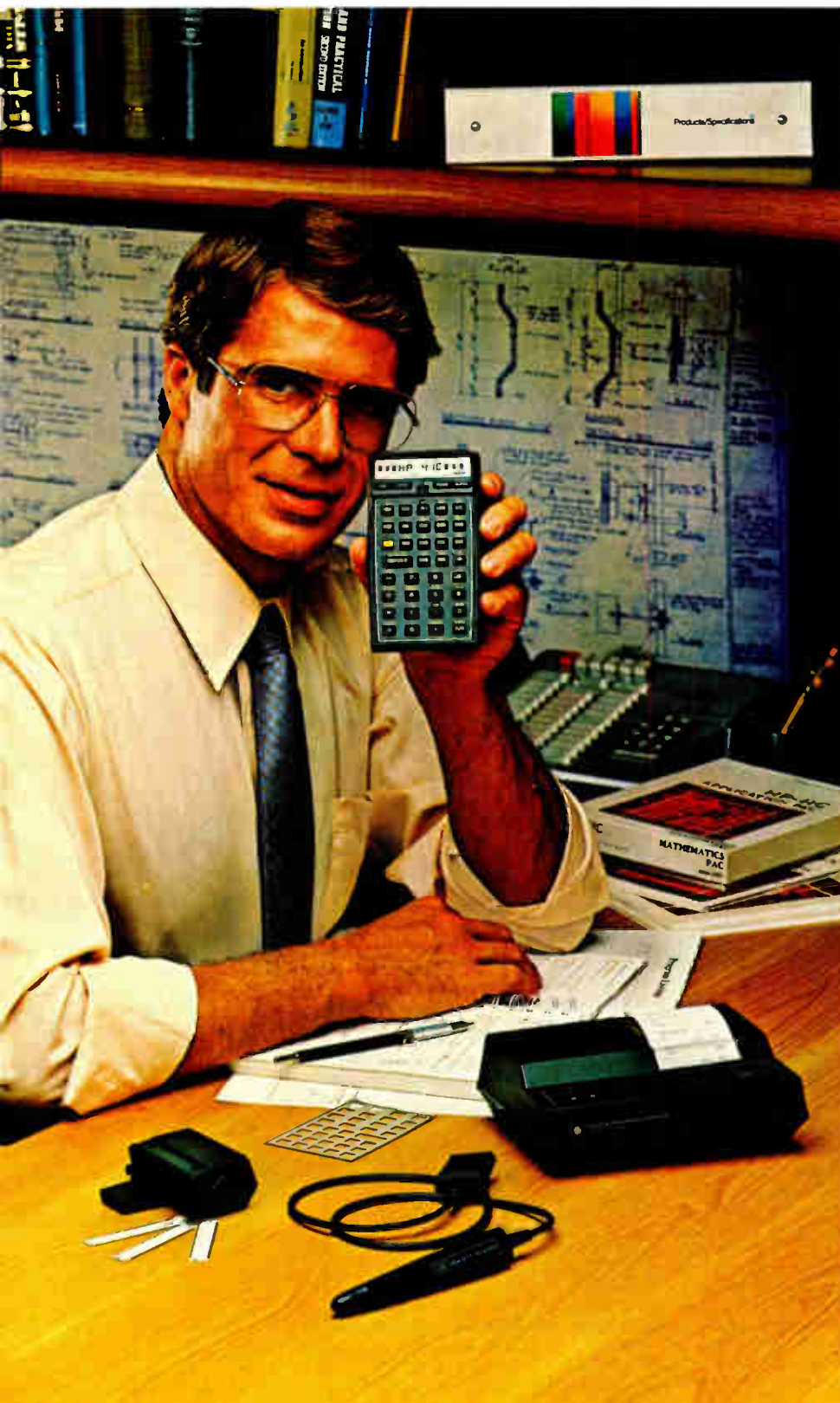

POWERFUL AND FLEXIBLE

As your professional problem-solving requirements change and grow, you may find yourself having to upgrade to a more powerful calculator. Not so with the HP-41C. By itself, the HP-41C could easily be all the calculator you'll ever need. It has a resident memory of over 400 lines, or 63 data registers, or any combination. It has over 130 functions. And any function, or any program, may be assigned to any key—allowing you to customize your HP-41C to meet your specific needs. The HP-41C Continuous Memory retains your programs, data, and key assignments even after the calculator is turned off. And it is alphanumeric: programs may be named, output can be labeled, error messages and prompts appear in words.

PLUG-IN PERIPHERALS, TOO

But if you need more problem-solving power, the HP-41C can become a complete personal computation system. Expand memory to 2,000 lines. Add a Card Reader, an Optical Wand that inputs bar-coded programs, a Printer that also plots, and Plug-in Application Modules that provide solutions to problems in business, science, and engineering. The HP-41C Owner's Handbook can guide even novice programmers to problem solution with easy-to-understand, step-by-step procedures.

AVAILABLE NOW

We urge you to see your dealer for a demonstration and "hands-on" experience with the HP-41C. We assure you, you'll be pleasantly surprised. And, of course, the HP-41C is immediately available for your productive use. For the address of your nearest dealer. CALL TOLL-FREE 800-547-3400, Department 214F, except from Hawaii/Alaska. In Oregon, call 758-1010. Or write Hewlett-Packard, Corvallis, OR 97330, Dept. 214F.

610/23



**HEWLETT
PACKARD**

Circle 17 on reader service card

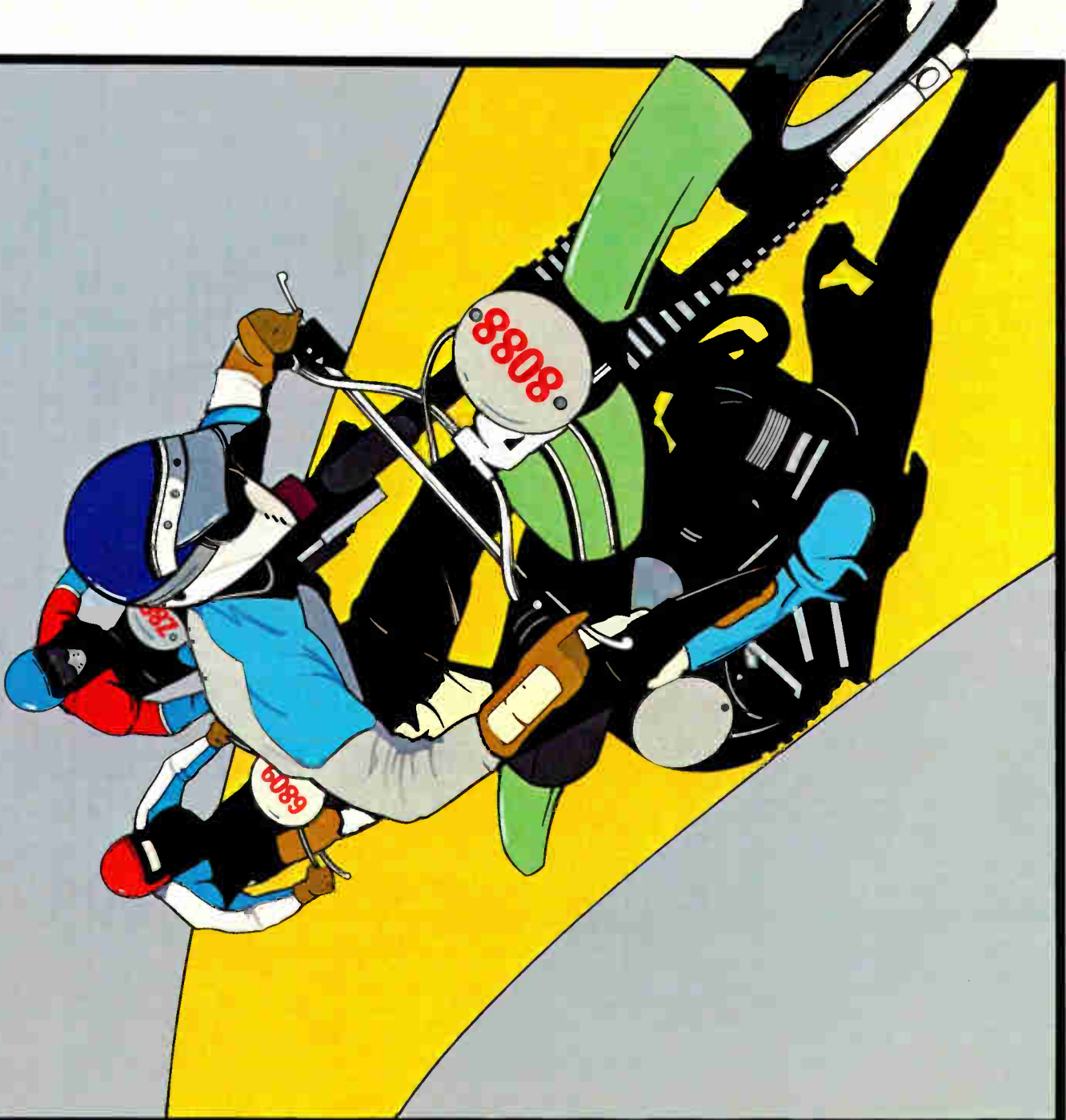

8-Bit Champion

In price-performance, look to Intel's powerful iAPX 88 microprocessor to leave the pack behind. Both now and down the road.

In price-performance races, the iAPX 88 is the one to beat. It's two times faster than the Z-80A and the 6809. And recent benchmark tests show that the iAPX 88, with its 8088 CPU, consistently outperforms its closest competitors in memory efficiency, ease of programming and throughput—by as much as 4 to 1. This is especially important in high-performance tasks such as block moves, character searches, word shifts, and 16-bit multiplies. All critical for applications like word processing, terminal control, scientific instrumentation and industrial control.

And because it's the only 8-bit microprocessor that addresses up to 1 million bytes of memory, the 8088 can take on large programs. Without having to slow down due to overlays or memory bank switching, like other 8-bit processors.

Tough price competitor

In price competition with other 8-bit microprocessors, the iAPX 88 has become the front runner.

You save dramatically on

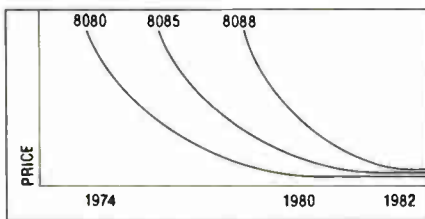

8-Bit Microprocessor Price Trends

memory chips, too. The iAPX 88 takes—on the average—30% less memory than competitors for the same programs. Then too, it allows you to use lower cost memory to get the same throughput as competitors. With a 5MHz 8088, you can use our 450ns memories and still outperform a 4MHz Z-80 requiring 250ns chips. Depending on

the application, your cost savings here can be substantial.

No contest now with new Intel software

To unleash the new power that the iAPX 88 puts in your hands, it takes more powerful software—

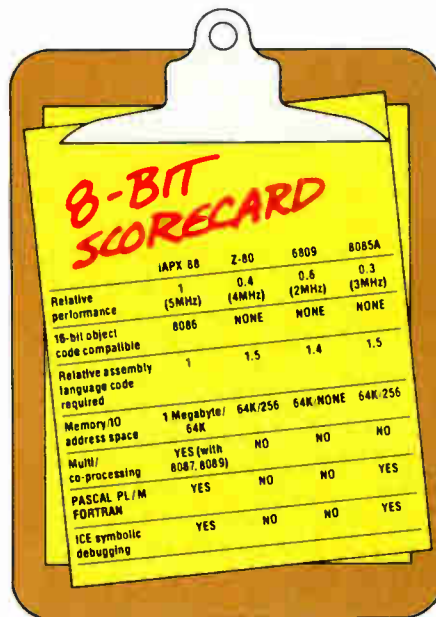

the kind only Intel delivers today. Software that produces object code directly and gives you important extensions that allow you to fine-tune the software to your application.

Software such as PASCAL-88, the block-structured application language rapidly becoming the one most widely used. With our PASCAL-88, you can do direct port I/O and interrupt handling, as well as independent program module compilation. And produce code that runs faster than other, P-code interpreter versions.

Along with PASCAL-88, you get PL/M-88, our systems implementation language, our ANSI-compatible FORTRAN, and our ASM-88 macroassembler. So with more software capability than you've ever had before, now you

can choose the right language tool for each application—whatever it calls for.

Get out in front with complete development support

All the development support tools you need are ready to go today from Intel. Start with the Intellec® Microcomputer Development System. Add to that our ICE-88™ in-circuit emulator. Together they give you CPU emulation in real time, plus features like symbolic debugging, diagnostic commands and program trace capability. With these tools you'll get your products to market faster than by any other route.

Looking down the road

Best of all, with the iAPX 88, your investment in today's solution is protected. Since the 8088 is 100% object-code compatible with the 16-bit 8086—plus its future generations, the iAPX 186 and iAPX 286—you have the industry's only guaranteed headstart on the path to the future. Regardless of which language you're writing in.

So if you want to outdistance the pack, choose the iAPX 88—available today from your local Intel distributor. To get your copy of benchmark results, contact your local Intel sales office or distributor. For more information write Intel Corporation, 3065 Bowers Avenue, Santa Clara, CA 95051. Or call (408) 987-8080.

intel® delivers solutions.

Europe: Intel International, Brussels, Belgium.
Japan: Intel Japan, Tokyo. United States and Canadian distributors: Alliance, Almac/Stroum, Arrow Electronics, Avnet Electronics, Component Specialties, Hamilton/Avnet, Hamilton/Electro Sales, Harvey, Industrial Components, Pioneer, L.A. Varah, Wyle Distribution Group, Zentronics.

Circle 19 on reader service card

Hard sell.

Just what you've been waiting for – another hardware manufacturer with another line of products.

We understand the problems facing users, OEMs, and hardware manufacturers. So we make sure our systems are modular and flexible. They're expandable and upgradeable without reprogramming. And they can interface with other types of computers on the market.

Choose from complete systems or from individual terminals, printers, and disk drives – 5¼" or 8" floppies and 8" Winchester disks that offer from 630K bytes to 30 megabytes.

We also offer our ZCB single board computer with PROM, RAM, serial and parallel ports. Plus High Resolution Graphic, Video Digitizer, and Precision Analog boards. You can get a memory-mapped video board for development of systems with fast, efficient screen handling.

All our products are S-100 Bus compatible. So you can build products with virtually any capabilities by slipping in any board you want.

We don't just make hardware, we make it simple.

Contact Gary Bennett, Vector Support Center, 31364 Via Colinas, Westlake Village, CA 91362. Or call 213/991-2302.



VECTOR

Economy Sized Computer™ Hardware

Soft sell.

We don't think software should be hard to use.

To make things easier for you, we offer software expertise as well as software.

Our Z80 assembly language comes with RAID (our memory-mapped rapid interactive debugger) which saves debugging time, and SCOPE (our screen-oriented program editor) which provides advanced word processing in a program editor. It cuts 35% of the time it takes to create new programs. What's more, ZSM is a Z80 assembler that generates files compatible with higher level languages – including CIS COBOL, PASCAL, APL, and FORTRAN.

We offer CP/M, the industry standard operating system. So transportable software developed on one system can run on others.

Vector offers a great system for developing BASIC programs with an interpreter for on-line development and an optional compiler for end-user programs.

It's the least we could do. Because we make software development a soft job.

Contact Gary Bennett, Vector Support Center, 31364 Via Colinas, Westlake Village, CA 91362. Or call 213/991-2302.

SCOPE and RAID – trademarked Vector Graphic Inc. Z80 – trademarked ZILOG Inc. CP/M – Registered DIGITAL Research Inc. CIS COBOL – trademarked Micro Focus



VECTOR

Economy Sized Computer™ Software

3870 momentum continues.

For single-chip applications, no other microcomputer family offers you more design momentum than the 3870 family from Mostek. Now there's even more momentum because eight new parts give you ROM and RAM options never before available. A total of 16 choices. You save by buying only what you need now, yet you'll also be designing in future flexibility.

That's because all our 3870 microcomputers are software compatible and basically pin-for-pin hardware compatible. So expansion or upgrading from 1K ROM to 4K ROM can be as easy as exchanging one 3870 device for another. In the same socket. There's no new architecture to learn. No retooling of artwork. No new vendors to qualify. In other words, there's no loss of design momentum.

This ongoing product line expansion is all part of our commitment and response to your unprecedented demand for Mostek 3870 microcomputers. A demand so strong for so many different applications that we literally ran out of 3870 numbers for all the variations you requested.

So to simplify identification of all our 3870 devices, we developed an expanded, easy to understand numbering system. In this system, the first four numbers designate three generic families: MK3870, MK3873, and MK3875. All three families have multiple combinations of ROM and RAM. The first slash number indicates the amount of ROM available in 1K byte increments; the second slash number identifies the amount of executable RAM in multiples of 32 bytes.

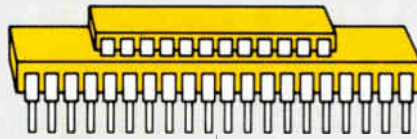

38P70/02

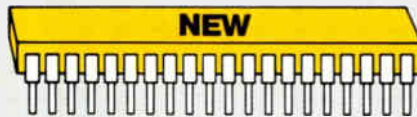

3870/10

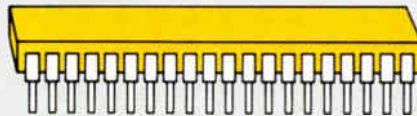

3870/20

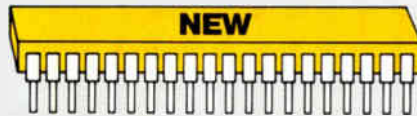

3870/30

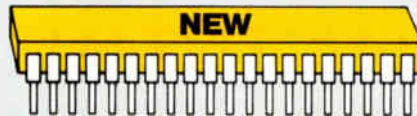

3870/40



3870/12

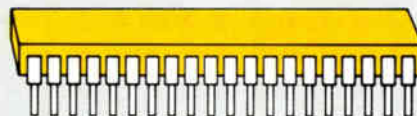

3870/22



3870/32

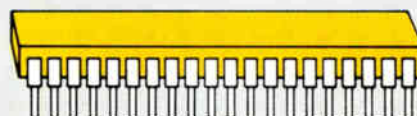

3870/42



3870

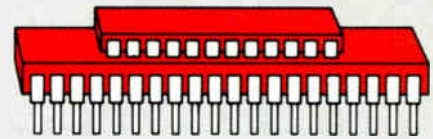

38P73/02



3873/10

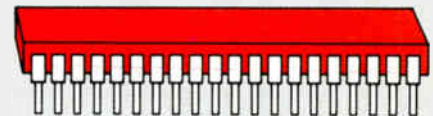

3873/20



3873/12



3873/22



3873 (Serial I/O)

8 new ROM and RAM options give you 16 compatible single-chip choices.

MOSTEK.

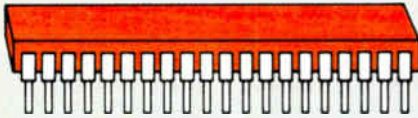

3875/22

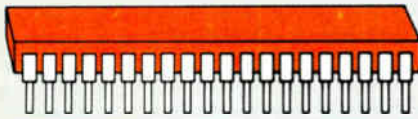

3875/42

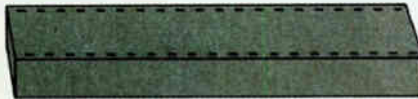

3875 (Battery Back-up)

Designation	ROM (bytes)	Executable RAM (bytes)	Parallel I/O (bits)	Special I/O	Old Part Number
MK3870-10	1K	0	32		*New
MK3870-12	1K	64	32		*New
MK3870-20	2K	0	32		MK3870
MK3870-22	2K	64	32		MK3876
MK3870-30	3K	0	32		*New
MK3870-32	3K	64	32		*New
MK3870-40	4K	0	32		*New
MK3870-42	4032	64	32		MK3872
MK3873-10	1K	0	29	SI, SO, SCLK	*New
MK3873-12	1K	64	29	SI, SO, SCLK	*New
MK3873-20	2K	0	29	SI, SO, SCLK	MK3873
MK3873-22	2K	64	29	SI, SO, SCLK	*New
MK3875-22	2K	64	30	V _{SB} , V _{BB}	MK3876 ^w Standby
MK3875-42	4032	64	30	V _{SB} , V _{BB}	MK3872 ^w Standby
MK38P70-02	External	64	32		MK3874
MK38P73-02	External	64	29	SI, SO, SCLK	MK38P73

The Mostek 3873 family has 29 bits (4 ports) of parallel I/O plus a hardware serial I/O port capable of handling either synchronous or asynchronous data transfers. Two different ROM versions are currently available, and executable RAM options are coming soon.

The MK3875 microcomputer family features 30 lines (4 ports) of parallel I/O and a standby power mode to protect the executable RAM during low-power situations. Both our 3875 versions have 64 bytes of executable RAM; ROM is 2048 bytes or 4032 bytes.

Unique to the entire 3870 line are our piggyback EPROM (P-PROM™) microcomputers. Designated MK38P70/02 and MK38P73/02, these devices let you prototype and field test your software programs prior to ordering masked-ROM versions. P-PROM microcomputers are also ideal as production circuits in low volume applications.

To simplify software as well, choose our Matrix™ floppy disk development system with real-time in-circuit emulation. The Matrix system can support our entire 3870 line, including low power CMOS versions now being developed.

Three basic 3870 families. EPROM versions. And comprehensive software tools to back it up. It all adds up to more momentum. The kind of momentum that can simplify your design, and extend your product life. To find out how, call or write Mostek Corporation, 1215 W. Crosby Road, Carrollton, Texas 75006; phone 214/323-1000. In Europe, contact Mostek Brussels; phone 660.69.24.

387X/XX

Generic Part Type

Amount of ROM in 1K increments
 1 = 1K
 2 = 2K
 3 = 3K
 4 = 4K

Amount of executable RAM in 32 byte increments
 0 = 0
 2 = 64 bytes

Since all our 3870 devices have 64 bytes of scratchpad RAM, that portion of the memory isn't included in the part number.

The basic Mostek 3870 microcomputer family, with 32 bits (4 ports) of parallel I/O, presently has 8 versions. ROM options range from 1K to 4K bytes with an executable RAM option of 64 bytes.

MOSTEK®, Matrix, MK3870, MK3873, MK3875, and P-PROM are trademarks of Mostek Corporation
 © 1980 Mostek Corporation.

The new Sputnik: part 2

The problems facing the U. S. electronics industries in the international marketplace are in many ways the outcome of a long-time adversary relationship between business and Government. The situation was described succinctly recently by Robert Herzstein, under secretary for international trade in the U.S. Department of Commerce, when he said: "Over the years, the Government's attitude was that business is a cornucopia that will continue to pour forth benefits without needing much attention and that the role of Government is to regulate business to keep it from having undesirable social impacts. We have to start looking at the other side of the coin now and examine ways in which Government policies and programs are an excessive burden on the competitive ability of business in world markets."

Well and good. But the operative phrase here should jolt us all. *We have to start.* Herzstein's statement reflects enlightenment, but the rest of his speech is replete with suggestions for "analysis" and "evolving a new relationship" and "learning the facts." By now, the problems have been analyzed to a fare-thee-well, the need for a "new relationship" has been the cry of industry for years, and the facts have been laid before one congressional committee after another. The facts are these:

- Japan and other nations have targeted specific high-technology industries like electronics as the major growth areas of the future and are supporting them with all the resources at their command.
- Japan is outgunning the U. S. in producing engineering graduates — 19,000 EEs to the U. S.'s 14,000 annually.
- The Japanese government's incentive and subsidy program makes capital available to its electronics industries at lower cost than is possible for the U. S.
- Japan restricts access to its home market

while it enters foreign markets aggressively by price-cutting and absorbing the added cost of high quality to capture market share.

- With efforts like the VLSI program the Japanese are marshaling their technological resources for R&D on a national basis.
- There's evidence that other nations are embarking on industry-government partnerships.

What does U. S. industry require?

Basically, industry leaders are asking Government to restore and augment incentives that fueled the growth of the industry in the first place. They don't want direct subsidies or infusions of cash. Rather, they want to foster an environment in which the unique American system can work effectively under the new international conditions. To do this requires, as Robert Noyce, vice chairman of Intel Corp., puts it, "the setting of a new national objective — to provide a commitment to favor development of new productive and innovative industry." Noyce and others have strongly urged specific steps:

- Foster innovation by increasing R&D tax writeoffs and by channeling Government funds to applied research and R&D grants to universities on industrywide problems.
- Give tax credits to firms that support technical education.
- Offer incentives for saving in the U. S. to help capital formation — vital for expanding capacity — and incentives for new ventures.
- Allow the formation of trading companies to increase U. S. effectiveness in export markets.
- Press for equitable treatment in and access to foreign markets.

The political ramifications of some of these steps are complex and forbidding. But we must get on with them. The situation calls for a new Sputnik reaction. As Charles Sporck of National Semiconductor Corp. said recently, "The time to do something is now — not three years from now, not a decade from now, either. By then it'll be all over."

"We asked for a high frequency counter that measures accurately in tough RF environments. We weren't disappointed."

"Measuring frequencies on-site can be a difficult job. Signals from nearby transmitters can interfere with the frequency we're monitoring. But Fluke has packed all the features we need for high frequency

measurements into their new 7220A Frequency Counter, and then some."

"A full 10 Hz to 1300 MHz bandwidth through 2 input channels, and 5 mV rms basic sensitivity give us the full frequency coverage we

need. The 7220A's X1 to X100 variable attenuator, effective overload protection, and 100 kHz low-pass filter on the Channel A input help us take clean, stable readings of audio signals with RF contamination. And an integral stainless steel RF shield surrounds this \$1050 U.S. counter."

"We take accuracy with us."

"An optional battery pack combines with a choice of ovenized oscillators for high-accuracy, no-warm-up readings - even in the field."

"And because the 7220A is a member of Fluke's Portable Test Instrument (PTI) family, this counter quickly stacks-and-latches to any PTI Instrument. With the 1120A IEEE-488 Translator, we can even assemble an inexpensive, transportable **IEEE-488** system."

Convincing Evidence.

Communications specialists everywhere are finding that the new Fluke 7220A makes their tough frequency measurements on the bench or in the field. For more information on Fluke Counters, call toll free **800-426-0361**, use the coupon below, or contact your Fluke Sales Office or Representative.



Fast-Response Coupon

E1 10/80

IN THE U.S. AND NON-EUROPEAN COUNTRIES:
John Fluke Mfg. Co., Inc.
P.O. Box 43210 MS #2B
Moundlake Terrace, WA 98043
(206) 774-2481
Telex: 152662

IN EUROPE:
Fluke (Holland) B.V.
P.O. Box 5063
5004 EB Tilburg,
The Netherlands
(013) 673 973 Tlx: 52237

- Please send me the 7220A Brochure.
- Please have a Sales Engineer contact me.

Name _____
Title _____ Mail Stop _____
Company _____
Address _____
City _____ State _____ Zip _____
Telephone () _____ Ext. _____

For technical data circle no. 25

Meetings

21st Annual Symposium on the Foundations of Computer Science, IEEE Computer Society, Sheraton Inn-Syracuse, Liverpool, N. Y., Oct. 13-15.

Annual Meeting, Optical Society of America (1816 Jefferson Pl. N. W., Washington, D. C. 20036), Pick Congress Hotel, Chicago, Oct. 13-17.

27th National Vacuum Symposium and Show, American Vacuum Society (335 E. 45th St., New York, N. Y. 10017), Detroit Plaza Hotel, Detroit, Mich., Oct. 13-17.

Mini/Micro Computer Conference and Exposition, Mini/Micro 80 (32302 Camino Capistrano, Suite 202, San Juan Capistrano, Calif. 92675), Brooks Hall, San Francisco, Oct. 14-16.

1980 Japan Electronics Show, Japan Electronics Show Association (3-23-5 Nishishinbashi, Minato-ku, Tokyo 105), International Fairgrounds, Tokyo, Oct. 14-19.

1980 Fall Conference on Emerging Technologies—Teletext and Viewdata, Society of Cable Television Engineers Inc. (1900 L Street N. W., Suite 614, Washington, D. C. 20036), Playboy Resort and Country Club, Great Gorge, N. J., Oct. 15-16.

1980 Canadian Conference on Communications and Power, IEEE, Queen Elizabeth Hotel, Montreal, Quebec, Canada, Oct. 15-17.

First Brussels NATO Command, Control, and Communications Symposium, Armed Forces Communications and Electronics Association (5205 Leesburg Pike, Falls Church, Va. 22041), Brussels Hilton Hotel, Brussels, Belgium, Oct. 16-17.

ISHM 80—International Microelectronics Symposium, International Society for Hybrid Microelectronics (P. O. Box 3255, Montgomery, Ala. 36109), Hilton Hotel, New York, Oct. 20-22.

ISA/80—International Instrumentation Automation Conference and Exhibit, Instrument Society of America (ISA/80, P. O. Box 3561, Durham, N. C. 27702), Astrohall, Houston, Texas, Oct. 20-23.

PC 80 West—International Printed Circuits Conference and Exhibition, Benwill Publishing Corp. (1050 Commonwealth Ave., Boston, Mass. 02215) *et al.*, Convention Center, Los Angeles, Oct. 21-23.

1980 Biennial Display Research Conference, IEEE *et al.*, Cherry Hill Inn, Cherry Hill, N. J., Oct. 21-23.

Military Microwaves 80, Institution of Electronic Engineers (Savoy Place, London WC2R 0BL, England), Cunard International Hotel, London, Oct. 22-24.

Integrated Circuit Quality Control Workshop, American Society for Quality Control, Electronics Division (Ralph A. Evans, IC-QC, 804 Vickers Ave., Durham, N. C. 27701), Durham, Oct. 23-24.

1980 Fall Meeting—Electronics Division of the American Ceramic Society (65 Ceramic Dr., Columbus, Ohio 43214), Sheraton Palace Hotel, San Francisco, Oct. 26-29.

10th Annual Monterey Conference, American Electronics Association (2600 El Camino Real, Palo Alto, Calif. 94306), Del Monte Hyatt House, Monterey, Calif., Oct. 26-29.

10th Annual North American Thermal Analysis Society Meeting (Robert C. Johnson, Du Pont Central Research and Development Department, Experimental Station, Bldg. 228, Wilmington, Del. 19898), Copley Plaza Hotel, Boston, Oct. 26-29.

1980 Conference on Electrical Insulation and Dielectric Phenomena, National Research Council Assembly of Engineering (2101 Constitution Ave., Washington, D. C. 20418), Parker House, Boston, Oct. 26-30.

ACM Annual Conference, Association for Computing Machinery (1133 Avenue of the Americas, New York, N. Y. 10036), Opryland Hotel, Nashville, Tenn., Oct. 27-29.

NEC-NECF/80, 36th Annual National Electronics Conference and National Communications Forum, National Engineering Consortium Inc. (Oak Brook Executive Plaza No. 2, 1211 W. 22nd St., Oak Brook, Ill. 60521), Hyatt Regency O'Hare, Chicago, Oct. 27-29.

ICCC/80—Fifth International Conference on Computer Communication, International Council for Computer Communications (ICCC/80, Box 280, Basking Ridge, N. J. 07920), Peachtree Plaza Hotel, Atlanta, Oct. 27-30.

1980 Photovoltaic Solar Energy Conference, IEEE *et al.*, Palais des Festivals et des Congrès, Cannes, France, Oct. 27-31.

17th Department of Defense—Association of Old Crows Electronics Warfare Symposium, AOC (15233 Ventura Blvd., P-8, Sherman Oaks, Calif. 91403), Disneyland Hotel, Anaheim, Calif. Oct. 28-30.

Fourth Annual Symposium on Computer Applications in Medical Care, George Washington University (Janice W. Eldridge, Registrar, SCAMC, Office of Continuing Medical Education, 2300 K St. N. W., Washington, D. C. 20037), Capital Hilton Hotel, Washington, D. C., Nov. 2-5.

Autotestcon '80, IEEE, Sheraton Washington Hotel, Washington, D. C., Nov. 3-5.

Midcon/80, IEEE and Electronic Representatives Association, Convention Center, Dallas, Texas, Nov. 4-6.

Electronica 80—Components and Assemblies Trade Fair and Microelectronics Congress, MMG P. O. Box 121009, 8000 Munich 12, West Germany), Fairgrounds, Munich: Fair, Nov. 6-12; Congress, Nov. 10-12.

“What if we...”

What if we added calculating and programming capabilities to a versatile new 5½-digit multimeter?

Our product designers are proud of the new Fluke 8860A, and rightly so. This excellent new DMM can be both a fully-programmable stand-alone system or an inexpensive **IEEE-488** instrument.

The concept is as practical as it is

powerful. For benchtop use, the 8860A combines the analog measuring precision of a 5½-digit DMM with an optional calculating controller similar to a programmable calculator. This allows you to develop software for your

specific applications. **Programmable power goes to work for you.**

Use the 8860A's math and programming talents to perform statistical analyses. Convert and directly display the output of transducers measuring temperature, pressure, power, and other physical events. The calculating controller can both configure and command the DMM, so the 8860A can make measurements, execute mathematical operations and branch on conditionals.

When you need the measurement power of the 8860A in an IEEE-488 system, choose the inexpensive interface option for full function/range programming.

“Tell me more!”

Either way you configure your new 8860A DMM, you'll have the power you need today with the flexibility you'll want for tomorrow. For more information, call toll free **800-426-0361**; use the coupon below; or contact your Fluke sales office or representative.

“Our customers asked for a powerful, easy-to-program computing multimeter. We designed just that... a precision benchtop DMM with an optional calculating controller that transforms it into an incredibly versatile stand-alone measurement system.”



Calculating controller option uses RPN logic for fast, easy programming.

Five-function DMM with 0.01% basic accuracy features autoranging and four advanced math functions - off-set, peak-to-peak, limits, and zero.

Interchangeable non-volatile memory cartridges for convenient program storage.

Exclusive Portable Test Instrument Packaging lets you stack-and-latch the 8860A with other PTI Instruments from Fluke.

Excellent value as stand-alone or systems instrument. U.S. price for basic DMM \$1395; calculating controller \$550; extra memory cartridges \$50 each; IEEE interface \$295.



-----Fast-Response Coupon-----

IN THE U.S. AND NON-EUROPEAN COUNTRIES: E1 10/80

John Fluke Mfg. Co. Inc. P.O. Box 43210 MS #2B Mountlake Terrace, WA 98043 (206) 774-2481 Telex: 152662	Fluke (Holland) B.V. P.O. Box 5053, 5004 EB Tilburg, The Netherlands (013) 673 973 Tlx: 52237
---	---

- Please send me complete 8860A specifications and applications literature.
- I have to see this computing multimeter for myself. Please have a salesman call.

Name _____

Title _____ Mail Stop _____

Company _____

Address _____

City _____ State _____ Zip _____

Telephone () _____ Ext. _____

For technical data circle no. 27

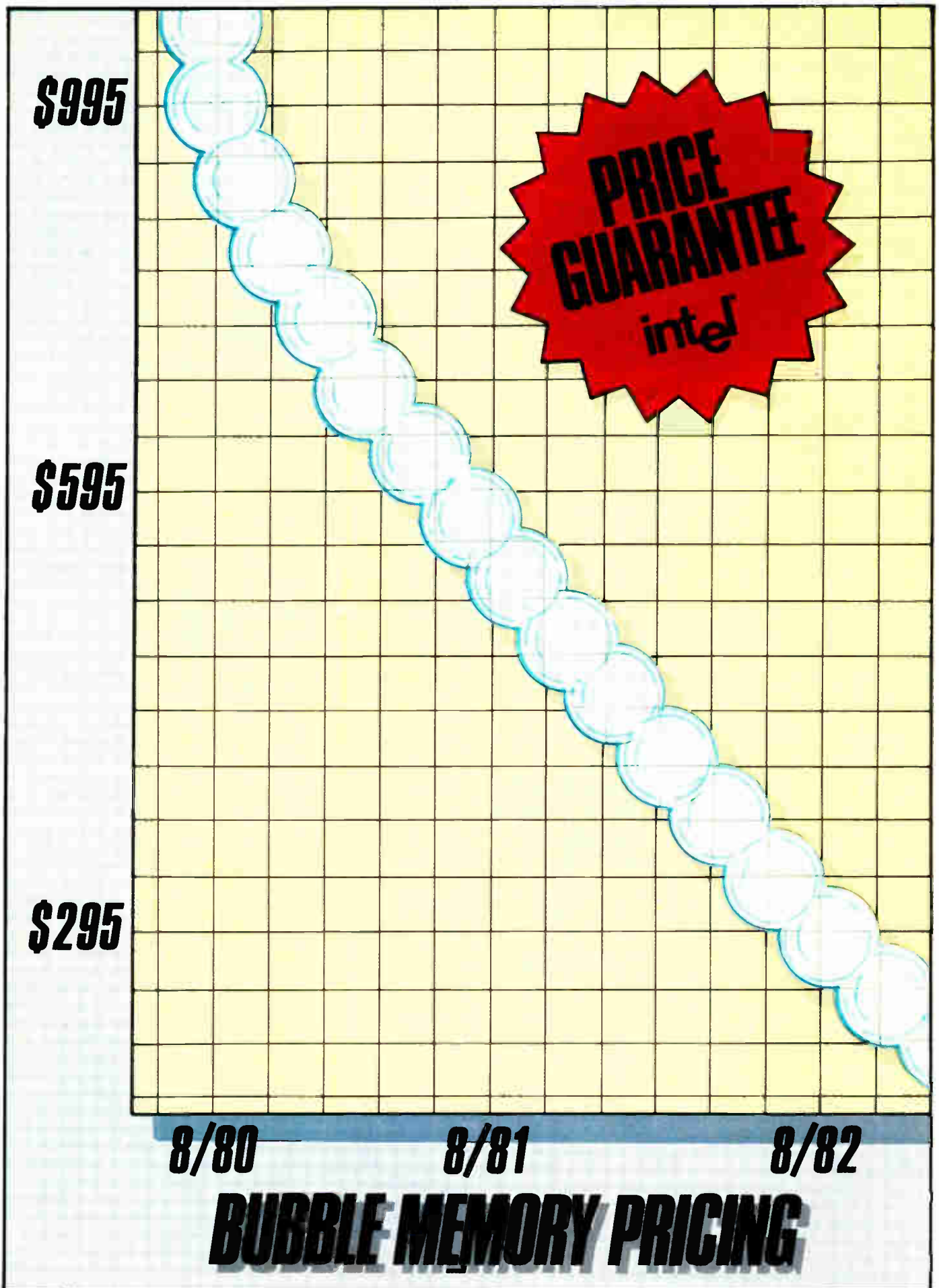

Bubble Price Break

Intel reduces prototyping prices of 1-megabit bubble memories by 40% now. And guarantees a volume price of \$595 for complete component sets by August 1981.

Fast-breaking bubble technology. You've been hearing about it for years. Now Intel announces the kind of break you've been waiting for: a price break.

On August 11th, Intel lowered its 100-unit price for the BPK72 Bubble Memory Kit by 40% to \$995—less than 100 millicents per bit.

By August 1981, the price of megabit bubble memories ordered in 5,000-unit lots will be an unprecedented \$595. That's 60 millicents per bit. Not "projected." Not "expected." *Guaranteed.*

One year later, for 25,000-piece orders, the unit price will be \$295—cutting the per-bit price in half once more. Again, we guarantee it.

How can Intel guarantee such a sharp price reduction? Simple. Intel was the first to bring production 1-megabit bubble memories to market. We've been delivering them for over a year, for a wide range of applications, and now we're moving prices down the manufacturing learning curve.

Get more than bubbles

Intel's bubble memory is a complete set of bubble components for microprocessor-based applications. This set consists of six special support ICs: a controller, a formatter/sense amp., three packages for coil driving and a current pulse generator. It interfaces to Intel® and other microprocessor system buses via the controller, which handles up to eight bubble memory packages, and provides built-in power fail protection and error correction.

The bubble element and its small set of associated ICs can be

treated as a peripheral subsystem. This allows designers to concentrate on higher level system objectives, instead of spending time learning the intimate details of bubble device interfacing. Thus minimizing expense in hardware and software development.

Add more value to your product

With Intel's solid-state bubble memory, all that moves is the information. That means high reliability and low maintenance for your products, even in harsh or unclean environments—the kind where disks and tapes won't go. And since the memory is completely nonvolatile, your data

remains secure when the power goes off. No battery backup or replacement is necessary.

As the natural mass storage for LSI microprocessor-based systems, Intel's megabit bubble memory makes it practical to design more features into your equipment. So now you can build in programmability. Portability. Reduced service and repair costs. All with ensured data integrity, even in hostile environments. Consider what that means in your applications.

Start designing now

Everything you need to start designing your next generation product is included in our Bubble Memory Prototype Kit (BPK72), available now from distributor stock. It contains all the components necessary for a 1-megabit system, plus a printed circuit board and complete documentation.

To find out how bubble memories can give you that competitive edge in your next project—and to receive our bubble brochure, contact your local Intel sales office/distributor. Better yet, have one of our field sales engineers give you a firm quote based on exactly what you need for your next product. Write Intel Corporation, 3065 Bowers Avenue, Santa Clara, CA 95051. Or call (408) 987-8080.



remains secure when the power goes off. No battery backup or replacement is necessary.

Furthermore, Intel's bubble memory system is small, lightweight and silent. By packing over 1 million bits into less than 100 square centimeters of board space, it allows you to reduce the size, weight and power con-

intel® delivers solutions.

Europe: Intel International, Brussels, Belgium.
Japan: Intel Japan, Tokyo. United States and Canadian distributors: Alliance, Aimag/Stroum, Arrow Electronics, Avnet Electronics, Component Specialties, Hamilton/Avnet, Hamilton/Electro Sales, Harvey, Industrial Components, Pioneer, L. A. Varah, Wyle Distribution Group, Zentronics.

BIOMATION K100-D



Get a glitch?
FIXER
FROM GOULD

Compare this general purpose logic analyzer with the currently accepted industry standard.

The K100-D wins over Hewlett-Packard's 1615A hands down!

Logic designers have made Gould's powerful Biomation K100-D our fastest selling logic analyzer

mode to catch glitches as narrow as 4 ns. It gives you the most precise logic analysis for today's high speed minicomputer, main-frame and microprocessor systems. Best of all, you're already prepared for faster designs as they arrive.

binary or ASCII. And the list goes on and on.

The final analysis.

To help you evaluate these two fine instruments before you buy, we've prepared a point-by-point *competitive comparison* of the two. If you're designing and debugging high-performance digital systems, you'll want to read this document carefully. To get your free copy, just use the reader service number or write Gould Inc., Biomation Division, 4600 Old Ironsides Drive, Santa Clara, CA 95050. For faster response, call 408-988-6800.

Compare capacity.

The K100-D's 1024 word memory is *four times as deep as the 1615A's*. This dramatically extends the length of data you can trap from your system at any one time. And that means faster, more accurate debugging. In addition, the K100-D's standard 16 channel format can be expanded to 32 channels for work on the new generation of 16-bit microprocessors.

Compare your productivity.

Finally, the K100-D makes designers more productive with convenience features superior to those of the 1615A. The K100-D has a larger keyboard, plus an interactive video display. Comprehensive status menu. Data domain readout in hexadecimal, octal,

ever. You'll see why once you compare it to its nearest competitor, the 1615A from Hewlett-Packard.

Compare clocking speed.

With a 100 MHz clock rate, the K100-D gives you resolution to 10 ns—*five times better than the 1615A's*. Use the K100-D's latch



Hewlett-Packard 1615A
A very good logic analyzer



Speed: to 20 MHz
Resolution: 50 ns
Memory: 256 words
Channels: 8 timing & 16 data,
or 24 data

Biomation K100-D
The industry's finest logic analyzer



Speed: to 100 MHz
Resolution: 10 ns
Memory: 1024 words
Channels: 16 timing or 16 data,
or 32 data

 **GOULD**

An Electrical/Electronics Company
Circle 31 on reader service card

Vrrroom to grow.

It started as a racehorse. It's becoming a workhorse. Because our Sentry® Series 20 LSI test system is adding the capabilities to run more devices in more technologies. And still grow to meet the future head on.

Modularity makes it work. Configure Series 20 to meet a variety of duties. Characterization. Production testing. Incoming inspection. Or a combination. Its designed-in expandability lets you get exactly what you need. When you need it.

Start by testing a full 60 pins of microprocessor, peripheral chip and memory at 20MHz. Or 30 pins at 40MHz. With full I/O operation on each pin. Then enjoy higher resolution and accuracy, with greater flexibility, because our Enhanced Timing Module is built in.

If you're working with CMOS or



PMOS devices, try our new high voltage test head. You can run 28V at 5MHz, 16V at 15MHz or 10V at 20MHz.

And if high speeds or high pin counts are in your future, Series 20 should be on your line. Modular bays let you expand your system with surprising ease.

Series 20 has an improved software system. You can convert Sentry VII and VIII programs to Series 20 format, usually within minutes. And you can test devices

more thoroughly and efficiently. Getting better data while saving valuable time.

So give our workhorse a workout. It's backed by the industry's largest service and support group. Call us at (408) 998-0123 for more information. Or write Fairchild Test Systems Group, 1725 Technology Drive, San Jose, California 95110. You'll see how Series 20 will grow on you.

FAIRCHILD

A Schlumberger Company

**The
First Family
of ATE.**



DEC to unveil its 32-bit VAX-11/750

Digital Equipment Corp.'s second 32-bit computer, well placed to compete with IBM's smaller 4300s and priced to appeal to original-equipment manufacturers, will bow Oct. 21. Originally code-named Comet, the new VAX-11/750 is compatible with VAX-11/780 software and peripherals [*Electronics*, Nov. 10, 1977, p. 36], but is slower and lower-priced. Expected to run at 650 to 700 whetstones (a measure of throughput) rather than the larger machine's 1,000 to 1,100, the 750 could be priced as low as \$40,000 to \$90,000 in minimal configurations. It will have a full set of commercial software, but many **industry sources expect the 750's central processing unit also to be the Maynard, Mass., firm's first entry into the 32-bit OEM market.**

The 750's low price owes much to DEC's heavy use of custom TTL large-scale integrated circuits. The resulting drastic reduction in parts count has allowed the firm to implement the 750's CPU on about six large circuit boards—about one fourth the number needed for the 780. Thus, the 750 fits almost entirely into a single 19-in. rack or a free-standing waist-high cabinet. Industry sources expect the MOS main memory to be intentionally limited in size, probably to 2 megabytes, to avoid competition with low-end versions of the 780. However, given the 750's price, the similarly priced 16-bit PDP-11/70—and, perhaps, even the 11/44—may sacrifice market share to the new machine.

The 750's introduction has been postponed repeatedly since 1979, say industry observers. Among the reasons mentioned are a desire to avoid fratricidal competition with the PDP-11 line (which is selling well and at a good profit), a large backlog for the 780, teething problems with DEC's new LSI design and production facilities, and competitive considerations.

Hughes adds laser, sees true 3-D ICs as a possibility

Another big jump in integrated-circuit packing density appears closer to reality after further studies into laser annealing reported by Hughes Aircraft Co.'s Malibu (Calif.) Research Laboratories. Already a leader in developing laser annealing to replace the conventional furnace heating of ICs, Hughes says its scientists, in experiments, have rigged a second laser as a real-time instrument to measure the annealing process precisely. With the setup linked to a master minicomputer, **they can monitor the growth of large-grain (25- μ m) silicon crystals**, which make it possible to stack circuit structures on top of each other. The potential, according to Laverne D. Hess, who directs the Hughes work: "It gives hope for the first time of fabricating true three-dimensional microelectronic circuits."

Bell uses LEDs as transmitters in 23-, 7-km lines

As part of its work with long-lasting light-emitting diodes as transmitters for fiber-optic communications systems, Bell Laboratories has built both the longest and the highest-capacity line thus far achieved using LEDs. Researchers at Crawford Hill, N. J., attained **274 Mb/s on a 7-km line with no need for an amplifier.** The line can handle 4,032 telephone conversations simultaneously. The second line, 23 km long, carried 44.7 Mb/second equal to 672 conversations, without regeneration.

The main point of the work is that it appears to reduce the importance of laser diodes as components of fiber-optic systems. The LEDs are easier to construct and can be less costly, especially for the second-generation systems coming along to operate at wavelengths of 1.3 to 1.6 μ m, where cable loss and dispersion are even less than in the 0.8- μ m region now commonly used.

RCA to design its own codec

RCA Corp.'s Solid State division plans to introduce a codec of its own in the last quarter of 1981. The complementary-MOS device will have an on-board filter and thus enable the Somerville, N. J., operation to **leap into the codec fray, though late, with a strong entry** (see p. 41). Meanwhile, the company expects that samples of two codecs and two codec filters that it is second-sourcing from Motorola Semiconductor will be available this quarter, with production set for the first quarter of 1981.

CP/M operating software to be extended to 16-bit systems

Look for the introduction next month of CP/M-86, an extension of the *de facto* standard 8-bit operating system, to work on Intel's 8086 and 8088 16-bit microprocessors. Produced by Digital Research of Pacific Grove, Calif., **CP/M-86 is a single-user operating system that maintains the file format of CP/M release 2, giving it file-structure compatibility with CP/M.** CP/M-86 can also function in a slave mode in a multiprocessor networking scheme controlled by CP/Net.

National to make boards compatible with Intel's Multimode

National Semiconductor Corp. will attempt to capture more of Intel Corp.'s market for board-level products by producing boards compatible with Intel's Multimodule series. These are the small piggyback boards that plug into sockets provided on the Multibus series to expand their capabilities. The Santa Clara, Calif., company will ship parallel- and serial-interface and the math-processor piggyback boards by the first quarter of 1981. **National's connectors will be identical to those Intel custom-designed.**

Ethernet specs available from DEC, Intel, Xerox

The long-awaited specifications for Ethernet, a local-area digital communications network, have been made available by its designers: Digital Equipment Corp., Maynard, Mass.; Intel Corp., Santa Clara, Calif.; and Xerox Corp., Stamford, Conn. **Both a specification document for hardware and a protocol description are available from any of the three companies.** The documents will be submitted by the parties concerned to the Local Networks committee of the Institute of Electrical and Electronics Engineers, which meets this month in its efforts to develop a local network standard. Hewlett-Packard Co. has already said that if Ethernet is accepted by the IEEE group, it will adopt the standard (see p. 48).

Addenda

After eight years of development and test, GTE Products Corp.'s Sylvania Systems group, Needham, Mass., **has won a \$190 million, four-year production contract** for 300- and 600-line versions of its AN/TTC-39 circuit switch and for the 50-line AN/TYC-39 message switch—both part of TriTac, the triservice tactical communications program. . . . A new family of intelligent desktop terminals from Data General Corp., based on the Westboro, Mass., firm's 16-bit microNova, **will be software-compatible with all Data General processors, including the Eclipse MV8000 32-bit Supermini.** . . . A 20-bit multipurpose computer to emerge soon from BBN Computer Corp., a Cambridge, Mass., subsidiary of consulting firm Bolt Beranek & Newman Inc., **promises faster operation than machines three times its price.** . . . Semiconductor industry pioneer **Patrick E. Haggerty, honorary chairman and general director of Texas Instruments Inc., Dallas, is dead at 66.**

An EPROM's a great off-the-shelf solution when you need an instant program. But as a substitute for a ROM, the numbers just don't work out. Especially when you can get *quality* ROMs in 4 to 5 weeks from Electronic Arrays.

For instance if you're building 500 systems using 32K of ROM, we can demonstrate how you'll save almost \$5000 using our EA8332 32K ROM instead of 2716 16K EPROMs. If you're building 2000 systems the savings climb to over

\$23,000 — on ROM costs alone!

And that's not counting savings on labor, extra sockets, PC board holes and space. Moreover, EA ROMs are more reliable than EPROMs, since there's no chance for your program to "leak away" with time.

There's more to our story. Call us for details. Electronic Arrays, 550 East Middlefield Rd., Mountain View, CA 94043. (415) 964-4321; Philadelphia (215) 643-1447; Chicago (312) 858-8508.

**EPROMs ARE FUNNY.
THE MORE YOU USE,
THE MORE YOU LOSE.**

ELECTRONIC ARRAYS.

THE HOUSE OF ROMs.



**Only one company
can deliver octal interface
in four weeks.**

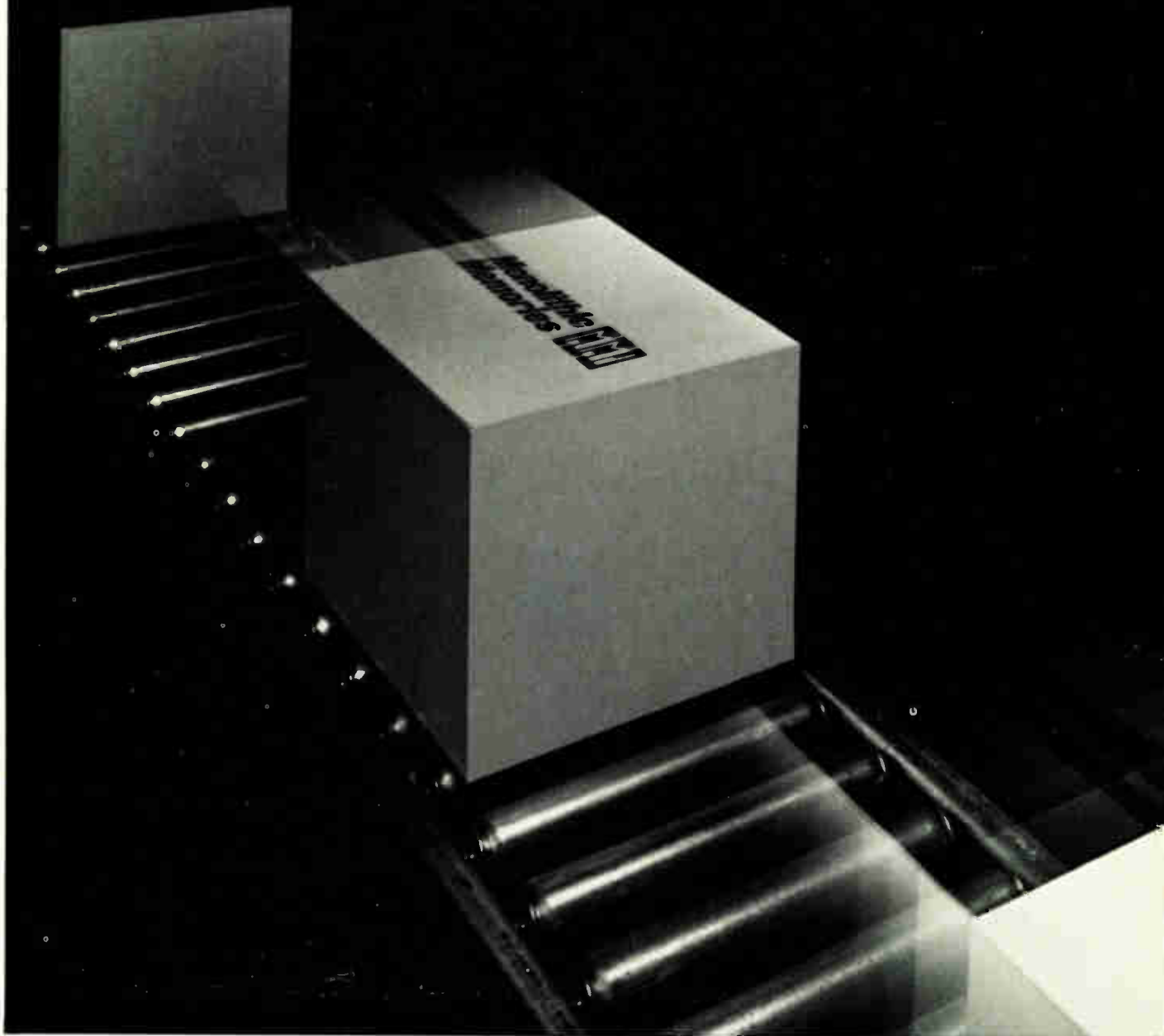

Get speedy delivery on Monolithic Memories LS and S 54/74 buffers, latches, registers & transceivers.

Monolithic Memories' broad family of octal interface devices is rolling off the lines right now, with up to five thousand pieces of each type available in four weeks... a fraction of the delivery time quoted by other suppliers!

Industry standard and multiple sourced.

Many of these are the same enhanced parts developed by Monolithic Memories and formerly designated our 57/67 series. We added such niceties as on-board inverters, Schmitt triggers with true hysteresis and high-output-current options. We put them in our space-saving 20-pin SKINNYDIP™ packages. And now they're



renumbered, part of the industry standard, widely second-sourced 54/74 family.

Now pick from three octal transceivers.

To our 54/74LS645 transceiver we've now added two brand new companions: the 54/74LS245 and the hi-drive (48 mA)

74LS645-1, allowing you to pick just the right transceiver for your application.

Contact your nearest Monolithic Memories franchised distributor or sales representative for a complete brochure on our entire octal interface family. Monolithic Memories, Inc., 1165 E. Arques Ave., Sunnyvale, CA 94086.

TM—SKINNYDIP is a trademark of Monolithic Memories, Inc.

Monolithic Memories 

Circle 37 on reader service card

Memory Expert.

IMMEDIATE DELIVERY

763 KSR Bubble Memory Data Terminal

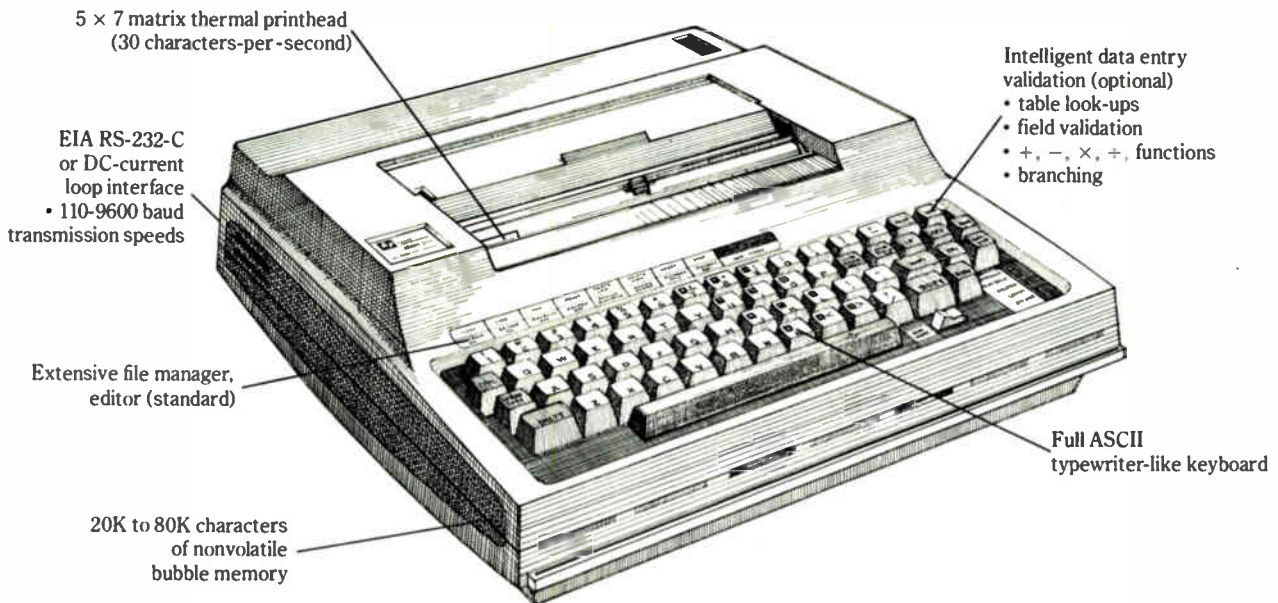

TI's *Silent 700** Model 763 Bubble Memory Data Terminal is ideal for remote data capture, and off-line data preparation and manipulation applications. Storing up to 20 typewritten pages of information in its built-in nonvolatile bubble memory, the 763 eliminates the need for more costly data storage devices and allows users to batch transmit data at their convenience. A Data Entry Validation option on the 763 provides program execution, file management interface, arithmetic operations

and data verification. The 763 with its other features and options, is a specialist when it comes to quick, accurate data entry and transmission.

TI is dedicated to producing quality, innovative products like the Model 763 Bubble Memory Data Terminal. TI's hundreds of thousands of data terminals shipped worldwide are backed by the technology and reliability that come from 50 years of experience, and are supported by our worldwide organization of

factory-trained sales and service representatives.

For more information on the 763 terminal, contact the TI sales office nearest you or write Texas Instruments Incorporated, P.O. Box 1444, M/S 7784, Houston, Texas 77001 or phone (713) 937-2016.

In Europe, write Texas Instruments, M/S 74, B.P. 5, Villeneuve-Loubet, 06270, France.



*Trademark of Texas Instruments Copyright © 1980, Texas Instruments Incorporated

TEXAS INSTRUMENTS

We put computing within everyone's reach.

Circle 38 on reader service card

Four-state cell doubles ROM bit capacity

by John G. Posa, Solid State Editor

Read-only-memory cells on two new microprocessors have three transistor sizes with varying voltage levels

By varying the size and resistance of the transistor—and hence the voltage level—in each cell of on-chip read-only memory, Intel Corp. is able to store 2 bits of information in the ROM cells of its latest microprocessors. Since each cell can therefore hold double the information of an ordinary cell, the Santa Clara, Calif., chip maker can multiply storage capacity without restoring to finer lithography.

The new cells, found in the 8087 mathematics coprocessor [*Electronics*, May 8, p. 114] and the forthcoming iAPX 432 [*Electronics*, May 22, p. 39], can be manufactured with the company's standard high-performance MOS, or H-MOS, process. In fact, the 2-bit cell idea is simple, almost bordering on the obvious.

Sizes. In a standard read-only memory, there is only one size of transistor and there is at most one transistor per bit, explains Moty Klein, engineering coordinator for Intel Israel, where the 8087 was designed. "If there is a transistor, there is a 1; if not, you store a 0. When you raise the select line, current flows if you have a transistor, and it doesn't if you don't."

The key to the new ROM is that "there are three sizes of transistor," continues Klein, "one that conducts large currents, one medium, and one small." At each cell site in the ROM array, one of these three transistor

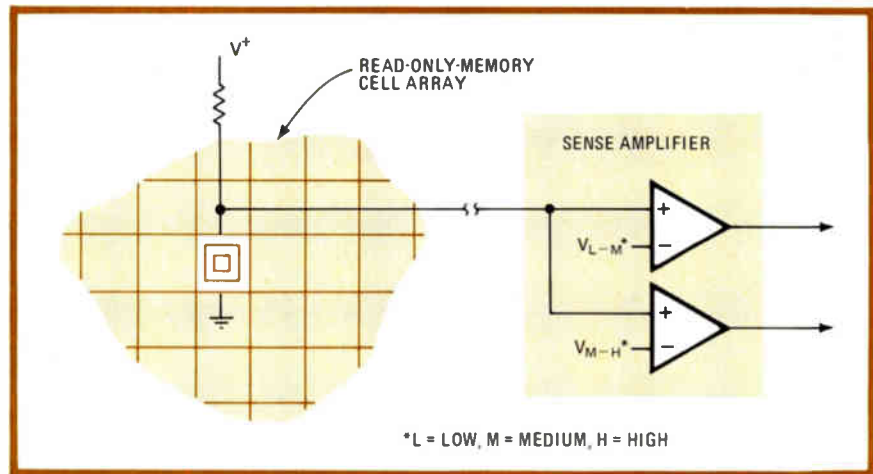

Four voltages. On Intel's newest microprocessors, each read-only-memory cell has one of four voltage levels. Two comparators determine which output is at a given address.

types—or no transistor at all—is placed during programming.

To determine which type of transistor is at a selected memory location, a specially designed sense amplifier is used. When a cell is chosen, it is effectively connected through a resistance to a logical high voltage. The potential developed across the cell—which corresponds to the size of the transistor—is fed to two comparators (see figure).

One comparator's second input is tied to a voltage between the two that would be generated by a small and a medium-sized transistor. The other comparator's second input has a voltage between those of the medium-sized and large devices.

Consequently, the two outputs of the comparators will reflect which of the three voltage levels (or lack of voltage) is at that address. The sensing is done in parallel, so that there is no need to cycle through the four voltages in the sense amplifier, says Klein.

Because room must be allocated at each ROM cell for the largest transistor, even if a smaller device or no transistor is placed there, there is some wasted silicon area. However, says Klein, "it is more than made up for by not having to store the 4 states separately."

Microsystems

Mini makers facing another IC challenge

Another heavyweight entry into the 16-bit microcomputer board business weighed in at last month's Wescon, when Motorola Inc. announced its board computer line based on its 68000 microprocessor. A major new direction for the company's Semiconductor Group in Phoenix, Ariz., the Monoboard Microcomputer draws even more sharply the battle lines between the two camps contest-

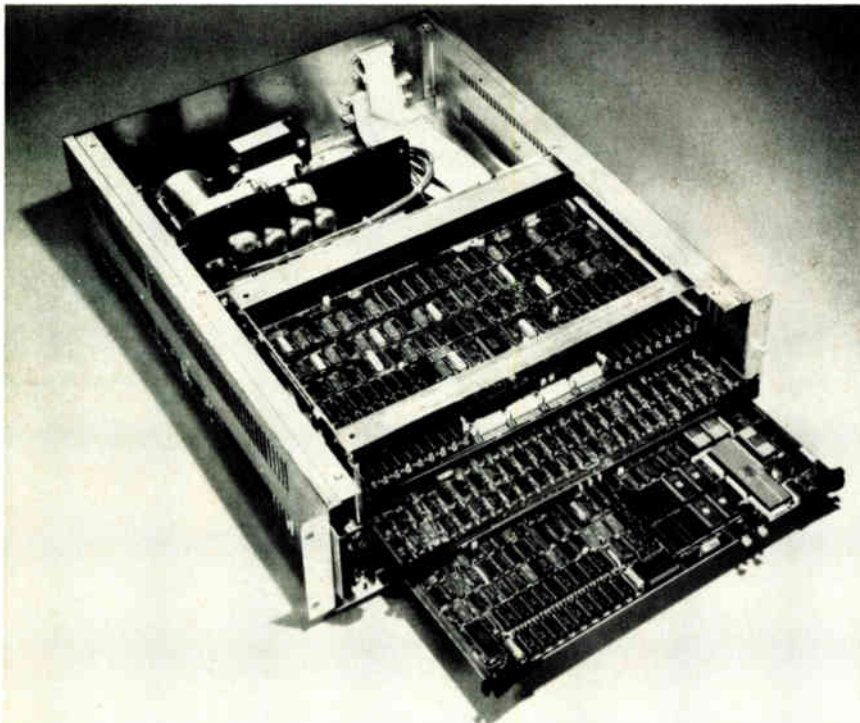

Caged. Motorola's Versamodule boards include, from bottom, the 68000-based Monoboard Microcomputer, a floppy-disk controller, and 128-K bytes of random-access memory.

ing this burgeoning business.

Defending the traditional 16-bit ground are the minicomputer makers. These are led by Digital Equipment Corp., whose LSI-11 board computers hold more than half the market. The attack is coming from the chip makers, led by Intel Corp. with its iSBC 86/12A line, Texas Instruments Inc. with its TM990 line, and now Motorola. Also getting attention is Zilog Inc.'s new 16-bit board based on the Z8000.

Powerful. A key issue will be software—but since Motorola's entry has the high-performance 68000 going for it, it is the most powerful 16-bit hardware yet in terms of sheer throughput and flexibility, as most competitors admit.

Operating at 3 megahertz, the processor board holds 32 or 64-K bytes of random-access memory, as much as 64-K bytes of read-only memory, serial and parallel input/output circuitry, and programming counter-timers. With peripheral boards, it can be configured for mass storage, for data communications and networking, and by adding another microcomputer board, for

high-throughput array processing.

What might be the typical mini maker view of a semiconductor firm's microcomputer board comes from DEC. "The hottest, niftiest chip isn't always equal to the best board," says Lloyd Fugate, planning manager for the microcomputer products group. "Building a new board is not that big a thing; software is more important in the 16-bit world."

He says operating and applications software accumulates in value, especially if it is transferable to new machines. DEC has been building its library since the LSI-II came along in 1977, and it remains for Motorola, Intel, and others to achieve such a track record, he argues.

Coming. For Motorola's part, it is bringing out operating software to go with the Monoboard, which sells for \$1,300 apiece in volume. A memory-resident multitasking software package will be ready for first shipments of the microcomputer in November, and a disk operating system is slated for completion in 1981.

The remainder of the family—called Versamodules—will be a board with 128-K bytes of RAM, a

floppy-disk controller, a multichannel communication module, a universal peripheral controller, a chassis, and a power supply. Plans for 1981 include an advanced microcomputer and a 1-megabyte bubble memory module.

Chip makers argue that they have a hardware advantage over the mini-computer makers. The Motorola board illustrates "the industry's two- or three-year technology lead," says Robert Brannon, marketing manager of Intel's OEM Microcomputer Systems division, Hillsborough, Ore.

Upward. He firmly believes momentum lies with the chip firms, which "represent VLSI versus LSI, multiprocessing against uniprocessing." He downplays the mini makers' software lead, claiming it will dwindle as his company and others put more programming onto chips.

However, Intel is moving to make it easier for original-equipment manufacturers by introducing soon a lower-cost, stripped-down development system that contains only the software tools necessary to write these programs. At present, the semiconductor-supplied microcomputer boards use high-ticket full-scale development systems. DEC's LSI-II, on the other hand, has a resident editor for assembling applications software as part of the board price.

Closing. As the two sides increasingly battle, most observers expect the semiconductor houses to close the gap. "They can give DEC and the others a run for their money," says one industry consultant. "The bottom line will be how easy they make it to write software."

Sales in this market are still fairly small—in the \$100 million range for 1980—but growing, says G. S. Bush-ee, vice president for small computer services at Dataquest Inc., the Cupertino, Calif., market research firm. He and other market analysts agree that DEC is the clear leader and that Intel has likely overtaken TI for second place this year. Overall, the 16-bit board business is a tough one to categorize "because it is so evolutionary at the moment," Bush-ee says. "It's neither quite a system nor a chip."
-Larry Waller

Superconductivity at room temperature reported by Air Force researcher

The dazzlingly fast supercomputers envisioned for the 1990s ordinarily are thought of in terms of Josephson junctions, which require supercooling to near absolute zero. However, Fred W. Vahldiek, a materials research engineer at Wright-Patterson Air Force Base in Dayton, Ohio, may have stumbled upon superconductivity at room temperature.

Such a discovery could lead to uncooled computers with picosecond machine cycles, to 100% delivery of the power from generating stations without loss or heat in transmission, and to a whole world of new applications based upon extremely efficient superconducting magnets.

"It was an accident," says Vahldiek. He was trying to obtain ductility from titanium bromide crystals, ordinarily extremely brittle. "I did get the ductility after all these years. Then we looked at some other properties, and . . . the superconductivity came along as a gift."

Materials. Vahldiek was working with borides of titanium "because they are very good conductors, yet they have boron in there, supposedly an insulator. How do you explain a conductivity five, six, seven times better than the host metal's—titanium, in this case?"

The composition change was

found by accident through deformation at room temperature under hydrostatic conditions. "The inner core of the crystals had a quite different composition—there was a change in the structure. . . . That's when I found the ductility," Vahldiek explains.

Resistance. He used a four-point probe to test for electrical resistance, and "in two directions the resistance appeared normal." But in the third direction, to his amazement, "the resistance was zero."

A fluke that could never be duplicated? "No, I've got 15 or 16 crystals by now," he reports. Each time, the measurements show a complete absence of resistance.

Vahldiek has patents pending both on the methods used to grow the crystal and on the deformation process. The Japanese and Russians, too, have been growing titanium bromide crystals, but not in same size and shape.

Usually, titanium boride adheres to the formula TiB_2 with a hexagonal or quazi-cubic structure, explains the researcher. After deformation, the ratio of boron seemed to drop from 2 to about 1.5 or 1.6, "and X-ray data show a possible orthorhombic structure, with crystal symmetry that will boggle your mind."

Vahldiek feels that this symmetry, together with the change in composition, brings about the ductility and the superconductivity. "And these borides are supposed to be very stable," he says.

As for the prospect for room-temperature Josephson junctions for future supercomputers and the like, Vahldiek observes, "That's only one of dozens of other properties that will need further investigation. I'll be busy for about six, seven months at least."

-John G. Posa

Communications

IC makers readying codec-filter combos

Having successfully launched coder-decoder and filter integrated circuits for digital telecommunications equipment, IC makers are readying the next step: putting codec and filter, as well as peripheral functions, on the same chip. The merits of their various approaches already are sparking industry speculation and discussion.

No fewer than three major semiconductor houses—Motorola Inc., Mostek Corp., and Intel Corp.—are expected to provide samples of codec-filter ICs during the first quarter of 1981. Officials at Motorola's Integrated Circuit division and at Mostek are ready to discuss their designs, though not in detail.

Close behind that trio will be National Semiconductor Corp. and Advanced Micro Devices Inc. What's more, industry sources report that American Microsystems Inc. is already shipping samples of its single-chip codec and filter.

Still C-MOS. For increased density, Motorola will build the new MC14400/01/02 series in silicon-gate complementary-MOS [*Electronics*, Sept. 25, p. 34], packing codec, filter, a voltage reference, and other functions on a 30,000-square-mil IC, says Bob Karasch, product manager for standard telecommunications devices at the Austin, Texas, division. The present metal-gate C-MOS codec

'It's possible,' says IBM

Prominent among the researchers investigating superconductivity are those at International Business Machines Corp.'s Thomas J. Watson Research Center, Yorktown Heights, N. Y., and a scientist there acknowledges that Fred Vahldiek's claim could be sound. If electrical conduction is supported by normal electron-phonon interaction, he says, the upper temperature line for superconductivity is from 30 to 40 kelvin. But if conduction is carried out by another means, such as through exciton interaction or electron-hole pairs, superconductivity could occur even above room temperature, he says.

He does warn that a superconductor must pass two tests. It must not impede current flow, of course; but it must also repel magnetic flux, a property known as the Meissner effect. Vahldiek says that he is "setting up a coil right now to test for the Meissner effect." He has already seen magnetic repulsion caused by the fields in his electron microscope, he says. -J. G. P.

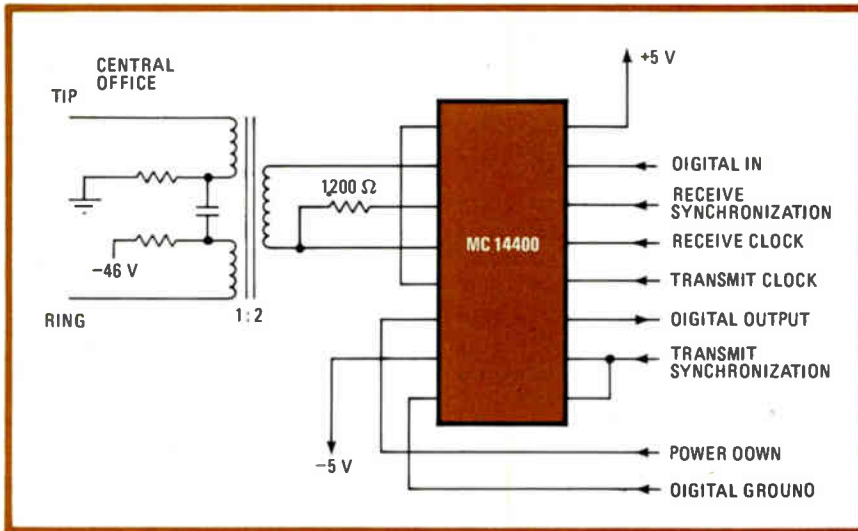

More on chip. Motorola's forthcoming codec and filter on a 30,000-mil² silicon-gate C-MOS chip may be used in such setups as the pulse-code-modulated voice channel shown.

and filter are 35,000 and 20,000 mils², respectively.

Motorola will continue its controversial approach of offering separate chips to assign time slots to the codec [*Electronics*, June 5, p. 125]. Karasch maintains that some systems will not need time-slot assignment, and for those that do, software assignment may be the solution in some applications.

Mostek says its forthcoming codec-filter, the MK5300, will integrate the circuitry for time-slot assignment, as Intel has already done with its codec IC. However, the Carrollton, Texas, firm will also offer a 5300 chip without the assignment function, says Robert J. Paluck, vice president of data and communications products.

N-MOS next. Though the current MK5116 codec is fabricated in C-MOS, Paluck says the 5300 will be done in n-channel MOS for improved density and cost. Designers intend to hold down dissipation through innovative circuit techniques like those used in the MK5912, an n-MOS filter IC unveiled earlier this year.

Though final specifications are not yet available, Paluck expects typical active power dissipation on the 5300 to come in at around 50 milliwatts. Motorola is specifying a 50-mw typical active power dissipation for its combined codec and filter, half that of its two-chip set.

At Intel, "our customers continue to find time-slot-assignment circuitry to be of great value, and one should expect future Intel products to have it," says Anthony R. Livingston, telecommunications marketing manager. Although the Santa Clara, Calif., company has made great strides in reducing the dissipation in

its n-MOS communications chips, it is likely that its codec-filter ICs will be available in C-MOS as well, dropping dissipation to the 50-mw range.

National Semiconductor will not disclose its approach on time-slot assignments; in fact, it will only say that its codec-filter chip will be available in samples around mid-1981. It is believed that the IC will be fabricated in the Santa Clara company's proprietary double-poly-silicon C-MOS (P²C-MOS) process.

In the works at AMD is what the Sunnyvale, Calif., firm calls a subscriber-loop audio-processing circuit, or SLAC [*Electronics*, June 19, p. 35]. It will be an n-MOS codec filter with a 150-mw active dissipation.

At AMI, also in Santa Clara, a spokesman will not comment on reports that the firm will be in production with its C-MOS chip by year's end. The part is expected to dissipate 100 mw when active.

The AMI chip is said to have been developed for Hitachi Ltd. for use in a subsystem in telecommunications equipment being designed by Nippon Electric Co. AMI's initial version

Competition already for the newest IBM 4341

Barely three weeks after its announcement, IBM Corp.'s 4341 group 2 processor has evoked a plug-compatible response. Moreover, the 4446 from IPL Systems Inc. is not only software- and microcode-compatible with the upgraded IBM machine, but it also runs 10% to 20% faster, says Stephen J. Ippolito, president of the Waltham, Mass., firm.

The 4446 executes instructions typically in 50 nanoseconds. Other specifications match those of the new 4341: 8 megabytes of maximum main memory, 16-K bytes of cache memory, and six standard channels.

Pricing is just a matter of deciding how much to undercut IBM, according to Ippolito. He expects shipments to get under way in the third quarter of 1981, soon after the scheduled first shipments of the 4341 group 2 [*Electronics*, Sept. 25, p. 51]. "We're counting on the old pattern, where a flood of orders forces IBM to announce longer and longer delivery times," Ippolito says. "The 4446 will be for customers who just can't wait for IBM."

The seven-year-old company has always been in the plug-compatible business, but in a break with the past, it will market the 4446 itself rather than through original-equipment manufacturers. Now beefing up its sales and service forces and offering remote maintenance, the firm has already begun going directly to end users with slightly modified versions of two earlier IPL processors, familiar in the U. S. as Control Data Corp.'s Omega series and sold in Europe under the Olivetti nameplate. These machines are the IPL 4443 and 4436, which are plug-compatible with IBM's 4341-1 and 4331-2, respectively. Like its predecessors, the 4446 incorporates high-speed emitter-coupled-logic circuitry, a modular, bus-based architecture, and IBM-compatible microcode control. The full line can be upgraded in the field, Ippolito says.

-Linda Lowe

There's a powerful new source in the electronic fuse market.



We're Gould Shawmut®, and we've been making fuses exclusively for the electrical industry since 1893.

In fact, we manufactured the wire for the first fuse invented by Thomas Edison. In more recent history we introduced the first complete line of low voltage current limiting fuses in America. The first single element time delay fuse, the first miniature 1000 volt fuse for Nautilus class atomic submarine service and much more. Our leadership in fuse technology is recognized throughout the electrical industry.

Now we're extending our expertise into the electronics industry, so you have an alternative source: A new line of miniature fuses for low voltage, over-current protection. In stock. Ready for immediate

delivery. And made by Gould Shawmut.

You'll be hearing a lot from us in the future. For more information about our glass and miniature fuses write: Gould Inc., Electric Fuse Division, Newburyport, MA 01950.

Tel: (617) 462-6662, 462-3131/Telex: 94-7427.

In Canada: 406 Adelaide St., E., Toronto, Ontario M5A 1N4.

Tel: (416) 366-1981/Telex: 06-219717.

 **GOULD**

An Electrical/Electronics Company



Circle 43 on reader service card

will offer the μ -law companding code for the North American market and an A-law part is in design.

-Wesley R. Iversen and Bruce LeBoss

Packaging

Elastomers cushion prototype reworks

Thanks to a solderless assembly method, circuits and ceramic motherboards damaged by the breaking of soldered connections during re-

work may become a thing of the past. Developed by Digital Equipment Corp. for prototype work, the new technique uses conductive elastomers to make temporary electrical contact between leadless chip-carriers and the ceramic substrates.

The soft assembly and test approach, as it is called, makes it possible to remove and replace faulty components both quickly and safely when a module fails in testing, says George A. Katronge, senior applied engineering manager of DEC's Applied Manufacturing division in Westboro, Mass.

Saves money. "Until you achieve full correlation between incoming electrical test programs and a device systems application—and this can take months—[hybrid subassembly] yields run extremely low," Katronge points out. "During that period, you have to rework continually, and a lot of ruined circuits have a large impact on the cost of introducing a new product."

At such an early stage, he says, soft assembly and testing pays high dividends. "Another plus is that when you return defective circuits, the maker can't claim they don't work because you damaged them."

Elastomer materials, from companies like Tecknit and Amp, have been used as connectors in products like digital watches and calculators. Using them as connectors in prototyping with leadless chip-carriers is a notion that has been around, but only now has the need arisen as the carriers are moving into more general use [*Electronics*, July 3, p. 45].

As the figure shows, the DEC scheme uses a Teflon nonconducting template between the ceramic substrate and the chip-carriers. The template also houses the elastomer elements, which make electrical connection between the carrier's pads and corresponding substrate pads.

Strips of the same elastomer also connect input/output pads on the subassembly with those of a test interface board in an electrical test system. A cover board containing spring-loaded pins clamps the whole assembly together with sufficient force to close all connections, and

the package is ready for testing as a complete module.

Unclamping and reclamping the package to replace defective parts may be repeated many times without harm to any of the components, Katronge says. When production begins, the chip-carriers can be soldered on ceramic motherboards, as DEC is doing with its LSI-11/23 minicomputer, which was the initial tryout of soft assembly and test.

Several manufacturers have approached DEC for details about soft assembly and testing, which pleases Katronge. "This is by no means a proprietary thing," he says. "The materials we use are readily available, and it's an easy matter to tool custom templates—anybody can do it."

-Linda Lowe

Production

Laser system speeds pc-board checks

Chrysler Corp.'s Huntsville (Ala.) Electronics division is teaming an automatic component inserter with a Chrysler-designed laser scanner that automatically inspects printed-circuit boards. The scanner, which the company plans to market, replaces human inspection and promises much higher throughput.

"This is the first time we have had a machine to do this kind of inspection," says Philip Geise, an engineering supervisor in the Electro-Optics Systems group at the division. Chrysler is applying the minicomputer-controlled scanner to a component inserter that stuffs boards for automobile spark-control computers. The 5-by-10-inch boards are scanned at the rate of 20 a minute.

Setup. As the figure shows, the system scans the bottom of each board with a 2-milliwatt helium-neon laser deflected by an X-Y moving-iron galvanometer and several folding mirrors. As each board moves off the insertion line, it is positioned to form the final side of a boxlike enclosure. The laser, inside the enclosure, scans the board and

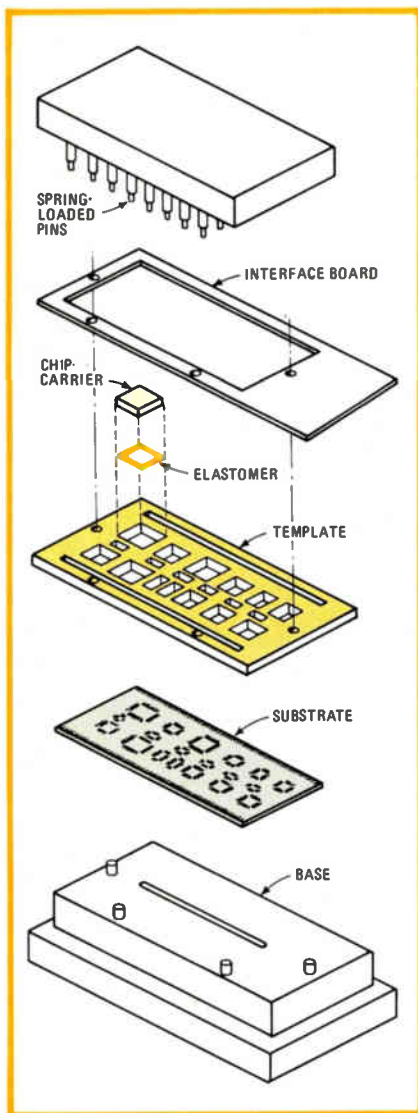

Easily altered. To avoid soldering chip-carriers to prototype boards, DEC uses a temporary elastomer connection and a template to hold them in place.

Kontron's Programmer Saves You Time and Money...

MPP 80S Programmer

We'll save you money from the very start. Why? Because we program following the PROM manufacturers specification . . . and we have approvals to prove it! No more lost bits in the field and expensive field service because of poor programming. Also, if you have to go to the field to update software, our MPP 80S goes with you. It is no larger than a briefcase.

Kontron's MPP 80S programmer is:

- Easy to operate
- Programs over 250 different devices
- Utilize RS232C interface
- Can be computer and remotely operated
- Have 17 data formats
- Offer auto baud and polarity select via key board
- Can be easily interfaced to IC handlers
- PROM manufacturer approved
- μ P controlled (Z80)TM
- Have standard UV lamp
- Full data manipulation

Now, Kontron offers a new EPROM gang programming module with interchangeable identifiers. Program and check via pass/fail Led's all popular EPROMS: 8 at a time.

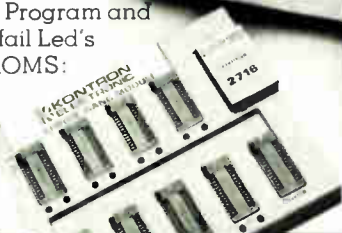

NEW

Write to:
Kontron Electronics
630 Price Avenue
Redwood City, CA 94063
(415) 361-1012
Outside CA (800) 227-8854

PROM PROGRAMMERS:

PROM PROGRAMMERS:

For data on Kontron[®] Computer/Controllers, Digital Multimeters, Counters, PROM Programmers, Logic Analyzer and Printers, call (800) 227-8834. In California call (415) 361-1012.



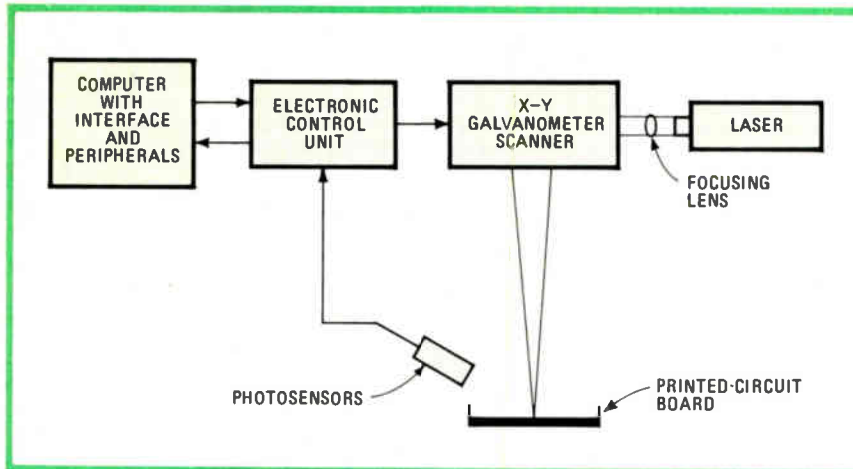

Laser Inspection. Chrysler's Electronics division has devised an automatic inspection system that uses a laser to look for incorrect or absent welded leads on stuffed pc boards.

the reflected beam is sensed by silicon photodiodes, whose signal feeds a General Automation 16/45 16-bit minicomputer.

The beam is programmed to scan the leads of the board's components according to a pattern stored in memory. A correctly clinched lead causes a characteristic null in the reflected beam; the lead blocks the laser beam from the photodiode sensor. If the lead is clinched in the wrong direction, is the wrong length, or is missing (perhaps because the component is missing), the characteristic signal fails to appear.

Memory sizes. The Chrysler setup has 32 kilowords of memory, even though 16 kilowords would be sufficient to store the scan patterns expected on a board, Geise says. The system includes a magnetic-tape reader for loading a board's scan routine and a cathode-ray-tube terminal. The minicomputer will alert the operator when a failure is repeated excessively.

The system can also be programmed to detect other circuit-board faults, Geise points out. On bare boards, for example, it can check hole location, line-run separation, over- and under-etching, superfluous conductors, and copper bridges. On flow-soldered boards, it can look for solder bridges. In that case, the insides of the scanning enclosure are coated with highly reflective paint. Since the bridges are also reflective and generate

glints on the reflective sides, the photosensors detect them.

Chrysler calculates its system can inspect at least 25 components or 50 component holes per second. "To reach this speed, a great deal of effort was needed to optimize the scan patterns," Geise reports. "We might not scan an entire lead, for example, but jump-scan from one to another. If a board were really bad—no leads at all, for example—it would take longer to scan than if it had no defects at all."

Right now Chrysler is completing tests of the system for the U.S. Army Missile Command, which

helped pay for its development as part of its manufacturing methods and technology program. When it goes on the market, it will sell for between \$80,000 and \$100,000 and be built around another General Automation processor, the GA-220 microcomputer. Geise described the scanner in a paper at a Huntsville meeting last week sponsored by the Society of Photo-Optical Instrumentation Engineers.

The Army's program manager in Huntsville for the laser scanner, Robert L. Brown, is quite pleased with the results. He points out that the scanner has been better than 99% effective at detecting failures on the Chrysler production line and that this is "an impossible percentage [to achieve] with human inspectors." **-Alfred Rosenblatt**

Business systems

Fujitsu office unit tests U. S. waters

Situated in an out-of-the-way corner at the recent Wescon show was what may be the tip of another Japanese iceberg: a 16-bit office business system to which Fujitsu Ltd. sought U. S. reactions. The Facom 9450 has

Wescon encore set at Anaheim

Pleased by the turnout for the first Wescon held in Anaheim, Calif., last month, show directors have voted to bring it back for an encore in 1982. The unaudited attendance total was 63,000; though that will drop, the final figure will still be well above the 35,300 audited total for the 1978 show at the Los Angeles Convention Center.

Also important in the decision by the board of Western Electronic Conventions Inc. was how well the show came off in Anaheim's convention center, says a spokesman. "Parking, more booth space, and convenient hotel locations all played a part," he notes.

Booths for exhibits numbered 1,150 this year, up from the 921 sold in Los Angeles in 1978. Also, most of the large hotels in Anaheim are within walking distance of the center, whereas the Los Angeles arena is in a rundown central-city location.

The biggest drawback of a permanent shift to Anaheim, some 35 miles south of downtown Los Angeles, however, is that the show is farther away from the major southern California population center, observers say, though they admit that criticism would be blunted by another good attendance total in 1982. As usual, the show in odd-numbered years will continue in San Francisco, at Brooks Hall for 1981 and afterwards at a new, bigger arena slated to be completed for the 1983 gathering. **-Larry Waller**

Easy Data Acquisition and Control.

PROSYS I

Here's an intelligent data acquisition and control system that is so simple to use even a child could operate it. One of its secrets is its English-language software that allows users with little or no programming training to easily communicate with PROSYS I. Standard application program aids are readily available for a wide variety of uses.

Its flexibility makes the PROSYS I ideal for laboratory, industrial control, test and measurement applications. PROSYS I offers cost effective solutions that fill the gap between large, expensive CPU based systems and less powerful programmable controllers.

The basic system includes a CPU, memory, a dual-port serial interface, a double-density floppy-disk drive, and a CRT terminal. This comprehensive system can accommodate any of 38 ADAC I/O devices. The entire system is DEC-compatible which makes it even more flexible for future modification.

Simple to use software. Field-proven hardware. The capability to handle practically any I/O function. That's what makes PROSYS I a remarkable tool.

And PROSYS I sells for only \$14,000 plus optional I/O.



70 Tower Office Park • Woburn, MA 01801
617-935-6668

Circle 47 on reader service card

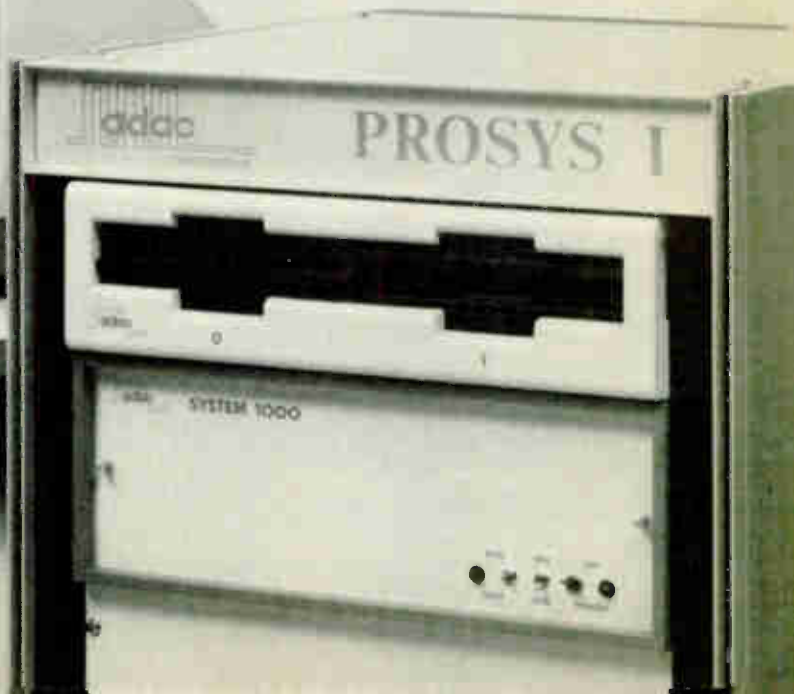

Mounting Ideas from Weckesser

6 Ways To Mount Cable Ties

-ALL NYLON-

SCREW FASTENED—

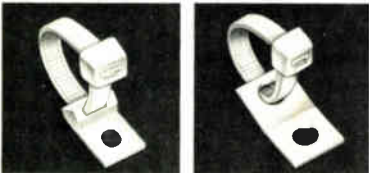
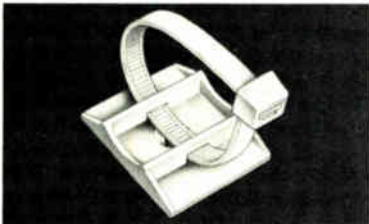

ADHESIVE FASTENED—

High-
temperature
adhesive
available

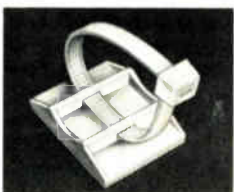

SNAP-IN—



Write for catalog.

Weckesser
COMPANY, Inc.

4444 W. Irving Park Road
Chicago, Illinois 60641 (312) 282-8626

Electronics review

been on sale in Japan as a terminal and is being introduced as a personal computer by its maker, Panafacom, a joint venture of Fujitsu and Matsushita. In the U. S., it is likely the new Fujitsu-TRW joint venture will market it.

For some time, industry observers have been expecting the Japanese electronics industry to jump into the U. S. very small business systems market, just as it has in consumer

electronics, semiconductor memories, and the like. If the Facom 9450 is indeed the first of many such Japanese products in this market, it sets a high mark for those to follow.

Target. While withholding performance figures, Fujitsu says the 9450 is much more powerful than top-of-the-line U. S. personal computers, whose makers are advancing into the market for very small business systems. If so, the expected

News brief

Ethernet starts to grow

Even as Hewlett-Packard Co. signaled its intention to adopt the Ethernet standard for local data networks, the protocol's originator, Xerox Corp., announced its second product that will link up with such a net: a 43-page-per-minute, laser-scan printing system for word and data processing, copying, and electronic mail. Novel in the Stamford, Conn., company's 5700, which accepts inputs from both Xerox and IBM word processors, is a touch-control screen similar in concept to the Proteus of Solid State Technology Inc. and Massachusetts Institute of Technology [*Electronics*, June 5, p. 39]. A typical system with two stations that accept input from an RS-232-C line, magnetic media, or Ethernet, plus copying facilities, forms compiler, and automatic stapler, has a purchase price of \$91,050. Meanwhile, HP added its stamp of approval to Ethernet by announcing that it plans to use a controller chip designed by Intel as part of a three-company pact with Xerox and Digital Equipment Corp. [*Electronics*, June 5, p. 89]. The Palo Alto, Calif., company says, however, that it will not adopt Ethernet unless it is accepted by the committee working on standards for local data networks.

Nestar's local net goes European

Cluster/One model A, a local network for hooking up as many as 65 Apple 2 microcomputers, is now being offered for sale in 17 European countries. The Model A was introduced earlier this year [*Electronics*, Jan. 31, p. 43] by Nestar Sytems Inc. of Palo Alto, Calif., and is being supported in Europe by Zynar Ltd., a subsidiary of the Rank organization in England headed by Colin Crook, of Motorola Semiconductor fame. Users may communicate with one another and share both resources and files with the system, whose cost may be as low as \$4,800 per station for a 10-station network.

EE to head National Science Foundation

The Senate has confirmed John G. Slaughter, former academic vice president and provost of Washington State University, as head of the National Science Foundation. From 1977 to 1979, Slaughter, now 46, was the NSF's assistant director for astronomical, atmospheric, earth, and ocean sciences. He has a Ph. D. in engineering science from the University of California at San Diego; a bachelor's in electrical engineering from Kansas State University; and a master's from the University of California at Los Angeles.

E-Systems looks to digital teleconferencing

By year-end, an E-Systems Inc. demonstration video teleconferencing setup using digital transmission will be in operation at the McLean, Va., headquarters of Satellite Business Systems Inc. The system, being developed under contract to SBS by the Dallas firm, is designed for sale to SBS customers and others with on-premise earth stations using digital satellite channels. In contrast, AT&T's Picturephone meeting service [*Electronics*, March 13, p. 12] uses land analog phone lines, and AT&T expects many users to come to its facilities in key cities, renting them on a per-conference basis.

Electronics review

\$8,500-to-\$10,000 price tag that includes a terminal, two minifloppy disk drives, and a matrix printer should be highly competitive.

The disk drives hold 320-K bytes each, and the processor addresses 128-K bytes of random-access memory, though between 26- and 56-K bytes of the RAM accommodate the operating system and utilities that Fujitsu designed. In contrast, the full 128-K bytes of RAM in the new Apple III are user-accessible.

The 9450's power lies even more in its software. It features foreground/background job processing, as well as real-time control and full-duplex communications capability over RS-232-C and IEEE-488 links. It also uses an intermediate code to separate editing, compilation, and execution modes into three clock phases that can run concurrently.

On top of this is the development software, which initially consists of business Basic and single- or double-precision scientific Basic. The software package also pays considerable attention to error detection.

Crucial. There are 12 user-definable keys for easy reference to often-used functions and commands, and the software is oriented towards a number of office functions, although it does not include word-processing features. In fact, application software is the crucial factor in the success of the Facom 9450 and other Japanese entries into the very small business systems market.

Already the leading American producers, notably Apple and Radio Shack, can point to impressive libraries of applications software—both their own offerings and those of software houses. They may not blanket the market, as Japan discovered IBM does with its mainframe applications software, but they already enjoy a healthy lead.

However, Fujitsu and its American partner, TRW Inc., are well aware of the importance of the applications software. TRW-Fujitsu Co. [*Electronics*, Sept. 25, p. 102] is hard at work writing the software for its initial offering, the Facom V-830 business computer aimed at the IBM System/34 market.—**Martin Marshall**

The DC to DC jewel

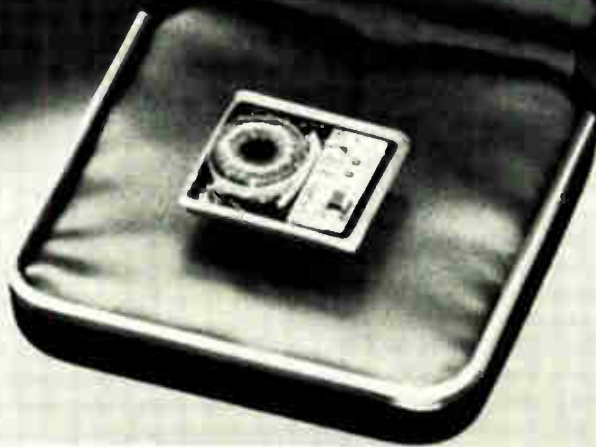

Now with a narrower input range.

The Tecnetics HC Series unregulated DC to DC power supplies are more of a jewel than ever. We've optimized performance by adding a more efficient core and narrowing the input range. And it still weighs only 0.45 ounces.

Choose from a wide variety of input voltages and single or dual outputs. HC Series power supplies are available in a non-hermetic package for industrial and commercial applications, a her-

metic package for military, space and industrial applications that require protection from severe environmental conditions, and a fully-encapsulated package for use where extreme shock and vibration are expected.

Write for our 28-page catalog that gives full specs and prices on the HC Series and over 1000 other power supplies.

HC SERIES UNREGULATED ISOLATED DC-DC CONVERTER

INPUT VOLTAGES	5VDC \pm 1V to 28VDC \pm 4V
OUTPUT VOLTAGES	5VDC @ 3 watts to 300VDC @ 3 watts
OPERATING TEMP.	-55° C ambient to 100° C case, without derating
DIMENSIONS	1.05 x 0.94 x 0.32 inches
EFFICIENCY	65% to 75% typically at full load 55% to 60% typically at half load
PACKAGE OPTIONS	HCN (Non-hermetic) 55.00
AND PRICES	HCH (Hermetic) 65.00 HCE (Encapsulated) 75.00

tecnetics INCORPORATED The Power Conversion Specialists

P O Box 910, 6287 Arapahoe Avenue,
Boulder, Colorado 80306
(303) 442-3837 TWX 910-940-3246

Circle 51 on reader service card

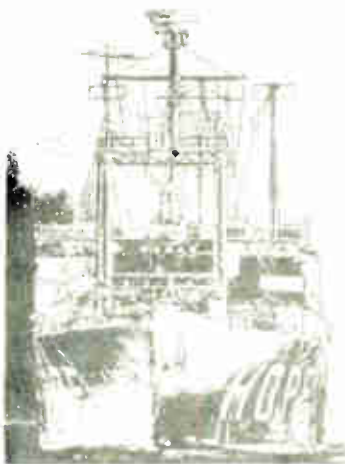

HOPE The project a ship launched.

First there was the hospital ship S.S. HOPE, now retired. Today HOPE is an established project which has carried its goal of improving health through education to 24 developing countries of the world and the United States.

Give to:

PROJECT HOPE

Department A
Washington, D.C. 20007

Time is precious Why lose it?

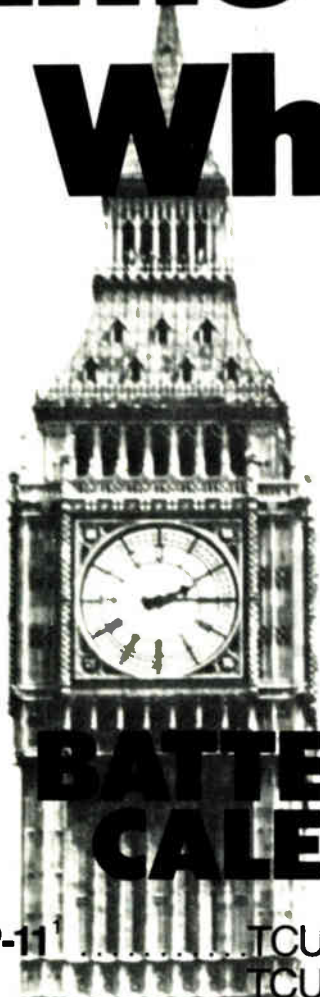

BATTERY SUPPORTED CALENDAR CLOCKS

PDP-11 ¹	TCU-100 • \$495
	TCU-150 • \$460
LSI-11/2 ¹	TCU-50D • \$325
Multi-Bus ²	TCU-410 • \$325
EXORcisor ³	TCU-68 • \$325
HP 2100	TCU-2100 • \$395
Lockheed SUE	TCU-200 • \$550
Naked Mini ⁴	TCU-310 • \$385

If automatic and accurate date and time entry is important to your system on power-up — you need a Digital Pathways battery supported calendar clock. All Digital Pathways' TCU's have on board NICAD batteries to maintain date and time during power down (typically up to



Serial Line Clock .. SLC-1 • \$640
(RS 232 or 20mA) Microprocessor controlled.
Auto message intercept and response.
10 Digit display option \$190.

three months). Timing is provided by a crystal controlled oscillator. Prices are U.S. domestic single piece. Quantity discounts available.

For more information on these timely products, contact:

*Digital Pathways Inc.
4151 Middlefield Road
Palo Alto, CA 94306
Phone: (415) 493-5544*

¹Trademark of Digital Equipment Corp.
²Trademark of Intel Corp.
³Trademark of Motorola Inc.
⁴Trademark of Computer Automation Inc.



DIGITAL PATHWAYS

We have a pollution solution!

Corcom is the world leader
in RFI pollution control!
Our SP series filters have
been designed to allow
switching power supplies
to comply with the
new FCC rules as well as
VDE 0875A. Write for
complete technical data.

 **CORCOM**
RFI Power Line Filters

Corcom Inc. 1600 Winchester Road Libertyville, Illinois 60048 U.S.A.
312-680-7400 TWX 910-684-3269 ©



Instrumentation
Engineering



“If you’re on the verge of an ATE buying decision, you must consider three things.”

Robert E. Ward, President
Instrumentation Engineering, Inc.

ATE may be one of your company’s most important investments this year. You will want to be certain that the system you select results in the lowest overall cost to you and will not be obsoleted by the explosive growth of technology.

As ATE pioneers, we at IE incorporated these criteria in conceptual studies of our System 390 over a decade ago. We concluded that, for lowest overall cost and proof against obsolescence, an ATE must meet three criteria:

It must be **MODULAR**; it must be able to interface between the Unit Under Test—the “UUT”—and a wide and ever-changing library of stimulus and measurement devices.

It must be **FUNCTIONAL**; it must surround the UUT with an input-output environment closely simulating the one in which it will actually operate. Stimulus signals and response measurements must be made in the real-time environment of your product to prevent faulty product escapes through your ATE, often a large and uncalled for expense.

It must be **FLEXIBLE**; it must be easily reprogrammable so that it can quickly respond to redesign of the UUT or to changes in field conditions.

MODULARITY, FUNCTIONALITY, FLEXIBILITY. These have been the key words in the IE design philosophy since our founding which has led to the IE System 390 family of ATE. It lets us create full test system configurations ranging from a stand-alone program development facility on up to an analog, digital or hybrid tester with its own programming capability. It means that you can test UUT’s ranging in complexity from PCB’s, to higher assemblies, to completely integrated, advanced electronic end products/systems.

This capability is essential in the commercial field where a test facility must remain viable for the maximum number of years, thus reducing to a minimum its Life Cycle Cost. A similar concept has emerged in recent military programs such as the Air Force’s MATE (Modular Automatic Test Equipment) and the Army’s DS/ATSS (Direct Support Automatic Test Support System).

Modularity means upgradeability. For this reason System “390s” built years ago can be made capable of testing today’s most sophisticated circuits and systems worldwide... that “390s” originally purchased for purely analog or digital testing are being upgraded for hybrid testing... that “390s” incorporating IE’s powerful time domain **MICROSIM™** simulator are aiding the design phase for new circuits insuring product testability.

If you have an ATE requirement, consult IE at your earliest opportunity. Just write or phone Frank Montenes, VP Business Development. It will prove well worthwhile.



Visit IE in Booths No. 178-179 at the Cherry Hill ATE conference.

HOW'S YOUR MEMORY?

Our MEMORIES Have Made US Famous!

WHY?

Reliability!

That's the secret of our success. We are dedicated to producing the most reliable memories possible for the S-100 bus and the new IEEE S-100 bus.

Flexibility!

No matter what CPU you use, we have the memory for you.

SUPERAM™ 2—We've delivered over 5,000 of these 64K dynamic RAM boards to OEMs worldwide. This board sets the standard for reliable operation.

SUPERAM™ 4—Now available for Z80A and 8085A users, with bank select and optional parity bit.

SUPERAM™ 5—Our forthcoming IEEE-696 (S-100) compatible RAM will provide 64 Kbytes of dynamic RAM as either 32Kx16 or 64Kx8.

With ECC, too!

Announcing the **SUPERMEM™ ECC!** This is the ultimate in memory

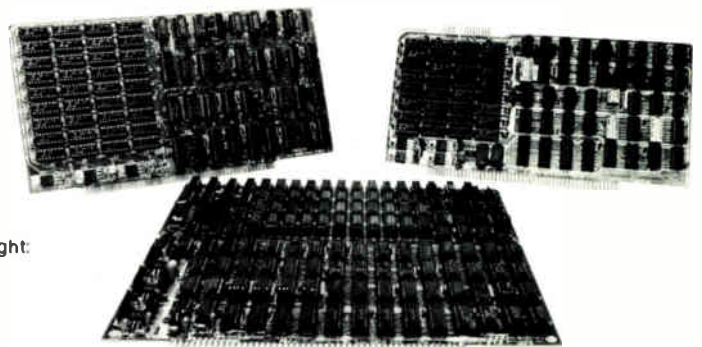

Shown Left to Right:
SUPERAM 4
SUPERMEM-ECC
SUPERAM 2

data protection: built-in automatic error correction. The SUPERMEM transparently corrects single bit errors and detects double bit errors.

We'll Design One for You!

If you have a special situation that calls for a custom design involving memory, processors, controllers, or even complete systems, give PIICEON a call. We might have the answer to your product need.

And That's Not All!

We also supply the following Microcomputer Boards:

- C-86 — 16-bit 8086 processor

board with multi-processor arbitration logic, on-board PROM and RS-232 port.

- V-100 — 80x24 high-speed video output board.
- D-100 — Coming soon, the answer to 5¼ and 8-inch Winchester control.

WRITE FOR OUR NEW BROCHURE

PIICEON™

OEM Computer Products

2350 Bering Drive
San Jose, CA 95131
(408) 946-8030

©PIICEON, INC. 1980

Washington newsletter

AT&T to seek competitive bids for fiber-optic link . . .

American Telephone & Telegraph Co.'s Long Lines department says it will solicit competitive industry bids in about a month for the Boston-to-New York leg of its proposed 611-mile, digital fiber-optic linking of the Northeast Corridor, pending Federal Communications Commission approval of the plan. The first leg of the net, connecting New York, Philadelphia, and Washington, D. C., will be built by AT&T's Western Electric Co. Atlanta works. AT&T's initial application for the system, filed in late January, estimated the cost of the system at \$79.1 million and an **operational goal of 1983 for the Washington-to-New York and 1984 for New York-to-Boston routes.** AT&T Long Lines officials say the competitive proposal requests will specify system bids to include fiber optics and light-emitting-diode signal sources and regenerators.

. . . as advances change plans, Long Lines says

Innovations and advancements in lightguide technology and manufacturing since the January filing with the Federal Communications Commission led AT&T Long Lines to seek competitive systems bids for the Boston-New York link, according to Thomas W. Scandlyn, network engineering vice president. Though the initial application sought authority to use a 90-Mb/second system known as FT3LC, Scandlyn told the FCC Common Carrier Bureau at the end of September that the unavailability of that system at the time of filing led the company to plan the New York-Washington route using the 45-Mb/second FT3L with light-emitting diodes operating at 820 nm. **"Refinements in manufacturing, the quality and yield of fiber,"** Scandlyn wrote the FCC, "now permit operations at 1,300 nm, using LEDs in the 90-Mb/s regenerators. Further, we expect those innovations to be available for the initial service."

IBM wins three key military jobs worth \$127 million

International Business Machines Corp.'s Federal Systems division won three key military system development contracts totaling more than \$127 million, as awards by the services rose sharply at the end of September to beat the Federal fiscal year-end deadline. **The biggest award was \$95 million** from the Air Force Space division for full-scale engineering development of the operational control system for the long-stalled Navstar Global Positioning System.

NIOSH to research possible hazards at component plants

A research study on potential occupational health hazards in the electronic components industry is being initiated by the National Institute of Occupational Safety and Health. NIOSH, an arm of the Department of Health and Human Services, says the effort, set for completion on Sept. 2, 1981, will begin collecting data at open meetings at 1 p.m. on Nov. 5 at the New York Academy of Sciences in New York City and at 9 a.m. on Nov. 7 at the State Office Building in San Francisco.

Project director Mark Boeniger at NIOSH offices in Cincinnati, Ohio, says the study group—assisted by North Carolina's Research Triangle Institute under a \$110,000 contract—plans approximately 15 visits over the next year to manufacturing operations in California, Texas, and a northeastern belt ranging from Boston to Pennsylvania. Boeniger said when asked for examples of potentially hazardous substances that the **arsenic in dust generated during the production of gallium arsenide light-emitting diodes might be harmful.**

Stemming the U. S. decline in R&D

Over the next several years the Department of Defense will pursue force readiness—more money for pay, munitions, spare parts, and fuel, for example—at the expense of research and development, much of it in electronics. That is the disturbing forecast of the Electronics Industries Association in its latest look at the U. S. military electronics market over the coming decade (see p. 95).

The EIA judgment is one that coincides with the Aerospace Industries Association's latest examination of the national R&D decline, a trend that could prove disastrous for the national economy overall if allowed to continue. AIA's litany of the interrelated issues is by now familiar to industry: capital investment in technological progress is down; U. S. funding of R&D is lower than a decade ago, with no substantial growth in sight; and the number of scientists and engineers in proportion to the population is down, as is the number of patents issued to U. S. citizens.

Other indicators confirm the decline, such as a drop in the productivity growth rate and an overall negative balance of trade despite the positive contributions of high-technology products. The recitation recalls "The Decline and Fall of the Roman Empire," with Edward Gibbon's pronouncement, "All that is human must retrograde, if it does not advance."

The U. S. has no policy

The AIA's valid conclusion that the United States has no long-range policy for R&D, innovation, and technology is one that deserves more attention than it has received, like similar warnings by other groups of industrialists, academicians, and professional societies in recent years. Although some citizens are misled by the fact that Federal R&D funds have recently been increasing in terms of current dollars, the national effort is actually declining in terms of inflation-adjusted dollars.

"Constant dollar figures," AIA says of Federal R&D, "show total funding in the last 10 years (fiscal 1972-81) to be 9% below the level of the previous decade. Instead of a steady upward trend, defense R&D has actually decreased 17% and the space effort is about half the total for the fiscal 1962-71 period."

Beyond calling for the establishment of a long-range national R&D policy—as a collaborative effort between the White House Office of Science and Technology, the National Science Foundation, and the Department of Commerce—the AIA also urges Federal rules that

would permit formation of industry consortiums to develop international markets with high potential, without the threat of antitrust action. On the congressional side, AIA wants "full and stable" R&D funding levels based on a national policy, plus passage of a variety of legislative incentives for R&D that are also supported by other high-technology industries. Tax credits for R&D investment are, of course, at the top of the list of incentives (see p. 24).

What industry must do

What is refreshing to some Government officials who have examined the new AIA study of America's R&D problem is, one points out, that "it calls for positive action by industry, too, and doesn't lay everything at Government's doorstep." Indeed, AIA does urge industry to increase its own R&D outlays as well as "increase capital investment to improve productivity, encourage innovation, enhance product quality, and lower unit cost, in order to be more competitive in world markets." It also recommends that manufacturers "promote and support more imaginative job-training programs—such as internships—to attract young people."

Perhaps the only option ignored is one that a number of electronics manufacturers favor—the provision of tax-free funds for encouraging more university R&D in either separate or joint efforts with corporations. Such a program would not only turn around declining student enrollments in technology but also diminish the number of university faculty departures for better-paying jobs in industry.

On the charge that America's decline in innovation is a product of "corporate short-sightedness," AIA responds that "the general economic climate certainly offers some rationale for defensive planning. In an uncertain domestic economic and political environment, a prudent businessman is forced to invest cautiously; that undoubtedly means a trend toward short-term investments for greater low-risk profits—and a de-emphasis on basic and exploratory research."

To break that trend toward pettifogging prudence, the nation does need the long-range national R&D policy, with appropriate industrial incentives, that AIA and others are calling for. But it also needs more in the increasingly competitive global marketplace if it is to maintain leadership. It needs to cultivate "the concept of a partnership between government and industry" that does not now exist. As developments in both Europe and Japan demonstrate, the time for more study has expired. **-Ray Connolly**

WE'VE GIVEN THE WORLD THE GREEN LIGHT.

Sprague Electric offers you the finest and broadest choice of interface ICs for driving fluorescent displays.





From the outset, Sprague has led the way in IC interface for fluorescent display panels. Its UDN-6118A was the pioneer. Today, Sprague product capability spans low voltage performance (required for automotive and aircraft dimming), to split supply operation (permitted by the latest Sprague VF drivers—UDN-6138 & UDN-6148), to the highest voltage operation obtainable (110V guarantee for UDN-6118A-1—also often used for gas discharge displays).

Sprague VF drivers incorporate output pulldown resistors and are guaranteed for less than 1.0V output OFF voltage (frequently a filament biasing concern). The use of proper interdigit blanking ($\geq 20\mu\text{S}$) eliminates ghosting problems. Sprague VF ICs also have a maximum turn-off delay of $5\mu\text{S}$ (under normal display loads).

Recognized as the industry standard, Sprague VF display ICs are compatible with TTL & MOS logic.

Plastic DIPs are supplied for 0°C to $+70^\circ\text{C}$ operation while both extended temperature range and hermetic versions are also available for automotive and other challenging applications.

For additional information or application assistance, write or phone Paul Emerald, Sprague Electric Co., Semiconductor Division, 115 Northeast Cutoff, Worcester, Mass. 01606. Telephone 617/853-5000.

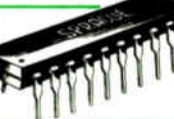
	DEVICE TYPES	CHANNELS/DIP	MIN BV (OUTPUT)	DIP
	UDN-6116A-2, 6126A-2 UDN-6116A, 6126A	6 6	+ 60 V + 80 V	16 lead 16 lead
	UDN-6118A-2, 6128A-2 UDN-6118A, 6128A UDN-6118A-1, 6128A-1 Anode driver, gas discharge displays	8 8 8	+ 60 V + 80 V +110 V	18 lead 18 lead 18 lead
	UDN-6138A-2, 6148A-2 Split supply (+20 V, -40 V)	8	60 V*	20 lead
	UDN-6138A, 6148A Split supply (+40 V, -40 V)	8	80 V*	20 lead

*Output BV referenced to V_{EE} Max. $V_{EE} = -40\text{ V}$

FOR FAST INFORMATION, CALL YOUR NEAREST SPRAGUE SALES OFFICE:

ALABAMA, Sprague Electric Co. 205 883-0520 • ARIZONA, Sprague Electric Co. 602 244-0154, 602 966-7233 • CALIFORNIA, Sprague Electric Co. 213 649-2600
714 549-9913, R. D. Miner Co. 714 421-5586, Wm. J. Purdy Co. 415 347-7701 • COLORADO, Wm. J. Purdy Co. 303 777-1411 • CONNECTICUT, Sprague Electric Co.
203 261-2551, Ray Perron & Co. Inc. 203 268-9631, 203 673-4825 • DIST. OF COLUMBIA, Sprague Electric Co. (Govt. sales only) 202 337-7820 • FLORIDA, Sprague
Electric Co. 305 831-3636 • ILLINOIS, Sprague Electric Co. 312 296-6620 • INDIANA, Sprague Electric Co. 317 253-4247 • MARYLAND, Sprague Electric Co.
301 792-7657 • MASSACHUSETTS, Sprague Electric Co. 617 899-9100, 413 664-4411, Ray Perron & Co. Inc. 617 969-8100 • MICHIGAN, Sprague Electric Co.
517 787-3934 • MINNESOTA, HMR, Inc. 612 831-7400 • MISSOURI, Sprague Electric Co. 314 781-2420 • NEW HAMPSHIRE, Ray Perron & Co., Inc. 603 742-2321 • NEW
JERSEY, Sprague Electric Co. 201 696-8200, 609 795-2299, Trinkle Sales Inc. 609 795-4200 • NEW MEXICO, Wm. J. Purdy Co. 505 266-7959 • NEW YORK, Sprague
Electric Co. 516 234-8700, 914 834-4439, 315 437-7311, Wm. Rutt, Inc. 914 834-8555, Paston-Hunter Co. Inc. 315 437-2843 • NORTH CAROLINA, Electronic Marketing
Associates, 919 722-5151 • OHIO, Sprague Electric Co. 513 866-2170, Electronic Salesmasters, Inc. 800 362-2616 • PENNSYLVANIA, Sprague Electric Co. 215 467-5252,
Trinkle Sales Inc. 215 922-2080 • SOUTH CAROLINA, Electronic Marketing Associates, 803 233-4637 • TEXAS, Sprague Electric Co. 214 235-1256 • VIRGINIA, Sprague
Electric Co. 703-463-9161 • WASHINGTON, Sprague Electric Co. 206 632-7761 • CANADA, Sprague Electric of Canada Ltd. 416 766-6123 or 613 238-2542

4SS-0116



a subsidiary of **GK Technologies**
INCORPORATED

INCREDIBLE INCREDIBLE

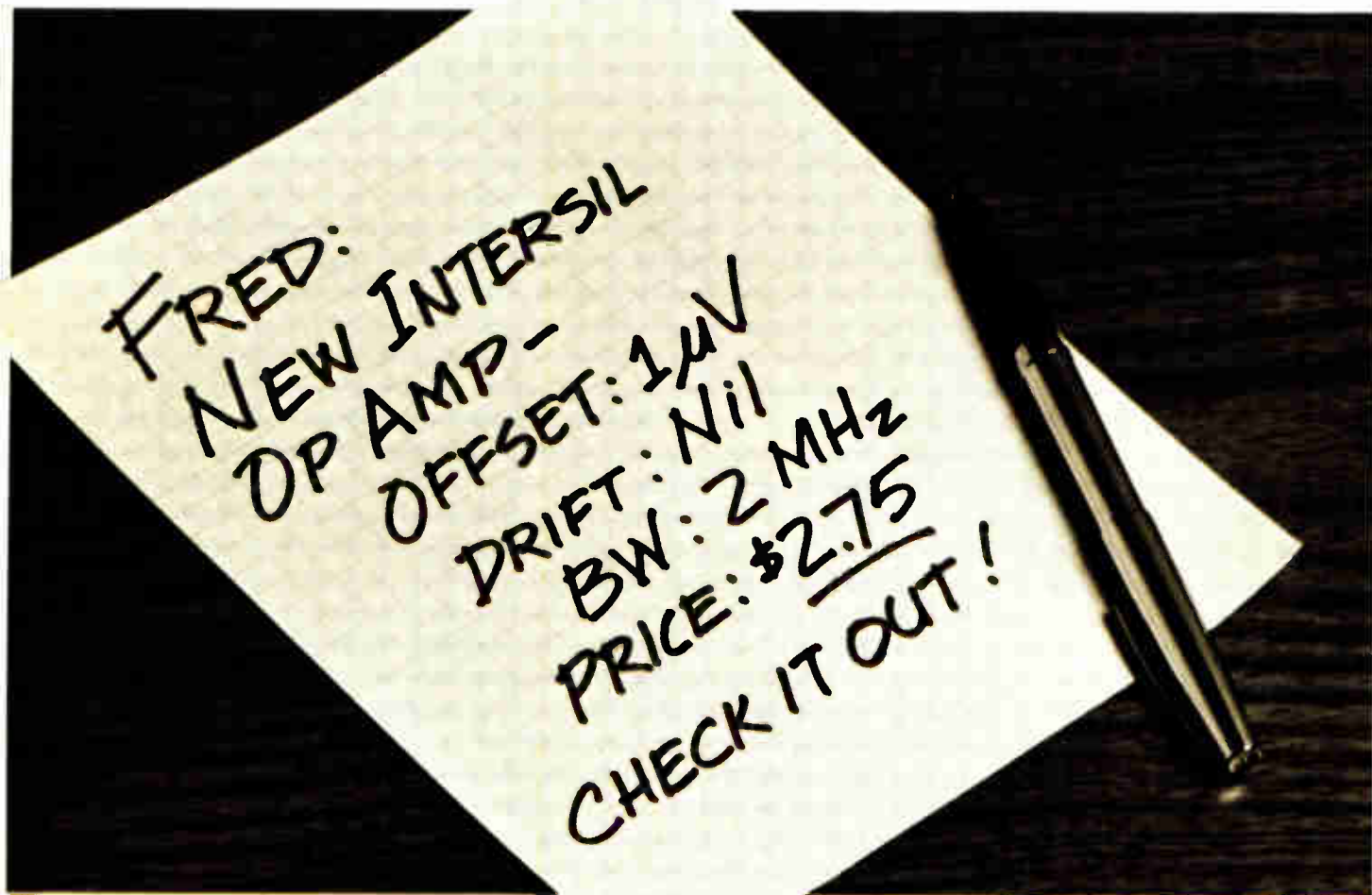

A blockbuster in technology and price.

Designing with op amps just became much easier. Announcing Intersil's ICL7650: A totally new generation of low-level differential operational amplifiers. With specs that approach perfection. And all for an unheard-of \$2.75!

Yes, \$2.75. In 100-piece quantities. Our intention? Quite simply to create a new industry-standard op amp. With the best technology and the best cost-effectiveness. Anywhere.

The universal op amp.

Now there's one monolithic op amp that's a smart choice for

virtually any amplifier design you can think of. The ICL7650 beats all other precision op amps hands down, both in ac and dc parameters. It even gives general purpose op amps a run for their money.

Especially when you consider that it eliminates the need for potentiometers. And all the adjustments and reliability worries that go along with potentiometers.

OP AMP. PRICE.

The ICL7650 streamlines design because you don't have to worry about error parameters. It streamlines manufacturing because you just put it in a system and forget it. No assembly people tweaking potentiometers. And no field service people recalibrating potentiometers later. The ICL7650 constantly self-corrects — so the specs don't change with time or temperature.

Incredible specs:

- Input Offset Voltage: $\pm 5\mu\text{V}$, max.
- Offset Drift w/Temperature: $0.01\mu\text{V}/^\circ\text{C}$
- Offset Drift w/Time: $100\text{nV}/\sqrt{\text{month}}$
- Large Signal Voltage Gain: 130dB
- Input Bias Current: 10pA, max.
- Common Mode Rejection Ratio: 120dB
- Power Supply Rejection Ratio: 120dB
- Unity Gain Bandwidth: 2MHz
- Slew Rate: $2.5\text{V}/\mu\text{s}$

Goodbye bipolar op amps. Goodbye BIFETs.

The ICL7650 has lower offset and lower drift than the best of the bipolar op amps. As for BIFETs, the CMOS ICL7650 beats their input current, and totally outscores them on offset and drift. Making it ideal for amplifying very low-level signals very accurately. With the speed to handle just about any application.

From the data acquisition innovators.

Leading-edge op amp performance with no compromises. At a price guaranteed to please your boss. From Intersil — the data acquisition innovators.

The ICL7650 is a good deal, pure and simple. To get the complete specs, just call us. Or send in the coupon.

Intersil Sales Offices:

CALIFORNIA: Sunnyvale (408) 744-0618, Long Beach (213) 436-9261 • COLORADO: Aurora (303) 750-7004 • FLORIDA: Hollywood (305) 920-2442 • ILLINOIS: Hinsdale (312) 986-5303 • MASSACHUSETTS: Lexington (617) 861-6220 • MINNESOTA: Minneapolis (612) 925-1844 • NEW JERSEY: Englewood Cliffs (201) 567-5585 • OHIO: Miamisburg (513) 866-7328 • TEXAS: Dallas (214) 369-6916 • CANADA: Brampton, Ontario (416) 457-1014

Intersil Franchised Distributors:

Advent (IN, IA) • Alliance • Anthem • Arrow • Bell Industries

• Cardinal • CESCO • Component Specialties • Components Plus • Diplomat (FL, MD, NJ, UT) • Harvey (upstate NY); • Kierulff • LCOMP • Newark • Panda • Parrott • R.A.E. Ind. Elect. Ltd. • RESCO/Raleigh • Schweber • Summit • Western Micro-technology • Wyle • Zentronics

INTERSIL

Analog Products — Data Acquisition
10710 N. Tantau Avenue
Cupertino, CA 95014
Tel: (408) 996-5000 TWX: 910-338-0171

Dear Intersil,

_____ The ICL7650 sounds like one incredible op amp! Please send me all the product data, fast.

_____ Also, please send me a Henrik Ibsen poster from your "famous quotations" ad series.

Name _____

Company _____

Address _____

City/State/Zip _____

Phone _____

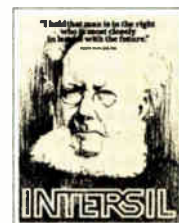

**We have a very simple philosophy about
high performance 16-bit micros.
They shouldn't fail.**



Since 1975, Digital Equipment Corporation has sold more 16-bit micros than any other company.

More than 100,000 of them.

And from the very beginning, our goal has been simple: to build failure-free microcomputer products.

To approach this goal, we use what we believe is the most comprehensive reliability program in the industry. In fact, we've adapted the same program we developed for our minicomputer and mainframe systems.

And it starts while a product is still on the drawing boards.

Reliability as a design goal.

We actually design reliability into Digital's micro products.

The original design team includes engineers from product assurance, diagnostics, product safety and field service. They make sure a micro design is inherently reliable to begin with.

Then before a component is qualified to go into one of our micros, it has to pass evaluations and tests lasting six months or more.

In production, we give every component a complete battery of functional and package tests. As the micro board moves through manufacturing, we test extensively at every important stage.

Even after a product is in the field, we continue to study its performance and failure rates so we can make design and manufacturing improvements.

All this effort has paid off in extremely high MTBFs. And an industry wide reputation for reliability.

The industry's most mature software.

Reliability is just as important for micro software as it is for hardware.

At Digital, we've been refining and enhancing the RT-11 family of development and application software for more than seven years.

RT-11 provides a wealth of high level languages and development aids. Plus you have the flexibility of using RT-11 with a wide range of LSI-11 hardware configurations.

RT-11 family capability ranges from multi-tasking, multiterminal support for larger configurations to a very small kernel for single-task applications. There's also a subset of RT-11 designed specifically for PROM applications. This subset, called SIMRT, is an integral part of FORTRAN IV.

And RT-11 development software is exactly the same as RT-11 target software, so you can debug your programs with complete confidence right on the development system.

The total approach to micros.

Reliable performance is just one of the ways we make micros easier to work with.

We also offer hundreds of hardware products to choose from—micro boards, boxes and development systems. Memory and interface boards. Terminals and printers.

And we back it all with over 13,000 service people worldwide, technical consultation and training, and support agreements that can be tailored exactly to the way you run your business.

It's the total approach to micros, only from Digital.

To learn more just send the coupon for a copy of our free brochure, "The Story Behind LSI-11 Microcomputer Reliability."

For more information, contact: **Digital Equipment Corporation**, MR2-2/M65, One Iron Way, Marlboro, MA 01752. Or call toll-free 800-225-9220. (In MA, HI, AK, and Canada, call 617-467-7000.) In Europe: Digital Equipment Co. Limited, Acre Rd., Reading, RG2 0SU, England. In Canada: Digital Equipment of Canada, Ltd. Or contact your local Hamilton/Avnet distributor.

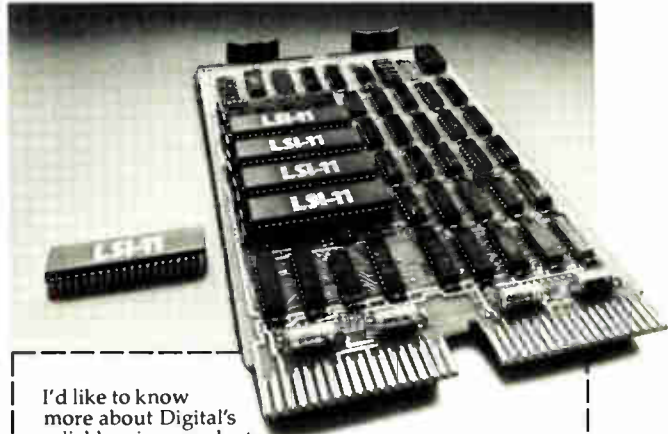

I'd like to know more about Digital's reliable micro products.

- Please send me your brochure, "The Story Behind LSI-11 Microcomputer Reliability."
 Please have a Sales Representative call.

Name _____

Title _____

Company _____

Address _____

City _____ State _____ Zip _____

My application is _____

Send to Digital Equipment Corporation, Microcomputer Products Group, MR2-2/M65, One Iron Way, Marlboro, MA 01752.

DEC-C-149

N-10-9-0

It took the minicomputer company to make micros this easy.

digital

Now RCA offers an interactive data terminal with color graphics for only \$255.*



RCA's new VP-3301,** is a professional quality, ASCII encoded, interactive data terminal, suitable for a wide variety of industrial, educational, business and individual applications requiring interactive communication between computer and user. Connects directly to a computer or to a standard modem for over the phone access to time sharing networks and data bases! Micro-processor intelligence and LSI video control integrated circuits bring performance, features and flexibility at a low price. Operates from 5 volt power supply (included).

Unique color locking circuitry creates sharp, jitter free, true color graphics and rainbow free characters.

Displays the entire field of characters in any of 8 colors against any of 8 background colors (8 gray scales with monochrome monitors).

Individual letters, words, or lines in different colors or in reverse video can be displayed.

The VP-3301 offers a choice of two software-selectable display formats: Either 40 characters by 24 lines. Or 20 characters by 12 lines.

The terminal's resident character set consists of 52 upper and lower case alphabets, 10 numerals, 32 punctuation/math symbols, and 31 control characters. Including: Greek letters and other foreign alphabets,

graphic symbols, large graphics building blocks, playing card suits, and unique character fonts.

The keyboard section features flexible-membrane key switches with contact life rated at greater than five million operations. A finger positioning overlay and positive keypress action give good operator "feel".

An on-board sound generator and speaker provides aural feedback for key presses and may also be activated with escape sequences to provide an audio output.

The sealed keyboard surface, is spill proof and dust proof. This combined with high noise immunity CMOS circuitry makes the VP-3301 ideal for hostile environments.

Output is industry standard asynchronous RS232C or 20 mA current loop with six switch selectable baud rates and 8 selectable data formats.

The terminal can be connected directly to a 525 line color or monochrome monitor. Or to a standard TV set using an RF modulator.

For more information, contact RCA Microcomputer Marketing, New Holland Avenue, Lancaster, PA.

Or call our toll-free number: 800-233-0094.

* OEM Price
** Available Dec. 1980

RCA

International newsletter

2-megabit capacity boosts yield of 1-Mb ROM from Japan

The use of 100% redundancy has increased the yield of a 1-Mb Japanese read-only memory from 1% to more than 20%. The huge 31-by-19.2-mm (1,220-by-756-mil) device, developed by the Musashino Electrical Communication Laboratory of the Nippon Telegraph and Telephone Public Corp., will be used in a portable terminal that employs a 15-by-18-dot thermal head to print Chinese and other characters. Both the terminal and the ROM are made by Oki Electric Industry Co.

The ROM employs a double level of polysilicon and is programmed by the enhancement or depletion ion implantation of individual memory cells. In the memory matrix, 47 memory cells in series each share a source-drain region with an adjacent cell. The resulting device has an equivalent cell area of only $99 \mu\text{m}^2$, dissipates only 420 mW for the entire chip, despite 8- μm design rules, but accesses in 12 μs . That slowness and its large size mean the device will probably be used only in **specialized applications like graphics displays, voice synthesizers, and dictionaries.**

Bell Canada goes to market

Plagued by problems with its regulatory agencies in the Canadian government and faced with strong competition by vendors selling equipment that connects to its lines, Bell Canada, much like its U. S. counterpart, has said that it is going to be an aggressive marketer. It has taken the first steps in that direction by establishing a subsidiary called Bell Communications Systems. **Customers will be able to buy new private-branch exchange and key equipment directly from the subsidiary,** which Bell says will be "totally independent and completely separate" from the parent.

CAD begets filter-detector chip for System X

A huge filter and detection circuit, one of the first examples of the computer-aided design of a telecommunications chip, will decode the Touch-Tone calls entering Britain's System X local exchange when it goes into operation at Woodbridge, Suffolk, later this year. Designed and fabricated by British Telecom, part of the British Post Office, at its Martlesham Research Centre, the silicon-gate MOS device uses 5- μm rules to pack 8,500 transistors into a 25-mm² (38,750-mil²) area. It comes in a 24-pin dual in-line package and runs on a single 5-v supply. The second-order filter incorporates four 16-by-13-bit multipliers and is designed to handle System X's basic 64-b/s channel rate. However, **it is entirely general-purpose, as different multiplier coefficients may be programmed** into the external programmable read-only memory.

Speech generator on a chip utters up to 32 words

Watch for the ITT Semiconductors Group to announce at the Nov. 6-12 Electronica components exhibition in Munich a one-chip speech generator in silicon-gate n-MOS technology. Designated the UAA 1103, the device is mask-programmable for a vocabulary of up to 32 words in different languages, according to Intermetall GmbH, the Freiburg-based lead house of the group. With that vocabulary, it is **suitable for use in telephone-answering equipment, alarm systems,** and other gear to give short announcements and warnings—to car drivers, for example. By combining several complex methods of data reduction and by doing away with redundant circuitry, the Intermetall designers have accommodated 30 kilobits of memory as well as the control, decoding, and digital-to-analog conversion functions on a 31-mm² (48,050-mil²) chip. The device operates off a 5-v supply and consumes about 25 mA. It will be available next year.

International newsletter

Spanish trains to show movies on TV screens

Spain will be the first country to provide video-taped movies on trains. As part of its \$17.5 billion 10-year modernization scheme, the Spanish National Railways (Renfe) has awarded a contract to Jusan SA, an affiliate of Rediffusion International Ltd., to install the video system on 1,000 coaches over a 5-to-10-year period. Jusan president Samuel Toledano estimates that it will cost \$20,000 to equip each coach with **eight 16-in. color TV monitors suspended along the length of the aisle, plus a coupler for headphones in each armrest.** The image and sound source is a video cassette system plus audio amplifier. One prototype is now undergoing tests.

LSI slashes cost of adapting VCR to record hi-fi music

An adapter for recording extremely high-fidelity music in the video channel of standard consumer video cassette recorders will shortly be selling for about a third of its present \$3,400 price in Japan. Hitachi Ltd. and Victor Co. of Japan cooperated on the design of a set of **five large-scale integrated circuits for pulse-code-modulation audio-signal processing,** and Hitachi has produced them. The complementary-MOS devices help cram the adapter onto a board about a fifth the previous size because they replace 500 to 600 small- and medium-scale ICs.

The PCM audio format standardized in Japan for video tape recording requires all this logic to compensate for the signal dropout experienced with VCRs. The technique has not been available to consumers before because it works only with a bandwidth as large as the video one.

Flat-screen TV proves economical to manufacture

Clive Sinclair's flat screen TV has moved a stage nearer to mass production following the successful demonstration in a pilot production line of the low-cost techniques involved in the manufacture of the miniature sardine-can-shaped cathode-ray tube [*Electronics*, July 19, 1979, p. 67]. But Sinclair's contract research company—Sinclair Research Ltd., Cambridge—has no plans to go it alone and will **likely seek a licensee to mass-produce it.** The U. S. watch manufacturer Timex Corp. is reportedly interested. The tube could form the basis of a paper-back-sized radio-TV combination with a 3-in.-diagonal black and white screen selling for approximately \$200.

Addenda

Perhaps to enhance Japan's position in the impending talks with the U. S. on liberalizing Nippon Telegraph and Telephone Public Corp.'s procurement policies, NTT **has announced plans to buy at least 40 IBM 5280 data entry units.** Eventually it may buy up to 450 of the units, which will be imported through IBM Japan Ltd. . . . The French government is planning to enlarge its components plan, **the five-year, \$180 million project designed to endow the country with a first-class integrated circuits industry.** An interministerial committee is deciding whether to add others to the five companies already involved or to boost government aid to those five. . . . **The first commercial satellite to move to the 14-GHZ band** from the crowded 6-GHZ one is the Canadian dual-bank Anik-B, which has just begun relaying TV programs to Quebec. . . . **By adding still-picture and slow- and fast-motion modes,** West Germany's Fürth-based Grundig AG has upgraded its version of the Video 2000 eight-hour video cassette recorder it developed with Philips. The Video 2×4 Plus, as it is called, will cost about \$85 more than the earlier Video 2×4.

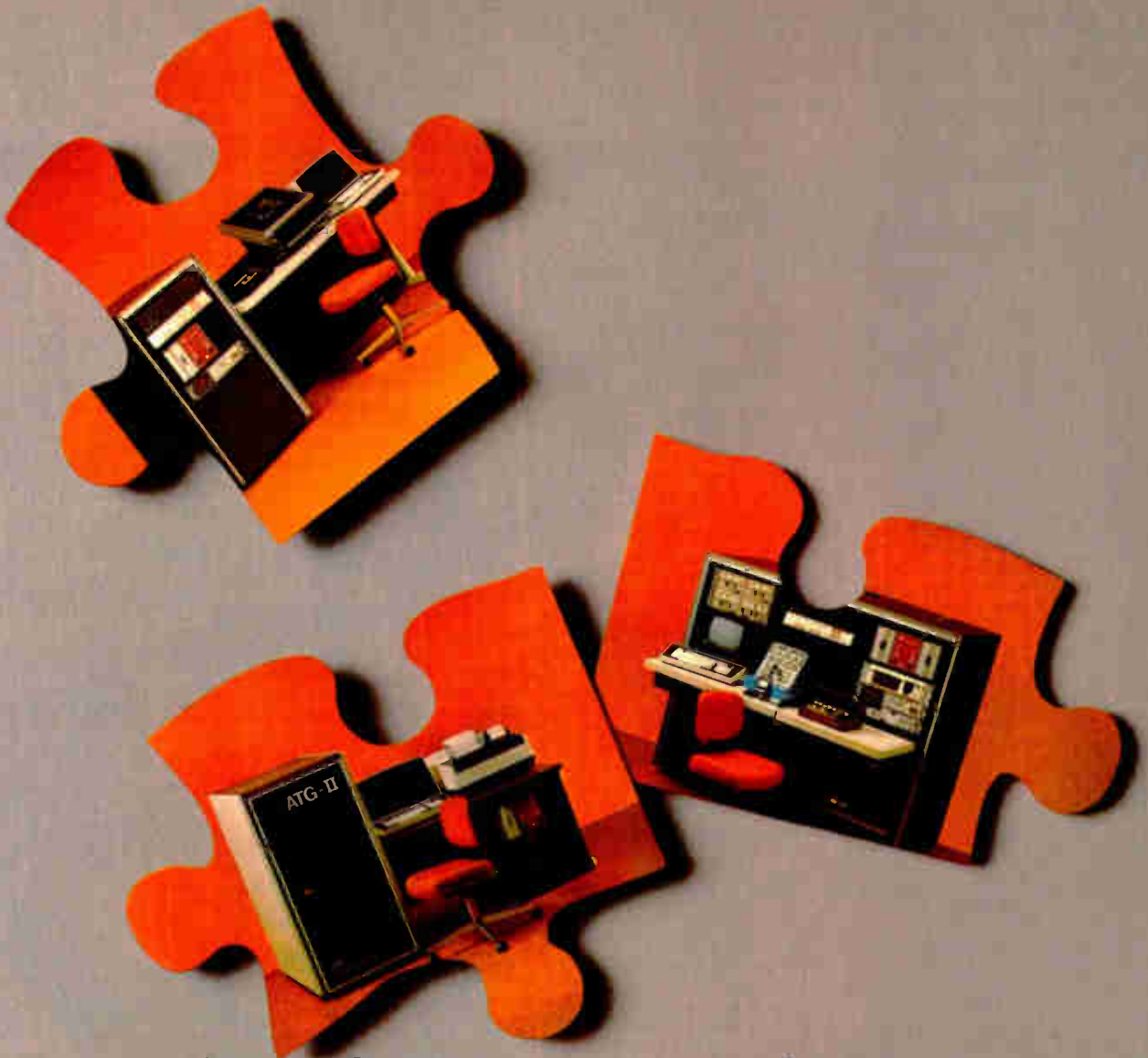

ONLY ONE OF THE LEADING TEST EQUIPMENT MANUFACTURERS HAS THE TOTAL SOLUTION TO THE ATE PUZZLE.

Until now, buying automatic test equipment was a puzzle. You had to work with whatever pieces were available. But who has time for hit-or-miss problem solving? And who has unlimited resources?

ComputerAutomation's 4000 Series of CAPABLE testers is a totally integrated, interlocking solution to the ATE puzzle. Truly modular in design, a CAPABLE tester meets your need now. And later, CAPABLE makes test equipment affordable today so that you can relax, knowing you won't have to buy a whole new tester every time your product changes.

For example, a basic system can be reconfigured to include higher pin capacities and new logic families. Hybrid boards? Add the analog option. Memory

Pattern Generation (MPG) with easily programmed, hardware algorithms is available as an add-on for highly repetitive functions like memory testing.

All configurations allow you to add emulation, the most powerful technique for speeding up manual program generation using ComputerAutomation's Integrated Circuit Description Language (ICDL). Want to eliminate manual program generation entirely? Try Automatic Test Generation (ATG-II) with its automatic fault analysis.

And the CAPABLE Real-Time is the best piece of all to complete the puzzle

for all those devices you can't touch with a static tester: microprocessors and their interface chips, dynamic/static memories, UART's, shift registers — all types of LSI and VLSI devices.

No other ATE company is pushing technology for your productivity and flexibility like ComputerAutomation. But then, ComputerAutomation is the only ATE company that's CAPABLE of solving the ATE puzzle.

Contact ComputerAutomation, Industrial Products Division, 2181 Dupont Drive, Irvine, California 92713, (714) 833-8830 Ext. 522.



ComputerAutomation Industrial Products Division
For productivity...today and tomorrow.

U.S. regional offices in Santa Clara, CA (408) 727-6900, Bensenville, IL (312) 860-1830, Bloomfield, NJ (201) 338-8870. District Offices in Newport Beach, CA, Boston, MA, Raleigh, NC, Dayton, OH, Dallas, TX. In Europe: CAI Ltd., Rickmansworth, Herts., England 011-44-9237-71211. Offices in Frankfurt, Germany and Rue Fourny, France.

 ComputerAutomation and CAPABLE are trademarks of Computer Automation, Inc.

Circle 67 on reader service card

FAIRCHILD

A Schlumberger Company

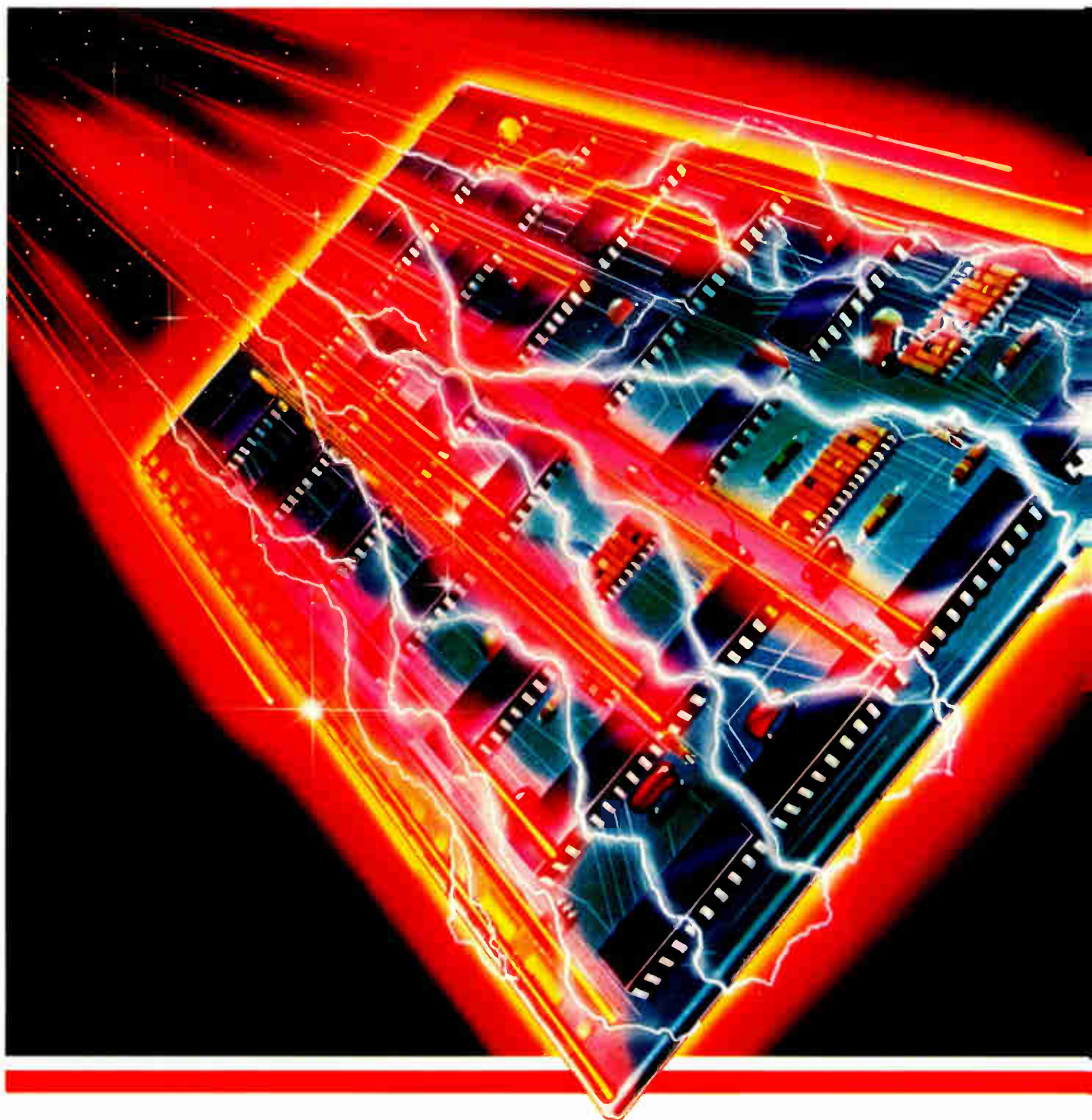

We have the fastest circuits

Our latches, flip-flops and counters are unsurpassed for speed and low-power requirements.

Fairchild's new FAST devices are fast being designed into more and more logic systems. That's because they clock in with the fastest times and some of the lowest power requirements in TTL history.

Our speedy specs.

LATCHES

74F373 and 74F533
(inverted output version)
3-state transparent octal latches

Setup time 2 ns min
Hold time 3 ns min
Enable/disable time 11 ns
Data-to-output propagation delay . . 74F533—9 ns max
74F373—6.5 ns max
I_{CC} . . 74F533—61mA max
74F373—55mA max

FLIP-FLOPS

74F374 and 74F534
(inverted output version)
3-state octal D-type flip-flops with common Clock and Output Enable Toggle

frequency . . . 110 MHz typ
Setup time 2 ns min
Hold time 2 ns min
Clock-to-output propagation delay . . . 9 ns max
Enable time . . . 10 ns max
I_{CC} 86 mA max

Both our 3-state latches and flip-flops contain a patented output structure for easier bus interface and design.

COUNTERS

74F190 Series high-speed up/down counters

Count frequency . . . 130 MHz typ
I_{CC} 38 mA typ
Clock-to-output delays 5 ns typ
Clock-to-terminal count delays 5 ns typ

This series of counters offers virtually twice the count frequency and less than one-third the power requirements of their Schottky counterparts.

All of this FAST talk adds up to just one thing. If you want a faster, more efficient

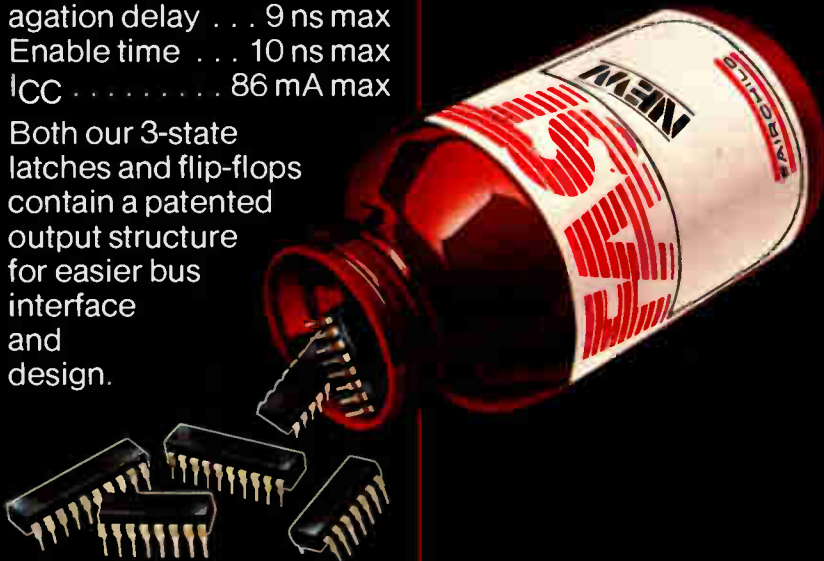

system, call your local Fairchild sales office, representative or distributor. Or write to FAST, Fairchild Semiconductor Products Group, P.O. Box 880A, Mountain View, California 94042. Telephone: (415) 962-FAST. TWX: 910-379-6435.

Fairchild Camera and Instrument Corp.

across the board.

Graphics on the powerful computers: a fast way

Today's complex computation and design tasks call for some very sophisticated graphics tools to help you peer into the heart of a problem. At HP, we build most of these capabilities right into our 9800 Series desktop units.

For example, our top-of-the-line 9800 Series System 45C includes a greatly enriched graphics language that lets you manipu-

late 4,913 shades of color with remarkable ease. A light pen and high-performance digitizer give you flexible options for entering data. And 3-D rotations allow you to view objects on the CRT from any desired angle.

For monochromatic applications, the Systems 45B and 35, as well as our new, low-cost

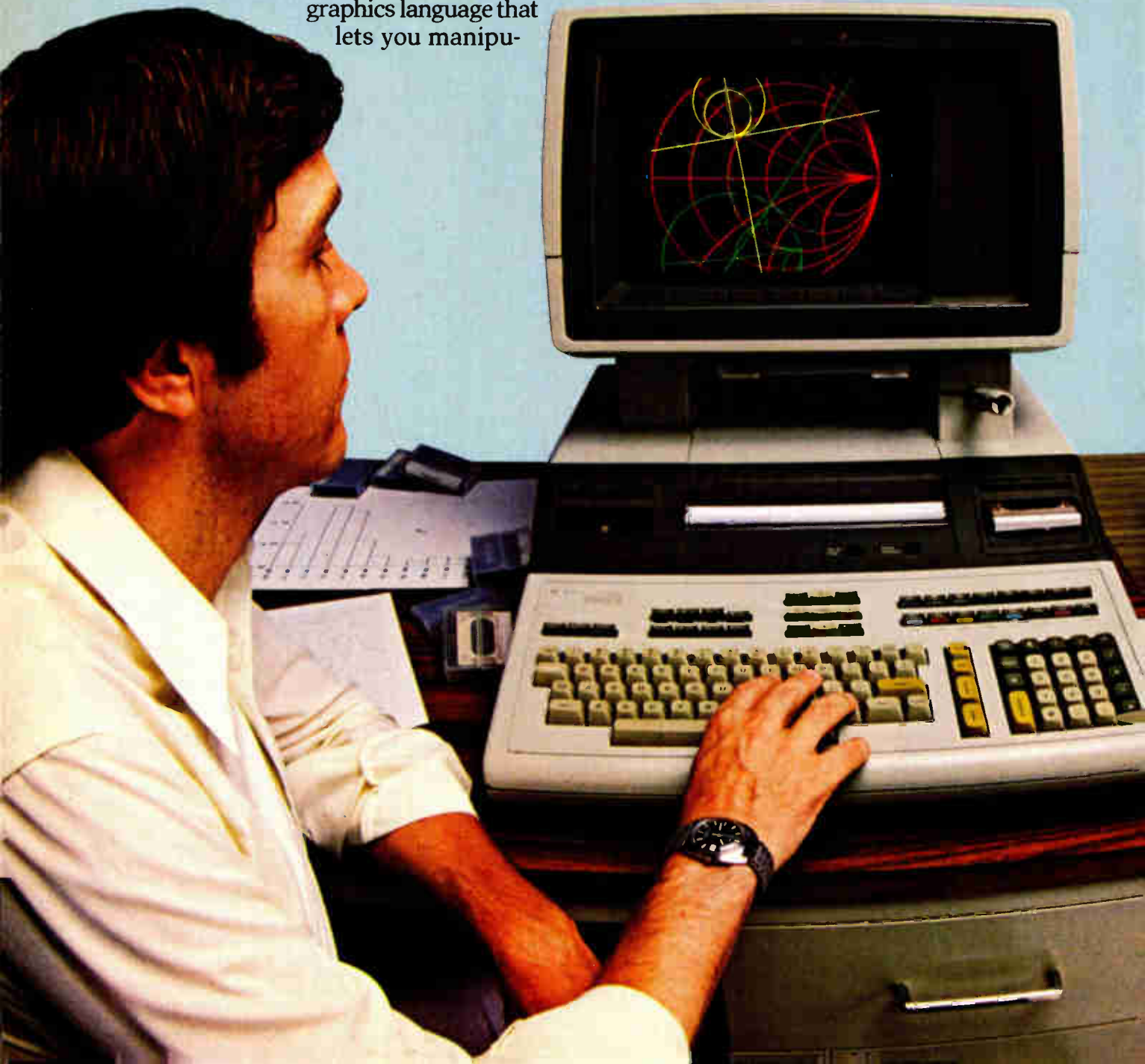

HP Series 9800 desktop to focus on the facts.

HP 85, also provide advanced graphics software. And when you add an input peripheral and our four-color plotter, you've got a full-function graphics workstation — a completely integrated computing system that operates under your own personal control.

Power you can get your hands on.

To compliment graphics capability a powerful data base management package on the disc-based System 45 models, you can store, retrieve, sort, modify and analyze large amounts of technical data — quickly and efficiently. User-addressable memories to 449K bytes give you plenty of room for complex manipulations. And hooking up to measuring instruments is a simple matter of choosing from among four protocols available: HP-IB, Bit-Parallel, BCD or RS-232-C.

As friendly as ever.

Even with major increases in power and graphics capabilities, HP desktop computers retain the easy-to-use features that have always been their hallmark. These include simplified programming in our HP Enhanced BASIC language (or optional assembly language on some models); built-in operating systems that let you start solving problems as soon as you turn the computer on; and reliable, low-maintenance operation.

Plenty of room for growth.

If your applications require a larger data base, you can link your desktop computer to our powerful HP 1000 or HP 3000 minicomputer systems (and to non-HP computers as well). Communication is easily managed — both async and bisync protocols are available — and, by combining the relative strengths of desktops and minis, you get a remarkable degree of flexibility for processing scientific, engineering, and managerial information.

If you'd like to find out more about how HP Series 9800 desktop computers can help improve your engineering productivity, just contact your local HP sales office listed in the White Pages. Or write for more information to Hewlett-Packard, Attn: Pete Hamilton, Dept. 685, 3404 East Harmony Road, Fort Collins, CO 80525.





Minicomputers

Microcomputer modules

Single-chip microcomputer

*Evolutionary computing power
from Texas Instruments continues with
a major milestone in 16-bit technology...*

TMS9940

16-bit single-chip microcomputer.

World's first. Here. Now. Available.

With the TMS9940, Texas Instruments significantly advances its 16-bit leadership.

With the TMS9940, Texas Instruments expands on what is already by far the industry's most complete 16-bit family. The 9900 Family of microprocessors, microcomputers, peripherals, microcomputer modules and software and hardware development systems, offers a unique software compatibility. So you can move from one product level to another, confidently, protecting your development system and software investment with no need for translators, code converters, etc.

TI's 9900 Family is the *only* family that maintains architectural and software compatibility from single-chips to multi-chips to modules to systems — all the way to the object code level.

With the TMS9940, Texas Instruments brings you high-volume, cost-effective solutions to tough system design problems, combining the computing power of a multi-chip 16-bit system with the reliability and compactness of a single-chip solution.

With its high-speed processing, bit I/O, and advanced memory-to-memory architecture, the TMS9940 offers computation power unequalled by any other single-chip product on the market, while retaining the programming ease of 16-bits.

High-speed number crunching and bit I/O

Powerful instructions — like BCD add, BCD subtract, 16-bit multiply with 32-bit results, and compatible divide — provide a number-crunching capability unsurpassed by any single-chip product.

Thirty-two on-chip, flexible, individually configurable input/output bits are addressable for manipulation by powerful bit I/O instructions.

I/O expansion modes permit up to 256 bits of external I/O to be added, allowing easy interface to 9900 Family peripherals and most industry peripherals.

Advanced memory-to-memory architecture

Advanced memory-to-memory architecture makes the TMS9940 ideal for interrupt-driven and extensive I/O applications.

This innovative architecture features multiple register files that provide ease of programming and unsurpassed interrupt response time.

The TMS9940 memory consists of 128 bytes of RAM and 2048 bytes of ROM. Other features include 4 levels of interrupts, plus an internal decremter which can be programmed as a timer or event counter.

TMS9940 — Key Features

- 16-bit instruction word
- Instruction set includes 16-bit multiply and divide, BCD add and BCD subtract
- 128 bytes of RAM on chip
- 2048 bytes of ROM (or EPROM) on chip
- 64 general-purpose 16-bit registers
- Program execution from RAM or ROM
- 4 prioritized interrupts
- On-chip timer/event counter
- 32-bits integral general-purpose I/O bits — expandable to 256 external I/O bits
- 4 MHz crystal operation — up to 117,000 interrupts per second
- 5-volt MOS technology
- Offered in a 40-pin, 600-mil DIP

Here-and-now availability

Perhaps just as important as the unmatched capacity for design flexibility, the 9900 Family is here-and-now and readily available. It's the lowest cost 16-bit CPU family. And proven where it counts most. In the marketplace. The choice of hundreds of companies for a wide range of systems and end products.

Microcomputers mean high volume and TI has unequalled production capacity and experience. In fact, TI is the

largest supplier of single-chip microcomputers and has shipped more than the next two suppliers — combined.

9900 Family development tools

Reliable, available, economical development systems designed to boost programmer efficiency and cut costs.

The AMPL* prototyping lab: A complete set of the software and hardware development tools for the TMS9940 as well as for other 9900 Family CPUs. The AMPL system provides a real-time TMS9940 emulator and a logic-analyzer function to solve complex programming and hardware debug problems.

TMS9940E: This EPROM version of the TMS9940 is the ultimate prototyping tool, allowing in-field system check-out, reducing turnaround time and expense for code revisions.

Leadership staying power

TI has paced the industry through generations of semiconductor innovation, pioneering the lion's share of major milestones.

The 9900 Family is an important part of that leadership tradition. The 9900 Family is a fact. A production-proven, available, deliverable fact.

The continuing introduction of new, advanced 9900 Family CPUs, with TI's state-of-the-art technology and proven production resources, demonstrates TI's total commitment to 16-bit leadership.

That's why you can design with the TMS9940, confident in a family that's a reality today. Confident that the family will grow with your needs to keep your systems competitive at the leading edge of tomorrow's technology.

For more information about the TMS9940, or any other 9900 Family member, contact the TI field sales office nearest you. For details and specifications, write to Texas Instruments Incorporated, P. O. Box 1443, M/S 6404, Houston, Texas 77001.



TEXAS INSTRUMENTS
INCORPORATED

Now you can get high performance colors in low cost sticks.

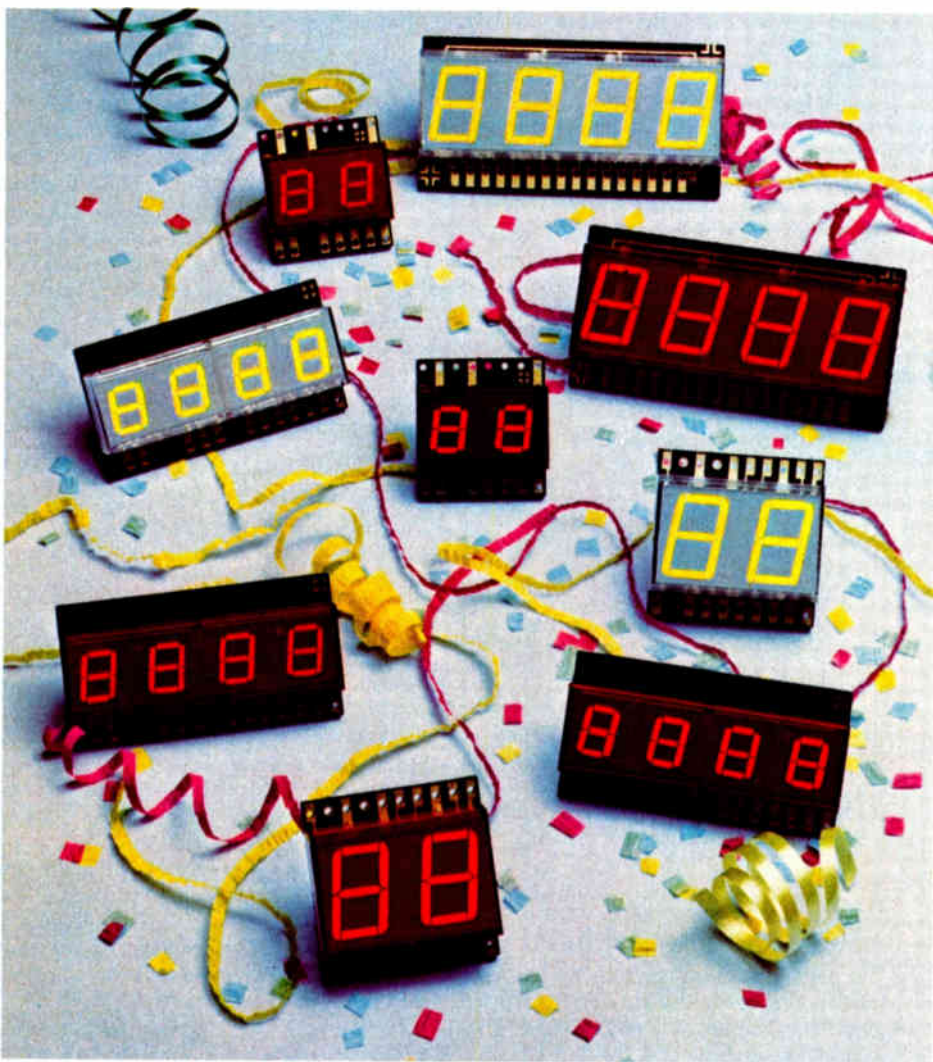

There's good reason to celebrate.

For the first time you can get low-cost, high-quality display sticks in four high performance LED colors: green, yellow, orange and high-efficiency red. Use them to upgrade your read-out. Or differentiate products in your line or your product from the competition.

General Instrument performance sticks have other advantages. You can use lower current drive circuits, for example, and still get a bright display. Each digit is pre-matched for brightness. That eliminates a step in your production. And since they are designed to meet automotive standards, they offer a degree of quality that can reduce rework and replacement costs.

And they're end-stackable so you can make a display as long as you need.

Want a custom stick? Tell us your quantity and ideas and we'll go to work.

For more information write to General Instrument, Dept. MCD-3, 3400 Hillview Ave., Palo Alto, CA 94304.

**The light
heavyweight**

GENERAL INSTRUMENT

The power is with a new 16-bit SOS microprocessor

by Charles Cohen, Tokyo bureau manager

Silicon-on-sapphire technology, hardware functions, two internal buses, enhance throughput

Mixed calculations done with three to six times the speed of Intel's 8086 or Zilog's Z8000—that's Toshiba Corp.'s claim for its new 16-bit T88000 microprocessor. The use of silicon-on-sapphire technology, which reduces the average propagation time of a gate to a mere 0.7 nanosecond, contributes to some of that computing power, and a multiplicity of hardware features supplies the rest.

Two internal parallel 16-bit buses

roughly double the processing speed possible with a single bus. The 32-bit input/output bus can be used in both time- and space-multiplexed fashion to increase throughput. Furthermore, an 8-bit buffer can store instructions prefetched from main memory—a desirable feature because it makes pipeline execution possible.

Moreover, instruction execution speed is enhanced by performing many functions not in software but in hardware, including floating-point and decimal processing. The chip features a hardware 16-by-16-bit multiplier that can perform fixed-point multiplications in 1.6 microseconds, or four machine cycles. The built-in barrel shifter provides 1-to-

15-bit shifts in only one machine cycle, or 400 ns.

Moreover, because most of the 151 user instructions are completed in one machine cycle, the processor can also perform conditional branches in as little as one machine cycle, although some take up to four machine cycles.

Lots of software. Unlike many recently introduced microprocessors, the Toshiba device has available a large library of software, because it is compatible with the company's series 7 minicomputers. But its application capabilities go much further than the series 7's, and it will be used in a wide spectrum of other applications, including small-business computers and equipment, ter-

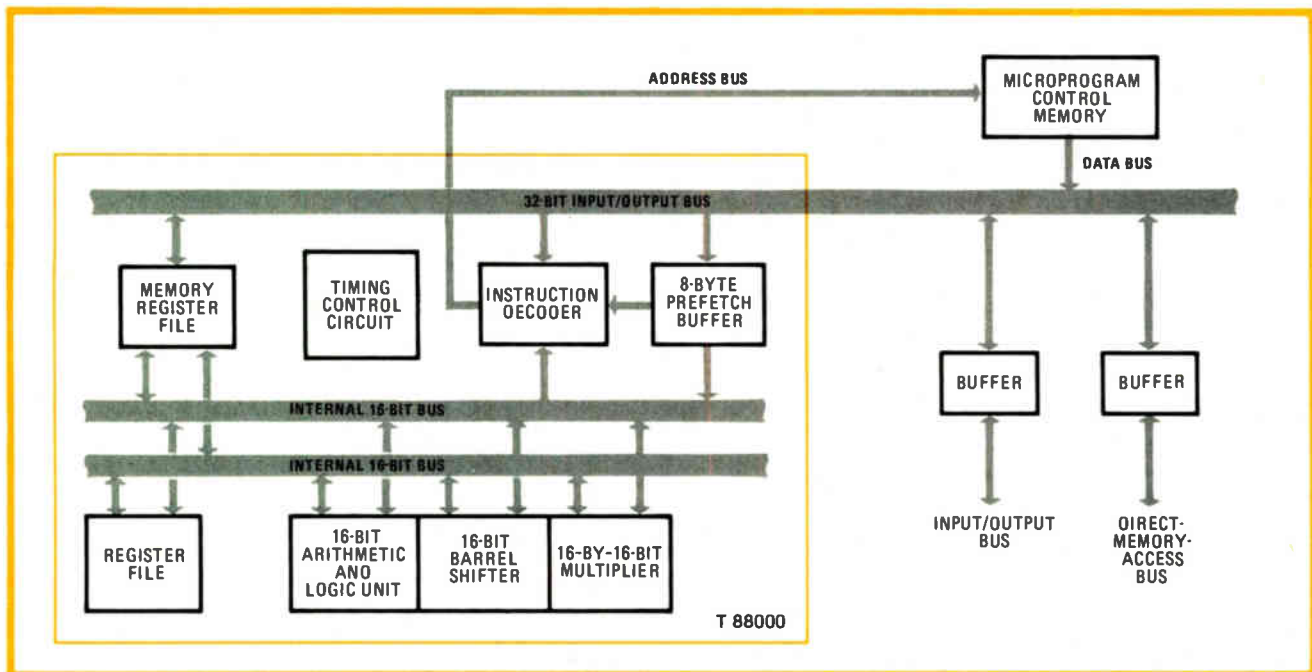

Master of many trades. Toshiba's 16-bit microprocessor owes much of its computing power to hardware features like two internal buses and a 16-by-16-bit multiplier. It is also versatile: different microprograms stored in its external ROM readily adapt it to different applications.

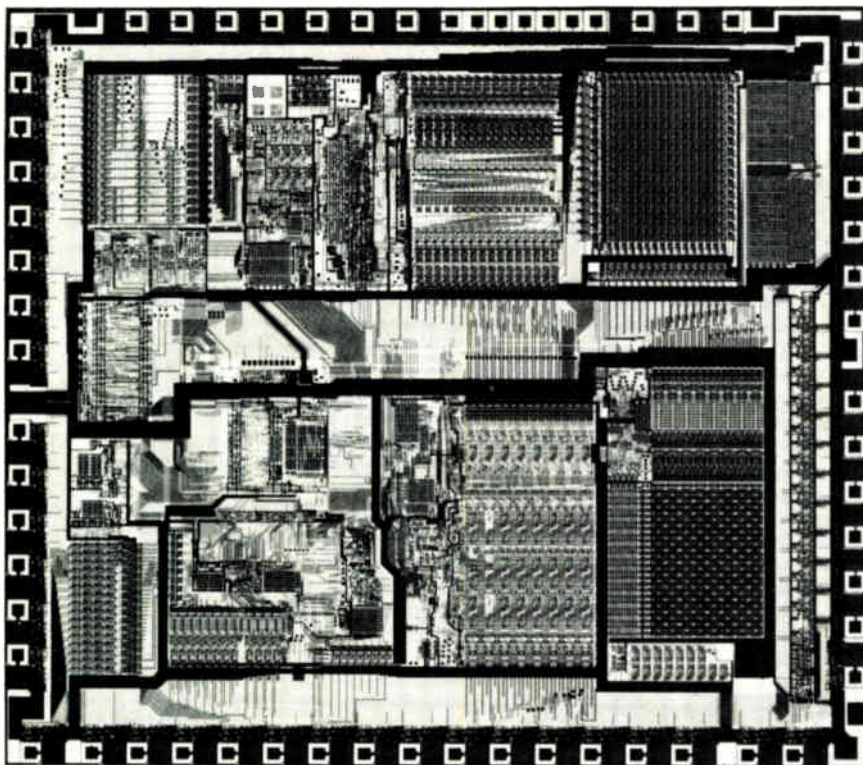

Not speed alone. Silicon-on-sapphire technology makes the T88000 easier to fabricate: 3.5- μm rules are adequate, and fewer masks are used than for bulk-silicon devices.

minals and other peripheral equipment, and industrial applications such as single-board computers.

Toshiba expects to be able to optimize the same chip for all these different applications because the T88000 is designed for microprogrammed instruction control—the microprogram resides in 80-K of standard external read-only memory. Prototype systems use six chips of 16-K capacity, but production systems will be supplied with three 32-K devices.

C-MOS and n-MOS. The new microprocessor has about 12,000 gates, almost equally divided among n-channel MOS gates, where speed or density is required, and complementary-MOS gates elsewhere. The high speed of the SOS process made it possible to design this device with 3.5-micrometer lithography rules and fabricate it using conventional unity-magnification full-wafer projection equipment.

For the same speed, a similar device on bulk silicon would need less-than-2- μm rules and be much more difficult to fabricate. It would

require higher-precision lithography than the Toshiba device and more masks, because the SOS design requires neither channel stoppers nor p wells. Worse yet, the bulk device would probably eat up something like 3 watts rather than the 700 milliwatts of the SOS device.

The device is fabricated in a 0.6- μm -thick epitaxial layer on the sapphire substrate. To stop leakage current in the interface region, the epitaxial layer has been given a deep implantation. To achieve a higher breakdown voltage, the surplus silicon between transistors is converted into silicon dioxide.

The n-MOS transistors are given four different threshold voltages by receiving two different ion implantations, one or other of the implantations, or neither of them. Silicon gates are used, but interconnection resistance is not the problem it is in memories because long connections are made in the aluminum level of interconnection. There is also a diffusion interconnection level and a polysilicon-gate one, making three levels in all.

France

Gallium arsenide to yield 5-GHz divider

Researchers at the main Philips group laboratory in France believe they have got what may well be the fastest frequency divider around. The gallium arsenide device developed by a team at the Laboratoires d'Electronique et de Physique Appliquée in the Paris suburb of Limeil-Brevannes should prove capable of performing binary frequency division from dc up to more than 5 gigahertz. What's more, the LEP researchers have placed a clock generator and complementary clock generator on the same chip—which means that the only input needed is the frequency to be divided.

"For the moment, we have not optimized the two elements [the logic and the clock], so that the entire chip now functions at a maximum frequency of 3.5 GHz," explains Jean-Paul Hurault, scientific director for the LEP's solid-state physics department. "But we are confident we will be able to optimize the circuit up to 5 GHz."

The basic logic gate in the frequency divider differs little from the buffered field-effect-transistor logic gates developed elsewhere, notably by Hewlett-Packard (see circuit diagram). What makes the LEP version special is the fact that it has been done in planar self-aligned technology with a standard photolithographic process. The active layer is made by implanting selenium ions directly into a gallium arsenide substrate. There is no need for a buffer layer.

"Typical design rules are gate width of 1 micron, with 3 microns between source and drain," says Marc Rocchi, an engineer on the design team. Using the GaAs techniques it has devised, the lab has managed to get actual gate width down to 0.6 micrometer with 1.9 μm source-drain spacing.

The buffered-FET gate, sometimes known as a multiplexing gate, has four inputs (ABCD in the circuit

Why do both Hurco and Web Printing Controls count on Electro-Craft?

<p>PRECISION, THAT'S WHY.</p>	<p>precisely matched to your needs. A range that often delivers the unexpected. Like our new 30 motors with continuous torque ratings of 55 lb-in. They can routinely</p>	<p>upon applications as varied as Hurco and Web and couple it with unmatched expertise. The result is precision products matched precisely to your applications. It's a combination that works for leaders like</p>
<p>One is a CNC machine tool leader. The other, a small, successful manufacturer of printing controls. What they have in common is precision. They design it into their products. They count on it from Electro-Craft.</p>	<p>precisely matched to your needs. A range that often delivers the unexpected. Like our new 30 motors with continuous torque ratings of 55 lb-in. They can routinely</p>	<p>Hurco, with all of their resources, and for smaller manufacturers who need both the products and the people. That's why both Hurco and Web count on Electro-Craft.</p>
<p>THEY BOTH COUNT ON ELECTRO-CRAFT SERVOMOTORS AND MOTOR-TACHS.</p>	<p>precisely matched to your needs. A range that often delivers the unexpected. Like our new 30 motors with continuous torque ratings of 55 lb-in. They can routinely</p>	<p>Large or small or in between, you can count on Electro-Craft. Count on us for servomotors and motor-tachs, for over one million dollars of standard inventory ready for shipment or for our full line</p>
<p>Hurco equips their high-accuracy CNC machining centers and Autobend® metal fabrication equipment—industry standards—with the power and precise feedback of our motor-tachs. Web uses them to provide their alignment control systems with unheard-of accuracy... a new industry standard. Both use our motor-tachs because they can count on Electro-Craft precision.</p>	<p>provide higher peak output than their continuous rating. And, that's the kind of performance manufacturers like Hurco need when their mills are operating at peak throughput.</p>	<p>of Motomatic Speed Control Systems, Amplifiers, Digital Positioning Systems and Optical Encoders. For complete information, call our Standard Product Sales Department toll free, 800-328-3983 or circle our number on the reader service card in this publication.</p>
<p>Electro-Craft servomotors and motor-tachs are industry standards, too. According to an independent survey, Electro-Craft servomotors and motor-tachs are preferred over all others.</p>	<p>IT'S MORE THAN JUST PRODUCT PERFORMANCE.</p>	<p>Count on us.</p>
<p>No one can provide a broader selection. Iron core, moving coil or brushless—in a broad range of torque, speed and horsepower. A range that assures precision drives</p>	<p>Product performance starts with people. People with the experience, expertise and willingness to provide you with solutions. That's the kind of people who stand behind Electro-Craft products. They draw</p>	<p>ECC ELECTRO-CRAFT CORPORATION 1600 Second Street So., Hopkins, MN 55343</p>

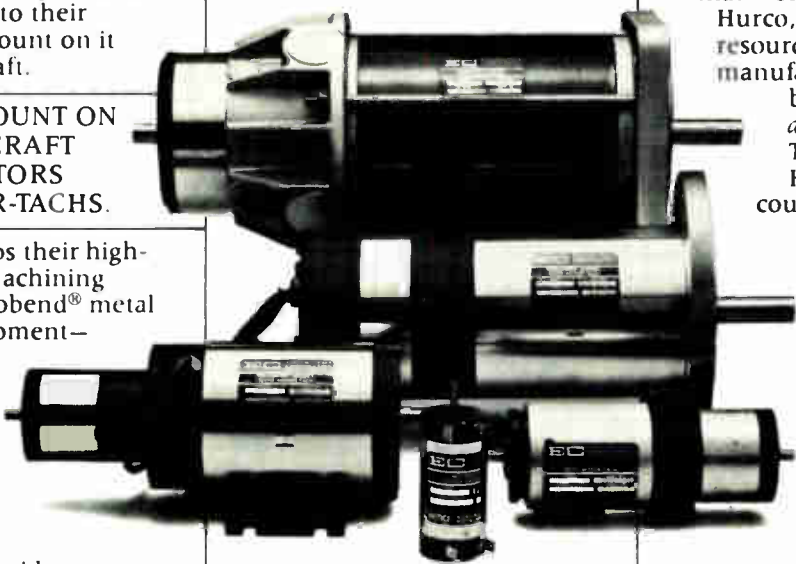

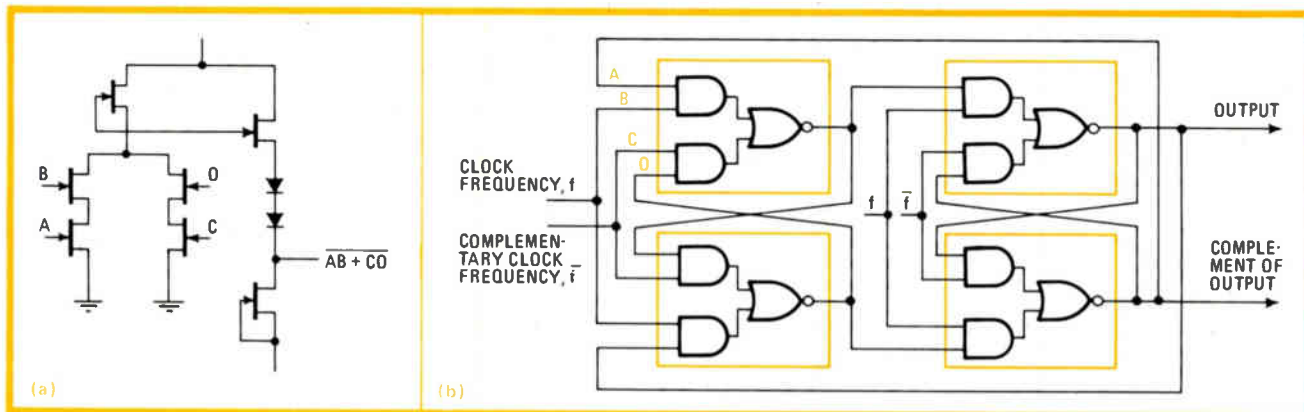

All together now. Basic to a frequency divider capable of handling up to 5 GHz is a buffered FET gate shown in the circuit diagram (a). Four of them, linked as shown in the logic diagram (b), fit on one gallium arsenide chip together with a clock.

diagram), and four of the gates are arranged in a gated master-slave flip-flop configuration (see logic diagram). The clock frequency is the frequency to be divided and is the input to the pair of AND gates in the master. The complementary clock frequency (\bar{f} in the diagram) controls the slave. The AND gate controlled by the complementary clock frequency (\bar{f}) in the master ensures a correct counting sequence when the clock frequency switches from high to low.

The pair of AND gates controlled by the clock frequency in the slave fulfills the same function for the complementary clock frequency. The typical logic-gate propagation time is less than or equal to 100 picoseconds. And the power consumption is

40 milliwatts per gate, for a total consumption of 160 mW.

"We believe we could reduce dissipation to 5 mW per gate," says Rocchi, "but we would of course lose some speed." The LEP researchers feel they could build a frequency divider that would operate at 3 GHz with a total power consumption of 20 mW. "The technology is fine for medium-scale integration," comments Hurault. "But it is not good enough for very large-scale integration, because the consumption is simply too high." That explains why the LEP researchers are now turning toward a nonplanar technology—specifically, recessed Schottky gates. In fact, their first circuit using recessed gates will be a frequency divider.

-Kenneth Dreyfack

enough for 16 speech channels.

The new modem incorporates an adaptive line equalizer that can compensate for poor-quality lines and prevent intersymbol interference. The technique is powerful: Plessey Digital and Network Systems Ltd. employs it in its new 16-kb/s modem for use on four-wire leased lines. But for two-wire operation and to cope with worst line conditions, adaptive echo cancelation is also necessary.

Answering echoes. In two-line operation, a hybrid transformer in the modem separates the transmitting and receiving paths, and discontinuities and mismatches between the transformer and the line cause talker echoes that can swamp the incoming signal. One solution is half-duplex operation, in which each end talks in turn, but that halves the data rate. The post office therefore employs an echo canceler network (see figure). The net's output models the echo response of the two-wire connection and, when subtracted from the line signal, removes the echo.

Precision digital signal processing is needed to achieve the 60-decibel echo suppression required. Conventionally enough, British Telecom employs a transversal filter that, to avoid aliasing distortion, has a sampling rate double the highest frequency present in the signal spectrum. Less conventionally, it implements the circuit in custom LSI. To cut chip complexity, the filter sampling clock is locked to the transmit clock and is a simple multiple of it. As a result, the amount of signal

Great Britain

Adaptive echo canceler helps modem run at 9,600 b/s on noisy phone lines

Envisioning a future abuzz with packet switching, digital facsimile, slow-scan television, and other digital services, British Telecom, part of the British Post Office, wants to be able to transmit data at high speeds anywhere over the public telephone network. To this end, its Martlesham Research Centre is developing a 9,600-bit-per-second modem that will double the data rate at present available and use large-scale integration to keep its cost low.

In terms of the two-wire 3-kilohertz standard phone connection, 9,600 b/s is a high speed, attained only by the use of advanced signal-processing techniques like adaptive echo canceling, say the center's engineers. In contrast, they note, commercially available modems with the same transmission rate require high-grade four-wire leased circuits, while those operating at 48 and 56 kilobits per second take up an entire group-band circuit from 60 to 108 kHz—

High Speed Connector Assembly Machines

NEW CONCEPTS FOR AUTOMATION

Eliminate costly labor and increase production.

Dependable, all mechanical, cam-operated, machines; tooled to assemble your products.

Automatic and semi-automatic designs available.

Submit drawings and samples for our recommendations.

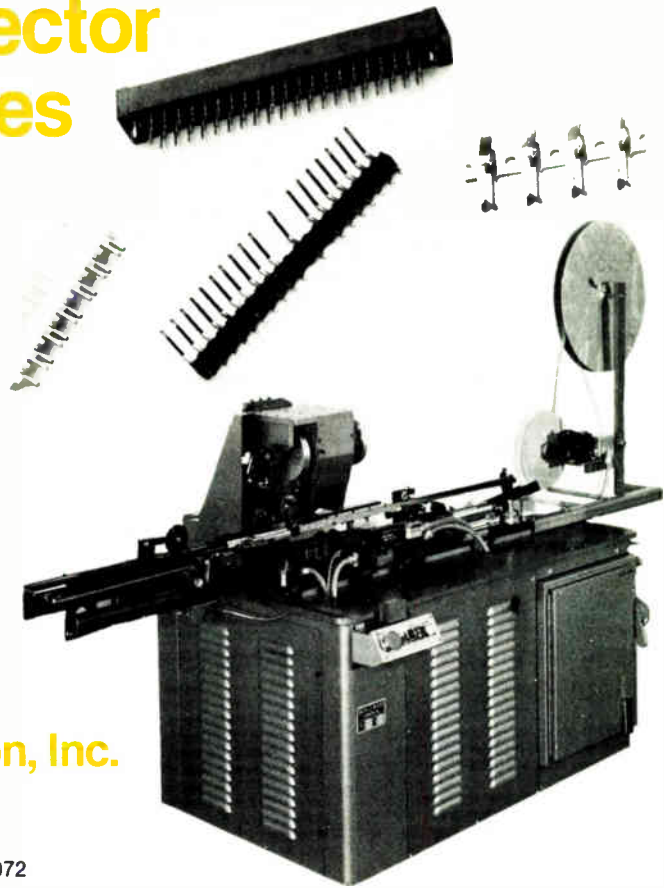

MID-WEST Automation, Inc.

SPECIAL MACHINES AND ASSEMBLY EQUIPMENT
350 HOLBROOK DRIVE
WHEELING, ILLINOIS 60090 U.S.A.
(312) 541-3570 • TELEX NO. TWX 910-651-0072

Circle 79 on reader service card

Robert Bosch announces a new Mini-Giant built to help resist moisture, dust and galloping inflation

Here's a new 30-amp, 12 VDC plug-in relay engineered to do the job better than ever. Yet it's available at or below our 1979 price. The secret is in the housing of rigid polyamide plastic.

Robert Bosch engineers chose this tough, impact-resistant plastic to replace traditional galvanized steel as the housing material. That helps explain the savings—in production costs for us, purchase price for you.

The relay is protected by a seamless housing. Neither moisture nor dust can easily penetrate. The bottom of the unit is vented with a single hole to avoid heat buildup. But for extra heavy-duty, outdoor applications, even this vent can be closed with a Teflon plug that filters out foreign matter while allowing air to circulate.

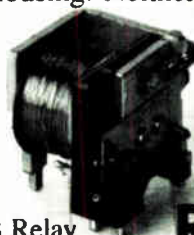

PCB Relay
0.56 cu. in.

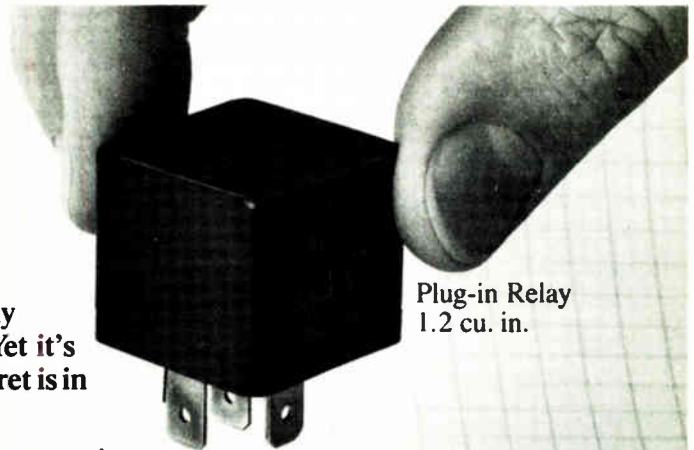

Plug-in Relay
1.2 cu. in.

For free specifications on the full line of Mini-Giant relays, both plug-in and PCB, write:

Robert Bosch Corporation
Dept. O/PGE 4
2800 So. 25th Avenue
Broadview, IL 60153
or phone Dave Robson,
(312) 865-5459

ROBERT BOSCH

©1980 Robert Bosch Corporation

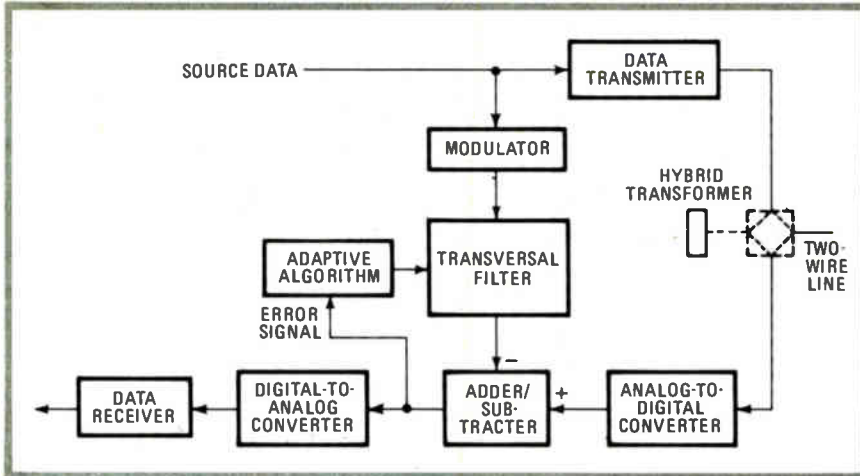

Canceled. British Telecom's modem uses a hybrid transformer to split incoming from outgoing data. Echoes that result are copied by this circuit and subtracted from the signal.

processing may be considerably reduced by driving the canceler directly from the source data.

For use on the switching phone network, the canceler must be adaptive, and an algorithm has been developed for this purpose. The circuit can cancel echoes having up to a 20-millisecond delay.

Custom LSI appears throughout the modem. It uses the Martlesham center's 5-volt silicon-gate n-channel MOS process with 6-micrometer de-

sign rules. Samples of the first chip have already been received, and delivery of all seven LSI circuits plus two shift registers is targeted for the end of 1981.

Good grades. Trials have already been carried out on the phone network with a prototype system using two- and four-wire connections. They were almost entirely successful. In only 3 of the 133 line tests were there residual uncanceled echoes, and these, believes British Tele-

Around the world

VHS video cassette system wins another convert

Victor Company of Japan says that its VHS video cassette recorders have been officially adopted by Standard Elektrik Lorenz and will be supplied the West German firm on a private-label basis. Other non-Japanese firms that have private-label or technical assistance agreements with Victor include Saba-Werke GmbH, Norddeutsche Mende Rundfunk AG, and Telefunken Fernseh und Rundfunk GmbH in West Germany; Thomson-Brandt in France; Thorn Consumer Electronics Ltd. in the UK; Rank Industries Australia Pty in Australia; and Grupo Industrial Alfa SA in Mexico.

Ferranti trades micropackaging for V-MOS technology

Add another name to the growing list of semiconductor companies moving into the V-MOS power field-effect-transistor market. Through a marketing and technology exchange agreement with V-MOS manufacturer Supertex Inc. of Sunnyvale, Calif., Britain's Ferranti Electronics Ltd. is to diffuse, assemble, and test n- and p-channel discrete power FETs with a vertical double-diffused MOS structure for sale in Europe and the U.S. It will introduce its first branded parts at the Electronica exhibition in Munich in November. In the deal, which involved no transfer of money, Ferranti traded in its microminiature packaging technology for discrete devices. The technology competes with Siemen's Sipmos and International Rectifier's Hexfet processes, among others, for high-speed, high-power applications in the industrial and consumer sectors.

AREA SALES OFFICES

Eastern Area

Dover, MA
(617) 785-0910

Central Area

Rolling Meadows, IL
(312) 991-4620

U.S. REPRESENTATIVES

East

CONROY SALES
Towson, MD
(301) 296-2444
DYNASEL ASSOC.
Waltham, MA
(617) 890-6777
KIMCONICS SALES
Pittsburgh, PA
(412) 824-9860
QUALITY COMPONENTS
Manlius, NY
(315) 682-8885

Western Area

Woodland Hills, CA
(213) 992-1885

Buffalo, NY
(716) 839-4170
SUNDAY O'BRIEN
Haddonfield, NJ
(609) 429-4013
TRIONIC ASSOC.
Great Neck, NY
(516) 466-2300

South

DYNE-A-MARK
Ft. Lauderdale, FL
(305) 771-6501
Clearwater, FL
(813) 441-4702
Maitland, FL
(305) 831-2097
Palm Bay, FL
(305) 725-3235
ELECTRONIC MARKETING
Greenville, SC
(803) 233-4637
Huntsville, AL
(205) 837-7363

Smyrna, GA
(404) 433-8941
Charlotte, NC
(704) 552-1977
Winston-Salem, NC
(919) 722-5151
ION ASSOC.
Grand Prairie, TX
(214) 647-8225
Houston, TX
(713) 461-5311
Austin, TX
(512) 458-2108

Midwest

A M E SALES
Overland Park, KS
(913) 492-8836
St. Louis, MO
(314) 965-1779
INDUSTRIAL REPRESENTATIVES
Chicago, IL
(312) 647-7755
Milwaukee, WI
(414) 259-0965
ION ASSOC.
Tulsa, OK
(918) 664-0186
J&B ENGINEERING
Ft. Wayne, IN
(219) 483-2813

Indianapolis, IN
(317) 842-2681
KEY ENTERPRISES
Elm Grove, WI
(414) 784-3390
KIMCONICS SALES
Englewood, OH
(513) 836-9677
Brunswick, OH
(216) 225-6111
PETERSON/SNATER
ELECTRONICS
Bloomington, MN
(612) 884-3483
S & O SALES
Cedar Rapids, IA
(319) 393-1845

West

BROOKS TECHNICAL GROUP
Palo Alto, CA
(415) 328-3232
MR ENGINEERING
Phoenix, AZ
(602) 956-4670
REIDER ASSOC.
Escondido, CA
(714) 741-0496

RICAL ASSOC.
Huntington Beach, CA
(714) 894-7257
VANTAGE
Bellevue, WA
(206) 455-3460
Portland, OR
(503) 297-1714

CANADIAN REPRESENTATIVES

MUNRO Montreal, Quebec
(514) 626-6723
ELECTRONIC COMPONENTS
Toronto, Ontario
(416) 676-1042

U.S. DISTRIBUTORS

ADVENT ELECTRONICS, ANTHEM ELECTRONICS, ARROW ELECTRONICS, BELL INDUSTRIES, FUTURE ELECTRONICS (Canada), GENERAL RADIO AND SUPPLY, HALL-MARK, LIONEX, RADIO, STERLING ELECTRONICS, SUMMIT, TAYLOR ELECTRIC, TECHNICO, VSI ELECTRONICS, WESTERN MICROTECHNOLOGY, ZEUS COMPONENTS

INTERNATIONAL DISTRIBUTORS

Australia AMPEC ENGINEERING, CEMA DISTRIBUTORS, ROYAL MICRO SYSTEMS
Austria BACHER ELEKTRONISCHE GERATE GmbH, FA. ING. E. STEINER
Belgium MICROTRON
Denmark C-88
England MEMEC, MACRO MARKETING, PRONTO ELECTRONIC SYSTEMS
Finland OY FINDIP AB
France ERN
Germany ASTRONIC, BITRONIC, ELECTRONIC-2000, HILMAR FREHSDORF GmbH
Hong Kong CONMOS PRODUCTS
Israel AVIV ELECTRONICS
Italy COMPREL S. R. L.
Japan SYNERDYNE, TEJIN, UNITEC, HIGH TECHNOLOGY
Korea LEEWOOD
Mexico & Latin America INTECTRA (Mountain View, California)
Netherlands MCA-TRONIX
New Zealand E. C. S.
NORWAY SOUTHMARK ELECTRONICS
Sweden SCANCOPTER
South Africa RADIOKOM
Switzerland KONTRON
Taiwan GENERAL ELECTRONICS, STOLZ
TANZANIA TAIWAN AUTOMATION INDUSTRIES, TAIWAN AUTOMATION
Venezuela IBARS & CIA

Using bipolar PROMs? Check out the Fast Cat™ ROM. Speed is only half the story.

The bipolar PROM market will never be the same. Introducing the SY3316 Fast Cat™ ROM. It's not only fast—80nsec—it also slashes costs wherever high performance, large bit storage and simple interface are important design considerations.

Synertek's engineering team designed the Fast Cat™ ROM that way. Now you can make a quick, cost-effective move from bipolar PROM prototyping into volume production—without costly PC board redesign. The SY3316 can do it because it's directly pin compatible with industry standard 16K bipolar PROMs.

There's even more to this cat. Like a single +5V supply, full input/output TTL compatibility, fully static circuitry, asynchronous operation, industry standard 2048x8 organization, three mask programmable chip selects and three-state outputs to facilitate system expansion.

We make ROMs our business. So that you get total commitment to servicing your ROM needs. With wafers waiting at contact mask, we can meet fast delivery requirements—just four weeks for your SY3316 prototype. That's flexibility. Already at work for you now. And we back it all up with high performance scaled N-channel MOS technology.

Need 8K bipolar PROMs? Then check out the SY3308 8K ROM, another fast member—at 70nsec—of the Fast Cat™ ROM family. And fully compatible with industry standard 1Kx8 bipolar PROMs. We've got a family of cats that's only going to get bigger. And better. Get a jump on the competition. And go with the MOS company. Go with Synertek. Call your area Synertek distributor now.

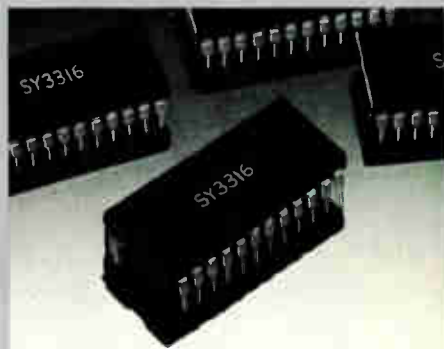

SYNERTEK

3001 Stender Way P.O. Box 552
Santa Clara, California 95052
(408) 988-5600
TWX: 910-338-0135

SY3316 80nsec

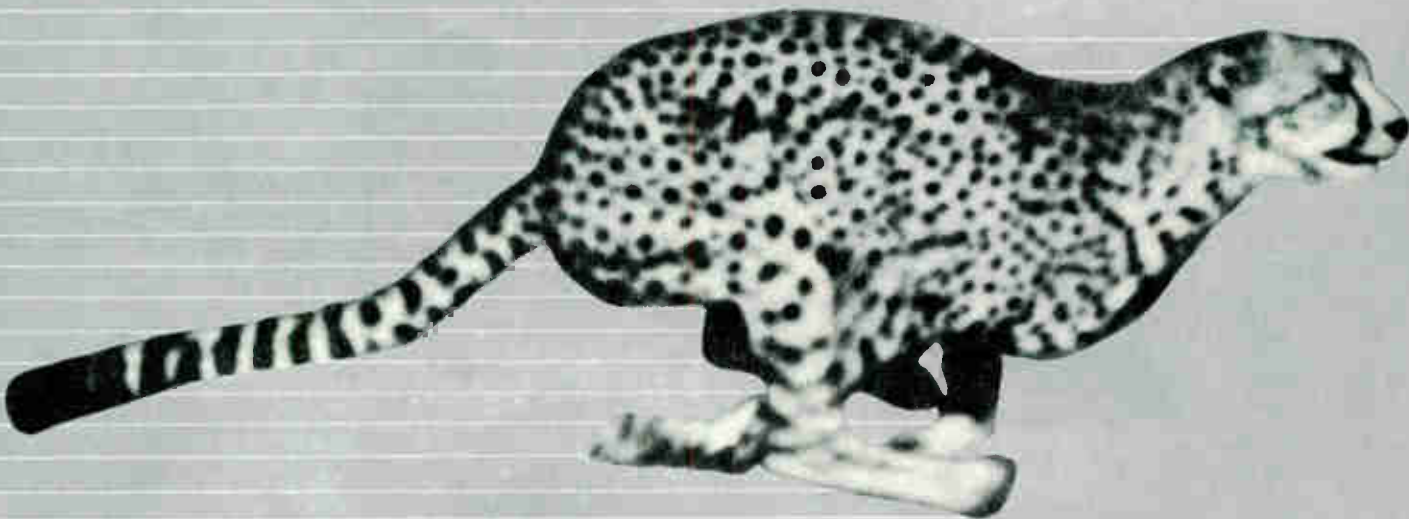

Coming in November: A series of Fast Cat™ ROM seminars coast to coast.

THERMAL PRINTERS FOR THE OEM

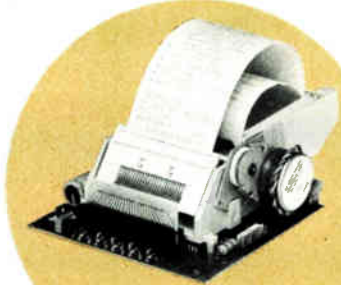

PL20E

Telpar uses multiple print-head technologies and mechanism designs to cover the full range of hard-copy applications:

- Computer terminals
- Data logging
- CRT "dumps"
- Test equipment
- Instrumentation

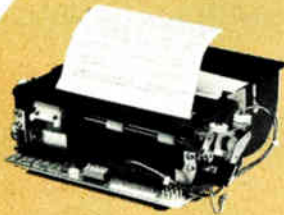

PS48E

KEY FEATURES	PL12E	PL20E	PS48E	PPS80E	PL80E
Columns	12	20	48	80	80/132**
Speed, cps	30	50	30	50	120
Interfaces	Serial and parallel furnished as standard				
Baud Rate*	110, 300 or 600	110, 300 or 600	110 or 300	50 to 9600	50 to 9600
Buffers	—	—	—	4K or 16K	4K
Invert Mode	•	•	—	—	—
Graphics	—	—	—	•	•
Reverse LF	•	•	•	•	•

*Switch selectable
**132 columns with compressed printing



PL80E

High reliability

- Few moving parts
- Computerized PCB testing
- 100% burn-in

Call or write for applications assistance or other information: 214/233-6631

telpar, inc.

The thermal printer company

4132 Billy Mitchell Road, Box 796, Addison, Texas 75001
Telex 73-2561 (TELSERV) DAL

Circle 82 on reader service card

FREE

Brochure describes Electronics editorial reprints, services, books...

- More than 70 article reprints in 15 subject categories
- Handy wall charts
- Custom-made reprint services
- Books especially for Electronics' readers
- Convenient postage-paid order cards



For your free copy, circle #275 on the reader service card.

Electronics international

com, could certainly be remedied by an improved version of the echo canceler.
-Kevin Smith

West Germany

Siemens aiming to sell more ICs abroad

The opening of yet another MOS fabrication center at Siemens AG's Munich-based components division is further evidence of the West German firm's determination to become a powerful force on the international market for very large-scale integrated circuits. Right now, it rates as the No. 2 IC supplier in Europe (after Philips of the Netherlands) and as No. 10 worldwide.

The new VLSI center, together with a similar one now nearing completion at Villach in Austria, "is to help Siemens stand up to the mighty competition of Japan and the U. S.," says Friedrich Baur, head of the components division and a member of the company's managing board. More than that, he is convinced it will help shift IC market shares from those countries to West Europe. The new Munich facility is equipped to fabricate devices with 2-micrometer geometries and 150,000 components per chip [*Electronics*, Sept. 25, p. 63].

Above average. Adds Gernot Oswald, sales and marketing manager for ICs and head of microcomputer activities at Siemens, "We are aiming to grow more rapidly in ICs than the world average, and the additional percentage points we will have to get abroad because our share of the West German market allows only moderate gains." In 1979 Siemens had a roughly 20% share of that market and a 12% share of the West European one.

Favoring its IC sales growth in the rest of Europe, Baur believes, is steeper expected growth of the equipment production industry there, plus the fact that ICs as yet pervade systems and equipment to a far lesser extent in Europe than in the U. S.
-John Gosch

MEET THE FIRST FAMILY OF PIN PROGRAMMABLE INSTRUMENTATION AMPS.

AD612A - When price is everything.

AD612B - For price and 10-bit performance.

AD612C - When accuracy is everything.

AD614A - When you want price and speed.

AD614B - For high speed and high accuracy.

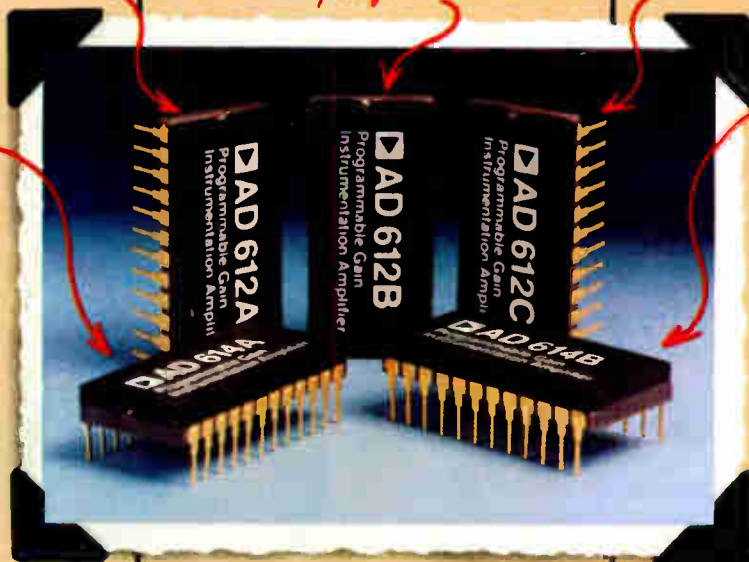

ONLY ANALOG DEVICES OFFERS 5 INDUSTRIAL PERFORMANCE GRADES.

Our new AD612 and AD614 comprise the most complete family of self-contained, high speed, industrial grade (-25°C to $+85^{\circ}\text{C}$) PGIA's available today. For the first time, the industrial data acquisition designer has a real choice of hybrid instrumentation amplifiers to fit his specific application requirement.

This new family of PGIA's is available in 5 versions: AD612A, our lowest priced amplifier (\$38.50*), our AD612B where accuracy and price are important ($\pm 2\mu\text{V}/^{\circ}\text{C}$ maximum input voltage drift, \$43.50), our AD612C for applications requiring the highest accuracy ($\pm 1\mu\text{V}/^{\circ}\text{C}$ max, \$52), our AD614A for high speed applications (settling time of $40\mu\text{s}$ maxi-

mum to 0.01%, \$49.50), and our AD614B for high accuracy and high speed ($\pm 2\mu\text{V}/^{\circ}\text{C}$ max; $40\mu\text{s}$ maximum settling time, \$61).

DESIGNED BETTER TO PERFORM BETTER.

Every AD612 and AD614 contains a precision thin-film resistor network that allows you to pin program gain in binary steps from 1 to 1024 V/V. Each offers low gain non-linearity of 0.01%, gain temperature stability

of 0.001%/ $^{\circ}\text{C}$ maximum, low input voltage noise of $1\mu\text{V}$ pk-pk, high CMR of 94dB minimum @ gain = 1024 V/V, and low power requirement of 240 mW.

A VERSATILE AMPLIFIER

WITH VERSATILE APPLICATIONS.

The wide dynamic input range ($\pm 10\text{mV}$ F.S. to $\pm 10\text{V}$ F.S.) combined with fast settling time ($20\mu\text{s}$ max to 0.05%; AD614A/B), makes these amplifiers a perfect choice for data acquisition systems, analytical instruments, transducer interfacing. Their high CMR, input protection, low noise and excellent temperature stability also make them a good choice for precise measurements in harsh environments.

If you want a broad selection and versatility, Analog Devices' AD612 and AD614 family is the answer.



National's only child.

ANALOG DEVICES

*All prices in 100's

The Bum Brown Twins.

WAY OUT IN FRONT.

Analog Devices, Inc., Box 280, Norwood, MA 02062; East Coast: (617) 329-4700; Midwest: (312) 894-3300; West Coast (714) 842-1717; Texas: (214) 231-5094; representatives around the world.

Circle 83 on reader service card

Technological leadership.

Now there's a CMOS 8-bit Motorola's economical high-

The MC146805E2 is the first CMOS microprocessor for the new era of the '80s, a merger of Motorola's strengths in microprocessors and CMOS standard logic.

It's the first CMOS MPU with the muscle and finesse to handle the tough demands for low-power systems in the '80s.

It's in volume production, and available now.

More than a processor.

The MC146805E2 is more than a powerful 8-bit CMOS processor. Also on-chip are two 8-line I/O ports, 112 bytes of RAM, an oscillator and a programmable 8-bit timer with a 7-bit prescaler. A multiplexed address/data bus permits addressing up to 8K bytes of external memory. For implementation of real-time applications, the MPU operates with two hardware interrupts, timer underflow and an external signal, plus a software interrupt.

The MC146805E2 is fabricated in silicon-gate CMOS to match NMOS speeds— 1 MHz cycle (from 5 MHz oscillator). Power is still conserved with anticipated CMOS efficiency. Typical full-speed power consumption is less than 20 mW, and in standby is less than 100 μ W.

Two power-saving, software initiated standby modes, STOP and WAIT, are used in the MC146805E2. In STOP, all internal processing and the timer are halted for the lowest possible power consumption. In WAIT, the timer is allowed to count in a normal sequence and power use is greater than in STOP, but still an order of magnitude below that of the operating mode.

Efficient use of program space, bit manipulation, memory mapped I/O and versatile interrupt handling are just a few of the programmable features of the MC146805E2. Single instructions modify any RAM bit or I/O pin. Even more unusual are single instructions which branch on the condition of any such bit. Three program-efficient indexing modes allow single-instructions access to memory tables. All of the powerful memory reference instruction functions of the MC6800 are incorporated into the MC146805E2.

A powerful two-chip system.

Complementing the MC146805E2 is Motorola's MCM65516 mask-programmable, byte-organized 16K CMOS ROM designed for use in multiplexed bus systems. The small 18-pin package is a tidy space saver, too. Like the MPU, the ROM also is in volume production.

Put them together for the ideal compact, cost-effective low-power CMOS two-chip system.

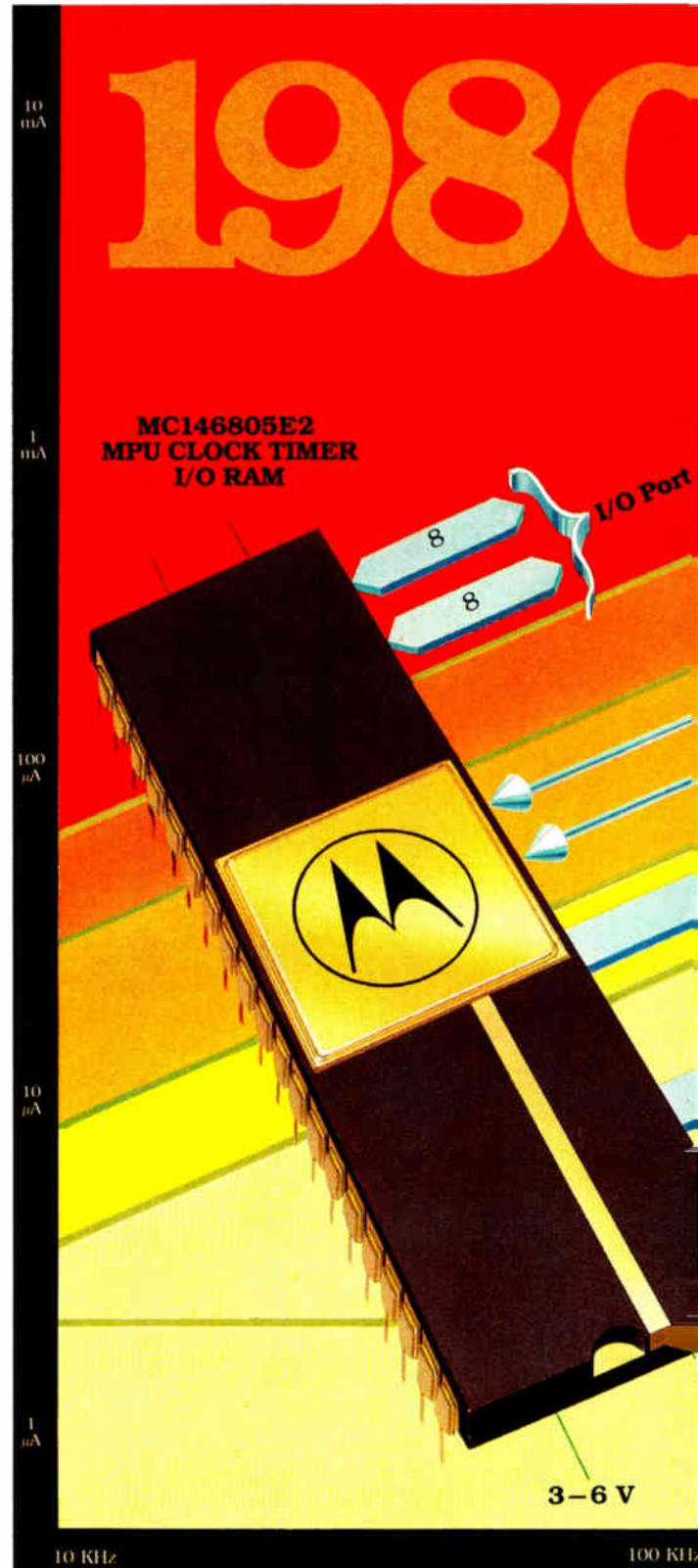

microprocessor for the '80s. speed, low-power, MC146805E2.



Family ties.

All CMOS and HMOS M6805 Family MPUs and MCUs are closely related, and share a common heritage as extensions of the best aspects of the original MC6800.

Just as the MC6805P2 was the first in a family of HMOS MCUs, so the MC146805E2 is the first of several products on the CMOS side of the family. An MC146805E2-based single-chip MCU, two CMOS Real-Time Clock plus RAM units and a CMOS Parallel Interface are on the drawing board, with others not far behind.

All M6805 Family MPUs and MCUs share many key features. They use the same optimized 8-bit processor architecture, based on the M6800, but with more indexing modes and true Bit Modify and Test instructions. Additionally, automatic external and timer interrupts, programmable timer with 7-bit prescaler, ROM-based look-up tables, multilevel subroutine nesting, and a variety of memory and I/O combinations are provided.

EXORciser®-based support system.

An MC146805E2-based hardware and software system, MEX146805, is now available for the Motorola EXORciser system.

The MEX146805 extends the EXORciser's powerful debugging capability to the user's target system. It also provides multiprocessor support, real-time emulation, and stand-alone operation.

A Macro Assembler allows use of relocatable object code and provides for conditional assembly.

Innovative systems
through silicon.



MOTOROLA INC.

TO: Motorola Semiconductor Products Inc., P.O. Box 20912, Phoenix, AZ 85036.
69E10-9/80

Please send me information on the MC146805E2.

Name _____

Title _____

Company _____

Address _____

City _____

State _____ ZIP _____

NAKED MINI 4 EVERYTHING YOU'LL

See all the NAKED MINI products
at the Mini Micro Show, Booth N, Oct. 14-16.

The NM 4/90

Twice as fast as the 4/30 and with a beefed up instruction set. With a hefty 128K bytes worth of direct addressing, it's an ideal choice for high-performance applications like industrial control and data communications systems.

The NM 4/95

Top of the line. Memory management unit for expansion to 8 megabytes. ECC RAM memory for reliability. High speed cache memory for faster throughput. And Page Protection to prevent destruction of another user's space.

The NM 4/30

A midrange beauty. Twice as fast as the 4/10 and with a larger instruction set. Double register shifts, multiple-word memory reference instructions, and more.

The NM 4/10

A half-card 16-bit mini with half-cost economy. Four on-board distributed I/O channels, hardware multiply/divide and DMA are standard. Cost? Even less than many micro-computers.

The NM 4/04

SCOUT™ the little fella that's had OEM's buzzing for months. Through the wizardry of ISOLITE™ SCOUT can test himself every time he's turned on. And a 16-bit CPU, I/O, 32K byte RAM, and card cage costs less than \$1,000.



ComputerAutomation has just what you need to cut a path through to your computer solutions.

You need compatibility? We've got it, with software compatibility from SCOUT through our 4/90. And I/O compatibility across the family, from the 4/10 through the 4/95. All with up to 128K Bytes of directly addressable memory. And up to 8 megabytes of physical memory for the 4/95.

You want software and development tools? We've got all the operating software to get you up and running. And our PROTOS system provides multi-user development support.

You demand reliability? We've got a track record of success in applications as diverse as automated bank tellers, aircraft control simulators, blood analyzers, laser welders and missile tracking systems.

Best of all, it's all part of CA's OEM philosophy that says to protect our profitability,

COMPUTERS. NEED IN THE OEM JUNGLE.

Interfaces

Our famous Intelligent Cables offer low-cost interfaces for async and bisync communications, CRT's, line printers, magnetic tapes, IEEE-488 and 16- and 32-bit parallel I/O.

Software

Operating Systems, a Real-Time Executive, FORTRAN IV, COBOL, PASCAL, editors, assemblers, and communication software.

Memories

The family never runs short of memories Core, RAM, and E/PROM. Plus battery back-up and parity or error correction. From 8K bytes to 256K bytes per card.

Peripheral Controllers

Provides interfaces for floppy disks, high capacity disk systems, communications and digital I/O.

we've got to protect yours. Which means competitive prices, a hassle-free software policy, timely deliveries and the best warranty in the business.

We've got everything you'll need to battle your way out of the OEM jungle.

And the path out begins on the right.

 **ComputerAutomation**
NAKED MINI Division

Where OEM's come first.

18651 Von Karman, Irvine, California 92664

Circle 87 on reader service card

Send help fast.

- Please send the latest full-color brochure on the entire NAKED MINI family.
- Please send a sales representative.

Please call me at _____

If you're really in a hurry to fight your way out, give us a call at (714) 833-8830 X455.

Name _____

Company _____ Title _____

Address _____ City _____

State _____ Zip _____ Phone _____

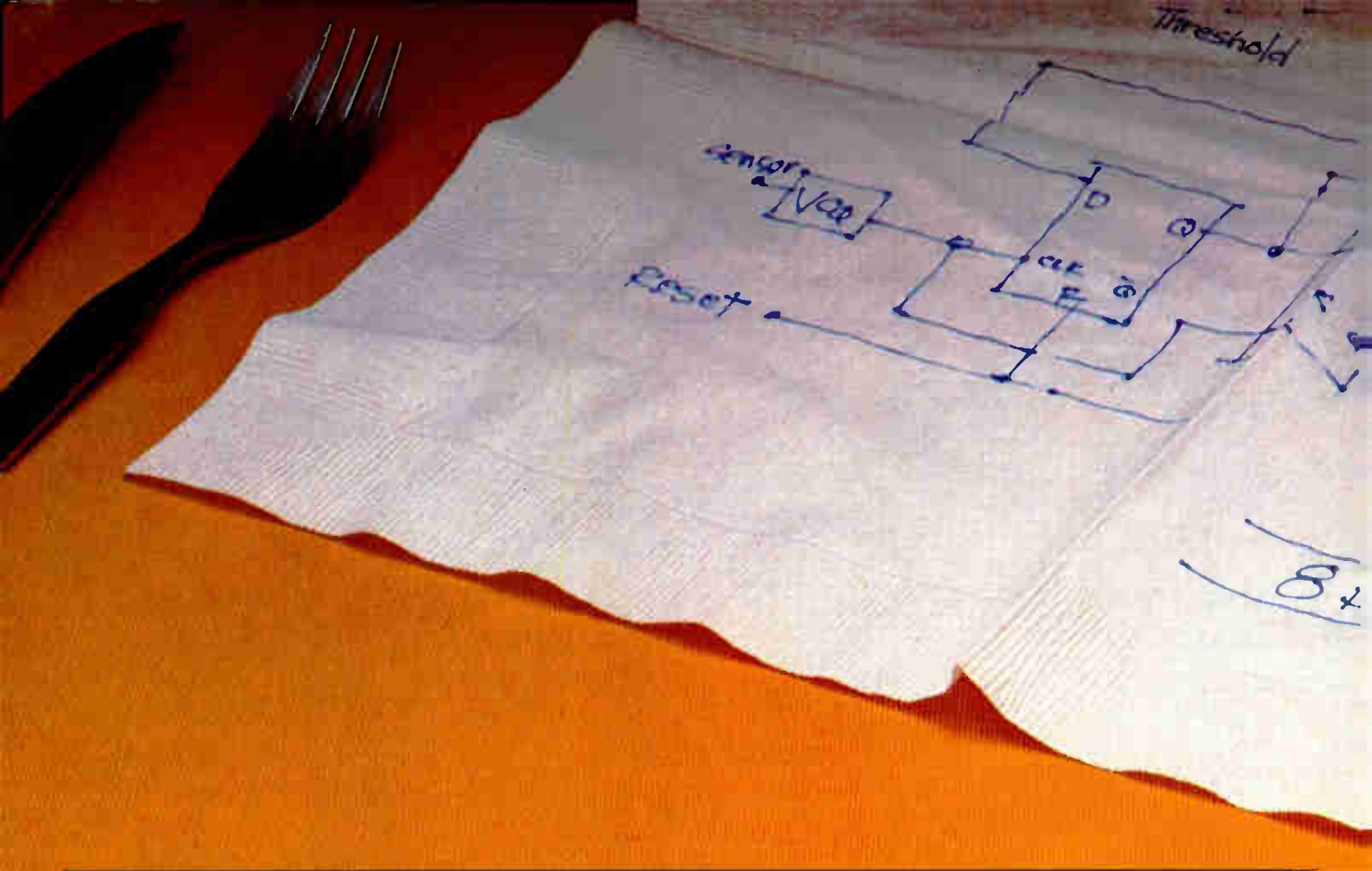

In a few short weeks Exar can into an I²L custom

Semi-custom—a fast, easy, reliable and inexpensive way to transform your digital or combined linear/digital designs into reality.

Exar's standardized semi-custom digital circuits combine high density I²L logic arrays and bipolar transistors on the same partially fabricated chip. You interconnect the gates and bipolar I/O interfaces. The end result: a customized digital circuit produced at a fraction of the cost of a full custom circuit, and in far less time.

These semi-custom I²L circuits perform exactly

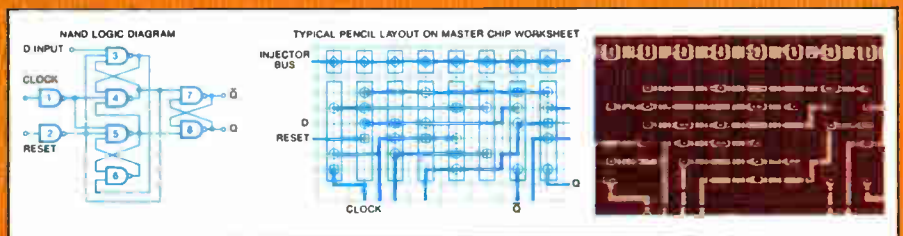

Easy 3-stage design. Logic diagram to worksheet layout to finished chip.

the same as bipolar LSI chips. Plus, I²L technology gives you high functional density and easy interconnection. Bipolar compatibility lets you interface with existing TTL and MOS logic families or retrofit into existing systems. A computer-generated three mask customizing technique eliminates mask

errors. And it packs more circuitry onto each chip.

Exar's alternative source agreements with other IC manufacturers let you specify and order custom circuits with confidence.

Go to full custom later.

As your product matures and your need for

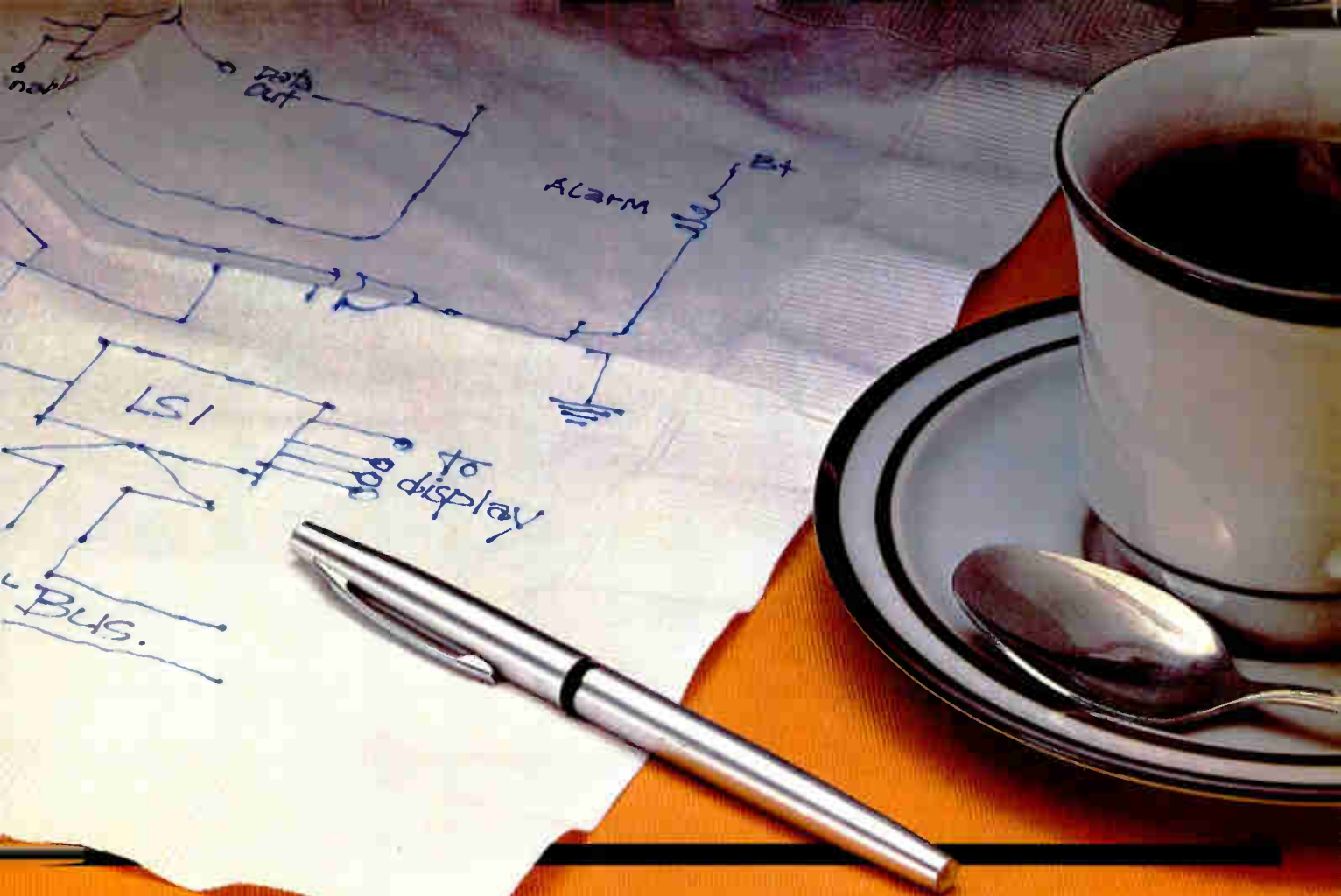

transform your inspirations digital circuit.

circuits increases, Exar can convert your semi-custom chip to a full-custom IC, reducing chip size, saving money, and often providing added performance benefits.

Design kits make it easy to get started.

Exar's digital kits include circuit components

for breadboarding, comprehensive design manual and layout worksheets corresponding to Exar's master chips.

Exar also has six bipolar semi-custom linear chips.

All provide a wide variety of NPN and PNP transistors, Schottky diodes, various resistors and ample bonding pads. These chips are direct replacements for other master chips.

CHIP TYPE	I ^L GATES	SCHOTTKY BIPOLAR I/O INTERFACES	AVAILABLE BONDING PADS	LINEAR COMPONENTS
XR-200	192	24	30	NO
XR-300	288	28	34	NO
XR-400	256	18	40	YES
XR-500	520	40	42	NO

Choose from four chips.



Learn the economics and advantages of semi-custom.

For a copy of our 40-page data book, "Semi-Custom IC Design Programs," and our product guide, write on company letterhead to Exar, 750 Palomar Ave., Sunnyvale, CA 94086 or phone (408) 732-7970.



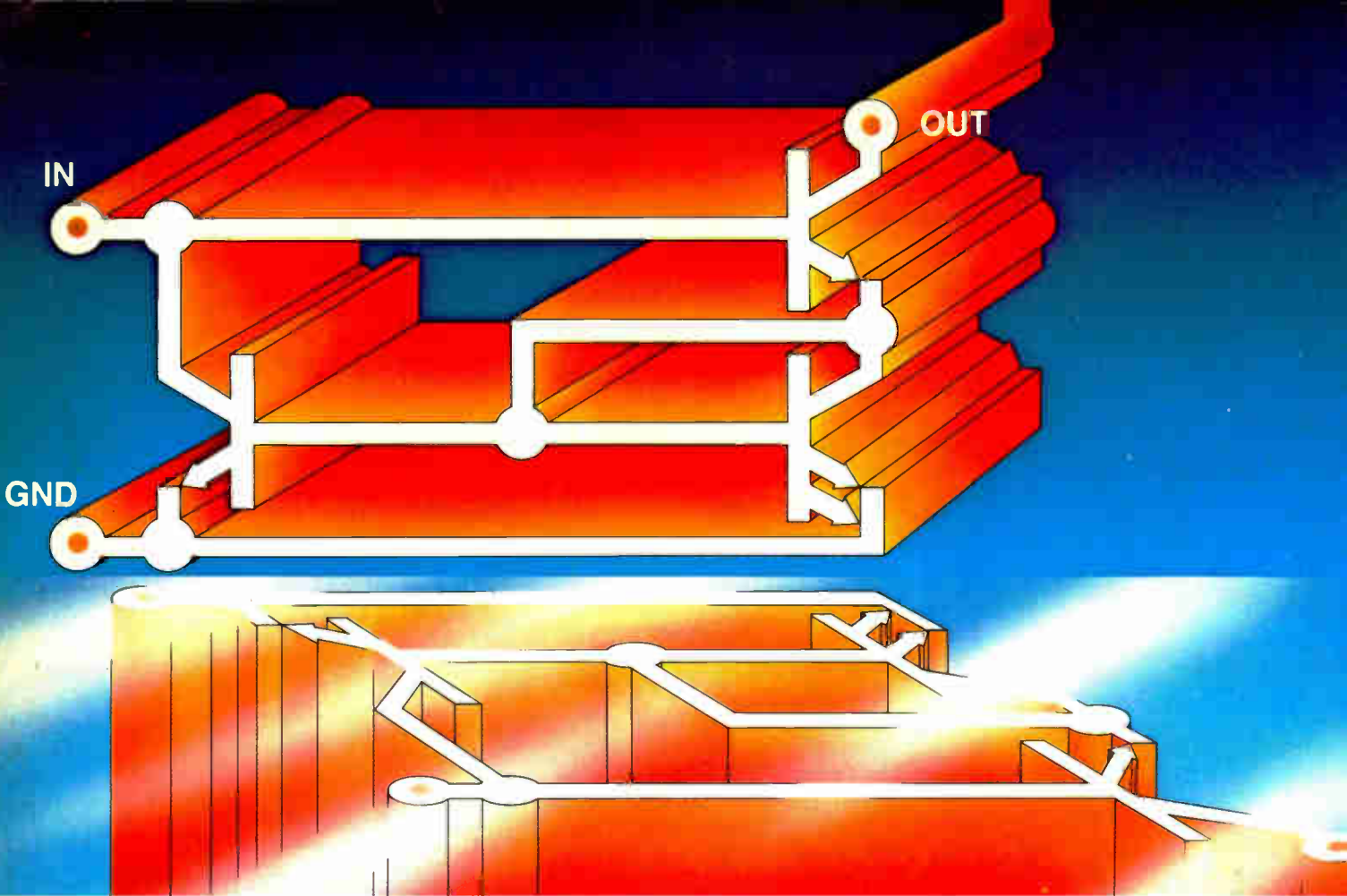

New current mirrors ...

Matched bipolar transistors. First time in monolithic form. More linear leadership from TI.

TI's new family of three-terminal current mirrors gives the engineer something to be thankful for. Flexibility. The flexibility to use these innovative circuit techniques without sacrificing matching or accuracy.

The TL011, TL012, TL014 and TL021 are Wilson current mirrors with fixed current ratios, of 1 to 1, 1 to 2, 1 to 4 and 2 to 1, respectively.

These devices provide a constant current output proportional to the reference current input and independent of output voltage or operating temperature changes.

The key is tight matching. That means making use of the tight matching properties of identical bipolar transistors produced on a monolithic IC to

Current Mirror Design Contest. Chance to win a TI-99/4 Home Computer.

We'll select the three most practical designs. The first prize is the TI-99/4 Home Computer. In addition, two TI-59 Programmable Calculators will be awarded. For entry information and data sheets write to TI Current Mirror Design Contest, P.O. Box 225012, M/S 964, Dallas, Texas 75265.

achieve current ratio accuracies to within 1% typical.

All devices will operate with reference currents up to 1 mA (2 mA for TL021) and output voltages up to 35 V. Operating temperature range is 0 to 70° C.

Output currents for the TL011, TL012, TL014, and TL021 are equal to, two times, four times, and one-half the input currents, respectively. All with an accuracy of $\pm 1\%$. 100-piece prices* are \$0.26, \$0.30, \$0.37, and \$0.30, respectively.

For more information about TI's new current mirrors, call your local TI field sales office, authorized distributor, or write to Texas Instruments Incorporated, P.O. Box 225012, M/S 308, Dallas, Texas 75265.

Fifty Years
of
Innovation



TEXAS INSTRUMENTS
INCORPORATED

*U.S. prices, subject to change without notice.
© 1980 Texas Instruments Incorporated

Circle 90 on reader service card

821768

Meter makers see market in optics

This month's first-ever meeting devoted to fiber-optic measurement indicates that industry is finally moving toward standards

by Richard W. Comerford, Test, Measurement & Control Editor

As the engineering and scientific communities near agreement on how to characterize fiber-optic links, instrument makers have their antennae out. With the prospect of low-cost fibers, sources, and detectors with increased telecommunications applications, they anticipate the development of a sizable market for instruments that will measure attenuation, the ratio of incident to reflected signal, bandwidth, and possibly core diameter and numerical aperture. Indeed, some small companies have already committed themselves.

A milestone is an upcoming meeting, the first dedicated to fiber-optic measurement. Called the Symposium on Optical Fiber Measurements, it will take place in Boulder, Colo., Oct. 28-29. The organizers—Douglas Franzen of the National Bureau of Standards with the aid of the Optical Society of America and the transmission systems subcommittee on fiber optics of the Institute of Electrical and Electronics Engineers—have attracted a roster that is a who's who of telephony.

Papers will be presented by representatives of Nippon Telegraph & Telephone Public Corp.'s Yokosuka Electrical Communications Laboratory, the Netherlands Postal and Telecommunications Laboratory, British Telecom Research Laboratories, Bell-Northern Research, and Bell Laboratories. In the words of one participant, the symposium will bring together "the top people in the world in fiber optics."

These will include representatives of some of the major standards groups: the International Electrotechnical Commission, the Interna-

tional Consultative Committee for Telephony and Telegraphy, and the Electronic Industries Association. The upshot, says Roy Love, will be the emergence of a standard approach for measurements of multimode fibers. Love is chairman of the EIA's P6.6 group, which is working on such standards.

Name it. According to Love, one of the fundamental debates in fiber-optic measurement is over whether to measure waveguide properties like scattering and absorption or some other property that would yield data more vital to the user. "What we are beginning to want now," Love believes, "is just to measure a number and call it attenuation." The major criterion for that number is that if a series of cables is concatenated—or linked—the attenuations of the individual cables add up to the concate-

nated attenuation. "That thought may seem obvious," Love agrees, "but, though in the background all the time, it has really just begun to crystallize."

Round-robin tests conducted by the NBS on a cable resulted in different measured attenuations mainly because of differences in the angle at which the light was launched. A second round of tests is now being conducted in which launch conditions are specified in accordance with proposed EIA test procedures.

"That's all that's really at issue now," says Love, "and anyone who is knowledgeable can see where that's going"—toward a specification of launch conditions that produce the most accurate concatenation predictions. He believes that it is the small size of the market that is holding back large instrument makers, and

Some standards already in place

The measurement standards generated by the Electronic Industries Association are included in RS-455, Standard Test Procedures for Fiber Optic Fibers, Cables, Transducers, Connecting and Terminating Devices and in addenda to it. The basic document contains three test procedures dealing with physical properties such as cable flexing, retention, and humidity effects on devices and one on insertion loss for fiber-optic bundles. Addendum 2 also deals with physical properties such as air leakage and crush resistance. Addendum 1 is still undergoing approval and addresses testing for impact, acceleration, and temperature cycling (thermal shock).

Joseph Neigh, EIA coordinator for the P6 standards group, says RS-455 "is a living document; it will change and grow as long as we have fiber optics." Therefore, rather than hold up test procedures until they can all be published, "which might be a couple of years," the members of P6 elected to use the addenda method.

Roy Love, chairman of the P6.6 subgroup, says that his unit will have a proposed test procedure dealing with attenuation measurement in single-mode fibers ready by January. This procedure will have to be approved by the entire P6 group, a procedure that can take as long as two years. But, he says, "there aren't going to be too many changes in the end from the general consensus of opinion that's emerging now."

Probing the news

that for field instruments—optical time-domain reflectometers that can find line breaks—the launch angle need only be adjusted.

Along with measurement practice, some basic fiber dimensions seem to be approaching standardization. A standard long-distance telecommunications fiber, one with a 125-micrometer outer diameter and a 50- μm -diameter core, is currently in the approval cycle of the EIA fiber-optics group. Love's opinion is that, given the relatively large demand in telecommunications for this fiber and related long-wavelength detectors and light-emitting-diode transmitters, many will find ways to use them in applications like process control and computer links, where noise immunity and data integrity will make them attractive.

Steve Storzum, senior engineer at McDonnell Aircraft Co., St. Louis, Mo., also sees things beginning to move. "It's starting to break out of the chicken-or-egg syndrome," he says, referring to a lack of applications due to a lack of standards and an absence of standard instrumentation due to an absence of applications. Not only is the 125/50 fiber becoming a long-distance standard, he says, but also the 140/100 fiber seems to be gaining acceptance for short distances.

However, instrument makers may not have to wait for the market to develop, according to Storzum. "I believe the fiber-optic measurement industry is ripe for *de facto* standardization," he says. If an instrument maker produces a versatile, low-priced optical time-domain reflectometer, users will start to write procedures around it, he feels.

With these properties percolating to standardization, the measurement tool market may approach critical mass in the not too distant future—as early as 1981, according to Love. The NBS's Franzen notes that already "a lot of big companies are putting a fairly large effort into it [development of fiber-optic instrumentation]—like Tektronix and Hewlett-Packard—but they are not saying anything about it publicly."

He feels that they are waiting

until standards settle a bit, but more importantly, until they can accurately predict where the market is going. "The big companies are doing things, but they want to see more of what the market is, to be more certain of the success of their instruments," Franzen believes.

Work at HP. That a large effort is currently under way at Hewlett-Packard is a "fair statement," according to Michael Cunningham, marketing manager for a variety of microwave instruments at the firm's Stanford Park (Calif.) division. He thinks that "steps in the direction of standard fiber diameters and connectors would make the instrument maker's job as well as the systems people's jobs easier," but "test procedures will have to become more cookbooklike." In fact, he thinks that instrumentation may have to be specified, as well. As to where the market may be in the next year or so, he comments, "We've done blue-sky projections based on some ratios that traditionally apply between end system expenditures and test equipment, but it remains to be seen whether that ratio will hold if fiber optics are as reliable as they promise to be."

Tektronix Inc., on the other hand, although following developments closely, says it is not involved in a major effort. Jean-Claude Balland, a

marketing program manager for the Beaverton, Ore., firm, notes, however, that there is some promotion of existing general-purpose instruments for such applications.

Balland sees the market shifting away from research and development as fiber optics go into manufacturing quantities. "The plan is now toward a more manufacturing-oriented [test] system. I don't think field service will begin to emerge for two or three years," he says. Right now, he believes, fiber-optics users are looking for such instruments only as samples. "Large companies are not coming in because the market isn't enough to justify designing an instrument."

Another company that has noted the shift into manufacturing production is EG&G Inc. Earlier this year, the company's Brookdale operation in Bracknell, Berks., England, introduced a microprocessor-based system for operation by unskilled personnel, able to measure attenuation in the 600-to-1,600-nanometer wavelength band [*Electronics*, March 13, p. 63]. The \$16,000 instrument is IEEE-488-compatible and so can be part of an automated test system.

Moving ahead. As many large companies hold back, smaller ones in the U.S. and abroad, hoping to ride fiber optics to new fortunes, are taking the risk that measurement trends will firm up. According to Dennis Horwitz, vice president of Photodyne Inc. of Westlake Village, Calif., the company predicts \$1 million sales for the current year with 30% to 50% growth in the next.

The only company selling optical instruments at this year's Wescon, two-year-old Photodyne introduced a new family of fiber-optic tools aimed at field service, the XE series. The series—two optical power meters and a fiber-optic power source—resembles 3½-digit hand-held multimeters. They can run for 150 hours, are autoranging, and display power in decibels relative to a milliwatt—a measurement that fits well with the current view of such measurement.

Among Japanese companies, Anritsu Electric Co.'s instruments are directly aimed at fiber-optic communications. The company has a fault locator that will likely go to market in another year or so. □



On the market. Optical meter from Photodyne resembles 3½-digit hand-held multimeter, runs for 150 hours, costs under \$600.

QTP™ ROMs... More Mileage From Your EPROM Dollar.



Simply switch to 16K and 32K QTP ROMs.

QTP ROMs are pin-compatible replacements for EPROMs. They offer the same performance at far less cost, plus the proven reliability of General Instrument's "dedicated" ROM facilities.

If you're using 16K EPROMs, consider the incredible cost advantages of ROMs. If you're designing with 32K EPROMs, consider the cost advantages and fast delivery of our QTP ROMs, and ask yourself, "Why not ROMs instead?"

QTP (Quick Turnaround Production) means we can start delivering your masked ROMs in quantity within 4 to 6 weeks. How can we do it? With vast dedicated ROM mask and wafer facilities, dedicated automatic assembly, dedicated and experienced QTP planning staff, and a personalized, computer verification service (ask about it!).

Check the pin-compatible replacement chart below. Then call 516-733-3107 for details. Or write Microelectronics Division, General Instrument Corporation, 600 West John Street, Hicksville, New York 11802. We'll help you get more mileage from your EPROM dollar.

PIN-COMPATIBLE REPLACEMENT CHART		
QTP ROMs		EPROMs
RO-3-9316	16K, 2K x 8, 24-pin	2516 2716 2708
RO-3-9333	32K, 4K x 8, 24-pin	2732
RO-3-9332	32K, 4K x 8, 24-pin	2532



We help you compete.®

GENERAL INSTRUMENT

THE TELEPHONE DESIGNERS' COLLECTION



3 OF THE MOST INNOVATIVE TELEPHONE COMPONENTS IN THE WORLD

Our designers at Mitel Semiconductor know the telephone. That's because they work side by side with Mitel Telecom engineers. The application of our semiconductor technology to the telephone has produced the most efficiently integrated phone components in the world.

The MT4320 Pulse Dialer

The MT4320 allows the rotary dial to be directly replaced by a push button pad. This pin for pin equivalent to the industry standard DF320 has an operating voltage range of 2 to 7 volts, 250 μ W operating power dissipation, and a stand-by current consumption of less than 1 μ A. The MT4320 stores up to 20 digits, has last number redial, pin selectable line break/make ratio and pin selectable impulsing rate of 10, 16 or 20 PPS.

The MT4325 Programmable Dialer

The MT4325 has all of the features of the 4320. In addition it has an audible key tone and access programming for automatic dialing pause in redial mode.

The ML8204 Tone Ringer

This replacement for the telephone bell, with a minimum of external components, provides a pleasant warbling sound, and interfaces to the telephone line. The ML8204 has low power consumption, an on-chip regulator, positive switch-on and is packaged in an 8 pin minidip.

MITEL SEMICONDUCTOR, we've got the goods for you.



MITEL SEMICONDUCTOR

United States: 1735 Jefferson Davis Highway, Suite 1009, Arlington, Virginia, U.S.A. 22202. Telephone (703) 243-1600
1223 Westchester Pike, Havertown, Pennsylvania, U.S.A. 19083. Telephone (215) 449-5556.
2321 Morena Blvd., Suite M, San Diego, California, U.S.A. 92110. Telephone (714) 276-3421.

Canada: P.O. Box 13089, Kanata, Ottawa, Ontario, Canada K2K 1X3. Telephone (613) 592-2122, Telex: 053-4596, TWX: 610-562-8529.

18 Airport Blvd., Bromont, Quebec, Canada J0E 1L0. Telephone (514) 534-2321, Telex: 05-267474.

Europe: Hamilton Road, Slough, Berkshire, England SL1 4QY. Telephone 0753-36137, 0753-36138, Telex: 847730
Fredericiagade 16, Suite 309, 1310 Copenhagen K, Denmark. Telephone (01) 119302, Telex: 27246

Asia: TST P.O. Box 98577, Kowloon, Hong Kong, 3-318256, Telex: 64235-Mitel HX

Copyright 1979 Mitel Corporation

Military electronics

Military purchases to slow

EIA study shows that system startups will be cut and inflation will outpace increases in R&D funding

by Ray Connolly, Washington bureau manager

Regardless of who occupies the White House next year, the military spending scenario is already set for the foreseeable future, and defense electronics contractors view it as one that limits the growth of their market to 2% per year after inflation.

The picture, says the Electronic Industries Association, is a grim one in which military leaders and Congress are pushing improvements in force readiness—including better training and salaries—at the expense of new weapons starts and an upsurge in strategic offensive systems at the expense of tactical requirements.

Military electronics research and development looms as the biggest loser over the next decade as budget increases are offset by an annual inflation rate ranging upward from 7%—perhaps as high as 10%—according to EIA's 10-year forecast of the military market (see table).

After interviews with 30 senior Pentagon and service officials, as well as with members of Congress and the Office of Management and Budget, the Washington, D. C.-based association's Government division presented its forecast during a Los Angeles symposium Oct. 7-9.

Nevertheless, the outlook is better for military electronics than for the defense industry overall. The reason: emphasis on readiness will call for product improvements of existing weapons platforms in lieu of multiple new starts—improvements with a high electronics content, according to EIA forecaster Jim Lee of Hughes Aircraft Co., Culver City, Calif.

Tactical aircraft upgrades are a prime example of where electronics firms will benefit, explains Lee, even though the aircraft industry itself will be "the most depressed area" because of the lack of new starts.

Using fiscal 1981 dollars, the

EIA's figures indicate that the \$25.4 billion available in the new fiscal year that began this month will be nearly 15% greater than the \$22.1 billion for fiscal 1980's total for R&D, procurement, and operations and maintenance. But in fiscal 1982, the market will grow only 7% to \$27.2 billion, slipping further the following year to 6.2%. Moreover, the largest slippage in percentage growth from prior years will come in monies for research, development, testing, and engineering rather than procurement.

The biggest single dollar share in the EIA's forecast goes for what the association calls E&C, for electronics and communications, which the analysts define as hardware "not dedicated to the support of one single weapons system or not classified elsewhere." For example, a system peculiar to a single type of weapon, like an aircraft or missile, is included

U.S. DEFENSE ELECTRONICS: R&D AND PROCUREMENT
(Total obligational authority in billions of dollars)

Fiscal year	Aircraft		Missiles		Space		Ships		Ordnance		Electronics and communications		Other		Operations and maintenance*	Overall total
	R&D	Proc	R&D	Proc	R&D	Proc	R&D	Proc	R&D	Proc	R&D	Proc	R&D	Proc		
1981	0.6	4.6	1.8	2.2	1.1	1.3	0.2	1.7	0.3	1.3	2.5	3.1	0.4	0.5	3.8	25.4
1982	0.5	4.8	1.9	2.7	1.2	1.4	0.3	1.8	0.3	1.5	2.6	3.3	0.4	0.5	4.0	27.2
1983	0.5	4.9	2.0	3.2	1.3	1.6	0.3	1.9	0.3	1.6	2.8	3.4	0.4	0.5	4.2	28.9
1984	0.5	5.0	2.1	3.4	1.3	1.8	0.3	2.1	0.3	1.9	2.9	3.5	0.4	0.5	4.4	31.4
1985	0.5	5.1	2.0	3.7	1.4	1.9	0.3	2.2	0.3	2.1	3.0	3.7	0.4	0.5	4.5	31.6
1986	0.5	5.2	2.0	3.9	1.4	2.1	0.3	2.4	0.3	2.3	3.1	3.9	0.4	0.6	4.6	33.0
1987	0.6	5.3	2.0	4.2	1.6	2.2	0.3	2.6	0.4	2.5	3.2	4.1	0.4	0.6	4.7	34.7
1988	0.6	5.4	1.9	4.4	1.7	2.5	0.3	2.7	0.4	2.7	3.3	4.4	0.4	0.6	4.8	36.1
1989	0.7	5.6	1.9	4.5	1.9	2.7	0.3	2.8	0.4	3.0	3.4	4.7	0.5	0.7	4.9	38.0
1990	0.7	6.0	2.0	4.7	2.1	3.0	0.3	2.8	0.5	3.2	3.5	4.8	0.5	0.7	5.0	39.8

*No R&D funds

SOURCE: ELECTRONIC INDUSTRIES ASSOCIATION

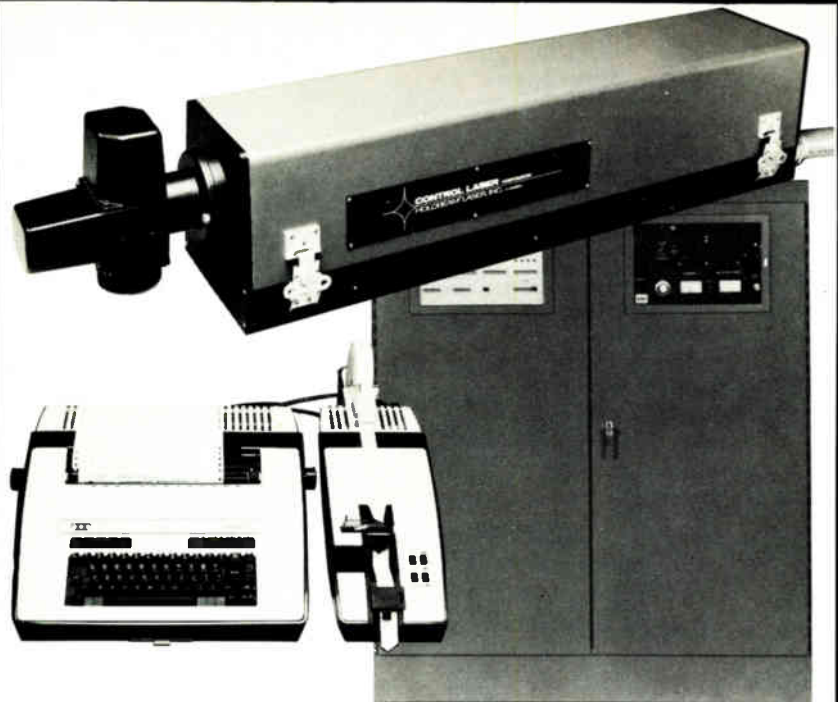

InstaMark Laser Engraver

**... combines speed, versatility,
flexibility, permanence, non-contact
operation, production adaptability
and operator simplicity!**

If you need to mark a product, consider the features of Holobeam's InstaMark Laser Engraving System. Because it is computer-controlled, InstaMark's laser beam has the full contouring capability necessary to inscribe alphanumeric characters, symbols and graphic designs at up to 8 in./second. In addition, computer control permits the system to be easily adapted to fully automatic operations, such as required for serializing components on a high-speed production line. Being a non-contact process, laser engraving does not apply pressure to the surface which could deform or fracture a workpiece. Through use of software programs and simple teletypewriter instructions, an operator trained only from a manual can put the system through its paces. If this sounds like the marker you should be using, contact one of our knowledgeable sales engineers.

CONTROL LASER CORPORATION

HOLOBEAM® LASER, INC. - A Subsidiary

11222 Astronaut Blvd. ■ Orlando, Florida 32809
(305) 851-2540 TELEX ■ 564407

under that weapon's category. On the other hand, the EIA explains, items that are "unique or used as a building block for several systems"—say, a command center, navigation and guidance, or electronic warfare—fall into the E&C category. Funds for E&C are forecast to grow by only 5% in fiscal 1982 from the current year, which reflects a 12% growth from just ended fiscal 1980. And that percentage growth rate in the decade's later years will slip even more, according to the forecast.

Missile drain. Modernization of strategic missiles is seen as constraining spending for tactical forces despite the political controversy and uncertainty still surrounding the Air Force's costly MX intercontinental ballistic missile and replacement of the old, liquid-fueled Titan ICBM force with solid-fueled D-5 versions. To the EIA analysts, the tradeoff between strategic and tactical priorities raises questions about the Pentagon's widely advertised Rapid Deployment Force. They question whether the RDF effort to move a tactical force into small conflicts quickly is not largely a "cosmetic" effort. In any case, the RDF is seen as offering few electronics opportunities compared with the program's need for new large cargo aircraft and ocean transports.

In the tactical ground forces area, the EIA's analysts see continuing heavy investment in antitank systems—with good potential for IMAWS, the Infantry Man-portable Anti-Armor Weapons System, now initially contracted to Honeywell Inc.—and the possibility of development of a lightweight tank for large-scale production at relatively low cost. The army sees such a tank, as well as a "high-mobility multiple-use vehicle" as candidates for airlifting.

Copter felled. For tactical air systems, however, the forecast describes as "dead" the prospect for an advanced Aerial Scout Helicopter (ASH), long pushed by Hughes Aircraft, to extend the reconnaissance range. Similarly, the Air Force is showing little interest in a two-seat version of the A-10 ground attack aircraft. However, the analysis also

SOLID STATE IMAGER

ACTUAL SIZE:

shows that the F-15 fighter may resurrect the need for a new electronics warfare tactical system using that airframe. Another tactical air loss for U. S. producers will be the Asraam—Advanced Short Range Air-to-Air Missile—which is to be produced by North Atlantic Treaty Organization partners in Europe, although the medium-range version, Amraam, will stay in the U. S. (For an examination of NATO program opportunities, see p. 104.)

Avionics makers will face a big Air Force push for integration and standards development in the coming decade, the EIA says. It is an issue that some producers say they have mixed feelings about, with one company's Washington representative noting that "it is an old story, of course. Everyone wants standards provided that those adopted are his."

Tactical naval forces still face a "numbers problem"—not enough ships—says the EIA. It notes that the lead entry is the DDGX/Aegis class, a ship smaller than the existing DDG-993 destroyer but equipped with the Aegis air-defense system. This employs phased-array radar and automated fire-control systems using an upgraded Standard Missile, the SM-2, that has a longer interception range and is more lethal than its predecessors.

Gold watch. In the area of C³I—command, control, communications, intelligence—the EIA sees the Air Force still pushing hard for approval of JTIDS, the Joint Tactical Information Distribution System for triservice combat use by air, ground, and naval forces, even though Congress cut funds for the program in the fiscal 1980 appropriations. After several years in R&D, the spread-spectrum JTIDS uses frequency hopping in the 960-to-1,125-megahertz band to prevent jamming. The EIA calls it an Air Force "gold watch"—a needed and wanted program to which the service regularly attempts to overcome congressional objections by annually resubmitting it for funding. The EIA's forecast sees "lots of gold watches this year," noting that the Patriot and Stinger tactical air defense missiles were the only gold-watch survivors of the fiscal 1980 budget process. □

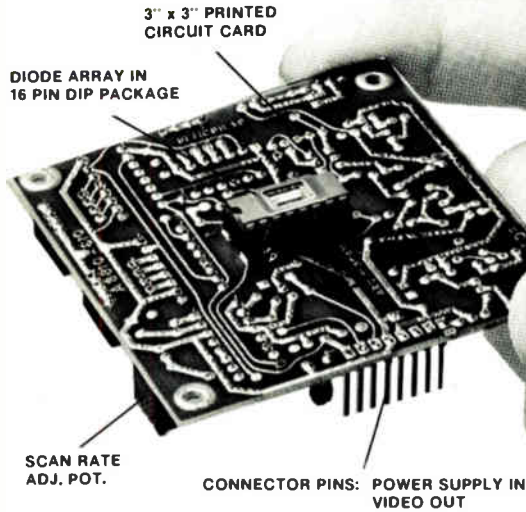

3" x 3" PRINTED
CIRCUIT CARD

DIODE ARRAY IN
16 PIN DIP PACKAGE

SCAN RATE
ADJ. POT.

CONNECTOR PINS: POWER SUPPLY IN
VIDEO OUT

ACTUAL PRICE:

\$98 or \$125

RC301 Circuit Card
with 128 Element
RL128G Array -

RC301 Circuit Card
with 256 Element
RL256G Array -

Now all engineers can afford to evaluate optical scanning techniques for their system application. For just \$98/\$125 RETICON offers the RL128G/RL256G self-scanning photodiode array with 128/256 diodes on 25 μ m (1 mil) centers and a complete interface circuit (model RC301) which allows the diode array to be operated over a wide range of scan rates and integration times to fit any system requirement. Just connect your standard power supply and get a wide dynamic range video signal out.

Applications include OCR, pattern recognition, noncontact size and position measurement, inspection for defects, spectrometer readouts and many more.

For higher resolution requirements, other RETICON self-scanning photodiode arrays are available with up to 2048 diodes in a linear configuration and 100 x 100 diodes in a matrix configuration.

This special offer valid only in the U.S. and Canada for a period of 60 days from publication. Don't delay—evaluate this exciting new technology today.

 **EG&G RETICON**

345 POTRERO AVENUE
SUNNYVALE, CALIFORNIA 94086
TWX: 910-339-9343

For assistance call: Boston (617) 745-7400, Chicago (312) 640-7713,
San Francisco (408) 738-4266, Tokyo, Japan 03-343-4411,
Wokingham, Berks, England (0734) 790772

Please see us in Hall #16 Booth 16191-2
Circle 97 on reader service card

All electronic problems are



MS-180 FREON® TF Solvent – High purity, low surface tension and fast evaporation. For critical cleaning of electronic components.



MS-190 FREON TMC Solvent – Fast cleaning action removes all types of organic flux.

FREON is Du Pont's registered trademark for its fluorocarbon compounds.



MS-165 FREON TMS Solvent – Outstanding for removal of activated rosin flux, ionic soil and particulate matter.



MS-176 FREON TES Solvent – Offers long term compatibility with reactive metals and other solvent-sensitive materials.

cleaning not alike...



That's why we offer 15 different solutions



MS-160 FREON T-P 35 Solvent — Excellent for precision cleaning and water film displacement.



MS-185 FREON TA Solvent — Stronger solvent action for oil film removal and other tough cleaning applications.

We've developed and perfected 15 different precise solvent cleaners. Miller-Stephenson spray cleaners are specially designed to meet the toughest kind of cleaning problems you'll encounter on printed circuit boards or any other electronic application.

For years we've recognized industrial cleaning as a vital link in maintaining component and system reliability. That's why we take every possible precaution to make sure that every Miller-Stephenson product has the lowest residual contamination in the industry — some approaching 5-7 parts per million. The general industry range is 50-130 ppm.

We use only the highest grade manufacturer certified solvents and nonflammable propellants and we *double filter* our solvents and propellants, first with a 5 micron filter, then with a Millipore 0.2 absolute filter. The filtered product goes directly into seamless cans, eliminating any possibility of flux contamination from seamed cans. We have complete quality control, from tanker to customer.

Send for free Solvent Selection Guide...

To help you quickly and easily find the precise solvent cleaner for your particular application, we're offering a FREE booklet. Simply circle the Miller-Stephenson reader service form in this magazine — or write to us.

 **miller-stephenson
chemical co., inc.**

George Washington Highway, Danbury, CT 06810
Phone: (203) 743-4447

• LOS ANGELES • CHICAGO • TORONTO • DANBURY, CT.
WORLDWIDE DISTRIBUTION

EM-10Y

Circle 99 on reader service card

Components

European components outlook is dim

Inflation, energy, unemployment woes dampen market growth
as manufacturers prepare for next month's Electronica

by John Gosch, Frankfurt bureau manager

"It's going to be a very tough year." That prediction, from Gernot Oswald, sales and marketing manager for integrated circuits and head of microcomputer activities at West Germany's Siemens AG in Munich, pretty much sums up how Europeans feel about the components business in 1981.

Thus, despite all the fanfare over new product introductions at the Nov. 6-12 Electronica components exhibition in Munich, apprehension will be the prevailing mood among the nearly 1,700 companies preparing to display their wares.

The causes for their concern are numerous. The continuing high rate of inflation, the nagging unemployment problem, and the climbing fuel prices in Europe's major economies are all directly or indirectly affecting Western Europe's \$10 billion-plus components markets. Compounding

the problems are the uneasiness over current world affairs and the protectionist tendencies in some countries, which could stifle free trade, and the uncertainty about whether the U. S. economic rebound is a real upswing. Taking the outlook for components, particularly semiconductor markets, on a country-by-country basis, the pervasiveness of concern is apparent.

Among the West German marketing people for example, there will be no arguing at Electronica over where one major problem for components producers lies: stagnating sales of color TV sets, traditionally the biggest single outlet for everything from electromechanical devices to integrated circuits.

As a result, semiconductor sales to the entertainment sector will creep upward only 2% to 3% in 1981, predicts Hans de Haan, market research administration manager at

Texas Instruments GmbH in Freising, West Germany. The moderate business with entertainment equipment makers will partly be compensated for by brisk semiconductor sales to original-equipment manufacturers—10% over this year's level, according to de Haan. Overall, he sees West Germany's 1981 semiconductor market going up 5% to 10%. Considered separately, ICs will do better, 12% to 15%, he says.

Rüdiger Karnatzki, marketing director for continental Europe at ITT Semiconductors Group in Freiburg, is a bit more sanguine about next year. Semiconductor sales should rise at least 15%, he says. Behind the growth will be the OEM sector, with telecommunications providing particularly strong impulses.

French fog. "Right now, business is very good in France," says Michel Brunet, research and development director at RTC-La Radiotechnique-Compélec, a components-making subsidiary of the Philips group. "But there is a fog hanging over the end of the year." As far as semiconductor devices are concerned, he sees the biggest question mark for standard ICs. "Everyone is wondering how consumers will act at Christmas time," he says.

Data processing, however, is one area where industry watchers expect continuing healthy growth. "Overall, the market is in good shape, largely because of the pressure for distributed data-processing equipment, especially minicomputers and terminals," explains André Rivière, deputy general manager for Paris-based CII-Honeywell Bull.

British layoffs. In the UK, the recession's effect on semiconductor



Looking ahead. With Electronica opening next month in Munich, European producers are wrestling with problems in their respective economies. The scene is from 1978's show.

"Every time we ask a MOS/LSI company about their custom experience, they change the subject."

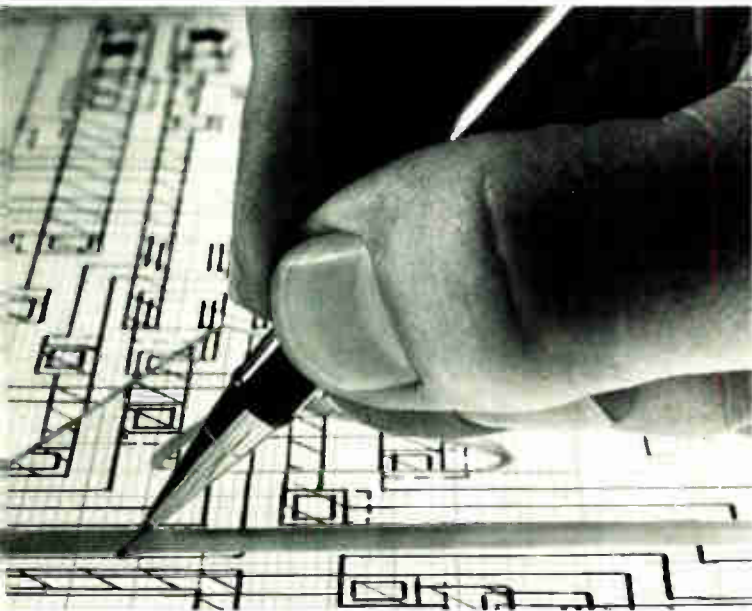

That's no surprise. Most MOS/LSI companies take on custom work only when market conditions force them to. And, no matter how big they may seem, they're usually only willing to handle a few limited jobs. So they really don't have much custom experience worth talking about.

AMI does. As the leader in the field, we have 14 years of successful custom work behind us. Since we opened for business in 1966, our engineers have designed over 1,300 LSI circuits. And for the entire period of time, custom has been the major — and most important part — of what we do.

We've designed circuits for appliance and consumer electronics companies, the telecommunications and EDP fields, the automotive industry and the military. In fact, we've created custom solutions for virtually every kind of company.

Which means that whatever business you're in, you can be just about certain that we'll understand your problems. And that we'll be able to offer you a MOS system solution tailored to the exact needs of your application.

We can design a MOS peripheral circuit for you that will interface with any standard micro-power memory and 4-, 8- or 16-bit microprocessor (ours or someone else's). Or we can offer you one of our own standard circuits customized to your specific requirements.

We've also designed complete systems on a chip with as many as 60,000 devices, and we're able to combine both linear and digital circuitry on the same piece of silicon. So if you need a chip with

switched capacitor filters, A/D and D/A converters and other linear type circuits, we can give it to you.

What's more, our SIDS (Symbolic Interactive Design System) is the world's most advanced design system. It's the reason we've been able to cut design time while producing increasingly more complex circuits.

We're very flexible. AMI's engineers work in 14 variations of the three major MOS processes: the very mature P-channel, high speed, state-of-the-art N-channel and CMOS. So when the time comes for you to choose the process you want, unlike other companies, we have no limitations to impose on you.

But AMI's flexibility doesn't end there.

If you want to design your own LSI circuits, we make it easy for you to work with us. We can interface with you at any stage of chip development, and we have the industry's only group specially organized to handle customer designed circuits. In six years, they've managed the production of over 750 of these circuits.

You'll be in good company. AMI's list of satisfied customers includes some of Fortune 500's biggest companies. But we work for a lot of small and medium size companies, too. That's another part of our flexibility. We're set up so that we can provide cost-effective, state-of-the-art results for just about any size company — and just about any size job.

If what AMI has to offer sounds like what you've been looking for, mail in the coupon. We'll send you two books that will help you decide if custom MOS is right for your application and tell you everything you should know about AMI's custom capability.

It's really the quickest way for you to start taking advantage of our experience.

I want to know more about AMI's custom LSI capabilities.

Send me the books. Have your applications engineer contact me.

Name _____ Title _____

Company _____

Address _____

City _____ State _____ Zip _____

Phone _____

What is your application? _____

Send to: American Microsystems, Inc.,
Dept. E10-9, 3800 Homestead Road,
Santa Clara CA 95051.

AMI
AMERICAN MICROSYSTEMS, INC.

Circle 100 on reader service card

FREE

TEN-TEC ENCLOSURE CATALOG

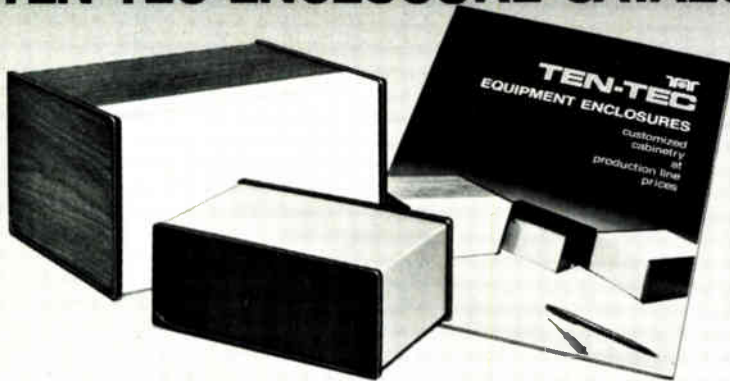

CUSTOMIZED CABINETRY AT PRODUCTION LINE PRICES

TEN-TEC's OEM cabinet line gives you *affordable* customizing freedom. 51 different sizes. Two construction styles: all-aluminum or aluminum and molded Cyclocac. Two color styles: beige with walnut-grain end panels or gray with black pebble-grain (or choose your own). Custom chassis punching. Custom silk-screening. Your cabinets arrive ready for your product. For less than you think. Ask for a quotation.

Write or call:



TEN-TEC, INC.

Hiway 411 E., Sevierville, TN 37862
(615) 453-7172

Circle 102 on reader service card

Still The **MOST USEFUL** and **MOST USED** Handbook on the Design of Reliable Equipment! *Especially Written for Design Engineers and their Managers!*

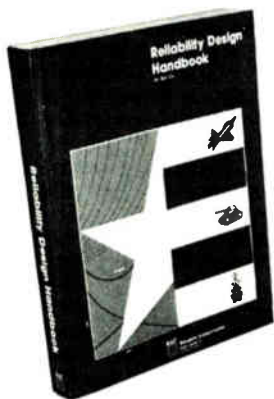

RELIABILITY DESIGN HANDBOOK (RDH-376)

- Reliability Theory and Application
- State-of-the-Art in Avionics Reliability
- Reliability Design Data and Guidelines
- Part Selection and Control
- Design Simplification and Analysis
- Design-to-Cost Goals and Achievement
- Over 400 pages: Ordering No. RDH-376, \$36 per copy (\$46 non-U.S.)

RAC



Reliability Analysis Center

RADC/RBRAC • Griffiss AFB, NY 13441 • Tel. (315) 330-4151; Autovon: 587-4151

RAC is a DoD Information Analysis Center Operated by IIT Research Institute

Circle 103 on reader service card

Probing the news

sales has been patchy. Deliveries of color TV sets have stood up well in the first half of this year, while the total unit market for black and white receivers is the highest since 1972. But a truer picture may be coming from the audio sector. There, Philips, Grundig, and Rank all have announced layoffs or closures in the UK, and other companies have shown signs of distress.

Telecommunications, led by a modernization program undertaken by the British Post Office's British Telecom, is still a strong growth sector, but government borrowing limits may eventually affect this program and slow components purchases. The cash limits have also led to a damaging moratorium on military purchases and distress to Britain's instrument makers, according to Colin Gaskell, managing director of Marconi Instruments Ltd., St. Albans. The computer sector, normally a bright spot, is showing its first signs of trouble, though the full impact has not yet shown up in component deliveries.

Italy is vague. The immediate future for the Italian components market is difficult to pin down. Prospects for the next six to eight months depend on a number of imponderables, many of them outside the influence of producers. Angelo Teli, secretary of the National Electronics Industry Association in Milan, explains the Italian state telephone company's long-discussed plans for a \$550 million investment program have finally been given the go-ahead on paper but that producers have yet to see the first order.

Teli adds that the video and audio sectors have been in a slump since April but, he says, producers are now hoping for a pre-Christmas lift. However, even if business picks up, sales during the final months of this year will only keep the components market stable, according to Enrico Villa, international sales and planning manager at SGS-ATES Electronici SpA in Agrate, near Milan. The only really bright spot for Italian components makers, then, is the industrial sector. There, consumption is growing at 15% to 17%. □

Electronics/October 9, 1980

The first scope that makes waveform measurements a simple process.

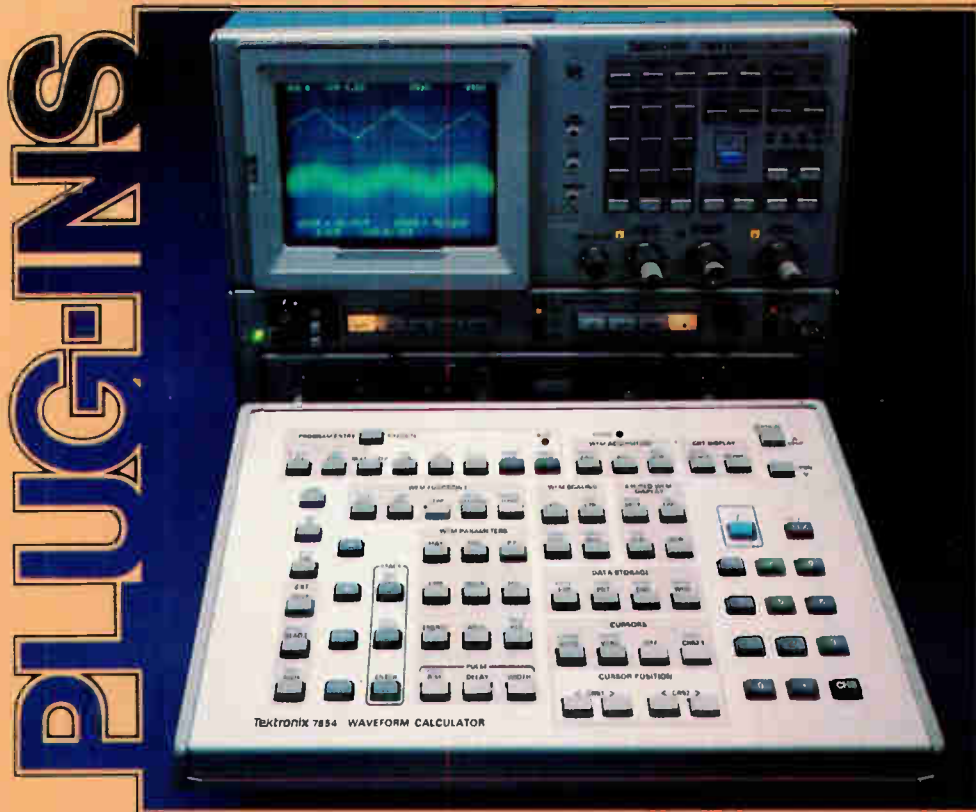

Now there's a digital scope that provides solutions to common waveform measurements, at the touch of a button. The 7854 Oscilloscope, featuring dc to 400 MHz digital and analog bandwidth. Its Waveform Processing, Keystroke Programming and IEEE-488 Bus can help you make significant advances in test and measurement productivity.

Waveform Processing.

The 7854 keyboard increases efficiency by reducing common measurements to push-button simplicity.

You'll save time and improve accuracy on rise time, fall time, delay, width and other pulse parameter measurements.

And for the first time, you'll have a scope that can automatically perform arithmetic functions, integration, differentiation, smoothing and signal averaging. Plus there's a Cursor Mode to parameterize any area for measurement. It even provides Δ -Time and voltage readouts.

Keystroke Programming.

It's as simple as a hand-held calculator. The keyboard lets you make several measurements automatically or generate routines for your own tailored measurement tasks. For example, you can use Keystroke Programming to automatically find the area of an X-Y display.

IEEE-488 Bus.

For even further processing capabilities or for mass storage, use our Bus to transfer data and programs to or from the 7854.

In fact, you may want to consider the Tektronix WP 1310 Waveform Processing System. It lets you combine the 7854 with the Tektronix 4052 Graphic Computing System for automation of extended waveform tests and measurements.

Want more information on the 7854? That's a simple process, too. Just call or write Tek at the address nearest you.

U.S.A., Asia, Australia, Central & South America, Japan
 Tektronix, Inc.
 P.O. Box 1700
 Beaverton, OR 97075
 Phone: 800/547-1512
 Oregon only 800/644-9051
 503/644-0161
 Telex: 910-467-8708
 Cable: TEKTRONIX

Europe, Africa, Middle East
 Tektronix International, Inc.
 European Marketing Centre
 Postbox 827
 1180 AV Amstelveen
 The Netherlands
 Telex: 18312

Canada
 Tektronix Canada Inc.
 P.O. Box 6500
 Barrie, Ontario L4M 4V3
 Phone: 705/737-2700

Tektronix
 COMMITTED TO EXCELLENCE

Military electronics

NATO dollars are flowing

American firms continue to pick off prime contracts despite the unhappiness of their European rivals

by James Smith, McGraw-Hill World News

Despite European concerns that U. S. firms are walking away with too many prime high-technology contracts, opportunities for electronics business with the North Atlantic Treaty Organization have never been better. If funding requests to be submitted to defense ministers next December are approved, NATO will probably lay out \$1 billion over the next five years for fresh programs and updates of existing communications and military command and control systems. And spending will continue apace into the 1990s.

Among the projects:

- ACECCIS (Allied Command Europe Command and Control Information System), an update and partial automation of present manually operated information systems.
- Ongoing modernization of Nadge (NATO Air Defense Ground Environment) through replacement of

radars, addition of computer capacity, and updating of control centers.

■ ACCS (Air Command and Control System), a new system and part of NATO's long-term defense program. It can be considered a subsystem of ACECCIS, incorporating both Awacs (Airborne Warning and Control System) and the updated Nadge.

■ A mammoth 15-year modernization of NICS (NATO Integrated Communications System), the basic communications network for the organization's civil and military authorities. It uses satellites, national telephone links, and NATO's own transmission facilities.

Bundle for Britain. Contracts for the programs are rolling in. Last month a consortium consisting of Hughes Aircraft Co., Plessey Co., and Marconi Radar won a \$240 million contract to update Britain's air defense system. This award comes

on top of a \$150 million contract to modernize the West German air defense network awarded exclusively to Hughes last summer.

The U. S.'s General Electric Co. sold two radars worth \$20 million to the UK last month, and Hughes, Plessey, and the French firm Thomson-CSF are competing for two others. Burroughs Corp., Computer Services Co., and Hughes are bidding on a \$60 million command and control system (eventually part of ACECCIS) for NATO's northern region, Denmark and Norway. Also, last month the NATO infrastructure committee awarded Ford Aerospace Corp. a \$90 million contract for a so-called Gap Filler communications satellite to bridge the time gap between the existing NATO Satcom 3 program and Satcom 4.

Some of the biggest programs will hit their stride after the 1980-85 funding period. Planning for the new ACCS system is only getting under way with establishment of a management agency. There is as yet no system architecture. But NATO military experts think procurement will start by 1985 and perhaps earlier.

NICS dollars. In addition, procurement for the 15-year phase 2 NICS modernization, the cost of which has now been increased from \$1.5 billion to \$2 billion, will start in earnest in 1985-86. If requests for an additional \$3 billion in infrastructure funds are met by NATO ministers in December, the organization will probably spend about \$500 million on NICS over the next four years. This sum will include some funds for additions to the first-phase program, which is now expected to cost nearly \$1.1 billion and to be operational in

Americans' success annoys NATO partners

European firms are unhappy about the growing dominance of U. S. electronics and aerospace firms successful in snatching choice North Atlantic Treaty Organization business. For example, practically all key prime contractors for NICS 1, the NATO Integrated Communications System, were Americans, exceptions being Siemens AG and AEG-Telefunken of West Germany. There has also been what some Europeans find a disturbing tendency for U. S. rivals to obtain repeat business.

One of these, Hughes Aircraft Co., which was system contractor for the Nadge (NATO Air Defense Ground Environment) consortium in the late 1960s, not only has piled up \$230 million in British and West German Nadge updates this year, but has also won contracts for integration of Awacs (Airborne Warning and Control System) with Nadge ground stations—not part of the Nadge program but closely associated with it. Also, Ford's Aerospace Corp. Gap Filler award came on top of its Satcom 3 business.

Much of the U. S. firms' success, of course, comes from greater cost competitiveness, especially on systems being produced for the U. S. military. But another key reason appears to be their greater willingness, compared with Europeans, to meet NATO's often highly complicated specifications, even though it means increased development costs.

—J. S.

Now, EAROM is airborne.

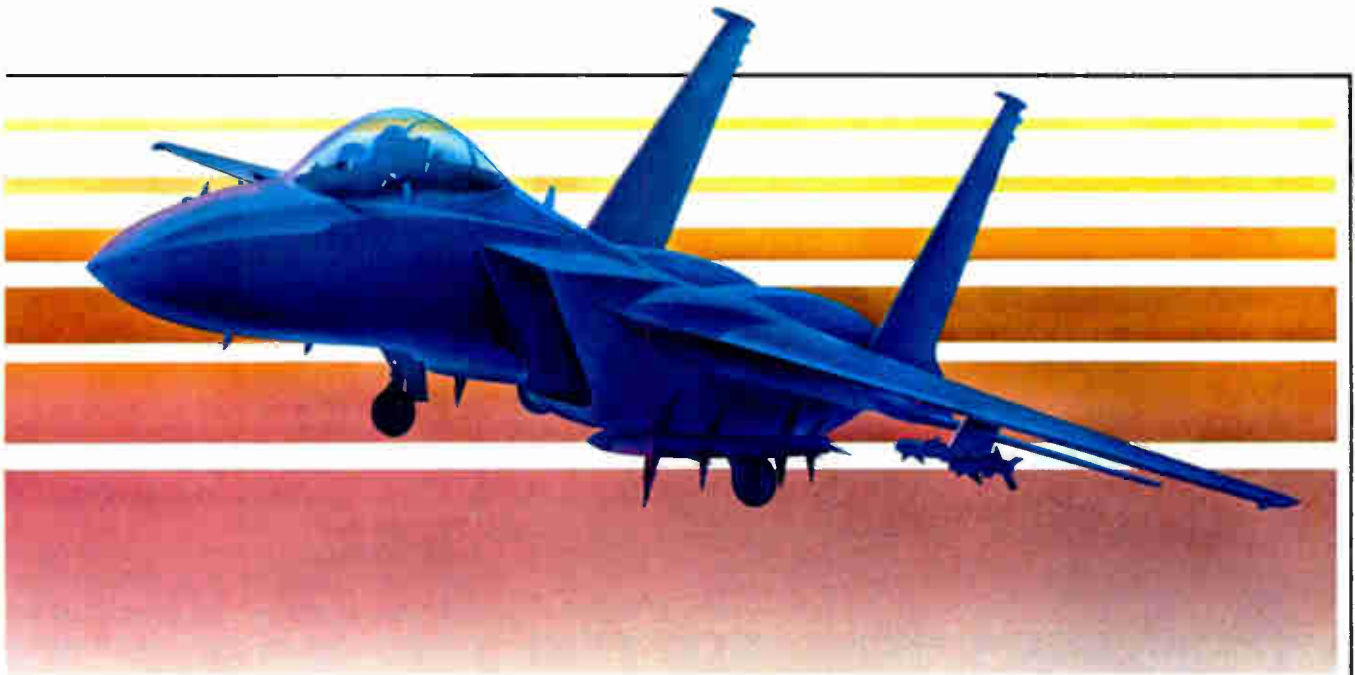

Applications for General Instrument's popular and proven non-volatile EAROM memory chips are soaring. In fact, they're on today's most advanced aircraft.

Our Hi-Rel EAROMs meet full military temperature requirements (-55°C to $+125^{\circ}\text{C}$) and are processed and screened per Mil-M-38510/Mil-STD-883B. Quality assurance and reliability are guaranteed by manufacturing controls which are certified to Mil-Q-9858A and Mil-I-45208A.

The design maturity and performance reliability of General Instrument's EAROMs are proven facts. Over 6-million devices have been shipped. Enough to position our EAROMs at the forefront of available technology,

Features	EAROM	RAM & Battery	UV PROM	TAPE	CORE	DISC
Word Alterability In-System	Yes	Yes	No	Yes	Yes	Yes
Access Time	$1\mu\text{s}$	$<0.5\mu\text{s}$	$<0.5\mu\text{s}$	secs	μs	ms
Re-programming Time	11ms	$<500\text{ns}$	15 mins	secs	μs	ms
Radiation Hardness	good	poor	poor	good	good	good
Temp Range	-55°C to $+125^{\circ}\text{C}$	ltd. by battery	-55°C to $+125^{\circ}\text{C}$	limited	limited	limited

replacing memory devices listed on the table here. With bit densities from 512 to 8192, EAROMs offer significant size, weight, reliability and power advantages over rotating memories and core, as well as clearcut advantages over RAMs and UV PROMs. The electrical alterability of EAROMs also facilitates in-system re-programmability.



General Instrument's Hi-Rel EAROMs are currently used in flight recorders, navigation and guidance systems, industrial instrumentation and measurement...wherever data recording and retention are needed. Unpowered data retention is guaranteed for one year over the Hi-Rel temperature range.

For more information on our Hi-Rel and Industrial EAROMs, write to: Microelectronics Division, General Instrument Corporation, Dept. LD, 600 West John Street, Hicksville, New York 11802, or call 516-733-3358 for applications assistance.

We help you compete.®

GENERAL INSTRUMENT

Our Alphanumeric Ticket Printer



For total versatility use our DMTP-9 programmable ticket printer to print the full alphanumeric ASCII character set. Print with ribbon on standard tickets, cards or single-sheet forms, or use impact-sensitive paper for multiple copies. Even program character pitch to handle standard or enhanced printing of up to 48 characters per line on 39- to 59-line tickets. Stepper motor advance for 6 lines to the inch or .110" for graphics.

Mountable on tabletop or wall, the DMTP-9 does it all with advanced stepper motor control electronics and a long-life needle matrix print head. For still more versatility, get it with the optional controllers, power supplies and interconnect cables systems for complete microprocessor/microcomputer compatibility, too. But first, write or call to get more details. Ask for Bulletin 924.



**PRACTICAL
AUTOMATION, INC.**

Trap Falls Road, Shelton, Conn. 06484/Tel: (203) 929-5381

Circle 106 on reader service card

Probing the news

1984, about five years late.

One of the problems spotted quickly in NICS planning—in the early 1970s—was the technical difficulty of obtaining nodal switches capable of accommodating the jumble of subsystem interfaces. These included analog, digital 64-kilo-bit/second pulse-code modulation, and digital 16-/32-kb/second delta modulation, as well as interfaces for narrowband speech-processing terminals and for emerging data services. It was decided to settle in stage one for separate voice and data systems—the IVSN (Initial Voiced Switched Network) being installed by ITT North Electric Co. and TARE (Telegraph Automatic Relay Equipment) by Litton Industries Inc. The third major subsystem, three Satcom 3 satellites, was launched by Ford Aerospace, which is installing 21 ground stations and modifying 12 others.

Questions. The upcoming debate over transition strategy will treat several critical questions, including how much of the NICS 2 system will eventually be scrapped and how much updated, and what technologies NICS should aim toward. NATO experts are divided between two switching technologies—16-/32-kb/second continuous-variable-slope delta (CVSD) modulation, the standard toward which NATO tactical military systems are moving, and 64-kb/second PCM, the direction of the European national telephone authorities. CVSD standards are already written into the NICS architecture and are also being defined for national tactical communication systems for the 1990s.

If NICS moves in this direction, some U. S. and British suppliers will probably be in a good position with CVSD hardware that will become available during the NICS 2 procurement period: the New U. S. unit-level switch TCC 42 and Britain's Ptarmigan tactical communications system. However, there are growing concerns that CVSD technology may be becoming dated and that NICS modernization could be more economically ensured by an evolutionary growth based on PCM. □

INTERNATIONAL OE CRYSTAL OSCILLATOR ELEMENTS

International's OE Series of Crystal Oscillator Elements provide a complete crystal controlled signal source. The OE units cover the range 2000 KHz to 160 MHz. The standard OE unit is designed to mount direct on a printed circuit board. Also available is printed circuit board plug-in type.

The various OE units are divided into groups by frequency and by temperature stability. Models OE-20 and OE-30 are temperature compensated units. The listed "Overall Accuracy" includes room temperature or 25°C tolerance and may be considered a maximum value rather than nominal.



All OE units are designed for 9.5 to 15 volts dc operation. The OE-20 and OE-30 require a regulated source to maintain the listed tolerance with input supply less than 12 vdc.

Prices listed include oscillator and crystal. For the plug-in type add the suffix "P" after the OE number; eg OE-1P.

OE-1, 5 and 10 can be supplied to operate at 5 vdc with reduced rf output. Specify 5 vdc. when ordering.

Output — 10 dbm min. All oscillators over 66 MHz do not have frequency adjust trimmers.

Catalog	Oscillator Element Type	2000 KHz to 60 MHz	67 MHz to 139 MHz	140 MHz to 160 MHz	Overall Accuracy	25°C Tolerance
035213	OE-1	\$15.66			± .01%	± .005%
035214	OE-1		\$17.99			
035215	OE-1			\$22.63	-30° to +60°C	
035216	OE-5	\$19.44			± .002%	± .0005%
035217	OE-5		\$22.91		-10° to +60°C	2 - 66MHz
035218	OE-5			\$30.17		± .001% 67 to 139 MHz ± .0025% 140 to 160 MHz
Catalog Number	Oscillator Element Type	4000 KHz to 20000 KHz		Overall Accuracy	25°C Tolerance	
035219	OE-10	\$22.91		± .0005% -10° to +60°C	Zero trimmer	
035220	OE-20	\$33.65		± .0005% -30° to +60°C	Zero trimmer	
035221	OE-30	\$69.63		± .0002% -30° to +60°C	Zero trimmer	



**INTERNATIONAL
CRYSTAL
MFG. CO., INC.**

10 North Lee
Oklahoma City, OK 73102
405/236-3741

HIGH-TECHNOLOGY ELECTRONICS IN JAPAN

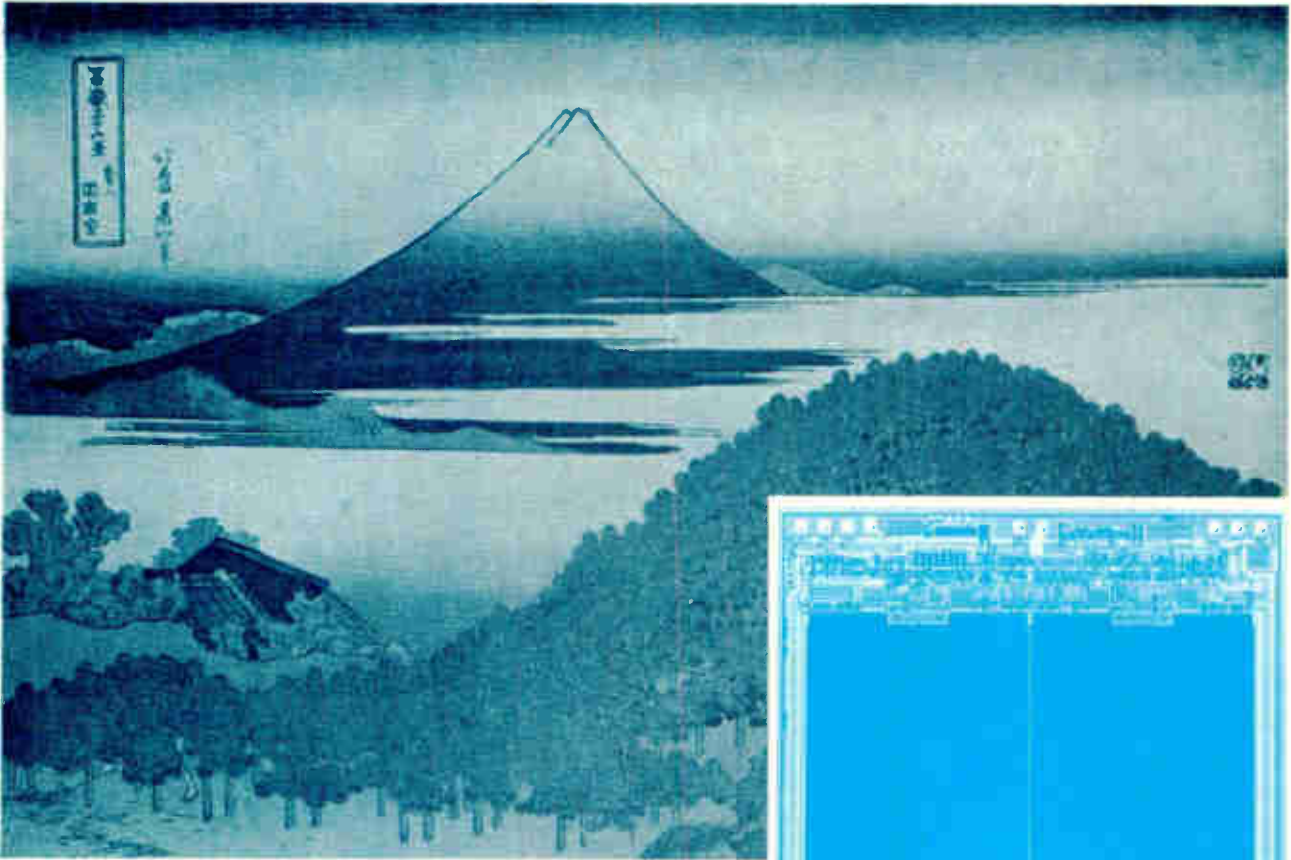

A LOOK AT
ITS ORIGINS,
ITS PRESENT STATE,
ITS FUTURE

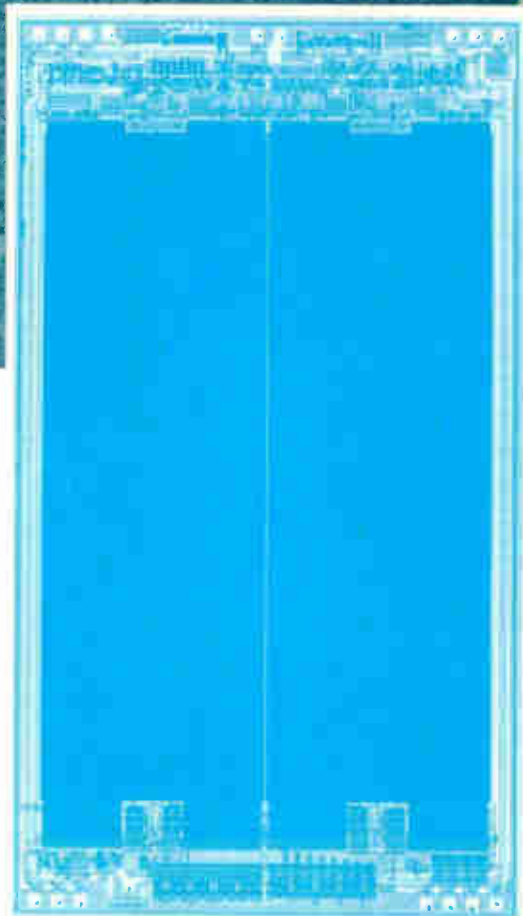

NEC. THE COMPUTER AND COMMUNICATIONS COMPANY

that has its own
advanced semiconductor technology.

The reputation of a company can rest on a few square millimeters.
To assure that our satellite earth stations, computer terminals
and other electronics products would perform to our standards,
we began making our own electronic parts and components.
Now NEC is a leading manufacturer of semiconductors in the world.
The large and the small. NEC does it all with a professionalism and pride
that have earned it the confidence of customers in over 130 countries.

NEC

Nippon Electric Co., Ltd.
Tokyo, Japan



Kyushu Nippon Electric Co.

GROWTH HAS ITS REASONS

By Yumi Murakami

The dynamism and potential of the Japanese electronics industries is almost without parallel. Last year, these industries achieved a total production figure of \$32.5 billion, which means they expanded 3.7 times during the past 10 years and registered an average growth rate of 12.6%. Japan's total economy grew at an unprecedentedly high rate during the 1970s, too, primarily because of its electronics industries, which profited by an upgrading of component quality, reliability, and production.

Unlike developments in other countries, the electronics industries' progress in Japan is attributable to specialization in consumer appliances. The introduction of merchandise like TV sets that appeals to the needs of consumer households worldwide and continuing innovative technology following the successful marketing of the transistor radio in the 1950s are factors in the growth.

Also, Japan's concentration on consumer electronics development, rather than on military research and development, is important. Whereas the industrial electronics industries in Europe and the U.S. developed with the support of large

government projects, the Japanese electronics industries did not. For example, technological advancement by the American industrial electronics industry—including the development of integrated circuits—was largely supported by an enormous U.S. budget for R & D in such areas as national defense and space exploration. Until recently, development of industrial electronics technology, requiring huge advance investment for large projects, was not required in Japan.

Another contribution was Japan's high economic growth between 1960 and 1970, combining with the substantially increased income levels to create a demand for leisure goods. Unlike the trend in Europe and the U.S. toward widely varied leisure activities, Japanese households fixed on consumer electronics for leisure activities.

The growth of the Japanese electronics industry faced a turning point in the mid-1970s. Because of the saturated domestic market and import restrictions by developed countries, a high growth in production volume was not to be expected. Furthermore, the driving force

of developing countries' industries was a potential threat to the competitive strength of Japan.

In response, Japanese industries introduced products with high value added. They achieved further growth, accompanied by an increase in nonprice-competitive strength, through the application of production and management techniques. In the future, the consumer electronics industry, which has reached substantial maturity, will probably not experience further rapid growth. High technology definitely will be the key to the expansion of electronics applications from consumer products to industry usage.

Certainly, integrated-circuit technology represents the leading edge of the development of the electronics industries in Japan, as in any industrially developed country. What follows is a look at the semiconductor industry in Japan, with particular attention to the industry's quest for mass-production volumes and high-quality products. Components are important too, and a discussion of a very important class—tubeless electronic displays—follows the section on the semiconductor industry.

An Advanced Memory Test System for the 1980s.



Minato Electronics new 9300M Automatic High-Speed, Large Capacity Memory Test System has surpassed present memory developments with a high 30 MHz memory testing speed and four simultaneous parallel test functions. In addition, a pin matrix function increases yields. And hybrid circuits and a pattern generator for free testing of memory capacity are also featured. The 9300M Memory Test System has extensive functions and capabilities which meet stringent memory test requirements of the 1980s.

- Test speed: 30 MHz
- Hybrid circuits: Driver, comparator, etc.
- Four tests including a function test and DC test can be accomplished simultaneously
- A pin matrix function which eliminates test board wiring
- A memory test pattern generator
Microprogramming is facilitated with 700 commands
Control memory capacity is expandable to 1 K words
- Address multi memory measurement
An address multi scramble function is utilized
- Fault analysis
Expandable 256 K bits of failure memory
A real time memory is utilized
- Timing generator
Resolution: 100 ps
Split level: 16 levels
- Partial and area inversion test are possible
- Built-in auto-skew adjustment
- Software
RX-11 with high through-put is employed

Automatic High-Speed Testing at 30 MHz

9300M

Memory Test System



MINATO ELECTRONICS INC.

4105, Minami Yamada-cho, Kohoku-ku,
Yokohama 223, Japan
Phone: 045-591-5611
Cable: MINATOELEC YOKOHAMA

SEMICONDUCTOR INDUSTRY MOVES BEYOND HIGH TECHNOLOGY

There are two major national semiconductor industries, but they are very different. It is not surprising that the *modus operandi* of the Japanese semiconductor industry should differ from that of the U.S. The development of any industry usually differs from country to country, due to differences in the availability of skilled labor, capital, and technology and, at other times, due to the competitive situation and economic environment of a given nation. In any case, it is not necessary for a country that learned the methodology of a new industry from another country to structure its own development process identically to that of the place of origin.

If we compare the structures of the American and Japanese semiconductor industries, we find some clear differences between "starter" and "follower." The semiconductor industry in the U.S. developed as a typical technology-intensive effort. The most important factor was technology to produce pure crystalline silicon and to design accurate and efficient circuits.

If a new U.S. company had the technology to develop a new product, it could sell the product at a price that not only absorbed the cost of production, but also created profits. This is one reason why many excellent technical experts could start business ventures. Furthermore, many investors were attracted to these businesses because of their high profitability and need for relatively small amounts of capital.

The Japanese, who have more recently entered the semiconductor market, must insure that the industry is more than simply a high-technology operation. The Japanese manufacturers of semiconductors, of necessity, must put great effort into lowering production costs and developing the highest-quality products, since they face stiff American price competition.

To compete in the world market, the Japanese had to build large facilities in order to receive increasing returns of scale. As

is well known, the technological revolution in the semiconductor industry is moving at a very rapid pace, thereby causing technology, products, and facilities to become outdated quickly. In order to survive, then, it is necessary for semiconductor manufacturers to receive reasonable returns on their investments by selling products as quickly as possible and by reinvesting money in research and development and in new and updated production facilities.

This pace makes the business quite risky. In 1974, for example, the investment of Japanese manufacturers in R&D was approximately 22% of sales, and the investment in their facilities was approximately 21% of sales.

It is a special kind of Japanese company that enters the semiconductor business. It is not a venture company as in the U. S. The Japanese companies that entered the business are big corporations that have stable internal demands for integrated circuits and that also have other highly profitable divisions, namely, telecommunications, computers, and consumer electronics. They have survived their startup periods in the highly competitive semiconductor market by investing profits from their telephone, microwave, television, and other businesses, at the same time that they benefited from in-house demands for their new products. This distinctly different environment that surrounded Japanese semiconductor manufacturers at the beginning has influenced their competitive stance.

Controversy between the Japanese and American semiconductor industries started about 1977. The most extreme criticism against the Japanese IC companies was raised by semiconductor manufacturers in the areas around Boston and Santa Clara, Calif. Their criticism focused on the strategy the Japanese used in their R&D.

The arguments were that the Japanese manufacturers copied

The power of Toshiba microelectronics.

airborne electronics radio/TV broadcasting VHF/UHF communications satellite communications educational equip. microwave communications telephone systems airfield lighting systems navigational aids

ATC systems automatic ticket inspection equip. ticket issuing machines radar equip. facsimile systems mobile communications mail processing machines TV telephone equip. small business computers

automatic vehicle identification systems CATV computer-aided message switching systems banknote processing machines closed circuit TV air cargo terminal systems

dictating machines, automatic teller machines cash dispensers automatic depositors diagnostic ultrasound equip. CT scanners

multi-phasic health check-up systems radiotherapy equip. computer terminals computer peripherals nuclear medicine equip. optical character readers

word processors calculators biomedical measuring/monitoring personal computers biochemical analyzing equip. minicomputers patient monitoring systems teleprinters data entry systems

document filing systems copying machines diagnostic X-ray equip. process computers hospital automation systems auto filing systems distributed data processing timepieces nuclear turbines/generators

power generating equip. industrial motors industrial automation systems AC/DC electric locomotives elevators/escalators steel & paper mill equip. air conditioners VTRs/TV cameras/video tuners hi-fi components

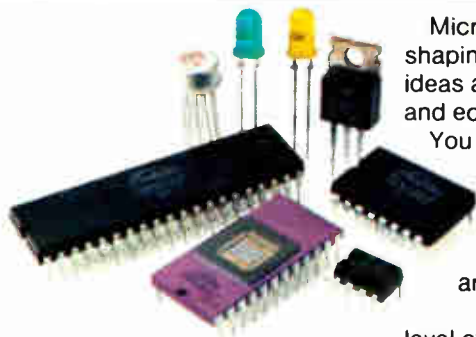

Microelectronic components being developed at Toshiba today are shaping the lifestyles of the future. They form the very core of powerful ideas and applications which reach out to satisfy human, environmental and economic priorities.

You can see the gigantic role they are playing in everything from brain CT scanners and optical character readers to satellite communications and computers that verbally instruct. Sitting at the controls for these 20th century wonders is a complex network of semiconductors. Miniaturized, thinking electronic elements that are epitomized by Toshiba's world-first C²MOS-LSI.

That's the technological power that Toshiba emits. And as the level of expectations continues to rise, people will continue to look to Toshiba for new electronic directions.

TOSHIBA
TOSHIBA CORPORATION TOKYO JAPAN

● Communications Systems (broadcast/telephone/facsimile) ● Information Systems (computer/word processor/data entry/computer peripherals & terminals) ● Business Machines (copying machines/calculators) ● Labor-Saving Equipment (mail processing/banknote processing machines) ● Medical Equipment ● Electronic Components

Circle 112 on reader service card

American technologies and received aid from the Japanese government in order to develop their own technology. Thus, the argument went, it is not fair for American corporations to try to compete with Japanese corporations in the same market. Therefore, U.S. semiconductor houses reasoned, that the Government has some obligation to assist the American companies so that they can compete with the "Japanese alliance of corporations and government."

It is well recognized by many people in the U.S. that the purposes of these arguments are not only to criticize the strategy of the Japanese corporations, but also to obtain some assistance from the American government. As a matter of fact, one of the main reasons why the position of a venture company has weakened in the U.S. market is that the semiconductor industry has developed into a capital-intensive industry that utilizes mass production. It is no longer at the stage of being a technology-intensive industry.

This is also apparent in Japan, where development of very large-scale integration is dominated by five big corporations; other smaller companies are concentrating on specialized IC products. Therefore, American semiconductor companies' positions in the U.S. market were weakened by the entry of corporations that have mass-production and mass-distribution systems; that the new entries are foreign companies is a secondary consideration.

The competitive conditions in the semiconductor industry, which has become very highly developed, are quite similar to those in the consumer electronics industry. One of the important factors allowing a corporation to compete successfully in this market is its ability to offer a product of high quality at a low price. To satisfy these conditions, a company should have a mass-production technology that also can produce high-quality products. Moreover, it should have a strong mass-distribution system in order to market these products. It is equally important for a corporation to acquire technology that can develop semiconductor products, applied semiconductor products, or both for user needs. Thus a big company, which has integrated its production system from semiconductors to some finished goods based on ICs, will have a stronger competitive position in the marketplace.

As mentioned above, companies in Japan that satisfy these conditions are enjoying good positions in the market. It is not an overstatement to say that, along with the development of the industry, competitive conditions changed—and this change unexpectedly created greater demand for Japanese semiconductors. Also, needless to say, American corporations that satisfy these conditions are enjoying great success in the market, even as difficulties increase for the venture companies that achieved success with their technological excellence but with small amounts of capital.

The technological development of the semiconductor in Japan can be seen in such products as the one-chip microcomputer and the random-access memory. If a system of many ICs is replaced by a single-chip microcomputer, the resulting design would be smaller and sell at a lower price at the same time that some complicated functions could be added. When products are redesigned to exploit these functions, many kinds of mass-produced products such as consumer electronic equipment, office equipment, automobiles, etc., are able to sell more competitively. This is important for the Japanese makers of these products, and so the demand for microcomputers has a high growth potential, especially since mass production is the strongest point of Japanese technology.

Another market expected to grow rapidly is that for the RAM. Lowering the cost of information units by increasing memory density gives more options for a computer memory. For example, many systems can be organized so that parts of their memories can be used as a buffer—increasing necessary microcomputers, and, therefore, the number of multipurpose ICs. This is a strategy that lowers the cost of existing products, rather than developing ground-breaking new products. Of course, the added demand for the ICs increases production efficiency for their makers.

Looking over the revolution in random-access memories, we see the greatest demand in the RAM market is for the 16-K part, which is expected to reach its peak in popularity in 1980. Technologically, it is possible to begin the mass production of 64-K RAMs by then. However, the return on investment in 16-K products has not been sufficient, so their life cycle should be extended. Because of this, the production of 64-K chips is

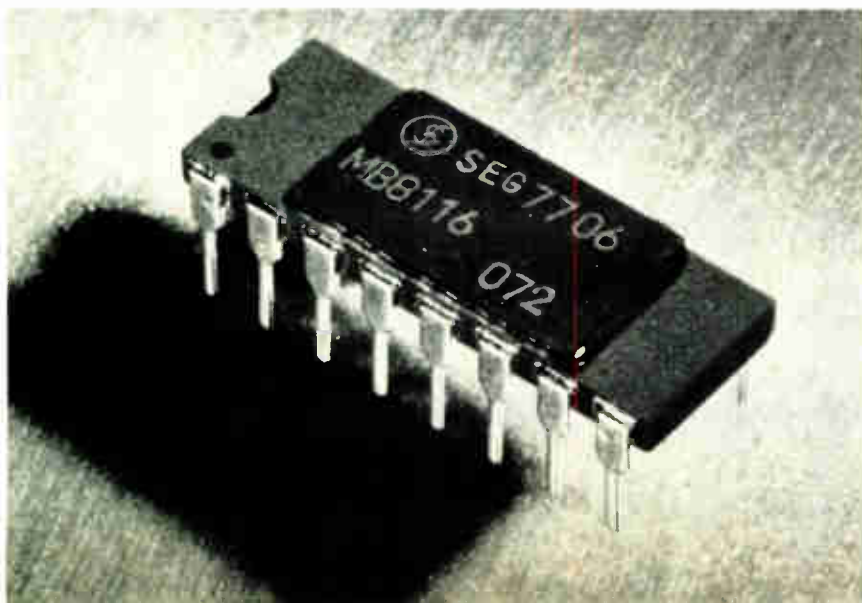

Since denser integration means more and more memory bits can be fitted into a RAM package, the popularity of these chips continues to grow.

Low-Cost, High-Performance Recorders for OEM and Lab Users

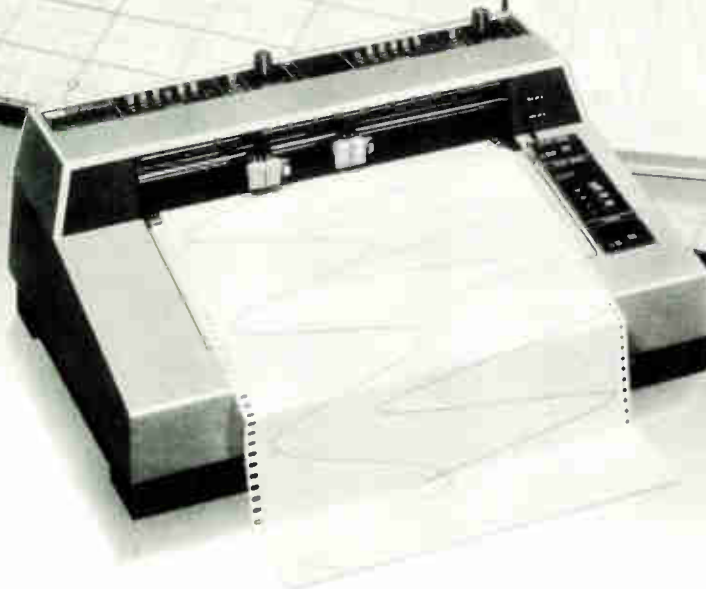

MODEL 3022 A4 X-Y recorder

MODEL 3021 Flatbed pen recorder

Models 3021 & 3022 offer maximum reliability and long operating life through the use of new, non-contact servo elements—ultrasonic pen position transducer and brushless DC servomotor.

Model 3021 is a one- or two-pen flatbed recorder, which records on Z-fold or roll chart. Model 3022 is a 250mm×180mm, one-pen X-Y recorder. With a $\pm 0.25\%$ accuracy, the recorders use disposable quick-change felt pens for excellent line quality.

Choice of a single or 12 input ranges, and a variety of options enables Models 3021 & 3022 to perform over a wide range of applications including OEM and laboratory uses.

- OEM discount available for both Models 3021 & 3022.



A complete range of new, top-quality recorders is also available...
Our new recorder family also includes well designed 1 to 3 pen vertical or flatbed recorders, 6 and 9-pen flatbed recorders, DIN A3, A4 and 250mm × 250mm X-Y recorders

Over 60 years of quality, precision instruments

YEW

YOKOGAWA ELECTRIC WORKS

YOKOGAWA ELECTRIC WORKS, LTD. 9-32, Nakacho 2-chome, Musashino-shi, Tokyo 180.
Japan Tel Tokyo 0422-54-1111 Telex 02822-327 YEW MT J
SALES OFFICE: P.O. Box 4125 Shinjuku Center Bldg (50F) 1-25-1 Nishi Shinjuku, Shinjuku-ku,
Tokyo 160, Japan Tel 03-349-0611 Telex J27584 YEW TOK

U.S.A.: YOKOGAWA CORP. OF AMERICA 2 Dart Road, Shenandoah, Ga. 30265, U.S.A. Tel: 404-253-7000 TWX: 810-/66-4760 YCA SHEN
EUROPE: YOKOGAWA ELECTRIC (EUROPE) B.V. Nederhoven 17-21, 1083 AM, Amsterdam, The Netherlands Tel: 020-423194 Telex: 14094 YEW NL
ASIA: YOKOGAWA CORP. OF ASIA PTE. LTD. Suite 805 World Trade Centre, No. 1 Maritime Square, Singapore 0409 Tel: 2729537 Telex: RS26137 YASSIN

limited to very special-purpose products, which makes the cost of these memories still higher.

However, the 64-K RAM is expected to begin replacing the 16-K part in 1981 and 1982 and to reach its peak in popularity in 1984. It is expected that the 128-K RAM will reach its peak in popularity by about 1988. Furthermore, a prototype of a 256-K memory has been presented, but it will take some time to develop it to the production stage.

Production technology has played an important role in increasing RAM densities. Ultraviolet light was utilized for photolithographic patterns in LSI memories; however, there is a limit of 1 micrometer for each pattern feature. It is necessary to use electron beams or X rays instead of UV rays in order to draw a pattern with less-than-1- μ m features. For instance, the 256-K RAM developed by the Nippon Telegraph and Telephone Public Corp. utilizes electron beams.

What is more, a 1-megabit RAM cannot be produced by making a photolithographic mask and transcribing a circuit pattern on a silicon wafer by using beams. So it is necessary to develop a method for directly transcribing a pattern on a wafer with electron beams. This technological development has been pursued by a VLSI research group, the national project group that has contributed in finishing the fundamental research into this technology. Now each manufacturer is researching utilization of the technology.

As mentioned, the mass-production technology of semiconductors is the major strength of the Japanese semiconductor industry in this very competitive market. Of course, one of the most important impetuses for the development of mass-production technology is lowering the cost of the product.

One of the methods many American corporations used to lower cost was to move their assembly lines to Southeast Asian countries. In the case of Japanese manufacturers, however, this strategy was not taken. They tried, instead, to automate their assembly lines by improved mechanization.

For example, they have developed automatic machines for installation of chips and wire bonding in their assembly lines, and they utilize these newest machines in their factories in order to reduce labor requirements. This automation of the assembly line has contributed not only to improving productivity, but also to increasing the reliability of the products by minimizing human error.

There are generally two ways to increase the reliability of products. One is to eliminate inferior products by strict inspection and screening. Another is total quality control in order to prevent inferior products.

The first method makes the cost of products higher by adding the costs of the inspections, screening, and loss of rejected products. On the other hand, the latter method increases the yield of products and reduces the cost of inspections. Therefore, it produces more reliable products at lower costs and has been utilized by most of the Japanese manufacturers, including those in the semiconductor industry.

Thus reliable mass-production technology is supported by the automation of production and by high quality control, which is as important in design as in production. To begin with,

NON-VOLATILE ANALOG MEMORY!

HAVING PROBLEMS
WITH AUTOMATIC ZERO
AND SPAN CALIBRATIONS?

Why not put our modules XE-120, 121 and 122 to work for you?

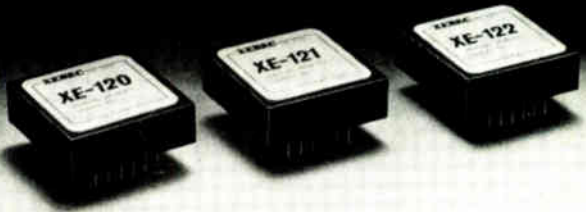

Specifications

Model	XE-120	XE-121	XE-122
Input & Output	0 - +5V or 0 - \pm 5V		
Input Impedance	1M ohm		
Accuracy	\pm 0.5%/FS	\pm 0.1%/FS	\pm 0.05%/FS
Power Supply	DC \pm 15V \pm 35mA		
Dimension	50W x 50D x 16H mm		

Applications

- Automatic zero & span calibration of pollution analyzers
- Automatic zero adjustment of medical instruments
- Automatic zero adjustment of strain amplifiers
- Automatic zero adjustment of electronic balances
- Automatic zero adjustment of logarithm amplifiers

OUR OTHER MODULES INCLUDE:

- * DIGITAL PANEL METERS
- * A/D CONVERTERS
- * LINEARIZERS
- * PEAK HOLDERS
- * DC-DC CONVERTERS

European Agents include:

- Tekelec Airtronics Tel. 027-75-35 France
- Dema Electronic GMBH Tel. 089-288018 Germany
- Microscan GMBH Tel. 040-630-5067 Germany
- Klassing-Reuvers Tel. 076-879250 Holland
- Mini Peripherals SA Tel. 01-568144 Switzerland

We are now actively seeking a few more sales agents for America and S.E. Asia.

We welcome all inquiries. Please contact:

XEBEC TRADING CORP.

No. 21-12, Kasuya 4-chome, Setagaya-ku, Tokyo, 157 Japan.
 Cable: XEBEC JAPAN
 Telex: 2324788 XEBEC J.
 Telephone: (03) 326-1771

Hitachi's New Port --YOUR MIGHTY



V-550B DC~50MHz DUAL-TRACE · DELAYED SWEEP



V-352 DC~35MHz DUAL-TRACE



V-202 DC~20MHz DUAL-TRACE



V-151B DC~15MHz SINGLE-TRACE

• Economically priced oscilloscope

Hitachi Oscilloscope, having reached a new level of high performance at an astonishingly low price, has been spotlighted as a forerunner of general-used oscilloscopes. Taking full advantage of this past achievement, Hitachi Denshi,

Ltd. has concentrated its excellent oscilloscope technology on solution to the problem of cost performance, and in June 1980 succeeded in developing a new oscilloscope.

able Oscilloscopes RIGHT HAND.



V-302B DC~30MHz DUAL-TRACE

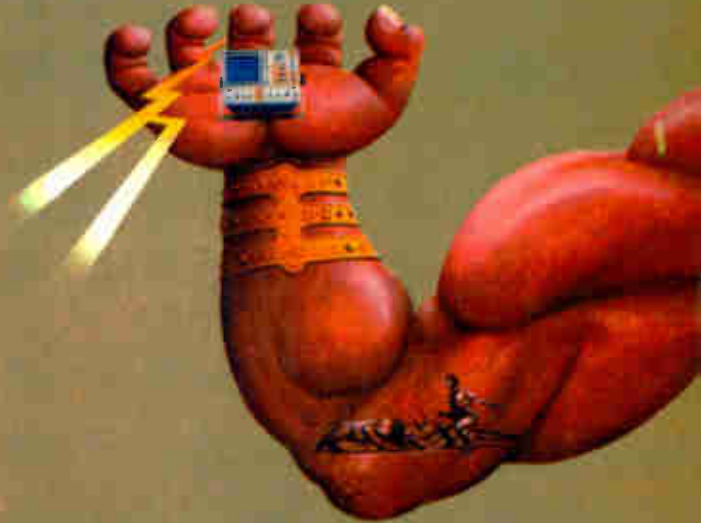

V-152B DC~15MHz DUAL-TRACE



V-059B DC~7MHz SINGLE-TRACE

Hitachi Denshi, Ltd.

1-23-2, Kanda Suda-cho, Chiyoda-ku, Tokyo 101, Japan Phone (03) 255-8411 Telex J24178

▪ **Hitachi Denshi America, Ltd.**

Headquarters and East Coast Office : 175 Crossways Park West, Woodbury, New York 11797, U.S.A.
 Phone (516) 921-7200, TWX (25) 510-221-1899

West Coast Office : 21015-21023 So. Figueroa Street, Carson, Calif. 90745, U.S.A.
 Phone (213) 328-2110, TWX (25) 910-349-6952

Midwest Office : 1725 North 33rd Ave., Melrose Park, Illinois 60160, U.S.A.
 Phone (312) 344-4020, TWX (25) 910-226-0411

Southwest Office : 14169 Proton Road, Dallas, Texas 75240, U.S.A.
 Phone (214) 233-7623, TWX (25) 910-860-5775

Southeast Office : 3610 Clearview Parkway, Doraville, Georgia 30340, U.S.A.
 Phone (404) 451-9453, TWX (25) 810-757-4228

Central Western Office : 3538 Peoria, Aurora, Colorado 80010, U.S.A.
 Phone (303) 344-3156, TWX (25) 910-932-2993

Northwest Office : 1051 Andover Park West, Tukwila, Wash. 98188, U.S.A.
 Phone (206) 575-1680, TWX (25) 910-444-2155

Washington D.C. Office : 4720P Boston Way, Lanham, Maryland 20801, U.S.A.
 Phone (301) 459-8262

Cincinnati Office : 11250 Cornell Park Drive, Suite No. 202, Cincinnati, Ohio 45242, U.S.A.
 Phone (513) 891-8091

▪ **Hitachi Denshi, Ltd. (Canada)**

Head Office : 922 Dillingham Road, Pickering, Ontario L1W 1Z6, Canada
 Phone (416) 839-5134, Telex (21) 698-1286

Quebec Office : 8100-G Trans-Canada, St-Laurent, Quebec H4S 1M5, Canada
 Phone (514) 332-6687, Telex (21) 582-5739

Western Office : 3433-12th St. North-East, Calgary, Alberta T2E 6S6, Canada
 Phone (403) 276-8508, Telex (21) 382-5861

▪ **Hitachi Denshi (Europa) GmbH**

Head Office : Weiskircher Straße 88, D-6054 Rodgau 1 (Jügesheim), West Germany
 Phone (06106) 3027/8/9, Telex (41) 417-849

▪ **Hitachi Denshi (U.K.) Ltd.**

Head Office : Lodge House, Lodge Road, Hendon, London NW4 4DQ, United Kingdom
 Phone (01) 203-4242, Telex (51) 27449

Leeds Office : Video House, 55 Manor Road, Leeds, LS11 5PZ, United Kingdom
 Phone 0532-30294/5

Circle 117 on reader service card

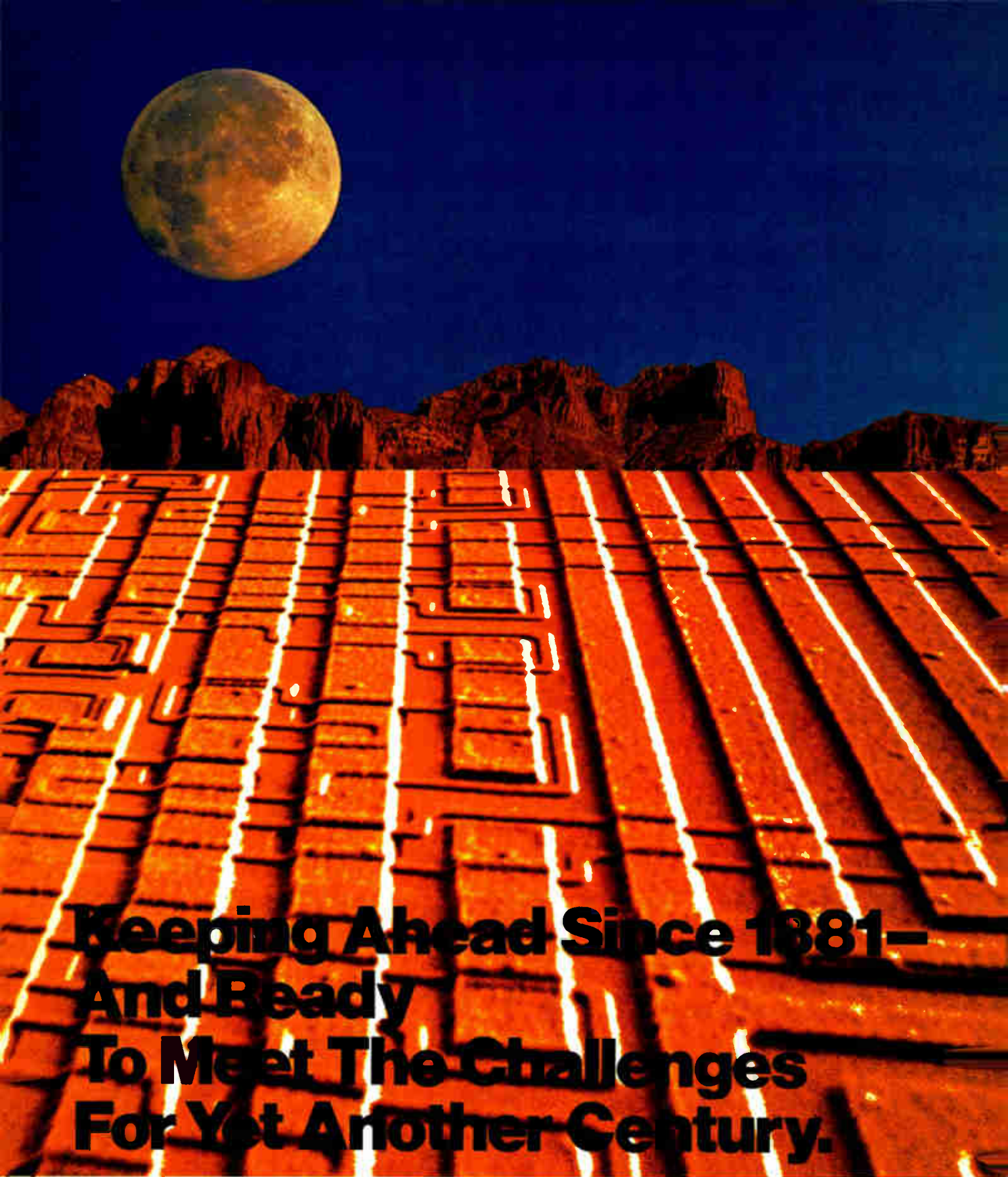

**Keeping Ahead Since 1881—
And Beady
To Meet The Challenges
For Yet Another Century.**

OKI Electric Europe GmbH:
Emanuel-Leutze str. 8, 4000.
Düsseldorf 11, West Germany
Tel: (0211) 59 20 31
Telex: 858 7218

OKI Semiconductor
Suite 405, 1333 Lawrence Expwy
Santa Clara, CA 95051
U.S.A.
Tel: (408) 984-4840, 4841
Telex: 910-338-0508

Head Office: (International Division)
10-3, Shibaura 4-chome,
Minato-ku, Tokyo 108, Japan
Tel: (03) 454-2111
Telex: J22627
Cable: OKIDENKI TOKYO

OKI
electric
industry
company, Ltd.

Circle 118 on reader service card

designers are often encouraged to learn new ways of increasing the reliability of products. After the design has been finished, they meet with related departments like engineering and quality control. The engineers in charge of engineering and production try to prevent any trouble on the production lines and to increase production capability. The engineers in charge of design try to make designs that are well fitted to the production process.

The second step is trial production. Any abnormality is completely analyzed through statistical and physical methods. Products that could not reach the necessary level of quality are eliminated at this point.

The last step is mass production. Many kinds of faults found in this step, such as dirt on products, directly affect the yield rate and reliability of products. It is imperative that production processes give close attention to prevention of dirt contamination. Furthermore, data on the yield of products is periodically checked to improve the stability of the production process.

As part of this quality control, a very important factor is education for the workers. A wide variety of education is offered, ranging from specific production problems to the building up of morale. A QC circle, which is a small-group activity, is especially effective in strengthening morale.

For the realization of this highly reliable mass-production technique, the operations of the inspection system during the manufacturing process must be given close attention. The inspection of photomasks, for example, has been performed visually by microscope. This method, however, can hardly be applied to the current complicated mask patterns of a 2-to-3- μm minimum feature width.

Automatic inspection equipment has been developed and is being widely utilized in Japan and to some degree in the U. S. This equipment enables automatic inspection by the combined use of a TV camera, a processor, and display equipment. When a flaw is detected in a mask, automatic correction is carried out by a laser adjustment device which is directly connected to the equipment. Alternatively, flaw information is initially stored in the memory and later corrected by a separate adjustment device that has received input flaw data.

Today there are several detection methods that can screen a minimum flaw size of 1.5 to 0.75 μm at speeds between 15 and 60 seconds per square centimeter. This highly efficient automatic detection system plays a significant role in the achievement of a mass-production technique that continuously yields highly reliable products.

We have been discussing the present situation in the Japanese semiconductor industry. Now let us turn the discussion to its future, concentrating on new applications that represent increased use of ICs.

Needless to say, the major new application area is in computer products. One kind of computer development will be to shrink the computer while speeding up information processing at the same time that memory size is increased. As a result, the capability of computers will be enhanced.

Another development will be to make the computer simpler to use. For instance, it could be programmed in the spoken and

The Power Behind The Power Scene.

When it comes to electronic components
the electronic industry comes
to Alps Electric.

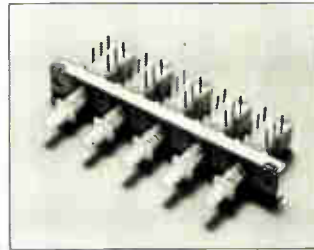

SUN series:

Multigang push switches
Used for selector switches
in audio equipment.

EC series:

**Miniature FM frontend
tuner**
Used for car audio equip-
ment and portable/home
stereos.



K12 series:

**Model 12 multi-section
volume control**
Used for car stereo volume
control switches.

KFF series:

Key switches
Used for keyboards for
electric typewriters, word-
processors, CRT terminals
and teleprinters.



Hi-B series:

**Cassette stereo combination
rec/playback head**

KFC series:

**Telephone keyboard
switches**

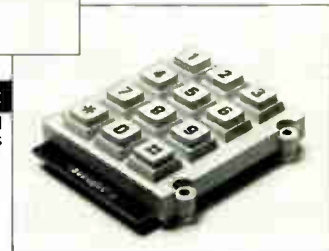

ALPS ELECTRIC CO.,LTD.

1-7, Yukigaya-Ohtsuka-cho, Ohta-ku, Tokyo, 145
Phone: (03) 726-1211 Tlx: 246-6076, 6649

ALPS ELECTRIC EUROPA GmbH

Karl-Rudolf Strasse 178, 4000 Düsseldorf F.R. Germany
Phone: (0211) 370573 Tlx: (08) 582 072

ALPS ELECTRIC (USA), INC.

100 North Centre Avenue, Rockville Centre, N.Y. 11570 U.S.A.
Phone: (516) 766-3636 Tlx: (23) 014-4508



ANRITSU HAS THE FULL LINE ON PCM TEST EQUIPMENT

When there's a fault somewhere along the line, you need a versatile line of PCM test equipment that can help you unravel it—the Anritsu line. Just name the problem and we'll name the Anritsu PCM testing equipment that can help you pinpoint its source quickly and easily.

INSTRUMENT	MULTIPLEX TESTER	LINE & REPEATER TESTER	CODE ERROR DETECTOR
AUDIO FREQ.	MS339A MH342A	—	—
1.544 Mbit/s	—	MS336A	MS337A
2.048 Mbit/s	MH340A MH341A	MS333A	MS334A

Above Anritsu equipment for testing multiplex terminal equipment, repeater and line.

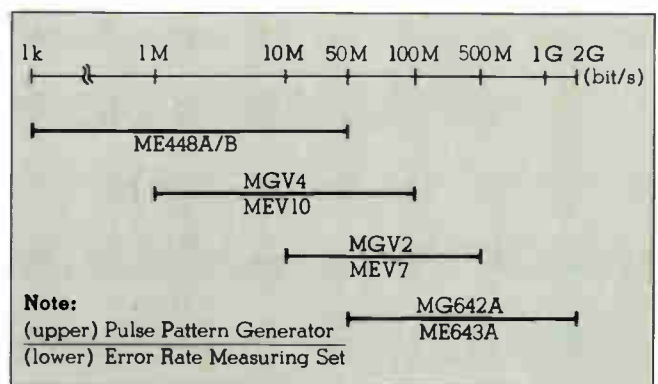

In addition, the models listed above are designed for testing PCM transmission systems.

• U.S.A. Anritsu America, Inc. Tel. (201) 337-1111 • West Germany Knott Elektronik GmbH Tel. (08178) 4085 • U.K. Anritsu Europe Ltd. Tel. Luton (STD. 0582) 418853 • France Tekelec Airtronic Tel. (1) 946-96 48 • Italy Vianello S.p.A. Tel. (02) 54 40 41 • Spain Unitronics, S.A. Tel. 242 52 04 • Holland C.N. Rood B.V. Tel. 070-99 63 60 • Belgium C.N. Rood S.A. Tel. 02-35 21 35 • Sweden Teleinstrument AB Tel. 08-38 03 70 • Singapore O'Connor's (Pte) Ltd Tel. 637944 • Australia NEC Australia Pty. Ltd. Tel. Melbourne 560-5233 • Malaysia O'Connor's (Malaysia) SDN BHD Tel. 51563/5 • Brazil Anritsu Eletrônica Comércio Ltda. Tel. Rio 221-6086

Circle 121 on reader service card

Anritsu
 ANRITSU ELECTRIC CO., LTD.
 MEASURING INSTRUMENTS DIVISION
 SALES DEPARTMENT
 10-27, Minamiazabu 5-chome, Minato-ku, Tokyo 106, Japan
 Phone: (03) 446 1111/Telex: 0 242 2353
 Cable: ANRITDENKI TOKYO

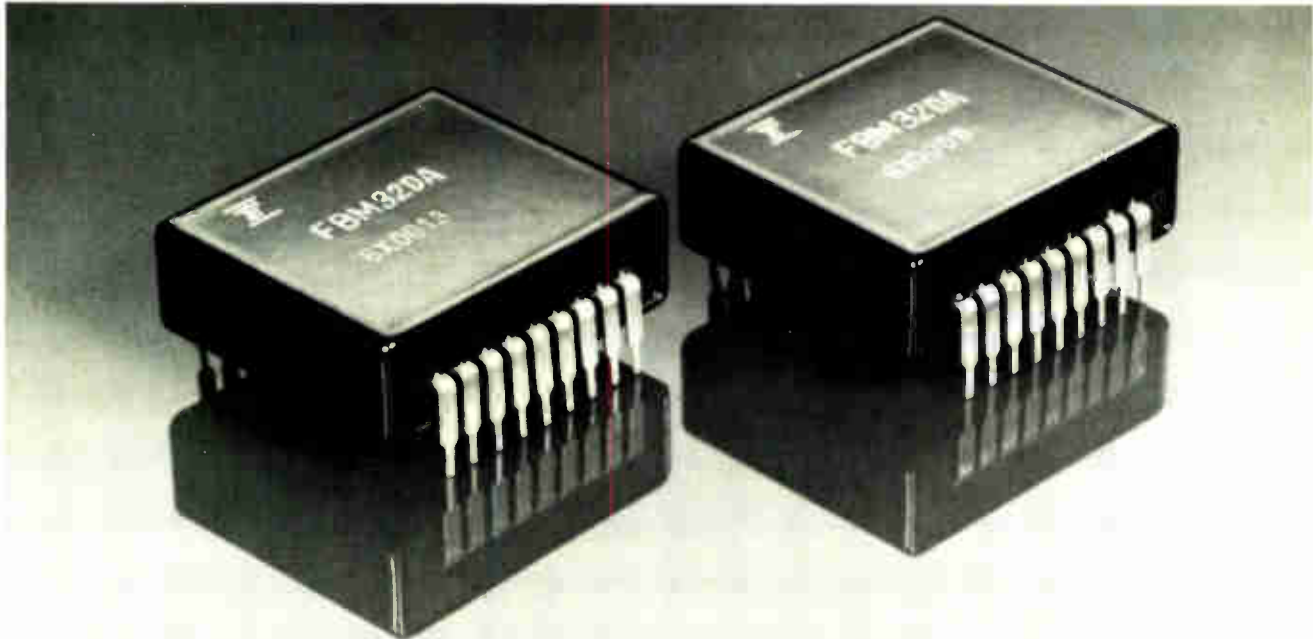

Nonvolatile magnetic bubble memories are finding a slot between magnetic disk and core memories and the IC memory.

written languages of people rather than programmed in computer languages and with keyboards. What's more, the computer output could be in natural voice, common alphanumeric characters, or both. The latter development, especially, could extend the usefulness of the computer to office and home users. This we consider to be very important.

In order to develop these new uses, we have to produce a computer that has such functions as running a very complicated program, recognizing patterns and voices, and synthesizing voice. It will be necessary to have high-density ICs, and this is the area on which VLSI designers should concentrate.

In software, we should develop systems that can recognize alphanumeric characters, understand the meaning of sentences, and fulfill the potential needs of users. The Japanese, who have such a complicated language, have a special interest in developing this kind of software. It also is the key for corporations seeking to win the Japanese market, which is potentially the second largest in the world.

For computer memories, the IC is related to the system's internal memory. In addition, the system has an external memory that files and stores input data in accordance with their usage. Relatively large and voluminous magnetic components like a hard disk, core system, floppy disk, or a cassette tape, have been commonly used for external memory. However, in anticipating the whole computer system reduced in size with a larger memory capacity for broader functions, it is inevitable that these external memories be minimized in size.

For this purpose, a promising medium is the magnetic bubble memory. Following its announcement by Bell Laboratories in 1967 in the U. S., research and development has been conducted in many countries to achieve higher integration and a larger memory capacity. The objective is to minimize the

diameter of the magnetic bubble that controls the overall memory capacity.

In the past 10 years, the diameter of the magnetic bubble has been reduced from 50 to 100 μm to 2 to 3 μm . This reduction also led to a change in the memory structure from multi-chip to single-chip. The majority of magnetic-bubble memory systems presently manufactured around the world have a 64-K capacity. However, those with a 256-K capacity are also in the marketplace, and a few 1-megabit systems can be found.

The bubble memory is a highly integrated external system of compact size and broad capacity. It is a nonvolatile memory that permits easy replacement and alteration of data. Different from the conventional file memory, it is a complete solid-state system having no detachable sections, which means strong mechanical and environmental durability. Its compactness enables direct application to a printed-circuit board. Benefits of low electrical consumption also are a factor.

In a sense, this memory system is a medium-speed medium-capacity memory located between the conventional magnetic-disk or magnetic-core memory—those with large capacity but slow speed—and the IC memory—those with relatively small capacity but very high speed. It may be possible to boost capacity, and it is anticipated that demand by users of medium-speed systems will increase.

In light of the recent increases in demand for numerical control, computer terminals, minicomputers, and office computers utilizing cassettes and floppy disks, the production of bubble memory systems will increase. Furthermore, developments such as mass production, cost reduction, and higher integration are expected through future R & D. In two to three years, the 1-megabit chip will be a major product, while a 10-megabit chip will be achieved in the future.

Stand-Alone In-Circuit Emulation Probe?

IN-CIRCUIT DEBUGGER

ICD-178/Z80*

- debugs your objects by simply inserting its probe, instead of the microprocessor (Z80*) CPU chip.
- debugs, stand-alone, when combined with TTY, CRT or MC177 microcommunicator (another of our products)—big advantage in field maintenance and on production lines.
- may also be used as in-circuit emulation probe by combining it with a higher level machine, such as mini-computers or microcomputers.

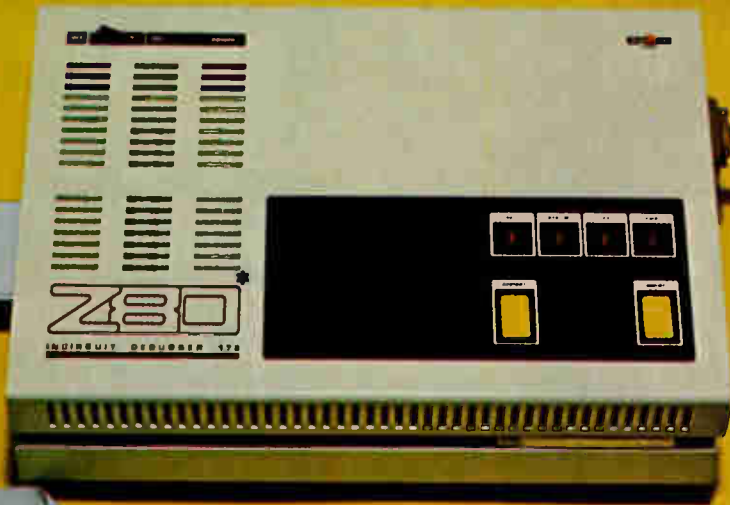

FEATURES

● Compact and light. ● 48K memory: mapping ICD and target at a 1K byte block. ● All 256 I/O ports can be used. Each serial port is equipped with 2 channels as standard (RS232C/Current Loop/TTL).

SPECIFICATIONS

● Dimensions, weight: 300(W) x 210(D) x 80(H)mm, 3.2kg ● Processor: Z80* (10kHz to 4MHz) ● System memory (for OS): 6K byte Debugger OS, 8K byte Option (self-assembler, etc.), 1K byte System RAM, 1K byte Memory Map, I/O ● User memories: 48K byte built-in (dynamic RAM), 1K byte block mapping possible (EXT for connection of static RAM) ● Communication ports:

RC232C/20 mA current loop/TTL x 2CH/110 to 9600BPS in 8 increments ● Break points: Hardware 2 points, Break modes: Instruction fetch/memory read-write/I-O read-write/external signals ● Trace: Real time/branch/1-step ● Memory mapping mode: 1) All memories of ICD 2) All memories of targets 3) 1K byte block mapping

TM of Zilog, Inc.

APPLICATIONS:

- Microcomputer system development 1 ↔ 3
- Microcomputer system maintenance 1 ↔ 2
- Cross-debugging of high level machines 1 ↔ 4

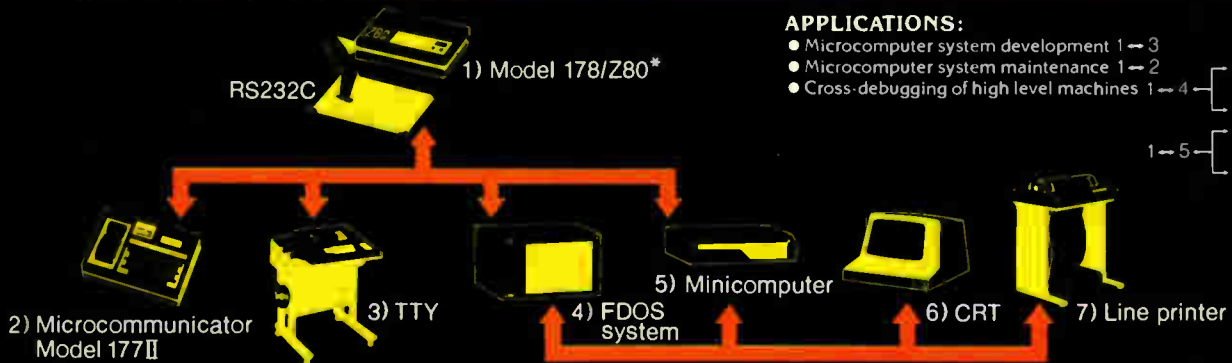
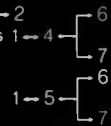

ZAX

*For more information write to
BELL CORPORATION

4-11, Hongo 2-chome Bunkyo, Tokyo, Japan Phones 813-6581 Telex J25209 Cable RINGABELL

R&D: **ZAX CORPORATION**

7-7 Miyamae 1-chome, Suginami, Tokyo, Japan Phones 331-5201

Circle 122 on reader service card

TUBELESS DISPLAYS GROW

The story of tubeless electronic displays and their uses illustrates various trends in the highly technological electronics industries of present-day Japan. In fact, the display market has grown as the applications for advanced electronic components have grown.

In 1979, the market for tubeless displays experienced sudden and rapid expansion, and the demand for several types, including the light-emitting-diode, liquid-crystal, plasma, and fluorescent displays, increased by more than 50%. It is anticipated that the markets for the products utilizing these parts will exhibit substantial growth.

An important factor is that the technological development of these electronic displays was closely interrelated in the past with the development of integrated circuits. Until recently, production shortages of large-scale integrated circuitry created problems in expanding the electronic-display markets. However, it is expected that these problems will be alleviated.

Let us review 1979. The primary items on the market quickly shifted from electronic calculators in the first half to watches at the midyear and to diversified products at year-end. Such rapid shifts in demand and the diversification of display types for various purposes have created good results for manufacturers. These developments formed sound bases for further diversification in the 1980s. A glance at products like calculators and watches supports this conclusion.

To take electronic calculators as an example, the type of the display has varied from the gas-discharge tube to fluorescent and liquid-crystal displays (LED displays are common). Watches employ LED and liquid-crystal displays, and electrochromic displays have been introduced quite recently to the market.

Technological developments in the use of large-scale integrated circuits and electronic displays in watches and calculators are at present expanding the scope of these components. Moreover, since the microcomputer first made its appearance, the display market has been growing at a rate of 30% to 50% annually, a rate similar to that of the microcomputer market (including other LSI chips).

Conventionally, the cathode-ray tube

is employed as the display for computers. For the new small applications of computing power like point-of-sale terminals and personal computers, however, use of the LED, liquid-crystal, and fluorescent displays is relatively widespread. The



ELCO brings power supply with quality and low price.

You don't have to sacrifice quality for cost.

Total quality assurance-That's what motivate our qualified technicians.

We are the leading manufacturer of power supplies in Japan-for quality and price.

We are convinced that you will benefit most from us.

Call us for more information about our fine line of products.

ELCO CO., LTD. 1-6-43 Kamiakae-machi, Toyama city, Toyama Japan
Phone:(0764)32-8151 Telex:5152911



**SPECIAL
ADVERTISING
SECTION**

power consumption, the size, and the high-voltage requirement of the CRT militate against its use, especially when displaying large amounts of information is unnecessary. Yet, the tubeless displays are technologically inferior to the CRT as large-capacity information displays, although they function adequately when applied to microcomputers.

To develop effective demands for various tubeless displays, segmenting the market is effective to a certain degree. For example, the U.S. automobile industry is expected to become a major market for fluorescent displays since they are considered most appropriate for the electronic and digital car clocks and dashboard panels. Liquid-crystal manufacturers, at the same time, are strengthening their sales activities in order to find new applications that can ignore the material's limited temperature range, which hinders their use in such areas as automobiles. Manufacturers of LEDs are maintaining a relative calm even though there is need for several LED technological improvements, such as brightness.

Requirements in future displays include a wider range of colors and multicolored panels. Developments here have been advanced by individual manufacturers, and some have introduced products. However, the realization of full-scale practical applications is expected in the latter half of the decade.

In regard to multicolored designs, it is expected that the problems still remaining, such as quality of displays, brightness of the light-emitting type, and prices of elements, will be solved in the near future. It is certain that multicolored units will play a significant role in the development of display markets.

Japan produced 866,788,000 LEDs in 1979—an increase of 75% over the previous year. In monetary terms, a value of \$85 million was recorded—a rise of 64% from the previous year. An analysis of this substantial growth was carried out by major manufacturers, and some of their conclusions follow.

The rapid increase in applied products is regarded as having contributed to the growth. Improvement and sophistication in certain products are considered to have increased demand for LEDs. Appli-

- **Plenty Model**
Sharp's photocouplers have 3 series of PC-500, PC-600, PC-700 (High withstand voltage), so that you can choose for your purpose.
- **Compatibility**
Since Sharp's photocouplers are pin Compatible type, they are exchangeable for those TI's, GE's, Monsanto's, Fairchild's and other makers.
- **High Quality**
Sharp's photocouplers adopt GaAs emitting diode as light emitting device and Si planar phototransistor as photo sensitive device.
- **Wide Application**
Sharp's photocouplers are useful in interface and noise cut for system appliances, and also useful in conveying signals of unmatching voltage or impedance.



Type No	Package	Absolute Maximum Ratings				CRT (%)		Response Time				
		IF (mA)	V _{CEO} (V)	P _{Tot} (mW)	V _{ISO} (kV)	TYP	V _{CE} (V)	I _F (mA)	t _r (μs) TYP	t _c (mA)	R _L (Ω)	
PC 508	Tubular 5P (base)	50	45		5.0	67	5	30	6.0	1	100	
PC 525	DIP 6P (Darlington)	70	200	350	1.5	600	2	5	25	20	100	
PC 627	DIP 8P (2 ch)	70	35	200	2.0	120	5	5	4.0	2	100	
PC 637	DIP 12P (3 ch)	70	35	200	2.0	120	5	5	4.0	2	100	
PC 713	DIP 6P	50	35	170	5.0	100	5	5	4.0	2	100	
PC 714	DIP 6P	50	35	170	5.0	100	5	5	4.0	2	100	
PC-715	DIP 6P	50	35	170	5.0	1600	2	1	60	10	100	
PC 716	DIP 6P	50	35	350	5.0	3000	2	1	130	20	100	
PC 618	DIP 8P	25	(V _{EBO}) 5	100	2.0	20	4.5	16	(I _{PHL}) 0.3 (I _F) 16	1.900	(I _{PHL}) 0.3 (I _F) 16	1.900

Absolute Maximum Ratings T_{case} = -25 ~ 100°C • PC 713 714 715/716 High Withstand Voltage Type • PC 618 High Speed Type

SHARP CORPORATION
International Division
Electronic Components Export Sales Department
22-22, Nagaike-cho, Abeno-ku, Osaka 545, JAPAN
Phone: (06) 621-1221 Cable: LABOMET OSAKA
Telex: J63428 Attn: OSKPA (LABOMET A-D)

U.S.A. : SHARP ELECTRONICS CORPORATION
10 Keystone Place, Paramus, New Jersey 07652
Tel: (201) 265-5600 For further information,
write to: Mr. M. Miyagawa
EUROPE: SHARP ELECTRONICS (EUROPE) GMBH
Sonninstrasse 3, 2000 Hamburg 1, F. R. Germany
Tel: (040) 28511 Attention: Mr. H. Asano

DYNASYN

STEPPING MOTOR

HYBRID PM STEPPING MOTORS

WANT TO MAKE RELIABLE COMPUTER PERIPHERALS INEXPENSIVELY?



START EXAMINING THE **DYNASYN** STEPPING MOTORS.

DYNASYN will provide you with highly accurate positioning, sufficient holding torque, high reliability, and cost saving, too.

If your positioning application requires frequent repetitive stops/starts operation and accurate multiple positioning, try **DYNASYN** to achieve higher performance and lower production costs.

DYNASYN is available 4-phase, bi-directional, 1.8° step angle.

We'll work to your specifications and furnish pre-production sample for your testing.



JANOME ELECTRIC CO., LTD.

1463 Hazama-cho, Hachioji-shi, Tokyo, Japan
Tel: 0426-61-2121 Cable: "JANOME HACHIOJI" Tokyo

Circle 34 on reader service card

OL

The Mark
You Can Trust



New PBB LAMP

Bayonet Base Subminiature Lamp
Directly Replaceable on P.C. Board

No soldering or socket required.

Just insert and turn 90 deg. to mount.

● Mountable to either side of P.C. Board. ● Bulb can be provided on either, or both ends on request.

● For detailed literature and sample, call or write:

WAMCO TECHNICAL SALES, INC.

705 W. 16th Street, Costa Mesa, California 92627
TEL: (714) 833-9361 TELEX: 678459

OSHINO ELECTRIC LAMP WORKS, LTD.

Shinagawa, Tokyo, Japan.



Circle 36 on reader service card

NEW LONG SCREEN PRINTING MACHINE

Hydraulic-powered Precision Screen Printing Machine
for Printed Circuit Boards.
MODEL LS-50A

Hydraulically driven mechanism ensures high printing pressure resulting in clear and in uniform printing.

- Printing area: 10 × 22 in. (500 × 500mm)
- Frame size: 37 in. (950 × 950mm)
- Squeegee stroke: Max. 28 in. (700mm) Variable
- Squeegee speed: 0~12 in. (0~300mm)

Automatic Precision Screen Printing Machine
for Thick-films, LCD, LED, and Silicon Wafers.
MODEL LS-15GT

Designed to give precise and accurate printing. It's equipped with an automatic ejector.

- Printing area: 6 × 6 in. (150 × 150mm)
- Frame size: 12.6 × 12.6 in. (320 × 320mm)
- Squeegee stroke: 2~8 in. (50~200mm) (Variable)
- Squeegee speed: 0~4 in. sec. (0~100mm sec.)

In 30 years as the leading manufacturers, we have developed from our own technology a complete line of over 20 standard models. Our production total of more than 5,000 units gives us a 70% share of the Japanese market, the most competitive and demanding in the world. If our present models do not fill your needs, tell us your requirements. Our engineering department can meet any challenge.

Distributors

U.S.A.

The Christopher Group
23342 South Pointe Drive Unit D
Laguna Hills Ca. 92653 U.S.A.
Phone: 714-581-7491. Telex: 9105952462

EUROPE & W. GERMANY

Gunze Oüsseldorf GMBH
4, Dusseldorf Königsallee W. Germany
Phone: 0211-80271-2 Telex: 8587450

HONG KONG

Kong King Trading Co., Ltd.
Wongs Industrial Bldg., 6/FL., 42 Hung To Rd.,
Kwun Tong, Kowloon, Hong Kong.
Phone: 3-450111 Telex: 36810

Manufacturer:



NEW LONG

NEW LONG SEIMITSU KOGYO CO., LTD.

4-6, NISHIGOTANDA, 7-CHOME, SHINAGAWA-KU
TOKYO 141, JAPAN
PHONE: (03) 492-7571 TELEX: 2466040 NEWLON J

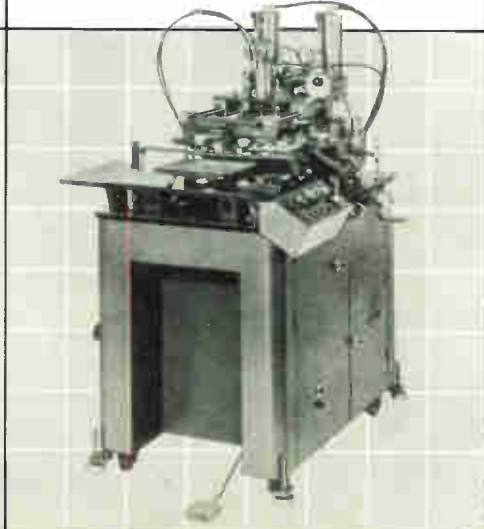

State-of-the-art for the '80s!

ATE for LSI and MEMORY ICs from ANDO

With the growing demand and the rapidly increasing complexity of ICs, manufacturers and users are becoming more concerned about throughput, reliability, costs and profits. The need is urgent for automatic test equipment (ATE) that will handle ICs with high pin counts at high speeds at no sacrifice in quality.

ANDO ELECTRIC COMPANY, LTD. has been designing, developing and manufacturing and delivering ATE for ICs since 1968. Responding to the industry's needs for quality, capability and economy, ANDO is proud to offer the SERIES DIC-8000 . . . planned for the future as well as for today's requirements.

FEATURES OF THE DIC-8000 SERIES

- Hierarchical / distributed system. The host computer is a stand-alone mainframe. It is designed to preclude technological obsolescence through its ability to be updated readily.
- System configuration is modular, enabling expansion and flexibility to meet the changing needs of production and IC technology.
- Simplified startup and operation. A new language has been developed for programming the DIC-8000 Series of ATE. Based on a conversational mode, it is easy to learn, easy to use, and readily updated to meet changes in technology.

ANDO DIC-8000 SERIES . . . ATE FOR IC!

- DIC - 8010 SSI/MSI Test System (Parallel testing)
- DIC - 8020 MEMORY IC Test System (64k or more, 10 MHz)
- DIC - 8030 LSI Test System (128 pins, 10 MHz)
- DIC - 8032 LSI Test System (Economy type of DIC-8030)



DIC-8032 LSI Test System



ANDO ELECTRIC CO., LTD.

For details and technical data, contact or write to:

L.A. Wortman Associates
536 Weddell Dr., Ste #1
Sunnyvale, California 94086
Tel: (408) 734-4336

Ando Electric Co., Ltd.
19-7, Kamata 4-chome, Ohta-ku
Tokyo, 144 Japan
Telex: 246-6425

SPECIAL ADVERTISING SECTION

cations in home appliances, sound equipment, and industrial products will become major markets. The resulting growth rate is expected to exceed that of last year.

It is rather difficult to forecast the next major market from the above. However, it is most likely that the automobile industry will develop into a significant market. At the same time, display manufacturers will increase their efforts to promote the application of light-emitting diodes. That market, on the whole, is expected to grow at a higher rate than those of other tubeless displays.

In regard to the problem of brightness, some improvements were made by the manufacturers, who have announced that LEDs are able to compete with other light-emitting displays. Aided by improvements in the output power of LSI chips, light-emitting diodes have found their way into automobile clocks and digital displays of car radios. The expansion of applicable fields, attributable to the improvements in brightness, permits custom production according to user specifications, although it indicated unfavorable trends in standardization.

Liquid-crystal displays are most frequently seen in calculators and watches. Major advantages of LCDs are low power consumption and relatively low operating voltage. Moreover, their nonemissive characteristics avoid problems resulting from lack of contrast under sunlight, due to insufficient brightness. In fact, the brighter the ambient light becomes, the more readily a high contrast is obtained.

The demand for LCDs has increased substantially in recent years because of growth in calculators and watches and remarkable increases in their application of liquid-crystal displays. Although the LCD industry had at one time encountered some problems due to shortages of ICs, the demand for liquid-crystal panels has been stable.

Many LCD manufacturers are confident that calculators and watches will continue to use many liquid-crystal displays. However, the majority of these manufacturers have reached the conclusion that the makers of both products already have established their LCD

DC BRUSHLESS FAN AC MINIATURE FAN

Newly Designed

for cooling Portable or
Miniaturized Equipment.



FEATURES:

1. PORTABLE TYPE,
OVERALL DIMENSIONS: 80 x 80 x 32 MM
92 x 92 x 25 MM
120 x 120 x 38 MM
2. LONG SERVICE LIFE: OVER 10,000 TO 15,000 HOURS
3. LOW POWER CONSUMPTION AND HIGH OUTPUT
4. UL APPLIED
5. FRAME MATERIAL: ALUMINIUM DIECASTING

SPECIFICATIONS

TYPE	RATED VOLTAGE V	FREQUENCY Hz	MAX. AIR FLOW m ³ /MIN.	MAX. AIR PRESSURE mm H ₂ O	RATED SPEED rpm	RATED INPUT W
TF8012D	DC12	—	0.8	3.1	3,450	4.8
TF8024D	DC24	—	0.8	3.1	3,450	4.8
TF12012D	DC12	—	1.9	4.0	3,150	7.2
TF12024D	DC24	—	1.9	4.0	3,150	7.2
TF92115A	AC115	50	1.1	5.5	2,650	11
TF92115A	..	60	1.3	8.0	3,250	10
TF92230A	AC230	50	1.1	5.5	2,650	11
TF92230A	..	60	1.3	8.0	3,250	10
TF120115A	AC115	50	3.5	8.6	2,750	14
TF120115A	..	60	3.8	9.8	3,200	13
TF120230A	AC230	50	3.5	8.6	2,750	14
TF120230A	..	60	3.8	9.8	3,200	13

**Distributors
Wanted !!**

For details,
please contact:



TOYO CORPORATION

P.O.B. 5014, Tokyo International, Tokyo 100-31
JAPAN Telex: 222-2973 TOYOCO J

Circle 39 on reader service card

sources. Therefore, new fields of application will be sought.

One application is in portable electronic games, which have a high degree of variation in display patterns. These LCD panels are rather larger than conventional panels and are capable of providing the most appropriate display patterns to meet the respective game requirements. It is predicted that LCD panels made for this purpose will undergo an increase in growth rates over the next few years.

Dot-matrix panels were developed for wider applications, including cash terminals at banks, ticket reservation terminals, and electronic translators. Most of these applications used CRT displays in the past. However, it is expected that LCD panels will rapidly replace CRT displays, since they are better suited to deal with restricted power and physical space. Additionally, extensive use of color will be rapidly demonstrated in the future.

In June and July of this year, the Eighth International Liquid Crystal Conference and the Liquid Crystal Exhibition were held at the Kyoto International Conference Hall. Eighteen Japanese and European companies that have establishments in Japan participated. Their exhibits included dot-matrix LCDs with three or four rows of 20 to 40 characters, game panels, and many experimental automobile dashboard panels with multi-colored displays.

In a separate conference sponsored by the Society of Automotive Engineers, practical automobile dashboard panels with LCDs were viewed as a likely trend. This indicated the appropriateness of applying liquid crystals to automobile displays. Not emitting light, they do require alternative lighting sources at night. LCDs are brighter than light-emitting displays in the daylight.

The application of liquid-crystal displays to portable TV displays has been tried by sandwiching liquid crystal between glass plates and a silicon substrate with transistors manufactured by IC technology as a switching component. Certainly, LCDs have gained a firm position through use in watches and calculators. Further developments are expected to multiply their fields of application.

Incandescent Digital
Display Devices

Newtron

1 inch display

readable from
more than 30 feet



DA-2500



(Actual size)

Interchangeable with RCA Numitron
DR 2000 Series circuit

Apollo
CORPORATION

10-13, Nishishinagawa 2-chome, Shinagawa-ku, Tokyo 141
Tel: 03-491-0615 Telex: APOLLO J27842
Cable: APOLLOHAGITA TOKYO

SINCE 1948

SPECIAL ADVERTISING NEW PRODUCTS SECTION

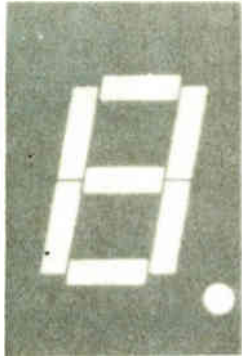

Stanley Electric Co. uses temperature-difference liquid-phase epitaxial growth to produce its Superbright light-emitting diodes for seven-segment numeric displays. With character heights of 10, 15, and 25 mm, the displays come with red, green, yellow, or amber LEDs. They feature low current drive with extremely high light-emitting efficiency, and they are excellent for dynamic driving applications because of the nearly linear characteristics of the GaAlAs red diode in the current vs. brightness tradeoff. (501)



Jepico Corp. offers the UT series of miniature switches, which can be mounted on printed-circuit boards. Developed for dry-circuit applications, the switches have contacts and terminals that are 1.3- μ m gold or silver plate over 3 μ m of nickel. Case material is Valox/94V-O U/L. (505)



Minato Electronics Inc.'s Z-80-equipped model 1860 programmer for programmable read-only memories can be used with single MOS and bipolar PROMs. Personality modules adapt it to different memories, and the microprocessor gives a wide range of functions. (502)

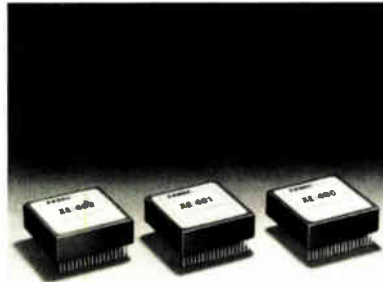

Xebec Co. converts linear signals into nonlinear and vice versa using a piece-wise linear-approximation method in the XE-400 series function converter modules. Ease of use comes from the simple, independent adjustment of the various settings, such as overall span. (504)



Toyo Corp. employs ball bearings in its ac and dc miniature fans, giving an operating life of at least 15,000 hours. Intended for office equipment, computer peripherals, medical equipment, and the like, the fans come with a variety of performance specifications. (506)



The 1961 PROM programmer from *Minato Electronics Inc.* can gang-program as many as eight MOS memories. It has a 16-kilobyte memory capacity. Like the model 1960, it has parallel and serial interfaces and check functions, such as memory test and improper-circuit test. (503)



Sankyo Seiki Manufacturing Co. makes its double-sided flexible disk-head assembly to exceed required drive life expectancy. The assembly is designed to operate at zero penetration, and the gimbal upper fixture maintains head stability during load and unloading. (507)

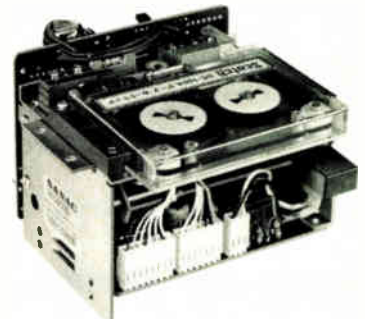

The STC-8000-2A read-after-write cartridge drive from *Sankyo Seiki Manufacturing Co.* operates from a single supply, consuming less than 700 mA during normal running and less than 2 A during start/stop/reverse. It has an inter-record gap of less than 0.7 in. nominal. (508)



Sankyo speaks your language.

When you need magnetic heads and super-efficient DC motors for mini-floppy disc equipment, Sankyo speaks your language with a fluency that is hard to match: *Custom designs.*

Variety in type. Compact size. Long-life performance. And competitive prices.

The performance of Sankyo magnetic heads and efficient DC motors is well-proven in the latest mini-floppy disc equipment. Put us to the test and see if the quality doesn't come shining through.



Sankyo

Sankyo Seiki Mfg. Co., Ltd.
Electronic Equipment Div.

Export Dept. 17-2, 1-chome, Shinbashi, Minato-ku, Tokyo 105, Japan. Tel: (03) 502-1157 Telex: 29548

SPECIAL ADVERTISING NEW PRODUCTS SECTION



Bell Corp. offers a portable computer terminal, the Microcommunicator 177 Mark II, that is compatible with Teletype's ASR 33. With an ASCII full keyboard, a 32-digit printer, and a 16-digit display, the MC 177 II has built-in RS-232-C and current-loop interfaces. (511)



Sharp Corp. fits its ultra-compact liquid-crystal display clock module into a 19.8-by-9.8-by-4.7-mm package. The LX-3101X micro-digital clock operates from a single 1.5-V power supply and incorporates a complementary-MOS large-scale integrated circuit on a thin-film-carrier substrate. It features simple time setting with two buttons and signals the passing seconds by flashing the colon between the hours and minute digits. It is intended for consumer applications, such as pendant clocks and ball-point pens. (509)

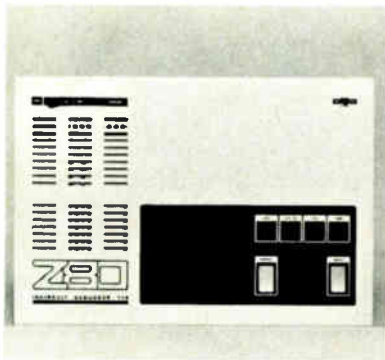

The ICD 178/Z80 in-circuit debugger offered by *Bell Corp.* is a portable in-circuit emulator that is essentially a low-cost, compact microprocessor development system for debugging, field service, etc. The Z80 ICD is available now; coming are models for the 8085 and 6809. (512)



Anritsu Electric Co. combines optical power meters and sensors for the ML93A digital meter shown and the ML94A analog meter, both with wavelength ranges of 0.4 to 1 μm or 0.75 to 1.7 μm and with a variety of measuring ranges that go as low as -90 dBm up to $+10$ dBm. (513)



The ML442A selective-level meter from *Anritsu Electric Co.* covers a wide frequency range from 200 (20) Hz to 30 MHz with a ± 0.1 -dB level-measuring accuracy and a 70-dB intrinsic distortion. A microprocessor plays a role in level measurement, autoranging, etc. (514)



Ando Electric Co. has developed its AE-4100 series microprocessor system analyzers for use in development, product inspection, and maintenance of hardware and software of setups using the 8080A, 8085A, and Z80 processors and their equivalents. The AE-4100 performs tests directly on the processor, and, in addition to its monitor

functions, it tests units while controlling them, permitting reading and writing to and from registers and memories. It is easy to operate, since all required functions may be performed with the 16-key function and numerical keyboards; also, it may be connected through its trigger output to an oscilloscope or logic analyzer for detailed analyses. Available options include an input/output interface card, a keyboard printer, and a user-mode random-access memory. Clock rate is 0 to 3 MHz. (510)

Quality Reliability Performance Hakuto delivers

Highly reliable precision tantalum alloy resistors.

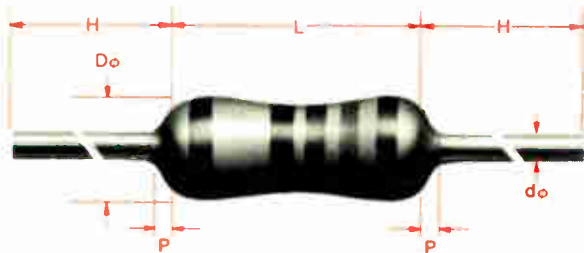

TS-60	1/4W at 70°C, 10 ohm—1 Mohm, ±0.10%—±2.00%
TS-65	1/2W at 70°C, 10 ohm—1 Mohm, ±0.10%—±2.00%
TM1/4	1/4W at 70°C, 10 ohm—1 Mohm, ±1.00%—±2.00%

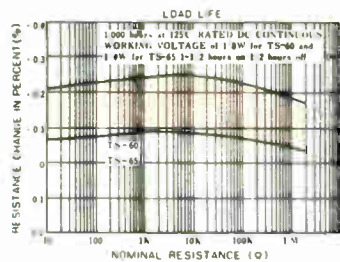

Dimension	Type	TS60	TS65	TM1/4
L max.		6.9	9.9	6.5
H		2.7±1	3.6±3	2.7±1
Dø max.		2.6	4.3	2.5
dø		0.60 ±0.02	0.70 ±0.02	0.60 ±0.02
P max.		0.2	0.3	0.2

Electric characteristics of TS-60 and TS-65: Unique heat treatment of surface of spattered element enables conformance to MIL-R-10509F for molded type resistors.

High reliability. Micro-chip capacitors for RF applications.

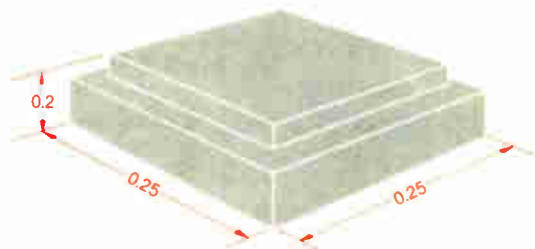

Unit: mm

- World's smallest size—Height 0.2mm or less × 0.25 × 0.25mm —with high dielectric withstanding voltage.
- Proven performance..... excellence up to 40GHz.
- Au electrode assures the best bondability.

Standard specifications

Type	Ceramic monolayer
Electrode	Au, single and binary type
Model	Hi-K or temperature compensating
Dielectric withstanding voltage	600 to 800V
Capacitance	0.7 to 100pF

SELCON photoelectric lighting control switches.



- Save money and energy through efficient on-and-off operation.
- Extremely low power requirement to automate street-side, roadway or similar outdoor lighting systems.
- Many types to meet a wide range of specifications—a few are listed below.
- Operating level: 20—125 Lux ON; under 400 Lux OFF.
- Operating temp. range: -10°C to 40°C.
- Rated voltage: AC 100V, 120V, 200V, 220V, 240V; 50 or 60Hz.

TYPE	RATING	MAXIMUM LOAD				NET WEIGHT (g)	
		INCANDESCENT LAMP		FLUORESCENT LAMP			
		HIGH POWER FACTOR	LOWER POWER FACTOR	HIGH POWER FACTOR	LOWER POWER FACTOR		
AS-2203E	220V 3A	660W	320W	240W	200W	100W	130
AS-2203F-P	220V 3A	660W	320W	240W	200W	100W	200
AS-2210K-P	220V 10A	2,200W	1,040W	880W	1,000W	700W	320
SS-2202F3	220V 3A for any load with rapid response (3 lead wire, plug in type)						

Versatile, high quality silicone rubber connectors.

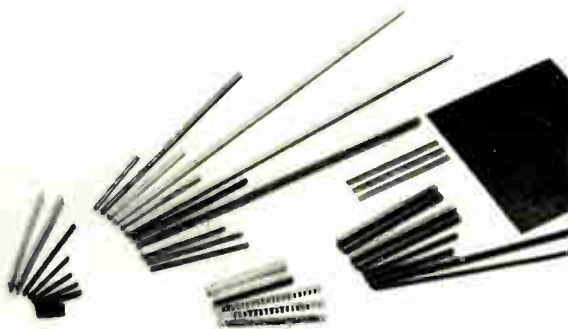

- High quality conductive silicone rubber connectors between LCD and PCB, PCBs and between LSI and PCBs.
- Outstanding durability, compression sets and resistance to temp., humidity, moisture and corrosion.
- Top advantages in assembly and in your finished products.
- Easy, simple assembly saves costs, decreases rejects.
- Superior elasticity to absorb shock and vibration.

Product lines includes S, SS, SG, H, HL, E, G, K, M and AF connectors made to your length, height and width specifications.

HAKUTO CO., LTD.

2-29, Toranomon 1-Chome, Minato-ku, Tokyo 105, Japan Telephone: (03) 502-2211 Telex: J22912 BRAPAN Cable Add.: BRAPAN TOKYO P.O. Box 25-TOKYO CENTRAL 100-91

MINI DIP SWITCH & PC MOUNTABLE SWITCH

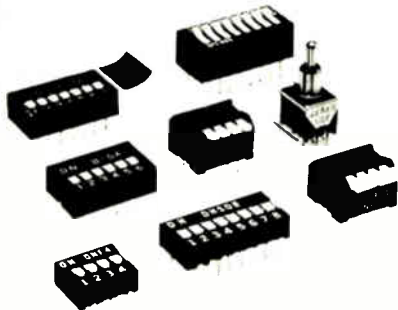

Choice of 2,4,5,6,7,8,9 and 10 poles

Slide: B-2,4,5,6,7,8,9,10A

(Tape sealed is available)

DNS04,06,08-GF

(Tin alloy plated is available)

DNF4,6,8

(Light touch version)

Piano: DNP4,8 DNT4,8 DNP1

Rocker: SPC002,4,5,6,7,8,10

Transfer: NP2,4 B-AX (2,4,6,8,10)

PC mountable switch: UT series

Representatives

ALFRED NEYE-ENATECHNIK GMBH

2085 Hamburg, Schillerstr. 14, W. Germany Phone: 04106/612-1

COMPEA

34, Rue Jacquart-93500 Pantin, France Phone: 844-87-39

DOTT. ING. GIUSEPPE DE MICO S. P. A.

20121 Milano-Via Manzoni, 31, Italy Phone: (02) 65.31.31.

INOTEC A/S

Marielundvej 46 A DK-2730 Herlev, Denmark Phone: (02) 948033

INTERNATIONAL TECHNOLOGY RESOURCES INC.

One World Trade Center Suite 345, New York, N.Y. 10048, U.S.A.

Phone: (212) 839-0988

MEMOTEC AG

CH-4932 Lotzwil, Switzerland Phone: 063 28 11 22

NORDSWITCH AB

Sodra Kungsvagen 236 Lidings, Sweden Phone: 08/7665410

P. CARO AND ASSOCIATES LTD.

2347 Coventry Road, Sheldon, Birmingham B26 3LS,

United Kingdom Phone: 021-742-1328

SAEN

Apartado 50 San Cugat Del Valles (Barcelona)

Phone: (93) 674 10 12

SAHKOLIKKEIDEN OY

Sahkometsa PL 88/P.O. Box 88 01301 Vantaa 30, Finland

Phone: 90-8381

TELEREX NEDERLAND B. V. (Holland Netherland Luxemburg

Belgium) P.O. Box 180 5680 AD Best, Netherland

Phone: 04998-4295

TELEREX N. V.

Kouwenbergrdreef, 6 2230 Schildre, Belgium Phone: 031/83.33.50.

CHEMICO TRADING COMPANY

RM. 1102, New Seoul Bldg., No. 62-7, 2-ka, Chungmu-ro,

Chungku, Seoul, Korea Phone (02) 777-5768

KARIN ELECTRONIC SUPPLIES CO., LTD.

RM. 100 1-2 Chow Sang Sang Bldg., 229 Nathan Road, Tsimshatsui,

Kowloon, Hong Kong Phone: 3-668338 (695321)

MICROTRONICS ASSOCIATES PTE LTD.

35B Block 1003 Aljunied Avenue 5 Singapore 1438, Singapore

Phone: 447-1835

XENITEK PTY LIMITED

P.O. Box 128 2, 10 Wattle Road, Brookvale, N.S.W.

Australia Phone: 932-4311

H. KOPP AND CO. (PTY) LTD.

P.O. Box 2944 Johannesburg 2000, South Africa Phone: 23-6511

TELSYS LTD.

12 Kehilat Venetsia Street Tel Aviv, Israel Phone: 482126-7-8

INDUSTRIAS ELECTRICAS "NAZA" S. R. L.

Uruguay 267-1870 Avellaneda, Buenos Aires, Argentina

Phone: 208-5914

JEPICO

JEPICO CORPORATION
Overseas marketing section

Shinjuku Dai-Ichi Seimei Bldg., P.O. Box 5016

Shinjuku-ku, Tokyo 160, Japan

Telex: 2323167 JEPICO J

SPECIAL ADVERTISING NEW PRODUCTS SECTION

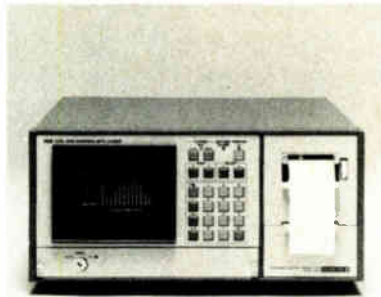

Yokogawa Electric Works Ltd. employs an interactive programming system with a built-in cathode-ray-tube display in the 3848 universal data logger. The result is simplified operation through menu programming. The 3848 also provides comprehensive computational ability. (515)



The 2433 ac power meter from Yokogawa Electric Works Ltd. measures true rms voltage, current, and power in single-phase or balanced three-phase circuits—without interrupting service. Voltage range is 20 to 600 V; power ranges are 2 to 200 kW and 0.2 to 20 kW. (516)



Nippon Electric Co. offers two read-only memory options in its μ PD8048 family of single-chip 8-bit microcomputers. The μ PD8048 has 1 K by 8 bits of mask ROM, and the μ PD8035L uses an external program memory. Both microcomputers are compatible with standard 8080A/8085A peripherals, which may be used, for example, for the μ PD8035L's ROM. Their n-channel MOS technology requires only a single +5-V supply, and cycle time is 2.5 μ s. Of the 96 instructions, 70% take 1 byte; the rest take 2.

The two microcomputers each have a 64-by-8-bit random-access memory, an eight-level stack, 27 input/output lines, an interval time/event counter and an internal clock generator. They function efficiently in control, as well as arithmetic applications, and the flexibility of their instruction set allows direct set and reset of individual data bits within the accumulator and I/O port structure. Standard logic-function implementation is facilitated by the variety of branch and table look-up instructions. (517)

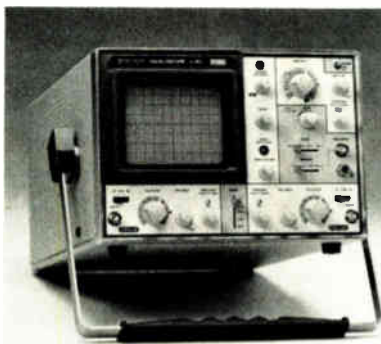

Hitachi Denshi Ltd.'s V-352 dual-trace portable oscilloscope has a vertical sensitivity of 1 mV/division and a frequency range of dc to 35 MHz. A companion V-202 scope has a dc-to-20-MHz range. They offer high-accuracy voltage and time axes set at $\pm 3\%$. (518)



The KP-500 color video camera from Hitachi Denshi Ltd. uses solid-state MOS sensors, giving greater sensitivity than charge-coupled-device sensors, which drop in transfer efficiency in dim light. Also, each picture element is larger for a given image area, aiding sensitivity. (519)

Carrousel Type
MAGNETRON SPUTTERING
SBH-5000 SERIES

This extremely compact system features water-cooling of the substrate, low temperature rise, and multi-layer coating of metal-to-metal and metal-to-oxide. One, two, and three layer models are available. The Model SBH-5115 has a capacity of forty-eight 3 inch diameter substrates and the Model SBH-5112 has a capacity of thirty-six 3 inch diameter substrates.



TWO NEW HIGH THROUGHPUT COATERS FROM ULVAC

ULVAC, Japan's pre-eminent vacuum specialist, has been making substantial contributions to the advancement of the world's science and industry through the development of superior vacuum technology and equipment since 1952.

The SBH-5000 and EBX Series introduced here are new high throughput coatiers developed to meet the ever increasing worldwide demand for more and better vacuum equipment.

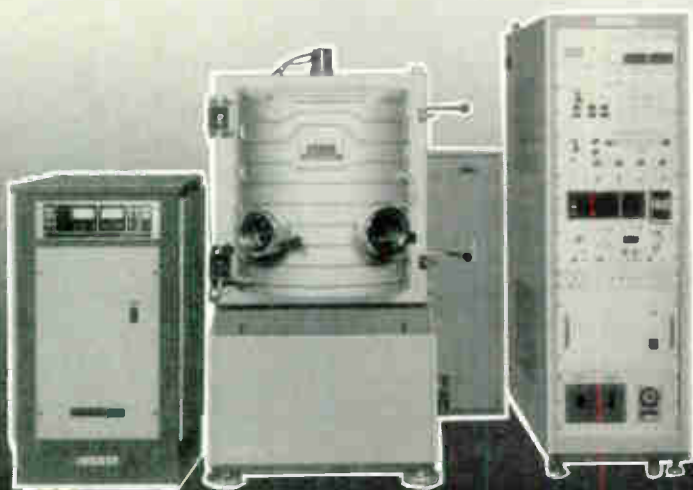

Large Capacity
HIGH VACUUM COATER

EBX SERIES

This large capacity box type coater features an interior 20% smaller than that of conventional systems, thus making it easy to clean and outgas. One, three, and four layer models that can be operated from inside a clean room are available. Capacity is seventy-five 3 inch diameter substrates.

ULVAC
ULVAC CORPORATION

International Division
1-10-3, Kyobashi, Chuo-ku, Tokyo 104, Japan Tel: (03) 535-6381 Telex: 252-2215
ULVAC North America Corp.
P.O. Box 799 (105 York Street) Kennebunk, Maine 04043 Tel: (207) 985-2973 Telex: 944344
ULVAC Europe S.A.R.L.
66 Boulevard Napoleon, 00352 Luxembourg, g.d. LUXEMBOURG Tel: 446536 Telex: 2649

Circle 133 on reader service card

SPECIAL ADVERTISING NEW PRODUCTS SECTION

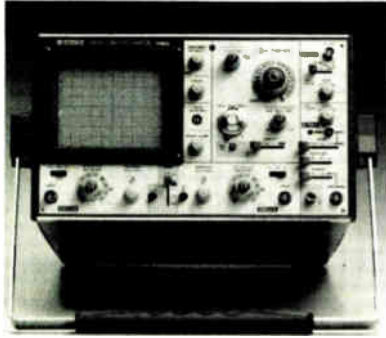

Hitachi Denshi Ltd. provides oscilloscope users with a delayed sweep, variable trigger hold-off, and automatic focus correction in its V-550B 50-MHz dual-trace scope. Other features include a single-sweep mechanism and third-channel display. Sensitivity is 1 mV/division. (520)



The SK-91 color video camera from Hitachi Denshi Ltd. weighs only 4.4 kg and runs for over two hours on a rechargeable battery belt. A new F1.4 prismatic beam splitter, together with low-noise preamplifiers, provides high sensitivity and an excellent signal-to-noise ratio. (521)

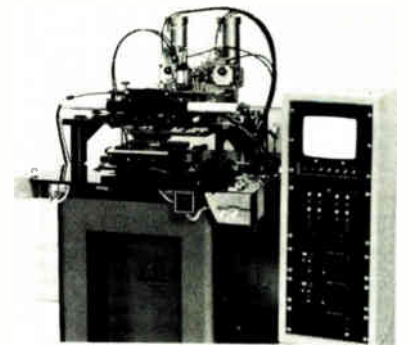

Newlong Seimitsu Kogyo Co. combines a TV monitor with its screen printer in order to let users check mask alignment and make the necessary adjustments. Since the monitor is then set to the right alignment, placing subsequent wafers in the right position is easy. (524)



Hakuto Co. exports the model 1861 gang programmer for programmable read-only memories. The unit can program the Intel 2716 and 2732 and Texas Instruments TMS 2532 PROMS and equivalents and has RS-232-C and 20-mA current-loop interfaces. Among its check func-

tions is a system check that tries out the 1860 to see if it is working properly, as well as checking to see that the PROMS are programmable. Data inputs for the programming may come from a master device, a computer program, or a paper-tape reader. (522)



Ulvac Corp. designed its System 1200 vacuum deposition and evaporation unit to process, at one time, 78 3-in. or 51 4-in. wafers under fully automated control. A high-capacity electron gun and a planetary jig provide excellent step coverage and uniform film thickness. (525)

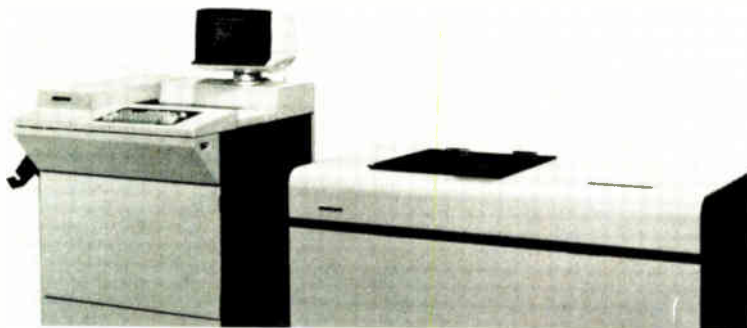

Toshiba Corp. incorporates laser-beam technology in its document filing system, which easily and speedily records and reproduces printed image information. There are four parts to the system: a laser scanner that converts input information into electric signals; an optical disk memory that permanently records the signals; a laser

printer that reproduces the data on plain paper; and a microcomputer-controlled operation and control unit. Capacity is 10,000 pages per 30-cm optical disk; random-access time is 0.5 s; read and record time is 3.5 s; and reproduction and output time is 10 s. Resolution in reading and output is 8 lines/mm. (523)

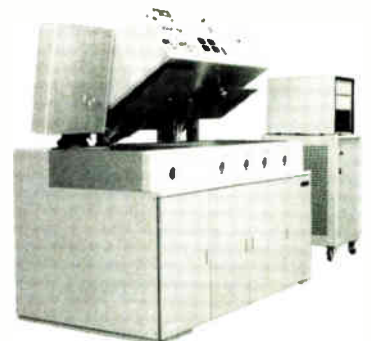

The MLH-6000 high-rate sputtering system from Ulvac Corp. consists of a loading/unloading chamber and a sputtering chamber. As one tray of substrates is being sputtered, the previous one may be unloaded and the next one loaded, contributing to the high sputtering rate. (526)

STANLEY. SUPER BRIGHT AND SUPER RIGHT.



Actual Size

Stanley now for all low-current-drive display applications calling for a super-bright and colorful face.

Super bright LED Seven Segment Displays

Stanley quality is here now — Stanley is twice as bright as ordinary displays. So the readout is easier to see, the equipment that much more applicable to the use it is designed for. Color adds the final touch — red, yellow, green and amber — while various combinations of digit with plus figure, 1-digit or 2-digit configurations mean wide-ranging uses for measuring equipment, testing and audio equipment, computer, digital clock, office equipment and other applications.

See the brighter side of Stanley LEDs
at ELECTRONICA '80

Hall No. 20, Booth No. 22027, 22028

The Stanley logo, featuring the word "STANLEY" in a stylized, bold, red font with a white outline.

**STANLEY
ELECTRIC CO., LTD.**

LED Sales Sec.:

2-9-13, Nakameguro, Meguro-ku, Tokyo 153, Japan
Tel. Tokyo 03-710-2531 Telex. 2466623

Circle 135 on reader service card

High Performance on Display From Hitachi, the Reliable Performer

High-resolution Color Display Tube

Features

- High-resolution in-line electron gun
- Fine pitch dot type screen
- Self-convergence, preset deflection yoke

Applications

- Character and graphic display, picture monitor



Main Specifications

Size (in.)	Type No.	Spot Dia. (mm)	Brightness (fL)	Anode Voltage (kV)	Beam Current (μ A)	Dot Trio Quantity (K pair)	Character Numbers
14	370JYB22	0.5	50	23	450	750	3000
14	370JSB22	0.8	70	23	700	380	2000
20	510XJB22	0.8	26	27.5	450	1,350	6000
20	510XTB22	1.2	55	27.5	1,000	600	4000

Note: Monochrome display tube is available.

Liquid Crystal Dot Matrix Display Module

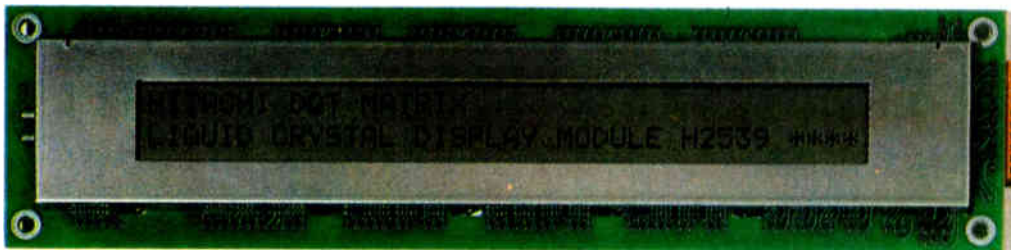

Features

- Alpha-numeric display module having 5 x 7 dots/characters with cursor
- Compact and slim design
- 1-chip control C-MOS LSI (HD43160A) which has 160 characters (ROM) and character memory (RAM) is available.
- Easy-to-use TTL or C-MOS level interface
- Suitable for battery drive and portable use

Applications

- Small-sized terminal displays, microcomputers, measuring instruments, POS terminals, telephone receivers, machine translators

Main Specifications

Module	Number of Characters	Module Size (WxHxD), mm, max.	Power Supplies, V	Power Dissipation, mW	Weight, g
H2532A	16x1	84x44x15	+5, -5	2 (typical)	40
H2535	16x2	84x44x15	+5, -5	2 (typical)	40
H2538A	40x1	220x53x15	+5, -5	2 (typical)	100
H2539	40x2	220x53x15	+5, -5	2 (typical)	100
H2555	40x1	227x38.5x15	+5, -5	2 (typical)	90

Note: The Hitachi LC display module can be manufactured to meet special design specifications. Please contact Hitachi for special modules.



Head Office: Hitachi, Ltd. Electronic Devices Group, 6-2, Otemachi 2-chome, Chiyoda-ku, Tokyo 100, Japan, Telephone: Tokyo (03) 270-2111, Cable: "HITACHY" TOKYO, Telex: J22395, J22432, J24491, J26375/ U.S.A.: Hitachi America, Ltd. Chicago Branch Office P.O. Box 973, Arlington Heights, Ill. 60005/ United Kingdom: Hitachi Electronic Components (U.K.) Limited P.I.E. Building, 2 Rubastic Road, Southall, Middlesex UB2 5LF/ West Germany: Hitachi Electronic Components Europe GmbH 4000 Düsseldorf 1, Königsallee 6



- More new products and Professional Program sessions than at any high-technology convention in the Southwest.
- Involvement by the major electronics firms in the Southwest and across the nation. Joint sponsorship by units of IEEE and ERA.
- Demonstrations...the hands-on kind, that is.
- Concentration on leading-edge technology, with more than 120 Professional Program presentations and upwards of 700 exhibit booths.
- Opportunity to examine what's new in state-of-the-art ideas and products.
- Needed by every electronics professional seeking to advance his company and its technology...and himself.

Join us at *Midcon/80* at the Dallas Convention Center next November 4-5-6. To make it easier to attend—and get a \$2 discount over at-the-door admission – complete the registration card below and mail it with \$3 before October 17 to:
Midcon, 999 North Sepulveda Boulevard, El Segundo, California 90245.



Midcon/80
Electronic Show and Convention
Dallas—Convention Center
November 4—6 1980

PERSONS UNDER 18 YEARS OF AGE NOT ADMITTED

ENCLOSE \$3 CHECK WITH THIS COUPON FOR PRE-REGISTRATION

CIRCLE APPLICABLE BLOCKS

A	Electrical/Electronic Engineering
B	Mechanical/Product Engineering
C	Test Engineering
D	Production/Mfg. Engineering
E	Engineering Services
F	Quality Engineering/Control
G	Purchasing
H	Sales/Marketing
I	Management
J	Student/Educator
K	Other
L	Active Components
M	Passive Components
N	Electro-Mechanical Components
O	Tools and Production Equipment
P	Computers and Peripherals
Q	Instrumentation/Test Equipment
R	Control Systems
S	Mechanical/Electronic Packaging
T	Data Communications
U	Power Sources
V	Other

Please **PRINT** as you want shown on badge.

Name _____

FIRST OR INITIALS _____ LAST _____

Position _____ Telephone (OPTIONAL) _____

AREA CODE _____ NUMBER _____

Company/Organization _____

Address: Bus or Home _____

City, State, Zip Code _____

STATE _____ ZIP CODE _____



Dallas
Convention
Center
Dallas,
Texas
November
4-5-6

Sponsored by Dallas and Chicago Sections, Regions IV and V, IEEE / Southwest and Chicagoland Chapters and Mid-USA Council, ERA
Produced by Electronic Conventions, Inc., a nonprofit corporation 

YOU KNOW THE LARGEST ELECTRONIC COMPANIES IN THE WORLD. DO YOU KNOW ISKRA?

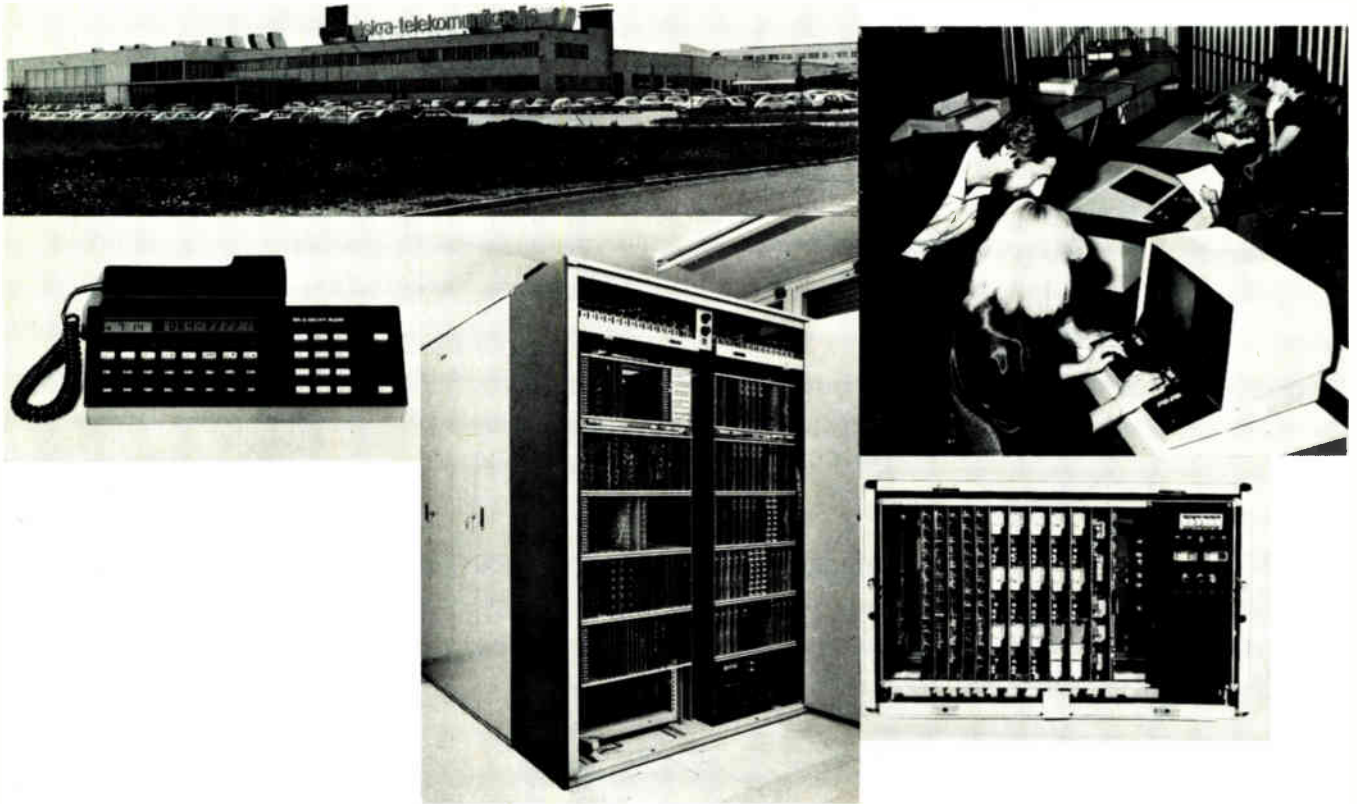

Iskra group has some 29,000 employees including 2,000 research and development engineers in 81 factories, research, marketing and other organizations, and the most up-to-date technologies to work with. With a total turnover of 1.294 billion dollars last year, it has been classified among 16 largest manufacturers of electronic products in Europe.

In its development, Iskra is oriented towards tomorrow's activities which go far beyond the traditional limits of electromechanics and extend to the widest application of electronics with priority being given to the promotion of the development of computers, communications, automation, microelectronics, optoelectronics and engineering activities. All to ensure that every project we handle comes within schedule and budget requirements and meets performance and client expectations.

Iskra has 24 trading companies, representative offices and production plants in 18 countries all over the world. In the period 1974-1979, Iskra's exports increased by 153% reaching 120 million dollars in 1979. In 1980, the total turnover is expected to be 1.486 billions of dollars and the export figure approximately 145 million dollars.

For more information call or write:

Iskra Commerce, Trg revolucije 3, 61001 Ljubljana, Yugoslavia, Telephone-international: + 38 61 324 261; Telex: 31 356 yu iskexp
 USA: Iskra Electronics Inc., 8 Greenfield Road, Syosset, N.Y. 11791, Tel.: (516) 364 2616—Germany: Iskra Elektronik, GmbH, Furtbachstrasse 2b, 7000 Stuttgart 1, Tel.: (711) 60 30 61—CEFRA, GmbH, Ungererstrasse 40, 8000 München 40, Tel.: 39 20 61—Italy: Iskra Elettronica Italiana, S.r.l., Piazza de Angeli 3, 20 146 Milano, Tel.: 49 80 036—France: Iskra France, 354, rue Lecourbe, 75015 Paris, Tel.: 554 04 27—United Kingdom: Iskra Limited, Surrey CR 3 2 HT, Redlands, Coulsdon, Tel.: 66 87 141—Switzerland: Iskra Electronics AG, Stalden 11, CH 4500 Solothurn, Tel.: (065) 22 81 22—Czechoslovakia: Iskra, Lazarska 5, 11000 Prague, Tel.: 20 27 71—Poland: Iskra, Swietokrzyska 36 m 15, Warsaw, Tel.: 20 12 53—Germany DR: Iskra, Hermann-Maternstrasse 46, 104 Berlin, Tel.: 28 28 322—Rumania: Iskra, Str. Visarion nr. 6, Bucharest, Tel.: 50 26 75—U.S.S.R.: Iskra, Mosfilmovskaja 42, Moscow, Tel.: 147 84 03—Egypt: Iskra, 34 Adiy Street, Cairo, Tel.: 74 76 95—Iran: Iskra Teheran, 9th Street No. 6, Maydan Sanal, Teheran, Tel.: 82 67 65—Turkey: Iskra Istanbul, Yenicsarsi Biltex Han No. 40, Galatasaray, Tel.: 44 75 00—Venezuela: Eurocommerce S.A., Apartado 68901, Altamira, Caracas, Tel.: 72 88 21.



Iskra

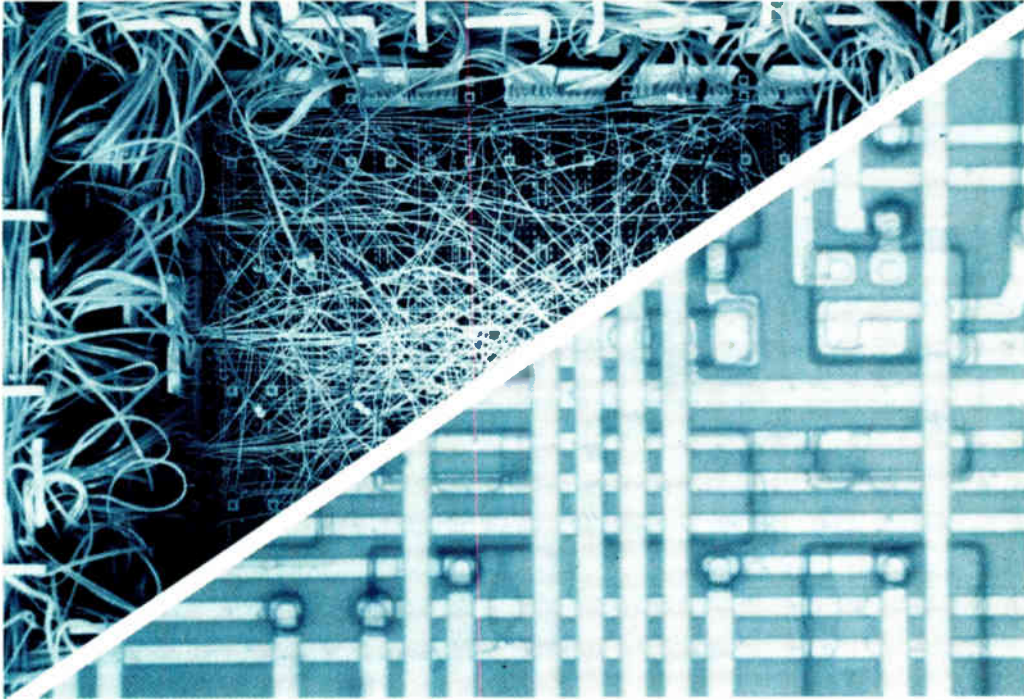

The System/370 processor chip: a triumph for automated design

Programs for wiring up a complex gate array
surmount the challenge of very large-scale integration

□ In the fall of 1978, a team at International Business Machines Corp.'s Data Systems division in East Fishkill, N. Y., mobilized to reduce the central processing unit of the System/370—the most prominent computer in the main-frame class—to a piece of silicon. In other words, the group was asked to position and wire nearly 5,000 logic gates on a master slice measuring 7 millimeters (276 mils) on a side. The gates comprise over 45,000 components on what might be the most complex bipolar integrated circuit built to date.

This audacious experiment was undertaken to assay the effectiveness of IBM's automatic placement and wiring system for gate arrays by pushing it into the realm of very large-scale integration. The company wanted to know if this was a reasonable way to build an advanced microprocessor.

The three articles that follow outline the proceedings of that trial. To be sure, the undertaking was a success; but the jury is still out about the degree. One criterion is the definition of central processing unit, for IBM points out that its VLSI processor embodies only the data flow portion of the CPU. The accomplishment is nevertheless remarkable.

The first article in the series describes the architecture of

the machine—that is, the paths over which the data flows between registers and arithmetic units. The second describes the automated design process used to position and interconnect logical blocks in the array. The third deals with the array's physical characteristics. It describes the internal cell and shows how such cells and the input receivers and output drivers are arranged on the die. This article also tells how the speed and power of the internal cells were adjusted to compensate for long on-chip interconnections.

The technology here is impressive, though it had really been proven previously—albeit with fewer gates and larger geometries. The points to ponder are that only nine months was required for logic entry, computer-assisted cell placement and interconnection, and test-pattern generation and verification; that these steps were carried out on a System/370, the same architecture that was being cloned; and that future turnaround time will be markedly reduced now that the CAD tools are in place.

Overall, this achievement is reassuring to everyone in the U.S. semiconductor industry who wants it to retain its position of technological leadership.

—John G. Posa



Gate array embodies System/370 processor

by C. Davis, G. Maley, R. Simmons, H. Stoller, R. Warren, and T. Wöhr, IBM Corp., Data Systems Division, East Fishkill, N. Y.

The central processing unit of a System/370 mainframe computer now sits on a single chip (see Fig. 1). The goal was to see if the computer-aided design of gate arrays could meet the challenge of very large-scale integration, and it can—only nine months were required to encode the processor's logic design, automatically place and wire the logic gates, and generate and verify the test patterns. No commercial production of the device itself is planned, however.

On the chip . . .

Figure 2 shows how the chip connects to other system components, and Figs. 3 and 4 explain the chip architecture. A circuit count of nearly 5,000 and a 2.2-nanosecond NAND circuit—conservatively clocked at 4 ns—gives the machine a cycle time of 100 ns. The rich instruction set of the IBM System/370 requires a weighted average

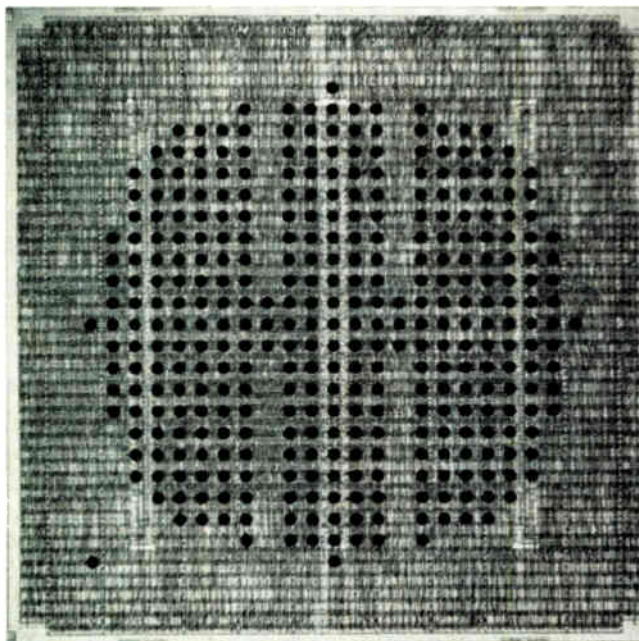

1. Master mainframe. Along 1,405 wiring channels and through 33,516 vias, 4,923 Schottky bipolar gates out of a possible 7,640 were automatically interconnected. The third and final metal level on the 7-by-7-millimeter (75,950-mil²) die ties to 200 I/O solder dots.

of 50 machine cycles for each instruction, resulting in a system performance rating of 200,000 instructions per second.

An 8-bit arithmetic and logic unit is all that can be permitted if hardware assists such as program relocation are to be included. A shared incrementer/decrementer (I/D) is used rather than counters, because sequential circuits can be difficult to test.

. . . and off the chip

An off-chip control store, assumed to be read-only memory, provides overall control of the processor (see Fig. 2). The ROM word is 54 bits wide, including 3 parity bits. On the assumption that up to a quarter of a million bits of ROM would be required, a full 2 bytes of ROM addressing, gated off the CPU chip, is provided.

Enough pads (200) were supplied on the master slice to allow horizontal microprogramming. This means that system resources are controlled by microcode bits directly, without the need for vertical microprogramming. The directness of such an approach should reduce timing and logic errors, while its horizontal nature should lessen the testing problem and in general add to the flexibility of the chip.

The System/370 architecture requires many active registers that could not fit on the chip, so an off-chip high-speed local store is instead used for this purpose. Given the performance of the bipolar processor chip, this local store complies nicely with the requirement for a 100-ns machine cycle time. (The access time of the register bank is 60 ns.)

Data flow

The 8-bit ALU, incrementer/decrementer, and both off-chip memories are controlled by the 54-bit microcode word, as shown in Figs. 3 and 4. The microcode is also responsible for its own sequencing.

The ALU performs its arithmetic and logic operations on two 8-bit binary numbers, producing one 8-bit binary result with carry and overflow signals. It can also perform the same operations on two packed 4-bit binary-coded decimal numbers or on 8-bit binary numbers that represent alphabetic characters. It produces negative numbers in the 2's complement form.

Its three 8-bit logical operations are OR, AND, and exclusive-OR. Its arithmetic operations may be controlled directly from a microcode ROM field or indirectly through a bit located in the status register, S. This indirect control allows microprogramming routines to be shared for adding and subtracting operations.

The output of the ALU is connected to a bus that is used to pass the data to a series of machine registers. As for the input, two registers, A and B, each hold a byte for the ALU. Fields in the ROM word decide how the contents of the A and B registers are presented to the ALU. This gating is important to decimal operations because it gives easy access to each of the two 4-bit hexadecimal digits in each byte. The two hexadecimal digits in the A register can also be swapped—a feature that is very useful for the packing and unpacking instructions required by the System/370 architecture.

The incrementer/decrementer is really a 24-bit binary

arithmetic unit having limited capabilities. It can perform only eight arithmetic operations: add or subtract the values 0, 1, 2, and 3. The primary input to the I/D comes from the 24-bit memory-address register. A ROM field selects which of the eight arithmetic operations is to be performed, as well as which set of registers is to feed the memory-address register (MAR) and thus the I/D. The output of the I/D is always returned to the same set of registers that feed the MAR.

A 24-bit shifter with a very limited number of complex instructions is connected in parallel with the I/D. The shifter primarily handles the 12-bit address field used for page addressing in a virtual storage system.

Memory control

Twenty-four address lines from the processor chip address 16 million bytes of main storage—another requirement of the System/370 architecture. The chip can accept or transmit memory data in either 1- or 2-byte increments. For reasons of performance, however, a 2-byte interface is preferred and is assumed here.

The parity of each data byte from the main store is checked by the chip. Parity generators affix a parity bit to each memory data byte leaving the chip, and these bits are tested when the bytes return.

The two main memories with which the chip works can have different speeds. Since they share the same address and data buses, they cannot be referenced on the same cycle. Two independent signals, generated by a ROM field, leave the chip and select either memory or neither memory. This arrangement allows I/O devices to be affixed to the same set of address and data lines as the main memories.

The CPU will operate at almost any memory speed, since the memories are asynchronous with it. Any memory reference causes the processor to enter a wait state that lasts until a data-valid signal is received from the referenced memory. A separate control line from the chip requests a read or write operation.

A 16-bit ROM address is generated very early in each machine cycle to ready the next 54-bit microcode word (see Fig. 3). Thus, while one word controls the chip, the next word is being fetched. As the generation of the next ROM address requires 25 ns, the access time of the microcode ROM must be 75 ns for the 100-ns machine cycle time.

ROM addressing

The CPU generates 2 low-order bits of ROM address by examining conditions internal to the chip. Two fields in the ROM data word, one field for each bit, dictate which internal conditions the CPU is to consider. This technique provides a four-way conditional branch that appears to be adequate for a 1-byte CPU.

The next-higher 6 bits of the address are taken directly from a 6-bit field in the ROM data word, thereby enabling the ROM programmer to read any one of 64 words without consideration of the 2 branch bits. By setting each of the 2 branch bits to 0 or 1, a programmer can read any of 256 words without branching.

The memory address register is 3 bytes wide (refer to Fig. 4). Any bit pattern in this register will appear on the

24 address lines from the chip. The immediate source of the data to be placed in either the high-speed local store or the main memory is derived from one of four pairs of registers. Any of the 2-byte R, G, L, or H register pairs may be used as a memory-data register (MDR), significantly reducing the need for data transfer among registers. The G register pair has special ROM branching capabilities that dictate its use as an operation-code register.

A 3-byte instruction counter (the I register) is updated by having its contents passed through the I/D. Another 3-byte register, U, serves as an operand-address register for main store; it, too, can be updated by the I/D. The 2-byte T register is used for addressing local store, limiting the size of the local store to 65,536, or 64-K, words. Although this feature is not shown in Fig. 4, the I, U, T, and R registers can pass 2 bytes of data—with or without displacement information—among themselves to aid in implementing the virtual storage requirements of the System/370 architecture.

More registers

As mentioned, the S register is a CPU status register. The microprogram uses it for branching by altering the 2 low-order bits of the ROM address generated by the chip. The higher-order byte of the S register can be set and reset by external inputs.

The 1-byte F register is for interrupts, and all 8 of its bits may be set in accordance with external conditions. The response to the setting of these bits is under control of the microprogram, and action is usually delayed until the end of a System/370 instruction. This delay time can therefore vary from a few to hundreds of machine cycles.

The execution of some System/370 instructions may require hundreds of microinstructions. It is therefore

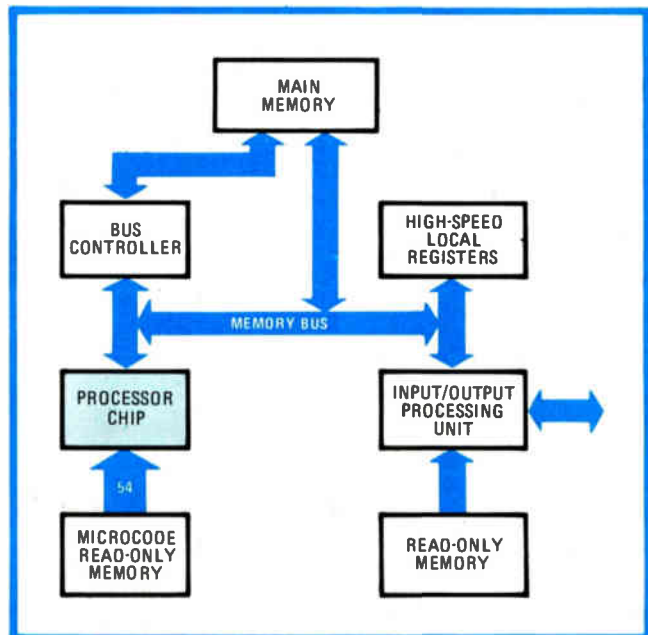

2. In its place. To complete the System/370 architecture, the processor chip talks to main memory, a high-speed local store, and a separate I/O channel processor over a multiplexed memory bus. Microcode is brought in directly over a separate 54-bit bus.

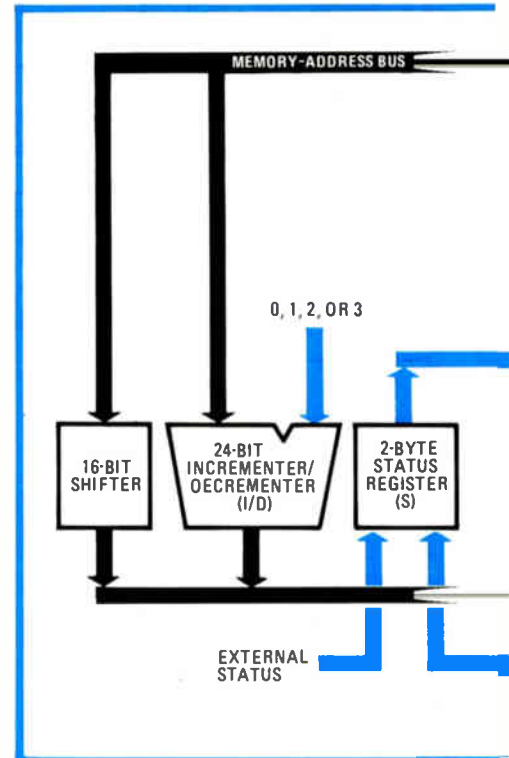
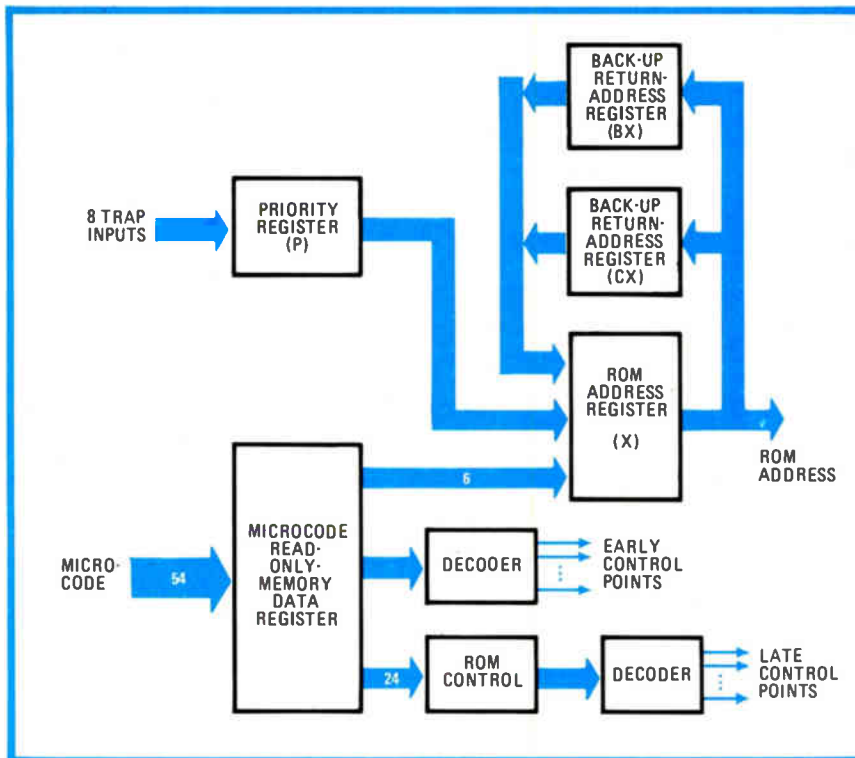

3. Decoding. The 54-bit microcode gets divided up for control and sequencing of the microcode ROM itself. The next address is based upon bits from the ROM, from trap inputs, and from backup registers holding return addresses if a trap was taken.

advantageous to provide a hardware-forced microprogram-entry, or trap, system to transfer control between microprograms on a microinstruction boundary rather than on a macroinstruction boundary. Once included, this hardware can be expanded to solve other difficult control problems such as the handling of parity errors, push-button interrupts like those generated through a front panel, and memory wraparound.

Eight trap levels

The processor chip incorporates eight trap levels, each of which forces a different address onto the ROM address lines. The eight levels are executed in the following order:

- Parity errors.
- Initial program load (IPL) request.
- Page overflow (virtual storage operation).
- Memory wraparound.
- Memory-protect violation.
- Stop request.
- I/O control.
- I/O control.

The last two levels are intended to handle high-speed I/O devices that cannot wait until the end of a System/370 instruction.

Once a trap has been taken, a latch is set and all future trapping is suspended until a microinstruction is executed to reset the latch. In addition, each of the seven low levels (all below parity error) can be individually masked off. As shown in Fig. 3, the ROM address register has two backup registers to save return addresses when a

trap instruction is in progress.

No macrocircuits are used in the physical design of the logic. Every logic function on the chip—whether a register, latch, or one-shot—is created exclusively out of NAND gates.

Furthermore, every function was designed so that the placement program could locate the component NAND blocks anywhere on the chip. For example, the latches were designed to operate even if the four NAND blocks comprising the network were located at each of the corners of the chip. This approach was adopted because it gave maximum flexibility to the automatic placement and wiring programs.

Redundant logic can improve performance and reliability. Unfortunately, it cannot be used if high test coverage of stuck faults is desired.

Performance enhancement was therefore achieved without redundancies. For instance, clock timing was used to eliminate logic glitches (noise). In addition, for easier testing, all clock lines can be activated by test input signals, allowing data to be flushed through the registers. As a result, the entire chip becomes one large combinatorial—rather than a sequential—network. Moreover, all registers may be loaded directly from input pads and read directly from output pads, which further enhances testability.

Testing details

Manually generated test patterns were used to test the microprocessor chip. The initial objective was to select reasonably good chips from the first fabrication run through flush testing. Chips that passed this preliminary screening would then be mounted on modules and functionally exercised. The exerciser would clock the chips at full speed while executing test microcode.

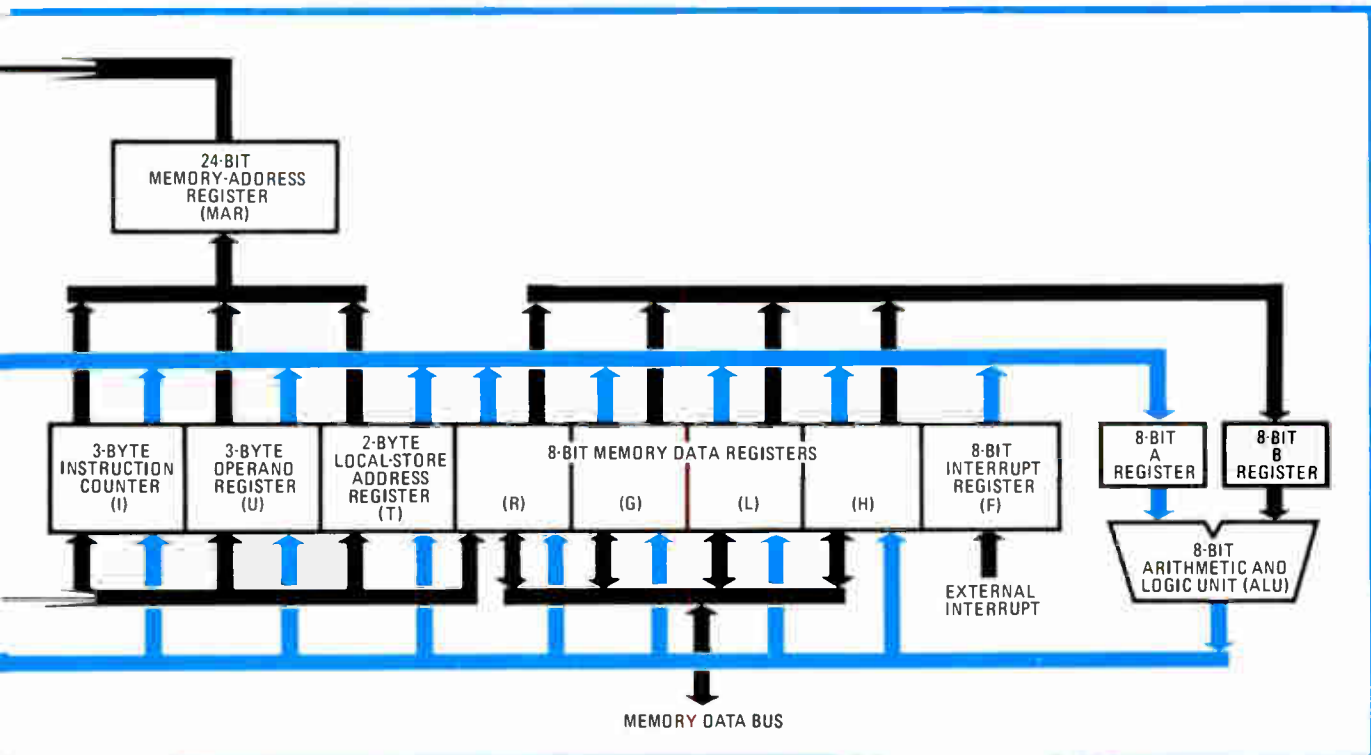

A limited number of flush tests caught 40% of the stuck faults. Close to 100% may be caught by exercising the registers and propagating the stuck faults through the sequential circuits. Some test patterns could cause the chip to oscillate or lock up. These were spotted by means of a simulator and avoided.

The fault simulator produces an updated listing of the untested fault conditions. In working with this list, new test patterns are generated to cover the untested faults. Thus any degree of test coverage may be obtained.

The physical design

In the case of this gate array, 4,923 circuits had to be placed within 7,739 cells and 10,605 interconnections had to be wired on a 800-by-600-channel grid.

Two placement methods were pursued: fully automated placement and iterative structured placement. The automatic method ignored the functionality of the logic and instead grouped and placed the logic blocks on the basis of the interconnection matrix. This was possible because the basic logic gate had been designed to operate independently of the position of its constituent NAND blocks. Since not all the cells of the chip had to be used, rows of horizontal cells were kept clear of NAND blocks in order to provide avenues for additional horizontal wiring channels.

Three different automatic placement passes were made, and the most promising was chosen for automatic wiring. Each placement pass required approximately three hours of IBM System/370 model 168 data-processing time, as well as several hundred cylinders of disk space.

The structured, iterative placement method was pursued as an alternative in case the fully automatic method was unsuccessful. In addition, this method gives the

4. Architectural details. An 8-bit arithmetic and logic unit adds and subtracts, ORs, ANDs, and exclusive-ORs. The 24-bit memory address register feeds a 16-bit shifter and a 24-bit incrementer/decrementer that is actually an ALU with limited functions.

designer greater control during failure analysis and greater freedom to correlate the physical placement of a set of NAND blocks and their logical function.

The same automatic wiring program was used on placements resulting from both methods. The best fully automatic placement was wired with only 68 overflows. Wiring for the best structured method produced over 200 overflows. The detailed printout of the wiring required a plot measuring about 4 by 5 meters. Using this printout, and with the aid of a card input language to describe the wire additions and deletions, the 68 overflows were imbedded manually.

Few errors

After wiring, a sophisticated pattern-recognition program for checking circuit shapes was used to test for ground-rule (geometry) violations and for logical and physical errors. The first pass through this program ferreted out just five errors in a total of 750,000 shapes involved in the design. Two of the errors were in the definition of the gate array and the other three were wiring violations.

The second pass was error-free. The shape-checking procedure required about four hours of processing time on the IBM System/370 model 168 and several hundred cylinders of disk space.

The physical design took about three months to complete. Allowance should be made for the fact that this was the first time that this array and automatic placement and wiring programs were used. A second-pass design would take much less time. □



Computer-aided design wires 5,000-circuit chip

by M. Feuer, K. H. Khokhani, and D. Mehta
IBM Corp., Data Systems Division, East Fishkill, N. Y.

Automatic design aids that work well at one level of chip complexity may not succeed at a much higher level. Gate-placement and -wiring programs are crucial to the success of gate arrays much less complicated than the one needed to realize a System/370 microprocessor. Fortunately, with relatively minor modifications, the same design aids proved capable of organizing the logical elements into a 7-millimeter-square area.

Experience at IBM in the design of gate arrays dates back 10 years to the layout of 130-circuit bipolar chips and extends through the design automation of the 700-circuit logic chips in the System/38 and 4300 series to a 1,500-circuit bipolar gate array used in microcontroller applications. With its 5,000 gates, therefore, the System/370 processor chip quadruples the number of circuits and connections to be placed and wired. This adds a valuable empirical data point to a plot of the data-processing times required for the automatic placement and wiring of increasing numbers of circuits.

Wirability analysis

The feasibility of wiring so many circuits was tackled from many angles. Various master-slice elements and cells were evaluated in terms of the difficulty of wiring them. Overall wiring requirements were estimated from a wirability model. At meetings with chip designers, the details of cell topology were optimized. A test chip, one quarter the size of the proposed chip, was described to an automatic design system and the gates of a small microprocessor were placed and wired. Finally, a wiring analysis tool, consisting of simplified automatic placement and global wiring programs, was used on an early version of the logic to estimate how hard it would be to wire. In each case, the results confirmed the wirability of the proposed System/370 processor.

The various activities involved in designing and developing a gate array overlap considerably. The design and verification of the logic for this device began before the definition of the gate array and continued to within two months of its final layout. The wirability analysis was performed concurrently with both the design of the gate array and the coding of the data into the computer-aided design system. Necessary CAD programming changes began before the gate array data coding was completed,

and these changes were tested on preliminary logic when the gate array data became available.

In parallel with the CAD programming changes, a special test chip was both designed and manufactured to verify the electrical characteristics of the gate array. In the end, with the design system and the gate array both in satisfactory condition, a final version of the System/370 microprocessor logic was placed and wired. By that time a stockpile of gate array wafers had collected, awaiting the metalization patterns that were all they required for completion (see figure).

Automatic placement and wiring

The design process consisted of the following 11 steps, of which all but the tenth were automatic:

- Clustering. The 5,000 circuits were clustered into 144 supernodes of highly interconnected gates.
- Constructive placement of supernodes. The supernodes were assigned in sequence to various regions of the chip, called supercells, according to the degree of their connectivity to neighboring supernodes.
- Supernode interchange. Pairwise exchanges of supernodes were evaluated and accepted if they decreased the number of wires crossing supernode boundaries.
- Supernode decomposition. Each individual logic gate was placed in sequence in, or as near as possible to, the region to which its supernode was assigned.
- Iterative interchange. Initial placement was improved through several efficient interchange techniques. Interchange algorithms were used to balance horizontal- and vertical-channel utilization, improve channel crossings of boundaries, reduce total conductor length, and attempt to reduce congestion of wires by moving gates from crowded into uncrowded zones. The iterative process ended when a highly wirable layout was generated.
- Global wiring. Wires were assigned to groups of channels to produce a feasible overall wiring pattern.
- Vertical assignment. The entry points of vertical wire segments into horizontal channels were determined.
- Horizontal line packing. A channel router wired the horizontal segments.
- Clean-up maze runner. A local maze runner, which exhaustively searched a small region of the chip for all possible routes, completed special unwired connections.
- Manual wire embedding. The remaining wires were routed manually.
- Checking. A series of topological and electrical tests was performed.

The final logic became available on June 15, 1979. Automatic placement and wiring were completed roughly one month later for all except 68 of the 11,000 connections. Manual wire embedding of these 68 and checking was completed on Aug. 15, 1979. The elapsed time of two months is long, compared with production schedules. Even so two months compares favorably with the time needed to design a VLSI chip manually.

The running time for automatic placement (the first five steps in the design process) was 208 minutes on an IBM System/370 model 168, and wiring time (the next four steps) was 87 minutes.

These placement and wiring running times, T_p and T_w , in relation to the number of circuits involved, C , can be

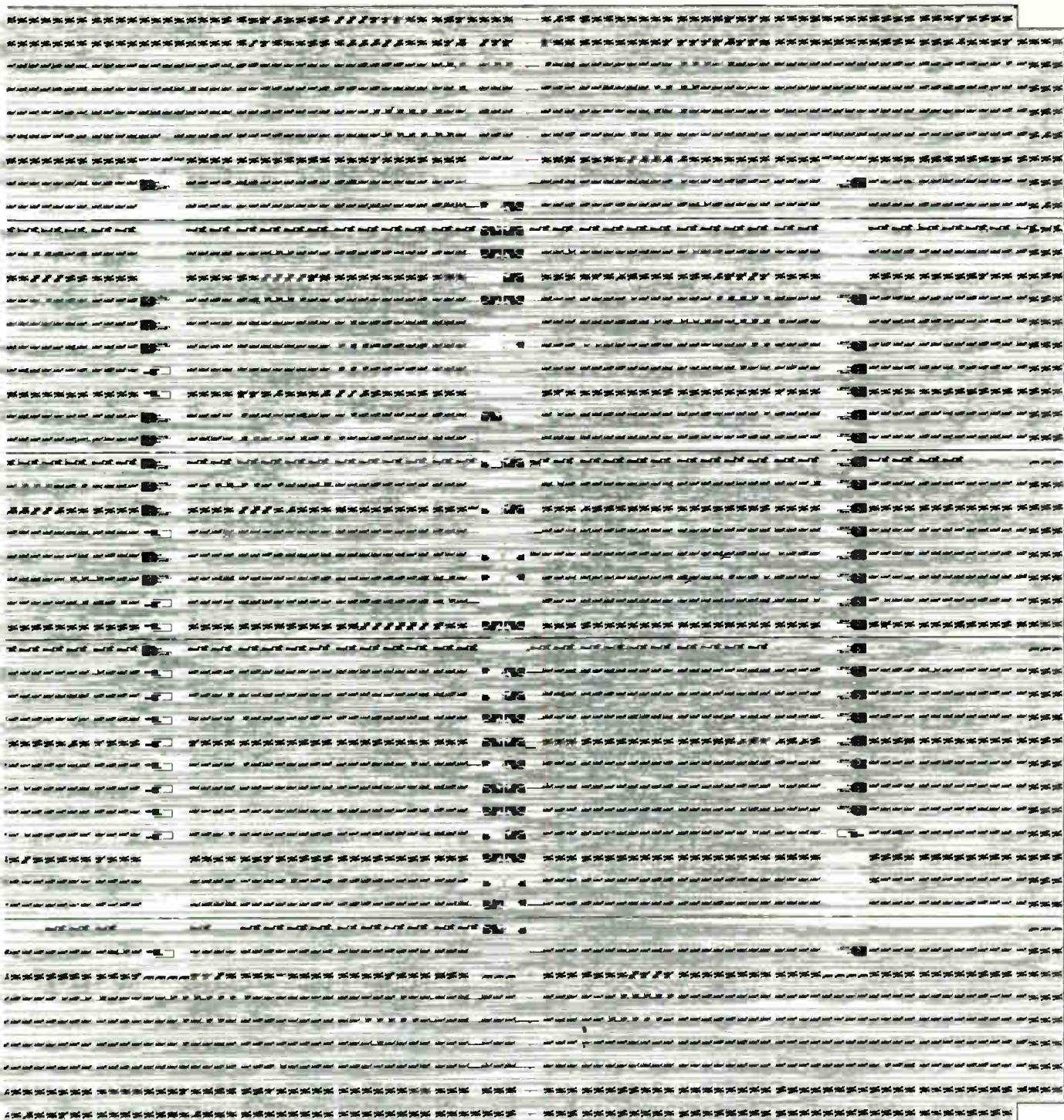

Complex. This is just the first layer of metal wiring on the System/370 processor chip. If the individual segments were laid end to end, they would span 2.4 meters. The second metal layer is even more complex; it would stretch 3.4 m. The third level is used for power and ground.

combined with the experience gained from previous chips to yield the empirical scaling formulas:

$$T_p \propto C^{1.2}$$
$$T_w \propto C^{1.1}$$

Evidently then, the hierarchical nature of the placement and wiring algorithms leads to only a mild increase in running time with increasing chip complexity, given constant intrinsic wirability. The overall running times

could be greatly reduced if more wiring channels were provided, but then chip size and manufacturing costs would be adversely affected.

The versatility and rapidity of designing with gate arrays has been proved yet again. Continuing advances in hierarchical automatic design tools, the inclusion of memory arrays, and technological advances that provide more wiring channels will further ensure this design style's future in very large-scale integration. □



Halving load resistances shortens long path delays

by A. H. Dansky
IBM Corp., Data Systems Division, East Fishkill, N. Y.

Long interconnections spell a high capacitance that can damage the performance of a very large-scale integrated circuit. In the case of the chip version of the System/370 central processing unit, some of the 5,000 logic gates are linked by interconnections more than 7 millimeters long—an unavoidable consequence of large functional chips. The microprocessor comprises 45,000 components at a density of 110 circuits per square millimeter.

To compensate for a long path's high capacitance, the drive capability of the basic logic circuit may be increased by lowering its output load resistance. This technique must be applied judiciously, however, as it also raises the gate's power dissipation.

It was to combine maximum performance at low power with minimum area that Schottky-clamped TTL was chosen for the basic CPU logic circuit. The circuit resembles the one used in the IBM 4300 computer series,

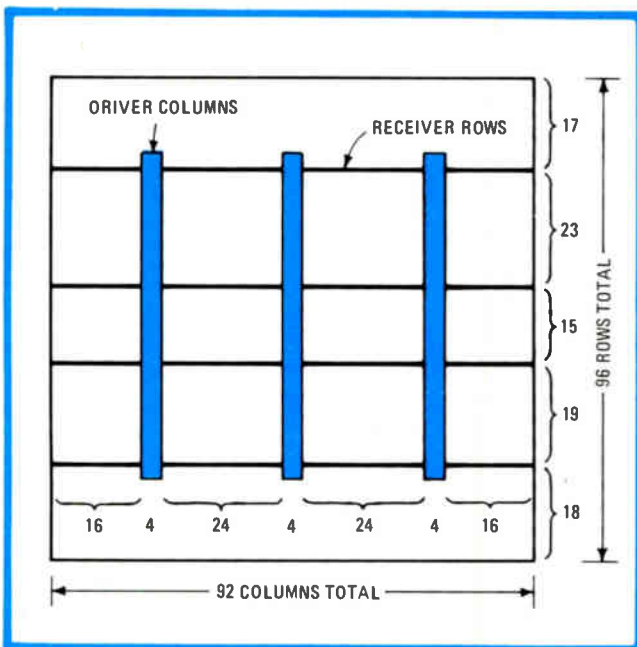

1. Arrangement. The array has 96 rows, 4 of which contain receiver circuits, and 92 columns, including 12 for drivers. Three metal levels provide interconnections. Only about 65% of the internal logic gates are used, but the unoccupied cells provide extra wiring channels.

except for the fact that it consumes less power.

In fact, the semiconductor process used for the System/370 gate array is virtually identical to the one developed for the bipolar random logic chips contained in the 4300 series [*Electronics*, March 15, 1979, p. 105]. Its main features are a 2-micrometer-thick epitaxial layer, recessed oxide isolation, and three levels of metal for interconnections. For this chip, however, the circuit geometries have been scaled down from 3 to 2.5 μm .

The gate array consists of a matrix of 96 rows by 92 columns of basic cells (Fig. 1). Each cell may accommodate one circuit—either the internal logic gate or a driver or receiver circuit for input and output. As Fig. 1 shows, these drivers and receivers are interspersed with the internal logic gates, with the drivers arranged in 12 columns and the receivers in 4 rows.

Altogether there are 7,640 internal cells, but only about 65% of them will be occupied by circuits. The unoccupied 35% of the internal cells provides additional wiring channel capacity. Each occupied cell provides 5 horizontal channels on the first level of metal and 10 vertical wiring channels on the second metal level. An unoccupied cell supplies an additional 4 horizontal channels, since no contacts to it are opened. The third metal level is used mainly for power distribution and I/O.

Wiring statistics

There are 1,404 wiring channels available on the chip after placement. This equals 80 columns of 10 vertical channels per column, or 800, plus 56 occupied rows of 5 horizontal channels per row, or 280, plus 36 unoccupied rows of 9 horizontal channels per row, or 324. Simulations and logic diagrams used logic macros such as registers and parity trees to simplify the logic description. But the physical design used only single circuits for maximum flexibility of placement and wiring.

The basic internal logic gate shown in Fig. 2 has a speed-power product of 0.7 picojoule and requires a low power-supply voltage of 1.7 volts. The receivers and drivers for off-chip data, however, require a higher supply voltage of 3.4 v to cope with the greater external voltage swings. The total nominal power dissipated by the chip's 5,000 or so circuits is 2.3 watts, of which 1.6 w is consumed by the logic gates.

The total interconnection length is 5.8 meters, com-

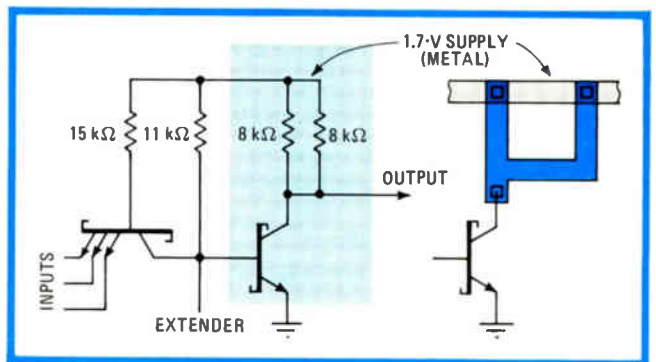

2. Ohm's law. About 13% of the paths on the chip exhibited capacitive loading in excess of 1 pF. To circumvent speed degradation, two load resistances were given to the cells. When both are wired in, the pull-up value is halved and drive increased.

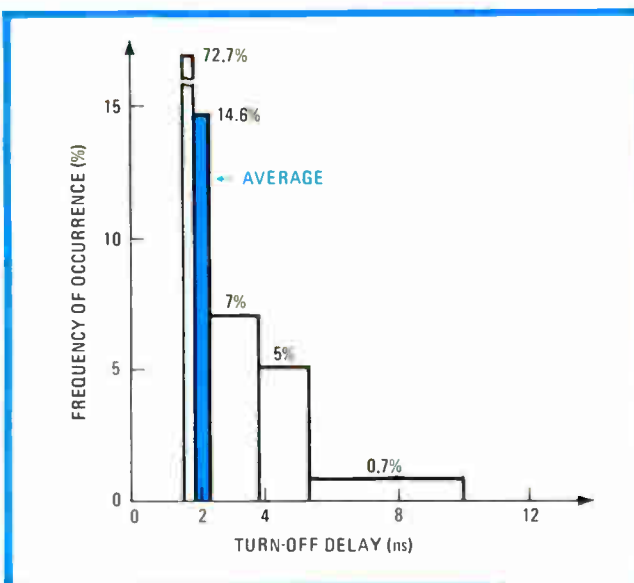
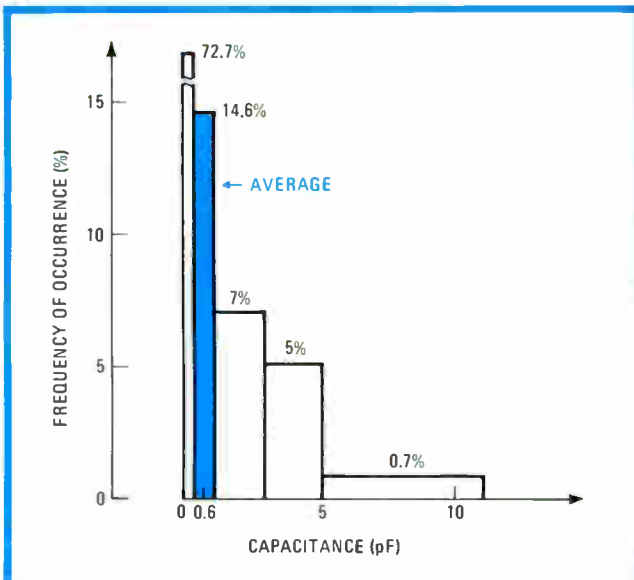
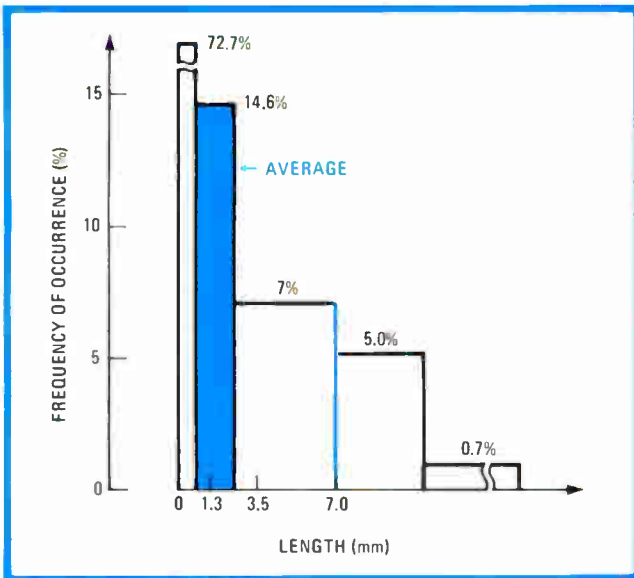

3. Histograms. One of the advantages of computer-assisted design is that statistical information is conveniently generated. It was decided to judiciously alter some load resistances in the circuit for more speed. Yet power consumption increased by only 0.1 W.

pared with the 2.2 m (typical) for the 704-circuit gate array used in the 4300 System/38. The average length of an interconnection path is then equal to 5,800/4,437 m, or 1.3 mm. To design for an optimum speed-power product, it is necessary to know not just the average but the distribution of path lengths also, since lengths significantly greater than the average increase the turn-off delay and degrade system performance.

The automatic placement and wiring programs were used to calculate the length, including stubs, of each of the 4,437 routes. As Fig. 3 shows, almost 6% of the paths exceed 7 mm.

The next step was to translate path length into total interconnection capacitance, so the distribution of circuit delay could be calculated. Given a single active load on a path, the sensitivity of the turn-off delay to load capacitance works out at 1.5 nanoseconds per picofarad for $R_L = 8$ kilohms and 0.75 ns/pF for $R_L = 4$ k Ω .

Estimating capacitance

Using a wiring capacitance of 0.63 pF/mm for the first level of wiring and 0.2 pF/mm for the second, a capacitance histogram was calculated from the path-length histogram. The step height of this histogram is the same as for the length histogram, and it also has a long tail, with 6% of the paths, or 265 of them, having a total wiring capacitance greater than 3.0 pF. Such a high capacitance, if not counteracted, would slow down those 265 paths and degrade performance.

In fact, in this design, long paths with capacitance values of almost 10 pF occurred in the output bus of the arithmetic and logic unit, which drives 19 working registers. So these circuits were powered up by reducing the collector pull-up register from 8 k Ω to 4 k Ω (Fig. 2). In fact, all 13% of the circuits exhibiting a capacitive load greater than 1 pF used the 4-k Ω pull-up resistor.

Figure 3 gives the distribution of turn-off delay for all of the circuits on the chip. The delay variation includes only the difference in turn-off delay due to the load capacitance that each internal circuit must drive on chip. Even with the 4-k Ω pull-up resistor, 6% of the circuits have a turn-off delay more than twice the average. But, if the 8-k Ω pull-up resistor had been used exclusively, the turn-off delay for 6% of the paths would be greater than three times the average. In sum, then, the turn-on delay distribution is narrower, since its sensitivity to load capacitance is less.

The increase in average power for the 13% of the circuits utilizing the 4-k Ω pull-up is 0.17 milliwatt. Thus, total chip power increases by only 4.5%—0.13 times 4,700 times 0.17 mW, or 0.1 W. The selective use of the 4-k Ω pull-up resistor, therefore, gives a good power-performance gain. □

The three articles presented here are based on papers prepared for the Institute of Electrical and Electronics Engineers' International Conference on Circuit and Computers '80 (Oct. 1-3). The papers are "Bipolar Circuit Design for VLSI Gate Arrays," by A. H. Danksy; "System/370 Bipolar Gate Array Microprocessor Chip," by C. Davis *et al.*; and "The Layout and Wiring of a VLSI Microprocessor," by M. Feuer *et al.* The copyrights to the papers belong to IEEE.

Adding to PLL chips' functions speeds rf synthesizer design

Programmable phase-locked-loop ICs contain reference oscillator and divide-down counters, offer dual-modulus prescaling

by John Hatchett, *Motorola Inc., Semiconductor Group, Phoenix, Ariz.*

□ A new family of large-scale integrated circuits is now available to provide those designing rf synthesizers with breakthroughs in performance, power drain, cost, and space. Each chip in the family provides large blocks of phase-locked-loop circuitry, thus reducing the effort in designing all kinds of radio-frequency equipment. By using complementary-MOS technology, this family of circuits has the added appeal of drawing a minimum of power over a wide range of supply voltages.

Applications abound for these easily implemented phase-locked-loop ICs. They include avionics, navigation and communications equipment, mobile radio transceivers, marine radio and sonobuoys, amateur radios, scanner receivers, cable and broadcast television tuning systems, and a-m/fm radios.

Each member of the MC145100 family of PLL synthesizer chips contains a reference oscillator, a selectable reference-frequency divider, a digital phase detector with a lock-detection output, and at least one programmable divide-by-N counter.

Some of the chips have a dual-modulus prescaling capability for extended frequency range (see "Dual-modulus prescaling"). With the loop filter, voltage-controlled oscillator, and suitable dual-modulus prescaler needed to complete the PLL circuit, these ICs can synthesize frequencies to over 500 megahertz.

Frequency is selected by programming the divide-

by-N and, where applicable, the divide-by-A counters with either a serial bit stream, a fully parallel word (14 or 16 bits wide), or coding on a 4-bit bus. The family's variety of frequency-selection schemes and other on-chip features allow the designer to minimize the need for additional components for an application (see Table 1).

Highlights of the synthesizer family are:

- 30-MHz input capability (typical at 25°C, 5 volts dc).
- Operation at 3 to 9 volts dc.
- Low power drain.
- -40° to +85°C operating temperature.
- Linear detector response.
- Low input drive level (500 millivolts peak to peak).
- On-chip latches and shift registers for serial and 4-bit-bus designs.

Interfacing the frequency synthesizers with microprocessor or microcomputer controllers is best accomplished employing the chips offering serial or 4-bit-wide inputs: the parallel-programmed devices interface best with mechanical switches, diode matrixes, and programmable read-only memories. The parallel input designs are housed in 0.6-inch-wide, 28-pin packages, and the other units come in narrow-lead-frame, 0.3-in.-wide, 16-, 18-, or 20-pin packages.

There are seven chips in the family. Each of the three programming methods (serial, parallel, and 4-bit data bus) is represented by both a single- and a dual-modulus

TABLE 1: FEATURES OF THE MC145100 FREQUENCY SYNTHESIZER CHIP FAMILY

Programming method	Features	Part number	Modulus	Number of pins
4-bit data bus	<ul style="list-style-type: none"> • latches • enable/chip-select • software-programmed reference divider 	MC145144	single	16
		MC145145	single	18
		MC145146	dual	20
Fully parallel	<ul style="list-style-type: none"> • pull-up resistors on all programming lines 	MC145151 (receive/transmit shift function)	single	28
		MC145152	dual	28
Serial bit stream	<ul style="list-style-type: none"> • shift registers • latches • enable • latched outputs for use as system switching functions 	MC145155	single	18
		MC145156	dual	20

Dual-modulus prescaling

Dual-modulus prescaling, used with three of the MC145100 family of large-scale integrated circuits, is a well-established method for designing high-performance high-frequency synthesizers. The technique allows the relatively low-frequency programmable counters on the synthesizer chip (the divide-by-A and divide-by-N functions of the MC145156, -52 and -46 devices) to function as a single high-frequency programmable counter. Actually, the lower-frequency counters on these ICs are used to control external high-speed chips called dual-modulus prescalers. The prescaler consists of one or sometimes two ICs made for this purpose. This control is done with the aid of special logic on the LSI chip for selecting one of two prescaler division values, either P or P + 1.

The division control signal generated by the synthesizer chip is supplied to the prescaler in a specific, timed format: the division value is P + 1 while A is counting down and P when A has stopped and N is counting the rest of the way down. Thus the low-frequency on-chip counters control the high-frequency prescaler. Note that $N \geq A$ is a requirement for using dual-modulus prescaling.

The greater the total system division value, N_{total} , the higher the output frequency of the synthesizer. N_{total} is a function of three input values: the prescaler division value, P; the value of A, programmed into the divide-by-A counter; and the value of N, programmed into the divide-by-N counter. The relationship is:

$$N_{total} = NP + A$$

To see how this equation is applied, consider the prob-

lem of tuning a radio receiver. A maximum resolution over the widest possible frequency range is desirable. For the minimum frequency increment, N is therefore held constant and A is varied between 0 and P - 1 in integral steps. N is then incremented to N + 1 and A is again incremented sequentially from 0 to P - 1. In effect, the system performs tuning in two stages—first coarse, then fine. The procedure is used over the entire N_{total} range. The actual tuning increment is equal to the reference frequency, f_r . Without dual-modulus prescaling—that is, with fixed prescaling—the tuning increment is $P' \times f_r$, where P' is the division value for the fixed prescaler.

A dual-modulus prescaler can operate up to the speed capability of the prescaler chip without sacrificing system resolution or performance, which would occur if a fixed (single-modulus) divider was used for the prescaler. High frequency is achievable because the dual-modulus prescaler must divide by only two different values (P or P + 1) and can therefore be designed for high operating speeds comparable to those of fixed dividers.

Motorola's dual-modulus prescaler chips, off-the-shelf parts, offer speeds to over 500 megahertz. They are used individually or in some cases combined with an additional counter IC to provide a variety of P and P + 1 values to best serve the application at hand. Figures 4 and 5 (pp. 153 and 154, respectively) show two examples.

The 145156, -52, and -46 chips can control prescaler division values that range from 3 and 4 through 128 and 129 (for the -56 and -46 devices) or 3 and 4 through 64 and 65 (for the -52).

version, and chips with 4-bit-wide data input include an extra single-modulus version designed specifically for television tuner applications, bringing the total number of chips to seven. Figure 1 depicts the internal functions of the chips, the variations available, and the external components required to complete the PLL. Table 2 summarizes the chips' basic characteristics.

Dual-modulus requirements

The MC145156, -52, and -46 are for use in synthesizers that employ the dual-modulus prescaling concept. Each contains the circuitry for all the lower-frequency functions, along with the modulus control signal for operating the prescaler in the divide-by-P or divide-by-P + 1 mode in the properly timed format for performance to over 500 MHz.

Synthesizing high frequencies using the dual-modulus concept requires a special high-speed counter, or prescaler. By matching a synthesizer chip with one or more of the ICs that make up the prescaler (Motorola makes a series of them), a designer may tailor a system to meet a variety of speed, performance, and cost goals.

The MC145156 and -46 contain 10-bit divide-by-N and 7-bit divide-by-A counters and can control prescalers having division values (P and P + 1) ranging from 3 and 4 through 128 and 129. Depending on the prescaler selection, a range from 9 to 131,199 in steps of unity can be achieved for the total system division value, N_{total} . The availability of only 6 bits in the MC145152's divide-by-A counter restricts it to controlling prescalers having

division values of 3 and 4 through 64 and 65. In this case, the upper N_{total} limit is limited to 65,599.

The other four devices, the MC145155, -51, -45, and -44 are used when programmability at higher frequencies using dual-modulus prescaling is not required. Since a modulus control signal is not generated, these ICs employ a single counter for the divide-by-N function. Except for the MC145144, the counter contains 14 bits and can be programmed to divide by 3 through 16,384. The 145144, although similar to the -45, is optimized specifically for TV tuning system designs and employs a fixed divide-by-256 prescaler.

Typical frequency characteristics are given in Fig. 2. As shown in Fig. 2a, the use of high-amplitude drive levels will have little effect on the maximum operating frequency for drain supply voltages, V_{DD} , less than about 5 V. However, for higher V_{DD} levels, high drive levels can increase the maximum frequency significantly.

Current drain is predominantly set by the counters and the driving-signal frequencies. Except at extremely low frequencies, the other on-chip functions will produce only secondary current-drain effects. This results in about the same total drain current value, I_{DD} , for all members of the family under the same operating conditions. From Figs. 2b and 2c a characteristic plot of I_{DD} as a function of voltage and frequency can be drawn to determine the current requirements with large-amplitude (rail-to-rail) input signals.

With low-amplitude drive levels (500 mV p-p), the current will remain essentially as shown in Figs. 2b and

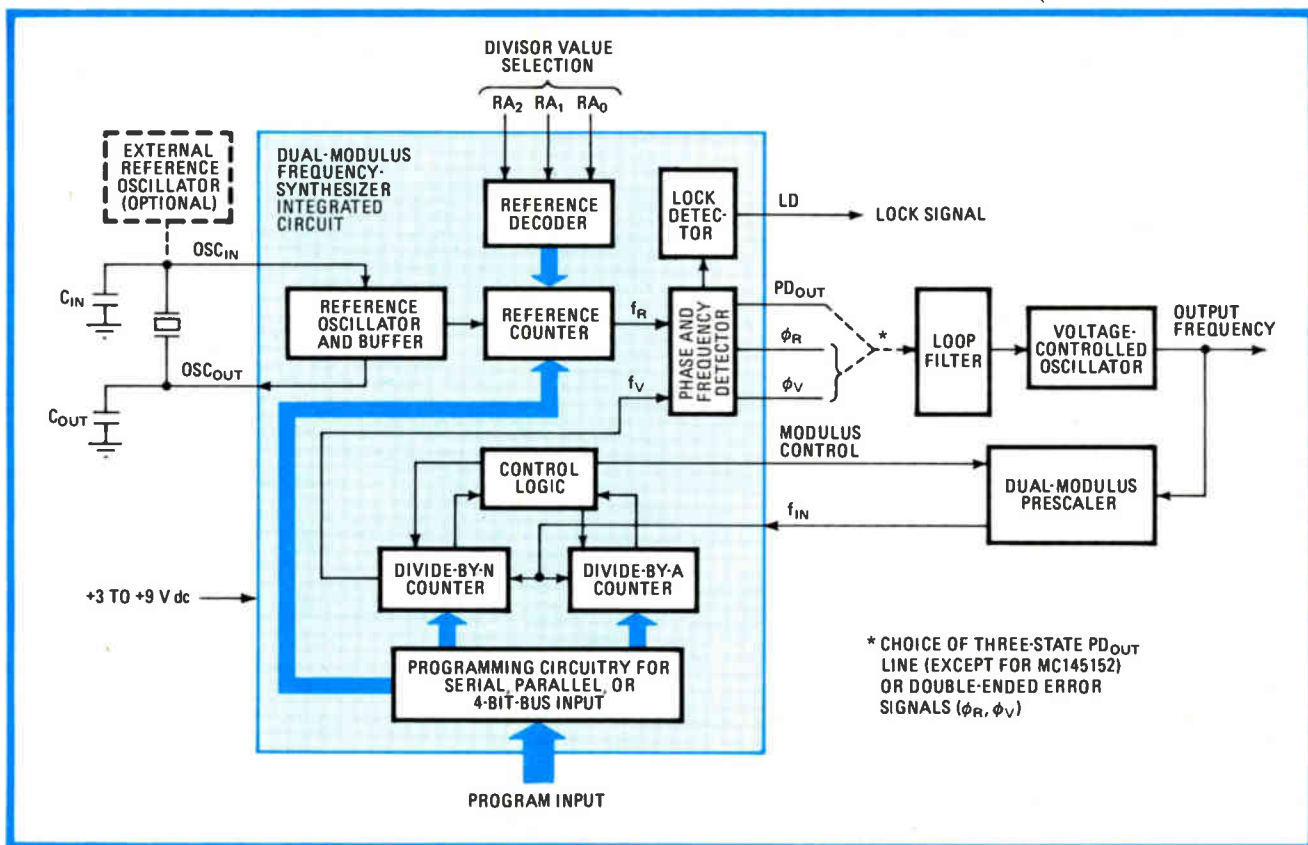

1. Integrated. The MC145100 family of C-MOS frequency synthesizer chips contain the bulk of the circuitry needed to implement a phase-locked-loop design. Dual-modulus prescaling for higher-frequency operation is optional on three of the family's seven members.

2c for a V_{DD} of 3 v. For the 5- and 9-v conditions and for operating frequencies in excess of a few hundred kilohertz, higher current drain results.

The reference oscillator and buffer on each chip is used for developing a crystal-controlled reference signal by connecting an external fundamental-mode crystal that is parallel-resonant at the desired operating frequency and by loading the crystal with two capacitors, C_{in} and C_{out} , to ground (see Fig. 1 again).

The acceptable loading capacitance, C_L , seen by the crystal depends upon the oscillator frequency. For a V_{DD} of 5 v, C_L should not exceed 32 picofarads for frequencies up to approximately 8 MHz, 20 pF for frequencies in the range of 8 to 15 MHz, and 10 pF for frequencies above 15 MHz.

These guidelines for C_L take into account IC-capacitance drive capability, variations in stray and IC input/output capacitance, and realistic crystal load-capacitance values. The load capacitance, C_L , presented across the crystal can be estimated to be a $C_{in\ total}$ in series with a $C_{out\ total}$, where:

$$C_{in\ total} = C_{in} + C_{in\ IC} + C_{in\ stray}$$

$$C_{out\ total} = C_{out} + C_{out\ IC} + C_{out\ stray}$$

with $C_{in\ IC}$ and $C_{in\ stray}$ representing the capacitance to ground at OSC_{in} contributed by the integrated circuit and stray circuit effects, respectively. Similarly, $C_{out\ IC}$ and $C_{out\ stray}$ apply to the OSC_{out} pin. C_{in} and C_{out} are capacitors that are added to achieve the proper C_L value. They should be chosen to make $C_{in\ total}$ and $C_{out\ total}$ approximately equal. In practice, C_{in} and C_{out} will be

nominally equal. The oscillator can be trimmed to frequency by making a portion or all of C_{in} variable.

The 145156, -55, and -45 provide a buffered oscillator output, REF_{out} , for use in other system functions. For the 145152, -51, and -46, the oscillator signal can also be obtained by lightly coupling to OSC_{out} . This can be done by using a capacitor-tap impedance-transformation network for C_{out} .

An off-chip reference source can also be used to drive the oscillator input. The reference signal is applied to OSC_{in} and the crystal, and C_{in} and C_{out} are omitted. The oscillator circuitry now behaves as a buffer amplifier. The external reference signal will typically be ac-coupled to OSC_{in} , but for high-amplitude signals (standard C-MOS logic levels), dc coupling may be used.

The reference counter's role

The reference counter divides down the high-frequency reference signal to the desired comparison frequency, f_R , which is fed into the phase detector. When using the 145156, -55, -52, and -51, the user chooses one of eight possible division values with a 3-bit code applied to division-value select pins RA_0 , RA_1 , and RA_2 .

The reference counters in the 145146 and -45 are fully user-programmable for integers 3 through 4,096 with a 12-bit binary code. Typically, the desired division value is selected by software through a microprocessor or microcomputer interface with the synthesizer's 4-bit-bus programming structure.

The digital phase-frequency detector on the synthesiz-

er chips compares positive-going edges of its two phase-compared input signals (f_R and f_V) and generates output error signals PD_{out} , ϕ_R , and ϕ_V as pulses of varying widths whenever the f_R and f_V edges are not in alignment (Fig. 3).

The error signals are filtered by the loop filter and thus establish the control voltage for a voltage-controlled oscillator. Except with the 145152 and -44, the user is provided a choice of either double-ended (ϕ_R , ϕ_V) or single-ended (PD_{out}) error information. The -52 offers only ϕ_R and ϕ_V and the -44 only PD_{out} .

Outputs ϕ_R and ϕ_V are well suited for use with loop filters that provide common-mode rejection and summing properties such as those employing operational amplifiers. PD_{out} is a three-state output and presents a high impedance and a minimum of error-signal energy to be filtered when the loop is locked—in other words, when f_R and f_V are equal in frequency and phase.

Previous detectors for frequency-synthesizer applications have typically exhibited large changes in gain (sometimes changing by an order of magnitude) near the zero, or phase-lock, point. This can result in many system design difficulties and compromises in loop performance. The detector used in the 145100 chips produces a linearized response that provides a relatively constant detector gain through the phase-lock region and synthesizer performance better than that of previous designs.

The user can maintain some flexibility in indicating an in-lock or out-of-lock condition by using the lock-detection output. When the loop is locked, a lock-detection pin, LD, is high except for a narrow low-level pulse (normally 100 nanoseconds wide for a V_{DD} of 5 V). When the loop is not locked, LD pulses low during the time an error signal of either polarity is generated (see Fig. 3 again). Typically, output LD is integrated and used to bias a transistor switch on and off. In this way, the user can assign the point when a phase-lock condition is actually to be indicated.

Programmable counters, too

The 145155, -51 and -45 contain a single 14-bit counter for the divide-by-N function. Those that control an external dual-modulus prescaler—the 145156, -52, and -46—must have this function made up of two separate counters. This is implemented using a 10-bit counter, designated divide-by-N, and either a 7-bit or 6-bit (145152) counter, designated divide-by-A. In addition, a fully programmable 12-bit reference counter is provided in the 145145 and -46. The division value of each counter corresponds to the number (in binary code) applied to the counter's programming inputs. The only exceptions are when binary codes having a value of less than 3 are applied to the divide-by-N and reference counters. For these cases, a binary zero code gives a division value of 2^b , where b is the number of bits of the counter. Division values for binary codes of 1 and 2 are not specified.

All the counters are preceded by buffer stages to allow the use of low-amplitude inputs (500 mV p-p) when ac coupling is used. If a large-amplitude signal is available (standard C-MOS logic levels), dc coupling may also be used. For optimum performance when ac coupling is

TABLE 2: CHARACTERISTICS OF THE MC145100 FAMILY OF FREQUENCY-SYNTHESIZER CHIPS

Operating voltage	3 to 9 V dc
Typical current drain, with $f_{IN} =$ OSC _{IN} = 10 MHz and $V_{DD} = 5$ V, at 25°C	4 mA dc
Operating temperature	-40° to +85°C
Maximum f_{IN} , with 500-mV peak-to-peak sine wave and $V_{DD} = 5$ V	15 MHz minimum
System frequency	> 500 MHz
Dual-modulus prescaler range MC145156, -46 MC145152	divide by 3 or 4 through 128 or 129 divide by 3 or 4 through 64 or 65
Maximum total division value (N_{TOTAL}) with dual-modulus prescaling MC145156, -46 MC145152	131,199 65,599
Time required to generate modulus control signal, at 25°C, with $V_{DD} = 5$ V	50 ns typical, 100 ns maximum
Divide-by-N range, MC145145, -51, and -55	3 through 16,384

employed, input signals should be symmetrical.

The control logic generates the modulus control signal. This signal is used to establish the divide-by-P and divide-by-P + 1 format of an external dual-modulus prescaler and therefore allows the 145156, -52, and -46 to function in dual-modulus prescaling modes.

The modulus control is dc-coupled to the prescaler's control input and will interface directly with most existing dual-modulus prescaling ICs. The prescaler should divide by P for a high signal on its control line and by P + 1 for a low signal. The prescaler's output should make a low-to-high transition after each group of P or P + 1 input cycles to the prescaler. This action provides the proper interface to the positive-edge-triggered divide-by-A and divide-by-N counters, maximizing the time available for generating the modulus control signal and thus optimizing system frequency capability.

The modulus control signal is low at the beginning of a count cycle and remains low until the divide-by-A counter has counted down from its programmed value, A. At that time, the modulus control signal is set high and remains high until the divide-by-N counter has counted the rest of the way down from its programmed value, N. This will be N - A additional counts, since both divide-by-N and divide-by-A counters are decrementing during the beginning of the cycle. The modulus control signal is then set back low, the counters are preset to their respective programmed values, and the sequence is repeated. This order of timed events results in a total programmable divide value for the system defined by $N_{total} = N \times P + A$, where $N \geq A$.

When using dual-modulus prescaling, the maximum input frequency, f_{in} , for the 145156, -52, or -46 is usually not limited by the speed capability of the divide-by-A or divide-by-N counter, but is dictated by the propagation time through the prescaler (period a), the prescaler's control-input setup or release time (period b), and the

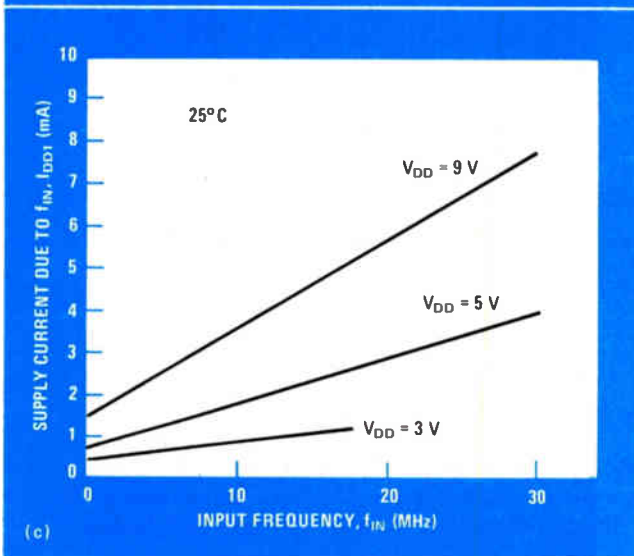
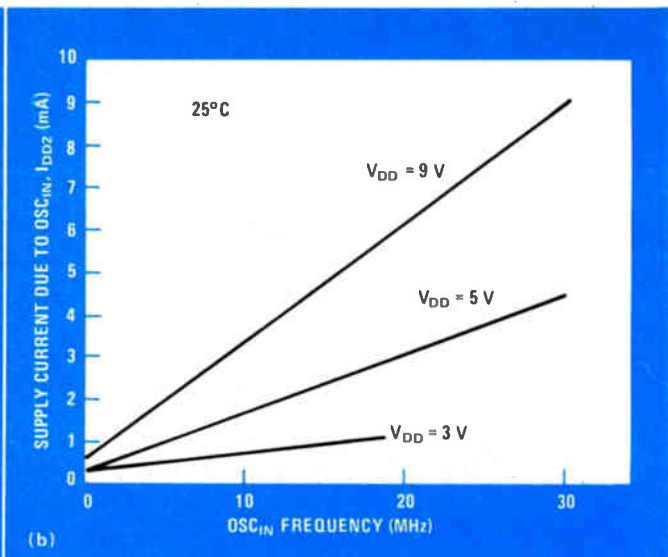
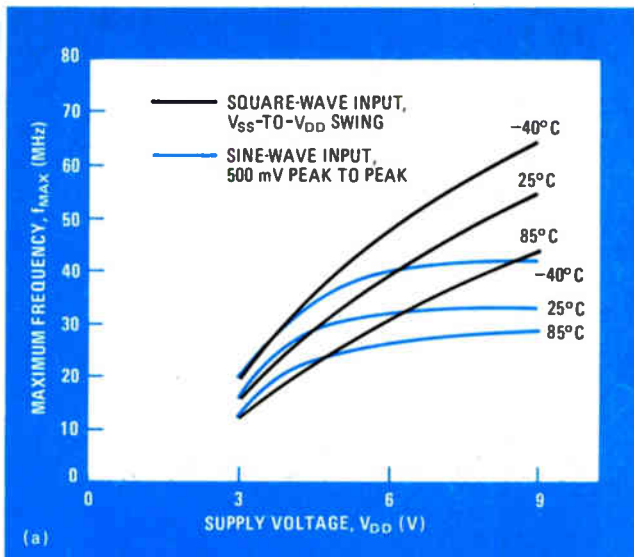

2. Performance. Maximum operating frequency (a) is achieved by increasing both supply and drive-signal voltages. Current drain is primarily a function of reference oscillator frequency (b) and input frequency (c). The total current is the sum of I_{DD1} and I_{DD2} .

time required for the LSI synthesizer to generate the modulus control signal (period c).

The f_{in} signal must be low enough in frequency so that its period is greater than the sum of periods a, b, and c. Two of these factors (a and b) are determined by the user's dual-modulus prescaler implementation. Period c is a factor determined by the LSI device and is typically 50 ns for a V_{DD} of 5 v (see Table 2 again).

For added flexibility, both the 145155 and -56 provide two latched open-drain outputs, SW_1 and SW_2 , for system switching functions. These functions are controlled by the first 2 bits in the serial data stream used to program the ICs and may be used in any way to aid the designer or enhance the system.

A logic 1 in the control bit causes the respective switch output to assume a high-impedance state, and a logic 0 causes the output to sink current and provide a low impedance. Both switches use an open-drain configuration capable of controlling dc levels to over 15 v, and as

a result off-chip pull-up resistors are required.

The 145151 provides an on-chip receive/transmit offset function that, when activated, adds 856 to the programmed divide-by-N value. Applications for this offset value include transceivers having intermediate frequencies of 10.7 or 21.4 MHz and channel steps of 12.5 or 25 kilohertz, respectively.

The divide-by-N counter output of the 145151 is buffered and brought out to a package lead. This allows access to a relatively fast, low-current programmable counter for general-purpose applications. The counter has all 14 of its programming lines available and can be programmed to divide by any integer from 3 to 16,384.

In the 145146, both inputs to the on-chip phase detector (f_R , f_V) are buffered and brought out. This allows an external detector to be employed. Also, it offers two relatively high-frequency, low-current programmable counters for general-purpose applications—the 12-bit reference counter and the 10-bit divide-by-N counter. Both are programmed using a 4-bit data-bus structure.

Programming the counters

The serial and 4-bit-bus devices are typically used in systems employing a microprocessor or microcomputer for the programming interface. The parallel units can serve in these applications also but are frequently at a disadvantage because they require a large number of interface connections.

For the serial devices, the 145155 and -56, programming involves only three interface lines: the data, clock, and enable lines. Programming is accomplished by clocking data serially into the on-chip shift registers and then transferring their contents into latches with the enable line. Each low-to-high clock transition causes the registers to shift right 1 bit as each data bit is shifted in on the data pin at the time of the clock transition. (As mentioned, the first 2 bits control the two open-drain switch outputs, SW_1 , and SW_2 , instead of programming the counters.)

An inhibiting feature, activated by holding enable low, allows new data to be entered without affecting the previously programmed information. The programming

3. Phase-locked. When the divided-down frequencies of the reference oscillator and the input are locked in phase, the detector output assumes a high-impedance state; the double-ended outputs and the lock-detector output are reduced to narrow slivers.

interface can be reduced to only two lines, the data and clock lines, by holding the enable line high. However, under this condition all program changes are continuously transferred to the latches and counters, resulting in erroneous information being entered during the programming time-frame. Depending on the application, such errors may or may not be acceptable.

A fully parallel input

For parallel devices 145151 and -52, all counter programming points are brought out to the package pins. Programming is accomplished by taking the appropriate pins high or low. There are 14 programming lines for the MC145151 (14-bit divide-by-N counter) and 16 for the -52 (10-bit divide-by-N and 6-bit divide-by-A counters). In applications in which lines will not be changed, they can be hardwired to the appropriate level. Built in pull-up resistors are provided on all the programming inputs.

Finally, for the 145145 and -46, which use 4-bit data buses, programming is done using eight interface lines—four for the data word, three for the address that directs data to one of eight latches (seven for the -45), and one for an enable/chip-select function. Although eight lines are involved, only the chip-select line, ST, must be dedicated to the synthesizer chip. The remaining seven can share the bus with other system functions, since they assume an inactive, high-impedance state when ST is

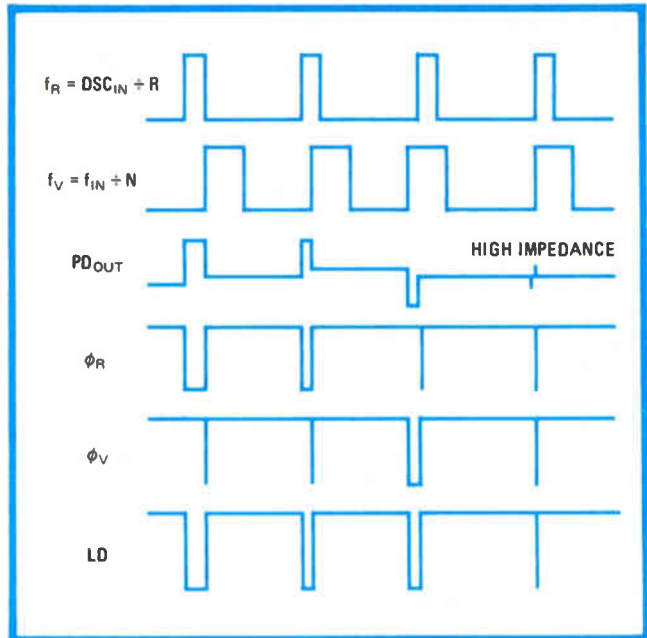

held low. They need to be activated only when programming changes are made.

Three data words program the reference divider. Five data words are used to program the divide-by-N and divide-by-A counters in the 145146, and four words program the divide-by-N counter in the -45. The addressable on-chip latches store the information between program changes.

The 145100 chips can be used in a variety of synthe-

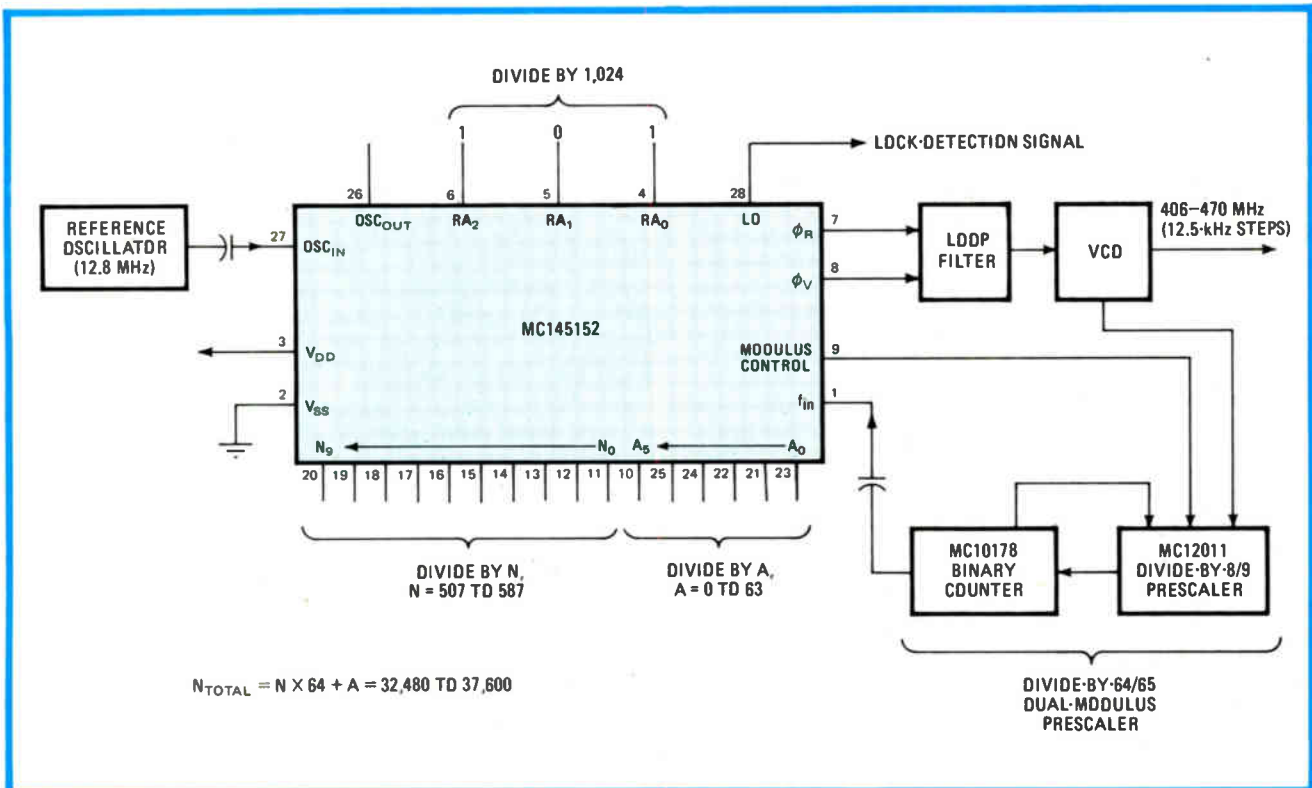

4. Uhf. Good tuning ability is easily implemented at ultrahigh frequencies. With the reference-divider code inputs RA₀, RA₁, and RA₂ set as shown, the reference oscillator division value is 1,024. Frequency can be stepped in 12.5-kHz increments for the 12.8-MHz oscillator shown.

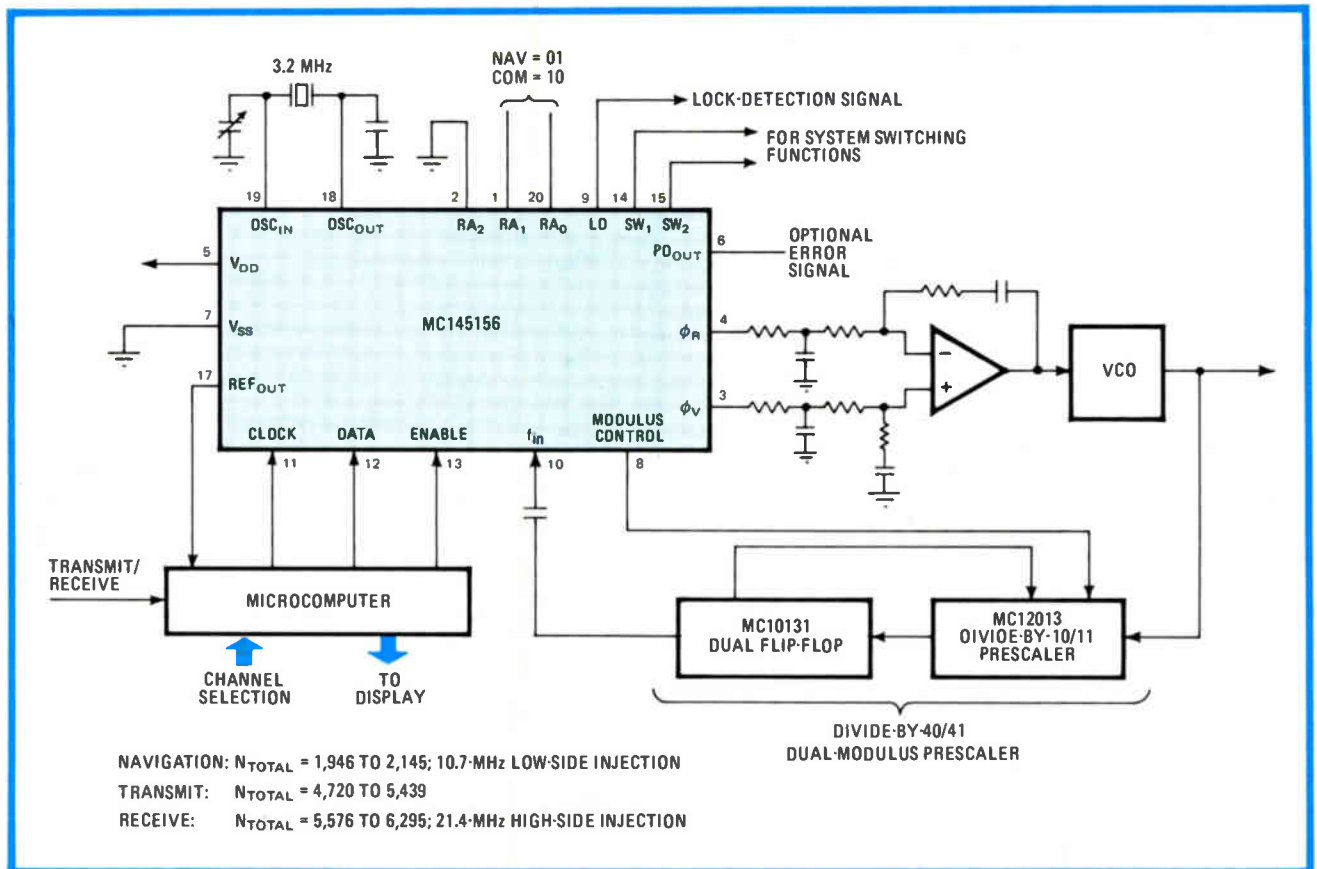

5. Multifunction. Both navigation and communication functions are incorporated in a single synthesizer. Different tuning increments are programmed into the reference frequency divider and a microcomputer serially programs the division values of the counters.

sizer designs. Figures 4 and 5 show samples of some possible implementations. Any of the three programming methods discussed can usually be chosen without major concept changes.

Applications

Figure 4 illustrates an approach for a high-frequency synthesizer employing dual-modulus prescaling intended for an ultrahigh-frequency mobile radio. As with all PLL frequency synthesizers, a comparison, or reference, frequency is compared in phase with the output of a voltage-controlled oscillator, and any difference generates a corrective signal that is fed to the VCO.

The countdown circuits discussed earlier allow the output frequency of the VCO to be many multiples of the comparison frequency. The exact multiple equals the effective division value of the countdown circuits between the phase detector and the VCO. Thus, changing the division value changes the output frequency, making the circuit tunable in discrete increments. Using the dual-modulus prescaling technique as shown in Fig. 4, the VCO tuning-increment resolution is equal to the comparison frequency, f_R , fed into the phase detector—in this example, 12.5 kHz.

Dual-modulus prescaling ICs with a maximum-frequency specification in excess of 500 MHz over the temperature range of -55° to $+125^\circ\text{C}$ are available. These devices may be used individually or combined with an additional divider to increase the prescaling divide

factor and thus lower the input frequency, f_{in} , to a value within the specifications of the LSI device. The MC10178 and MC10131 emitter-coupled-logic ICs in Figs. 4 and 5 perform this function.

For the navigation or communication synthesizer in Fig. 5, it is also possible to use a TTL device for the dual-flip-flop function in the prescaler. To facilitate this, an on-chip ECL-to-TTL translator is available in some dual-modulus prescaler ICs such as the MC12009, -11, and -13. In the circuit shown, the VCO's output ranges from 97.300 to 107.250 MHz in 50-kHz steps; for communications transmission, it is 118.000 to 135.975 MHz in 25-kHz steps; and for reception, it is 139.400 to 157.375 MHz, also in 25-kHz steps.

The 145145 and -46 synthesizer chips provide the user with the access to fully program the 12-bit reference divider for values from 3 to 4,096. This feature can be used to obtain divide-by-R values not available with other family members. Selecting a divide-by-R value allows the frequency of the reference oscillator to be chosen to serve multiple functions, such as the injection signal for a receiver's second mixer stage.

Another feature of these two chips is that they require only one dedicated program line. This is because four data lines and three address lines can share the data-bus system with other ICs. This sharing makes multiloop synthesizer designs more practical. Three or even more loops may be controlled without undue complexity at the programming interface. □

Integration is on the way for fiber-optic receivers

The slow takeover from hybrid designs will occur first in low-data-rate systems

by Harvey J. Hindin, *Communications & Microwave Editor*

□ Fiber-optic communications systems have won acceptance as a practical technology, but before they make it big in the marketplace, costs must drop. In particular, systems designers are looking for the makers of optical receiver parts to move beyond the present hybrid designs to monolithic implementations.

Such efforts are already under way, with some products offering varying degrees of integration available for systems with low data rates. Since fiber-optic technology has spread around the world, these efforts are taking place in many countries. Within five years, say industry participants, many receiver components will be implemented monolithically: integrated transmitters will lag because of the difficulties in producing laser or light-emitting diodes in this way.

With the first generation of integrated receiver components available or in the design stages, designers and users of both digital and analog optical communications systems can foresee industry trends for low-data-rate systems by looking at the state of design around the world. Some attention to hybrid designs of receivers is also valuable, for these receivers are likely to predominate for some time in high-data-rate systems where maximum performance is a must.

No one path

However, discerning trends is complicated by the fact that there is no one path to receiver integration. Just what can be achieved is a complex interaction between the intended system's data rate or bandwidth, digital bit-error rate or analog signal-to-noise ratio, modulation scheme, and other electrical parameters. Thus what may work in one application may fail in another.

Furthermore, state-of-the-art technology problems are only part of the story. Engineers may merrily combine more and more circuits on an integrated circuit, but just how far they may go can depend on competitiveness with the cost and electrical performance of the hybrid approach to receiver design.

For the engineer wanting some form of integrated optical receiver, there are but a few choices today.

1. Special detector. In the MFOD403F Motorola monolithic fiber optic receiver, a 10-mil-diameter collector-substrate diode (a) performs the functions of a p-i-n diode. Complete receiver chip (B) contains diode detector (circle) and preamplifier, minimizing noise.

Motorola leads the field, with Spectronics and TRW/Optron right in behind. Other efforts in the U. S., in Europe, and in Japan are still in the early stages but they do indicate the direction the technology is taking.

Perhaps the most sophisticated integrated receiver available comes from Motorola Inc.'s Semiconductor Group, which offers several types of p-n detectors integrated with preamplifiers (Fig. 1). One has a 35-megahertz bandwidth and a 5-millivolt-per-microwatt sensitivity; another has a 10-MHz bandwidth and a 25-mV/ μ W sensitivity, says Patrick O'Neil, a principal engineer at the Phoenix, Ariz., group, which has other

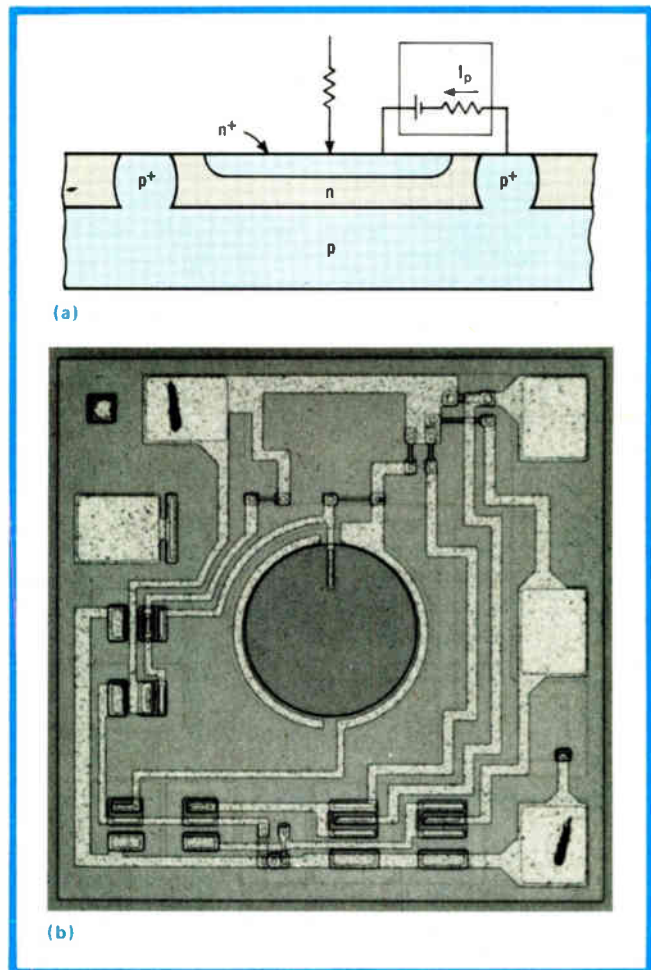

Optical receivers: light from within

The receiver is the key element in the design of a fiber-optic system, as important in long-distance communication as in busing data over short distances, and at low as well as high data rates. It detects the incident light and converts it into an electrical signal containing the information impressed at the transmitting end of the system.

The design goal is to minimize the amount of optical power that must reach the receiver in order to achieve a predetermined bit-error rate for digital systems or signal-to-noise ratio for analog systems. The minimization is necessary since neither transmitter power nor low-attenuation glass fiber comes cheap.

This minimum power level, the receiver sensitivity, is a complex function of the parameters of the design. There are other design considerations, and practical receivers have less than optimum sensitivity. For example, sensitivity may be traded off with receiver dynamic range, a measure of just how much the receiver input signal may vary and still provide usable outputs.

Essential components. As the figure shows, an optical receiver consists of a photodetector that acts as an optical-to-electrical converter, a low-noise preamplifier and post amplifier that convert the detector's weak signal into a usable level, and filtering to remove extraneous signals and noise. The design may be adapted to either digital or analog signals by adding such specialized circuits as decision logic to the digital device and demodulation to the analog.

The photodetector and preamplifier incorporate semiconductors and present problems for the designer who wishes to integrate them into one or two chips. Still, this front end is receiving most of the attention in the drive to integrate. The postamplifier can follow, and in any case, it does little to influence receiver sensitivity since it operates at an already high signal level. Next will come the filters, but as passive devices, they present few problems.

The photodetector may be either a p-i-n or an avalanche diode, although in present first-generation designs, it is more likely a p-n diode. Also, research is under way on other structures like field-effect phototransistors. Today, the diode is made from silicon, which provides a spectral match for the 0.8-to-0.9-micrometer wavelengths emitted from the aluminum-gallium-arsenide transmitters that are commonly used in fiber-optic systems.

However, other options are being studied, notably GaAs FETs that have better noise performance than their silicon equivalents, but introduce a second substrate into a silicon world. It is likely that future receivers will take advantage of the lower fiber attenuation in the 1.3-to-1.6- μm region of the spectrum and be made from materials absorbing in this spectral region, which include several GaAs compounds.

Choice. For now the choice is between a p-n or p-i-n diode or an avalanche device. For its part, the p-n or p-i-n diode merely converts the optical into an electrical signal. In contrast, an avalanche device adds internal current gain but requires applying several hundred volts to make it function. Such voltages are undesirable if the goal is to integrate the avalanche detector on a substrate with other important devices.

The current generated by the photodetector must be converted into a usable signal level for further signal processing by the receiver. It is critical that the preamplifier do this with a minimum amount of noise added to the system—since the lower the noise, the more sensitive the receiver. So the first stage of the amplification is performed by either a FET or a bipolar transistor. As is the case with the photodetector, the choice depends on the application at hand. In digital systems, for example, high data rates favor a bipolar device since its noise performance is better.

Whether a FET or bipolar device is used, there are two choices for the preamplifier configuration: either the high impedance (integrating) version that is a current amplifier or a transimpedance amplifier that is a current-to-voltage converter. Either type, with its associated circuitry, may be integrated onto a silicon substrate.

The integrating amplifier reduces all sources of noise to an absolute minimum. However, each receiver has to be tuned and temperature-compensated individually, making integration difficult. In addition, the dynamic range of such a design is limited. However, where the ultimate in sensitivity is required, this amplifier is the preferred approach.

The transimpedance amplifier is the most common design for either the hybrid or the monolithic approach. It can provide wide bandwidths and a greater dynamic range than the integrating amplifier approach, though its noise performance is somewhat inferior.

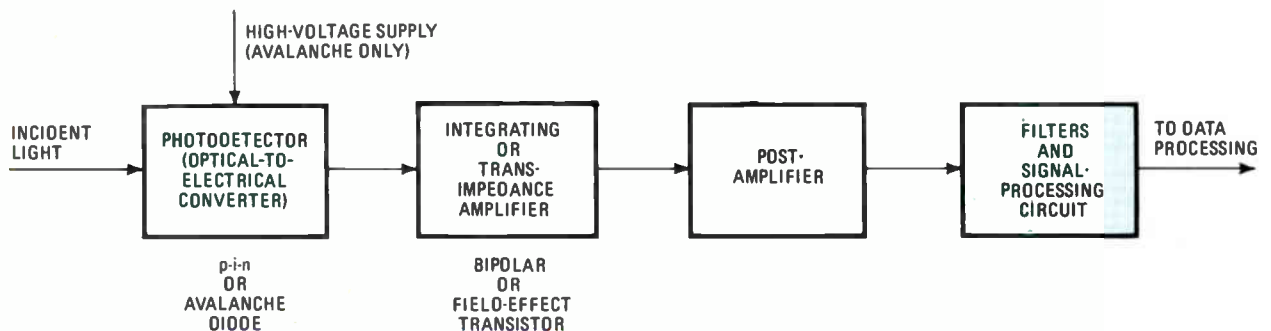

versions with still different specification tradeoffs.

System design is eased by an input fiber strand fed through a specially designed connector and leading to the light-sensitive area of the IC. The connector is a joint development of Motorola and Amp Inc.

The most common approach to a fiber-optic receiver is the combination of a p-i-n photodetector diode or variant like a pn detector and a transimpedance preamplifier (see "Optical receivers: light from within," p. 156). Such a design is relatively easy to implement and can be made

with specifications almost as good as the more exotic alternative devices: avalanche detectors and integrating preamplifiers.

In the Motorola design, an emitter-follower amplifier is included with the transimpedance preamp so that the receiver's output voltage is available from a low-impedance source. Thus the receiver can easily match and drive other signal-processing circuitry. What's more, this approach yields an output voltage directly proportional to the incoming light power over a wide range of input levels—the already mentioned sensitivity measured in millivolts per microwatt.

Benefits anticipated

Most engineers in the fiber-optic receiver industry believe that the integrated detector-amplifier will cost much less in large quantities than the hybrid components. However, it is too early in the game to make exact comparisons. Costs for both types are strongly dependent on specifications and quantities, and experience in producing large numbers of these parts is lacking.

However, the systems designer will find his or her task simplified by the integrated offerings. For one, the design of a transimpedance amplifier is a tough nut to crack, but it need not worry the user of an integrated detector-amplifier. For another, this integrated receiver front end comes enclosed in a shielded container, eliminating difficult-to-do and expensive shielding of printed-circuit boards.

Another design problem that the integrated front end can solve is electromagnetic and radio-frequency interference. The key here is a short lead length—the Motorola design has an equivalent detector lead length of only about 0.25 millimeter in the connections on the IC.

Both emi and rfi are problems for p-i-n diode receivers because they have high impedance. The shortest of leads will act as a pickup antenna, and the energy coupled into the receiver is amplified by the high-gain transimpedance preamp. Thus the shortest possible lead lengths are highly desirable in the fiber-optic receiver.

Such noise problems in the receiver are particularly frustrating to the system designer, who may be attracted to an optical transmission scheme because the dielectric fiber is totally free from emi or rfi pickup (unlike metal cable or wire). Worse yet, the interference tends to be random, so the only compensation is increasing the signal or transmitted power to maintain a satisfactory bit-error rate or signal-to-noise ratio.

The U. S. effort

After Motorola, the two manufacturers furthest along the integrated path are TRW/Optron, one of TRW Inc.'s Electronic Components divisions, and the Spectronics Inc. subsidiary of Honeywell Inc. Both manufacturers have already made their moves toward establishing an industry position.

The basic strategy at Optron in Carrollton, Texas, is a step-by-step integration of the signal-processing elements in the preamp stage, varying the elements integrated with the diode detector to determine the mix customers need. The company expects that the first true monolithic receiver will combine the detector with two or



2. Lots of modules. TRW/Optron is preparing for the advent of monolithic fiber-optic receivers by developing a line of integrated devices. Here engineers Ben Wagner and Joel Van Antwerp check photo mask artwork for accuracy on a light table.

three of the amplifier's building blocks, such as threshold detectors, comparators, linear amplifiers, automatic gain control, and phase-locked loops.

"By 1983 or 1984 the technology will be available for production of a very large-scale integrated fiber-optic receiver, but it will take until 1985 for these to become commodities," says Michael F. Ehman, vice president of materials technology and development. "Probably three of the modules [the building blocks] will be integrated with the detector. If you go much beyond three, the circuit is going to be too complex for the business/computer systems market. The dice would be too big and the yield would be reduced to a point where nobody could afford them."

A beginning

Optron introduced an IC family this year (Fig. 2) that features a threshold detector on a chip with a photodiode. But it is used for optical switching applications, not in fiber-optic receivers yet. The company plans to integrate other amplifier modules with a detector, eventually including several of the modules in a package designed specifically for fiber-optic receivers. Ehman expects the package's detector will be a p-i-n device (see "No rush to integrate an avalanche photodiode," p. 158) for low-performance systems in the industrial-control, office-of-the-future, and automotive markets.

Such low-performance systems are the only area where integration of the receiver will take place quickly, says J. R. ("Bob") Biard, chief scientist of Spectronics in Richardson, Texas. For systems needing 5-MHz speed or more, the basic incompatibility between high-speed

No rush to integrate an avalanche diode

Avalanche photodetectors, superior to p-i-n diodes in several respects, are being ignored in the race to integrate the fiber-optic receiver. The industry view is that, for the foreseeable future, they will not be seen on chip with other circuitry.

"The complexity of the avalanche photodiode process is so far away from the integrated-circuit processes of today that the two don't appear to be really compatible," says Michael F. Ehman of TRW/Optron. "The materials processes needed to fabricate avalanche devices and integrated circuits are going in opposite directions. Avalanche photodetectors tend to be high-sheet-resistance

devices, while low sheet resistance is needed for integrated circuits."

Texas Instruments' Shaun Shaunfield says flatly that "avalanche and IC technology just don't mix." Furthermore, the high voltage needed to make the avalanche function is an insurmountable stumbling block for Spectronics, whose Bob Biard sees no hope of integrating it into an IC. Add to this the device's problem with voltage control and temperature compensation (since the avalanche gain varies strongly with voltage and temperature), and it appears that the fiber-optic receiver designer can forget about it for now in integrated designs.

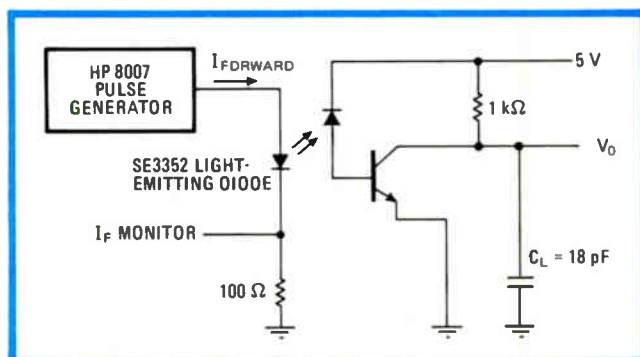

3. Check it out. The Spectronics fiber-optic photodiode with integrated preamplifier is checked for both optical and electrical parameters. Data obtained depends on such fiber parameters as cable diameter and numerical aperture, as well as the diode characteristics.

detector and IC processes is going to require hybrid implementation "for a long time to come," he says.

Like Motorola, Spectronics actually is producing integrated detector and amplifier products. One part, the SD3323 (Fig. 3), incorporates a photodiode with a transistor as a first-stage amplifier. It comes in a metal or plastic can and can be used to directly drive a TTL output if a short fiber line and a large-diameter cable are used.

The SD3323 sells in the \$10 range for the metal-can version. "Due to compromises in detector performance that had to be made in relation to the IC technology needed to put everything on the chip, the bandwidth is specified at 2 MHz," says William F. Stephen, the company's product manager. "This is significantly lower than our discrete devices."

Spectronics also offers what it calls a fiber-optic Schmitt-trigger detector. This chip integrates a photodiode, a preamplifier, and a Schmitt threshold and output compatible with TTL or complementary-MOS logic. The IC is made with what Biard calls a linear complementary bipolar process and is available in a plastic can or a metal can suitable for direct coupling to a fiber. The low speed of 200 kilohertz is a tradeoff for a better response than in the 2-MHz SD3323.

As in the Motorola offerings, the integrated Spectronics designs do not use a p-i-n device for the detector diode. In the case of the 3324 Schmitt trigger, the detector is formed at the junction between the epitaxial layer and the substrate.

"For the IC epilayer technology, the substrate is fairly high resistivity p-type material," Biard says. "You grow on it the epilayer that forms the collector of all the transistors on the circuit. That epilayer is the cathode of the photodiode and the substrate is the anode. So it really is just an n- or p-type diode. This has to be done because there just isn't any way to make a true p-i-n diode compatible with silicon IC technology."

This procedure makes the receiver slow to respond and only suitable for low data rates. "Since it is a p-n diode it has a fairly small depletion-layer width at the bias voltage that is available for it on the chip," Biard says. "So a lot of the response of the photodiode is from undepleted material. Those carriers have to diffuse to the junction before current flows in the external circuit, and that makes the detector slow."

The inherent bipolar collector's substrate junction is used as the photodetector in the Motorola devices, points out semiconductor industry consultant Lawrence A. Murray of Murray Consultants, St. Louis, Mo. "This is neither a low-capacitance approach nor highly efficient insofar as conversion efficiency is concerned, but meets the needs of low-data-rate baseband or computer links," he says.

Spectronics says the demand for these low-end integrated receivers is very strong for process-control and instrumentation applications. It adds that 50,000-unit production projections bring integrated devices to half the price of the discrettes.

A dissenting view

Not all U.S. makers of optical receiver components embrace integration enthusiastically. "While there is a trend toward integrating signal-processing circuitry with the detector in a fiber-optic receiver, there is no particular urgency," says W. N. ("Shaun") Shaunfield, manager of electro-optical components at Texas Instrument's Optoelectronics department in Dallas.

"TI has no specific program under way right now to integrate detectors on chip with circuitry elements," he says. Cost is a major factor, he adds. "Since detectors are likely to take up large portions of a chip, it's not economical to use valuable wafer real estate that could be used for more complex functions. It would probably be cheaper to process the simple two-to-three-mask detectors separately and go the hybrid route."

The fundamental physics is a problem too, Shaunfield says. He notes that integrated p-i-n diodes do not collect all the light incident on them, because their active regions are on the surface half mil or so and the incident light goes down several mils. The resulting efficiency problems might degrade responsivity as a function of wavelength by a factor of four or five.

Still, Shaunfield admits the integrated receiver will come along—especially for short fiber runs where lower performance is more acceptable. But five years from now such parts will be hard-pressed to capture as much as 30% of the market and will probably have to settle for something like 15% or 20%, he says.

Overseas action

With lead lengths causing grief over noise, it is no surprise that, as the receiver community investigates pure monolithic designs, it is attacking the lead-length problem with other clever approaches. Typical is the Hitachi Ltd. design consisting of a discrete p-i-n photodiode and a two-transistor integrated monolithic transimpedance amplifier (see Fig. 4). It can provide a 30-MHz bandwidth with a sensitivity of -35 dBm at the commonly used 0.83-micrometer wavelength.

The lead length is only 2 mm, so noise is no problem as long as the metal can is used. "The design might prove usable up to a bandwidth of several hundreds of megahertz," says its designer, Mitsuo Tanaka, senior researcher at Hitachi's central research laboratory in Tokyo. It has already been employed in a 4.2-kilometer, 10-megabit-per-second data highway that carries signals controlling a continuous casting steel mill, he says.

Not to be outdone, another Japanese group has built an IC with six p-i-n diodes as part of its effort to construct a compact receiver. The Yokoshuka Electrical Communications Laboratory of the Nippon Telegraph and Telephone Public Corp. built the array to match an experimental six-conductor fiber cable. Researchers there say that the lead lengths are such that there are no special problems with reduced frequency response or noise. Their experiments have been carried out at the 6.3-Mb/s rate used in Japan for transmission and at the 8.2-Mb/s rate used between telephone exchanges.

In another experiment the Yokoshuka group built a receiver front end with a silicon field-effect transistor mated to a p-i-n detector. The 6.3-Mb/s part has a 25-dB dynamic range and a sensitivity of -46.7 dBm. A gallium-arsenide FET would be more attractive for the amplifier's first stage because of its low noise—but its incompatibility with silicon causes integration problems.

However, GaAs fiber-optic receiver work is going on all over the world. For example, the Thomson-CSF Corbeville Laboratories near Paris have developed a fiber-optic transceiver dubbed EROS for emitter-receiver optical system (see "A timely conference for receiver fans," p. 160). A discrete GaAs diode functions both as a receiver and transmitter in a half-duplex scheme. The lab is far from having any prototypes of integrated fiber-optic receivers, a spokesman says.

The French are, however, busy in fiber-optic receiver integration, as they see its potential for more efficient, less expensive, and noise-free systems. At the Thomson-

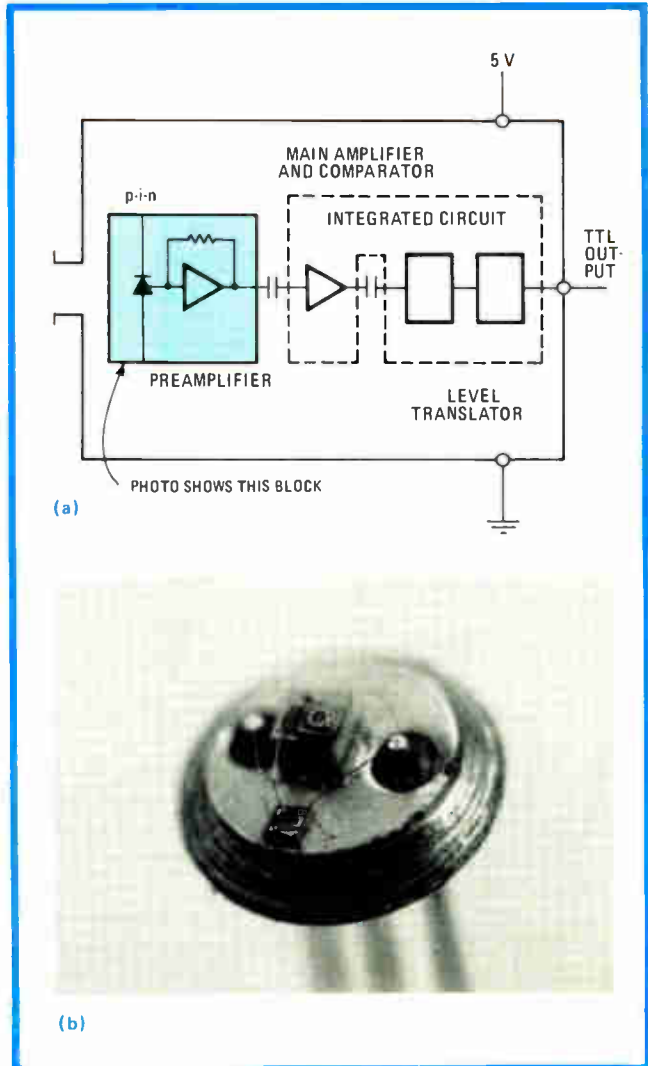

4. Two in one. In one Hitachi experimental fiber-optic receiver, a discrete p-i-n diode is mounted alongside a two-transistor monolithic transimpedance amplifier (a). Both are enclosed in a metal case (b), so that electrical noise is not a problem.

CSF Lignes Télégraphiques et Téléphoniques subsidiary in Paris, a group headed by Michael Eve has started to investigate the integration of a p-i-n detector with a FET amplifier, both being GaAs devices. So far "the problem is getting the device capacitance low enough for suitable amplification," Eve says. It will be as much as two years before anything is ready to market, he adds.

Even further away from a product is the effort at Compagnie Générale d'Electricité. The word from its central research laboratory in Marcoussis near Paris is that engineers are starting to look into an all-silicon photodetector and amplifier combination, but they will have nothing to report until 1981.

Meanwhile, West Germany's Siemens AG has been busily developing integrated photodetector amplifiers at its Munich operation, but it has not devoted much effort to the fiber-optic integrated receiver. Instead, the company has chosen to go after the now more lucrative market for camera exposure meters, electronic flashes, and the like. Its TFA 1001 W is typical: an IC with

A timely conference for receiver fans

Designers and users of fiber-optic receivers, whether integrated or in hybrid form, will find much to ponder in presentations recently at the FOC-80 fiber optics and communications conference in San Francisco. The conference offered three papers directly concerned with receivers and others that touched on the subject.

The French EROS hybrid transceiver was discussed by its authors L. d'Auria and P. Richin of Thomson-CSF. They emphasized a description of the discrete module system.

National Semiconductor Corp. sent Eric M. Miller to tell the audience he designed a hybrid fiber-optic receiver for medium performance because such general-purpose units have been ignored in the past.

For its part, Motorola's Semiconductor Group presented two papers on the system use of its integrated fiber-optic receivers. Also, Lawrence A. Murray of Murray Consultants presented his prediction of the evolution of the fiber-optic receiver business.

photodiode and an amplifier. The technology has enough in common with the requirements for integrated optical receivers so that Siemens will probably introduce a line of monolithic receiver products when the time is ripe.

In England, development of integrated fiber-optic receivers is also in the beginning stages. Researchers are devoting their efforts to optimizing hybrid designs with the experience gained being transferable to integrated designs. Typical is a hybrid p-i-n photodiode plus gallium-indium-arsenide FET receiver operating at the high data rate of 140 Mb/s [*Electronics*, Sept. 25, 1980, p. 73].

The p-i-n diodes were fabricated at Plessey Co.'s Allen Clark Research Center in Caswell. The system itself was put together by the Post Office research center in Martlesham Heath and has sensitivities at the 1.3- μ m wavelength of -44.2 and -40.1 dbm for 140- and 280-Mb/s data rates respectively. A system bit-error rate of 10^{-9} is maintained. Such second generation fiber-optic systems are important because they exploit the lower fiber attenuations available at the 1.3-to-1.6- μ m wavelengths. Thus longer fiber runs between repeaters are possible.

Still life in hybrids

The pace of worldwide development is such that it will be three to five years before the integrated approach takes over from the hybrid receiver designs running the show now. As well as fundamental technical reasons, the size of the markets the receivers serve and their cost are factors.

The important technical factor is that "you can't do monolithic photodetectors right now for the high bandwidths," says David B. Medved, president of Meret Inc., a Santa Monica, Calif., maker of fiber-optic components and subsystems. He defines this as 30 MHz and up and sees hybrids as the answer for the next two or three years, at least. "Nobody has found a way to put a high-speed p-i-n photodiode onto low-resistivity silicon," he explains.

Dennis Haynes, marketing manager for analog products of Burr-Brown Research Corp. in Tucson, Ariz., agrees that the detector-amplifier integration is the hard part. "What has held back the development of integrated fiber-optic receivers is disappointment by manufacturers with the slowness of the fiber-optic market to become important," he adds. Only as the market matures will research and development into integration pick up its pace, he believes.

Burr-Brown, Meret, Spectronics, and other manufacturers have lines of hybrid receiver components avail-

able. They cost \$100 or more, depending on specifications and quantities. These prices are high because the sales volumes are not yet enough to attract the mass semiconductor producers, says consultant Lawrence Murray, although he expects a change in the next few years [*Electronics*, July 17, 1980, p. 44].

Furthermore, "a push toward integrated fiber-optic receivers will require expertise that the small suppliers of hybrid devices just don't have," he says. Only a few of the six dozen suppliers of optical receiver parts could do an integrated receiver he says, mentioning TI, RCA, Hewlett-Packard, Hughes, Motorola, Spectronics, and Optron. However, only the last three companies will admit to ongoing R&D programs in integrated optical receivers.

Costs may tumble

Murray points out that a standard discrete p-i-n silicon diode is made with three masks on a 50-by-50-mil substrate and may sell for \$7. "This is twice the selling price of a 200-by-200-mil chip with thousands of transistors, so there is certainly room for prices to fall, especially when you consider that the larger device has much tighter tolerances."

That inexpensive integrated fiber-optics receivers will first make their mark in low-data-rate systems is clearly the industry viewpoint. For example, Eric N. Randall, vice president of engineering and director of optical communications products for Galite Inc., a Wallingford, Conn., division of Galileo Electro-Optics Corp., says that he suspects that integrated devices will be especially well suited to the sort of short links that exist in minicomputer setups or between computers and peripherals where maximum bandwidth is not a problem. In fact, "widespread availability of monolithic detectors with an amplifier stage would make the short link market even more active than it is now."

While agreeing with Randall's assessment, Stephen C. Lang, senior marketing specialist at systems maker Valtec Inc. in West Boylston, Mass., says the key question is not price but reliability. He says that Valtec's discrete optical modulator-demodulators have mean times between failures in the field of more than 100,000 hours and "we wouldn't consider retreating from that to save a few dollars." □

Inputs to this article came from Electronics staff members Arthur Erikson, James B. Brinton, Charles Cohen, John Gosch, Wesley R. Iversen, Kevin Smith, and Larry Waller.

Once again, Wavetek has gone to extremes to bring you the function generator bargains you crave.

At one extreme is Model 182A, a 4 MHz function generator with trigger and gated modes, DC offset, and up to 20 volts peak-to-peak output. All for just \$295.*

Circle #160 for demonstration

At the other extreme is Model 188. Besides doing everything Model 182A does, it also has 1,000 to 1 linear and 10,000 to 1 logarithmic sweep with convenient start and stop frequency controls. And Model 188's price of \$445* is far below any comparable instrument.

Circle #161 for literature

More and more features, less and less to pay. More and more to talk to us about: Wavetek San Diego, 9045 Balboa Ave., P.O. Box 651, San Diego, CA 92112.

Tel: (714) 279-2200.

TWX: 910-335-2007.

WAVETEK[®]

*U.S. prices only

**More and more
for less and less.**



Opto-isolated line monitor provides fail-safe control

by Eric G. Breeze and Earl V. Cole
General Instrument Corp., Optoelectronics Division, Palo Alto, Calif.

Because of the degree of isolation they provide, optically coupled ac-line monitors serve well as a small, reliable low-power interface in ac-to-dc control applications, where status information of the ac line is crucial. When a type is used that is TTL- and microprocessor-compatible—like the MID400, which performs the basic monitoring function on a single chip—a circuit can be built that ensures fail-safe control under the most difficult monitoring assignments. And when combined with a 555 timer, the monitor will have improved drive capability, more precise control of the turn-on and turn-off delay times, and better noise immunity than units that are typically available.

As shown in Fig. 1, two gallium arsenide infrared-light-emitting diodes connected back to back and optically coupled to an integrated photodiode and high-gain amplifier make up the MID400, which is encased in an eight-pin dual in-line package. In operation, each LED conducts on alternate half cycles of the ac-input waveform, together producing 120 pulses of light per second. Thus the photodiode periodically conducts, causing the amplifier to drive the npn transistor at the output to its

on state. As the amplifier's switching time has been designed to be slow, it will not respond to an absence of input voltage lasting a few milliseconds; therefore it will not respond to the short zero-crossing period that occurs each half cycle.

The MID400 operates in one of two basic modes: saturated or unsaturated. It operates in the saturated mode when the input signal is above the minimum required current of 4 milliamperes root mean square and the photodiode pulses keep the output of the MID400 low. It operates in the unsaturated mode if the input current drops below 4 mA rms. Under these conditions, a train of pulses will appear at the output. In this way, a clean clock generator, devoid of power-line transients because it is isolated, may be realized.

If the input current drops below 0.15 mA, the device turns off. This causes the output of the MID400 to remain high.

Adding an external capacitor, C , to pin 7 of the device produces a time-delay circuit. The amount of delay on power-up is short because the photodiode has a low impedance when conducting. When ac is removed, however, the delay is long because the capacitor must discharge through the leakage resistance of the amplifier and photodiode. The larger the capacitor, the longer the delay.

In lieu of capacitor C , the use of a 555 timer also provides pulse shaping by yielding faster rise and fall times at the output. Here, the 555 is used as a Schmitt trigger with well-defined thresholds, the high state being $\frac{2}{3} V_{cc}$ and the low state being $\frac{1}{3} V_{cc}$. Besides providing

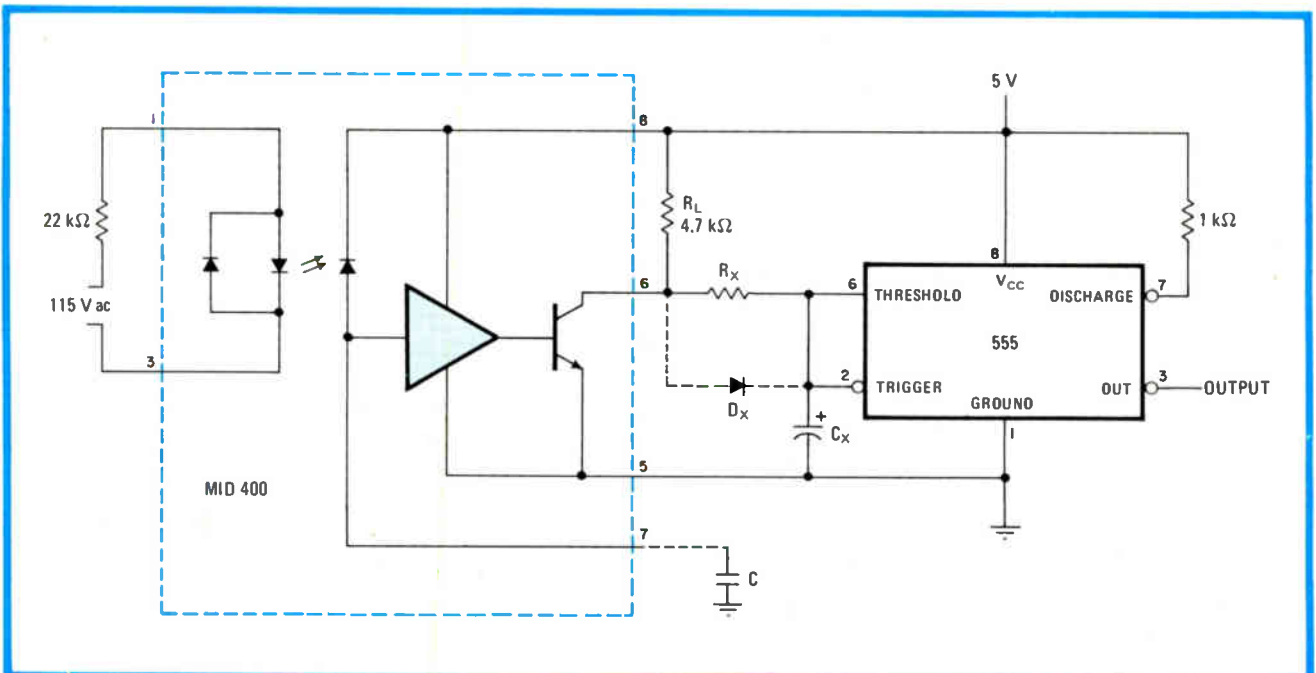

1. Control chip. Opto-isolated power-line monitor on single IC provides hash-free driving signals for ac-to-dc control applications. When united with 555 timer, circuit provides precise control of on and off delay times, improved driving capability, and good noise immunity.

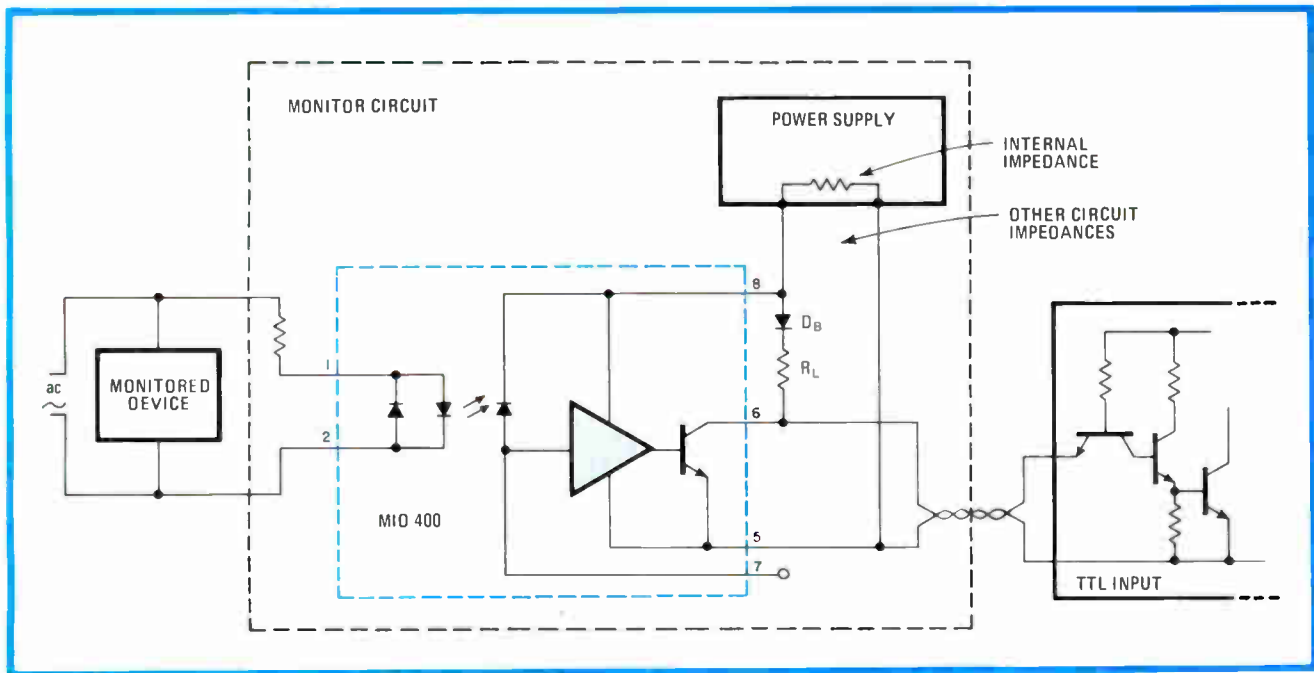

2. Immune. Monitor is easily modified for fail-safe control tasks, such as are required in industrial applications. Diode prevents component failures from creating output glitches. MID400's output circuit design inherently prevents generation of glitches caused by supply anomalies.

noise immunity, use of the 555 also minimizes oscillations that might occur if a TTL device were to drive a minicomputer.

Timing elements R_x and C_x set the delay. With appropriate choice of the time constant, the circuit can be made to respond to, or to ignore, one or more ac input cycles. Diode D_x permits the fast charge and slow discharge of C_x or, if the diode's polarity is reversed, the slow charge and fast discharge of the capacitor. The actual delay time will depend on the operating mode of the MID400.

For industrial, military, or medical applications in which fail-safe operation is important, the circuit's response must also be considered for the cases where either the ac input or the MID400 supply is removed.

Fortunately, the MID400 has been designed so that its output transistor is on (low) only when both the ac input voltage and the supply voltage are present, thus simplifying the problem of providing a valid fail-safe control signal. Consider the case where the MID400 is powered by a separate 5-volt supply and the monitor drives a TTL-compatible interface through a twisted-pair line (Fig. 2). Normally, the inherent truth table of the device will prevent an erroneous output to the TTL interface circuit. Should R_L fall below 1 kilohm for one reason or another, however, and the power supply be off, the TTL input of the minicomputer will appear low because of excessive current flow through R_L . Diode D_B in series with R_L blocks any reverse current, eliminating the problem. □

Three-level inverter conserves battery power

by Geert J. Naaijer
Laboratoires d'Electronique et de Physique Appliquée,
Limeil-Brévannes, France

Converting 12 volts dc into a well-regulated 220 v ac at high efficiency is especially desirable when the input power source is derived from solar cells or a car battery. Often, too, output harmonics generated by the conventional square-wave inverter must be reduced to a point where it does not create other practical drawbacks. These design requirements are met with this inverter, which maintains efficiency and reduces harmonics at all power levels by ensuring that the driving current is

almost linearly proportional to the output power and by producing a three-level output waveform that more closely approximates a sine wave.

As shown, the CD4013 dual flip-flop generates a 100-hertz pulse train (duty cycle is $\frac{1}{6}$) and a 50-Hz square wave (the oscillator is easily modified for 60 Hz), both of which are independent of input voltage and load variations. The AND gates formed by the diode-resistor networks at the output of the flip-flops apply these signals to the power transistor drive circuitry (BC548, MJE801, etc.), which, configured in a two-phase switched-mode arrangement that sends a pulse through the primary of the line transformer every quarter cycle at 50 Hz, generates a three-level waveform.

Because the positive and negative output swings each last one third of a cycle, separated by sixth-period intervals at the zero crossings, third-harmonic attenuation is theoretically reduced to zero. By appropriate modulation

HERE AT LAST!

A Standard "Custom" Data Collection Device The Memodyne M80 Cassette Computer

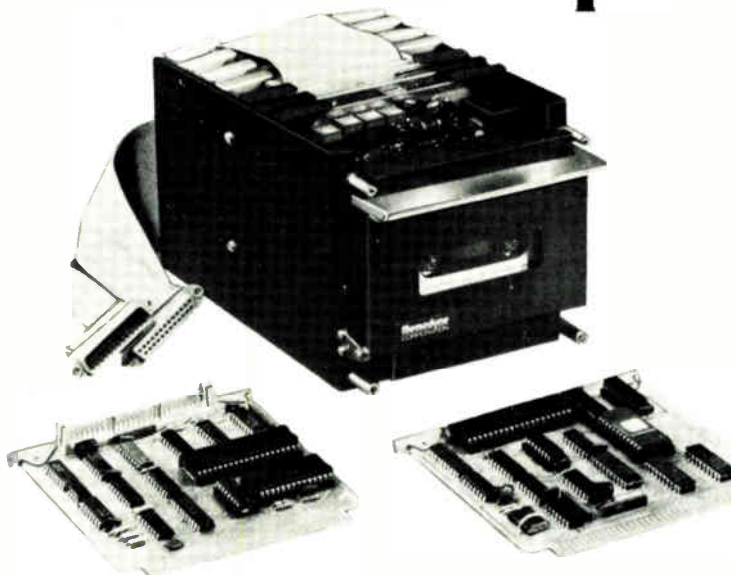

The M80 is a general purpose Z80™ based computer combined with a rugged, high-speed digital cassette drive in a compact, panel mounting module. Modem and terminal RS232C and TTY current-loop serial ports are provided for easy interfacing. A 2K PROM is programmed to implement completely interrupt driven control of the recorder and communications functions. A 1K RAM provides data buffering which allows the M80 to handle continuous streams of data up to 9600 BAUD.

T.M. Z80 is a trademark of ZILOG Corp.

FEATURES:

- Standard program in CPU Card Prom implements 30 recorder and communication commands plus numerous mode selections.
- A Microprocessor based computer that is small and compact, a rugged module that can operate in hostile environments with its own removeable medium memory, immune to hazards that disable disks, printers, and other peripherals.
- High speed: Can read or write continuous data streams at up to 9600 Baud with block size of 100 bytes or more.
- 500,000 Byte formatted capacity.
- ANSI/ECMA-34 compatible tapes, both tracks accessed.
- Programmable block size up to 256 Bytes.
- Recorder control and communications are interrupt driven and transparent to user programs.
- Small cards make for sensible modularity with modern high density ICs and are easily inserted and extracted.
- Small module fits behind standard 5 inch panel.

IF YOU NEED:

1. A Process Control Computer.
 2. A Computing Data Logger.
 3. A Custom Cassette Recorder.
 4. An Airborne Recording Computer.
 5. The Highest Speed RS232C Cassette Recorder.
 6. A Medical Data Acquisition System.
 7. A Numerical Controller.
 8. An Intelligent Cassette Terminal.
 9. An Analytical Instrumentation Recorder.
 10. An Automatic Tester.
- ... An application we haven't thought of . . .

**THEN ALL YOU HAVE TO DO
IS PROGRAM OUR PROM
(AND IF YOU DON'T WANT TO
WE WILL).**

WRITE FOR COMPLETE DETAILS INCLUDING
COLOR BROCHURE TO:

Memodyne
CORPORATION
220 RESERVOIR STREET
NEEDHAM HEIGHTS, MA 02194 U.S.A.
TELEPHONE (617) 444-7000
TELEX 922537

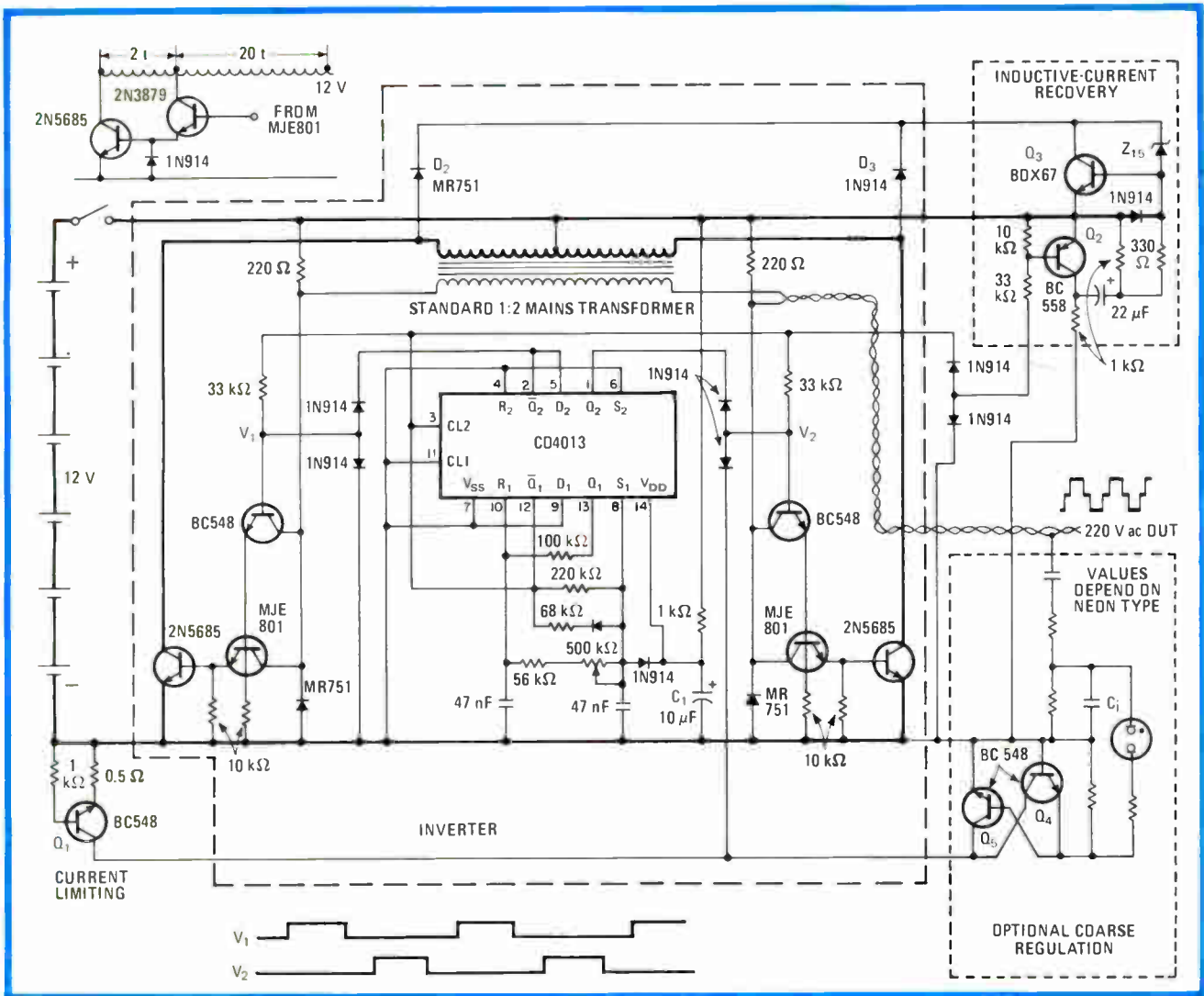

Cell saver. Switched-mode inverter attains high efficiency and low harmonic distortion over a wide range of power levels, thus conserving solar cells and batteries. Output frequency is independent of input fluctuations. Current limiting and voltage regulation are provided.

of these zero-voltage intervals, good regulation is achieved at low loss without reintroducing excessive third harmonic energy. Although this method is not as elegant as the transformerless method of summing phase-shifted square waves or stepped sine waves,¹ it is much simpler.

D_1 and C_1 ensure reliable startup. Current limiting is provided by Q_1 , which diverts drive current if output current soars. Output impedance is kept virtually constant during all parts of the cycle, including zero-voltage periods, where Q_2 saturates Q_3 , thus feeding an inductive current back into the battery via diodes D_2 and D_3 . The zener diode provides spike suppression. A neon lamp or similar symmetrical-breakdown device allows simple voltage regulation. When V_{out} soars, C_1 attains breakdown before the normal zero-voltage period, and Q_4 or Q_5 diverts current.

Because this is a switched-mode inverter, efficiency is excellent at nominal output power. But, in contrast to other inverters, its high-efficiency characteristic extends down to very low output-power levels. This is achieved by forcing output current to flow not only through the

transformer's secondary, but also through the base-emitter junctions of the 2N5685 power transistors. Thus, base drive closely tracks the output power requirements. As long as the transformer winding ratio is compatible with the gain needed to saturate the power transistors, significant power can be saved at the lower power levels. Efficiency exceeds 88% at 120 volt-amperes, 75% at 175 VA, and 50% at 15 VA. No-load loss is only 12 watts.

Still better performance can be obtained by adopting the power Darlington configuration, as shown at the upper left. Using the Darlington, the inverter's efficiency will be 89% at 150 VA, 70% at 225 VA, and 50% at 15 VA. Lower transformer step-up ratios further improve performance, because the output transistors switch more totally into saturation. Thus, 12-v-dc-to-110-v-ac and 24-v-dc-to-220-v-ac designs are more efficient than this 12-v-dc-to-220-v-ac circuit. □

References

1. Geert J. Naaij, "Transformerless inverter cuts photovoltaic system losses," *Electronics*, Aug. 14, 1980, p. 121

Designer's casebook is a regular feature in *Electronics*. We invite readers to submit original and unpublished circuit ideas and solutions to design problems. Explain briefly but thoroughly the circuit's operating principle and purpose. We'll pay \$50 for each item published.

Small talk.

**Bussmann speaks your
language in miniature fuse protection.
And selection.**

When you think small, think Buss. With today's miniaturization of electronic equipment and components, you don't have to sacrifice quality for size. Not if you get protection from the most complete source for fuses and accessories in the industry — Bussmann. As a part of our overall line, we offer you a *full line* of miniature and subminiature fuses and fuse clips. All with the same state-

of-the-art dependability as our larger fuses.

Bussmann makes everything you need to protect delicate printed circuit boards and other sensitive electronic equipment. Also equipment for overseas markets. When you're specifying Buss fuses, specify Buss clips at the same time. That way you get complete compatibility and high quality. It's that easy.

But you get more than single-source convenience. You'll get expert technical help whenever you need it. Just contact your Bussmann representative. He's the prime source for application data. And he has the full backup of specialists at the plant.

For the best protection money can buy, talk to your local distributor or Bussmann representative today. Because Bussmann is the only name you need to know in circuit protection. No matter how big the job. Or how small.

McGraw-Edison

**Bussmann.
The Protection
Experts.**

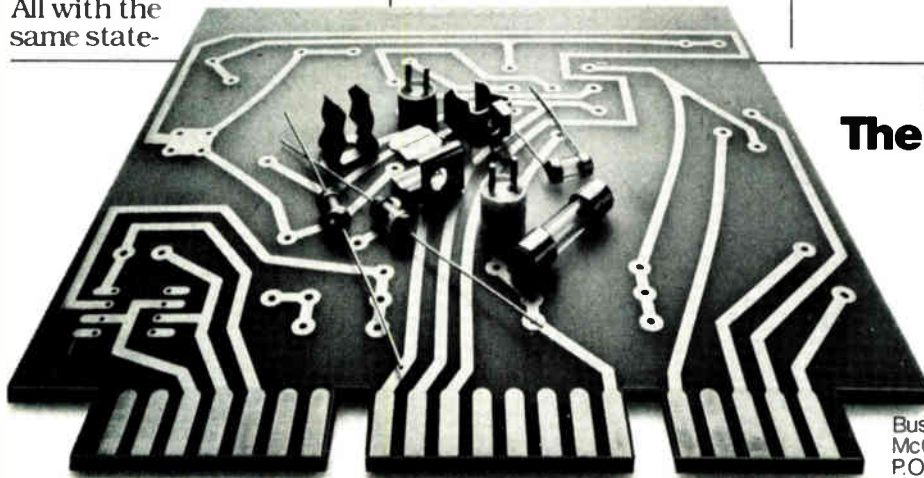

Bussmann Division
McGraw-Edison Company
P.O. Box 11460
St. Louis MO 63178

High linearity and video speed come together in a-d converters

Digitally corrected subranging in analog-to-digital converters ensures high precision at no loss in speed

by William J. Pratt, *Analog Devices Inc., Computer Labs Division, Greensboro, N. C.*

□ Conversion speed is obviously paramount for analog-to-digital converters meant to operate in the 1-to-20-megasample/second range. But linearity is also a most important parameter. Unfortunately, a tradeoff must usually be made between top speed and maximum conversion precision in the design of such converters. The result is a less-than-ideal transfer function.

Increasing the resolution of the first encoder in a conventional subranging a-d converter is the basis of a digital error-correction technique, called digitally corrected subranging, that extracts superior performance from 9- to 12-bit a-d converters. As a bonus, this better performance can be achieved with components that are less accurate, smaller, and dissipate less power than those needed in conventional designs, since less attention need be paid to system errors. Examples of a-d converters using the DCS approach include the 10-bit, 20-megahertz MOD-1020 and the 12-bit, 5-MHz MOD-1205, both from the Computer Labs division of Analog Devices Inc.

Subranging a-d converters are widely used at conversion rates of 1 megasample/second and higher and for resolutions of 9 to 12 bits. The conventional subranging a-d converter circuit (Fig. 1) employs two encoders, connected in series with one another. The encoders quantize the analog input signal and produce a binary output.

They can be flash (parallel) or Gray (foldback amplifier) encoders. The digital error-correction scheme described here is useful only for subranging a-d converter circuits. As such, it is best understood by a closer examination of the error factors in a subranging a-d converter circuit.

Encoder accuracy

A conventional subranging a-d converter produces a binary output with a resolution of 2^N , where N is the total number of converter binary bits, or N_1 plus N_2 , the respective resolutions of the first and second encoders.

The first encoder must be at least as linear as the converter is overall, even though its resolution may be much lower. For example, a 10-bit subranging a-d converter with 10-bit linearity must have a first encoder whose minimum linearity is 10 bits, even though its resolution may be, say, 8 bits. A closer look at the circuit reveals why this is so.

The first encoder quantizes the analog input signal. The resulting digital word drives the digital-to-analog converter, whose output is subtracted from the original analog input signal and the difference amplified by the operational amplifier. The op amp's output is a composite signal, consisting of a "residue," or unquantized portion of the original analog input signal, plus any

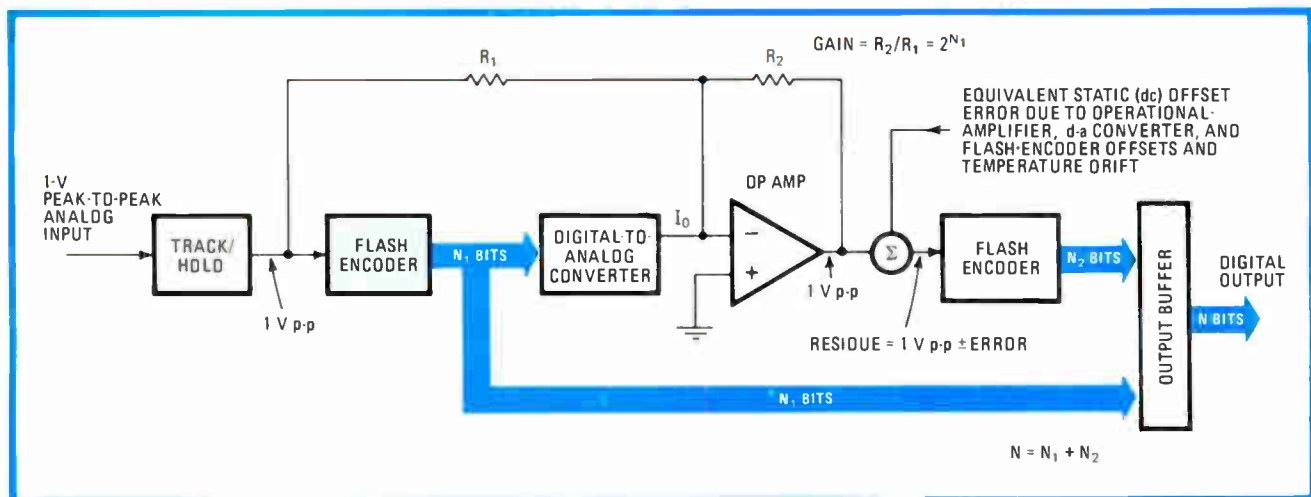

1. **Subranging.** A conventional 9-to-12-bit analog-to-digital converter operating at rates of 1 megasample/second and higher uses a subranging conversion circuit. A common variation is the use of a Gray code (foldback amplifier) encoder in place of the first flash encoder.

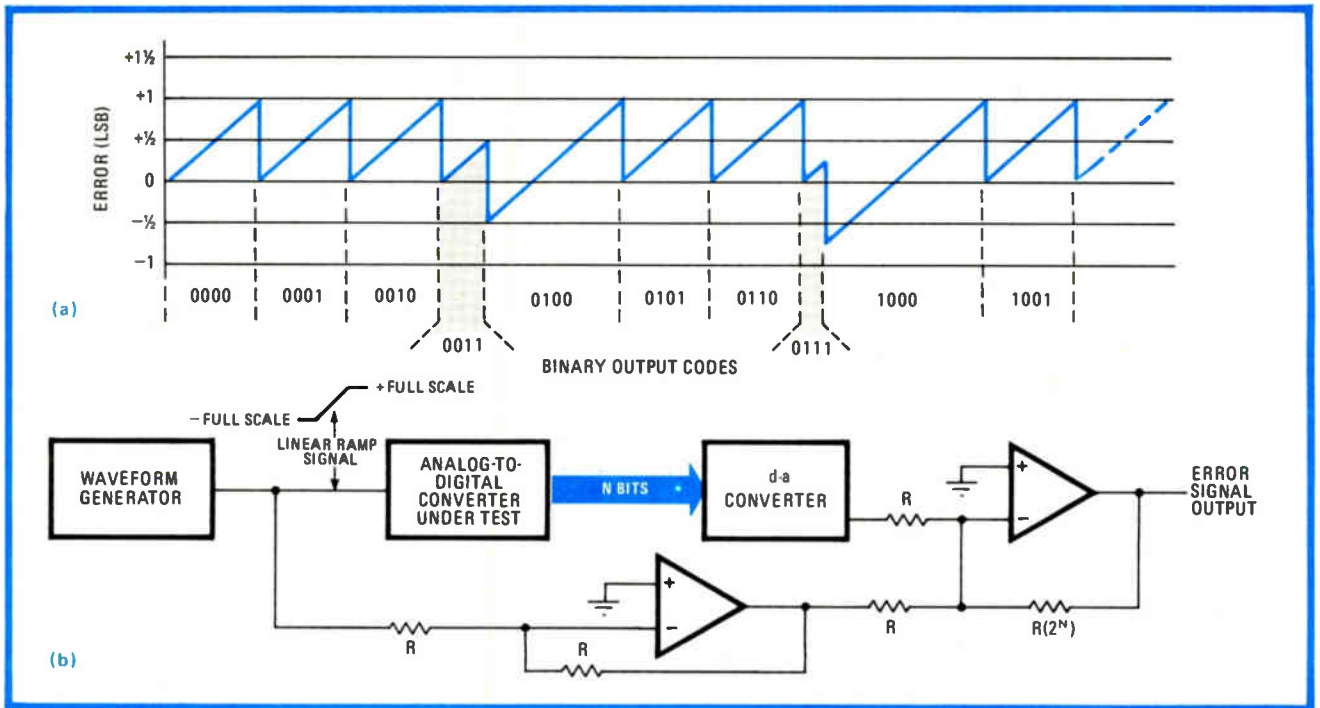

2. Errors. In a conventional 4-bit subranging a-d converter using two 2-bit flash encoders, the error at 0011-0100 is due to static offset effects, while the error at 0111-1000 is due to bias effects as well (a). The test circuit (b) measures converter input-signal linearity.

errors resulting from nonideal behavior of the encoding circuitry. These errors must be removed from the output signal if a low-accuracy (and thus low-cost) encoder is to be used. The second encoder quantizes the composite signal, producing an output byte that is combined with the digital output of the first encoder to form the final output of the a-d converter.

The circuit works much like a successive-approximation a-d converter circuit. The difference is that more

than 1 bit at a time is encoded and the input to the d-a converter digital is in parallel. Such an arrangement allows operation at much higher speeds.

The required resolution can be provided only if the input range of the second encoder is equal to one quantization step of the first encoder and if the residue signal at the input of the second encoder is always within that encoder's input conversion range. Should the residue signal exceed the limits of the second encoder, signal

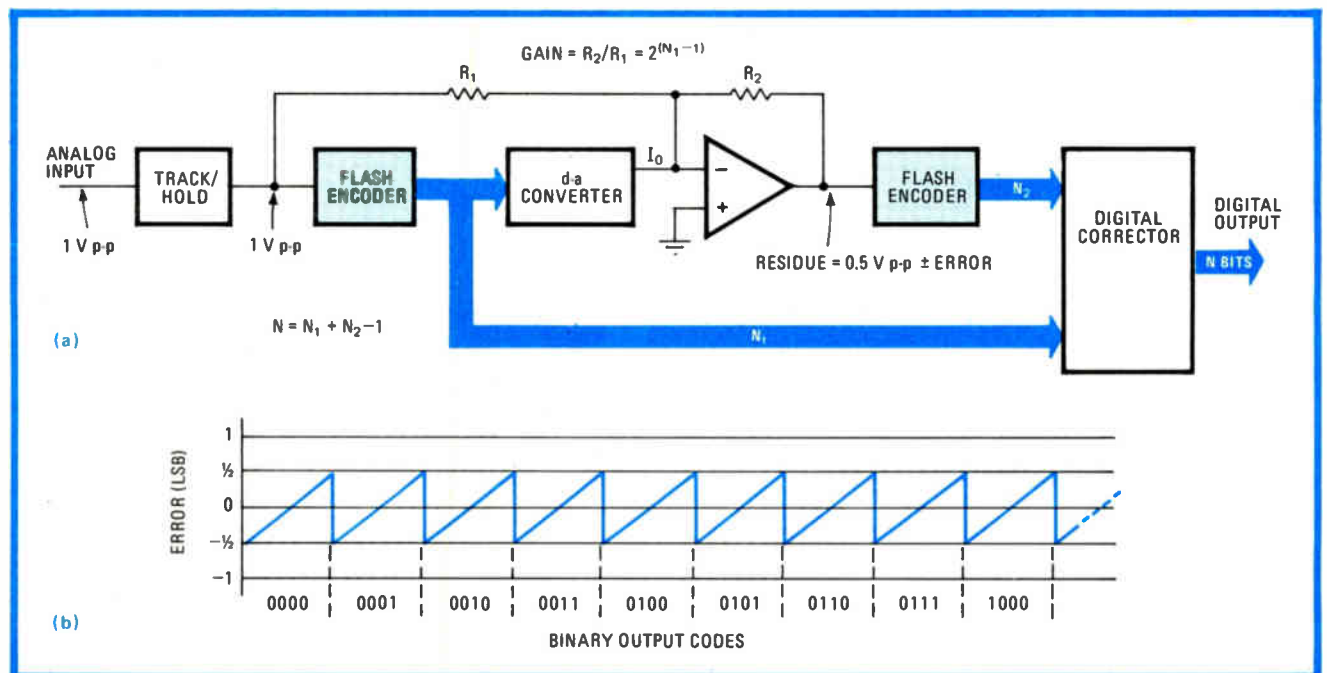

3. Elimination. Digital correction (a) can be used to eliminate conventional subranging a-d converter linearity errors. Note the error response (b) of the conventional circuit in Fig. 1 is within at least $\pm 1/2$ least significant bit, after the use of digital error correction.

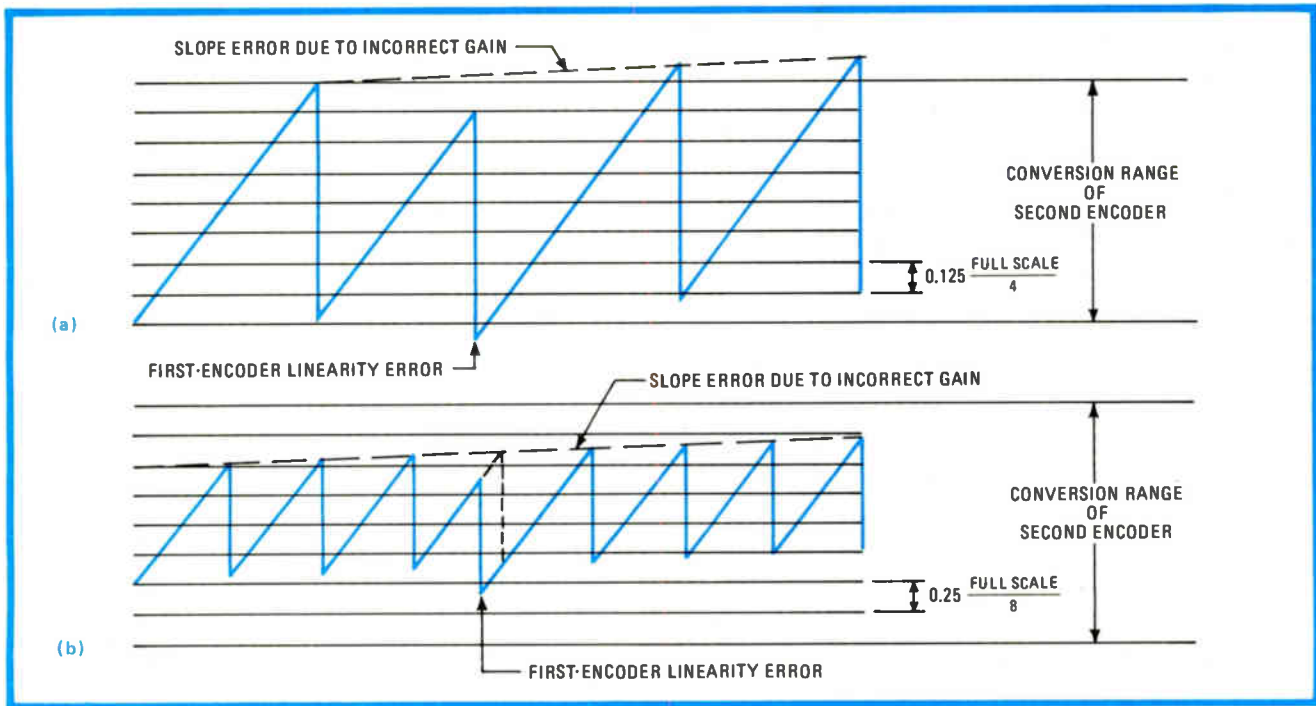

4. Residue. When second-encoder input range is exceeded by residue and error signals in a conventional sub-ranging a-d converter, information is lost (a). Digital correction improves signal linearity in the presence of the same signal errors and residue (b).

information is lost. On the other hand, a smaller residue signal than what the second encoder can handle results in the encoder's underutilization and subsequent loss of resolution. Consequently, the range of this encoder is set after amplification exactly equal to the ideal quantization error of the first encoder. Any other error causes the residue signal to exceed the bounds of the second encoder's input range. Irrevocable a-d conversion errors result and signal information is lost.

Sources of error

The linearity of a conventional sub-ranging a-d converter must generally reflect the sum of all the error sources in the design, including those contributed by the second encoder.

Figure 2a shows typical output errors of a conventional sub-ranging a-d converter, as measured in the test setup of Fig. 2b. Those errors include:

- Track/hold droop errors (dV/dt during hold time).
- First-encoder gain error.
- First-encoder offset error.
- First-encoder linearity error.
- Operational-amplifier offset error.
- D-a converter offset error.
- Second-encoder offset error.
- Operational-amplifier gain error.
- D-a converter gain error.
- D-a converter linearity error.
- Second-encoder gain error.
- Second-encoder linearity error.
- Noise generated by all components.
- Inadequate-settling-time errors due to the d-a converter and operational amplifier.

The first seven of these error sources can be ignored with the digital error-correction scheme to be described.

A digitally corrected sub-ranging a-d converter circuit (Fig. 3a) is similar to the conventional sub-ranging converter, save for the first encoder. An error-free, or ideal, waveform would appear as in Fig. 3b. In the digitally corrected circuit, the first encoder has 1 more bit of resolution. The residue input to the second encoder consists of the same elements as in the conventional circuit, but the quantization error is halved because of the doubled resolution. Figure 4a shows the residue signal for a conventional sub-ranging a-d converter, and Fig. 4b, the results of adding another bit to the first encoder. Note that since the same error sources will not cause the residue signal to exceed the input range of the second encoder, provided that they add up to less than half the maximum input range (the other half is needed to quantize the ideal residue of the first encoder), no signal information is lost. Errors can be corrected by measuring them and subtracting their digital effect from the digital output. Error measurement is performed by the second encoder, which also provides its normal function of increased resolution for the a-d converter.

The digitally corrected circuit permits the existence of errors that, in a conventional design, would cause gross nonlinearities at the a-d converter output, at the cost of only 1 extra bit of resolution in the first encoder. Furthermore, the linearity of both the first and second encoders need only be commensurate with their resolutions.

Since component tolerances and accuracies are significantly relaxed in a digitally corrected design, monolithic flash encoders with conventional accuracies of within 0.2% may be used, reducing design costs, power dissipation, size, and failure rates. A flash encoder—of any resolution—for a conventional 12-bit a-d converter, for example, must be accurate to within 0.01%. Such a

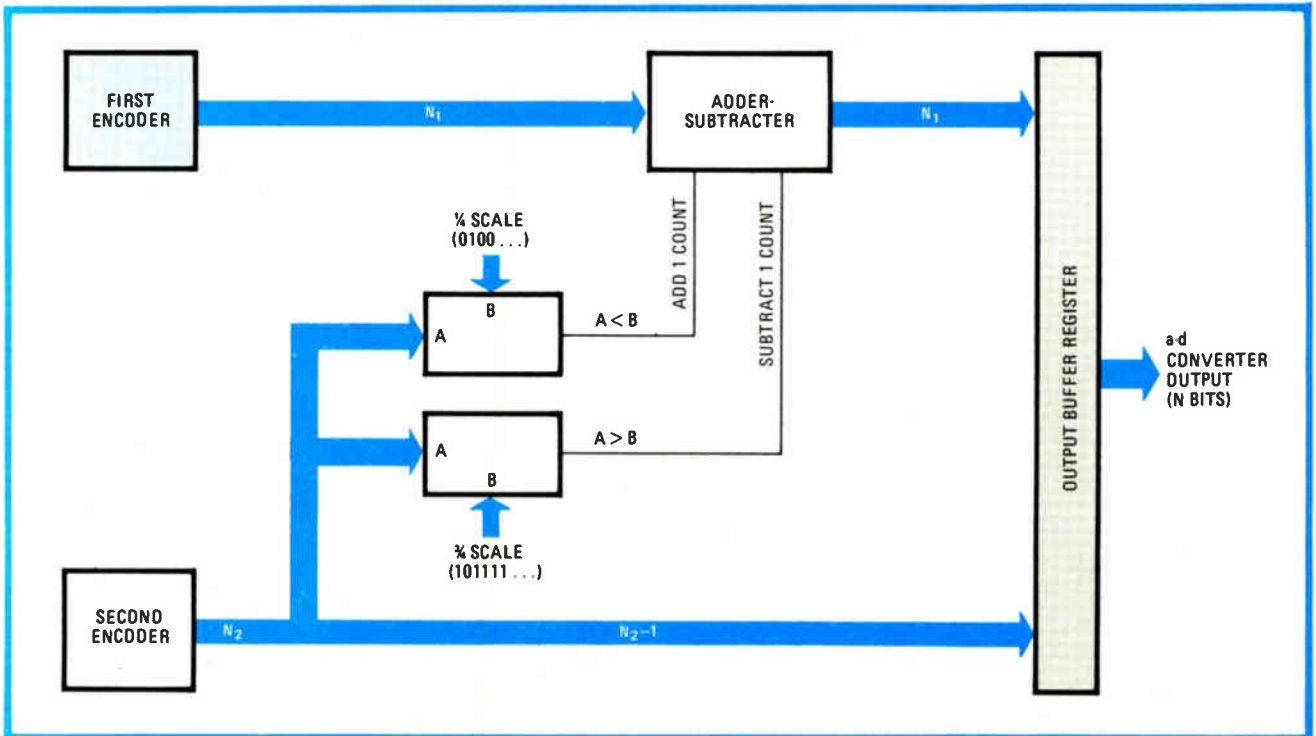

5. Digital correction. This circuit can be used to correct linearity errors of conventional subranging a-d converters. In practice, the circuit can be simplified further by inserting an offset error at the first-encoder's input, so that its output is always less than ideal.

converter cannot be built without precision resistors, comparators, and potentiometers.

Furthermore, the accuracy of conventional designs is difficult to maintain in harsh environments; frequent recalibrations are needed. No such constraints hobble digitally corrected designs since their errors are completely corrected.

Making corrections

The output of the digitally corrected converter's second encoder provides the additional resolution required to meet the converter's specification. It also contains a quantization of the linear and nonlinear errors that must be identified and corrected.

Linear errors include gain and offset errors, as well as track/hold droop. They appear as additive signals (in other words, they shift the output of the second encoder but do not cause linearity errors), provided the residue signal stays within the bounds of the second encoder. These errors (the first seven listed above) are rendered relatively harmless in a digitally corrected subranging design, appearing in the output as an equivalent dc offset that is easily adjustable to zero with a single offset control at the a-d converter input. No digital processing is required to correct these errors.

Nonlinear errors contributed by the first encoder—incorrect digital words at the encoder's output—require some digital processing. The digital-to-analog converter must be as linear as the overall a-d converter to ensure that the first encoder's nonlinearity is measurable. Hybrid d-a converters are available that take care of this aspect. Correcting the output bits of the first encoder simply involves subtracting the error from the output digital signal.

The nature of the digital processing can be seen most easily for the case where gain and offset errors are zero, and first-encoder linearity error is as shown in Fig. 4. It is assumed that the digitally corrected circuit is biased such that a perfect first encoder produces a residue signal ranging from $1/4$ to $3/4$ scale on the second encoder. If the residue signal is less than $1/4$ scale, the first encoder's output must have changed state too soon because of the error, that is, two of its transition zones are too close together and its output code should be one count less than it is when the residue signal is less than $1/4$ scale. When the residue signal returns above $1/4$ scale, the output code is correct again. It is at this point that the first encoder should have changed state. The binary output codes are always correct, then, if left unchanged, except when the second encoder produces an output of less than $1/4$ scale (when one count will be added to the first encoder's output) and when the second encoder produces a result in excess of $3/4$ scale (when one count must be subtracted from the binary output of the first encoder).

Some modifications

Correction is implemented with the circuit of Fig. 5. This circuit may be simplified further by introducing an offset error at the input of the first encoder such that the encoder's output will always be less than ideal. Thus the circuit need never perform subtraction. Leaving the bits unmodified or adding them suffices.

In a further modification, the range of the second encoder is offset so that only its most significant bit is used to indicate whether or not a count is to be added to the first encoder's digital word. In practice, the correction circuit involves one or two adder chips. □

Introducing the **SUPER ANALYZER**

**Ono Sokki Dual Channel FFT Sound
and Vibration Analyzer**

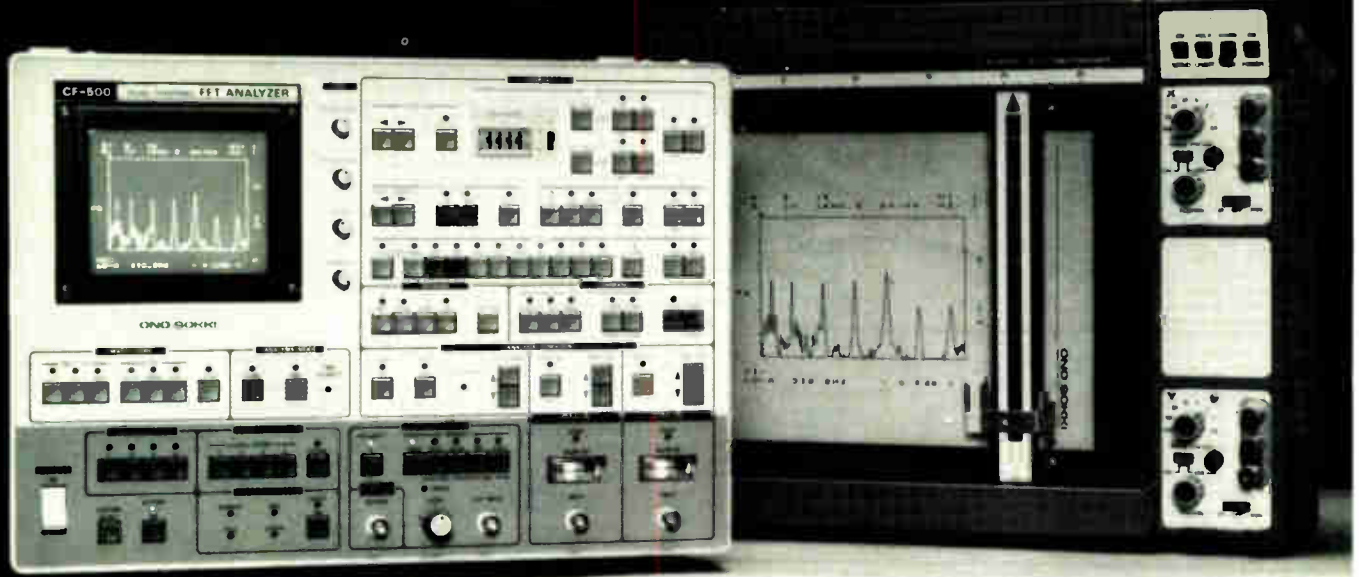

64K byte mass storage data memory user area.

The CF-500 is an all new FFT Analyzer with dual-channels, multi-functions, high accuracy and low cost! It incorporates a 64K byte large-capacity mass storage data memory, and features improved real time FFT analysis. Features include a digital oscilloscope which displays an amazing twenty-eight thousand 12-bit words, and running to 3-dimensional recording of power spectra, and coherence-and-transfer functions. All switches are feather-touch, which combine beautifully with the many functions to make the CF-500 a powerful, highly accurate, easy-to-use analyzer.

Distributors and Sales Representatives wanted.

CALL TOLL-FREE 800/323-0315
in Illinois 312/640-8640.

Exclusive Agents

SHIGMA, INC.

80 Martin Lane • Elk Grove Village, IL 60007

WESTERN HEADQUARTERS
2471 East Bayshore Suite 501
Palo Alto, California 94303
Telephone (415) 328-3351

Manufacturer **ONO SOKKI** CO., LTD. Tokyo, Japan

Specifications

- Dual-channel, real-time FFT
- 14 ranges from DC to 1 Hz and from DC to 20 kHz, plus external control
- Resolution—401 lines overall
- 12-bit A/D, dynamic range is 68 dB or more
- Transient recording (Memory capacity: 28K words)
Power spectrum (2 ch. simultaneously)
Linear spectrum (2 ch. simultaneously)
1/3 octave analysis
Coherence function
Transfer function (gain/phase)
Multiplication and subtraction of each spectrum
- Provision of a 64K-byte user area data memory
Twenty eight block continuous memory spectrums are possible.
- Complete copies of CRT information with the CX-445 X-Y recorder. Three-dimensional recording is possible.
- GP-1B interface (optional)

**SEND FOR
FREE
BROCHURE**



Single-chip computer aims at multiprocessing

16-bit instructions also help bring word processing, personal computers, and smart terminals within reach

by Phillip Hughes, Thomas Dugan, James Handy, and Ronald Pasqualini, *National Semiconductor Corp., Santa Clara, Calif.*

□ Many single-chip microcomputers aim only at low-end control applications, a high-volume market where they have found wide-ranging success. But as more memory becomes available on chip because of increasing semiconductor densities, they can set their sights higher—at terminals, personal computers, word processors, and even machines that speak only a high-level language.

Perhaps the most exciting openings lie in multiprocessing applications, in which several processors operate simultaneously on different programs while sharing common memory and peripherals. With their on-chip program and data memory, microcomputers are admirably

suited to these situations because they seldom need to use the common bus and consequently all run at nearly full speed.

To serve this emerging market, National Semiconductor has developed its series 70 of 8-bit microcomputers, complete with on-chip read-only and read/write (random-access) memory. More distinctively, the devices include the control logic needed for handling the bus contention problem that is a part of multiprocessing. In short, they are ideal for applications requiring the economy of a single chip, the flexibility of multiprocessing, and the power and convenience of special 16-bit arithmetic instructions (Fig. 1).

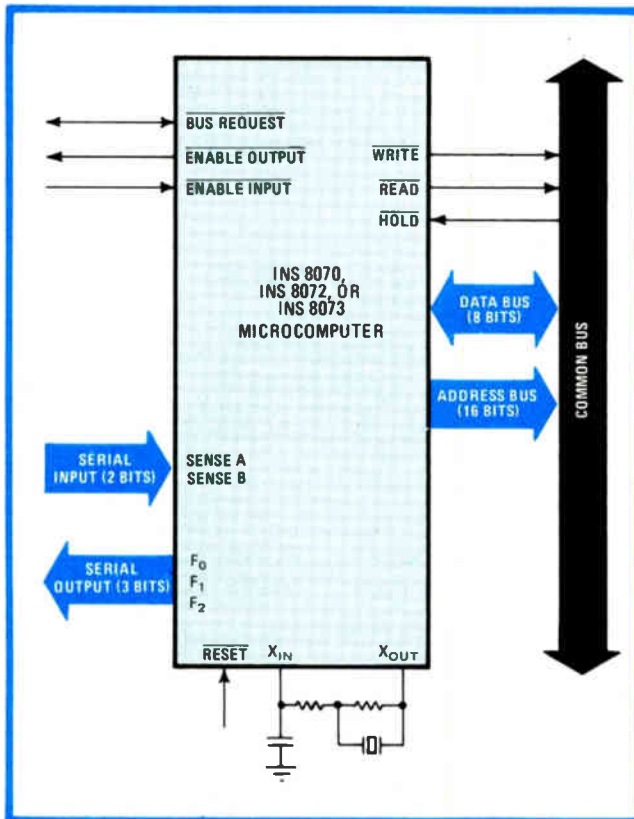

1. Single-chip solution. Series 70 microcomputers have identical pinouts. These govern the data, address, and control lines that make up the bus common to all multiprocessors as well as serial inputs (SA and SB), serial outputs (F_0 , F_1 , and F_2), and the bus priority control pins (\overline{BREQ} , \overline{ENIN} , and \overline{ENOUT}) essential for multiprocessing.

Multiprocessing purposes

In a multiprocessing application the data, address, and control lines of several processors are tied together, so that they form a common bus. However, only one processor at a time is allowed to use the bus, the other processors meanwhile keeping their pins in the high impedance state.

Ordinarily a substantial amount of extra hardware is needed to prioritize use of the bus and to ensure that no two processors attempt to use it simultaneously. On the series 70 microcomputers only a single additional pull-up resistor is needed on the bus request line (\overline{BREQ}), no matter how many processors happen to be sharing the bus (Fig. 2). That is made possible by the control logic built into the chips.

The enable output (\overline{ENOUT}) of the higher-priority microcomputer is connected to the enable input (\overline{ENIN}) of the one next in priority, thus forming a daisy chain of bus priority. Whenever a processor wishes to use the bus, it first checks to see if the (\overline{BREQ}) is active. If it is not, then it pulls \overline{BREQ} low and checks to see if \overline{ENIN} is active as well. If no other processor has made a bus request during the same clock cycle, then it receives control of the bus. Other processors that subsequently wish to use the bus will delay issuing their request until they observe \overline{BREQ} going high.

However, it is possible for more than one processor to make a bus request simultaneously, especially if they have all been waiting for \overline{BREQ} to go high. In this case, they will be granted use of the bus in the order determined by a hardwired priority scheme.

To illustrate, the top processor in Fig. 2 has the

highest priority in the system because its $\overline{\text{BREQ}}$ line is connected to its $\overline{\text{ENIN}}$. It will maintain a high level on its $\overline{\text{ENOUT}}$ line until it has finished using the bus, and by passing this $\overline{\text{ENOUT}}$ signal along down the daisy chain of $\overline{\text{ENOUT}}$ s to $\overline{\text{ENIN}}$ s, it will prevent any other processor from attempting to use the bus.

When the highest-priority processor finishes with the bus, it releases its hold on $\overline{\text{BREQ}}$ and drives the $\overline{\text{ENOUT}}$ low. That output propagates to and enables the processor next in priority that is requesting use of the bus. This action continues down the daisy chain until all the processors that have simultaneously requested the bus have been granted its use. When the last of these processors releases $\overline{\text{BREQ}}$, the pull-up resistor brings it high, signaling to the ones that have been waiting that the bus is now available for them to issue their own bus requests, and the cycle repeats.

In this way no processor is locked out of using the bus even though it may have a low priority as determined by its position in the daisy chain. Regardless of priority, all waiting processors that issue their requests simultaneously will be serviced before any new requests are allowed.

The architecture

Fabricated with a standard silicon-gate n-channel MOS process and requiring only a single 5-volt supply, members of the series 70 family include the INS8070, with 64 bytes of on-chip RAM for data and no program ROM; the INS8072, which adds 2.5-K bytes of ROM; and the INS8073, with a Basic interpreter stored in the 2.5-K bytes of ROM.

Each contains an 8-bit arithmetic and logic unit and an 8-bit accumulator (with an 8-bit extender for double-precision arithmetic). Also on the chip are four 16-bit registers for storing addresses—a program counter, a stack pointer (SP), and two other pointers (P_1 and P_2)—as well as a temporary register (T), used in multiply or divide operations, and a status register (Fig. 3).

The series 70 instruction set contains several specialized instructions, two of which are especially helpful in word-processing applications. The SSM instruction, used to search and skip if a character is matched, scans memory for the character that matches the one being held in the accumulator. It searches the 256 bytes above one of the pointer registers and skips the next 2 program bytes if a match is found. This is handy for searching an ASCII file for an end-of-line marker, usually a carriage-return code. Since the instruction uses indexed addressing, the pointer register will be left pointing to the next character after the end-of-line marker when the match is found; nothing could be more appropriate for processing the next line in a text file.

Another ASCII-oriented instruction (BND) tests the character present in the accumulator and converts it into its BCD equivalent, if there is one. If it is not a valid ASCII decimal numeral, then a conditional branch is executed to a user-supplied service routine. Word-processing applications can employ this instruction for doing ASCII-to-BCD conversion while simultaneously checking for valid decimal characters.

For multiprocessing, the ILD and DLD instructions are

especially useful. The former increments the contents of any memory location while the latter decrements, thus in effect performing a read-modify-write operation. In multiprocessor applications, several processors may perform these operations on the same flag (memory location) in order to determine the next task to be performed and/or which processor will execute it. In order to ensure that tasks are correctly assigned, the ILD and DLD instructions retain the bus throughout the complete read-modify-write period.

Multiplying fast

In applications that are number-intensive, the slow process of performing double-precision multiplication and division in software has been a bottleneck for 8-bit microcomputers. The series 70 processors have therefore been equipped with instructions that multiply and divide 16-bit integers directly. With a 4-megahertz clock, multiplying two 16-bit integers to obtain a 32-bit result can

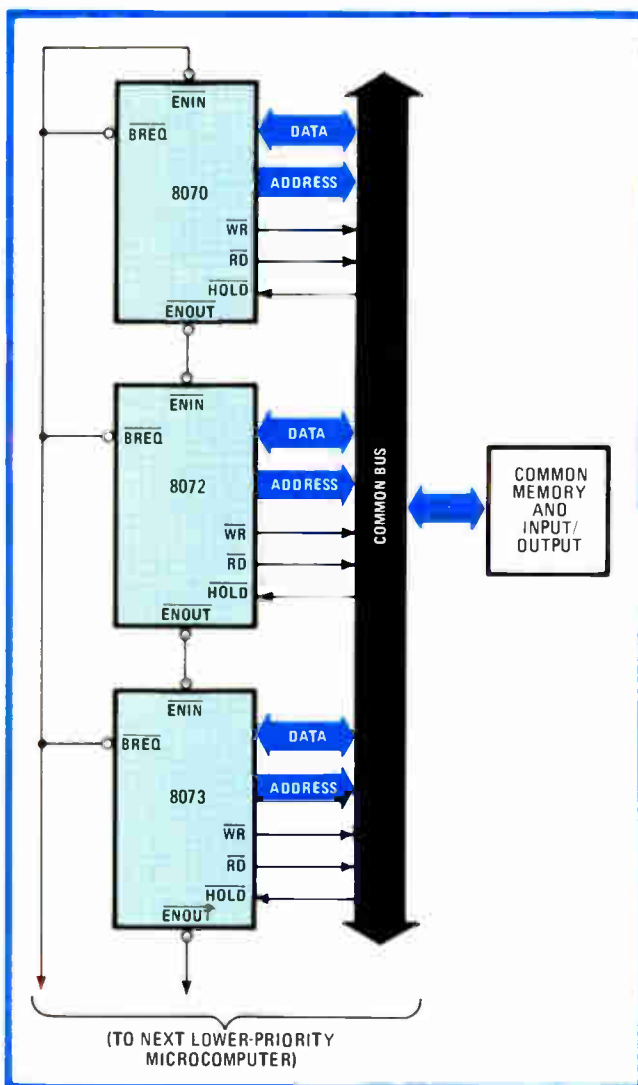

2. Multiprocessing made easy. Several series 70 microcomputers may be connected to a common external bus quite conveniently. Bus use priority is a hardwired function built into the chips and needing only a pull-up resistor on the bus request line. The enable outputs are daisy-chained to the enable inputs of the various processors.

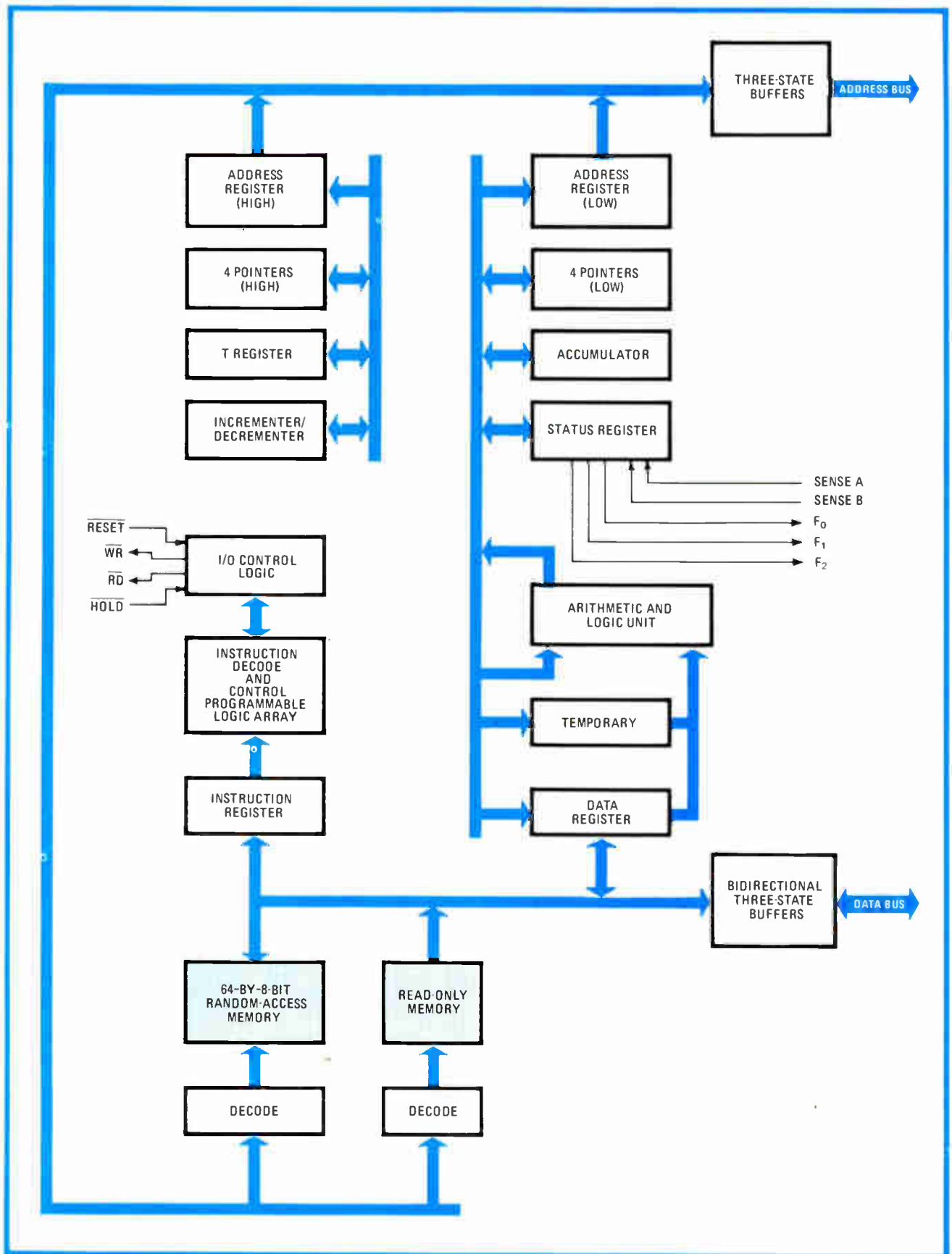

3. Architectural features. An 8-bit accumulator combines with an extension register for 16-bit operations; the temporary register assists with the multiply and divide instructions. Four 16-bit registers are supplied as well for convenient storage of addresses.

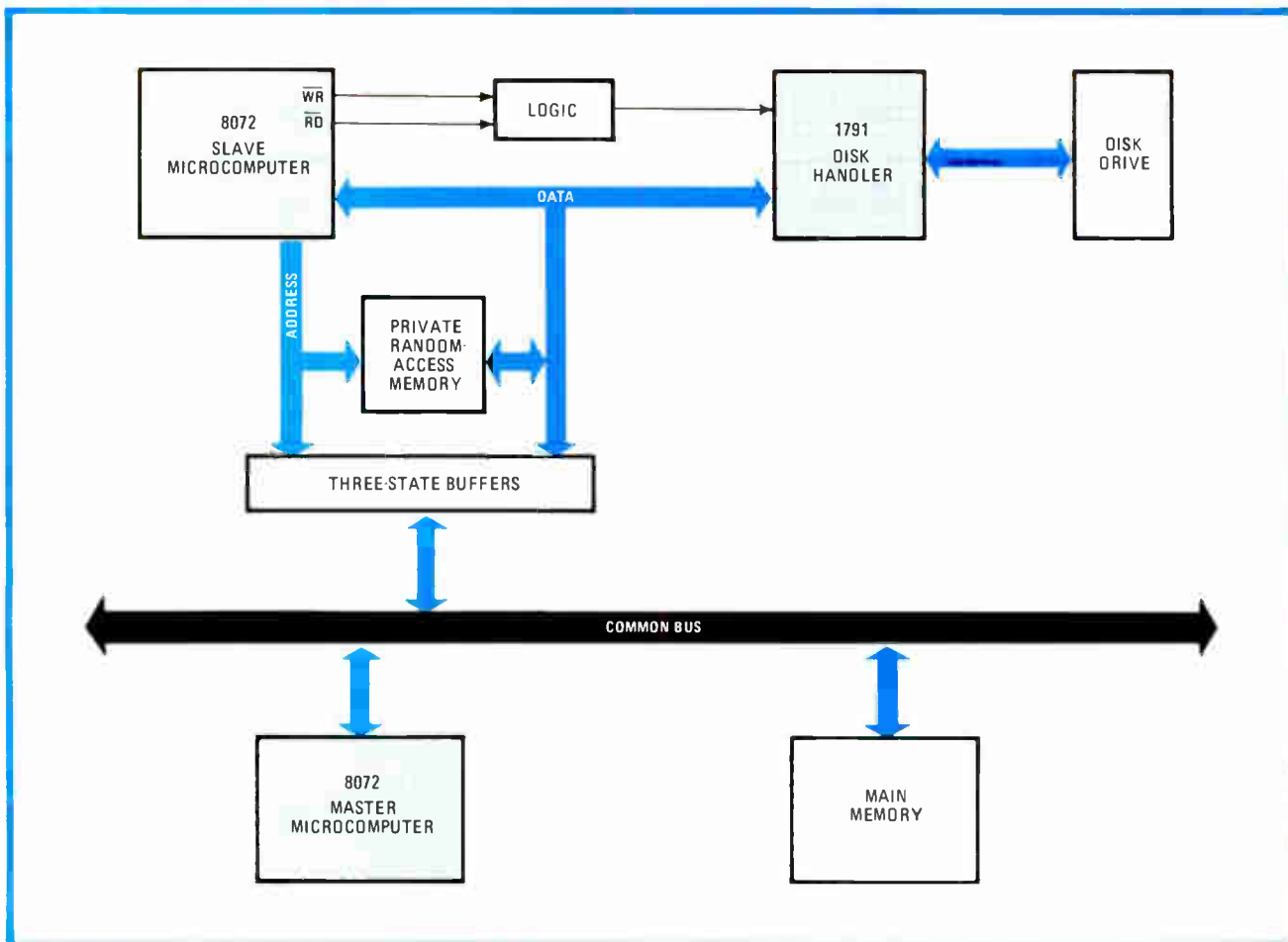

4. Smart slave. An intelligent disk controller may be formed by complementing the Western Digital 1791 disk handler with a series 70 microcomputer. The processor handles disk formatting, track and sector assignment, and file management, freeing the main processor.

be done in a fast 37 microseconds. A similar division takes 42 μ s. Such speeds are comparable with those of many 16-bit microprocessors.

The key to the high speed achieved by these processors lies in their use of a programmable logic array acting as the internal microprogram that specifies the cycles necessary to execute each instruction. The speed of a PLA is, for all practical purposes, independent of the complexity of the logic equation that it realizes. In contrast, the speed of random logic implementations is usually inversely proportional to the complexity of the logic equation realized. Comparatively, then, the PLA makes faster work of the complex operations that many of the instructions mentioned above perform.

Ordinarily with these parts, input/output is memory-mapped so that all processors may use the memory reference instructions to communicate with the common peripherals. However, serial I/O may be performed directly, without using the common bus, by utilizing the two input pins, sense A (SA) and sense B (SB), along with the three output pins (F_0 , F_1 , F_2). In this way private serial I/O channels can be readily implemented, under software control, to communicate with devices like teletypewriters, terminals, and modems.

The series 70 microcomputer family has been designed to be especially effective in applications where high-level

processing needs to be coupled with a low parts count. A case in point is a dumb terminal, which can be implemented with as few as 16 extra TTL packages. Intelligent terminals and personal computers need only the addition of external memory and mass storage interfaces.

Another application

In fact, another series 70 device could be used as an intelligent controller acting as a slave for the main processor. An intelligent floppy-disk controller, for example, can be economically designed by adding a Western Digital 1791 (Fig. 4). While the 1791 actually handles the floppy drive, the slave processor can be performing the necessary housekeeping tasks such as diskette formatting and track and sector assignment, as well as general file management. Since the main processor is free to execute programs and released from the need to handle interactions with the disk, and since data transfers between host and slave are being carried out through direct access to common memory, system throughput is greatly increased.

Stand-alone applications, such as home appliances, often require that the processor communicate with untrained human operators in a high-level English-type language. The large ROM of these processors (up to 2.5-K bytes) suits them to these applications as well. \square

Transistor probe simplifies solid-state gaussmeter

by Shanker Lal Agrawal and Rama Swarni
Banaras Hindu University, Department of Physics, Varanasi, India

As a result of the subatomic energy exchanges that take place in many semiconductors because of particle-wave interaction, the electrical characteristics of the unijunction-transistor oscillator can be significantly changed by an external magnetic field. This property makes the low-cost unijunction transistor ideal for use as a probe in a gaussmeter or other flux-measuring instrument. Although it is not as linear, is not as easily calibrated, and does not provide the readout precision of some of the more elegant designs,¹ this circuit is simpler, just as sensitive, and virtually as accurate.

As shown, the gaussmeter is based on the comparator technique, wherein the frequency of the relaxation oscillator-probe is matched against a reference whose nominal frequency is about 400 hertz. Both generate positive-going spikes, which are lengthened by the pulse-stretching 74121 one-shot multivibrators. The NAND gate serves as a digital comparator, turning off the light-emitting diode when frequency $f_1 = f_2$.

In operation, the frequency of the reference oscillator is adjusted by resistor R until f_2 equals the free-running (free-field) frequency of the probe. Placing the oscillator-probe within the field to be measured will cause its frequency to change; potentiometer R in the reference must then be adjusted until the difference between f_1 and f_2 is minimized. The change in resistance of R from its nominal position may then be related to the strength of the magnetic field with the aid of the unit's individual calibration curve, which is shown at the right side of the figure.

As for calibration, at least three standard magnets will

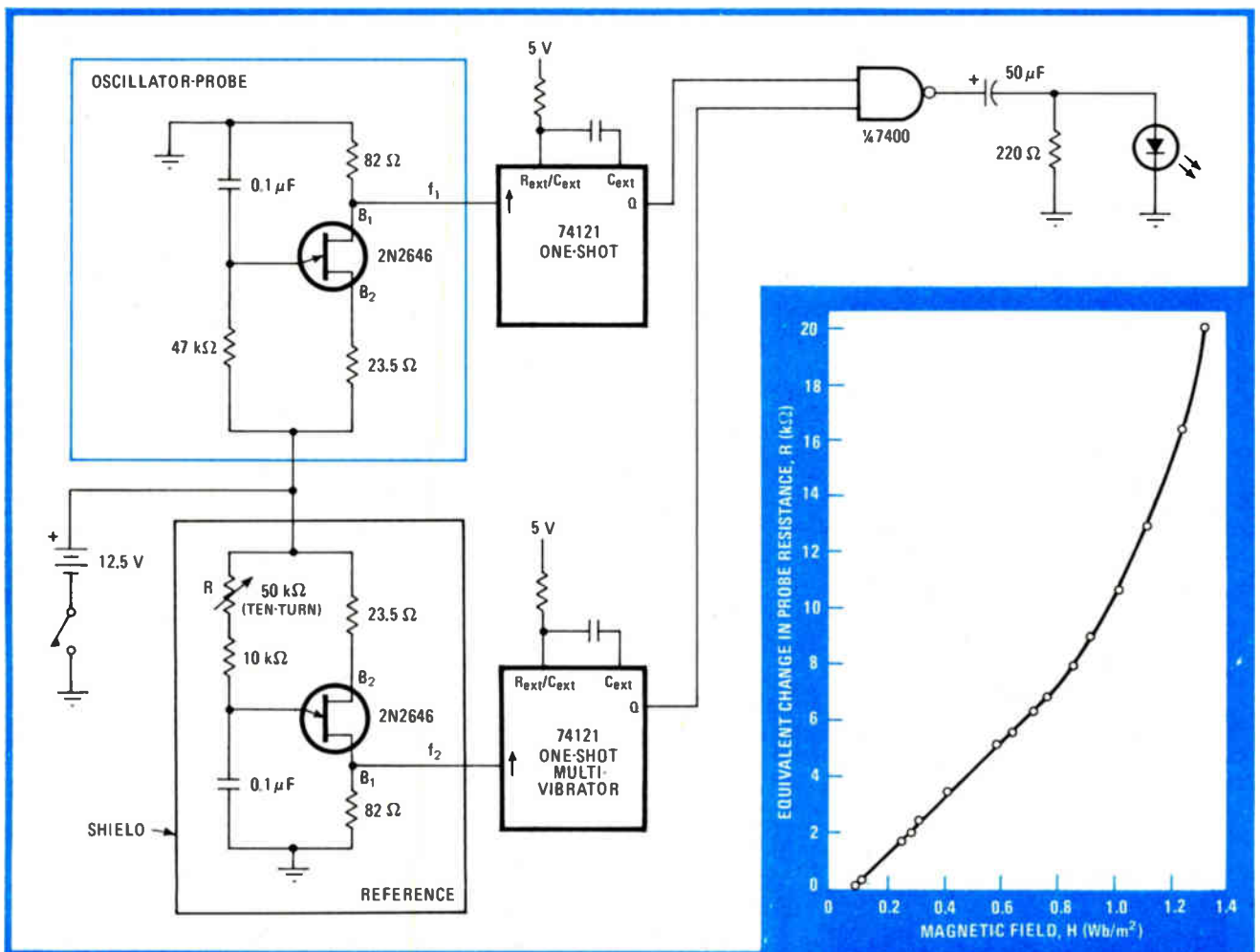

Flux finding. The low cost of the rudimentary unijunction transistor, which is sensitive to externally applied magnetic fields, makes it ideal for use in comparison-type gaussmeters. The circuit range is 0 to 1.5 Wb/m², with circuit response linear to 1.0 Wb/m².

be required over the range of 0 to 1.5 weber per square meter, which is the range of the instrument. The circuit response is not likely to be linear above 1.0 Wb/m², and depending on the particular UJT used, the standard-marker points will vary considerably as a function of R.

Still, the circuit will hold calibration and will serve well in most general-purpose applications. □

References

1. Henno Normet, "Hall-probe adapter converts DMM into gaussmeter," *Electronics*, Jan. 3, 1980, p. 179.

Appliance-controller interface aids the paralyzed

by David Rye
BSR (USA) Ltd., Blauvelt, N. Y.

The popular BSR System X-10 controller, which serves so well in home-security systems, can be easily adapted for use by the paralyzed with this interface, whose puff-and-sip switches enable the handicapped to turn on

appliances. Here, the switches are used to activate the desired output device via a stepped counter, instead of the push-button console normally required. Light-emitting diodes provide the visual feedback to the user.

The heart of the X-10 controller is BSR's 542C chip, which transmits a common-carrier code on the ac power line corresponding to the user-defined location of the desired appliance in the system, when it is appropriately addressed. The control signal is then decoded by plug-in modules connected to the individual appliances. This standard scheme is modified by adding circuitry to accommodate the sip switch, which is used to select the desired appliance, and the puff switch, which is used to

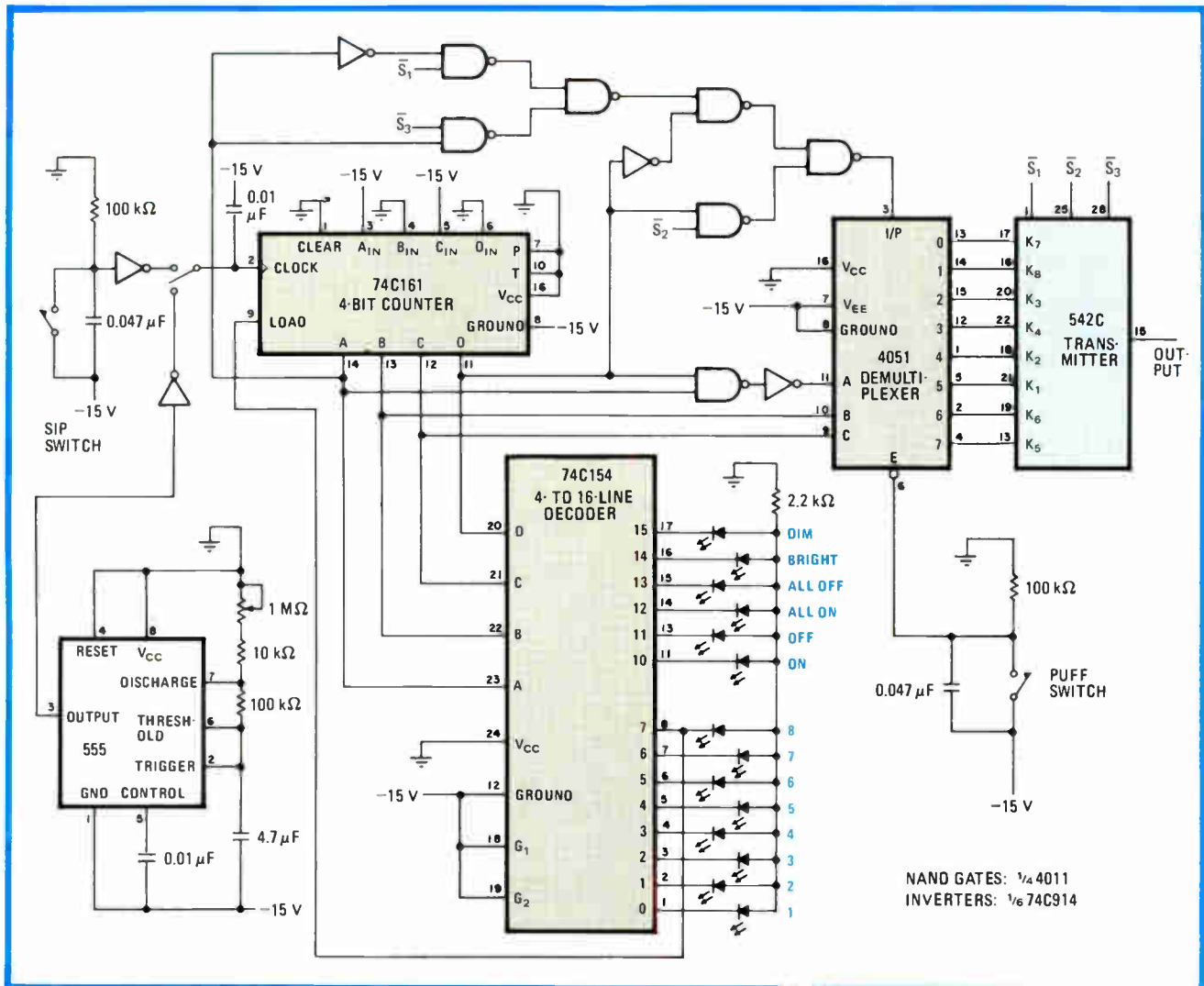

Handy. BSR X-10 controller, the heart of the Sears Home Control System, is easily adapted for the physically handicapped with interface that uses tongue-depress, head-activated, or sip and puff switches. Eight appliances can be activated. Eight additional commands provide all-on and all-off functions, light-dimming duties, and so on. Light-emitting diodes supply user with required visual feedback of controller's state.

TRUTH TABLE: CONTROLLER FOR USE BY THE MOTION-HANDICAPPED

Count	Counter				4051			4051 O/P	K	S	Code sent
	A	B	C	D	A	B	C				
0	0	0	0	0	0	0	0	0	K ₇	S ₁	1
1	1	0	0	0	0	0	0	0	K ₇	S ₃	2
2	0	1	0	0	0	1	0	2	K ₃	S ₁	3
3	1	1	0	0	0	1	0	2	K ₃	S ₃	4
4	0	0	1	0	0	0	1	4	K ₂	S ₁	5
5	1	0	1	0	0	0	1	4	K ₂	S ₃	6
6	0	1	1	0	0	1	1	6	K ₆	S ₁	7
7	1	1	1	0	0	1	1	6	K ₆	S ₃	8
8	0	0	0	1	0	0	0	0	K ₇	S ₂	*
9	1	0	0	1	1	0	0	1	K ₈	S ₂	*
10	0	1	0	1	0	1	0	2	K ₃	S ₂	on
11	1	1	0	1	1	1	0	3	K ₄	S ₂	off
12	0	0	1	1	0	0	1	4	K ₂	S ₂	all on
13	1	0	1	1	1	0	1	5	K ₁	S ₂	all off
14	0	1	1	1	0	1	1	6	K ₆	S ₂	bright
15	1	1	1	1	1	1	1	7	K ₅	S ₂	dim

transmit the corresponding code onto the power line.

The modification is made with the aid of a 74C161 4-bit counter for stepping and a 4051 demultiplexer for code selection, as shown. In this configuration, the address lines of the 4051 are controlled by the divide-by-16 counter, whose outputs step through a count of 0 to 7 twice in each 16-count cycle when advanced by the sip switch, which serves as a clock (see truth table). The eight K inputs of the 542C will therefore be selected in sequence, twice for each complete cycle of the counter. The circuit is wired so that numbers 1 to 8 corresponding to the numbered wall module are transmitted during the first eight clocked states of the counter. The D output of the counter is low at this time, and odd numbers are sent when S₁ is at logic 1. Even numbers occur during the time that S₃ = 1, meaning that S₁ or S₃ can be selected by the A output of the counter, which is high on odd counts and low on even counts.

Alternatively, the 555 timer can be used for the clock to yield automatic code selection. This eliminates the need for the sip switch, making the controller easier to operate. An external potentiometer is included to set the scanning speed to the user's preference and ability.

In either case, outputs 0 to 7 of the 4051 are enabled

in sequence. Note that each is connected to the K inputs of the 542C in such a manner as to ensure that the transmission of numbers is in the correct order. It is seen that the proper sequence can be transmitted by using the counter's A output to select S₁ or S₃, using the D output to disable the A input of the 4051 so that only even-number outputs on the multiplexer are enabled, and connecting the four even-numbered outputs to the appropriate K inputs of the 542C.

Eight additional functions can be sent on the second eight counts, including the off, on, all-off, all-on, bright, and dim commands. The D output of the counter is set high during this time. S₂ is selected when D = 1. Under this condition, the input to the 4051 is a binary number that steps from 0 to 7, and all its outputs will be enabled in sequence.

Note that during counts 8 and 9, the 542C transmits invalid codes. It is therefore suggested that these states be avoided. To achieve this, it is necessary to preset the counter to 10 after count 7 is decoded.

The 4-to-16-line decoder (74C154) monitors the state of the counter. Fourteen light-emitting diodes indicate the function addressed, thus providing the user with the necessary feedback information. □

Calculator notes

TI-59 inverts Laplace transforms for time-domain analysis

by Kin-chu Woo, Texas A&M University,
Department of Electrical Engineering, College Station, Texas

Performing quick mathematical inversion of Laplace transforms so that they may be instantly analyzed in the time domain, this short program will be highly useful to engineers engaged in network design. Many transforms

can thus be converted and evaluated, with the only restriction being that of the user's ability to express the terms with the limited set of key functions available.

Taking the given Laplace transform, F(s), the program finds the function's corresponding value for any specified time, t, from the following equation derived by Gaver:¹

$$f(t) = \frac{\ln 2}{t} \sum_{i=1}^{10} V_i F\left(\frac{\ln 2}{t} i\right)$$

where the set of V_i coefficients are constants, and it is assumed that f(t) is suitably bounded and well behaved.

As for the mechanics of introducing the functions,

Location	Code	Key	Location	Code	Key
000	76	*LBL	028	71	SBR
001	11	A	029	16	A'
002	35	1/x	030	65	X
003	65	X	031	73	RCL *Ind
004	53	(032	00	00
005	02	2	033	85	+
006	23	ln x	034	43	RCL
007	54)	035	12	12
008	95	=	036	54)
009	42	STO	037	42	STO
010	11	11	038	12	12
011	25	CLR	039	97	Dsz
012	42	STO	040	00	00
013	12	12	041	12	B
014	01	1	042	53	(
015	00	0	043	43	RCL
016	42	STO	044	12	12
017	00	00	045	65	X
018	76	*LBL	046	43	RCL
019	12	B	047	11	11
020	53	(048	54)
021	43	RCL	049	91	R/S
022	11	11	050	76	*LBL
023	65	X	051	16	A'
024	43	RCL	-	-	-
025	00	00	-	-	-
026	54)	-	-	-
027	53	(-	92	INV SBR

Registers	
R ₁	0.0833333333
R ₂	-32.08333333
R ₃	1279.000076
R ₄	-15623.66689
R ₅	84244.16946
R ₆	-236957.5129
R ₇	375911.6923
R ₈	-340071.6923
R ₉	164062.5128
R ₁₀	-32812.50256

Instructions

- Key in program and place equation coefficients V_i in registers 1-10
- Enter the desired Laplace transform in the program subroutine:
 $GTO \text{ *A' , LRN, (enter function), INV SBR, LRN}$
- Specify the time for which the function is to be evaluated:
 $(t), A$
 The calculator will display the corresponding value of the function.

EVALUATION OF $1/s^4 \leftrightarrow t^3/6$		
t (s)	True value (t function)	Calculated (s function)
1	0.1667	0.1657
2	1.3333	1.3254
3	4.5000	4.4732
4	10.6667	10.6030
5	20.8333	20.7090
6	36.0000	35.7852
7	57.1667	56.8256

strokes. For example, with $F(s) = (1/s^4)e^{-2/s}$, the exponential term is first entered with STO 13 ((RCL 13) × 0.5), 1/x, ±, INV ln x, X. Then, for the remainder of the function, ((RCL 13) √x), 1/x, =. Note that the programming of a function always begins with the variable s (specified by the program itself) and that it is usually advantageous to store it in a register (for example, STO 13), as shown.

Consider the simple example where the short-term output voltage of a network is given by $V_o(s) = 1/s^4$. This function can be simply expressed with the key sequence 1/x, x², x². Entering this sequence into the subroutine as instructed and specifying the times over which the function is to be evaluated yields the results shown in the table. The results compare favorably with the equivalent time-domain function, $t^3/6$. □

References

1. D. P. Gaver, "Observing Stochastic Processes and Approximate Transform Inversion," *Operational Research*, Vol. 14, No. 3, 1966, pp. 444-459.

Engineer's notebook is a regular feature in *Electronics*. We invite readers to submit original design shortcuts, calculation aids, measurement and test techniques, and other ideas for saving engineering time or cost. We'll pay \$50 for each item published.

Check out data encoding with new tests

Want to find out if your data-encryption chip is working properly? Unfortunately, it is not easy to know if something is going wrong, since determining if an encryption is as good as it might be is laborious. The National Bureau of Standards has come to the rescue, however, with **four readily applied in-service tests that are fast enough to test the chips in actual operation.** Send \$2 for Stock No. 003-003-02225-0 to the Superintendent of Documents, U. S. Government Printing Office, Washington, D. C. 20402. The 29-page publication tells how to make sure that unclassified data transmission is secure.

Keep your LCD warm

With winter coming, there's word that existing printed-circuit heaters can help protect liquid-crystal displays used in cold environments. With the heaters, for example, LCDs can replace mechanical counters and light-emitting-diode readouts in gasoline pumps. In fact, when the devices are placed behind the LCD, high-contrast digital readouts are possible at temperatures as low as -45°F . Only low voltage is needed, and the **etched-foil heaters consume a low 2 to 5 w.**

High-volume prices are approximately \$1 for heaters measuring 1 in. wide and 4 in. long. They are made from Kapton, silicon rubber, and neoprene dielectric material and can be applied to the LCD using pressure-sensitive adhesive or liquid adhesives. Alternatively, they can be simply held in place with a pressure mounting.

The heaters are designed to custom requirements and can be supplied with an integral thermistor for temperature sensing. Information can be obtained by writing Sierracin/Thermal Systems, 13920 South Broadway, Los Angeles, Calif. 90061, or calling (213) 321-4350.

Connector standard extended to 75 Ω

If you're a microwave or radio-frequency engineer concerned with the new generation of standard 14-mm rigid precision coaxial lines and associated hermaphroditic precision coaxial connectors, you'll want the new International Electrotechnical Commission standard on such devices. An updated version of IEC Publication 457-3 (originally issued in 1974 and covering only connectors with a characteristic impedance of 50 Ω), the latest edition has been extended to cover connectors of the same design but with a characteristic impedance of 75 Ω .

The standard describes mechanical, electrical, and environmental specifications of the 14-mm precision connector, the reflection coefficient and attenuation of which has to be measured up to 8.5 GHz for 50 Ω and to 9.5 GHz for 75 Ω . For a copy, write to the IEC at 1 rue de Varembe, 1211 Geneva 20, Switzerland. The 13-page document costs 18 Swiss francs.

Make a precision pot decision

A small but mighty slide rule offered gratis by Beckman Instruments' Helipot division **allows design engineers to select standard single-turn and multiturn potentiometers easily.** The desktop reference guide gives vital information on Beckman's standard line of pots, consisting of some 44 model numbers. Among the specifications included are number of turns, starting and running torque, resistance ranges, linearity, tolerance, power rating, ambient temperature ranges, and rotational load life. The slide rule also is an aid in comparing Beckman pots with those of the competition.

Write Beckman Instruments Inc., Helipot Division, 2500 Harbor Blvd., Fullerton, Calif. 92634, or phone (714) 773-8355. **-Harvey J. Hindin**

INFRARED

LOGICAL SOLUTIONS FROM TRW OPTRON

Do you need to convert manual, electromechanical, or pneumatic control of mechanical motion to a precision microprocessor based system? Or, do you want to simplify and reduce the cost of your sensing interface?

The logical solution to your design problem is TRW Optron's unique new family of photosensitive IC's with TTL compatible logic outputs. We call them PHOTOLOGIC™.

Direct Drive TTL

PHOTOLOGIC devices contain a monolithic IC which incorporates a photodiode, a linear amplifier, and a Schmitt Trigger. Capable of directly driving up to 8 TTL loads, PHOTOLOGIC features data rates of up to

250 KHz and typical output rise and fall times of 25 ns. Hysteresis is included on-chip for high noise immunity.

Family Available Now

PHOTOLOGIC devices are available now, in many different package styles and logic configurations including totem pole and open collector outputs. PHOTOLOGIC assemblies have optically matched GaAs emitters in either standard or custom mechanical configurations.

Optoelectronic Innovations

Look to TRW Optron for the optoelectronic IC innovations you have wished someone would make. We just might be working on them right now.

Broadest Range

TRW Optron has the broadest range of high performance infrared design solutions available to you when you need them. If your design requires the sensing of motion or precision switching, chances are we can save you time and money, out front and in the future.

Standard PHOTOLOGIC devices are available immediately from your local TRW Optron distributor. For your special PHOTOLOGIC solution call TRW Optron (214) 323-2200. TRW Optron, a division of TRW Inc., 1201 Tappan Circle, Carrollton, Texas 75006.

TRW OPTRON

Technological leadership.

The most advanced one- now user-programmable.

Motorola's new MC68701 is the user-programmable version of the industry's most advanced single-chip microcomputer in production today, the MC6801.

The MC68701 microcomputer has all the power, speed and design flexibility of the MC6801, and the original combination of on-chip functions, too. But where the MC6801 has mask-programmable ROM, the MC68701 provides 2K bytes of MCM2716-equivalent EPROM.

This on-chip EPROM adapts the MC68701 especially well for prototyping, because the control program is easily evaluated and changed during development. User programmability also makes the MC68701 ideal for low-volume systems where factory programming isn't practical, for initial production field test units of a user's system, and for systems that require reprogramming in the field.

Filling out the powerful complement of MC68701 on-chip functions are, of course, the high-efficiency, enhanced MC6800-type CPU, 128 bytes of RAM, 29 parallel I/O lines, a serial communications I/O port, a clock and a 16-bit programmable timer.

User-selectable operating modes.

The unique flexibility of the MC6801-MC68701 is rooted in the wide range of built-in, user-selectable operating and test modes. Among them are the three basic operating modes.

In the single-chip mode, all ports are configured for I/O—29 I/O and two control lines. The expanded multiplexed mode enables an impressive 64K-byte addressing capability. And, in the expanded non-multiplexed mode, no external logic is required to directly address 256 external locations, including any and all M6800 Family peripherals. Thirteen to 20 I/O lines are still available.

Additional modes permit testing and other special operations. In all modes, the 16-bit timer can count or time events and generate or measure pulses. The complete combination represents an unparalleled advance in design convenience.

The on-chip, fully-buffered Serial Communications Interface (SCI) offers operation at four baud

rates—full duplex asynchronous formats. The SCI operates at over 75K baud, and other special features—such as wake-up capability, NRZ and biphase—promote efficient multiprocessor system configuration.



chip microcomputer is Motorola's MC68701.

The MC6801-MC68701 CPU is an enhancement of the highly-capable MC6800 which puts seven addressing modes at the designer's disposal. An MC6800 machine-code-compatible instruction set is expanded by 16-bit instructions, including a $10 \mu\text{s}$ hardware multiply. Execution time of most instructions has been reduced by reducing the instruction cycle count to increase throughput.

Compare the MC6801-MC68701 to any other general-purpose, single-chip microcomputer for on-board functional capability, programming ease and system performance. We believe the MC6801-MC68701 can get you to market faster, with more competitive designs.

Total hardware, software and training support.

Motorola fully supports the MC6801-MC68701 in every way. The entire, fully-compatible M6800 Family provides a broad range of microcomponents and memories for system expandability. One of the highest VLSI production capabilities in the world and the Motorola training course curriculum back up the product. EXORciser® development systems and Motorola development software support all M6800 Family units, including MC6801-MC68701.

For additional information, contact your Motorola sales office or authorized distributor, or write to Motorola Semiconductor Products, Inc., P.O. Box 20912, Phoenix, AZ 85036.

Motorola's MC6801-MC68701 is the world's most versatile single-chip microcomputer, representative of Motorola's dedication to product excellence.

Innovative systems
through silicon.



MOTOROLA INC.

TO: Motorola Semiconductor Products Inc., P.O. Box 20912, Phoenix, AZ 85036.
87 E 10/9/80

Please send me information on MC68701.

Name _____

Title _____

Company _____

Address _____

City _____

State _____ ZIP _____

MC68701

Super D*



Rapid Solderless Termination 4-point Contacts Eliminate Wire Stripping.



Super D Adaptor System For D-type Connectors



Choose From Four Standard Super D Connector Sizes ... 9 (on left), 15, 25, and 37 (right) contacts.

Trademark IBM®

IBM Family
1200 104 4203, 1044 4208, 104
IBM Family Pricing

A unique all plastic snap-locking connector system that costs less and does more than standard D-Subs.

Here's Why Super D* is "The D With The Difference".

Different? You bet! TRW Cinch's all new Super D connector system has the exclusive design features and cost-saving benefits that move it to the top of any D-Sub line!

Let's begin with cost savings. Most D-sub's require soldering or crimping. Not Super D connectors. Our new pre-loaded pin/socket contacts provide solderless insulation displacement 4-point termination.

This unique contact also gives you twice as many contact points at mating end as other D-sub designs. All without wire prepping or stripping. Result? Immediate assembly time reduction and a positive cost savings with increased reliability!

But that's not all! Besides fast, solderless termination, Super D connectors also have snap-on plastic hoods that feature an exclusive Latch-N-Lock design for positive, audible locking with no additional tools, parts or labor. Just push to connect, squeeze and pull to disconnect. It's that easy!

To convert standard TRW Cinch D-sub's to the Super D system, ask us about our special adaptor system for D-type connectors.

Looking for style and design? Look no further! Super D's cost-effective all-plastic assembly is both smooth and functional to complement the styling of your computer, peripheral, data communication, instrumentation or video equipment.

This plastic design effectively insures against shock hazards.

Super D connectors employ *selective* gold plating only where it is needed. We've eliminated expensive gold from non-functioning surfaces. So you get performance without added cost.

The Super D connector is available in four sizes (9, 15, 25, and 37 contacts) for cable-to-cable and cable-to-panel modes. Each will intermate with existing D-type connectors. And, you'll be glad to know that the Super D system is designed to meet EIA Standard RS449 plus IS04902 and 4903 for your DTE and DCE equipment.

To further speed your termination time, TRW Cinch has designed three terminating tools specifically for the Super D connector system. Use Auto-Clinch D* for high volume; Certi-Clinch D* for moderate production and field installation; and Uni-Clinch D for field repair.

So take a long, hard look at the D-sub's you're using now. Then, take a look at Super D connectors. There is a big difference! To get the Super D difference, write or call your TRW Electronic Component Sales Office... listed in EEM, or TRW Cinch Connectors, A Division of TRW Inc., 1501 Morse Avenue, Elk Grove Village, IL 60007. 312/981-6000



TRW CINCH CONNECTORS

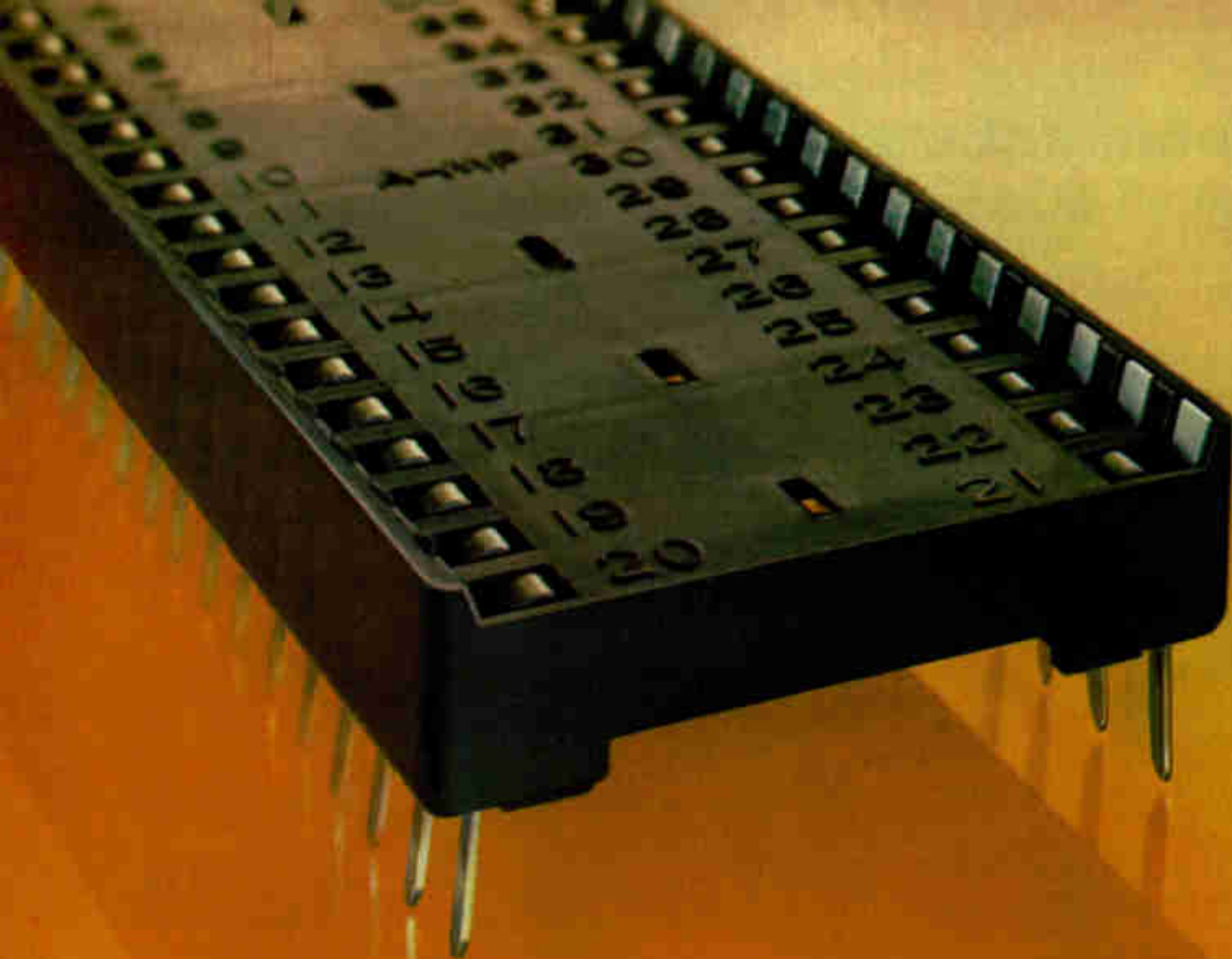

“For engineers who want all

AMP DIPLOMATE 175 Sockets feature:

- 8 to 40 position sizes
- reliable interconnect in tin or select-gold plate
- large entry target area
- dual wipe contacts
- internal contact anti-overstress stop wall
- closed bottom design
- compatibility with automatic insertion equipment
- immediate delivery via a computer-linked regional inventory system

For the delivery details or for more information, call the DIPLOMATE .175" Profile Socket Information Desk at (717) 780-8400. Or write us. AMP Incorporated, Harrisburg, PA 17105.

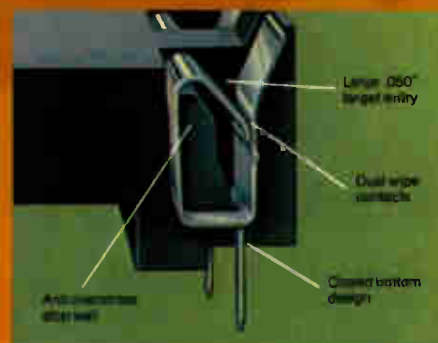

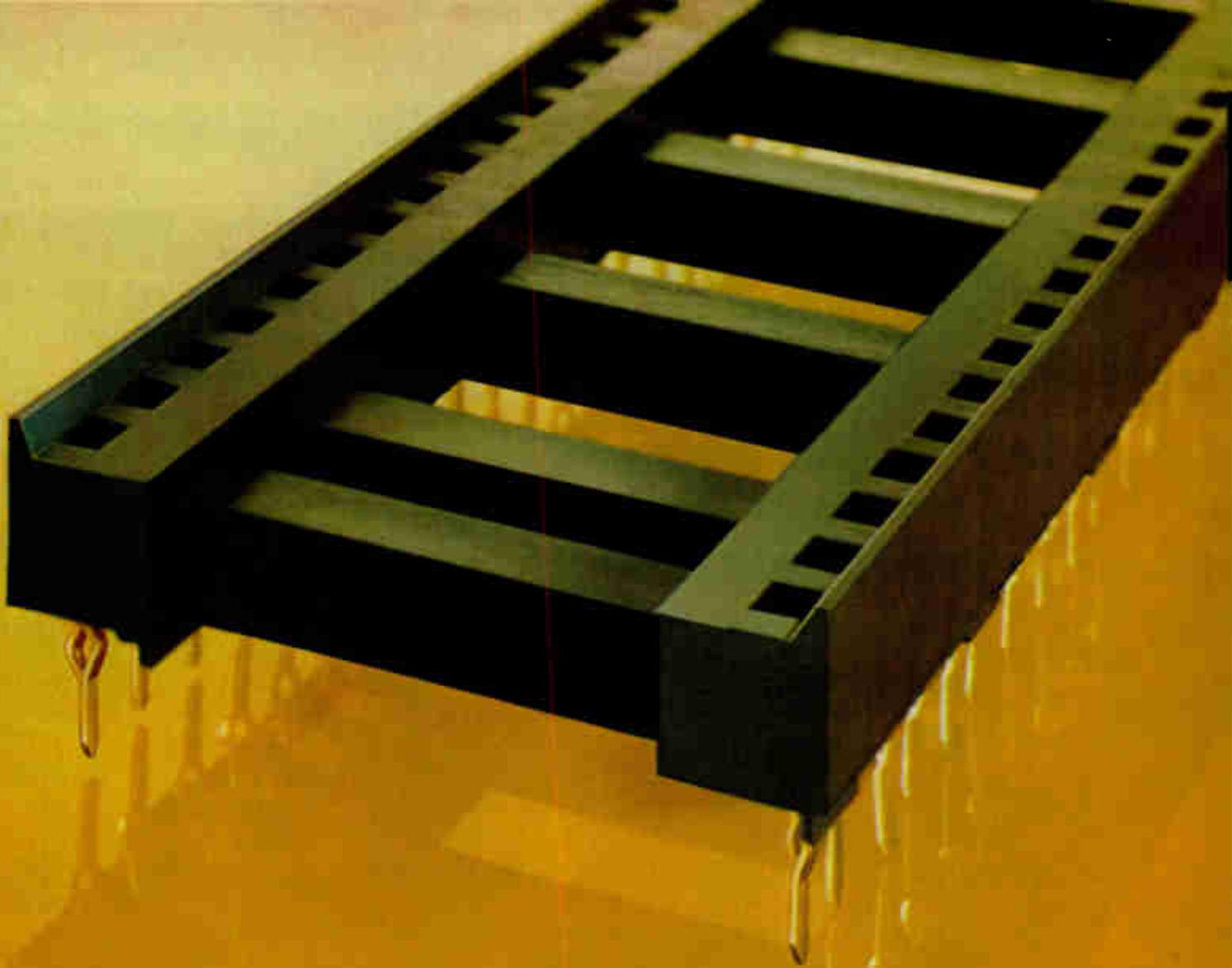

the best features-plus choice.”

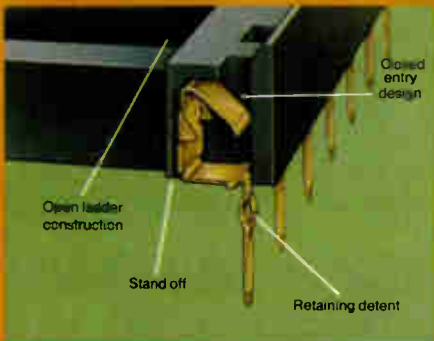

AMP 160 Sockets feature:

- 8 to 44 position sizes
- lowest economical profile available (.160 ins.)
- anti-wicking, anti-bridging contact design
- ladder housing construction
- tin or select-gold plated contacts
- single row versions for packages with non-standard spacings
- qualification to MIL-S 83734

For the delivery details or for more information, call the AMP .160" Profile Socket Information Desk at (717) 780-8400. Or write us. AMP Incorporated, Harrisburg, PA 17105.

AMP has a better way.

AMP

Circle 187 on reader service card



When Sheik Ahmad heard we were famous for our custom work, he asked us to hand-tailor 100 suits.

Sorry Sheik. It's custom MOS/LSI.

Hand-tailoring custom suits is a bit far afield for us. But tailoring MOS/LSI circuits for a customer's special needs — that's roughly half our business today.

Over the past couple of years, in fact, we've designed and built well over 100 different custom LSI circuits for America's leading companies. In every field, from data communications and computer peripherals to business machines, avionics and entertainment.

A leader in creating new MOS/LSI technology, we pioneered high performance n-channel silicon gate devices with our patented COPLAMOS® technology. We also introduced another technological breakthrough that's fast becoming a buzzword in the industry. It's called CLASP® which stands for COPLAMOS Last Stage Programmable.

With CLASP we can complete all of the wafer

processing steps including metalization before defining the bit pattern for read-only-memories.

Standard Microsystems provides a total capability. We design, develop, process, assemble and test state-of-the-art MOS/LSI circuits. That means we can design from scratch, or enter the custom cycle at any point you want. And assisting us at every step is the latest computer-aided design and diagnostic equipment.

So, whenever you have a need for custom LSI, come to Standard Microsystems. We can suit you. Perfectly.

STANDARD MICROSYSTEMS CORPORATION

35 Marcus Blvd., Hauppauge, N.Y. 11787
(516) 273-3100 TWX-510-227-8898

We keep ahead of our competition so you can keep ahead of yours.

Storage scope samples at 50 MHz

Special CCD helps digital oscilloscope achieve sampling rate without expensive high-speed analog-to-digital converter

by John Gosch, Frankfurt bureau manager

Many oscilloscope makers have beaten NV Philips Gloeilampenfabrieken to the punch with digital storage scopes, but the Dutch electronics giant is determined to make a virtue of its tardiness. By biding their time while the Philips components specialists developed their new scope's key element, a so-called profiled peristaltic charge-coupled device (P²CCD), designers at the Eindhoven-based Scientific and Industrial Equipment division have leapfrogged the competition with a dual-channel digital storage scope that offers higher performance at a lower price.

The PM 3310 has a sampling frequency of 50 MHz and an analog bandwidth of 60 MHz. Repetitive signals with frequencies up to the analog bandwidth limit can be stored, as well as single-shot events that occur at frequencies within the Nyquist-criterion limit. The scope will sell for about \$5,900 in the U. S., less than the price of other digital scopes with lower sampling rates.

The new instrument, from the division's Test and Measuring Equipment group, is being shown for the first time at Interkama, the international instrumentation and automation exhibition being held in Düsseldorf, West Germany, Oct. 9-15. It can be had in small quantities in Europe and the U. S. right after that event, "with larger numbers available early next year," says Rob van der Werf, the group's product manager for oscilloscopes.

The P²CCD used in the scope evolved from a purely experimental component in the Philips research labs a few years ago [*Electronics*,

Sept. 4, 1975, p. 53 or 5E] into a product ready for commercial use at the company's Electronic Components and Materials division. "This is another example of a development in one division having a stimulating effect on equipment design at another," van der Werf notes.

In a name. The P²CCD is called profiled because the charge-transfer layer includes an extra surface-transfer layer on top: a thin, heavily doped region over the less-doped bulk layer. Charge packets are transferred down the line in peristaltic movements reminiscent of the alternating waves of contraction and dilation that move food through the digestive tract—hence that part of the name. The P²CCD can operate at a higher clock rate and higher transfer efficiency than conventional charge-coupled devices.

The new device replaces the

expensive high-frequency analog-to-digital converters used in other storage oscilloscopes—converters that can cost as much as \$1,000. The P²CCD is effectively an analog shift register with a short transfer time and large charge-handling capacity. The signal is fed in as a high-frequency series of charges; it is read out at a much lower frequency, yielding a signal typically at 78 kHz. A low-cost, low-frequency a-d converter can then be used to change the signal into digital form for storage in solid-state memory. The contents of the memory are reconverted into analog form for display as discrete dots on the screen.

"The savings achieved by employing a P²CCD were partly passed on to the customer and partly used to provide the PM 3310 with some special features," van der Werf says. The instrument has a remote-control

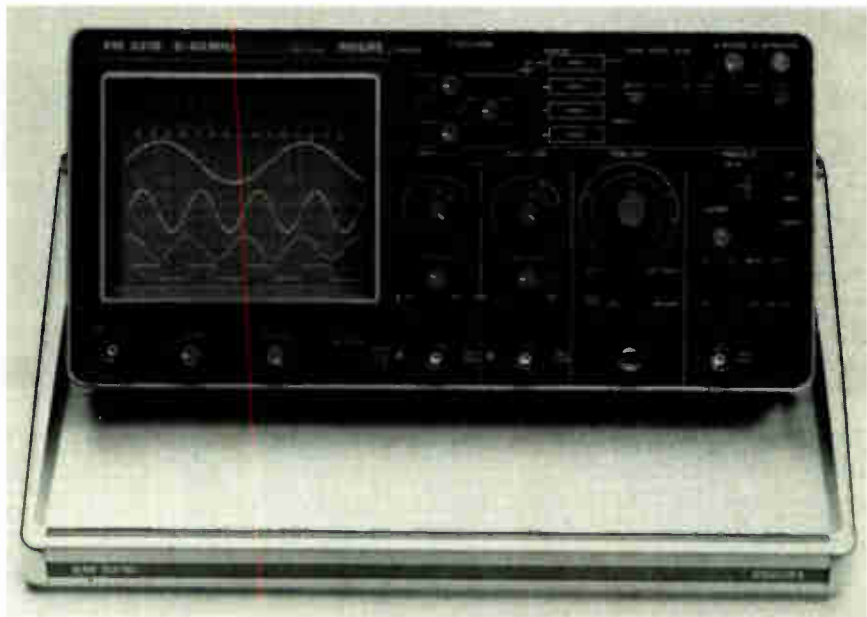

A PERFECT MATCH



Get the design advantage—match up with Triad. We manufacture one of the world's largest and most complete lines of transformers and related magnetic deflection components, both OEM and replacement. In all probability we can serve your needs from our vast parts inventory. But if your requirements are specialized, our professional team will custom design to your specifications.

Either way, you'll have the Triad advantage.



TRIAD-UTRAD
Litton Distributor Services

305 North Briant Street
Huntington, Indiana 46750
219-356-6500
TWX 801-331-1532

Circle 190 on reader service card

New products

facility, four separate 2-K (2,048-bit) banks of random-access memory for storing digitized waveforms, an output for X-Y and chart recorders, and pre- and post-triggering extending from -9 to +9,999 divisions. A roll mode for analyzing slow-moving phenomena allows samples to be taken every 0.2 s; at that rate, 40 hours' worth of data may be stored.

In addition to those of a conventional analog scope, the prime applications of the PM 3310 are in analyzing single-shot events that may be encountered in destructive tests and in investigating multiple-shot events like spikes occurring at unknown intervals in power supplies.

Single shots. The PM 3310 provides a good representation of single-shot signals up to 5 MHz with virtually no loss of information and a reasonably good representation of such signals up to 12.5 MHz with only a small loss of information. Single-shot bandwidths up to 25 MHz can be handled with computer analysis. The scope feeds the data via its IEEE-488 or IEC-625 bus interface to the data-processing system.

Either or both inputs to the dual-channel instrument are stored in the four memories as needed—by manually selecting the signal from the first accumulator memory for guarding in one of the other three or by automatic transfer in sequential fashion until all memories are filled.

The contents of all four memories can be displayed simultaneously, with each occupying one fourth of the 8-by-10-cm screen. The display is a 250-by-250-dot matrix for the content of each memory bank, or a 250-by-1,000-dot matrix (1,000 dots in the vertical dimension) for the whole screen. In the scope's dot-join mode, the dots are linked to give a continuous and clear display of the waveform.

Separate light-emitting-diode displays indicate the attenuator and time-base settings at the time of recording of each stored waveform.

NV Philips Gloeilampenfabrieken, Scientific & Industrial Equipment Division, TQ III-4, Eindhoven, the Netherlands [351]

Phillips Test and Measuring Instruments, 85 McKee Dr., Mahwah, N. J. 07430 [352]

Keeping you ahead of the pack...

You (and we) are in a quick-moving business. News breaks frequently. Change is the name of the game. Awareness is the way to win.

Give us one hour of your time every two weeks and we will keep you aware of what's going on around you and around the changing world of electronics technology.

Keep ahead of the pack. Send in one of the subscription cards in this issue.



Electronics Magazine

The 1800 series keeps expanding: Our new CMOS EPROM is another reason to consider RCA.

When it comes to low power consumption and low heat, no NMOS microprocessor line can match RCA's all-CMOS 1800 series.

Now, with our new UV-erasable EPROM, getting into CMOS microprocessing is easier than ever.

The new CDP 18U42 is a 256-word x 8 bit, static, asynchronous EPROM that interfaces directly with our 1802 microprocessor. Other benefits are low power dissipation

(20 mW typical), 5-second programming time (typical), and write erase endurance of more than 300 cycles.

Our new EPROM is supplied in a 24-pin, hermetic, dual-in-line ceramic package.

New databook.

The RCA COS/MOS Memories, Microprocessors,

and Support Systems databook, SSD-260. Price \$7 (optional distributor resale price).

Send check or money order to RCA Solid State, Box 3200, Somerville, N.J. 08876.

For more information on the CDP 18U42, contact your local RCA Solid State Distributor.

Or contact RCA Solid State headquarters in Somerville, New Jersey. Brussels, Belgium. Tokyo, Japan.

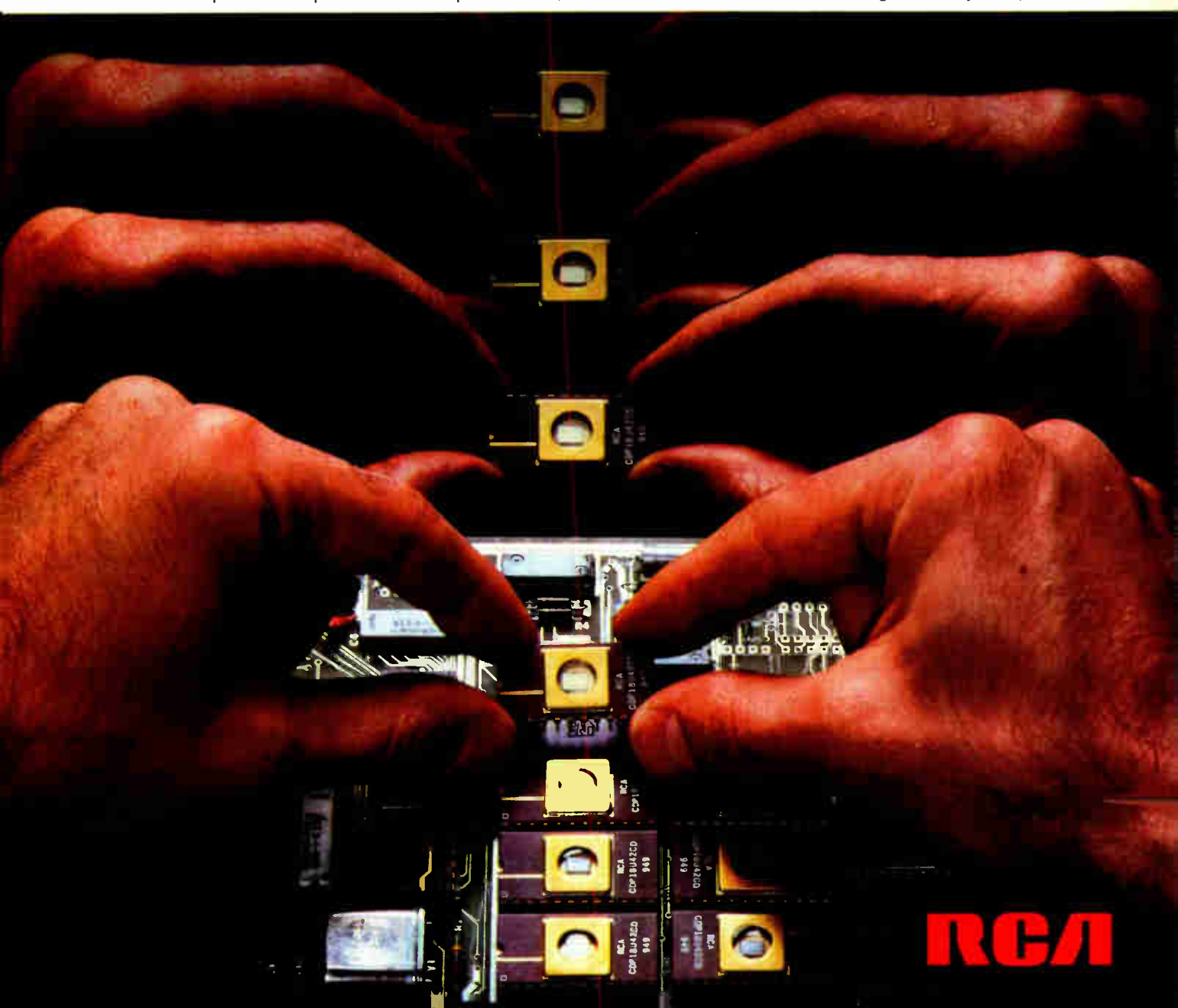

RCA

A man in a light blue dress shirt, a dark vest, and a striped tie is leaning on a black computer tower. He is looking directly at the camera with a slight smile. The background is dark and out of focus.

**A good OEM computer can be
easily tailored to your needs.**

The same goes for OEM service.

DEC service Agreement

Basic Service Agreement

Worldwide Service

Module Mailer

OEM Service Agreement

Self Maintenance

Software Consulting

Remote Diagnosis

Terminals Agreement

Educational Services

That's why we offer you so many different ways to buy it. Or offer it to your customers. Everything from our most comprehensive DECservice™ agreement that can provide service people on site 24 hours a day seven days a week, to training schools for your staff if you want to do all the maintenance yourself.

And this capability is supported worldwide by over 8,000 specialists and a field inventory of over \$250 million in spares.

You can take advantage of Remote Diagnosis if you're a large system user. Seventeen worldwide product repair centers. Module Mailers if you're into self-maintenance. We even have software specialists to help you with applications software development. And advice on the right product/service combinations for your market.

At Digital, our approach has always been to give OEMs more than just great product. Just as important are the extra quality features, the extra testing that can make your design and marketing job easier. The software compatibility that can take you from micros to 32-bit large-scale computers, from one generation to the next.

You probably already know a lot about Digital performance. To find out the rest, send for our new brochure, "The Thinking Behind the Industry's Largest Selling Line of OEM Computers."

Digital Equipment Corporation,
Technical OEM Group, 129 Parker St.
(PK3/M-86), Maynard, MA 01754. (617)
493-5997. In Europe: 12 av. des Morgines,
1213 Petit-Lancy/Geneva. Tel. 93 33 11. In
Canada: Digital Equipment of Canada, Ltd.

**We build a lot more than performance
into an OEM computer.**

digital

Microcomputer has 32-K ROM on chip

Fully pin- and op-code-compatible with the 8048, the single-chip 8050 has four times as much memory

by Bruce LeBoss, San Francisco regional bureau manager

The 8048 microcomputer has been a favorite with designers for several years, ever since Intel Corp. introduced the 8-bit chip with 1-K byte of read-only memory. Now National Semiconductor Corp. has built a version with four times the program and data memory, which is bound to dramatically reduce systems costs.

With the INS 8050, which carries 4-K bytes of masked ROM and 256 bytes of random-access memory, "complex applications requiring large amounts of program space can now be implemented on a single chip," claims Tom Dugan, the firm's product marketing manager for single-chip microcomputers. For such jobs, users would previously have had either to use multichip processors or add external ROM, RAM, and latches to their one-chip system.

Fabricated with National's propri-

etary X-MOS technology—a scaled-down n-channel MOS process with single polysilicon loads and 3- μ m spacing—the 8050 has a die 35% bigger than National's own 8048 design.

The 8050 is also a cost-effective alternative for multipattern 8048 users. It is possible, Dugan says, to put up to 10 8048 programs into one 8050, including routines for displays, keyboard controls, input/output, mathematics, and self-diagnosis. Thus when large production runs of the 8048 are not justified, the 8050 may be ordered in volume instead, and routines called up for specific market needs.

Many users have a lot of engineering time and money invested in 8048 software. Unlike Intel's recently introduced 8051, an extension of its MCS-48 family with 4-K bytes of

ROM and 128 bytes of RAM, the 8050 does not require a separate converter to use 8048 assembly source code; it is both operating-code- and pin-compatible with the 8048. In-circuit emulation of the 8050 is available on National's Starplex development system.

The 8050's 8-bit central processor has an internal register and stack array, three programmable 8-bit I/O ports, eight control and timing lines, a programmable counter/timer, priority interrupt controls, and a system clock generator. It can operate as a byte processor or a binary or binary-coded decimal arithmetic processor, with RAM and ROM independently addressable and expandable.

The 8050 executes one of the 96 instructions in its set in 2.5 μ s, typically, when operating at a 6-MHz clock rate. That is about half as fast as the 8051, which is tailored to higher-speed applications, executing most instructions in 1 μ s when using a 12-MHz clock. However, National does plan to have an 11-MHz version of the 8050 available by year's end. Operating off a single 5-V power supply, total supply current of the 8050 is 75 mA maximum, 25 mA typical, at 6 MHz.

Available from stock to 30 days after receipt of order, the 8050 is priced at approximately \$19 each in quantities of 1,000, packaged in a standard 40-pin dual in-line package. A version without ROM, designated the INS8040-6N, sells for \$21.55 each in lots of 100. Both are available in ceramic packages for approximately \$3 more each.

National Semiconductor Corp., 2900 Semiconductor Dr., Santa Clara, Calif. 95051 [338]

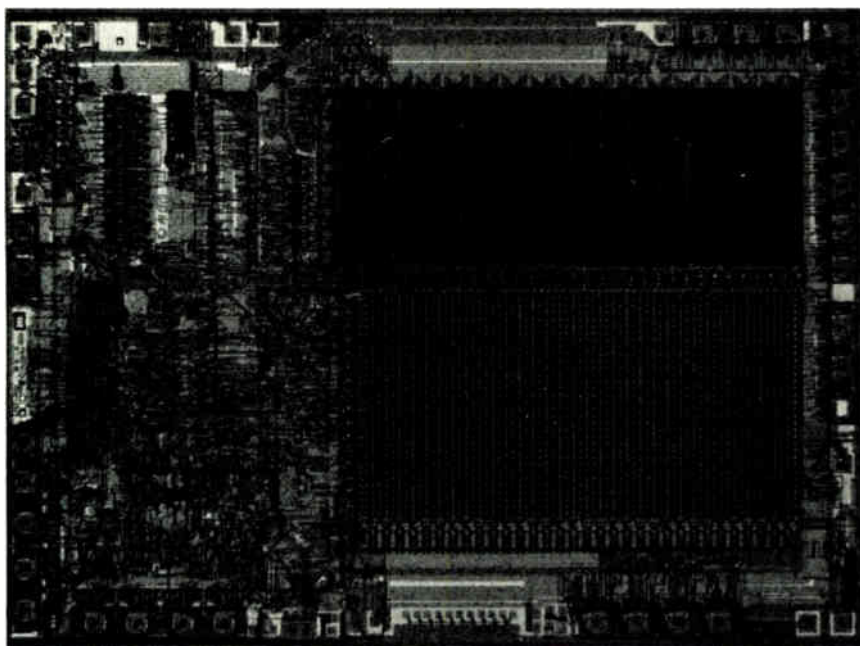

Buy now and get FREE Solid State Software™ Libraries.

TI Programmable 59 — \$300*

\$40
or more value
1 FREE module†
with purchase
of a TI-58C



\$98
or more value
2 FREE modules† &
PPX Membership
with purchase
of a TI-59

TI Programmable 58C — \$130*

Choose from these.



TI Programmables lead the field in performance, quality and value. When you're choosing a programmable calculator consider: Power. Total software support. Flexibility. And price/performance. You'll discover a clear-cut answer. A TI Programmable 58C or 59.

The TI-59 has up to 960 program steps or up to 100 memories. Magnetic card read/write capability lets you record your own custom programs or those received from PPX (Professional Program Exchange).

The TI-58C features up to 480 program steps or 60 memories. And it has TI's Constant Memory™ feature that retains data and program information even when the calcula-

tor is turned off.

And now free modules give you that added productivity you need. From August 15 to October 31, 1980 is your special opportunity to purchase one of the world's most advanced programmable calculators. And get a minimum of \$40 worth of free software modules with a TI-58C. Or, when you buy a TI-59, get a minimum of \$80 worth of software modules and an \$18 one-year membership in PPX. This will allow you to select up to 3 programs (from over 2,500) written by professionals in your field.

Visit your TI retailer for more information, and let him help you select the TI Programmable and free software that's right for you.

- I've bought a TI-58C, send me my free module. Here is my first choice and an alternate
- I've bought a TI-59, send me my two free modules and my membership (which entitles me to select three programs from the source catalog at no charge). Here are my module choices and an alternate

1 _____ 2 _____
3
Send to: TI Library Offer, P.O. Box 1984, Lubbock, TX 79408.

Return this coupon: (1) with customer information card (packed in box), (2) a dated copy of proof of purchase, between Aug 15 and Oct 31, 1980 — items must be post-marked by Nov 7, 1980

Name _____
Address _____
City _____ State _____ Zip _____ EL

Calculator Serial Number (from back of unit)
Please allow 30 days for delivery. Offer void where prohibited. Offer good in U.S. only.
TI reserves the right to substitute modules.

†U.S. suggested retail for all Libraries is \$40, except Farming, \$55, and Pool Water Analysis, \$45.
**For use with TI-59 only



Texas Instruments technology — bringing affordable electronics to your fingertips.

TEXAS INSTRUMENTS
INCORPORATED

*US suggested retail price.
© 1980 Texas Instruments Incorporated

45735

Circle 195 on reader service card

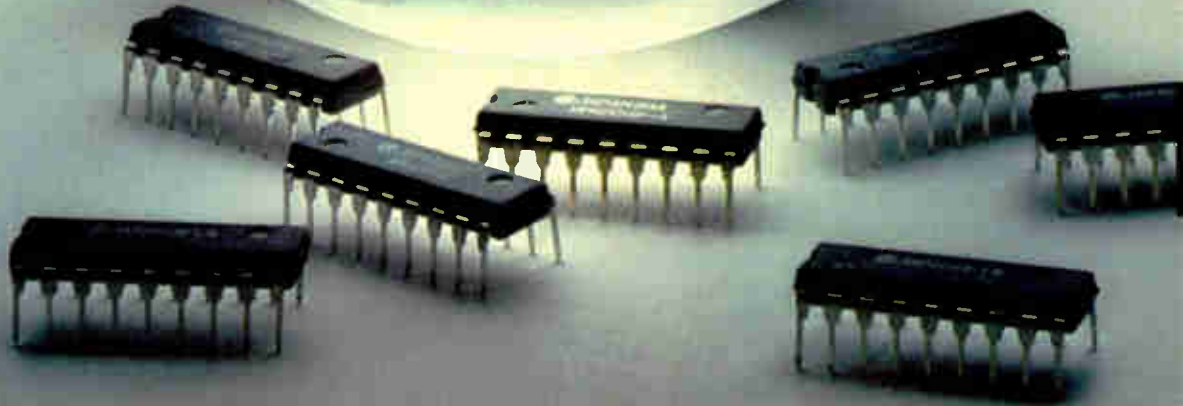

Regional Headquarters

Western

20430 Town Center Lane, Suite 5-F
Cupertino, CA 95014
(408) 255-8991
TWX 910-339-9502

Central

6200 Savoy Drive, Suite 704
Houston, TX 77035
(713) 974-0534
TWX 910-881-7043

Eastern

594 Morris Road, Suite 22
Livingston, MA 02173
(617) 861-1642
TWX 710-326-5413

Stocking Distributors:

Anthem • Bell • CAMTEC • Diarmid • Fuchs
Jaco • Maribel • Mgray • PC Components
Dade • TMI Electronics • Stirling
Time • Western Mass Technology

Hitachi's Just Made NMOS Obsolete With "HI-CMOS" Technology

"HI-CMOS" a technology so unique, it yields the high speeds of HMOS the high bit densities of NMOS at the low power dissipations of CMOS. This new technology permits us to produce our 16K, 120ns static memory in an all-new cost-effective plastic package today and allows plastic packaged 64K and 128K static RAMs for tomorrow. Hitachi has just made NMOS obsolete!

The bottom line unparalleled performance, plus the freedom of being able to design your system without the burden of costly cooling systems or

high current power supplies. And, all at a price that rivals NMOS cerdip RAMs.

The Hitachi commitment to advanced technology carries "HI-CMOS" still further with devices that can meet your design needs today and for years to come.

Compare the NMOS device you're now using with any Hitachi "HI-CMOS" RAM the difference is well worth your consideration.

Part No.	Organization	Speed	Typ. Operating Power	Max. Standby Power	Max. Power Down	Availability
HM 6116	2K x 8	120/150/200ns	200mW	60mW	0.5mW	Now
HM 6147	4K x 1	55/70/85ns	75mW	60mW	0.5mW	Now
HM 6148	1K x 4	55/70/85ns	150mW	60mW	0.5mW	Samples
HM 4334	1K x 4	300/450ns	20mW	5mW	0.5mW	Now
HM 4315	4K x 1	450ns	20mW	5mW	0.5mW	Now

Now that you know more about Hitachi "HI-CMOS" technology, don't let NMOS technology keep you behind. Call your local Hitachi representative or distributor sales office for complete information, or circle the reader service number below.



HITACHI

Hitachi America, Ltd. Electronic Devices Sales and Service Division
1800 Bering Drive, San Jose, CA 95112 (408) 292-6404

Symbol of Semiconductor Quality, Worldwide

In a look-alike field, Gordos and cooperation make the



It's true. Due to industry standard specifications and packaging, our products may look like their products. But when your company is setting industry standards of its own, an off-the-shelf product may not meet your needs.

Interface with Intelligence

This is where Gordos comes in — with the depth of experience and the

responsive attitude to deliver the right product, on time and on budget; and with a refreshing willingness to listen and to help solve new challenges in the relay, reed switch, and control field.

Call us. You'll find there are specific advantages to doing business with Gordos. Among them:

Broad standard line

Part of the applications engineering function is to know when a standard part will be adequate — and when it won't. With literally hundreds of standard models, our engineers can often meet your requirements from stock.

Unbiased assistance

In some cases, your application may require

engineering modifications or design services. With our expertise in both reed and optical devices, you and Gordos can make the best decision together.

Materials and process control

Gordos is a totally integrated manufacturer. We specify our own materials and

comes in subtle but important ways — such as special contact materials and higher insulation resistance needed in the automatic test equipment field. Our reputation for custom miniaturization and reliability in the medical field has made us the leading manufacturer of reed devices for today's heart pacemakers.

In-house thick film manufacturing

Gordos was the first solid state relay manufacturer to offer certain models with the higher reliability and cost advantages of hybrid thick film construction. Advanced laser technology allows tighter production tolerances; component values laser-trimmed to $\pm 0.3\%$. In harsh

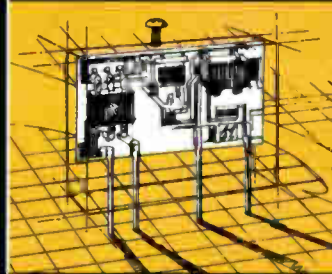

manufacture our own reed switches. The payoff to you



applications experience difference.

environments, thick film affords superior thermal properties, noise immunity,

specifications for the European market. In certain cases, this line of SSR products permits OEMs to eliminate expensive isolation transformers which were previously needed to comply with VDE requirements.

Computer interface systems

Gordos was one of the earliest developers of a plug compatible I/O module system. Newly available are buffered, bus compatible I/O boards to complete your signal and power level interface with the real world.

Distributor network

When one of our standard models will suffice, take advantage of immediate availability from your nearby Gordos Distributor.

and superior resistance to shock and vibration.

VDE compliance

Experience in thick film helped Gordos become the first U.S. manufacturer of relays and I/O modules to conform to VDE

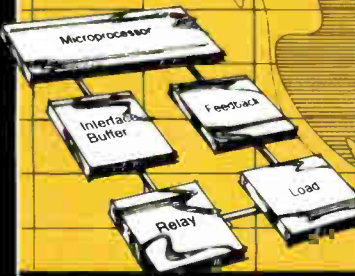

NAME _____ TITLE _____

COMPANY _____

ADDRESS _____

CITY/STATE/ZIP _____

PHONE (____) _____

MY APPLICATION IS _____

CHECK BOXES FOR BROCHURES DESIRED:

REED RELAYS DRY AND WET SWITCHES
250 GLENWOOD AVENUE, BLOOMFIELD, NJ 07003 USA • TWX 710 994-4787

REED COUPLED AND ALL SOLID STATE SSRs
 I/O SYSTEMS VDE SPEC SSRs
1000 N. SECOND STREET, ROGERS, AR 72756 USA • TWX 910 720-7998 E1 080

Quick-Response Coupon and Toll-Free Hotlines

Fill out the coupon, or simply attach your letterhead or business card and mail to the appropriate address. Or use our Toll-Free Hotlines for applications and ordering assistance.

CALL TOLL-FREE

Reed Relays
Dry and Wet Switches:
1-800-526-1392
In New Jersey 201 743-6800

SSRs and I/O Systems:
1-800-643-3500
In Arkansas 501 636-5000

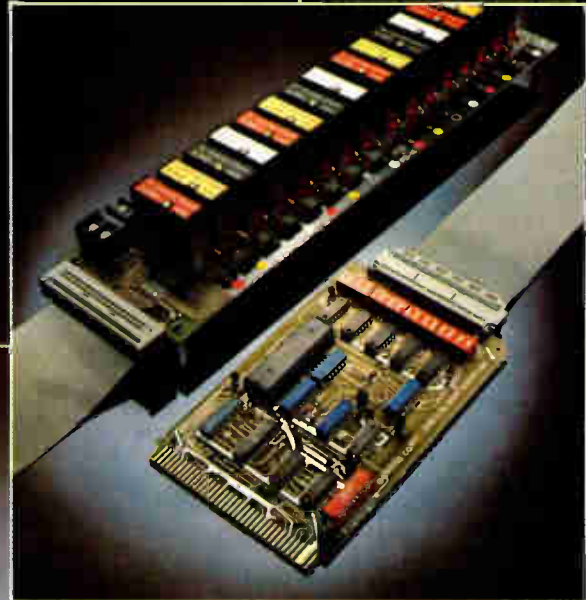
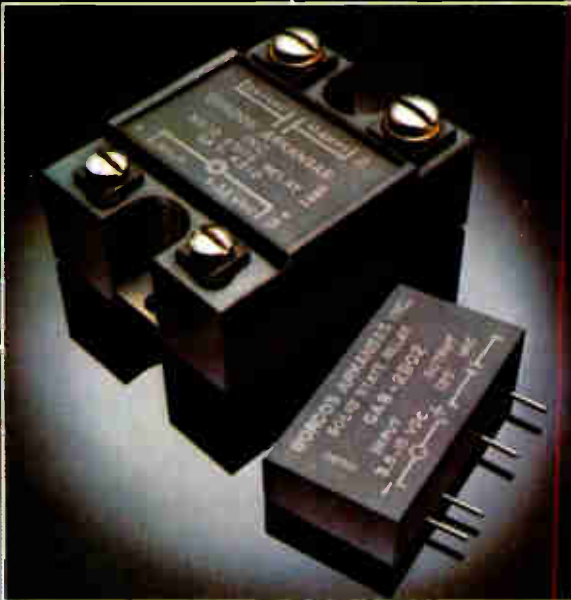

Interface with Intelligence



DRESSED FOR SUCCESS.



SUCCESSFUL FRONT PANELS DRESS IN DIALIGHT.

Even the most demanding industrial designer or design engineer will occasionally take switches, indicators and optoelectronics for granted. That's a mistake. Because they are often the first components people see and the ones they use most frequently.

That's why so many designers insist on Dialight standard products and custom designs. They know that precision Dialight products will give their computer, machine or instrument the look and feel of quality.



Choose from over 1,500,000 indicator lights.

Dialight is the world's largest manufacturer of incandescent, neon and LED indicator lights. For over 40 years we've introduced new sizes, styles and colors.

So there's a good chance our collection includes exactly the light you need. If it doesn't, we'll be happy to work with you on an original. After all, we didn't create over a million different designs by refusing special orders.



Rockers and toggles for panel and PC board mounting.

Dialight meets your needs for miniature switches with thousands of different designs in rockers, toggles and levers. All are 100% tested and made in the U.S.A.

Our rocker and toggle line contains a wide selection of actuators,

terminations, mountings and contact ratings. Included are dozens of styles for mounting on front panels and sub-panels as well as styles for snap-in and printed circuit board applications.

If our catalog doesn't show exactly the switch you need, we'll design and build it to order. All it takes is a call to our Applications Engineering department.



100% testing of every illuminated switch.

Dialight offers a complete line of computer-grade illuminated switches at reasonable cost. And to make sure they all work perfectly, we test every switch both electrically and mechanically before it's shipped.

Other switch suppliers may settle for sample testing. That's like leaving reliability to chance. You don't take chances with your designs, and we never will with our illuminated switches.

Depend on Dialight to supply exactly the switch you need, either from our catalog or on special order. Since we manufacture the entire assembly ourselves, we can respond faster and still maintain complete quality control.



LEDs ready to mount on panels and printed circuit boards.

When it comes to optoelectronics, once again Dialight offers a wide

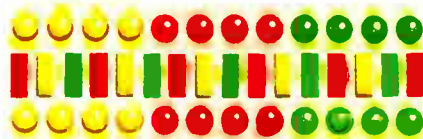

selection plus many unique advantages. For example, we now package LED indicators singly and in arrays for mounting on PC boards. As soon as you insert them into the board, they're precisely positioned and ready for wave soldering. Installation is far faster. And production costs are dramatically reduced.

For front-panel LED readouts, we package 7-segment displays with their associated decoder-driver circuitry and mounting bezel. The entire assembly, with as many digits as you need, is ready for instant panel mounting.

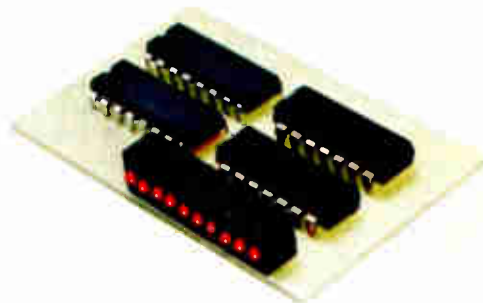

Dress your products for success.

Your products never get a second chance to make a good first impression. So send them into the marketplace looking their best. Dress all your front panels and PC boards in quality indicator lights, rockers and toggles, illuminated switches and optoelectronics from Dialight.

Dialight, 203 Harrison Place, Brooklyn, New York 11237. Phone: (212) 497-7600.

**DESIGN IN
DIALIGHT**
A North American Philips company.

16-K MOS ROM accesses in 80 ns

Read-only memories made with selective-oxidation process
are as fast as bipolar PROMs but use less power

by Bruce LeBoss, San Francisco regional bureau manager

Makers of MOS random-access memory have been able to challenge the performance of their bipolar counterparts with high-performance MOS technology. Now Intersil is applying its H-MOS technology to read-only memories, reducing cell size and improving performance.

Two basic ROMs, available in 1-K-by-8-bit and 2-K-by-8-bit configurations and designated the 82HM181 and 82HM191, respectively, are fabricated using the company's Selox selective-oxidation arsenic-diffusion process, which has a single layer of polysilicon and 3- μ m geometries. With it, the company can "provide ROMs that operate at sub-100-ns access times, equivalent to that of industry-standard bipolar PROMs," while using "only 75% of the power," claims Bob Gardner, director of product marketing for large-scale integrated digital products.

Whereas the standard 82HM181 has an access time of 70 ns when

operating off a 5-v \pm 5% power supply at 175 mA, the standard 82HM191 accesses in 80 ns maximum when operating at those voltage and current levels. Each of the 24-pin devices consumes a maximum of 965 mW. The inputs and three-state outputs of the ROMs are TTL-compatible and, Gardner notes, allow direct interfacing with common bus structures. Three chip-select inputs ease memory expansion.

Using the Selox process, Gardner claims, the MOS ROMs have a 50% smaller die area than their bipolar counterparts. The reduced size contributes to high-speed performance and results in "close to an order of magnitude improvement in yields." That is largely because the Selox H-MOS process reduces, by about one fourth, the number of mask steps used in producing bipolar programmable ROMs and, he adds, "because we are able to avoid the tough front-end [epitaxial growth] and back-end

[metalization] problems normally associated with bipolar processing."

The yield improvements have led Intersil to offer the H-MOS ROMs at approximately 10% to 20% less than equivalent bipolar PROMs. For example, the 82HM181 and 82HM191 will be priced under \$10 each and under \$40 each, respectively, in lots of 10,000, when all are to be delivered over a 120-day period with at least 2,000 pieces per code mask.

However, "the total cost savings to the user will be on the order of 30%," Gardner says, because a PROM needs to be tested and programmed, among other things. With a ROM, "the user has got a finished part that's programmed, marked, and burned in where appropriate, ready to use in his equipment," he points out. In large-volume applications, for which the H-MOS ROMs are tailored, the user gets a part that "falls right into a bipolar socket." Faster turn-around times are possible when reordering ROM code.

Intersil also plans to offer an 82HM141, a 4-K (512-by-8-bit) version of the 82HM181. Eventually, it will also produce the 82HM185, a 2-K-by-4-bit ROM, and the 82HM137, a 1-K-by-4-bit part as fallout from the 16-K ROM. Later, "we will produce 32-K [4-K-by-8-bit] and 64-K [8-K-by-8-bit] versions of those parts," says Gardner.

The availability of both the 82HM181 and 82HM191 is 8 weeks for prototypes, 16 weeks for production quantities, with reorders expected to slip to about 6 weeks by the second quarter of 1981.

Intersil Inc., 10710 N. Tantau Ave., Cupertino, Calif. 95014. Phone (408) 996-5000 [339]

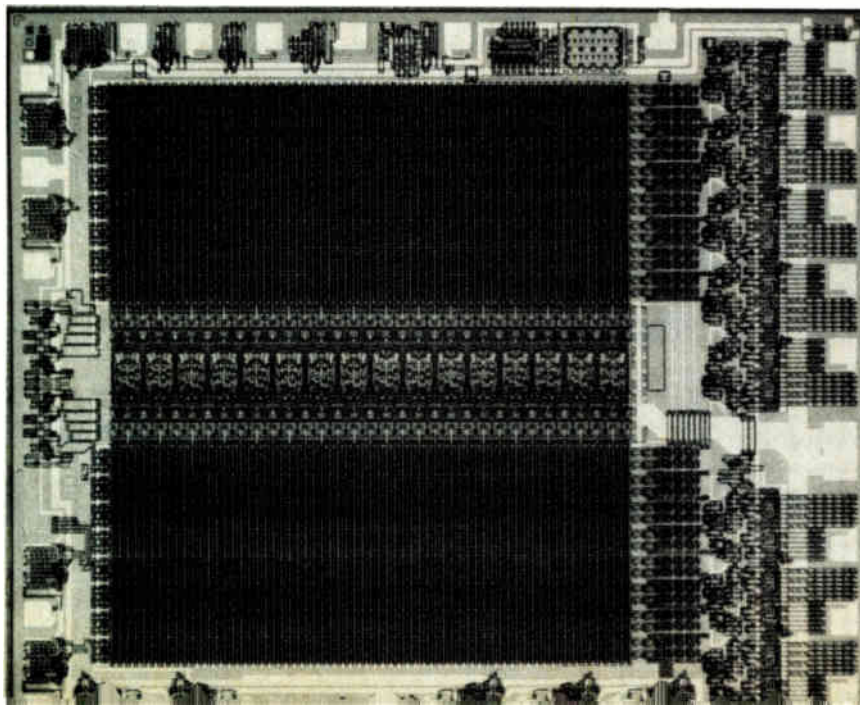

Hand-held computer power is here!

An autoranging DMM breakthrough from B&K-PRECISION.

B&K-PRECISION's new microcomputer controlled Model 2845 is a major advance in digital multimeter technology. At a price comparable to ordinary manually operated units the 2845 brings microcomputer intelligence to a handheld portable DMM. When applied to a circuit, its computer selects the range providing maximum resolution without the slow "hunting" action characteristic of many bench-type autoranging DMM's.

The 2845 is certainly the most user oriented hand-held DMM available. No other DMM can match its speed and simplicity of operation. With tilt stand, large display and optional AC power adapter, it becomes a remarkable inexpensive bench DMM.

- Microcomputer autoranging speeds operation and stabilizes readings
- Auto-skip program for best resolution in least time
- Easiest, fastest-to-use DMM available
- 0.1% basic DC accuracy
- 3½ digit, 0.5" LCD display
- Continuity test "beeper"
- Range-lock, holds selected range
- Measures AC/DC voltage; AC/DC current; resistance
- Meets tough U.L. 1244 safety standards

For immediate delivery, contact your local distributor or phone toll-free 800-621-4627 (except in Illinois) for detailed technical information.

BK PRECISION
DYNASCAN
CORPORATION

6460 West Cortland Street
Chicago, Illinois 60635 • 312/889-9087

Intl. Sls., 6460 W. Cortland St., Chicago, IL 60635
Canadian Sales: Atlas Electronics, Ontario

Model 2845 \$175

Circle #202 for free Demonstration
Circle #203 for Additional Information



Flying an aircraft is an exacting job HUD will help

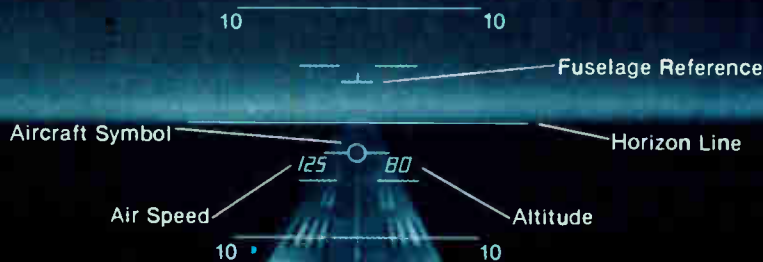

We supply deflection yokes to the major manufacturers of Head-up (HUD) display systems for aircraft, including the DC-9 Super 80. These displays enable pilots to focus attention straight ahead, and to see computerized flight information without looking away toward indicators and digital readouts for

airspeed, fuel consumption, altitude, etc.

Syntronic also designs and makes precision yokes and focus coils for navigation systems, weather radar, weapon systems and other CRTs used on most aircraft flying today.



Precision yokes for exacting displays

Syntronic Instruments, Inc., 100 Industrial Road, Addison, IL 60101 (312) 543-6444



Head-up display with flight symbols and digital information ...

Is visible to pilot through half-silvered mirror ...

from CRT display below pilot's field of view ...

Syntronic yoke provides sharp resolution at high brightness.

Circle 204 on reader service card

New evidence of precision from Switzerland



According to the legend, our national hero William Tell pierced an apple with his crossbow at 100 paces. Since then we have devoted ourselves to precision. We carry on these traditions even with new technology. Take our printed circuits for instance – they are a typical Swiss product. Repeatedly we offer drilling diameters having a precision of 0.22 mm – and that with a packing density of 4.7 connections per qcm.

Alongside this dimensional work, we offer additional quality features such as electrically protected circuit paths with defined values, prevention of solder bridging, no blockages in the metal plating, solderability in each required direction, etc. etc. Request further information.

electronica 80
Hall 16
Stand 16043

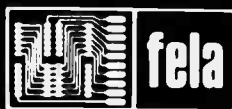

FELA E. Uhlmann,
AG for Printed Circuits
CH-8531 Thundorf/Switzerland
Tel. 054/982 71 · Telex 76 130

Marketing office in Germany:
D-7750 Konstanz
Gottlieb-Daimler-Str. 7



“You may be wondering why I called you all together.”

The business of manufacturing electronics can run you around the clock and all over the globe, taking you to meeting after meeting with marketing and support personnel, systems engineers and plant managers.

Bell can help manage one of your company's most important resources—your time. We do it by bringing many of those meetings to wherever you are. Electronically.

This is information management by teleconferencing—increasing profitability by improving productivity, conserving energy, controlling travel expenses. Participation is encouraged by a range of sophisticated voice, visual and facsimile systems.

The conference call is teleconferencing at its simplest. Conference calls can be enhanced by a speakerphone or portable conference telephone. Our innovative Gemini[®] 100 electronic blackboard can project visual representations to any group with a TV monitor. And Picturephone[®] meeting service,* the ultimate in teleconferencing, allows face-to-face meetings between groups in different cities.

Consider teleconferencing in the light of today's soaring costs and tight energy situation.

Consider, too, how our knowledge of advanced communications technology can answer still other information management needs in the electronics manufacturing business.

The process starts with one call to your Bell Account Executive.

The knowledge business



Microcomputers & systems

C-MOS 8048 uses 10 mA at 6 MHz

Power-saving NEC version needs only 1 mA when halted, operates at -40° to $+85^{\circ}\text{C}$

Although the chip remains essentially nonexistent, many circuit design engineers nonetheless know what an 80C48 is: a complementary-MOS version of the popular and widely sourced 8048 single-chip microcomputer. The designation is familiar because at least two U.S. semiconductor companies have promised C-MOS 8048s. But they have so far been unable to muster production volumes. Now Japan's Nippon Electric is crashing into that market with its $\mu\text{PD80C48}$, a part that it will ship in quantity by year's end.

Architecturally, the C-MOS counterpart is nearly identical to the original n-channel MOS microcomputer with its 8-bit central processing unit, 1-K byte of read-only memory, 64-byte random-access memory, and 27 input/output lines. Also like the n-channel device, the 80C48 features an internal timer/event counter, two interrupt modes, over 90 instructions, and bus compatibility with the wealth of peripheral chips that have

been designed for the 8080 and 8085 microprocessors.

But, of course, the key difference here is power consumption. Of the three new high-performance MOS, or H-MOS, cousins of the 8048 recently introduced by the originator of the part, Intel Corp., the lowest-power version—the 8048L—draws an active current of 40 mA at 3 MHz and just 4 mA on standby—admirable for n-MOS.

However, NEC's chip draws a maximum of 10 mA at a full 6 MHz. Through an added halt instruction (01₁₆), this can be taken to 1 mA. "In addition, for further power conservation, there is a stop mode," beams Dwain Aidala, manager of the product at NEC Microcomputers Inc., the Wellesley, Mass., marketing and sales connection for NEC in the U.S.

Upon reaching the halt instruction, the $\mu\text{PD80C48}$ keeps its on-chip oscillator running but denies clocking to internal logic. Either the interrupt or the reset pin on the 40-pin package can be lowered to bring the chip out of its halted state. The stop mode is initiated by reducing the supply voltage to the chip to about 2 V. This anesthetizes all but the RAM. Restoring 5 V on the supply pin will rouse the oscillator, and after a short stabilization period a reset will restart program execution at address zero. The block diagram depicts the standby control logic.

Besides being power-conscious, the C-MOS microcomputer offers

other benefits. The clock can be slowed right down to dc, unlike the n-channel chip, which "will go down to a little under 1 MHz," Aidala comments. The 80C48 also operates at -40° to $+85^{\circ}\text{C}$, compared with the 8048's 0° to 70°C .

Like the n-MOS 8048, the $\mu\text{PD80C48}$ carries a ROM-masking fee. It is \$1,000. For this reason, development versions of the chip have become important. So NEC will also produce, in C-MOS, the ROM-less version of the chip, the $\mu\text{PD80C35}$, and the erasable programmable ROM version, the 87C48, is also planned, says Aidala, adding that there is no reason why development cannot be done on an n-MOS 8035 or 8748.

Pricing is not yet firm, but Aidala expects the unit price to be below \$20 in 1,000-piece lots. Orders will be taken in December for 12- to 14-week deliveries.

NEC Microcomputers Inc., 173 Worcester St., Wellesley, Mass. 02181. Phone (617) 237-1910 [371]

Industrial controller handles 16 control loops in 200 ms

The iSBC 88/40 measurement and control computer based on the 8088 16-bit microprocessor is Intel's first single-board computer designed for industrial and laboratory applications such as real-time process control, production monitoring, supervisory control, and data acquisition. The board can concurrently process and update 16 control loops in 200 ms using a traditional proportional-integral-derivative (PID) control algorithm. Analog input capability consists of 32 single-ended or 16 differential channels. In addition, the board has 24 programmable parallel

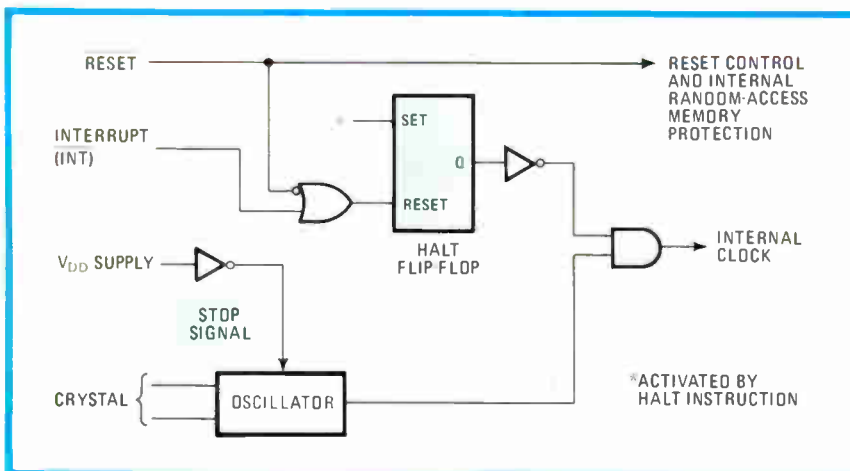

Full stop. In its halt mode, the 80C48's oscillator runs on, and the chip draws 1 mA. Dropping the supply to 2 V shuts down all but RAM, saving even more power.

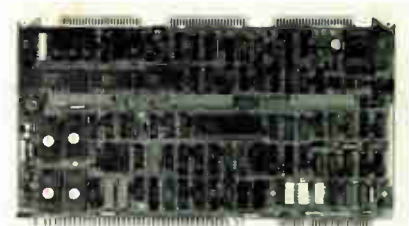

Test drive our high performance compact.

Over 20 million Aromat NF relays in use built for high performance, with a low profile that's perfectly suited for the busy traffic patterns of today's high density PC boards. Responsive handling is the key to the NFEs' reliability, with shock absorbing construction to ensure smooth long lasting performance. Aromat was the pioneer in plastic sealed relays over 10 years ago, and is now producing the NFEB in the U.S. Extensive test data, gathered here and abroad, prove the dependability of these relays.

SPECIFICATIONS

Contacts
 Arrangement 2, 4C
 Rating resistive load
 Max. switching power 60W 100VA
 Max. voltage 220V AC/DC
 Max. current 2A
 UL rating 0.5A 125V AC, 2A 30V DC
 VDE rating 1A 65V AC, 2A 30V DC
 Expected life, min. operations
 Mechanical NF2/3 x 10⁶, NF4/10⁶
 Electrical (2A 30V DC Resistive) 10⁶
 (1A 30V DC Resistive) 5 x 10⁶
 Initial contact pressure approx. 8.5g (0.3 oz.)
 Contact bounce approx. 1.5 msec.
Contact material
 Movable contact Gold-clad silver
 Stationary contact Gold-clad silver
 For telephone circuit applications
 gold-clad silver-palladium type is available
 rated 0.1A 50V DC 10 x 10⁶ operations
Initial contact resistance
 Maximum 50 mΩ
 Typical 25 mΩ
Coil
 Min. operating power (at 25°C) approx.
 NF2/150mW,
 NF4/240mW
 Nominal operating power (at 25°C) approx.
 NF2/300mW,
 NF4/480mW
 Max. operating power
 for continuous duty 1W at 40°C 104°F
Characteristics (at 25°C, 50% R.H. sea level)
 Max. operating speed 50 cps
 Operate time approx. 10 msec.
 Release time approx. 5 msec.
Electro static capacitance
 Contact/Contact approx. 4 pF
 Contact/Coil approx. 7 pF
 Contact/Ground approx. 6 pF
Breakdown voltage
 Between open contacts 750Vrms
 Between contact sets 750Vrms
 Between live parts and ground 1,000Vrms
 Between contacts and coil 1,000Vrms
 Initial insulation resistance 1,000MΩ at 500VDC
 Ambient temperature -40 to +65°C
 -40 to +149°F
Shock/Vibration resistance
 Deenergized condition 8G/8G 55 cps.
 Energized condition 20G/20G 55 cps.
 Unit weight approx. NF2/14g (0.5 oz.)
 NF4/16g (0.6 oz.)
Specifications for MBB contact types
 Expected life, min. operations
 Electrical (1A 30V DC Resistive) 10⁶
 Breakdown voltage
 Between open contacts 200Vrms
 All other characteristics are the same as those of
 standard types.

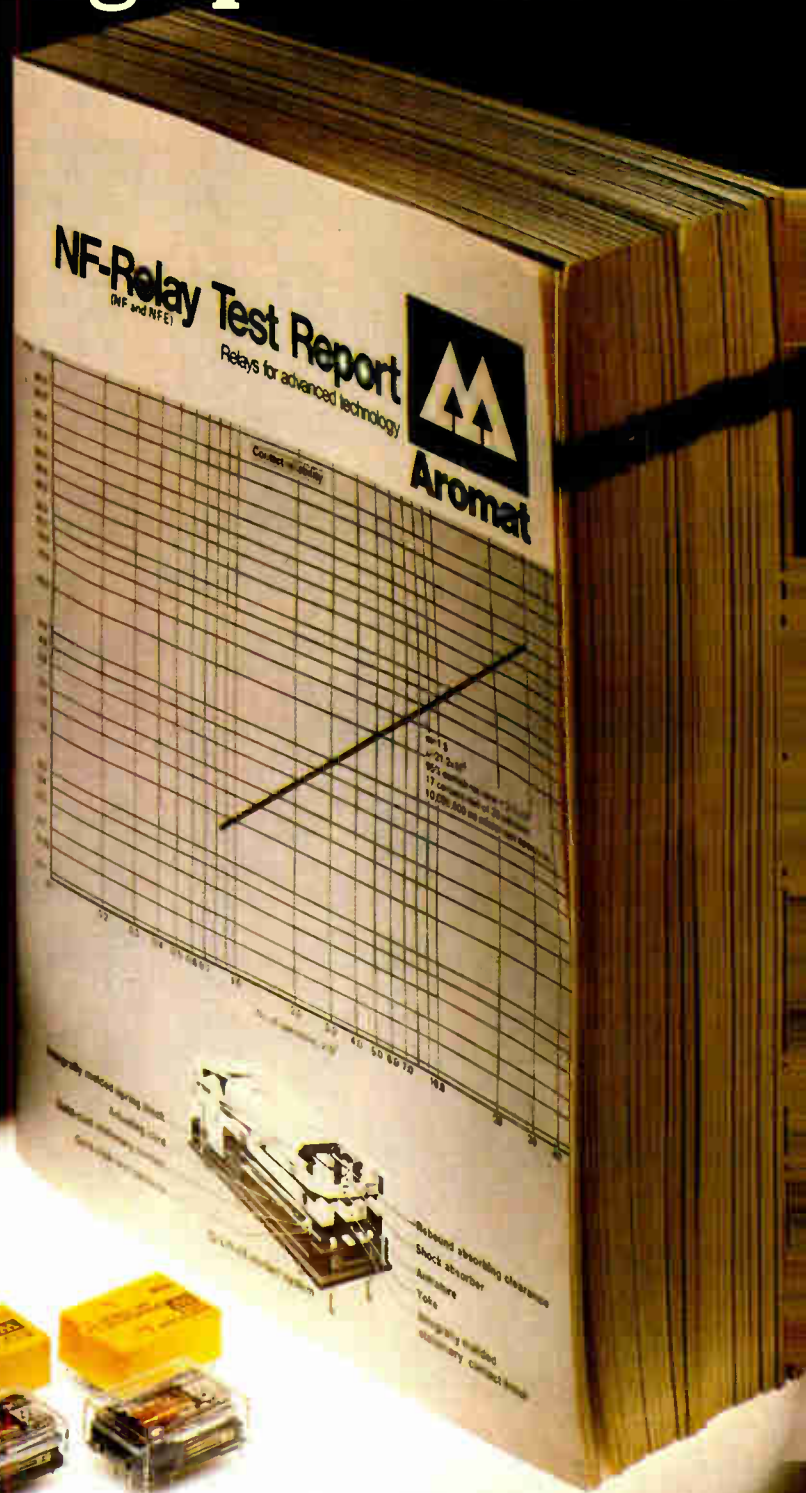

NFEB Amber Relay

Over 20 million
 Aromat NF Relays
 in use



Aromat
 Member of Matsushita Group

Aromat Corporation:
 250 Sheffield Street
 Mountainside, NJ 07092
 (201) 232-4260
Mid-Western Office:
 311 Lively Blvd.
 Suite 1
 Elk Grove Village, IL 60007
 (312) 593-8535
Western Office:
 10400 North Tantau Avenue
 Cupertino, CA 95014
 (415) 147-1000

Free Samples. Write to Aromat or your regional distributor today, and get a free sample and test data on the NFEB relay. Once you've driven this engineering marvel, you'll never turn back!

AVOID THE HASSLE. BUY JAN RECTIFIER BRIDGES.

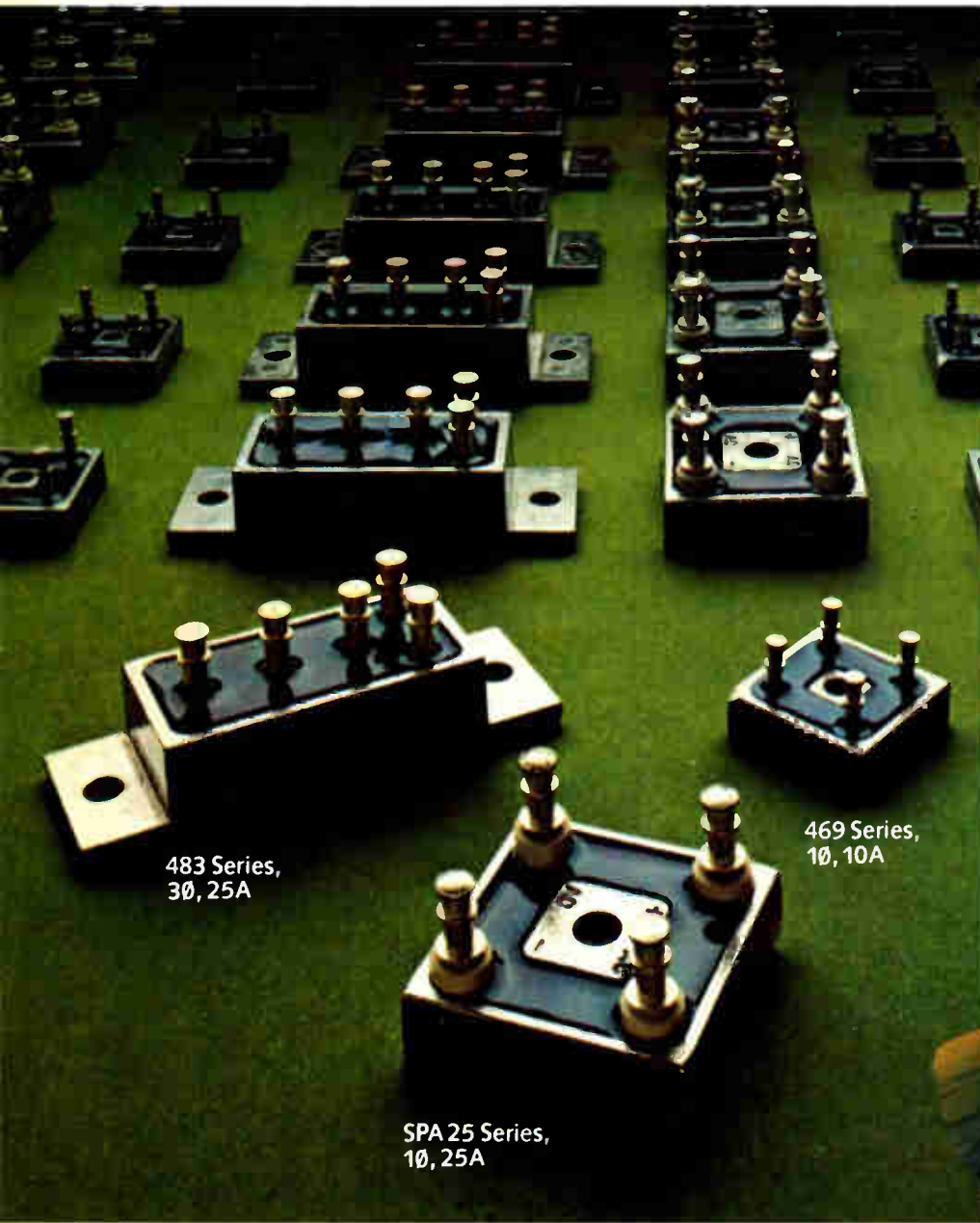

483 Series,
30, 25A

469 Series,
10, 10A

SPA 25 Series,
10, 25A

Qualifying your own rectifier bridge isn't worth the trouble anymore.

Because Unitrode now offers you a whole line of JAN and JANTX Rectifier Bridges right off the shelf.

They're already qualified, so you don't have to worry about time-consuming approvals. And you don't have to worry about reliability, either. Our rectifier bridges are assembled from the same Unitrode discrete military rectifiers that have been designed into every major defense project of the last two decades.

Simply choose the JAN or JANTX bridge you need from Unitrode's three families: 3-phase, 25A (MIL-S-19500/483); single-phase, 25A (/446); or single-phase, 10A (/469). Up to 600V.

Unitrode's JAN and JANTX Rectifier Bridges. Available now, in high volume. Without any hassles.

For more information, call or write: Unitrode Corporation, 5 Forbes Road, Lexington, MA 02173. Tel. 617-861-6540.



UNITRODE

UNITRODE RECTIFIER BRIDGES





UNITRODE

Unitrode Representatives:

Alabama: Conley & Assoc. 205-882-0316
 Arizona: Fred Board Assoc. 602-994-9388
 California: 12 408-988-3400; Great American Rep Company 714-832-8113; Great American Rep Company 213-990-4870; SR Electronics (San Diego) 714-560-8330
 Colorado: Component Sales 303-759-1666
 Connecticut: Kanan Assoc. 203-743-1812
 Florida: Conley & Assoc. (Oviedo) 305-365-3283; Conley & Assoc. (Boca Raton) 305-395-6108; Conley & Assoc. 813-885-7658
 Georgia: Conley & Assoc. 404-447-6992
 Illinois: Carlson Electronic Sales 312-956-8240
 Indiana: Carlson Electronic Sales 317-842-3740
 Iowa: Carlson Electronic Sales 319-377-6341
 Kansas: Rush & West Assoc. 913-764-2700
 Maryland: New Era Sales 301-768-6666
 Massachusetts: Kanan Assoc. 617-944-8484
 Michigan: Miltimore Sales 313-349-0260; Miltimore Sales 616-942-9721
 Minnesota: Electronic Innovators 612-941-0830
 Missouri: Rush & West Assoc. 314-394-7271
 New Mexico: Repronix 505-881-8001
 New York: Lorac Sales 516-681-8746; Reagan/Compar Albany 518-489-7408; Reagan/Compar Albany 315-732-3775; Reagan/Compar Albany 716-271-2230; Reagan/Compar Albany 607-723-8743
 North Carolina: Conley & Assoc. 919-787-8090
 Ohio: Baehr, Greenleaf & Assoc. (Cincinnati) 513-891-3826; Baehr, Greenleaf & Assoc. (Dayton) 513-293-1102; Baehr, Greenleaf & Assoc. 216-221-9030; Baehr, Greenleaf & Assoc. 614-486-4046
 Oregon: Vantage Corp. 503-297-1714
 Pennsylvania: GCM Assoc. 215-233-4600; Bacon Electronic Sales 814-796-2381
 Texas: Sundance Sales 214-699-0451; Sundance Sales 512-250-0320
 Utah: Component Sales 801-484-4222
 Washington: Vantage Corp. 206-455-3460
 Wisconsin: Carlson Electronic Sales 414-476-2790
 Canada: Kaytronics 514-487-3434; Kaytronics 416-669-2262; Kaytronics 403-276-9844

Unitrode Distributors

Alabama: Hall-Mark
 Arizona: Kierulff Electronics; Wyle Distr. Group
 California: (Northern) Arrow Electronics; Components Plus; Kierulff Electronics; Wyle Distr. Group
 California: (Southern) Arrow Electronics; Components Plus; Kierulff Electronics; Wyle Distr. Group
 Colorado: Arrow Electronics; Bell Industries; Kierulff Electronics; Wyle Distr. Group
 Connecticut: Arrow Electronics; Lionex
 Florida: Arrow Electronics; Hall-Mark; Kierulff Electronics; Pioneer
 Georgia: Arrow Electronics
 Illinois: Arrow Electronics; Hall-Mark; Kierulff Electronics; RM Electronics
 Indiana: Pioneer; RM Electronics
 Kansas: Hall-Mark
 Maryland: Arrow Electronics; Hall-Mark
 Massachusetts: Arrow Electronics; Kierulff Electronics; Lionex
 Michigan: Pioneer; RM Electronics
 Minnesota: Arrow Electronics; Hall-Mark; Industrial Components; Kierulff Electronics
 Missouri: Hall-Mark
 New Hampshire: Arrow Electronics
 New Jersey: Arrow Electronics; Kierulff Electronics; Lionex Corporation
 New Mexico: Arrow Electronics; Bell Industries
 New York: Arrow Electronics; Components Plus; Lionex
 North Carolina: Arrow Electronics; Hall-Mark; Hammond Electronics
 Ohio: Hall-Mark; Pioneer
 Oklahoma: Hall-Mark
 Pennsylvania: Arrow Electronics; Hall-Mark; Pioneer
 Texas: Arrow Electronics; Components Plus; Hall-Mark; Lenert
 Utah: Bell Industries; Kierulff Electronics
 Washington: Arrow Electronics; Kierulff Electronics; Shannon, Ltd.; Wyle Distr. Group
 Wisconsin: Hall-Mark; Kierulff Electronics; Taylor Electric
 Canada: Future Electronics

New products

input/output lines.

The on-board dual port and 4-K bytes of static random-access memory, in conjunction with Multibus system bus-control logic, enable the iSBC 88/40 to function as a stand-alone, multimaster, or intelligent slave analog preprocessor. The board also has support for electrically erasable programmable read-only memory; sockets for up to 32-K bytes of E-PROM; and a 12-bit analog-to-digital converter that works at 20 kHz and has programmable gain and multiplexed inputs.

Intel will introduce the computer board at the Instrument Society of America's ISA/80 conference and exhibit, Oct. 20-23 in Houston, but the unit can be ordered now for deliveries starting in March 1981. From then on, it will be available from stock for the U.S. price of \$2,000.

Intel Corp., 5200 N. E. Elam Young Pkwy., Hillsboro, Ore. 97123. Phone (503) 640-7147 [373]

MC6809 processor rides the S-100 bus

The ADS 6809 S-100 single-board computer brings the capabilities of Motorola's MC6809 to the S-100 bus. The board features provisions for 2-K bytes of random-access memory; 4-, 8-, or 16-K bytes of erasable programmable read-only memory; RS-232 serial communications with switch-selectable transmission rates; parallel input/output ports; and simulated 8080-type I/O.

A monitor 2-K bytes in size called Adsmon allows the examination and modification of memory and registers, as well as the testing of memory, the calculation of relative offsets, and the setting and display of breakpoints. The ADS 6809 S-100 computer is sold as a silk-screened solder-masked printed-circuit board, with a comprehensive manual included. The price is \$69.95, plus shipping.

Ackerman Digital Systems, 110 N. York Rd., Suite 208, Elmhurst, Ill. 60126. Phone (312) 530-8992 [374]

Microprocessor supports 16 users on S-100 bus

The CSSN system 1000-MP is a multiprocessor microcomputer system that supports up to 16 users on an S-100 bus. It provides each user with an independent operating system to eliminate response degradation and to simplify debugging. The Z80A-based system is expanded by adding single cards that contain a processor, memory, and a dual-port memory window. Special cards for high-speed communications are also available.

The system 1000-MP supports up to four 8-in. Winchester hard disks with a maximum storage of 96



megabytes and with file backup on cartridge tape drives. The PDOS hard-disk operating system offers large-scale file management facilities and user and file security. PDOS is upward-compatible with CP/M 1.4 and can run a variety of industry-standard languages and applications. With four users and 24 megabytes of storage, the 1000-MP is priced at \$25,000. It is available as a desktop or 19-in. rack-mounted model.

Computer Service Systems Network, 120 Boylston St., Boston, Mass. 02116. Phone (617) 482-2343 [376]

6800-based controller needs only power supply, terminal

The applications controller series 12 single-board computer features the Motorola 6800 microprocessor family and requires only a power supply and terminal to operate. The ACS-

New products

12-PRO provides two programmable 16-bit timers, software-controlled asynchronous communications interface adapter/modem interface on an RS-232 serial port, and two 8-bit or one 16-bit parallel port with hand-shake control.

The computer contains up to 4-K bytes of static random-access memo-

ry and 6-K bytes of programmable read-only memory. The ACS-12-PRO is supplied with 4-K-byte D-Forth software, a task-driven operating system that is a derivative of Forth. A 6-K-byte D-Forth version includes a 6800 assembler and a line editor. The 4.5-by-9.6-by-0.5-in. board's STD bus interface provides

the user access to a large selection of input/output devices. With 1-K byte of static RAM, the 4-K-byte D-Forth, and a manual, the ACS-12-PRO lists at \$495 from stock. The ACS-12-OEM lists at \$395.

Datricon Corp., 7911 N. E. 33rd Dr., Suite 200, Portland, Ore. 97211. [377]

'The Isotronics Difference'

Thermet... it's more than just a power package.

The problem with a power circuit is heat. Heat that can destroy the very circuit that produces it. And that can be a very serious problem.

After years of research and development, Isotronics came up with a powerful packaging solution to this hot problem. Thermet. A series of bonded-metal combinations offering up to 27 times the thermal conductivity of Kovar.

We've also designed a line of power packages using Thermet. But virtually any one of our thousands of packages — flatpacks, plug-ins, DIPs, standard headers, and AIDs — can become a power package if the bottom is made of Thermet.

Heat is a serious problem. We worked on it until we solved it. That's the Isotronics difference.



AUGAT

Isotronics

Isotronics, Inc., Industrial Park, New Bedford, Mass. 02745
(617) 998-2000 • TWX 710 344 1961 • Cable — Isotronics

Augat SA, 9 Allée de la Vanne (Z I Sofitic) B.P. 440 Cedex 94263/Fresnes, France/Tel 668 30 90/Telex 201 227

FLATPACKS • PLUG-INS • DUAL IN-LINES • AID'S • STANDARD HEADERS • MICROWAVE MODULES

Signetics' IFL family can be programmed in one step

By using the 950-0800 Logic Programming Pak, logic designers can prepare programming data for Signetics' 28-pin Integrated Fuse Logic (IFL) in a single step. The Pak is to be used in Data I/O's System 19 programmable read-only memory programmer. It accepts logic-variable data expressed as input- and output-state combinations. Integral software translates the data into the programming format for Signetics' IFL devices. The programming sequence, including a blank check, an illegal-bit check, and an array verification, takes from 3 to 15 seconds, depending on the device. Once a design is completed and tested, the



fuse-logic devices can be programmed using a master device or other memory as a data source.

The 950-0800 is priced at \$1,050, with a delivery time of six weeks. Users of Data I/O's existing Signetics' IFL Programming Pak, the 919-1542, may add the new data-preparation capabilities by ordering an update kit, 960-0800, for \$750. Delivery for the kit is seven to nine weeks.

Data I/O Corp., 1297 N. W. Mall, Issaquah, Wash. 98027. Phone (206) 455-3990 [378]

Want to cut your PC design cost by 50%?

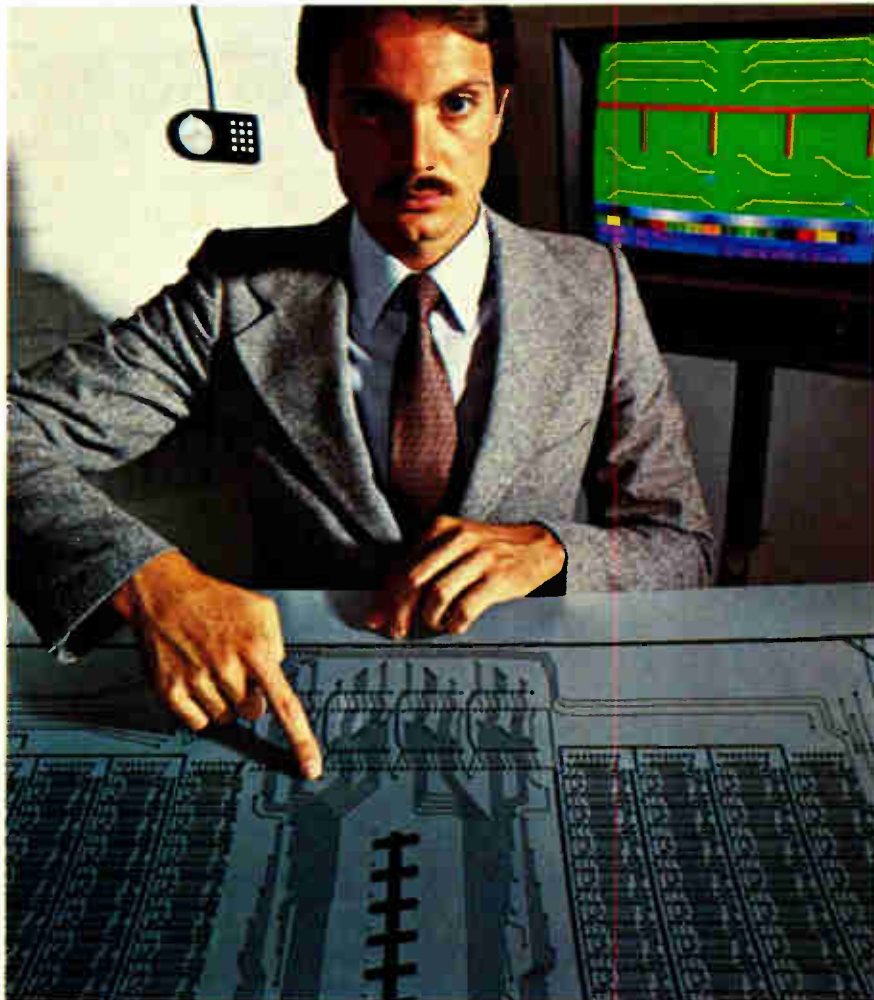

Then check out Nicolet's revolutionary System 80. It's a compact, easy-to-use electronic drafting table that fits right into your design department to speed work through faster than you thought possible.

Multiply your output without extra effort.

Your drafting department will become an efficiency center in no time. Because the System 80 does the drafting while you do the designing. You can work on any of 12 layers—and differentiate all the layers at once through instant color selection. If you move a DIP, you have simultaneous correction of all the layers of the drawing—including assembly drawing, silk screen, solder mask, ground plane, drill drawing and foil art. You pan over or zoom in on large drawings for fast close work. Draft and revise layouts quickly and easily. And automate tedious handwork.

All of which gives your staff more time for designing. And lowers your drafting costs tremendously.

**System 80™ costs less:
\$84,300 to buy.
\$2192 per month to lease*.**

And System 80 offers more capability for the money: more time-saving to cut lead time, more versatility, more options and more return on investment. In fact, you can recover the initial cost within a year.

So if you'd like to cut your PC design costs in half and double or triple your output, get in touch with Nicolet. Today.

*Based on one of our five-year plans now available.



NICOLET A Subsidiary of
NIC CAD Nicolet Instrument
CORPORATION Corporation

2530 San Pablo Avenue
Berkeley, CA 94702
(415) 848-6600. Ask for Jim Hirst.

**Can we be sure
they won't
disappoint
us?**

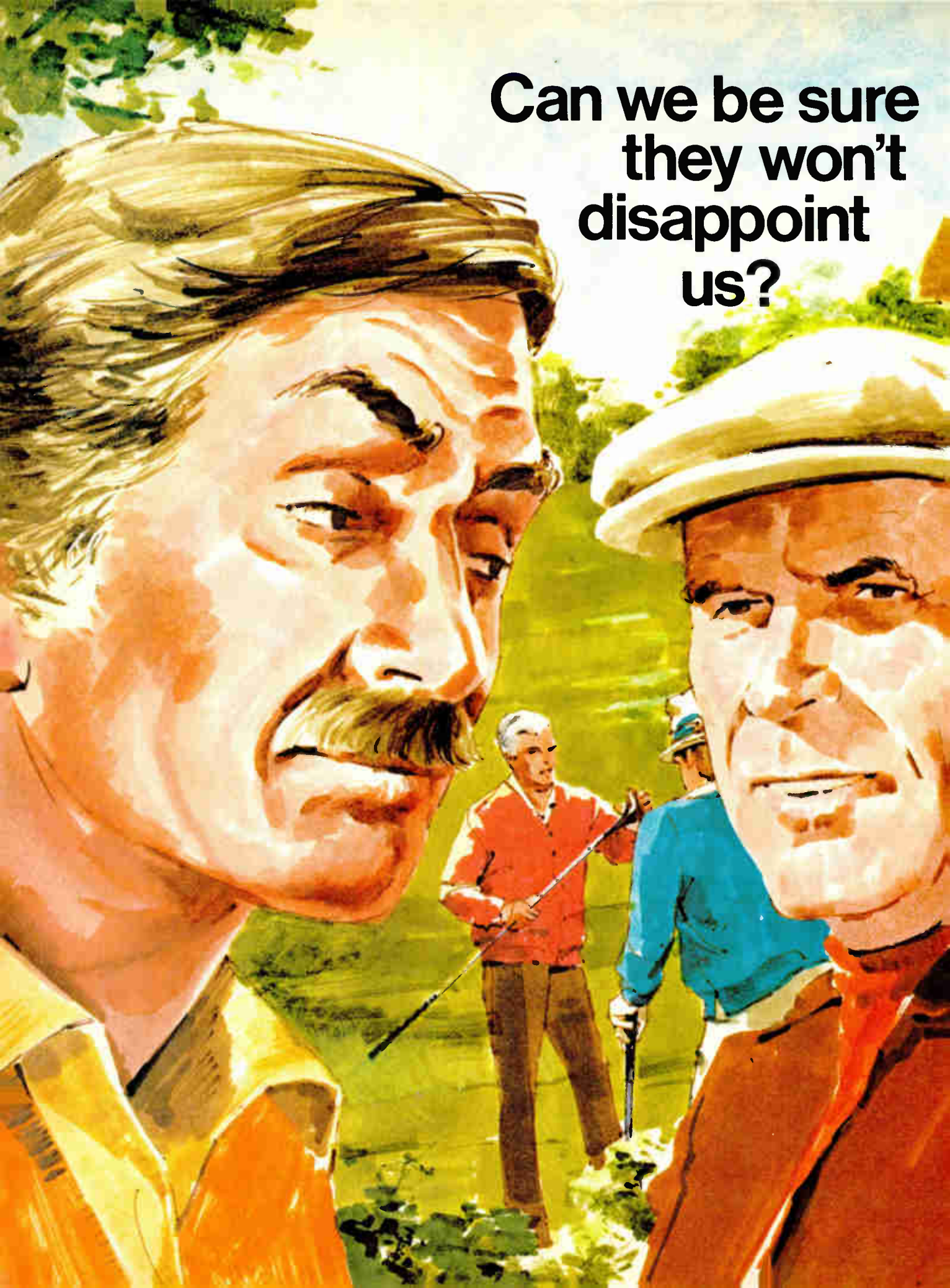



When it's TRW, the answer is yes.

At TRW, we think we have an enviable record for dependability and client concern. The need to meet your delivery dates, with the right product, is foremost in our thinking, at all involved levels within the organization.

Because we produce similar product lines in more than one facility, we'll even shift production to meet emergency situations. But we don't wait for the emergency to add people, production lines or extra shifts. It's a regular procedure when we know our products are needed.

As the first step in establishing a confidence-based relationship with a supplier that won't let you down, call any TRW/ECG sales office or Renfrew Electronics in Canada.

You'll find them listed in EEM, Gold Book, Electronics Buyers' Guide, Who's Who in Electronics, the Electronic Industry Telephone Directory and the Electronic Buyers' Handbook.

TRW CAPACITORS

TRW CINCH CONNECTORS

TRW CINCH-GRAPIK

TRW GLOBE MOTORS

TRW INDUCTIVE PRODUCTS

TRW IRC NETWORKS

TRW IRC RESISTORS

TRW LSI PRODUCTS

TRW OPTRON

TRW POWER SEMICONDUCTORS

TRW RF SEMICONDUCTORS

TRW ELECTRONIC COMPONENTS GROUP

DIVISIONS OF TRW INC.

5725 East River Road • Chicago, Illinois 60631

THINK BAUSCH & LOMB VALUE

For more than twenty years, StereoZoom® Microscopes have been the first choice of electronics assembly, packaging, and inspection operations.

The reasons all relate to Bausch & Lomb value. Like a dedicated effort to respond to your constantly increasing performance requirements. Persistent attention to quality to help you improve your product reliability. And versatile, high performance features that reduce operator fatigue and increase productivity.

This attention to your requirements has made StereoZoom Microscopes your best value year after year. Call or write today for a detailed catalog, applications assistance, or a personal demonstration.

Performance. Quality. Reliability.
Three good reasons to...
THINK BAUSCH & LOMB VALUE

BAUSCH & LOMB 
Scientific Optical Products Division
ROCHESTER, NEW YORK 14602

Consult Yellow Pages under "Microscopes"

Circle #214 for more information



TOP EFFICIENCY



TSK-125 A Unit

in continuous heat treatment — drying and thermal fixing — of ropes made of synthetic and natural fibers in UHF field:

Physical and mechanical properties of synthetic ropes

SIGNIFICANTLY ENHANCED:

- relative extension
REDUCED BY 20 to 40 %
- mass of linear meter
REDUCED BY 6 to 12 %
- breaking load
INCREASED BY 6 to 12 %

Circumference of handled ropes, mm

50 to 125

Throughput, kg/h	not below 150
Extension of ropes during thermal treatment	at 10 to 20 % of tensile strength
Parasite radiation level within operating area	within accepted norm (10 mmW/cm ²)
Overall dimensions, mm	16,000 x 2,500 x 2,000

THE OPERATION IS SIMPLE, WITH AUTOMATIC CONTROL THROUGHOUT.

 **TECHMASHEPORT**

35, Mosfilmovskaya Ul. 117330 Moscow, USSR. Tel. 143-86-60. Telex: 411 068 TEHEX SU

Circle 49 on reader service card

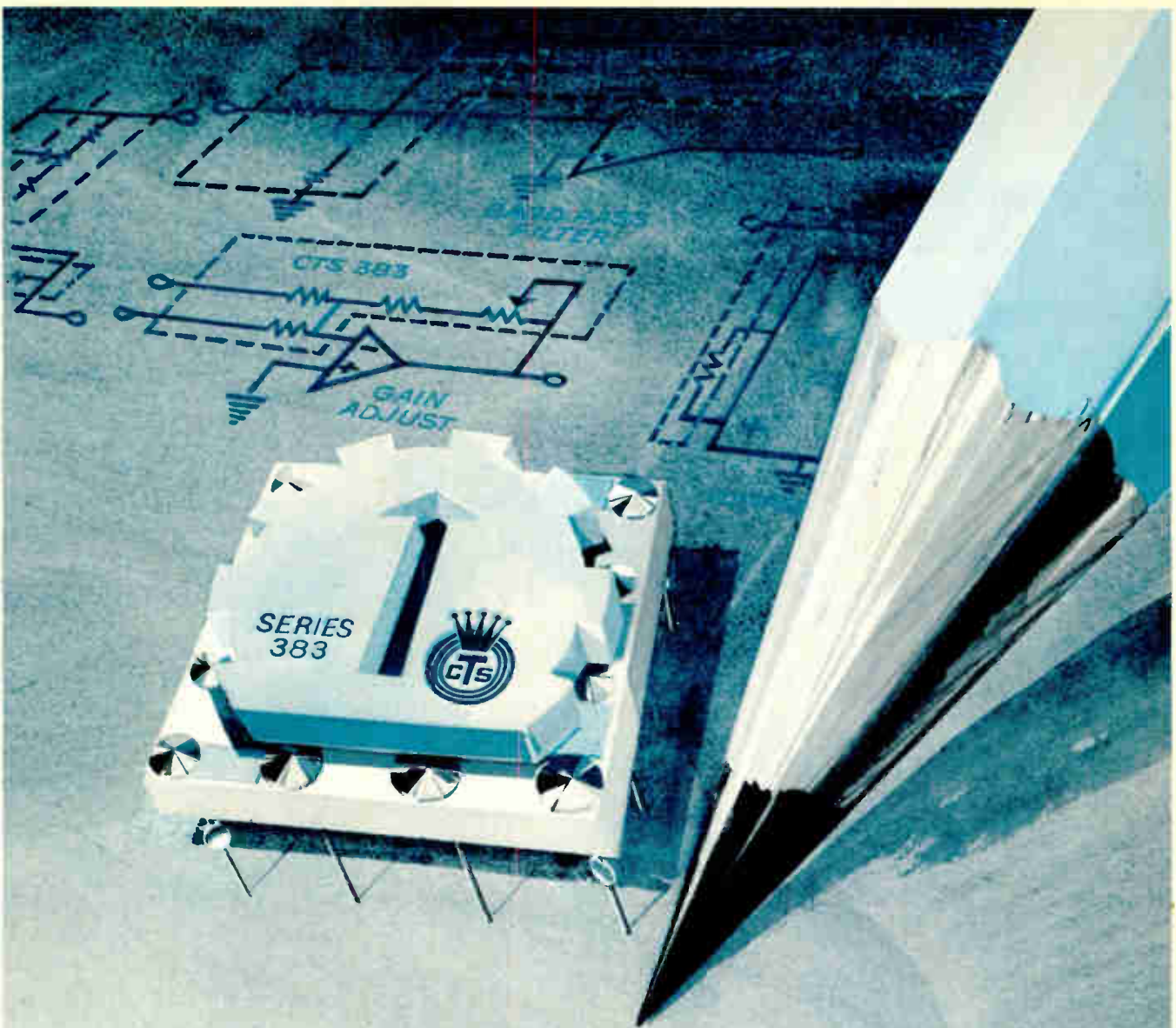

Specifying both resistors and trimmers? Here's a single solution from CTS.

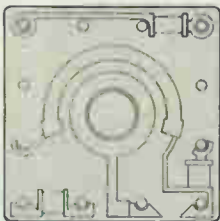

CTS proudly presents a single solution to many of the problems you face in specifying resistors and trimmers ... the Series 380 thru 384 Cermet Resistor/Trimmer combinations.

Have Board Space Problems? The Series 384 offers you up to eight fixed resistors plus a trimmer in a .46" square (.275" high) package.

Need Hefty Power Capability? All units in this Series can handle one watt at 70°C and ¾ watt at 85°C.

Need Cermet Stability? ± 250 ppm/°C is the standard temperature coefficient in this Series with ± 100 ppm available for your critical needs.

Want Rock Bottom Prices? The Series 383 (shown above) provides you combinations of three fixed resistors plus a trimmer for only 35¢ in production quantities. The Series 380 trimmer only is priced under 25¢. This economical space saving form factor is available as a trimmer only, in resistor/trimmer networks, and as resistor networks only. Let the Application Engineer from CTS Microelectronics help you decide which Series is best for your design.

CTS MICROELECTRONICS, INC., 1201 Cumberland Avenue, West Lafayette, Indiana 47906. Phone (317) 463-2565.

CTS CORPORATION

Elkhart, Indiana

A world leader in cermet and variable resistor technology.



Auto-ranging

POWER SOURCE

It Doesn't Cost More...

It Does More!

new

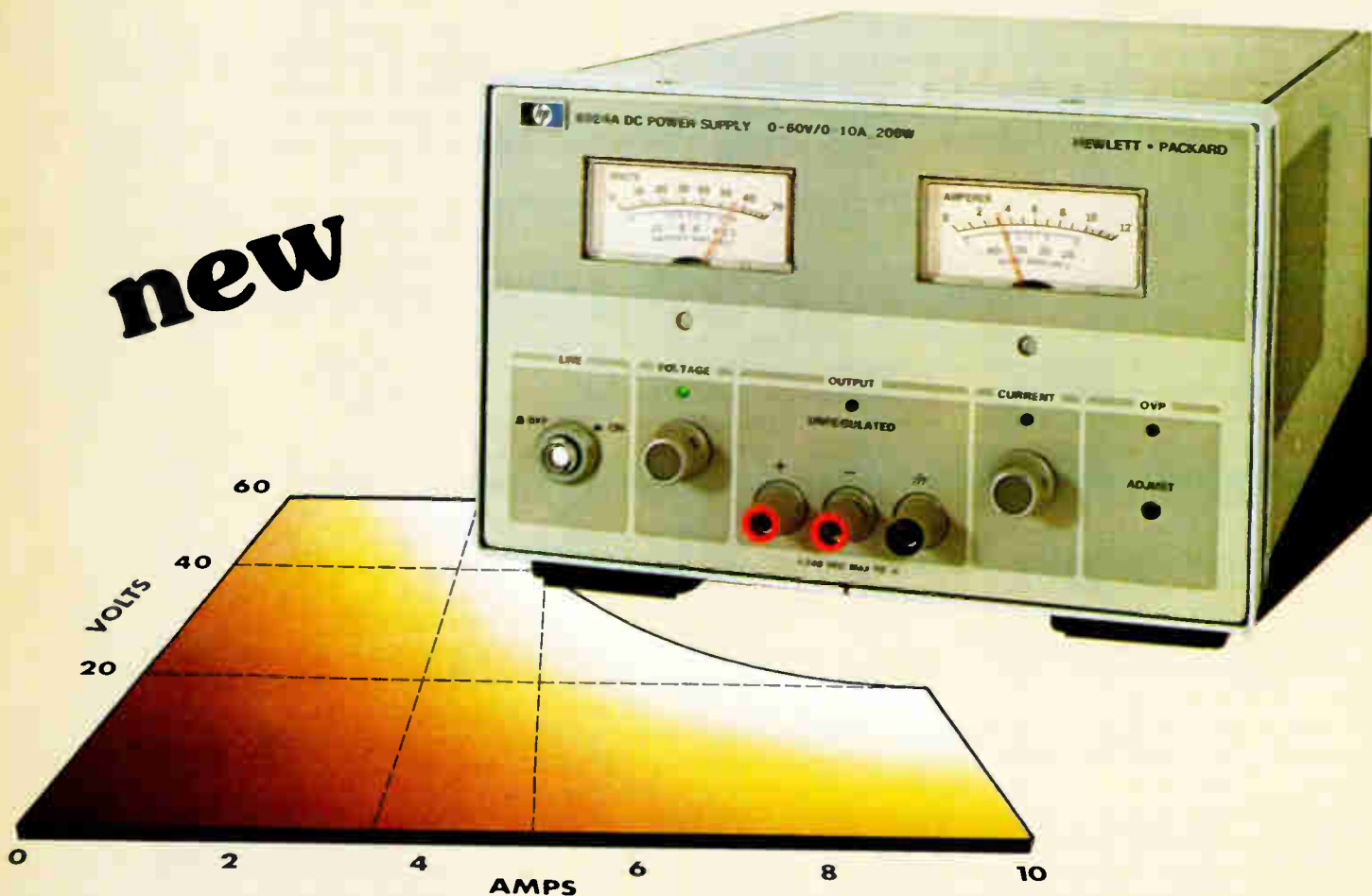

This autoranging supply uses high frequency switching technology to provide expanded capability in systems and laboratory applications.

Until now, you had to buy different power sources to satisfy your ever changing power requirements. Today, you have a better choice with the new HP AUTORANGING POWER SUPPLY. Autoranging provides you with continuous coverage — 200 watts from 0 to 60 volts at 0 to 10 amps — eliminating the need, cost and inconvenience of having many supplies. The circuitry, employing a switching regulator with state-of-the-art FET's, can be considered revolutionary. But what is more important is the versatility, high performance and features: 0.01% regulation; 3 mV rms/30 mV p-p noise; and status indicators for constant-voltage, constant-current and out-of-regulation conditions. All for only \$875 (domestic U.S.A. price only).

For more information on the many benefits of the 6024A Autoranging DC Power Supply, write to Hewlett-Packard, 1507 Page Mill Road, Palo Alto, CA. 94304. Or call the HP regional office nearest you: East (201) 265-5000, West (213) 970-7500, Midwest (312) 255-9800, South (404) 955-1500, Canada (416) 678-9430.



SYSTEM OPTION

Convenient system interfacing board allows complete remote control of output voltage and current — also provides isolated readback of supply status.



Autoranging Autoranging Autoranging Autoranging Autoranging Autoranging

**gives a continuous
range of voltage
and current
combinations**

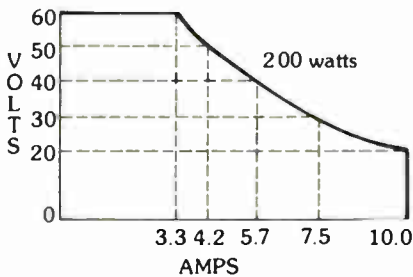

The HP 6024A Autoranging Power Supply provides maximum output power over a wide and continuous range of voltage and current combinations without having to manually select the proper output range. This feature, differs from conventional constant-voltage/constant-current power supplies which yield maximum output power at only one combination of output voltage and current. For example, an engineer would need a 20-volt 10-amp supply, a 40-volt 5-amp supply, and a 60-volt 3-amp supply to approximate the ranges available from the 6024A.

The HP 6024A is a convenient and cost-effective unit capable of satisfying many different dc requirements. Either in the lab or in a system, the consequent savings in space, interface complexity and equipment expense are significant.

 **HEWLETT
PACKARD**

21002

New products

Semiconductors

Small PROMs access in 45 ns

1-, 2-K bipolar PROMs have titanium-tungsten fuses; low-power parts are coming

At a time when manufacturers of bipolar programmable read-only memories are concentrating on supplying devices with 4,096 bits or more, at least one firm aims to quench the market's still considerable thirst for smaller PROMs—and with some performance improvements at that. Monolithic Memories Inc. is making available two families of bipolar PROMs with titanium-tungsten (TiW) fuses that access more quickly and dissipate less power than PROMs using nickel-chromium fuses.

MMI's new Schottky (S) and low-power Schottky (LS) families are fabricated with a new platinum silicide process that, claims Shlomo Waser, manager of product planning and applications, "allows designs with the highest speeds over operating temperature ranges." The high-performance PROMs use a new programming technique that does not require a separate programming pin as in standard PROMs with NiCr fuses. The TiW fuses store a logical

low and are programmed to the high state.

Initially available in 1-K (256-by-4-bit) and 2-K (512-by-4-bit) configurations, both the S and LS families have pnp inputs for low input current, full Schottky clamping, and three-state (suffix: 1) or open-collector (suffix: 0) outputs. Additionally, they are specified for operation over the commercial (prefix: 63) as well as the military (prefix: 53) temperature and voltage ranges. Thus, the two new families comprise a total of 16 devices.

Real-time switching speed. According to Waser, the S family of memory devices consumes the same amount of power (0.65 w) as do MMI's earlier NiCr-fused PROMs, but their 45-ns switching speed, he notes, represents a 25% speed improvement over the 60-ns rate of the older devices. Such switching speeds, he continues, are being demanded by "minicomputer manufacturers and some others who are building systems to perform real-time signal processing."

Furthermore, Waser points out that PROMs, if fast enough, can be used as programmable logic elements. "The majority of random logic can be replaced by PROMs if these devices are fairly fast. At 45-ns switching speeds, that becomes a viable approach."

In contrast, the LS family of devices maintains the 60-ns switching speeds of MMI's earlier PROMs with NiCr fuses, but they "nearly

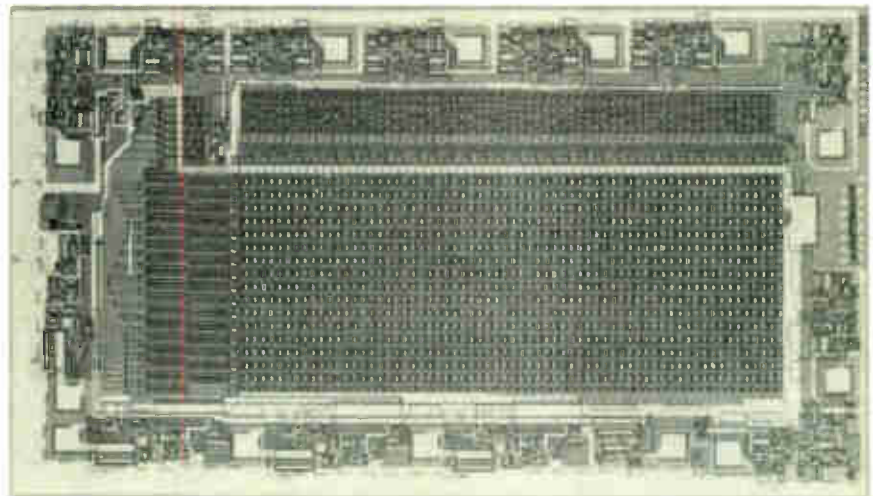

New products

halve power consumption" (0.35 w compared with 0.65 w) of the older devices. "The need for such low-power PROMs," Waser says, "is basically in two market areas: the telecommunications industry, which normally doesn't push speed to extremes; and the military, which needs low power for airborne sys-

tems," among other applications.

Waser expects the new devices to alleviate what he calls a worldwide shortage of bipolar PROMs. Furthermore, because of the limited capacity to make such devices, he adds, many companies have stopped supplying smaller PROMs and instead are manufacturing 4-K and

larger PROMs, with the 8-K bipolar PROM being the most popular at present. Thus, those bipolar PROM users that have designed smaller PROMs into their systems, Waser says, "are having difficulty in getting them."

Pin-compatible with standard Schottky PROMs, the new 16-pin devices from MMI will cost more. For example, the 63S140/1 commercial 1-K PROM will be priced at \$5 each in lots of 100, whereas their counterparts with NiCr fuses are priced at \$3.50 each in like quantities. Similarly, the 63S240/1 commercial 2-K device will be priced at \$7.50 each, as compared with \$5.83 each for 2-K NiCr PROMs in the same quantities. The LS family of bipolar PROMs will be priced "slightly higher" than the S series.

Small quantities of the S family are available off the shelf from distributors; large quantities (up to 5,000) are delivered 12 weeks after receipt of order. The LS family will be available by the end of this year.

Monolithic Memories Inc., 1165 E. Arques Ave., Sunnyvale, Calif. 94086. Phone (408) 739-3535 [411]

BEGONE CURSED ALIASES

The new Precision 616 cuts clean with programmable ease. 80 dB/octave attenuation slopes and time domain filters superior to Bessel. Up to 16 filter channels, programmable for gain and cutoff frequency. Interfaces with mini, micro or GPIB. Typical

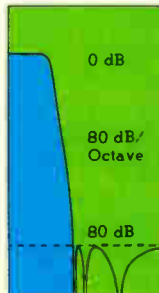

phase match is $\frac{1}{2}^\circ$, with worst case of 2° . You get performance that used to require a custom instrument, without paying a custom price. Call Don Chandler, 607-277-3550, or write for complete specs and a demonstration.



PRECISION FILTERS, INC.

303 W. Lincoln, Ithaca, N.Y. 14850



TI 92-K bubble memory system and kit available

Texas Instruments has two new 92-K single-board magnetic-bubble memory systems that are compatible with the STD bus—the TBB7090 and TBB7091. In addition, the company is offering two kits—the TIBK090 and TIBK091—for engineers who prefer to do their own board layout.

The TIBK091 kit contains the parts required to construct one minimum memory system and consists of one 92-K bubble memory, a sense amplifier, two coil drivers, a function driver, two diode arrays, one thermistor, one function-timing generator, and one controller. It sells for \$191. The 090 kit contains all these parts except for the function-timing generator and controller. It sells for \$151.

The completely assembled and tested single-board memories—TBB7090 and 7091—are supplied with one, two, three, or four 92-K

TIB0203 bubble memories for 11.5, 23, 34.5, or 46 kilobytes of storage. The 7090 contains 11.5 kilobytes of nonvolatile memory storage and all the necessary support circuits. The 7091 is designed to expand the storage capacity of the 7090 to a maximum of 104 kilobytes. Each 7091 contains up to 46 kilobytes of memory. Both boards are compatible with such microprocessors as the 8085, 6800, and Z80. They are available in two temperature ranges: from 0° to 50°C, and from 0° to 70°C. Depending on memory capacity and temperature range, they sell for \$610 to \$1,580 and are available within four weeks after receipt of order.

Texas Instruments Inc., P. O. Box 225012, M/S 308, Dallas, Texas 75262 [413]

2-K C-MOS E-PROM dissipates 20 mW

The CDP18U42C complementary-MOS 2-K (256-by-8-bit) erasable programmable read-only memory is erased with ultraviolet light (2,500 Å typical). The E-PROM is useful for asynchronous ROM applications and will interface directly with the CDP1802 microprocessor. It has common data inputs and outputs and utilizes a single 4- to 6.5-v supply during read operations. Three chip-select inputs are provided. Access time is a maximum of 1 μs and programming usually takes 5 seconds. The E-PROM dissipates 20 mW typically during read operations. It comes in a 24-lead hermetically sealed dual in-line ceramic package and sells for \$38.70 apiece in 100-unit lots. It is available from stock.

RCA Solid State Div., Box 3200, Somerville, N. J. 08876 [414]

Real-time clocks are Microbus-compatible

Designed with a bidirectional data bus in order to facilitate interfacing with microprocessor systems, the MM58167 and MM58174 real-time clocks are Microbus-compatible.

Both devices feature addressable real-time counters. The 174 measures from tenths of seconds through months and includes a write-only register for leap year calculation; the 167 measures thousandths of seconds through months and has corresponding addressable latches for alarm functions. Each counter and

latch is divided into 4-bit words. The two chips' time bases are generated with 32,768-Hz crystal-controlled oscillators. The model MM58174 is housed in a 16-pin dual in-line package and is priced at \$8.50 in quantities of 100. The MM58167 comes in a 24-pin DIP and is priced at \$9.25 in the same quantities. Both devices are

GOODBYE ALIAS, HELLO GAIN

The new Precision 416 combines filter and amplifier in 16 programmable channels. You save 35% by buying one instrument instead of two for conditioning analog data for digital conversion. Time delay filters superior to Bessel. Elliptics with 80 dB/octave attenuation. DC differential input stage with



100 db CMRR. Both pre-filter and post-filter gain are programmable for optimum signal quality. Both include overload indicators. Interfaces with mini, micro or GPIB. Phase match is less than 2°. Call Don Chandler, 607-277-3550, or write for demonstration and complete specs.



PRECISION FILTERS, INC.

303 W. Lincoln, Ithaca, N.Y. 14850

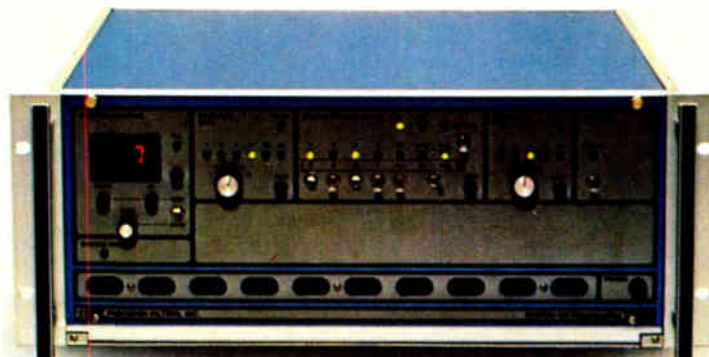

Keep Up With Change

Ferranti-Packard Electromagnetic Modules Let You Create the System

Three new additions to the Ferranti-Packard 7 Segment Readout Displays—9, 12 and 18-inch characters are ideal for remote-controlled numeric readouts for gas pricing signs, time/temperature signs, speed limit signs, scoreboards and industrial displays.

The light-reflecting display components come in white or fluorescent fade-resistant colors. They're designed to ensure visual impact over an extreme ambient light range, even direct sunlight.

Our Modules are rated for 400 million operations and there are no lamps to burn out.

Save energy too! Magnetic latching retains the data displayed with *zero power input*.

Ferranti-Packard Modules. Visibility. Reliability and Economy no other readout component can match. Before you specify a display, call Ferranti-Packard.

The Pioneer in electromagnetic displays.



Ferranti-Packard Electronics Ltd.



6030 Ambler Drive, Mississauga
Ontario, Canada L4W 2P1
Telephone: (416) 624-3020
Telex: 06-961437

Circle 58 on reader service card

Make tracks to Max

Nobel Prize winner, Max Planck did much of the work on his Quantum Theory of Radiation while a Professor in Bavaria. That

same tradition of scientific inquiry lives on at ten Max Planck Institutes throughout Bavaria, Germany's largest state.

More importantly, Bavaria has emerged as one of the leading technological centers for Germany. Here you will find for example manufacturing facilities of leaders in electronics, mechanical engineering and aerospace industry or production plants of wellknown chemical, pharmaceutical and automotive companies.

In electrical engineering and electronics alone, Bavaria is "home" for fully one-quarter of nearly one million German workers in this growing industry sector. A network of nine universities and ten technical colleges, as well as vocational and secondary schools supplies Bavaria with a labor force at once welltrained, industrious, dependable and stable. Energy, communications, transportation and some of Europe's most desirable recreational facilities combine with generous government programs of incentives, grants and loans in the development areas to make Bavaria first choice for overseas plant location.

If modern technology is your stock and trade, Bavaria is the place for your European facilities.

Make tracks to Max
There's room for many more!

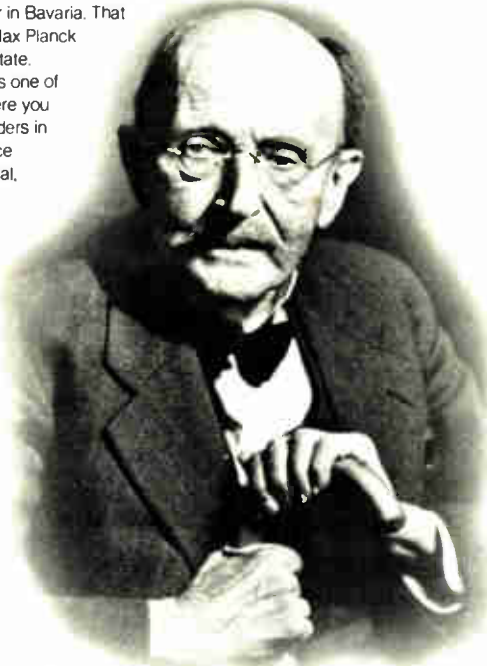

Bavaria

Industry Location Advisory Service
Bavarian State Ministry of Economics, Postfach, D-8000 Munich 22, West Germany
in US KALLMAN ASSOCIATES 30 Journal Square, Jersey City, N.J. 07306 Phone (201) 653-3304

This material distributed by Kallman Associates, 30 Journal Square, Jersey City, N.J. 07306, a registered agent of the Bavarian Ministry of Economics, Munich, Germany, under the Foreign Agents Registration Act. Copy is filed with the Department of Justice where the required registration statement is available for public inspection. Registration does not indicate approval of this material by the U.S. Government.

220 Circle 60 on reader service card

New products

currently available from stock.
National Semiconductor Corp., 2900 Semiconductor Dr., Santa Clara, Calif. 95051.
Phone (408) 737-5000 [415]

250-ns 64-K E-PROM comes
in Jedec-approved 28-pin DIP

The Intel 2764 64-K erasable programmable read-only memory with a 250-ns worst-case access time conforms to the new industry standard for high-density byte-wide memories. The E-PROM's 28-pin configuration matches the one recently approved by the JC-42 MOS memory standardization committee of the Joint Electron Device Engineering Council. This format permits two-line control to assure proper system operation at high speed. It can be used as a universal pinout for all byte-wide memories, including ROMs, E-PROMs, and random-access memories of 2-, 4-, 8-, 16-, and 32-K size to be interchanged in the same 28-pin socket.

Intel claims that by applying its

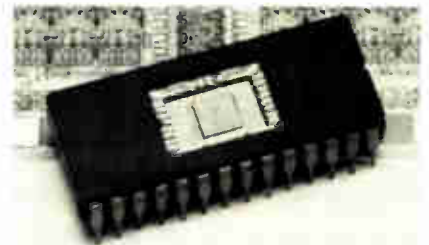

HMOS-E process technology to non-volatile memories it has made the 32,400-mil² 2764 the smallest 64-K E-PROM currently in production. The process has 3- μ m channel lengths. The 2764's speed eliminates the need for wait states in a central processing unit's program, so the CPU's performance is maximized, the company points out. Faster and slower versions, the 2764-2 and -3, are available with worst-case access times of 200 and 300 ns. The U.S. price for the 2764 is \$163 each for 100-piece purchases. Volume shipments will begin in the first quarter of 1981.

Intel Corp., 3065 Bowers Ave., Santa Clara, Calif. 95051. Phone (408) 987-6742 [417]

Electronics/October 9, 1980

New iSBX™ Multimodule™ boards™

Intel® introduces a whole new dimension in configuring single board computer systems.

Intel pioneered the concept of flexible microcomputer system design in 1976, with our family of iSBC™ single-board computers interfaced via the Multibus™ system bus—presently accepted as the industry standard.

Now we've extended this well-accepted concept to board-level design: A new generation of Multimodule boards interface to iSBCs via the new iSBX bus. So now you have a second design option. You can expand systems in large increments with Multibus boards. Or in smaller, more economical increments with Multimodules.

The key to configuration flexibility

The iSBX bus—the first physical/electrical interface for direct on-board expansion of iSBC systems—assures compatibility between these systems and the emerging Multimodule product line.

Present on all future Intel single-board computers, the iSBX bus saves design time and space, and facilitates fast, easy upgrading. System performance is

also improved because Multimodules tie directly to the iSBC internal bus. Connection to the iSBX bus is made with a set of rugged connectors—one on the iSBC board, the other on the Multimodule itself.

The new Multimodule family

Multimodules represent a whole new family of plug-in expansion boards. They allow you to add a variety of special performance features to your existing iSBC system. Currently available add-ons are shown below. Soon you'll also be able to add other Multimodules for D-to-A and A-to-D conversion, communications, peripheral interfaces—and more.

With those modules you can now respond

the more economical iSBX 331 or 332 math modules.

New Multimodule-compatible iSBC boards

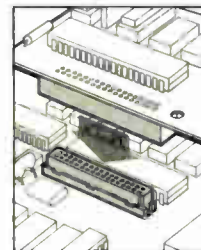

iSBX 960-5 Connector

Intel's new 8-bit iSBC 80/10B and 80/24 single-board computers are the first of many iSBCs to offer iSBX Multimodule expansion capabilities. Both are improved versions of widely used iSBC boards. (See table).

Custom tailoring, too

For users who want to design their own Multimodule boards, Intel offers iSBX 960-5 connectors. When used in conjunction with the iSBX specifications, this set of connectors lets you create modular boards that meet your own unique requirements.

Available from Intel today are the first four iSBX Multimodules and two iSBX-compatible iSBCs. For further information, or to order, return this coupon or call your local Intel sales office or distributor. Or contact Intel at the address below.

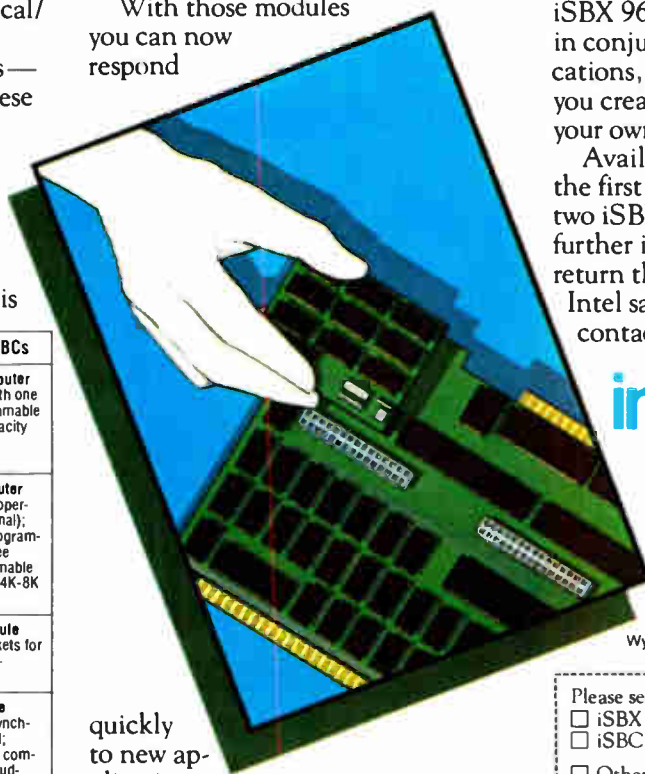

intel® delivers solutions.

Europe: Intel International, Brussels, Belgium.
Japan: Intel Japan, Tokyo. United States and Canadian distributors: Alliance, Almac/Strom, Arrow Electronics, Avnet Electronics, Component Specialties, Hamilton/Avnet, Hamilton/Electro Sales, Harvey, Industrial Components, Pioneer, L.A. Varah, Wyle Distribution Group, Zentronics.

New Multimodules and iSBX Bus-compatible iSBCs	
	iSBC 80/10B Single Board Computer 8080A-based microcomputer with one iSBX bus connector; 48 programmable I/O lines; one USART; timer; capacity for 1K-4K bytes RAM; up to 16K EPROM
	iSBC 80/24 Single Board Computer 8085A-2 based microcomputer operating at 4.8 MHz (2.4 MHz optional); two iSBX bus connectors; 48 programmable I/O lines; one USART; three programmable timers; programmable interrupt controller; capacity for 4K-8K bytes RAM; up to 16K EPROM
	iSBX 350 Parallel I/O Multimodule 24 programmable I/O lines; sockets for inverting and noninverting transceivers
	iSBX 351 Serial I/O Multimodule Programmable synchronous/asynchronous communications channel; standard RS232C or RS449/422 compatibility; software-selectable baud-rate generation; two programmable 16-bit BCD or binary timers/event counters
	iSBX 331 Fixed/Floating Point Math Multimodule Fixed point single- (16-bit) and double- (32-bit) precision arithmetic; floating point single- (32-bit) precision functions; floating-to-fixed and fixed-to-floating point conversions; transcendental functions
	iSBX 332 Floating Point Math Multimodule Single- (32-bit) and double- (64-bit) precision arithmetic; compatible with proposed IEEE format and existing Intel floating point standard.

quickly to new applications opportunities. Examples? Take data acquisition or industrial control: to add extensive I/O processing power, you simply plug in the iSBX 350 board. Or consider communications networks. Now there's no need to add entire USART boards; just use the iSBX 351 unit. In laboratory control applications, instead of an independent math processor, now you can choose

Please send information on:

- iSBX Multimodules iSBC 80/10B
 iSBC 80/24 Configuration Guide

- Other _____
 Please have a Sales Representative call.

Name _____

Title/Organization _____

Address _____

City/State/Zip _____

Phone _____

Intel Corporation, 3065 Bowers Avenue, Santa Clara, CA 95051. Telephone (408) 987-8080.

*The foremost solution
to switch design flexibility...*

Modular Pushbutton and Key Switches *from* **CENTRALAB**

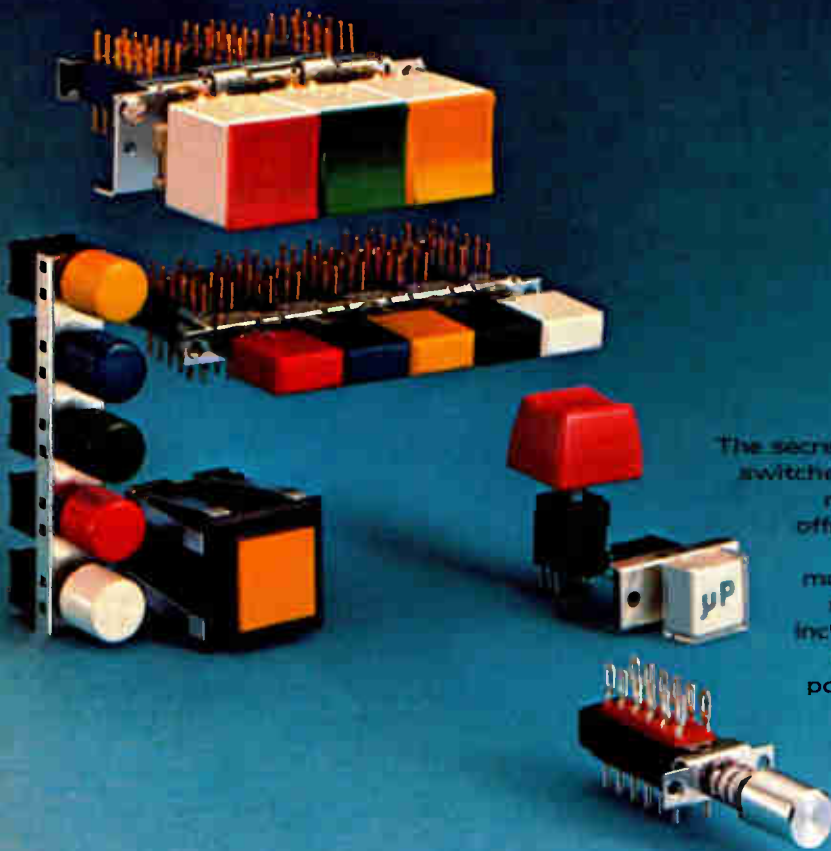

The secret to widening your choice of pushbutton switches is the unusual flexibility of Centralab's modular pushbutton switch systems. We offer the versatile PBS Series for horizontal mounting; the MPS Series for vertical mounting. Our long list of options help you meet the most demanding requirements, including microprocessor applications. You'll find lighted and non-lighted switches for pc board or snap-in panel mounting; single station or ganged assemblies with 10 to 25mm spacings; 2-4-6 or 8 pole designs for push-push, push-pull, momentary or interlocking operation with lockout options; silver or gold contacts; epoxy sealed terminals; and a variety of switch housing materials. An outstanding choice of other options includes buttons, colors, lenses, filters and legends.

One feature of Centralab pushbutton switches that's not an option is our outstanding service.

A nationwide network of Pushbutton Switch Distributors offers custom assembly and fast delivery of standard switches and options. And there's a Centralab Representative near you, ready to supply application help with your design.

Discover why the foremost source for switches is Centralab. Call your Centralab Distributor, Sales Representative or write Centralab, Inc., a North American Philips Company, 5855 N. Glen Park Road, P.O. Box 2032, Milwaukee, Wisconsin 53201.

CENTRALAB REPRESENTATIVES

AL	Huntsville	CARTWRIGHT & BEAN	(205) 533-3509
AZ	Phoenix	CLEMICK-NEENAN	(602) 279-7549
CA	Palo Alto	BROOKS TECH. GROUP	(415) 328-3232
	San Diego	CLEMICK-NEENAN	(714) 268-8540
	Sherman Oaks	CLEMICK-NEENAN	(213) 990-3150
	Tustin	CLEMICK-NEENAN	(714) 547-0966
CO	Evergreen	CENTRALAB	(303) 674-1092
CT	Meriden	CENTRALAB	(203) 235-0766
FL	Ft. Lauderdale	CARTWRIGHT & BEAN	(305) 735-4900
	Orlando	CARTWRIGHT & BEAN	(305) 422-4531
GA	Atlanta	CARTWRIGHT & BEAN	(404) 233-2939
HI	Honolulu	DOUGHERTY ENT.	(808) 847-4144
IA	Cedar Rapids	JERRY VRBIK CO.	(319) 366-8733
IL	Des Plaines	CENTRALAB	(312) 827-4487
IN	Indianapolis	LES M. DEVOE CO.	(317) 842-3245
KS	Shawnee Mission	LOWELL-KANGAS	(913) 631-3515
LA	Metairie	CARTWRIGHT & BEAN	(504) 835-6220
MA	Needham	CENTRALAB	(617) 444-4781
MO	Columbia	BRESSON ASSOC.	(215) 664-6460
MI	Lathrup Village	CENTRALAB	(313) 559-9095
	St. Joseph	CENTRALAB	(616) 983-0233
MN	Minneapolis	CENTRALAB	(612) 831-5212
MO	St. Louis	LOWELL-KANGAS	(314) 821-4050
MS	Jackson	CARTWRIGHT & BEAN	(601) 981-1368
NY	Albany	REAGAN/COMPAR	(518) 489-7408
	Endwell	REAGAN/COMPAR	(607) 723-8743
	Fairport	REAGAN/COMPAR	(716) 271-2230
	Great Neck	CENTRALAB	(516) 466-6570
	New Hartford	REAGAN/COMPAR	(315) 732-3775
NC	Charlotte	CARTWRIGHT & BEAN	(704) 377-5673
	Raleigh	CARTWRIGHT & BEAN	(919) 781-6560
OH	Brecksville	CENTRALAB	(216) 526-1205
	Worthington	CENTRALAB	(614) 888-2150
OR	Beaverton	CENTRALAB	(503) 643-5516
PA	Narberth	BRESSON ASSOC.	(215) 664-6460
TN	Knoxville	CARTWRIGHT & BEAN	(615) 693-7450
	Memphis	CARTWRIGHT & BEAN	(901) 276-4442
TX	Austin	CENTRALAB	(512) 454-9529
	El Paso	CENTRALAB	(915) 779-3961
	Farmers Branch	CENTRALAB	(214) 243-8791
VA	Lynchburg	BRESSON ASSOC.	(215) 664-6460
WA	Bellevue	CENTRALAB	(206) 454-7754
WI	Milwaukee	CENTRALAB	(414) 228-2122
PUERTO RICO	Hato-Rey	M. ANDERSON CO.	(809) 751-2026
CANADA			
B.C.	North Vancouver	ARWIN TECH SALES	(604) 980-4346
ONT	Ajax	McHUGH ELECTRONICS	(416) 683-1540
QUE	Ste. Dorothee Laval	HARNETT ENT.	(514) 689-4184

DISTRIBUTORS

CA	Brisbane	U. S. I.	(415) 468-4900
	Gardena	BELL INDUSTRIES	(213) 515-1800
	Los Angeles	KIERULFF ELECTRONICS	(213) 725-0325
	Palo Alto	KIERULFF ELECTRONICS	(415) 968-6292
	San Diego	KIERULFF ELECTRONICS	(714) 278-2112
CO	Denver	KIERULFF ELECTRONICS	(303) 371-6500
CT	East Haven	J. V. ELECTRONICS CO.	(203) 469-2321
FL	Orlando	HAMMOND ELECTRONICS	(305) 849-6060
IN	South Bend	RADIO DISTRIBUTING	(219) 287-2911
MA	Waltham	STERLING ELECTRONICS	(617) 894-6200
MN	St. Paul	GOPHER ELECTRONICS	(612) 645-0241
NC	Winston-Salem	KIRKMAN ELECTRONICS	(919) 722-9131
NE	Omaha	RADIO EQUIPMENT CO.	(402) 341-7700
NY	Buffalo	SUMMIT DISTRIBUTORS	(716) 884-3450
	Hempstead	ELECTRONIC EQUIPMENT	(516) 538-5510
	Lynbrook	PEERLESS RADIO CORP.	(516) 593-2121
OH	Cleveland	PIONEER-STANDARD	(216) 587-3600
	Dayton	STOTTS-FRIEDMAN	(513) 298-5555
PA	Montgomeryville	PYTTRONIC INDUSTRIES	(215) 643-2850
	Philadelphia	HERBACH & RADEMAN	(215) 426-1700
	Pittsburgh	CAM/RPC IND. ELECTS.	(412) 782-3770
TX	Stafford	SOUTHWEST ELECTS.	(713) 491-4900
WA	Seattle	ALMAC-STROUM ELECTS.	(206) 763-2300

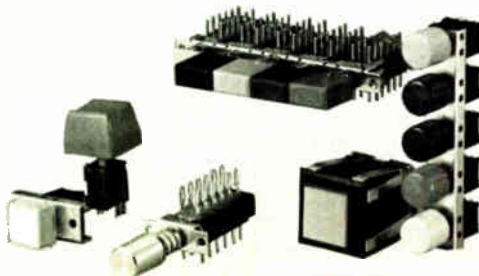

In Celebration of the 50TH Anniversary of *Electronics Magazine*...

The most exhilarating, comprehensible look at past and future developments in electronics that has ever been published.

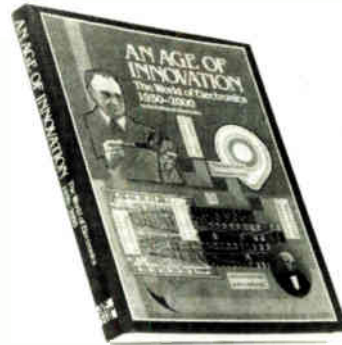

AN AGE OF INNOVATION

The World of Electronics 1930-2000
by the Editors of *Electronics*

The editorial edition of *Electronics'* 50th Anniversary issue of April 17, 1980, beautifully clothbound and jacketed for your permanent pleasure. 300 illustrations, many in full color. 274 pages, \$18.50

Painstakingly researched and written, AN AGE OF INNOVATION gives you an unforgettable overview of electronics. Everything from the individuals whose foresight and daring led to the great advances... to the origin of specific technological breakthroughs you use in your own work and home... to the challenges and discoveries we will face tomorrow.

Order your copy today!

Electronics Magazine Books
P.O. Box 669
Hightstown, NJ 08520
Tel. (609) 448-1700, ext. 5494



Please send me _____ copies of AN AGE OF INNOVATION @ \$18.50

Name _____

Company _____

Address _____

City/state/zip _____

McGraw-Hill pays regular shipping and handling on pre-paid orders.
Ten-day money-back guarantee on all books.

ELV

THE EVOLUTION OF A SCHADOW

The assignment: design a small, attractive, low-cost keyswitch for single-sided PC boards requiring complex circuit designs such as X-Y coding.

The result: ITT Schadow's "D-6" series.

At ITT Schadow, we specialize in designing switches that can be adapted to your specifications and front panel requirements. Our "D-6" keyswitch series is a good example.

The "D-6" is a normally open SPST keyswitch especially designed for digital electronic control. Its strapped terminals offer the possibility of X-Y coding with a single-sided PC board. Built-in square or round buttons fit directly through panel openings and come in a variety of appealing colors to suit any equipment decor. Positive tactile and audible feedback is provided to minimize input errors.

Also available is a new "D-7"

keyswitch which will accept most standard Schadow buttons or your custom-designed buttons. A wide variety of styles, colors, and graphics are available to suit your preferences. For more information on these and other Schadow switches, see your ITT Schadow manufacturer's representative or distributor. Or contact ITT Schadow Inc., a subsidiary of International Telephone and Telegraph Corporation, 8081 Wallace Road, Eden Prairie, MN 55344. Phone 612/934-4400.

ITT Schadow

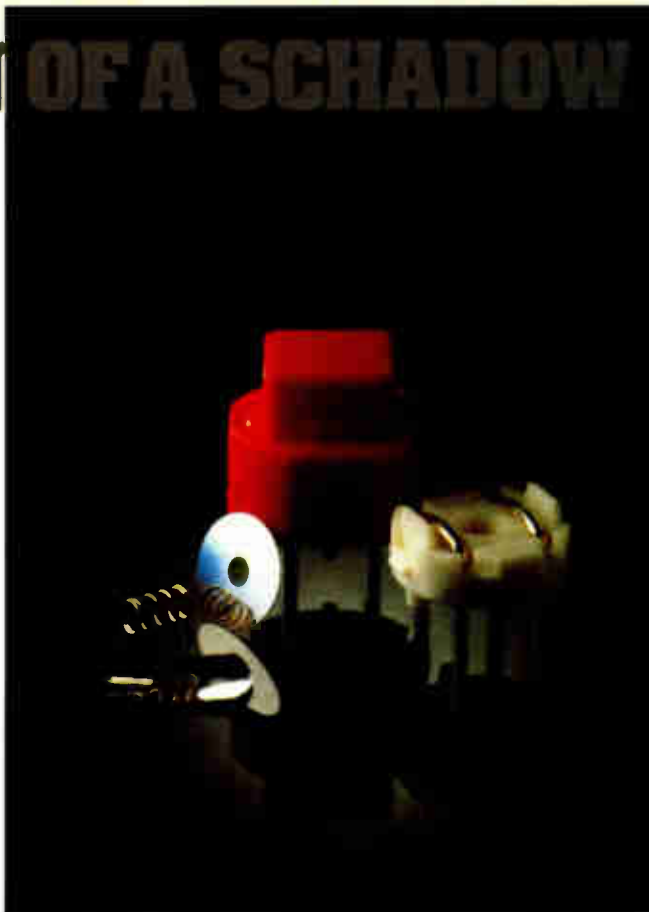

Circle 224 on reader service

LTI-501

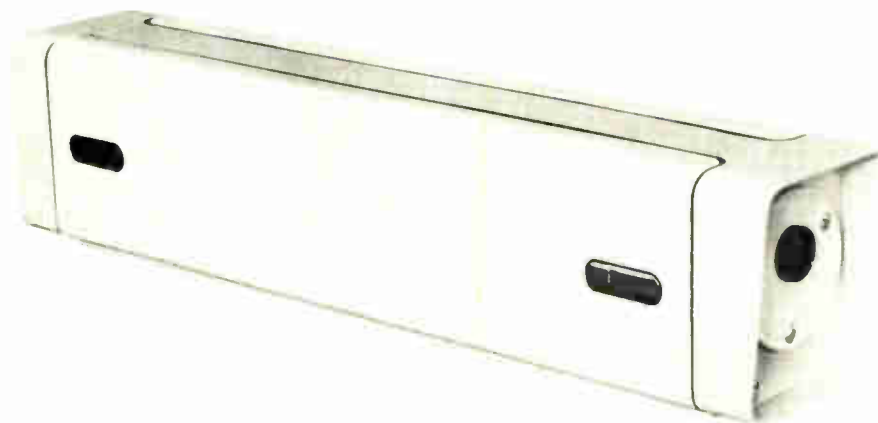

solid-state laser of proved efficiency in

- scribing semiconductor plates
- matching resistors
- dimensional working
- sputtering in vacuum
- conducting research in laser communication systems

Beam wavelength, nm	1,064.1
Radiated power, single-mode operation with 30 ± 10 % kHz pulse repetition rate, W	8 ± 20 %
Beam diameter at 0.5 energy level, mm	within 3
Beam divergence at 0.5 energy level, rad	within 3 · 10 ⁻³
Single-mode operable within pulse repetition rate from 5 to 50 kHz, with power output, W	at least 6
Power supply, V	220/380 ± 10 %
Mass, kg	within 222

 **TECHMASHEXPORT**

35, Mosfilmovskaya Ul. 117330 Moscow, USSR. Tel. 143-86-60. Telex: 411 068 TEHEX SU

Circle 61 on reader service card

COMPLETE BARE BOARD & BACKPLANE TEST SYSTEMS

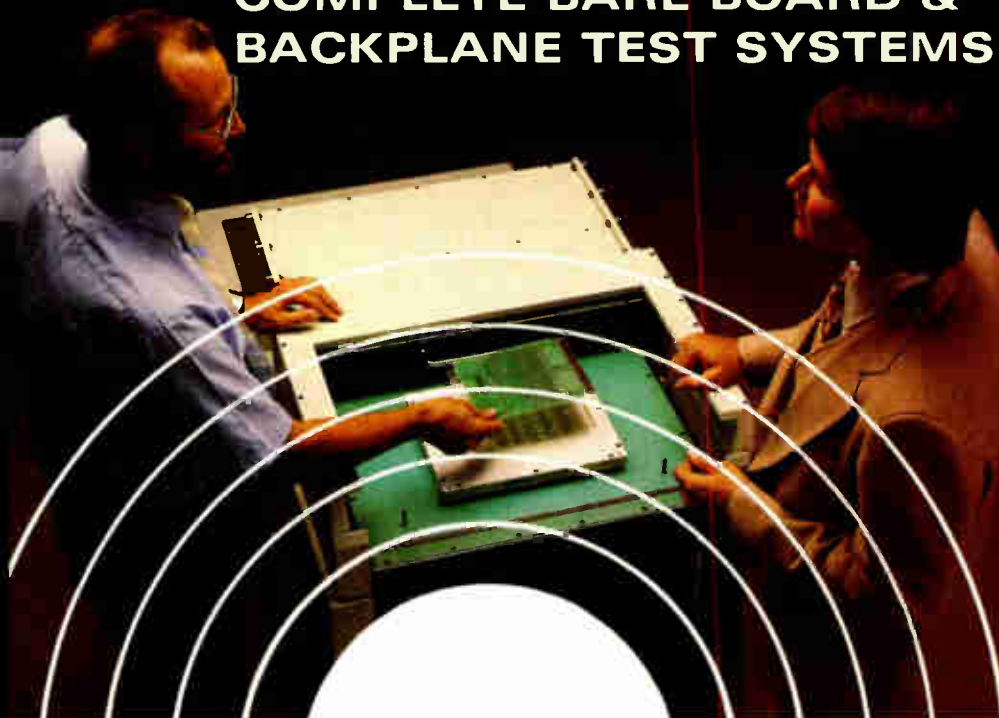

DIT-MCO TOTAL SYSTEMS CAPABILITY

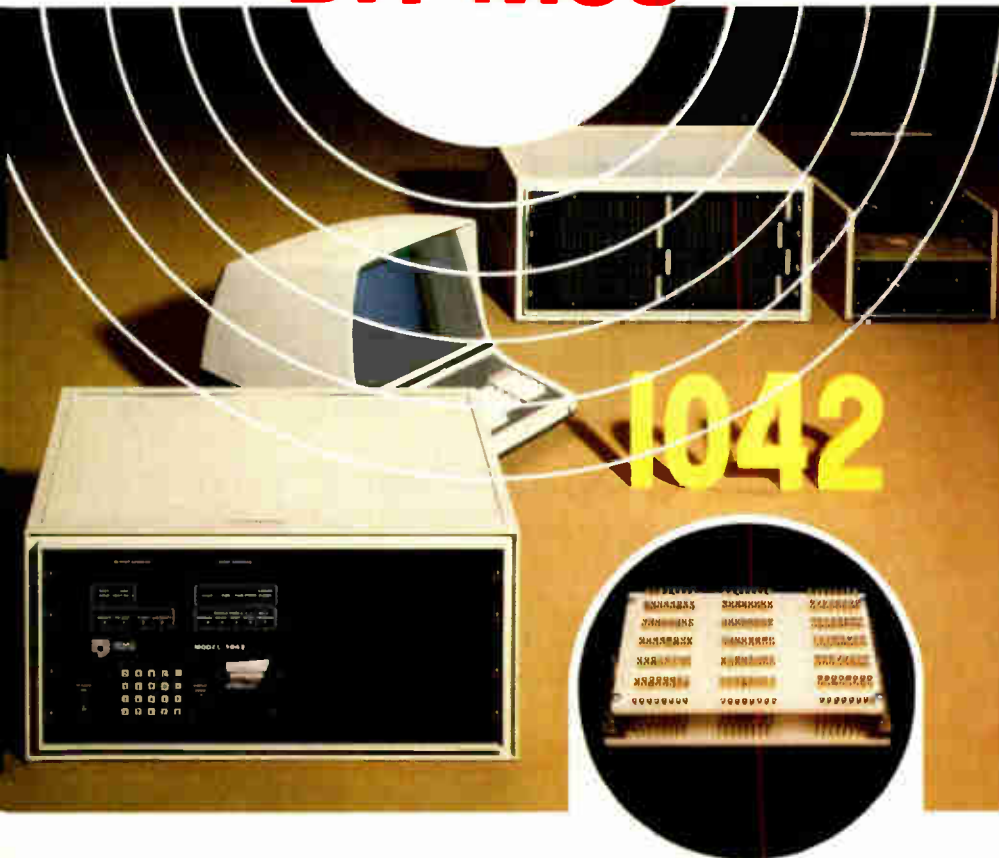

YOU'RE 100% RIGHT WITH DIT-MCO ATE

RIGHT PERFORMANCE.

DIT-MCO has continuity and short test systems to meet your testing needs. Total Systems Capability from low voltage MPU controlled testers to high voltage CPU driven analyzers. Termination capacities are available from 128 to over 100,000 points. Select from a broad range of analyzer-fixture combinations providing speed, versatility, flexibility, and over-all test performance.

RIGHT PRICE AND PAY-BACK.

Price performance factors of DIT-MCO analyzer fixture systems are cost effective. Increased operator efficiency, faster product throughput, and reduced TEST/QA costs contribute to a readily apparent and highly justifiable return on investment.

RIGHT SOURCE.

DIT-MCO analyzer-fixture systems are backed by over a quarter century of on-the-line field proven use. You're 100% right when your planning includes DIT-MCO, the world's leading manufacturer of interconnect test systems. Call our toll-free number or your closest international representative today. We'll tell you how DIT-MCO Total Systems Capability can satisfy your interconnect test requirements accurately, efficiently, reliably, 100%.

DIT-MCO MODEL 1042 INTERCONNECT TEST SYSTEM

Fully Automatic, Microprocessor Controlled, High Speed, With Floppy Disk...

- Powerful CP/M® and DIT-MCO software and software maintenance support.
- Separate Continuity and Short Test Levels.
- Creates Own Test Programs.
- Product Error Printout in Both Analyzer and Product Language.
- CRT Test Program Edit.
- Reliable High Speed Solid State Switching.
- TEST Program Listing on Printer.
- Communications Link with Host Computer.

ACCESS FIXTURE:

Select from the series of versatile standard DIT-MCO fixtures to complete the system. Model shown at left is Model AF-100 and Model AF-160 is above. Both feature quick change product adaptation through Transition Boxes or Offset Pin Boards.

DIT-MCO PATENTED OFFSET PIN BOARDS

The most cost effective method of interfacing product. As little as \$1 per point. Also available in kit form.

Call TOLL FREE 1-800-821-3487
(In Missouri Call 816-444-9700)

RADIX HOUSE • Central Trading Estate
Staines Middlesex • TW18-4-XA • England
Tel.: (0784) 51444

TEL • Shinjuku Nomura Bldg. • 26-2,
1-Chome, Nishishinjuku, Shinjuku-ku
Tokyo 160, Japan • Tel.: (03) 343-4411

Circle 225 on reader service card



DIT-MCO
INTERNATIONAL CORPORATION

QUALITY TESTING QUALITY!

5612 Brighton Terrace • Kansas City, Missouri 64130
Telex Number: 42-6149

DATA ACQUISITION: THRU-PUT AT 488 kHz

You can obtain true 12-bit performance . . . by combining Teledyne Philbrick's 4855 high-speed sample-hold with our new 4134 12-bit, progressive approximation A-to-D converter. Data acquisition thru-put rates of 488 kHz are achieved without the sacrifice of accuracy. With these and our other data conversion products, combinations of thru-put/resolution trade offs can be attained to solve your design problems.

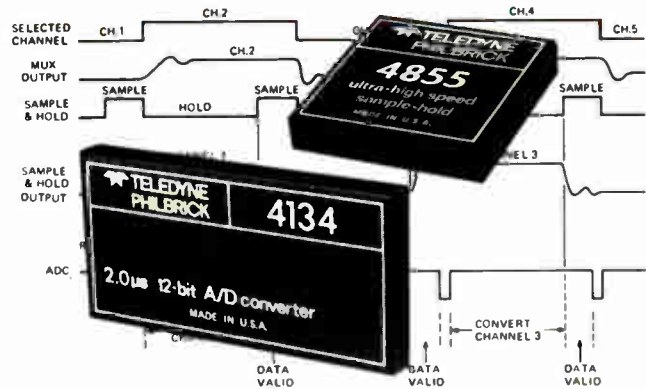

For additional information and special OEM pricing, contact the Marketing Department at (617) 329-1600



TELEDYNE PHILBRICK Data Converters, V/F/V Converters, Linears, Nonlinears, Power Supplies
Allied Drive at Route 128, Dedham, MA 02026
Tel: (617) 329-1600 TWX: (710) 348-6726 Telex: 92-4439

Circle 226 on reader service card

An invaluable, time-saving library of design facts and figures . . .

Circuits for Electronics Engineers

From *Electronics'* highly respected "Designer's Casebook," 346 circuits from all over the world—arranged by 51 of the most useful functions designers use to implement their systems, including . . . Amplifiers • Analog to digital & digital to analog converters • Counters • Detectors • Discriminators • Display circuits • Function generators • Integrators • Logic circuits • Memory circuits • Operational amplifier circuits • Power supplies • Protection circuits • Switching circuits • Temperature control • Timing circuits • Voltage regulating circuits . . . and many more. 396 pages, \$15.95.

Design Techniques for Electronics Engineers

The best of *Electronics'* popular "Engineer's Notebook," a host of proven design problem solutions to assist you at every point in the development of an engineering project—when you're making measurements . . . interpreting data . . . making calculations . . . choosing materials . . . controlling environment . . . laying out and purchasing components, and interconnecting them swiftly and accurately. The professional edge you can use to solve design problems fast, avoid tedious manual calculations, cut bench and development time. 370 pages, \$15.95.



Order today! And don't forget the other valuable Electronics Magazine Books on the coupon below.

Electronics Magazine Books P.O. Box 669, Hightstown, NJ 08520

I must be fully satisfied or you will refund full payment if the book is returned after ten-day trial examination. Send me:

- _____ copies of *Microprocessors* @ \$8.95
- _____ copies of *Applying Microprocessors* @ \$9.95
- _____ copies of *Large Scale Integration* @ \$9.95
- _____ copies of *Basics of Data Communications* @ \$12.95
- _____ copies of *Circuits for Electronics Engineers* @ \$15.95
- _____ copies of *Design Techniques for Electronics Engineers* @ \$15.95
- _____ copies of *Memory Design: Microcomputers to Mainframes* @ \$12.95
- _____ copies of *Personal Computing: Hardware and Software Basics* @ \$11.95

Discounts of 40% on orders of 10 or more of each book.

Payment enclosed Bill firm Bill me

Charge to my credit card:

American Express Diners Club
 Visa Master Charge

Acct. No. _____ Date Exp. _____

On Master Charge only, first numbers above name _____

Name _____ Title _____

Company _____

Street _____

City _____ State _____ Zip _____

Signature _____



When you design circuitry this tight, you need the protection of VACREL™ DRY FILM SOLDER MASK

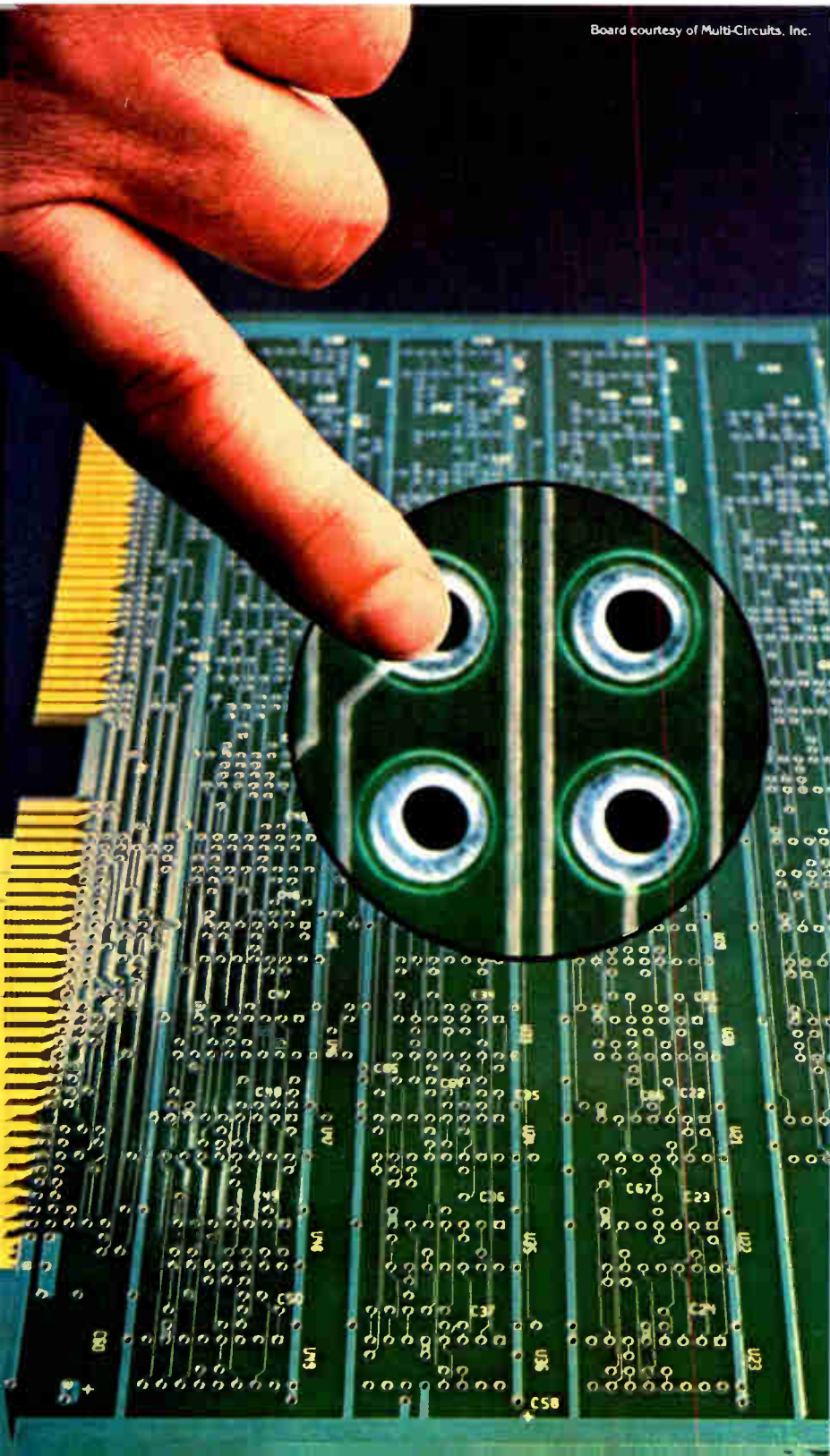

Board courtesy of Multi-Circuits, Inc.

Fine line printed circuit board designs call for tight conductor spacing. And with spacing tolerances of less than 0.3mm (0.012 inch), you need circuitry protection beyond the capability of ordinary screen printed solder mask. You need VACREL dry film solder mask.

In the cross sectional illustration below, VACREL uniformly covers the circuitry with no skips. It provides *maximum protection* of fine line circuitry, even below 0.2mm (0.008 inch) conductor spacings, resulting in electrical, environmental and mechanical protection.

Uniform coverage
with VACREL Solder Mask
0.2mm (0.008 in.)



Skips with conventional
screen printed solder mask
0.2mm (0.008 in.)



Conventional screen printed solder mask has limited utility in the protection of fine line circuitry.

Interested? Ask us to show you how VACREL dry film solder mask can protect your tightest circuitry designs. Write: VACREL Solder Mask, RISTON® Products, DuPont Company, Rm. 38014, Wilmington, DE 19898.

Innovations for Electronics



Circle 227 on reader service card

REDUCE CIRCUIT COSTS

3 WAYS

ERIE Tubular & Feed Thru Ceramic Capacitors



ERIE TUBULAR CAPACITORS

- Low cost
- Tubular shape is ideal for automatic insertion
- Low profile blends with high density packaging

ERIE Tubular Ceramic Capacitors are truly "a better way" to reduce circuit costs. In addition to these low cost, reliable capacitors, ERIE offers a broad range of Feed-Thru Ceramic Capacitors in mounting styles, capacitance ranges, TC types and voltages to suit any application.

These two ERIE-pioneered capacitor families are the finest quality in the industry. But then they should be, we've been building them for decades.

So check ERIE on your next capacitor buy. We probably have a standard design for your application.

Write for our new Fixed Capacitor catalog . . . or call 602-624-8231.

ERIE

ERIE TECHNOLOGICAL PRODUCTS, INC.
Erie, Pennsylvania 16501
602-624-8231

New products

Data acquisition

18-bit d-a unit contains reference

Hybrid converter also
includes op amp, latches,
as do low-cost 16-bit parts

Only 18 months ago, Hybrid Systems introduced its first 18-bit digital-to-analog converter, the DAC 374-18, packaged in a dual-width, 32-pin dual in-line package [*Electronics*, April 26, 1979, p. 180]. Claimed at the time to be the first hybrid of this resolution in such a small package, the DAC 374-18 has since been followed by units with fewer parts and improved price-performance ratios.

Now the firm is introducing two more converters, the 18-bit DAC 377-18 in a 28-pin hermetic package suitable for military environments, and the DAC 9377-16 (shown in photo), a 16-bit unit in a low-cost 24-pin package aimed at commercial sockets; they are available from stock. Both are equipped with an operational amplifier for voltage-output applications; both contain a variable-feedback 10-v reference

with a 5-ppm/°C temperature coefficient; and both have latches, or input registers, for interfacing with mini- or micro-computers.

Both converters use the large-scale integrated converter circuit introduced in the DAC 370-18 [*Electronics*, March 27, p. 199]. This complementary-MOS chip contains all converter electronics except a laser-trimmed resistor network, voltage reference, and operational amplifiers. Thus the parts count has dropped to about a quarter that of the DAC 374-18.

Analog LSI. The chip contains 29 tightly matched dual field-effect-transistor switches, 29 latches and drivers, 18 exclusive-OR gates, 16 decoders, and temperature-compensating electronics. All this packed into a single chip adds up to low price: for example, the DAC 9377-16, in 100-unit lots, costs \$65.

Much of this low price is due to Hybrid's proprietary glass-filled epoxy package, said to save the firm up to 95% of the cost of other commercial packages. The level of monotonicity achieved also affects the price: the \$65 figure applies to units with 14-bit monotonicity. Units with 15-bit monotonicity go for \$94 in the same quantities, while 16-bit monotonic units cost \$129 in hundreds.

DAC 377-18s are monotonic to 16 bits and are offered in two price and

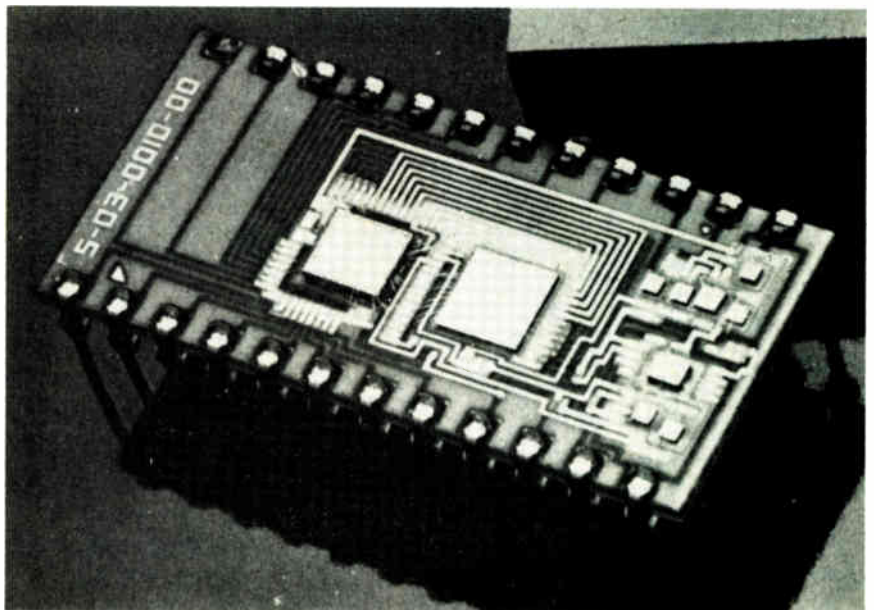

RUGGED

Bendix Tri-Start

Tough enough to tackle MIL-C-38999
And then some!

Bendix-designed and DOD-preferred, our high performance Series III Tri-Start connector meets the challenges of new technology. Challenges that depend on Tri-Start's ability to:

- withstand vibration (60G peak at temperatures up to 200°C)
- suppress electrolytic erosion
- provide superior EMI shielding
- resist corrosion (by withstanding 500 hour salt spray)

A new breed in connector capability, the general duty MIL-C-38999 Series III Tri-Start eliminates lock-wiring, couples in a 360° turn of the coupling nut, and intermounts with standard MS connectors. Tough and dependable, Bendix Tri-Start is available in a variety of shell styles and service classes, including class K firewall. Insert arrangements cover contact sizes 12 through 22D.

For complete information, call 607-563-5323 or write The Bendix Corporation, Electrical Components Division, Sidney, N.Y. 13838.

We speak connectors.

Bendix

Circle 229 on reader service card

All the moves in monolithics!

With the industry standard in selectivity on your side, our monolithic crystal filters give you the jump on the toughest of communications opponents. These interference-checkers are available to you now in 60 stock models at 10.7 and 21.4 MHz saving you design time and production cost. Others are available from 5 to 180 MHz. Make the first move and we'll send you the complete specs!

The standard in monolithic crystal filters.

EXCELLENCE ACROSS THE BOARD

Pi
Piezo Technology Inc.
 2525 Shader Rd., Orlando, FL 32804
 (305) 298-2000

Circle 230 on reader service card

DTMF-MODEMS

You are looking at the world's most complete line of DTMF receivers.

SSL's unparalleled performance in reliability, precision and competitive pricing have all come together to bring you the smallest and most advanced DTMF receivers available

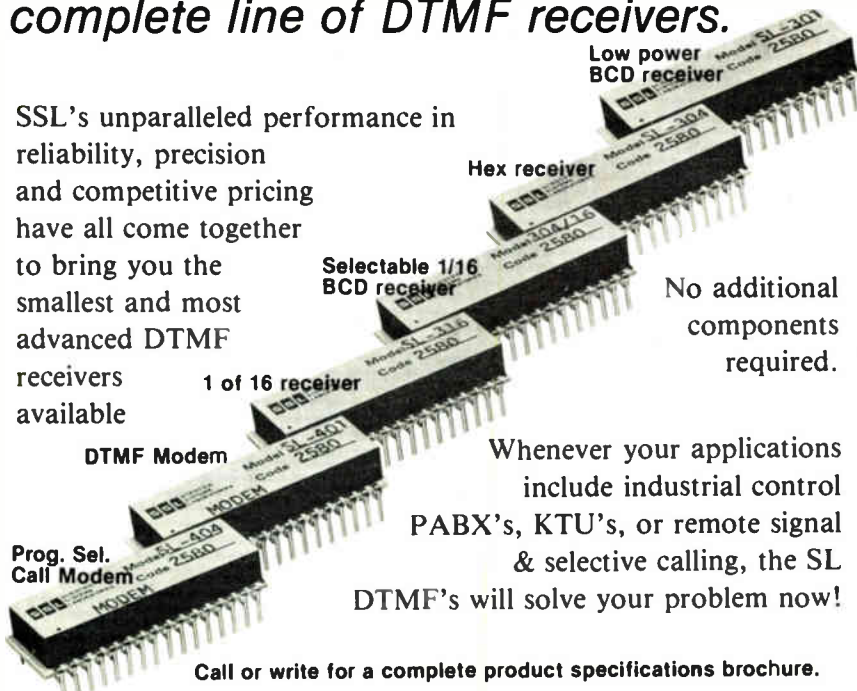

No additional components required.

Whenever your applications include industrial control PABX's, KTU's, or remote signal & selective calling, the SL DTMF's will solve your problem now!

Call or write for a complete product specifications brochure.

SSL SCIENTIFIC SYSTEMS LABORATORIES

2031 E. Cerritos, Suite J, Anaheim, CA 92806
 (714) 776-5003

230 Circle 65 on reader service card

New products

temperature ranges. For units operating over the 0°-to-80°C range, the 100-unit price is \$199, \$11 less than Hybrid's own six-month-old DAC 370-18, a current-output device with no voltage reference. For the -55°-to-+125°C military temperature range, the 377-18 sells for \$520 in hundreds. Much of the difference results from manufacturing to MIL-STD-883 reliability specifications and from the cost of documentation.

Both the 9377-16 and the 377-18 are expected to sell for so-called insurance applications: the 9377-16 to users who need a dependable 12 or 14 bits of resolution and the 377-18 to those needing a sure-fire 16 bits. User plans already are said to include high-resolution radar, sonar, and automatic-testing applications.

Both units accept either binary or offset-binary inputs and are compatible with diode-transistor-logic, TTL, and complementary-MOS. Input leakage current is rated at about 1 μ A maximum. Output is 0 to 10 v with current compliance of ± 5 mA and output impedance less than 1 Ω .

Relative to full scale, the scale factor is 0.1% and initial offset is $\pm 0.05\%$. Integral linearity for 377-18 and for the 16-bit-monotonic version of the 9377-16 is to within $\pm 0.0008\%$. Differential linearity typically is about half that figure.

Major-transition settling time (to 0.006% of full scale) is 20 μ s—faster than for most 16-bit converters and quite respectable for a voltage-output device. Power-supply requirements are a standard ± 15 v dc $\pm 5\%$. Power dissipation varies with model from a typical figure of 400 mW to a maximum of 500 mW, with most power going to the reference and output operational amplifier.

Hybrid Systems Corp., Crosby Dr., Bedford, Mass. 01730. Phone (617) 275-1570 [381]

16-bit a-d unit digitizes analog signal in 2 μ s

The ADC-1600 16-bit analog-to-digital converter will digitize an analog input signal in a maximum of 2 μ s. The converter can be configured



Wire Wrapping tools: Manual, battery, electric and pneumatic

Wire Wrapping bits and sleeves: Wire sizes 18 to 30 AWG (1,00 to 0,25mm)

Semi-automatic Wire Wrapping machines: Compact bench mounted systems to large floor mounted systems

Automatic Continuity Test equipment: 0-32,000 points

Automatic graphic data entry systems for generating N.C. program tapes

Component Preforming equipment

Just part of our comprehensive range — want to know more contact:

OK Machine & Tool Corporation
3455 Conner St., Bronx, N.Y. 10475 U.S.A.
Tel. (212) 994-6600 Telex 125091

High Speed Analog Memories

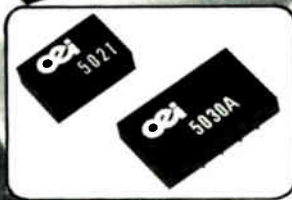

PEAK SENSE AND HOLD
Sinusoidal Bandwidth: DC-10MHz
Acq. Time, +10V Step, 30ns
Reset Time: 1 μ s Gate Time: 1 μ s

Model 5030A \$102.00 (3-9)
2.5" x 1.5" x 0.5" Module

MIL Packages also available
Request 72-page Op Amp,
Function Module Catalog.

Tr. Mode Bandwidth: 100MHz
Tr. Slew Rate: 150V/ μ s, Cx=0
Aperture Time: 3ns
Acq. Time, 10V: 1 μ s, Cx=100pF
Decay Rate: 100 V/sec, Cx=10pF

Model 5021 \$85.00 (3-9)
2" x 1" x 0.6" Module

OEI • Box 11140 • Tucson, AZ 85734 • (602) 624-8358 • TWX: 910-952-1283

Circle 232 on reader service card

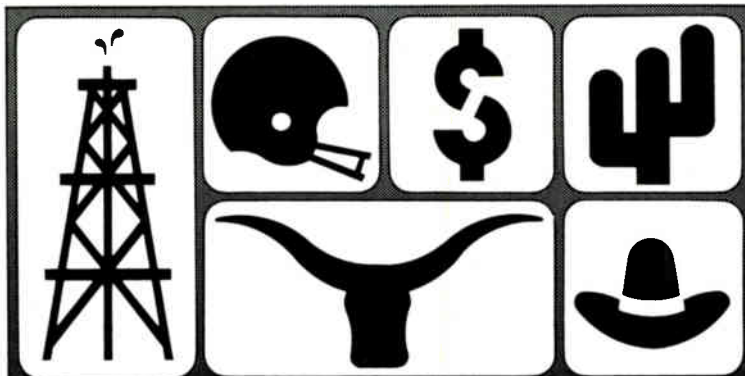

TEXAS

If you'd like your career to get back in the saddle again,
watch for the Texas Career Opportunities Section in
ELECTRONICS' October 23rd Issue.

New products



with either single-ended or differential inputs in its basic form, offering conversion times of 2 or 4 μ s. It comes with sample and hold inputs, and options include either a 2- or a 5- μ s sample-and-hold in a single-ended input configuration. Temperature coefficients are ± 7 ppm/ $^{\circ}$ C and maximum nonlinearity error is $\pm 1/2$ least significant bit. All inputs are diode-transistor-logic- and TTL-compatible. In quantities of one to nine, the ADC-1600 is priced from \$2,050; delivery is from stock to 12 weeks.

Intech Function Modules, 282 Brokaw Rd., Santa Clara, Calif. 95050. Phone (408) 727-0500 [383]

Monolithic data-acquisition system includes RAM on chip

A monolithic data-acquisition system includes on-chip random-access memory. The AD7581 contains an 8-bit successive-approximation analog-to-digital converter, an eight-channel multiplexer, an 8-by-8-bit dual-port RAM with address latches,

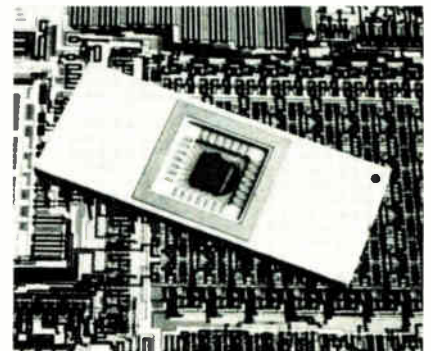

Cost Effective Systems for the Microcomputer OEM.

Ohio Scientific has been building small business microcomputers and personal computers since the beginning of the microcomputer revolution. Most Ohio Scientific products incorporate a bus architecture utilizing modular circuit cards mated to a multi-slot backplane. Ohio Scientific's 48 signal line bus is designed to effectively marry the versatility and modularity of bus architecture with the economies of consumer products producing an ultra-low cost yet reliable system. Many industrial users of microcomputers recognize the economy and versatility of Ohio Scientific's modular computer boards and utilize these boards and subsystems as well as customers who purchase complete computer systems on an OEM basis.

Ohio Scientific's New OEM Program

Ohio Scientific now recognizes the importance of the OEM marketplace and is introducing a complete program for the board level OEM user as well as the system OEM. The program starts with our standard products including three CPU boards, a broad range of static and dynamic memory boards, mini and 8" floppy disk controllers, printer controllers, multiple RS-232 port boards, a hard disk controller, and video interface with optional keyboard. Backplanes with two, four, eight or sixteen slots are available. These standard products are now being supplemented by a broad range of

products specifically for the OEM user including:

- New universal telephone interface board which has auto-dial capability, auto-answer capability, tone encoding and decoding, answer and originate 300 baud modem and voice I/O via tape recorder or optional phonetic voice output system.
- New calendar-clock with several month battery backup capability which can be programmed to automatically restart the computer or shut off the computer at set times. The circuit board also includes automatic power-fail restart capability.
- Instrumentation quality high speed, 12-bit analog A/D - D/A module with a 16-channel input multiplexer and two 12-bit D/A converters.
- A large range of parallel interface options including circuit cards containing 48 parallel I/O lines.
- New solderless prototyping board which connects to the computer system and allows rapid prototyping of new interface ideas.
- System PROM blaster which accepts 8K through 64K bit industry standard EPROMS and a universal EPROM-ROM card.
- A card edge extender, bus analyzer and bus compatible breadboards.

Documentation

All of Ohio Scientific major circuit boards are now fully documented by Howard Sams (the originator of the Sams Photo-fact series for Consumer Electronics) servicing manuals which include block diagrams, schematics, detailed pictorials, parts placement diagrams and parts lists

providing the designer, systems integrator and serviceman with detailed hardware information. Ohio Scientific is offering qualified OEM users its principal disk operating system (OS-63D V3.2) which supports multiple languages, mini-floppies, 8" floppies, printers, modems and other accessories in documented Source Code and machine readable form which can be reassembled on standard OSI computers. This gives the product developer the ultimate flexibility in integrating these components into his total system design.

Best of all is the Price

Because of Ohio Scientific's hundreds of thousands of boards per year volume for the consumer and small business market, these products cost a mere fraction of the corresponding LSI-11, SBC or S-100 bus boards. This economy allows you to utilize a floppy subsystem in your product at a total cost typically less than an EPROM based system from other vendors.

Ohio Scientific's reasonably priced universal telephone interface and voice output capabilities allow you to integrate advanced telecommunications, remote control capabilities and/or unlimited vocabulary voice response in your systems at the same price as a "bare bones" implementation with other bus architectures.

Easy to Start With

Getting started with the OSI bus architecture is now easy with documentation, off the shelf availability, and economical computer systems for in-house software development using Assembler, BASIC FORTRAN or PASCAL. Ohio Scientific's new OEM contract provides easy to start with terms and generous volume discounts.

For more information and the name and phone number of your local Ohio Scientific OEM representative call 1-800-321-6850 toll free. Please specify your interest as an OEM user.

OHIO SCIENTIFIC

1333 SOUTH CHILLICOTHE ROAD
AURORA, OH 44202 • [216] 831-5600





Digital accuracy in an analog recorder: Gould's ES 1000.

Our new fixed linear array writing system gives you trace precision and reliability unmatched by conventional writing methods.

The ES 1000 electrostatic analog recorder provides faster rise time, higher resolution, full-scale overlapping display of all channels at user's discretion, excellent square wave and peak capture, simultaneous grid generation, and complete annotation of necessary information from internal and external sources. It produces high contrast, permanent records on low cost electrostatic paper (¼ the cost of photo sensitive paper).

For more information, write Gould Inc., Instruments Division, 3631 Perkins Ave., Cleveland, Ohio 44114. For brochures call toll-free: (800) 331-1000. In Oklahoma, call collect: (918) 664-8300.

 **GOULD**
An Electrical/Electronics Company

Circle 66 on reader service card

Tailored to your needs



Electronic Service Kits

Now top quality Snap-on electronic tools are offered in four standard or individually tailored tool kits for the professional electronic technicians and manufacturers of electronic components and equipment. Kits are available in various styles of attache cases and tool holding inserts. For full details write us or call your nearest Snap-on branch. Snap-on Tools Corporation, 8051J 28th Avenue, Kenosha, Wis. 53140.

Snap-on Tools

554

234 Circle 234 on reader service card

New products

control logic, comparator, and three-state buffers. The system connects directly to the 8080, 8085, Z80, 6800, and other microprocessors; the converter is transparent to them. Input channels are scanned sequentially and continuously, averaging 680 μ s for eight channels. On-chip logic provides interleaved direct memory access.

Six versions are available, all in 28-pin dual in-line packages: the JN, KN, and LN grades are specified for the 0°-to-70°C temperature range and come in a plastic DIP; AD, BD, and CD grades are specified for the -25°-to-85°C range and are housed in a ceramic DIP. Differential nonlinearity is $\pm 3/4$, $\pm 7/8$, and $\pm 1 1/8$ least significant bit maximum over the specified temperature ranges for LN and CD, KN and BD, and JN and AD versions, respectively. Relative accuracy is to within $\pm 1/2$, $\pm 3/4$, and $\pm 1 1/8$ LSB maximum within given temperature ranges. The AD7581 sells for \$13.90 in 100s and large quantities can be delivered 90 days after an order is received.

Analog Devices Semiconductor, 804 Woburn St., Wilmington, Mass. 01887. Phone (617) 935-5565 [385]

15-bit sample-and-hold has 300-ps aperture uncertainty

The model 1569 is a digital gain-controlled differential-input sample-and-hold amplifier suitable for up to 15 bits of resolution. Really two separate differential sample-and-hold amplifiers contained on one printed-circuit board, it exhibits low offset and drift characteristics in both sample and hold modes. Its low aperture uncertainty time of less than 300 ps permits the acquiring of analog data containing high frequencies while the unit maintains high accuracy. The model 1569 has been designed for installation into the TEC A/D x-1500 Data System and is available from stock. The fixed-gain model is priced at \$200 per unit and the programmable-gain version at \$250.

Tustin Electronics Co., 1431 E. St. Andrews Place, Santa Ana, Calif. 92705 [384]

Electronics/October 9, 1980



LRC test and evaluation.

BIN	LO X	HI X	COUNT
01	- 1.00	+ 1.00	00005
02	- 2.00	+ 2.00	00017
03	- 5.00	+ 5.00	00152
04	- 10.00	+ 10.00	00153
05	- 20.00	+ 20.00	00069
06	- 20.00	+ 80.00	00036
07	+ 0.00	+ 0.00	00000
08	+ 0.00	+ 0.00	00070
00	MAIN REJECT BIN		00000
0	REJ>	.001000 RS/XS DS	00012
1	NOM=	10.0000P FARADS CS	
0	STATUS		

1. High & Low Sorting Limits
2. Parts Count Per Bin
3. Loss Reject Limit
4. Nominal Value
5. Measurement Functions
6. Programmable Test Frequency
7. Programmable Test Voltage
8. Measurement Modes
9. Settling & Integration Time
10. No. of Measurements for Averaging
11. Capacitance Measurement
12. Dissipation Factor
13. Communication Lines

6	01000 HZ	NOM= 0.00000	FARADS	4
7	0500 MV	SINGLE	DIRECT	
	SETL=0005NS	INTGR=0010NS	AVE=10	10
	AUTO			
	11. 10.1858 pF			CS
	12. .02044			5
	0 > SINGLE			
13	0 > STATUS			

Now you get the full picture ...at LED prices.

Get the complete view of your LRC measurements with the new 2100 and 2110 VideoBridges from ESI. They're the first LRC meters to combine effective software, memory, a CRT and keyboard, to give you interactive operation... with a price comparable to LRC meters with only LED readout.

Both VideoBridges will display 12 impedance and loss characteristics, measureable at test frequencies from 20 Hz to 20 kHz, at programmable voltage or current levels, with accuracy from 0.05%.

With the 2110 VideoBridge, you can program your test conditions

on cassette, acquire the data, store it, and manage and display your test results. You can store test programs for different components, for repetitive testing needs.

Find out how our VideoBridges can fill your impedance measuring requirements, both today and tomorrow. Call your nearest ESI representative or circle the reader service number below.

ESI VideoBridges™. You can communicate with them.



Electro Scientific Industries • Portland, OR 97229 • (503) 641-4141

Circle 235 on reader service card



AILTECH high-quality, high-power Broadband Linear Amplifiers.

**Frequency range 10 kHz
to 1 GHz in 4 bands, 8
models available**

- ALC signal provided.
- Dual directional true wattmeter reads true forward and reflected power.
- Up to 50 watts output power.
- All Solid State.
- Positive no-load protection.
- True linearity (ask for a side-by-side comparison before you buy).

Applications: Wattmeter calibration, EMI susceptibility testing, high power testing of transistors, amplifiers, components, NMR systems.

AILTECH RF Power Signal Sources



- 10 kHz to 2.5 GHz
- Plug-in versatility
- Up to 50 Watts output
- AM/FM options

**Modules for OEM
applications.**



Broadband amplifier modules tailored to customer requirements are supplied for OEM applications at considerable cost savings. They are packaged in RFI proof modules and operate from a standard 28 volt power supply. For further information on AILTECH products, contact Eaton Corporation, Electronic Instrumentation Division, 19535 East Walnut Drive, City of Industry, CA 91748. Telephone (213) 965-4911

EATON
Advanced
Electronics

AMAZINGLY SIMPLE R&D EFFORT YIELDS UP TO 20 PERCENT EXTRA MOLDED DIP PRODUCTION.

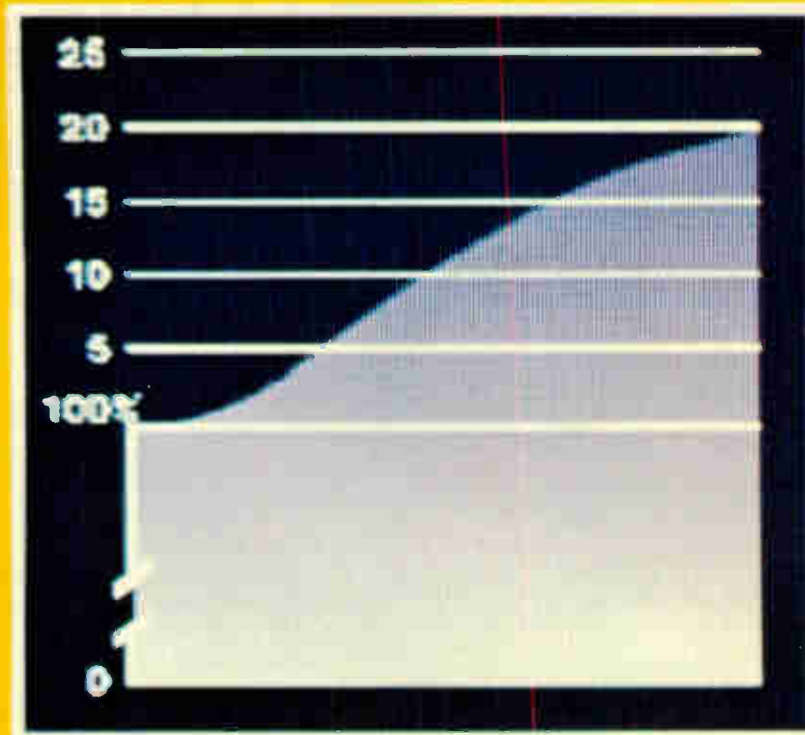

Incremental Hysol
Molded DIP
Productivity

Typical Molded
DIP Productivity

The amazingly simple research works like this.

You pick up the telephone.

You call Hysol and ask for facts on our state-of-the-art semiconductor transfer molding compounds.

These advanced epoxy compounds are formulated for optimum production characteristics as well as superior device performance.

For example, Hysol epoxies develop a higher hot hardness than conventional epoxy compounds. So instead of

an average three minute mold cycle, the same mold press can produce a finished shot in *two*.

Hysol epoxies can also significantly reduce the need for deflashing. Or eliminate it completely.

They can help reduce post-cure time by a hefty 60 to 70 percent.

And because they leave your molds clean more than twice as long, they can reduce cleaning maintenance from once per shift to just once every two shifts or three.

Result?

You get five, ten—up to 20 percent extra molded DIP production per shift. With no extra investment.

Along with better productivity, of course, you get the extra assurance of Hysol quality.

Plus all the advantages of Hysol performance. Like improved moisture resistance, better thermal cycling characteristics and increased thermal stability—for better reliability.

Hysol is the leader in semiconductor epoxy technology. And to prove it, we'll supply the Hysol epoxy and qualified field support for a full productivity and performance comparison on your test line.

So if you're looking for

a major breakthrough in molded DIP production, just call Hysol.

The best discoveries are always simple.

HYSOL DIVISION
THE DEXTER CORPORATION

15051 East Don Julian Road,
Industry, CA 91749.
Telephone (213) 968-6511.



CABINET DECISION.

When you're considering small cabinets, instrument cases and utility boxes, consider Bud. These sleek, clean, contemporary cabinets and our reputation for value make Bud Standard enclosures the outstanding choice.

And, there's a Bud Authorized Distributor near you to deliver these standard products from stock. Now, in most cases, you won't have to wait to get the most respected name in enclosures.

Bud offers the industry's largest, most diversified line of standard enclosures, accessories and hardware...from stock. For full information on the Bud family of enclosures, write or call: Bud Industries, Inc. 4605 East 355th Street, Willoughby, Ohio, 44094. Phone: 216/946-3200. Bud West, Inc. 3838 North 36th Avenue, Phoenix, Arizona 85019. Phone: 602/269-3151.

BUY BUD

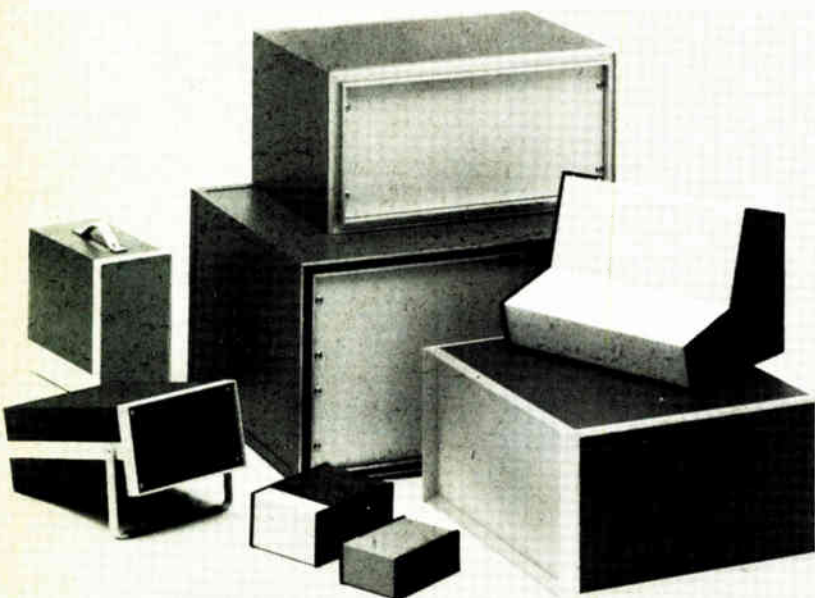

Circle 238 on reader service card

NEW 1980 Electronics Buyers' Guide

The only book of its kind in the field. If you haven't got it, you're not in the market.

To insure prompt delivery enclose your check with this coupon.

Yes, please send me _____ copies of 1980 EBG.

I've enclosed \$30 per copy delivered in USA or Canada. Address: EBG, 1221 Avenue of the Americas, New York, N.Y. 10020.

I've enclosed \$52 for air delivery elsewhere. Address: EBG, Shoppenhangers Road, Maidenhead, Berkshire S16, 2Q1 England.

Name _____

Company _____

Street _____

City _____

State _____

Zip _____

Country _____

For more information call these Bud Representatives

AL	Huntsville, Cartwright & Bean Co.	205-533-3509
AZ	Scottsdale, Summit Sales Co.	602-994-4587
AR	Memphis, TN, Cartwright & Bean Co.	901-276-4442
CA	Ingelwood, Jack Berman Co.	213-649-6111
CA	Santa Clara, David Ross Co.	408-988-8111
CO	Denver, Lindberg Co.	303-758-9033
CT	Needham, MA, Mullin Technical Sales, Inc.	617-444-4780
DE	Cherry Hill, N.J. Trinkle Sales, Inc.	609-795-4200
DC	Cherry Hill, N.J. Trinkle Sales, Inc.	609-795-4200
FL	Ft. Lauderdale, Cartwright & Bean Co.	305-735-4900
FL	Orlando, Cartwright & Bean Co.	305-422-4531
GA	Atlanta, Cartwright & Bean Co.	404-233-2939
ID	Denver, Co. Lindberg Co.	303-758-9033
IL	Chicago, Industrial Representatives, Inc.	312-647-7755
IN	Maryland Heights, MO, PMA Corp.	314-569-1220
IN	Carmel, Rich Electronic Marketing, Inc.	317-844-8462
IN	Ft. Wayne, Rich Electronic Marketing, Inc.	219-432-5553
IA	Cedar Rapids, PMA Corp.	319-362-9177
KS	Overland Park, PMA Corp.	913-381-0004
KS	Wichita, PMA Corp.	316-684-4141
KY	Louisville, Rich Electronic Marketing, Inc.	502-239-2747
LA	Metairie, Cartwright & Bean Co.	504-835-6220
ME	Needham, MA, Mullin Technical Sales, Inc.	617-444-4780
MD	Cherry Hill, N.J. Trinkle Sales, Inc.	609-795-4200
MA	Needham, Mullin Technical Sales, Inc.	617-444-4780
MI	E. Detroit, Jack M. Thorpe Co.	313-779-6363
MN	Minnetonka, Gibb Electronic Sales	612-935-4600
MS	Jackson, Cartwright & Bean Co.	601-981-1170
MO	Maryland Heights, PMA Corp.	314-569-1220
MT	Denver, Co. Lindberg Co.	303-758-9033
NE	Maryland Heights, MO, PMA Corp	314-569-1220
NV	Santa Clara, CA, David Ross Co.	408-988-8111
NV	Scottsdale, AZ, Summit Sales Co.	602-994-4587
NH	Needham, MA, Mullin Technical Sales, Inc.	617-444-4780
NJ	Cherry Hill, Trinkle Sales, Inc.	609-795-4200
NJ	E. Rockaway, N.Y. Willgold Sales Corp.	516-764-4022
NM	Albuquerque, Lindberg Co.	505-881-1006
NY	E. Rockaway, Willgold Sales Corp.	516-764-4022
NY	Rochester, Marchese, Marsey & Barden	716-544-4300
NC	Charlotte, Cartwright & Bean Co.	704-377-5673
NC	Raleigh, Cartwright & Bean Co.	919-781-6560
ND	Minnetonka, MN, Gibb Electronic Sales	612-935-4600
OH	Cleveland, Marlow Assoc., Inc.	216-991-6500
OH	Columbus, Marlow Assoc., Inc.	614-885-7643
OH	Dayton, Marlow Assoc., Inc.	513-435-5673
OK	Dallas, TX, Erickson Sales, Inc.	214-739-5833
OR	Portland, Earl & Brown, Inc.	503-245-2283
PA	Cherry Hill, N.J. Trinkle Sales, Inc.	215-922-2080
PA	Pittsburgh, Marlow Assoc., Inc.	412-831-6113
RI	Needham, MA, Mullin Technical Sales, Inc.	617-444-4780
SC	Charlotte, N.C. Cartwright & Bean Co.	704-377-5673
SD	Minnetonka, MN, Gibb Electronic Sales	612-935-4600
TN	Knoxville, Cartwright & Bean Co.	615-893-7450
TN	Memphis, Cartwright & Bean Co.	901-276-4442
TX	Austin, Erickson Sales, Inc.	512-327-5486
TX	Dallas, Erickson Sales, Inc.	214-739-5833
TX	Houston, Erickson Sales, Inc.	713-498-2959
UT	Salt Lake City, Lindberg Co.	801-534-1500
VT	Needham, MA, Mullin Technical Sales, Inc.	617-444-4780
VA	Cherry Hill, N.J. Trinkle Sales, Inc.	609-795-4200
WA	Seattle, Earl & Brown, Inc.	206-284-1121
WV	Cleveland, OH, Marlow Assoc., Inc.	216-991-6500
WI	Milwaukee, Industrial Representatives, Inc.	414-259-0985
WY	Denver, Co. Lindberg Co.	303-758-9033

BUD

BUD INDUSTRIES, INC.
4605 East 355th Street
Willoughby, Ohio 44094
(216) 946-3200

BUD WEST, INC.
3838 North 36th Avenue
Phoenix, Arizona 85019
(602) 269-3151

VACTEC Photodiodes

Vactec photodiodes are the Gateway* to solutions for detection problems requiring:
Blue spectrum response, high signal to noise ratio, excellent linearity, superb stability, high voltage operation, fast rise times, low shot noise, low cost

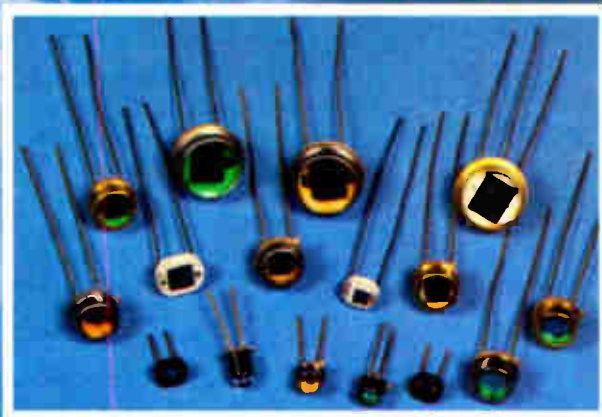

Just a few of the applications for which Vactec photodiodes have found solutions are:
light pens, colorimeters, spectrophotometers, analyzers for color film processing, blood analysis, color sorting, camera exposure controls, and hand held exposure meters.

Packages for our photodiodes cover the complete range from hermetic with glass or U-V transmitting windows, isolated detectors, to ceramic headers epoxy coated. Custom arrays are readily fabricated and packaged in dual-inline configuration. Write for Bulletins VTB-1B and VTP-1.

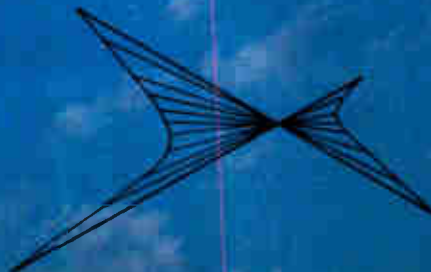

Vactec, Inc.

2423 Northline Ind. Blvd.
Maryland Heights, Mo. 63043
(314) 872-8300
TWX 910-764-0811

*St. Louis Arch in background.
"The Gateway to the West."

Circle 239 on reader service card



The use of our large experience in the electronic industry for know-how, engineering, licences, technology, studies, design, manufacturer's marks, complete assembling lines, technical assistance, training of the staff, services, would certainly give you a complete satisfaction.

High qualified specialists of a large experience are ready to answer accurately your most exigent demands just contact them!

Ask for technical data and any other informations on the following address:

ELECTRONUM
 EXPORT - IMPORT
 Specialized Foreign
 Trade Company
70317 Bucharest-Romania
 11-15, Olari Street
 P.O.B.: 34-36
 Telex: 11547, 11584



New products

Materials

Chip-processing chemicals become 1,000 times purer

The materials used in making semiconductors, especially fine-line large- and very large-scale integrated circuits, must be kept fanatically clean. Allied Chemical's new line of chemicals caters to that need. The Particu-lo low-particle-grade, low-mobile-ion processing chemicals are filtered and packaged to deliver a purity 1,000 to 10,000 times greater than that of products currently on the market. They are virtually free from many of the particles found in other low-mobile-ion-grade processing chemicals and are already in use in the fabrication of devices with 2- μ m geometries, reports Gary J. Clancy, manager of marketing for electronic chemicals in Morristown, N. J.

A 30% hydrogen peroxide solution will typically have about 8.3 million 1- μ m or larger particles per liter if it is classified as a low-grade, low-mobile-ion substance. The same chemical when processed to Allied's Particu-lo standards will contain only 10,000 particles/l maximum, 5,000 typically.

The line runs the gamut of processing chemicals for etching and cleaning and includes sulfuric acid, hydrogen peroxide, and isopropyl alcohol, as well as a variety of stripping solutions. Altogether nearly 30 chemicals are being offered. "Any product that would be used in a semiconductor processing line is available in the Particu-lo line, with the exception of photoresists," notes Clancy.

The chemicals may be completely substituted for any products now being used, according to Clancy, with no changes needed in the manufacturing process. "We recommend that tanks and process vessels be kept as clean as the wafers are kept, however," he advises. The products are available in 2.2-l glass bottles,

3.8-l amber glass bottles, and 3.8-l polyethylene bottles, depending on the particular chemical. The bottling is done in a controlled, clean atmosphere, and each filled container is wrapped in two plastic bags to protect its exterior.

Clancy estimates that the Particu-lo products sell, on average, for about three times the price of low-mobile-ion-grade chemicals. For example, sulfuric acid now sells for about \$5 per 2.2-l bottle, whereas the Particu-lo product will sell for about \$19 for the same size bottle. A 3.8-l bottle of isopropyl alcohol sells for about \$5 now, and the Particu-lo product will sell for about \$16. He notes that for most semiconductor manufacturers, a yield increase of up to 10% will often offset this additional expense.

Particu-lo products are now available in sample quantities for production use.

Allied Chemical Corp., Chemicals Co., P. O. Box 1139R, Morristown, N. J. 07960 [476]

Thick-film resistor material ranges to 1 M Ω per square

The 1800 series of thick-film resistor compositions developed for potentiometers and trimmers includes eight members, ranging in value from 1.5 Ω per square to 1 M Ω /sq. The Birox 1800 materials exhibit low contact resistance variation even in the low-resistivity compositions. The temperature coefficient ratio for the 1-k Ω /sq



WE TURN OUT MORE LIGHTS THAN ANYBODY ELSE.



We've developed the industry's broadest and most advanced line of infrared LEDs and detectors. We also offer more opto package configurations. And more products available in volume orders.

That's everything you need for precision switching and sensing functions in applications requiring encoding, card and tape sensing, object positioning and detection.

On the emitter side, our LEDs

utilize power efficiently to provide reliable and accurate operation in a variety of packages. We match that capability with high performance photodiodes, phototransistors, photodarlington and photo ICs. Plus, we manufacture the only opto Schmitt component with internal voltage regulation that's compatible with TTL, CMOS, and other standard logic families.

All Spectronics parts are available in volume from a nationwide network of distributors. And our staff of

highly trained engineers is available to answer any questions you may have about the design or implementation of our products.

So, if you've been in the dark about opto design, give us a call. We turn out more lights so you can turn out better designs.

For more information, call us at 214/234-4271. Or write to Spectronics, 830 East Arapaho Road, Richardson, Texas 75081.

Spectronics
A Division of Honeywell

Light years ahead.

TYPICAL SPECS FOR SPECTRONICS' EMITTERS AND DETECTORS

LED
Near IR Emission: 830 nm
T_c: 0.4 µs
High efficiency submilliwatt green
P_o: 1 mW @ I_f = 100 mA
High pulse current: 20 A

PHOTODIODE
T_c: 5 ns
I_c: 40 µA @ I_h = 5 mW/cm² @ V_o = 20V
Application: visible, analog or hi frequency

PHOTOTRANSISTOR
T_c: 5 µs
I_c: 100 µA @ I_h = 5 mW/cm² @ V_o = 5V
V_o (SAT): 0.2V @ I_c = 4 mA
Application: General Purpose Detector

PHOTODARLINGTON
T_c: 100 ns
I_c: 1 mA @ I_h = 4.2 mW/cm²
V_o = 5V
I_h @ I_c = 1 mA
Application: High current or high speed switching requirements

PHOTO IC
Schmitt Trigger Output
T_c: 1 µs
Output Time: 50 ns
Propagation Delay: 10 TTL loads @ V_o = 0V
T_o: 5 µs
T_o: -55 to +100°C
Application: Opto Switching

Programmable DIP Switches

Designed for automatic
insertion

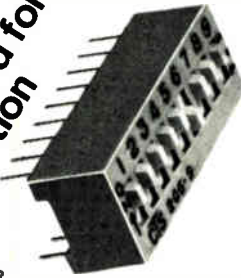

CTS Series 206 programmable DIP switches are competitively priced, yet offered in a variety of circuit choices, dimensions and profiles that are unbeatable. SPST, SPDT, DPST or DPDT circuitry. Contact wiping on make and break. Available with low profile or extended actuators, resistant to sealed in contamination. CTS 206 DIP switches are approved to MIL-S-93504/4. Switch settings can withstand 25 G's as well as vibrations with 10-50 cps sweep and 60 cps constant vibration. CTS 206 switches are available for immediate delivery from your local CTS distributor. Get complete data from: CTS Corporation, 905 North West Boulevard, Elkhart, Indiana 46514. Phone: (219) 293-7511.

CTS CORPORATION
ELKHART, INDIANA



Circle 242 on reader service card

New products

through 1-M Ω /sq materials is ± 50 ppm.

Du Pont Co., Electronic Materials Division, Wilmington, Del. 19898. Phone (302) 774-2358 [477]

Substrates feature high dielectric constants

Sapphire, quartz, and alumina substrates for microwave and microelectronic applications feature high dielectric constants. From 10^4 to 9×10^9 Hz, sapphire has a 9.3 to 10.3 constant perpendicular to the optical axis, 11.5 to 13.2 parallel to the optical axis. From 0 to 30 GHz, quartz has a 3.7 to 3.8 constant, and from 60 Hz to 25 GHz, alumina has a 9.8 to 10.1 constant. The substrates are parallel within 1 mil and provide tolerances of ± 1 mil on length and width and 10 waves/in. on flatness.

Sapphire substrates range from $\frac{1}{4}$ in. per side to 2 by $1\frac{1}{2}$ in. (5 to 25 mils thick); quartz goes from 1 to 3 in. per side (5 to 25 mils thick); and alumina ranges from 1 to 4 in. per side (10 to 25 mils thick). Standard finish is 1 μ in./side, but sapphire and quartz are also offered with one side chemically polished to be scratch-free. Small quantities of the substrates can be delivered in three to six weeks.

Adolf Meller Co., 120 Corliss St., Providence, R. I. 02940. Phone (401) 331-3717 [478]

Copper-nickel-tin alloy comes in three versions

A copper-nickel-tin alloy, marketed as spinodal 770, was developed for use in high-performance connector applications. The alloy consists of 77% copper, 15% nickel, and 8% tin. Two other compositions of the alloy are also available: spinodal 850 with 85% copper, 9% nickel, and 6% tin; and spinodal 920 with 92% copper, 4% nickel, and 4% tin. The spinodal alloys have unusual properties of strength, formability, and electrical conductivity as well as excellent spring and resistance to stress relax-

NEW FROM

Ovenaire

OSC 94-2 SERIES OF CRYSTAL OSCILLATORS
VALUE ENGINEERED TO PROVIDE UNPARALLELED PERFORMANCE FOR THE PRICE.

Combines a precision 10MHz, third overtone, vacuum baked, HI-Q glass enclosed crystal and Ovenaire's unique thermal environment resulting in outstanding control of output frequency. Retrace error due to loss of input power is controlled and specified within tight limits. The crystal, two buffer stages and all critical components are housed inside a high mass proportional controlled oven. Precise mechanical frequency adjustment is made possible by a 17 turn piston trimmer capacitor and an external potentiometer. The oscillator package is ruggedly constructed and sealed against humidity. Internal voltage regulation and trimmer reference voltages are provided. Four output configurations are available - OSC 94-2-0 5MHz Sinewave; OSC 94-2-1 5MHz Squarewave; OSC 94-2-2 10MHz Sinewave; OSC 94-2-3 10MHz Squarewave.

OVENAIRE-AUDIO-CARPENTER

Division of Kidde, Inc. 706 Forrest St. Charlottesville Va. 22901
KIDDE 804-977-8050 TWX510-587-5461

ENGINEERS: WANT BIG MONEY, EXTRA LONG VACATIONS, JOB CHALLENGE? MAIL THIS CARD.

Aramco is offering outstanding incentives to get the outstanding engineers we want. Tell us about yourself. We'll keep it confidential.

PLEASE DETACH HERE.

Name _____

Address _____

City _____

State _____ Zip _____

Phone (Home): _____

(Office): _____

High School, year _____

College degree(s):

B.S. in _____

School _____

M.S. in _____

School _____

Ph.D. in _____

School _____

Present Employer (will not be contacted):

Job Title _____

Employment Dates (From): _____

(To): _____

Salary Range \$15,000 + \$20,000 +
 \$25,000 + \$35,000 +

Job Responsibilities _____

Past Employer _____

Job Title _____

Employment Dates (From): _____

(To): _____

Years professional experience:

3-5 years 5-10 years 10 years +

Electronics/ELT100980BRCT

PLEASE DETACH HERE.



NO POSTAGE
NECESSARY IF
MAILED IN THE
UNITED STATES

BUSINESS REPLY CARD

FIRST CLASS PERMIT NO. 16681 HOUSTON, TEXAS

POSTAGE WILL BE PAID BY ADDRESSEE

ARAMCO SERVICES COMPANY

Attn: B. Anderson

Foreign Services Employment

1100 Milam Building

Houston, Texas 77002





With 40 days' paid vacation every 12½ months, Aramco people can see the heart of Asia, from Delhi to Bangkok to Hong Kong, and still have time for an African game park, Paris in the spring, or ski trips in the Alps.

The money isn't the only reason so many top people are going to Saudi Arabia with ARAMCO

As great as the money is, it's the travel opportunities, the challenge, and casual living in American-style hometowns that make Aramco people stay on.

Aramco employees in Saudi Arabia have travel opportunities that most people only see in daydreams. They get 40 days' paid vacation every 12½ months. And in Saudi Arabia they are already halfway to wonderful places in Europe, Asia and Africa.

Equally as important as money and travel are the challenging jobs and secure, comfortable living conditions.

Aramco is the world's largest oil-producing company. Our projects and operations are huge, complex and professionally rewarding. Many are the largest of their kind ever undertaken.

We need more first-rate people to join the 4,000 North Americans who work for us. We have openings for qualified engineers, technicians and professionals of all types.

North Americans and Saudi Arabs have worked together for over 40 years

Since the early 1930's, North Americans have worked very closely and successfully with their Saudi hosts in developing the energy resources and infrastructure of this friendly, conservative nation.

These North Americans live in a



4,000 North Americans work for Aramco in Saudi Arabia. They're helping the Kingdom develop energy resources that are being used all over the world.

foreign country, yet they still find it a very comfortable place to live and work. American-style communities, housing, schools, medical services and recreation facilities have prompted a long line of Aramco professionals to stay on and on.

What kind of compensation package accompanies all this? Aramco employees earn a competitive base salary, plus a cost-of-living differential. They also get a tax-protected premium for overseas work of up to 40 percent of the base salary, and a one-time bonus of up to \$5,000 for signing up for overseas work.

Interested in more information about Aramco and Saudi Arabia; or in a job with us? Write: Aramco Services Company, Dept. ELT100980MCLA 1100 Milam Building, Houston, Texas 77002.

ARAMCO
SERVICES COMPANY

Superior X-Y value.

Now — a high performance recorder without a high price.

The versatile Gould 3054 has value superior to any other analog X-Y recorder in its price or performance ranges.

- X- and Y-axis sensitivities to 200 μ V/cm
- Minimum slewing speed of 85 cm/sec
- Acceleration of 7700 cm/sec² in Y-axis and 5100 cm/sec² in X-axis
- Plus calibrated zero offset, switchable low pass filter, switchable input polarity reversal, superior trace quality and an optional time base.

For information write Gould Inc., Instruments Division, 3631 Perkins Avenue, Cleveland, OH 44114.

For brochure call toll-free: 800-331-1000. In Oklahoma, call collect: 918-664-8300.

 **GOULD**
An Electrical/Electronics Company

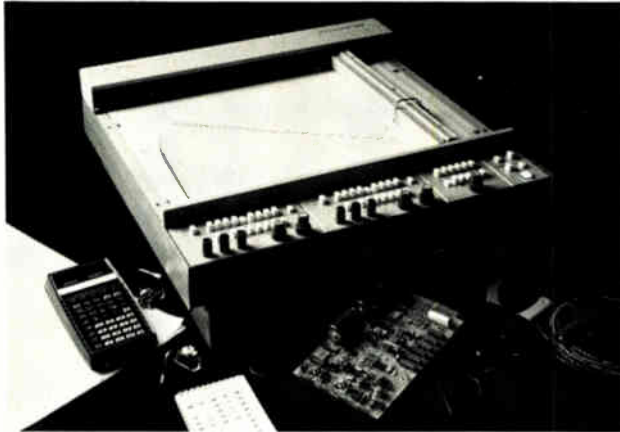

Circle 246 on reader service card

New products

ation, says the manufacturer. Other advantages the company claims are better corrosion resistance and fatigue strength than beryllium-copper alloys, good joining characteristics, and nontoxicity.

Handy & Harman, Industrial Products Division, 850 Third Ave., New York, N. Y. 10022. Phone (212) 752-3400 [479]

Conductive adhesives offer high performance, low cost

Four Eccobond conductive adhesives offer high performance at a reasonable cost. One, 57C, is a silver-based solder that cures at room temperature to a typical volume resistivity of $6 \times 10^{-4} \Omega\text{-cm}$. With bond strength in shear of over 700 lb/in.² (49 kg/cm²), it is priced at about \$350 per pound. Solder 72C is about \$108 per lb; its resistivity is $6 \times 10^{-3} \Omega\text{-cm}$.

A one-component carbon-based adhesive, 60C, sells for about \$15.50 per pound and provides a volume resistivity of 50 $\Omega\text{-cm}$. A two-part 60L is similarly priced but resistance through a thin film of it is less than 5 Ω , whereas through the 60C it is less than 1 Ω .

Emerson & Cuming, W. R. Grace & Co., Canton, Mass. 02021 [480]

Sprayable acrylic emi shield satisfies FCC requirements

An acrylic coating that provides effective shielding against electromagnetic interference for consumer, commercial, and industrial electronic products can be sprayed on. Electrically conductive, the Enforcer complies with FCC and VDE requirements for electrical components housed in plastic. Offering a surface resistance of less than 2 Ω/sq , it withstands continuous-use temperatures from -54° to $+82^\circ\text{C}$. When coating approximately 35 ft²/lb to a thickness of 2 mils, it dries tack-free in 30 minutes and is fully dry in 2 hours at 65° to 82°C .

Chomerics Inc., 77 Dragon Court, Woburn, Mass. 01888. Phone (617) 935-4850 [481]

LARGEST RADAR INVENTORY IN THE WORLD

SYSTEMS & SPARES

AN/ALT-6-7-8
AN-APG-33
AN/APG-51
AN/APN-69
AN/APN-102
AN/APN-169
AN/APQ-50
AN/APQ-55
AN/APS-20
AN/APS-31A
AN/APS-42-45
AN/APS-64
AN/ASB-4/9
AN/CPS-6B
AN/CPS-9
AN/DPN-32
AN/FPS-6-8
AN/FPS-14-18
AN/FPS-20-75
AN/FRC-39
AN/FRT-15
AN/GPA-30
AN/GPA-126
AN/MPQ-4A-10
AN/MPQ-29
AN/MPS-19
AN/MPX-7
AN/MSQ-1A
AN/SPA-4A
AN/SPA-8
AN/SPN-5
AN/SPS-5B
AN/SPS-6C
AN/SRW-4C
AN/TPN-12/17
AN/TPS-1D, E
AN/TPS-10D
AN/TPS-28
AN/TPS-34B
AN/TPS-37
AN/TPX-21
AN/UPA-25-35
AN/UPX-4-6
AN/UPX-14
HIPAR
MK-25
Nike Ajax
Nike Hercules
SCR-584

AUTOTRACK ANTENNA SCR-584 RADAR SYSTEM

360 deg AZ 210 deg EL. 1 mil. accuracy. Missile vel. accel. and slew rates. Amplidyne control. Handle up to 20 ft. dish. Compl. control chassis. ALSO in stock 10 cm. van mounted rad. system. Conical scan. PPI. 6 ft. dish. 300 pg. instr. bk. on radar. \$50.

RF SOURCES

17-27 KHz 200 W CW
125-450 KHz 4 KW CW
2-30 MHz 3 KW CW
4-21 MHz 40 KW CW
24-350 MHz 100 W CW
80-240 MHz 500 W 2-5 μ S
175-225 MHz 300 KW 1, 20 μ S
200-2000 MHz 40 W CW
210-225 MHz 1 MW 5 μ S
385-575 MHz 1.5 KW CW
400-700 MHz 1 KW .03 DC
950-1500 MHz 1 KW .06 DC
900-1040 MHz 5-10 KW .006 DC
1.2-1.35 GHz 500 KW 2 μ S
1.5-9.0 GHz 150 W CW
3.2-3.3 GHz 10 KW .002 DC
2.7-2.9 GHz 1 MW 1 μ S
3.1-3.5 GHz 1 MW 1.3 μ S
2.7-2.9 GHz 5 MW 2-3 μ S
4.4-5.0 GHz 1 KW CW
5.4-5.9 GHz 5 MW .001 DC
6 GHz 1 MW 1 μ S
6.2-6.6 GHz 200 KW .37 μ S
8.5-11 GHz 200 W CW
9.375 GHz 40 KW .5-1-2 μ S
8.5-9.6 GHz 250 KW .0013 DC
15.5-17.5 GHz 135 KW .33-1-3 μ S
24 GHz 40 KW .15 μ S
35 GHz 50 KW .1 μ S

MODULATORS

25 KW 5.5 KV 4.5 A; .0025 DC
144 KW 12 KV 12 A; .001 DC
250 KW 16 KV 16 A; .002 DC
405 KW 20 KV 20 A; .1 DC
500 KW 22 KV 28 A; .001 DC
1 MW 25 KV 40 A; .002 DC
3 MW 50 KV 60 A; 30 μ S
10 MW 76 KV 135 A; .001 DC
66 MW 160 KV 400 A; .00

TRACKING SYSTEMS

K BAND MONOPULSE 40 KW E-34
X BAND NIKE AJAX/HERCULES
X BAND HI-RES MONOPULSE MOD IV
X BAND GCA PAR II
X BAND FIRE CONTROL 250 KW M-33
X BAND MOBILE 40 KW AN/MPQ-29
X BAND BEACON 100 W AN/DPN-62
S BAND 10' DISH 500 KW AN/MPQ-18
S BAND 250 KW AN/MPQ-10A
S BAND 250 KW AN/MPS-9
X BAND HAWK MPQ-34
X BAND HAWK MPQ-33
C BAND 1.5 MW MPS-19(C)
S BAND 14' DISH PRELORT

SEARCH SYSTEMS

KU BAND AIRBORNE 135 KW B-58
X BAND WEATHER 250 KW AN/CPS-9
X BAND WEATHER 40 KW AN/SPN-5
X BAND 7 KW AN/TPS-21
X BAND CW DOPPLER AN/PPS-9/12
C BAND HGT FDR 1 MW TPS-37
C BAND 285 KW AN/SPS-5B/D
S BAND HGT FINDER 5 MW AN/FPS-6
S BAND COHERENT 1 MW AN/FPS-18
S BAND 1 MW NIKE AJAX/HERC
L BAND 40' ANT 500 KW AN/FPS-75
L BAND 500 KW AN/TPS-1D/GSS-1
UHF 1 MW HELIHUT TPS-28

C BAND TRACKER

Pwr: 1.5 MW Range: 250 miles
Recv: param Display 5" "A" scopes,
10' dish w/linear or circ. polarization.

NIKE HERCULES SPARES/MAINTENANCE

Over 10,000 major components in stock w/repairs and overhaul facilities incl: SHOP 1 & 2 MAINTENANCE VANS.

SEND FOR FREE 24 PAGE CATALOG



Radio Research Instrument Co., Inc.

2 Lake Avenue Ext., Danbury, CT 06810
(203) 792-6666 • Telex 962444

Smooth Operators!



The Spectrol Model 15 Dials

There's nothing on the horizon to match the smooth operating mechanism and the quality "feel" of the Spectrol Model 15 turns-counting dials. These good looking, low-profile dials are available as 3-digit 10-turn models and in 4-digit 100-turn versions, with satin chrome or black finish. All models feature large, highly readable numerals . . . positive braking action . . . and a handsome removable knob that conceals setscrews and permits access to pot shaft after mounting for fast accurate phasing. These Model 15 dials make natural companions for our popular Model 534 10-turn potentiometers. Send for data sheet or Short Form Catalog today.



SPECTROL ELECTRONICS GROUP

UNITED STATES Spectrol Electronics Corporation P.O. Box 1220, City of Industry, Calif. 91749, U.S.A. • (213) 964-6565 • TWX (910) 584-1314

UNITED KINGDOM Spectrol Reliance Ltd. Drakes Way, Swindon, Wiltshire, England • Swindon 21351 • TELEX: 44692

ITALY SP Elettronica SpA Via Carlo Pisacane 7, 20016 Pero (Milan) Italy • 35 30 241 • TELEX: 330091

GERMANY Spectrol Electronics GmbH Oberauerstrasse 15, 8000 Munich 70 West Germany • (089) 7145096 • TELEX: 52/3014

PUERTO RICO Spectrol Caribe Corporation Las Marias Industrial Park, Anasco, Puerto Rico • (809) 826-3012 • TELEX SCC PR 3452012

Circle 247 on reader service card

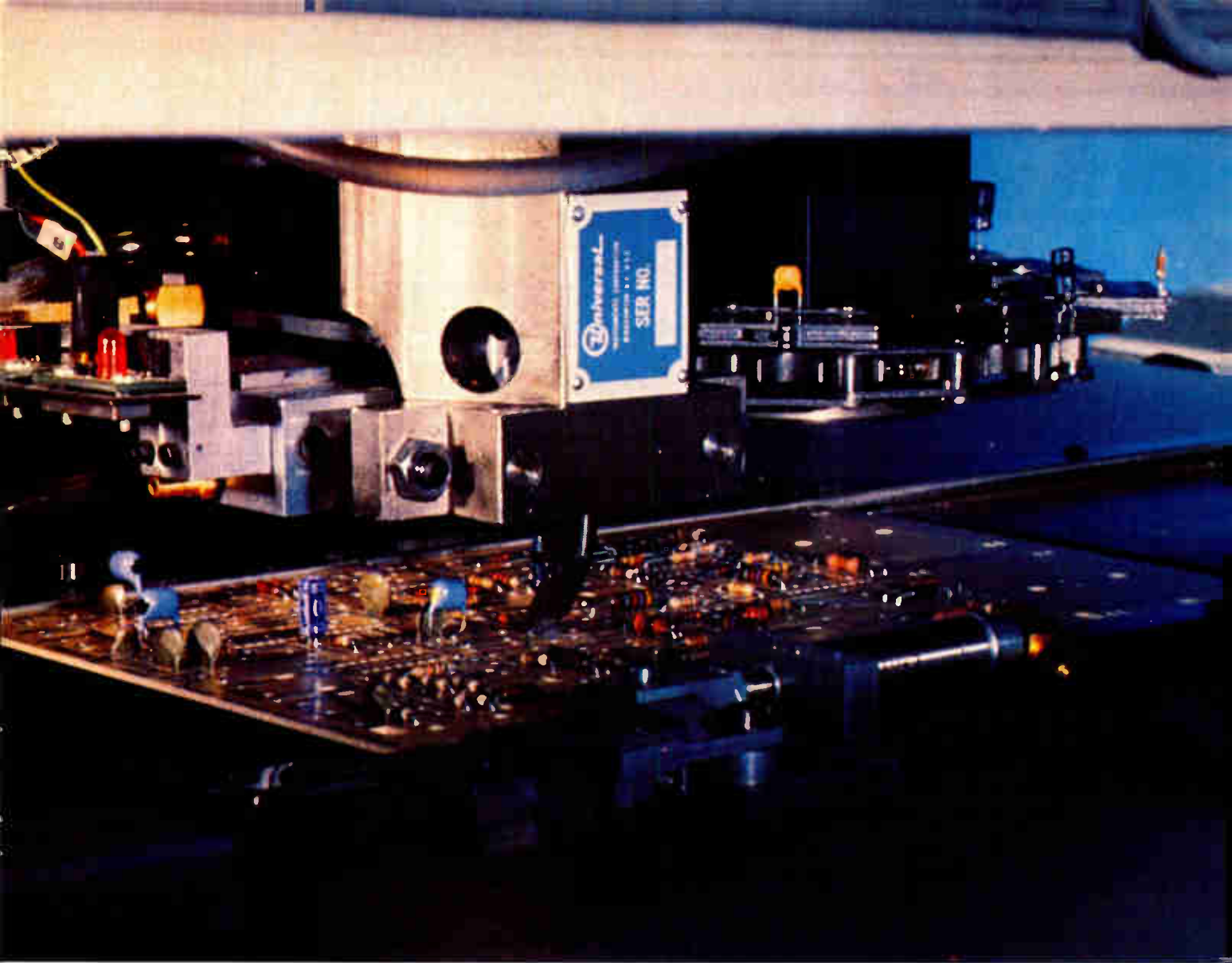

Sequence and insert radial lead devices fast and reliably.

One of the last barriers to total automation of PC board assembly has fallen. In a single computer-controlled program, Universal's Model 6341 Radial Lead Component Sequence/Inserter sequences, feeds, orients and inserts capacitors, peaking coils, resin-mold transistors, and stand-up axial lead components. Your boards are filled reliably and accurately at a rate of 7,000 insertions an hour.

For greatest possible productivity, the Model 6341 can be equipped with Universal's new Pass-Thru™ automatic board handling system. This keeps the machine's X-Y table supplied with fresh boards while delivering assembled boards to a magazine loader. If the versatility and speed of the Model 6341 are more than you need, we can equip you with the 40-station 3,600 an hour Model 6385.

Ask your Universal sales engineer to show you our Radial Lead Insertion video tape, or send for literature on these remarkable new machines.



Subsidiary of **DOVER CORPORATION**

Universal Instruments Corporation ■ Box 825, Binghamton, New York 13902 ■ Tel: 607/772/7522 ■ TWX: 510/252/1990
Circle 248 on reader service card

**Precision trimmer
potentiometer
sells for \$2.92**

Vishay Resistive Systems Group of Vishay Intertechnology Inc. is ready to market a 3/4-in. **precision trimmer potentiometer at \$2.92** each in 100-unit quantities. The 1280 features a temperature coefficient of resistance of less than 15 ppm/°C between -55° and +125°C and can be set to within 0.05%. The group in Malvern, Pa., says that the 1280 "has all the critical characteristics of a precision trimmer at an economical price."

**Digital scope
stores four times
more data**

The need to retain more data on the low-frequency phenomena that are investigated by digital storage oscilloscopes may be met with Gould Inc.'s OS 4020. The latest addition to its scope line, to be introduced in November by the firm's Cleveland, Ohio, instruments division, will feature a **4-k-by-8-bit memory that holds four times more waveform data than other portable digital scopes.** It will be priced at about \$5,500.

**Microprocessor
prevents auto theft**

A microprocessor and a programmable read-only memory packed into an automobile's starter can protect the vehicle from theft. When activated, the Phantom system from Elpac Automotive Systems Inc. of Santa Ana, Calif., prevents engine startup unless the car's key is turned to the ignition position the number of times required by the unit's **factory-programmed three- or four-digit code.** Phantom sells to original-equipment manufacturers for \$45 to \$50 and retails for \$299.

**Teledyne Philbrick
second-sources
military LH0032**

Teledyne Philbrick claims that its version of the military-grade model of National Semiconductor's LH0032 operational amplifier, the model TP0032, has **more consistent performance over the full temperature range of -55° to +125°C.** Though most specifications tally with the LH0032's, the TP0032 has typical power-supply and common-mode rejection ratios of 75 dB and a typical dc open-loop gain of 85 dB, versus about 60 and 70 dB for the original, says the Dedham, Mass., firm. The TP0032 costs about \$50 in lots of 100 or more.

**National cuts
prices for 8-bit
a-d converters**

National Semiconductor Corp., Santa Clara, Calif., is slashing prices as **much as 45% on its microprocessor-compatible 8-bit analog-to-digital converters.** For example, the ADC0806, an eight-channel multiplexing a-d unit with a maximum error of 0.5 least significant bit is going from \$17.95 to \$9.96 apiece in 100-piece quantities. Also, the ADC0801, a single-differential converter with 0.25-LSB maximum error, is reduced from \$16.90 to \$12.25.

**NTC thermistors
come in the form
of ceramic chips**

Monolithic ceramic negative-temperature-coefficient (NTC) thermistors have been developed by Sierracin/Western Thermistor, Oceanside, Calif., in **two diameter ranges: 0.010 to 0.025 in. and 0.050 to 0.100 in.** Designed for a temperature range of -50° to +150°C, they feature sensitivities from -3%/°C to +0.7%/°C. They are available with tolerances of ±0.05°, ±0.1°, ±0.2°, ±0.5°, and ±1.0°C.

Tomorrow's TECHNOLOGY Today

PHASE CONTROL & INVERTER POWER THYRISTORS

As a dedicated manufacturer who understands we offer in-depth availability of Phase Control and Inverter Grade Thyristors covering an rms current range of 390 to 2400 Amps with V_{DRM} ratings up to 2600 Volts. All products incorporate Center Amplified Gate Geometry with high di/dt , dv/dt characteristics and, in the case of inverter devices, fast switching times (down to 10 μ Secs) to meet all power conversion requirements.

We can supply complementary Conventional and Fast Recovery Power DIODES too

Why not contact us for in-depth details.



EE Tech

**ELECTRONICS
& ENERGY
TECHNOLOGY**



electronica 80
MUNICH
Hall 19
Stand No. 19055

2352 UTAH AVENUE • ELSEGUNDO CALIFORNIA 90245 • TELEPHONE (213)675 9141 • TELEX 664455

Itron Advanced Alphanumeric. They'll put your readouts upfront.

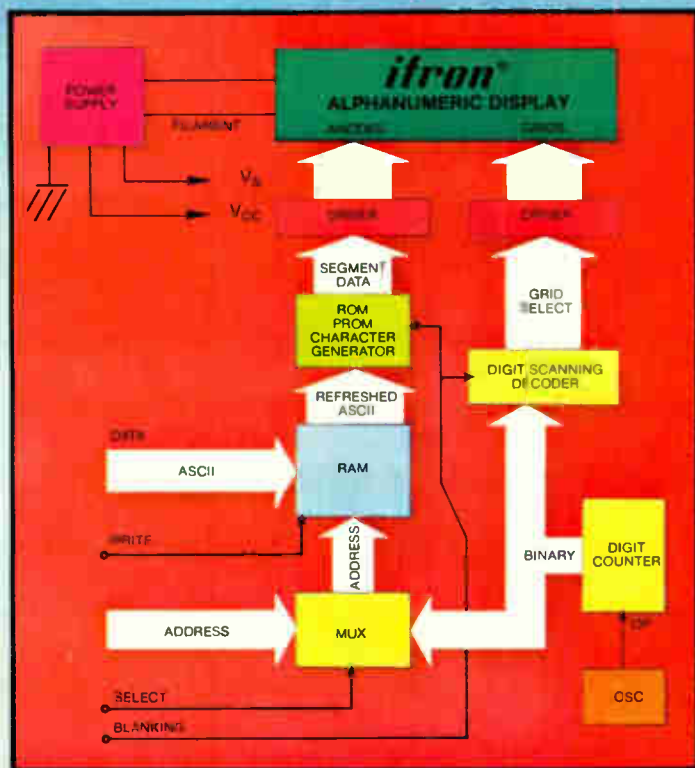
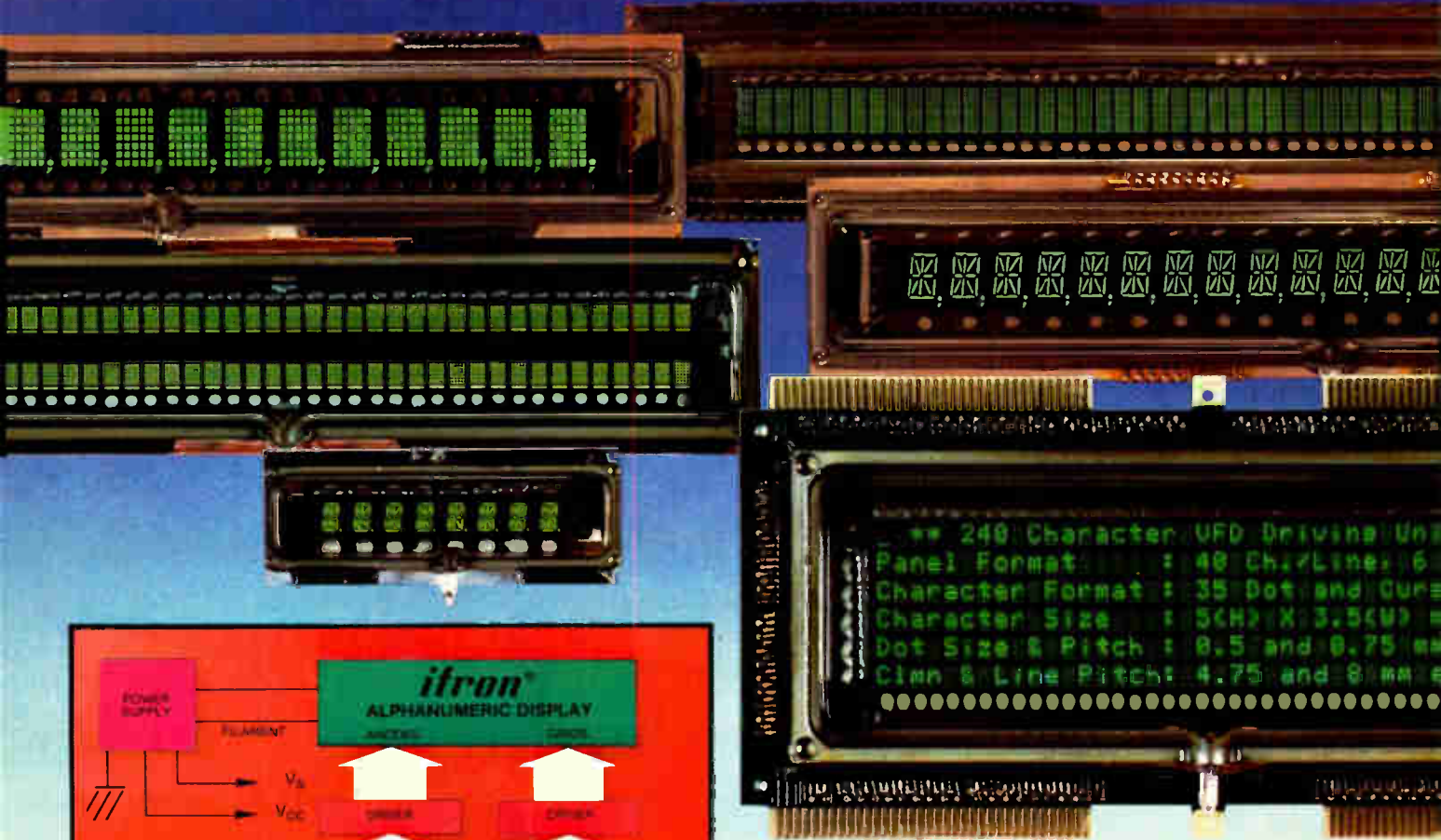

With Itron's evolutionary 14-segment and dot matrix alphanumeric displays, your readout designs are sure to be front-runners everytime. They're offered in a wide selection of character heights from 5 mm to 15 mm, and character counts that range from an 8-character 14-segment mini-package array, all the way up to the unique 240 character, 5 x 7 dot matrix (6 line x 40 characters/line) plug-in panel—and even 5 x 12 dot matrices for upper/lower case fonts.

Their long-term field-proven reliability, even under severe environments, further enhance their desirability for most every application where bright, easy-to-read legibility (even at a distance and under high ambient light), wide viewing angles and flat-glass simple-to-mount packages—plus low voltage and low current-drain are paramount. So, since brevity is called for, contact us to find out all the particulars on how to put your readout designs in the forefront with Itron's Advanced Alphanumerics.

itron[®]
 FLUORESCENT DISPLAYS
 Patented and Manufactured by
 ISE ELECTRONICS CORP.

INTERNATIONAL REPRESENTATIVES

WEST GERMANY Neumüller GmbH, Eschenstr. 2 8021, Taufkirchen, Munich Phone 089/6118-245 Telex 522106

FRANCE Europavia France, 5 Avenue Leon Harmel 92167 Antony Cedex Phone 666-21-10 Telex 42204381

UNITED KINGDOM ITT Meridian, West Road, Harlow, Essex CM20 2BP Phone 0279-35351 Telex 817202

SWEDEN AB Nordqvist & Berg, Box 9145 S-10272, Stockholm Phone 08 690400 Telex 10407

DENMARK E. V. Johanssen Elektronik A-S, Titagade 15-2200, Copenhagen Phone: 01/839022 Telex: 16522

HONG KONG Phone: 5-232420 TAIPEI Phone 351-0293

NORITAKE ELECTRONICS, INC.

EASTERN OFFICE: 41 Madison Avenue, New York, NY 10010 • (212) 481-3440 • Telex: 12-5469

CENTRAL OFFICE: 16250 Northland Drive, Southfield, MI 48075 • (313) 569-0088

WESTERN OFFICE: 22410 Hawthorne Boulevard, Torrance, CA 90505 • (213) 373-6704 • Telex: 67-4910

NORITAKE COMPANY, LIMITED

JAPAN: 1 - 1, Noritake-Shinmachi, Nishiku, Nagoya-Shi • (052) 562-0336 • Telex: J59738

EUROPE: Burotel Belgium SA, Rue de la Presse 3-5, 1000 Bruxelles • (02) 217-83-60 • Telex: 4626962

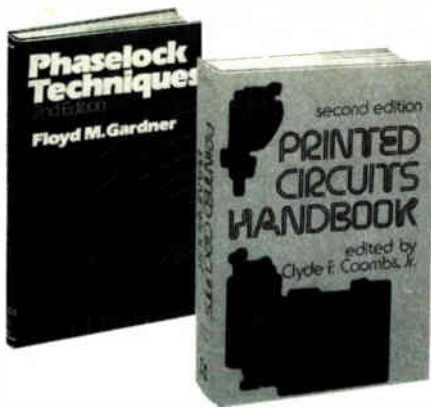

BUY ONE of these great professional books when you join McGraw-Hill's Electronics and Control Engineers' Book Club and GET ONE FREE (values up to \$62.50)

ELECTRONICS ENGINEERING FOR PROFESSIONAL ENGINEERS' EXAMINATIONS. By C. R. Hafer. 336 pp., more than 200 illus. Actually two books in one—a quick preparation manual to help you pass your P.E. exams on the first try and a rich source of practical electronics engineering information and know-how. 254/303 Pub. Pr., \$19.50 Club Pr., \$15.50

ELECTRONICS ENGINEER'S HANDBOOK. Editor-in-Chief, D. G. Fink. 2,104 pp., 2,026 illus. Huge in every sense, this instant-reference volume gives you every latest essential in the field. 2,100 formulas and equations, a 2,500-item bibliography, and every illustration you need to clarify all of modern electronics! 209/804 Pub. Pr., \$57.50 Club Pr., \$40.50

ELECTRONIC DISPLAYS. By E. G. Bylander, Texas Instruments Incorporated. 172 pp., illus. The book describes current electronic displays by family types, discussing their operation, application, and circuit requirements. You cover photometry and contrast enhancement, together with such critical components as mounts and drives, interface requirements, and other necessary engineering information. 095/108 Pub. Pr., \$24.50 Club Pr., \$18.50

HANDBOOK OF ELECTRONICS CALCULATIONS FOR ENGINEERS AND TECHNICIANS. Edited by M. Kaufman and A. H. Seidman. 653 pp., 725 illus. This first comprehensive tool of its kind includes hundreds of worked-out problems in analog and digital circuits. Includes more than 700 diagrams, curves, tables, and graphs. 333/920 Pub. Pr., \$24.50 Club Pr., \$18.95

MICROCOMPUTER-BASED DESIGN. By J. B. Peatman. Expanded 4th printing. 604 pp., over 400 photos and other illustrations. Do all your best day-to-day designs, as well as your supercreative and special designs, around the new microcomputers and the specific "how to" help you get here! 491/380 Pub. Pr., \$28.95 Club Pr., \$20.95

MICROPROCESSORS/MICROCOMPUTERS/SYSTEM DESIGN. By Texas Instruments Learning Center and the Engineering Staff of Texas Instruments Inc. 634 pp., illus., outsized 7¼ x 10¼ format. This practical, authoritative guide details the versatile, proved-in-action methods and technical features of the 9900 minicomputer architecture that can be employed to create outstanding products and systems. 637/58X Pub. Pr., \$24.50 Club Pr., \$19.50

HANDBOOK OF OPERATIONAL AMPLIFIER CIRCUIT DESIGN. By D. F. Stout; edited by M. Kaufman. 434 pp., 223 illus. Compact, concise, highly concentrated, and containing a storehouse of information, this one-stop volume will help you quickly solve any op amp circuit problem! 617/97X Pub. Pr., \$31.50 Club Pr., \$20.50

PRINTED CIRCUITS HANDBOOK, 2/e. By C. F. Coombs, Jr. 256 pp., 327 illus. Blueprints every important phase of printed circuitry. Provides the information you need to establish a production facility and control the processes. A virtual encyclopedia in the field, five major sections cover engineering, fabrication, assembly, soldering, and testing. 126/089 Pub. Pr., \$32.50 Club Pr., \$24.50

Choose any one of these books at the special Club discount, and select any other as your gift free-of-charge when you enroll!



INTRODUCTION TO RADAR SYSTEMS, 2/e. By M. I. Skolnik. 698 pp., 244 illus. This new edition of a widely used text on radar from the systems engineer's point of view brings you full discussions of the many major changes that have occurred in the field recently. 579/091 Pub. Pr., \$34.95 Club Pr., \$27.95

TRANSISTOR CIRCUIT APPROXIMATIONS, 2/e. By A. P. Malvino. 371 pp. Makes your arrival at an ideal solution to problems in your transistor work much easier than you ever dreamed! Using the "idealize and improve" approach, the book shows you how to arrive at a working degree of accuracy in the shortest time. All transistor topics—from power supplies and linear ICs to types of coupling, JFETs, and MOSFETs—are covered. 398/78X Pub. Pr., \$15.95 Club Pr., \$11.95

MICROELECTRONICS: Digital and Analog Circuits and Systems. By J. Millman. 881 pp., 700 illus. This giant book takes you step by step from a qualitative knowledge of a semiconductor, to an understanding of the operation of devices, and finally, to an appreciation of how these are combined to form microelectronic chips. 423/27X Pub. Pr., \$28.95 Club Pr., \$22.50

ELECTRONICS and CONTROL ENGINEERS' BOOK CLUB MEMBERSHIP ORDER CARD

Please enroll me as a member and send me the two books indicated, billing me for my first selection only at the discounted member's price, plus local tax, postage and handling. If not satisfied, I may return the books within 10 days and my membership will be canceled. I agree to purchase a minimum of 3 additional books during the next 2 years as outlined under the club plan described in this ad. Membership in the club is continuous but cancelable by me any time after the four book purchase requirement has been fulfilled.

Write Code # of
FREE selection here

Write Code # of
FIRST selection here

Orders from outside the U.S. must be prepaid with
international money orders in U.S. dollars.

Signature _____

Name _____

Address _____

City, State, Zip _____

This order subject to acceptance by McGraw-Hill. All prices subject to change without notice. Offer good only to new members. A postage and handling charge is added to all shipments.

ELECTRONICS and CONTROL ENGINEERS' BOOK CLUB MEMBERSHIP ORDER CARD

Please enroll me as a member and send me the two books indicated, billing me for my first selection only at the discounted member's price, plus local tax, postage and handling. If not satisfied, I may return the books within 10 days and my membership will be canceled. I agree to purchase a minimum of 3 additional books during the next 2 years as outlined under the club plan described in this ad. Membership in the club is continuous but cancelable by me any time after the four book purchase requirement has been fulfilled.

Write Code # of
FREE selection here

Write Code # of
FIRST selection here

Orders from outside the U.S. must be prepaid with
international money orders in U.S. dollars.

Signature _____

Name _____

Address _____

City, State, Zip _____

This order subject to acceptance by McGraw-Hill. All prices subject to change without notice. Offer good only to new members. A postage and handling charge is added to all shipments.



NO POSTAGE
NECESSARY
IF MAILED
IN THE
UNITED STATES

BUSINESS REPLY CARD

FIRST CLASS PERMIT NO. 42 HIGHTSTOWN, N.J. 08520

POSTAGE WILL BE PAID BY ADDRESSEE

**Electronics and Control
Engineers' Book Club**

P.O. Box 582
Hightstown, New Jersey 08520

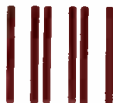

NO POSTAGE
NECESSARY
IF MAILED
IN THE
UNITED STATES

BUSINESS REPLY CARD

FIRST CLASS PERMIT NO. 42 HIGHTSTOWN, N.J. 08520

POSTAGE WILL BE PAID BY ADDRESSEE

**Electronics and Control
Engineers' Book Club**

P.O. Box 582
Hightstown, New Jersey 08520



BIT-SLICE MICROPROCESSOR DESIGN. By J. Mick and J. Brick. 320 pp., 230 illus. All in one place—the crucial information you've been needing about the 2900 family of bit-slice microprocessor components! A remarkable "first," this book designs right before your eyes not just one but two complete 16-bit machines!
417/814 Pub. Pr., \$18.50 Club Pr., \$14.50

MICROCOMPUTER INTERFACING. By B. Artwick. 352 pp., illus., 7 x 9 1/4 format. Here's your passkey to trouble-free, low-cost interfacing! The book gives you the data and describes the techniques you need to conceptualize, select, mate and match, build, and interface microcomputer systems—no matter what the application.
789/436 Pub. Pr., \$18.95 Club Pr., \$14.95

ELECTRONICS DESIGNERS' HANDBOOK, 2/e. Edited by L. J. Giacometto. 2,344 pp., 1,686 illus. Now doubled in size and with 90% of its material new, this famous classic (first edition by Landee, Davis, Albrecht) has been thoroughly revised and updated to give you not only the *how* and the *why* of all your design work but also the *how much* of every design step you take!
231/494 Pub. Pr., \$62.50 Club Pr., \$46.50

INTRODUCTION TO THE THEORY AND DESIGN OF ACTIVE FILTERS. By L. P. Huelsman and P. E. Allen. 430 pp., illus. Once you add active filter design to your repertory of specialties, you'll possess a skill that's in great demand today. Here's one of the best texts we know on the theory, design, application, and evaluation of modern active filters and the various techniques used today.
303/543 Pub. Pr., \$25.95 Club Pr., \$19.95

PHASELOCK TECHNIQUES, 2/e. By F. M. Gardner. 285 pp., illus. This edition of the standard working reference shows you not only better methods of analysis and better procedures for deciding on loop parameters, but also the circuits and the results.
582029-3 Pub. Pr., \$21.50 Club Pr., \$16.95

SEMICONDUCTOR DEVICES AND INTEGRATED ELECTRONICS. By A. G. Milnes. 816 pp., 605 illus. The main secret of this book's quick and tremendous success with engineers is the way its logical grouping and handling of the material builds and strengthens your in-depth grasp of the subject, plus its real-world application of just the right amount of theory.
789/487 Pub. Pr., \$26.50 Club Pr., \$20.95

ELECTRONIC COMMUNICATION, 4/e. By R. L. Shrader. 801 pp., 870 illus. This thoroughly updated edition offers all the theory and fundamentals you need to prepare yourself for the FCC commercial and amateur grade license examinations—and pass them the first time!
571/503 Pub. Pr., \$19.50 Club Pr., \$15.50

DESIGN OF SOLID-STATE POWER SUPPLIES, 2/e. By E. R. Hnatek. 640 pp., illus. A total revision and expansion of an essential, ready-to-use sourcebook on the design of power supplies, particularly of the switching variety. Incorporates the latest developments in the field while emphasizing the how-to help designers want.
582054-4 Pub. Pr., \$27.50 Club Pr., \$21.50

STANDARD HANDBOOK FOR ELECTRICAL ENGINEERS, 11/e. By D. G. Fink and H. Beaty. 2,448 pp., 1,414 illus. Today's most widely used source of electrical engineering information and data serves you as no other single work when you need detailed, timely, and reliable facts and how-to on the generation, transmission, distribution, control, conversion, and application of electric power.
209/74X Pub. Pr., \$54.50 Club Pr., \$41.95

Be sure to consider these important titles as well!

DIGITAL FILTERS. By A. Antoniou. 021/171 Pub. Pr., \$26.95 Club Pr., \$20.50

HANDBOOK OF ELECTRONIC SYSTEMS DESIGN. By C. A. Harper. 266/832 Pub. Pr., \$39.50 Club Pr., \$29.50

ELECTRONICS DICTIONARY, 4/e. By J. Markus. 404/313 Pub. Pr., \$24.50 Club Pr., \$19.50

ENGINEERING FUNDAMENTALS FOR PROFESSIONAL ENGINEERS' EXAMINATIONS, 2/e. By L. M. Polentz. 503/80X Pub. Pr., \$22.50 Club Pr., \$16.95

ENGINEERING MATHEMATICS HANDBOOK, 2/e. By J. J. Tuma. 654/298 Pub. Pr., \$24.95 Club Pr., \$19.95

RADIO HANDBOOK, 21/e. By W. Orr. 772/630 Pub. Pr., \$21.50 Club Pr., \$16.80

TRANSFORMER AND INDUCTOR DESIGN HANDBOOK. By W. T. McLyman. 786/755 Pub. Pr., \$35.00 Club Pr., \$26.50

CRYSTAL OSCILLATOR DESIGN AND TEMPERATURE COMPENSATION. By M. E. Frerking. 784/973 Pub. Pr., \$18.95 Club Pr., \$14.95

NATIONAL ELECTRICAL CODE HANDBOOK, 16/e. By J. F. McPartland. 456/909 Pub. Pr., \$19.95 Club Pr., \$14.50

NOISE REDUCTION TECHNIQUES IN ELECTRONIC SYSTEMS. By H. Ott. 789/63X Pub. Pr., \$27.95 Club Pr., \$20.95



MAIL THIS COUPON TODAY

McGraw-Hill Book Clubs
Electronics and Control Engineers'
Book Club

P.O. Box 582, Hightstown, New Jersey 08520

Please enroll me as a member and send me the two books indicated, billing me for my first selection only at the discounted member's price, plus local tax, postage and handling. If not satisfied, I may return the books within 10 days and my membership will be canceled. I agree to purchase a minimum of 3 additional books during the next 2 years as outlined under the club plan described in this ad. Membership in the club is continuous but cancellable by me anytime after the four book purchase requirement has been fulfilled.

Write Code # of
FREE selection here

Write Code # of
FIRST selection here

Orders from outside the U.S. must be prepaid with international money orders in U.S. dollars.

Signature _____

Name _____

Address _____

City _____

State _____ Zip _____

This order subject to acceptance by McGraw-Hill. All prices subject to change without notice. Offer good only to new members. A postage and handling charge is added to all shipments.

E33446

Why YOU should join now!

■ **BEST BOOKS IN YOUR FIELD** — Books are selected from a wide range of publishers by expert editors and consultants to give you continuing access to the latest books in your field.

■ **BIG SAVINGS** — Build your library and save money too! We guarantee savings of at least 15% off publishers' list prices on every book. Usually 20%, 25%, or even higher!

BONUS BOOKS — You will immediately begin to participate in our Bonus Book Plan that allows you savings between 70-80% off the publisher's price of many books.

■ **CONVENIENCE** — 14 times a year you receive the Club Bulletin FREE, fully describing the Main Selection and alternate selections, together with a dated reply card. If you want the Main Selection, you simply do nothing — it will be shipped automatically. If you want an alternate selection — or no book at all — you simply indicate it on the regular reply card and return it by the date specified. You will have at least 10 days to decide. If, because of late mail delivery of the Bulletin you should receive a book you do not want, just return it at the Club's expense.

As a Club member, you agree only to the purchase of four books (including your first selection) over a two-year period.

Are your products Aehr conditioned?



Functional test during burn-in saves money in test time and product reliability.

Aehr Test Systems, a leader in dynamic burn-in systems, has designed a new product line of functional tester/burn-in systems. These systems can utilize the necessary burn-in cycle to generate all combinations of patterns without the concern for shortening test times as is the case with memory testers.

Device outputs are continuously monitored and errors are datalogged. This permits the detection of soft errors in real time and accurate analysis of the mean time to failure never before available.

For more information on these or our standard dynamic burn-in systems contact:

AHR **AEHR TEST SYSTEMS**

160 CONSTITUTION DRIVE • MENLO PARK • CALIFORNIA 94025
PHONE: (415) 321-1580 • TWX: (910) 373-2040

THE CELCO MACHINE

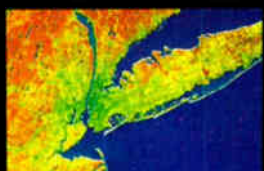

LANDSAT DATA



XEROX DATA

ABCDEFGHIJKLM
 NOPQRSTUVWXYZ
 abcdefghijklm
 nopqrstuvwxyz
 0123456789
 *+/:;<=>?@!
 #\$\$%&'()-
 Helvetica Bold
 Font 3

MAGI DATA



N.Y. INST. OF TECH. DATA

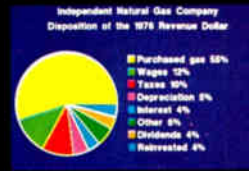

DARKROOM DATA

records your data at the world's highest resolution and fastest speed on color film.

Today the world is looking to CELCO for answers to the problems arising in the exciting field of color graphic arts. And now you can create your own color slides on THE CELCO MACHINE. CELCO's High-Speed, High-Resolution Color Film Recorder.

The CELCO MACHINE provides rapid production of high resolution color film from 16mm to 105mm. 4 x 5 and 8 x 10 inch color Polaroid is also available for instant monitoring.

CELCO MACHINES in the field are now producing over 180 (35mm) color slides per hour, 24 hours per day, day after day, month after month,

year after year. At 4600 line resolution and in less than 20 seconds per slide. For black and white requirements, THE CELCO MACHINE provides even faster speeds and higher resolution.

Unequaled performance. In an independent survey for the U.S. government, THE CELCO MACHINE was shown to provide the *highest resolution and speed* of all the laser and CRT film recording systems available in the world. Think what this can mean in savings alone to your organization. Instant data management from your own computer-generated image data.

Picture your imaging requirements on THE CELCO MACHINE. Whatever the demands of your unique software for business slide generation, CAD/CAM applications, Landsat, animation, microfiche and micro-publishing. Or for other applications ... from architecture and design to city planning. You can record it on color film on THE CELCO MACHINE.

Send for our colorful and detailed data brochure. Or call Paul Constantine, Vice-President, at 201-327-1123 in Mahwah, NJ for immediate information on THE CELCO MACHINE for YOU. (CELCO Pacific Division: 714-985-9868)

Circle 257 on reader service card

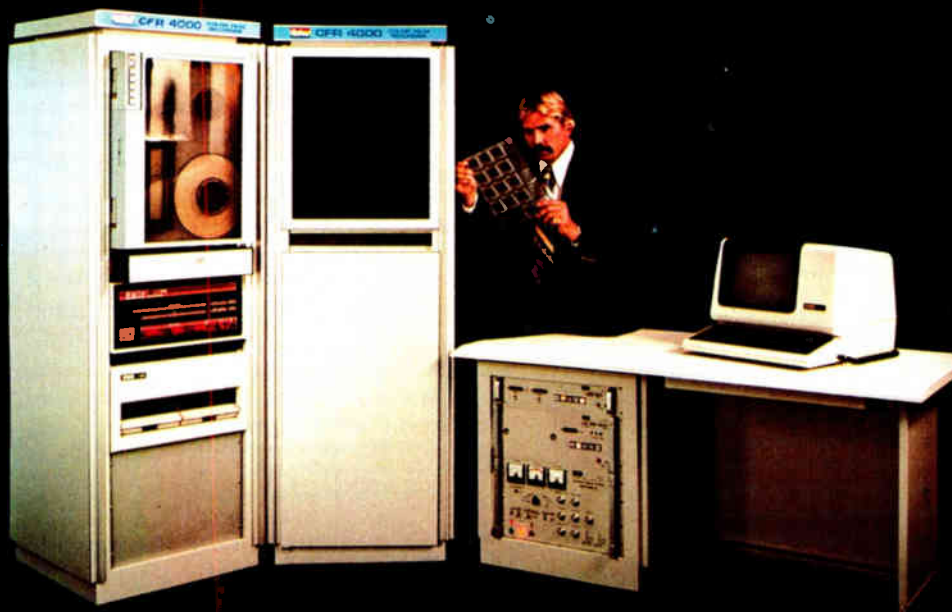
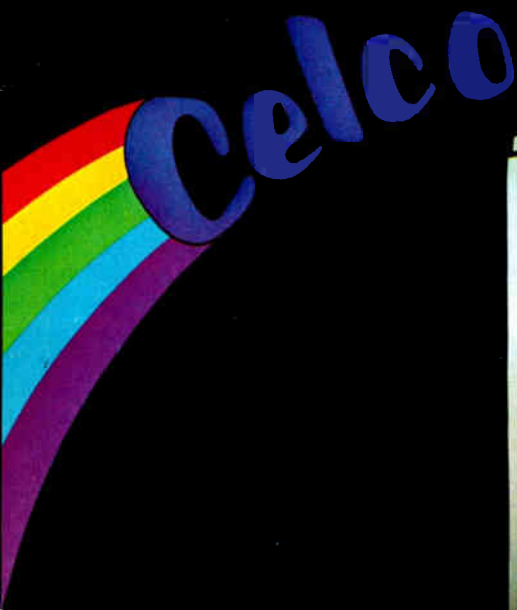

Leaders in Electronics

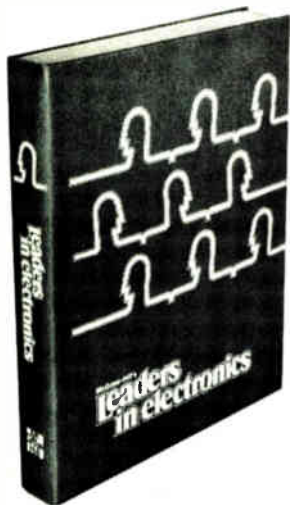

The only reference devoted solely to biographies of the most influential people in electronics

- corporate executives • technical managers • designers/developers • government and military officials • academics • consultants • editors/publishers • trade/professional group directors • securities analysts

Plus an 80-page index of biographies by affiliation, including independent consultants in every electronics specialty.

Prepared by the staff of Electronics magazine. 5,240 biographies. 651 pages, clothbound. \$39.50

Electronics Magazine Books
P.O. Box 669, Hightstown, NJ 08520
Send me...

_____ copies of *Leaders in Electronics* @ \$39.50 plus applicable sales tax. McGraw-Hill pays regular shipping and handling charges on pre-paid orders.

I must be fully satisfied or you will refund full payment if the book is returned after ten-day trial examination.

- Payment enclosed Bill firm Bill me
Charge to my credit card: American Express
 Diners Club Visa Master Charge
Acct. No. _____ Date Exp. _____

On Master Charge only, first numbers above name

Name _____

Company _____

Street _____

City _____ State _____ Zip _____

Signature _____

Career outlook

Government fellowships. The National Science Foundation plans to award nearly 550 fellowships in the spring of 1981 for advanced study to help meet the continuing national need for qualified scientific personnel. Included will be 400 graduate fellowships, 50 minority graduate fellowships, 50 postdoctoral fellowships, and 50 North Atlantic Treaty Organization postdoctoral fellowships. Application materials for all programs are now available.

Open to all qualified citizens and nationals of the U. S., the awards will be made on the basis of merit in all fields of science, including interdisciplinary and multidisciplinary areas. The application deadline for the graduate fellowships is Nov. 26, 1980, and for the postdoctoral, Nov. 3, 1980.

For more information on the three NSF fellowships, write to the Fellowship Office, National Research Council, 2101 Constitution Ave. N. W., Washington, D. C. 20418. For the NATO fellowship, write to the NATO Fellowship Program Office, Division of Scientific Personnel Improvement, National Science Foundation, Washington, D. C. 20550, or call (202) 282-7154.

Computers and the law. A special two-issue set of the Computer/Law Journal will be published in early 1981, and a call for papers has been issued. The set, "Law and Information Policy," will contain papers on all areas of information processing, from the legal aspects of fact gathering to those of information storage, retrieval, and transmission. Topics include privacy, protection of data bases, cryptography, and antitrust policies in the telecommunications industry. Articles about international information law and policy are of particular interest.

Authors who wish to submit papers should write to Dr. Jon Bing at the Norwegian Research Center for Computers and Law, Oslo University, Karl Johans Gt. 37, Oslo 1, Norway; or to Michael Scott, Editor-in-Chief, Computer/Law Journal, 530 West Sixth St., 10th floor, Los Angeles, Calif. 90014.

Hybrid tutorial. For those able to attend the International Society for Hybrid Microelectronics technical symposium later this month in New York who have no solid grounding in hybrid technology, a one-day course is being offered. Aimed at executives, engineering professionals, technicians, and students, "Introduction to Hybrid Technology" will give a fundamental understanding of the field.

Robert J. Ost, hybrid technology group leader for the Sperry division of Sperry Corp., Great Neck, N. Y., will outline what is currently available in production equipment, materials, and components, as well as the latest assembly and quality assurance techniques in both thick- and thin-film microelectronics. Emerging technologies will also be covered.

Enrollment will be limited to 120 people; the registration fee for the tutorial is \$30 per person or \$15 for full-time students. The course will be held on Oct. 21, from 9:00 am until 5:00 pm. Additional information is available by writing ISHM Headquarters, P. O. Box 3255, Montgomery, Ala. 36109, or by calling (205) 272-3191.

Considering the ergonomics. A special session at the Eastern Design Engineering Conference—to be held this year Oct. 28–30 at the New York Coliseum—will focus on the relationship between machines and the people who operate them. Entitled "The Human Factor in Design," there will be four presentations in the session: "Human Factors Considerations in Computer-Aided Design of Mechanical Parts," "Integrating Human Factors Engineering into Product Design: A Case Study," "Practical Applications of Human Factors Engineering," and "Human Factors in Control System Design: From Simple Machines to Large Processes."

For more information on this session, or on the conference, write to Clapp & Poliak Inc., 245 Park Ave., New York, N. Y. 10017.

Cryptology as a practiced art. The need to protect data by coding or

Why the switch is on to film capacitor filters.

(30-80% higher SPS efficiency.)

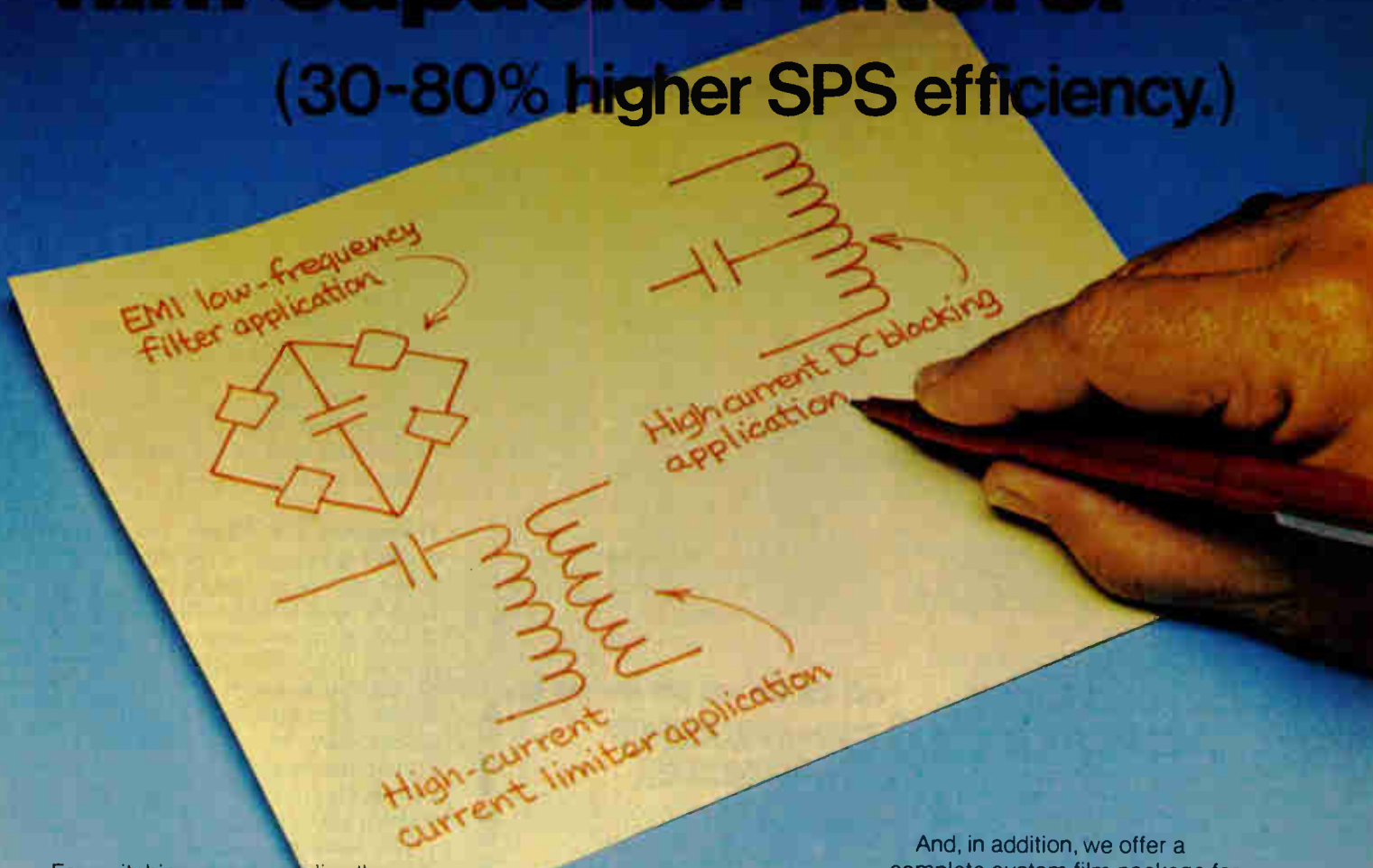

For switching power supplies the evidence is conclusive. Where a filter capacitance of 50 mfd or less will do, metallized polypropylene (film) capacitors far surpass electrolytics in impedance characteristics.

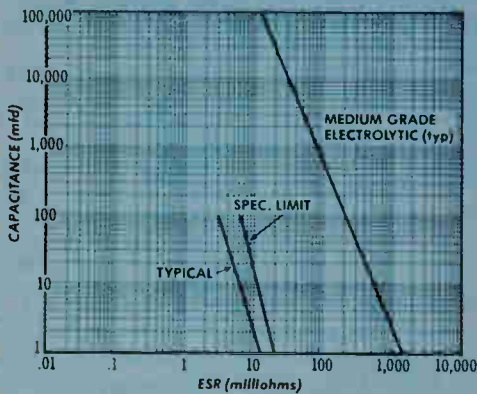

Here's why:

At resonance, ESR for a film capacitor is less than *one-tenth* that of an electrolytic. The film's

capacitance won't dwindle at higher switching rate frequencies, so you can design with a lower value cap.

With a constant 2 armp ripple current, a film cap will cut I^2R losses — by *orders of magnitude*. Its current-carrying capacity is greater, so paralleling is usually not required. And ripple voltages are significantly less.

Film caps can be round or flat — you gain design versatility. And weight reduction: 16 grams/cu. in. vs. 26 for electrolytics. The bottom line: maximum current, minimum size and minimum loss.

At TRW, we're past pioneering a superior concept. We're delivering a buttoned-down product: the TRW-35 film capacitor is available now for input/output filtering in your state-of-the-art SPS design.

And, in addition, we offer a complete custom film package for your specific needs in the 40KHz and above SPS range.

Get the evidence in hand — send for the TRW-35 data sheet. And we'll provide you a reprint of the technical article that triggered the switch to a new SPS technology.

Send in coupon or call us at (308) 284-3611.

TRW Capacitors
 An Electronic Components Division of TRW Inc
 301 W. "O" Street, Ogallala, Nebraska 69153
 Please send data on your **SPS Capacitors**.

Name _____

Company _____

Dist/Dept _____ Mfg Cod# _____

Address _____

City _____

State _____ Zip _____

E-10

Circle 259 on reader service card

TRW CAPACITORS
 ANOTHER PRODUCT OF A COMPANY CALLED TRW

MULTIPLE OUTPUT SWITCHER

\$96⁰⁰

MODEL 4027-2
5V @ 4A, $\pm 12V @ 0.4A$
(other output
voltages available)
SINGLES
(OEM discounts available)

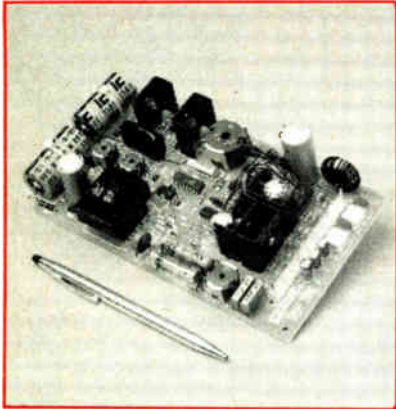

- Up to four outputs, 30 watts, 0.1 to 0.5% Regulation
- True off-the-line switcher
- Wide input voltage range 90-130 VAC/180-260 VAC
- 75% efficiency
- 16 oz. total weight
- No heat sink required
- RFI filtering
- Alternate source for Conver 2000, 2000/1 and Bochert OL-50

SEND FOR NEW POWER SUPPLY HANDBOOK



152 Will Drive, Canton, Ma. 02021
Tel. 617-828-6216
TWX: 710-348-0200

Circle 260 on reader service card

SOLID STATE TEMPERATURE MONITORING DEVICES MOXIE AND TFT



- TCR slopes from 4% to 300% / °C
- Temperature range -20°C to +140°C
- 1% precision tolerance available
- High reliability, excellent lifetime stability
- Direct device to device interchangeability
- Fast thermal response Time (approx. .5 sec)
- Standard TO-18 and TO-92 packages

CANADIAN THERMOSTATS AND CONTROL DEVICES LTD.

8415 Mountain Site Avenue
Montreal P.Q. H4P2B8
(514) 739-3274 TELEX 05-25277

Also manufacturing a complete line
of bi-metallic switching devices

CALLS From Indep. Reps Invited

IN-PLANT OFFICES

Design Space International has gained leadership by being first where it counts.

In-plant singles and multiple units respond to the changing needs of business. Need a guard house, in-plant office, inspection room, first aid station, locker room or a quiet place in a noisy plant, etc.? DSI offers a wide range of 8, 10 and 12 foot wide units.

For free brochure and additional information.

Name _____ Title _____

Address _____

Company _____

City _____ State _____ Zip _____

Telephone/Area Code _____

Call toll-free In Pennsylvania
800-523-7918 215-581-0400



DESIGN SPACE
INTERNATIONAL

P.O. Box 7100, Bala Cynwyd, PA 19004

Career outlook

ciphering is becoming more necessary as computer crime escalates. A one-day seminar for executives and managers responsible for data processing, telecommunications, corporate operations, security, or planning is being given Oct. 20 in Los Angeles and Nov. 10 in Palo Alto, Calif. "Cryptology and Data Security" is normally a three-day seminar, but this shortened version is intended to give the executive a perspective on the types of threats companies are facing in these areas, the counter-measures that may be taken, and the costs of these measures.

For more information, write to Hellman Associates, 299 California Ave., Palo Alto, Calif. 94306, or phone (415) 328-4091.

Prototyping the future. For those design engineers who cannot wait to begin prototype work on Intel Corp.'s soon-to-be-available family of single-chip microcomputers made with its HMOS technology, the EM-51 emulation board is now being offered. The functional and electrical equivalent of the 8751, the EM-51 may also be used for development work calling for the 8051 and 8031 microcomputers.

The board plugs directly into the 8751 sockets without a cable. It includes sockets for 2716 or 2732 erasable programmable read-only memories, which substitute for the on-chip memory during prototyping.

The EM-51 sells for \$950, with delivery in six to eight weeks. For more information, write to Intel Corp., 5200 N.E. Elam Young Pkwy., Hillsboro, Ore., 97123.

Boston job fair. A specialized career open house for technical and professional people in the fields of electronics and commercial data processing will be held in the Boston area, Oct. 27-28, at the Northeast Trade Center. More than 50 companies are expected to participate.

Contact Jim Peck, Managing Director, Technical Job Mart, Northeast Trade Center, 100 Sylvan Rd., Woburn, Mass. 01801, or call him at (617) 935-8090, for more information.

WHY NEW YORK IS A SOLID STATE FOR THE ELECTRONICS INDUSTRY.

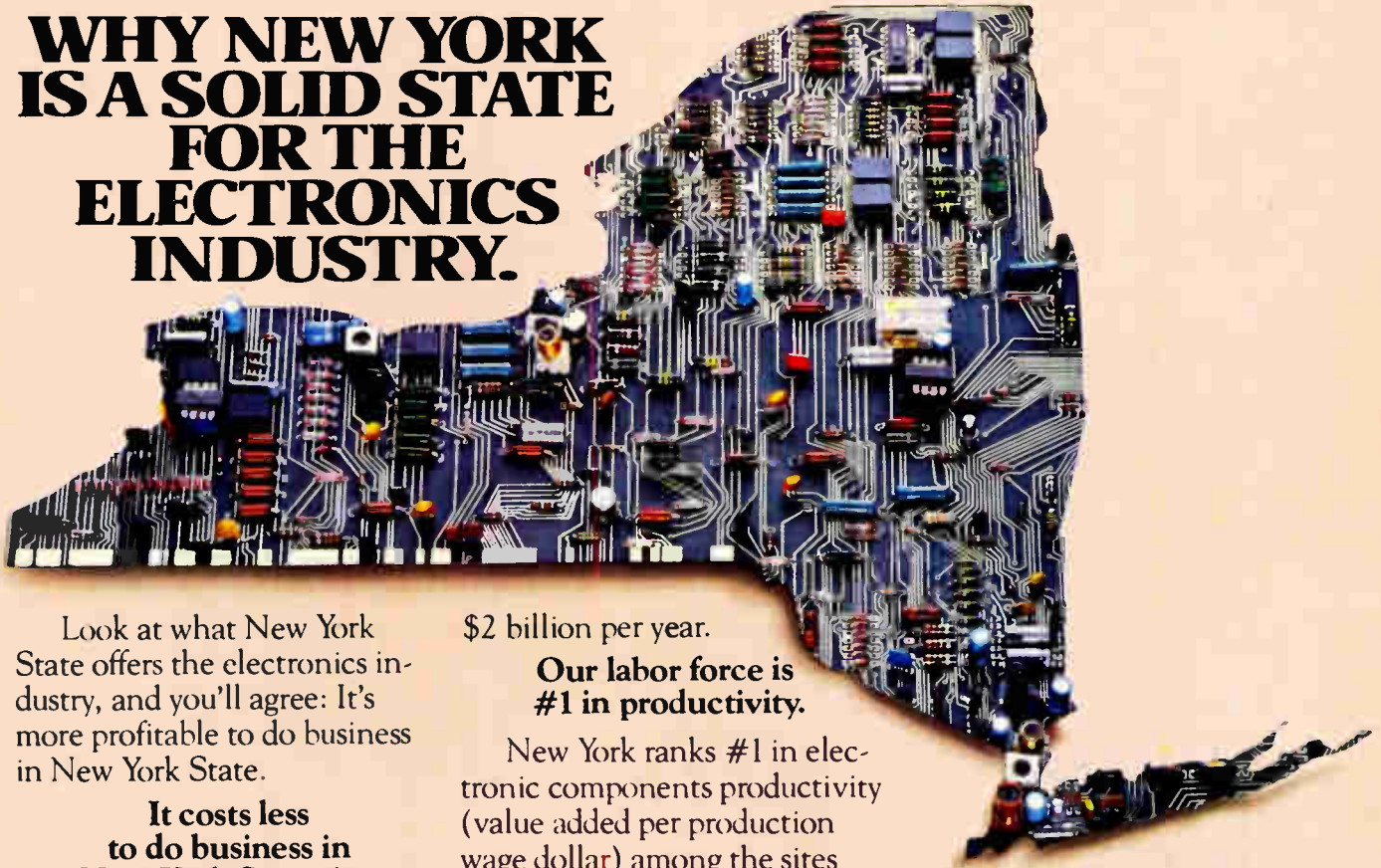

Look at what New York State offers the electronics industry, and you'll agree: It's more profitable to do business in New York State.

It costs less to do business in New York State sites than in San Jose, California. And we can prove it.

An independent study analyzed the four critical costs of taxes, wages, power and construction for a model new electronics firm. It showed that New York State offers sites where these costs are less than they are for choice electronics industry sites around the country.

For example, these costs would total \$7.6 million annually in San Jose, versus only \$6.4 million in, say, Brookhaven, New York.

New York has the best business advantages in America.

Our costs are lower because we have the best tax incentives and credits. We have on-the-job training and job incentive programs. Long-term, low-cost financing. And, we've cut personal and business taxes by

\$2 billion per year.

Our labor force is #1 in productivity.

New York ranks #1 in electronic components productivity (value added per production wage dollar) among the sites analyzed. And in the past five years, New York's number of idle man-days due to work stoppages was half that of the national average.

We graduate more electronics engineers than any other state.

Thanks to universities like RPI and Cornell – and dozens of other fine colleges – more electronics engineers are graduated each year in New York State than any other state including California or Massachusetts. And since many of the largest electronics firms are already doing business here – GE, IBM, to name only a couple – our graduates are quickly turned into seasoned professionals.

When you look into New York, you'll love New York.

We have an abundance of electric power. Lots of afford-

able housing for your employees. And our 30 million acres include thousands of available plant sites. Not to mention some of the most magnificent outdoors and year-round recreation on the American continent.

Tell me more about why New York is a solid state for business. I am particularly interested in information on:

- Electronic Components
- Small Computers
- Semiconductors

William D. Hassett, Jr.
Commissioner of Commerce
New York State Dept. of Commerce
230 Park Avenue
New York, New York 10169

Name _____
Title _____
Company Name _____
Address _____
City _____
State _____ Zip _____

MSEC

**NEW YORK STATE.
The best place in the world to do business.**

Hardware Engineers and Software Engineers:

MAKE YOUR

RESERVATION NOW.

Take your place with the Strategic Systems Division engineering staff. In 1981, we'll be occupying a new 300,000 square foot design and development facility in Westborough, Massachusetts. This suburban location, conveniently close to Boston, will be the new home of the talented professionals responsible for the MX C³ and Minuteman programs.

Our MX C³ program, as well as the continuing development of the Minuteman System, is creating new roles for those who are capable and ready to accept them. MX C³ will involve the world's largest fiber optic cable network, over 15,000 Kilometers; a radio communications system incorporating over 600 VLF, MF, HF, VHF, UHF and SHF radios; a hierarchy of over 5000 computers; and one of the largest software communications networks ever developed.

By joining us now, you reserve your place in a program that offers all you're looking for...and more.

You're looking for the excitement-charged atmosphere of a really new project? Our MX program is venturing into advanced areas most engineers only read about. The term "state-of-the-art" takes on new meaning here.

You want flexibility? You can work in any or all of the areas listed below, as your interests change. We'll give you the freedom to explore every function, every discipline, every one of your strengths.

You like the visibility of a small work environment? Our engineers cluster in balanced teams, for maximum creative interaction. Those who join us now will always play a crucial role in our activity.

You're looking for technical growth? The intense involvement, front end development, advanced techniques, and exceptional talent associated with this program make one or two years here worth many times that anywhere else. And to enhance your growth you can participate in in-house training and instructional programs.

You want a rewarding lifestyle? Our salary and benefits program is highly competitive and our location offers all the attractions... the educational, the cultural, the recreational amenities that New England and the Boston area in particular are famous for.

If you have what it takes, you're already interested. So make your reservation now to join us...GTE's Strategic Systems Division.

Hardware Engineering

You will have your choice of assuming a leadership role and direct the efforts of other professionals or if you prefer, you can be a major individual contributor in one, or more of the following areas:

- Distributed Processing
- Modems
- Data and Voice Multiplexing
- Switching
- Microprocessor Hardware and Firmware Design
- Power Supply Design (High-Efficiency, Switching)
- Analog Design
- Frequency Synthesizers
- Digital Radio
- Digital Signal Processing
- Fiber Optics Interfaces
- Electronic Surge Arrestors
- Display and Control
- Telephone Switching
- I/O Controller Design
- Antenna Design: VLF-SHF
- Equipment Integration
- COMSEC Interface

State-of-the-art development involvement will include:

- Timing Analysis
- Synchronization Techniques
- Worst Case Analysis
- Computer-Aided Design
- Circuit Simulations

We're seeking the hardware professional with between 2 and 10 years experience in Analog and/or Digital circuit design or logic design.

You should have the technical depth to make you a strong leader or major contributor. You should be able to interpret system requirements, and translate them into viable implementation. Microprocessor design and firmware background would be a distinct asset.

Software Engineering

You will have your choice of working in one, some, or all of the following areas:

- Real-Time Command and Control
- Telecommunications/Computer Networking
- Real-Time Simulation
- Diagnostics/ATE
- Operating Systems and Compilers
- Microprocessor Development

Your involvement will be in all phases of state-of-the-art development:

- Requirements Definition
- Specifications
- Design
- Implementation

You should have anywhere from 2 to 10 years experience, be a self-starter, with the relaxed attitude and sense of humor that works well with others, under pressure. Your background should include real-time software engineering, preferably with minis and micros.

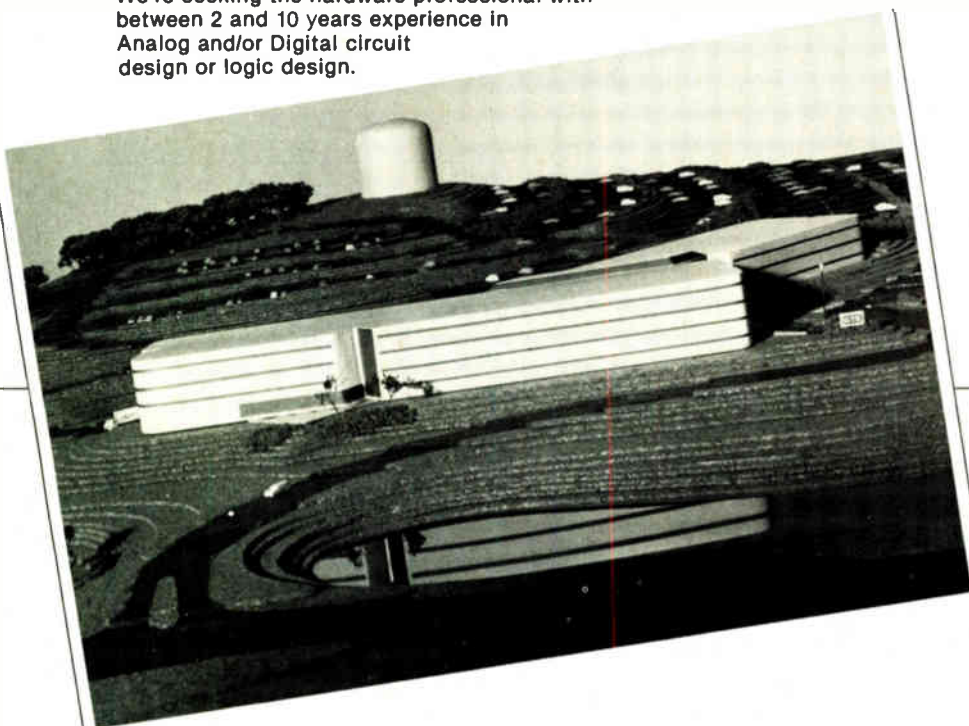

GTE

Systems

An equal opportunity employer

ENGINEERING MANAGER PRODUCT DEVELOPMENT

To Become A Part Of Our Management Team.

We are an advanced technology company with a substantial R & D Budget, dedicated to designing and manufacturing electro-mechanical systems for the military. Technology involves lasers, radar, navigational systems & integration with weapons & delivery systems.

We need a director for our applied R & D effort. The challenge is two fold. First, develop new products or advanced versions utilizing new combinations of state-of-the-art electronics. Second, perform business planning with presentations to top management & contractors, for a multi-million dollar program.

This position is located in suburban St. Louis, reports to a senior vice president, and is a member of the Strategic Management Team. Salary will be around \$50,000 depending on qualifications, plus substantial benefit package.

The successful candidate will probably have a degree in EE, Physics, or ME. Experience will consist of 10 or more years designing military hardware involving advanced technology. Component or systems background is desirable. Specific experience with microprocessors computers, software, lightweight mechanical devices, automatic test equipment, electronic warfare, and vehicles would be helpful.

Please forward resume to P-2859, Electronics
Class. Adv. Dept., PO Box 900, NY, NY 10020

All replies will be received by our personnel consultants and none revealed without your permission after a preliminary review of mutual interests.

An equal opportunity employer, M/F

ENGINEERS

ELECTRONICS ENGINEERS, \$60,000. Choice entry level to management positions immediately available in Pennsylvania & national locations. Reply in strict confidence to J. G. Weir, President, WEIR PERSONNEL SERVICES, 535 Court St., Reading, PA 19603 (215/376-8486).

GROWTH POSITIONS, \$22K-\$50K. 25+ yrs exp placing EE's nationwide. Many exclusive clients. Design/Mfg/Mktg/Mgmt. Reply to Gordon Hassell, V.P., LONGBERRY EMPLOYMENT SERVICE, 911 Main Place, Niles, OH 44446 (216/652-5871).

ELECTRONICS ENGINEERS, \$18,000-\$40,000. Suburban NJ and Nationwide. Numerous choice positions in co's utilizing the latest State-Of-Art methods & equip in areas of data & telecommunications & navigation. Reply in confidence to Jim Mann, VP/Eng, Suite 06, 8 Forest Ave., Caldwell, NJ 07006 (201/226-4555.)

DESIGN ENGINEERS to \$38K. Central Penna. & nationwide. Design connectors/terminals, microprocessors & controls. Reply in confidence to Z. A. Gonglewski, MECK ASSOC. PERSONNEL, 1517 Cedar Cliff, Camp Hill, PA 17011 (717/761-4777).

npc NATIONAL PERSONNEL CONSULTANTS

ENGINEERS TO 50K EXECUTIVES TO 100K +

We're one of the leading technical recruitment firms in S.E. Mass. Our professional staff of ten specialists have specific choice career opportunities within 150 mile radius of Boston—national opportunities also exist. Call collect or send your resume in strict confidence to John B. Ruck, V.P. Engineering, for a confidential discussion.

Career Associates, inc.
583 State Road
P.O. Box 86
North Dartmouth, MA 02747
Area 617-997-3311

SOFTWARE/HARDWARE SPECIALISTS

We urgently need high technology Engineering & Data Processing candidates to be considered for superb career opportunities in multi-facets of microelectronics field. Hardware-Computers/Datacom Eqmpt./Peripherals—Software—for varied micro-electronic computer systems, \$23-\$45,000 range. Client companies nationwide—Hundreds of job listings—Never a fee to an applicant. Contact CORPORATE RECRUITERS, Ste. 525, 2120 S. 72nd Street, Omaha, NE. 68124. 402/393-5515.

Test Engineers

RCA Avionics Systems, a leader in the commercial manufacture and development of radar related equipment, has an immediate need for Test Engineers.

The individuals we seek will formulate, design and program automatic test systems for avionic products, as well as evaluate production test performance and automatic test equipment for radar (color displays) data navigation production.

Join RCA for a leading compensation program and total benefit package that includes family life and health insurance, income savings plan, retirement plan and much more. Please send your resume in confidence to Randall Takahashi.

RCA Avionics Systems

Dept. E
8500 Balboa Blvd.
Van Nuys, CA 91409

We are an equal opportunity employer.

RCA

A Tradition On The Move!



Solid State Research Group Leader

Tektronix Laboratories has need for an experienced professional in the area of advanced silicon IC process technology. The individual will be responsible for contributing to and leading (5 to 10 engineers) a growing research effort in new materials and advanced IC structures and circuits. Primary focus will be high power laser processing techniques. Background must include significant R & D experience in all aspects of device oriented materials and processing. A well equipped research oriented IC cleanroom facility is available for R & D work as well as others for engineering development and manufacturing. We feel this position represents an excellent opportunity for someone to join a respected company that has been developing and manufacturing high performance custom IC's for over 13 years in the Portland metropolitan area.

For consideration, please call Gary Hecht at (800) 547-1164, or send resume to Gary Hecht, MS 55-033, Tektronix, Inc., P.O. Box 500, B-4, Beaverton, Oregon 97077.

An equal opportunity employer m/f/hc.

Tektronix
COMMITTED TO EXCELLENCE

At the new brazilian national telecommunication R & D centre several interesting development projects are now in progress.

These projects are being carried out with the aid of international

experts recruited (on contracts ranging from 2 months to 3 years) through the International Telecommunication Union – ITU.

At present there are several openings for high level telecommunication specialists in the following areas:



UNIQUE OPPORTUNITY IN BRAZIL

SPC TIME DIVISION SWITCHING

- Electrical/mechanical packing
- System testing
- Software testing
- Special components
- Operation and maintenance
- System reliability
- Production
- Documentation
- Software documentation

A minimum of 5 years experience with a major telecommunication industry and evidence of having completed at least one major switching product development in the field of speciality is required.

SATELLITE COMMUNICATION

- Design of Ground Control Equipment for Satellite communication

A minimum of 5 years experience is required in system design of GCE and SCPC/FM equipment.

ENGINEERING SERVICES

- Semiconductor component reliability
- Technical documentation

The right men will have experience in both setting-up and running respective laboratories for semiconductor reliability evaluation, modern technical information and/or technical documentation centres.

LOCATION

The R & D centre is located in Campinas in the State of São Paulo. Campinas was some years ago the coffee centre of the world, but it is known today as an important brazilian scientific and cultural centre, where there is rapid growth of light industry. The town has some of the best medical service facilities in South America and excellent educational facilities (among the latter an excellent American school).

For information about the posts and contractual conditions please contact:

MRS. INA WICKIHALDER
Caixa Postal 1579
13 100 – Campinas
Brazil
Telex: 191 070

RESEARCH & DEVELOPMENT OPPORTUNITIES

Digital Voice Products

These are opportunities to join a group of professionals working on advanced data communications systems and equipment. Codex is a world leader in data communications technology, making these positions an opportunity for advancement in your field.

Hardware Design Engineer

The responsibilities are Design and Development of real-time microprocessor/signal processing hardware for low bit rate digital voice products. Requires a BSEE, and two years experience in Digital Design, Computer Architecture, Bit-Slice Design, Telecommunications or Signal Processing.

Software Design Engineer

Responsibility is for the Design and Development of Systems and Applications Software for real-time low bit rate digital voice products and multiprocessor architectures. Requires a BS, (MS preferred) in EE or CS and experience in Real-Time Micro-Computer Based Systems, Real-Time Operating Systems, Micro Programming or Signal Processing.

In addition to a competitive salary, we offer a comprehensive benefits package including profit sharing and dental insurance.

Please reply in confidence to Jerry Dombrowski, CODEX CORPORATION, 20 Cabot Boulevard, Mansfield, MA 02048.

codex

A Subsidiary of  MOTOROLA INC.

An Equal Opportunity/Affirmative Action Employer M/F

We're a world leader in the manufacture of electronic components and are proud of our commitment to keep pace with advancing technology. Join us at Sprague!

We have outstanding career-growth opportunities for you in the following positions:

PROCESS ENGINEER - Precious Metals Area - Process engineering on precious and non-precious metal powders.

SR. PRODUCT ENGINEER - Ceramic Materials - Technical responsibility for chemical and physical property specifications for ceramic powder compositions.

PROCESS ENGINEER - Finishing monolithic chip capacitors requiring mechanical aptitude for designing jigs, fixtures.

EQUIPMENT DESIGN ENGINEER - Design and monitor construction of process and engineering equipment for multilayer capacitors.

Norma M. Hays, Recruiting Coordinator
Sprague Electric Company
87 Marshall Street, North Adams, MA 01247

An Equal Opportunity Employer M/F

SPRAGUE[®]

THE MARK OF RELIABILITY

New England Is Our Area Of Expertise . . . AND The Best Place For Yours.

Since the birth of the electronics industry, "New England" has been an instant synonym for state-of-the-art research and development, for explosive growth, for unique professional challenge and satisfaction.

Now, "Carpenter Consultants" is quickly becoming synonymous with professional search and placement services in the electronics field, everywhere in our six-state region. Our clients include many of New England's largest employers and some that soon will be, offering immediate R&D, Applications and Marketing Support opportunities in a wide variety of computer peripheral and instrumentation environments.

If your area of expertise is:

Software Design	Applications
Data Base Design	Systems Prog.
Telecommunications	Compiler Design
Minicomputers	Analog Design
Programming	Diagnostics
Signal Processing	Data Communications
Digital Systems	Microprocessor Design

our area of expertise is waiting.

Carpenter Consultants, Inc.

824 Boylston Street
Chestnut Hill, Mass. 02167
(617) 731-3730

ENGINEERS:

FIND OUT WHAT WANG HAS TO OFFER. YOU'LL BE MOVED.

You'll like the company. Wang is the \$500 million leader with the state-of-the-art reputation that's made us #1 in CRT-based word processing systems, and #2 in small computers. We're Fortune 576. Our sales have risen spectacularly from \$78.5 million to \$321.6 million in four years. And the future looks better than ever.

You'll like the opportunity. Wang technology is already revolutionizing office work. And when it comes to Integrated Information Systems no other manufacturer comes close to having the variety of processors, terminals, communications software and simplicity of operation to make this concept a reality.

You'll like the rewards. Wang offers excellent salary and benefits including profit sharing and stock bonus plan; stock purchase plan; medical, dental and life insurance; tuition reimbursement and, more importantly, a real chance to make your mark on the office of the future.

A number of challenging opportunities are immediately available for:

- Analog Engineers
- Circuit Design Engineers
- Electro-Optical Engineers
- Electronics Packaging Engineers
- Mass Storage Engineers
- RF/Radio Frequency Engineers
- Reliability Engineers

Interested applicants should contact Steve Eldridge at (617) 459-5000 Ext. 3736; or send your resume, complete with salary history to Steve's attention at Wang Laboratories, Inc., MS 1106, One Industrial Avenue, Lowell, MA 01851. But you better get a move on.

**WANG**

Making the world more productive.

We are an affirmative action employer.

SOFTWARE ENGINEERS.

WITH US, YOUR PROJECT IS THE WHOLE PROJECT.



LOCK, STOCK AND BARREL.

At Coulter Electronics, we have a total systems approach to engineering.

You'll take special pride in your own projects. Because you're involved from start to finish. From concept to production to marketing.

It's an approach that's helped make us a recognized and expanding leader in biomedical electronics and instrumentation.

When you apply your **micro-processor/mini-computer experience in our top-down design, structured programming environment**—you'll see your ideas take full form.

When you utilize your degree in Math, Computer Science or Electrical Engineering—you'll be improving the state of health care worldwide.

It's a big job. A thorough, complete, far-reaching job. It could be your job.

Send your resume and salary history to: **Employment Manager, Coulter Electronics, Dept. E, P.O. Box 5-2794, Miami, Florida 33152.**

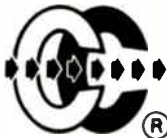

COULTER ELECTRONICS, INC.
INNOVATING A VITAL TECHNOLOGY.

An Equal Opportunity Employer M/F

SOUTH & SOUTHWEST POSITIONS

Engineering and Management positions throughout the South, Southwest and U.S. Employers pay all fees. Send resume or call Bob Hogue, P.E. (513) 658-3525.

SouthWest Technical
P.O. Box 33070,
San Antonio, Texas 78233

SPECIAL SERVICES

Arabic Technical Translations from English and French, electronics, radio communications, computers, related disciplines. Call (evenings) 312-693-2931.

EMPLOYMENT SERVICES

Electronic engineering growth positions with clients located nationally. Our service is enhanced by the fact that I am an EE with 20 years in industry and over 10 years in placing professionals on an employer fee paid basis. Send your resume to Joe Torcassi, Director, J. Anthony & Associates, PO Drawer AD, Lynchburg, OH 45142. 513/364-2305.

Engineers: Electrical-Civil-Mech. Nationwide openings—all levels—\$15-60K Energy, Environment, Chemical, Power, Oil/Gas, HVAC, Piping etc. Send resume w/salary requirements to: Engrg/Mgmt Recruiting Services—416 E. Downs, Stockton, CA 95204. "Mitch" (209) 529-8145—All Fees Paid.

EMPLOYMENT SERVICES

Engineers—EE/CS. Engineers—M/E. Engineers—C/E. Immediate openings National and Overseas. Micro-processor/Applic. Programmers/Analysts/Systems. Designers/Systems/Analysts. Avionics Electronics. Microwave Components. Rel./Maint.-QC/QA. Switching/Telecom. Also. Power*HVAC*Piping*Oil/Gas. Estimators & Sales*R&D. \$20-50K. Send resume w/salary requirements to: Engrg/Mgmt Recruiting Services—416 E. Downs St., Stockton, CA. 95204. "Mitch" (209) 529-8145. All Fees Paid.

Engineers

- Design
- Development
- Project
- Software

\$20,000-\$50,000

Riddick Associates' Engineering Division specializes in placement of electrical and electronics engineers with top companies in the Southeast and throughout the U.S. We provide advice on careers, resumes and interviews for a position tailored to your skills. Client companies pay all fees. For details call or send resume in strict confidence to Phil Riddick, President.

Riddick Associates, Ltd.
9 Koger Executive Center
Norfolk, VA 23502
Area 804-461-3994

**ENGINEERS
SUNBELT**

**\$20,000 -
\$40,000**

Specializing in those critical 1st through 3rd moves upward for all types Electronic and Computer experience (Degree). We cover the Southeast and Southwest like a blanket—with over \$8,000,000 of success behind us. Client companies pay interview, relocation and our fee. For fast, personal attention, send your resume to Mike Howard,

Mike Howard Personnel
608 S. Gay St. Suite 206
Knoxville, Tn. 37902
(615) 546-9446

ENGINEERS

Quality Control Industrial
Maintenance/Instrumentation

DESIGN

Analog Digital
Software Micro Processing
Test Equipment Instrumentation

Salary ranges are \$20-45,000 per year. Our firm is associated with a leading network & all costs are paid by client companies including interviewing, fees, relocation & free resume service. Call Dan Wheeler at 1-317-899-1777 or send resume to

TWT & Associates Inc.
3724 N. Mithoefer Rd.
Indianapolis, Indiana 46236

RESUMES

Resumes—Complete instructions and examples; \$4. Consultants, Box 567—J. Bergenfield, N.J. 07621.

MITRE...

At MITRE, we value your informed perspective on the future. And we appreciate broad vision as well as sharp focus on detail. As General Systems Engineer in Command, Control and Communications (C³) systems for the US Air Force's Electronic Systems Division, we offer you a chance to help shape tomorrow's technology—defining problems, finding working solutions and translating them into comprehensive recommendations for action.

You'll be challenged by a variety of projects, in an environment of professional cooperation and pride. And you'll enjoy stability as the nation's emphasis on C³ expands and projects increase in number and importance.

If you have a BS degree in EE, Math, Physics or Computer Science and several years of appropriate experience, try MITRE. Career positions are immediately available in the following areas:

COMPUTER SYSTEMS

- Requirements Analyses
- Simulation and Analytical Modeling
- Systems Analyses
- Technology Assessment
- Software Acquisition Management
- Systems Acquisition
- Performance Analyses
- Specification and Verification

COMMAND AND CONTROL

- Air Defense Systems (Deployable and Fixed)
- Tactical Air Control Systems (Deployable and Fixed)
- Systems Analysis and Specification
- Software Development

SYSTEMS ARCHITECTURE

- Advanced Systems Design
- Intersystems Engineering
- Advanced Planning
- Systems Inter-Operability
- Cost Analyses

COMMUNICATIONS

- System Design and Analyses
- Digital Communications
- Microprocessor Applications
- Communications Processors (Hardware & Software)
- Modulation/Coding Techniques
- Secure A & D Communications
- Systems Test and Evaluation

RADAR SYSTEMS

- Digital Signal Processing
- Radar System Surveillance Techniques
- Radar System Analyses
- Anti-Jam Analyses
- Intelligence/Operations Analysis

Send your resume to David L. Finnegan, The MITRE Corporation, 3909 Middlesex Turnpike, Bedford, MA 01730. U.S. Citizenship or resident alien registration required.

...SHAPING TOMORROW'S **C³** SYSTEMS



MITRE is an equal opportunity employer actively seeking applications under its affirmative action program.

Creativity Stifled? Switch to Nixdorf.

It's pointless to work where you can't make an impact.

That's why you should consider a career with Nixdorf Computer. We're ready for some creative professionals to take the initiative in implementing and extending our vision. In fact, we're at just the right point for you to have a significant influence on our technological future.

Nixdorf is moving ahead aggressively. Our sales exceeded \$100 million, last year, a 25% jump. Our product lines reach from state-of-the-art business system mainframes right down to hand-held personal computers. So there's variety, choice and technical challenge. And the opportunity to let your creativity loose.

When you factor in Nixdorf's competitive salaries, full benefits package and Burlington, MA location just 20 miles from Boston, a switch to Nixdorf is a pretty creative career move.

Hardware Engineering

Hardware Design Engineer

Define and create the logic for a new state-of-the-art data and word processor.

Principal Diagnostic Engineer

Act as project leader involved in remote diagnostic efforts. Management experience and excellent system software design skills required.

Project Engineer

If you're a hands-on problem-solver with at least 8 years hardware experience in minis, diskdrives and displays, here's your leadership opportunity.

Additionally, we seek seasoned hardware talent to become involved in terminals, interfaces, peripherals and firmware.

Software Engineering

We seek a wide variety of software professionals with Assembly language experience for these project areas:

- Source Data Processing • Multi-Functional Processing • Communications • Networking • Word Processing

Even if you don't see your specific area of expertise represented here, if you're a hardware or software professional whose creativity is stifled, forward your resume, with salary history, to Steven E. Anderton, Nixdorf Computer Corporation, 23 Fourth Avenue, Burlington, MA 01803, 617-273-0480, or outside of Massachusetts call 1-800-225-1484.

We are an equal opportunity employer m/f/h.

Committed to Success.

NIXDORF
COMPUTER

Engineering & Marketing Opportunities

YOU'LL BE VISIBLY DIFFERENT AT MODICON.

Ever feel that your work's the best-kept secret since the Manhattan Project? You'd like to say something to somebody, but you're not sure what — or to whom. How about speaking to us?

We went the "industry leaders" one better when we created the Programmable Controller industry. And now that productivity has become a national concern, our 40% share of the market is growing every day.

More important for you, the people who count know who they can count on, what everyone's doing, and what everyone's done. At Modicon, there are no invisible contributors.

There's the difference.

We also offer excellent salaries, generous benefits and an informal atmosphere for growth and advancement. Please send your resume to George E. Street, Technical Recruiter, Gould/Modicon Division, P.O. Box 83, Shawshen Village Station, Andover, MA 01810. Equal opportunity employer m/f/h.



ENGINEERS



ENGINEERING PROFESSIONALS JOIN OUR TEAM and LIVE IN BOULDER, COLORADO

Ball Aerospace Systems, a Division of the Ball Corporation, is seeking engineers who want challenging career opportunities in the aerospace industry.

We have become a leader in the development of space science instrumentation, electro-optics, antennas, military electronics, satellite systems and subsystems.

We would like to talk to qualified individuals in the following areas:

Electrical Engineers
Mechanical Engineers

Quality Engineers
Antenna Engineers

Ball Aerospace Today. People and Ideas working together in Boulder — a community nestled in the foothills of the Rocky Mountains. Nearby you can hike, fish, hunt, ski and enjoy some of America's greatest recreational areas. You and your family will have time to relax in cool, colorful Colorado.

We offer an excellent salary and benefits package including medical, dental, life insurance, stock purchase plan, credit union, 100% tuition reimbursement and **FOUR WEEKS VACATION after one year**. If you are seeking a career with a leader in the industry, send your resume to the attention of Joni Coffin.



AEROSPACE SYSTEMS DIVISION

Employee Relations Department
P.O. Box 1062
Boulder, Colorado 80306
Call Collect: (303) 441-4111

Equal Opportunity Employer M/F

WHY ON EARTH WOULD ANYONE WANT TO WORK FOR US?

No one would. Unless they were interested in the excitement of major new product developments in instrumentation tape recorders, graphic and imaging recorders, digital data acquisition systems, and ultrasound systems.

No one would unless they were intrigued by a company offering challenges, growth and a rewarding career within a broad and sophisticated spectrum of new technology.

No one would unless they preferred a variety of opportunities as opposed to being locked into one single project.

And no one would unless they liked the idea of living and working on the high, dry plains at the foot of the Rocky Mountains, with a magnificent climate, a wonderful view, professional sports, culture, and golf, tennis, skiing and other outdoor endeavors.

At present, we have choice

openings for engineers and scientists experienced in

- Pulse Code Modulation Systems
- Video (Helical Scan) Recording Technology
- High Density Digital Recording
- Graphics and Imaging Recorders using Dry Silver Technology and Toner Based Writing Techniques
- Digital Data Acquisition
- Analog/Signal Conditioning
- Digital and Digital/IC Design
- Software and Systems Design
- Ultrasound Transducers

We've got everything you're looking for if you've got what we're looking for.

Interested? Call Sue Wells at 303/771-4700. Or write Personnel Dept., Honeywell Test Instruments Division, Denver Operations, Box 5227, Dept. E., Denver, Colorado 80217.

Find out about us. And about some of the best living and working on earth.

WE'LL SHOW YOU A BETTER WAY.

Honeywell

An Equal Opportunity Employer M/F/H

ENGINEERS

Expanded career opportunities are at your fingertips

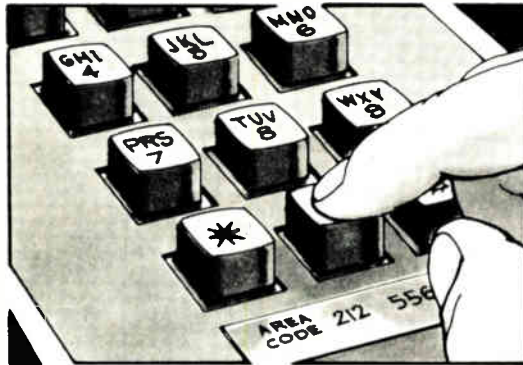

call 800-321-6980

(In Ohio 800-362-6120)

**Talk to Tom O'Brien
about your skills and background for,
positions such as...**

Software Engineers Capitalize on your Comp. Sci. or related degree and apply your software experience – assembly languages, PASCAL, FORTRAN. Utilize our VAX 11/780 DEC 11/34 or TEKTRONIX Development Systems to support your designs.

Hardware/Firmware Design Engineers Design NC and PC systems employing advanced digital techniques. Degree and 2+ years experience desired. Your involvement would include design verification using VAX 11/780, DEC 11/34 or TEKTRONIX Development Systems.

Application Engineers Define customer control system requirements, prepare proposals and assist new product planning.

Product/Marketing Engineers Research and identify product opportunities based on industry requirements utilizing your degree and 2+ years of electronics or industrial experience.

These are opportunities with a future.

We are a dynamic part of an international corporation employing over 17,000 people. Our products apply "leading edge" computer and microprocessor technology that increases productivity for all types of industry.

Our careers are challenging and rewarding...

Let's Talk About It – Call Today: or if you prefer, send your resume to:



ALLEN-BRADLEY

747 Alpha Drive
Highland Heights, Ohio 44143

An Equal Opportunity Employer M/F

ENGINEERS

COMPUTER PERIPHERALS

Magnetic Peripherals—Oklahoma City, a subsidiary of Control Data Corporation, is a facility dedicated to the design and manufacture of computer peripheral devices such as disk drives (both flexible and rigid), high speed reader/sorters and non-impact printing systems.

Continued expansion of our business and our people in the growing mini-computer market has created a variety of technically challenging opportunities for engineers and experienced technologists.

Our facilities are located in Oklahoma City, a growing metroplex in the heart of the Sooner State. Our city offers a number of desirable advantages that you owe to yourself to investigate. Included are reasonable cost of living (including taxes and energy costs), moderate year-round sunbelt climate, excellent educational facilities at all levels, immediate access to outstanding recreational opportunities, and much more.

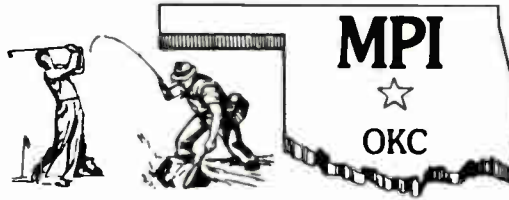

If you have been thinking that 1980 might be your year for a change in the direction of your career, we invite you to investigate the technical careers available with us in Oklahoma. We have immediate opportunities for

ELECTRICAL ENGINEER (3 required per "A", "B" & "C" below)

"A" Design of phase locked loop, closed loop systems and linear phase filters and amplifiers. Prefer familiarity and experience with LSI design for disk products or similar technology background. BSEE required or MSEE preferred and 4-9 years experience or equivalent experience.

"B" Design of analog and digital circuits. Ability to analyze problems and develop practical solutions. Experience in the area of read amplifiers required. BSEE degree required or MSEE preferred plus 9 years experience.

"C" Ability to handle all phases of design on rotary positioning systems, including electro-mechanical design of positioning motor and all electronics related to 8" rigid disk design. BSEE required or MSEE preferred. A minimum of 9 years design experience or equivalent required.

ELECTRICAL ENGINEER (2 required as per "D" and "E" below)

"D" Analyze, design and develop analog circuits required for new products. Involves servo mechanism circuit design; A/D and D/A techniques; optical, ultrasonic, and magnetic transducers; bar code and character reading; ink jet circuitry; and use of micro processors as related to above. BSEE required; MSEE desirable plus 9 years design experience emphasizing analog circuit design.

"E" Project Engineer responsible for the design and development of test equipment and test systems. Will include Design and Design Leadership; Project Planning, Scheduling and Monitoring; and Development Coordination for a group of Engineers and Development Technicians. BSEE or BSME required plus 6-9 years of equivalent experience.

MANUFACTURING ENGINEER —PLATING & PAINTING

Knowledge of paint and plating processes; must include electro-plating of zinc on steel anodizing aluminum and paint systems.

DESIGNER

Create, design, and prepare layouts of products from written or oral information. Should be creative and well-versed in drafting techniques, as well as engineering and manufacturing processes and procedures. Should have 6-9 years related experience.

MECHANICAL ENGINEER

Mechanical design, development, evaluation, manufacturing release and continuation of new flexible disk drive products. Experience in cost reduction programs desired. BSME required; MSME preferred plus 6 years related experience or equivalent experience.

SENIOR SYSTEMS ENGINEER

Responsible to develop systems requirements and specifications for new non-impact printer products as well as analyze and propose potential hardware/software design approaches. You will be a project leader for custom and special customer interfaces. Requires three (3) years of logic/system design experience in the field of minicomputers or mainframes with knowledge of disk/tape/terminal controller design and operation and knowledge of IBM or Honeywell operating system. A BSEE or BS Computer Science degree or equivalent is desired with MS degree preferred.

MANUFACTURING ENGINEER —MECHANICAL ASSEMBLY

Mechanical Assembly Tool Designer. Will design small to medium tools and fixtures for Mechanical Assembly. Minimum of three (3) years tool design experience preferred and drafting techniques are required.

QUALITY ENGINEERS —INSPECTION

Responsible to develop and evaluate quality plans and inspection procedures. Will investigate component part problems and initiate corrective action. May provide supervision of assembly inspection personnel. Good communication skills essential. Should have BS degree in technical discipline plus minimum of 3 years quality control experience, especially in high-volume precision electro-mechanical devices.

AUTOMATION ENGINEERS

Experienced in design, creation and implementation of automation tooling, systems and methods. Strong background in mechanical, hydraulic and pneumatic applications in design of sophisticated assembly devices for automatic assembly of electro-mechanical

devices. Desire experience in design of machines to assemble small linkage mechanisms and experience in tool and die design or control systems background using microprocessor controllers in automatic assembly equipment. Desire technical degree with 6 or more years related experience.

MANUFACTURING ENGINEER —SHEETMETAL

Delineate sheetmetal process instructions. Tooling justifications, work planning revision update and problem solving.

MANUFACTURING ENGINEER —PWA TEST

Design PWA Test programs, procedures and equipment. Circuit analysis worse case, interface with Design Engineering. Analysis of repair data on PWAs for failure modes and corrective actions. Circuit analysis to provide PWA test diagnostics. Should have 6-9 years experience.

TEST EQUIPMENT DESIGN ENGINEER

Will design special test equipment of sophisticated analog/digital instruments for total electrical/electronic measurement system. Will create specifications, design equipment, checkout designs and create operating procedures. Skills desired include digital/analog circuit design, hardware/firmware/software incorporation techniques. Desire BSEE with test equipment design experience.

SOFTWARE ENGINEER

Experience in development of systems software, especially as it relates to peripherals (disks, Reader/Sorters, printers). Assembly language programming skill a must. Should be experienced in microprocessor firmware/software development. Degree in Engineering discipline or Computer Science required with 2-4 years software/firmware design background.

If you are interested and qualified for any of these career opportunities, please forward your resume to:

Magnetic Peripherals, Inc.
P.O. Box 12313, Oklahoma City, OK 73157
Attn: Dick Hill, Dept. E-1

or contact us on our TOLL FREE line

1-800-654-3685

MAGNETIC PERIPHERALS INC.

 a subsidiary of
CONTROL DATA CORPORATION

Addressing society's major unmet needs

An Affirmative Action Employer

FOXBORO... OUT FRONT.

With the introduction of the SPECTRUM series of electronic systems Foxboro continues on the leading edge of the Process Management and Control industry.

Embracing a variety of existing Foxboro products including SPEC 200; VIDEOSPEC operator workstation; FOX 1/A and FOX 3 computers; MICROSPEC Digital Control Systems and FOXNET a major step forward in data communication links, SPECTRUM can meet the present and anticipated needs of large and small users alike.

At Foxboro you'll find an environment for research that is truly state-of-the-art. Put your career where Foxboro is. Out front. To stay.

These are immediate openings:

RESEARCH ENGINEER, DISPLAY TECHNOLOGY APPLICATION

You will work as a member of a research team responsible for the application of new display concepts to assist in the control of industrial processes. Applications include single loop displays, multiloop displays, and sophisticated color graphic displays for the person-process interface.

You should have a BSEE, MSEE or the equivalent and two or more years experience in the evaluation and application of display technologies. Experience in the design of controllers for keyboards, hardcopy devices, printers, plotters, etc. is desirable.

SENIOR RESEARCH ENGINEER, COMMUNICATIONS NETWORKS

You will work as a key contributor in research projects concerned with the design of sophisticated distributed process control systems. You will provide leadership in the design of suitable communications networks, which will interconnect such multiprocessor-based systems.

You should have a BSEE, MSEE or a computer science background. Your expertise should be in these areas; analysis of today's communication protocols (SDLC, EI-SYNC, etc.), definition and design of software for the efficient use of such protocols, design of multiprocessor networks for distributed processing; analysis of failure modes, reliability and loading of such networks. Design experience using today's commercial microprocessor would be a plus.

SENIOR RESEARCH ENGINEER, LINEAR CIRCUIT DESIGN

You will design sensor electronics and analog front end for new concepts in the measurement of pressure, temperature, flow, level, etc. while working with a team of research engineers engaged in the development of new measurement techniques using ultra-sonic, infrared, optics and other technologies. You will also interface the basic measurement devices with microprocessors to produce intelligent measurement systems.

You should have a BSEE, MSEE or the equivalent with at least five years of concentrated experience in linear circuit design using state-of-the-art semiconductor technology. Experience in digital design using microprocessor technology would be a plus.

Foxboro offers excellent salaries and a complete benefits program featuring cash profit sharing, employee investment plan, promotion from within, paid pension plan and tuition assistance.

Forward your resume to **Dan McCoy, The Foxboro Company, Dept. E925, 38 Neponset Avenue, Foxboro, MA 02035.** Foxboro is an equal opportunity employer, M/F.

FOXBORO

S.W. & SUNBELT

- System EE's
- Software
- Design EE's
- Design ME's
- Product EE's
- Communications

\$20,000 to \$50,000
100% Fee Paid

Specializing in placing technical people with data acquisition and peripheral equipment manufacturers located across southern U.S. Send complete resume, salary history and geographic preferences to:

J. ROBERT THOMPSON COMPANIES, INC.

Management & Employment Consultants
2200 West Loop South, Suite 800
Houston, Texas 77027 713/627-1940

ENGINEERS \$20,000-\$60,000

Nationwide fee-paid opportunities in aerospace, defense electronics, weapon systems, microwave, communication systems

- DIGITAL & ANALOG
- MICROPROCESSOR
- MARKETING
- CONTROL

Call collect or send resume to Glenn English, President

GLENN ENGLISH AGENCY
7840 Mission Center Court
San Diego, CA 92108
(714) 291-9220

POSITIONS VACANT

Positions available in the aerospace, military & industrial fields for electronic & electrical engineers. Require degree + U.S. experience in design, development, QA, QC or reliability of hardware or software. Fee, interview & relocation paid by client companies throughout the U.S. since 1959. U.S. citizens or permanent residents send resume & current salary or call collect (215) 735-4908 for application. Atomic Personnel, Inc., 1518-L Walnut Phila, PA 19102.

Electronic Engineers—Sunbelt/Southwest. Opportunities in Design Software, Digital/Analog, Micro-processing, Personalized representation. Employer fee paid. J. Gifford Inc., 5310 East 31st Street, #225 Tulsa, Oklahoma 74135. (918) 665-2626.

Electrical Engineer—Will design, construct, test and perfect components of new NMR spectrometers and associated instruments. Requires good knowledge of digital pulse and RF circuitry and knowledge of digital pulse and RF circuitry and knowledge of computer hardware structure and programming. Salary \$18,000-\$22,000. Apply Carnegie-Mellon University, Personnel Services, 5000 Forbes Ave., Pittsburgh, PA 15213. An equal opportunity affirmative action employer.

Writer Wanted—Regis McKenna PR Agency, Palo Alto, CA., seeks professional writer with EE background and/or solid trade book experience to join writing department. New product releases, news and application stories for technical clients. Growth opportunity for right person. John Kane, Regis McKenna, Inc., 1800 Embarcadero Road, Palo Alto, CA 94303. EOE.

EXPLORE YOUR FUTURE IN THE PERFECT CLIMATE.

Located in the Technology Square complex in Cambridge, Draper Laboratory is a world renowned research center with a volume of nearly \$100 million a year and nearly 2000 employees, 850 of whom are scientists and engineers. We're a hands-on laboratory solving pressing national problems. Here, you'll find all the facilities you need to develop your ideas to the fullest. Working in close proximity to MIT, you'll have all the freedom you need. To think. To pursue the goal of excellence. To bring your ideas to proof in an academic environment. And, still take home an industry-level salary.

We do fascinating and rewarding work, attracting some of the world's most imaginative, inventive people. If you're one of them, arrange for a Draper interview. Once you experience our climate you may decide to make it home.

We currently have the following openings both at the entry level and for persons with advanced degrees at all levels of experience.

ELECTRICAL ENGINEERING • CONTROL SYSTEM DESIGN • ANALOG/DIGITAL DESIGN ENGINEERING • ELECTRONICS SYSTEMS ENGINEERING • COMPONENT TESTING AND ANALYSIS • ELECTRONICS PACKAGING ENGINEERING • NAVIGATION SYSTEM ANALYSIS AND DESIGN • COMMUNICATIONS SYSTEMS ENGINEERING • AERONAUTICAL ENGINEERING • QUALITY ASSURANCE ENGINEERING • AVIONICS • COMPUTER SCIENCE

Please forward your resume to John McCarthy at The Charles Stark Draper Laboratory, Inc., 555 Technology Square, Dept. E9, Cambridge, MA 02139.

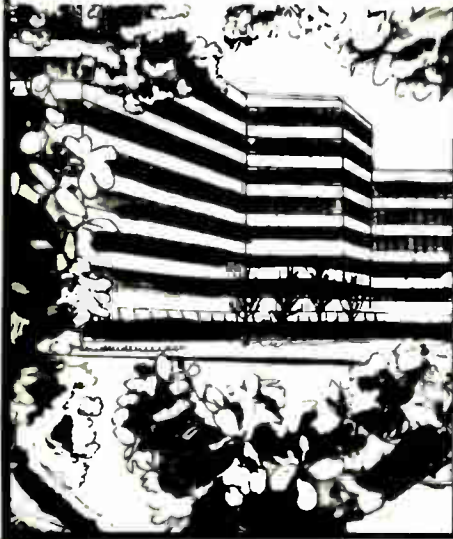

**The Charles Stark
Draper Laboratory, Inc.**

We are an equal opportunity/affirmative action employer.

AT GCA... BE HEARD.

The Burlington Division of GCA is a leader in designing and building manufacturing equipment improving productivity for the semiconductor industry. At GCA, you can sound out your creativity in electronics.

We need fresh talent like yours on our industry-leading team. If you've got bright new ideas, we're ready to listen.

These positions are based at GCA's facilities right in the heart of the famed Massachusetts Route 128 high technology belt surrounding Boston.

Current opportunities include:

Sr. Design Engineer

Design, debug and document various digital equipment using TTL logic and microprocessors. CMOS experience helpful. BSEE plus 3 years design experience.

Senior Electronic Technician

Develop high speed and accurate deflection circuitry required in designing a direct-writing E-Beam Lithography system for semiconductor processing. Requires knowledge of linear analog circuitry and transistor parameters.

Electronics Manufacturing Engineer

Strong background in the design of analog and digital circuit test equipment plus testing procedures and methods. Degree or equivalent and programming background desired.

Engineering Technician

Layout, build, test prototype digital and analog circuits. Troubleshooting experience a must as well as ASEE or equivalent.

Electro-Mechanical Designer

Prepare layouts of new products and modifications to existing products as well as perform various tasks related to R&D projects.

P.C. Design Drafter

Prepare design layouts and art work masters for both digital and analog P.C. boards. Minimum 5 years experience.

We offer excellent salaries, a trend-setting benefits package and generous relocation assistance. To apply, please send your resume to Ray Church, GCA/Burlington Division, 174 Middlesex Turnpike, Burlington, MA 01803.



an equal opportunity employer m/f

ENGINEERS AND PROGRAMMERS

Lockheed Engineering & Management Services Company is seeking qualified applicants for immediate positions at NASA's JOHNSON SPACE CENTER in Houston, Texas. These positions are in support of the Space Shuttle and Earth Resource Programs and require applicants (U.S. Citizenship or permanent residency) experienced in the following areas:

- **MICROWAVE ANTENNA DESIGN/ANALYSIS/TEST ENGINEERS:**
With experience in design, development, analysis, and/or testing of antenna systems. Preferable in S-Band through K-Band frequency range.
- **ENGINEERING ANALYSTS:**
Responsible for developing and evaluating math models of spacecraft/aircraft sub-systems including control surface actuators, landing gear systems, etc., for use in large scale digital simulation. Applicants should have a knowledge for modeling dynamic systems.
- **CONTROL SYSTEMS ENGINEERS:**
With experience in digital control systems to perform simulation and analysis of spacecraft/aircraft flight control systems. Applicants should have the knowledge of FORTRAN and be familiar with the use of digital and computer analysis of control problems.
- **SCIENTIFIC PROGRAMMERS:**
Analyze scientific, engineering and mathematical problems and develop numerical models and programs for their solutions on high speed digital computers. Applicants should have a thorough knowledge of FORTRAN and be familiar with the use of large scale computers.
- **SIMULATION APPLICATIONS:**
Support the development, evaluation and operation of a large dynamic simulation dedicated to Shuttle Flight testing. Applicants should have worked with spacecraft/aircraft GUIDANCE, NAVIGATION AND CONTROL SYSTEMS.
- **MECHANICAL/AEROSPACE ENGINEERS:**
Responsible for development and use of programs for structural, thermal or environmental Control Systems analysis. Applicants must be familiar with and capable of effectively utilizing large scale digital computers in the analysis of engineering problems.
- **COMMUNICATIONS ENGINEERS:**
Support performance analysis of various communications and tracking links accessed by spacecraft/aircraft. Applicants should be familiar with TACAN, MSBLS, and GPS SYSTEMS, have the ability to develop and evaluate math models, have a high level of competence and written communications and have a knowledge of FORTRAN.
- **DIGITAL DESIGN ENGINEERS:**
With experience in design and development of digital/analog equipment including computer interface, display, control and signal conditioning hardware.
- **COMPUTER MAINTENANCE ENGINEERS:**
To be cross-trained to support a large, diverse simulation laboratory. Facility includes analog computers, mini-computers and second and third generation medium-to-large scale systems manufactured by several companies.

Send resume in confidence to William R. Jancha at Lockheed Electronics Company, Dept. C-20-E, 1830 NASA Road #1, Houston, Texas 77058

LOCKHEED ENGINEERING & MANAGEMENT SERVICES COMPANY

An Equal Opportunity Employer M/F/H

NEW ENGLAND POSITION OPENINGS

Client companies with numerous openings in the electronics/computer manufacturing industry. Require product development, firmware and systems engineers, programmers, analysts, data communications specialists and marketing personnel. Candidates with appropriate experience send resumes in confidence to:

W. Garner Bee
C.O.S.T. Inc.
212 Worcester Rd., Wellesley, MA 02181
617-237-1247



★ ATTENTION ELECTRONIC ENGINEERS!!! ★

Electronic Design Engineers	24-36K
Design Engineers (Digital)	25-35K
Analog Design Engineers	-25-35K
Systems Design Engineers	-28-35K
Electrical Design Engineers	-24-40K
Instrumentation Design Engineers	-25-40K
Test/Design Engineers	-24-35K

Our clients are aerospace and electronic firms who pay our fees for locating engineers. For more information, send note or resume to Gregg Whit.

CORPORATE PERSONNEL CONSULTANTS, INC.
5950 Fairview Road, Two Fairview Plaza, Suite 608
Charlotte, North Carolina 28210
(704) 554-1800



HIRE NEXT YEAR'S GRADUATING ENGINEERS — THIS SUMMER! —

First, it's in our industry's best interest to provide career-conscious undergraduate engineering students with meaningful summer job experience in their future profession.

Second, since there'll always be more anxious applicants than openings, you'll be able to select the cream of the crop, then evaluate them under "game-conditions" with an eye towards hiring them next year, when as coveted graduates, the job market may well be in their favor.

By filling out and returning the coupon below, your organization will be included in summer job listings to be featured in the January/February 1981 issue of McGraw-Hill's GRADUATING ENGINEER.

This edition, edited especially for next year's graduates, will be distributed on approximately 500 campuses by engineering department heads, directors of computer centers, placement officers, and minority advisors. Students will then contact you directly.

Free summer job listing

MAIL TO: ELECTRONICS/POST OFFICE BOX 900/NEW YORK/NY 10020

NAME/TITLE (of individual to be contacted)

ADDRESS: (Mailing address of your personnel office)

ORGANIZATION: (Firm, Company, Government Agency or Institution)

TYPE AND NUMBER OF STUDENTS SOUGHT: Electronics Avionics

Technician Computer Science Other: (Draftsperson, etc.)



Note: Last date coupons can be accepted for this year's summer job listings is 11/24/80

Our Most Important Resource Is Our People

Burroughs Corporation, an innovator in the exciting field of Laser Based Optical Computer Memories, has career opportunities for problem-solving oriented individuals interested in developing project and technical leadership skills. These positions offer exciting opportunities to contribute technically in this unexplored area of technology.

Error Detection & Correction Engineer

The error detection & correction engineer shall be responsible for the development and implementation of an error detection and correction (EDAC) system for the optical disk memory.

A minimum of a BA (MS preferred) in Electrical Engineering or Computer Design and at least 2 years experience in the design of EDAC systems for data storage devices is required.

Lead Test Equipment Engineer

The lead test equipment engineer will be responsible for the design of the test equipment necessary to fully test all phases of manufacturing and assembly of a laser based computer memory. Additional responsibilities include the development of special test requirements during the development phase of the product.

Experience in the design of automatic test equipment and test fixtures for analog and digital electronics as well as electro-mechanical devices and BSEE is required.

Diagnostic System Engineer

The diagnostic system engineer will be responsible for the design and development of the diagnostic systems for an optical computer memory. Responsibilities include the definition of diagnostic and maintenance philosophy for both manufacturing and field test programs.

Experience in diagnostic system for electro-mechanical devices and microprocessors as well as extensive software experience in diagnostic systems is required. A BS in Engineering, Physics, or Computer Sciences is required.

Servo Writer Project Engineer

BSEE or MSEE and 5-7 years experience with precision electro-mechanical systems. Specific tasks will include coordination of the development of systems to initialize and certify optional recording disks, includes precision mechanics, servo systems, logic design, micro-processor control, wide band D/A and A/D circuits, and optics. Experience in all of these areas with strength in analog circuit design as well as project level experience is required.

Read/Write Engineer

BS or MSEE with 2-5 years experience in communications and signal processing theory and circuit design and analysis of low noise, wide bandwidth (20MHz) amplifiers, and worst case analysis. Experience in computer modeling of these areas is desirable.

Lead Analog Design Engineer

BSEE or MSEE and 5-7 years experience. Candidate will act as section head, and be responsible for the technical performance of about 6 analog design engineers in addition to own design responsibilities. Specific tasks will require experience in the analog signal processing, wide band, low noise amplifier design and hybrid circuit design, with a strong background in worst case design theory.

We offer you these unique opportunities and challenges with an outstanding growth company in a perfect climate for both personal and professional growth. Our Westlake Village facility is only 20 minutes from the beach, less than an hour from Santa Barbara, and 35 minutes from metropolitan Los Angeles in a new, growing, prosperous, smog-free, progressive, recreational community. Call COLLECT to speak with Ed La Budde right away. (213) 889-1010, ext. 1035. Or send resume to:

Burroughs Corporation
Dept. ELECT
5411 N. Lindero Canyon Rd.
Westlake Village, CA 91361

An Equal Opportunity Employer

Burroughs

ADAC	47	Digital Equipment Corp., OEM	192, 193	Hitachi, Ltd.	136
Advanced Micro Devices	10, 11	Digital Pathways, Inc.	52	■ P.R. Hoffman	279
■ AEG Telefunken	9E	DIT-MCO	225	Hysol	237
Aehr Test Systems	256	• Ducati Elettrotecnica Microfarad	29E	■ Hytek Microsystems	281
Alpe Electric Co., Ltd.	119	DuPont Company, Vacirol Solder Mask	227	• IEEE	215
• Alta Computer Systems	196, 197	Eaton Corp., Electronic Instrumentation	236	Instrumentation Engineering, Inc.	54, 55
American Microsystems, Inc.	101	• EDCIS	26E	Intel-Magnetics	28, 29
American Telephone & Telegraph	205	EG&G Reticon	97	Intel MPO	18, 19
■ AMP, Inc.	186, 187	Elco Co., Ltd.	123	Intel OMS	221
Analog Devices	83	■ Electro-Craft Corporation	77	International Crystal Manufacturing Co.	106
Ando Electric Co., Ltd.	126	Electronic Arrays	35	Intersil	60, 61
Anritsu Electric Co., Ltd.	120	Electronics & Control Engineers Book Club	252-255	Iskra Commerce Marketing	138
Apollo Corporation	127	Electronic Conventions, Inc.	137	Isotronics, Inc.	210
A.P. Products	16	Electronics & Energy Technology	250	• Italtel/SIT	207, 211
Aramco Services Company	243-245	■ Electronic Navigation Industries	3C	• ITT Capacitors	19E
‡ Aromat	207	Electronum	240	■ ITT Schadow, Inc.	224
Bausch & Lomb Scientific Optical Products	214	■ Electro Scientific Industries	235	• Iwatsu Electric Co., Ltd.	18E
State of Bavaria	220	Emerson Electric	5	Janome Electric Co., Ltd.	125
Bell Corporation	122	• Enertec Schlumberger (Velizy)	11E	Jepico Co., Ltd.	132
Bella Center	282	■ Erie Technological Products	228	‡ Kontron Electronics, Inc.	45
■ Bendix Electrical Components Division	229	EXAR	88, 89	■ Krohn-Hite Corporation	7
■ B & K Precision	203	Fairchild Semiconductor	68, 69	• Lemo SA	38E
Robert Bosch Corporation	79	Fairchild Test Systems	32	■ Memodyne Corporation	164
■ Bourne, Inc.	4C	FELA	204	Midwest Automation, Inc.	79
• Brown Boverie & Cie	62	• FEME S.P.A.	27E	■ Miller-Stephenson Chemical Co., Inc.	98, 99
• Buckbee-Mears Company	8	Ferranti-Packard, Ltd.	220	Minato Electronics, Inc.	110
Bud Industries	238	■ First Computer Corporation	15	■ Mini-Circuits Laboratory	2
■ Busemann Manufacturing	166	• Fivve S.P.A.	23E	Mitel Semiconductor, Inc.	94
Canadian Thermostats & Control Devices	260	John Fluke Manufacturing Company	25, 27	• Molex, Inc.	212, 213
■ CELCO (Constantine Engineering Labs. Co.)	257	• Frini Antenne	16E	Monolithic Memories	36, 37
‡ Centralab, Inc.	222, 223	• Fujitsu, Ltd.	195	Mostek Corporation	22, 23
■ Cherry Electrical Products	13	General Instrument Microelectronics	93, 105	Motorola Semiconductor Products	49, 50, 84, 85, 182, 183
• Citel	24E	General Instrument Opto Electronics	74	‡ National Instruments	8
• Clinton Electronics Corp.	20E	Golden River Corporation	281	NEC	108
Computer Automation, Inc., IPD	67	■ Gordos	198, 199	• Neohm SPA	222
Computer Automation, Inc. MND	86, 87	Gould, Inc., Biomation Division	30, 31	New Long Seimitsu Kogyo Co., Ltd.	125
‡ Control Laser Corporation	96	Gould, Inc., Electric Fuse Division	43	New York State Department of Commerce	261
■ Corcom	53	Gould Inc., Instruments Division	234, 246	‡ Nicolet Cad Corporation	211
‡ CTS Corporation	215, 242	Hakuto Co., Ltd.	131	Noritake Electronics, Inc.	251
■ Custom Electronics	279	■ Hamlin, Inc.	22E	• Novotechnik KG	21E
Design Space International	260	■ Hewlett Packard	2C, 1, 17, 70, 71, 216, 217, 279, 281	N.R.D. Div. of Mark IV Industries, Inc.	282
■ Dialight	200, 201	‡ Hitachi America, Ltd.	196, 197	Ohio Scientific	233
‡ Digital Equipment Corp., Microcomputer	62, 63	Hitachi Denshi, Ltd.	116, 117	OKI Electric Industry Co., Ltd.	118

HP 9825 owners: don't get a new computer if all you need is more memory!

If you find that your applications are starting to outgrow your 9825's memory, we've got good news for you.

For a fourth the cost of a new model, HP's new upgrade kit lets you more than double the 9825's existing memory. Check out these powerful features:

- 62k bytes read/write memory — completely compatible with all of the option ROMs.
- No speed degradation — the HP 9825 retains its high-speed performance.
- 100% software compatibility — no modifications to your HPL programs are necessary.

• Option ROMs, now standard — you can use all ROMs simultaneously.

So if you're looking for an economical way to keep up with expanding applications, call your local HP sales office today (we're listed in the White Pages). Or write for more information to Hewlett-Packard, Attn: Larry Inman, Dept. 684, 3404 East Harmony Road, Fort Collins CO 80525.



37002 HPDC-12

Circle 262 on reader service card

Semi-Finished Quartz Crystals

Choose from the largest
inventory in the U.S.

P. R. Hoffman is one of the world's largest producers of semi-finished quartz crystal wafers.

For nearly 40 years, we specialized in providing crystal blanks to finishers. Today we grow our own High-Q pure Z cultured quartz and process natural and cultured quartz to meet customer requirements for electronic and electro-optical applications. We supply crystal blanks lapped to the customer's final frequency tolerances. We can also meet the most stringent specifications supplied with regards to dimensioning and orienting to precise angles.

P. R. Hoffman maintains an inventory of over 2,000,000 crystals and can often ship from stock to meet your requirements. For information and prices, send your specifications to:

P.R. Hoffman A Norlin
Technology Co.

321 Cherry Street, Carlisle, PA 17013 Telephone: 717-243-2011

for energy storage
specify Custom MICA Capacitors

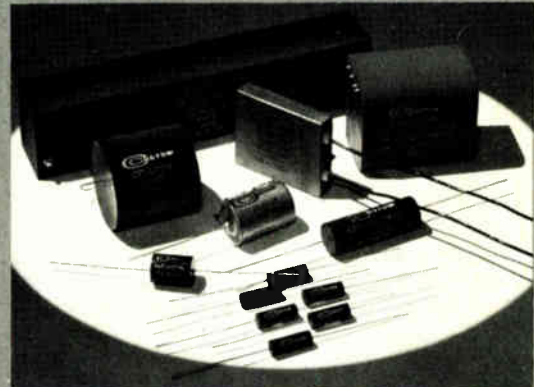

Energy Density .05-.25
joules/in³ at high voltage
Capacitance to 40 uF
Voltage to 50 KV
Temperatures to 125°C.
without derating
Custom's C Series mica
capacitors will meet your
requirements for a totally solid
capacitor. Dielectric inspected
before production for maximum
reliability.

Available in three basic types:
CMR ("wrap and fill"); CER
(epoxy housed); CEM (epoxy
molded). Quick quotation and
delivery.

Also available: High Voltage K
Series mica for maximum volumetric
efficiency and Low
Voltage T Series film for high
temperature applications.
Write for FREE C, K, T Series
TechniTips.



CUSTOM ELECTRONICS, INC.
12 Browne St., Oneonta, NY 13820
PH: 607-432-3880 TWX: 510-241-8292

Circle 263 on reader service card

Circle 264 on reader service card

HP 9825 owners: optimize performance with flexible disc storage.

Now you can break out of the restraints of tape storage by adding high-performance random access storage to your HP 9825 computer.

The 9885 single-drive flexible disc adds 1/2 megabyte per disc to your HP 9825 A/B (up to 2 megabytes through optional slave drives). And our new double-sided, double density 9895 floppy gives the model 9825T up to 2-1/2 megabytes in a single package.

In both cases, you'll be able to access any file on the disc in less than 1/3 of a second. And file referencing is done through a smart directory by simply designating the file name.

The result? You'll be assured of rapid and complete analysis of your data for better problem-solving and more confident decision-making.

So check out what better data management is all about. Just call your local HP sales office listed in the White Pages. Or write for more information to Hewlett-Packard, Attn: Larry Flaherty, Dept. 684, 3404 East Harmony Road, Fort Collins, CO 80525.



**HEWLETT
PACKARD**

37003 HPDC-13

Circle 265 on reader service card

CRYSTAL CLOCK OSCILLATORS.

- We have more than 50 standard frequencies
- We can ship within 48 hours from receipt of your order.
- All Oscillators feature hermetic D.I.P. Packaging.
- Included are direct replacement for 16 manufacturers, such as the following series: K1100, MX0, X0, M1100, HS, CM, BW, 1300, 7400, and QT.
- Specify these Hytek Part numbers:

TTL	HY 4550 - 250 KHZ to 75 MHZ
CMOS	HY 4560 - 600 HZ to 5 MHZ
Z80(A)	HY 4580 - 4 MHZ

hytek microsystems
incorporated

16780 LARK AVENUE, LOS GATOS, CALIFORNIA 95030
PHONE (408) 358-1991 TWX 910-597-5393

Circle 266 on reader service card

GR AVAILABLE EX-STOCK PASCAL

**FOR FAST, EFFECTIVE PROGRAMMING
OF 1802 APPLICATIONS**

- Typically 20% of time and cost compared to programming in Assembler
- High efficiency of code with minimum overhead
- Natural structured programming
- Full 16 Bit Arithmetic Package included
- Executes in standard 1802 development system CDP 18S005 and CDP 18S007

**Price:
Compiler - \$1450. User Manual - \$20**

Other Products:
Low Powered Single Board Computers
4K Ram Card for CDP 18S005 Development Systems



AVAILABLE FROM

GOLDEN RIVER CORPORATION

7315 Redfield Court Falls Church Virginia 22043
Telephone: (703) 827-9090

Circle 267 on reader service card

281

PERMANENT
EXHIBITION

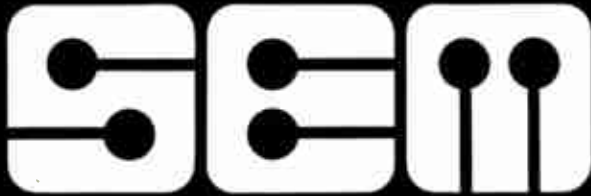

Scandinavian Electronics Mart

Europe's first permanent exhibition of Scandinavian electronics.

Here a number of leading Nordic producers show the latest achievements of the Scandinavian electronics industry within the fields of research, know-how and production.

Scandinavia's high technical standard is demonstrated through quality and functional electronic products.

Visit the new centre for rational purchasings and concentrated information on electronic components, instrumentation and manufactured equipment when you pass Copenhagen.

Open Monday - Friday from 10 a.m. - 4 p.m.

Jorgen Andersen Ingeniortirma A/S, DK - Arcodan Antenne Systemer A/S, DK - Bang & Olufsen A/S, DK - Chemitalic A/S, DK - Danavox A/S, DK - Dancorn A/S, DK - Danica Elektronik A/S, DK - Danica Supply ApS, DK - Dansk Digital Teknik ApS, DK - Diplomat A/S, DK - DISA Elektronik A/S, DK - A/S Elektrisk Bureau, N - Elektronikcentralen, DK - ELMIA/S, DK - EMRI ApS, DK - Fossnit A/S, DK - GNT Automatic A/S, DK - Hellesens, DK - Holweg-Mikkelsen Instrument A/S, DK - A/S Tobias Jensen, DK - Kamstrup-Metro A/S, DK - LK-NES A/S, DK - Luxor Industri AB, S - H & K Lubcke Aktieselskab, DK - A/S Logstrup-Steel, DK - MicroMatic A/S, DK - Minitryk ApS, DK - Modulohm I/S, DK - Jorgen R. Muller A/S, DK - Neselco A/S, DK - OY Nokia AB, SF - Peerless Fabrikerne A/S, DK - Piezodan ApS, DK - Polyamp AB, S - Poxypriint ApS, DK - Radiometer Electronics A/S, DK - Christian Rovsing A/S, DK - Salcomp OY, SF - Salora OY, SF - Seas Fabriker A/S, N - Skandinavisk Elektroakustik A/S, DK - Det Store Nordiske Telegraf-Selskab A/S, DK - Storno A/S, DK - K. Suhr A/S, DK - Transduktor A/S, DK - Aktieselskabet Videbank Hottjalerfabrik, DK - Vitrohm Elektronisk Fabrik A/S, DK - Wicon Kondensatorfabrik A/S, DK - Zodiac Communications ApS, DK

Please send me further information on
the Scandinavian Electronics Mart.

Send to:

BC Bella Center

Marketing dept.
Center Boulevard
DK-2300 Copenhagen S
Denmark
Tel.: +45-1-51 88 11

Scandinavian Electronics Mart E9/710
Firm _____
Address _____
Person to contact _____
Tel.: _____

NRD Static Eliminator

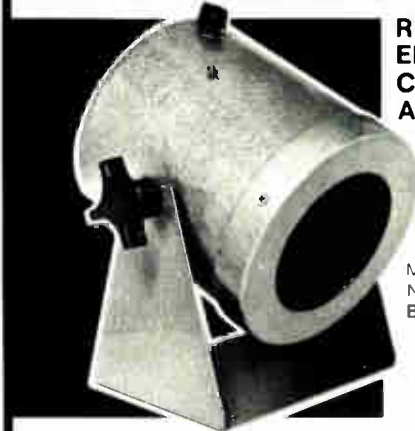

REDUCES
ELECTRONIC
COMPONENT
ASSEMBLY
LOSSES

MODEL 2061
NUCLECEL
BLOWER

PROTECTS STATIC-SENSITIVE MOS
AND IC DEVICES WITH CONDUCTIVE
IONIZED AIR

- Costs pennies per day to operate
- Can save dollars per hour in components
- Preferred method for neutralization
- Low volume blower on swivel stand
- Controls both low and high level static charges

NRD DIV. MARK IV INDUSTRIES

2937 ALT BOULEVARD N. / GRAND ISLAND, NEW YORK 14072
716-773-7634 / TELEX 91-578

Circle 272 on reader service card

POWERFUL

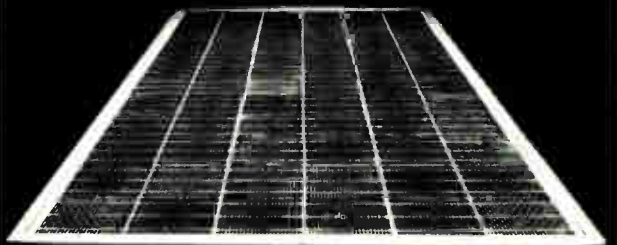

World's leading maker of
electricity generating
solar cells, panels, systems.



SOLAREX

SOLAREX CORPORATION Industrial Products Div., Dept. 100EG
1335 Piccard Drive, Rockville, Maryland 20850
301-948-0202 TWX: 710-828-9709 Cable: Solarex

Western office:

SOLAREX CORPORATION 8141 I-70, Frontage Road North
Arvada, Colorado 80002 Telephone: 303-425-5992

Never before... 200 watts of RF power with incredible versatility.

Now there's a completely solid state power amplifier that provides 200 watts of linear power over a frequency range from 250 kHz to 120 MHz. And at 175 watts, the range extends to 150 MHz.

Imagine the wide range of applications you can cover with this single Class A linear unit. All you need is any standard signal or sweep generator and you have



3200 L spans 250 kHz to 150 MHz.

the ultimate in linear power for RFI/EMI testing, NMR, RF Transmission, and general laboratory applications.

And, like all ENI power amplifiers, the 3200 L features

unconditional stability, instantaneous failsafe provisions, and absolute protection from overloads and transients.

The 3200 L represents a breakthrough in RF power versatility and packaging. Never before has there been anything like it commercially available anywhere!

Contact us for a demonstration of the 3200 L and our complete catalog on the other amplifiers in our wide line. ENI, 3000 Winton Road South, Rochester, NY 14623. Call 716/473-6900, or Telex 97-8283 ENI ROC.

ENI

The advanced design line of RF power amplifiers

Circle 901 on reader service card

Now, a Switchable Attenuator...

**Replaces network and switch
in a single, cost saving package.**

Bourns, Inc. has combined switching and resistor network functions in a single, permanently sealed integrated package to save you time . . . and money. The new Bourns® Model 3100 switchable attenuator replaces a resistor network and DIP switch, or up to 16 discrete resistors and associated switches. The result: Reduced component count, lower assembly costs, increased reliability and PC board space savings.

Available in both "T" and "O" pad configurations, the Model 3100 switchable attenuator has a standard impedance rating of 600 ohms for telecommunications applications such as voice frequency repeaters, line amplifiers, Central Office carrier equipment, voice transmission and recording studio use. Four rotary-type switches are ratioed in a 1, 2, 4, 8 binary sequence to permit selection of attenuation in dB steps for each of the three ranges available: 0-1.5dB (0.1dB steps); 0-15dB

(1.0dB steps); and 0-24dB (1.5dB steps).

An unbalanced "T" pad configuration with an input impedance of 75 ohms and a 0-15dB range is also available for applications such as CATV.

Sealed for board washing and dip wave soldering, the Model 3100 switchable attenuator withstands a variety of environmental conditions. Gold switch contacts assure low insertion loss and long-term operating stability. It is pre-tested and designed for direct PC board mounting with no DIP socket required. Special and custom versions are available, including additional impedance values

DIMENSIONS:
0.58" x 1.34" x 0.25"

and increased ranges and steps.

Call or write today for complete details on the Model 3100 switchable attenuator . . . another innovative multi-function component from Bourns.

TRIMPOT DIVISION, 1200 Columbia Avenue, Riverside, CA 92507.
Phone: 714 781-5235. TWX 910 332-1252.

European Headquarters: Bourns AG, Zugerstrasse 74 6340 Baar, Switzerland.
Phone: 042 33 33 33. Telex 78722.



For Immediate Application—Circle 120 For Future Application—Circle 220