

AUGUST 28, 1980

THE NEW WEST: NEW STRATEGIES, NEW PLACES AND FOREIGN MONEY/88

Power MOS FETs gate directly from logic-level signals/ 145

Disneyland welcomes Wescon/ 190



FOUR DOLLARS A MCGRAW-HILL PUBLICATION

Electronics®

**DELAY LINES
CUT NOISE IN
PROGRAMMABLE
RF SIGNAL
GENERATOR**

1420 SW1105 CASAV DEC80
SE SAWICKI
DATA ACQUISITION SYSTEMS
105 N CHAPEL ST
TORRINGTON CT
06790

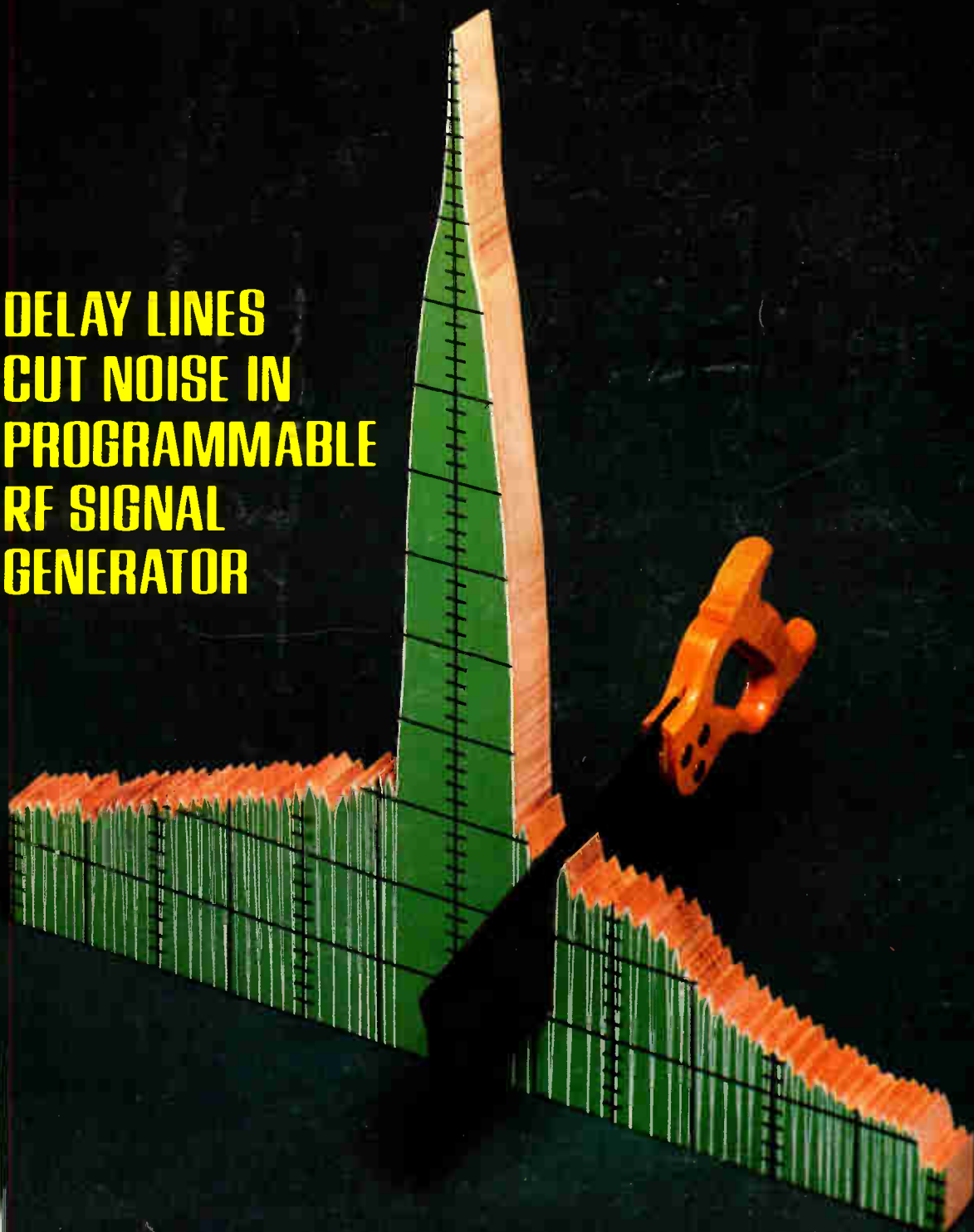

New, Standard Resistor Network Interfaces Between Logic and Memory...

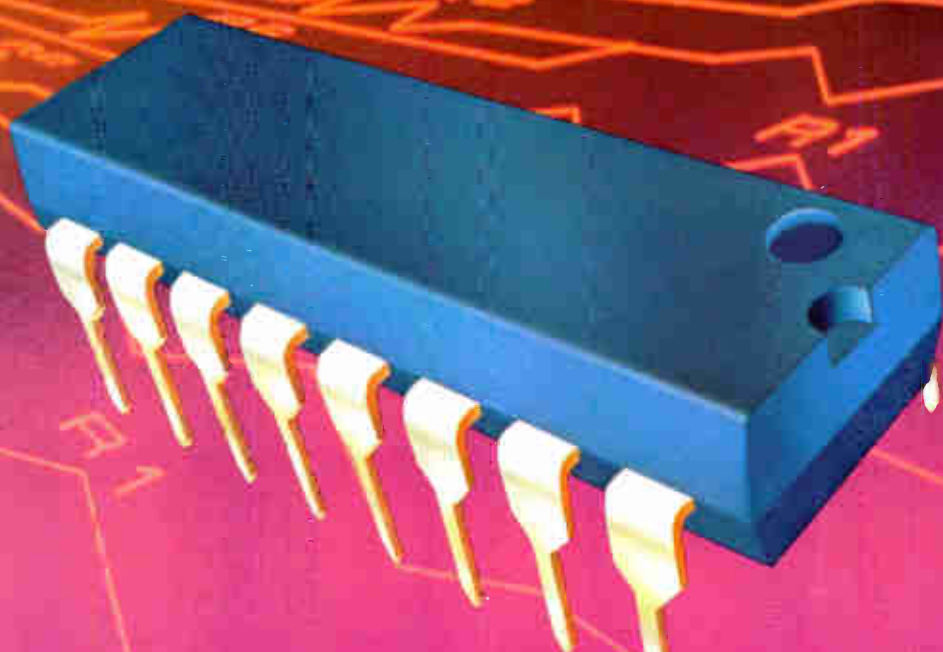

Saves you time and money.

Now, there's no need to order custom or special networks for your logic/memory applications. Bourns new DIP networks interface with any of these RAMs:

21L02-1	μ p2102	S2114	2117-2	4116	TMS4416
2102	AM2102	2116-2	P2141	MC4116	MB8116
2102N	UA2102	MK2116	2690-2	MCM4116	F16K2

These new *standard* networks save you time because they're available now. And they save you money, too . . . customs and specials are expensive.

Bourns Model 4114R-064 and 4116R-064 networks meet your high volume circuit requirements where operating speed is a major consideration. Available in 14 and 16 pin configurations, the networks contain either 12 or 14 thick film resistors paired in series. Input terminals are connected to the center points of the resistor pairs. Each resistor pair consists of a 1K ohm pull-up resistor for maintenance of the proper logic level from your open collector or wired "OR" circuitry and a 30 ohm pass-through resistor for elimination of noise problems at high frequencies.

What's custom for others is standard for Bourns. And, what's standard for Bourns is available off-the-shelf from your local Bourns distributor. Call your local Bourns representative or distributor for more information on the complete line of Bourns resistor networks and for your new 24-page RN-2 Resistor Networks catalog. For a free sample, write to Networks Application Department on your company letterhead.

NETWORKS DIVISION, BOURNS, INC., 12155 Magnolia Avenue, Riverside, CA 92503.
Phone: 714 781-5415. TWX: 910 332-6134.

European Headquarters: Bourns AG, Zugerstrasse 74 6340 Baar, Switzerland.
Phone: 042 33 33 33. Telex: 78722.

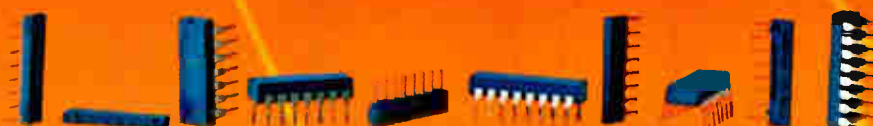

The last word in resistive components

BOURNS®

HP-33C, 34C, & 38C with Continuous Memory. They're ready when you are.

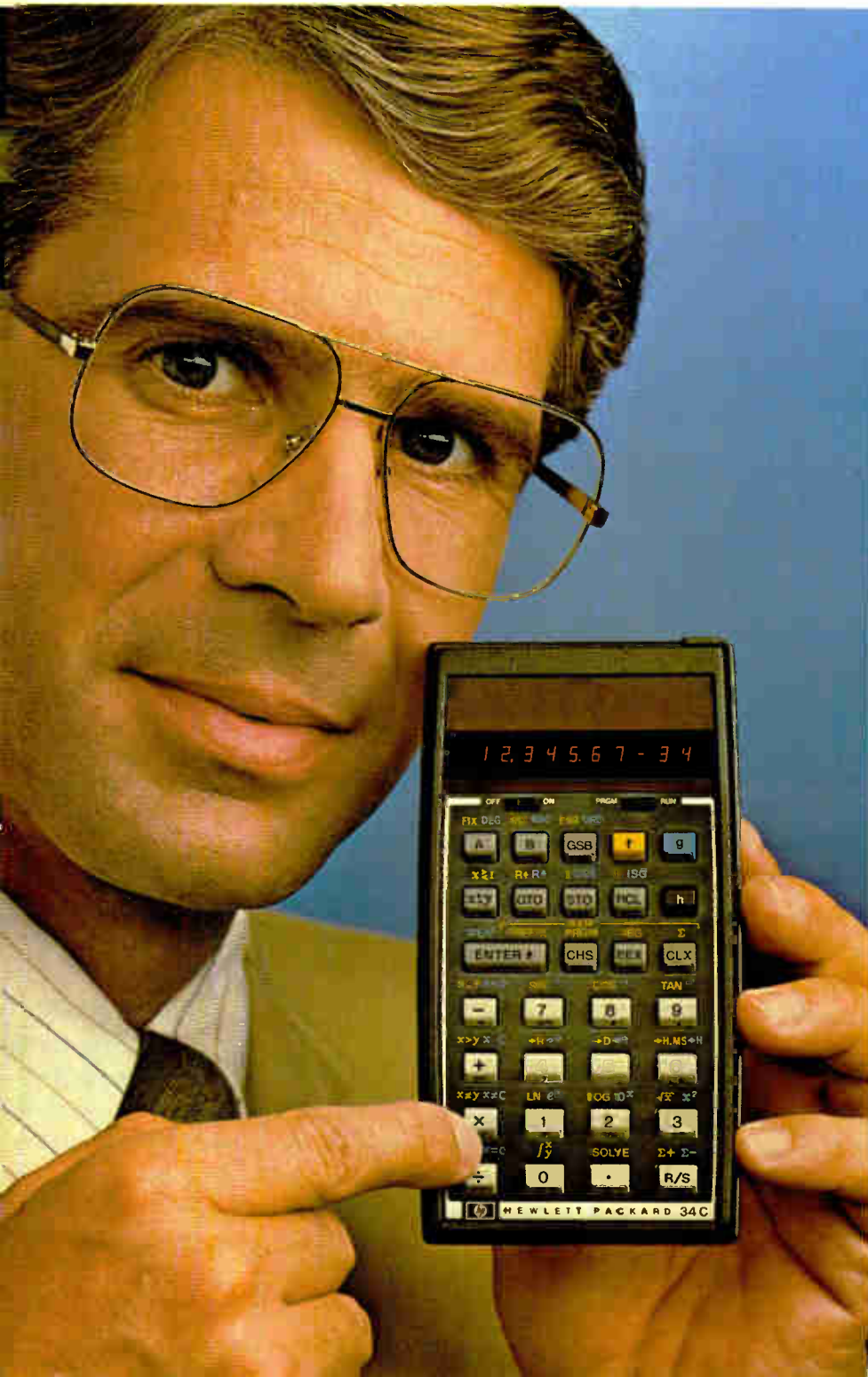

These advanced programmable calculators from Hewlett-Packard retain your data and programs even after they've been turned off. Just think how much more quickly and easily you'll be able to solve your business or scientific problems.

But these remarkable calculators do more than just remember. Consider the HP-34C, for instance. It provides up to 210 program lines. Up to 3 keystroke instructions are automatically merged into one program line, expanding memory to the equivalent of 370 program lines. And editing is a snap. The HP-34C's editing features let you review your programs and insert or delete instructions as needed. The HP-34C also has two special function keys, Solve and Integrate, to determine the roots of an equation or compute the definite integrals of a function.

Hewlett-Packard supports the HP-33C, 34C and 38C with the most comprehensive instruction manuals and software solutions to problems for science, engineering and business applications.

Visit a Hewlett-Packard dealer now and experience the advantages of Continuous Memory in one of these outstanding calculators.

- HP-33C Programmable Scientific with Continuous Memory \$110*
- HP-34C Advanced Programmable Scientific with Continuous Memory \$150*
- HP-38C Advanced Financial Programmable with Continuous Memory \$150*

For details and the address of your nearest HP dealer, CALL TOLL-FREE 800-547-3400, Department 214E, except from Hawaii or Alaska. In Oregon, call 758-1010. Or write to Hewlett-Packard, 1000 N.E. Circle Blvd., Corvallis, OR 97330, Dept. 214E.

*Suggested retail price excluding applicable state and local taxes—Continental U.S.A., Alaska and Hawaii. Display photographed separately to simulate typical appearance.

610/13



Circle 1 on reader service card

Pushing performance to the physical limits, yet versatile and easy to use.

HP's new 3456A DVM.

Performance well beyond what you expect in a DVM. That's what HP's new 3456A offers. You get standards lab accuracy under many test conditions, with quiet, repeatable 100 nanovolt resolution on the 100 millivolt range. What's more, the inherent noise rejection of integration is enhanced by an advanced A to D converter to give you 48 readings per second with useable one microvolt resolution. That's performance approaching theoretical limits.

And, you enjoy this state-of-the-art performance with no sacrifice in flexibility or ease of use. The 3456A brings unusual convenience to your application, on the bench or in a system.

Maximum versatility over a wide range of uses.

For example, you can easily tailor the 3456A for optimum measuring conditions. Choose from a solid one microvolt resolution at up to 48 rdgs/s, or 10 microvolt resolution

And the 3456A memory lets you store both program instructions and measurement data. . . up to 350 readings or 1400 bytes of instructions.

What a system DVM should be.

In your system, the 3456A offers much more than a bus interface — it provides a combination of hardware and firmware that speeds system integration and improves system efficiency. For example, with its intelligence and program memory, the 3456A can store a sequence of operations, perform them, store the results, and signal the computer when done. You can also use the front panel to send program information. This means less programming effort for you, and more effective use of your computer.

Outstanding as a bench instrument.

On the bench, the 3456A's front panel math and measurement functions are easy to use and totally flexible. Its comprehensive set of statistics functions preprocesses data to save you time in data reduction.

One keystroke lets you make thermistor temperature measurements directly in °F or °C. And the Reading Store mode lets you acquire readings as fast as 200 rdgs/s without a controller. Convenience features include comprehensive self-tests and front panel calibration. With its superior performance and modest price, the new 3456A is one of today's outstanding DVM values.

Find out more about HP's remarkable new 3456A, priced at just \$3500.* For a data sheet, write: Hewlett-

Packard, 1507 Page Mill Road, Palo Alto, CA 94304. Or call the HP regional office nearest you: East (201) 265-5000, West (213) 970-7500, Midwest (312) 255-9800, South (404) 955-1500, Canada (416) 678-9430.

*Domestic U.S.A. price only.

at 330 rdgs/s. There's a choice of 3, 4, 5 and 6½ digit display as well.

Select the noise rejection you need at the speed you want. You can use the analog input filter, digital averaging, or both. Integration time is fully selectable, too, as is the settling time delay. Built-in delays in the AC, ohms, and filter functions give you confidence that the reading is right, regardless of the measurement environment.

 **HEWLETT
PACKARD**



HP-IB: Not just IEEE-488, but the hardware, documentation and support that delivers the shortest path to a measurement system.

Circle 2 on reader service card

133 Technical Articles

TEST AND MEASUREMENT

Delay lines give rf generator spectral purity, programmability, 133

SOLID STATE

TTL can drive power MOS FETs, 145

COMMUNICATIONS

Spread of PCM carries LSI to regenerative amplifiers, 149

PACKAGING & PRODUCTION

Automated molecular beams grow thin semiconducting films, 160

COMPUTERS & PERIPHERALS

Floppy-disk controller adapts to data format and drive, 171

WESCON/80

The wide world of technology takes center stage at Disneyland, 190

DESIGNER'S CASEBOOK: 154

ENGINEER'S NOTEBOOK: 176

39 Electronics Review

COMPUTERS: Compact supercomputer goes faster, 39
PHOTOVOLTAICS: Amorphous Si is 6.2% efficient, 40
SOLID STATE: Fast scope uses Josephson junctions, 40
PRODUCTION: Lasers help terminate flexible circuits, 41
CAD: Single program checks VLSI chips, 42
COMPONENTS: Metal wrap drops device costs, 42
PRODUCTION: Stitch wiring fits standard boards, 44
COMPONENTS: TI turns the trick for n-MOS op amps, 46
GOVERNMENT: Mini buys outstrip mainframes', 46
NEWS BRIEFS: 48
COMMUNICATIONS: PBX takes messages, 50

67 Electronics International

WEST GERMANY: E beam makes surface acoustic waves visible, 73
GREAT BRITAIN: Coax car system replaces harness, 74
JAPAN: Government and industry team up for optoelectronics drive, 76
WEST GERMANY: GTO switches 1,500 V in 0.5 μ s, 78
GREAT BRITAIN: Chips, twisted pair build local net, 80

88 Inside the News

The New West: on the move, 88

109 Probing the News

COMPUTER-AIDED DESIGN: C-MOS for the novice, 109
CONFERENCES: Fall is here in France and Japan, 113
ABROAD: Britain's last chance in VLSI, 120

206 New Products

WESCON PRODUCT PREVIEW: 206
A wide-ranging survey of exciting products that will be making their debut at the big show in Anaheim, Calif.
IN THE SPOTLIGHT: Bucket brigades weight taps internally, 245
Chip gives processors time of day, 253
MICROCOMPUTERS & SYSTEMS: C-MOS board hits n-MOS speeds, 260
COMPONENTS: Schottky rectifier protects itself, 272
SEMICONDUCTORS: Op amp has low offset, 288
SOFTWARE: Fortran added to UCSD software, 302
MATERIALS: 313

Departments

Highlights, 4	Electronics newsletter, 33
Publisher's letter, 6	Washington newsletter, 59
Readers' comments, 8	International newsletter, 67
News update, 12	Engineer's newsletter, 180
People, 14	New literature, 318
Editorial, 24	Products newsletter, 329
Meetings, 26	Career outlook, 337

Services

Reprints available, 116
Employment opportunities, 339
Reader service card, 361

EDITOR-IN-CHIEF: Samuel Weber

MANAGING EDITORS
Technical: Raymond P. Capece,
Alfred Rosenblatt
News: Gerald M. Walker
International: Arthur Erikson

ASSISTANT MANAGING EDITORS: Howard Wolff,
Margaret Eastman

SENIOR EDITOR: Ray Connolly

ART DIRECTOR: Fred Sklenar

ASSOCIATE EDITOR: Benjamin A. Mason

DEPARTMENT EDITORS
Aerospace/Military: Ray Connolly
Circuit Design: Vincent Biancomano
Communications & Microwave:
Harvey J. Hindin
Components: Roger Allan
Industrial/Consumer: Gil Bassak
Microsystems & Software: R. Colin Johnson
Test, Measurement & Control:
Richard W. Comerford
New Products: Alan Serchuk,
Ana Bishop
Packaging & Production: Jerry Lyman
Solid State: John G. Posa

CHIEF COPY EDITOR: Margaret Eastman

COPY EDITORS: Mike Robinson,
Charlotte Wiggers, Jeremy Young

ART: Charles D. Giatto, *Associate Director*
Paula Piazza, *Assistant Director*

EDITORIAL SECRETARIES: Maryann Tusa,
Alan Kleinberger, Dawn Ramsay

EDITORIAL ASSISTANT: Marilyn B. Steinberg

REGIONAL EDITORS
New York: Pamela Hamilton (212) 997-2666
Boston: James B. Brinton,
Linda Lowe (617) 262-1160
Chicago: David Cook (312) 751-3805
Dallas: Wesley R. Iversen (214) 742-1747
Los Angeles: Larry Waller (213) 487-1160
Palo Alto: Bruce LeBoss, *Manager*
Martin Marshall, *Computers & Instruments*
(415) 968-2712
Washington: Ray Connolly (202) 624-7592
Frankfurt: John Gosch 72-5566
London: Kevin Smith 493-1451
Paris: Arthur Erikson,
Kenneth Dreyfack 720-20-70
Tokyo: Charles Cohen 581-9816

McGRAW-HILL WORLD NEWS

Editor: Michael Johnson
Brussels: James Smith
Milan: Jeff Ryser
Moscow: Peter Hann
Stockholm: Robert Skole
Tokyo: Robert Neff

PUBLISHER: Paul W. Reiss

GENERAL MANAGER, DIRECT MARKETING
OPERATIONS: Horace T. Howland
CIRCULATION MANAGER: Herbert A. Hunter
RESEARCH MANAGER: Margery D. Sholes
PROMOTION MANAGER: Jane De Court
MARKETING ADMINISTRATION MANAGER:
Frances M. Vallone
BOOKS & SPECIAL PROJECTS MANAGER:
Janet Eyster
SERVICE REVENUE SPECIALIST:
Penny Reitman

Cover: Programmable rf generator produces very pure signal, 133

New design approaches enable synthesized-signal generators to overcome the drawbacks of earlier units. Key is the use of a delay-line discriminator, which holds down phase noise and spurious responses and allows the frequency to be programmed and linearly modulated.

Cover design is by Lawrence Piazza.

The electronics face of the West is changing, 88

Like the technologies they employ, the electronics industries of the West, which has meant primarily California, are undergoing rapid changes. For one, many semiconductor firms are building plants in the Southwest and Northwest. And foreign companies are buying into U. S. firms or building their own plants in the area. For another, this time semiconductor makers are not running scared in the face of a recession. (See also Wescon coverage starting on page 190 and on page 206.)

Power MOS FETs can be driven by TTL signals, 145

Offering lower on-resistances and higher voltage levels than conventional power MOS field-effect transistors, the Sipmos family of devices has been designed to work with standard logic levels and hence microcomputers. Drawing little power from 5-volt signals, they boast operating drain-source voltages of up to 1,000 v.

Molecular beams near commercial use, 160

The promise of molecular-beam epitaxy, especially for new and state-of-the-art optoelectronic and microwave devices, is exceptionally bright, having been proven in research and development labs. The main reason: unmatched precision in controlling dopant concentration and epitaxial thickness, even for extremely thin layers.

Controller takes on any type of floppy-disk drive or encoding, 171

Attaching any floppy-disk drive to various computers, a family of controllers does away with the need for a controller for each type of drive and format in a system. Based on the Z80, it can now attach a single-density or DEC's double-density format to the LSI-11. For other computers and format types, firmware is being developed that leaves the hardware essentially unchanged.

And in the next issue . . .

Fast static random-access memory achieves speed without scaling . . . 16-bit microcomputer is well protected against illegal instructions and other exceptions . . . comparing waveform-generator chips . . . an intelligent first-in, first-out buffer links slow and fast peripherals to microprocessors . . . an updated communications satellite chart.

August 28, 1980 Volume 53, Number 19 104,235 copies of this issue printed

Electronics (ISSN 0013-5070). Published every other Thursday with an additional issue this April by McGraw-Hill, Inc. Founder: James H. McGraw 1860-1948. Publication office 1221 Avenue of the Americas, N.Y., N.Y. 10020; second class postage paid at New York, N.Y. and additional mailing offices.
Executive, editorial, circulation and advertising addresses: Electronics, McGraw-Hill Building, 1221 Avenue of the Americas, New York, N.Y. 10020. Telephone (212) 997-1221. Teletype 12-7960 TWX 710-581-4879. Cable address: MCGRAW HILL NEW YORK.

Subscriptions limited to professional persons with active responsibility in electronics technology. No subscriptions accepted without complete identification of subscriber name, title or job function, company or organization, and product manufactured or services performed. Based on information supplied, the publisher reserves the right to reject non-qualified requests. Subscription rates: in the United States and possessions \$18 one year, \$31 two years, \$48 three years; company addressed and company libraries \$23 one year, \$41 two years, \$58 three years; APO/FPO addressed \$35 one year only; Canada and Mexico \$19 one year, \$32 two years, \$47 three years; Europe \$50 one year, \$85 two years, \$115 three years; Japan, Israel and Brazil \$70 one year, \$115 two years, \$165 three years; Australia and New Zealand \$95 one year, \$170 two years, \$240 three years, including air freight; all other countries \$50 one year, \$85 two years, \$125 three years. Limited quota of subscriptions available at higher-than-basic rate for persons allied to field served. Check with publisher for these rates. Single copies: \$4.00; special Anniversary issue: \$9.00 each. Please allow four to eight weeks for shipment.

Officers of McGraw-Hill Publications Company: Paul F. McPherson, President; Executive Vice Presidents: James E. Boddorf, Gene W. Simpson; Group Vice President: Daniel A. McMillan; Senior Vice President-Editorial: Ralph R. Schulz; Vice Presidents: Kemp Anderson, Business

Systems Development; Stephen C. Croft, Manufacturing; Robert B. Doll, Circulation; James E. Hackett, Controller; William H. Hammond, Communications; Eric B. Herr, Planning and Development; John W. Patten, Sales; Edward E. Schirmer, International.

Officers of the Corporation: Harold W. McGraw, Jr., President, Chief Executive Officer, and Chairman of the Board; Robert N. Landes, Senior Vice President and Secretary; Ralph J. Webb, Treasurer.

Title registered in U.S. Patent Office; Copyright © 1980 by McGraw-Hill, Inc. All rights reserved. The contents of this publication may not be reproduced in whole or in part without the consent of copyright owner.

Where necessary, permission is granted by the copyright owner for libraries and others registered with the Copyright Clearance Center (CCC), P.O. Box 8891, Boston, MA 02114, to photocopy any article herein for the base fee of \$0.50 per copy of the article plus \$0.25 per page. Payment should be sent directly to the CCC. Copying done for other than personal or internal reference use without the express permission of McGraw-Hill is prohibited. Requests for special permission or bulk orders should be addressed to the publisher. ISSN 0013-5070/80\$0.50+.25.

Subscribers: The publisher, upon written request to our New York office from any subscriber, agrees to refund that part of the subscription price applying to copies not yet mailed. Please send change-of-address notices or complaints to Fulfillment Manager; subscription orders to Circulation Manager, Electronics, at address below. Change-of-address notices should provide old as well as new address, including zip codes. Attach address label from recent issue. Allow one month for change to become effective. Subscriber Service: call (609) 448-8110, 9 a. m. to 4 p. m. EST.

Postmaster: Please send form 3579 to Fulfillment Manager, Electronics, P.O. Box 430, Hightstown, N.J. 08520.

Now Available...

IW AMPLIFIERS

0.05-1200 MHz from \$199

- Broadband ... each model multi-octave (see table)
- High linear output ... up to 30 dBm (1 W)
- Gain ... available from 16 dB to 27 dB
- Very flat gain response ... ± 1 dB
- Connectors ... BNC Std; SMA, TNC, N available
- Compact .. 3.75" \times 2.60" \times 1.92" (ZHL-A Models)
4.75" \times 2.60" \times 2.22" (ZHL Models)
- Self-contained heat sink
- One-week delivery



ZHL-2-8

If your application requires up to 1 watt for intermodulation testing of components ... broadband isolation ... flat gain over a wide bandwidth ... or much higher output from your frequency synthesizer or signal/sweep generator ... MiniCircuits' ZHL power amplifiers will meet your needs, at surprisingly low prices. Five models are available, offering a selection of bandwidth and gain.

Using an ultra-linear Class A design, the ZHL is unconditionally stable and can be connected to any load impedance without amplifier damage or oscillation. The ZHL is housed in a rugged $\frac{1}{8}$ inch thick aluminum case, with a self-contained hefty heat sink. BNC connectors are supplied; however, SMA, TNC and Type N connectors are also available. Of course, our one-year guarantee applies to each amplifier.

So from the table below, select the ZHL model for your particular application now ... we'll ship within one week!

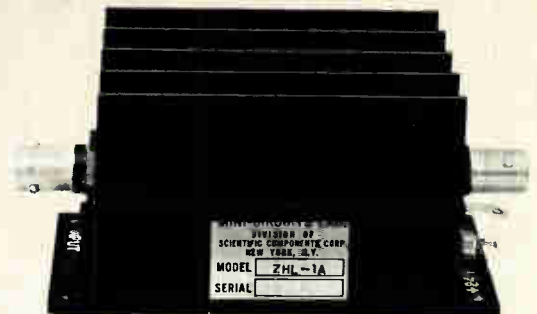

ZHL-1A

MODEL NO.	FREQ. MHz	GAIN dB	GAIN FLATNESS dB	MAX. POWER OUTPUT dBm 1-dB COMPRESSION	NOISE FIGURE dB	INTERCEPT POINT 3rd ORDER dBm	DC POWER		PRICE	
							VOLTAGE	CURRENT	\$ EA.	QTY.
ZHL-32A	0.05-130	25 Min.	± 1.0 Max.	+29 Min.	10 Typ.	+38 Typ.	+24V	0.6A	199.00	(1-9)
ZHL-3A	0.4-150	24 Min.	± 1.0 Max.	+29.5 Min.	11 Typ.	+38 Typ.	+24V	0.6A	199.00	(1-9)
ZHL-1A	2-500	16 Min.	± 1.0 Max.	+28 Min.	11 Typ.	+38 Typ.	+24V	0.6A	199.00	(1-9)
ZHL-2	10-1000	15 Min.	± 1.0 Max.	+29 Min.	18 Typ.	+38 Typ.	+24V	0.6A	349.00	(1-9)
ZHL-2-8	10-1000	27 Min.	± 1.0 Max.	+29 Min.	10 Typ.	+38 Typ.	+24V	0.65A	449.00	(1-9)
ZHL-2-12	10-1200	24 Min.	± 1.0 Max.	+29 Min.*	10 Typ.	+38 Typ.	+24V	0.75A	524.00	(1-9)

Total safe input power +20 dBm, operating temperature 0° C to +60° C, storage temperature -55° C to +100° C, 50 ohm impedance, input and output VSWR 2.1 max.

*+28.5 dBm from 1000-1200 MHz

For detailed specs and curves, refer to 1980/81 MicroWaves Product Data Directory, Gold Book, or EEM.

2625 East 14th Street Brooklyn, New York 11235 (212) 769-0200
Domestic and International Telex 125460 International Telex 620156



World's largest manufacturer of Double Balanced Mixers

Mini-Circuits

MINI-CIRCUITS LABORATORY

A Division of Scientific Components Corp.

C46 REV F

Circle 5 on reader service card

Now... the only RF power amplifier you may ever need.

The new ENI 550L
delivers 50W, 1.5-400 MHz.

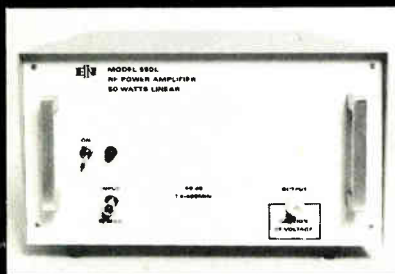

This single unit is so incredibly versatile it can replace several you may be using now. And you may never need another. It's an extremely broadband high power, solid state, Class A linear amplifier. It's rated at 50W from 1.5-400 MHz. But it can provide 100 Watts from 1.5-220 MHz. All you need with the 550L is any standard signal or sweep generator and you've got the ultimate in linear power for such applications as RFI/EMI testing, NMR, RF Transmission, ultrasonics and more.

And, like all ENI power amplifiers, the 550L features unconditional stability, instantaneous failsafe provisions, and absolute protection from overloads and transients.

The 550L represents the pinnacle in RF power versatility. There's nothing like it commercially available anywhere! And it may be the only RF power amplifier you ever need.

For more information, a demonstration, or a full line catalog, please contact us at ENI, 3000 Winton Road South, Rochester, NY 14623. Call 716/473-6900, or telex 97-8283 ENI ROC.

ENI



The advanced
design line of
power amplifiers

Publisher's letter

One sure reminder that fall is coming is our annual Wescon issue—and this is it. To mark the biggest Wescon show ever, we've added something to our traditional review of the technical program and special New Products section: an Inside the News story that takes a long look at what we are calling the New West.

As reported by our three western regional bureaus, electronics industries in the American West are stepping into a new era that in 10 years should bring as many fundamental changes as have the last 10. We are all aware of one easy-to-notice change as Silicon Valley firms strike out to new parts of the West for plant expansions.

Still, the geographic dispersion is only the tip of the iceberg, notes Assistant Managing Editor Howard Wolff, who put together the report that begins on page 94. "You have to look at the whole picture, including the effects of the current recession, the changes in technology, the influx of the Japanese," he states.

There's even more to the New West, electronically speaking, than that—as our article makes clear. When you're through, turn to our analysis of the Wescon technical program, beginning on page 190, and don't miss our Wescon New Products Preview, starting on page 206.

When the frequency-sources group at John Fluke Manufacturing Co. set out over three years ago to design the 6070A and 6071A rf signal generators, group members had their goals clearly before them. "What we wanted to do was to build a signal generator that was automatable and therefore used synthesis, that embodied all the best characteristics previously available in cavity-type signal generators, and that would be offered at a price that the market could bear," recalls Fred Telewski, the engineering manager of the group.

These goals were already set when he joined the Mountlake Terrace, Wash., company in 1977 as group engineering manager (he now holds a similar position for the system

meters group as well). But it was not clear how they were to be realized.

The new instruments feature a broad range of capabilities—"just an enormous amount of settings," he says. Therefore "many times, circuits that worked well in some areas did not perform in other areas."

The solution, the designers came to feel, was to ignore the standard approaches to signal generators and to fashion a whole new design. "The most prominent elements are the use of delay lines and the single-sideband mixer," Telewski says. For an in-depth look at their design, turn to the technical article that begins on page 133.

This issue's cover is based on that story, and it features a sculpture designed by assistant art director Paula Piazza and realized by her woodworking father.

Starting with this issue, we have yet another reason for you to read all the way through the magazine. Our new feature, Career Outlook, begins on page 334, and we think you'll find this potpourri a valuable addition.

What we have set out to do is to gather in one place important information on your career objectives. That's a pretty broad categorization, but Career Outlook will be appearing each issue, so we'll have the space to treat the many relevant items.

Our New York bureau manager, Pamela Hamilton, is in charge of the new column—a natural enough choice, since one of Pam's reporting specialties is engineering careers. For her first effort, she has assembled a mixture that begins with a look at a little-noticed proposed change to the constitution of the Institute of Electrical and Electronics Engineers and ends with an item on standardizing the exchange of graphic computer-aided-design information.

open the door to IEEE-488

multi-channel interface

with a KEPCO

with the Kepco interface, Model SNR-488-8, you can put up to eight different programmable power supplies on an IEEE-488 bus



you can control

- high voltage (up to 1kV)
- unipolar or bipolar outputs
- both voltage and current
- with 12 bit or 3-bcd resolution
- small voltages with range selection
- power from 20 watts to 1000 watts
- any instrument that'll respond to 0-10V

Use the reader service number to request an informative 12 page Brochure on how to interface power supplies to IEEE-488 or write Dept. CYF-14

KEPCO®

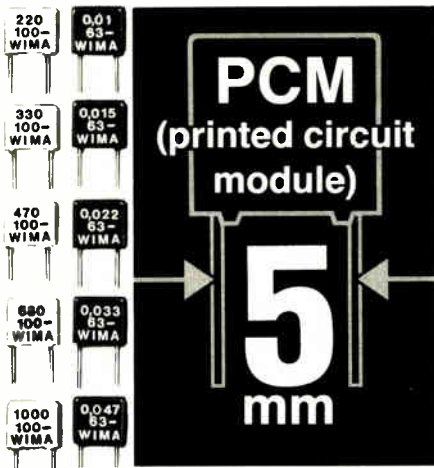

Complete ranges from 220 pF to 1.0 μ F

WIMA were first with 5 mm pcm plastic film capacitors – miniature components designed for semiconductor technology.

WIMA plastic film capacitors show greater reliability and should be preferred to other types.

The uniform lead spacing of 5 mm for the complete capacitance range is ideal for automatic component insertion.

WIMA have always been in the forefront of plastic film capacitor technology.



FKP 2: 220 pF to 0.01 μ F: D.F. $2-4 \times 10^{-4}$
 FK2: 220 pF to 0.01 μ F: D.F. $1-2 \times 10^{-3}$
 FKS 2: 1000 pF to 0.015 μ F: D.F. $5-6 \times 10^{-3}$
 MKS 2: 0.01 μ F to 1.0 μ F: D.F. $5-8 \times 10^{-3}$
 (Typical values at 1000 Hz)

WILHELM WESTERMANN

Spezialvertrieb elektronischer Bauelemente
 P. O. Box 2345 · D-6800 Mannheim 1
 Fed. Rep. of Germany

U. S. Sales Offices:
 THE INTERNATIONAL GROUP INC.
 North Dearman Street · P. O. Box 23
 Irvington · New York 10533 · (914) 591-8822

TAW ELECTRONICS CO.
 4215 W. Burbank Blvd., Burbank
 California 91505 · (213) 846-3911

Readers' comments

Early space saver . . .

To the Editor: I must take exception to an Electronics Newsletter item in your June 19 issue [“‘Super capacitor’ from Nippon achieves 1 F at 5 v,” p. 35] concerning the size of capacitors a decade ago.

The Symbol 2R computer system, built by Fairchild and delivered early in 1971 to Iowa State University, where I was associated with the Symbol project, numbered among its power supplies a 300-ampere, 6.8-volt unit incorporating a little more than one farad of filter capacitance. This was fabricated as a parallel combination of six 225,000-microfarad, 15-v electrolytics, each measuring approximately 3 inches in diameter by 12 in. long. The entire supply occupied something like 14 in. of a 24-in.-wide rack space. It did not begin to challenge the capacity of even a small closet, much less a reasonably sized room.

Perry C. Hutchison
 Beaverton, Ore.

. . . and a recent achievement

To the Editor: We were surprised to see in the June 19 issue that “‘Super capacitor’ from Nippon achieves 1 F at 5 v.” Panasonic “achieved” 100 farads (at 1.6 volts, though) in February 1980. Though our press release gave specifics on a 10-F unit (smaller, by the way, than Nippon’s 1-F “super capacitor”), the complete line includes 1- to 100-F units.

Frank Winters
 Panasonic Co.
 Secaucus, N. J.

More than home use

To the Editor: I would like to correct two statements made in “Hand-held computers star at CES” (July 3, p. 99). Concerning the Nixdorf LK-3000 hand-held personal computer, described as not portable, it would be hard to imagine a more portable unit designed for data-entry purposes. Although the basic unit does require an acoustic coupler (which Nixdorf also markets), the whole configuration weighs less than 3 pounds and will fit easily into most any briefcase.

The second error is the statement

that the unit is “tailored to the needs of the hobbyist for use in the home.” Michael Levy of Lexicon could just as well have been describing our product when he said later in the article that “A salesman with access to his company’s computer could sit at a customer’s facility and get things like the exact status of an order, inventory situation, or price quotes.” These are the kinds of needs the Nixdorf LK-3000 with the RS-232 interface was designed to fill.

John C. Hill
 Nixdorf Computer
 Personal Systems Inc.
 Burlington, Mass.

MIT R&D workshop

To the Editor: “R&D unites companies, colleges” [July 3, p. 104], mentioning a program at the Massachusetts Institute of Technology and my role in it, contains a few errors. The program is entitled the Product Development Workshop, not the Program Development Workshop. Also, it will be run by the Faculty Executive Committee, with Prof. William F. Schreiber, who has also been appointed to the Gordon chair, and Mr. Jerome E. Levy, industrial consultant, as well as myself.

Stanley R. Rich
 Massachusetts Institute
 of Technology
 Cambridge, Mass.

Correction

Some key parameters of the thin-film MOS-on-glass transistors developed at the Central Research Laboratory of Hitachi Ltd. were garbled in the July 31 International Newsletter. The correct values are: film thickness, 1 micrometer, with grains about 100 to 200 nanometers in diameter; channel length, 20 micrometers; on-off resistance ratio, 10,000; and drain current, 20 microamperes.

An error in the description of Raytheon Data Systems Co.’s Phase Two Raynet data-communications system (Aug. 14, p. 35) should be corrected to read that a multiple-bus multiprocessor is the heart of the system, not a Multibus-compatible multiprocessor.

TWO NEW FOILS FROM GOULD WILL HELP YOU DESIGN MORE RELIABLE PRINTED CIRCUIT BOARDS.



TCS™ foil. The growing use of multilayer laminates has placed a premium on the reliability of the printed circuit board.

Thermal z-axis expansion of multilayer laminates during the solder operation can induce strains in the copper foil near the edge of plated thru holes. Gould TCS foil has been developed to help withstand this thermally induced strain. That means added reliability in the circuit board.

Double treated copper foil. TC/TC™ double treated copper foil is used in the manufacturing of the copper clad inner layers of high density multilayer printed circuit boards. TC/TC double treated foil eliminates the need for the oxide treatments currently in use. The foil is uniformly treated on both drum and matte sides with a TC treatment

to enhance the bonding strength.

Add an extra dimension of reliability to the circuit boards you design. Specify TCS foil and double treated copper foil from Gould.

For more information, write Mr. Frank Zust, U. S. Marketing Manager, Gould Inc., Foil Division, 17000 St. Clair Ave., Cleveland, Ohio 44110.



GOULD

An Electrical/Electronics Company

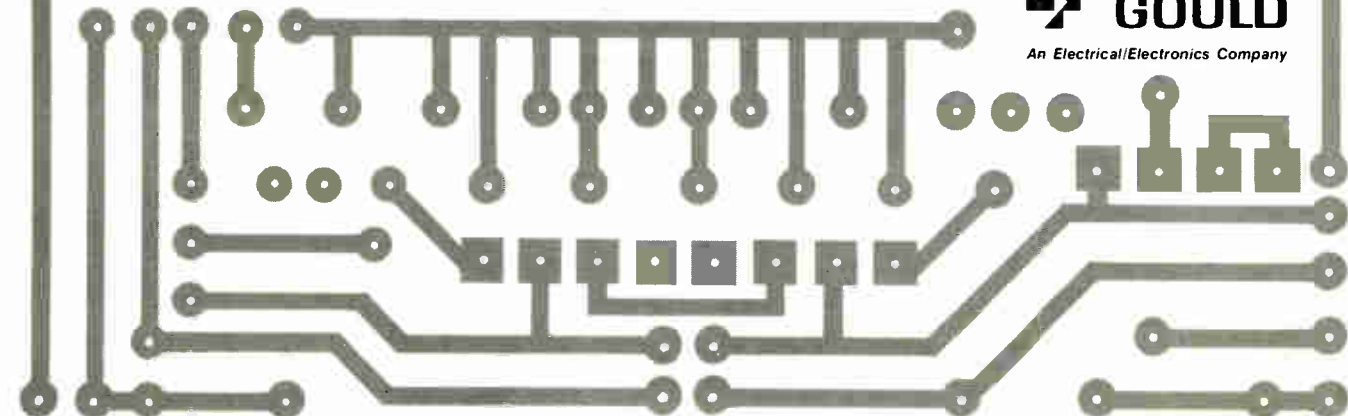

Most IC companies
make three kinds of chips:
Okay. Good. And military.
Not Advanced Micro
Devices.

We don't think quality
is something you turn on
and off.

That's why, since
the first day we
opened for busi-
ness, we've given
every single
part we
make

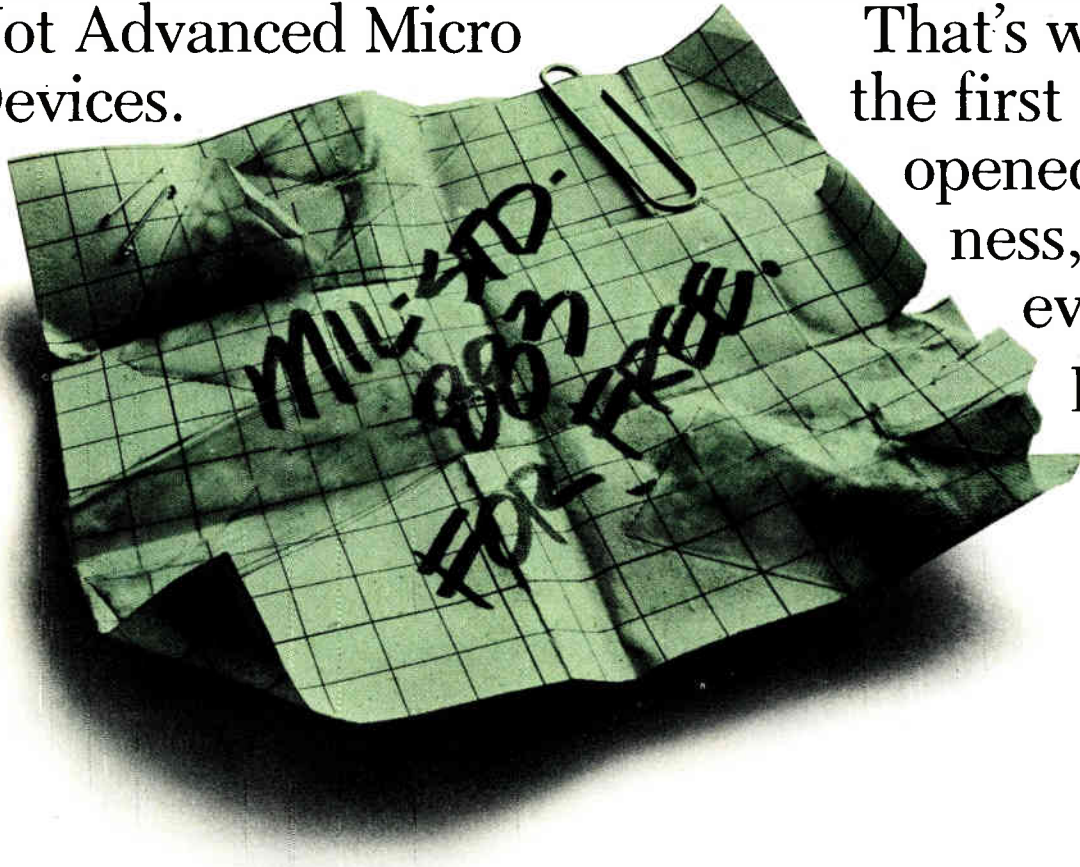

**ALL OUR PARTS
HAVE BEEN
THROUGH THE MIL.**

MIL-STD-883 for free.

That's why we put every part—commercial, professional and military—through thousands of hours of life testing, torture them in grueling conformance tests, and just generally beat the hell out of them.

Most people think we're crazy for making our parts

better than we have to. But if it's crazy to go from zero to \$300 million in sales in less than twelve years, then crazy is just fine with us.

Next time you need hi-rel military or commercial devices, call or write

Advanced Micro Devices.

And put us to the test.

Advanced Micro Devices 

901 Thompson Place, Sunnyvale, CA 94086 • (408) 732-2400

Right, from the start.

News update

■ Next month Vydec will begin shipping its series 4000 word processors, which offer advantages in data security and transient-voltage protection. The reason is that Vydec links its word processors and printers by fiber-optic cables.

"The office environment is a static nightmare," notes Kenneth G. Brock, communications engineer for the Florham Park, N. J., company. "We're using fiber-optic cable because of its isolation characteristics. There are no induced errors as with a twisted pair or coaxial cable. Fiber-optic cable doesn't react to power spikes."

Security. Fiber-optic technology is also allowing the Exxon Information Systems division to provide a high degree of data security. Because data is transmitted in a series of light pulses rather than individual electrical signals, the cable cannot be tapped nor the data intercepted.

Du Pont Co. is supplying the plastic fiber-optic cable for the hookup. "The plastic cable is less expensive and more rugged [than glass]," says Brock. "You can run it under carpet, put a file cabinet on it, or walk across it with spike heels, and nothing seems to harm it." However, attenuation limits its range to 100 feet—in contrast to glass fiber, which may run for several thousand feet before repeaters are necessary.

Vydec's systems [*Electronics*, July 19, 1979, p. 81] are configured with a word processor, a cathode-ray tube and keyboard, dual diskettes, and a printer. The 4200 comes with 150,000 characters of storage space per diskette and the 4400 with a capacity of 250,000 characters per diskette. The 4200 will sell for \$14,900 and the 4400 for \$15,500.

Although Vydec does not offer a fiber-optic connection for a large-scale system, Brock notes that such a scheme is indeed possible. In fact, it will be offered with the company's newly introduced Network system, which allows the individual word processing stations to function in a distributed processing network. He observes that such a development will have to use glass cable because of the distances involved.

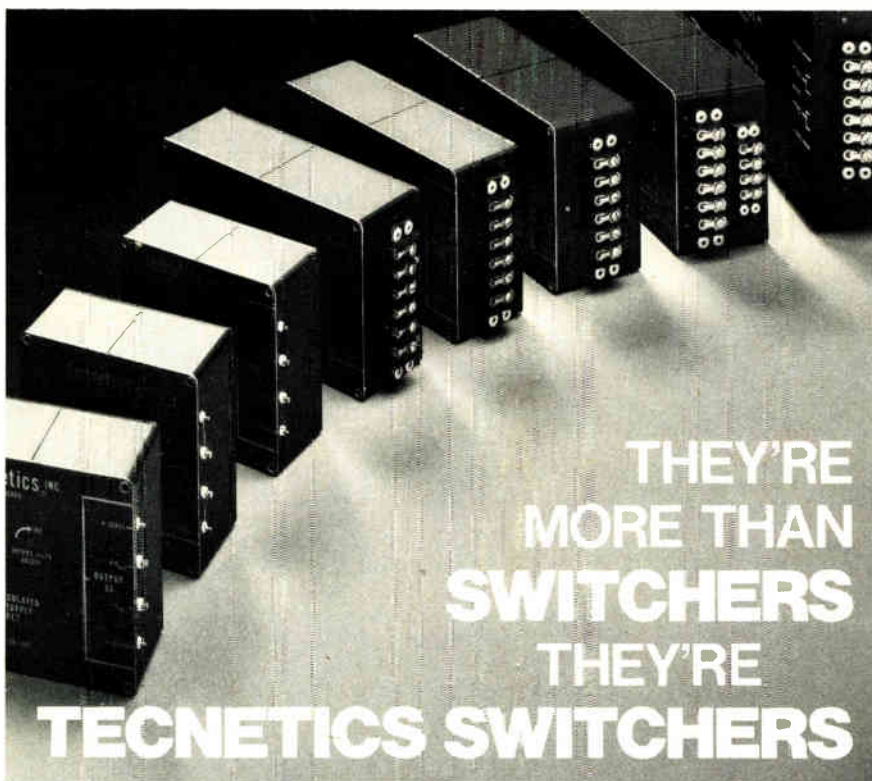

THEY'RE
MORE THAN
SWITCHERS
THEY'RE
TECNETICS SWITCHERS

A Tecnetics switching power supply is better than most for good reason. First of all, we pioneered pulse width modulation techniques to achieve higher efficiency, cooler operation and compactness. In fact, our 1974 catalog offered switchers as standard items.

Secondly, Tecnetics is a major supplier of high rel switchers to the defense and aerospace industries. These are people that

demand the most in reliability and performance.

And finally, Tecnetics today offers nearly 100 switchers, both AC to DC and DC to DC, with power ratings between 25 and 200 watts. They offer EMI filtration, efficiencies up to 92%, overload protection and multiple outputs.

Write for our 1980 catalog today. Look at the specs and you'll see why the switch is on to Tecnetics switchers.

Series	Power	Output	Input	Freq.	Price
3000	25-150	5-48VDC	28 & 48 VDC		\$440-665
4000	25-200	5-48VDC	115 VAC	360-440 Hz	440-1030
6200	200	5-48VDC	115 VAC	47-440 Hz	725

tecnetics
INCORPORATED

The Power Conversion
Specialists

P.O. Box 910, 1625 Range Street,
Boulder, Colorado 80306
(303) 442-3837 TWX 910-940-3246

Circle 12 on reader service card

NEW 1980 Electronics Buyers' Guide

The only book of its kind in the field. If you haven't got it, you're not in the market.

To insure prompt delivery enclose your check with this coupon.

Yes, please send me _____ copies of 1980 EBG.

I've enclosed \$30 per copy delivered in USA or Canada. Address: EBG, 1221 Avenue of the Americas, New York, N.Y. 10020.

I've enclosed \$52 for air delivery elsewhere. Address: EBG, Shoppennangers Road, Maidenhead, Berkshire S16, 2Q1 England.

Name _____

Company _____

Street _____

City _____

State _____

Zip _____

Country _____

HIGH SPEED ENTRY?

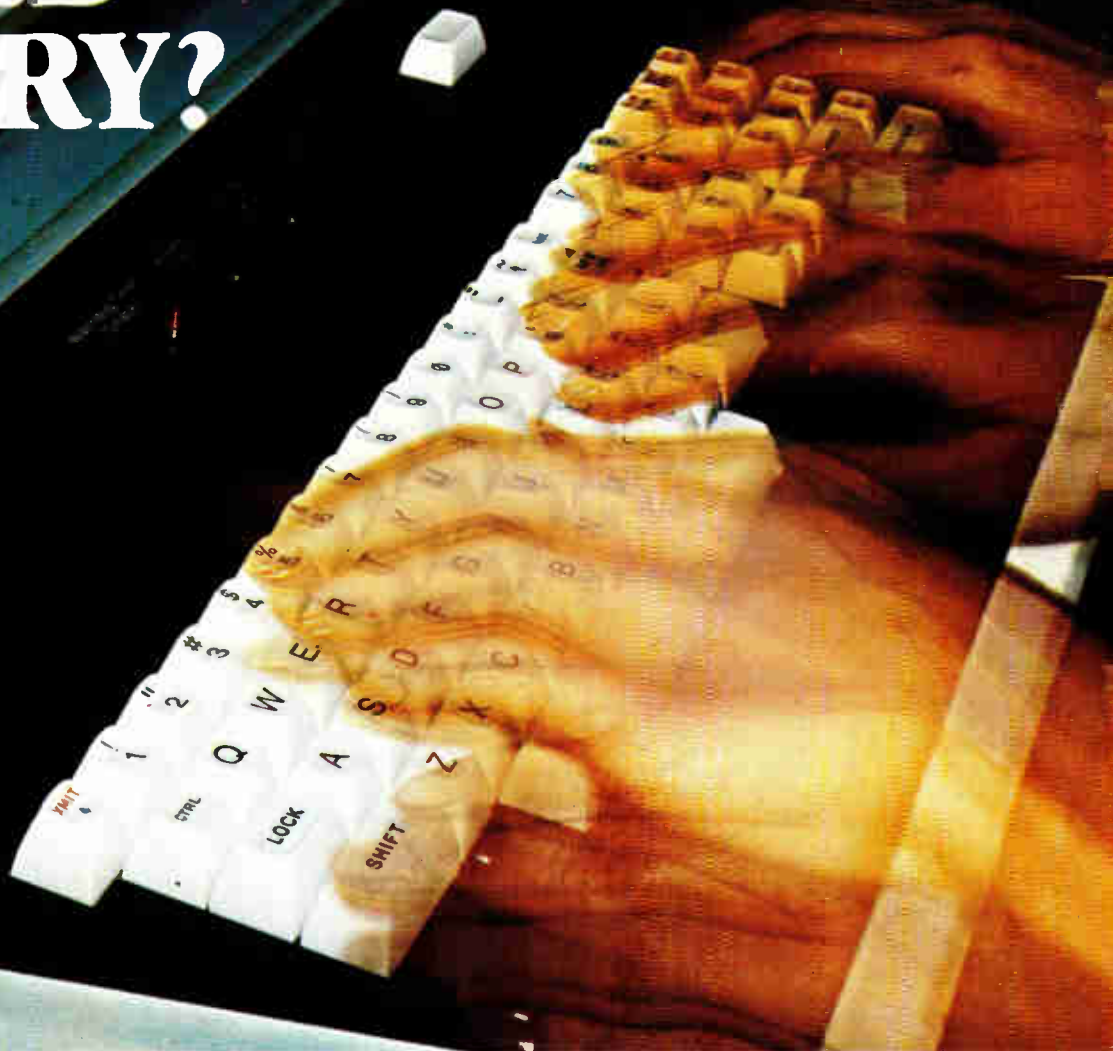

The fastest fingers can't outrun Cherry's new solid state keyboard

Word processing... phototypesetting... key-to-disc... no application exceeds the capability of this Cherry keyboard. Scan time externally adjustable to as little as 1.1 milliseconds accumulated total (entire keyboard). Burst rate speed is 1000 characters per second.

Capacitive design delivers error-free operation... long life dependability.

No chance for false signals. A unique noise immunity circuit tests continuously for valid key depressions. Elec-

tronic hysteresis circuit eliminates "teasing." Reliable contactless design gives long, trouble-free service life.

Custom designs for your specific application, do-it-yourself options and user assignable keys on standard models add surprising versatility at affordable price.

Put solid state reliability to work in your data entry operation.

Call or write Cherry today for your free copy of our 36 page keyboard catalog and the "How To" book of detailed application data.

See Our BOOTH #1440 at "WESCON" Show

Circle 13 on reader service card

CHERRY



SOLID STATE KEYBOARDS

CHERRY ELECTRICAL PRODUCTS CORP. 3608 Sunset Avenue, Waukegan, IL 60085 • 312/689-7612 • TWX: 910/235-1572

Our worldwide affiliates and phone numbers: Cherry Semiconductor Corp., Cranston, RI, U.S.A., 401/463-6000 • Cherry Mikroschalter GmbH, Auerbach, Germany, (09643) 18-1 • Cherry Electrical Products Ltd., Harpenden (Herts) England, 058-27-63100 • Chercio Brasil Industria E Comercio Ltda., Sao Paulo, Brazil, 55 11 246 4343 • Hirase Cherry Precision Co., Ltd., Kawasaki, Japan, (044) 933-3511



NEW!

Socket/Carrier Systems for Leaded "Chip Carriers" and 4-Sided Flat-Packs

Versatile Textool test systems accept wide range of devices on .040" centers (up to 64 leads) and .050" centers (up to 48 leads).

This new Textool test system series is designed to accept leaded "chip carriers" and other 4-sided packages up to .750" square (on .040" centers) and .600" square (on .050" centers). With only a minimum of tooling, the series will accept other package sizes.

Like all Textool sockets/carriers, these systems offer maximum device protection. The contacts give firm wiping action, but do not damage device leads. The carrier completely protects the device leads and offers a fast, efficient method of testing or aging.



The sockets have a lid design that eliminates shorting against contacts and which will not separate from the socket body under normal usage. Other significant features include integral chassis mounting holes and minimum lid overhang at the back of the socket to permit maximum P.C. board mounting density.

Since Textool's socket/carrier system series accepts package sizes up to 64 leads, it offers test versatility previously unavailable.

Detailed technical information on Textool's expanded line of socket/carrier test systems for leaded "chip carriers" and 4-sided flat-packs is available on request.

**Textool Products Department
Electronic Products Division/3M**

1410 W. Pioneer Dr., Irving, TX 75061
214/259-2676



People

Davis, Hurant keep Intel's microcomputer users current

Two natives of New York City, Alan M. Davis and Tal Hurant, have joined forces on the West Coast to provide Intel Corp.'s microcomputer users with sophisticated support tools that enable them to keep pace with device complexity.

The 39-year-old Hurant, who was born in Brooklyn, joined Intel this past spring as product marketing manager for its Development System operation in Santa Clara. Previously, he was marketing vice president at Scientific Micro Systems Corp. in nearby Mountain View, having come to that maker of microcomputer disk-memory systems in 1974. Before that was a five-year stint as marketing director with computer maker Systems Engineering Laboratories in Fort Lauderdale, Fla.

Although the 37-year-old Davis actually considers himself a Los Angeleno, his first few years were spent in the Bronx. Before joining Intel last summer as marketing manager for its Microcomputer Instrumentation operation in Hillsboro, Ore., he was marketing director for Basic/Four Corp.'s Distributed Data Processing division in Tustin, Calif. He came to the small-business computer manufacturer in early 1977, after six years in various sales and marketing management posts with Digital Equipment Corp. in Maynard, Mass.



Responsible for planning and marketing microcomputer development system products for their respective operations, both see their roles as providing the same level of support—assemblers, compilers, and debugging aids, including in-circuit emulators, for example—to two different levels of user requirements. "The needs of users of medium-sized and large microcomputers are quite different from those of small and single-chip microcomputer users," states Davis.

Davis concentrates on providing development tools in support of Intel's 8-bit microcontrollers and peripheral processors for control applications. Such devices include the new 8051 Boolean processor and older 8048 and 8049 microcontrollers, as well as the 2920 analog signal processor, among others.

By contrast, Hurant focuses on support of 8-, 16-, and 32-bit microprocessors (the 8086, 8088, 8085, and soon to be introduced iAPX 286) for data-processing applications, as well as on support of single-board computers, such as the 86/12 and 80/30. "Tal's area typically is aimed more at software-intensive applications," explains Davis, "whereas my area is generally tailored toward applications that are more hardware-intensive, requiring bus-structured architectures."

The recipient of a bachelor's degree in electrical engineering from Brooklyn Polytechnic Institute in 1964 and a master's in operations



Developers. Tal Hurant, left, and Alan M. Davis see Development System and Microcomputer Instrumentation operations as "spanning the range of microcomputer functionality."

PDP-11[®] and LSI-11[®] TAPE and DISK CONTROLLERS



AUTHORIZED EMULEX DISTRIBUTOR

First Computer Corporation, the world's leading DEC computer system integrator now distributes the complete spectrum of EMULEX Tape and Disk controllers for the PDP-11 and LSI-11 family of computers.

HARDWARE/SOFTWARE TRANSPARENCY

These microprogrammed, emulating Tape and Disk Controllers are fully software transparent to both the PDP-11 hardware and software. The use of these controllers protects you from the impact of future versions of the operating system software. They are so compatible you can plug them into your system and be up and running the standard DEC diagnostics and operating systems in minutes.

ADDED FEATURES

These controllers provide you with added features such as automatic self-testing, onboard pack formatting, and programmable bandwidth control at no additional cost.

BROAD RANGE OF DEVICES SUPPORTED

It makes no difference which of the DEC PDP-11 or LSI-11 family you are using or which type of storage device is required for your application. We can support 59 different drives from 13 different manufacturers.

HIGHEST QUALITY AND SUPER RELIABILITY

You can be assured of the quality and reliability of these Tape and Disk Controllers because First Computer Corporation specializes in PDP-11 and LSI-11 computer systems, components, and peripherals. Over the years our reputation was built on the quality and reliability of the products we sell. We continue to protect this reputation by selling only the very best.

SUPER FAST SERVICE

Because we are the largest system integrator specializing in PDP-11 and LSI-11 systems, components, and peripherals, First Computer Corporation can satisfy most of your Tape and Disk Controller requirements directly from our stock.

GUARANTEED SATISFACTION

Your satisfaction is fully guaranteed by First Computer Corporation. We believe in every product we sell. If for any reason these Tape and Disk Controllers do not meet your expectations, simply return them freight prepaid and insured, within 10 days of receipt and we will refund your money in full. First Computer Corporation backs each of these products with a full one year warranty.

AUTHORIZED REPRESENTATIVES AND DEALERS

Authorized EMULEX Sales Representatives earn full commissions for orders filled by First Computer Corporation. Attractive Dealer discounts are available to all Authorized EMULEX Dealers.

PRICE AND PERFORMANCE

You pay no more for First Computer Corporation service. Write or call today for our free EMULEX Buyer's Guide.

® Registered trademark of Emulex Corporation

® Registered trademark of Digital Equipment Corporation

™ Trademark First Computer Corporation



computer corporation

corporate square / 825 north cass avenue / westmont, illinois 60559 / (312) 920-1050

TWX NUMBER 910-651-1916

CE3

Electronics / August 28, 1980

Circle 15 on reader service card 15

These days, an American made relay is like money in the bank.

Think of the U.S. economy as a bank, one with too many withdrawals and too few deposits, and you've got a major cause for inflation. Putting your money into American made goods, like Wabash Relays, can help bring inflation under control.

Wabash relays are 100% American made. That says something special about our quality and our fast, dependable service and delivery. Wabash offers over 6,000 reed relay variations alone, at a price competitive with those manufactured outside the U.S.

For relays you can bank on, give Wabash a call. Just tell 'em Sam sent you.

Wabash Relay & Electronics
First and Webster Streets
Wabash, Indiana 46992
(219) 563-2191

wabash[®]
The Reed Relay Specialists



Circle 160 on reader service card

INTERNATIONAL OE CRYSTAL OSCILLATOR ELEMENTS

International's OE Series of Crystal Oscillator Elements provide a complete crystal controlled signal source. The OE units cover the range 2000 KHz to 160 MHz. The standard OE unit is designed to mount direct on a printed circuit board. Also available is printed circuit board plug-in type.

The various OE units are divided into groups by frequency and by temperature stability. Models OE-20 and OE-30 are temperature compensated units. The listed "Overall Accuracy" includes room temperature or 25°C tolerance and may be considered a maximum value rather than nominal.



All OE units are designed for 9.5 to 15 volts dc operation. The OE-20 and OE-30 require a regulated source to maintain the listed tolerance with input supply less than 12 vdc.

Prices listed include oscillator and crystal. For the plug-in type add the suffix "P" after the OE number; eg OE-1P.

OE-1, 5 and 10 can be supplied to operate at 5 vdc with reduced rf output. Specify 5 vdc. when ordering.

Output — 10 dbm min. All oscillators over 66 MHz do not have frequency adjust trimmers.

Catalog	Oscillator Element Type	2000 KHz to 66 MHz	67 MHz to 139 MHz	140 MHz to 160 MHz	Overall Accuracy	25°C Tolerance
035213 035214 035215	OE-1 OE-1 OE-1	\$15.66	\$17.99	\$22.63	±.01% -30° to +60°C	±.005%
035216 035217 035218	OE-5 OE-5 OE-5	\$19.44	\$22.91	\$30.17	±.002% -10° to +60°C	±.0005% 2-66MHz ±.001% 67 to 139 MHz ±.0025% 140 to 160 MHz
Catalog Number	Oscillator Element Type	4000 KHz to 20000 KHz			Overall Accuracy	25°C Tolerance
035219	OE-10	\$22.91			±.0005% -10° to +60°C	Zero trimmer
035220	OE-20	\$33.65			±.0005% -30° to +60°C	Zero trimmer
035221	OE-30	\$69.63			±.0002% -30° to +60°C	Zero trimmer



**INTERNATIONAL
CRYSTAL
MFG. CO., INC.**

10 North Lee
Oklahoma City, OK 73102
405/236-3741

People

research from the University of Southern California (where Davis was an EE student) in 1967, Hurant says the formation of two distinct development system operations "enables us to do a better job of providing products for both ends of the microcomputer applications spectrum. It allows us to specialize the development systems so we can get more sophisticated systems out to users earlier."

Hurant describes the combined development systems offerings as the products that add substance to his firm's motto, "Intel delivers solutions." He adds, they "are the reason why Intel can continue to come out with advanced microcomputers and enable its customers to get off the ground and begin developing solutions around them."

Because the complexity of developing microcomputer-based systems will increase as microcomputers themselves become more advanced, Davis and Hurant intend their respective operations to provide systems that will "allow the user to stay on the high end of the learning curve and make the complexity of the components transparent to the user," Davis says. Perhaps equally important, they want to keep "the universality and continuity" of such systems, so as to "prevent obsolescence of the capital investment made by our customer base."

Thus the capabilities that are provided in the Development System operation's new Intellec series III high-performance 16-bit development system and model 290 disk-file-sharing system for multiple users "can be derived from all prior Intel development systems, by virtue of a few plug-in upgrades, including high-level languages," says Hurant. From the MDS-800, the first disk-based development system introduced in 1975, up to and beyond the Microcomputer Instrumentation operation's recently introduced model 120 [*Electronics*, Aug. 14, p. 50], "which drives down the entry-level cost for the small-volume user," Davis claims "we're committed to spanning the range of microcomputer functionality." □

Ask us anything about SerenDIP[®] Solid State Relays.



An SSR in a DIP package? Certainly. All have logic compatible inputs. Some feature zero voltage switching for AC applications. Some are rated to switch 1.5 amps at 250 VRMS. Others are rated to 400 ma DC. Did you expect anything less from the people who introduced hybrid micro-circuits to SSR design?

But you probably have other questions about this little relay and how to use it. So go ahead. There are no dumb questions.

- How can an SSR switch both AC and DC?
- Are speed, long life, and bounce-free operation the only SerenDIP advantages?
- How will SerenDIP[®] solve my low power AC switching needs?
- How can I get prototype quantities quickly?

Sorry. You missed my question. Here it is. _____

Name _____ Title _____

Company _____ Phone _____

City _____ State _____ Zip _____

 **TELEDYNE RELAYS**
Ask us anything. There are no dumb questions.

Mail to: TELEDYNE RELAYS 12525 Daphne Ave., Hawthorne, California 90250, (213)777-0077

Circle 17 on reader service card

We have a PCB Switch for your next design.

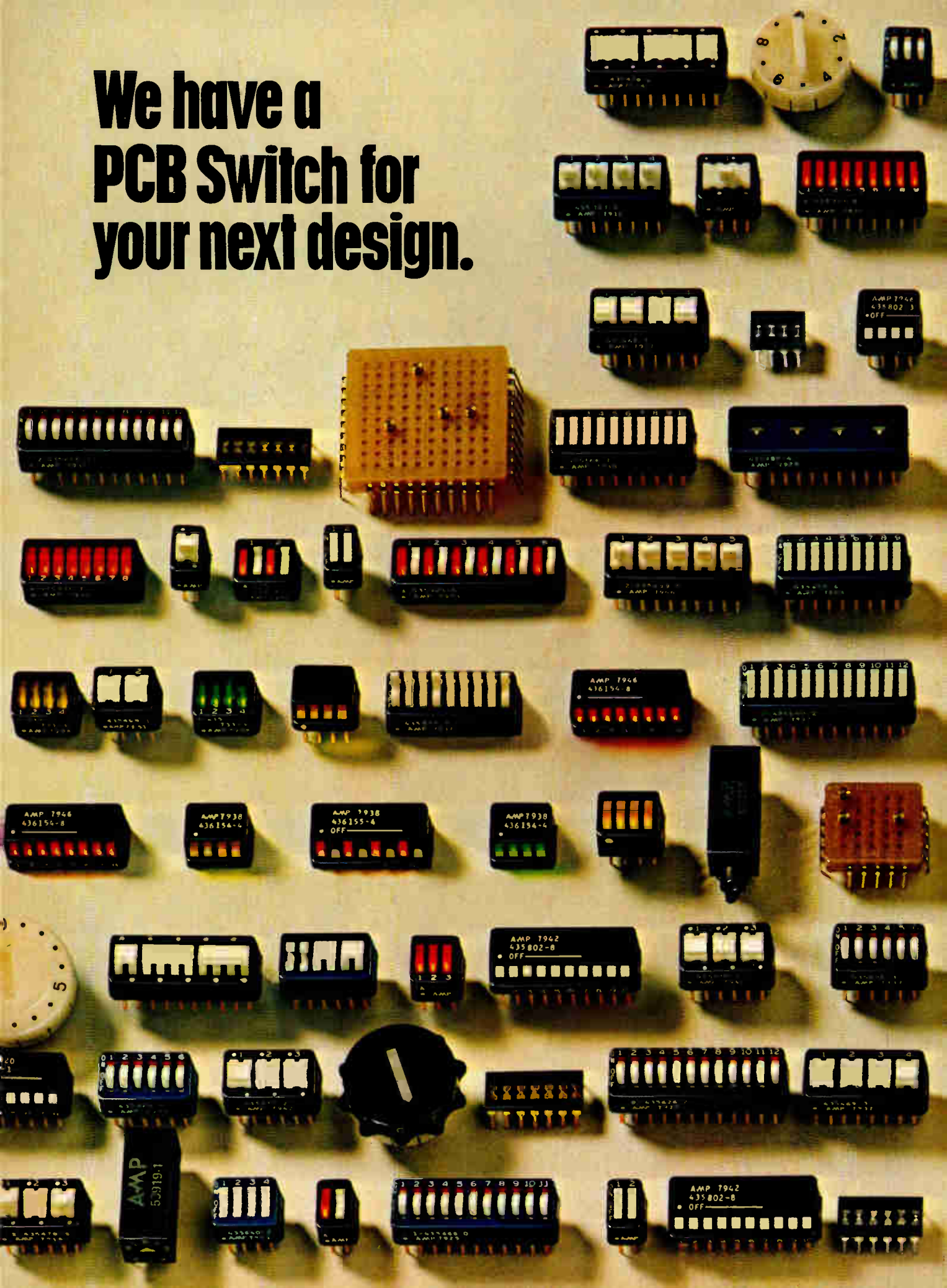



Available now.

AMP invented the DIP switch and today continues as the leader with performance, styles and delivery—all at a competitive price.

Variety—DIP switches are available in several profiles with top, side or end actuation, and with color LEDs. Or in unique and economical shunt designs. We also have miniature thumbwheel, flat rotary and matrix styles, giving you even more design flexibility.

Function—No matter what your switching requirements, AMP has the switch. SPST, DPST, SPDT, DPDT, 4PST, Decimal, Hexadecimal, BCD or BCO designs.

Availability—There's no problem with our new regional computer-linked inventory system. For information, call the PCB Switch Information Desk at (717) 780-8400 or write AMP Incorporated, Harrisburg, PA 17105.

AMP is a trademark of AMP Incorporated.

AMP has a better way.

AMP

Circle 19 on reader service card

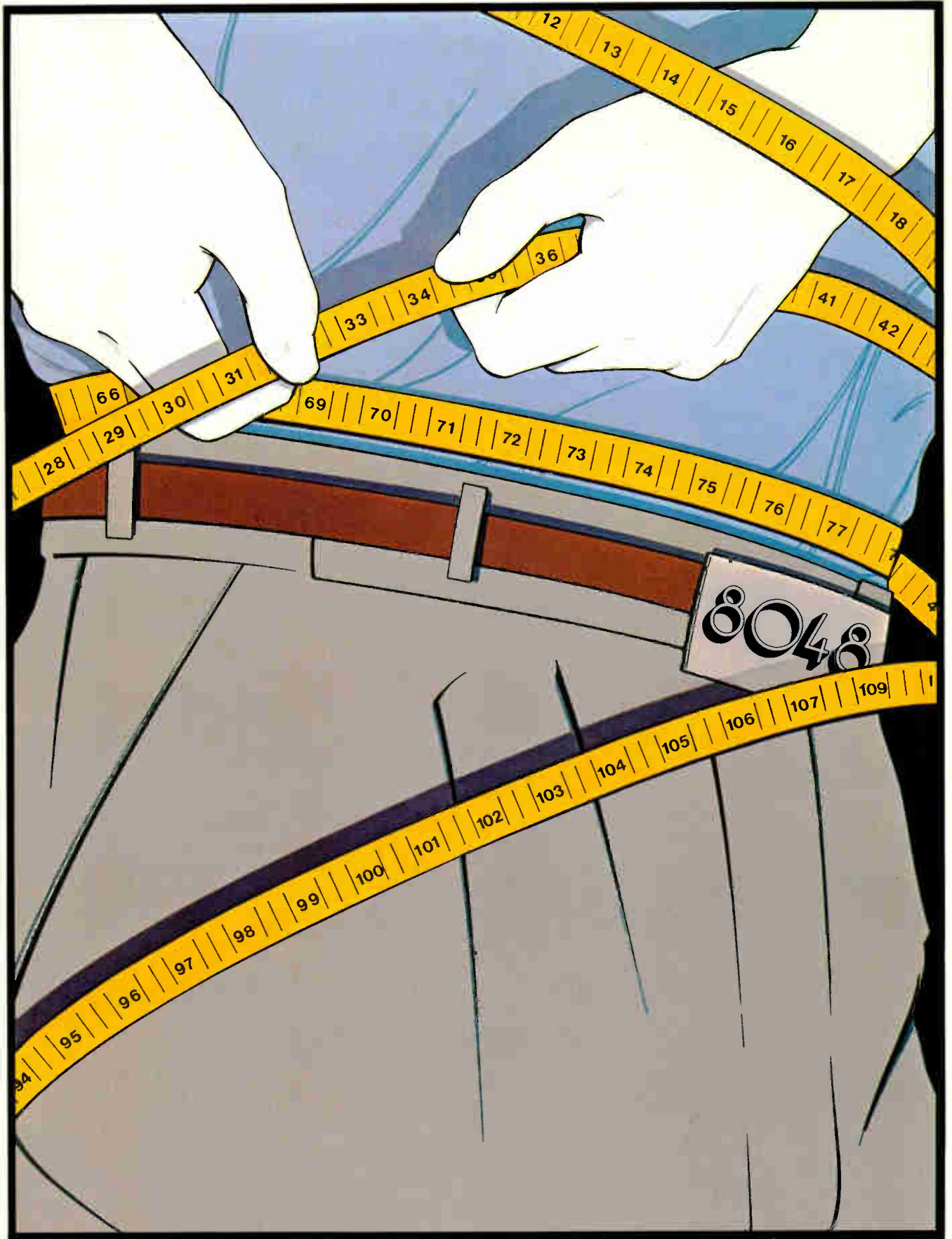

Watt Watchers

Introducing three power saving 8048H microcontrollers and improved support tools for trimmer product development.

For years Intel's 8048 has been the industry standard 8-bit single-chip microprocessor for control applications. Now we're offering a wide selection of high-performance HMOS 8048s, suitable for expanded applications—all consuming less power than before, and all backed by extensive development support.

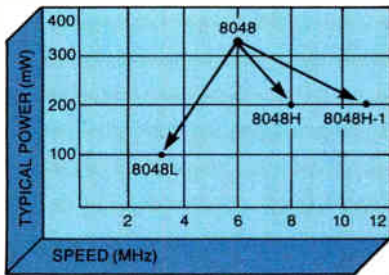

New 8048Hs put on strict power diets

Our three new microcontrollers—the 8048H, 8048H-1, and 8048L—cut power consumption from 40 to 70%. Maximum operating currents for the first two are 80 mA; for the third, just 40 mA. In fact, for those applications requiring RAM-stored data to be retained, consumption at power-down falls to just 8 mA for the 8048H and 8048H-1, and to a mere 4 mA for the 8048L. These power economies are an especially important consideration when you're designing portable, battery-powered equipment. And they help cut power supply costs as well.

Because they're produced with Intel's high-reliability HMOS* technology, these new direct-replacement devices boost performance to dramatically higher levels, too. With these three new versions—operating at 3.6, 8, and 11 MHz—cycle times are reduced to less than 4.2, 1.9, and 1.4 microseconds, respectively, with performance specified over the full operating

range. At 11 MHz, that's almost twice the processing speed of the original 8048. And since these units are totally compatible with existing 8048s, you can easily upgrade your current products, as well as create new designs.

Reduce your development cycle with Intel support

In microcontroller system development, time is money. To save you both, Intel offers the most advanced microcontroller support, including real-time debugging to 11 MHz. Our Intellec® Microcomputer Development System and new microcontroller development tools can speed your product from concept to production line months ahead of your competition. And dramatically reduce your bottom-line development costs.

At the Intellec console you can write and edit application programs



quickly, using 8048 assembly language, and then have the system translate them into highly efficient machine code. Our ICE-49™ In-Circuit Emulator also enables you to debug your programs—in single steps or in real time—using high-level English-like instructions

8048 Family—Commercial Grade** (0° to 70°C)

Model	Program Memory (Bytes)	Data Memory (Bytes)	Cycle Time (μsec)
8021	1K ROM	64	8.38
8022	2K ROM	64	8.38
8048H	1K ROM	64	1.88
8048H-1	1K ROM	64	1.36
8048L	1K ROM	64	4.16
8748	1K EPROM	64	2.5
8035	(External)	64	2.5
8049	2K ROM	128	1.36
8039	(External)	128	1.36

**Industrial Grade: 18022, 18035L, 18039, 18048, 18049, 18748
Military Grade: M8035L, M8048, M8748

and symbolic address references. Your software can even be executed and debugged in your prototype or production unit, with full control and monitoring from the Intellec console. There's just no more effective way to use your company's engineering resources. And no better way to reduce your development cycle.

The Intel way to product fitness

With Intel's expanded family of HMOS 8048s and Intellec support tools, your next generation of microcontroller-based product—and sales—can now be the picture of health. To find out how, write for our Success Manual for Single Chip Microcomputer Users and the new 8048H data sheet. Or call your local Intel sales office/distributor, or Intel Corporation, 3065 Bowers Avenue, Santa Clara, CA 95051. Telephone (408) 987-8080.

*HMOS is a patented Intel process.

intel® delivers solutions.

Europe: Intel International, Brussels, Belgium. Japan: Intel Japan, Tokyo. United States and Canadian distributors: Arrow Electronics, Alliance, Almac/Strom, Component Specialties, Cramer, Hamilton/Avnet, Harvey, Industrial Components, Pioneer, Sheridan, Wyle/Eimar, Wyle/Liberty, L.A. Varah and Zentronics.

BIOMATION K100-D



Got a glitch?
glitch
FIXER
FROM GOULD

Compare this general purpose logic analyzer with the currently accepted industry standard.

The K100-D wins over Hewlett-Packard's 1615A hands down!

Logic designers have made Gould's powerful Biomation K100-D our fastest selling logic analyzer



ever. You'll see why once you compare it to its nearest competitor, the 1615A from Hewlett-Packard.

Compare clocking speed.

With a 100 MHz clock rate, the K100-D gives you resolution to 10 ns—*five times better than the 1615A's*. Use the K100-D's latch

mode to catch glitches as narrow as 4 ns. It gives you the most precise logic analysis for today's high speed minicomputer, main-frame and microprocessor systems. Best of all, you're already prepared for faster designs as they arrive.

Compare capacity.

The K100-D's 1024 word memory is *four times as deep as the 1615A's*. This dramatically extends the length of data you can trap from your system at any one time. And that means faster, more accurate debugging. In addition, the K100-D's standard 16 channel format can be expanded to 32 channels for work on the new generation of 16-bit microprocessors.

Compare your productivity.

Finally, the K100-D makes designers more productive with convenience features superior to those of the 1615A. The K100-D has a larger keyboard, plus an interactive video display. Comprehensive status menu. Data domain readout in hexadecimal, octal,

binary or ASCII. And the list goes on and on.

The final analysis.

To help you evaluate these two fine instruments before you buy, we've prepared a point-by-point *competitive comparison* of the two. If you're designing and debugging high-performance digital systems, you'll want to read this document carefully. To get your free copy, just use the reader service number or write Gould Inc., Biomation Division, 4600 Old Ironsides Drive, Santa Clara, CA 95050. For faster response, call 408-988-6800.



Hewlett-Packard 1615A
A very good logic analyzer



Speed: to 20 MHz
Resolution: 50 ns
Memory: 256 words
Channels: 8 timing & 16 data,
or 24 data

Biomation K100-D
The industry's finest logic analyzer



Speed: to 100 MHz
Resolution: 10 ns
Memory: 1024 words
Channels: 16 timing or 16 data,
or 32 data

Proposed IEEE amendment should be defeated

As we noted earlier [*Electronics*, Aug. 14, p. 12], the reform zeal of many engineers that flamed during the 1970s seems to have cooled considerably now that the 1980s are here. It is axiomatic that people are less eager for change during good times—after all, why tinker with a design that seems to be doing its job—and the members of the Institute of Electrical and Electronics Engineers are no exception.

Even though the IEEE board of directors' candidates for president and executive vice president are running unopposed, one might say that the reform movement has made some impression: presidential candidate Richard W. Damon says he wants the institute to play a stronger role in the social and political sides of the engineer's life. On the other hand, the ballot this year, for the first time in a while, lacks any proposed amendment to the constitution that was placed there by petition.

However, what the ballot does contain is an amendment placed there by the board. Every IEEE member should be aware of it, because in its own way it may say more about the future of the reform movement than all the fuss and fury of the 1970s. Stripped of its legalese, the proposed amendment to Article XII would do no less than transfer control of the annual vote away from the membership and to the board. According to the current rules, any change in the way IEEE elections are held must be put before the entire membership in the form of a referendum. Under the proposed measure, determination of when and how nominations and elections

will take place would become part of the bylaws, and these bylaws can be changed by the board. In fact, the directors routinely make such changes at their meetings, so the election process could be tinkered with rather easily.

The suggested changes will be on the ballot embodied in an amendment that, ostensibly, had another purpose. A mean-spirited person could go so far as to say that the matter is buried in the amendment that would establish the office of president-elect and past president because the directors would just as soon keep the whole thing as quiet and below board as possible. In fact, IEEE officials tend to brush off the whole thing as merely a procedural change that has little importance in the day-to-day work of the institute. Giving the directors the added powers apparently is viewed as a way to cut away a good deal of the time and expense involved in going to the general membership for approval of such changes.

Nonsense. While the directors' desire to save time, trouble, and money is admirable, it is mistimed, misplaced, and misguided. Now that the IEEE has been opened, if ever so slightly, to the fresh breezes of social awareness, it would be an incredibly shortsighted move to strip away one of its few democratic procedures, in which all the members, from no matter what region, have a right to make their wishes known on the same issues. The officers and the board of directors of the IEEE would be better advised to look for ways to give more voice to the engineers they represent, not take some away.

It's new! The PROM Programmer of the future. Here are 10 ways it makes your job easier today.

Pro-Log presents the powerful, portable new M980. It makes PROM programming simple and easy, yet it's loaded with performance features designed specifically for engineering, manufacturing and field service.

1. Built to handle the programmable devices of today... and tomorrow!
The M980 programs over 350 devices, with capacity for devices up to 64K x 16 bits.
2. Will accept all existing Pro-Log personality modules, as well as modules for future devices as they are developed.
3. One-button duplicating makes the M980 ideal for fast, mistake-proof volume PROM programming.



4. Expandable, 32K bit RAM buffer provides capacity up to 128K bits, and the memory is safe for 7 days without external power.
5. Audio prompting serves as an audible guide through the programming process.
6. Programming-error safeguard system stops the process, alerts you with an audio tone, and identifies the error in the display.
7. Self testing function lets you check keyboard, buffer memory and display.

8. Accepts input data from external sources, including computers, development systems, paper tape readers, TTYs, all in multiple formats.
9. Light, compact and portable, the M980 comes in its own attache case.
10. Dependable, rugged construction makes the M980 ideal for field service. And it's backed by a two-year parts and labor warranty.

And there's a lot more.

Get the whole M980 story. Call or write for a free brochure. Pro-Log Corporation, 2411 Garden Rd., Monterey, CA 93440. Phone (408) 372-4593.

 **PRO-LOG**
CORPORATION

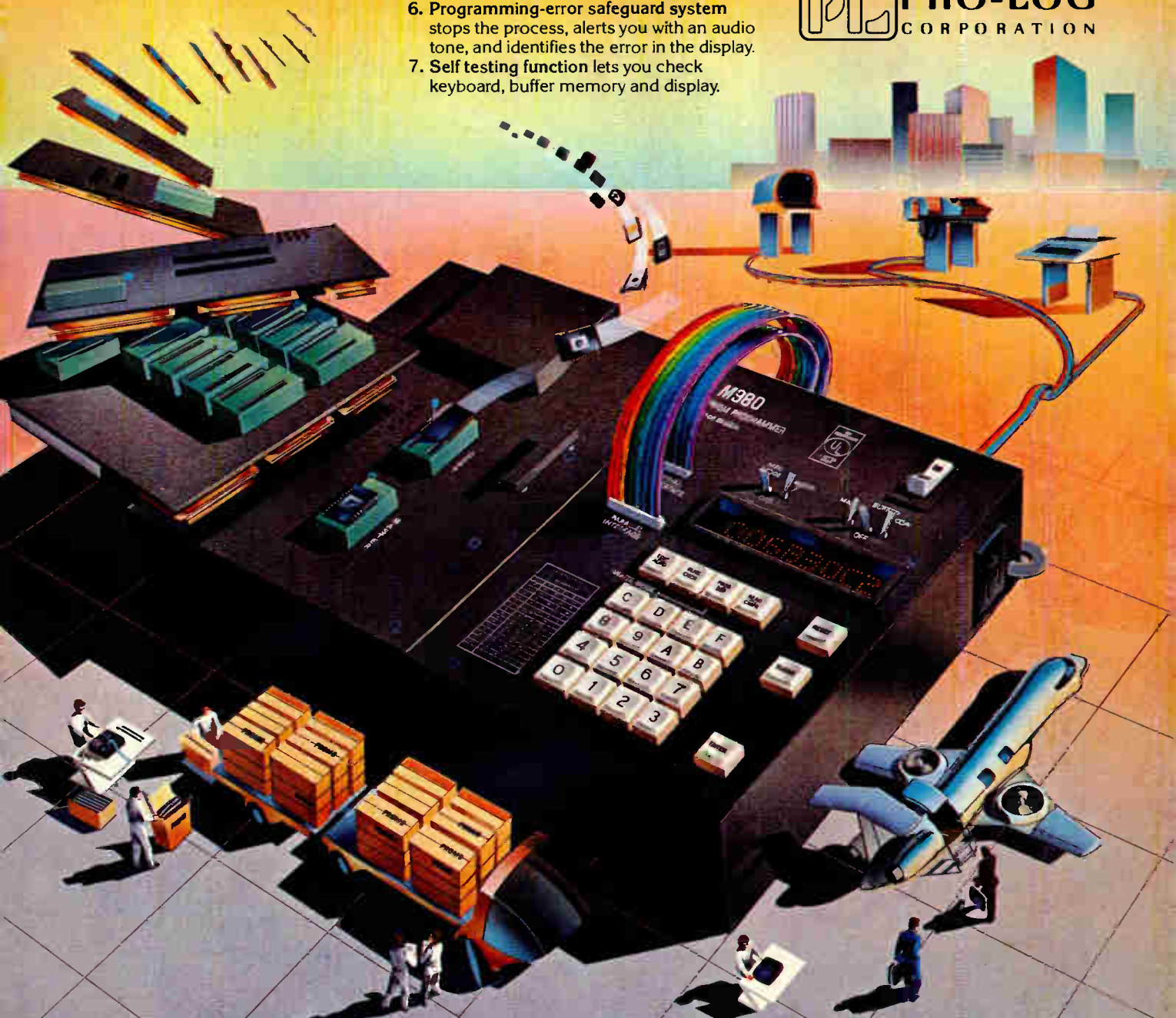

VACTEC

CdS/CdSe

LIGHT

DEPENDENT

RESISTORS

VACTEC LDR's are photoconductive cells responding to visible light by proportional resistance change. A typical cell such as the VT833 will be $>10M\Omega$ under moonlight illumination and $<1.0K\Omega$ in room light. Their small size, low cost, and spectral range of 400-700nm makes LDR's an excellent ambient light sensor for day/night threshold controls, automatic brightness controls for CRT terminals, TV sets, digital clocks, automotive, and aircraft instrument displays. Apply them as any variable resistance.

VACTEC LDR's are useful for audio gain controls, limiters, gates and special effect generators. With $<1ms$ attack time and a few hundred ms release time, cells are resistive, non-polarized, distortion and noise typically .01% at 1 VAC.

VACTEC LDR's are rated at 500 peak V for use in 115 and 230 VAC direct relay controllers, SCR and triac gating.

VACTEC LDR's come in five ceramic and three hermetic cases; 6 materials; wide range of resistance levels to match discrete, TTL and CMOS circuits. For additional information on these versatile and low cost devices, request Bulletin PCD-6.

**VACTEC,
INC.**

10900 Page Blvd.
St. Louis, MO 63132
(314) 423-4900
TWX 910-764-0811

Meetings

Oceans/80, Ocean Engineering in the 1980s, IEEE and Council on Oceanic Engineering, Seattle, Wash., Sept. 8-10.

International Institute of Communication Annual Meeting (J. M. Bryan, Canadian Department of Communications, 300 Slater St., Ottawa K1A0C8, Canada), Holiday Inn—Ottawa Center, Ottawa, Ontario, Canada, Sept. 8-11.

Second International Colloquium on Reliability and Maintainability, Centre National d'Etudes des Télécommunications and Centre National d'Etudes Spatiales (CNET Reliability Center-Lannion B, B. P. 40—22301 Lannion, France), Perros-Guirec and Trégastel, Brittany, France, Sept. 8-12.

10th European Microwave Conference 80, Association of Polish Electrical Engineers (Microwave Exhibitions & Publishers Ltd., Temple House, 36 High Street, Sevenoaks, Kent TN13 1JC, England), The Palace of Culture and Science, Warsaw, Sept. 8-12.

Electrical Overstress/Electrostatic Discharge Symposium, Illinois Institute of Technology Research Institute (IITRI Symposium, RADC/RBRAC, Griffiss Air Force Base, Rome, N. Y. 13441), Town and Country Hotel, San Diego, Calif., Sept. 9-11.

Convergence 80—30th International Congress on Transportation Electronics and Vehicular Technology Society Conference, IEEE and Society of Automotive Engineers, Hyatt Regency Hotel, Dearborn, Mich., Sept. 15-17.

Essderc 80—1980 European Solid State Device Research Conference, Institute of Physics (47 Belgrave Sq., London SW1X 80X, England), University of York, York, England, Sept. 15-18.

Sixth European Conference on Optical Communication, Institution of Electrical Engineers (1 Savoy Pl.,

London WC2R 0BL, England), University of York, York, England, Sept. 15-19.

Euromicro 80, Institution of Electrical Engineers (L. R. Thompson, Hawker Siddeley Dynamics, Manor Road, Hatfield, Herts. AL 109 LP, England), Imperial College, London, Sept. 16-18.

FOC 80: Fiber Optics and Communications, Information Gatekeepers Inc. (167 Corey Road, Suite 111, Brookline, Mass. 02146), Hyatt Regency Hotel, San Francisco, Calif., Sept. 16-18.

Wescon/80, IEEE, Anaheim Convention Center and Disneyland Hotel, Anaheim, Calif., Sept. 16-18.

Eusipco: European Signal Processing Conference, IEEE *et al.*, Swiss Federal Institute of Technology, Lausanne, Switzerland, Sept. 16-19.

ACM Symposium on Small Systems, Association for Computing Machinery (Liza Loop, 3781 Starrking Circle, Palo Alto, Calif. 94306), Hyatt Rickey's, Palo Alto, Calif., Sept. 17-19.

30th Sicob—Salon International de l'Informatique, de la Communication, et de l'Organisation de Bureau (6 Pl. de Valois, 75001 Paris, France), Init—Paris La Défense, Sept. 17-26.

Eighth IBC—International Broadcasting Convention, Electronic Engineering Association *et al.* (1 Savoy Pl., London WC2R 0BL, England), Metropole Conference Center, Brighton, England, Sept. 20-24.

Sixth Esscirc—European Solid State Circuits Conference, Eurel *et al.* (G. Grunberg, Thomson-CSF, B.P.5., 92403 Courbevoie, France), University of Grenoble, Grenoble, France, Sept. 22-25.

Semicon/East 80, Semiconductor Equipment and Materials Institute (625 Ellis St., Suite 212, Mountain View, Calif. 94043), John B. Hynes Auditorium, Boston, Sept. 23-25.

We make a big case for support.

Seems in the race to sell hardware, a lot of people relegate service and support to a low priority. We don't. Because we're convinced that the better we back up our test systems, the more effective they'll be for you. And that's the best way we know to lower your testing costs.

Training starts you off. Hands-on experience with the kind of test equipment you'll be using. From fundamentals to advanced techniques. At training centers located in the U.S., Europe and Asia. And if you can't come to us, we'll make arrangements to come to you.

Applications get you going. A library of ready-to-run test programs that can save you thousands of dollars. And a worldwide team of application engineers to help you develop



custom programs that let you keep pace with changing technologies.

Service keeps you running. More than 25 major centers throughout the world. Each offering a range of services. Installation and startup. Monthly maintenance. Automatic hardware and software updates. Spare parts distribution. And the industry's fastest solutions to even the most difficult problems. For our general-purpose LSI testers, there's even a unique

remote diagnostic system that gives you access to our top ATE specialists, no matter where you're located.

It's a strong case for buying Fairchild. Backed by nearly 400 service and support people worldwide. So find out more. Call or write Fairchild Test Systems Group, 1725 Technology Drive, San Jose, California 95110. (408) 998-0123. You'll see why we make a big case for support.

FAIRCHILD

A Schlumberger Company

**The
First Family
of ATE.**



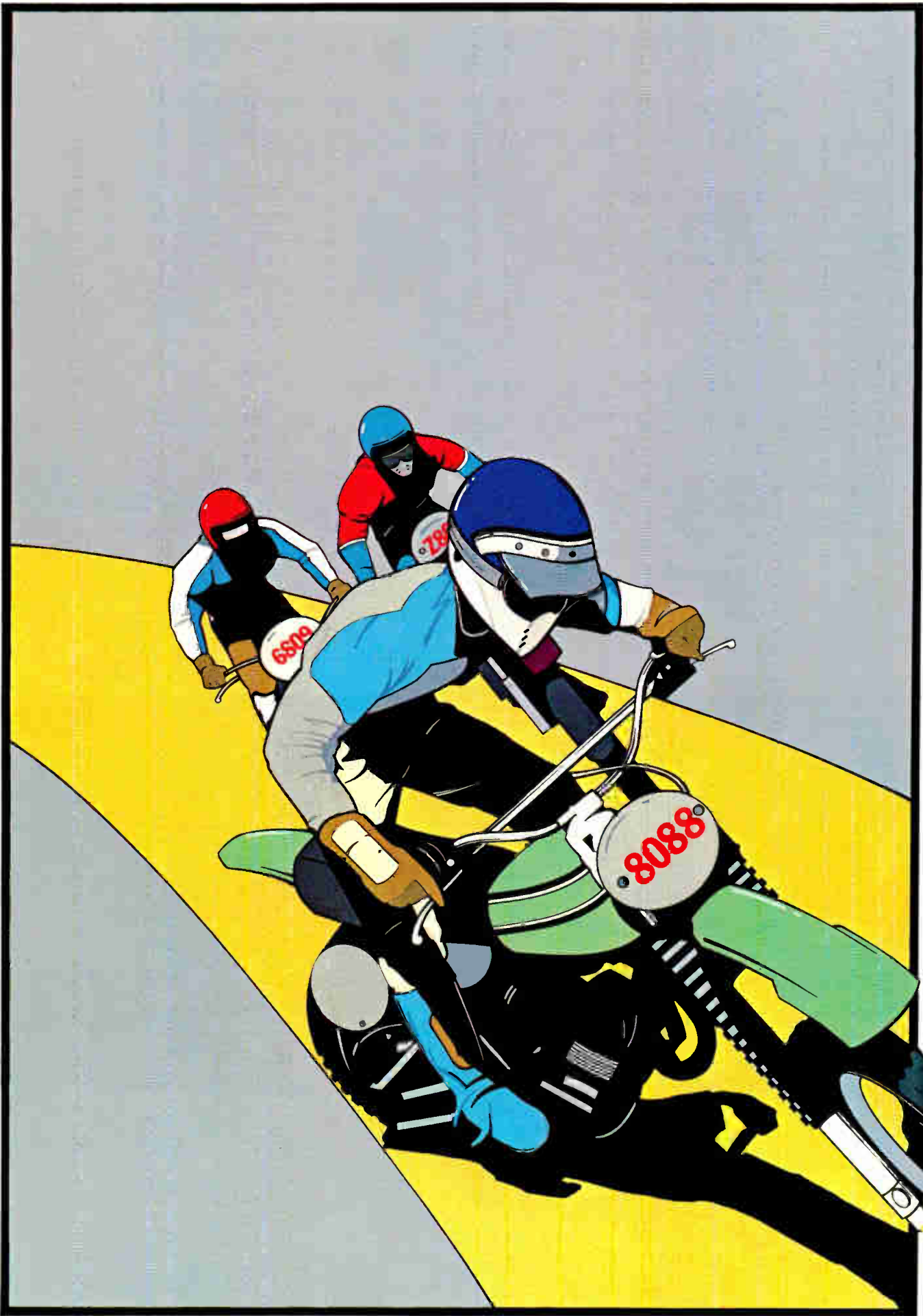

8-Bit Champion

In price-performance, look to Intel's powerful iAPX 88 microprocessor to leave the pack behind. Both now and down the road.

In price-performance races, the iAPX 88 is the one to beat. It's two times faster than the Z-80A and the 6809. And recent benchmark tests show that the iAPX 88, with its 8088 CPU, consistently outperforms its closest competitors in memory efficiency, ease of programming and throughput—by as much as 4 to 1. This is especially important in high-performance tasks such as block moves, character searches, word shifts, and 16-bit multiplies. All critical for applications like word processing, terminal control, scientific instrumentation and industrial control.

And because it's the only 8-bit microprocessor that addresses up to 1 million bytes of memory, the 8088 can take on large programs. Without having to slow down due to overlays or memory bank switching, like other 8-bit processors.

Tough price competitor

In price competition with other 8-bit microprocessors, the iAPX 88 has become the front runner.

You save dramatically on

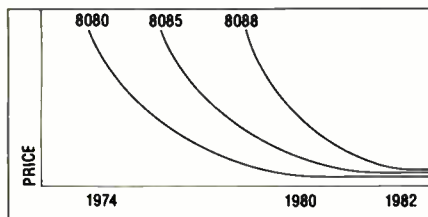

8-bit Microprocessor Price Trends

memory chips, too. The iAPX 88 takes—on the average—30% less memory than competitors for the same programs. Then too, it allows you to use lower cost memory to get the same throughput as competitors. With a 5MHz 8088, you can use our 450ns memories and still outperform a 4MHz Z-80 requiring 250ns chips. Depending on

the application, your cost savings here can be substantial.

No contest now with new Intel software

To unleash the new power that the iAPX 88 puts in your hands, it takes more powerful software—



the kind only Intel delivers today. Software that produces object code directly and gives you important extensions that allow you to fine-tune the software to your application.

Software such as PASCAL-88, the block-structured application language rapidly becoming the one most widely used. With our PASCAL-88, you can do direct port I/O and interrupt handling, as well as independent program module compilation. And produce code that runs faster than other, P-code interpreter versions.

Along with PASCAL-88, you get PL/M-88, our systems implementation language, our ANSI-compatible FORTRAN, and our ASM-88 macroassembler. So with more software capability than you've ever had before, now you

can choose the right language tool for each application—whatever it calls for.

Get out in front with complete development support

All the development support tools you need are ready to go today from Intel. Start with the Intellec® Microcomputer Development System. Add to that our ICE-88™ in-circuit emulator. Together they give you CPU emulation in real time, plus features like symbolic debugging, diagnostic commands and program trace capability. With these tools you'll get your products to market faster than by any other route.

Looking down the road

Best of all, with the iAPX 88, your investment in today's solution is protected. Since the 8088 is 100% object-code compatible with the 16-bit 8086—plus its future generations, the iAPX 186 and iAPX 286—you have the industry's only guaranteed headstart on the path to the future. Regardless of which language you're writing in.

So if you want to outdistance the pack, choose the iAPX 88—available today from your local Intel distributor. To get your copy of benchmark results, contact your local Intel sales office or distributor. For more information write Intel Corporation, 3065 Bowers Avenue, Santa Clara, CA 95051. Or call (408) 987-8080.

intel delivers solutions.

Europe: Intel International, Brussels, Belgium.
Japan: Intel Japan, Tokyo. United States and Canadian distributors: Alliance, Almac/Strom, Arrow Electronics, Avnet Electronics, Component Specialties, Hamilton/Avnet, Hamilton/Electro Sales, Harvey, Industrial Components, Pioneer, L.A. Varah, Wyle Distribution Group, Zenronics.

3870 momentum continues.

For single-chip applications, no other microcomputer family offers you more design momentum than the 3870 family from Mostek. Now there's even more momentum because eight new parts give you ROM and RAM options never before available. A total of 16 choices. You save by buying only what you need now, yet you'll also be designing in future flexibility.

That's because all our 3870 microcomputers are software compatible and basically pin-for-pin hardware compatible. So expansion or upgrading from 1K ROM to 4K ROM can be as easy as exchanging one 3870 device for another. In the same socket. There's no new architecture to learn. No retooling of artwork. No new vendors to qualify. In other words, there's no loss of design momentum.

This ongoing product line expansion is all part of our commitment and response to your unprecedented demand for Mostek 3870 microcomputers. A demand so strong for so many different applications that we literally ran out of 3870 numbers for all the variations you requested.

So to simplify identification of all our 3870 devices, we developed an expanded, easy to understand numbering system. In this system, the first four numbers designate three generic families: MK3870, MK3873, and MK3875. All three families have multiple combinations of ROM and RAM. The first slash number indicates the amount of ROM available in 1K byte increments; the second slash number identifies the amount of executable RAM in multiples of 32 bytes.

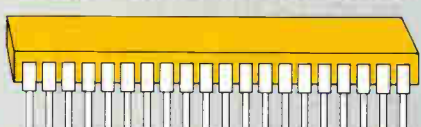
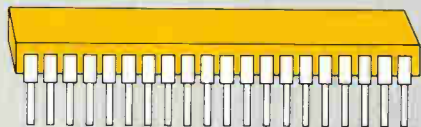
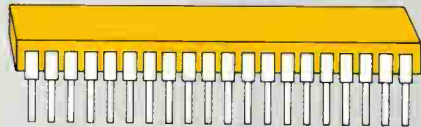
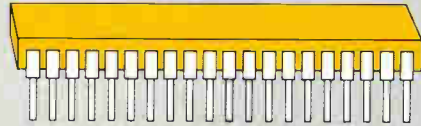
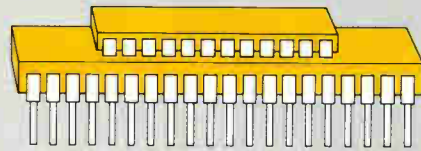

3870

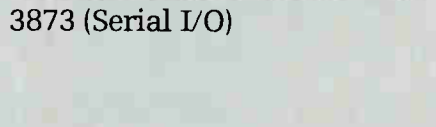
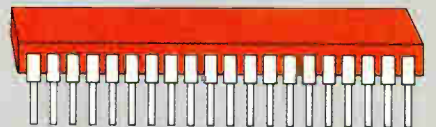
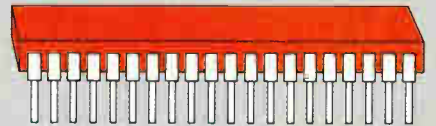
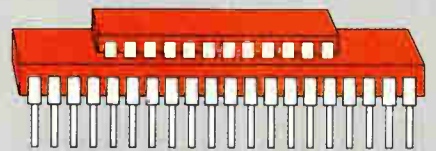

3873 (Serial I/O)

8 new ROM and RAM options give you 16 compatible single-chip choices.

MOSTEK

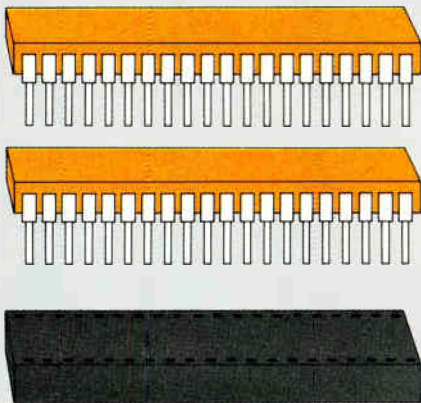

3875 (Battery Back-up)

Designation	ROM (bytes)	Executable RAM (bytes)	Parallel I/O (bits)	Special I/O	Old Part Number
MK3870-10	1K	0	32		• New
MK3870-12	1K	64	32		• New
MK3870-20	2K	0	32		MK3870
MK3870-22	2K	64	32		MK3876
MK3870-30	3K	0	32		• New
MK3870-32	3K	64	32		• New
MK3870-40	4K	0	32		• New
MK3870-42	4032	64	32		MK3872
MK3873-10	1K	0	29	SI, SO, SCLK	• New
MK3873-12	1K	64	29	SI, SO, SCLK	• New
MK3873-20	2K	0	29	SI, SO, SCLK	MK3873
MK3873-22	2K	64	29	SI, SO, SCLK	• New
MK3875-22	2K	64	30	V _{SB} , V _{BB}	MK3876-w Standby
MK3875-42	4032	64	30	V _{SB} , V _{BB}	MK3872-w Standby
MK38P70-02	External	64	32		MK3874
MK38P73-02	External	64	29	SI, SO, SCLK	MK38P73

387X/XX

Generic Part Type

Amount of ROM in 1K increments
 1 = 1K
 2 = 2K
 3 = 3K
 4 = 4K

Amount of executable RAM in 32 byte increments
 0 = 0
 2 = 64 bytes

Since all our 3870 devices have 64 bytes of scratchpad RAM, that portion of the memory isn't included in the part number.

The basic Mostek 3870 microcomputer family, with 32 bits (4 ports) of parallel I/O, presently has 8 versions. ROM options range from 1K to 4K bytes with an executable RAM option of 64 bytes.

The Mostek 3873 family has 29 bits (4 ports) of parallel I/O plus a hardware serial I/O port capable of handling either synchronous or asynchronous data transfers. Two different ROM versions are currently available, and executable RAM options are coming soon.

The MK3875 microcomputer family features 30 lines (4 ports) of parallel I/O and a standby power mode to protect the executable RAM during low-power situations. Both our 3875 versions have 64 bytes of executable RAM; ROM is 2048 bytes or 4032 bytes.

Unique to the entire 3870 line are our piggyback EPROM (P-PROM™) microcomputers. Designated MK38P70/02 and MK38P73/02, these devices let you prototype and field test your software programs prior to ordering masked-ROM versions. P-PROM microcomputers are also ideal as production circuits in low volume applications.

To simplify software as well, choose our Matrix™ floppy disk development system with real-time in-circuit emulation. The Matrix system can support our entire 3870 line, including low power CMOS versions now being developed.

Three basic 3870 families. EPROM versions. And comprehensive software tools to back it up. It all adds up to more momentum. The kind of momentum that can simplify your design, and extend your product life. To find out how, call or write Mostek Corporation, 1215 W. Crosby Road, Carrollton, Texas 75006; phone 214/323-1000. In Europe, contact Mostek Brussels; phone 660.69.24.

MOSTEK®, Matrix, MK3870, MK3873, MK3875, and P-PROM are trademarks of Mostek Corporation
 © 1980 Mostek Corporation.

Mepco/Electra's "Blue Chip" Tantalum Capacitors Plus...

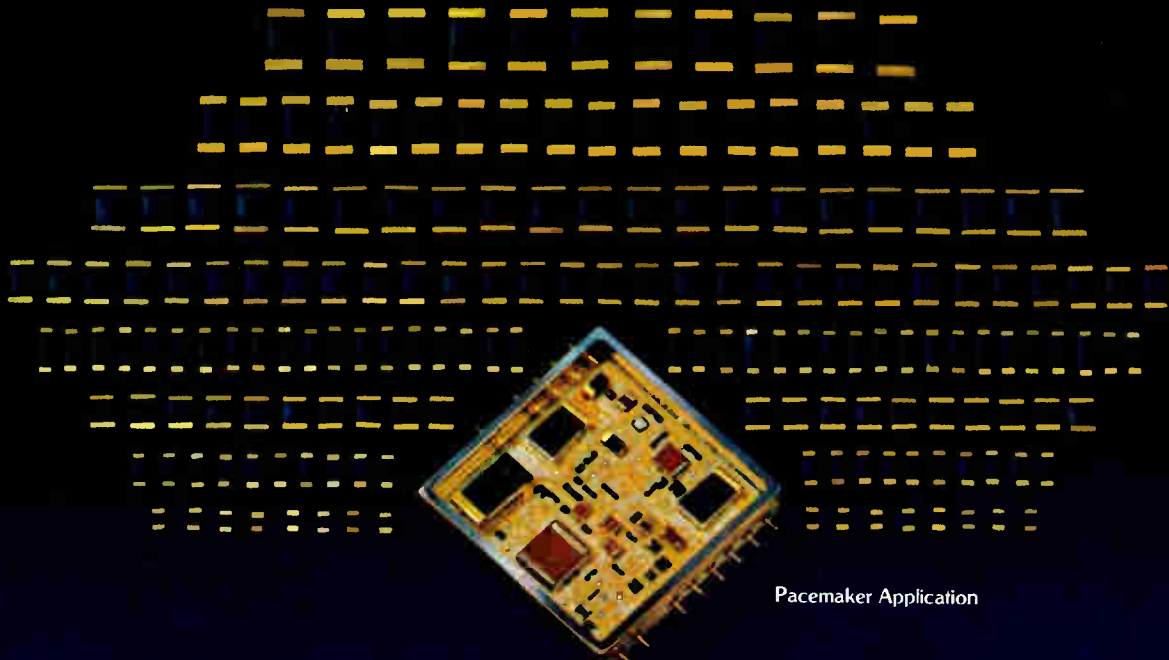

Pacemaker Application

From the company with the broadest range of capacitance, Mepco/Electra brings you complete Tantalum Capacitor coverage. Dipped, Solid, Wet Slug, Foil and State-of-the-Art, Series 49BC "Blue Chip" Tantalum Capacitors.

Our advanced technology allows us to offer you chip tantalum capacitors for military hybrid circuits and medical electronic applications.

"Blue Chip" Tantalum Capacitors With . . .

- Proprietary "Blue Seal" fluoropolymer coating provides high temperature protection and electrical insulation.
- Gold plated or solder dipped solid nickel terminations.
- Solder reflow, conductive adhesive, solder paste, thermo-compression or ultra-sonic wire bond mounting options.

- Max. volumetric efficiency: 100,000 $\mu\text{F V/in}^3$.
- Excellent shock resistance to thermal excursions: units available which meet Mil-Std 883, method 1011.1, condition "C".
- Qualification to Mil-C-55365/4 Style CWR-06 "R" failure rate.
- Eight body sizes from .050" x .050" x .100" to .110" x .150" x .285".
- A capacitance range of 0.1 μF to 100 μF .
- A voltage range of 4VDC to 50VDC.
- An operating temperature range of -55°C to $+125^\circ\text{C}$.
- Tolerance of $\pm 5\%$, $\pm 10\%$ and $\pm 20\%$.

"Blue Chip" Tantalum Capacitors backed up by tomorrow's technology today.

For your complete Chip Tantalum Capacitor needs, call (305) 842-3201.



Your resistor/capacitor company with the technology of the 80's edge.

Columbia Road, Morristown, New Jersey 07960 (201) 539-2000 TWX: 710/986/7437

Linearity scheme gives 8-bit converter 12-bit ability

A scheme to increase linearity statistically is squeezing 12 bits' worth out of an 8-bit analog-to-digital converter, reports Datel-Intersil Inc. The Mansfield, Mass., firm's ADC-881 successive-approximation a-d converter boasts nonlinearity of only 0.022 least significant bit, improving on typical 8-bit performance by a factor of 11.2. **It works by generating and applying pseudorandom codes to analog inputs, thus modifying each signal prior to conversion.** Linearity errors, therefore, occur at constantly changing points over the converter's full range instead of clustering around one unvarying transition point. Frequent sampling distributes errors so widely that nonlinearity appears as noise, which external averaging techniques can cancel out. Designed originally for medical imaging systems, the ADC-881 has a 1.3- μ s typical conversion time.

Software-driven CRT terminals adapt to user requirements

The first of a new series of video terminals will be delivered next month by Direct Inc., Sunnyvale, Calif. The VP 800/A uses a Z80A microprocessor and a combination of programmable read-only memory and random-access memory to let users configure it for operation with a variety of host computers, to emulate other terminals, to design custom character fonts, and to set the input/output rate. The unit holds 8- to 30-K bytes of RAM, of which only 2-K bytes are used for customization. Thus, unlike some terminals with more limited internal storage, **the 800/A can store from 3 to 40 pages, or screens, of data depending on display density.**

Base-priced at \$2,250, the 800/A will be followed before year's end by the \$2,550 800/B, optimized for text editing, and the 800/C, tailored to downline-loading applications and priced below \$3,000. Due early in 1981, the VP 900 desktop microcomputer system will use twin Z80As and dual 5-inch floppy disks and is aimed at what Direct spokesmen call distributed logic applications.

Mining monitor, control systems use landline and ulf transmissions

Two microcomputer-based monitor and control systems for use in underground coal mines are being delivered to the U. S. Bureau of Mines by developer Arthur D. Little Inc., Cambridge, Mass. One uses an ultralow-frequency carrier and long-wire antenna for "through the earth" propagation and communication at about 12 bits/second. The other operates at about 10 times that rate using a 16.3-kHz carrier superimposed on a mine's existing phone lines. Both use phase-modulated digital signals to transmit control signals to start and stop fans, pumps, and other equipment. Both also include sensors for air flow, carbon monoxide, and methane. **Flame and smoke sensors may come later in the program, which may represent a new direction for mining.**

Pascal compiler from Perkin Elmer handles 64 users

Perkin Elmer Corp.'s Computer Systems division, Oceanport, N. J., is introducing an optimizing Pascal compiler for use on its family of 32-bit minicomputers. **Up to 64 users can share access to the compiler for both development and testing; the optimized code also can be shared.** The license fee is \$5,250, with additional copies at \$525 each. The compiler conforms to ANSI-draft language standards, and language extensions include modular program development, separate compilation of Pascal procedures, easy access to external library routines written in Pascal, Fortran, or assembly language, and facilities providing access to executive service routines.

GI speech processor to house 256 sounds in ROM

General Instrument Corp. will be singing, talking, buzzing, and chirping at the Consumer Electronics Show in Las Vegas, Nev., next January. Its Hicksville, N. Y.-based Microelectronics Group plans to have a speech processor sounding off with up to 256 discrete sounds stored in on-board read-only memory. **Working in the frequency domain, the SP 0256 device produces waveforms controlled by data input at 80 to 2,000 bits/second.** External read-only memory will extend the device's vocabulary up to more than 3,000 utterances.

RAM and timer for COP boasts low power use

Can n-MOS microcontrollers operate at complementary-MOS power levels? Yes, says National Semiconductor Corp. Offered in proof: the new COP498 random-access memory and timer peripheral for its COP (control-oriented processor) microcontroller family, whose philosophy is to tie together multiple chips with a serial input/output system called Microwire. The new C-MOS chip **turns off power to its host n-MOS microcontroller during idle periods.** Volatile data is held in the peripheral's 64-by-4-bit memory until a preset time interval or external interrupt signals the chip to wake up the microcontroller and transfer back the stored data. The result, says National, is C-MOS power at n-MOS cost.

The COP498 is part of a line of processors and peripherals introduced by the Santa Clara, Calif., chip maker that includes low power n-MOS and C-MOS processors, display drivers, an analog-to-digital converter, and a counter-timer-frequency generator.

Addenda

Officials at Motorola Inc.'s Semiconductor Group in Phoenix decline to provide details but confirm statements made recently in Japan by Motorola vice president Alfred J. Stein that the firm **plans to build a semiconductor manufacturing plant there "within the next five years."** Texas Instruments Inc., Dallas, is currently the only U. S. company that manufactures semiconductors in Japan . . . National Semiconductor Corp. of Santa Clara, Calif., will build a 250,000 ft² semiconductor manufacturing plant in Arlington, Texas, **for production of bipolar devices using 5-in. wafers.** . . . U. S. semiconductor industry shipments rose 9% to \$2.17 billion in the second quarter of 1980. **It was the best quarter in the industry's history,** according to figures released by the Semiconductor Industry Association, Cupertino, Calif. Specifically, discrete semiconductors increased 1.7%, while IC shipments shot up 14.5%. . . Samuel N. Irwin, founder of Sycor Inc., which was sold to Northern Telecom Ltd. in 1978, **is starting a new venture to produce information-storage products** for small-business and personal computer original-equipment manufacturers. The company, called Irwin International, will have headquarters in Ann Arbor, Mich. Details of the first product are to be announced next month. It is to be a high-capacity, fast-access Winchester disk drive with fully integrated backup. . . As expected, **Richard Sanquini is leaving RCA Corp.'s Solid State division to become director of microprocessor operations at National Semiconductor Corp.,** Santa Clara, Calif. At the same time, Brent Welling has been promoted by National to director of microprocessor marketing. The two replace Howard Raphael and George Chow, who went to Cermetek Inc. of San Jose, Calif.

EMCS

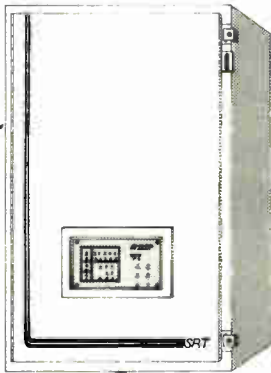
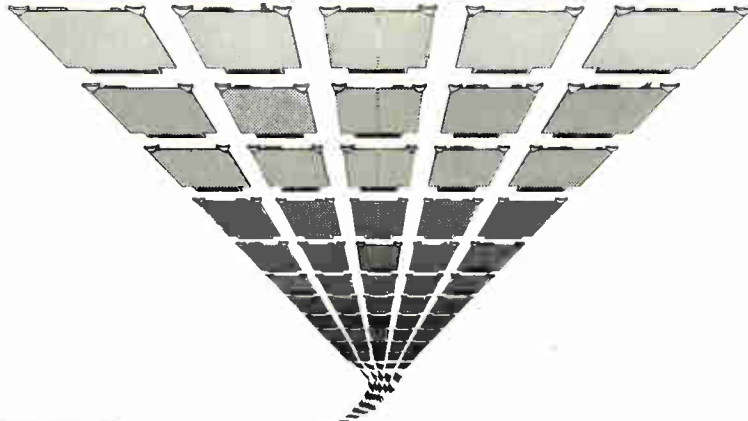

EcompTM
1802 OFF-THE-SHELF
Systems, Cards and Support Tools

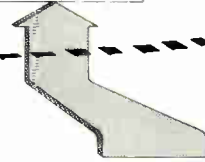
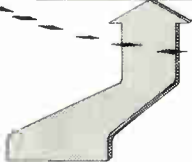
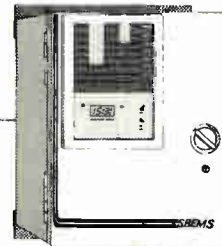

Smart Remote Terminal for Process Control

- TRI-SERVICES EMCS GUIDE SPEC. COMPLIANT
- MODULAR UP TO 384 CONTROL PTS. PER BOX
- DEVELOPMENT COMP. CAPABILITY
- MASTER/SLAVE CONFIGURATION
- HIGH LEVEL ROM BASED OPERATING SYSTEM

Single Building Energy Management System

32 CONTROLLABLE
LOAD CAPABILITY

TEMP, HUMIDITY and
other ANALOG INPUTS
for OVERRIDE
CAPABILITY

- FEATURES
- On-Off/Time of Day Control
- Duty Cycle
- Demand Limit
- Stand Alone Operation

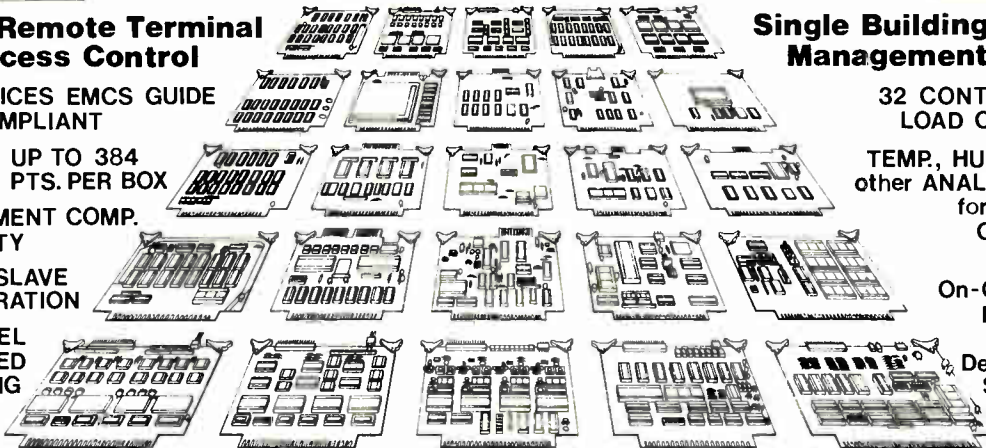

52 CARD FAMILY

EComp is a Division of Diversified Technology, Inc. / An Ergon Company / P.O. Box 465 / Ridgeland, MS 39157
Phone 601/856-4121 / TWX 810 966-2626 / Cable MMT JKS / TELEX 585326 / Cable ERGON INC JKS

OF COURSE YOU NEVER VOLTAGE CONVERTER.

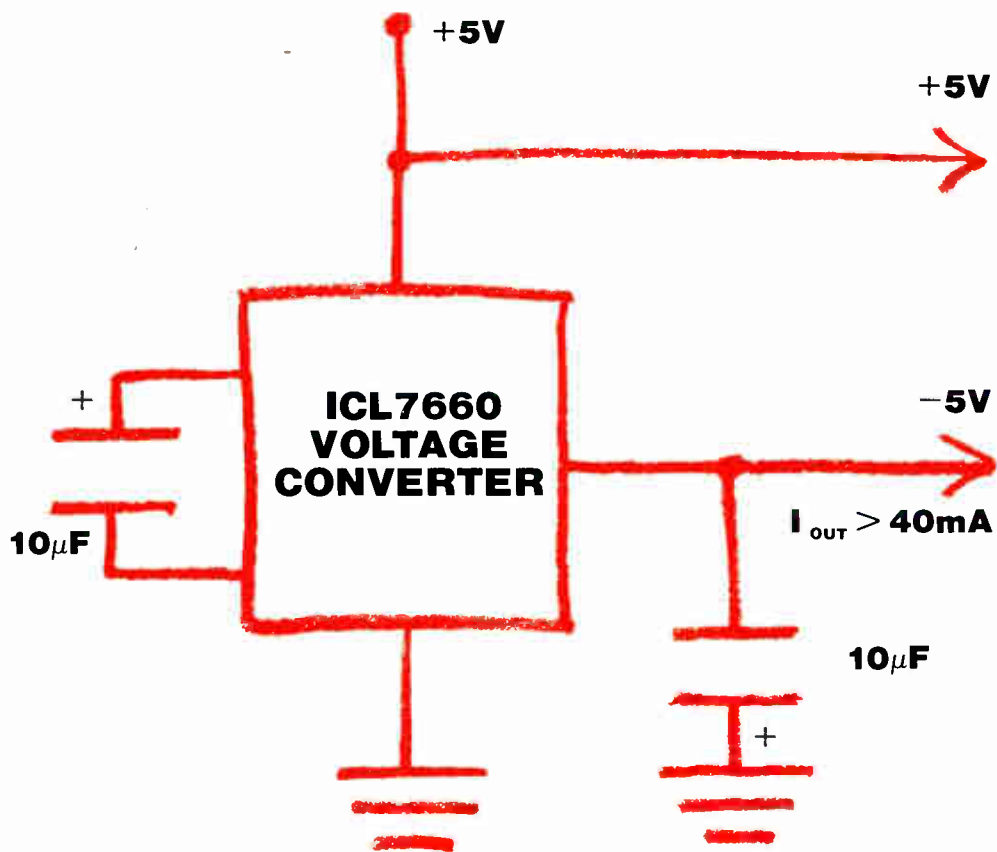

POWER CONVERSION EFFICIENCY -98% @ $R_L = 5\text{K}\Omega$



HEARD OF A MONOLITHIC WE JUST INVENTED IT.

+5V IN. -5V OUT.

Now, you can power your analog circuitry from your digital power supply. With a single chip. The ICL7660 monolithic voltage converter generates the negative voltages required by the analog functions in your system. Or, one ICL7660 provides -5V for a board-full of dynamic RAMs. +5V in. -5V out. Or, +1.5V to +10V in and -1.5V to -10V out. Require higher negative voltages? Cascade 7660's. Need more current? Just put 'em in parallel.

EFFICIENCY PLUS.

Intersil's MAXCMOS™ process brings you another first. A monolithic voltage converter with a voltage conversion efficiency of 99.9% ($R_L = \infty$). Power conversion efficiency of 98% ($R_L = 5K \Omega$). And I_{OUT} capability greater than 40mA ($R_{OUT} = 55 \Omega$). You simply can't beat it. Period.

NO MORE KLUGES.

One chip and two caps. Put 'em wherever you need 'em. And the ICL7660 virtually eliminates EMI problems caused by inductive converters.

GOOD NEWS.

- Monolithic
- Short circuit protection
- Latch-up proof
- 1.5 to 10V operation
- Direct parallelling for more output current
- Operates in simple voltage multipliers:

$$V_{OUT} = -nV_{IN}$$

MORE GOOD NEWS.

The ICL7660 monolithic voltage converter costs just \$1.95 in lots of 100 (8-pin epoxy DIP). Be sure to ask for quantity prices.

THE SYSTEMS APPROACH.

The Intersil MAXCMOS™ process, coupled with our broad experience in data acquisition

products, has led to a continuing series of high performance, low-power analog and data conversion products. Analog products that operate from a $\pm 5V$ supply. And now, a monolithic voltage converter that powers analog functions from your digital supply.

MORE INFORMATION?

Call your Intersil Sales Office, Franchised Distributor, or return the coupon below. The ICL7660 is available now. In prototyping or production quantities.

INTERASIL SALES OFFICES:

CALIFORNIA: Sunnyvale (408) 744-0618, Long Beach (213) 436-9261 • COLORADO: Aurora (303) 750-7004 • FLORIDA: Hollywood (305) 920-2442 • ILLINOIS: Hinsdale (312) 986-5303 • MASSACHUSETTS: Lexington (617) 861-6220 • MINNESOTA: Minneapolis (612) 925-1844 • NEW JERSEY: Englewood Cliffs (201) 567-5585 • OHIO: Miamisburg (513) 866-7328 • TEXAS: Dallas (214) 369-6916 • CANADA: Brampton, Ontario (416) 457-1014

INTERASIL FRANCHISED DISTRIBUTORS:

Advent (IN, IA) • Alliance • Anthem • Arrow • Bell Industries • Cardinal • CESCO • Component Specialties • Components Plus • Diplomat (FL, MD, NJ, UT) • Harvey (upstate NY) • Kierulff • LCOMP • Newark • Panda • Parrott • R.A.E. Ind. Elect. Ltd. • RESCO/Raleigh • Schweber • Summit • Western Microtechnology Sales • Wyle • Zentronics

INTERASIL

ANALOG PRODUCTS—
LINEAR CIRCUITS
10710 No. Tantau Ave., Cupertino, CA 95014
Tel: (408) 996-5000 TWX: 910-338-0171

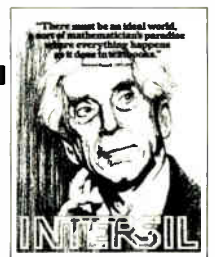

Gentlemen: +5V in and -5V out? Monolithic?
Send me the details on your ICL7660.

____ While you're at it, send me your 20" x 24" Bertrand Russell poster.

Name _____
Company _____
Address _____
City _____ State _____ Zip _____
Phone _____

Spend less. Test more.

Integrated circuits are very private devices. When something goes wrong, they just don't work. Which is tough enough when part or all of *one* IC goes bad. But often worse, because a single bad IC usually means a large, complex system that won't function properly.

Until now, you could spend a lot of money and time — and still only be guessing what was happening at any point in a logic system.



Logic Probe LP-1. Captures pulses as fast as 50 nanoseconds, to 10MHz. Latching memory. Bargain-priced at only \$50.00*

We put troubleshooting at your fingertips. Now, there's a quicker, surer, less expensive way to get the information you need. Our multi-family Logic Probes. Their LEDs light to show you at a glance the logic state at any point — and more. Catch fast pulses, even store them if you like. A flashing light signals pulse trains. And you can even approximate the duty cycle of asymmetrical waveforms.

Nothing could be simpler. No complex

settings, no sync, no wait. A switch selects the proper logic family. The probes derive their



Logic Probe LP-2. All the basic features of LP-1, with pulses as fast as 300 nanoseconds, to 1.5MHz. Doesn't have LP-1's memory feature . . . but features even lower price: \$28.00*!

power from the circuit under test. High input impedance prevents circuit loading. And all you do is touch the tip to any pin, pad or path for an instant picture of circuit conditions.

Laboratory quality. Economy price.

High speed. High precision. Even memory. Our Logic Probes deliver all the performance you need for design, development, debugging and servicing. Making digital work less of a chore, more of a bargain.



Logic Probe LP-3. Five times the speed of LP-1 at less than twice the price. Captures pulses as narrow as 10 nanoseconds, to over 50MHz. Latching memory. The new value standard, at \$77.00*.

Smarter tools for testing and design.

70 Fulton Terr. New Haven, CT 06509 (203) 624-3103. TWX 710-465-1227
OTHER OFFICES: San Francisco (415) 421-8872, TWX 910-372-7992
Europe: Phone Saffron-Walden 0799-21682, TLX 817477
Canada: Len Finkler Ltd., Downsview, Ontario

**GLOBAL
SPECIALTIES
CORPORATION**

Call toll-free for details
1-800-243-6077
During business hours

*Suggested U.S. resale Prices. specifications subject to change without notice. © Copyright 1980 Global Specialties Corporation.

Supercomputer design goes faster, but is smaller, cheaper

by Martin Marshall, West Coast Computers & Instruments Editor

Livermor lab plans a compact machine that can be ganged together for multiprocessing

Supercomputers: the label conjures up machines that are faster, bigger and costlier than ordinary mainframes—but not if the researchers on the S-1 project at the Lawrence Livermore Laboratory succeed. They envision a supercomputer faster than the present generation, but much smaller and cheaper.

Their S-1 Mark IIA uniprocessor (at left in the photograph) is the key element in a 16-processor system with over 10 times the power of the industry benchmark, the Cray 1. Yet the system could cost at least a million dollars less than the \$7 million price tag of a typical Cray-1.

Signal processing. The Mark IIA uniprocessor can function on its own and has an architecture and instruction set oriented to signal processing. It will operate at rates up to 400 million floating-point operations (megaflops) per second. "In signal-processing applications, the Mark IIA uniprocessor can operate about four times faster than a Cray-1, whereas in a typical scientific instruction mix, it is about equal to a Cray-1," notes Mike Farmwald, the arithmetic unit designer.

The object of the S-1 project is not a commercial product, but to demonstrate a cost-effective way of building the next generation of supercomputers. The design may then go to a commercial computer maker, and the Livermore lab's funding source,

the U.S. Navy, will use the Mark IIA hardware to provide the benchmarks needed for future computer developments.

The Livermore, Calif., lab is using its Scald computer-aided-design program [*Electronics*, July 31, p. 75] for the S-1 project. It began with the Mark I processor, which is slightly less powerful than a Control Data Corp. 7600-series computer.

The Mark IIA hardware incorporates the latest 100,000-series emitter-coupled-logic circuitry. These chips are denser than earlier 100K ICs and account for a power consumption a thirtieth that of the Cray-1 and for some of the speed.

The principal factors in the speed of the Mark IIA are the signal processing instruction set and hardware

and the inclusion of memory in the central processing unit. The Mark IIA has 700 kilobytes of 1-K and 4-K ECL random-access memory used for cache, control store, input/output, and registers.

Multiprocessor. Due to be powered up for the first time this fall, the uniprocessor should cost around \$300,000 to manufacture. In its multiprocessor configuration, it will be combined with other Mark IIAs and two fully redundant crossbar switching modules that will allow teaming processors for a single task or partitioning them for multiple tasks.

Each uniprocessor will be able to draw on its own 80-kilobyte cache memory as well as upon the system's main memory, implemented in cost-effective MOS circuitry and with a

Superduper. Livermore lab's S-1 project began with the Mark I mainframe and is at the Mark IIA supercomputer stage. Next will be a much smaller Mark IIA in a box: the Mark III.

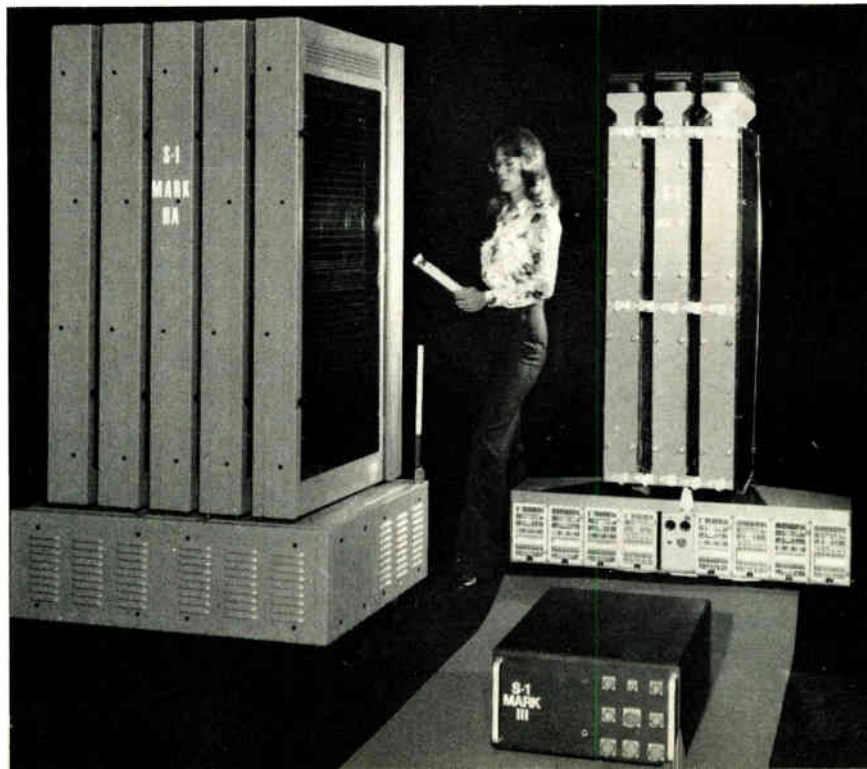

staggering 16-gigabyte maximum capacity. The crossbar switch will have a maximum peak bandwidth of more than 10 billion bits per second when all 16 channels are transferring data simultaneously.

The 16-by-16 crossbar contains a mixture of 10,000-series and 100K circuitry. There are two of them because "the Navy likes reliable systems, and this ensures it," observes Tom McWilliams, technical director of the S-1 project.

Others. Though the Mark IIA is an impressive step over present supercomputers, it is unlikely to be alone for long. CDC has already announced its ECL-based Cyber 205, claiming a maximum speed of 800 megaflops per minute—but the system has yet to be tested against benchmarks. Also, Cray Research is working on the Cray-2, sure to offer significantly better performance than its present machine.

However, the Livermore researchers are not resting on their laurels. As the photograph shows, plans are afoot to condense the Mark IIA to the size of a microwave oven.

"The Mark III, which would implement this, is only a shell at present," observes L. Curtis Widdoes, Scald project leader. "A working prototype is at least a couple of years away." It would be used on the Navy's ships for applications in high-speed signal processing and in fire control.

Photovoltaics

Amorphous silicon is 6.2% efficient

Even as Arco Solar Inc. jumps to the forefront in production of conventional photovoltaic cells, it is reporting encouraging test results on amorphous silicon cells: 6.2% conversion efficiency. The amorphous cells are the first supplied by Energy Conversion Devices Inc. under a \$25 million contract signed early this year.

The conversion rating gives amorphous cells "extremely high potential for low-cost cells," says J. W. (Bill) Yerkes, Arco Solar president. Although Yerkes will not discuss results in detail, a Department of Energy scientist familiar with the work agrees. "The whole thing is going rather well," he says.

Sticking point. Amorphous cells, with their random molecular structure, should be cheaper to make than the conventional single-crystal solar cells. The sticking point is getting them to a break-even conversion efficiency of 8%. However, the DOE scientist thinks reaching 8% to 10% efficiencies is possible in the next few years.

He does note that there are key differences between the ECD amorphous work and that of the pioneer-

ing Solid State division of RCA Corp., still the leader in the field. Though efficiencies are about the same, cell sizes are not. "RCA is reporting on 1.2 square centimeters, and ECD, 4.2 square millimeters," he says.

RCA is employing a p-i-n (p-type, intrinsic, n-type) junction and ECD uses a Schottky barrier junction. The latter approach has problems with device stability and reproduction of the 2-to-40-angstrom-thick oxide layer over a large area.

RCA encountered these problems with similar units in 1977. Though efficiencies got up to 5.5%, the Schottky barrier structure was abandoned in favor of the p-i-n junction. According to David E. Carlson, head of photovoltaic device research at RCAs' Sarnoff Laboratories, "we think it has a better chance of making it."

Interest in the Arco-ECD contract is high, both because it is the biggest non-Government photovoltaic award and because ECD's amorphous research and development program has run into a legal controversy [*Electronics*, July 31, p. 40]. In addition, industry officials have expressed skepticism about ECD's claims because the company has kept results of its photovoltaic work close to its vest.

At ECD, Richard A. Flasck, manager of semiconductor and memory products, reports that its newest

Fast scope uses Josephson junctions

Capable of measuring signals as small as 120 microvolts, an experimental system using superconducting lead-alloy Josephson tunnel junctions (the small circle in the center of the photograph) is being tested at IBM's Thomas J. Watson Research Center, Yorktown Heights, N. Y. Essentially a sampling oscilloscope, it is designed to reproduce the waveforms of repetitive signals and display them on a screen or strip-chart recorder.

The present resolution of the cryogenic system is 6 picoseconds, compared with 25 ps for the best commercially available room-temperature sampling scopes, according to IBM. The researchers believe the resolution could be pushed into the subpicosecond realm by reducing the capacitance of the Josephson junctions or by using a superconducting electrode material with a higher transition temperature in the junctions.

The technique could be used to investigate the dynamic properties of Josephson junctions themselves. It might also be extended to measurement of non-electrical signals, including optical signals, because the Josephson devices are sensitive to them.

-Pamela Hamilton

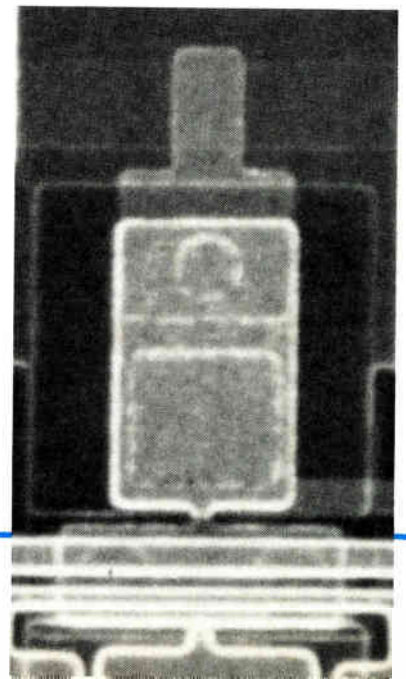

solar cells have reached an efficiency of 6.3%. The silicon cell's composition includes hydrogen and fluorine, he says.

In the field of single-crystal cells, Arco Solar has designed and built a new photovoltaic production facility that may be the most highly automated in the business. Located in Camarillo, Calif., some 35 miles west of the company's Chatsworth headquarters, by the end of the year it will be turning out enough solar cell modules each year to generate a total of 1 megawatt. Others at about this level are long-time industry leader Solarex and fast-growing Solar Power, owned by Exxon Corp.

Arco Solar itself is a subsidiary of oil industry behemoth Atlantic Richfield Co., which has spared little effort to go to the forefront of the business. Of its total investments, Yerkes will only say, "the \$25 million is the tip of the iceberg."

Pace. Besides the parent company's financial backing, Yerkes offers another explanation for Arco Solar's fast pace. "We base our strategy on the fact that photovoltaics are not semiconductors. There's no longer any question that they are really a materials-handling problem." Photovoltaic circuitry is extremely simple, he says, especially compared with integrated circuits.

Yerkes says the major expense of making solar cells is moving the 4-inch wafers from point to point on the production line. So Arco engineers concentrated on mechanization of production flow.

Some semiconductor production equipment is used, but is improved in

speed. "If they move 200 parts an hour, it's good, but we have to move 10 times that fast," Yerkes says.

Arco Solar has come up with other improvements to speed production. Among them are a silk-screen process for printing contacts on thick-film layers and an automated testing system that characterizes all cell parameters. **-Larry Waller**

Production

Lasers help terminate flexible circuits

That electro-optical wunderkind, the laser, is solving the termination problem that has long bedeviled flexible printed wiring. The Westinghouse Defense and Electronic Systems Center is using two types of lasers to provide high-speed, reliable, and low-cost termination of the flexible circuitry.

Consisting of flat copper conductors on a flexible film, the flexible circuitry is considered an elegant interconnection technique because it can be compressed into small spaces or even bent around corners. Despite the lack of a completely satisfactory termination method, it is used in consumer products like cameras, calculators, and miniature radios.

The Westinghouse technique, which was developed under U.S. Army sponsorship, also appears to extend to these consumer applications. The systems center has designed a highly automated production line, in which the keystone is the

application of the two lasers (see figure below).

The first step in Flexicon, as the center is calling it, is the removal of insulation from the circuit's copper leads by a carbon dioxide laser. This laser use has been known for some time [*Electronics*, Sept. 16, 1976, p. 50], although it apparently has not been widely used. As well as eliminating direct mechanical contact with the circuitry, it permits narrow widths of insulation to be stripped cleanly.

Laser. Westinghouse is using a 150-watt carbon dioxide continuous-wave laser, with a two-axis numerically controlled table moving the circuit through the beam. The 10.6-micrometer wavelength is absorbed by the Kapton insulation and reflected by the circuit's copper conductors, giving selective stripping.

Then a 400-w neodymium-yttrium-aluminum-garnet pulsed laser welds the 20-mil-wide conductors to flat or rectangular connector pins on 50-mil centers. As with the stripping operation, this step is suited to microprocessor control.

Visual inspection of the welds, using a microscope, easily picks out faults. A cathode-ray-tube display monitors the wave shape and duration of the laser pulse, because these parameters are directly related to the laser's output power.

Encapsulated. The final step in the Flexicon process is encapsulation of the welds. Westinghouse is using its own injection-molded epoxy/anhydride compound. The entire process will be described at the 13th Annual Connector Symposium, Oct.

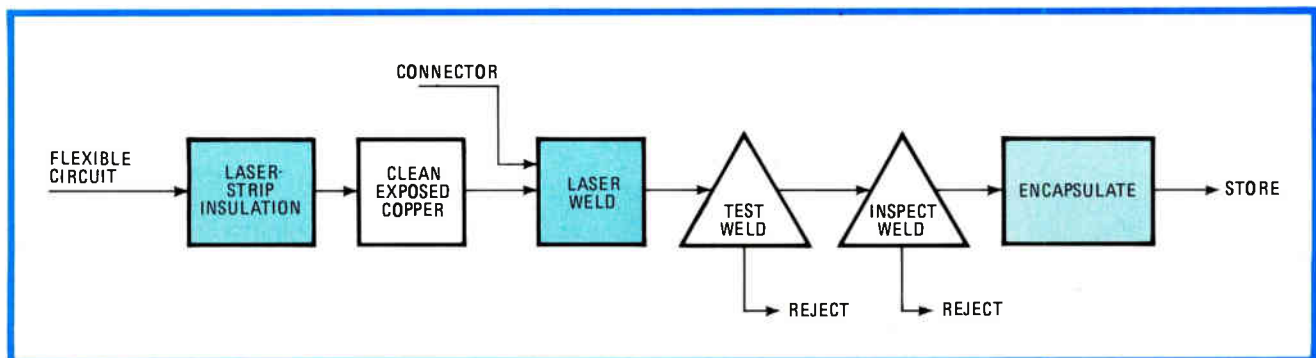

Light up. In Westinghouse's Flexicon process, a carbon dioxide laser strips insulation and a neodymium-yttrium-aluminum-garnet laser welds flexible-circuit conductors to the connector pins. The termination is then encapsulated in an epoxy/anhydride compound.

8-9, in Philadelphia. The systems center has completed design of a full automated Flexicon line with the capacity of 4,500 assemblies per 8-hour shift.

James A. Henderson, fellow engineer for mechanical design at Westinghouse, estimates 4 minutes of labor per assembled connector pair versus 3 man hours of labor with present techniques. Thus he anticipates one sixth the production costs.

Westinghouse is already applying the new termination technique to some of its own programs, such as the Aquila drone, an advanced airborne radar, and an electronic warfare pod. Since Flexicon's development was funded by the Federal government, information on the technique will be made generally available.

-Jerry Lyman

Computer-aided design

Single TRW program checks VLSI chips

Working to bring computer-aided design into the VLSI era, TRW Inc. has come up with a CAD program checking the design of very large-scale integrated circuits. Bringing together in one program the routines that had to be run separately offers much faster design turnaround.

DRCCCL-3D, a program written at the Microelectronics Center of TRW's Defense and Space Systems Group, Redondo Beach, Calif., has successfully checked chip designs having 30,000 devices and can handle much higher densities.

Many processes. So far, it has been used primarily with TRW's triple-diffusion bipolar process, but it has worked with epitaxial bipolar and charge-coupled ICs. When used with MOS circuitry, it can calculate parasitics, which has been a difficult CAD chore.

"It allows complete checking of VLSI circuits with complete confidence," says James G. Peterson, staff engineer for design, methodology, and architecture at the microelectronics center. He notes that the

firm considers the DRCCCL-3D proprietary, and so he will not discuss full details.

Implemented on a Control Data Corp. Cyber 175 mainframe in about 10,000 lines of Pascal, the program is available through Aplicon CAD units to designers at the microelectronics center and at the nearby El Segundo headquarters of the Commercial Semiconductor division, LSI Products. Essentially, the designer transmits a digitized description of an entire IC, or part of it, to the Cyber 175; input time ranges from 5 to 30 minutes, depending on the designer's skill.

The DRCCCL-3D takes over, often needing only a few minutes of machine time to start printing results. These deal with the usual design-rule checks of layout geometry and spacing, including underlapping and overlapping, which require much more sophistication and computing power for VLSI than for LSI.

The program also finds and checks interconnections, often a source of error. It locates all devices and characterizes their performance down to specific resistor values.

Modular. Its modular organization makes it easily adaptable to new VLSI design approaches, since only the necessary modules need to be changed. For example, says Peterson, it is easily adaptable at the logic or mask level to hierarchical architecture [*Electronics*, June 10, p. 58].

Underscoring the significance of the software package are the comments of Hewlett-Packard Corp.'s top CAD official. "Linkage is extremely important. By themselves, the parts are too difficult," says Merrill W. Brooksby, manager of HP's corporate design aids.

At HP, programs that perform the same steps as DRCCCL-3D operate separately. Some are in Pascal, and more will be soon.

Also important in a unified program is a setup such as TRW's that lets data be stored for easy retrieval. HP is also working towards such a unified system, Brooksby says.

There are several key factors that made the package possible, according to TRW's Peterson. Foremost is

the use of Pascal, "which makes a big difference because of its efficiency," he says. Also, Pascal implementation gives DRCCCL-3D portability, as well as adaptability to different semiconductor processes.

A second factor is the Cyber 175. This mainframe has the capacity to handle the entire package, whereas the minicomputers that run most CAD programs lack the speed and power to deal with the details of VLSI circuitry.

-Larry Waller

Components

Metal wrap drops power-device costs

By developing a new metalization technique for the carriers of high-frequency power transistors, Communications Transistor Corp. has come up with a line of high-power devices that can operate at as high as 500 megahertz yet can be packaged in a conventional TO-220 plastic case. Thus, the company claims, the cost is about half that of the typical high-frequency, high-power transistor, which is packaged in a copper-ceramic case.

The more expensive case has been needed, the company says, because a plastic-packaged high-frequency power transistor is limited in output power to about 10 watts at frequencies of 30 MHz and higher. Paradoxically, that limitation stems from the grounding of the transistor's emitter lead, desirable for higher output-power levels. The lead's inductances and parasitic capacitances increase with higher frequencies and lead length, so output suffers.

Dispute. The 10-w limitation is disputed by Motorola Semiconductor Products Inc., which offers plastic-encased 12-volt transistors that work at up to 175 MHz with outputs of 30 w. Still, the 500-MHz capability of Communication Transistors' new line is truly impressive, acknowledges Alan Wagstaffe, Motorola's planner for high-frequency products in Phoenix.

Key to the San Carlos, Calif.,

There's a powerful new source in the electronic fuse market.



We're Gould Shawmut®, and we've been making fuses exclusively for the electrical industry since 1893.

In fact, we manufactured the wire for the first fuse invented by Thomas Edison. In more recent history we introduced the first complete line of low voltage current limiting fuses in America. The first single element time delay fuse, the first miniature 1000 volt fuse for Nautilus class atomic submarine service and much more. Our leadership in fuse technology is recognized throughout the electrical industry.

Now we're extending our expertise into the electronics industry, so you have an alternative source: A new line of miniature fuses for low voltage, over-current protection. In stock. Ready for immediate

delivery. And made by Gould Shawmut.

You'll be hearing a lot from us in the future. For more information about our glass and miniature fuses write: Gould Inc., Electric Fuse Division, Newburyport, MA 01950.

Tel: (617) 462-6662, 462-3131/Telex: 94-7427.

In Canada: 406 Adelaide St., E., Toronto, Ontario M5A 1N4.

Tel: (416) 366-1981/Telex: 06-219717.

 **GOULD**
An Electrical/Electronics Company



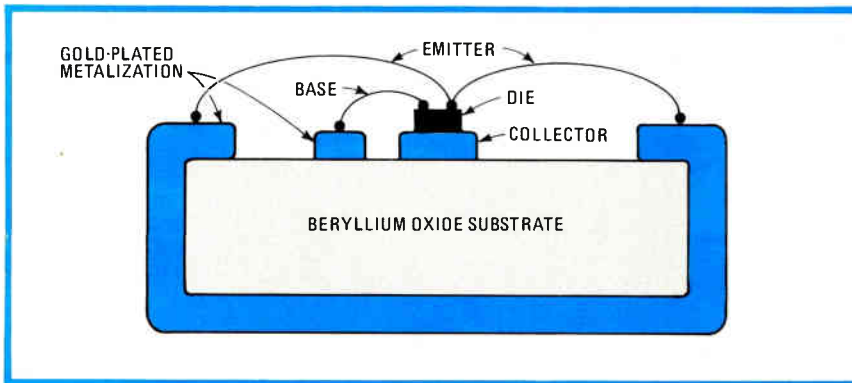

Added layer. A metalization layer wrapped around a ceramic chip-carrier facilitates the use of low-cost plastic packages for high-frequency, high-power transistors.

company's scheme is the wrapping of a gold-plated tungsten metalization layer around the usual beryllium-oxide substrate of the chip carrier (see figure). The relatively short distance between the edges of the metalization and the transistor die permits shorter emitter leads. To complete the ground, the metalization layer is connected to the TO-220 package's heat-sink tab.

This new structure can support transistors with 30-w output power at 500 MHz, says Mark Burkett, mobile product engineer for Communications Transistor. A 12-v transistor with a 30-w output exhibits a gain of 13 to 14 decibels at 50 MHz, compared with 10 to 11 dB for a typical device in a copper-ceramic case, claims Dave Wisherd, vice president for land mobile and microwave products.

Gain. The company says its tests have shown that its new transistors retain these power-gain advantages at higher frequencies, although by smaller margins: $\frac{1}{2}$ dB better at 175 MHz, for example. However, Wisherd says, these higher-frequency conventional devices use more expensive exotic-metal cases.

A typical unit price for the new line is \$5.55 for the 500-MHz, 10-w CP10-12 with a 5.2-dB gain. A comparable ceramic-encased part costs almost \$15.

Although the firm is looking to manufacturers of the 12-v land mobile radios for its first market, it foresees even bigger sales in dielectric heating applications. For example, a clothes dryer wastes much of

its heat, and one of the new power transistors can supply heat at a frequency determined by the clothes being dried (the dielectric). With a microprocessor-based control, there can be much more efficient use of energy.

-Roger Allan

Production

Stitch wiring adapts to standard boards

Stitch wiring, the highly reliable semiautomatic technique, is entering its third generation in a development that adapts it to conventional copper-clad printed-circuit boards with plated-through holes. The third-generation system, called Presterm, offers even better reliability, claims Larry R. Conley, president of Interconnection Technology Inc., Huntington Beach, Calif.

With Presterm, low-profile stainless-steel pins are press-fitted into the plated-through holes and the wires are welded to them. The pins extend only 20 to 90 mils above or below a board, giving almost as low a profile as did the second-generation stitch wiring, but without the special steel-clad pc boards the latter requires.

The basis of stitch wiring when it first appeared in the early 1970s was welding insulated nickel wires to a

Low profile. Presterm has two pin types to which the wires are stitched: socket (top) component mounting and solid (bottom).

matrix of gold-plated stainless-steel pins staked into a pc board. It was soon applied to many avionic and space electronic systems where its welded connections proved extremely reliable.

Earlier. Still in use in military and aerospace applications, it evolved into a lower-profile, higher-density method. In this second generation, the same type of wire is welded to pads selectively etched from a laminate clad in stainless steel [*Electronics*, Jan. 18, 1979, p. 133].

In the original process, the steel pins must be first nickel- and then gold-plated for soldering to pc traces. Both plating thicknesses must be tightly controlled for good solderability and for a good weld of the stitched wire. Presterm boards eliminate plating by using a gas-tight press-fit connection for its pins, and this should improve reliability.

In the second-generation system, a high-current welding pulse passes directly through the plated-through hole and could damage the plating. In the Presterm configuration, the current pulse passes directly through the pin, not through the hole, contributing to reliability.

Conley points out that the press-fit principle has been successfully

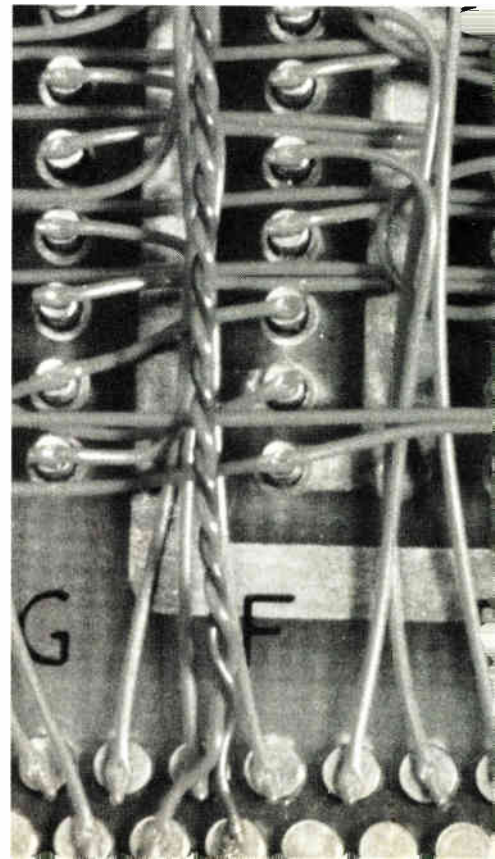

A FLIP OF THE SWITCH CONVERTS FROM 115V (U) TO 230V (VDE)

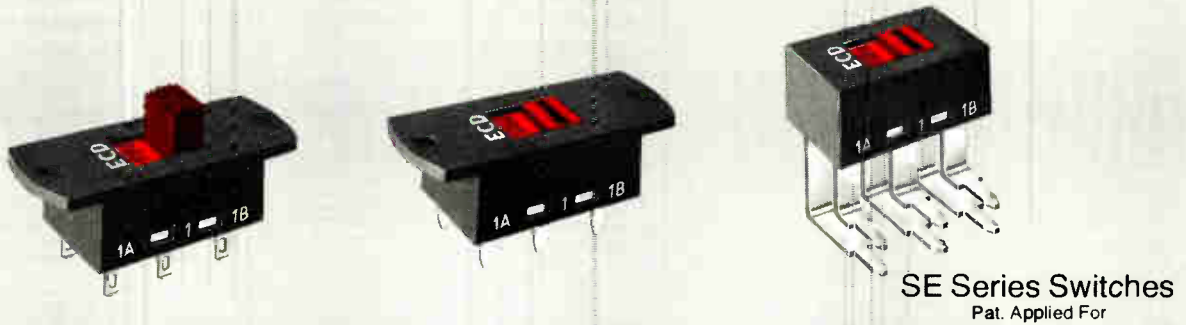

THE ALL AMERICAN SWITCH WITH **UL AND VDE** **APPROVAL**

SHELF STOCKED FOR IMMEDIATE DELIVERY!

Designed to meet the needs of manufacturers throughout the world, these sophisticated switches are designed to meet requirements of UL, VDE, CEE, CSA, SEMKO and DEMKO.

This new series offers a choice of actuation either by screwdriver slot or raised handle, available with a wide variety of terminal styles.

Contact Walt Dinneen, Switch Product Manager
For Engineering Information & Sample



Electro-Components Division

2713 Gateway Drive, Pompano Beach, Florida 33060
Tel.: 305/973-8620 TWX: 510/956-9400

See it At Our Booth #1631



Western Electronic Show and Convention
Anaheim Convention Center
Anaheim, CA
September 16, 17, 18, 1980

AMF Electro-Components Division manufactures RCL Resistors, Delay Lines, Switches & UID Switches

applied to backplanes since the 1960s by companies like Elfab, Methode, Teradyne, and others. He decided to apply this highly reliable technique to stitch wiring in 1978, and the result was Presterm.

As the photograph on page 44 shows, there are two pin types. One is solid and the other is a socket for insertion of component leads on one side and welded wire on the other.

The solid pin is stainless steel, pressed into a hole 0.041 inch in diameter with a wiring surface extending 20 mils out from the

board. The cost is about 4¢ per pin.

For higher board densities, there is the 7.5¢ socket pin, comprising a stainless steel shell with a nickel- and gold-plated beryllium-copper spring clip and fitting into a 0.056-in. hole. The actual thickness of the Presterm system's wiring layer is about 125 mils, with the pin body extending 90 mils out from the board. This configuration is similar to the socket pins used for Wire-Wrap terminals, and it also resembles Augat's widely used Holtite pins.

-Jerry Lyman

Components

TI turns out n-MOS operational amplifiers with p-doped well in epitaxial layer

Bringing MOS operational amplifiers into competition with bipolar op amps for jobs in single-supply systems, Texas Instruments Inc. has come up with a technique that allows the building of n-channel parts. The

new technique, with a p-doped well in an n-type epitaxial layer, overcomes process contamination and noise that have hobbled the development of practical n-MOS op amps.

The goal is worth pursuing be-

cause the n-channel parts can operate from either negative or positive collector supplies referenced to ground, where a p-channel op amp requires two power lines. In the p-MOS part, the input field-effect transistor requires a voltage, usually from a negative supply line.

P-well isolation. In the new structure (part b of the figure), the p well isolates the n-type epitaxial layer from the p-implanted top gate and n-implanted channel. The conventional op amp structure (part a) has an n-implanted top gate and p-implanted channel.

TI has not disclosed details of its new manufacturing process [*Electronics*, Aug. 14, p. 36]. However, a spokesman will say that the implantation is being performed by equipment bringing to bear "quite a bit more energy than conventional ion implanters."

Eliminating the second power-supply line improves the common-mode power-supply range for low-level input signals, says Dale Pippenger, linear integrated-circuit applications manager for the Dallas firm. "Many temperature and pressure sensors, for example, are powered by a positive potential with respect to ground," he explains.

"The low-level outputs of these sensors must typically stay within at least 1.5 volts of the usual +15- and -15-v supply lines used to power most conventional p-channel FET-input op amps. Thus the sensor signal range was from -13.5 to +13.5 V, and any signals beyond these limits were clipped by the op amp. With the new op amps, the negative supply line can now be a zero reference line, allowing the input signal to gain an additional 1.5 V of common-mode signal range."

-Roger Allan

Single supply. A p-channel field-effect transistor for op amp (a) requires negative and positive supply lines; an n-channel device (b) needs only one, referenced to ground.

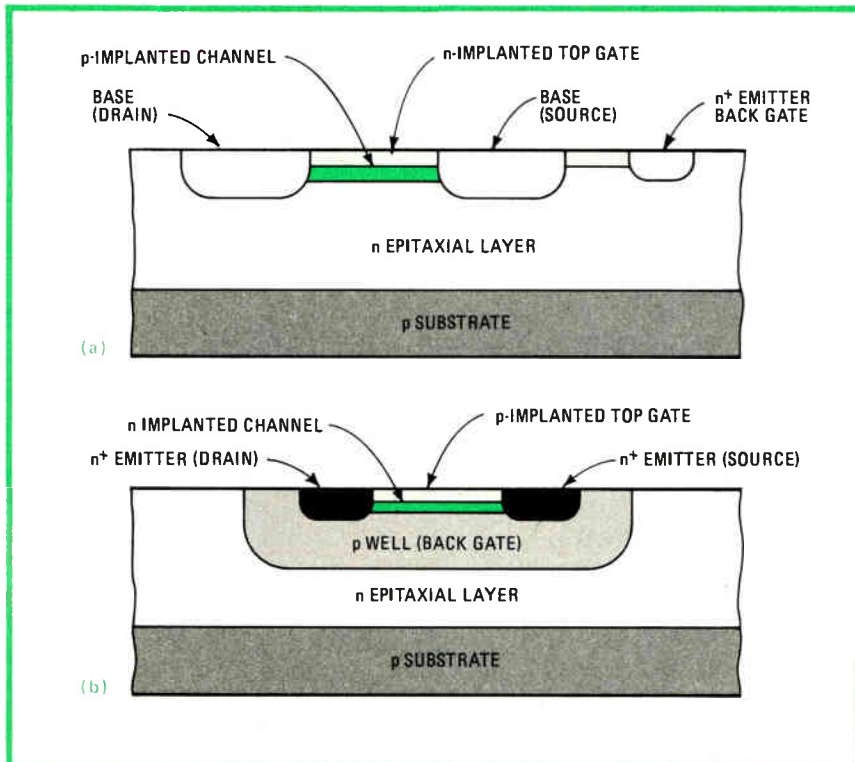

Government

Minicomputer buys outstrip mainframes'

Digital Equipment Corp.'s share of the 14,333 computers installed in 55 Federal agencies stands at more than

LCD DRIVERS

FOCUS HUGHES EXPERIENCE ON YOUR PROGRAM.

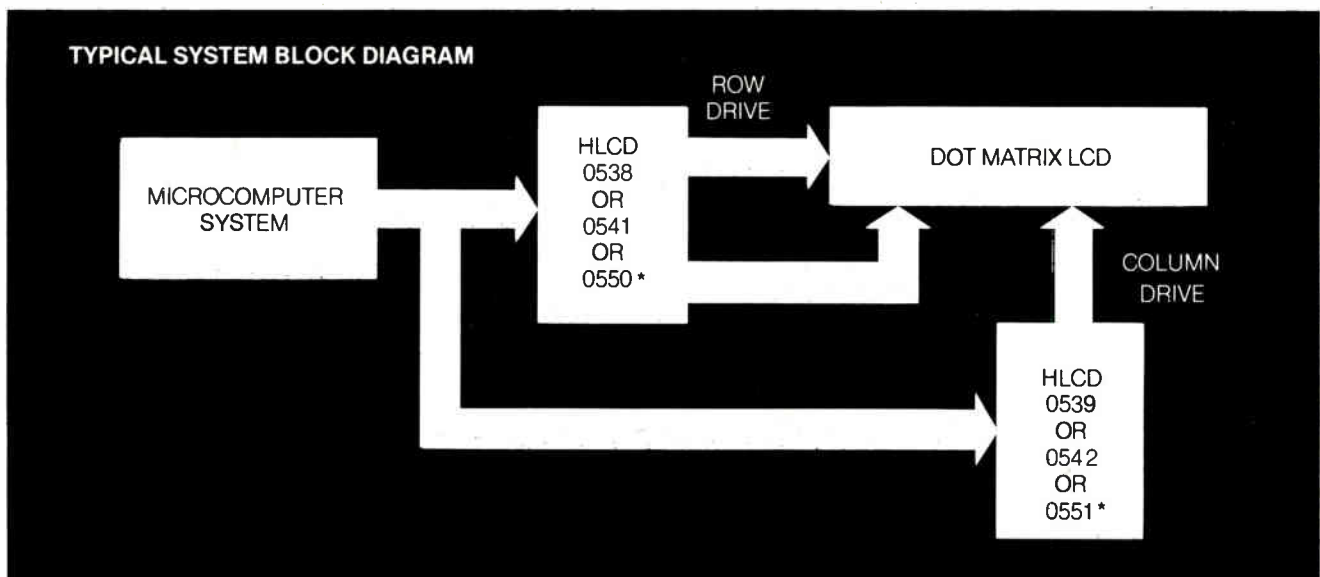

As the first source in LCD Drivers, Hughes-Solid State Products delivers millions of Drivers for products ranging from complex computer chess games to digital volt meters. Hughes standard products drive multiplexed arrays and custom displays, as well as 7 segment numerics. The Drivers are all CMOS and include oscillators, precision voltage dividers, and dual rank latches. Naturally, these circuits are cascadable and microcomputer compatible.

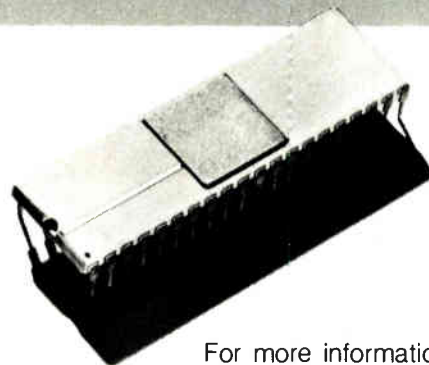

For more information on the only complete line of LCD Drivers, call or write:

DRIVER	CAPABILITY
HLCD 0550/1*	Up to 32 characters, 5 x 7 Dot Matrix. Includes character encode and refresh
HLCD 0541/2 } HLCD 0538/9 }	5 x 7 Dot Matrix or 8 row array with arbitrary number of columns, serial or parallel input
HLCD 0540	Up to 32 x 32 array, 2 circuits required
HLCD 0548	Up to 16 x 16 array
HLCD 0438A	Any LCD, multiplexed or parallel drive, regardless of size
HLCD 0437	4 digit, 7 segment



HUGHES AIRCRAFT COMPANY
SOLID STATE PRODUCTS DIVISION

500 Superior Avenue, D80
Newport Beach, California 92663
(800) 854-3515 or (714) 759-2942

*3 Q, 1980

25%, while International Business Machines Corp.'s share has slipped to 9%. These figures reflect the Government's turn to small computers for its management needs.

"That [turn] represents a complete reversal of the situation a decade ago," says one General Services Administration analyst. He cites 1970 data showing that IBM computers represented 26.4% of the 5,277 Federal installations, with DEC holding a 9.5% share.

The GSA's latest 905-page inventory of Federal management computers at the end of fiscal 1979 ranks Sperry Univac in second place. However, its 12.4% market continues to decline from the 22.7% level of a decade earlier, as makers of small computers bite off bigger chunks of the market each year.

Univac still leads the industry in military installations with 1,200 machines, nearly 68% of its Federal total. But the company has also been gaining in the proportion of small computers it sells to agencies; 887 of its installations are priced in the Government's lowest category.

Some 9,531 of the Government's computers—or two-thirds of its inventory—cost \$50,000 or less, according to the GSA's Automated Data and Telecommunications Service, which controls agency purchases of all computers except those used in weapons systems.

Energy tops. The biggest computer buyer among the civilian agencies is the Department of Energy, whose 3,390 installations—half of them by DEC—put it far ahead of the second-place National Aeronautics and Space Administration with 1,862. No other individual agency's inventory comes close to the 500 mark except for the military, whose 12 user agencies operate a total of 6,498 machines.

Like the military and space agency users, the DOE needs smaller computers for special management tasks. Thus these agencies are prime targets for the manufacturers of minis.

Hewlett-Packard Co., for example, has 1,093 computers in the Federal inventory for a 7.6% share. HP's Government sales tripled over the

News briefs

New gear boosts IC makers productivity

Photoresist processing, projection and direct-stepping alignment, dry etching, ion implantation, and new deposition technologies are "major contributors to improved productivity and yield" within the U. S. semiconductor industry, according to a profile developed by market researcher Dataquest Inc. Howard Z. Bogert, director of technology for the Cupertino, Calif., firm's semiconductor industry service, says that although the new equipment is complex and expensive, it is proving to be cost-effective. As one example from the 130-page industry analysis, Bogert notes the impact on costs of new projection printing systems on photomasking. "While initially costly compared to older contact printers, they reduce mask costs per wafer to below the \$1 level," compared with \$4 to \$5 for contact printers, he says.

Boschert lightens load . . .

Relinquishing the day-to-day running of the switching supply company he founded, Robert J. Boschert has stepped down as president and chief executive officer of Boschert Inc., Sunnyvale, Calif. Taking his place will be Raymond J. Noorda, most recently with System Industries Inc., Sunnyvale, as president and CEO, and previously president and CEO of General Automation Inc. in Anaheim. Boschert will continue as chairman of the board of directors and as vice president of engineering.

. . . Amdahl, Madden sever ties with Amdahl Corp.

Gene M. Amdahl has resigned as consultant and chairman emeritus of the Sunnyvale, Calif., company he founded on leaving IBM 10 years ago. His intent is to found a new company to design a high-performance mainframe to address the IBM marketplace and the scientifically oriented marketplace, according to Clifford J. Madden, Amdahl Corp.'s senior vice president and chief financial officer, who will become president of the new venture.

Apple plans to go public

Expecting to generate capital in excess of \$20 million, Apple Computer Inc., Cupertino, Calif., has registered its intent with the Securities and Exchange Commission to file for a public offering of common stock. An undetermined number of shares will be offered by the company and present shareholders, including some its senior managers. Apple needs the capital to help finance its ambitious expansion plans, which include new manufacturing plants in Texas, Ireland, and Japan.

HP forms Business Computer Group

Sporting the first Hewlett-Packard division dedicated to software, HP's new Business Computer Group contains three divisions that were formerly efforts within the General Systems division. The new Cupertino, Calif., group includes a redefined General Systems division, which will develop small computers, including the HP 250, for the business market. It also includes the newly formed Computer Systems division, which will take over responsibility for the HP 3000 computer systems hardware and operating systems. The new Information Systems division will develop business software tools, such as commercial languages and data-base management programs. It will also be responsible for the HP 300 small-business computer.

Synergy seen for Burroughs, software house hookup

The proposed acquisition of System Development Corp. by Burroughs Corp. for \$98 million, announced earlier this month, is seen by industry observers as a boon for both. Computer manufacturer Burroughs gets one of the last major independent software houses (with annual sales of \$168 million) at a time when program-writing capability is in short supply. Also, some 40% of the firm's business is from long-term government contracts—a desirable market for Burroughs. For its part, the Santa Monica, Calif., systems development firm obtains dependable financial backing while it is attempting to bring out its first hardware lines.

NATIONAL ANTHEM

SEMICONDUCTOR NEWS FROM THE PRACTICAL WIZARDS OF SILICON VALLEY.

MST™ weeds out system failures in dynamic RAMs.

MEMORY SYSTEM TEST PROGRAM CUTS OEM TESTING TIME BY 50-90%.



CMOS
microcontroller
enhances
COPS™ Family

Low-cost
references for
12-bit systems

The Custom
MOS/LSI
solution

TO-237s
last up to
8 times longer
than TO-5s

Practical
Series/80
innovations

Free
literature—
details inside

Data Acquisition	Logic	Transistors	Hybrids	Linear	Interface	Bubble Memory
RAMs/ROMs/PROMs	Transducers	Microprocessors	Displays	Custom Circuits	Circuits	Optoelectronics
Memory Boards	Microprocessors	Development Systems	Microcomputers	Modules		

NATIONAL ANTHEM

National's TO-237 puts heat on ice.

TO-237 transistors run cooler to last up to eight times longer than metal cans. Yet they cost 40% less.

The Practical Wizards from National Semiconductor are offering a refreshing alternative to the TO-5 and TO-39 transistors: the pin-compatible TO-237†.

The TO-237 transistor is encased in National's patented Epoxy B* plastic.

But the key to the TO-237's cool disposition is an exclusive combination of the Epoxy B used in conjunction with an efficient heat dissipating thermal tab. The result, as shown in the graph, is a reliable workhorse component that can last 8 times longer than the cans (at 0.5W dissipation).

National sorts them out. The TO-237s are currently available off-the-shelf in 65 standard part types and pin configurations. However, should a special selection be required, National would be more than willing to supply it.

This kind of design and production versatility

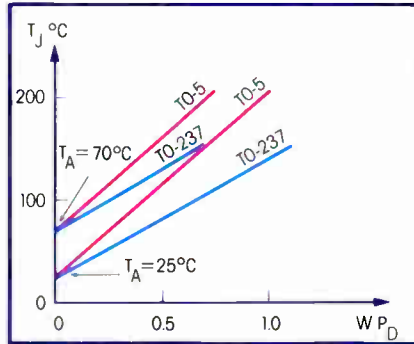

comes from over 20 years in the transistor business. So it's no surprise that only National can offer this cool, low-cost alternative to metal can transistors.

For additional information about the Epoxy B transistors, be sure to check this issue's National Archives coupon or contact your local distributor or National sales rep. ☐



*U.S. Patent Number 3838094.
†NSC originally applied for JEDEC package registration (1979)

Low-cost precision references for 12-bit systems.

National guarantees the long term stability of their LH0070 and LH0071 references for one full year.

National Semiconductor, the leader in linear technology, is offering their LH0070 and LH0071 buffered voltage references to designers of precision 12-bit D/A and A/D systems.

The LH0070 has a 10.000V nominal output for BCD applications. The LH0071 provides a stable 10.240V reference for binary applications. These low-cost, totally self-contained components also feature:

- 12.5V to 40V input voltage range.
- ±0.05% output accuracy (T_A = 25°C).
- ±0.05%/year long term stability.
- ±0.04% output voltage change with temperature.
- operates over -55°C to +125°C range.
- mil. std. 883 level B processing available.

Both of these precision references are actively laser trimmed using ultra-stable thin film resistors. In fact, National actually guarantees the long term stability of the LH0070 and LH0071 for one full year.

Check this issue's coupon for the Special Functions Data Book and a free LH0070/71 data sheet. ☐

COP420C CMOS microcontroller features programmable power optimization.

CMOS microcontroller, with software controllable idle modes, consumes as little as 36μW.

National's COP420C is the CMOS member of their COPS™ Family of single-chip microcontrollers. This device features the family's lowest power dissipation (50μW typical), lowest operating voltage (2.4V), 1K x 8 ROM, 64 x 4 RAM and 23 I/O lines on chip.

Also, a MICROWIRE™ compatible port allows the COP420C to interface to the COPS Family's wide range of peripheral chips, including display drivers, A/Ds, memories and more.

Using power-saving idle modes, the COP420C software can dynamically alter the controller's speed of operation.

and power consumption to more closely fit the various needs of the application. So useful work can be done at any power level – even while idling.

The COP420C (also available in an extended temperature version called the COP320C) utilizes the family's high-efficiency instruction set. The simpler task-oriented COPS instructions not only take up less memory space, they also accomplish each task in less time than do other single-chip microcontrollers.

The COPS Family offers controllers in any combination of CPU sizes (.5K to 2K ROM; 32 x 4 to 128 x 4 RAM). Fabrication technologies (high-speed NMOS, lower-power NMOS as well as the ultralow-power CMOS). A broad 2.4V to 9.5V voltage range. Standard (0°C to 70°C) and extended (-40°C to

+85°C) temperature ranges. Mask selectable I/O characteristics. Even a MICROBUS™ option.

This family approach therefore results in significant cost savings in three ways. First, the engineer can apply all of the knowledge he has gained using any single COPS device to any application addressable by the entire COPS Family. Second, the entire family is supported by a single product development system (the COP400-PDS). And third, COPS devices provide the lowest cost microcontroller solution to your application problems.

For complete information on the COP420C CMOS microcontroller and the entire COPS Family, check this Anthem's coupon. ☐

COPS, MICROBUS, and MICROWIRE are trademarks of National Semiconductor Corporation.



MST™ cuts OEM testing time by 50-90%.

National's exclusive Memory System Test program exercises dynamic RAMs for up to four hours in a 9 megabyte system environment to weed out system failures that component level testing can't catch.

When it comes to dynamic RAMs, the OEM testing cycle is far and away the most time-consuming aspect of producing memory boards.

This costly cycle typically lasts anywhere from 2-6 months. Whether performed by an independent test laboratory or by the OEM himself, every dynamic RAM that comes in the door must pass a variety of inspections, burn-ins and rechecks, plus board and system level tests before any finished product goes out the door.

National Semiconductor, with their exclusive Memory System Test (MST) program*, considerably reduces OEM testing time for dynamic RAMs. In fact, MST can cut this time by 50-90%. Which translates directly into lower testing and inventory costs.

An order of magnitude reduction in system errors. When a customer requests MST processing, every dynamic RAM he receives undergoes a rigorous sequence of board and system level tests in addition to National's routinely stringent component level tests.

By testing the RAMs for up to four hours in a 9 megabyte system, MST weeds out those parts that pass the individual component tests yet experience one or more system failures when placed in a



system environment.

The result is an order of magnitude reduction in system bugs due to noise, alpha particles or marginality.

MST increases the reliability of each RAM shipment by providing parts that

have already operated in a system environment to accomplish burn-in and checks for early life failures plus board level testing over the 25°C to 70°C temperature range.

The Memory System Testing sequence. After passing the component level test, each MST-specified dynamic RAM is loaded onto a 72-unit memory storage card. The MST program tests 64 storage cards at a time, performing the following sequence of tests.

- initial functional test at 25°C.
- accelerated dynamic burn-in to weed out early life failures.
- Memory System Test (up to 4 hours at extreme operating conditions).
- MST continues for an additional hour while the system cools to 25°C.
- storage cards removed; parts with one or more logged errors are separated from the good parts.

All remaining RAMs must then undergo National's standard final test and quality assurance test prior to shipment. The Practical Wizards currently have the capacity to Memory System Test over 3 million 16K dynamic RAMs per month.

The bottom line, of course, is that National's MST program saves the OEM both time and money spent on costly test equipment and independent labs. Simply because MST yields dynamic RAMs of unsurpassed system quality at a lower cost.

For additional information on MST and National's complete line of RAM products – including a Reliability News Brief on Alpha Particle test results – be sure to check this issue's coupon.

*Pat. Pending.

MST is a trademark of National Semiconductor Corporation.

"National Custom MOS/LSI came through with the most advanced keyboard encoder chip of its time!"

"As a leading supplier of solid state keyboard units, Cortron first found a need for sophisticated signal encoder electronics way back in 1972. But at the time, the semiconductor industry had no standard offerings that satisfied our cost/performance requirements.

"So we turned to National's Custom MOS/LSI group for a solution – and found one. National's solution was to design and build the most advanced chip of its kind: a signal encoder that greatly enhanced the flexibility of our keyboards while reducing their dependence on the host processor.

"National Custom MOS/LSI clearly has

the technical and production expertise to develop such sophisticated solutions. But more than that, they're extremely easy to do business with. They worked very closely with our own engineers and kept us fully informed every step of the way.

"So far, Cortron has gone to National for four Custom MOS/LSI components. And in every case, National came through with highly advanced cost-effective solutions backed by good solid service."

Keith Engstrom
Engineering Manager CORTRON
A Division of Illinois Tool Works, Inc.



Draw from the industry's largest selection of microcomputer boards.

National offers the broadest line of practical Series/80 board level computer products that feature functional design, reliable operation and easy availability.

When it comes to selecting board level computer products, it never pays to gamble on boards that don't easily lend themselves to practical application.

This is precisely why National offers over 75 MULTIBUS™ compatible Series/80 products. Because the Practical Wizards believe that no product should have to be forced into an application.

And although many customers come to National for plug-compatible replacements for SBC products, their Series/80 BLC line is hardly just a second source supply.

In fact, a full two-thirds of their Series/80 Family is made up of proprietary products, including CPUs, memories, controllers, analog and digital I/Os, peripheral controllers, rack-mounted systems, a full complement of card cages, power supplies, cables and other accessories.

And each one features high reliability, functionality of design, and the longest warranty coverage in the business.

The depth and range of the Series/80 product line can best be illustrated by examining just a few of its members.

The BLC-8222 Double Density Floppy Disc Controller can handle up to four dual-

or single-sided drives (either standard or mini). It features CRC error checking with programmed re-try, user definable sector sizes and switch selectable base addresses that allow multiple controller systems.

The BLC-8737 Analog I/O board with 12-bit resolution makes each input and output channel appear to be a RAM address. On-board logic eliminates the need for the system CPU to drive the analog circuitry through its conversions. Its 16 single-ended (8 differential) input channels are easily expandable to twice that capacity.

The BLC-8715 Intelligent Analog I/O board was specifically designed for industrial and process control systems. This new product offloads all of the analog data processing and many of the control functions normally performed by the host CPU.

And in doing so, the CPU may then devote more of its valuable resources to the rest of the control system.

Check this issue's National Archives coupon for free literature on these and all of the practical Series/80 products from National Semiconductor.

With the strength of the industry's broadest selection to choose from, you can't go wrong.

MULTIBUS is a trademark of Intel Corporation.

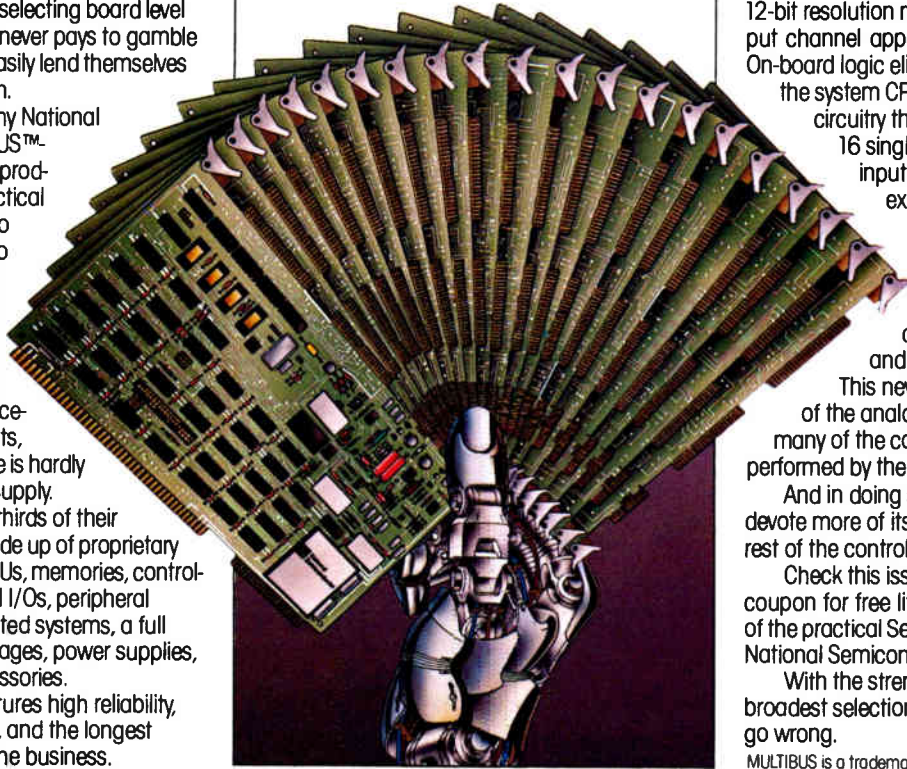

What's new from the National Archives?

- | | | |
|--|---|---|
| 005 <input type="checkbox"/> Additional Custom MOS/LSI Information | 036 <input type="checkbox"/> Optoelectronics Handbook (\$3.00) | 045 <input type="checkbox"/> 1980 Data Book Package (4 books; \$20.00)*
qty. _____ |
| 006 <input type="checkbox"/> Special Functions Data Book (\$6.00) | 037 <input type="checkbox"/> Additional STARPLEX and ISE Information | 047 <input type="checkbox"/> 1980 Linear/Data Acquisition Data Book Package (2 books; \$10.00)*
qty. _____ |
| 015 <input type="checkbox"/> MST Program Brochure and Additional Information | 041 <input type="checkbox"/> LH0070/71 Data Sheet | TOTAL \$ _____ |
| 028 <input type="checkbox"/> Additional COPS Family Information | 042 <input type="checkbox"/> TO-237 Transistor Data Sheets and Additional Information | |
| 035 <input type="checkbox"/> Additional Series/80 Information | 043 <input type="checkbox"/> Memory Data Book (\$6.00) | |
| | 044 <input type="checkbox"/> 1980 Linear Data Book only (\$6.00)*
qty. _____ | |

*Special offer: prices effective until September 1, 1980

For desired information, mail coupon to:
National Semiconductor Corporation
2900 Semiconductor Drive
Mail Stop 16250
Santo Clara, California 95051

In Europe, mail coupon to:
National Semiconductor GmbH
Industriestrasse 10
D-8080 Fürstenfeldbruck
West Germany

Enclose check or money order based upon appropriate currency. Make checks payable to National Semiconductor. Allow 4-6 weeks for delivery. This coupon expires on November 30, 1980.

NAME _____ TITLE _____
 COMPANY _____ PHONE _____
 ADDRESS _____
 CITY _____ STATE _____ ZIP _____

 **National Semiconductor**
The Practical Wizards
of Silicon Valley

Electronics review

past five years, the most dramatic gain by any producer.

Nearly three-quarters of HP's computers fall into the \$50,000-or-less category, and its total installations are about equally split between civilian and military agencies. The DOE is its largest single customer with 272 machines, although the Navy is not far behind with 235.

Data General Corp. comes hard on the heels of HP as a Federal supplier. Its 1,052 installations—90% of them priced at \$50,000 or less for special management applications—give it 7.3% of the Federal market, nearly double five years ago.

Rising. Modular Computer Systems Inc. is another fast-rising newcomer, according to the GSA. Modcomp, not even ranked five years ago, has 4.1% of the market with 588 installations, 60% of them in

NASA and another 23% in the DOE.

As the Government turns toward smaller, less costly machines for special single applications, the GSA says it sees other significant trends. "The number of vendors is growing substantially as users buy more minis with separate peripheral equipment from different vendors, adding peripherals later as they need them," says the GSA analyst, citing the agency's list of 332 contractors for computers and peripherals.

A second trend is the decline in computer leasing overall, with most users buying less expensive systems to meet special requirements, limiting leasing to large-scale general management systems. "But even there the proportion of computers being purchased is rising as the popularity of leasing declines," he points out. **-Ray Connolly**

Communications

PBX takes text and voice messages; some operations need no operator

A giant step toward the intelligent private branch exchange is in the final development stages at BNR Inc., the Mountain View, Calif., arm of Canada's Northern Telecom Ltd. The new system, called VIMS for voice-text integrated message system, is essentially a software package for a PBX that lets callers leave or receive text and voice messages.

The current setup handles text messages: if the caller has a terminal and the person calls a terminal or printer, messages can be left directly. The caller can also leave messages with the VIMS operator, who will enter them into the system's data base.

Next. Voice storage is not quite as far along. "We still need to settle upon a very dense storage medium, such as video disks or existing computer disks using compressed, digitized voice data," says Geoffrey Archibald, who is BNR's manager of office systems software development.

"We also need to work further on automatically synthesizing voice

from stored text," he says. The goal for this is speech compressed by a factor of 10.

BNR emphasizes that the voice messages are not simply tape recordings but will be compressed for random access from a disk. An important selling point, the firm believes, will be the ability of a user to leave a message for an expected caller, who can receive it later through the VIMS operator.

Indicator. For operations sliding slowly into the office of the future, the system can be set up so that call recipients have a simple neon light indicating that he or she has messages. Such an indicator is already part of handsets connected to the SL-1 PBX, for which VIMS was designed.

The company has been using its own offices for tests and has found it useful to have both a VIMS and a PBX operator. "We've found that one operator can handle up to 50 extensions, providing services that seem to the outside caller like that of a per-

NEW LONG

SCREEN PRINTING MACHINE

In 30 years as the leading manufacturer, we have developed from our own technology a complete line of over 20 standard models. Our production total of more than 5,000 units gives us a 70% share of the Japanese market, the most competitive and demanding in the world. If our present models do not fill your needs, tell us your requirements. Our engineering department can meet any challenge.

Automatic Precision Screen Printing Machine MODEL: LS-15GT

SPECIFICATIONS

- Printing size: 6 × 6 in.
(150 × 150m/m)
- Screen frame: 12.6 × 12.6 in.
(320 × 320m/m)
- Squeegee stroke: 2~8 in.
(50~200m/m)
(variable speed)
- Squeegee speed: 0~4 in./sec.
(0~100m/m/sec.)

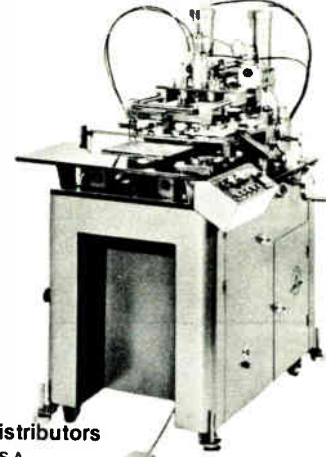

Distributors

U.S.A.

The Christopher Group
23342 South Pointe Drive Unit D
Laguna Hills Ca. 92653 U.S.A.
Phone: 714-581-7491 Telex: 9105952462

EUROPE & W. GERMANY

Gunze Düsseldorf GMBH
4, Düsseldorf Königsallee W. Germany
Phone: 0211-80271-2 Telex: 8587450

HONG KONG

Kong King Trading Co., Ltd.
Wongs Industrial Bldg., 6/FL., 42 Hung To Rd.,
Kwun Tong, Kowloon, Hong Kong.
Phone: 3-450111 Telex: 36810

Manufacturer:



NEW LONG

NEW LONG SEIMITSU KOGYO CO., LTD.

4-6, NISHIGOTANDA, 7-CHOME, SHINAGAWA-KU
TOKYO 141, JAPAN
PHONE: (03) 492-7571 TELEX: 2466040 NEWLON J

A Quality DIP Production Socket For Pennies!

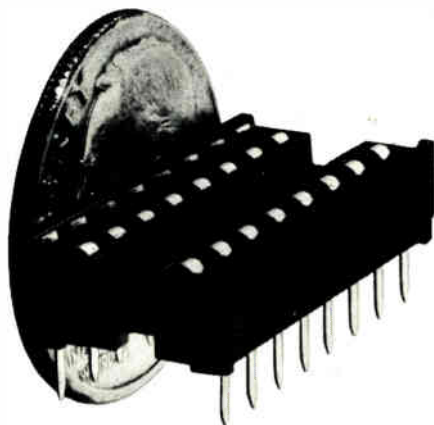

Now... all the features you asked for in a production socket from a proven leader in test/burn-in sockets.

Our 802 "Lo-Rise™" DIP Socket offers many high performance features at a very affordable price. "Metal-to-metal-to-metal" face wipe contacts provide a positive conductive path and easy entry... a low insertion force of only 39.91 grams per pin. Extraction force is higher... 72.90 grams to resist shock and vibration. Four corner standoffs and open frame construction simplifies P.C. board cleaning. Closed bottom eliminates solder wicking, prevents solder contamination of contact area. Orientation groove designed for use with all standard automatic insertion machines.

All sizes from 8- to 40-pins with any one of three contact platings. Tin-plated phosphor bronze, tin-plated beryllium copper or gold-plated beryllium copper. Glass-filled polyester body meets UL 94V-O Spec.

Our "802" Socket is a total package of recognized Welcon socket reliability. From the time of ordering to delivery date we'll meet your special needs. We're customer oriented. Give us a call—219/287-5941 or telex 25-8325—and discover just how responsive a company can be.

Welcon™

Wells Electronics Inc., 1701 So. Main, So. Bend, IN 46613 U.S.A.

Circle 54 on reader service card

DUAL, FACE WIPING CONTACTS



"Metal-to-metal-to-metal" contacts. For easy entry and positive conduction.

CLOSED BOTTOM



Top loaded contact. Press-fit into housing prevents solder wicking.

WIDE TARGET AREA



Dual-sided contacts, ramped in. Handles splayed leads or off-center insertion.

LOW INSERTION FORCE



Only 39.91 grams per pin. High extraction force of 72.90 grams for excellent I/C retention.

OPEN FRAME CONSTRUCTION



Allows for easy P.C. board cleaning and trace observation or repair.

END AND SIDE STACKABLE

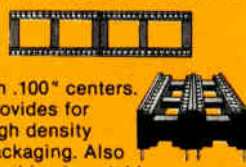

On .100" centers. Provides for high density packaging. Also machine insertable.

Electronics review

sonal secretary," observes Lee Talbert, BNR's director of advanced business systems.

Next year. When the prototype becomes a full-speed production model, the operator may be able to handle as many as 75 individual extensions, he says. It should be ready for commercial introduction next year.

Though there are other voice-plus-data systems announced, ENR states its development is the "first intimate connection of an interceptor out-board processor to a PBX system," says Archibald. "The VIMS processor is connected logically into the call-processing circuitry of the PBX. What is also new is that the digital PBX becomes a digital data-communications multiplexer—and it does the call processing."

Prototype software is written in C language for processors using the Unix operating system. It will be rewritten in Pascal so that it will be transportable to other operating systems, other processors, and later other PBXs.

RS-232. Eventually, many individual users may have full-scale terminals attached to their phone extensions, and BNR says that there are no restrictions on the terminals that can be used—so long as they can communicate over an RS-232 link. The VIMS software uses the V-35 protocol, so it can transmit at a 56-kilobit/second rate over existing twisted-pair wiring.

With the initial stages of development nearly complete, BNR is looking for other capabilities that might be built into the system. One strong possibility is speech-recognition circuitry, once that technology is sufficiently developed.

BNR expects that VIMS can appreciably affect the operation of an office. "We have calculated that if we can save an engineer 15 minutes a day, we justify a \$2,500 capital investment," Talbert says. What's more, "the VIMS system has freed our secretaries from the few repetitive tasks that normally absorb most of a secretary's time, such as message taking, duplication, and distribution."

-Martin Marshall

**a job
that'll get you
somewhere**

Professionally trained Navy people are serving throughout the world.

For adventure, security and a challenging career, see your Navy recruiter or call toll-free: 800-841-8000 (in Georgia, 800-342-5855)

Navy

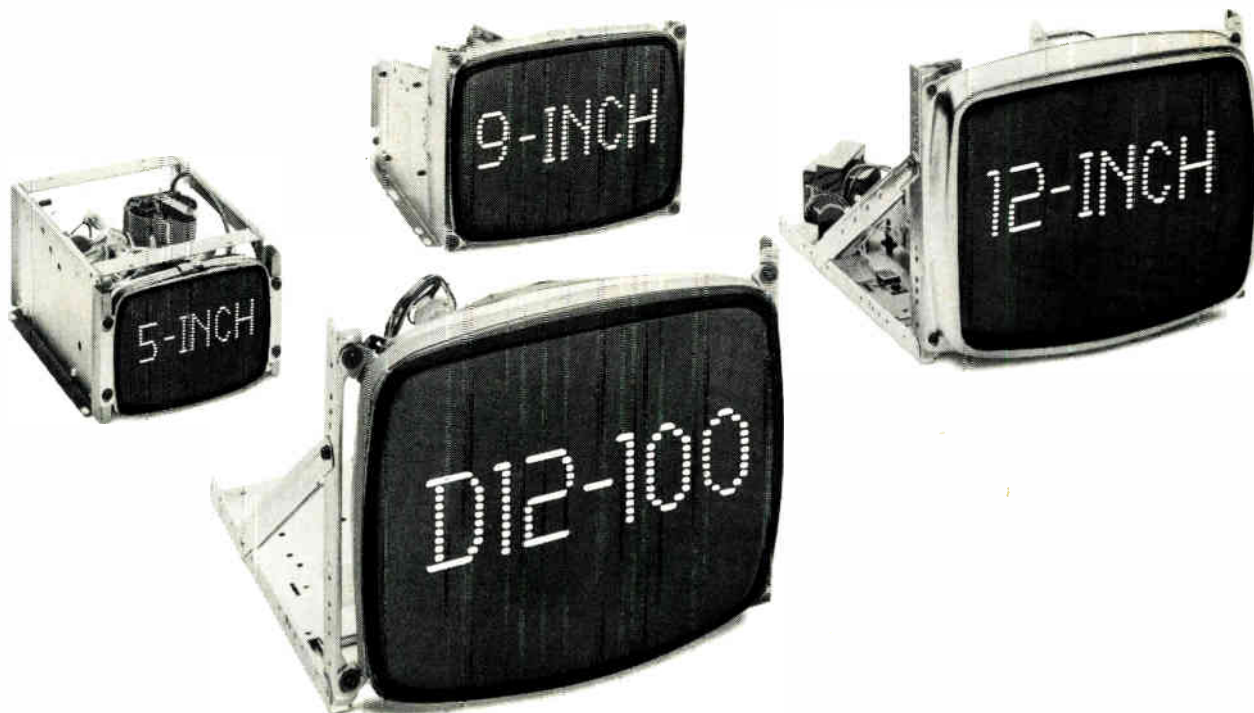

NOW ZENITH GIVES YOU A BRAND NEW WAY TO MEASURE CRT DISPLAY QUALITY.

Now Zenith technology comes packed into a brand new CRT Display format. Introducing the D12-100. This new model in our expanding line has a diagonal measurement of 12 inches. But the story is much, much bigger.

THE D12-100

To deliver maximum performance at lower cost, our new D12-100 is designed with a 4x5 aspect ratio rather than the currently used 3x4 aspect ratio. In those applications where the D12-100 is appropriate, it offers all the reliability and dependability of our fully featured, top-of-the-line 3x4 aspect ratio models.

No wonder. The D12-100 is designed and tested to meet the same quality and reliability

standards established for all Zenith CRT Displays. Thousands of test hours under extreme humidity, vibration, altitude and temperature conditions. And exhaustive analysis, including electron microscope and thermograph scans in the Zenith Reliability Lab.

APPLICATION ENGINEERING

The D12-100, like every Zenith CRT Display, can be designed to meet your own specifications, as well. We'll meet with you to determine your exact requirements. And then custom build a D12-100 to fit. Since the D12-100 is also the start of a new series of CRT Displays, we'll be happy to talk about

other screen sizes as well.

ZENITH TRADITION

At Zenith, we're building CRT Displays with the same commitment to excellence that's made us number one in the television industry. When you want a product that works, with delivery on *your* time schedule, plus proven reliability and dependability... you want what we've been giving our customers for over 60 years.

More big ideas are coming. For further information and specifications, write: CRT Display Engineering Division, Zenith Radio Corporation, 1000 Milwaukee Avenue, Glenview, Illinois 60025, or call (312) 773-0074.



The quality goes in before the name goes on.

**Anyone can build great performance into a micro.
Only Digital helps you get it all out.**



This Bridgeport CNC Vertical Milling Machine, controlled by Digital's powerful LSI-11/2 microcomputer, is cutting production times for customers by up to 85%.

In 16-bit micros, great hardware doesn't guarantee great performance. You need high-powered software too. And only Digital gives you both.

Because while everyone else is just getting started in high-performance micros, we've been shipping them for years.

So we give you all the software tools you need to make the most of great hardware.

We start where the others leave off.

Digital's LSI-11/23 micros offer the only double-precision floating point processor in the industry. Built right into the hardware so it doesn't cost you memory overhead.

You also get a memory management unit so efficient, you can run several real-time programs at once.

And you get the basic instruction set of our PDP-11 minicomputer family. It can do in one memory cycle what others would take four to accomplish.

But like we said, hardware is only half the story.

The industry's only high-performance micro software.

Digital's software systems are literally years ahead of the competition.

The RSX-11M operating system, for example, is the industry-standard real-time software for superminis.

Proven and refined over five years. And you can get it with our LSI-11/23 micros, with high-powered languages like an optimized FORTRAN IV-PLUS compiler and BASIC-PLUS-2.

And for your run-time software you can use RSX-11S, a streamlined version of 11M that takes up an incredibly small amount of memory.

Advanced development tools.

Digital's programming tools are easily the most advanced in the business. So you can concentrate on refining your application software, instead of struggling with it.

For example, you get an interactive debugger that's built right into the processor. With English diagnostics for the linkage editor, FORTRAN, and even MACRO, so you can catch bugs before your programs ever run.

And if you ever need help in your development work, Digital's Command Language will help you solve your problem with clear, English-like statements.

The total approach to micros.

At Digital, we look at micros with a systems understanding. Which is why we offer our microcomputer family — in boards, boxes and systems — with the most advanced high-performance software in the industry.

And why we offer hundreds of hardware tools, including memory and interface boards, complete development systems, peripherals and terminals. All backed by 13,000 support people worldwide.

It's the total approach to micros, only from Digital.

For more information, contact:

Digital Equipment Corporation, MR2-2/M65, One Iron Way, Marlboro, MA 01752.

Or call toll-free 800-225-9220. (In MA, HI, AK, and Canada, call 617-467-7000.)

In Europe: Digital Equipment Co. Limited, Acre Rd., Reading, RG2 0SU, England. In Canada: Digital Equipment of Canada, Ltd. Or contact your local Hamilton/Avnet distributor.

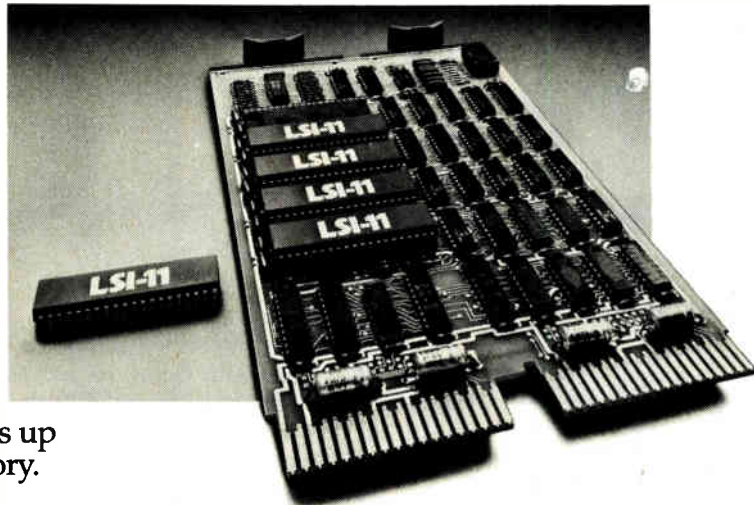

It took the minicomputer company to make micros this easy.

digital

FUJITSU: READILY AVAILABLE

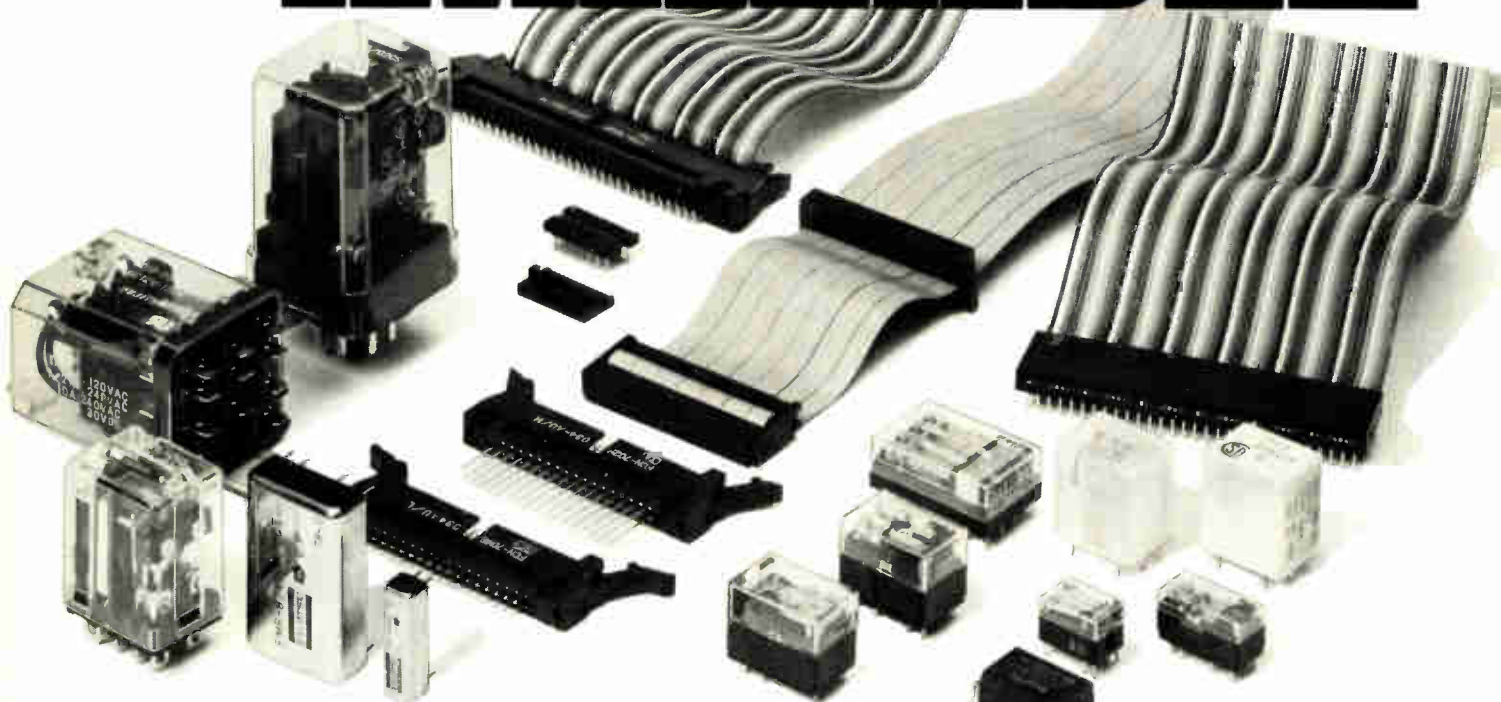

World famous for design and quality, these Fujitsu components are available now.

And through our national network of distribution. This means the most popular configurations are in stock and as near as your telephone. You'll find that Fujitsu com-

ponents not only have the reliability others can only hope to attain but that they are competitively priced as well. Just contact your local distributor. Should you need technical help, don't hesitate to call on Fujitsu direct.

You'll quickly see why Fujitsu has the products, quality and the service that is known around the world as the finest.



FUJITSU

FUJITSU AMERICA, INC.

Component Sales Division
910 Sherwood Drive-23, Lake Bluff, IL 60044
(312) 295-2610, Telex: 206196, TWX 910-651-2259

AND CAPACITORS AND KEYBOARDS AND

Washington newsletter

AT&T setting up mandated competitive, unregulated unit . . .

American Telephone & Telegraph Co. is pushing ahead fast to spin off a "fully separated subsidiary" to compete in the deregulated enhanced services and terminal equipment market. The action was called for by March 1982 in the Computer Inquiry II ruling of the Federal Communications Commission that became effective July 18. Despite an appeal pending in the U. S. District Court for the District of Columbia by the Computer and Communications Industry Association and others, as well as multiple petitions to the FCC for reconsideration, AT&T says it is restructuring its management, effective Sept. 1, to deal with setting up the new corporation under the direction of vice chairman James E. Olson. All regulated activities will be the responsibility of AT&T president William M. Ellinghaus. Also, to simplify the corporate spin-off planning, AT&T says it plans to spend about \$1.13 billion **to acquire the outstanding minority interests it does not already own in four operating companies.**

As for reactions, opponents of AT&T's market dominance like the Computer and Communications Industry Association expressed initial concern. They say that AT&T did not make it clear whether or not the subsidiary would have separate R&D and manufacturing facilities, or as CCIA vice president Phillip Nyborg puts it, "be indirectly subsidized in these areas by the parent company."

. . . as restructuring also produces International unit

Along with its potentially controversial restructuring in the domestic marketplace, AT&T created a new international subsidiary to compete in world markets. Called AT&T International Inc., it consolidates Western Electric International with American Bell Inc., an overseas marketing operation whose combined revenues top \$100 million. President and chief executive officer of the new operation will be Robert E. Sageman, formerly AT&T Long Lines executive vice president for network operations. Charles E. Hugel, who retains his post as AT&T executive vice president, will take on the additional duties of chairman of the international subsidiary.

The initial reaction to AT&T's proposed expansion into world markets was positive in the capital—for example, John Sodolski, vice president of the Electronic Industries Association's Communications division, says the move should "be in the national interest by **enhancing the U. S. presence in overseas markets.**"

Postage rate hike new spur to electronic mail

Electronic mail and burgeoning telecommunications services like consumer bill paying by telephone are getting a big boost from the U. S. Postal Service's proposal to raise first-class mail rates by one third. The Service wants to raise the price of a stamp by a nickel to 20 cents for the first ounce and the cost of the second ounce from 13 to 17 cents. **"The public may soon begin to conduct more of its financial transactions electronically,** rather than continuing to pay ever increasing postage costs," warns William R. Frazer of the American Banking Association.

EIA pushes for full tax credit on domestic R&D . . .

A change in the U. S. Tax Code to allow full deduction of research and development expenditures made within the United States is being sought from Congress by the Electronic Industries Association, which says the present rule **"amounts to an incentive for companies to relocate R&D activities to nations overseas** where expenditures, if made there, are deductible—and where, incidentally, new technologies are warmly wel-

comed.” EIA president Peter F. McCloskey told the House Ways and Means Committee that Treasury Regulation 1.861-8 is inequitable by only allowing portions of R&D expenditures as foreign-source deductions when resultant products might produce foreign-source income. The EIA’s proposed change in the rule came as part of what it calls a “pro-productivity package” of tax cuts that would enhance the competitiveness of U. S. electronics in world markets. The EIA’s package also supports pending bills H. R. 4646 and its companion S. 1435 [*Electronics*, July 31, p. 50] accelerating recovery of capital costs; a 25% tax credit for increased corporate R&D outlays in a year compared to the three prior years (H. R. 7909 and S. 2906), plus credits for R&D grants to universities (H. R. 6632); and income tax breaks for Americans working overseas (H. R. 5211 and S. 2321).

. . . but opposition from economists remains strong

Opposition to business tax cuts supported by the EIA and other business interests remains strong, however, from economists convinced it will prolong the recession and thwart recovery of the national economy. For example, Herman I. Liebling, the U. S. Treasury’s chief economic forecaster in 1962–76 and now a Lafayette College professor, contends the \$30 billion in tax cuts now proposed **“would swell the Federal deficit to \$60 billion or more in 1981”** and thereby accelerate inflation, raise interest rates even further, and deter investment. While sympathetic to industry’s need to increase productivity and improve after-tax corporate rates of return, Liebling argues that tax cuts should be deferred “until the 1982–3 Federal budget outlay commitments become known for defense and the inflation-indexed entitlements of current social programs.”

Martin Marietta joins GE team in VHSIC effort

General Electric Co. has added missile maker Martin Marietta Corp.’s Orlando (Fla.) division to its team competing in the triservice very high-speed integrated circuits program known as VHSIC [*Electronics*, March 27, p. 41]. Industry and government sources say the GE move appears to be a response to increasing belief among military officials that one of VHSIC’s **earliest and largest applications will be in precision guided air-to-air and air-to-ground tactical missiles, as well as ground-based projectiles.** The Martin Marietta addition raises the number of GE team members to six.

AT&T settles interconnection suit by terminal makers

Independent makers of telecommunications terminals, including private branch exchange and key equipment, say they achieved “a significant breakthrough with the Bell System” when American Telephone & Telegraph Co. negotiated a pretrial settlement of a six-year-old antitrust suit by seven interconnection companies. The litigants, led by Jarvis Inc. of Richmond, Va., had charged in 1974 that AT&T and its subsidiaries conspired to put them out of business by refusing interconnection or charging artificially high tariffs limiting their sales of non-Bell equipment. Edwin Spievack, Washington, D. C., counsel for the companies, says **the negotiated plan calls for AT&T to set up a “centralized operations group” in each of the 24 Bell operating companies** to process customer installation requests, schedule Bell operating company service, and coordinate its cutover.

LOW COST, TIGHT CAPACITANCE TOLERANCE

TYPE 287P STYRACON® CAPACITORS



- Polystyrene film dielectric . . . rugged epoxy coating.
- Capacitance tolerances . . . $\pm 1\%$, $\pm 2\%$, $\pm 3\%$.
- Extended foil construction avoids reliability and inductance problems of laid-in-lead imports.
- Short lead times . . . unlike uncertain deliveries of imported film capacitors.
- Standard capacitance values from 100 pF to .1 μ F. Voltage ratings of 50 and 100 WVDC.

Write for Engineering Bulletin 2052.3 to
Technical Literature Service, Sprague Electric Co.,
35 Marshall St., North Adams, Mass. 01247

45P-0120

THE BROAD-LINE PRODUCER
OF ELECTRONIC PARTS



Circle 59 on reader service card

ULTRA-SMALL INTERFERENCE CONTROL COMPONENTS

SERIES JX2000/3000 FILTERS



- Qualified to Military Specification MIL-F-15733.
- High insulation resistance over operating temperature range of -55°C to $+125^{\circ}\text{C}$.
- Available in Feed-thru, L, PI, T, and 2L circuits.
- Current ratings from 0.1 to 15 amperes.

Write for Engineering Bulletin 8132 to
Technical Literature Service, Sprague Electric Co.,
35 Marshall St., North Adams, Mass. 01247.

45F-0140

THE BROAD-LINE PRODUCER
OF ELECTRONIC PARTS



Circle 60 on reader service card

THE 'ZERO TC' CAPACITOR

TYPE 834P METFILM® 'S' CAPACITORS



- Metallized polysulfone-film section in rectangular molded plastic case offers superior electrical characteristics, small size, rugged construction.
- Capacitance change is typically $\pm 0.25\%$ over broad temperature range of -40°C to $+125^{\circ}\text{C}$.
- Low dissipation factor (high Q), low dielectric absorption.
- Capacitance tolerances as close as $\pm 1\%$.

Write for Engineering Bulletin 2610 to
Technical Literature Service, Sprague Electric Co.,
35 Marshall St., North Adams, Mass. 01247.

45D-0135

Dearborn electronics
division
SPRAGUE ELECTRIC COMPANY



Circle 162 on reader service card

THE STABLE SPACE SAVER

TYPE LP66 METALLIZED POLYCARBONATE CAPACITORS

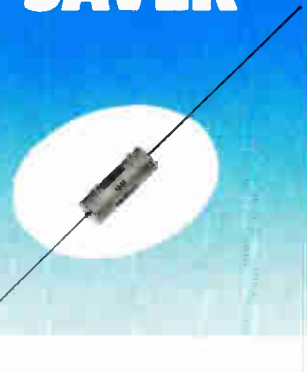

- Exceptional capacitance stability, long life expectancy, low dissipation factor, low temperature coefficient, high insulation resistance.
- Space saving wrap-and-fill tubular construction.

Write for Engineering Bulletin 152B to
Technical Literature Service, Sprague Electric Co.,
35 Marshall St., North Adams, Mass. 01247

45O-0136

Dearborn electronics
division
SPRAGUE ELECTRIC COMPANY



Circle 61 on reader service card

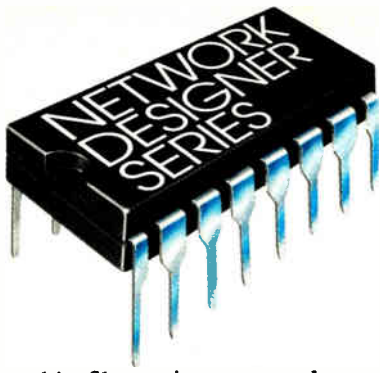

Beckman thin film reduce cost,

Beckman thin film resistor networks can reduce cost while improving your linear circuit design.

Per resistor prices of Beckman networks are lower than matched resistors, and comparable in price to the metal film discretely they replace. That's because thin film networks are a *standard* product line at Beckman. High-volume production contributes to significant cost reductions over traditional thin film networks.

Inherent cost-saving features in thin film networks also include ratio matching and low tempco tracking error, eliminating the high labor costs of tolerance sorting and tempco testing.

Additional cost advantages over discretely are board space conservation, manufacturing/assembly time reduction and increased reliability. Using Beckman standard thin film networks also makes implementation of the linear circuit easier and more efficient.

To enable you to purchase *only* the degree of precision needed and to enhance design flexibility, Beckman offers a variety of accuracy ranges.

Improved Circuit Performance

The Beckman vacuum deposition process creates consistent resistor values with typical tempco performance of 25 ppm/°C; 50 ppm maximum. More importantly, tracking tempco is only 5 ppm.

With absolute tolerances from 1% down to 0.1% and ratio matching from 0.5% to 0.05%, standard thin film networks from Beckman can boost linear circuit performance — especially when similar values or matched resistor sets are required.

As demonstrated in the digital addition or subtraction circuit below (Fig. 1), several common value resistors are supplied by a single thin film network.

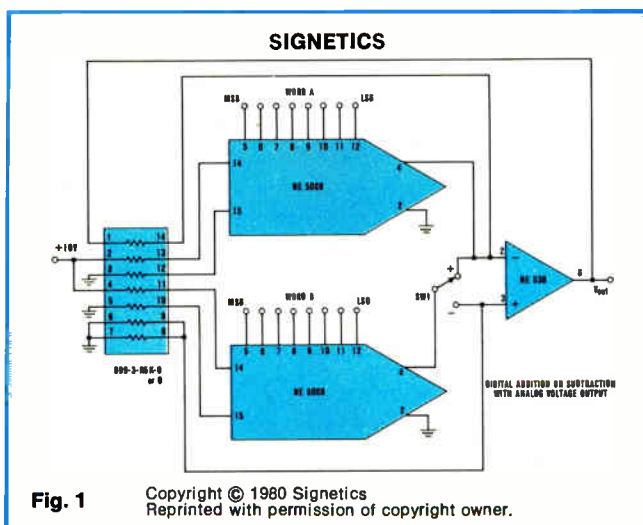

In this example, the common reference voltage drops across two inherently ratio matched network resistors, providing precise and equal reference currents to the DACs. Since the feedback resistor is part of the network, it too is ratio matched with the input resistors and tracks their movement with temperature change. The result is output stability because the input currents to the op amp track the DAC reference currents, thus the output voltage tracks the reference voltage.

Inherent Ratio Matching

The following encoder/decoder circuit application (Fig. 2), used in pulse code modulation transmission systems, again demonstrates the advantages of inherent network resistor ratio matching.

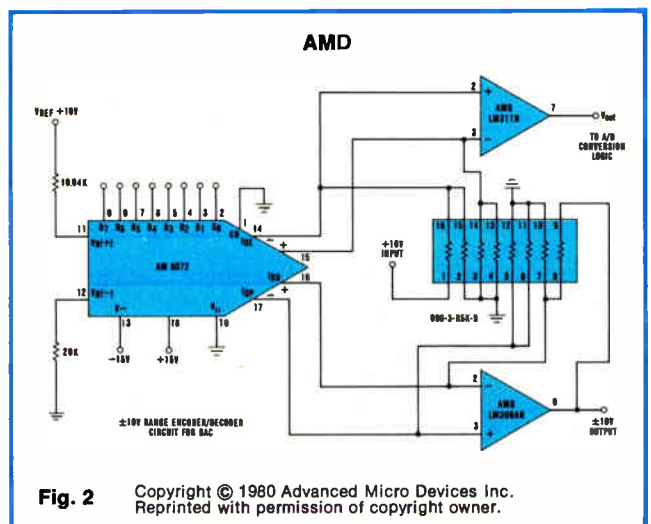

By utilizing a series of 5K resistors with 0.5% tolerances (matched to within 0.1%) the thin film network provides stable inputs to the comparator in the encoding mode or to the op amp in the decoding mode.

The feedback resistor of the op amp tracks the input resistors to within 5 ppm, resulting in an extremely accurate gain on the output.

Additionally, a 2.5K resistor is required to tie the non-inverting input of the op amp to ground. This resistor is created by paralleling two of the 5K resistors in the network. The new value will also track the other resistors to within 5 ppm.

The precision summing amplifier circuit (Fig. 3) is an excellent example of how requirements for a matched set of resistors can be supported with a standard thin film network.

resistor networks

boost performance over discretetes

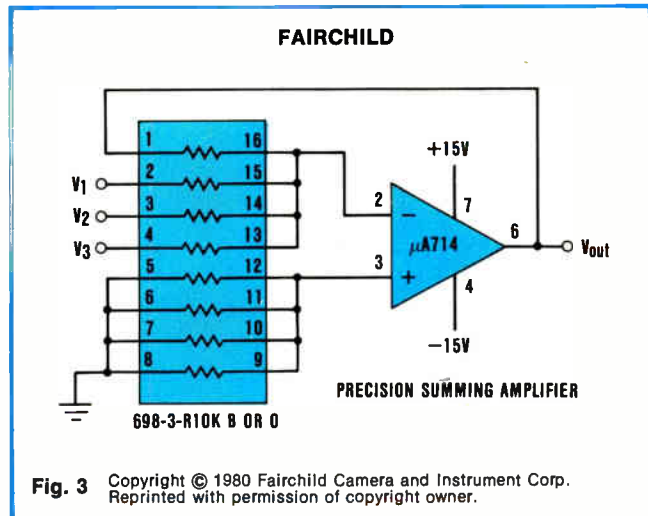

Fig. 3 Copyright © 1980 Fairchild Camera and Instrument Corp. Reprinted with permission of copyright owner.

In this application, the accuracy of the input resistors determines the common mode noise rejection. Matching the feedback resistor to the input resistors sets the accuracy of each input to the summing point. Close ratio matching is therefore essential.

The non-inverting input resistor is used in this application to cancel the effects of the bias current, and should be equal to the parallel combination of feedback and input resistors. This can be easily accomplished using the network — especially where equal weighting of the inputs is desired.

Since the amplifier error can be as low as .0015%, most of the error results from the resistors. This error can be minimized by using a standard thin film network with a $\pm 0.1\%$ tolerance and ratio match.

Accurate Voltage Ratios

The capability to create accurate voltage ratios which track throughout the temperature change can also be used to improve circuit performance. In the bipolar out circuit below (Fig. 4), Beckman's new thin film mini-DIP is employed to achieve a 2:1 voltage ratio between the output of the first op amp and the input from the voltage reference.

This ratio will remain stable throughout temperature change and permits a simple — yet accurate — circuit for bipolar output.

The use of the Beckman thin film mini-DIP allows the designer to gain the performance improvement of a network even in applications that require only a limited number of matched resistors.

These four applications have graphically demonstrated how Beckman standard thin film networks can improve your circuit design in the critical areas of performance, cost and versatility.

Beckman is the number one resistor network producer, and can fully support your thin film requirements with off-the-shelf stock from our nationwide distributors.

New Thin Film Catalog

For more information on any of these thin film applications, or to request our new Thin Film Resistor Network Catalog, contact your nearest Beckman distributor or write: Network Products Operations, Beckman Instruments, Inc., 2500 Harbor Blvd., Fullerton, CA 92634. (714) 773-8525.

BECKMAN

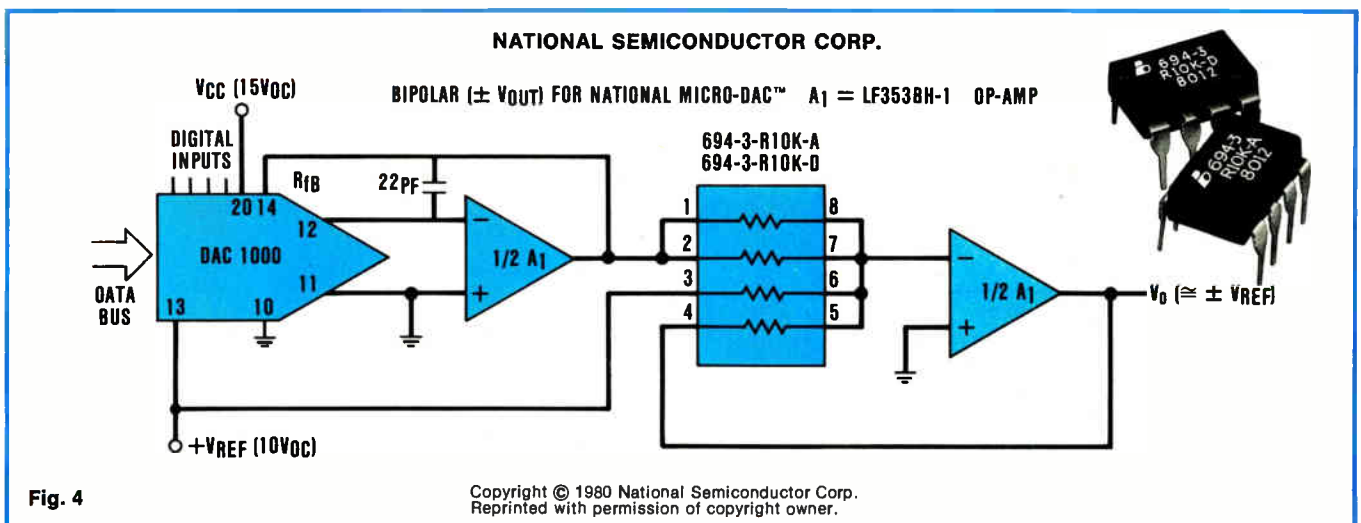

Fig. 4

Copyright © 1980 National Semiconductor Corp. Reprinted with permission of copyright owner.

MOTOROLA HELPS STRETCH GAS MILEAGE

Automotive manufacturers are caught between a rock and a hard place. They are obliged not only to reduce fuel consumption, but also, at the



Government-mandated Corporate Average Fuel Economy (CAFE) standards. Source: NHTSA

same time, to reduce harmful exhaust gas emissions. And these objectives seem to be mutually exclusive.

An engine whose carburetor and spark timing are

adjusted to give high mileage tends to produce unacceptable levels of pollution. The same engine, adjusted for low pollution levels, uses more gas and gives disappointing performance.

The trick is to burn exactly the right amount of fuel at exactly the right moment. But what is "right" depends on a whole complex of constantly changing factors, including terrain, engine and air temperature, barometric pressure, and the load and speed of the car.

It would take a genius to juggle all those factors. Fortunately, Motorola has been working on the problem for

some time, and has in fact produced just such a genius.

ELECTRONIC ENGINE MANAGER.

It's an electronic engine-management system, controlled by a microcomputer that thinks like a first-rate automobile mechanic. It lives inside the car, and because it can perform a million functions each second, it can automatically regulate carburetion, spark timing, and the recirculation of exhaust gases through the engine. It makes all these adjustments continuously, so you get as much performance with as little pollution as possible, whatever the driving conditions are at



BY MAKING ENGINES THINK.

that particular moment.

It's a real computer in miniature, with a memory and the ability to manipulate what it learns in terms of what it already knows. Motorola's electronic engine-management system is so efficient that some domestic car makers are already using it in their current models. Other car and heavy-duty-equipment manufacturers in America and Europe are planning to use it in the near future.

IMPOSSIBLE WITHOUT ELECTRONICS.

Such precise, continuous engine management would be impossible without the integrated circuit, an electronic microcosm that contains the equivalent of twelve thousand transistors and measures

about 5mm square. These small miracles are the central nervous system of Motorola's electronic engine-management system, and they're a remarkable but not unique demonstration of the kinds of things Motorola is doing with microelectronics today.

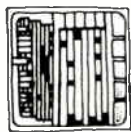

A microcomputer, drawn larger than life.

IMAGINATIVE ELECTRONICS.

Motorola is not only one of the world's largest manufacturers dedicated exclusively to electronics, but also one of its foremost designers of custom and standard semiconductors.

We've come a long way from the time when

we put radios into cars fifty years ago, and TV sets into America's living rooms. Now we make hundreds of models of two-way radios, and we no longer make home TV sets here at all.

We make microelectronics carry telephone services to places where there are no phone lines. Transmit electrocardiograms and voice messages simultaneously from the scene of an accident to a nearby hospital. Help the energy industries develop the resources of the earth, the sea and the sun.

And we help make automobile engines think about how they use precious fuel.



MOTOROLA

Making electronics history.

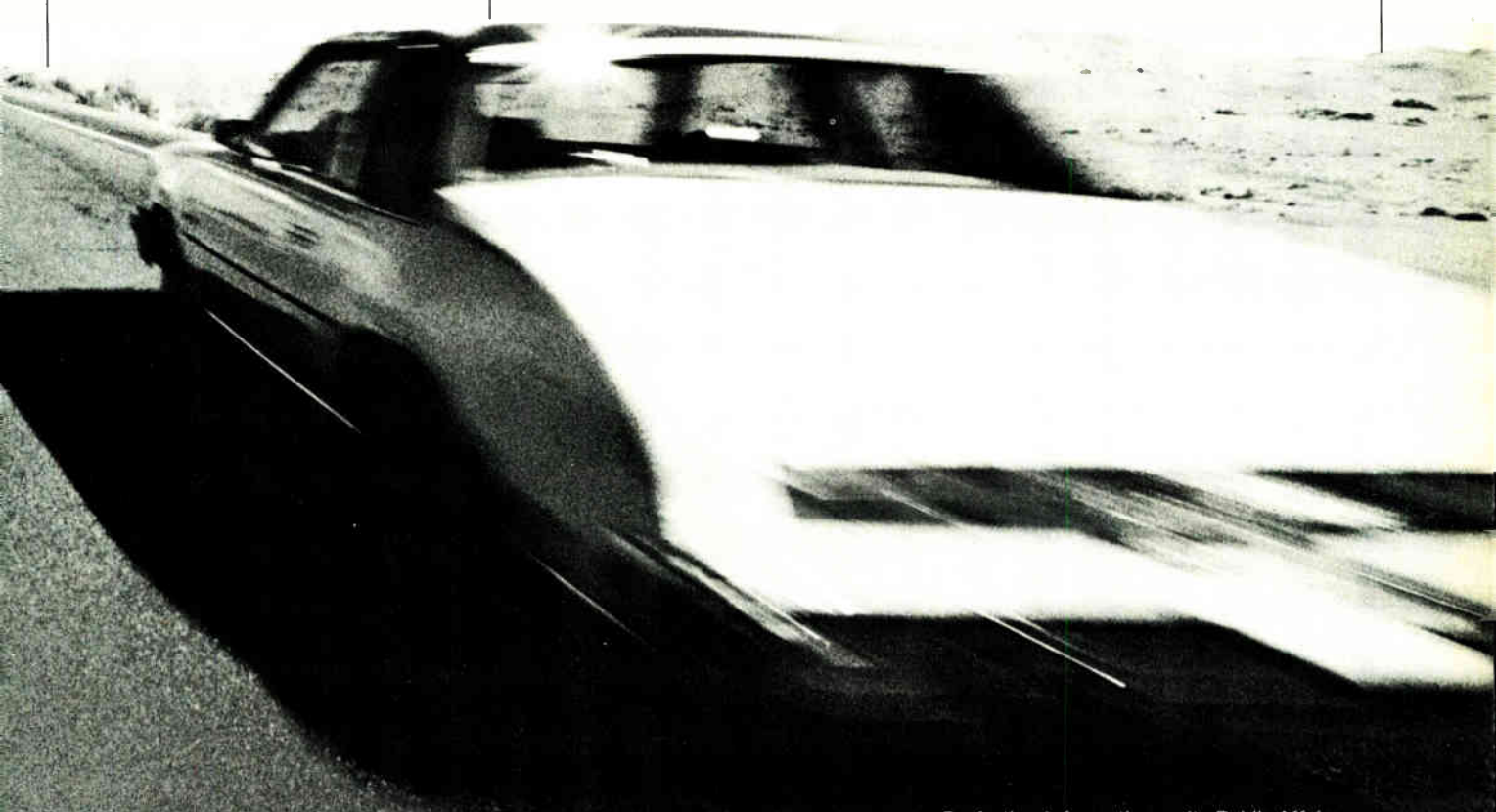

For further information, write Public Affairs Office, Corporate Offices, Motorola, Inc., 1303 E. Algonquin Road, Schaumburg, Illinois 60196.

Motorola and  are registered trademarks of Motorola, Inc.
Circle 65 on reader service card

We have a pollution solution!

Corcom is the world leader
in RFI pollution control!
Our SP series filters have
been designed to allow
switching power supplies
to comply with the
new FCC rules as well as
VDE 0875A. Write for
complete technical data.

 **CORCOM**
RFI Power Line Filters

Corcom Inc. 1600 Winchester Road Libertyville, Illinois 60048 U.S.A.
312-680-7400 TWX 910-684-3269 ©

Samples of French 10-ns 1-K RAM being shipped

RTC—La Radiotechnique Compélec, the French components house in the Philips Gloeilampenfabrieken group, has started shipping samples of a 1-K static random-access memory with a maximum access time of 10 ns—the fastest RAM yet to hit the market, it maintains. **The fully decoded chips come in two versions: 1,024 by 1 bit and 256 by 4 bits**, compatible with either the 10000 or the 100000 emitter-coupled logic family. A block-selection feature makes it possible to reconfigure the 256-by-4-bit chip to 512 by 2 bits or 1,024 by 1 bit. RTC fabricates the chips using its Subilo-p technology, based on lateral oxide isolation.

Coplanar power device switches in 100 ns

Researchers at the University of Dortmund, West Germany, have developed a 300-v coplanar silicon power switch that works in 100 ns. To be discussed at the Sixth European Solid State Circuits Conference being held at Grenoble, France, Sept. 22–25 (see p. 113), **the device, which uses n-channel and p-channel double-diffused MOS (D-MOS) transistors, is process-compatible with large-scale and very large-scale integrated complementary-MOS technology.** In the dynamic mode, it has a power dissipation of 0.6 W at a 200-pF load and a 300-mA drive current. One design features an input drive of less than 20 v.

British address LCD with amorphous silicon thin-film transistors

A small experimental liquid-crystal display that is addressed by a matrix of amorphous silicon thin-film transistors has been developed by researchers at Dundee University, Scotland, with funds from Britain's Royal Signals and Radar Establishment. The display panel is far from complex—it measures 1.6 by 2.2 cm (0.6 by 0.9 in.) and consists of a five-by-seven array of display elements each 2 mm square. But its development, which began four years ago [*Electronics*, June 21, 1979, p. 69], points to the potential of amorphous silicon thin-film transistors as a means of overcoming the addressing limitations of LCDs at low cost. **The electrical performance of individual devices looks acceptable, with an on current of 5 μ A, a 10^5 on- to off-current ratio, and a response time for each liquid-crystal element of less than 100 μ s.** The work is to be described in a paper at the Sixth European Solid State Device Research Conference at York, England, Sept. 15–18, together with one from Plessey's Allen Clark Research Centre on device physics of amorphous silicon transistors—work also funded by the RSRE.

European Commission to pick builders of photovoltaic generators

The European Commission will start selecting this fall more than a dozen participants for a \$15 million research program on photovoltaic electrical generation. **Each participant will set up a dozen generator of 30 to 300 kw by mid-1983.** EC officials say that photovoltaic generators of this size have not yet been built in Europe, and the program is expected to test the concept of solar-power electrical production there and to lay the basis for such technology in developing countries. The commission, which will choose from about 30 proposals submitted last May, is putting up about \$10 million dollars for the program; somewhat more than that will come from national governments and private industry on a matching-grant basis. The project is part of a four-year Common Market research program on solar energy, the commission's share of which is about \$65 million.

International newsletter

Hitachi may sell M-200H computer to National

National Advanced Systems Corp. may soon be offering its customers a **computer 50% to 100% more powerful than the IBM 3033**. Hitachi Ltd. confirms that it is negotiating exports of a private-label version of its M-200H to the Palo Alto, Calif., firm. The National Semiconductor subsidiary already sells several of Hitachi's IBM-compatible machines as part of its AS/7000 series [*Electronics*, Jan. 31, p. 46]. Hitachi also says it **will be exporting a version of the M-200H to Olivetti in Italy**.

Packet-switching service now on for West Germany

West Germany's post office has just begun a packet-switching service with a **network of 17 exchange systems installed in major cities throughout the country**. Called Datex-P and inaugurated in the city of Düsseldorf on Aug. 26, it is providing digital data communications for several dozen customers. Judging by the number of applicants and the interest shown, there may well be several hundred customers by the end of the year, a postal official says. Significantly, a link to Canada also exists, and one to the U. S. will be put into operation soon. The post office considers data communications to the North American continent especially important because of the large amount of traffic flowing in that direction.

Mitsubishi adopts 128 refresh cycles for 64-K RAMs

Mitsubishi Electric Corp. has joined most semiconductor firms in supplying samples of a 64-K dynamic random-access memory with a 128-cycle refreshing scheme. Designated the M5K4164S, it is **plug-compatible with the equivalent self-refreshing part from Mostek Corp.** The present device accesses in 200 ns, and samples of a 150-ns part will be available in October. Mitsubishi says that it has discontinued its 256-refresh-cycle part, the M58764S, because **market surveys in the U. S. showed that its customers want a 128-refresh-cycle device**.

British CAD system selling well in U. S.

Compeda Ltd., the Stevenage, England-based CAD software group, has **just sold a \$250,000 computer-aided design system to the U. S.'s General Electric Co.** and says that another eight orders of similar size from U. S. customers are in the works. Called Gaelic, the system, which runs on a powerful Digital Equipment Corp. VAX minicomputer, among others, supporting six terminals, was developed at Edinburgh University [*Electronics*, March 30, 1978, p. 63] and has been adopted by the post office's British Telecom, the universities, and the Science Research Council's Rutherford Laboratories. In the latest version, the ergonomic efficiency of Gaelic as a graphics terminal has been greatly enhanced by the adoption of a package from the British Post Office supporting a twin-screen work station: to the main Tektronix 4014 storage-scope display has been added an inexpensive yet flexible viewdata-style raster-scan terminal for temporary data storage.

French may build telecomm plants for Iraqis

Thomson-CSF apparently has the inside track for a whopping contract to set up a communications-gear manufacturing complex in Iraq. Plessey Co., the UK firm that was vying with Thomson for the job, last week aired its impression that the negotiations were not running in its favor. Thomson officials refused to comment. The contract involves something like \$700 million over three or four years for plant machinery, know-how, and training, plus another roughly \$250 million for buildings.

**You might have thought
our world was round**



Think again.



BELDEN FLAT CABLE & CONNECTOR SYSTEMS

Sorry, Columbus. When it comes to cable, round is not always right. And we should know, we make both round and flat cable.

For mass terminations, Belden Flat Cable and Connector Systems offer substantial improvements in installation time, serviceability and cost effectiveness when compared to round cable. What's more, Belden Flat Cable is worlds away from other flat cable. With tough, flexible insulations; uniform centers; easier breakouts; and much more. It's the kind of quality that keeps total end costs down to earth.

We offer a wide range of custom and standard flat cables—.050", .100" and .156" centers; laminated;

bonded; jumper cables in bulk rolls or pre-stripped lengths; and our unique twisted pair cable, Vari-Twist™.

Vari-Twist is the only twisted pair cable which has both opposite direction lays—and varying length of lay—on each adjacent pair as a standard product.

Combine all our flat cable with dependable Belden connectors and accessories, and you have a complete flat cable and connector system. A complete system which is made even better by the full service and custom engineering capabilities you've come to expect from Belden.

Let us put our world of flat cable to work for you. You'll discover we beat the competition flat.

CIRCLE NUMBER 222 ON THE READER SERVICE CARD.



Belden takes the system approach

Quality Flat Cables

Belden makes flat cable for all types of applications.

Among our flat cable capabilities:

- Round conductors (solid, stranded, or unistrand)
- Flat conductors (Mylar or Kapton insulation)
- Bulk and pre-cut, prestripped jumper cables
- PVC solid or color-coded laminations
- Cable assemblies made to specifications
- Compatibility with all major makes of connectors
- Passes VW-1 Vertical Flame Test

Compatible Connectors

Belden connectors provide fast, easy installation; reliable connections; and long service life. Among the features offered by all Belden connectors:

- -55°C to +105°C temperature range
- 30V DC UL voltage ratings
- Phosphor-bronze (gold-over-nickel plating) contact materials
- Highly reliable U-contact (double action IDC) on all IDC connectors
- Solvent-resistant glass-filled PBT housings
- UL recognized 94V-0

Bonded Flat Cable

- 10 to 30 conductors
- 22, 24 and 26 AWG stranded
- 80°C temperature rating
- 300V voltage rating
- UL style number 2697



Laminated Flat Cable

- .050" (1.27mm) spacing
- 10 to 64 conductors, 28 AWG stranded
- 105°C temperature rating
- 300V voltage rating
- UL style number 2651

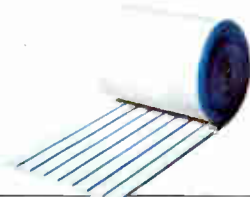

Rainbow Flat Cable

- .050" (1.27mm) spacing
- 10 to 64 conductors, 28 AWG stranded
- 105°C temperature rating
- 300V voltage rating
- UL style number 2884



.100/.156 Flat Cable

- .100" (2.54mm) spacing, 2 to 28 conductors
- .156" (3.96mm) spacing, 2 to 24 conductors
- 22, 24, 26 and 28 AWG stranded
- (.100)/18, 22, 24 and 26 AWG stranded
- (.156)
- Rated to 105°C & 300V



Vari-Twist™ Flat Cable

- .050" (1.27mm) spacing
- 5 to 32 pairs
- Adjacent pairs have opposite lays
- Lay length varies with each adjacent pair
- 105°C temperature rating
- 300V voltage rating



Headers

- .100" (2.54mm) grid contact/terminal spacing
- Selective plating (gold-plated contact and solder-plated terminal)
- Flex lock/eject hooks
- Many diversifications (10 to 60 pins, wire-wrap/straight/right angle)



Socket Connectors

- .100" (2.54mm) contact spacing
- Double-cantilever contact
- Bottom-entry contact
- Many diversifications (10 to 60 pins, closed-end/through-end)
- Dual-beamed contacts
- Polycarbonate strain relief



Low-profile Socket Connectors

- .100" (2.54mm) contact spacing
- Double-cantilever contact
- Bottom-entry contact
- Dual-beamed contacts
- Many diversifications (10 to 60 pins)

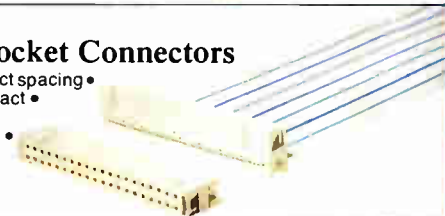

Card Edge Connectors

- .100" (2.54mm) contact spacing
- Bifurcated contacts
- Many diversifications (10 to 60 pins; with ears, half ears or without ears; and with or without strain relief)

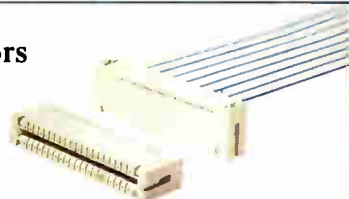

D.I.P. Connectors

- Plugs into IC sockets or can be soldered for permanent connections
- Low-profile installation on PC board
- Many diversifications (10 to 60 pins)



Write for our free Catalog

Belden Corporation, Electronic Division, P.O. Box 1980, Richmond, IN 47374. Phone: (317) 983-5200. Out west, call our regional sales office at (714) 833-7700. In the east, call our sales office at (617) 872-7846.

CIRCLE NUMBER 222 ON THE READER SERVICE CARD.

P.C.B. Transition Connectors

- Tinned pins for excellent solderability
- For reliable permanent PC board connections
- 1.6mm (1/16") standard thickness of PC board
- 14, 16, 24 and 40 position connectors

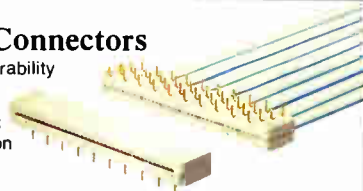

BELDEN

Coming through...

with new ideas for moving electrical energy

Printed in USA

E beam makes surface acoustic waves visible

by John Gosch, Frankfurt bureau manager

Siemens setup strobos beam at SAW frequency, yields photograph or TV image of traveling wave

Seeing is not just believing—it aids understanding. That is why a research group at Siemens AG is happy to have found a way to make the undulations of surface-acoustic-wave devices visible.

By operating a scanning electron microscope stroboscopically and hitting the device under investigation with a low-energy electron beam, Hans-Peter Feuerbaum and his associates at the Siemens research labs in Munich have succeeded in making visible the movements of acoustic waves as they traverse the surface of devices such as SAW filters and delay lines. The propagation of these waves can either be recorded photographically or shown *in situ* on a television screen.

Useful. The visibility of traveling surface acoustic waves—achieved for the first time, according to Siemens experts—has important implications in SAW device design and development. “It enables engineers to better understand the mechanisms active in such components,” Feuerbaum says, and so will help them meet the stringent design specifications for SAW devices in communications equipment, for example.

Conventional methods of probing the workings of SAW devices have

their drawbacks. One, based on calculations, cannot account for all the effects of wave propagations because the calculated data applies to ideal, not actual, boundary conditions.

Others, which involve laser beams for detecting surface deformations or mechanical probes for determining the electrical fields associated with such deformations, lack local resolution and require many time-consuming point-by-point measurements.

The Siemens technique, on the other hand, is conclusive and fast, taking only several minutes to perform.

Acceleration voltage. The scanning electron microscope Feuerbaum and his colleagues use has a fast blanking system to provide stroboscopic operation and is optimized for a beam acceleration voltage of 2.5 kilovolts. At a diameter of 1.2 micrometers, the beam has a current of 100 nanoamperes. The beam's low

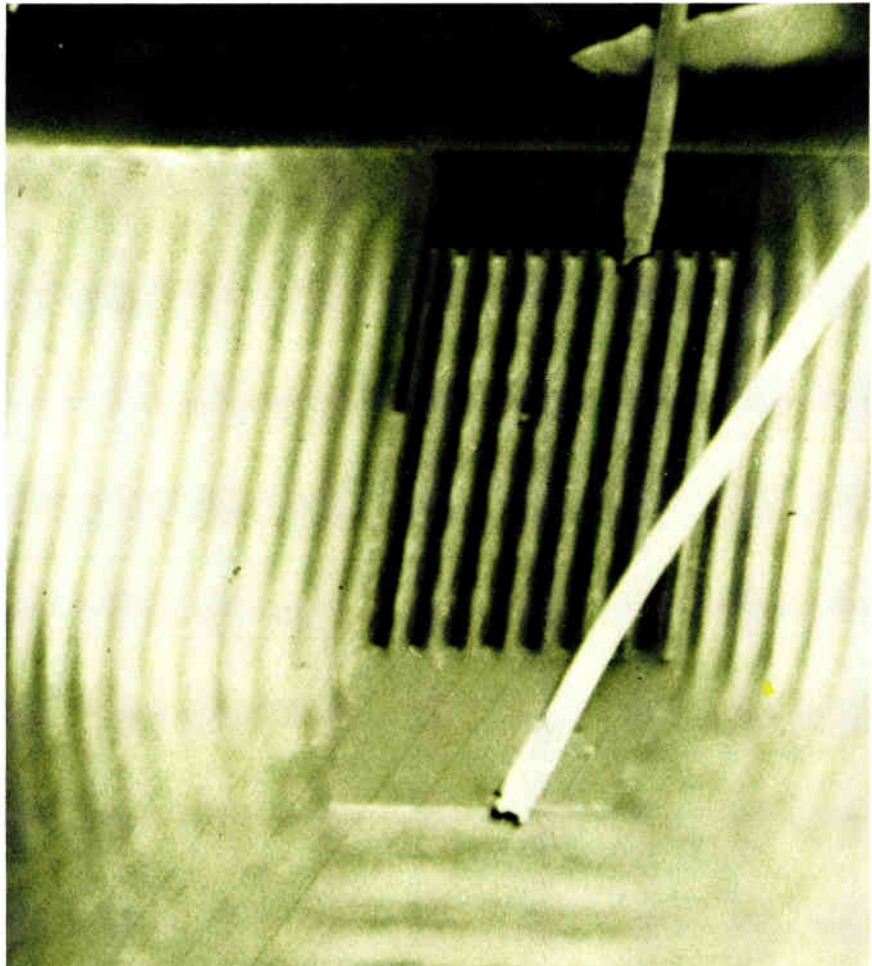

In sight. Strobed electron beam and voltage contrast method yield photograph (right) or TV image of surface acoustic waves.

acceleration voltage ensures that the device being investigated does not charge up. That, in turn, guarantees undisturbed and reliable pictures of wave propagation.

The Siemens setup, being routinely used in SAW device design for several months, makes traveling waves visible in three modes of operation, two yielding photographic pictures and one a TV representation. All involve qualitative time-resolving measurements based on voltage contrast and stroboscopic methods.

Standard. In the first and standard mode, the electron beam striking the SAW device is pulsed synchronously with the frequency of the signal at which the SAW device is being driven. The stroboscopic effects produce a static pattern of the traveling wave on a photograph.

In the second mode, the device is driven with wave packets of particular periods. The beam's pulses are synchronized with the repetition rate of these packets and that makes the packets visible on the photograph. This mode, Feuerbaum says, allows the investigation of such effects as acoustic wave reflections from device edges, the reflections being free from any superimposed waves.

On screen. Using the third mode, the traveling waves can be shown on a TV screen. The high signal-to-noise ratio needed for a screen representation is achieved first by the beam's relatively high current of 100 nA and secondly by a low duty cycle at which stroboscopic operation takes place in this mode. A duty cycle of 10 is already sufficient for showing the propagated wave, Feuerbaum says. (Here, the duty cycle is defined as the wave period divided by the width of the electron beam pulses.)

The third mode provides pictures similar to those achieved with the standard mode. But instead of being static, the wave pattern is moving, the movement being obtained by shifting the phase of the electron-beam pulses relative to the surface waves. This mode allows observing not only the waves themselves but also their direction of propagation, which can also be recorded on video tape for later evaluation.

Great Britain

Coax car system replaces harness

A multiplexing scheme in which a single coaxial cable replaces a conventional custom-built wiring harness, switching the car loads on the outer sheath and carrying both digital and analog data on the central core, could be on the road within four years.

That at least is General Electric Co. Ltd.'s most optimistic expectation for a system called Salplex that has already clocked 15,000 fault-free miles on British roads in an adapted Ford Escort.

Making it attractive. Together with wiring-harness manufacturer Ward & Goldstone, GEC is setting up a small company at Rugeley, Staffs., to manufacture the system, which was originally developed by M. J. Hampshire at the University of Salford. The goal is to produce an electronic system that in terms of design, capital, and installation costs will be cheaper than its electrical equivalent, more flexible, and capable of providing for upcoming electronic automotive systems. Also, self-diagnostic features make Salplex relatively easy to troubleshoot.

The system can be readily be modified to cater to different market cat-

egories. The mass-produced car is the real sales plum, of course, but Salplex will probably be used first in buses, trucks, and military vehicles, on the production floor, and in other areas demanding a highly secure, multiplexed data-transmission and control scheme.

Basics. A single coaxial cable provides a power feed and data transmission to a number of solid-state control and data-gathering units distributed around the vehicle. Load currents carried in the outer sheath form a protective equipotential surface for the inner data bus and are switched by either solid-state devices or relays with a ground return through the chassis. Solid-state switching devices suitable for car multiplexing schemes and combining circuitry for load diagnostics are only now becoming available, according to Jonathan A. Williamson, who heads development of the system at Ward & Goldstone.

As many as 32 control and data-gathering units, called transmitter-receivers, may link eight local loads each to the bus for a total capacity of 256 channels. That is more than adequate for the 40 loads plus instrumentation found on the average car today.

The prototype transmitter-receiver was engineered in complementary-MOS small-scale integrated circuits. But now GEC Semiconductors Ltd. is supplying Ward & Goldstone with a more highly integrated

Message. Longest pulse starts a transmission. Next widest is data bit 0, to allow for analog sample-and-hold. Clock pulses (black) aid timing of sampling of 3 or 4 run-on bits; each pulse is wider than the last to accommodate not-quite-synchronous receiver clock.

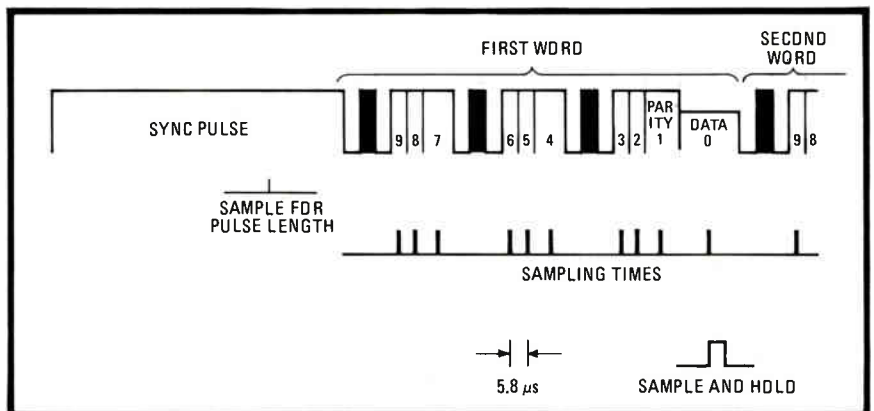

At last, a Darlington optocoupler that does what it's supposed to!

High gain (up to 1000% min. CTR) and a voltage rating (up to 100V) you can count on...without false turn on...without sluggish switching speeds...without thermal runaway.

Compare the H11G series to the 4N33 industry standard.

		4N33	H11G1	H11G2	H11G3	
On State	Current, I _c	2	100	100	50	mA
	Gain	25	1000	1000	250	%
	Voltage Drop	1.0	1.0	1.0	1.2	V
Off State	Voltage	10	80	60	30	V
	25°C Leakage	100	100	100	100	nA
	80°C Leakage	*	100	100	*	uA

*Not Specified

General Electric's new H11G incorporates the first significant performance improvement since the introduction of the Darlington optocoupler — an integrated base shunt resistor.

H11G series is designed to interface logic circuitry in 24, 28, 36, 48 volt dc loads in applications such as telecommunications, industrial controls, transportation and business machines. The high gain and current capability also prove valuable in noise immune, cost optimized triac triggering circuits for AC power control.

All General Electric optocouplers — phototransistor, SCR, analog FET, ac input — offer high reliability, maximum current transfer and low degradation because of the liquid phase epitaxial IRED process.

For technical literature and a free sample of the H11G1, 2 or 3 problem solver, contact your local GE distributor, electronic component sales office or write General Electric Company, West Genesee Street, Mail Drop A, Auburn, NY, 13021.

222.26



**GE makes the big difference
in semiconductors**

GENERAL  ELECTRIC

version consisting of three custom C-MOS chips plus a couple of standard ICs. Furthermore, this multi-chip design will most likely shrink to a single large-scale C-MOS IC before Salplex takes to the road in a production car.

Democratic. Though the use of a coaxial cable is novel, the real originality in the Salplex scheme lies in its completely asynchronous operation. The system is entirely democratic—there is no master controller to fail and bring the entire system down. Instead, healthy transmitter-receiver units will continue to communicate with each other despite the failure of any one of their number. Asynchronous operation also guards against the possibility that synchronous noise might corrupt transmitted data totally.

Once the bus is free, any transmitter can seize it and will then transmit eight 10-bit data words, one for each of the eight loads it controls. The transmitter is then inhibited from further transmission for 66 milliseconds, and this pause gives time for the remaining 31 transmitters to communicate with the bus. In this way all data in the system is repeated 15 times a second.

Each 10-bit word comprises a 5-bit address for up to 32 receivers, a 3-bit address to specify the load, a parity address bit, and a single data

bit (see figure). By varying its pulse height, the single data bit can be made to represent either an on-off command or an analog voltage level, but in view of the current trend to transducers with digital output, the scheme has been modified so that a location address could be followed by a full 8-bit data word. However, Williamson will not spell out the details.

Timely. Without a master clock to beat time for the rest of the system, each data word is preceded by a long synchronizing pulse, and interspersed between every 3 or 4 bits is a clock pulse, so that each data slot can be accurately sampled by the receiver for the presence or absence of data. That way system clocks need only lie within 10% of their design speed, Williamson says.

Other subtleties are built into the system. Priority loads such as brake lights can jump the line of transmitters waiting to use the bus. Every load has an inherent time constant or is supplied with an electronic time constant, so that several signals in sequence must be received before a load is switched.

Again, when a receiver is commanded to change the state of a load, the change is not implemented until the transmission is completed so that switching transients cannot corrupt transmission. **-Kevin Smith**

Japan

Government and industry join in drive to develop optoelectronics

Japan's government and industry are teaming up to force the blooming of the optoelectronics industry.

Research is accelerating on a government-sponsored eight-year \$80 million project to develop sophisticated optical measurement and control systems suitable for large plants or industrial parks. Later this year an industry group similar to the VLSI Technology Research Association will be formed to manage the project, probably with the aid of a laboratory similar to but

smaller than the recently disbanded VLSI Cooperative Laboratories.

Meanwhile a partly industry-backed foundation for the promotion of the optoelectronics industry has just been set up (so far it has no official English name). In its first year its work will encompass the entire optoelectronics field, as well as a total optoelectronic system survey to be done under contract for the government project. Overall, the foundation will attempt to set goals for the direction of development and

spell out the problems that need to be solved. It will conduct both surveys of the state of technology at home and abroad and feasibility studies for new systems. Also on its list of activities will be standardization of vocabulary and test methods.

The foundation will build its fund of about \$2.1 million during a two-year period, half from contributions of optoelectronics manufacturers and half from a portion of the profits on bicycle racing betting, which must by law be used for the promotion of industry. Operating monies will be derived from the earnings of the fund and from contributing memberships. The foundation will have only a very small staff of its own, with most of the important work being done by task forces and by committees of scholars or engineers from industry that will provide a general view and guidelines. The foundation will neither develop materials or devices nor maintain a laboratory, because it is felt that these joint activities would cause a loss of vitality. All research and development will be done by manufacturers at their own risk.

Specialties. The Ministry of International Trade and Industry selected measurement and control systems for its project because this field appears to be one that is both needed and feasible but neglected. Nippon Telegraph and Telephone Public Corp. and others are working on fiber-optic communications, though this market may develop slowly in view of the fact that the transmission equipment now in place should last at least another 20 years. Computer manufacturers are working on data-processing applications, including laser printers, optical-disk data storage, and facsimile. One other field, however, optical-energy transmission, is being left for the future.

In its preliminary plans, MITI envisions five subsystems. A high-speed picture subsystem will implement direct measurements, transmission, and monitoring of picture data from multiple locations. Another picture subsystem will permit processing, recording, and distribution of high-quality picture data with

SCIENCE/SCOPE

A revolutionary mosaic infrared seeker, which creates TV-like pictures of a scene's radiated heat to allow missiles to lock on and guide themselves to tactical military targets, promises to provide increased performance at reduced size, cost, and complexity. The seeker incorporates more than 1000 infrared detectors mated to a corresponding number of charge-coupled devices used for signal processing. All these elements are located at the focal plane of the seeker. Unlike conventional sensors, which mechanically scan a scene, the focal plane array "stares" at an entire scene to provide extremely high sensitivity. The seeker, only four inches in diameter, is being developed for the U.S. Army and the Defense Advanced Research Projects Agency (DARPA) for a man-portable "fire-and-forget" missile for day and night operations.

A new series of PIN photodetectors uses high-purity intrinsic silicon for high responsivity. The devices operate over a broad wavelength range spanning the entire visible spectrum from 400 to 1100 nanometers. At 900 nanometers, responsivity is .63, and quantum efficiency is 87 percent. Applications include computed axial tomography, instrumentation using lasers, and fiber-optic communication and data links. Hughes HPIN diodes are available in single and multi-element arrays in standard or special configurations.

Technology borrowed from TV-guided missiles is helping to make better and less expensive microelectronics. Hughes is building automatic wire bonders that use pattern recognition techniques based on those the company developed for missile tracking. The difference in the approach is that where missile electronics seek targets such as tanks, the TV-equipped bonder locates reference points to position dies on substrates. Once a match is made, the machine bonds gold wires on the substrate to interconnect different circuits. The bonder positions a die in one-third the time needed by a human and is five times as accurate.

Career growth opportunities exist at all levels at Hughes Support Systems for a variety of engineers qualified by degree or extensive work experience. They include systems engineers and software and hardware design engineers for major simulation and test equipment programs. Also, field engineering posts throughout the U.S. and the world offer travel, autonomy, and responsibility for the life cycle of Hughes electronic systems. Phone collect (213) 670-1515, Ext. 5444. Or send your resume to Professional Employment, Dept. SE, Hughes Aircraft Company, P.O. Box 90515, Los Angeles, CA 90009. Equal opportunity employer.

A unique sun shield will protect the antenna dish of a communications satellite from temperature changes that could distort the antenna pattern and interfere with the spacecraft's performance. The covering, made of specially treated Kapton foil, shuts out the sun's thermal energy yet allows radio signals to pass through. The shield will be installed on satellites that Hughes is building for Satellite Business Systems and Telesat Canada. The SBS spacecraft will provide U.S. businesses with voice, data, facsimile, and teleconferencing services beginning in 1981. The Anik C satellites for Telesat will serve Canada with audio, video, data, and telecommunications services.

Creating a new world with electronics



more than 1,000 by 1,000 picture elements. A fast data highway will link more than 20 measurement and control terminals without relays. A fourth subsystem will use wavelength multiplexing to provide more than 20 parallel channels for data measurement, transmission, and process control. Finally, a data-control subsystem will be able to operate at more than 1 gigabit per second.

Foundation funds appropriated so far include \$90,000 for total system design, \$300,000 for subsystem design, and \$3.6 million for development of devices and fiber optics. Nippon Electric Co., Toshiba Corp., Fujitsu Ltd., Hitachi Ltd., and Mitsubishi Electric Corp. are among the firms developing devices like monolithic integrated diode arrays and optical waveguides for wavelength-multiplexed transmission sources, and visible light lasers.

In addition, Furukawa Cable Works Ltd. is developing infrared optical fibers and Sumitomo Electric Industries Ltd. is developing fiber bundles with more than 1 million individual fibers for high-quality picture transmission (the diameter of this bundle is said to be on the order of 1 centimeter). These same companies will be the main members of an optoelectronics association when one is started.

-Charles Cohen

West Germany

GTO device switches 1,500 V in 0.5 μ s

A gate turn-off power semiconductor device, compatible with microprocessor requirements, operates on gate currents as low as 100 milliamperes and switches on and off in less than 0.5 microsecond. A gate turn-off switch—GTO for short—it comes from the Electronic Components and Materials (Elcoma) division of NV Philips Gloeilampenfabrieken in the Netherlands.

Elcoma's GTO combines the thyristor's high-voltage and high-current handling with the simple gate drive and fast switching common for

The GTO demand

Because of its versatility, the new gate turn-off switch will eventually claim a sizable chunk of the power device market, according to Peter ten Have of Philips' Elcoma division. As he figures it, this year's worldwide market for semiconductor devices—encompassing mainly thyristors, bipolar power transistors, and Darlington's, but not radio-frequency power transistors—will amount to about \$1.2 billion and grow in dollar value between 5% and 10% a year in the near future.

For GTO devices and those of the relatively new power MOS variety, ten Have sees much faster growth ahead. By 1985, he says, sales of power MOS and GTO devices together could account for about 15% of the total power device market.

-J. G.

bipolar transistors and Darlington's. Like a thyristor, it can be turned on by a positive gate drive and, like a transistor, turned off by a negative gate drive.

Developed at the Philips power products facilities in Stockport, England, where it will also be produced in volume, the device will be described at the Sept. 3-5 Power Conversion Conference in Munich, West Germany. The first samples will also be shown there.

The initial BTW58 family will come in 1,000-, 1,300- and 1,500-volt versions, all with a maximum on-state current of 5 amperes. Sam-

ples will be offered shortly and volume quantities will become available early next year.

According to Peter ten Have, product manager for power semiconductors at Eindhoven-based Elcoma, the new GTO should appeal both to transistor-oriented designers as a rugged and fusible high-gain, high-voltage latching transistor and to thyristor-oriented designers, because it can be turned off at the gate and hence needs no commutation circuitry, inductors, or capacitors.

The GTO is a three-terminal, four-layer pnpn device, resembling a thyristor in structure and a pair of npn

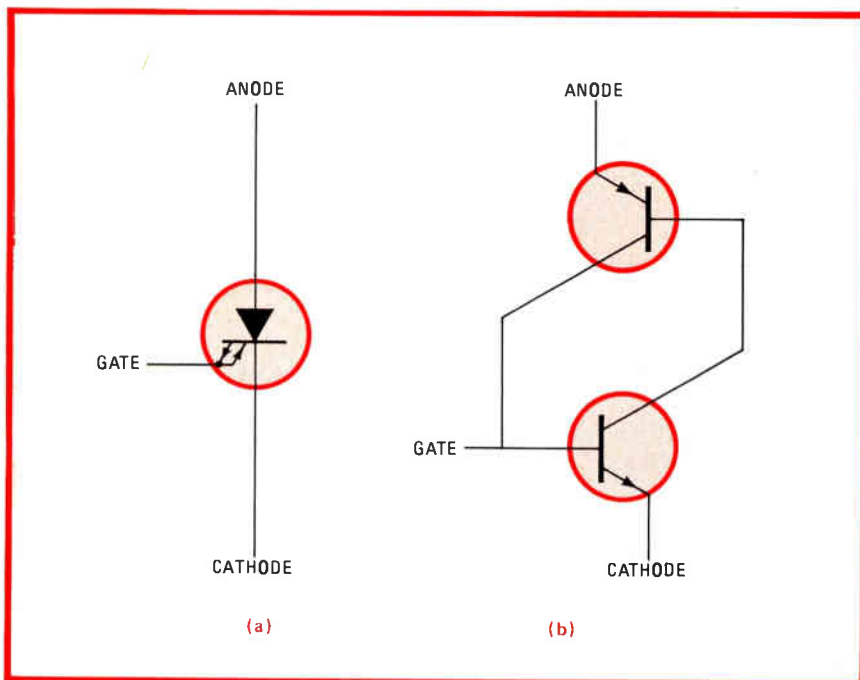

On, off. A gate turn-off switch (a) functions like two transistors (b). A positive gate turns on npn transistor, whose collector acts as the base for the other, pnp transistor. If sum of gains exceeds 1, GTO turns on. Negative drive turns it off.

First leadless chip carrier memories.

The military package of the future is here today, in quantity, at DIP-competitive prices.

MOSTEK.
MILITARY UPDATE

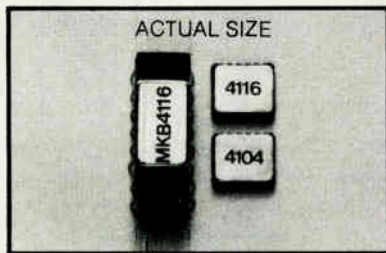

If your military system design calls for truly high density packaging, our leadless chip carrier memories are the answer. Our industry standard MKB4116E⁺ 16K dynamic RAM in a LCC package is a good example. Screened to MIL-STD 883 Class B, this 285 mil x 350 mil hermetic carrier has all the quality and reliability you expect from a standard ceramic DIP, yet occupies less than 25% of the board area. Is 5 times lighter. And because our unit production is in the millions, it's priced comparably to the same circuit in side-brazed DIP. Attachment methods include reflow soldering to a ceramic motherboard or other substrate with standard techniques.

As evidence of our support for this package type, JAN pre-qualification is already in progress. The same spec that defines our QPL listed 4116 in side-brazed DIP [MIL-M-38510/240 (USAF)] also details the case outline (Z) for our chip carrier. So you can expect us to pursue QPL listing for the chip carrier as well.

Other chip carrier memories from Mostek include the low power MKB4104 4K static RAM. It's also available now, in production quantities. Coming in 1981 will be the MKB2147 fast 4K static RAM and the MKB4516 5V 16K dynamic

RAM. Also, look for next generation BYTEWYDE* memories of compatible RAM, ROM, and EPROM circuits in a new 450 mil x 550 mil, 32-pin chip carrier designed to meet JEDEC standards. Commercial Hi-Rel versions with extended burn-in will be available too (prefix "MKM").

Leadless chip carrier memories from Mostek Military. Not just an isolated innovation from the

world's leading supplier of dynamic RAMs, but part of a long-range commitment to pioneer the memory package of the future.

For detailed specifications, consult the 1980 Mostek Memory Databook or contact: Mostek Military Products, 1215 West Crosby Road, Carrollton, Texas 75006 (214) 323-6250/6821. Chip carrier mechanical samples available on request.

LCC MILITARY MEMORIES

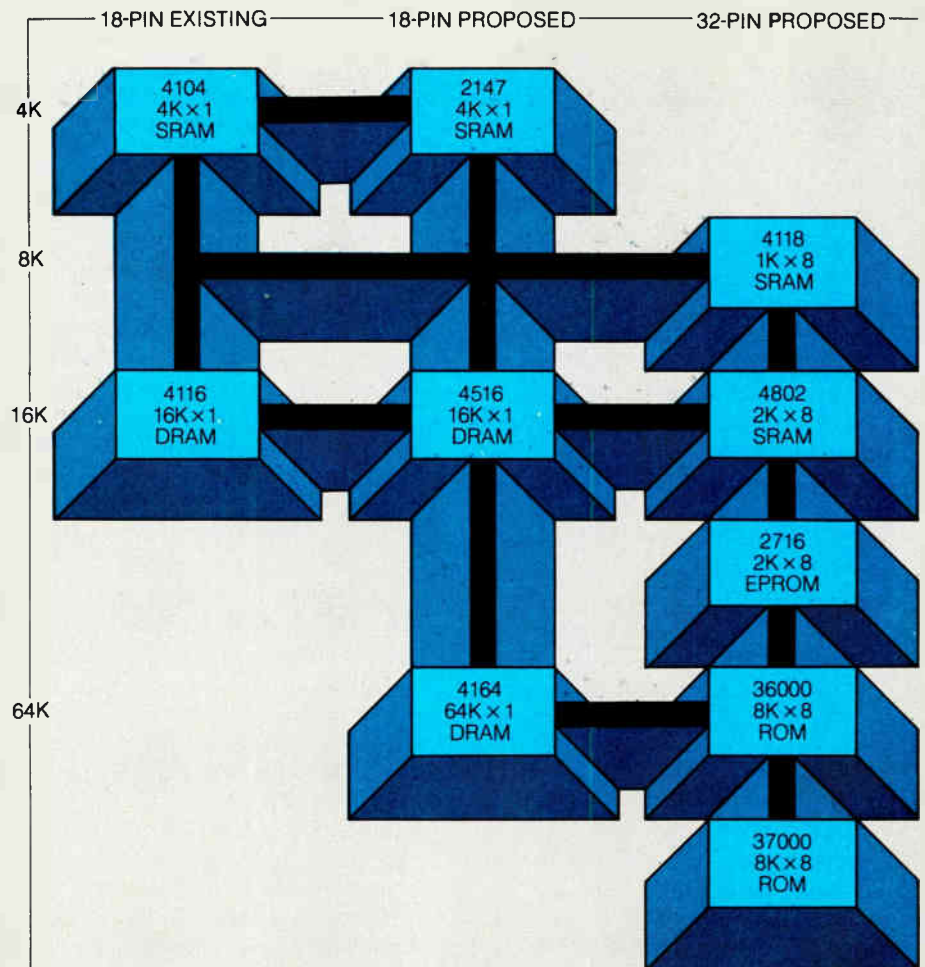

*The prefix "MKB" denotes full MIL-STD 883 Class B processing.
*BYTEWYDE and MOSTEK® are trademarks of Mostek Corporation.

and pnp transistors in operation (see diagram).

As Henk Rem, technical commercial manager for power semiconductors at Elcoma, explains it, its four layers give the device several advantages over the three-layer transistors and Darlingtons—most obviously its higher voltage- and current-handling capabilities.

The first of these capabilities frees users from "worry about safety margins and transients," Rem points out. The second promotes device saturation, permitting a smaller chip to be used and a high overload capacity to be obtained. The 5-A BTW58, for example, can pass 50 A without damage.

At about 16 square millimeters (24,800 square mils), a 1,500-V 5-A GTO occupies roughly half the chip area a bipolar transistor would need and a third the area of a power MOS device, were it possible to build these two components with the same voltage and current ratings.

Fast on and off. Also distinguishing the GTO from high-voltage bipolar transistors and thyristors are its fast switch-on and switch-off times of less than 0.5 μ s (achieved by driving the gate correctly) and its low fall time of less than 1 μ s, including turn-off (achieved by gold doping). The GTO has a dynamic dV/dt capability of 1,000 V/μ s.

Glass passivation ensures stability of device parameters, and void-free bonding makes for high thermal stability. The thermal resistance from junction to mounting base is a low 1.5°C/watt in the TO220 package the device uses.

—J. G.

Great Britain

Chips, twisted pair build simple local net

A local computer network that appears to the user to place all its resources entirely at his disposal does so by extremely simple means—a twisted-pair cable plus two large-scale integrated interface circuits for each attachment, be it

processor, peripheral, or disk store.

Under construction by Prof. David Wheeler and Andrew Hopper at the Computer Laboratory of Cambridge University, it is attracting the attention of British companies. A commercial version will be out next year from the software and systems company Logica Ltd. [*Electronics*, April 12, 1979, p. 63].

The Cambridge Ring, as it is called, is an updated LSI version of an earlier TTL-based net that has been in operation at the university for four years but whose capacity is now being stretched. The second ring's two LSI circuits employ uncommitted logic arrays of 1,000-gate complexity from Ferranti Semiconductors and are the equivalent of some 80 TTL package mounted on one interface board in the earlier ring. Samples of the chips—the second design iteration—are expected within five weeks.

The Computer Laboratory is devising a gateway interface that will enable the two rings to communicate with each other. Local networks of any desired capacity or response will then be configurable.

The Cambridge Ring meets similar goals to those Ethernet, developed by Digital Equipment, Intel and Xerox, which links equipment by a coaxial cable in a building or a group of neighboring buildings [*Electronics*, June 5, p. 89].

But there are differences, and each will likely find its own applications. As a simultaneous broadcast system using passive coaxial-cable links, Ethernet has a high inherent reliability. The Cambridge Ring is cheap—around \$2,000 per station for a 15-station system—error-free, and modular, allowing ready expansion, and it squares well with fiber-optic technology. But, though reliable in other respects, it is disabled by the failure of any one element—a drawback its advocates recommend overcoming with a parallel standby ring or by the provision of a continuous maintenance mechanism.

Empty packets. The ring's attractions stem from its conceptual simplicity. By adopting a ring structure, bus contentions and therefore arbi-

tration and routing problems are avoided. On being switched on, the network creates a procession of empty data packets that circulate round the ring, like containers in an pneumatic-tube transport system.

Each 38-bit packet begins with a start-of-packet bit and a second bit that indicates whether it is full or empty. The third bit is used by a monitoring station to delete packets that are circulating indefinitely because of errors. Two 8-bit address bytes for destination and source follow and then come two 8-bit data bytes. The packet finishes with 2 control bits and a parity bit.

The ring communications hardware at each interface port examines the address of each packet and interrupts the machine to which it is connected only if the packet is addressed to it. Otherwise the packet is transmitted to the next port down the line without interruption. To prevent any one device from monopolizing the ring, each packet is cleared by the sender before being passed on.

Long hops. The ring, which operates at up to 10 megahertz, has a maximum distance between nodes of 100 meters, compared with 200 m for Ethernet. But the researchers have also developed, with support from General Electric Co. Ltd.'s Hirst Research Laboratories, a fiber-optic link for use in long hops and in noisy environments. Error rates for the system are 1 in 5×10^{11} .

As for Logica Ltd., it plans to use the ring to link its word processors, currently marketed by the National Enterprise Board-backed Nexos Ltd. office equipment venture, and also sees a use for it as a program development system, with several video terminals sharing a big disk. According to Pat Cowen, who heads work on the ring at Logica, the hope is to market a ring system next year with interfaces to most common microcomputer buses.

Toltec Data Ltd. a Cambridge-based software firm, is also marketing its version of the ring, and International Computers Ltd. is interested in the ring for linking its word processors and small office computer and data-collection systems. —K. S.

Meet HP's new System 45C color graphics computing center. It plugs into the wall--not into another computer.



Engineering Design

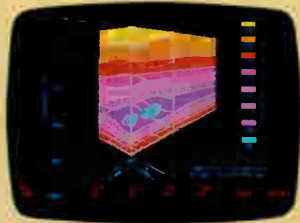

Scientific Research and Analysis



Complex Data Presentation



Management Graphics

Imagine what you could do with a powerful, easy to use graphics system that sits on your desk and is not dependent on another computer. A desktop computer that combines outstanding color graphics and the computational power to handle complex problems. All built into a compact, functionally-integrated unit, and all under your own individual control.

Based on HP's proven Series 45 desktop computers, System 45C is much more than a display. It's a color graphics processing system with significant computational abilities.

You get to your solutions faster through new developments in graphics language extensions to BASIC.

High resolution and 4913 bright, crisp colors give you a realistic, lifelike display of your design. A light pen lets you work interactively with color images.

Solving tough problems with an outstanding color graphics system, up to 449K bytes of user-available read/write memory, and high-performance I/O is a rewarding experience when it's done the HP desktop system way — under your total control, and at your own pace. To learn more about the graphics capabilities of HP desktop computers, and to request literature or a demonstration of the new System 45C, please turn the page.

400 2

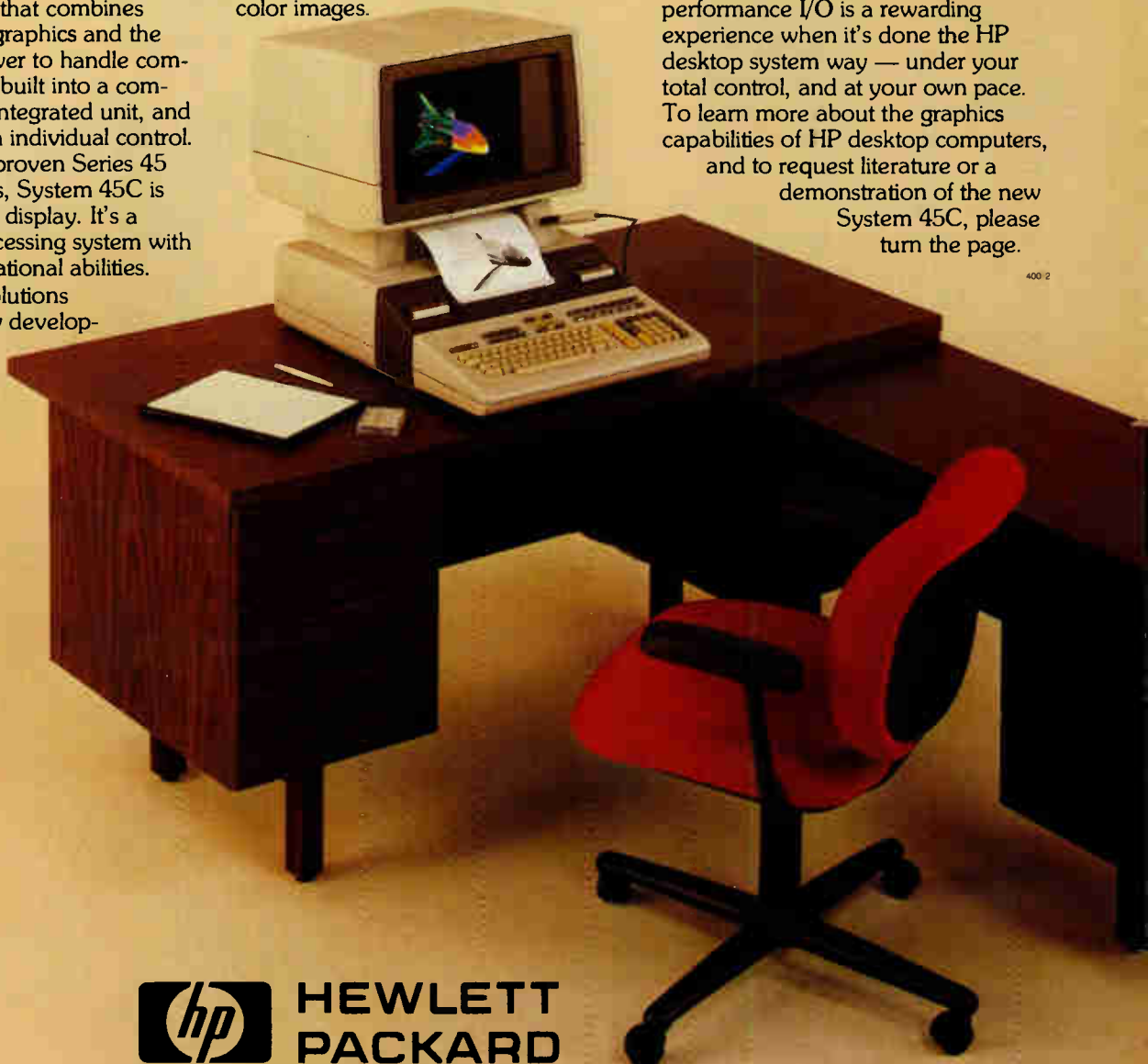

**HEWLETT
PACKARD**

Scientists and engineers computer systems powerful

Why?

The Power of HP Graphics.

Today's Hewlett-Packard desktop systems offer an impressive array of powerful graphics capabilities to help you analyze data more thoroughly and solve complex problems more quickly. With both full-color and monochromatic displays, and a broad range of HP input, output and storage peripherals, it's easy to tailor a graphics system to match your needs. And, you'll realize benefits that reach well beyond the power of display graphics.

HP systems today give you powerful computing capabilities with user-available memory to 449K bytes, high-performance I/O, data base management and mass memory options to 120M bytes. Whether you're computing, optimizing a design or acquiring data from instruments, HP graphics systems put big computer power under your individual control.

An Interactive System.

Your data can be entered in a number of ways. You can use the desktop computer's interactive key-board. Or, if you're



working with drawings, photographs, maps and other graphic material, the HP Digitizer enables you to transfer this data to the computer. System 45C's Light Pen provides a natural way to let you move and construct objects on the system's CRT screen.

Results the Way You Want Them.
Your HP graphics system will let you

choose the way you want your results presented. You can display your solutions on the desktop computer's CRT screen, and the image can be dumped onto the



find today's desktop graphics tools.

desktop's built-in printer. Your output can be in the form of color plots or overhead color transparencies, made by an HP four color plotter. These can be useful in group presentations. Printed results, including letter

quality output, can also be obtained from HP printers. When your system is assembled to give you the graphic results you want, HP's high-performance language and industry standard I/O will ensure smooth interaction among all the components.

Advanced Graphics Language.

To simplify your development of computational graphics, we've formulated a graphics language extension of HP Enhanced BASIC. With up to 70 commands, our graphics language eliminates numerous statements and hours of programming, letting you quickly manipulate monochromatic and color images from simple charts and diagrams to complex geometrical figures.

Extended Capabilities.

The power and versatility of your desktop system can be extended through two new HP capabilities. Data Comm allows desktops to communicate with larger mainframes in High Speed Asynchronous or Bisynchronous modes. With this capacity, the desktop becomes a very powerful and fully integrated work station in a large computer system. Technical Data Base Management provides HP's award-winning IMAGE facilities that let you access information in the system without writing applications programs. DBM also includes a powerful adaptation of the QUERY inquiry program.

A Choice — and Two New Systems.

We build a broad range of desktop computers, with one just right for your graphics applications. The new System 45C offers powerful color graphics and up to 449K bytes of computational power.



System 45B provides monochromatic graphics (including 3-D) and large read/write memory capacity. The new HP-85 is a modestly priced professional desktop computer with integrated graphics, CRT and printer. All three of these systems can be used with HP peripherals.

A Growth Path.

As your needs expand, HP desktop computers can communicate with the HP 1000 family of real-time computer systems over data links. For dedicated graphics applications that require a multi-user, multi-terminal system, the HP 1000 Model 45 includes a graphics terminal and versatile graphics/1000 software. The multi-programming power of an HP 1000 can be teamed with the graphics devices described above, and can also control up to four full-color graphics display systems.

For more information. Call 800-821-3777, extension 303, toll-free day or night (Alaska and Hawaii included). In Missouri, call 800-892-7655, extension 303. Or write 3404 E. Harmony Road, Fort Collins, Colorado 80525.

For a demonstration. Call the HP regional office nearest you: East 201/265-5000; West 213/970-7500; Midwest 312/255-9800; South 404/955-1500; Canada 416/678-9430.



**HEWLETT
PACKARD**

Let's Cut Through the Haze of Specmanship and Gimmicks . . .

Simpson Hand Portable DMMS Have The Features You Really Need!

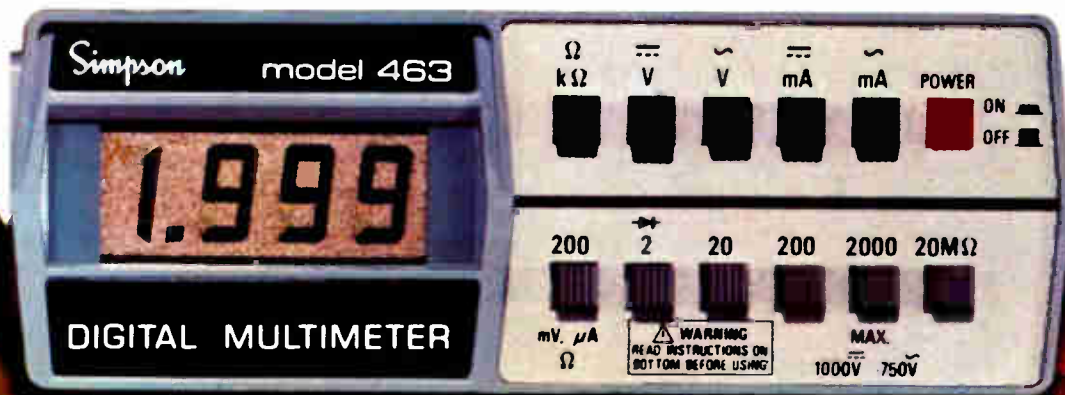

Model 463
Actual Size!
\$190



Model 461
\$178



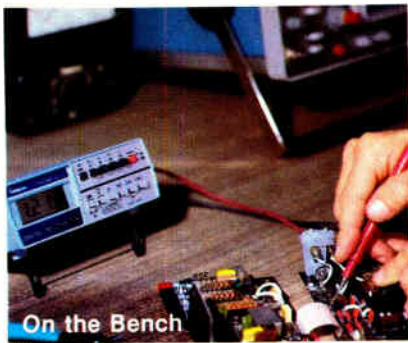

On the Bench



On the Shelf



In the Field

The Best All-Around Design for hands-free measurements in all situations . . . in the production line, on the service bench, on the test-lab shelf, in the field.

Designed For Years Of Trouble-Free, Reliable Service by the maker of the world famous 260®.

These Simpson hand portable DMMs meet the new UL 1244 standard for safety of electrical and electronic measuring and testing equipment.

. . . and also meet ANSI C39.5.

Built To Last, Inside And Out — on the inside, with quality-selected active and passive components Plus a *high-energy, double fusing protection system*; on the outside, with a rugged high-impact ABS molded case.

100%

Double Burn-In!

Every Simpson DMM gets double burn-in and final factory test of every range and function.

One-Year Warranty. Every Simpson DMM is backed by a *one-year factory warranty*. (Fully stated in operator's manual and warranty registration card. Copy available at factory or authorized Simpson distributors.)



UL Approved Safety-Engineered Test Leads are included with each instrument.

The Cordless Model 463 has easy-to-read .5" liquid crystal display, 26 most needed measurement ranges. Rated accuracy is 0.1% on DC V ranges. You can get up to a year of service on a 9-volt alkaline battery, included. **\$190**

The Popular Model 461 has large, bright .3" LED display, 26 most needed ranges, 0.25% DC V accuracy. Gives 8 hours of continuous battery operation on a single charge. *Price includes nickel-cadmium batteries and AC charger/adaptor.* **\$178**

The Autoranging Model 462 automatically selects the range and the decimal point position on voltage and resistance measurements. Has bright .3" LED display, 0.25% DC V accuracy. Gives 8 hours of operation on a single charge. *Price includes nickel-cadmium batteries and AC charger/adaptor.* **\$221**



Positive, Simple, One-Finger Push-button Selection of Functions and Ranges.

10 Megohm Input Impedance on both DC and AC voltage ranges . . . as most often referenced in factory service manuals.



A Broad Line Of Accessories expands the measurement capabilities of the 461, 462, 463 and other popular Simpson DMMs. (A) universal temperature probe, (B) rf probe, (C) high-voltage probe, (D) AC Ammeter adapter, (E) deluxe carrying case.

Available from Simpson Distributors Worldwide. Ask or Write for Free Catalog.



Model 462
\$221

Circle 85
Simpson
INSTRUMENTS THAT STAY

SIMPSON ELECTRIC
853 Dundee Avenue
Telex 72-2416 • California
(312) 697-2260

CMOS takes another giant step against NMOS.

RCA adds 12 new Microboards now,
7 more by the end of 1980.

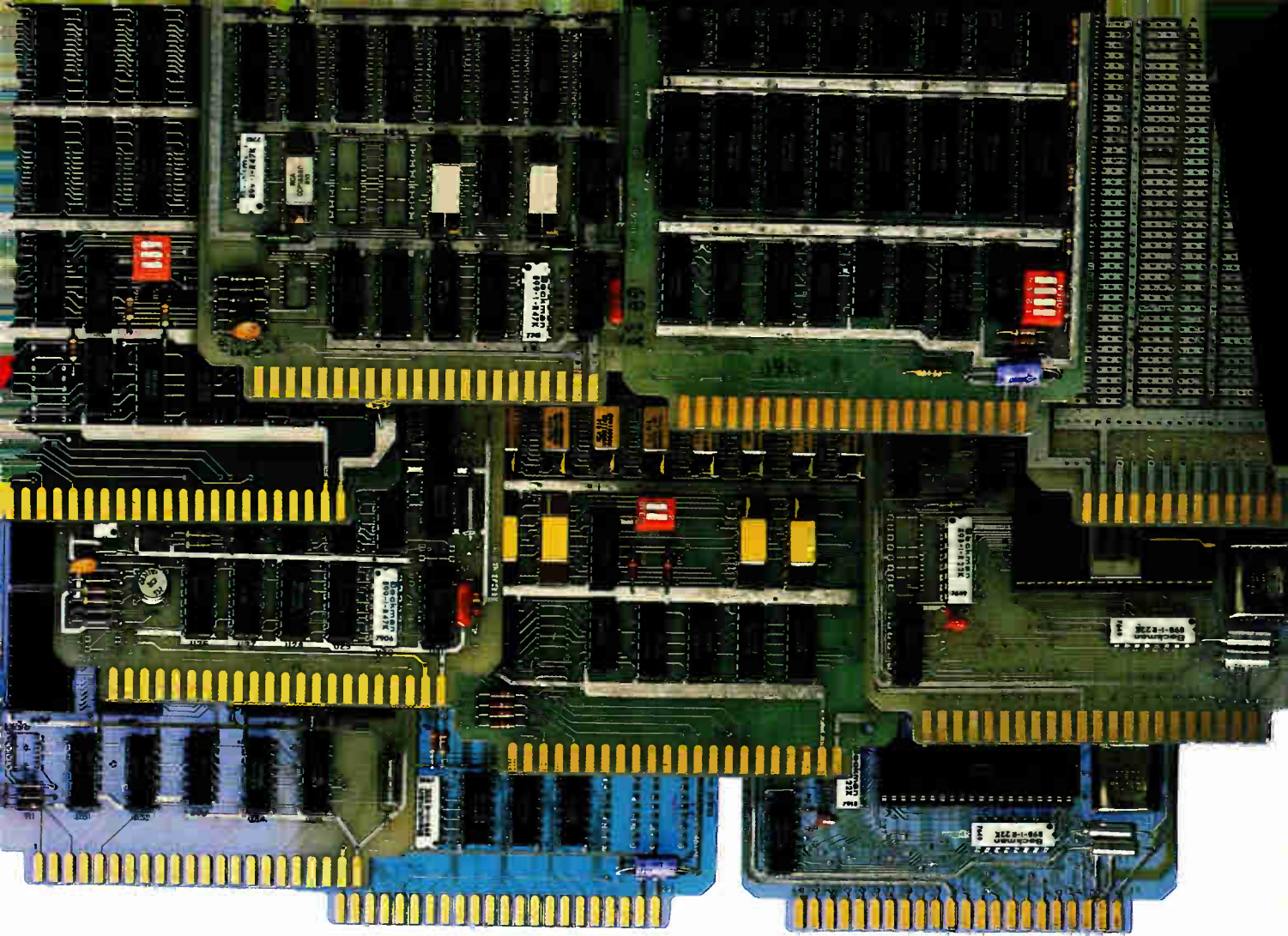

RCA CMOS Microboards consume far less power (7.0 milliamperes), give off far less heat, and provide more functions in less space (4.5 x 7.5 inches) than any NMOS board on the market. And at competitive prices.

With 17 boards available now (24 by 4th quarter 1980) plus a range of chassis and accessories, RCA can provide a CMOS system to suit a wide variety of applications.

Microcomputer boards.

CDP18S601 Microboard Computer w/4K CMOS RAM, 4K/8K ROM/PROM sockets, serial I/O port, 20 programmable parallel I/O lines

CDP18S602* Microboard Computer w/2K CMOS RAM, 2K/4K ROM/PROM sockets, UART, parallel I/O port

CDP18S603 Microboard Computer w/1K CMOS RAM, 4K/8K ROM/PROM sockets, serial I/O port, 20 programmable parallel I/O lines

CDP18S604* Microboard Computer w/512 bytes CMOS RAM, 1K/2K ROM/PROM sockets, parallel I/O port

Memory boards.

CDP18S620 4K Static CMOS RAM

CDP18S621 16K Static CMOS RAM

CDP18S621V1 16K Static CMOS RAM

CDP18S622 8K Static CMOS RAM/Battery backup

CDP18S623 8K Static CMOS RAM

CDP18S624 4K Static CMOS RAM/Battery backup

CDP18S625 8K/16K ROM/PROM

Combination memory I/O.

CDP18S660 40 I/O Lines, 2K CMOS RAM, 4K/8K ROM/PROM sockets

I/O boards.

CDP18S640 Control/Display Module

CDP18S641 UART Interface

CDP18S642 12 Bit D/A Converter

CDP18S643 12 Bit A/D Converter

CDP18S644* 8 Bit A/D-D/A Converter

CDP18S646* Parallel I/O

CDP18S649* LCD Interface/Display

CDP18S661V1* Video-Audio-Keyboard Interface

CDP18S661V3* Video-Audio-Keyboard Interface (PAL Version)

Chassis and accessories.

CDP18S023V1 5 Volt Power Converter (100 V, 50-60 Hz)

CDP18S023V3 5 Volt Power Converter (220 V, 50-60 Hz)

CDP18S480 PROM Programmer

CDP18S502 Extender Card

CDP18S659 Breadboard w/rewired power and ground

CDP18S670* 25 Card Chassis w/power supply

CDP18S675 5 Card Naked Chassis

CDP18S676 5 Card Chassis w/Case

Prototyping systems.

CDP18S691 Microboard Prototyping System with CDP18S601 Computer Board

CDP18S692* Microboard Prototyping System with CDP18S602 Computer Board

Full design support.

RCA Microboards are backed up by a complete line of hardware and software compatible development systems.

Plus, 36 RCA "Systems Appointed Distributors" offer technical assistance, systems demonstrations, and off-the-shelf delivery.

For more information and a free brochure on RCA Microboard Computer Systems, contact your local RCA Distributor.

Or contact RCA Solid State headquarters in Somerville, New Jersey. Brussels, Belgium. Tokyo, Japan.

*Coming in 1980

RCA

Circle 87 on reader service card

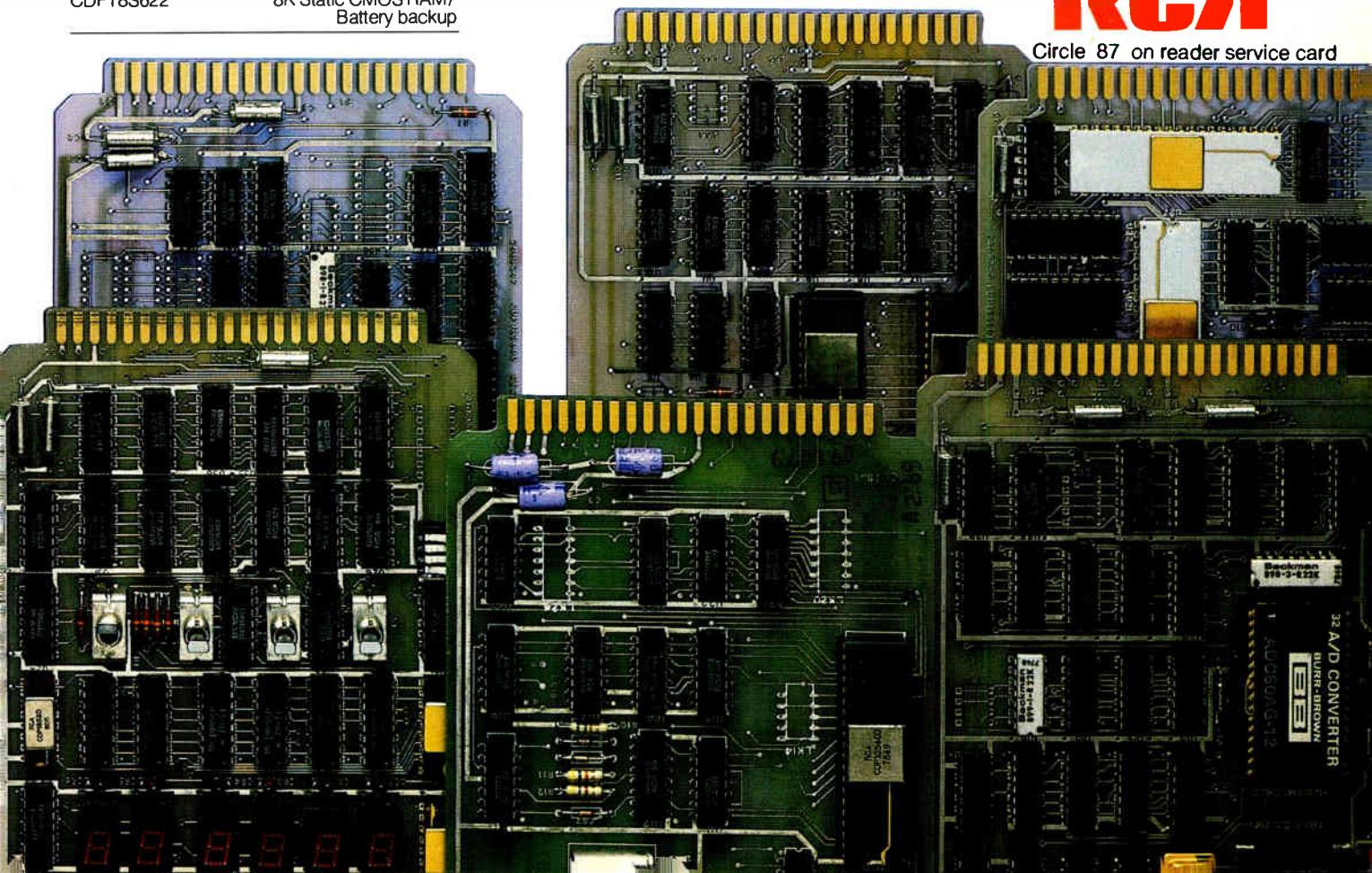



Inside the news

Electronics firms are following new anti-recession strategies, building outside California, and watching nervously as foreign money and plants move in

The New West: an industry on the move

by Howard Wolff, Assistant Managing Editor

Nothing is so constant for the electronics industries as change. In at least that respect, electronics and California are ideal mates. And as Wescon/80, the big electronics show and convention, prepares for its Sept. 16-18 stand at Disneyland in Anaheim, Calif. (see p. 190), electronics in that region stands on the threshold of some of the most fundamental changes in its relatively short history, many of them deeply affected by and affecting the Golden State of California.

With the nation in a recession, electronics executives are coolly fending off the extreme penalties of a slump with a new economic game plan. Then there is a new feeling for geography, a departure from the golden fields of Silicon Valley for other parts of the West, particularly the Southwest. Couple those with the arrival of new foreign investors buying interests in or control of existing companies, as well as new plants being built by foreign companies, and it is clear that the face of the West is changing. The 1980s, then, will see basic shifts in the industries and in the region.

The economic, political, and, perhaps, social climates are quite different from those of a mere 10 years ago. Most significantly, the industries seem to have matured and, at long last, learned from past mistakes like the painful experience of 1974. Notably, semiconductor manufacturers are not cutting back on capital equipment purchases as they did in the mid-1970s, when they pared such expenditures by 50% or more.

Rather, they are expected to continue to invest heavily in new generations of production equipment and the buildings to house that equip-

ment. At worst, semiconductor makers "are likely to buy 70% to 80% of what they're now budgeted for," predicts Ed Segal, marketing vice president at Computervision Corp.'s Cobilt division in Santa Clara, Calif.

Typically, Texas Instruments Inc.'s president and chief operating officer J. Fred Bucy says that its 1980 capital-spending plans, projected at \$570 million, are running on schedule. That figure is up from last year's \$435 million; Bucy expects the Dallas company to be able to stick to its spending plans in terms of the economic scenario he sees for the rest of the year. And Intel Corp. of Santa Clara plans to lay out \$150 million this year, half of which is earmarked for building and site expansion, says chairman Gordon E. Moore.

Equally reassuring is industry analyst Benjamin M. Rosen of Rosen Research Inc. in New York. He expects capital equipment expenditures by semiconductor makers, which rose 60% last year over 1978, to rise by 48% in 1980.

Hiring. Another basic change in philosophy from that of 1970 is the reluctance of semiconductor producers to lay off personnel. Most extreme is Jerry Sanders, president of Advanced Micro Devices Inc. of Sunnyvale, Calif. He promises that "no employee who is performing to AMD standards will be laid off." While it remains to be seen if he can stand by that pledge—or if many employees fail to come up to AMD standards—it reflects a realization that the rapid growth of the industry has led to great imbalance in the supply and demand of engineers and production personnel. Citing "a moral responsibility to our employees"

as well as a need to earn loyalty by first offering it, Sanders says, "If you believe in the future, it is self-serving and short-term to lay off employees." Such a policy, perhaps unprecedented in this country, is taken for granted in other places, particularly Japan.

Adding overtime. Intel's Moore does not go so far, saying, "We will be responsive to business pressures." But to avoid cutbacks, several Intel assembly operations have taken to "laying on" overtime heavily, rather than hiring new employees only to lay them off later. Although no additions are being made to the assembly force at three of its five fabrication facilities, Intel's operations near Portland, Ore., as well as its embryonic operations near Phoenix, are still growing.

Such are the lessons learned from the recession of 1974-75, when manufacturers lopped many people from their payrolls and cut their capital investments to the quick. The latter move "led to the Japanese getting a much greater share of market," says Greg Reyes, vice president of Eaton Corp.'s semiconductor equipment operations in Sunnyvale. Cobilt's Segal agrees. "The U.S. semiconductor industry can't afford to stop buying," he says. "The last time it did, the Japanese entrenched themselves in its markets." It is clear that Intel and its fellow manufacturers are determined that that will not happen again.

Another driving force behind increased capital outlays that the semiconductor houses cannot afford to ignore is changing technology. For example, new computer-aided-design (CAD) techniques will enable them to cope with the design prob-

changes where and how it does business

Inside the news

lems of very large-scale integrated circuits [*Electronics*, July 31, p. 73]. Once again determined to be a leader, Intel is demonstrating its awareness of the VLSI problem by spending up to a third of its equipment budget on CAD.

Getting those VLSI geometries below 1 micrometer also means using expensive electron-beam lithography, or other advanced production equipment, whose cost will have to be borne if leadership is to be maintained. The devices of the 1970s could be built with the equipment of the 1960s, says Eaton's Reyes. However, he adds, "In the 1980s, if semiconductor makers don't have revolutionary equipment, the latest generation of devices just won't happen—1-micron lines are not going to happen with the equipment of the 1970s." Larry L. Hansen, president of Varian Associates' Industrial Equipment group in Palo Alto, Calif., says, "They can't hold off buying the very latest equipment; they have to keep the technology moving or they are in trouble."

To illustrate, GCA Corp. of Bedford, Mass., notes that the latest automated wafer-processing and di-

rect-step-on-wafer systems turned out by its IC Systems Group in Sunnyvale are for 64- and 256-K dynamic random-access memories as well as bubble memories. "They are for plants that will make the newer generations of devices," says a spokesman. "The semiconductor manufacturers don't want to be caught short like the last time."

Keeping bookings. While the semiconductor people are focusing more these days on long-term forces than on the immediate economics, they are also keeping their eyes on book-to-bill ratios. For example, Intel reports a ratio above 1:1 for the first two quarters of 1980, but expects it to be slightly below unity in the third quarter and is uncertain about whether it will rebound in the fourth. Edward L. Gelbach, senior vice president and general manager of Intel's components group, labels September the bellwether month of the recession. Overall, says analyst Rosen, the semiconductor industry's book-to-bill ratio slipped from 1.3:1 in March to 1.1:1 in June.

One major concern in the last recession, but curiously of little moment this time around, is drastic inventory reductions by customers and distributors coupled with cancellations caused by multiple bookings,

or double and triple ordering, by customers. The reason: already tight inventories as well as close monitoring and reduction of multiple bookings that include deliveries scheduled for six months to a year from now.

"Our customers are working on less than 30-day inventories," says Intel's Moore, "and our backlogs are negotiated only within six-month periods." Intel, as well as other semiconductor makers, also tried to weed out orders from customers in financial trouble. Such close scrutiny of the customer base was not apparent in the mid-1970s.

Perhaps TI's Bucy sums up the picture best when he says that even though the industry may want to keep capacity full to be ready for the upturn, "you still have your shareholders to worry about" and profitability may be allowed to slide only for so long before cutbacks become necessary. Also, he says, the current recessionary period is a critical time for the U. S. semiconductor industry—a large cutback now would give the Japanese a hold that U. S. firms may not be able to regain.

Who's No. 1? Still another major shift that has taken place in the last decade is in the leadership profile of Western semiconductor makers. Then, Fairchild Camera and Instrument Corp. of Mountain View, Calif., held center stage. It was the principal raiding ground for competitors and start-up companies. In fact, many, if not most, of the firms that are now the darlings of investors and technology watchers have their roots in Fairchild.

Entering the 1980s, however, the technology leadership spotlight is on Intel, AMD, and Zilog Inc., among others. At the same time, Fairchild's image has dimmed. "I can't recall the last time an acknowledged technology leader was pirated out of Fairchild," notes one industry observer. And the acquisition of Fairchild by Schlumberger Ltd. likely will not enhance that image because of the close-mouthed policy of the new owner. But, as one Fairchild insider counters, "It's hard to argue with the policy of a company that makes 40% pretax profits."

A final and significant change in the economic picture is a reshuffling of the roles of competitors: the major

What a difference a decade makes

The more than 600 exhibitors that will fill approximately 1,200 booth spaces at Wescon/80 include several that displayed their wares at the Los Angeles Sports Arena and distant Hollywood Park racetrack back in 1970. But many, if not most, exhibitors bear little resemblance to those of a decade ago. Even more dramatic is the change in appearance, performance, and price of the hardware exhibits that, in addition to the professional program, are expected to attract upwards of 50,000 industry spectators and participants.

Unlike at the Wescon of 1970, there will be little ado about desktop calculators, under-\$1,000 digital instruments, and lasers. Neither will there be much discussion about whether MOS will ever become a viable semiconductor technology, nor whether light-emitting diodes can supplant Nixie tubes in digital equipment, nor whether minicomputers will erode the mainframe computer market.

Rather, the hardware caravan and 35 sessions, including nearly 150 technical and scientific presentations, will be rife with displays and discussions of 8-, 16-, and 32-bit microcomputers; single-board computers; personal computers; and bubble memories. There also will be telecommunications developments and advanced techniques of semiconductor design, production, and packaging, among other technological breakthroughs. As has become the custom of late, this year's array of electronic products will be in four groups—instruments and control systems; production, packaging, and test equipment; components, fiber optics, and microelectronics; and minicomputers, microcomputers, and peripherals—and many of the wares will have been brought from abroad.

—Bruce LeBoss

DATA I/O INTRODUCES A UNIVERSAL MOS EPROM PROGRAMMER FOR PEOPLE WHO THINK AHEAD.



System 19/MOS Pak programs all of today's EPROMs and offers plenty of room for future growth. MOS Pak lets you program all currently available EPROMs including the 2704, 2708, 2758, 2508, 2516, 2716, 2532, 2732, 2732A, 2564, 2764, 68764, and the new Hitachi 48016 EEPROM.

And what about the future? Simple software changes to the MOS Pak will enable you to program new devices as they're developed—even if you decide to design a 128K EPROM into your product.

Semiconductor manufacturers' approval provides user security. System 19/MOS Pak is the first "MOS only" programmer to meet the high programming standards set by the

semiconductor industry. Programming algorithms and waveforms have

received written approval from all of the manufacturers.



Approval plus

Data I/O's unique built-in calibration system assure you of high reliability and device yield.

System 19/MOS Pak is self-contained and easy to use.

System 19/MOS Pak goes where you need it: engineering lab, service department or in the field. It requires only ten seconds to set up and begin programming. Simply key in a four digit code for the particular type of EPROM you want to program. A lighted LED on the MOS Pak will tell you which socket to use.

And the MOS Pak's new programming algorithm for 64K devices can shorten programming time by as much as 75%.



System 19's modular concept incorporates a mainframe and a variety of programming paks.

With the System 19/MOS Pak, Data I/O now offers three great ways to program MOS EPROMs.

For EPROMs

- MOS Pak programs single MOS devices
- Gang Module programs eight EPROMs at once
- Unipak programs more than 200 MOS and bipolar PROMs

For individual PROM and logic families

- More than 40 approved programming paks

Let us show you the future. The Data I/O MOS Pak is available now.

To make arrangements for a demonstration or to get your free copy of our MOS programming brochure, circle reader service number or contact Data I/O, P.O. Box 308, Issaquah, WA 98027. Phone 206/455-3990 or Toll Free 800/426-9016.



DATA I/O

Circle 91 on reader service card

THINGS TO CONSIDER BEFORE YOU MAKE A DECISION

Is automatic testing a panacea? With today's PC volume and complexity, it's not so much a panacea as it is a necessity. But to implement a test solution requires a thorough understanding of the available test systems and your production environment.

When to test?

That's as important as how. The cost of fault identification increases dramatically with each production step. Thus, you want to catch faults as early in the production process as possible, but it doesn't necessarily follow that extensive incoming parts inspection is the answer. Your real goal is high turn-on rates in final test. That demands high-yield PC boards. And as the diagram below shows, several factors including good parts go into high-yield PC boards.

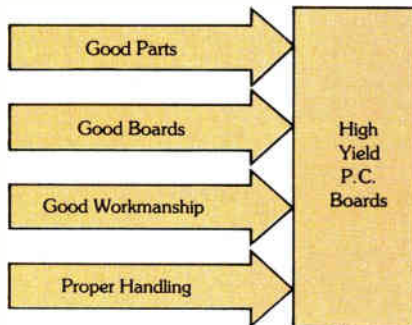

A PC board assembly process will produce anywhere from 20% to 80% good boards. A typical number is 60%. Of the faulty boards, a fault spectrum might look like this:

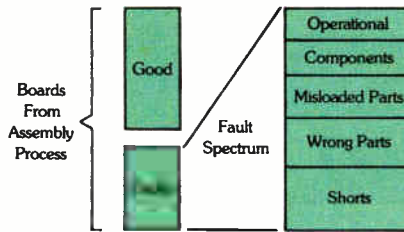

With a good board yield of 60% and no PC board testing, even a simple product with five boards would overload final test. This makes board level a good place for thorough testing. For this is the first opportunity to locate faults across the entire fault spectrum. But which tester is for you?

Choosing a circuit board tester.

There are no simple answers to selecting an automatic circuit test system. But, from our experience, we know that these are some of the factors involved: Production yield, test yield, fault spectrum, PC volume, board type, and anticipated new products.

Will the system test for the spectrum of faults that you will encounter? Will it generate component level diagnostic information? Will it test present and future board types and do it fast? Is it easy to expand and adapt to changing requirements?

What are the true costs? How much time and effort is involved in programming, debugging, fixturing and training? And will you get prompt, competent service if you need it? HP can help you answer these key questions.

Over two million boards worth of experience.

HP's new Automatic Circuit Test Systems are the result of our extensive in-house experience with automatic circuit testing.

In fact, we were spending such large sums on dedicated equipment and manual test stations that back in 1970 we developed an automatic circuit test system called Optest I. This system, along with its more recent companion Optest II, is still in operation today. Optest I and Optest II are now testing over 100,000 printed circuit boards annually. Our new circuit test system is, in reality, a third-generation product, which originated from over eight years' experience in actual in-use operation. Today, HP is using 46 of these new automatic test systems within our own plants.

The case for in-circuit plus functional testing.

The marketplace has many potential test solutions. You can choose from simple shorts testers to completely automated systems. From testers that measure components in-circuit to functional test systems that verify dynamic performance of complete circuits.

HP's new 3060A Board Test System (\$85,000* for standard operational system) is an advanced system that combines the latest in-circuit technology with functional testing. It includes a comprehensive software package for fast program development. It is a proven package, which combines ease of use with flexibility to handle tough test problems. The addition of functional testing to in-circuit testing may provide a relatively small increase in board yield. But that small increase can



3060A



ON AUTOMATIC TEST EQUIPMENT.

result in large improvements in product yield, as shown below. For example, in a ten PC board product, increasing board yield by only 8% (from 90% to 98%) will leverage product turn-on rate from about 35% to 80%. That's a large payoff, and an excellent reason to consider HP's 3060A.

PRODUCT YIELD VS. PRODUCT COMPLEXITY

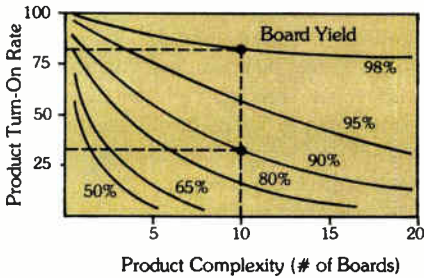

The standard 3060A has a full set of analog and digital functional testing tools for testing most analog, digital or combined boards including at-speed testing of microprocessor-based boards using signature analysis techniques.

Some boards, such as large complex logic boards, will benefit from the use of HP's DTS-70 Digital PC Board Test System (\$94,750* for standard operational system). This simulator-based tester tells you how effective your test programs are and identifies the portion of the circuit not completely tested. This is important feedback permitting better program development. A useful tool in R&D, the DTS-70 can model your designs and help you produce better products. Your test engineers will appreciate its ability to

model feed-back loops, find open traces and identify intermittent faults.

Just as important, the DTS-70's power and flexibility comes from its controller, the HP 1000 Computer System. Using a Real-Time Executive operating system, you can simultaneously test PC boards and develop new programs. As your testing needs expand, two more test stations and several programming terminals can be added without the expense of additional computer power. The operating system is compatible with data-base management software to keep track of your test data and help you better manage your production. The DTS-70 will easily fit into your long range computer network plans providing distributed processing and communication to your data processing center.

The bottom line.

Can automated PC board test equipment save you money? Again, there are no simple answers. But it has saved us money and chances are it will save you money, too, if any of these conditions exist in your plant: high PC volume, complex boards, production testing backlog, low turn-on rates of complete systems, high in-process inventory costs and high warranty costs.

Your production operation is unique, but we can help you characterize it by comparing the cost of testing, or not testing, at each level to arrive at your best test resource allocation. Let us help you answer these key test questions. Write for more details to Hewlett-Packard, 1507 Page Mill Road, Palo Alto, CA 94304. Or call the HP regional office nearest you: East (201) 265-5000, West (213) 970-7500, Midwest (312) 255-9800, South (404) 955-1500, Canada (416) 678-9430.

*Domestic U.S.A. price only.

DTS-70

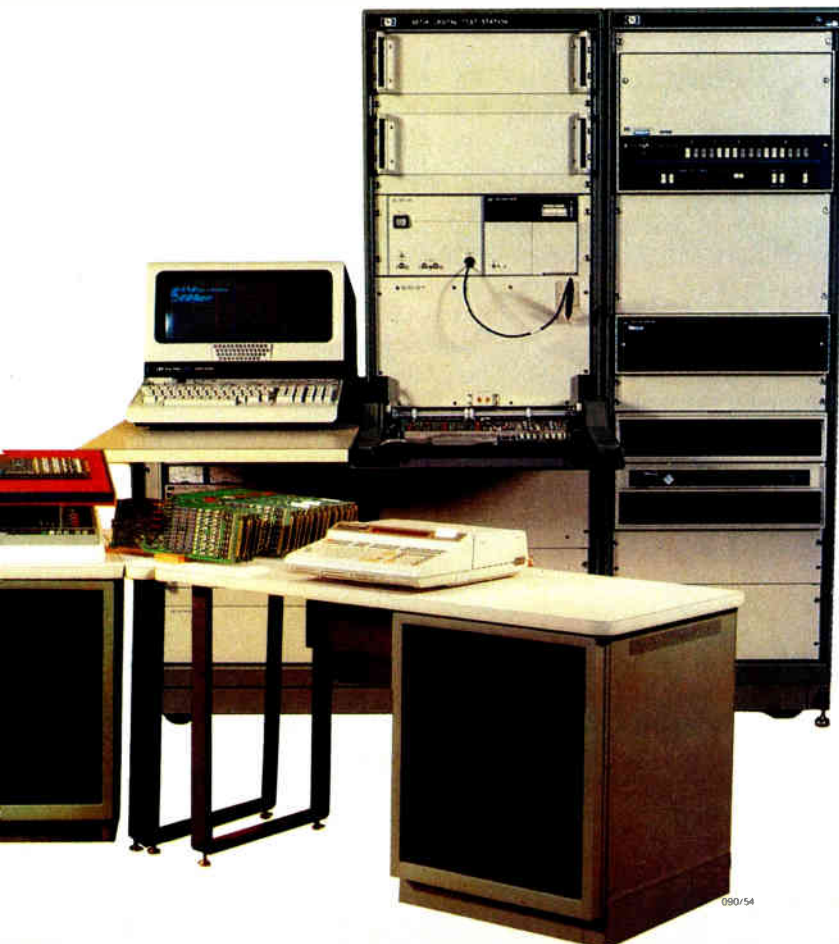

**HP Circuit Testers —
The Right Decision**



**HEWLETT
PACKARD**

Circle 93 on reader service card

Inside the news

West Coast semiconductor powers no longer view one another as the major competition. Instead, as Intel's Moore enumerates it, they are looking at competition from Nippon Electric Co. in the microprocessor area, from Hitachi Ltd. in dynamic random-access memories, and from Fujitsu Ltd. in electrically programmable read-only memories.

Not so bright. For West Coast computer and peripherals manufacturers, working in the broad shadow of International Business Machines Corp., things are not so sunny. For example, Memorex Corp. of Santa Clara has been ravaged by IBM's pricing and introduction of new disk memory systems as well as its own delays in bringing products to market. The result: two waves of layoffs totaling 330 persons, with estimates that the total will reach 1,200 to 1,600. Going through its most traumatic experience since 1974, Memorex reported a second quarter loss of \$24.5 million.

Still, IBM's continued strength in the disk market has not prevented new enterprises from springing up. In fact one firm, Dastek Corp., has been formed in Los Gatos, Calif., around several former IBMers to compete in the thin-film-head disk drive market [*Electronics*, April 24,

p. 201]. Dastek also represents part of a quiet diversification effort by Dysan Corp. of Santa Clara, a disk media maker. On the low-end of the hard-disk market, Dysan also funded the development of Shugart Technology's pioneering 5.25-inch Winchester disk drives [*Electronics*, June 19, p. 104].

IBM has not limited its accomplishments to the disk drive. Among makers of central processing units, the shock waves set off by IBM's 4300 series are just beginning to subside. One result has been the virtual absorption of Itel Corp.'s Data Products group, a manufacturer of IBM-plug-compatible machines, into a new National Advanced Systems subsidiary of National Semiconductor Corp. [*Electronics*, Oct. 11, 1979, p. 89]. National Advanced Systems is now waiting for Hitachi to decide whether to send its new super computer to the U. S. for National to market. What's more, as shall be seen later, several manufacturers have sought successfully to be taken over by foreign multinational corporations in order to survive.

The shadow also stretches over the large mainframe computer field. Amdahl Corp. of Sunnyvale, which appears at least for the time being to have weathered the impending announcement of IBM's so-called H series, has had a roller-coaster ride so far this year. The aborted merger negotiations with Memorex and then with Storage Technology Corp. have been accompanied by an equally up and down financial record for the first six months. In the first quarter profits plunged 97%, only to improve by 150% in the second quarter.

Two factors have helped such growth in the market for larger machines. First, there have been delays in the H series; second, lower interest rates spurred purchases rather than leases of systems. Also, the 4300 market is attracting some new vendors. One is Magnuson Computer Systems Inc. of San Jose, whose new M80/31 [*Electronics*, July 3, p. 210] is viewed as the first competitive response to IBM's 4331

Group 2 mainframes. Magnuson also has attracted the backing of giant venture capitalist Venrock Inc.

Looking up. For instrumentation, the decade brought with it a relatively soft order rate. "This does not mean an actual decline in dollar volumes, but rather a deceleration in growth rates," explains Bob Brunner, marketing manager for Hewlett-Packard Co.'s Instrumentation group in Palo Alto. "My guess is that in 1981 the acceleration will come back again, and that by the end of next year it will be back to speed," he predicts.

Brunner also is optimistic about the outlook over the full decade. "The electronics industry is going to be second only to the energy industry among world markets," he reasons, "and since instrumentation provides the tools that drive electronics, its long-term growth should be similar." Brunner also sees an acceleration of two trends that began in the 1970s: the increasing importance of automatic test equipment and the presence of electronic instruments in new industries. "Computers and microcomputers are automating a number of industries that formerly were not involved in electronics, and ATE instrumentation will follow the computers into those areas," he says.

The new geography. Recessions may come and go; profit curves may have their ups and downs; volcanoes may rumble in the Northwest; but one thing, for the electronics community at least, is a given: California's Santa Clara County, the peninsula south of San Francisco, is the *sanctum sanctorum* of the semiconductor industry. And, through the ripple and spin-off effects, it is also home to a great many instrument, computer, and peripherals makers.

But during the past few years, because of a confluence of causes ranging from high taxes and astronomical housing costs to personnel shortages and aggressive raids by other states and regions, there has been an outflow running from a trickle to a steady stream, depending on which chamber of commerce is doing the gauging. Although no one is going so far as to predict that the plants of Silicon Valley will be turned into bowling alleys, the trend has been strong enough to cause

Going to spend. TI's J. Fred Bucy says his company will stick to its capital-spending plans calling for \$570 million this year despite the slump in the nation's economy.



ACCEPTABLE PRODUCT YIELD IN FINAL TEST—THE BOTTOM LINE FOR A COMBINATION OF IN-CIRCUIT AND FUNCTIONAL TESTING.

In-circuit testing is a powerful test approach. But today's complex products require more than in-circuit testing. Higher and higher PC board yields are required to maintain an acceptable product yield in final testing.

Leverage product yield.

The addition of advanced in-circuit test techniques, together with functional testing, adds that extra increment to your PC board yield as shown below.

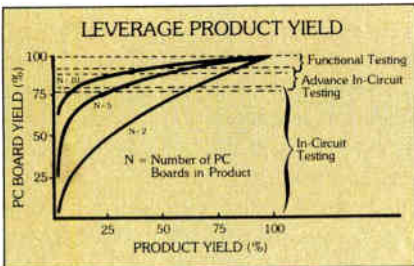

For example, in a five PC board product, increasing the PC board yield from 75% to 98% will leverage product yield from 23% to 90%. This can result in substantial savings, since the cost of fault detection increases dramatically with each production step.

What is advanced in-circuit testing?

In-circuit testers contact each PC board node through a bed-of-nails fixture. The system switches from component to component and "inspects" for value, placement, etc. Today, the wide diversity of component values, tolerances, components, and interconnections, means that conventional in-circuit techniques often leave some parameters untested.

On the other hand, the HP 3060A Board Test System (\$85,000* for standard operational system) utilizes advanced techniques that allow component isolation in commonly found but difficult circuit configurations. For example, a .01 μF

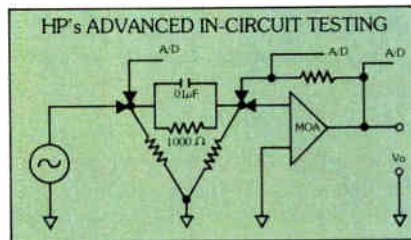

capacitor can be measured to an accuracy of 4% even when it is shunted by a 1000 Ohm resistor. The key to this measurement is a phase synchronous detector. This is a valuable tool for measuring components and circuits with significant real and reactive characteristics.

Functional testing makes the difference.

The standard HP 3060A also has a useful set of analog and digital testing tools. It incorporates board level stimulus/response testing in order that components such as operational amplifiers, DACs and optoelectric devices can be tested. This functional testing permits circuit parameters, such as frequency and period, to be measured and circuit adjustments made. The 3060A's functional testing capability extends to digital pattern, analog and combined circuits. For example, the 3060A can be used to test a D/A converter by applying digital patterns and then monitoring the analog output voltage.

At-speed testing of micro-processor boards.

The big news in PC board testing is the microprocessor. Conventional digital testers do not have the massive data storage required to test microprocessors. But the HP 3060A uses an HP developed technique called Signature Analysis to test these microprocessor boards at operating speed. The 3060A collects lengthy bit streams at circuit nodes and converts them to short, four-character hexadecimal signatures. Under test, the bit stream signature at each circuit node is compared to the expected value, making it easy to locate nodes with faulty signatures. This data compression technique makes microprocessor-board testing manageable. Company after company is becoming convinced that HP's signature analysis technique is the right solution to testing micro-processor boards.

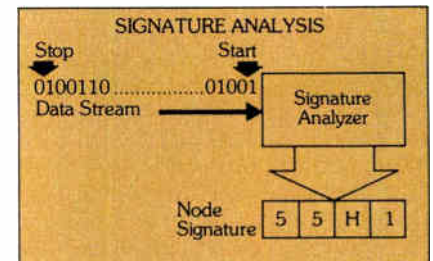

For complete details.

There are other benefits to PC board testing with the HP 3060A. For data sheets and application notes, write to Hewlett-Packard, 1507 Page Mill Road, Palo Alto, CA 94304. Or call the HP regional office nearest you: East (201) 265-5000, West (213) 970-7500, Midwest (312) 255-9800, South (404) 955-1500, Canada (416) 678-9430.

*Domestic U.S.A. price only.



**HP Circuit Testers—
The Right Decision**



Circle 95 on reader service card

Inside the news

some concern and some action in the way of tax cuts and other aid from Government.

Nevertheless, the hard fact remains that the valley is bursting at the seams and corporate planning officials are looking elsewhere—the Pacific Northwest, Colorado, Texas, and the Carolinas, for example—to expand their companies. But few, if any, want to move corporate headquarters out of the area.

The Santa Clara County Manufacturing Group, a nonprofit organi-

zation formed two years ago by the principal officers of the valley's major firms, projects that by the end of the decade an additional 225,000 to 330,000 jobs will be created in the area, a minimum increase over 1975 of 45%. In the same period, only 30% more housing units will become available.

No wonder, then, that Silicon Valley's semiconductor and other companies project that half of their growth during the next two years will be outside the area. This merely continues a recent trend: semiconductor plants have been built or proposed by Zilog in Idaho; Intel in

Oregon, Arizona, and Israel; National Semiconductor in Washington and Utah; and AMD in Texas.

Other industries are following suit. Typical are Memorex' plans to build on a 42-acre site in Plano, Texas; Shugart Associates' expansion in the Sacramento, Calif., area; and Apple Computer Inc.'s new facilities in Texas and Ireland. HP, which has recently built new plants in Washington, Oregon, and Colorado and has plans for additional building in those states, is also going to expand eastward into North Carolina and Puerto Rico. In fact, after its new headquarters is completed in Palo Alto this year, HP says, it will not build in Silicon Valley.

Squeezing out. The theory that the migration is traceable mainly to overcrowding is spelled out by Edward E. Ferrey, president of the American Electronics Association, which has headquarters in Palo Alto. "It's more like an oozing out of a congested area," he says, adding, "how much more can we get in?" The startup rate of new companies in the San Francisco Bay Area "has not diminished and is close to two per week," he says.

Ferrey maintains that the rapid expansion over a short time experienced in the area could not go on indefinitely. He says that the shortage of real estate has exacerbated the problem, with industrial development far outstripping plans for housing. "Where are we to get the people to work in these plants?" he wants to know. However, Ferrey is quick to point out that corporations are not moving out of the area, but are "expanding outside at the same time they are expanding inside."

Another trade association official, executive director Philip L. Gregory of SEMI, the Semiconductor Equipment and Materials Institute, with headquarters in Mountain View, maintains that "other areas are not as attractive as they were first thought to be. Some now question whether they should have moved, because the magnitude of the problems they're facing is almost as great as if they had stayed." Gregory's view from California is that "Colorado is becoming saturated with companies, and there's doubt that Arizona has the manpower and other

Going and staying

Once the requisite trade show for instrumentation companies, Wescon is now viewed with mixed emotions by potential test equipment exhibitors. Of the two dominant forces in instrumentation, Hewlett-Packard Co. withdrew its major participation in 1978, and this year Tektronix Inc., too, will be absent from the list of exhibitors.

"The reason for our withdrawal was certainly not a distaste for Wescon," notes Bob Brunner, HP's Instruments group marketing manager. "It was simply that we had some very attractive alternate means of communication upon which to spend our monies." The primary one is a series of product-oriented seminars HP has put on in major cities around the country. "The HP Journal also plays a part in the tradeoff," notes Brunner, referring to the widely circulated company publication.

Herb Quigley, the corporate marketing communications manager for Tektronix, explains the Beaverton, Ore., company's pullout from Wescon in terms of a sharper focusing of market objectives. "Wescon is an excellent show, but we are not going this year because we do not have a well-designed rationale for going there," he asserts. "We participate in over 100 trade shows worldwide, but almost all of those are vertical market shows. Wescon is a very horizontal show."

Tektronix, too, has developed its own product-oriented traveling seminars, one on graphics products and another a microprocessor development laboratory workshop. Such seminars, which compete with Wescon for Tektronix' marketing dollars, attract a highly qualified, select audience. "The research that I have seen on the character of the audience at Wescon is all very general in nature," Quigley points out. "The kind of data I would like to see on Wescon would include numbers on the specific disciplines of the audience, and what problems they have to solve."

For the smaller instrumentation companies, however, Wescon represents an opportunity for exposure that is too good to pass up. "If customer contacts were our only criterion for Wescon, we probably wouldn't go, but there are other benefits that we see," notes Ira Spector, president of Paratronics Inc. of San Jose, Calif. Spector cites Wescon as an excellent place to keep abreast of the industry, making both customer and media contacts. Since Paratronics' marketing organization is still in its infancy, he also sees Wescon as a place to make face-to-face contacts with potential international and domestic representatives. "We also use Wescon to do market research on potential areas of product diversification. We can see what our competitors have, and what our potential competitors have."

At the bottom line, Spector believes that the exposure that Wescon affords is more beneficial to the small company than to the large one. "When we reach the HP-Tektronix sales level, we will consider pulling out of Wescon also," Spector says. "In the meantime, it is important for us to be there every year, so that people know that Paratronics is for real. We don't want them asking 'Para-who?'"

-Martin Marshall

SOFTWARE: THE HIDDEN CONSIDERATION IN SELECTING AN AUTOMATIC BOARD TEST SYSTEM.

The hardware of an automatic PC board test system is tangible. It can be seen, touched, and specified. However, software is much more difficult to evaluate. Yet, as the diagram below shows, software costs can be a large percentage of the total cost of ownership. For this reason, software is one of the most important considerations in selecting a board test system.

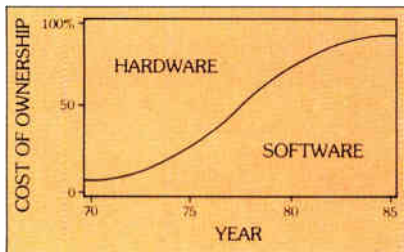

Three important criteria.

The three factors that have the greatest impact on software costs are: ease of programming, ease of debugging, and expansion capability.

Program generation is a large part of your software investment. But high-level languages and automatic program generation packages can save time and minimize the need for skilled programming personnel.

Program debugging and changes necessitated by engineering change-orders can also require large software revisions. But advanced debugging techniques can minimize that investment.

Finally, system expansion could require significant software revisions unless there is provision to add programmable instruments without major software changes.

Programming and debugging by nonprogrammers.

Hewlett-Packard's approach to software in the HP 3060A Board Test System (\$85,000* for standard operating system) enables non-programmers to quickly generate and edit test programs.

For example, with in-circuit testing, you simply assign node numbers to all nodes on the schematic. Using the schematic, plus a parts list with values and tolerances, the board topology can then be entered into the 3060A by a nontechnical person.

From that point, the 3060A's automatic In-circuit Program Generator (IPG) takes over. It selects appropriate guarding and measuring techniques; analyzes measurement errors and adjusts tolerance specs if necessary, and generates a complete program in HP's Board Test Language (BTL) as shown below. It also calculates an estimated run time and even produces a map to aid in fixturing.

Functional testing is also simplified. HP's BTL provides high-level language

```

0: "LEAVE FIRST THREE LINES!"
1: Jmp 2
2: *to "START"
3: "SBus":cscan,0201
4: "IBUS":cscan,0302
5: "REUS":cscan,0405
6: "GBUS":cscan,0503
7: "BBUS":cscan,0606
8: "LBUS":cscan,0704
9: "START":dss "Install board,press continue"
10: rssi1:ifoon
11: ncon4,0302,5,0403
12: scomp "D 1 nodes 4 5"
13: ncon3,0202,6,0503,2,0004
14: scomp "nfn 1 nodes 3 6 2",250,120
15: ncon1,0002,5,0403
16: guard2,0105,2,0007,1,0304,5,0006
17: rcomp "C 1 nodes 1 5",4,3e-4,20,20,
18: ncon1,0002,2,0103
19: guard5,0205
20: rcomp "C 2 nodes 1 2",1e-4,20,20,"esen"
21: ncon5,0402,2,0103
22: rcomp "R 1 nodes 5 2",2,7e1,5,5,"as"
23: ncon9,0002,1,0003
24: rcomp "L 1 nodes 9 1",2,2e-4,5,5,"edss"
25: ncon1,0002,6,0503
26: scomp "Z 1 nodes 1 6",0,93,0,00
27: faoff 11f f1=12!tss
28: *to "START"
*14002

```

statements (as shown below) that are used to set up stimulus and response instruments for analog, digital, or combined testing. A technician or test engineer familiar with the board and its test requirements can easily master BTL and develop the functional test program.

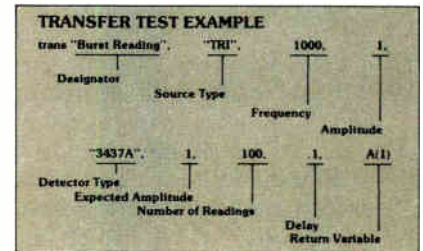

Program debugging and editing to optimize testing is speeded by the 3060A controller's typewriter-style keyboard and dedicated editing keys. It's a simple matter to call up a specific program line, revise appropriate portions, and store the corrected line.

When you expand.

Expansion of your board test system is almost certain, and addition of programmable instruments shouldn't require another major software investment.

With the 3060A, expansion capability is built in through the HP-IB.** That means you can add measurement capability yourself — without factory modification or special software.

For additional information.

There are other benefits to PC board testing with the HP 3060A. For a copy of the HP 3060A data sheet, write to Hewlett-Packard 1507 Page Mill Road, Palo Alto, CA 94304. Or call the HP regional office nearest you: East (201) 265-5000, West (213) 970-7500, Midwest (312) 255-9800, South (404) 955-1500, Canada (416) 678-9430.

*Domestic U.S.A. price only.

**HP Circuit Testers —
The Right Decision**



**HEWLETT
PACKARD**

Circle 97 on reader service card

Inside the news

resources to absorb the expansion that's going on there. The eruption of Mount St. Helens in Washington has scared people looking into the Pacific Northwest, and the recent heat wave in the Southwest may do the same to people looking to expand in that direction." The Carolinas? "They seem to be the latest attraction, but there may be hidden labor-union problems there," he says.

California itself is benefiting from some of the migration. The most popular area is San Diego, where an industry-funded development program is attracting several major operations a year. And it is particularly successful with Japanese companies because their executives like the area. In fact, the area now boasts a Japanese school for children of executives, along with restaurants and stores. The number of Japanese banks is doubling this year to six.

Also, Southern California is already experiencing a step-up in military spending, which has a high electronics content. Besides the big business firms such as Hughes, TRW, Rockwell, and Litton, which see military business counteracting the recession, smaller component and instrument makers are digging into the pie. Insiders expect the new business to leave the region relatively unscathed by the recession.

From deep in the heart of Texas's own version of a Silicon Valley,

known to local wags as Silicon Gulch, the only part of Gregory's assessment that draws agreement is that the Colorado Springs area's potential is limited. The way L. J. Sevin sees it, the trend out of California is not slowing. Sevin, chairman of Mostek Corp. of Carrollton, says the Bay Area is "just too expensive a place to build semiconductors. Companies are beginning to recognize the tax advantages of being in Texas, even though we don't have mountains."

Hedging bets. But Mostek boasts a 300,000-square-foot plant in Colorado Springs that is scheduled to come on line with direct-step-on-wafer equipment and 5-inch wafers by next January or February. Sevin is quick to agree that the Rocky Mountains setting makes recruiting easier, but points out, "We've been having a lot more luck lately recruiting here in Dallas" (Carrollton is a suburb). This he attributes both to harder work and to a recognition by engineers that jobs are leaving California.

For AMD, the company whose president says he won't lay off anyone who is performing up to standard, the capital of the Lone Star State is attractive. AMD began producing 16-K RAMs on its 4-in.-wafer fabrication line at its new Austin plant last October. It now has 260 employees at the facility and is adding 20 to 30 per month. Plant manager Frank di Gesualdo says the city is a good place for semiconductor

startups—as operations manager for Motorola Semiconductor in Austin he helped that firm bring up its first chip fabrication line (complementary-MOS) in 1974—because of the availability of specialty gases, lots of electricity, and a plentiful supply of water, even during the Southwest's current blistering heat spell and drought. Not only that, but it is close to a good engineering school at the University of Texas.

Bucy of TI believes that now that the industry has begun to disperse geographically, there no longer will be large concentrations such as Silicon Valley. Semiconductor makers, he explains, are not dependent on such factors as proximity to highways or seaports. Rather, it is most dependent on its ability to train people and since it is a clean industry, it can be set up anywhere. He does concede the danger of congestion around Colorado Springs, but that can be avoided if the companies there do not overbuild, he adds.

One company that went shopping picked Austin for the advantageous state tax structure and the generally conservative outlook of Texas state government. The company, Omex, a firm based in Santa Clara, is aiming to market an office filing system in 1981 that will employ an optical recording system, and it had two important criteria: proximity to a major university and a pool of untapped technical talent—that is, a place where freshly graduated engineers were leaving the area to find jobs but

Productivity, not protection, called key

The question to ask about offshore capital flooding into the U. S. electronics industry is not whether it is good or bad, states Fred W. O'Green, president of Litton Industries Inc. "Foreign investment is inevitable, because the U. S. is the biggest market, particularly for the Japanese." Capital always flows across national boundaries to seek opportunities, he adds.

But from the U. S. point of view, says O'Green, the right question to be addressing deals with productivity. "That's the problem, and the U. S. has to fix it to survive," says the operating head of the Beverly Hills, Calif., firm, which does some \$2 billion annual sales in electronics. Trying to protect home-based businesses with tariffs, controls, and regulations not only "won't work, but is dead wrong," he says. They work against what should be the chief goal: helping industry to be more efficient.

The trouble, in O'Green's view, is that the "U. S. doesn't understand productivity very well," and all discussions about improvements have been superficial. What are needed are such changes as faster depreciation of new equipment, tax incentives for investors, and dropping double taxation of dividends. These are taken for granted in most other industrial nations against which the U. S. competes.

-Larry Waller



COUNTERACTING THE INCREASED COST OF LARGE DIGITAL CIRCUIT BOARD TESTING.

The amount of logic on today's average PC board poses some difficult problems for production test . . . bottlenecks and increasing costs of testing and rework, to name a few. Yet, many of these costs and problems can be minimized with efficient test techniques. Often, that calls for a simulator-based test system.

Simulator-based testing defined. Board-test simulation is a technique in which the circuit to be tested is modeled—component by component and node by node—in the test system computer. From this model, the system can calculate the correct response to any input pattern, plus predict failure modes and their responses. This allows only those patterns which identify faults to be used as the test pattern stimulus.

A major benefit of simulation is that it provides an accurate measure of test effectiveness. You know to what extent you're exercising board components. Thus you can determine test efficiency, and, just as important, you know when to halt test software development.

Another benefit of having the circuit and all of its failure modes stored in the computer is that you then have detailed information to aid in fault isolation. Finally, advanced simulation techniques allow circuit modeling in the test system so that engineering can test designs before they're built and thus eliminate many problems before they reach production.

The advantages of test flexibility. HP's answer to simulation and to the reduction of testing costs and time is the DTS-70 Digital PC Board Test System (\$94,750* for standard operating system). It provides the benefits of a simulator and offers other advanced features as well.

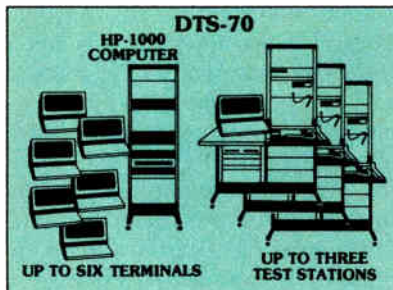

When you expand your production capacity, you can add test stations (to a total of three) without buying additional computing power. Need more test software development capability? Then simply add an inexpensive CRT terminal to your basic system. You can add up to six software development terminals, as shown, and they won't interfere with your production testing.

In addition, the DTS-70 software is compatible with data base management software to keep track of data and help you better manage your production. For example, the system can store test data and give you reports such as specific board or component failure rates and modes. The DTS-70 will easily fit into your long range computer network plans, too, providing distributed processing and communication to your data processing center.

Simplified troubleshooting.

Testing isn't the only problem. You also need a rapid and inexpensive way to locate the specific faulty component or components for replacement. Using HP's FASTRACE software,

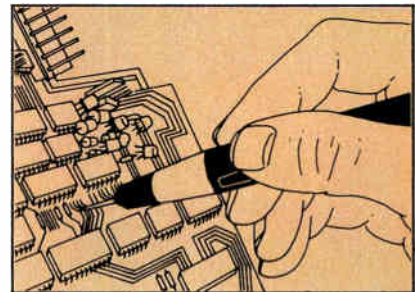

the DTS-70 accesses faulty board models developed by the simulator and guides the operator in a quick series of probe tests to isolate faults. Unlike many simulator systems, the DTS-70 catches intermittent faults. And it has zero delay capability, allowing you to detect races and hazards—a critical problem in logic circuit operation.

For more information.

There are other benefits to PC board testing with the HP DTS-70. And for analog and hybrid circuit testing, HP offers the 3060A with combined functional and advance in-circuit testing. For data sheets on both these systems, write to Hewlett-Packard, 1507 Page Mill Road, Palo Alto, CA 94304. Or call the HP regional office nearest you: East (201) 265-5000, West (213) 970-7500, Midwest (312) 255-9800, South (404) 955-1500, Canada (416) 678-9430.

*Domestic U.S.A. price only.

**HP Circuit Testers—
The Right Decision**



Circle 99 on reader service card

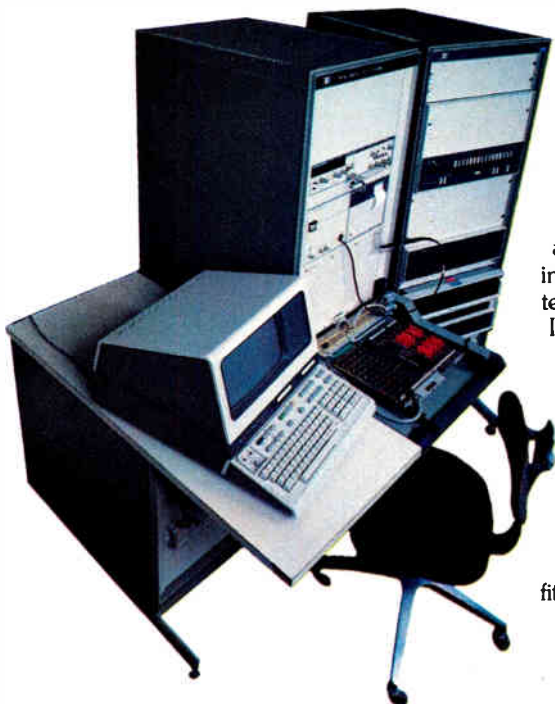

Carborundum noninductive ceramic power resistors solve tough problems.

Carborundum makes three types of noninductive ceramic resistors that can solve tough resistance problems, save money and space.

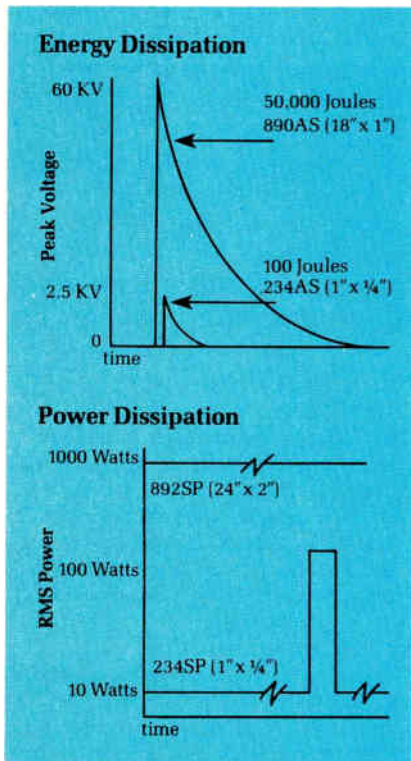

Regardless of the pulse shape, we have the resistor. Our Type SP handles large amounts of power from 60 cycles to many megahertz. Type AS can absorb huge amounts of energy while maintaining its noninductive properties at high voltages. Type A solves high resistance problems in high voltage situations.

For more information on ceramic power resistors and our broad line of thermistors and varistors, contact: The Carborundum Company, Graphite Products Division, Electronic Components Marketing, P. O. Box 339, Niagara Falls, New York 14302. Telephone: 716-278-2521.

CARBORUNDUM



A Kennecott Company

Inside the news

would prefer to stay home.

Gary D. Hornbuckle, who as assistant vice president of the Systems Products division presides over a group of 10 employees with technical degrees who are designing graphics terminals and optical-scanning equipment, says about 15 communities fit that mold. When the requirement of an established electronics community was added, the list narrowed to five. Among other prime candidates were Albuquerque, N. M.; Colorado Springs; and Raleigh-Durham, N. C. In Hornbuckle's mind, Raleigh-Durham lost out simply because it was too far from the West Coast. But keep your eye on it, he advises, because he sees it as the southern electronics center of the East Coast.

America the bountiful. While some electronics companies have been moving away from the West Coast, foreign counterparts are moving in by buying large shares or control of American companies. The Japanese have been particularly active with their investments—Fujitsu Ltd. in Amdahl, NEC in Electronic Arrays Inc., and Toshiba Corp. in Maruman Integrated Circuits, to name a few.

The trade associations keep close track of such trends. "This is good

investment land for Japan," says Gregory of SEMI. "The return on investment that they are used to is much less than what Americans expect of their companies. And the Japanese have the faculty of establishing goals and producing faster and better with a degree of dedication and commitment that blows U. S. companies off the map." That commitment, from top management to the production line, yields reliability, quality, and service that Gregory calls fantastic.

Gregory believes that while it is not good for American manufacturers to "lose control of advanced technology or the flexibility of management to control," the infusion of foreign investors has its merits. The primary one in this time of a weak and inflated dollar is money. "The very lack of capital," he says, "has been the albatross that negated the expansion of many of our companies."

Ferrey of the AEA adds that foreigners, rather than making off with American technology, may even contribute some of their own. Gregory concurs, noting that in many areas of technology "they already are the leaders and don't have to play catch-up. They don't need to set up listening posts here."

But money is what does most of the talking. Take Pertec Computer Corp., the Los Angeles computer

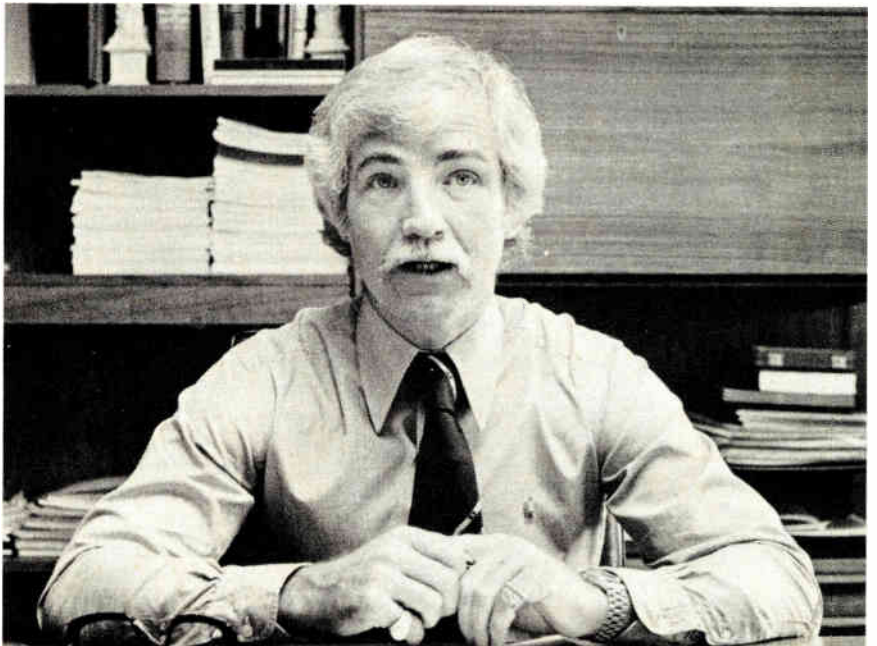

No layoffs. AMD's Jerry Sanders says there will be no layoffs of employees who meet company standards because such action would be "self-serving and short-term."

JUSTIFYING THE PURCHASE OF AN AUTOMATIC BOARD TEST SYSTEM IN LIGHT OF TODAY'S HIGH COST OF CAPITAL.

Today, an automatic board test system can easily cost \$100,000 or more. Given the current high cost of money, can a purchase of this size be financially justified? If you choose the right kind of test system it can be. In fact, the right automatic test system will not only pay for itself — including interest costs — but will actually save your company additional money.

The secret! Leveraging.

There are any number of testing alternatives now available. However, HP's 3060A Board Test System combines the latest in-circuit testing technology with board level functional testing. The addition of functional testing to in-

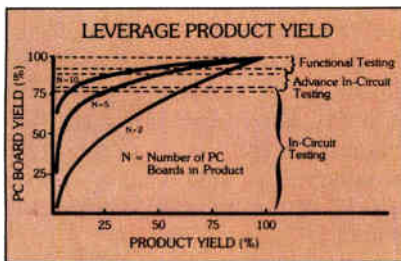

circuit testing provides a relatively small increase in board yield. But as you can see from the accompanying diagram,

this small increase can mean a large improvement in product yield. For example, in a 5 PC board product, an increase in board yield of only 8% (from 90% to 98%) will leverage product turn-on rate from about 59% to 90%.

The impact of leveraging on production test costs.

As you may have already discovered, production testing costs increase exponentially. In other words, a fault that costs 18¢ to find during in-circuit testing can easily cost \$20 or more if not detected until final product test. Why? Because of the additional time — and increased labor costs — associated with fault diagnosis and repair at this level.

By helping leverage product yield through in-circuit plus functional testing, the HP 3060A can help decrease production test costs. For example, in a five PC board product, with a product volume of 12,000 per year, the 3060A can slash production test costs as much as \$19.94 per unit. And that's a total of nearly \$250,000 per year.

Will it work for you?

As you can see from the graph, today's increasing cost of capital means the savings to be generated by an investment such as the HP 3060A must be substantial in order to produce a reasonable break-even point. How can you determine whether or not the 3060A would deliver a large enough reduction in production test costs — to justify its purchase?

To help you determine this for yourself, HP now offers a very helpful brochure titled "Financial Justifi-

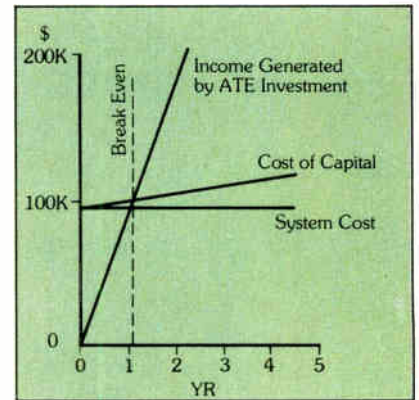

cation — Circuit Test Systems." It includes a production test model worksheet, and has guidelines for calculating the 3060A Automatic Board Test System's payback period, average return on investment and/or discounted cash flow. You can use this information to determine the rate of return offered by the HP 3060A in your facility, even in light of today's high-interest economy. For your free copy of "Financial Justification — Circuit Test Systems," or for more information on the HP 3060A, (Priced at \$85,000* for standard operational system) write to Hewlett-Packard, 1507 Page Mill Road, Palo Alto, CA 94304. Or call the HP regional office nearest you: East (201) 265-5000, West (213) 970-7500, Midwest (312) 255-9800, South (404) 955-1500, Canada (416) 678-9430.

*Domestic USA price only.

090/58



**HP Circuit Testers —
The Right Decision**



12 Weeks
From This

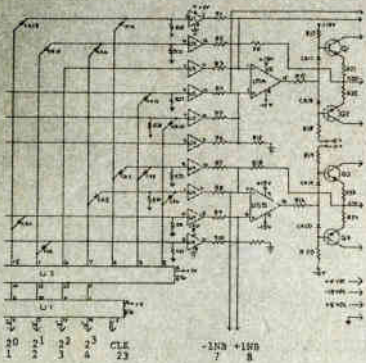

To This

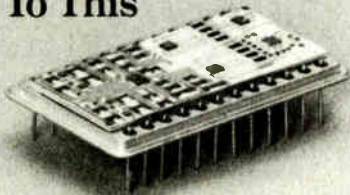

Custom Hybrids Aerospace Military Medical

Crystalonics can deliver prototype quantities of custom hybrid circuits in less than 12 weeks from the time you present your debugged design. Our people have been designing and building devices and circuits exclusively for high reliability applications for twenty years. Our engineers have sharpened their skills in teamwork with designers of aerospace, military and medical projects, such as F15, Hawk, Viking Mars, Intelsat and implantable pacemakers. We can ease you quickly and confidently through the transition from schematic to finished hybrid package. Utilize the hybrid's advantages of space, weight, reliability and cost by calling on our experience: (617) 491-1670.

 **TELEDYNE
CRYSTALONICS**

147 Sherman Street
Cambridge, MA 02140
Tel: (617) 491-1670
TWX 710-320-1196

Inside the news

and peripherals manufacturer. Ryal Poppa, president, says that it gained an additional \$8 million (\$2.5 million for research and development, \$5.2 million for marketing) when it was acquired earlier this year by Triumph-Adler Inc., a unit of West Germany's Volkswagen organization. Money and more was the attraction when super-minicomputer manufacturer Two Pi Corp. of Santa Clara became a subsidiary of United States Philips Corp., an affiliate of the giant NV Philips Gloeilampenfabrieken of the Netherlands.

The elusive dollar. It is fair to say that if some of the young and growing firms acquired by overseas investors could find venture capital in the U.S. they would rather take that route. "There's money around; the problem is in identifying it," says Gregory. "Domestically, the capital-formation rules have tightened up quite a bit in the last decade. As a result, you rarely hear of venture-capital groups buying into startup companies and putting in new management teams to turn them around." The price of entry has become too high and the margin for error too small, he adds.

For James J. Conway, however, encouraging signs are appearing. Conway, president of the 350-company Electronics Association of California based in Sunnyvale, says, "There is a lot of good legislation being pushed, such as that involving capital-gains reduction, that is improving the climate for startup opportunities. There seems to be a ground swell of support for legislation that will abet capital formation."

The AEA's Ferrey agrees, pointing to such as the Cranston bill, which seeks to lower the maximum capital-gains tax to 21% from 28%, and the Danforth-Bradley bill, which seeks to create a 25% tax credit for R&D increases over the average outlay for the prior three years, as indications that the mood in Washington is

Adding hours. Gordon Moore's Intel is having employees put in overtime rather than hire new ones only to lay them off later in case business conditions require that move.

changing and that legislative powers are "listening to the needs of our industry."

Out of the Far East. But perhaps of the whole package of changes—economics, geography, and investment—no element is exerting more influence on the electronics industries in the West than the growing number of Japanese startups in the area. Their speed and pervasiveness in going about that business in California, particularly the southern part of the state, is causing industry executives throughout the region to shake their heads in awe.

Nor are they just the major Japanese firms in the flashy computer and semiconductor businesses, for growing in the fertile soil is a whole infrastructure of equipment manufacturers that are relatively new names on the U.S. scene. Some examples: in the Los Angeles area there are power supplies and batteries from Kikusui, Matsuo, and Yuasa; Matsuo also makes capacitors. What's more, Richard Davis, who as head of the San Diego Development Corp. seeks new plants for his area, estimates that some 400 Japanese firms have their U.S. headquarters in Los Angeles, and a majority of those are in the electronics industries.

All this has brought about a marked change in the way formerly outspoken executives now talk about Japanese competitors. Such discussion is lower-keyed and less emotional than in the past, for two reasons.



HOW DEPENDENT SHOULD YOU BE ON THE ATE SUPPLIER?

Automatic board test equipment can provide a powerful solution to today's testing needs. But choosing the right system can be a complex and bewildering task, because of all the non-hardware factors to be assessed.

Purchase alternatives.

One factor is the question of system responsibility. At one end of this spectrum is a turnkey system. Here the ATE manufacturer assumes total responsibility and the user is dependent upon the supplier for hardware, software and system implementation. At the other end is the do-it-yourself system tailored to your exact application, in which case the user is almost self-sufficient. Other alternatives also exist. So how can you choose the right one?

Some helpful criteria.

The three most important criteria are: your environment, departmental resources, and the system supplier.

Production environment is critical. How high is the PC board volume? Are the boards extremely complex? How many new products are anticipated? For example, if you have fairly simple boards and few requirements for changes, a turnkey solution may be your answer. But for highly complex boards and a stream of new products, you may wish to keep expansion and revision control in-house. What about departmental resources? Do you have the technical people to assemble and program a do-it-yourself system?

Finally, the

system supplier should be evaluated. Does the company have knowledge of your business and applications engineers familiar with your needs? Will service and support personnel be available when and where you need them?

The concept of shared responsibility.

HP's answer is shared responsibility . . . a concept that minimizes both start-up difficulty and your dependence upon outside suppliers (see chart below).

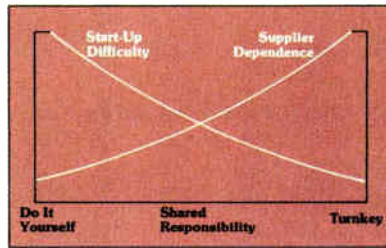

When you choose the HP 3060A Board Test System, you get a system designed to put you on the road to independence. Here's why:

First, you get two weeks of intensive training in system use and software development. Second, HP supplies the software aids that take the mystery out of programming. Non-technical people can easily program in-circuit tests by entering node numbers plus parts values and tolerances. HP's In-circuit Program Generator (IPG) does the rest, selecting appropriate test methods, determining uncertainty, generating the test program and more.

Then, your technical people can easily master BTL (Board Test Language), using commands such as the one shown, to

program functional tests. Because they know the circuit best, testing becomes more thorough and more meaningful.

Third, you get reliable hardware that's ready to operate. Most systems are up and running the same day they're installed. And because the system is HP-IB compatible, you can modify and expand its capability right in your facility without a major software investment.

If you have problems, HP doesn't desert you. Our specialists are available to help. And with the self-diagnostics built into the system, you'll be up and running again quickly.

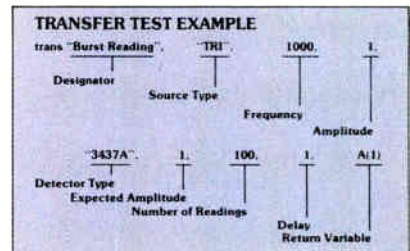

Supplier independence.

The net result is greater independence. With the HP 3060A, you learn to solve your own problems. That means faster response to changing needs. Direct control over expenses. And, generally, lower overall cost of ownership.

For additional information.

There are numerous other reasons to consider the HP 3060A (\$85,000* for standard operating system). To get complete details, write: Hewlett-Packard, 1507 Page Mill Road, Palo Alto, CA 94304. Or call your nearest regional sales office: East (201) 265-5000, West (213) 970-7500, Midwest (312) 255-9800, South (404) 955-1500, Canada (416) 678-9430.

*Domestic USA price only.

090/45



HP Circuit Testers —
The Right Decision

 **HEWLETT
PACKARD**

Circle 103 on reader service card

LSI-11/PDP-11

Displays

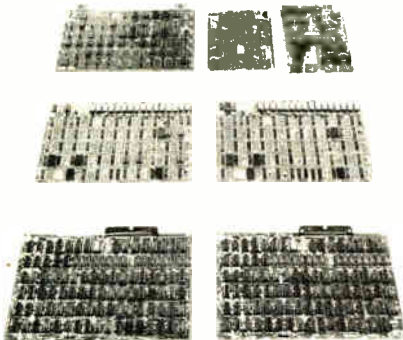

LSI-11

MLSI-2480	24 x 80 alphanumerics
MLSI-256	256 x 256 graphics
MLSI-512 x 256	512 x 256 graphics
MLSI-512	512 x 512 graphics
MLSI-1024	1024 x 256 graphics
QRGB-ALPHA	Color alphanumerics
QRGB-256	256 x 256 color graphics
QFG-01	Video digitizer

PDP-11

MDC-2480	24 x 80 alphanumerics
MDC-256	256 x 256 graphics
MDC-512 x 256	512 x 256 graphics
MDC-512	1024 x 256 graphics
MDC-1024	Color alphanumerics
URGB-256	256 x 256 color graphics
UFG-01	Video digitizer

SOFTWARE

MDC-GRAPH	Software for: MLSI/MDC-256, MLSI/MDC-1024, MLSI/MDC-512 x 256, MLSI/MDC-512
PLOT-512	PLOT-10 compatible software for MLSI/MDC-512

MATROX makes adding a monochrome or color data display unit to your PDP-11 or LSI-11 computer both easy and inexpensive. You can choose from a wide variety of plug-in alphanumeric and high-resolution graphic video display controller cards that meet almost every data display requirement.

Software is available as well; a powerful PLOT-10 compatible, plotting package that speeds the development of your graphics application software.

Plug us into your next video display application.

DEC



US & CANADA:

5800 ANDOVER AVE., T.M.R., QUE., H4T 1H4, CANADA
TEL.: 514-735-1182 TELEX: 05-825651

EUROPE:

HERENGACHT 22, 4924 BH DRIMMELEN, HOLLAND
TEL: 01626-3850 TELEX: 74341 MATRX NL

Inside the news

Sees danger. International Rectifier's Eric Lidow calls takeovers by foreign firms a technological giveaway. He suggests the U. S. need controls over such investments.

One is the recognition among them that no concerted action is going to take place despite all the protests about unrestricted investment, tariffs, dumping, trade barriers, and the like. The other is that many have forged a Japanese connection or are negotiating for one. In other words, why get identified with a fight that cannot be won when they can take advantage of the Japanese search for American partners.

That is why a scheduled Wescon panel on the influences of Japanese electronics in the U. S. was canceled. John F. Darcy, who is president of the Los Angeles distributor Kierulff Electronics Inc. and was to have been the panel's moderator, says top semiconductor officials are loath to speak out because they are dealing with the Japanese. "The most outspoken people are now silenced," he says.

Opinions on the effects of foreign investment in U. S. firms, and Japanese building of plants in the U. S., are predictable, based on where one sits. Pertec's Poppa, who thinks investment benefits everyone—"employees keep their jobs, stockholders receive a premium, and customers maintain a continuity of product delivery"—sees the new plants in a less favorable light. The real issues are not tariffs and free access to markets, he maintains, "but the Japanese government's subsidy of technology at home that later is brought into the U. S." The size and coordinated nature of this program make it impossible for individual U. S. companies to compete, he says.

The trend for European and Japanese firms to buy and start U. S. operations "amounts to a technological giveaway," says Eric Lidow, chairman and president of International Rectifier Corp. in Los Angeles. He says that among major industrial nations, the U. S. is alone in having no controls over foreign investment in electronics, either by government or industry, other than



in pure military equipment. Lidow and his son Alex, who is vice president of R&D for the company's Semiconductor division, emphasize that the flow of technology is one way, from the U. S. out. Also, says the older Lidow, it should not be forgotten that any U. S. operation of a foreign firm "is a tentacle, not the head," and in times of economic pullback such U. S. operations "will be lopped off first."

Old hand. To some, the hue and cry about the foreign investors' influence in the U. S. is ironic. At Litton Industries Inc. in Beverly Hills, Calif., Charles S. Bridge, chief scientist, remembers hearing the same charges against his company and other multinational giants when they were out buying up European companies in the 1960s.

Some of the complaining companies feel more comfortable now with the Japanese and are starting to do more business with them, says Bridge. "What all the yelling was about was caused by VLSI work sponsored by MITI [Japan's Ministry of International Trade and Industry]," he believes, adding that the program is pretty much over now and U. S. firms are seeing no big technological secrets coming out of it. He says that the vaunted Japanese technology onslaught is nothing more than "hard-working gals on their production lines" who turn out such products. □

Reporting for this article was provided by Bruce LeBoss, Martin Marshall, and Chris Lindauer in Palo Alto, Larry Waller in Los Angeles, and Wesley R. Iversen in Dallas.

**Is
General Instrument
big in
optoelectronics?**

Here's our line...

...actual size.

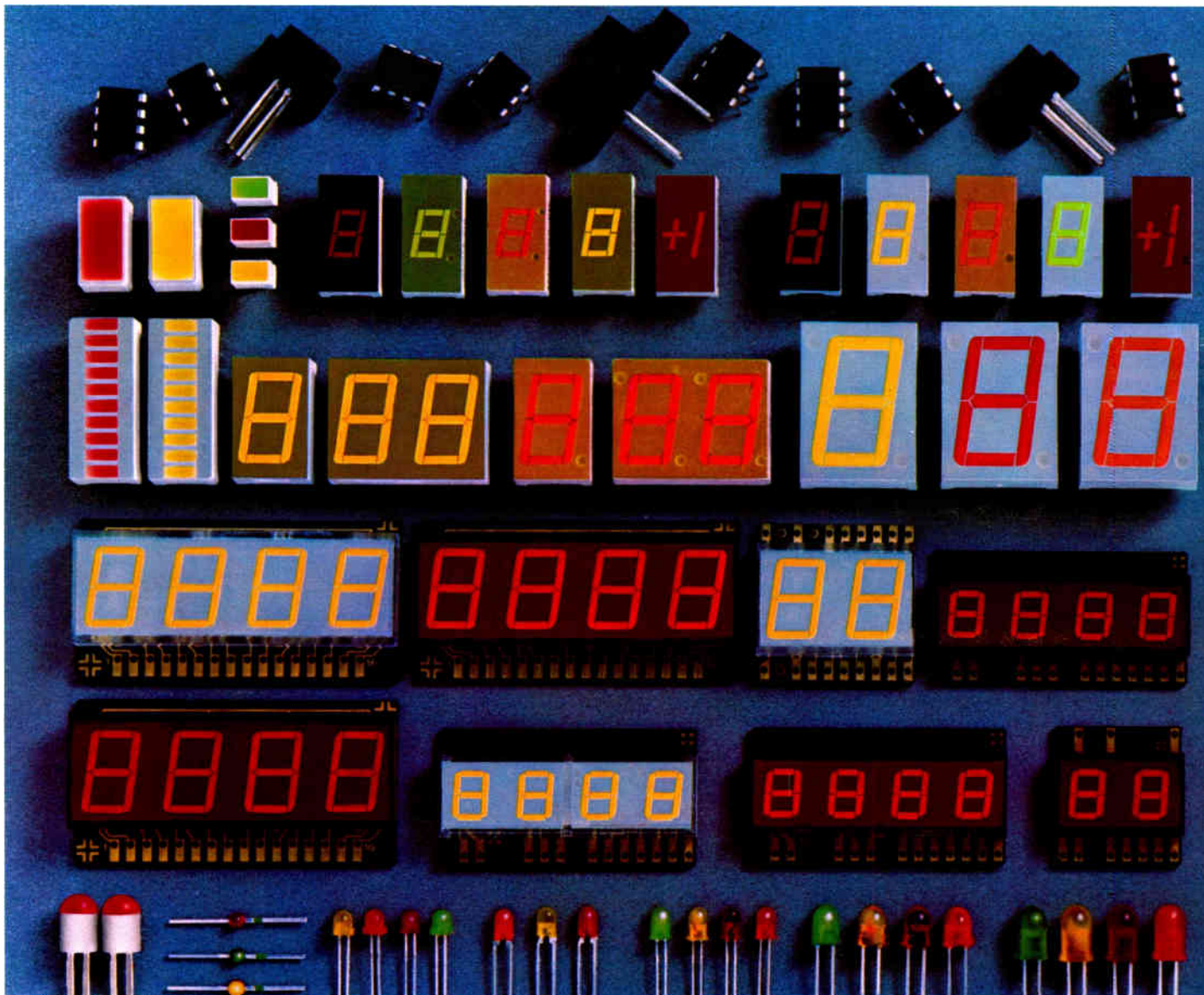



General Instrument is one of the biggest names in optoelectronics today.

Our line proves it.

It includes 4 different sizes of lamps, single digits in 4 sizes, .6" double digits, high performance sticks in 2 sizes and a variety of shaped lamps.

All in high efficiency color.

It also includes an optoisolator for virtually every function — from microprocessor to microprocessor interfacing to AC line monitoring to simple switching.

Our distribution network is just as big. More than 113 electronic distributor branches carry the General Instrument line of lamps, displays and optoisolators.

For more information on any of the optoelectronic devices shown here, call your local General Instrument representative or distributor. Or write to:

General Instrument
Dept. MCD-3
3400 Hillview Ave.
Palo Alto, CA 94304

In Europe contact:

General Instrument Europe
Dendermondsesteenweg 502 C
9120 Destelbergen, Belgium

1. OPTOISOLATORS:

Types: Phototransistor, photodarlington/split darlington, photo SCR, power-to-logic, logic-to power.

2. DISPLAYS:

Single Digit Sizes: .3" .4" .6" and .8"

Double Digit Size: .6"

Alphanumeric sizes:

.320" (5 x 7 array),

.135" (14 segment).

Colors: green, red, high eff. red, orange, yellow in .3" and .4" Orange, yellow and high eff. red in .6" and .8"

Alphanumerics available in red only.

Stick sizes: .3" and .5" (2 and 4 digits).

Colors: high eff. red, orange, yellow.

3. SHAPED LAMPS:

Rectangular:

.220" x .150" Colors: green, yellow, high eff. red.

.500" x .250" Colors: high eff. red, yellow.

Bar Graph:

.400" x .995" Colors: yellow, high eff. red.

4. LAMPS:

Sizes: T-3/4, T-1, T-1-3/4.

Colors: green, orange, red, yellow, high eff. red.

Illuminator:

Sizes: T-1-3/4

Colors: orange, yellow.

GENERAL INSTRUMENT

The light heavyweight.



Lamps

General Instrument offers a complete line of LED lamps that anticipates the changing needs of electronic design engineers. We have pioneered new materials and designs. Result: our standard line of high efficiency lamps is equal to the brightest available in the industry. And they're available in five bright colors — orange, green, yellow, red, and high efficiency red — and in the sizes needed most.

General Instrument is creating new light bars and bar graphs, giving designers more freedom and options in size, shape and color.

Our illuminator line of high performance LED's sets a new standard for LED lamps the world over. For the first time, design engineers can uniformly back-light up to one square inch with the reliability of an LED. And there's more to come. Brighter colors, higher efficiency, more sizes.

We won't stop improving the light.

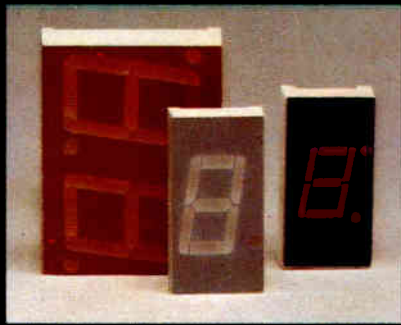

Displays

A complete family of LED displays is available from General Instrument. All are based on recently improved high efficiency materials to produce a level of brightness far exceeding that of common red displays. Our single digit capability spans four high efficiency colors in .3, .4, .6 and .8-inch sizes. A General Instrument exclusive. Our .6-inch display is also available in a double digit package in several colors.

We also pioneered the high efficiency multi-digit display stick. Our new sticks are available in 3 colors, 2 sizes, and come in 2 and 4 digit packages. If it's an alphanumeric display you need we have that, too. Choose our MAN2A (5 x 7 array) or the MAN2815 (14 segment, 8 char.). Both are capable of producing every number, letter and punctuation mark in the English language.

Displays share in General Instrument's work to further improve the performance of current high efficiency materials. So today and tomorrow, expect brilliant displays from General Instrument.

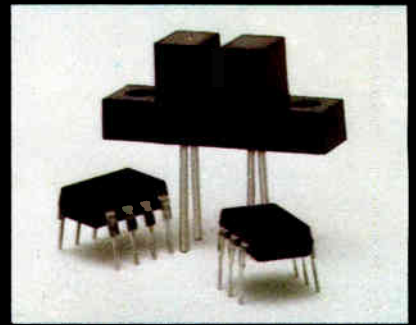

Optoisolators

General Instrument's optoisolator line is one of the largest in the industry. It includes virtually every type of device: power-to-logic, logic-to-power, microprocessor to microprocessor, phototransistor, photodarlington/split darlington and photo SCR.

And the applications are just as far reaching. From data transmission to AC line monitoring to simple switching.

Due to the need for custom parameters in optoisolators, General Instrument has assembled a technically competent application assistance team. Do not hesitate to call on them. You know your needs in optoisolators. Know that General Instrument has the optoisolators and the team to meet those needs.

GENERAL INSTRUMENT

CAD to spread C-MOS know-how

New United Technologies Microelectronics Center will aid other divisions via semicustom gate arrays

by Wesley R. Iversen, Dallas bureau manager

When a broad-line industrial conglomerate acquires a high-volume manufacturer of standard MOS products, what is the quickest and most effective way to enable its various operating divisions to take advantage of the chip maker's technology?

In the case of United Technologies Corp.'s recent acquisition of Mostek Corp. [*Electronics*, Oct. 11, 1979, p. 100], the answer may lie in semicustom gate arrays built using computer-aided-design techniques. UTC has committed an initial \$20 million two-year budget to the approach with the creation of United Technologies Microelectronics Center Inc., which is scheduled to begin operation early next month at a leased

Bigger goals. Mostek chairman L. J. Sevin says that Mostek can accomplish more using United Technologies' resources. New Microelectronics Center is an example.

facility in Colorado Springs, Colo. By late 1981, the center expects to be in its own 40,000-to-50,000-square-foot building on a 27-acre site beside Mostek's Colorado Springs MOS manufacturing plant.

In a nutshell, the plan is to develop CAD software tools that will let the various UTC divisions design their own custom logic circuits by defining the final metal interconnections on a standardized array of transistor gates. Designers at the divisions will work at alphanumeric or graphics terminals, using software supplied by the Microelectronics Center to do logic entry, circuit simulation and generation of test vectors, and associated documentation. Completed circuit designs will then be sent over data-network lines to the center, which will in turn subcontract the manufacturing job to Mostek. Routing of the metal interconnections for mask making will be generated automatically.

Since the manufacturing process will involve only the final few mask steps necessary for metal interconnections and installation layers on a preprocessed master-slice gate array, turnaround time can be short. The Microelectronics Center's goal is to produce working chips within two weeks of receiving a "chip design file" from a UTC division, says Gordon Hoffman, general manager for the Colorado Springs center. Other advantages of the gate-array technology include the fact that a variety of circuits can be designed without a customer requalification each time, since all devices will be built from the same master-slice process.

With revenues totaling \$9.1 billion last year, Hartford, Conn.-based

UTC encompasses myriad operating divisions involved in the production of everything from jet engines, air-conditioning equipment, and elevators to telecommunications products, space systems, helicopters, automotive systems, and more. "Our basic charter is to try to supply the circuit needs of the divisions that are not met on the outside," says Hoffman.

Many needs. The gate-array approach was selected because of the diversity of the needs, he explains, as well as because many involve custom requirements for low-volume applications. Since many UTC applications involve the military, the center will probably offer both a radiation-hardened master-slice process as

Heads center. Gordon Hoffman says his Microelectronics Center will enable systems engineers to design digital circuits without knowing anything about silicon.



Probing the news

well as an ordinary version, Hoffman says. He concedes that the gate-array approach does give up some efficient use of chip real estate, compared with standard or fully custom designs. But he contends that this is not as important to the divisions as factors such as high quality, fast turnaround, and a reliable supply source, which the center will offer.

The technology of choice for the initial gate arrays will be complementary MOS, with a range of array sizes that might run from about 200 gates up to about 4,000 gates, Hoffman indicates. "We feel that C-MOS will meet the needs of almost all of the divisions," he says. The continued scaling of C-MOS geometries will lead to significant speed improvements for the technology that, coupled with its low-power characteristics, may make it a strong competitor against the bipolar process for gate arrays during the 1980s, Hoffman figures. "Mostek has a very aggressive program to push the C-MOS technology," he adds.

May go commercial. The center will be a captive operation providing services to UTC's various divisions. But since one of those divisions is Mostek, the possibility exists that the gate-array services could be marketed outside, Hoffman confirms.

Though a separate corporation,

the Microelectronics Center will be overseen by Mostek and will obviously benefit from the Carrollton, Texas, company's process expertise. The 37-year-old Hoffman—previously a Mostek employee—will report to Mostek chairman and chief executive officer L. J. Sevin. Sevin, in turn, reports to Peter L. Scott, who heads UTC's Electronics group formed following the Mostek acquisition late last year [*Electronics*, July 3, p. 14].

Hoffman expects to have initial CAD software tools in the hands of UTC division engineers by late next

year or early 1982. Hiring of the staff that will develop those tools is under way now. By early 1982, the center's staff will number about 100, half of them engineers, including an applications staff and others who will train UTC division personnel in use of the software and the CAD system. In an age when circuit designers are in extremely short supply, the CAD approach will enable systems engineers and others to design digital circuits in a way that is transparent to them, Hoffman points out. "They don't have to know anything about silicon," he says.

In motion. "In the CAD services, one of the keys is that we want to transfer the designability to each division," Hoffman explains. "If you look at it from a strategic standpoint, we're going to constantly pass back to the divisions tools and techniques so they can operate on what we've just done and then we'll move on to the next phase while continuing to support them."

Following about a 2½-year development period for the gate-array CAD approach, the plan involves development of advanced CAD tools that will go beyond gate arrays and move toward system design. Eventually, he expects to develop a "silicon foundry" type of operation [*Electronics*, July 31, p. 33] that would automatically produce chips from bare silicon based on data-network inputs from circuit designers. □

Mostek: out to cause trouble

Thanks to an influx of funding from new parent United Technologies Corp., capital spending this year at Mostek Corp. will zoom to about \$125 million—about three times last year's outlay.

Among other things, Mostek is spending the money on a 300,000-square-foot MOS manufacturing plant in Colorado Springs, Colo., that will employ 5-inch wafer fabrication lines using direct-step-on-wafer equipment. The Rocky Mountain plant is scheduled to start up early next year and will be the production site for the company's 64-kilobit dynamic random-access memory, planned for introduction this fall. The company is also beginning conversion to 5-in. wafers at its Carrollton, Texas, headquarters and is building a new research center there for process-development work. Additional funds are going for expansion of the company's Ireland plant.

Mostek chairman and chief executive officer L. J. Sevin is quick to agree with observations by industry watchers that the transition from independence to UTC subsidiary status has been unusually smooth. Mostek officials "have traded one set of goals for another," Sevin explains. "We've shifted gears, I guess. We've suddenly realized that with all these resources behind us, we can accomplish a hell of a lot more than we could before, and we're going for it." Before it's over, he predicts, "we're gonna be a lot of trouble for a lot of people."

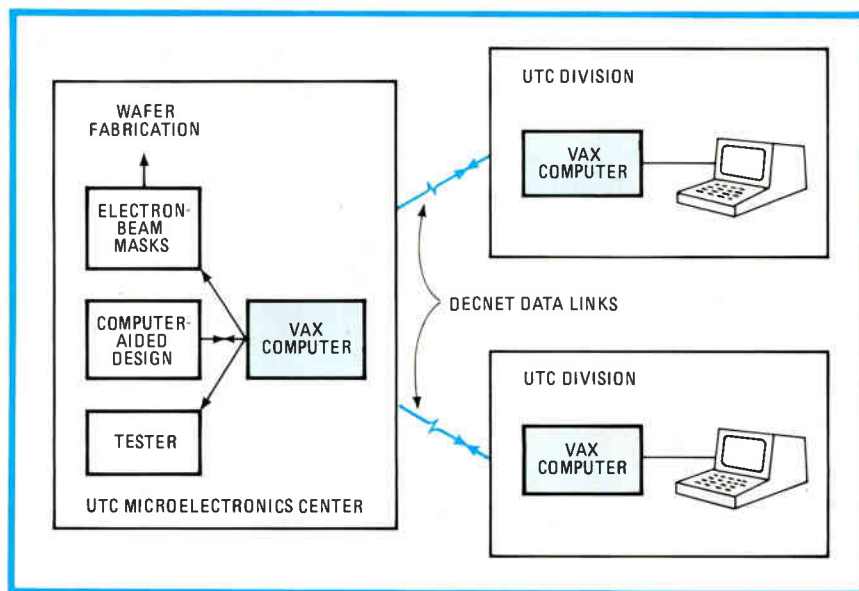

Remote design concept. Designers will work at terminals using Microelectronics Center-supplied software to come up with custom logic circuits needed by their own divisions.

See SCOUT save.

SCOUT™ has a red light. It does not mean what you think. The red light says one of SCOUT's boards does not feel well.

Will this make you sad because your minicomputer can't play anymore?

Will the expensive repairman take a long time to get it fixed?

No no, silly. Since SCOUT's ISOLITE™

showed you which card is bad, all you do is pull it out and put in a spare 6.25" x 8.3" card.

What fun! Now SCOUT can run and play again. And save you a lot of jack.

Save SCOUT, save.

Save on service costs. Save on system costs.

Save on 16-bit minicomputer performance. SCOUT starts at less than \$1000 for a CPU, I/O, 32K Byte RAM and card cage.

Isn't saving fun? Save SCOUT, save.



See SCOUT save.

Money. Time. And end user aggravation. Plus other ways to save in our how-to-save-on-maintenance primer, *A Plug for SCOUT*. Get your free copy with this coupon and a business card. Or, for immediate information call 714/833-8830, Ext. 455.

Name _____ Title _____

Company _____

Address _____

City _____ State _____ Zip _____

 **Computer Automation**
NAKED MINI® Division
Where OEM's come first.

18651 Von Karman, Irvine, CA 92713

SCOUT and ISOLITE are registered trademarks of Computer Automation Inc.

SETTING NEW STANDARDS

ISO-CMOS™ OCTAL INTERFACE

THE LS REPLACEMENTS

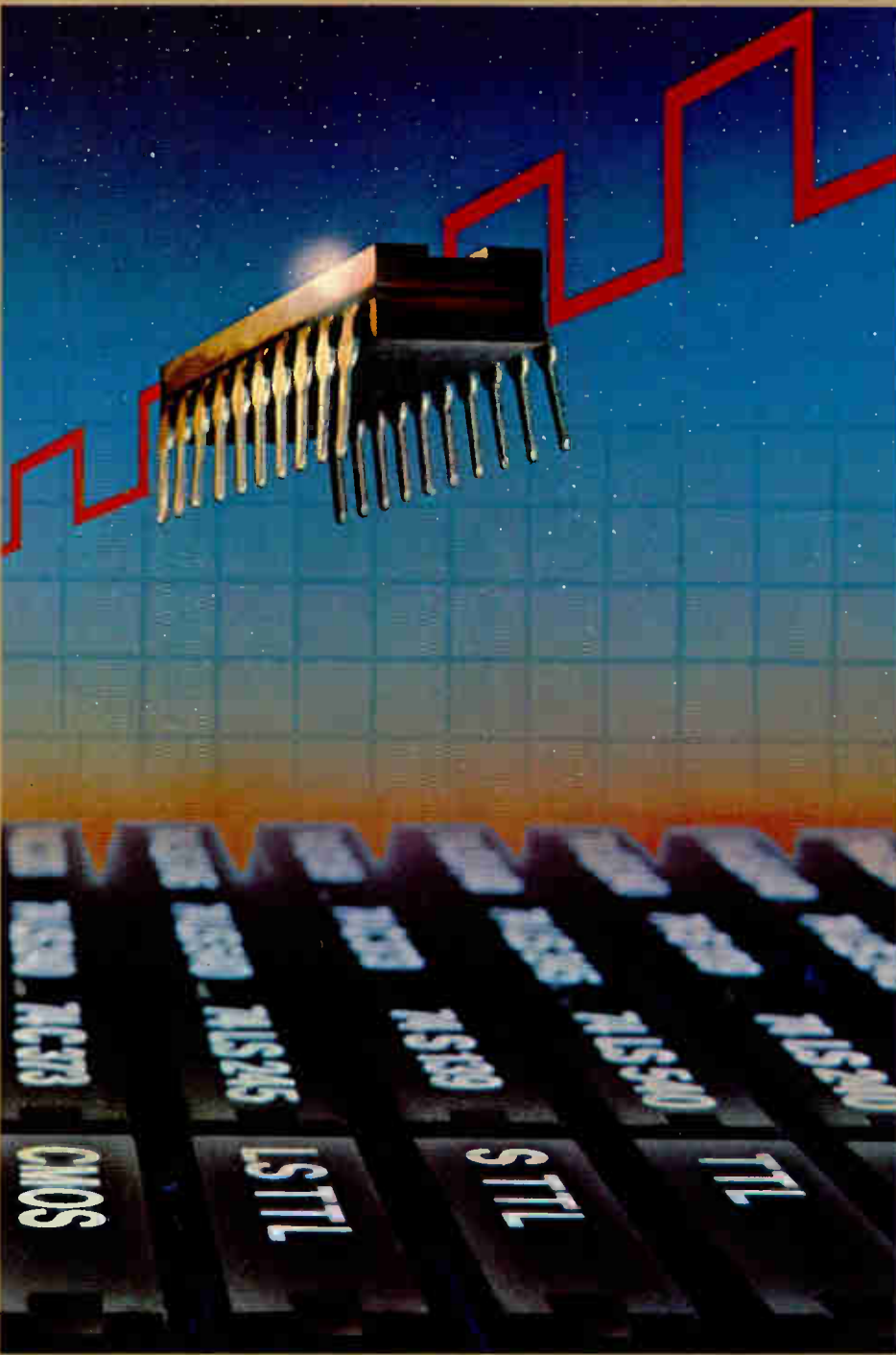

Remember when microprocessor designs were an either-or proposition — either high speed but power hungry bipolar TTL or low power but painfully slow CMOS?

Mitel Semiconductor has come up with a solution that gives you your highs with your lows — HIGH SPEED and LOW POWER ISO-CMOS technology. Established pin-outs and logic layouts of a range of 20 standard Octal circuits have been incorporated with a proven production process that does justice to today's LSI.

ISO-CMOS achieves fast propagation by use of a recessed oxide silicon-gate process that minimizes the inherent long time constants of traditional metal-gate CMOS. All the advantages of noise immunity and practically no quiescent power dissipation have been retained.

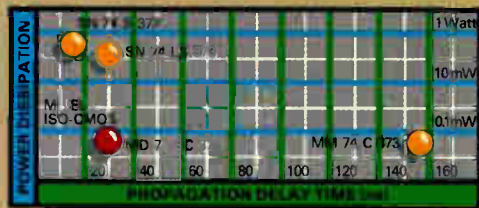

Our family of latches offer transparent or clocked operation and include inverted or non-inverted 3-state outputs. The decoder family has single one of eight, latched or unlatched, or dual one of four configurations. Bus buffering is catered for with high-current drivers having assorted configurations of chip selects for single or bi-directional connection.

A comprehensive range of circuits allows improvement of design, by direct pin for pin compatibility with their 74LS series counterparts. For redesign to maximize ISO-CMOS advantages, a simplification of layout is achieved by the preferred bus-oriented 74SC5XX selections.

- MD 74 SC 137 1 of 8 Inverting Decoder with input latches
- MD 74 SC 138 1 of 8 Inverting Decoder
- MD 74 SC 139 Dual 1 of 4 Inverting Decoder
- MD 74 SC 237 1 of 8 Decoder with input latches
- MD 74 SC 238 1 of 8 Decoder
- MD 74 SC 239 Dual 1 of 4 Decoder
- MD 74 SC 240 Octal Inverting Buffer
- MD 74 SC 241 Octal Buffer
- MD 74 SC 244 Octal Buffer
- MD 74 SC 245 Octal Transceiver
- MD 74 SC 373 Octal Transparent Latch
- MD 74 SC 374 Octal D-Type Flip Flop
- MD 74 SC 533 Octal Inverted Output, Transparent Latch
- MD 74 SC 534 Octal Inverted Output, D Type Flip Flop
- MD 74 SC 540 Octal Buffer
- MD 74 SC 541 Octal Buffer
- MD 74 SC 563 Octal Inverted Output, Transparent Latch
- MD 74 SC 564 Octal Inverted Output, D Type Flip Flop
- MD 74 SC 573 Octal Transparent Latch
- MD 74 SC 574 Octal D Type Flip Flop



MITEL SEMICONDUCTOR

United States: 2321 Morena Blvd., Suite M, San Diego, California, U.S.A. 92110. Telephone (714) 276-3421, TWX: 910-335-1242, 1223 Westchester Pike, Havertown, Pennsylvania, U.S.A. 19083. Telephone (215) 449-5556, TWX: 510-662-6653.
 Canada: P.O. Box 13089, Kanata, Ottawa, Ontario, Canada K2K 1X3. Telephone (613) 592 2122, Telex: 053-4596, TWX: 610 462-8529.
 Europe: Hamilton Road, Slough, Berkshire, England SL1 4QY. Telephone 0753-36137, 0753-36138, Telex: 847730. Fredericiagade 16, Suite 309, 1310 Copenhagen K, Denmark. Telephone (01) 119302, Telex: 22321.
 Asia: TST P.O. Box 98577, Kowloon, Hong Kong. Telephone 3-318256, Telex: 64235.

Circle 112 on reader service card

TM Trademark of Mitel Corporation
 Copyright 1980 Mitel Corporation

"VISIT US AT WESCON, BOOTH 2743-2745"

Conferences

Grenoble show kicks off big month

September in Europe means 30 meetings, with Esscirc 80 featuring papers from U. S. and Japan as well as Europe

Arthur Erikson, International Managing Editor, and Charles Cohen, Tokyo bureau manager

For followers of solid-state technology meetings, a global outlook has become as necessary as a copy of the proceedings of the latest conference. A case in point is the just ended Conference on Solid State Devices in Tokyo, as well as a major upcoming session in France.

The French meeting underlines the fact that September is the cruelest month for technology-show-and-meeting goers in Europe. The calendar commences on the first with the International Air Show and Exhibition at Farnborough, England, and ends more than 30 events later with Sonimag, the Barcelona radio and television show, which spills over into early October. The crammed calendar is studded with stellar events, and one that advanced-hardware people are circling in red is the Sixth European Solid State Circuits Conference, known as Esscirc 80.

Running Sept. 22-25 at Grenoble, France, an Alpine city whose best known industries are semiconductors and skiing, Esscirc 80 has outgrown its name and become a world-class meeting. To be sure, most of the fourscore papers selected discuss

European advances in solid state. But, points out program chairman Georges Grunberg, deputy director of the Semiconductor division of Thomson-CSF, "some of the best papers are from Japan and the United States."

That is particularly true of the session on memory devices, where Nippon Electric Co. and IBM Corp. dominate. But European exploits, not surprisingly, figure to generate most of the excitement in other leading-edge sessions—very large-scale-integration design methods, logic arrays, consumer integrated circuits, analog circuits, and telecommunications.

NEC will make news at Grenoble with a fully static 16-K complementary-MOS random-access memory. The NEC memory is not the first of its size in C-MOS; but it stands out among its predecessors because of its ultralow power consumption—79 milliwatts for a 200-nanosecond cycle, with an access time of 87 ns.

The key to the design is dynamic circuitry, controlled by an internal clock, for all the main memory sections except the address buffers.

That way, the direct current that ordinarily flows in digit lines and sense amplifiers at fully static operation becomes negligible. The pull-up transistor on digit lines, for example, is switched on only when the transfer gate of the memory cell is off, so there is no dc flow to the current cell. The sense amplifier operates as a dynamic flip-flop with an output swing large enough to cut off dc current.

NEC implemented this design using double-layer polysilicon technology and 3-micrometer design rules on a chip 5.84 by 6.38 millimeters. The organization of the memory is 2-K by 8 bits.

IBM's number. Memory men at IBM, whether working in West Germany, France, or Essex Junction, Vt., keep coming up with the number 18, which fits nicely in systems where a parity bit accompanies an 8-bit data byte. At Grenoble, the data-processing giant will bare details on three 18-K MOS RAM chips that are used in current IBM hardware, an experimental 18-K bipolar RAM, and a small, very fast RAM that pairs up with 18-bit buses. All

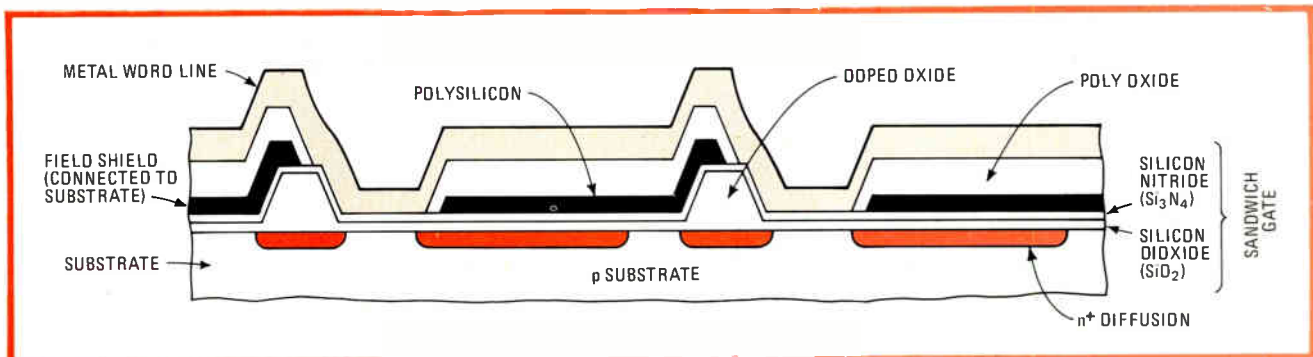

IBM's twin technology. IBM will describe at the Grenoble conference three MOS random-access memories based on a twin cell. The twin-cell arrays are fabricated in IBM's Samos technology, which is shown in this cross section. Device cycle times are about 300 ns.

PERFORMANCE! PRICE! PAY-BACK!

**THE QUALITY AUTOMATIC
INTERCONNECT TEST ANALYZER
ACCESS FIXTURE SYSTEMS**

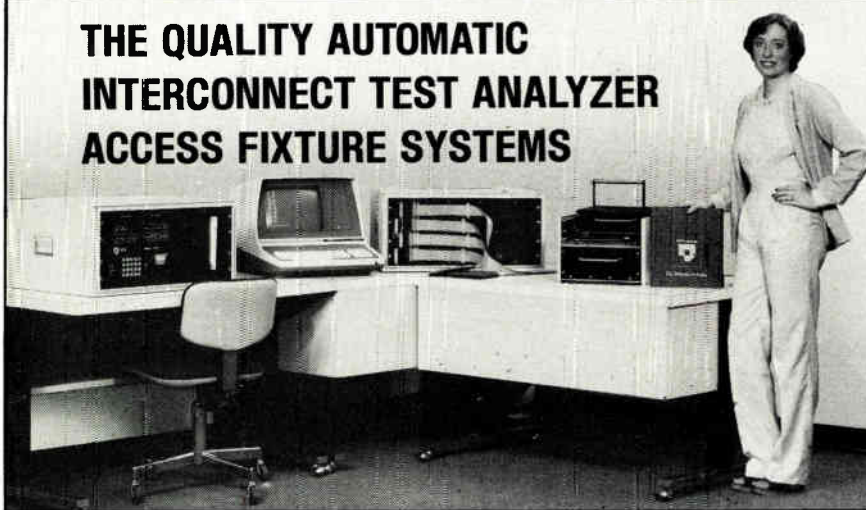

CONTROL • CRT • SWITCHING • ACCESS FIXTURE



**DIT-MCO
MODEL
1042**

*A Fully Automatic,
Microprocessor Controlled,
High Speed, Solid State,
Self Programmable Circuit Tester . . .*

- Test program printout in both analyzer and UUT language
- Pluggable solid state switching expandable to over 16,000T capacity
- Diskette Test Program Storage
- Data Base Edit
- Product error printout
- Test program listing on printer
- Self program and playback
- Asynchronous communications link with host computer and port

for download batch transfer of test programs.

Access Fixture:
Select from the series of versatile standard DIT-MCO fixtures to complete the system. The fixture shown above is Model AF-100. It is manually operated and features quick change product adaptation through transition boxes or offset pin boards.

Price performance factors of DIT-MCO analyzer/fixture systems bring TEST/QA cost savings to areas where costs to test previously were marginal or prohibitive. DIT-MCO test packages offer the speed, versatility, flexibility and overall test performance to sharply reduce throughput time and rework costs.

On the line proof! For over a quarter century the world's leading manufacturer of interconnect test systems.

Call or Write Today —



**DIT-MCO INTERNATIONAL
CORPORATION**

Quality Testing Quality!

5612 Brighton Terrace • Kansas City, Missouri 64130 • Telephone: (816) 444-9700
Telex Number 42-6149

European Technical Representative, RADIX HOUSE, Central Trading Estate, Staines Middlesex, TW18-4-XA,
England. Telephone: (0784) 51444

TEL Shinjuku-Nomura Bldg., 26-2, 1-Chome, Nishishinjuku, Shinjuku-ku, Tokyo 160, Japan. Tel: (03) 343-4411

Probing the news

three of the MOS RAMs are based on a twin cell—two identical one-device cells associated with a common word line and a bit-line pair. This arrangement lends itself to folded bit lines, which make possible a simple and fast sense amplifier—a gated flip-flop without loads. The much faster experimental bipolar chip puts a two-device merged cell into action to achieve an 18-K RAM with an access time of 75 ns and cycle time of 300 ns.

At meetings like Esscirc 80, people are always ready to hear about ways to slash the time it takes to design circuits with very large-scale integration. Ferranti Electronics Ltd. of England; the General Electric Co. Ltd., also British; and West Germany's Siemens AG all have new logic arrays to propose for shortcuts.

Ferranti, the European pioneer in uncommitted logic arrays (ULA), will report on its 2,000-gate chip. It comprises 990 current-mode-logic (CML) cells—each with enough components to hook up a pair of two-input gates or a single quad gate—and 64 input/output cells. The typical gate delay is a fast 6 ns. To fabricate this ULA, Ferranti employs collector diffusion isolation, a technology originally conceived by Bell Laboratories in the U.S. that requires only five mask steps. As perfected by Ferranti, it achieves minimum feature sizes of 3 μ m.

Hardwired edge. For its part, GEC has put together a suite of computer programs to speed design of LSI based on a 512-cell ULA in silicon-on-sapphire C-MOS technology with 5- μ m gate length. GEC points out that its ULA has hardwired logic gates rather than the usual groups of components, which makes for a more compact design: there are few uncommitted contact holes.

Siemens, which has been into fast, large-scale arrays since 1977, has added a 1,000-gate version compatible with TTL. Grenoble show-goers will learn. This chip acts like a CML array with 1-ns internal gate delay on the inside, but its input/output ports have level lifters that make the array look like TTL. The chip measures 5.57 by 6.57 mm and comes in

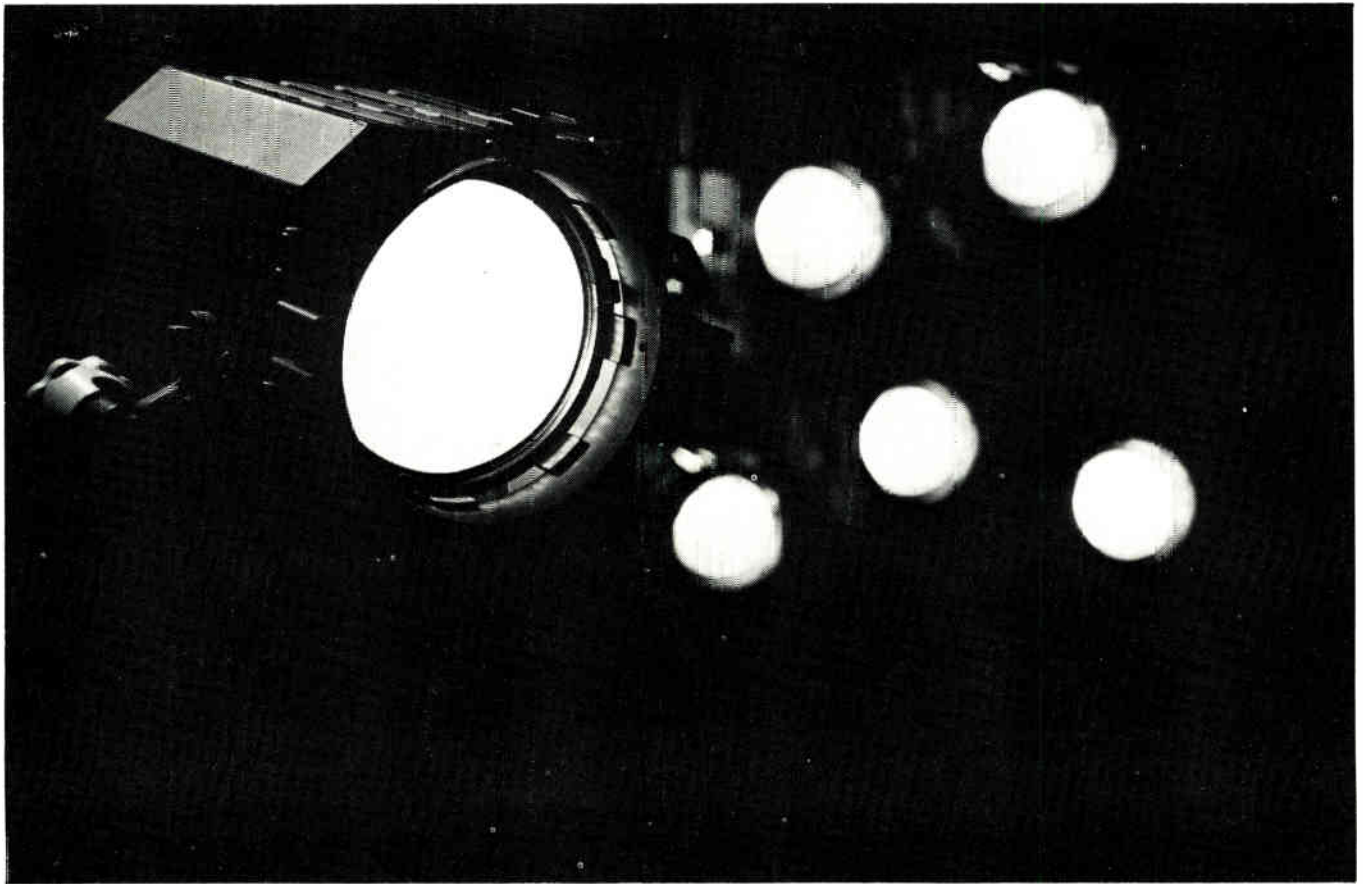

But for those who CAN'T add extra light... we created the Super-Nocticon.®

In most common TV applications, supplementary lighting can be used to compensate insufficient pickup tube sensitivity. But for situations where this approach is undesirable, impossible, or just not relevant, we added the Super-Nocticon to our extensive range of high-quality TV camera tubes. The Super-Nocticon is an ultra-high-sensitivity pickup tube featuring a light-intensifying first stage and an electron-multiplying target. It gives exploitable images with scene illuminations typically as low as 10^{-4} lux.

● If you're in surveillance, why advertise your

presence with spotlights?

- If you are investigating light-sensitive physical, chemical, or biological phenomena, why falsify your experimental conditions with excessive light levels?
- If you're investigating high-speed phenomena, the photons per image may be very low, even though the lux are high.
- If you're an astronomer, "your" stars are never in the spotlight! Whatever your TV applications, if lighting levels are low, or if exposure times are very short, the Super-Nocticon could well be the answer to your imaging problem.



THOMSON-CSF

THOMSON-CSF ELECTRON TUBES

750 BLOOMFIELD AVENUE / CLIFTON NJ 07015 / TEL.: (1.201) 779 10 04 / TWX: 710 989.7149

BRAZIL - SAÕ-PAULO / THOMSON-CSF COMPONENTES DO BRASIL LTDA
TEL.: (11) 61 64 83

FRANCE - BOULOGNE-BILLANCOURT / THOMSON-CSF
DIVISION TUBES ELECTRONIQUES / TEL.: (1) 604 81 75

GERMANY - MÜNCHEN / THOMSON-CSF GmbH
TEL.: (89) 75 10 84

UNITED KINGDOM - BASINGSTOKE / THOMSON-CSF COMPONENTS
AND MATERIALS LTD / TEL.: (256) 29 155

ITALY - ROMA / THOMSON-CSF TUBI ELETTRONICI SRL
TEL.: (6) 638 14 58

SPAIN - MADRID / THOMSON-CSF COMPONENTES Y TUBOS S.A.
TEL.: (1) 419 88 42

SWEDEN - STOCKHOLM / THOMSON-CSF
KOMPONENTER & ELEKTRONRÖR AB / TEL.: (8) 225815

JAPAN - TOKYO / THOMSON-CSF JAPAN K.K.
TEL.: (3) 264 36 46

NEW NICKEL FLAKE OUTSTANDING FOR RFI-EMI SHIELDING.

NOVAMET * Ni-HCA-1 Nickel Flake Pigment Newly Developed for Electronics Applications

Ni-HCA-1 is especially suited for RFI-EMI shielding as well as conductive adhesives. Specially developed for electronic applications, this new nickel flake pigment has been treated to yield metal-filled epoxy, acrylic and urethane paint and adhesive formulation with low surface resistance (1-3 ohms/sq).

Due to the high aspect ratio of the flake morphology (33:1 average) equivalent electrical or shielding performance can be obtained with lower pigment loadings of Ni-HCA-1 than conventional powders. This means

easier handling and improved application characteristics of the coating or adhesive system.

NOVAMET Ni-HCA-1 flake gives you outstanding environmental stability. You also gain significant economies over silver filled coatings.

You can take advantage of lower pigment loadings than conventional powder with Ni-HCA-1 and still maintain equivalent electrical or shielding performance. This is the result of Ni-HCA-1's high aspect ratio of flake morphology (33:1 average). And lower pigment loadings mean easier handling and application characteristics for both coating and adhesive systems.

You should know more about NOVAMET's new nickel flake pigment. Call Sharon Perkins at (201) 891-7978. Or write to Sharon Perkins, NOVAMET 7, 681 Lawlins Road, Wyckoff, N.J. 07481

Typical Properties of NOVAMET Ni-HCA-1	
Specular Reflectance (R_g)	>40%
Average Flake Thickness	1.2 microns
Typical Size Distribution:	
-44 μm (-325 mesh)	97%
-30 μm	90%
-20 μm	80%
-10 μm	35%
Approx. Bulk Value	.033 gal/lb
Approx. Specific Gravity	3.66
Approx. Apparent Density	1.30 g/cc

*TM of an INCO Company

Circle 116 on reader service card

NOVAMET

DIV OF MPDTECH CORP.

Probing the news

a 64-pin package, 58 of them usable for logic signals.

At home, Efcis, the semiconductor house owned jointly by Thomson-CSF and the French Atomic Energy Agency, will be on its home turf for the meeting and has to make a strong showing. So Efcis will present a microprocessor peripheral chip, a graphics processor. Paired with an 8-bit microprocessor and a 16-K RAM, the chip displays a 512-by-512 raster-scan, writing pixels for vectors and symbols as fast as 1.5 million per second.

Thomson-CSF, whose major IC facility is tucked against a mountainside on the outskirts of Grenoble, will come through for the home team as well. It has developed an interface chip that drives loads like lamps and relays that has a bipolar input section but a double-diffused aluminum-gate MOS transistor for the output stage. To keep the on-state resistance low, the D-MOS output transistor needs high gate voltages. Thomson-CSF manages this by incorporating a voltage doubler—essentially an oscillator and an MOS capacitor—on the chip. The chip can switch supplies in the 100-to-200-v range at currents of several hundred milliamperes. Die size is 4.1 mm².

Tokyo signposts. New directions in device fabrication were pointed out in some of the papers given at the Twelfth Conference on Solid State Devices in Tokyo on Aug. 26-27. The conference was sponsored by the Japan Society of Applied Physics.

Engineers at Hitachi Ltd.'s Central Research Laboratory and Musashi Works described the technology they have developed for the fabrication of linear bipolar devices that operate from power supplies as high as 150 v. The first commercial product is a vertical deflection output for color TV. It operates from 115 v supplied by direct rectification of the household power line, and includes npn and pnp transistors and resistors that can withstand 200 v.

The new ICs feature an epitaxial layer with two different thicknesses—a thin portion of 10 to 15 nm, into which isolation junctions

FREE

Brochure describes Electronics editorial reprints, services, books...

- More than 70 article reprints in 15 subject categories
- Handy wall charts
- Custom-made reprint services
- Books especially for **Electronics'** readers
- Convenient postage-paid order cards



For your free copy,
circle #275 on the
reader service card.

PIC™ Microcomputers. More For Your Money.

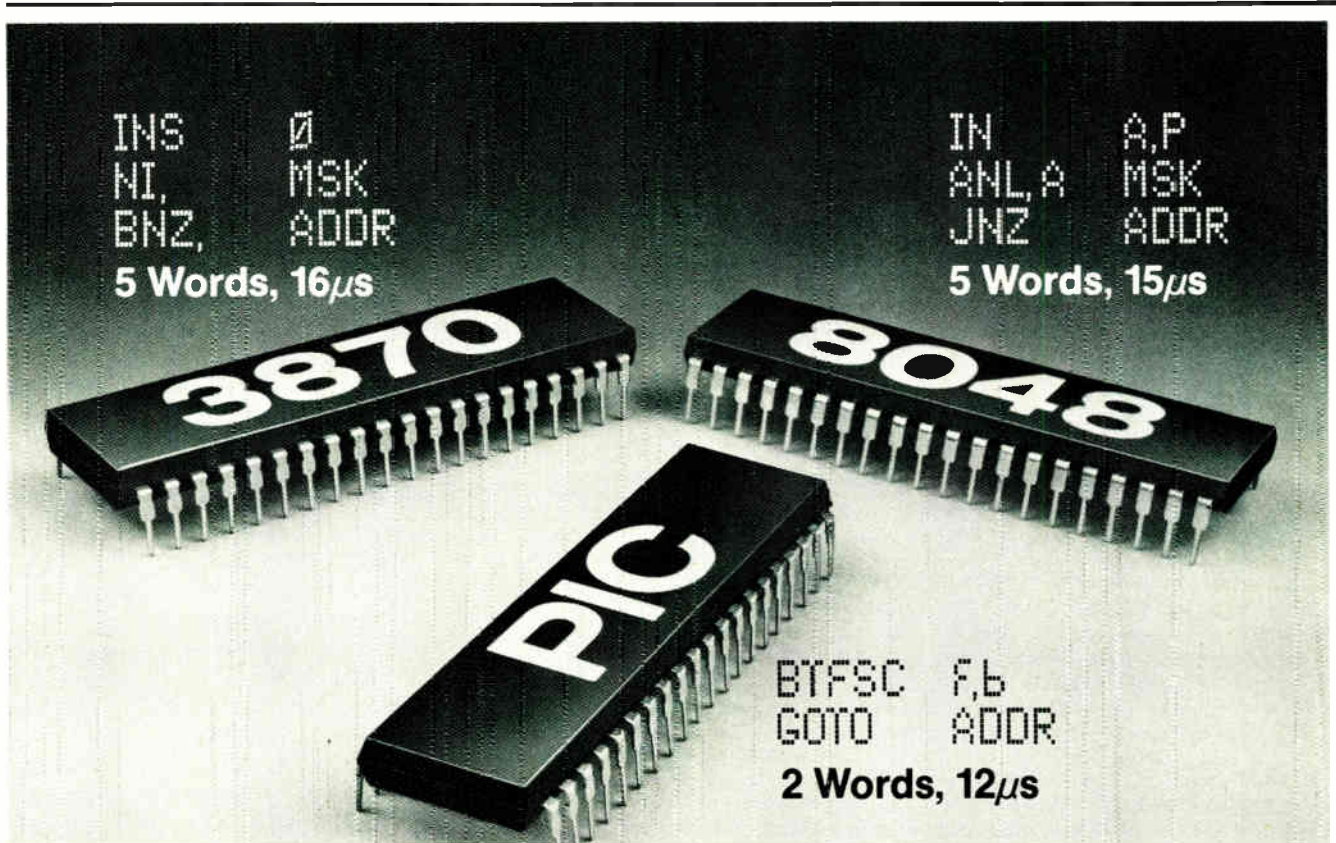

Fast and efficient. PICs 12-bit instruction word does more for less.

When you want power, efficiency and cost advantages, PIC can do it better. Its powerful, efficient 12-bit instruction word allows it to do the same job as the other 8-bit microcomputers using far less ROM. And it's easier to program, too. One example is PICs more efficient bit handling capability. Let it work for you...it's a real time and money saver.

Behind every PIC there is complete hardware and software support. Our PICAL macroassembler program and PICES In-Circuit

Emulation System make the design, development and evaluation of your product a lot easier. And our QTP program delivers initial production quantities in 4 to 6 weeks, way ahead of our competition, for true Quick Turnaround in your Production, too!

The PIC family offers you 512 12-bit words of ROM, 32 8-bit registers, an optional double interrupt structure and 20 or 32 I/O lines...enough performance capability for your most challenging designs.

Whatever microcomputer controlled equipment you're designing... appliances, automotive, telecommunications, industrial, or

business systems...you'll design faster, easier and more efficiently with PIC. The high quality, low cost alternative. And that's why we deliver more microcomputers, because our microcomputers deliver more to our customers.

Want more information right now? Call 516-733-3107, or write to Microelectronics Division, General Instrument Corporation, 600 West John Street, Hicksville, New York 11802.

We help you compete.®

GENERAL INSTRUMENT



Government Microcircuit Applications Conference-'80

Wed—Thurs—Fri 19-20-21 November 1980

Shamrock Hilton/Houston, Texas

DEPT. OF DEFENSE, NASA, NSA

Participants: DOE, USPS, DOT, DLA, NBS

DEPT. OF HEALTH & HUMAN SERVICES

If you have anything at all to do with modern electronic technology, you really can't afford to miss this one! This year, GOMAC's central theme will be "The Directions of Government Electronics for the 1980's", with emphasis on Signal Processing—including the first major conference coverage of the multimillion dollar VHSIC Program.

Major sessions will be devoted to:

- Digital Signal Processing
- Analog Signal Processing
- Gigabit Logic
- Microwave Devices & Systems
- Electro-Optics Technology
- Direct Energy Conversion
- Semi-Custom Device Design
- Fault Tolerance/Built-in Test
- Reliability & Maintainability
- Radiation Hardening
- Testing Technology
- Packaging & Assembly

Keynote and other invited speakers will include Senator Harrison Schmitt, Member of the Senate Appropriations Committee; Dr. William Perry, Under Secretary of Defense for Research and Engineering; and Mr. Jack S. Kilby, co-inventor of the integrated circuit. Senator Schmitt, in his address "Technology Options for the 80s," will provide valuable insights into the relationship between politics, government spending and technology advance. Dr. Perry, in his keynote address entitled "VHSIC in Perspective," will discuss the implications of the VHSIC program to the defense effort. Mr. Kilby will chair the eagerly anticipated "Spotlight on VHSIC" forum scheduled for the full afternoon of the first day. The inauguration of the "Jack Kilby Lecture Series" will be another highlight, as will the welcoming address of Mr. Larry W. Sumney, Director of the VHSIC Program and General Chairman of GOMAC-80.

A Poster Session will be held Thursday evening to help accommodate the large number of papers expected—over 100. All papers will be published in the Conference Digest. A separate session on Thursday evening will be devoted to classified papers. A social hour and banquet, featuring guest speaker Mark Russell, will be held on Wednesday evening.

So, make it a point to make it to Houston this November. Bring the family if you like—there'll be a diverse and engrossing "Companion's Program" featuring tours and lectures. For further information, use the coupon below or phone Miss Hilda Hammond at

(212) 620-3388

Palisades Institute for Research Services, Inc.
GOMAC Secretariat
201 Varick Street
New York, NY 10014

Please send program and registration information for GOMAC-80.

Name _____ Title _____

Organization _____

Address _____

City _____ State _____ Zip _____

Probing the news

are diffused, and a thick portion of 30 to 35 μm , in which active and passive elements are fabricated. The key to the different thickness is wells that are etched into the substrate. After the buried-layer collector diffusion in the wells, a thick epitaxial layer is grown on the substrate, the depressed portion of the epi layer is masked with silicon dioxide, and the whole layer is leveled by etching. The ability to perform isolation diffusions in the resulting thin regions decreases the amount of real estate occupied by the diffusion isolation.

Nippon Electric Co.'s Central Research Laboratories built a high-speed 4-K-by-1-bit static RAM with platinum silicide-coated polysilicon gates and platinum silicide-coated n+ diffusion layer as low-resistance wiring. Its typical performance when operated from a single 5-v supply is access in 20 ns and chip selection in 22 ns. Operating power dissipation is 500 mW; standby, 50 mW.

Getting together. A laser diode and twin field-effect transistor combination was the forerunner of electro-optical devices built into integrated circuits. Researchers at Hitachi wanted to build a true integrated circuit, but stopped at the twin FET. The use of two diodes provides a convenient high-speed modulator that operates at gigahertz speeds because one diode sets the quiescent current, while the other provides pulse modulation. Thus, the quiescent-current setting and modulation are independent and do not interact.

An undoped high-resistivity gallium aluminum arsenide layer formed on top of the laser diode isolates the FETs from the laser. The FET active layer is a tin-doped gallium arsenide liquid epitaxial layer on top of the isolation layer. It is etched to form two independent FET regions. The metal for the Schottky-diode gates and the ohmic contacts to the FET source and drain contacts and laser diode contact is patterned by a lift-off photolithography technique. The Schottky diode metal is a gold-chrome alloy, whereas the ohmic contacts are a gold-germanium-nickel alloy. A zinc diffusion provides connection to the laser.

YOU KNOW THE LARGEST ELECTRONIC COMPANIES IN THE WORLD. DO YOU KNOW ISKRA?

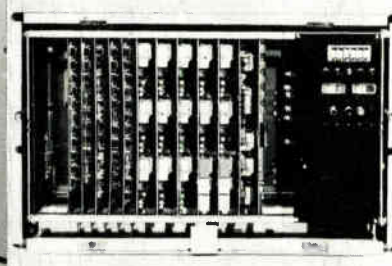
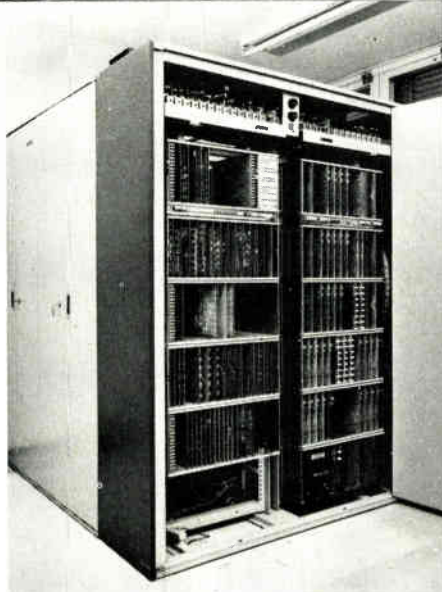

Iskra group has some 29,000 employees including 2,000 research and development engineers in 81 factories, research, marketing and other organizations, and the most up-to-date technologies to work with. With a total turnover of 1.294 billion dollars last year, it has been classified among 16 largest manufacturers of electronic products in Europe.

In its development, Iskra is oriented towards tomorrow's activities which go far beyond the traditional limits of electromechanics and extend to the widest application of electronics with priority being given to the promotion of the development of computers, communications, automation, microelectronics, optoelectronics and engineering activities. All to ensure that every project we handle comes within schedule and budget requirements and meets performance and client expectations.

Iskra has 24 trading companies, representative offices and production plants in 18 countries all over the world. In the period 1974-1979, Iskra's exports increased by 153% reaching 120 million dollars in 1979. In 1980, the total turnover is expected to be 1.486 billions of dollars and the export figure approximately 145 million dollars.

For more information call or write:

Iskra Commerce, Trg revolucije 3, 61001 Ljubljana, Yugoslavia, Telephone-international: + 38 61 324 261; Telex: 31 356 yu iskexp
 USA: Iskra Electronics Inc., 8 Greenfield Road, Syosset, N.Y. 11791, Tel.: (516) 364 2616—Germany: Iskra Elektronik, GmbH, Furtbachstrasse 2b, 7000 Stuttgart 1, Tel.: (711) 60 30 61—CEFRA, GmbH, Ungererstrasse 40, 8000 München 40, Tel.: 39 20 61—Italy: Iskra Elettronica Italiana, S.r.l., Piazza de Angeli 3, 20 146 Milano, Tel.: 49 80 036—France: Iskra France, 354, rue Lecourbe, 75015 Paris, Tel.: 554 04 27—United Kingdom: Iskra Limited, Surrey CR 3 2 HT, Redlands, Coulsdon, Tel.: 66 87 141—Switzerland: Iskra Electronics AG, Stalden 11, CH 4500 Solothurn, Tel.: (065) 22 81 22—Czechoslovakia: Iskra, Lazarska 5, 11000 Prague, Tel.: 20 27 71—Poland: Iskra, Swietokrzyska 36 m 15, Warsaw, Tel.: 20 12 53—Germany DR: Iskra, Hermann-Maternstrasse 46, 104 Berlin, Tel.: 28 28 322—Rumania: Iskra, Str. Visarion nr. 6, Bucharest, Tel.: 50 26 75—U.S.S.R.: Iskra, Mosfilmovskaja 42, Moscow, Tel.: 147 84 03—Egypt: Iskra, 34 Adly Street, Cairo, Tel.: 74 76 95—Iran: Iskra Teheran, 9th Street No. 6, Maydan Sanai, Teheran, Tel.: 82 67 65—Turkey: Iskra Istanbul, Yenicasri Biletiz Han No. 40, Galatasaray, Tel.: 44 75 00—Venezuela: Eurocommerce S.A., Apartado 68901, Altamira, Caracas, Tel.: 72 88 21.



Iskra

Electronics abroad

Britain faces last chance in VLSI

Government decides to put another \$57 million into Inmos despite some doubts the country needs a semiconductor industry

by Kevin Smith, London bureau manager

The dreams of the British government of establishing a presence in the market for standard high-volume very large-scale integrated circuits, so bright as recently as a year ago, have now come down to one last chance. The end of the planned joint venture between Britain's General Electric Co. Ltd. and Fairchild Camera and Instrument Corp. of the U. S. leaves Inmos Ltd. as the remaining hope.

Yet Britain's three other manufacturers, GEC, Plessey Co., and Ferranti Ltd., do not seem dismayed at leaving the bulk of the standard-circuit market to others as they argue that the technology is now in a transitional phase in which semicustom—or programmable circuits—capable of housing very large systems on one chip are assuming an

increasing importance and are positioning themselves to meet this requirement. In this scenario Inmos and multinationals like Motorola Inc., ITT Semiconductors, and National Semiconductor Corp., all with modern VLSI plants in the UK, would meet British equipment manufacturers' requirements for standard circuits together with imports from the U. S. and Japan. UK companies would meet local custom requirements using primarily high-density C-MOS processes.

Just two years ago, though, both the previous Labour government and GEC, Britain's largest electrical and electronics group, had decided to make up for past neglect by buying U. S. technology in order to gain access to and control over a source of

modern n-channel VLSI technology. Inmos and the planned GEC-Fairchild Ltd. grew out of that, but a new government and new ownership at Fairchild skewed all plans.

After Fairchild's parent, Schlumberger Ltd., and GEC agreed to call off the GEC-Fairchild venture to manufacture memories and microprocessors at a jointly owned production unit in Neston, Ches., GEC showed a fleeting interest in Inmos. But it quickly decided instead that it is no longer interested in the standard-circuits market and intends to concentrate on building up its in-house custom capability based on a new production unit at Lincoln, Lincs., headquarters for its Power Semiconductor division.

The plant will be used for the

Nonalliance. This was to have been the GEC-Fairchild semiconductor plant at Neston in Cheshire. Now that the planned joint venture has been called off, GEC will use the plant, almost completed, to make the Sting Ray advanced lightweight torpedo system.

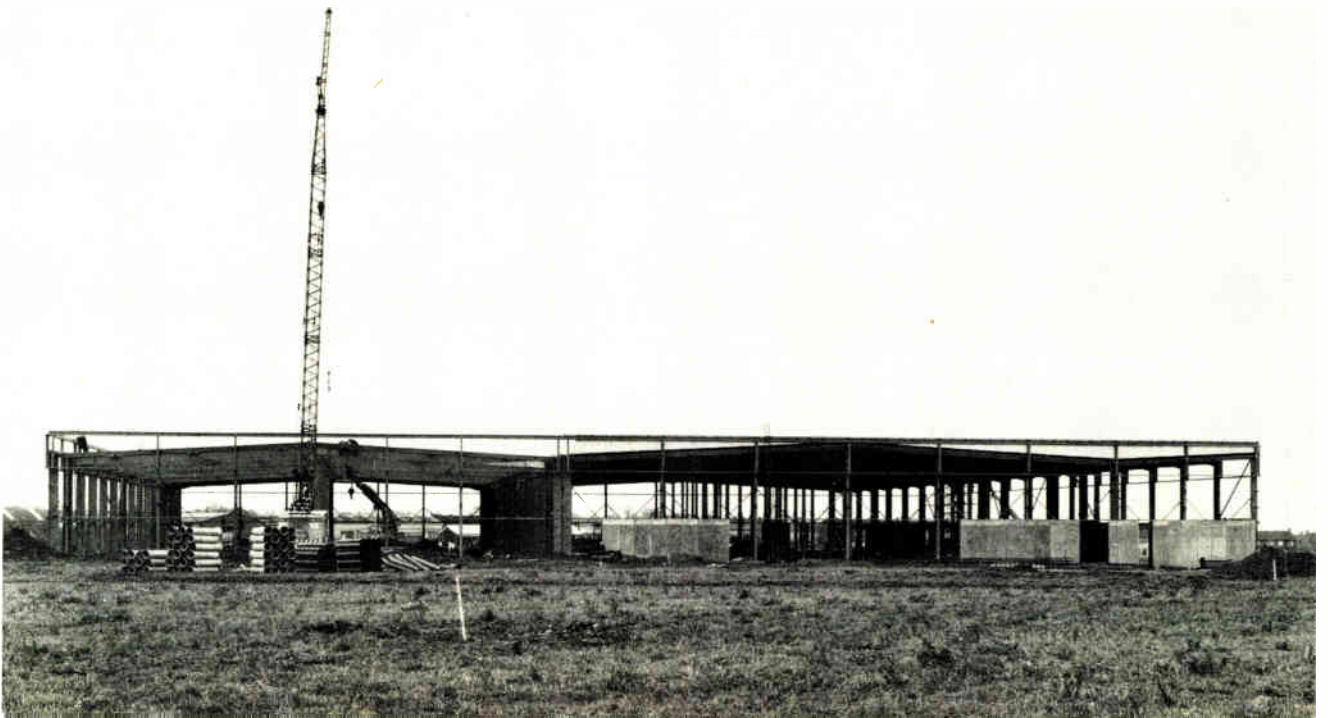

SURPRISE!

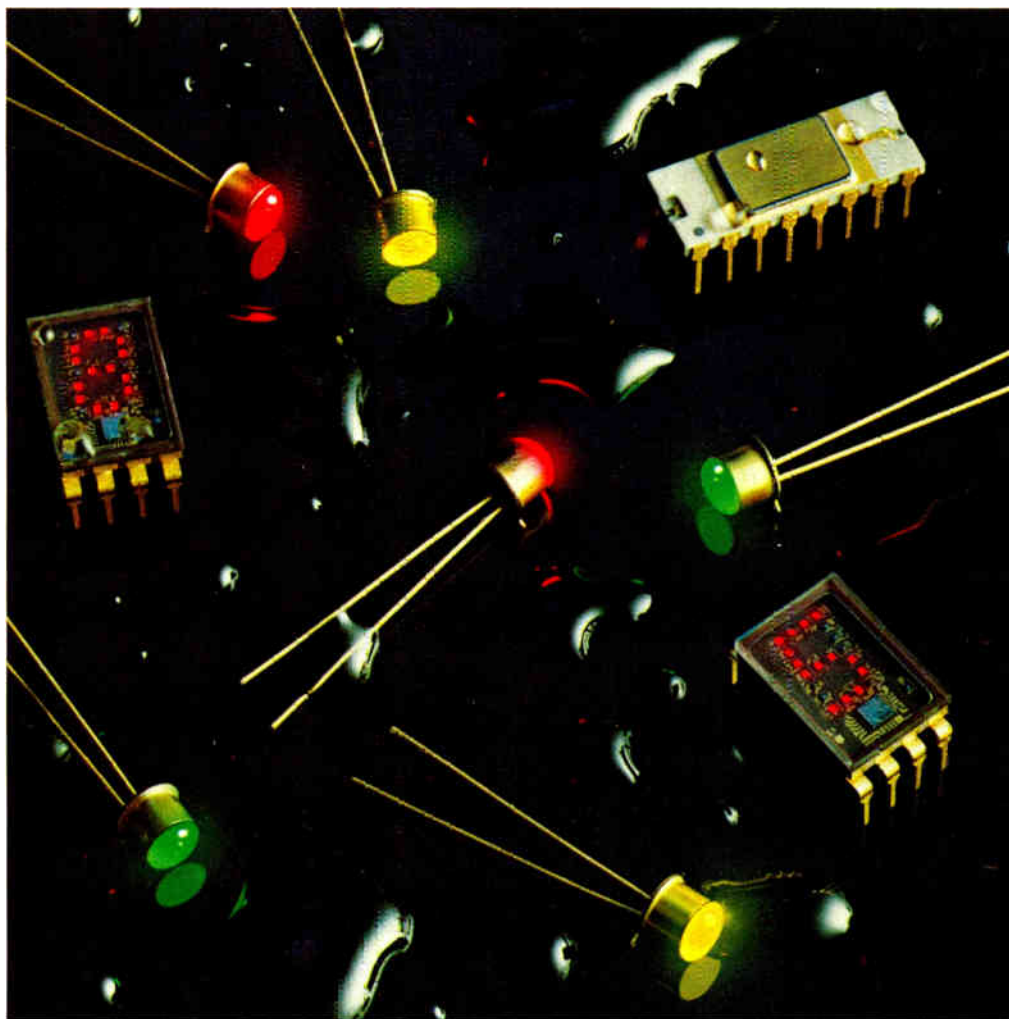

High Reliability Optoelectronic Products.

Look to HP for high reliability in hermetic lamps, displays and optocouplers. They are ideal for ground, airborne and shipboard equipment, medical instrumentation, fire control and space flight systems. HP is the only supplier of JAN and JAN TX qualified true hermetic light emitting diode lamps. HP also supplies hermetic numeric and hexadecimal solid state displays which are impervious to moisture.

Couplers are high speed, low input devices and are supplied as hermetic duals or quads, and are being used in defense electronics and EW systems.

For years HP has been a leader in the production of high reliability optoelectronic products—products that are continually tested and upgraded. Many of HP's plastic components are also used in high reliability applications.

They're in stock right now at your local HP Components franchised distributor. In the U.S. contact Hall-Mark,

Hamilton/Avnet, Pioneer Standard, Schweber, Wilshire or the Wyle Distribution Group (Liberty/Elmar).

In Canada, call Hamilton/Avnet or Zentronics, Ltd.



Probing the news

manufacture of custom complementary-MOS circuits for use in the Mark 2 version of System X and in other of GEC's telecommunications, industrial, and military products. The new plant is one part of a three-pronged strategy aimed at giving Britain a major presence as a manufacturer of advanced high-density

C-MOS devices—seen by many as the technology that sounds the death knell of a good slice of the old standard TTL market.

GEC, British Telecom—the telecommunications arm of the British Post Office—and Plessey have together obtained a manufacturing license from the Canadian telecommunications device manufacturer Mitel Corp. for its high-performance, high-density Iso-C-MOS pro-

cess. British Telecom will have a pilot production unit at its Martlesham Research Centre and Plessey will have its first line operational within nine months at its Plympton production unit.

Plessey muscle. Plessey, after a period of uncertainty during which it came close to selling its semiconductor division, is now beefing up the operation under the management of Melvin Larkin, who comes to the group from Motorola (UK) Ltd., where he was managing director.

Ferranti Semiconductors Ltd., the third of the trio of British-owned semiconductor companies, pulled out of the standard market back in 1971 to develop one of the industry's first uncommitted logic array technologies. Ferranti used its high-density bipolar collector-diffused-isolation process. Now, with its U.S. subsidiary, Interdesign Inc., the group claims annual sales in the region of \$60 million and five profitable years in a row. It also has imitators, with both Racal Microelectronics Ltd. and Smiths Industrial Ltd. in Britain offering a ULA design service of between 1,000- and 2,000-gate complexity using prediffused C-MOS wafers from Mitel.

So Inmos is now Britain's last chance of maintaining a presence in the high-volume n-channel standard part market for memories and microprocessors and with it a place at the leading edge of microcircuit technology. Some, like Robert Heikes, international vice president of National Semiconductor Corp., doubt the need for an indigenous European semiconductor industry and have even greater doubts about its viability. Europeans, he says, are wasting their time trying to catch up with the Americans and Japanese and should instead concentrate on applications.

NEB confident. But the National Enterprise Board, now under the leadership of Sir Arthur Knight, appointed by Industry Minister Sir Keith Joseph to trim the NEB's wings, is more confident that Inmos will be a success. The decision to go ahead with a UK production plant—to be located in South Wales where it will also qualify for Common Market and UK regional development grants—was taken after an

These Headers can be headed your way today.



Need headers for connector systems, PCB's or wire wrapping? Your A P Distributor has them in stock and ready for delivery.

Female headers come in single or double rows of 36 contacts.

Male headers come in straight or right angle configurations in single or double rows of 36 contacts. All can be cut to any number of contacts by you or your A P Distributor.

- Dielectric is black thermoplastic polyester and unaffected by flow soldering or board cleaning solvents.
- Contacts are full hard-copper alloy 770. Gold plated or unplated.

Immediate delivery!

Call TOLL FREE, 800-321-9668, for the name of the distributor nearest you. (In Ohio, call collect: (216) 354-2101.)



A P PRODUCTS
INCORPORATED
1359 West Jackson Street
Painesville, Ohio 44077
(216) 354-2101

In Europe, contact A P PRODUCTS GmbH Baumlesweg 21 • D-7031 Weil 1 • W. Germany

SURPRISE!

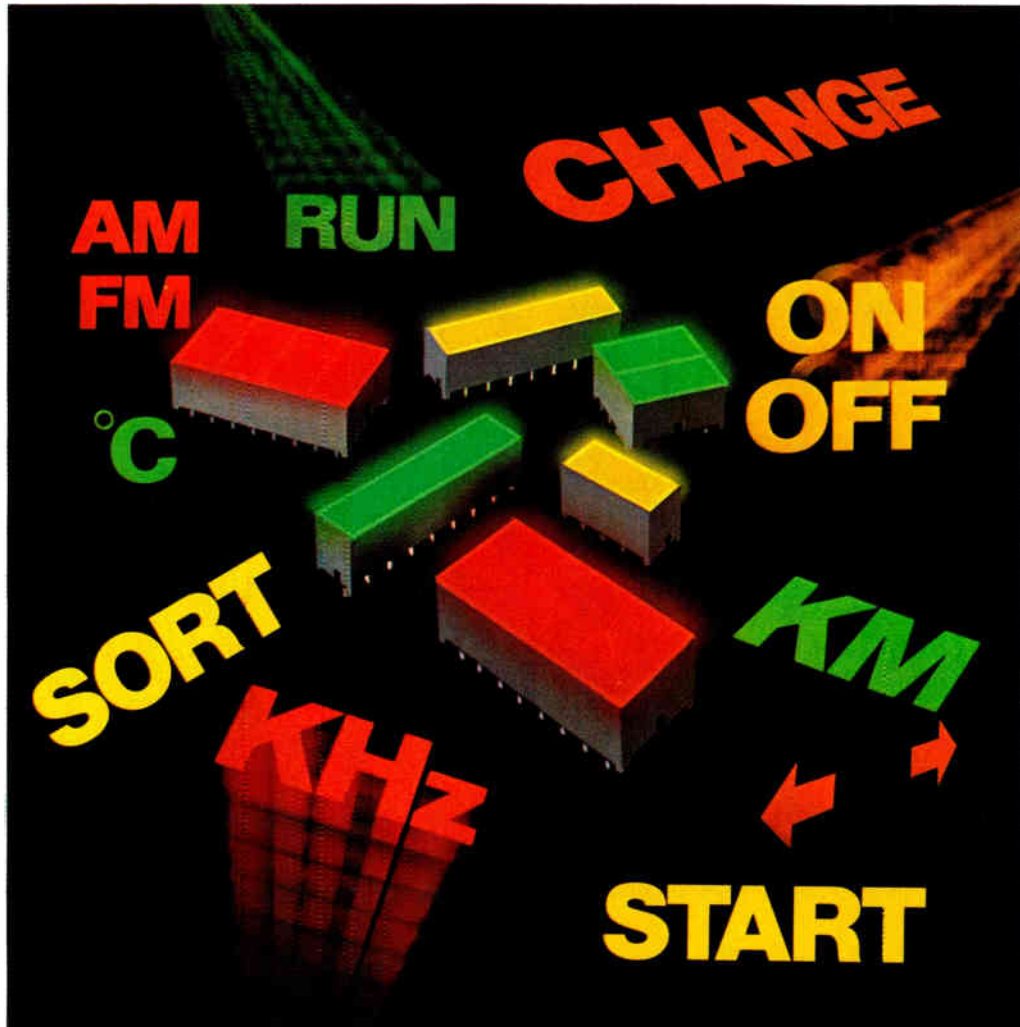

Light up your Message with HP's Largest and Brightest Light Bars.

HP's HLMP-26XX, -27XX, -28XX series are the largest light emitting diode, single-packaged backlighting products commercially available in the world. Instead of using incandescent lamps, bright backlighting is possible with these light bar modules, in High Efficiency Red, Yellow or Green.

The light emitting surface areas range from 8.89mm x 3.81mm to 8.89mm x 19.05mm. Each device contains from one to four surface areas to give you a variety of options for lighting your word or symbol legends.

Prices start at \$.98* in quantities of 1000.

For more information or immediate off-the-shelf delivery, call any franchised HP distributor. In the U.S. contact Hall-Mark,

Hamilton/Avnet, Pioneer Standard, Schweber, Wilshire or the Wyle Distribution Group (Liberty/Elmar). In Canada, call Hamilton/Avnet or Zentronics, Ltd.



SERIES SE3000

Lightweight, instrumentation recorders

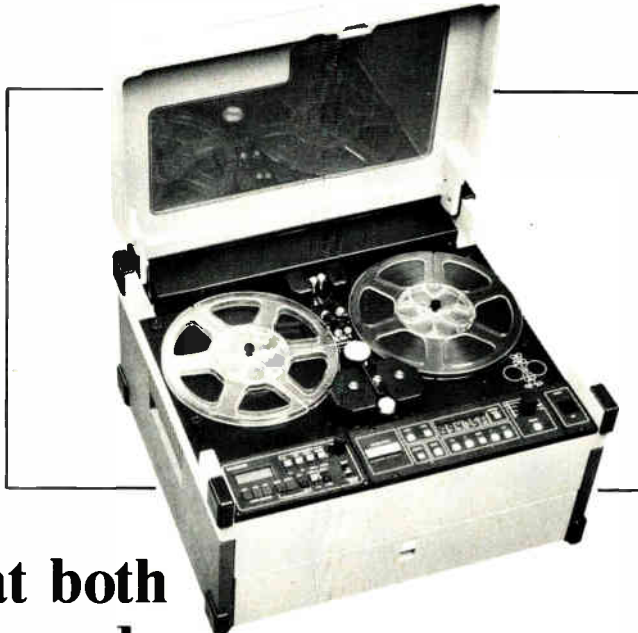

that both
you and your
budget can carry

These IRIG compatible $\frac{1}{4}$ and $\frac{1}{2}$ inch portable instrumentation recorders are the first to offer the features and performance of 1 inch laboratory recorders that weigh and cost much more.

- 8 tachometer or tape servo controlled speeds, from 15/32 to 60 inches/second
- IRIG compatible recording up to 40 kHz FM, 300 kHz direct, and 0.5 Mbit/second HDDR
- 4, 7, 8, or 14 record/reproduce channels, plug in for any mix of FM, direct, and HDDR, fully aligned for 8 speed operation
- Built-in calibration, complete electronics-to-electronics checkout (FM and direct)
- Choice of interchangeable ac or dc power supplies

Call today. You'll be surprised how little a 55 lb, 14 channel portable instrumentation recorder can cost.
Or write for our new 4 page brochure.

EMI EMI Technology Inc.

100 Research Drive P.O. Box 2046 Stamford, CT 06906
Telephone (203) 356-1300 TWX: 710-474-0128
Toll Free Instrumentation Service: 800-243-2572

A Member of the THORN EMI Group.

Sales Offices:

- Newport Beach, CA 92660
Telephone (714) 760-1955
- Atlanta, GA 30339
Telephone (404) 952-8502

International:

SE Labs (EMI) Ltd.
Spur Road, Feltham, Middlesex
TW14 0TD, England
Telephone 01-890-1477 Telex: 23995

Probing the news

independent assessment by two U. S. consultants.

They found that Inmos designers, based at a pilot production unit in Colorado Springs, Colo., were well advanced with designs for technically competitive 16-K and 64-K designs. "I am confident they will be profitable by 1984," says Sir Arthur. Even so, the skeptical Sir Keith, who is unhappy about state intervention in industry, would like to interest the private sector in investing in the company.

But it will not be that easy to involve the private sector. For one thing Richard Petritz, Paul Schroeder, and Iann Barron, the founders of Inmos, have a 15% stake in the company with stock options that block unwanted takeovers. "There may come a time when a private partnership may depend on whether the [Inmos] entrepreneurs are willing to renegotiate the scale of their equity interest in the company," comments Sir Keith, who adds that his government "will not be entering into any more contracts like that." If Inmos reaches its projected sales of \$345 million by 1984 each founder will be worth \$14 million, says Petritz.

Design control. Some British executives concede that Heikes' viewpoint may be at least half right. "What's important, says GEC's recently appointed research director, Derek Roberts, "is that equipment companies must retain control of the design process." So as more and more of the equipment manufacturer's system is placed on a chip, Roberts foresees the emergence of a second-tier engineering-intensive and service-oriented industry using relaxed design rules and providing computer-aided and semiprogrammable design services—in fact, a philosophy already adopted by most UK companies.

Standard circuits, believes GEC, can be bought like any other commodity on the open market. The GEC-Fairchild plant, it says, was intended to secure a source of supply for standard circuits, but the emergence of the Japanese in the market will ensure availability at competitive prices. □

SURPRISE!

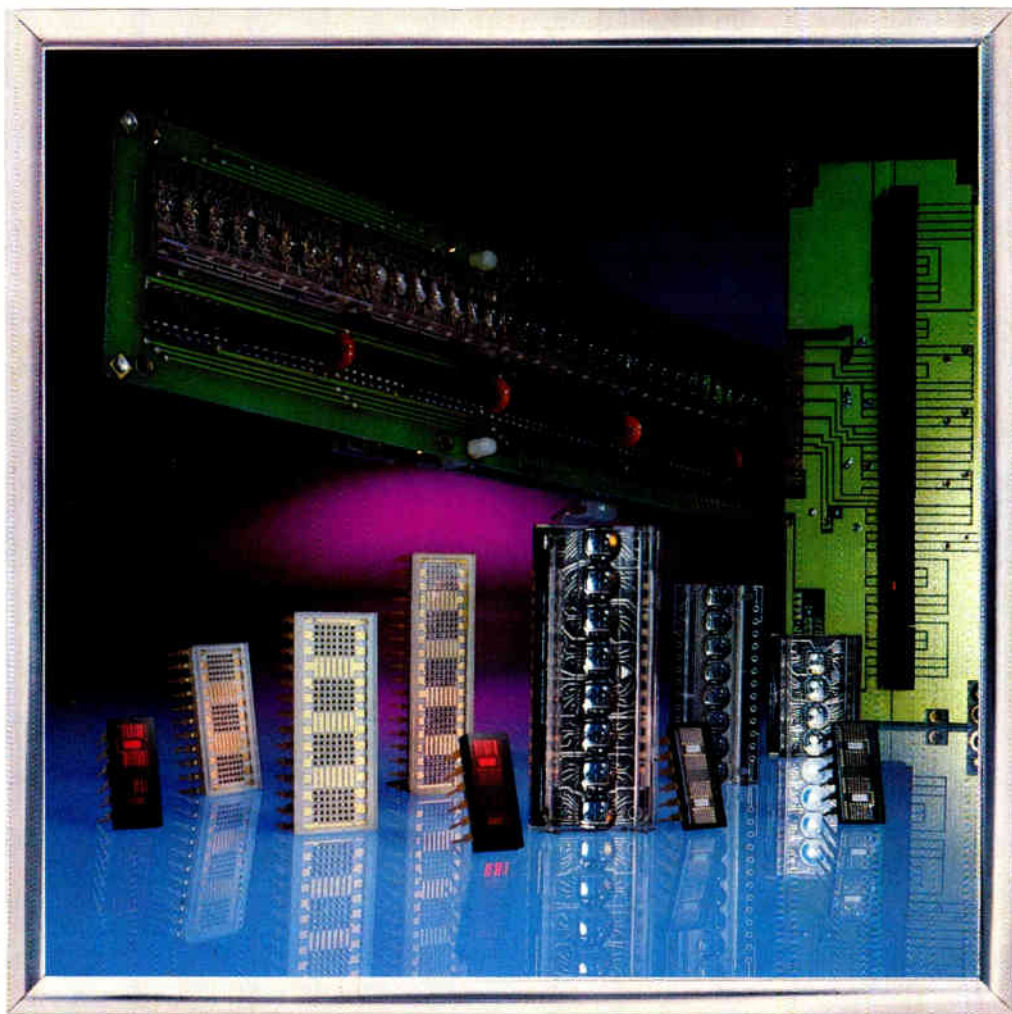

HP's Family Portrait: A Growing Line of Alphanumerics.

HP's long-standing commitment to the alphanumeric display market has resulted in the largest family of these LED displays available anywhere. And more are on the way! If your intelligent system requires visual interface for its operation or service, put one of our reliable products to work for you.

Light up an inexpensive 18-segment display or one of our sophisticated 5 x 7 dot matrix devices—compact red, yellow and extended temperature range displays available with integrated shift registers and constant current drivers.

Rounding out your selection are 16-, 24-, 32-, or 40-character systems, dot matrix or segmented, which free engineers from costly design time. HP's whole gallery of displays receives our strong applications support.

They're in stock right now at your local HP franchised distributor.

In the U.S., contact Hall-Mark, Hamilton/Avnet, Pioneer Standard, Schweber, Wilshire or the

Wyle Distribution Group (Liberty/Elmar).

In Canada, call Hamilton/Avnet or Zentronics, Ltd.



Lower your cost of testing. Get your hands on Fluke's new Instrument

You're looking at a new breed of controller. It's not a calculator adapted for control. It's a powerful instrument dedicated to controlling test and measurement systems. We've engineered the 1720A to trim the fat out of automated testing costs by making operation simple and programming a breeze.

The hands-on demo takes on a whole new meaning.

When you get your hands on the 1720A, you'll understand why this controller is so exciting. After programming the 1720A, just unplug the keyboard and interact directly with the touch-sensitive display. Without knowledge of computer languages or

programming, technicians can operate a complex system of instrumentation with just a touch.

Power to the programmer.

The 1720A offers the best of two worlds: simplicity for the operator, sophistication for the programmer.

When you plug the standard ASCII keyboard into the 1720A,



Controller at our seminar - and find out how.

you take control of its powerful BASIC software. You determine what an operator sees and how it's presented. It's like sitting at the operator's elbow guiding him through each test procedure.

One-source system building.

With the introduction of the 1720A, you can now build your measurement system with Fluke

precision throughout. Rack up a 1720A with Fluke DMM's, signal generators, counters, calibrators, data loggers, scanners and printers. Four independent interface ports — two each for  and RS-232-C make configuration simple. And programming the system is just as easy with:

- Three memory devices — 60K byte main memory, 175K byte floppy disk and two optional 128K byte high-speed electronic disks (E-Disk™)
- Enhanced BASIC language with IEEE commands — for easy systems programming
- Virtual arrays — enlarges effective read/write memory capacity

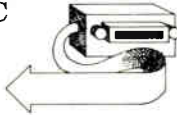

Why a seminar?

What better way to show you how the Controller can save you money than with a hands-on demonstration of the 1720A. Here, you'll see the Instrument Controller in actual system operation with other test instruments. And, you'll learn how a controller *designed for* test instrumentation can make system building a far simpler task.

Here's how to sign up.

Contact your Fluke Sales Engineer or Representative. He'll make arrangements to schedule you for a seminar, conducted by one of our system specialists. Each specialist is a computer systems engineer extensively trained on the 1720A and ready to work with you in evaluating your specific instrumentation requirements.



If you prefer, use our toll free number **800-426-0361** or send in the fast-response coupon below. We'll send 1720A literature and the name of the Fluke Sales Engineer nearest you.

A few hours of your time now can save you hours and money later.

Take a couple hours out of your busy schedule this Spring and get your hands on the new 1720A Instrument Controller. It could save you thousands by Summer.



-----Fast-Response Coupon-----

IN THE U.S. AND NON-EUROPEAN COUNTRIES:	IN EUROPE:
John Fluke Mfg. Co., Inc.	Fluke (Holland) B.V.
P.O. Box 43210 MS #2B	P.O. Box 5053, 5004 EB
Mountlake Terrace, WA 98043	Tilburg, The Netherlands
(206) 774-2481, Telex: 152662	(013) 673 973, Telex: 52237

Sign me up!

Week preferred: _____

Test application: _____

- Send 1720A Literature.
- Send info on other Fluke IEEE products.

Name _____

Title _____ Mail Stop _____

Company _____

Address _____

City _____ State _____ Zip _____

Telephone () _____ Ext. _____

For Technical Data Circle No.127

E2 8/80

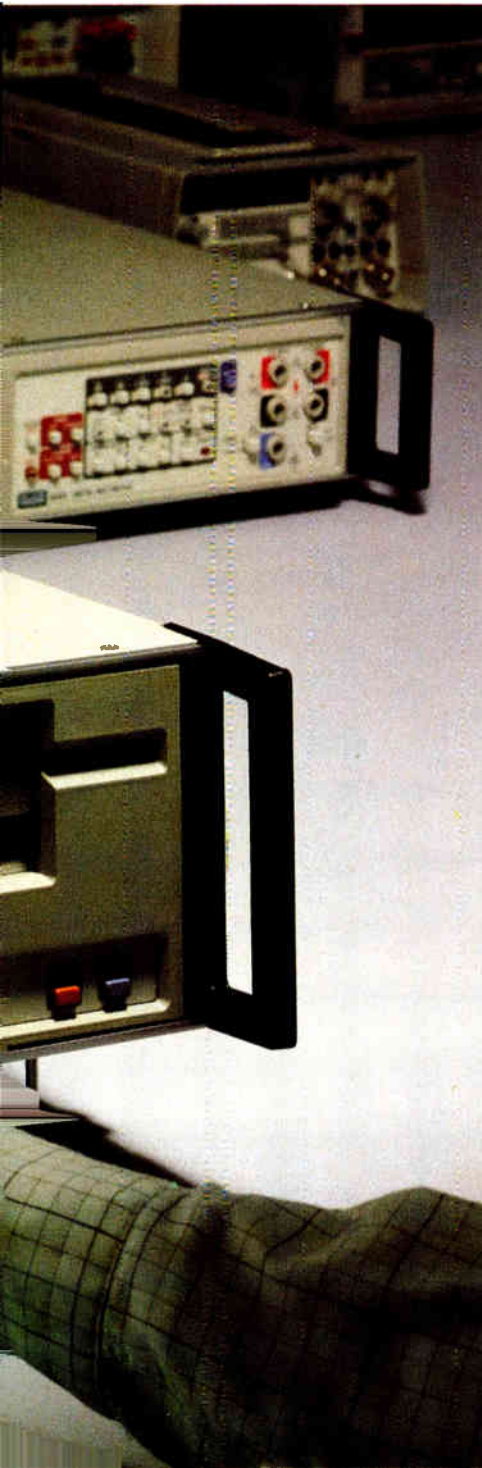

Technological leadership.

MC6805P2. Only this does so much, for so

Motorola's inexpensive new MC6805P2 single-chip microcomputer uses HMOS technology to provide you with a level of performance and combination of features never before available in its price class.

It is the first in a large family of Motorola HMOS and CMOS 8-bit single-chip microcomputing units designed for maximum cost-effectiveness in high-volume control applications: industrial controllers, appliances, automobiles, consumer products and a variety of others.

Volume shipments to customers for these applications are now routine.

The M6805 Family MCUs all have RAM, clock, timer and bidirectional I/O on-board with the MPU. The 28-pin HMOS MC6805P2 also has 1100 bytes of user ROM on-chip. M6805 Family plans include other versions with A/D conversion, or 2K of ROM or EPROM.

Facts say it's a better MCU.

Most inexpensive MCUs have no interrupts. The MC6805P2 has three: external, timer, and software.

Most MCUs are locked into a single configuration. M6805 Family MCUs are designed for versatility, for use in varied configurations, in either HMOS or CMOS.

Some day most MCUs will be able to "test themselves". Only the MC6805P2 has on-chip self-check capability today. It means simpler and less expensive testing for users, resulting in lower overall costs.

And there's still much more to the MC6805P2. Twenty I/O lines are organized into three flexible ports, with one able to drive the widely-used common cathode LEDs. And the 8-bit timer is software programmable with a mask-programmed prescaler.

Programming is easiest.

Mnemonically meaningful instructions and clean computer-type architecture. Motorola traditions begun with the M6800, are continued and expanded in the M6805 Family. The power of true bit-manipulation instructions, plus the best programming features of the M6800 have produced the most versatile MCU yet introduced.

The MC6805P2 has ten addressing modes, more than any other in its class. Byte-efficient, enhanced indexed addressing is included.

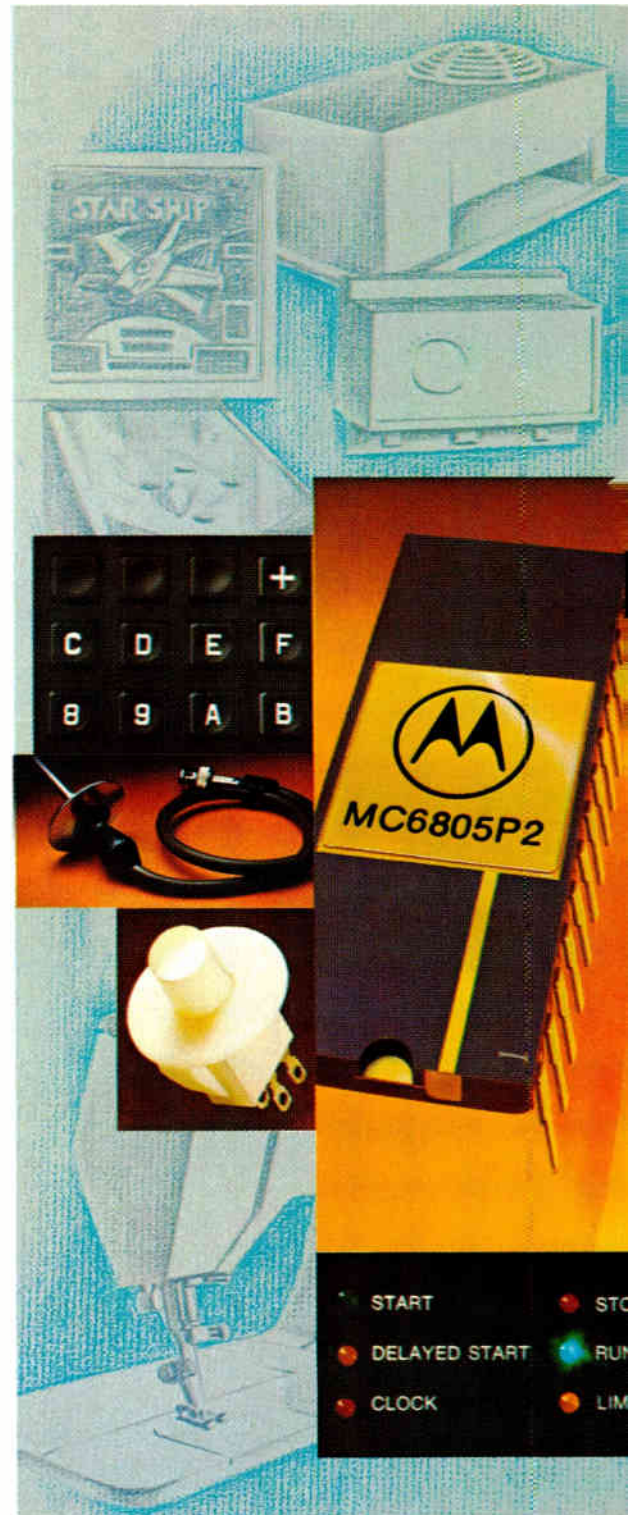
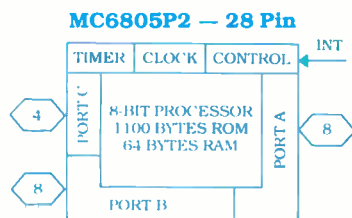

single-chip 8-bit MCU many, for so little.

M6800 users are having no difficulty programming M6805 MCUs. Conversely, it's an easy transition from M6805 to other M6800 processors.

Most programmers will agree: M6805 Family MCUs are programmed more easily and quickly, and at lower cost, than any competitive MCU.

Complete development support.

System development support for the MC6805P2 is provided by the MEX6805 Support Module. It's fully compatible with the MC6800-based EXORciser®/EXORterm™ development systems, and provides a complete memory map, selectable via software, using RAM, EPROM, mask ROM, or external memory. All existing M6800 support products are automatically usable for M6805 system development.

Debugging features include the display of registers and memory, single-step capability, halt-on address and break points, and the powerful MEX68USE (User System Evaluator) is easily used by the module.

Evaluation units available now.

An HMOS evaluation unit, the MC6805P2L1, is available with a program for interfacing with a terminal, and contains sample routines like time-of-day and serial I/O. It also demonstrates the "self-check" feature and performs standard monitor functions.

The "L1" is available now in the Microdemo 6805 kit, which includes the MC6805P2L1, a PC board, and a users' manual which describes several circuit configurations and a complete ROM program listing. The inexpensive Microdemo 6805 kit is available through your Motorola distributor as the SCPROM03.

For information, contact your Motorola sales office or authorized distributor, use the coupon or write to Motorola Semiconductor Products Inc., P.O. Box 20912, Phoenix, AZ 85036.

Innovative systems
through silicon.



MOTOROLA INC.

TO: Motorola Semiconductor Products Inc., P.O. Box 20912, Phoenix, AZ 85036.
64E8/28

Please send me information on MC6805P2.

Name _____
Title _____
Company _____
Address _____
City _____
State _____ ZIP _____



TIME OUT
CYCLING
ALARM

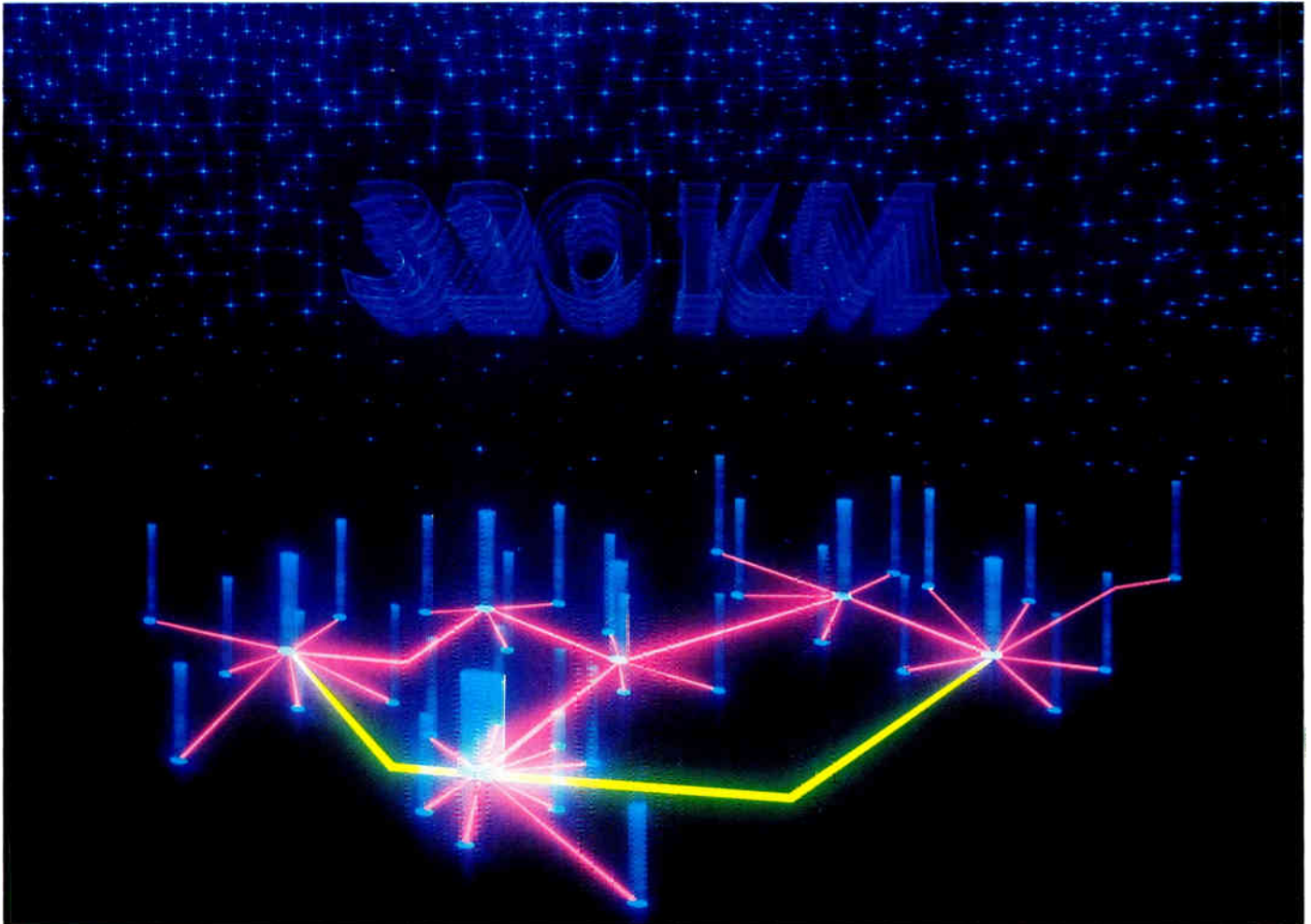

320-KM FIBER OPTICS DIGITAL TELEPHONE SYSTEM FOR BUENOS AIRES

NEC will soon start constructing an ultra-modern telephone network in Buenos Aires under the terms of a contract recently signed with ENTEL, Argentina's national telephone authority.

The system will be the largest digital switching network ever to be built in a single city and will incorporate high-capacity fiber optics transmission

systems, also the largest of their kind.

The new digital telephone network will have 6 tandem exchanges and about 60 telephone offices interconnected by means of large-capacity transmission lines. Each tandem exchange will have circuits equivalent to 80,000 subscriber lines and will be provided with a NEAX61 digital switching system.

A 140 mbps (1,920 telephone circuits) fiber optics transmission system will be used to interconnect the tandem exchanges. A 34 mbps (480 telephone circuits) fiber optics system will be employed to interconnect the tandem exchanges and telephone offices. The length of these optical systems will be 80 and 240 kilometers, respectively. The transmission links will be backed up 100% by an advanced, fully solidstate digital microwave system operating at 11 GHz. Cut-over date is scheduled for the end of 1981.

WORLD'S
LARGEST-CAPACITY
FPLA.

NEC has introduced the world's first 9,216-bit bipolar field programmable logic array. The new product, called μ PB450D, can bring about tremendous reductions in the size, cost and power consumption of electronic digital control systems while improving availability, turn-around time and design flexibility.

The new product has 9,216 programmable points in the form of AND- and OR-arrays, as well as 16 J-K flip-flop feedback loops. Flexibility is an outstanding feature of the device which allows the customer to achieve any kind of sequential logic by programming the 9,216 points arbitrarily.

It is contained in a 0.6-inch width, 48-lead, dual-in-line package with 24 inputs, 16 outputs and 6 control terminals. It works in TTL levels with a single 5-volt power supply; power consumption is 600mW typ. (1.1 watts max.); input-to-output time delay is



100 nsec typ. (200 nsec max.).

A medium-speed device, μ PB450D is highly suitable for microcomputer-control circuits. Applications include both industrial and consumer electronics. The range goes from peripheral and terminal equipment to TV games and electric washing machines.

Circle 131 on reader service card

MNC-80A PORTABLE CAMERA
FOR ACTION TV.

TV audiences are demanding more dynamic and varied programs. This, in turn, creates a need for versatile, high-performance cameras that can be used with equal ease in the studio or out on location. NEC has been responding to this need with a growing line-up of advanced television cameras.

The latest offering is the MNC-80A series fully self-contained portable color camera. Light enough for hand-held operation, it is engineered for maximum stability and reliability both in the studio or out

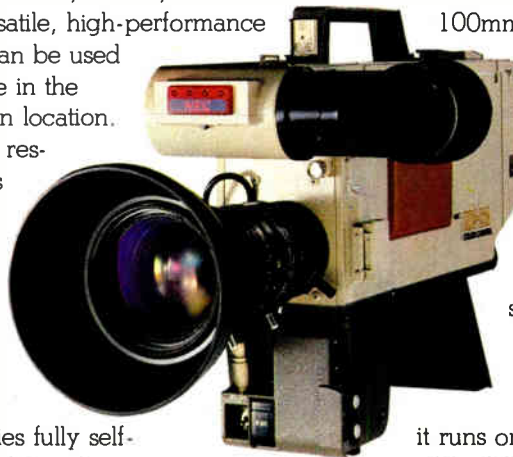

in the open air.

The MNC-80A weighs only 4.5 kg and measures 260mm (h) x 100mm (w) x 293 mm (d).

Yet it produces pictures of astounding clarity, and because its circuitry is based on extensive use of LSIs, the MNC-80A consumes significantly less power than comparable cameras. In fact, it runs on a mere 24 watts.

The MNC-80A series comes with a wide range of accessories; models are available for NTSC, PAL, PAL-M and SECAM standards.

Circle 271 on reader service card

NEAX61 SYSTEMS IMPROVE
PHONE SERVICE IN RURAL IRAQ.

NEC has won a major contract to improve telephone services in rural districts of Iraq with ultra-modern digital switching systems. Under the terms of the contract, NEC will manufacture and install a total of ninety NEAX61 rural digital switching systems, plus a digital radio communications system to interconnect the new switching network.

The NEAX61 rural digital switch is capable of accommodating 50 to 1,500 subscriber lines. It is a smallish version of the popular NEAX61 for central office use.

The digital radio system will consist of 30-station 28 microwave links using PCM 240/480-channel equipment, and 86-station 62 UHF links using PCM 60-channel equipment.

To lower the construction cost and hasten installation, most of the telephone offices will house their switching systems and radio equipment in container-type shelters. Some offices located in deserts will be unattended, and controlled and maintained centrally.

NEC plans to complete Iraq's new digital telephone network in 1982.

NEC

Nippon Electric Co., Ltd.
P.O. Box 1, Takanawa, Tokyo, Japan

THE LITRONIX SAMPLER.

Here's a tiny part of the broadest line in optoelectronics.

INTELLIGENT DISPLAYS™



Four character, 17 segment LED alphanumeric display with on-board memory, character generator ROM, and LED multiplex and drive circuitry. Product available with .112", .160" and .225" characters. Interfaces just like a RAM.

LED DISPLAYS.

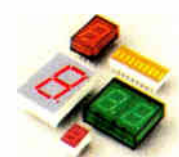

Red, orange, green and yellow digits. Numeric, alphanumeric and bar graph styles. Eight sizes from .1" to .8" high. In DIPs of one to four digits. Light pipes with wide viewing angles, air gap reflectors and filled reflector displays.

LED LAMPS.



Red, orange, yellow and green lamps. T-1, T-1 $\frac{3}{4}$ and miniature axial lead packages. Arrays of two to ten lamps. Lamps that flash on/off. Constant current lamps.

OPTO-ISOLATORS.

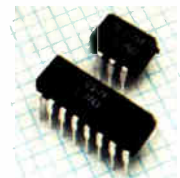

One, two and four-channel opto-isolators. Current transfer ratios up to 450%. Isolation voltages up to 5000v. Nine JEDEC types.

IR EMITTING DIODES.



Lowest degradation available from any source. From medium to very high power. Beam widths from 6° to 60° Hermetic and low cost non-hermetic TO-18 packages. Axial or radial leads. Arrays of two to ten diodes.

PHOTO-DETECTORS.

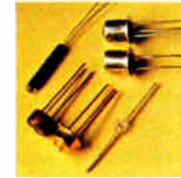

Photo-transistors and photo-diodes with acceptance angles from 6° to 73°. Hermetic and low-cost non-hermetic. TO-18 packages, ceramic packages and miniature radial lead configurations. Arrays of two to ten detectors.

ASK FOR YOUR COPY OF LITRONIX 1980 CATALOG THROUGH YOUR LOCAL DISTRIBUTOR:



U.S. Distributors:
Advent,
Almac-Stroum,
Arrow,
Component
Specialties, Gerber,
Hamilton Avnet,
Harvey, Kirkman, Lionex,
Marshall, Moltronics, Pioneer,
Summit and Zeus.
Canadian Distributors: C.M. Peterson,
Electro Sonic, Future, Hamilton
Avnet and L.A. Varah.

Litronix, 19000 Homestead Road,
Cupertino, California 95014.
Phone (408) 257-7910.

Circle 132 on reader service card

litronix
AN AFFILIATE OF SIEMENS

THE LIGHTS FANTASTIC



Delay lines give rf generator spectral purity, programmability

by Fred Telewski, Kingsley Craft,
Eric Drucker, and Joe Martins

John Fluke Manufacturing Co., Mountlake Terrace, Wash.

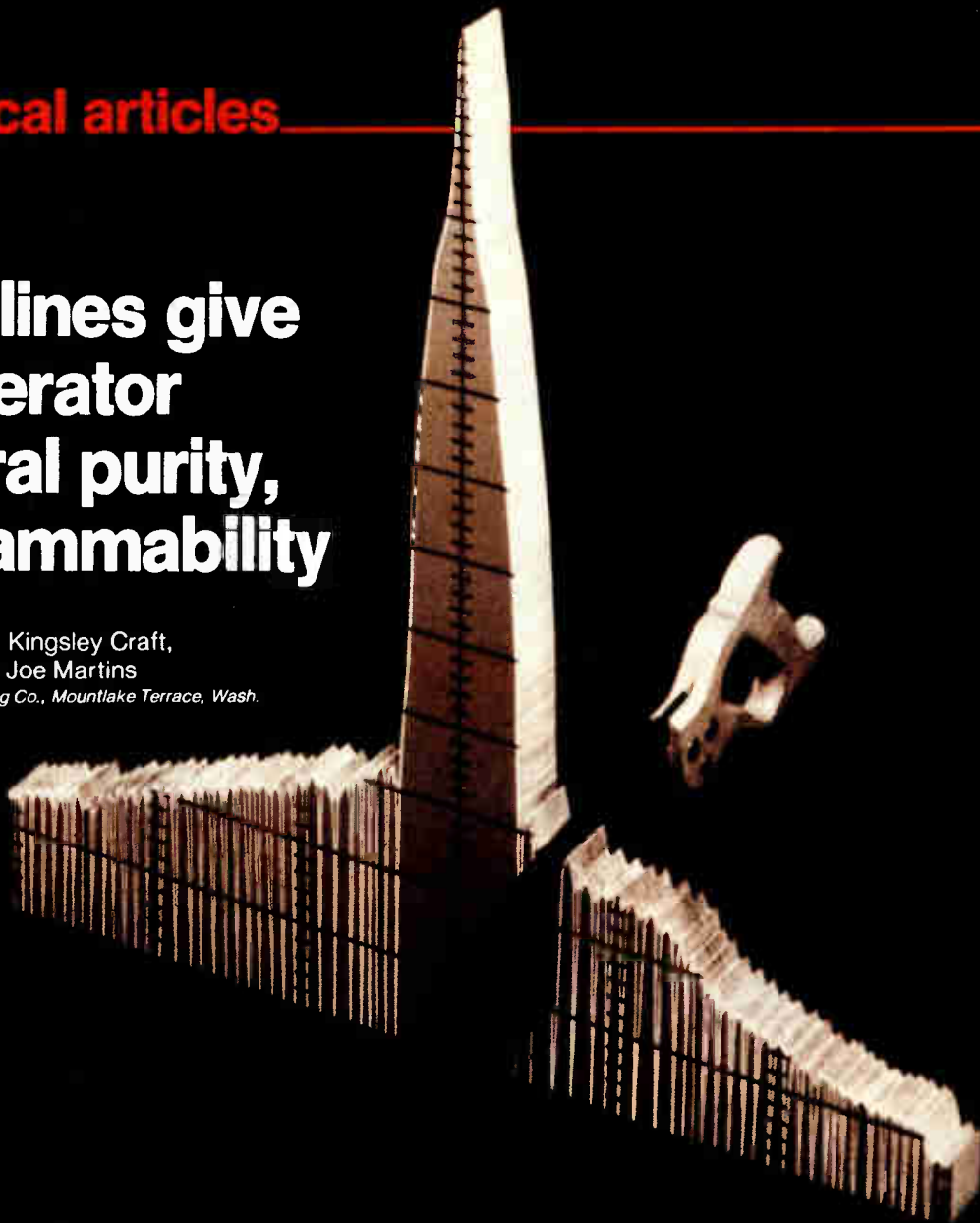

□ A programmable rf signal generator capable of producing a very pure test signal has been expensive until now because of the difficulty of keeping phase noise, as well as spurious responses, from degrading its output. Then, too, obtaining fine resolution is not a trivial problem in a high-performance unit. In the 6070A and 6071A synthesized-signal generators, these difficulties have been overcome by taking new approaches to generator design, most prominently in the application of delay lines to the economical achievement of low phase noise. As a result, it is now possible to fully automate off- as well as on-channel testing at a reasonable cost.

Among the new designs incorporated in the instruments is the use of a delay-line discriminator to discipline the generator's main voltage-controlled oscillator. It is this use of the delay line that makes possible a typical phase noise of -140 dBc/hertz at 20 kilohertz from the carrier. At the same time, it allows frequency to be electronically programmed and linearly modulated.

Another novel application of a delay line is in the

520-megahertz oscillator that is used in a down-conversion scheme for generating signals in the 200-kHz-to-62.5-MHz band. The oscillator uses the third overtone produced by a specially constructed surface-acoustic-wave device to provide low-noise oscillation.

Other significant aspects of the 6070A and 6071A are the design of the single-sideband mixer and tracking phase-locked loop that permit resolution of the lower-frequency digits inexpensively and the development of a multitasking software architecture that maintains a real-time presence in the machine, much as rack-and-pinion steering gives tighter control of a sports car. These developments arose from applying the most current technology in the course of rethinking rf signal generator design to achieve programmability inexpensively.

A designer is faced with several paths in seeking to construct a programmable rf generator with low phase noise. Most direct and indirect synthesis techniques, while capable of providing the fast frequency switching needed for automated receiver testing, are too costly and

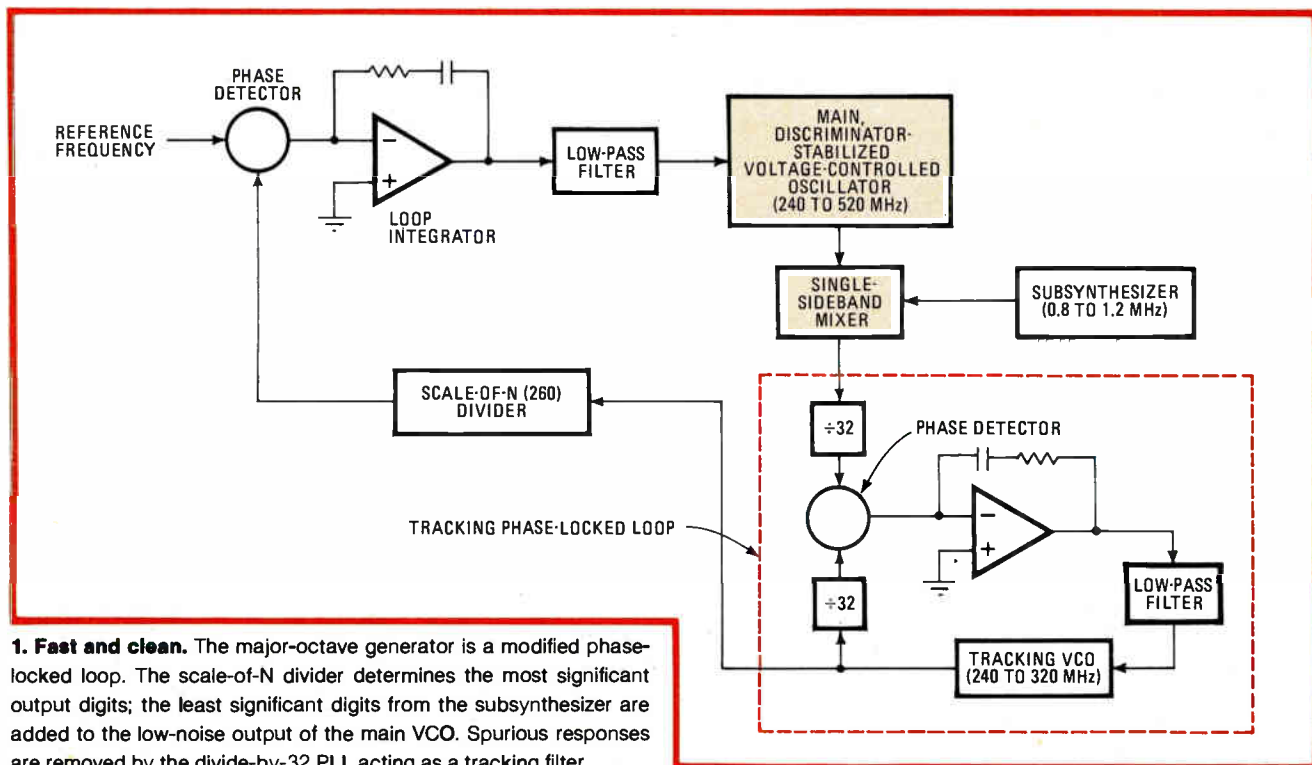

1. Fast and clean. The major-octave generator is a modified phase-locked loop. The scale-of-N divider determines the most significant output digits; the least significant digits from the subsynthesizer are added to the low-noise output of the main VCO. Spurious responses are removed by the divide-by-32 PLL acting as a tracking filter.

complex. But techniques employing divide-by-N phase-locked loops seem promising because of the number of standard integrated circuits that support their widespread application.

The most common form of PLL frequency synthesizer is one consisting of a scale-of-N divider, a phase detector, a low-pass filter, and a voltage-controlled oscillator. The VCO, from which the output of the circuit is taken, would have to be an extremely low-noise, and therefore high-Q, oscillator. To design such a VCO to cover an entire rf octave of, say, 250 to 500 MHz using traditional means would be extremely difficult, yet segmenting the band would incur considerable cost.

But supposing that such a unit could be built easily and economically, the remainder of the PLL circuit presents its own problems. To provide programmability to within, say, 100 hertz or less would necessitate an N in the divide-by-N circuit of 2,500,000 or more. Then, to prevent phase noise from this source from degrading the VCO's performance, the loop bandwidth would have to be on the order of 0.5 to 5 Hz. With this size N and so small a loop bandwidth, the time required to settle to within 100 Hz would be on the order of several seconds, much too long for use in an effective automated system.

Automation alternatives

An alternative approach that reduces settling time is one in which the modulus N is much smaller, say, 50 to 500. This would permit the loop bandwidth to be increased to about 1 kHz. Settling time would then be decreased, but resolution would be lost.

To recover the lost resolution, the output of several low-modulus PLLs could be heterodyned, with each PLL resolving part of the final output. But heterodyning the output of the locked VCOs would create a signal with

many image frequencies and spurious responses, so that a matrix of filters to suppress them would be needed to meet reasonable spurious response specifications. The cost of the hardware in such a design would make it uneconomical for ordinary applications.

The solution to this cost-performance dilemma comes from a new heterodyne-tracking-PLL design. Shown in Fig. 1, it uses a single-sideband mixer and tracking PLL to add the components of the final frequency generated by the subsynthesizer and the main VCO. The subsynthesizer, made of medium-scale integrated circuits, operates from 0.8 to 1.2 MHz and provides 1-Hz accuracy. Since N for the loop is now on the order of 260, the loop bandwidth can be approximately 1 kHz and the switching speed to within 100 Hz is less than 85 milliseconds, quite sufficient for automatic testing.

The single-sideband mixer suppresses the image response that would normally be generated by heterodyning the main VCO and subsynthesizer outputs. This enables the tracking phase-locked loop to acquire the desired signal and, in so doing, to perform the function of a continuous tracking filter.

Dividing both inputs to the tracking PLL's phase detector by 32 provides two benefits. First, it reduces the frequency to within the operating range of the phase detector. Second, it reduces the fm deviation seen by the phase detector when the VCO is frequency-modulated, thereby permitting the phase detector to operate within its linear range.

Having formulated a scheme capable of providing low-noise signals in the 240 to 520 MHz band, what remains is to complete coverage from 0.2 to 1,040 MHz. As shown in Fig. 2, this is accomplished in the top octave (520 to 1,040 MHz) by a filtered frequency multiplier. Two lower octaves, 125 to 250 MHz and 62.5 to 125

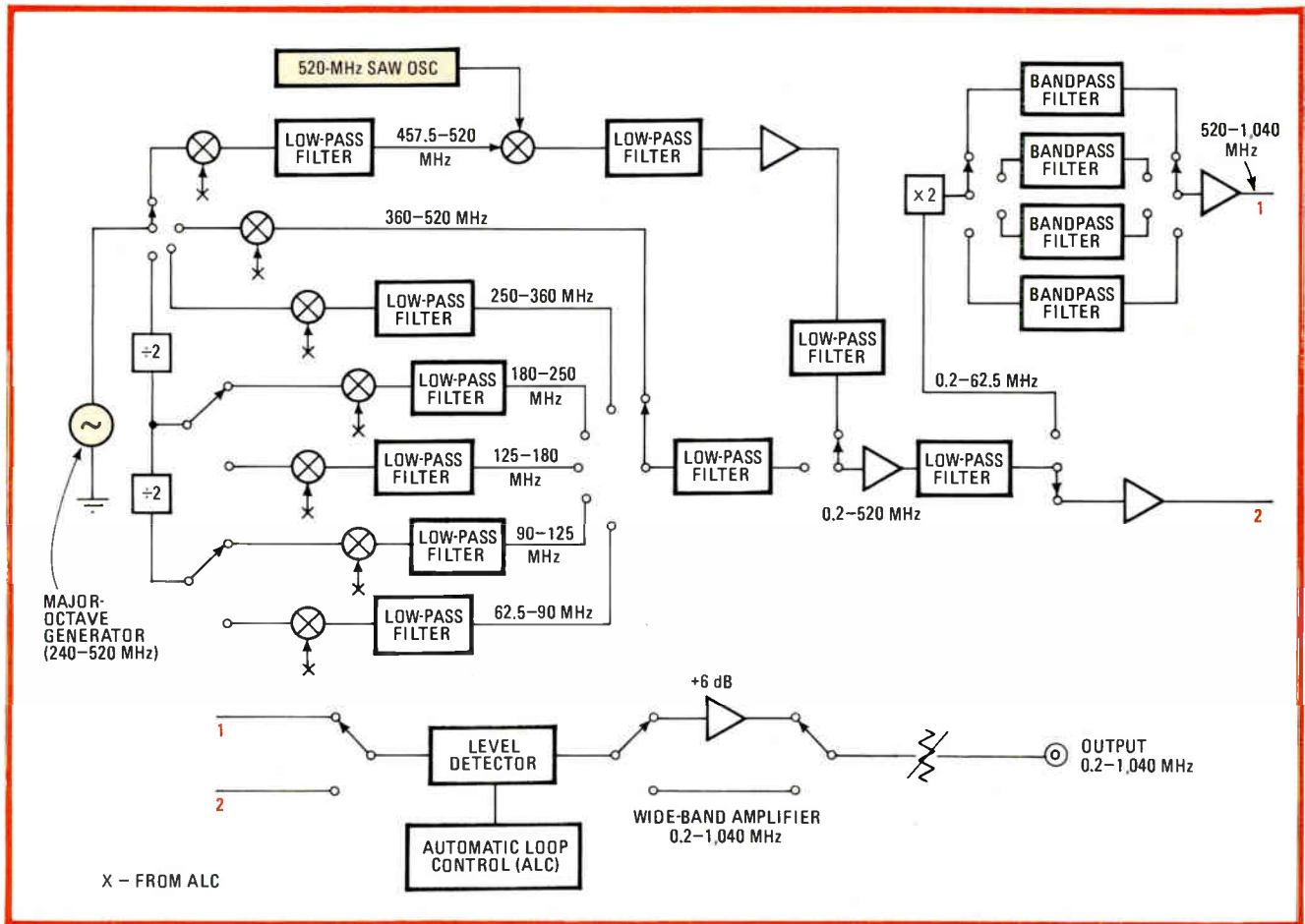

2. Full range. Most of the rf generator's full-output bandwidth is derived from the major-octave generator using frequency dividers and multipliers. The lowest part of the range is derived by mixing the major-octave generator's output with a specially constructed SAW device's.

MHz, are divided from the major octave.

Coverage from 0.2 to 62.5 MHz is provided by a lower-sideband down-converter. The heterodyne oscillator, which employs the SAW delay line, is also a low-noise unit like the main VCO. Designing these units economically was critical to the entire design.

Delays save the day

The low-noise performance of the 6070 and 6071 is due mainly to a major innovation in signal generator design—the use of delay lines. One of the two is a SAW delay line; it is used to construct the fixed-frequency oscillator heterodyned with the major-octave generator to produce the 0.2-to-62.5-MHz band. The other is a wideband cable delay line used in the programmable frequency discriminator that controls the noise performance of the major-octave generator's VCO.

Certain types of delay lines have long been used in radar equipment for canceling clutter and generating chirp signals. But it is only recently, with the advances of the past six years or so in SAW design, that they have been used in low-noise oscillators. The rediscovery in 1977 of delay-line discriminators as a means of measuring an oscillator's performance is also quite recent, and in this series of instruments it is directly applied to improve oscillator phase-noise performance for the first time. Thus there are now viable alternatives to the use of

high-Q resonators in the design of low-noise oscillators.

Figure 3 shows the characteristics of three types of devices that may be used in low-noise oscillator design. What really determines the high-Q resonator's noise behavior is not its narrow amplitude response but the rapid change in phase with frequency that accompanies it. Any network whose phase-frequency response has sufficient slope could emulate a high-Q resonator if its amplitude response were properly adjusted.

The slope, or derivative $d\theta/d\omega$, is called the group delay of a network. To produce the equivalent phase slope at the center oscillation frequency, f_0 , the relationship between the Q of a single-frequency resonator and the delay, τ , of a delay line is:

$$Q = \pi\tau f_0$$

Thus it is possible to design two different circuits—one using a resonator with a Q of 1,000 at 520 MHz and another using a 612-nanosecond delay line—and obtain identical performance from both.

A problem peculiar to the use of delay lines in oscillator design is that there are multiple 360° responses that are capable of supporting oscillation. The multiple 360° phase responses that cause oscillation at several frequencies are not present in resonators, where phase shift never exceeds $\pm 90^\circ$.

In any delay line used in an oscillator, amplitude

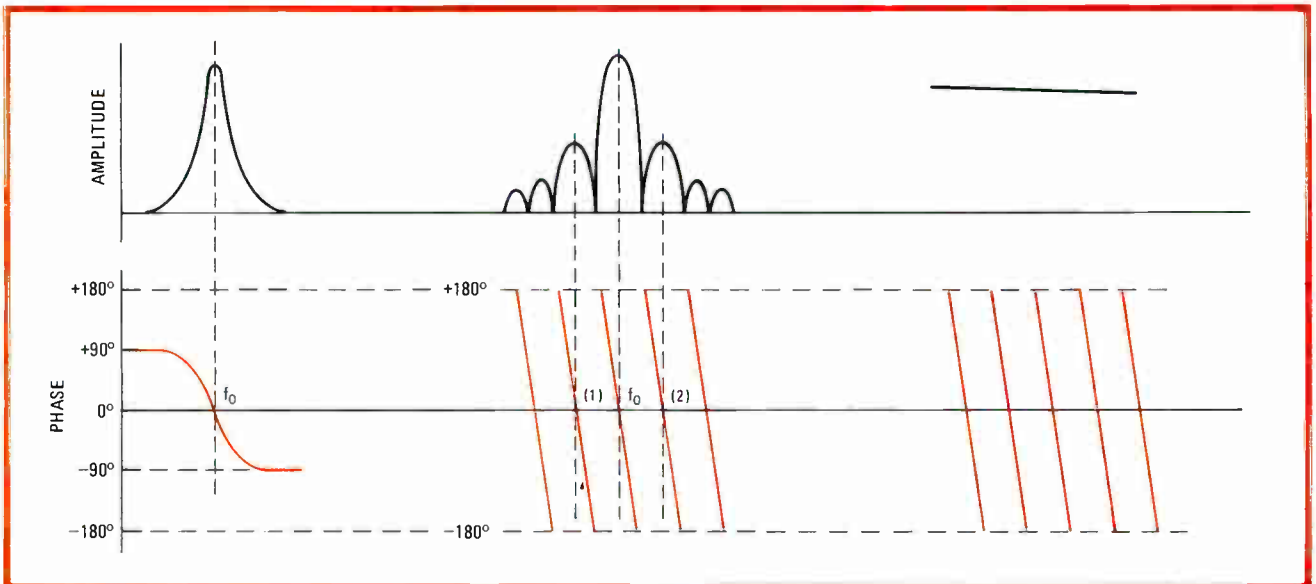

3. Important characteristic. The amplitude and phase characteristics of a resonator, SAW delay line, and cable delay line are shown in (a), (b), and (c), respectively. It is the phase characteristic of a device that determines whether or not it can operate as an oscillator.

responses at frequencies where there is a 360° phase shift other than that at the desired amplitude peak, increase the noise floor of the oscillator by $(1 - A)/A$, where A is the ratio of the amplitude of the major response to that of the adjacent response. For a typical SAW device, 10-dB-down sidelobes would cause a 3-dB increase in noise at these frequency offsets from the carrier. This increase is not objectionable in view of the type of selectivity provided by the SAW delay line.

For the cable delay line, on the other hand, there is very little, if any, amplitude selectivity. The adjacent 360° phase-shift responses can therefore increase noise 40 to 60 dB. In the extreme case, oscillations will occur at more than one frequency simultaneously. Thus the cable delay line does not provide a practical basis on which to construct a high-Q oscillator in the absence of additional amplitude selectivity.

A high-frequency tunable SAW oscillator

Unlike the resonator, in which 0° phase shift and the amplitude maximum are interdependent and coincide, the SAW device's delay (phase) and amplitude characteristics are independent of each other. Thus the design of SAW delay-line oscillators is somewhat more involved; in addition to producing the positive feedback (360° phase shift) that causes oscillation, the design must result in the SAW delay line's peak amplitude response being lined up with the desired oscillating frequency. The amplitude characteristics of the SAW delay line depend primarily on the interdigitated transducer—the number of and spacing between the individual fingers, or digits—whereas the phase slope depends on the acoustic path length, which is determined by the spacing between each array of fingers.

In practice, the oscillating frequency is adjusted not in the device design but by an additional phase shift element in the feedback path of the oscillator. This is done because manufacturing tolerances would be too tight if all three characteristics (delay, amplitude, and

phase) were allowed to define the device geometry.

A particularly troublesome aspect of designing a SAW delay line that works well in a linear fm oscillator is the triple travel delay (TTD). Inherent in the SAW device, it can create distortion. A signal passing through the delay line is reflected back to the input and then reflected again to the output. This results in a spurious signal with a delay of 3τ that, unless suppressed, combines with the signal with delay τ and produces amplitude and phase ripples (as a function of frequency) that cause severe fm distortion.

Two mechanisms produce TTD distortion—port mismatch and finger reflections. The first is due to the fact that the SAW delay line transducer used has three ports and there is naturally an impedance mismatch. The only way to reduce the TTD distortion in this case is to increase the permissible device insertion loss. An insertion loss of about 20 dB reduces distortion from this mechanism to a negligible level.

The physical discontinuity created by the presence of many fingers on the SAW delay line's surface also creates TTD distortion. The usual technique for reducing this source of distortion is to use split-finger geometry, which tends to produce canceling reflections.

However, this halves the width of the transducer fingers and, for a 520-MHz oscillator, would result in 0.7-micrometer-wide fingers—making for a costly, hard-to-manufacture device. To overcome this design obstacle, the SAW device used is designed for operation in the third overtone mode, much as conventional crystal resonators use overtones. The resultant device uses 2.1- μm fingers, and its response is shown in Fig. 4.

The remainder of the oscillator design is fairly direct. With a 500-ns SAW delay line and a $\pm 90^\circ$ phase shifter, the oscillator can be tuned linearly or may be frequency-modulated within ± 0.5 MHz about the 520-MHz center frequency.

As noted previously, the cable delay line cannot be used to construct a practical oscillator. It can be used,

however, in a frequency discriminator circuit that, with the major-octave VCO, emulates the performance of a low-noise oscillator. Recent advances in wide-dynamic-range phase detectors and in extremely low-noise op amps make possible this electronically programmable oscillator, which has a noise performance rivaling that of a high-Q cavity oscillator.

Output stabilization

Figure 5 shows the discriminator being used to stabilize the output of the major-octave VCO. The delay discriminator, or interferometer, produces a sinusoidal output whose amplitude varies as a function of frequency. The period of that frequency is equal to the reciprocal of the delay time. The frequency of the sinusoid can be adjusted by adjusting the phase within the interferometer loop.

By positioning the zero crossing of the sinusoid at the operating frequency of the VCO, the linear portion of the sinusoid's slope can be used as an fm discriminator. Fed back to the tuning port of the VCO, it will reduce noise or, with an appropriate audio voltage applied, produce linear frequency modulation.

To adjust the sinusoid's zero crossing for any frequency at which the VCO is set to operate by the scale-of-N synthesizer, a continuously variable phase shift of at least 360° is required in the discriminator loop. This is achieved by using four 90° stepped phase shifters in one arm of the discriminator and a continuously tunable ±45° shifter in the other. The shifter, which provides fine resolution between the four stepped phase shifters, is controlled by a feedback path that automatically positions the zero crossing of the interferometer at the VCO's frequency.

Applying an audio signal to the amplifier shown in Fig. 5 produces up to 200 kHz of peak frequency deviation with low distortion. The feedback loop forces the frequency to vary about the zero crossing of the discriminator sinusoid, producing linear fm. As the digital phase-shift elements and the 250-ns delay line do not have constant loss characteristics with frequency, correction coefficients corresponding to the stepped phase-shift position for each frequency are applied to the audio voltage using a multiplying d-a converter. The result is accurate frequency modulation.

Little noise

The phase noise performance, $L(fm)$, of this delay-line discriminator, in decibels, is described by:

$$L(fm) = 10 \log_{10} [1/2 (V_n/k_o)^2 \{1 + (f_3/f_m)^2\}]$$

where f_3 is equal to the reciprocal of twice the product of the delay time, τ , and π ; V_n is the noise of the feedback amplifier; k_o is the phase-detector gain of 0.5 v/rad; and f_m is the frequency offset from the carrier.

Typical constants for the delay-line discriminator are a delay time of 250 ns, feedback-amplifier noise of 1.6 nanovolts, and a phase-detector gain of 0.45 for an applied power of +5 dBm. Using these to compute the single-sideband noise performance at 20 kHz from the carrier yields -142 dBc/Hz, which compares to the typical measured performance of -140 dBc/Hz. The

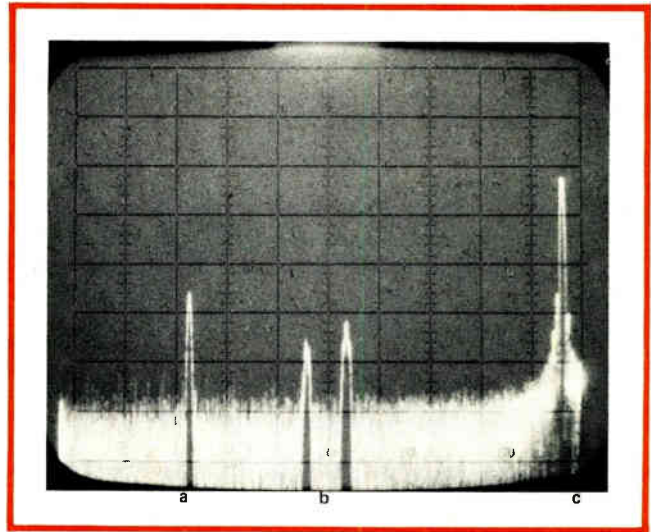

4. Third overtone. The 6070A's SAW delay line has the above frequency response. Designing to suppress the fundamental at 153 MHz (a) and the bulk spurious response (b) and to accentuate the third overtone at 520 MHz (c) makes the device producible.

2-dB difference is attributable to the noise contribution of the VCO, reduced by loop gain, and to the residual noise produced by the scale-of-N synthesizer.

The same calculated -142-dBc/Hz noise performance would be produced by a resonator oscillator having a resonator power of +5 dBm, a Q of 408 at a frequency of 520 MHz, and an oscillating noise figure of 10 dB. (Unless special care is taken in the design of the oscillator's limiting circuits, it is normal to achieve an oscillating noise figure of 10 to 15 dB.) It can be seen, therefore, that a delay-line discriminator produces noise performance equivalent to that of the resonator oscillator, with the added benefit of permitting programmability.

Locked modulation

With excellent spectral purity provided by the discriminator-stabilized VCO, it is now possible to construct the circuit shown in Fig. 1. However, other properties of the synthesized-signal generator must be taken into account if both phase and frequency modulation are to be achieved with acceptable accuracy.

In Fig. 6a, the audio signal V_1 is the input to the fm modulation amplifier previously shown in Fig. 5. The fm deviation, Δf , that results from modulating the discriminator-stabilized VCO input with ΔV_1 will be flat outside the loop bandwidth, but will fall off inside it.

The relationship of the deviation to the modulation signal can be expressed as:

$$\begin{aligned} \Delta f / \Delta V_1 &= k_v / [1 + k_v k_p F(s) / Ns] \\ &= k_v s / [s + f_c F(s)] \end{aligned}$$

where: k_v = the gain coefficient of the discriminator-stabilized VCO

k_p = the phase-detector coefficient

N = the PLL modulus

$F(s)$ = the Laplace transform of the loop amplifier-integrator and the low-pass filter transfer function

s = Laplace transform variable (for real frequency, $s = j\omega$)

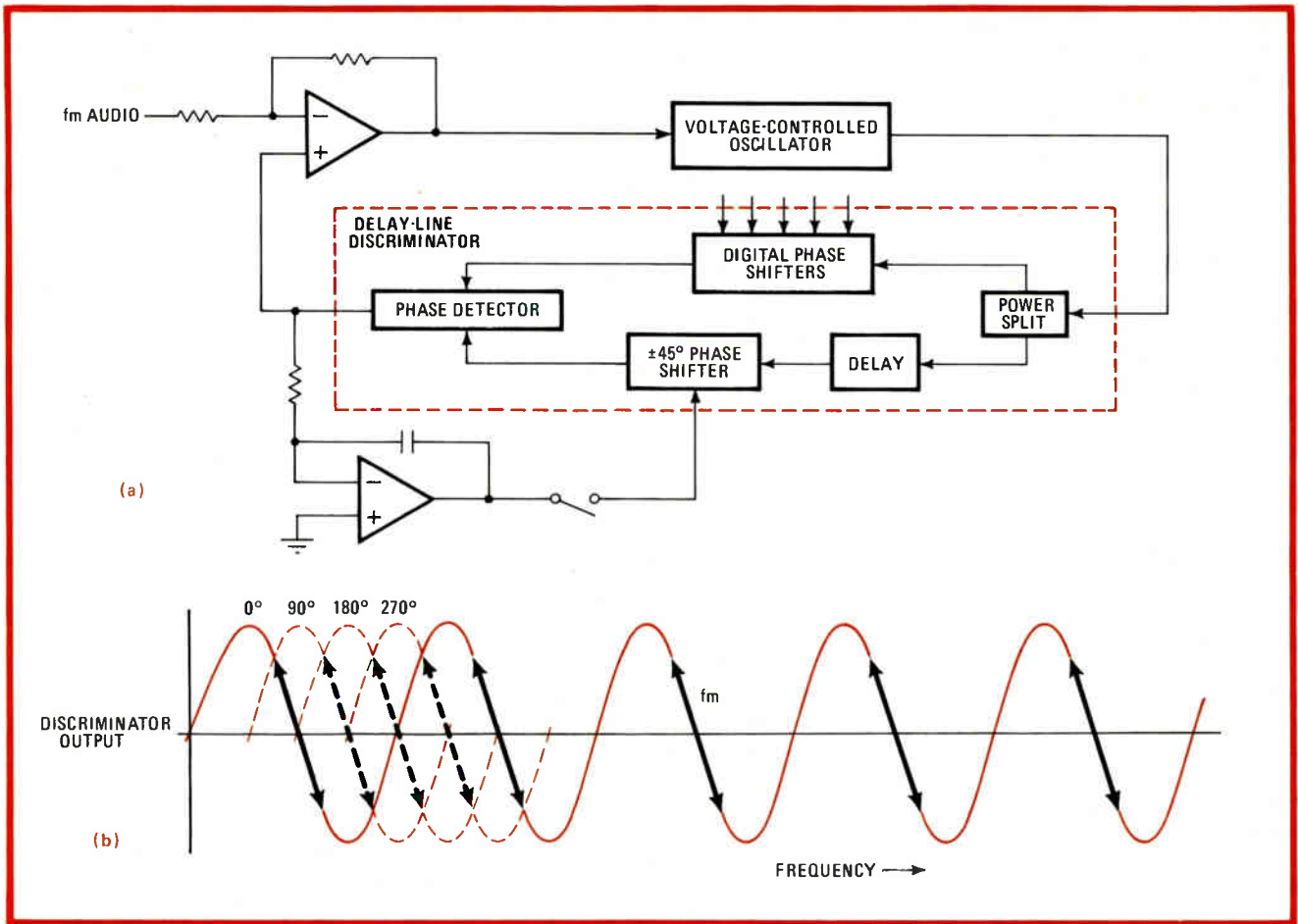

5. Discriminator. Digitally programming the stepped phase shifter of the discriminator (a) to the VCO's operating frequency reduces phase noise. With the feedback path to the $\pm 45^\circ$ phase shifter open, the discriminator's output with respect to frequency is that shown in (b).

f_c = the loop bandwidth equal to $k_v k_p / N$.
 (The virtual integrator in the feedback path converts frequency deviation to phase deviation.) Outside the loop bandwidth, the above equation reduces to:

$$\Delta f / \Delta V_1 = k_v$$

This equation shows that modulating the output in this way provides a high-pass function in the loop. Balancing this with the low-pass function will provide the full wideband modulation desired.

One way to obtain modulation in the low-pass range would be to modulate the loop reference oscillator, a voltage-controlled crystal oscillator (VCXO). Here the relationship between the fm deviation and the modulating signal is expressed as:

$$\Delta f / \Delta V_2 = [(k_x/s)k_p F(s)] / [1 + k_v k_p F(s) / Ns] = Nk_x f_c F(s) / [s + f_c F(s)]$$

where k_x is the transfer coefficient for the VCXO. Inside the loop bandwidth, the relationship becomes:

$$\Delta f / \Delta V_2 = Nk_x$$

If k_v is equal to Nk_x , then fm deviation will be independent of modulation frequency. Whereas applying modulation to both points simultaneously would produce a flat response, it would also mean that the loop reference would no longer be locked to a stable reference.

There is an alternative means of providing full-bandwidth modulation, however, in which the modulation signal is summed with the output of the phase detector through an integrator as shown in Fig. 6b. The integrator converts the phase modulation (which would be needed were the modulation signal summed directly into the phase detector) into frequency modulation. The constraint for flat frequency modulation is that the integrator time constant must equal the reciprocal of the loop bandwidth. The equation describing this is:

$$\Delta f / \Delta V_3 = [(F(s)k_v / \tau_i s) + k_v] / [1 + k_v k_p F(s) / Ns] = k_v [(F(s) / \tau_i s) + 1] / [1 + (f_c F(s) / s)]$$

If τ_i , the integrator time constant, is equal to the reciprocal of the loop bandwidth, f_c , the equation becomes:

$$\Delta f / \Delta V = k_v$$

Now the loop is locked with a stable reference.

However, the amount of deviation produced is limited by the maximum phase-detector swing. It is necessary to avoid the region near phase crossover to minimize modulation distortion; therefore the phase detector is biased at 2.5 radians giving a maximum swing of ± 2 rad at the phase detector.

In the actual design, the presence of the tracking phase-locked loop in the feedback path, necessary to reduce the unwanted sidebands and carrier from the

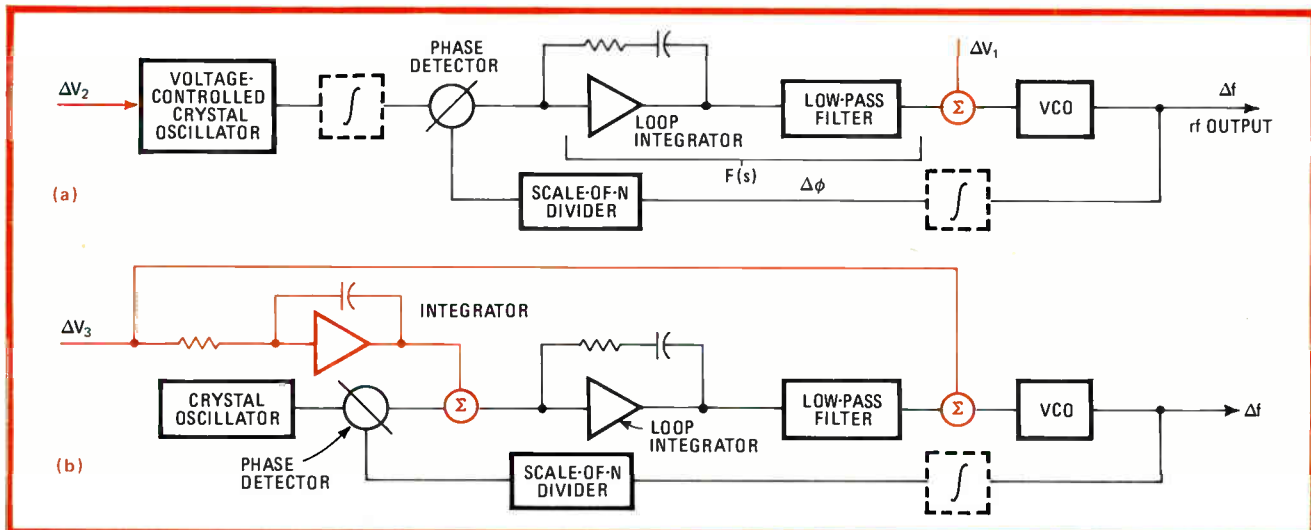

6. Frequency modulation. Modulating a simple PLL's voltage-controlled crystal oscillator and VCO (a) yields full-bandwidth modulation but reduces stability of the reference. Integrating and adding the modulating voltage after the phase detector (b) keeps the reference stable.

single-sideband mixer, produced a bump in the fm frequency response. It was found that, by putting an equalization network in series with the integrator or in series with the dcfm reference oscillator, the fm modulation could be made flat. This network, shown in Fig. 7, is an analog model of the tracking phase-locked loop.

It is necessary to maintain flat fm frequency response and constant fm deviation for a given modulation signal across the 240-to-520-MHz band. Since the modulation coefficient of the discriminator-stabilized oscillator changes as a function of rf output frequency, the audio voltage is adjusted using a multiplying digital-to-analog converter to produce a constant deviation. In calibration, an audio voltage is used to modulate the synthesizer at a rate way beyond the loop bandwidth. The deviation produced is measured approximately every 1 MHz and the converter adjusted to produce a constant deviation at every step. These correction factors are measured for each instrument and stored in a programmable read-only memory later to be used by the microprocessor to program the converter.

Processor at work

Using the modulation coefficient, the loop bandwidth correction factor is calculated by the microprocessor. The phase-detector gain is varied to give a constant loop bandwidth by changing the current from a d-a converter, which is gated into the loop amplifier-integrator by the digital phase-frequency detector. Similarly, the tracking phase-locked loop bandwidth is compensated for to match the equalization network bandwidth.

The block diagram for the angle-modulation scheme is shown in Fig. 8. To have good fm-deviation resolution and to maintain a high signal-to-noise ratio while modulating, a 1-2-5 range scheme is used. These ranges cover from 10- to 200-kHz deviation full scale in the discriminator-stabilized mode. A multiplying d-a converter is used to provide the fine resolution within the range determined by the user and set by the processor.

These range attenuators are located as close to the end of the audio-signal-processing chain as possible, so that

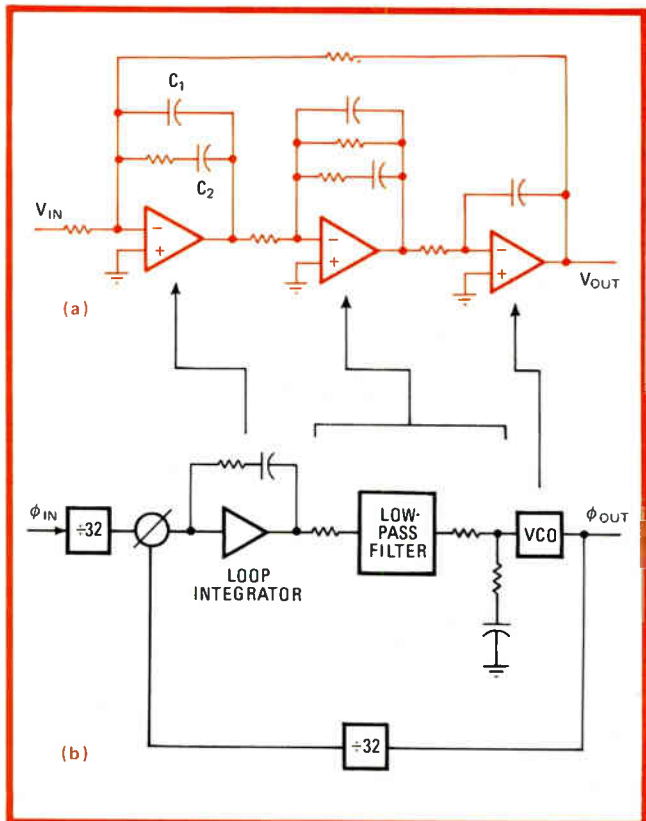

7. Equalization. The transfer function of the equalization network (a) is an excellent approximation of the transfer function of the tracking PLL (b), for which it compensates. Capacitors C_1 and C_2 approximate the many-element network of the tracking PLL's integrator.

op amp noise does not degrade the S/N ratio. The audio signal, from either an external source or the internal wide-band low-distortion audio oscillator, is first processed by a multiplying d-a converter-amplifier that provides the fine deviation steps and appropriate scale factors necessary to keep the deviation ranges constant with changing frequency bands. A programmable inverting/noninverting amplifier is used to reverse the phase of

the audio signal when operating in the heterodyne band.

The audio signal is then processed by the modulation-compensation d-a converter and simultaneously fed to the equalization network-integrator and fm port of the discriminator-stabilized oscillator. By converting the integrator into an amplifier and changing the amplifier feeding the discriminator to a differentiator, true phase modulation can be produced.

In the dc mode of frequency modulation, when not in the heterodyne band, the audio signal is sent to modulate the dcfm SAW oscillator, which then provides the reference to the main loop; the audio to the phase detector is turned off. The same equalization network and a multiplying d-a converter, necessary to correct for the multiplication factor of the main loop, is in the audio path. When dcfm-modulating in the heterodyne band, the audio is sent directly to the SAW oscillator and the main loop is not modulated.

All these functions are controlled by the microprocessor and remain transparent to the user. In addition, the microprocessor flags illegal modulation settings to prevent unspecified operation.

8. Processor-configured modulation path. The audio signal is compensated for the VCO's frequency-dependent modulation coefficient by the generator's 16-bit processor using the converter and amplifiers at left. Then it is fed either directly into the major-octave generator along the top two paths or, if the SAW oscillator is not being used to create a 200-kHz-to-62.5-MHz signal, to that oscillator.

The 6070A's microprocessor makes possible the coexistence of the seemingly incompatible combinations of high performance with low cost and high complexity with ease of use. It is the TMS 9900, a 16-bit microprocessor capable of performing unsigned 16-bit multiplication and division. This math capability gives the instrument the power needed to program frequency with up to 10 digits of resolution in less than 20 ms. In that time, the signal path is fully linearized and the output amplitude's accuracy enhanced. The processor power also makes it possible for the front panel edit knob to handle all requests without exhibiting any rubber-banding effects or ignoring any counts.

Analog computer

The processor is the heart of the central processing unit board, which also contains 32-K bytes of ROM and 2-K bytes of random-access memory, a 16-K erasable PROM for calibration and compensation data, the IEEE-488 interface logic, an input/output port and interrupt-handler chip, and the power-on and clock circuitry.

To minimize rf noise contamination from the digital circuitry, the digital control hardware communicates with the analog circuitry through a bit-serial link on each board to TMS 9900's communications-register-unit port. The board's serial link is active only when a change in the generator's output is required; at all other times it is kept in the high-impedance state.

The system's software performs three main functions.

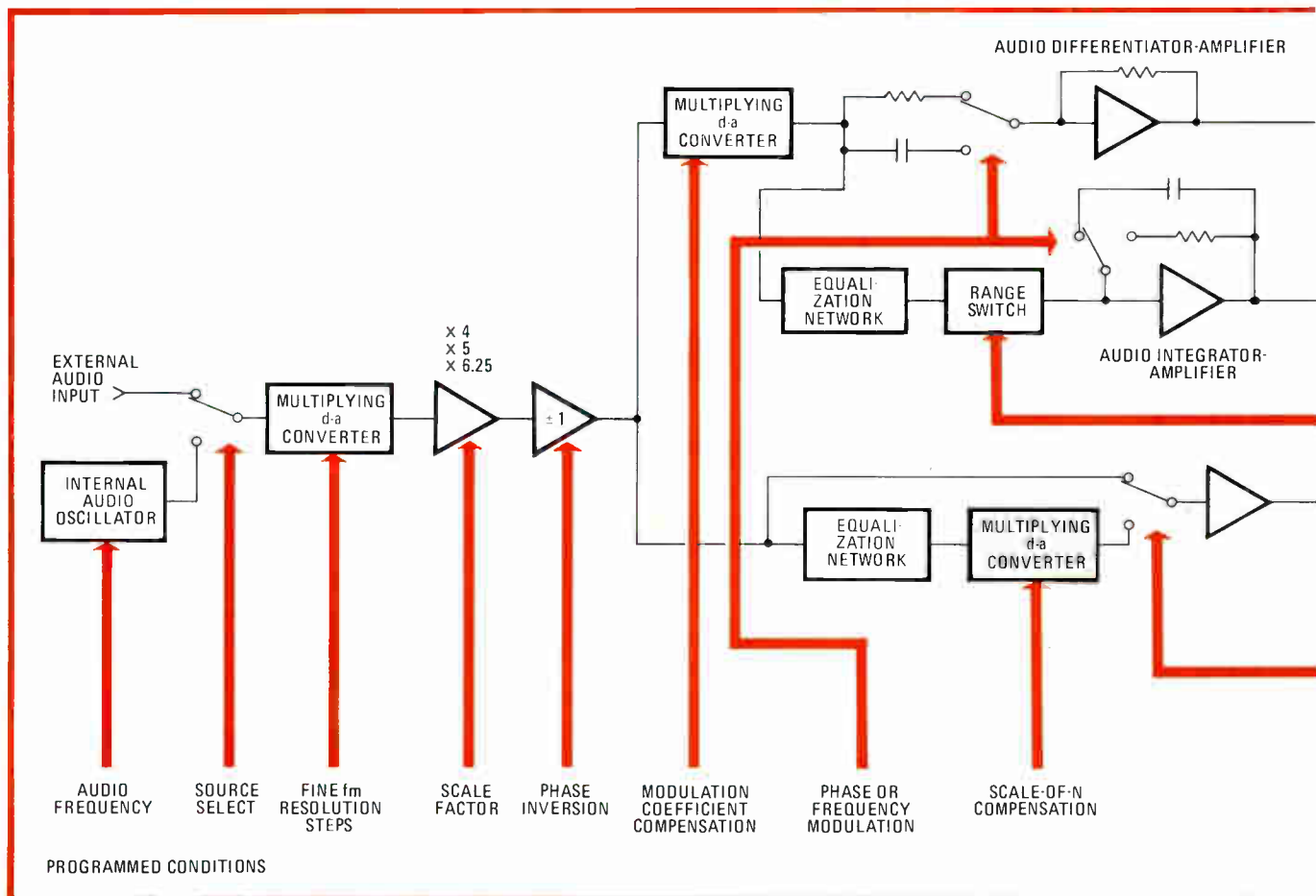

It implements a collection of user-programmable functions that are directed towards signal-generator applications and make the instrument powerful and easy to use. It selects and configures the appropriate hardware building blocks to produce the required output and then linearizes and calibrates the signal path for maximum quality and resolution. It also implements an extensive set of self-test and diagnostic functions.

To assemble all these features in an instrument without creating an unmanageable level of software complexity, the software was defined for a concurrent multitasking environment. In effect the software package operates as a simple timesharing system where different instrument functions use the resources of a common CPU in an independent fashion but share communication links and utility routines.

This architecture has several major benefits. It allows:

- Instrument functions to be partitioned into well-defined and cohesive modules that communicate with each other through simple data links. This results in a product that is easier to implement, test, and maintain.
- Instrument functions to operate as concurrent tasks. For example, the generator can monitor and update its status while simultaneously sweeping and processing IEEE-488 interface commands. Each task operates independently of the others and several tasks may be simultaneously active. A simple and effective operating system allocates the CPU resources in a round-robin fashion.
- The software to process immediately only what it must

because of real-time requirements and to postpone processing of whatever it can. This results in a very responsive and orderly instrument because, of all the work that must be performed, less than 10% must be done immediately. All other work can be postponed and scheduled in an orderly fashion.

Software at work

At power-on, the software performs instrument self-checking and initializes both the RAM and the instrument hardware to the power-on setting. Then the operating system is booted up by loading a RAM-based task table from ROM. The task table contains six frames, each consisting of four words and each corresponding to a task. The first word points to the microprocessor register workspace in RAM, the second points to the task-program counter, the third contains the processor status word, and the fourth is a pointer to the task stack. Once the task table is initialized, multitasking is initiated and the operating system is invoked. The instrument is now fully operational.

At the heart of the operating system is the task scheduler. The scheduler is actually a subroutine that returns to a routine different from the one that called it. The operating system is not a typical time-slice system, where an interrupt causes transfer of control from one task to another at a predetermined rate.

In the generator, each task executes until it wants to relinquish control to another task, whereupon it suspends

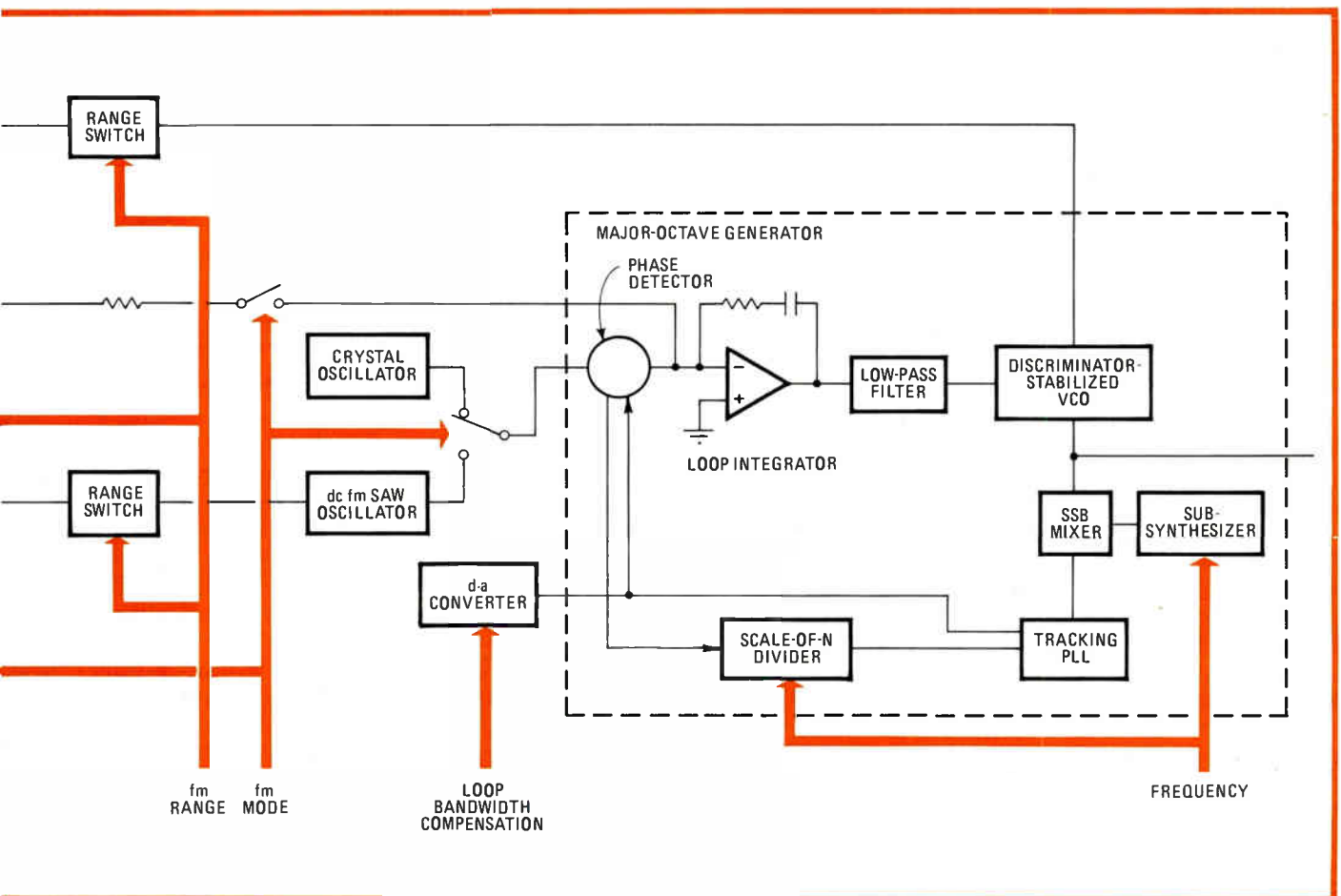

SEMAPHORE OPERATIONS			
PS	abs	s	; tests and make s positive (block access)
	jlt	GS	; if data was unblocked, jump to continue
	suspend		; else access is blocked, suspend
	jmp	PS	; loop back and check again
	GS		; continue
V\$	seto	s	; make s negative (unblock)

and allows another to resume. This transfer of control happens only at well-defined points. The operating system supports four primitive functions: suspend, resume, and two binary operations on semaphores, P and V, that implement mutual exclusion.

The suspend function is a call to the scheduler to save the current task frame in the task table. Because the scheduler operates in a round-robin fashion the suspension of a task always triggers the resumption of the next task in the queue. When invoking the suspend operation, a task may specify a period of time during which it does not want to be activated. For example, if the sweep task wants to lift the recorder pen to retrace, it merely commands the pen to lift and then suspends for a period of 200 ms.

The resume operation performed by the scheduler involves the restoration of the workspace pointer, program counter, status register, and stack pointer for the next task.

The final two operations are used to resolve contention problems when a task wishes to update a critical item without having the data interfered with until the task is through updating the item. To do so, critical data items are recognized and assigned semaphores in the software design phase. When the generator is running, the state of these semaphores is controlled by the two operations: P, the block operation, and V, the unblock operation. These operations are shown in the table.

To be used successfully, each of these operations must be time-indivisible. The P operation is sufficient to block access by other tasks, while the V operation unblocks the data. It should be noted that these operations are implemented here with very few statements.

Throwing out the rubber band

The signal generator posed some interesting problems for the software to solve. For example, the front-panel knob is capable of generating in excess 500 counts/second (20 revolutions/s). Since updating frequency takes approximately 18 ms, the software will fall behind. Discarding counts is undesirable because, if the user rocks the knob, more counts are processed in one direction than in the other and the frequency tends to move in the direction in which the most counts are processed.

To prevent rubber-banding, an algorithm was needed that converged almost instantaneously on the final value, even when the operator spun the knob beyond a boundary limit. The solution implemented was to process knob requests in groups. Every time the knob is turned, the

knob-interrupt routine increments or decrements the variable KNBCNT, depending on the direction of the motion.

When the task that processes the knob is activated, the accumulated count in KNBCNT is first copied into a working register to avoid contention problems. The count in the working register is then scaled with the use of a scale table containing a list of values carefully chosen to optimize both display aesthetics and speed of convergence. The scaled quantity is then processed, after which the number of counts processed is subtracted from KNBCNT and the knob task is suspended to allow other tasks to execute.

Any remaining knob counts are processed in subsequent passes through the knob task. If the value of the scaled count would cause the generator parameter being adjusted to exceed a boundary limit, the knob task sets either the up- or down-count error flag to prevent the knob interrupt from accumulating any more counts in the direction of the error. It then loads KNBCNT with the value of the scaled count less 1 and suspends. Subsequent passes through the knob task will cause the parameter being adjusted to converge to its final value.

Number crunch

Another problem the software had to handle was the varied mathematical characteristics of the different instrument parameters. For example, frequency required 10 decimal digits of dynamic range and 10 of resolution plus a sign bit. Amplitude quantities, on the other hand, required at least 12 digits of dynamic range, but only 4 of resolution plus sign. Angle deviation required 4 digits of dynamic range and 3 of resolution.

To accommodate all these requirements with a common internal representation would require double-precision floating-point representation, slowing instrument operation with the many calculations required. Instead, each parameter is given the most efficient form representation. Frequency is handled internally as an extended 2's complement integer (32-bit quantity) with 1-Hz resolution. Amplitude quantities are treated as single-precision floating-point numbers with 1 bit for sign, 7 for a base 16 exponent, and the remaining 24 bits for mantissa. Fm deviation is treated as a simple 16-bit integer.

The problem with this approach, however, is that the parameters are interrelated; angle deviation is a function of the value of the center and modulation frequencies and the amplitude must be corrected as a function of frequency. To get around this problem, it was necessary to use two properties: multiplication is both commutative and associative, and the internal representation of the instrument parameters changes as a given parameter is programmed.

For example, amplitude starts out as a floating-point quantity, but before the hardware is programmed it takes on the form, $d \cdot a \text{ converter output} / 2^n$, where n is a multiple of 6-dB attenuation. It is possible to take advantage of these properties and apply the frequency-dependent correction to the d-a converter value portion of the amplitude parameter, a calculation that is, at worst, of the extended-integer type. The result is a fivefold gain in programming speed. □

STRATHCLYDE

Scotland's integrated circuit of electronic achievement.

Many of the achievements of electronics companies in Strathclyde have been formidable in terms of technology. Immense in terms of trade.

I.B.M., Honeywell, MESL, Motorola, National Semiconductor are just a few of the world names in electronics who have found Strathclyde an ideal base for profitable operations.

Why? Good labor relations, high productivity, large labor pool (deep in quality as much as quantity), world-wide communications, low labor costs, and abundant energy supplies coupled with excellent research and development facilities makes

Strathclyde the ideal environment for electronics industries.

But there's more . . .

Strathclyde's Special Development Area status entitles industry to maximum UK government assistance.

There's a special report which has been prepared on the electronics industry in Strathclyde. If you are expansion-minded you should read it. You'll learn how you can become part of the integrated circuit of electronics achievers in Strathclyde.



For your copy write to: Strathclyde Regional Council Industrial Development Unit,
21 Bothwell Street, Glasgow G2 6NJ, Scotland.
Or telephone 01144-41-221 4296. Telex 777237 Ans Back SRC V.

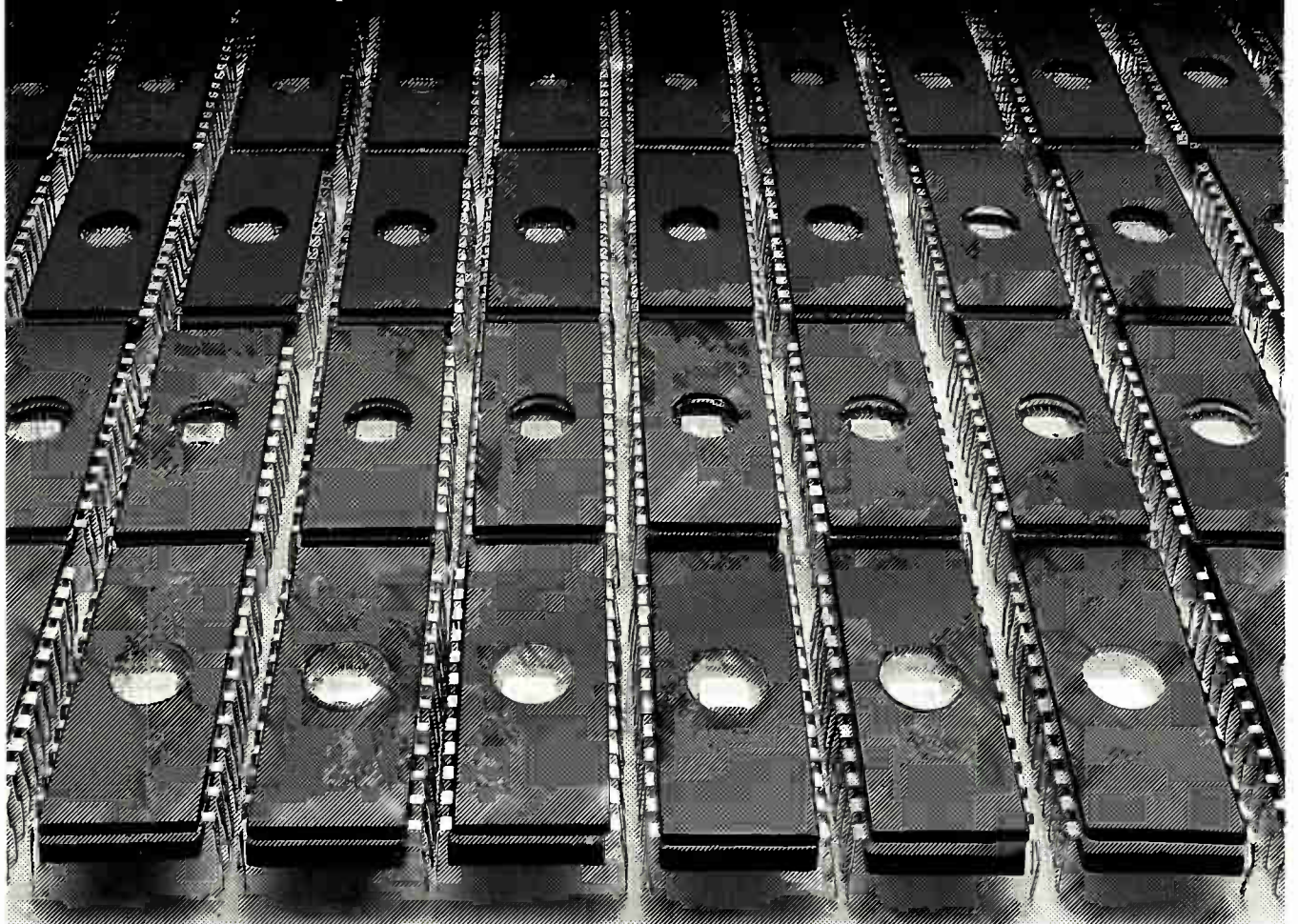

DATEL-INTERSIL

Sinetrac^{T.M.} A/D-D/A Boards For LSI-11 Computers

Compatible to: LSI-11 / 2®, LSI-11 / 23, PDP®-11 / 03

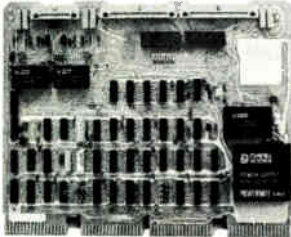

FULL QUAD A/D & D/A: ST-LSI SERIES

- 32 Single-ended or 16 Differential A/D Channels
- 2 12-bit D/A channels plus 4-20 mA current loops
- 20 μ S A/D throughput
- Programmable Gain Amplifier option
- Hi-gain instrumentation amplifier option
- Pacer clock with 16 programmable timebases
- 4-bit TTL output
- ST-LSI-ADX expander for 64S/32D channels
- Optional \pm 15V DC/DC Converter
- From \$657 (single qty.)

HALF QUAD A/D & DMA: ST-LSI2

ST-LSI2

- 16 Single-ended or 8 Differential A/D channels
- 20 μ S A/D throughput
- Programmable Gain Amplifier option
- Pacer clock with 16 timebases
- From \$625, incl. DC/DC Conv.

ST-LSI2-ADX

- Adds 48S/24D A/D channels
- Accepts 24 differential current inp shunts
- From \$358 (singles)

ST-LSI2-DMA

- Controls 32K DMA 16-bit A/D block transfers
- End of Conversion, End of Block Interrupt Vector addresses
- 50 kHz A/D scans
- From \$350 (singles)

HALF QUAD D/A: ST-LSI-DA

- 4 12-bit D/A channels
- Optional DC/DC Converter
- 12-bit TTL output for external device control
- \$562 with DC/DC Conv.
- \$499 less DC/DC Conv.

INDUSTRIAL HI-GAIN ISOLATED A/D: ST-LSI-RLY

- 8 Differential Channels, 12 binary bits, half quad
- 126 dB Common Mode Noise Rejection
- 250 VRMS high common mode isolation
- Programmable Gain Amplifier
- High-gain Instrumentation Amplifier: Works directly from millivolt transducers
- EOC Interrupt; external trigger start
- Includes DC/DC Converter
- \$695 single quantity

LSI-11 and PDP are Digital Equipment Corp. trademarks

**Systems manual and Diagnostic Program included.
Plug your LSI-11 into the Analog world.**



Printed in U.S.A. Copyright © 1980 Datel-Intersil, Inc. All rights reserved.
11 CABOT BOULEVARD, MANSFIELD, MA 02048/TEL. (617)339-9341/TWX 710-346-1953/TLX 951340 • Santa Ana, (714)835-2751 • Sunnyvale, CA (408)733-2424 • Gaithersburg, MD (301)840-9490 • Houston, (713)781-8886 • Dallas, TX (214)241-0651 OVERSEAS: INTERSIL DATEL (UK) LTD — TEL: BASINGSTOKE (0256)57361 • INTERSIL DATEL SARL 602-57-11 • INTERSIL DATEL GmbH (089)77-60-95 • DATEL KK Tokyo 793-1031

Power MOS FETs run directly off TTL

Double-implanted, self-aligned structure builds multi-cell FETs with on-resistances as low as 0.03Ω , breakdown ratings up to 1,000 V

by Jürgen Krausse, Jenő Tihanyi, and Peter Tillmanns, *Siemens AG, Munich, West Germany*

□ Power MOS FETs are lightening the burden of interfacing power circuits with the world of small-signal logic and microcomputers. These sensitive devices are finding uses in process-control applications, for instance, where they require less drive power than bipolar power transistors, thyristors, or triacs. Nevertheless, the drive levels often needed by available MOS field-effect transistors are still too high for microcomputer and logic circuits to handle comfortably; these power transistors do not eliminate the expense of additional drive amplifiers.

A new family of power devices dubbed Sipmos (for Siemens power MOS) has now been developed that is compatible with small-signal logic. Sipmos devices can be driven directly with 5-volt TTL signals, like those from microcomputer output ports. These ac and dc switches offer lower on-resistances and handle higher voltage levels than conventional power MOS FETs. The first members of the Sipmos family are transistors; other power control devices will follow.

When compared to other power MOS FETs, Sipmos power devices offer a number of advantages:

■ A low threshold voltage that can be set independently of other MOS FET operating parameters.

- High transconductance and current yield.
- Microcomputer and TTL compatibility, typified by a 5-v gate voltage.
- Low on-resistance per unit of chip area.
- High drain-source voltage capability, up to 1,000 v.
- Extremely low gate resistance, resulting in very fast switching speeds under appropriate drive conditions.

Low on-resistance

Sipmos FETs are now available in six voltage ratings, their operating drain-source voltages ranging from 50 to 1,000 v. The 1,000-v device can handle as much as 4.2 amperes, yet exhibits a drain-source on-resistance of only 2.0 ohms maximum. The 50-v transistor offers rock-bottom on-resistance: as little as 0.03Ω . Devices are mounted in TO-220, TO-3, and TO-238 packages.

The Siemens Dimos (double-implanted MOS) process is used to manufacture Sipmos power devices; their structure is shown in Fig. 1. The principal feature of a power device made by this process is the tapered edge of the polysilicon gate. The gate serves as an implantation mask for the preparation of the source and p-barrier zones; it yields a channel length of less than 1 micrometer.

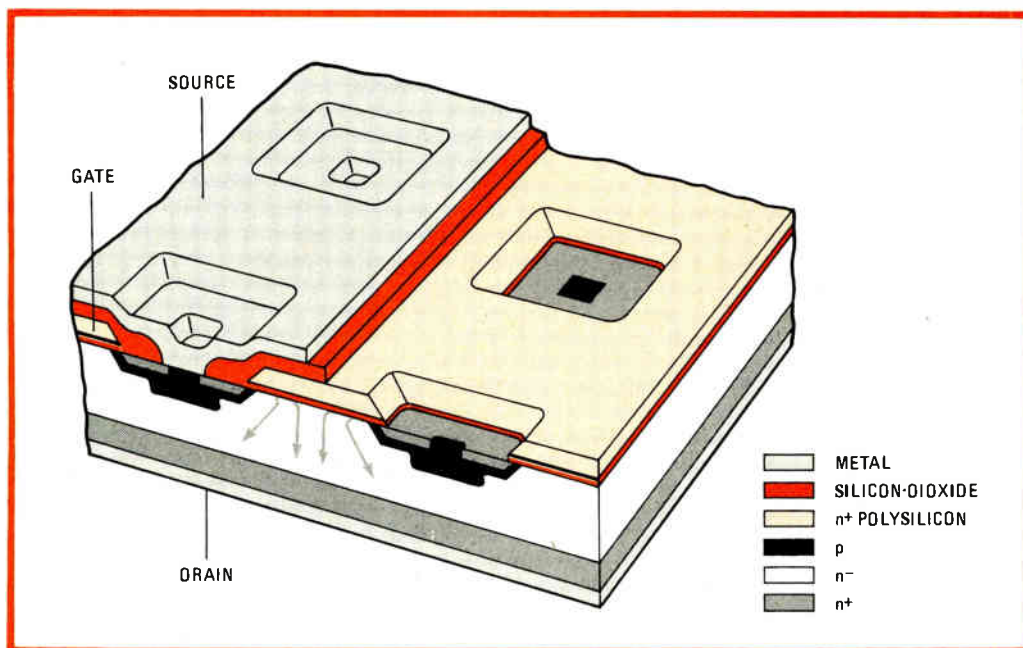

1. Vertical. A power Sipmos (Siemens power MOS) FET is made of several thousand individual FETs in parallel. The self-aligning implantation process uses the gate layer as a mask for preparation of the source and p-barrier zones; it yields a channel length of less than 1 micrometer.

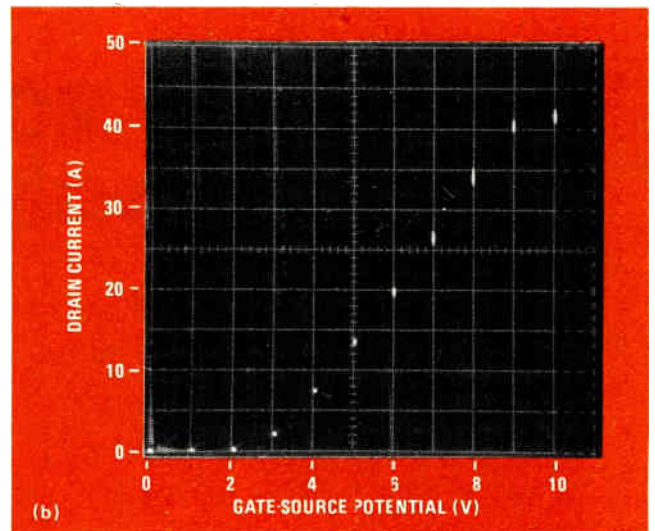
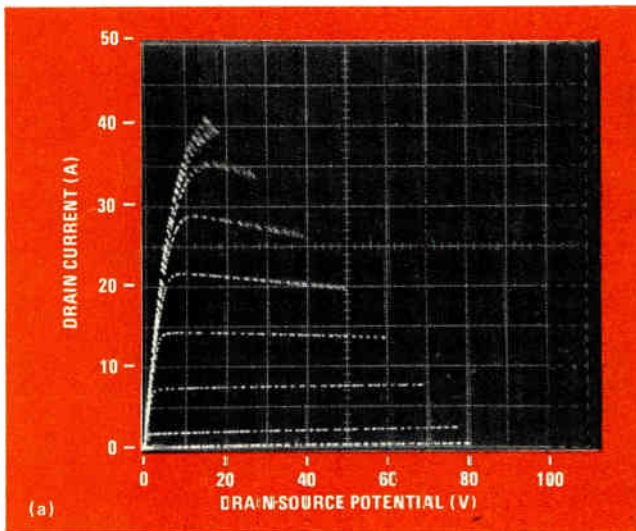

2. Drain current. A Sipmos FET produces drain current curves that recall the characteristics of a vacuum-tube pentode (a). The curves are for gate-source potentials of 0 to 10 volts in 1-v steps. When drain current is plotted against V_{GS} (b), a slope of 7 A/V is seen.

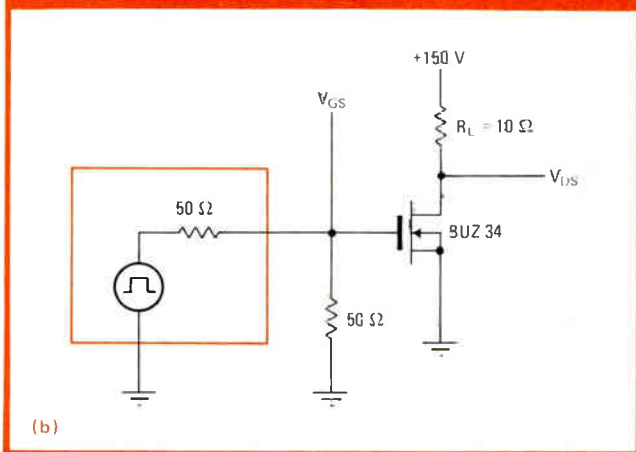
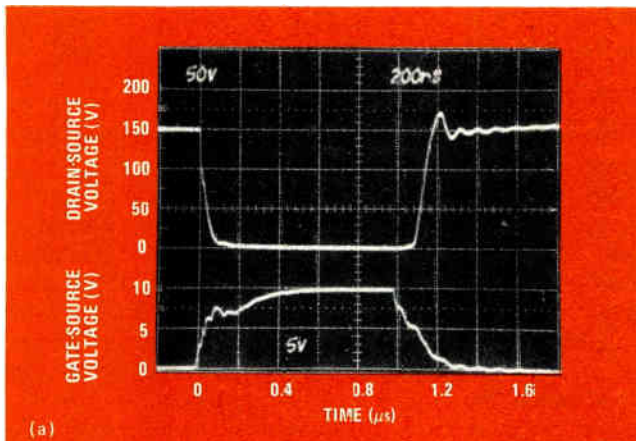

3. Switching. A Sipmos FET's switching time depends on the impedance of the drive circuit. As shown in (a), the 50- Ω -impedance drive circuit (b) switches 15 A in 50 ns.

surface damage caused by ion implantation and plasma etching. The implantation process is self-aligning, allowing an extremely short channel—less than 1 micrometer wide—to be formed.

The threshold voltage of the Fig. 1 structure is established independently of any other MOS FET operating

parameter. This threshold-voltage independence and the simplicity of the implantation process afford maximum flexibility in the development of Sipmos devices, as shown by the development of laboratory-type Sipmos thyristors and optically coupled triacs.

A Sipmos transistor is a vertical MOS device. It consists of an n-doped epitaxial layer on an n^+ substrate (drain), n^+ source regions implanted in p zones, and an n^+ polysilicon gate electrode isolated from bulk silicon below and aluminum source metalization above by a layer of silicon dioxide. The gate forms a lattice structure in which the source regions are implanted as holes. Its electrode is bonded to the surface at the edge of the chip. The source metalization covers the entire structure, save for the gate contact, and connects the various source cells in parallel. Thus a Sipmos transistor is in fact an assembly of several thousand single MOS transistors, all connected in parallel.

When a Sipmos device is in the off state, that is, when its gate-source voltage, V_{GS} , equals zero, the p-doped barrier zone prevents the emission of electrons from the source. Such a Sipmos device represents a planar diode whose breakdown voltage depends on the doping concentration and the thickness of the epitaxial layer. The transistor is turned on when V_{GS} reaches the threshold voltage. The flow of electrons is shown in Fig. 1. The device's turn-on resistance corresponds approximately to the resistance of the vertical current path plus the resistance of the inversion layer in the p region. The latter, however, is so small that the resistance of the epitaxial layer predominates.

Pentode-like characteristics

Figure 2a shows the drain-current curves for currents up to 40 amperes and voltages up to 80 v for a 200-v BUZ34 Sipmos FET. The current curves are shown for V_{GS} from 0 to 10 v in 1-v steps; measurement is made by 300-microsecond pulses. Note that the FET's characteristics are similar to those of a vacuum-tube pentode. The threshold voltage for this device is 2 v and the on-resistance is about 0.14 Ω . At a gate voltage of 5 v, a

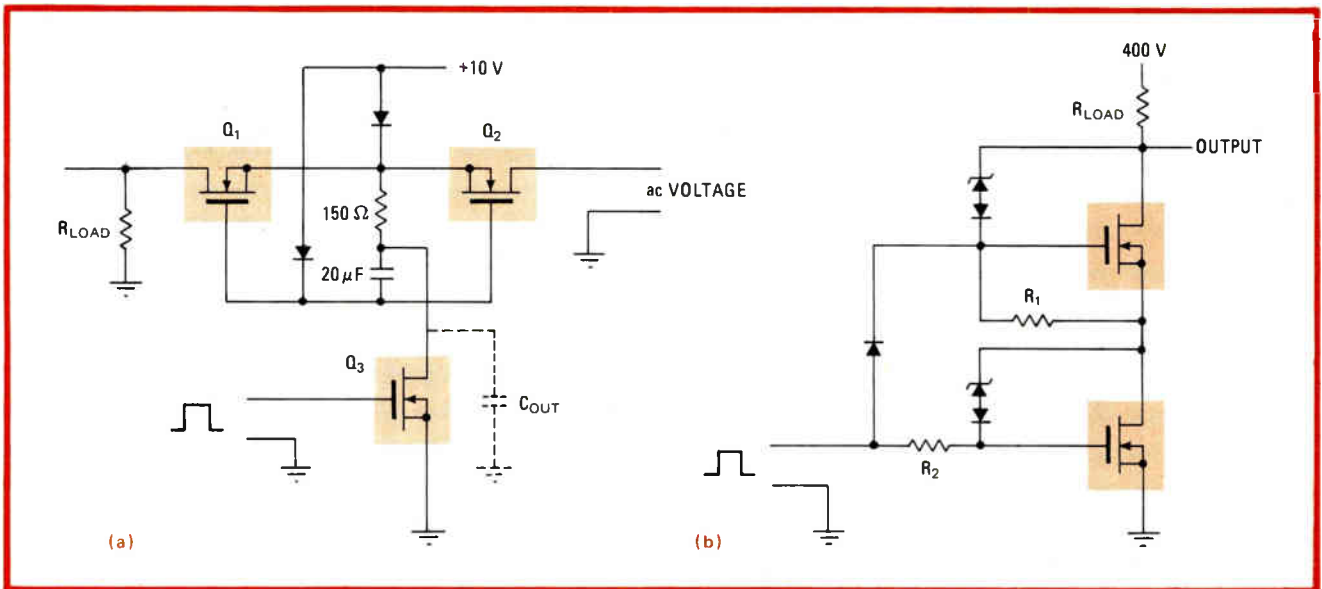

4. High-voltage switch. Combining Sipmos FETs allows their use in high-voltage and low-resistance switching applications. Three can be used as a high-voltage, low-resistance, and low-capacitance analog switch (a). Two in series make a high-voltage, low-resistance switch (b).

current of 14 A flows, for a drop of 1.96 v.

Figure 2b shows the drain current of the same device as a function of V_{GS} . Pulses of 300 μ s and a drain-source voltage of 15 v are used. The slope of the BUZ34's current curve is on the order of 7 A/v and remains constant over a wide range.

A closer look at the BUZ34's behavior near the zero point sheds more light on its operation. When in the off state ($V_{GS} = 0$), it acts as a diode that is forward-biased in the presence of negative drain-source voltages. Increasing the gate voltage causes current to flow parallel to the diode through the transistor, reducing the device's forward voltage drop. When the FET is fully turned on, it exhibits ohmic behavior in both directions. This reverse-direction behavior allows the Sipmos FET to be operated as a rapid-switching diode with an extremely low forward bias voltage. The diode's switching characteristics include a turn-off time of less than 100 nanoseconds and a turn-on time of less than 20 ns.

Capacitance effects

The switching speed of a Sipmos FET, like that of other power MOS FETs, depends almost entirely on the drive conditions. Load-current and temperature effects on the FET's capacitances (which are recharged during switching) are negligible.

A Sipmos device's switching characteristics are essentially defined by the Miller capacitance, which reaches its maximum value when drain-source voltage is less than V_{GS} . This increase in the Miller capacitance causes the FET's output voltage to subside gradually on the completion of turn-on and to increase gradually at the beginning of turn-off.

Switching times depend on the impedance of the drive circuit. If the drive-circuit impedance is 50 Ω , the BUZ34 has turn-on and turn-off times of about 50 ns while switching 15 A (Fig. 3). Faster switching times can be obtained by a smaller drive-circuit impedance.

The two major advantages of very low on-resistance

and high-voltage capability for a Sipmos FET family are important for certain applications. For example, the low on-resistance advantage of the 50-v devices is important in switching power supplies for photovoltaic power systems or in replacing electromechanical relays in automobile electronics. The high-voltage advantage is important in switching power supplies and motor-control systems that operate from 220-v ac power lines.

High-voltage applications

Figure 4 shows two somewhat unusual Sipmos applications. Figure 4a illustrates an application in which three transistors are used for a high-voltage, low-capacitance, and low-resistance analog switch. The high input resistance of the transistors allows them to be bootstrapped. When the switch is on, the circuit exhibits a low capacitance represented by C_{out} of FET Q_3 . The circuit's voltage capability is equal to the breakdown voltage of the FETs, which in this case are 500-v BUZ45 units. The on-resistance of the analog switch is about 1.5 Ω . Switching Q_3 off switches the circuit on.

Figure 4b shows how two Sipmos FETs can be used in series for a high-voltage, low-resistance switch. Since the on-resistance of an FET increases proportionally to the operating voltage taken to the power of 2.7, for the same chip size, a 400-v device has about six times the on-resistance of a 200-v device. Thus two 400-v devices in parallel would have about 1.5 times the on-resistance of two 200-v devices in series. The Sipmos FETs used here are 200-v BUZ31 types whose combined on-resistance is under 0.4 Ω . A further advantage of using lower-voltage FETs is a higher current capability.

The turn-on time for this circuit is about the same as it would be for a single FET. The turn-off time, on the other hand, is longer than for a single FET and depends on the values of R_1 and R_2 . □

This work has been supported under the technological program of the Federal Department of Research and Technology of the Federal Republic of Germany. The authors alone are responsible for the contents.

Crystal Clock Oscillators by



MOTOROLA

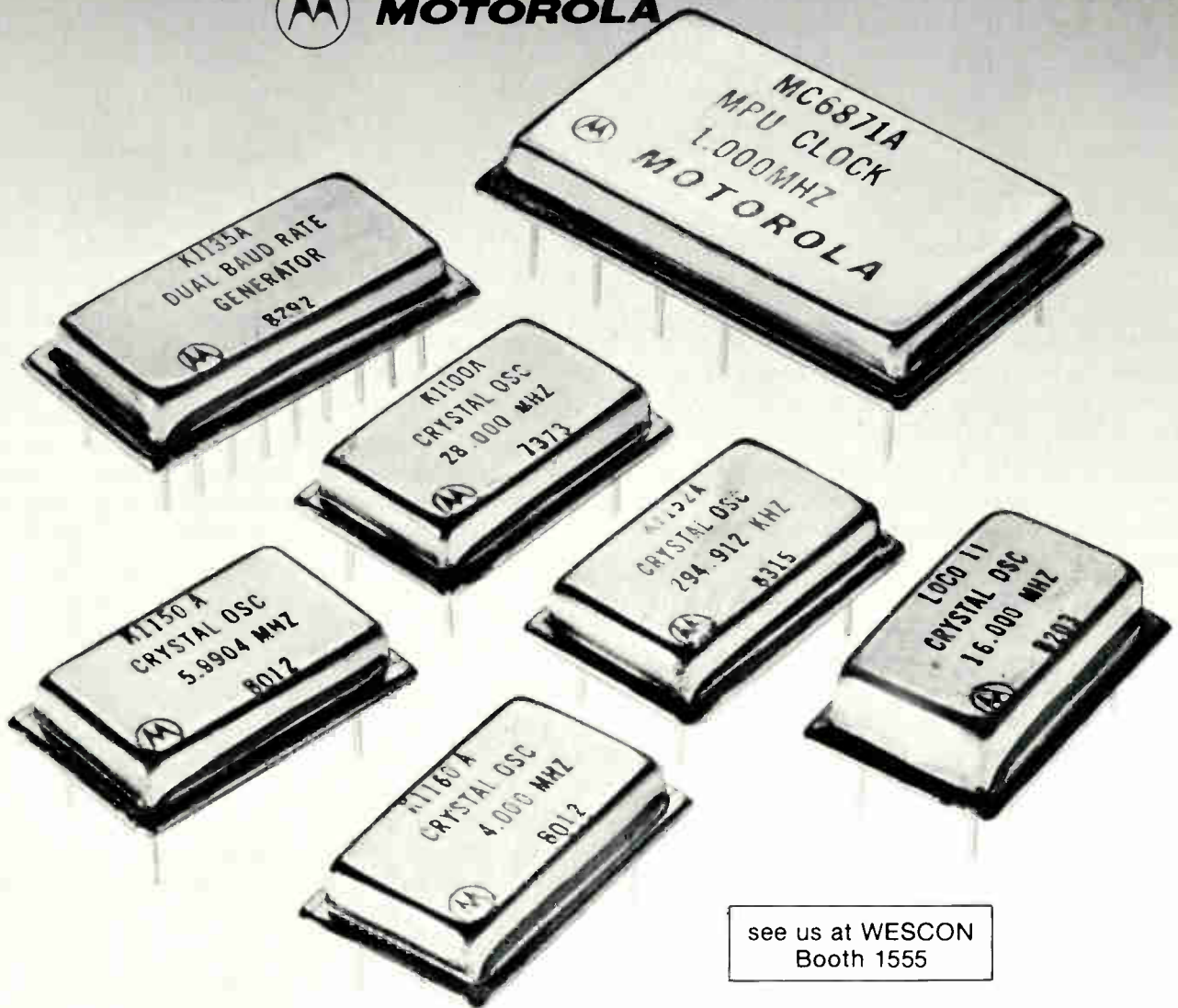

see us at WESCON
Booth 1555

...the timing standard of the computer industry

The widest selection of thick film hybrid oscillators available anywhere for computer and microprocessor applications. Logic outputs are available for TTL, CMOS, NMOS, and dual complementary TTL.

Frequencies as low as 25 KHz, and as high as 70 MHz. High stability when you need it, tolerance tradeoffs for applications in which economy is more important.

Complete in-house control, from quartz growing

through thick-film processing enhances reliability.

High volume production capability plus fast prototype delivery helps you meet your own delivery requirements.

DIP packaging saves board space, cuts assembly time over discrete component equivalent. Simply plug a Motorola Clock into your circuit to satisfy all your system timing requirements.

Send today for more information on the clock oscillator to fit your application.



MOTOROLA INC.

Spread of PCM carries LSI to regenerative amplifiers

Only two supplies and 13-mA drain characterize the latest chip to contain all the active devices a pulse-code-modulation receiver needs

by Tac Berry, Precision Monolithics Inc., Santa Clara, Calif.

□ In the wake of the widespread adoption of digital switching systems, the rest of the telephone network is starting to go digital, too. The use of pulse-code modulation throughout is far less expensive than converting back and forth between the bit streams that enter and leave T1 systems, often 24 multiplexed channels at a time, and the analog voice frequencies sent over the transmission lines.

However, to prevent the PCM signals from being wiped out by the attenuation and noise of the twisted-wire pair,

regenerative amplifiers have to be installed at least every 6,000 feet of line. The demand for such repeaters has in turn encouraged the development of large-scale integrated circuits, like Precision Monolithics' RPT/81 and 82, which contain all the active components the amplifiers need.

As the latest devices in the field, the 81 and 82 consume much less power than their predecessors. A normal amplifier configuration based on one of them uses less than 100 milliwatts to produce the large, 5-

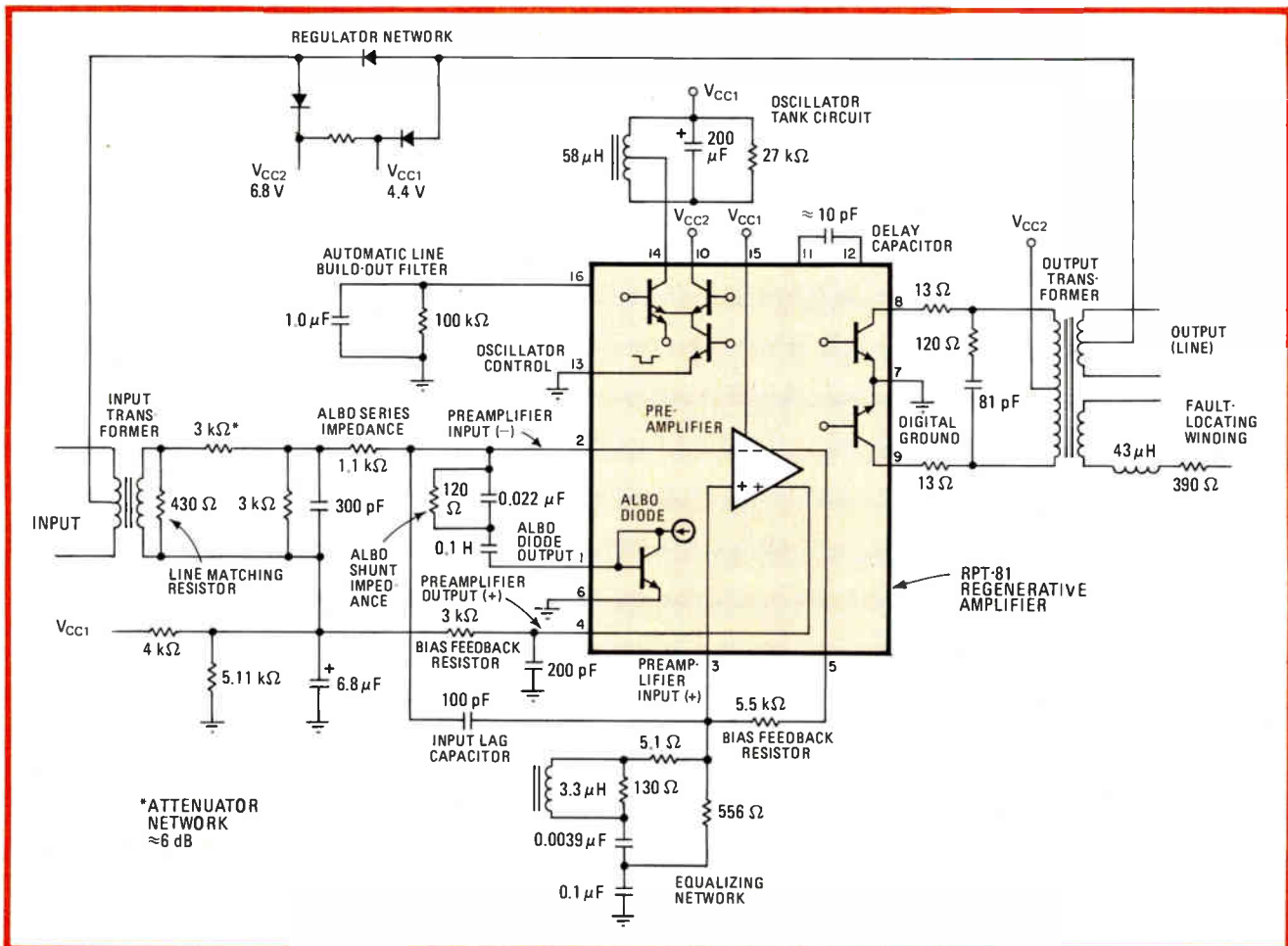

1. Two ways. A typical transmission-line amplifier using either the 81 or 82 has a separate channel for each transmission direction. The monolithic chips provide only the active portion of the amplifier, so that many other components are needed in the one channel shown.

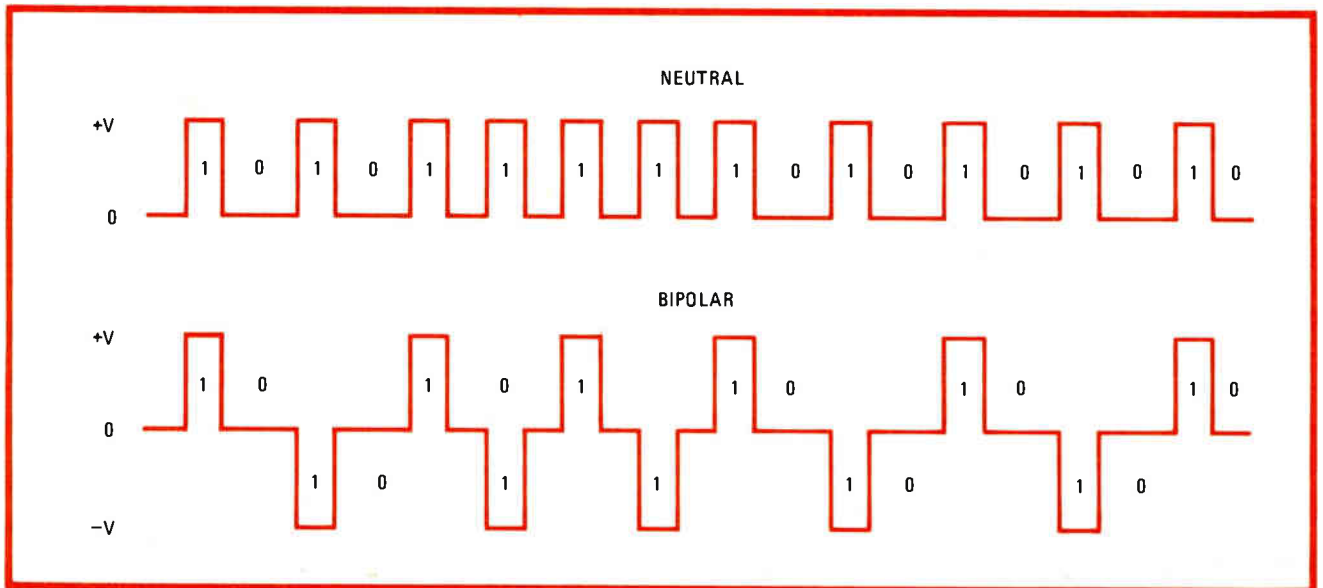

2. Conversion. Before the digital pulse train leaves the pulse-generating station for the pulse-code-modulation transmission line, it is converted into a bipolar code by means of alternate mark inversion. Every other pulse is reversed to form a bipolar pulse train.

megahertz bandwidth required by T1 systems. In addition, the 81 and 82 have no problems with output-pulse timing during their startup sequences, for their internal strobe pulses, which are used to sample the input data stream, ensure fast and accurate device response for all possible input frequencies. They can therefore achieve an error rate of 1 bit in 10^6 or better under a wider variety of noise, bandwidth, and other signal input conditions than was possible before.

In other respects the 81 and 82 are like their chip predecessors. They perform all the amplifying, filtering, and signal-processing functions required for a regenerative receiver, accurately reproducing the original digital pulse train as it was transmitted by the PCM generating terminal or regenerated by the preceding PCM repeater. The main difference between the two is that the 81 has a clock shutdown feature that greatly reduces repeater noise—its clock amplifier turns off in the absence of an incoming stream of signals.

Necessary additions

However, neither the 81 nor the 82 is a complete amplifier, in which they also resemble other such chips. For example, they avoid problems of heat dissipation by being powered by an external regulator network of discrete zener diodes and resistors, while some flexibility in the final amplifier design is obtained by the use of external input and output transformers, attenuators, feedback resistors, and miscellaneous other components.

One advantage the 81 and 82 share with other chips is an overwhelming superiority to the discrete-component approach. PCM amplifiers based on the RPT devices use only two power supplies—one fewer than any other such device—and need only 13 milliamperes of current—less than in any other approach. Only one active device need be specified, bought, and tested; in its 16-pin package it occupies much less board space; design is simplified; and fewer of the components need be burned in to check their reliability before the circuit is manufactured.

A typical regenerative repeater built around the 81 or 82 is shown in Fig. 1. It employs separate chips for signals travelling in the opposite directions. Bipolar technology allows the construction of high-speed digital outputs on the same chip as the wideband amplifier needed for a T1 system.

A PCM transmission system almost completely eliminates cumulative noise from a transmission line because the incoming signal is in essence renewed at each regenerative amplifier site. The amplifier has three functions: to reshape, regenerate, and retime the signals. To perform these three Rs, as they are called, the 81 and 82 employ the coding system, or protocol, that has been in use for a number of years on PCM transmission lines.

Alternate mark inversion

Before leaving the pulse-code-modulating terminal, the conventional digital train of pulses (logic 1s) and empty time slots (0s) is converted into a bipolar code called alternate mark inversion (Fig. 2). This procedure encodes alternate pulses (1s) with opposing polarities in order to remove the transmission line's dc signal component and thus allow the regenerative amplifiers (repeaters) to be transformer-coupled (Fig. 3).

When a pulse arrives at a regenerative amplifier after being transmitted over many thousands of feet of lossy, noisy transmission line, it is severely attenuated. Worse, it has been widened by the line's poor frequency response. These factors cause intersymbol interference—a superposition of succeeding pulses. For example, a typical PCM transmission over 6,000 feet of 22-gauge paper-insulated cable will spread the pulse out over three to four time slots instead of confining it to one well-defined position.

To be properly recognized, these pulses must be compared with a reference threshold defined as the average received pulse amplitude. This comparison is facilitated by "building out" the transmission line, so that it seems that each repeater span has the same length and hence

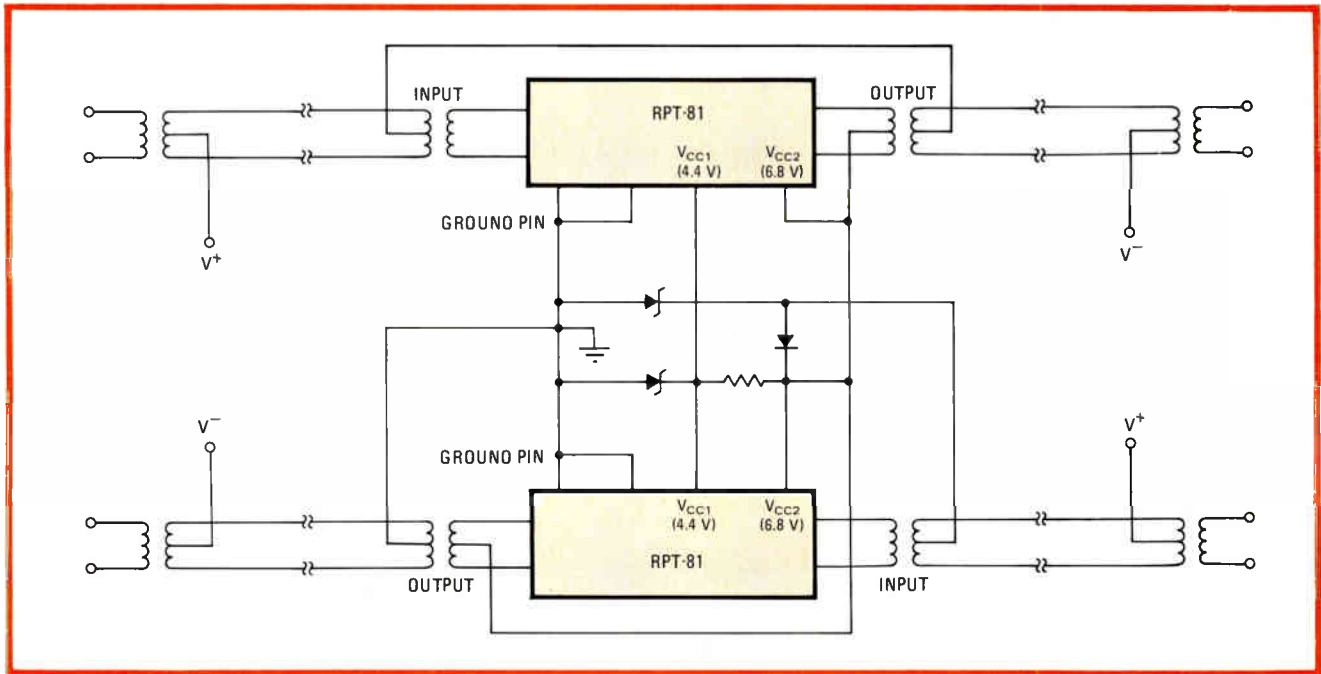

3. Alternating current only. Since all dc signal components are removed by the alternate mark inversion code, the 81 and 82 amplifier chips can be transformer-coupled to the pulse-code-modulation transmission line, letting one power supply handle full-duplex transmission.

the same attenuation. This line build-out must simulate the amplitude and phase response of an additional length of line—not a trivial task, since the skin effect makes this response a function of line length. Modern repeaters have automatic line build-out, or ALBO, which employs the equivalent of an automatic gain-control circuit whose attenuation and frequency response are functions of the average received pulse amplitude.

In a typical repeater (Fig. 4a), the ALBO circuit attenuates the signal in proportion to the voltage on the ALBO filter. The peak detector-comparator sends a current pulse into the ALBO filter each time a pulse from the preamplifier exceeds a fixed threshold. The effect of this current pulse is to increase the ALBO filter voltage, which in turn increases the ALBO attenuation. The feedback loop adjusts to this change until the pulses out of the preamplifier are equal in amplitude to the reference pulses. The full-wave rectifier and logic threshold detector references are set at fixed ratios of this peak reference, so that their thresholds are fixed with respect to the pulse shape and relative amplitude (Fig. 4b).

The preamplifier amplifies and equalizes, or reshapes, the pulses from the ALBO network. Equalization peaks up the pulses, so that most of the pulse amplitude is restricted to its own time slot. This reshaping eliminates most intersymbol interference.

Two more Rs

Pulse retiming and regeneration begin with the full-wave rectifier for the clock threshold circuit. For each pulse received, regardless of polarity, this circuit sends a current pulse to the oscillator circuit. The current pulse energizes a tuned tank circuit whose resonant frequency is very close to the optimum T1 pulse-train data rate of 1.544 megabits per second.

The 81 and 82 are designed so that the oscillator can

be made to operate in the locked-oscillator mode—that is, with the oscillator control pin grounded. Here, the oscillator runs all the time, but it is phase-locked to the full-wave rectifier's output.

The alternative is to operate in the pulse-tank mode—that is, with the oscillator control pin ungrounded. Now the tank circuit is only energized each time the full-wave rectifier sends a current pulse. After that, it simply oscillates very near its resonant frequency. Which of the two approaches is to be preferred depends on the application—the type of amplifier being designed and the PCM system being used.

In either case, clock recovery is easy because the oscillator circuit is phase-locked to the pulse-train frequency. The sine wave the circuit generates is amplified and shaped by the clock amplifier, whose outputs are a regenerated clock square wave and strobe waveforms. The strobe waveform consists of a series of narrow negative-going pulses that coincide with the rising edge of the regenerated clock square wave. In other words, the repeater can generate a pulse whose rising and falling edges coincide with the positive-going portion of the regenerated clock square wave. All that remains is to determine whether a pulse existed on the transmission line within a particular time slot and, if so, what its polarity was.

This determination is made by the logic threshold detector, which sends a negative-going pulse either on the T+ line when a positive input pulse is received from the transmission line or on the T- line when a negative input pulse is received. The negative-going T+ or T- pulses are inverted and ANDed with the inverted strobe pulses to set the FF+ or FF- flip-flops, respectively (Fig. 4a). The negative-going portion of the regenerated clock then resets the flip-flops. Since the output buffer transistor's collectors are connected to opposite ends of

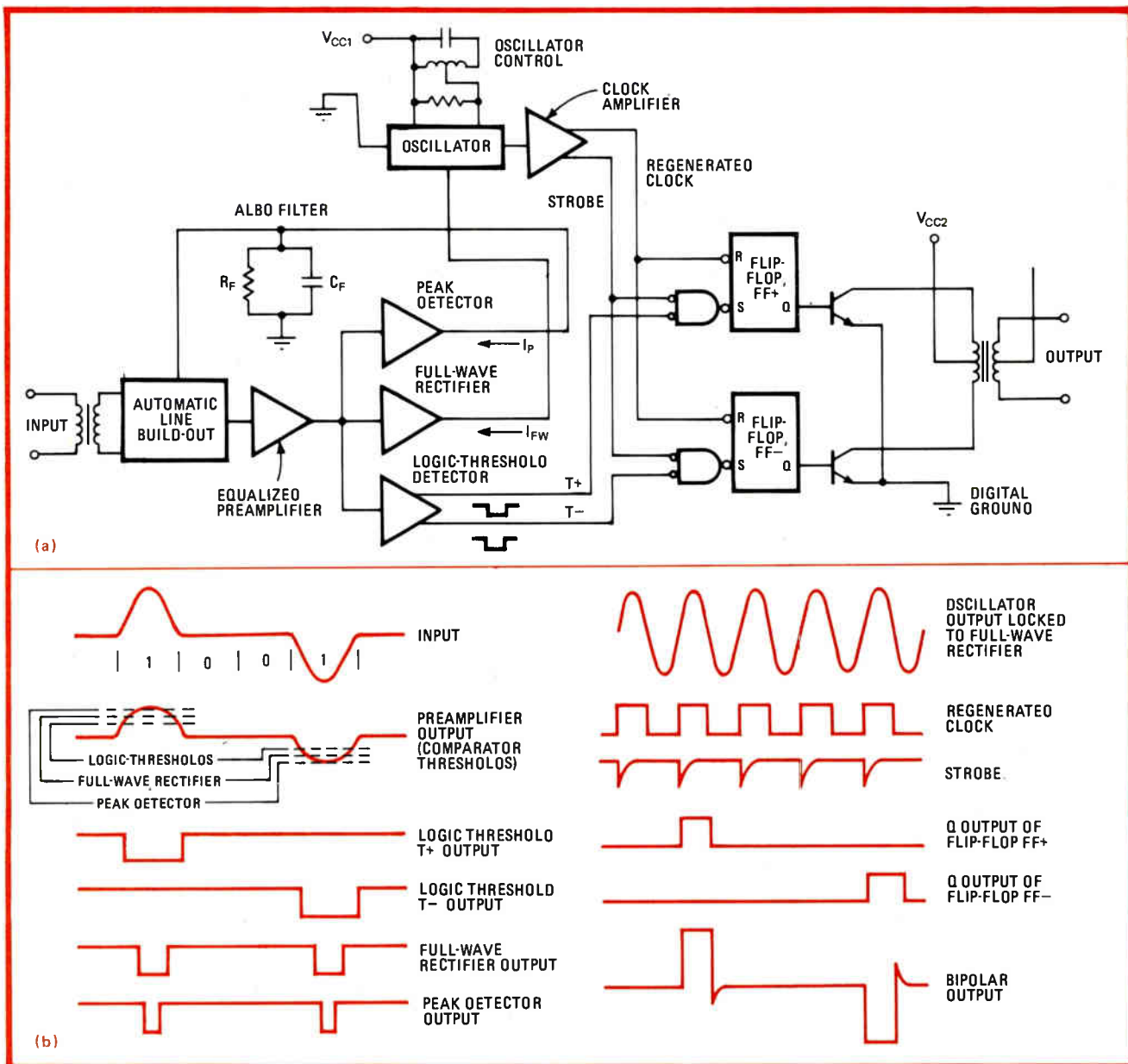

4. Regeneration. In a typical PCM repeater (a), the distorted bipolar code input (b) is regenerated, reshaped, and retimed until it is an almost perfect replica of the signal sent down the transmission line by the previous repeater or the signal-generating station.

the output transformer's primary winding, a pulse is generated at the transformer secondary with the correct polarity.

The pulse train at the output of the repeater should now be an exact replica of the pulse train at its input except for a time delay. In practice, though, the output pulse train still departs from the ideal because of amplitude and timing fluctuations.

Deviations from the ideal

Amplitude fluctuations are caused by random noise, which is partly due to repeater output instability and partly intersymbol interference, but mostly adjacent channel interference—twisted pairs often number in the hundreds or even thousands in a bundle, so that the crosstalk between individual pairs can be severe. Timing fluctuations are caused by the movement of the zero

crossings of the signals from their proper time of occurrence. The source of this jitter is the repeater, which performs the primary function of retiming the signal and phase-locking it to the long-term average of the clock frequency (derived from the line).

However, it is possible to evaluate the sensitivity of a regenerative amplifier to all these disturbances by sending a pseudorandom series of bipolar pulses into it and observing the oscilloscope pattern made by its analog output transitions. This eye diagram, or pattern (Fig. 5), is viewed over a two-pulse transition interval and synchronized with the transmission clock signal. Because of the randomness of the input pulse train, all possible logic bit transitions are apparent, superimposed on one another but leaving an open area in their midst. This space remains as the pulses shift from the negative level through the zero level to the positive level and vice versa.

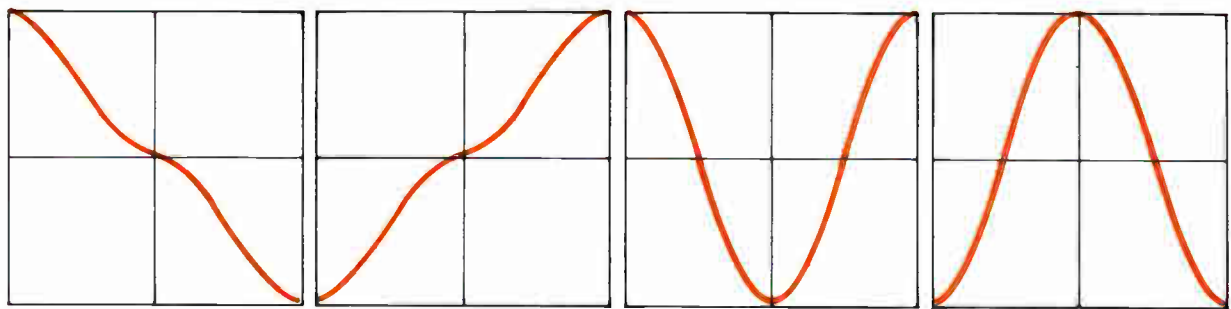
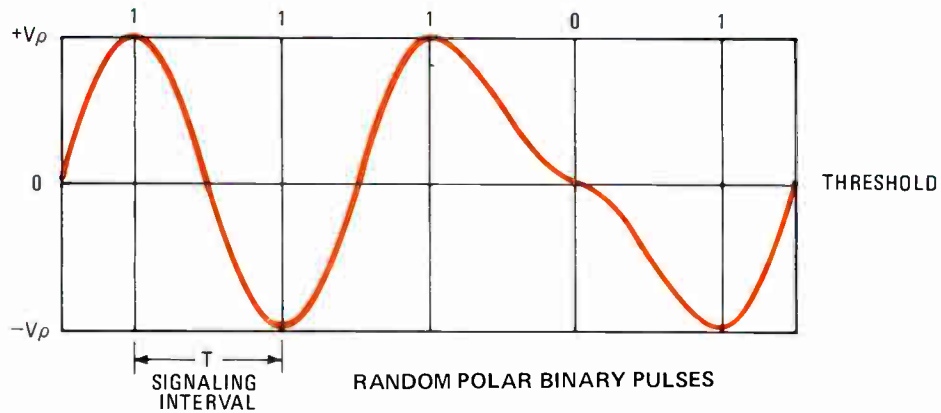

ALL POSSIBLE BIPOLAR PULSE-TRAIN TRANSITIONS

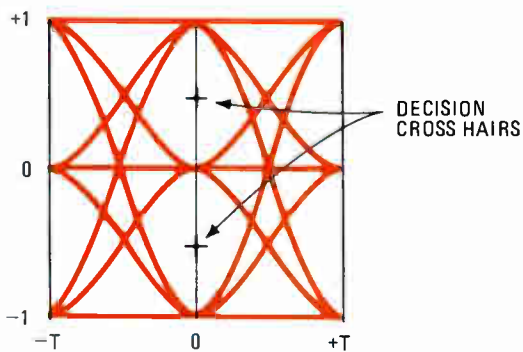

IDEAL EYE PATTERN

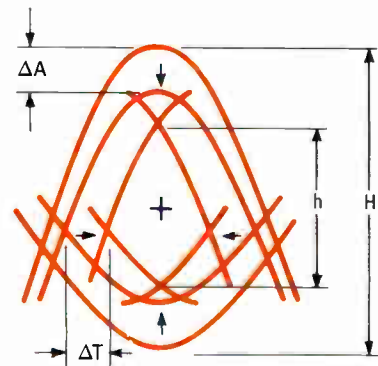

EYE SHRINKAGE DUE TO NOISE

5. Decision time. The eye diagram, a composite of all possible pulse-train transitions, is used to evaluate the effect on the PCM system's bit error rate of either amplitude or timing fluctuations. The eye shrinkage is proportional to these noise sources.

The size of the open area can also be shown to relate directly to the probability of bit error, which is attributable to poor amplifier regeneration of the pulse train. For example, any change in the vertical height of the open area may be caused by degradation in either the pulse train or the repeater's performance. Furthermore, the amplitude may be affected by intersymbol interference, echoes, output drive-circuit variations, and input threshold inaccuracies. In all cases, the effect on the

signal is a vertical collapse of the eye pattern. Similarly, changes in the timing of the output pulse due to jitter are seen as a horizontal narrowing. Thus, two major contributions to pulse-train errors made by the regenerator design can be immediately observed.

The eye diagram shows that the 81 and 82 regenerate all pulses that meet threshold requirements without inserting pulses into empty time slots at an unacceptably high rate. □

Antilog amplifiers improve biomedical signal's S/N ratio

by T. G. Barnett and D. L. Wingate
London Hospital Medical College, Department of Physiology, England

Low-voltage, biphasic signals recorded by instruments monitoring biomedical variables such as heart rate are often accompanied by high noise levels due to inadequate sensing, movement artefact, paging systems and power-line interference. Using paired antilogarithmic amplifiers, however, to provide the nonlinear amplification required, the level of the biphasic signals can be raised well above the amplitude of the interfering signals. The signal-to-noise ratio can thus be improved from 2:1 at the input to 10:1 at the output.

Such a scheme is superior to the use of paired logarithmic amps, which cannot handle biphasic signals at

the zero-crossing points ($\log 0 = \infty$), and provides more sensitivity than conventional diode clippers, which introduce noise and cannot pass signals that drop below the circuit's 0.7 clipping threshold.

Input signals are amplified by A_1 and are separated into their positive and negative components by precision half-wave rectifier A_2 and inverter A_3 . The corresponding outputs are then introduced into the AD759N and AD759P log/antilog amplifiers, which are wired to yield $e_o = E_{ref} 10^{e_{in1}/K}$ for $-2 \leq e_{in1}/K \leq 2$, where E_{ref} is an internal reference voltage of approximately 0.1 volt and K is a multiplying constant that has been set at 1 as a consequence of utilizing input e_{in1} . The output voltages generated by A_4 and A_5 are of negative and positive polarity, respectively.

These components are then summed by A_6 , whose output yields a bipolar, antilogged signal that can be introduced to appropriate trigger circuits. If desired, the original signal can be reconstructed by passing it through paired logarithmic amplifiers. □

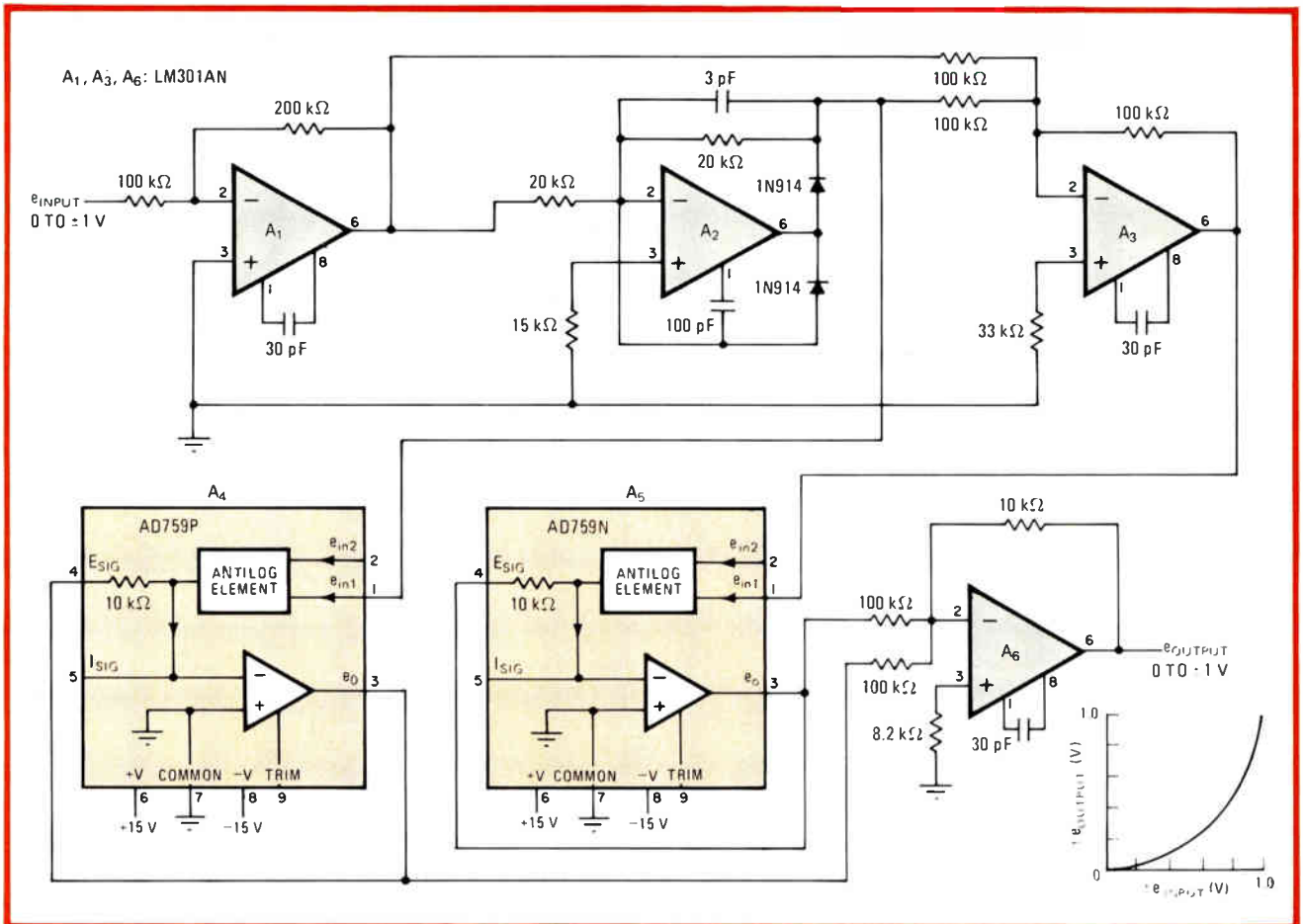

Biomedical booster. Paired AD759 antilog amps provide bipolar, nonlinear amplification, thus raising level of biphasic signals such as EKGs with respect to noise and so increasing S/N ratio. Circuit is superior to those using log amps, which cannot provide accurate output at zero crossings of signals, and is more sensitive than diode clippers, provides greater noise rejection than filters, and introduces no phase shift.

Dual one-shot keeps firmware on track

by Patrick L. McLaughlin
Teletech LaGuardia Inc., R&D Labs, Lafayette, Colo.

By noting the absence of pulses generated by status-reporting statements inserted in a running program, this missing-pulse detector reinitializes a microprocessor-based system when glitches on the power line or peripheral circuitry occur. The circuit provides more efficient system performance than a periodic reset timer and is much less expensive than installing line filters or isolators. Only one chip is required—a dual retriggerable monostable multivibrator.

Problems created by a power glitch—such as shuffling of information in the data registers and program jumps to undefined locations or to a location that gives rise to

infinite loops—are conventionally solved by placing a timer in the system's reset line to initialize the system every 15 minutes or by using a brute-force power-line filter or even a dynamotor power isolator. A timer probably offers the best low-cost solution, but system speed is degraded by the unnecessary periodic interruptions.

A better solution is to provide a way for the program to report to the system hardware that it is running and on track. Using the 74123 dual one-shot, as shown in the figure, to monitor so-called report statements that are entered in the program's housekeeping loop automatically resets the microprocessor if and when the reports stop for longer than a specified period.

In general operation, both one-shots (one serving as the missing-pulse detector, the other as the output timer) trigger each other alternately in an astable, free-running mode, with R_1C_1 setting the report window, t_w , and R_2C_2 setting the reset time, t_s . On power up, pin 12 of the 74123 is low and the processor is kept at rest until both one-shots time out. Then pin 12 is brought high, enabling the processor. If no report is made before time t_w ,

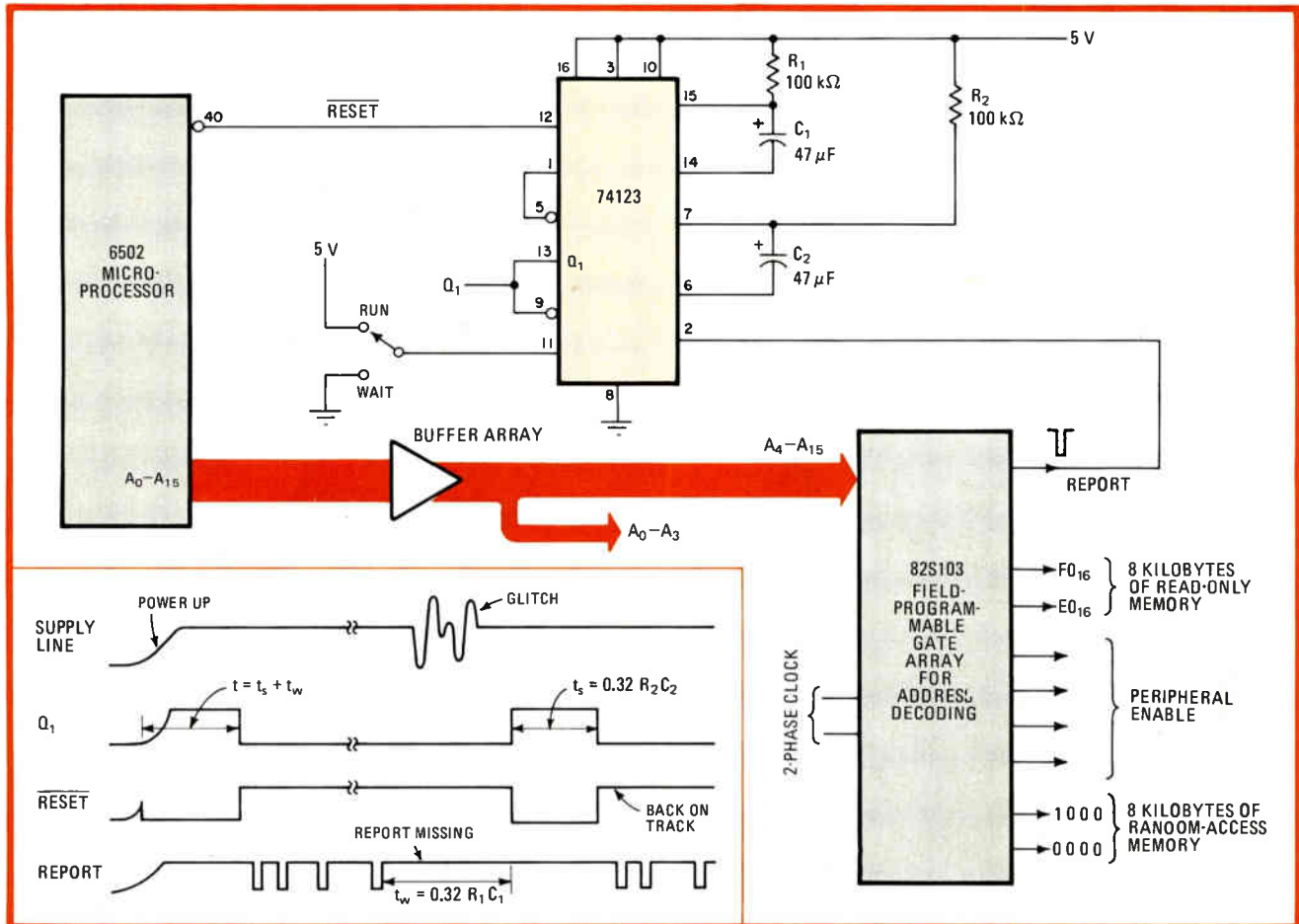

Restart. 74123 dual one-shot, configured as missing-pulse detector and output timer, detects absence of program report statements caused by power-line glitches in order to efficiently reinitialize microprocessor. Reports are entered as often as required in wait-for-data-type systems to ensure pulse rate falls within t_w window. Circuit accommodates static-type stop typical 8080/8085 wait instructions.

NEW



CURRENT GUN plus

SELF-CONTAINED
3½ DIGIT LCD READOUT

Hand-held Non-contact Current Meter



Now the famed Bell Current Gun probe goes a giant step further, and puts the "answer" right in your hand with a built-in readout. Reads dc to 400 Hz from 0 to 200 A. Features automatic reading hold. Has output for use with scope. Utilizes principles tried and proven in

Bell's broad line of Hall effect current measuring instruments.

Request full specs, or order direct. Send check or company P. O. for \$249 (plus \$3.50 shipping) to F. W. Bell, 6120 Hanging Moss Rd., Orlando, FL 32807.

 Magnetics &
Electronics, Inc.
An Amptron Corporation Company

F. W. BELL

Subsidiary, Magnetics & Electronics, Inc.

the cycle is repeated. An active-low series of report pulses made any time before t_w resets the missing-pulse detector (the output is Q_1), keeping pin 12 high and the processor running.

Usually, report statements are routinely entered before, after, or at both ends of the program's house-keeping loop and in most cases will be called frequently enough to fall within the t_w time window. In loops that may delay normal reporting, however, such as wait-for-data types, inclusion of additional report statements is advisable.

Note that if pin 11 is brought to ground, the one-shot at the output will be inhibited without resetting the

processor. Thus, this circuit can accommodate static-type stops typical of the 8080/8085 wait instruction and is usable with slow-running programs and single-stepping arrangements.

The 74123 can be rewired to accept positive-going report pulses simply by introducing the report line to pin 1 of the chip and making pin 5 the output reset line. Pin 3 is then connected to 5 volts and pin 10 disconnected from the positive supply and connected to pin 4 instead. Finally, pin 2 is connected to pin 12. □

Designer's casebook is a regular feature in *Electronics*. We invite readers to submit original and unpublished circuit ideas and solutions to design problems. Explain briefly but thoroughly the circuit's operating principle and purpose. We'll pay \$50 for each item published.

Power-up relays prevent meter from pinning

by Michael Bozoin
Ann Arbor, Mich.

Sensitive microammeters with d'Arsonval movements are still manufactured and used widely today, but surprisingly, there has been little attempt to correct one defect in their design—they are still very prone to pointer damage from input-signal overload and turn-on/turn-off transients. Although ways of protecting the meter movement from input signals of excessive magnitude are well known and universally applied, no convenient means of preventing the pointer from slamming against the full-scale stop during power-up or power-off conditions has so far been introduced or suggested in the literature. However, the problem may be easily solved by the use of a 555 timer and two relays to place a protective shunt

across the meter during these periods.

Basically, the 555 timer closes reed relay A's normally open contacts on power up and puts shunt resistor R across the meter for 5 or 6 seconds until the turn-on transients have subsided, as shown in the figure. The normally closed contacts of relay B are also opened at this time.

On power-down, relay B reintroduces the shunt to protect the meter from turn-off transients. Such a scheme is more effective than placing a diode across the meter, as is often done and is much more elegant and less bothersome than manually activating an auxiliary mechanical switch for placing R across the meter each time it is used.

R has been selected for a meter movement having a full-scale output of 200 microamperes and an internal resistance of 1,400 ohms. The complete circuit may be mounted on a 2-by-2¼-inch printed-circuit board. The only design precaution is to ensure that relay B is energized from a source that has a fast decay time during power-off conditions. Here, the voltage has been tapped from the meter's power-supply rectifier. □

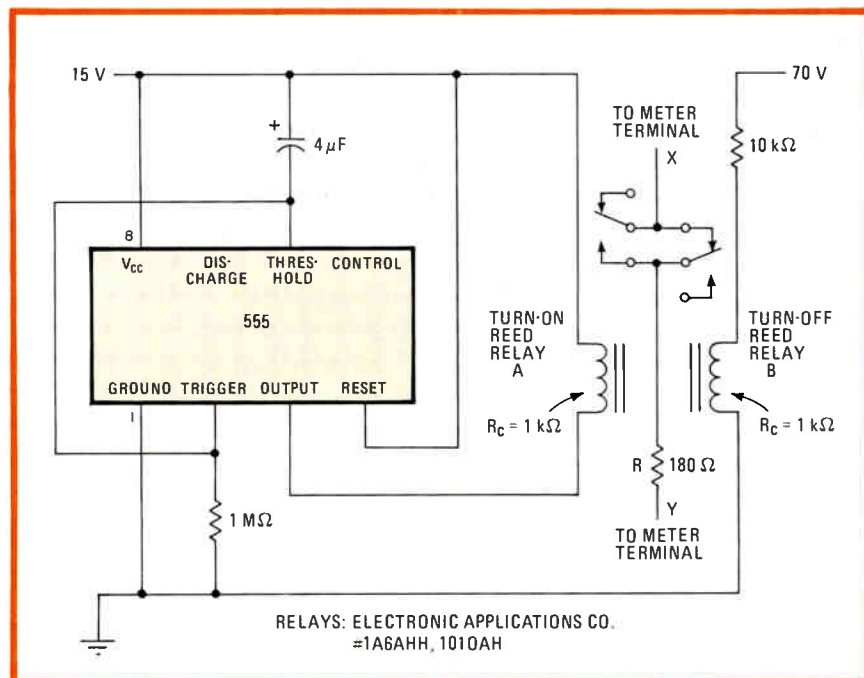

Shunted. Reed relays and 555 timer prevent d'Arsonval movement from slamming against microammeter's full-scale stop during power-up and power-down conditions by introducing shunt resistor across meter terminals until transients die out. Method does not degrade meter's accuracy or its transient response to input signals.

Whodunit?

Radar & Radio Communications IC Handbook

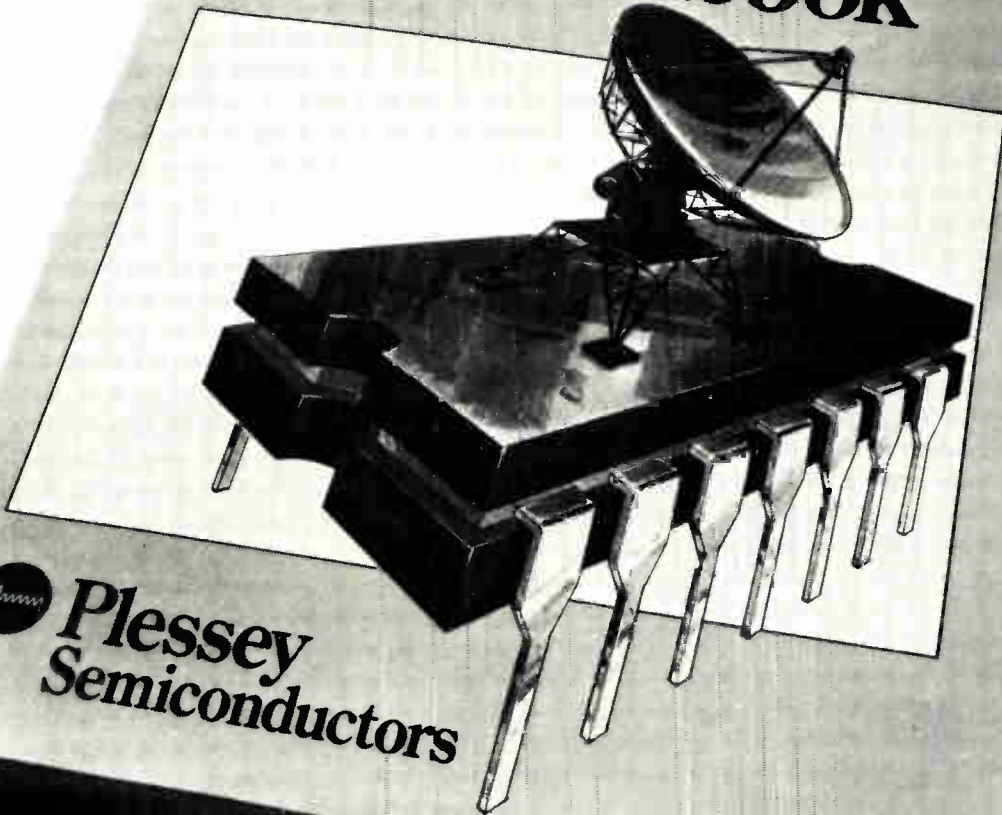

 **Plessey**
Semiconductors

Forget the cloak and dagger.
Don't bother to question the butler
or the upstairs maid.

The perpetrator of this micro-
electronic masterpiece is as plain as the
Plessey logo on the front cover.

Take the mystery out of specifying IC's for radar and radio systems applications.

Plessey makes a complete array
of complex "function block" IC's for
radar signal processing and radio
communications.

And you can read about all of them

in the just-published, 450-plus-page
RADAR & RADIO COMMUNICA-
TIONS IC HANDBOOK. It's chock-full
of applications notes and design tips,
a "cookbook" for all you high frequency
fans that will simplify your designs,
increase reliability, improve per-
formance and lower your system cost.

PLESSEY IC'S FOR RADAR I.F.S

Wideband Amplifiers for Successive Detection Log Strips

- SL521 30 to 60 MHz center frequency, 12 dB gain.
- SL523 Dual SL521 (series).
- SL1521 120 to 160 MHz center frequency, 12 dB gain.
- SL1522 Dual SL1521 (parallel).
- SL1523 Dual SL1521 (series).

Low Phase Shift Amplifiers

- SL531 True log I.F. amplifier, 10-200 MHz, $\pm 0.5^\circ/10$ dB max phase shift.
- SL532 400 MHz bandwidth limiting amplifier, 1° phase shift max. when overdriven 12 dB.

Linear Amplifiers

- SL550 125 MHz bandwidth, 40 dB gain, 25 dB swept gain control range, 1.8 dB noise figure, interfaces to microwave mixers.
- SL1550 320 MHz bandwidth version of SL550.
- SL560 300 MHz bandwidth, 10 to 40 dB gain, 1.8 dB noise figure drives 50 ohm loads, low power consumption.

Video Amplifiers and Detectors

- SL510 Detector (DC to 100 MHz) and video amplifier (DC to 24 MHz) may be used separately, 11 dB incremental gain 28 dB dynamic range.
- SL511 Similar to SL510 with DC to 14 MHz video amplifier, 16 dB incremental gain.
- SL541 High accuracy op amp configuration, 175 V/ μ s slew rate 50 ns settling time, stable 70 dB gain, 50 ns recovery from overload.

"Must reading for every radar systems buff..."

Whether you're working with radar and ECM, weapons control or navigation and guidance systems, you'll quickly surmise that Plessey IC's are a simpler, less expensive, more flexible alternative to whatever you're now using for any I.F. strip up to 160 MHz.

The handbook abounds with examples of Plessey's Radar IC prowess.

A case in point is the Plessey SL531 True Log Amplifier. A six stage log strip requires a minimum of external components (one capacitor, one resistor per stage), yet has a bandwidth of 500 MHz, a dynamic range of 70 dB and has a phase shift of only $\pm 3^\circ$ over its entire range.

As with most other Plessey devices, it operates over the full MIL-temp range and is available screened to MIL-STD-883.

This thriller goes on for page after page with more of the same—highly integrated function blocks that are on the leading edge of technology without pushing the ragged edge of capability. You'll just have to get your copy of the HANDBOOK for the rest of the details.

"I couldn't put it down. The only mystery was why I hadn't tuned Plessey into my radio communications systems before now..."

Even the most casual reader will appreciate the benefits of devices such as the Plessey SL600 Series (hermetic) and SL1600 Series (plastic DIP).

Even more exciting is the Plessey SL6000 Series. It extends the Plessey IC "building block" concept even further, with devices that permit higher levels of integration, lower power consumption and provide exceptional performance.

The HANDBOOK is full of gems in silicon, but one example should suffice. The Plessey SL6600 is a monolithic IC that contains a complete IF amplifier, detector, phase locked loop and squelch control. Power consumption is a meager 1.5 mA at 6V, S/N ratio is 50 dB, dynamic range is 120 dB and THD is just 1.3% for 5 kHz peak deviation. The SL6600 can be used at I.F. frequencies up to 50 MHz, with deviations up to 10 kHz. Plessey's comprehensive line of radio communications function block IC's is cutting costs, increasing reli-

ability and reducing system size in applications that range from commercial communications to military manpack radios. Read all about it in the HANDBOOK.

PLESSEY RADIO IC'S

Amplifiers

- SL610 SL1610 140 MHz bandwidth, 20 dB gain, 50 dB AGC range, low 4 dB N.F., low distortion.
- SL611 SL1611 100 MHz bandwidth, 26 dB gain, sim. to SL610.
- SL612 SL1612 15 MHz bandwidth, 34 dB gain, 70 dB AGC range, 20 mW power consumption, 145 MHz bandwidth, 12 dB gain, limiting amp/detector.
- SL613

Mixers

- SL640 SL1640 Double balanced modulator eliminates diode rings up to 75 MHz, standby power 75 mW typical.

Detectors and AGC Generators

- SL620 SL1620 AGC with VOGAD (Voice Operated Gain Adjusting Device).
- SL621 SL1621 AGC from detected audio.
- SL623 SL1623 AM SSB detector and AGC from carrier.
- SL1625 AM detector and AGC from carrier.
- SL624 AM/FM/SSB/CW detector with audio amplifier.

Audio Amplifiers

- SL622 Microphone amp. with VOGAD and sidetone amp.
- SL630 SL1630 250 mW microphone/headphone amplifier.

I.F. Amplifiers/Detectors

- SL6600 FM double conversions with PLL detector.
- SL6640 FM single conversion, audio stage (10.7 MHz).
- SL6650 FM single conversion (10.7 MHz).
- SL6690 FM single conversion, low power for pagers (455 kHz).
- SL6700 AM double conversion.

Audio Amplifiers

- SL6270 Microphone amplifier with AGC.
- SL6290 SL6270 with speech clipper, buffer and relay driver.
- SL6310 Switchable audio amplifier (400 mW/9V/8 ohms).
- SL6440 High-level mixer.

The \$4 solution.

It's elementary, dear reader.

If you're involved in the design of systems for radar signal processing or radio communications, the new Plessey RADAR & RADIO COMMUNICATIONS IC HANDBOOK should be at the very top of your current reading list.

Even if our Handbook unravels but one small systems solution for you, it will have been well worth the \$4 (postage paid) purchase price.

For your copy, just write Plessey Semiconductors, 1641 Kaiser Avenue, Irvine, CA 92714. Telephone (714) 540-9979.

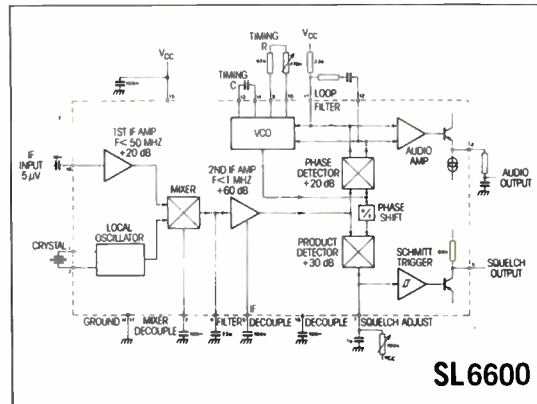

Plessey's radio IC prowess at work. The SL 6600 is a masterful monolithic IC that contains a complete I.F. amp, detector, PLL and squelch control. Power consumption is exceptionally low. Performance is exceptionally high (Reprinted from RADAR & RADIO COMMUNICATIONS IC HANDBOOK).

Plesseydunit.

Automated molecular beams grow thin semiconducting films

Molecular-beam epitaxy is proving ideal for fabricating new and state-of-the-art high-frequency and optoelectronic devices

by Paul E. Luscher, Walter S. Knodle, and Young Chai, *Varian Associates, Palo Alto, Calif.*

□ Epitaxy, a term describing growth of a single-crystal film on a similar substrate, is one of the building blocks of semiconductor processing. The importance of epitaxy in semiconductor-device manufacture is a direct consequence of two fundamental needs: for thin, defect-free single-crystal films with precisely defined geometrical, electrical, and optical properties and for heterojunction structures free of interfacial impurities, defects, and lattice-mismatch strain.

Until recently, most semiconductor manufacturing employed either liquid- or vapor-phase epitaxial growth. A newer technique, molecular-beam epitaxy (MBE), achieves epitaxial growth on a heated single-crystal substrate placed in an ultrahigh vacuum (UHV) through the reaction of multiple molecular beams of differing intensity and chemistry. Essentially confined to research and

development laboratories until about 1976, MBE is now emerging as a full-fledged technology with great growth potential. In particular, the progressively thinner, planar epitaxial structures of optoelectronic and microwave devices are brightening its commercial promise.

Precise control

The strength of the MBE process lies mainly in its unprecedented precision in controlling dopant concentration and epitaxial thickness in layers as thin as a few tens of angstroms, with an exceptional interface morphology and uniformity of the epitaxial-layer thickness that is easily reproduced. In addition, MBE is highly versatile. Thus the process is capable of incorporating various shadow-masking techniques in the growth process and of growing epitaxial heterostructures with a wide variety of

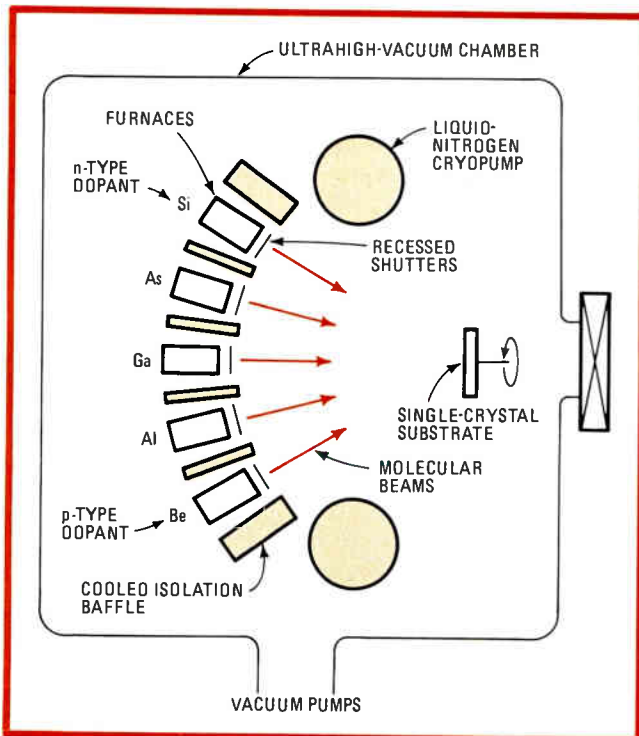

1. Beamed epitaxy. In molecular-beam epitaxy, film growth takes place in ultrahigh vacuum. Molecular beams with different intensities and chemistries are focused on a heated substrate. The diagram shows the essential components for molecular growth of (AlGa)As.

TABLE 1: SEMICONDUCTORS AND METALS GROWN BY MOLECULAR BEAM EPITAXY

Group IV	Group II - VI	Group IV - VI
germanium germanium silicide silicon	cadmium selenide cadmium sulfide cadmium telluride zinc selenide zinc sulfide zinc selenide telluride zinc telluride	lead germanium telluride lead selenide lead sulfide lead selenium telluride lead telluride lead tin selenide lead tin telluride tin telluride
Group III - V	Metals	
aluminum arsenide aluminum gallium arsenide gallium antimonide gallium arsenide gallium arsenide antimonide gallium arsenide phosphide gallium indium arsenide phosphide gallium indium phosphide gallium phosphide indium antimonide indium arsenide indium phosphide	aluminum gold silver	

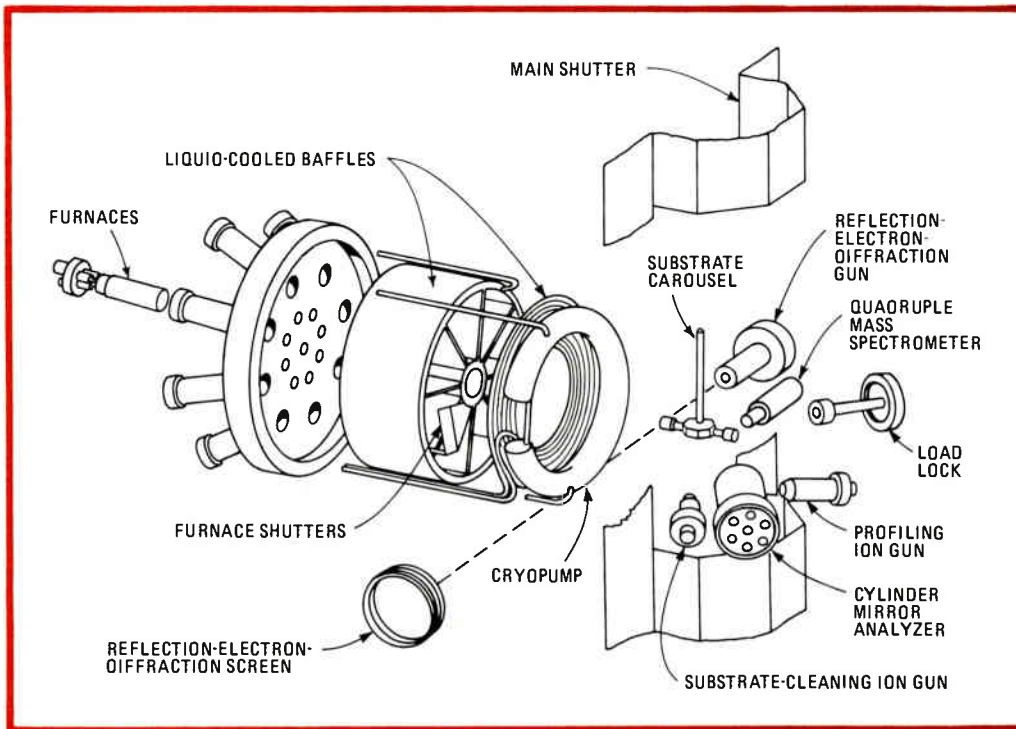

2. MBE system. The MBE-360 system contains all the functions needed for the growth of epitaxial layers and the on-site analysis of metals and compound semiconductors. This exploded view shows all the epitaxial and surface-analysis components.

materials (including elemental and compound semiconductors, metals, and insulators) with lattice-matched or graded heterojunctions. What's more, it can conveniently include surface-analysis instruments in the growth environment.

The essential components for a MBE machine for n- and p-doped aluminum gallium arsenide are illustrated in Fig. 1. Each furnace contains a crucible that holds one of the constituent elements or compounds of the desired film. The temperature of each furnace is chosen to generate molecular beams of the appropriate intensities. For some low-vapor-pressure materials, the temperatures required to achieve adequate beam fluxes are so high that direct electron-beam evaporation is employed instead of evaporation from crucibles in resistively heated furnaces.

By choosing appropriate furnace and substrate temperatures, stoichiometric epitaxial films of the desired chemical composition can be obtained. The beam flux at the substrate is abruptly started or stopped by individual shutters placed between each furnace and the substrate.

Although growth of elemental semiconductor films such as silicon and germanium by MBE is relatively straightforward, flux matching is impractical for achieving stoichiometry in most compound semiconductors. However, a fortuitous dependence of the sticking probability of group V elements on the availability of unsaturated group III elements allows stoichiometric III-V compounds to be obtained simply by growing films in excess group V fluxes.

One of the notable advantages of MBE for group III-V compounds is its low growth rate—approximately 1 micrometer per hour, which is roughly equivalent to two single atomic layers per second. This characteristic demands a stringent vacuum requirement and is partly responsible for the control over host lattice composition

and dopant incorporation on an atomic scale.

Preparation of epitaxial structures with atomic dimensions, however, requires growth on atomically smooth surfaces at temperatures low enough that bulk diffusion is negligible. The optimum growth temperature for MBE is generally 100° or 200°C lower than for either liquid- or vapor-phase epitaxy, and the step-propagation growth mechanism results in a progressive smoothing of the surface on an atomic scale. That the criteria for control of the atomic level in the direction of growth are met is exemplified by the growth of superlattice materials, some with 10⁴ alternating aluminum arsenide and gallium arsenide molecular monolayers.

Table 1 lists materials that have been grown by MBE.

Hardware details

Although Fig. 1 suffices for a discussion of the basic MBE process, its implementation is more complex than the drawing implies. Figure 2 is an exploded view of a commercial system, the MBE-360, that contains:

- An ultrahigh-vacuum system, including a specimen-exchange vacuum load lock.
- Multiple furnaces.
- Furnace shutters.
- Furnace baffles.
- A heated substrate holder.
- Epitaxial control instrumentation.
- Components for in-place substrate cleaning.
- Surface-analysis instrumentation.

The need for an ultrahigh vacuum arises from MBE's low growth rates, coupled with the obvious requirement of minimal unintentional film-impurity concentrations. Achieving an ultrahigh vacuum takes far too much time to allow exposure of the growth chamber to atmospheric pressure simply for substrate exchange, and substrate-exchange load locks are now integral parts of MBE

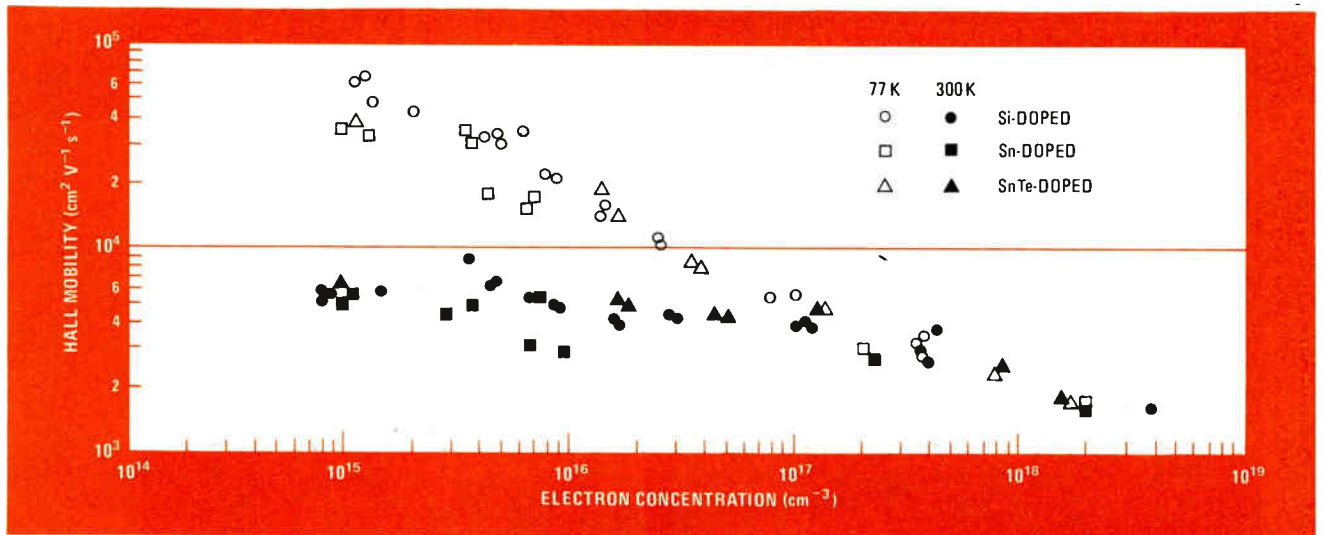

3. Electron mobility. Electron mobility versus doping concentration was measured at 77 K and 300 K for thin n-type gallium arsenide films (less than 5 μm thick) grown in a MBE-360 system. At 300 K, electron concentrations as high as $4 \times 10^{18} \text{ cm}^{-3}$ were achieved.

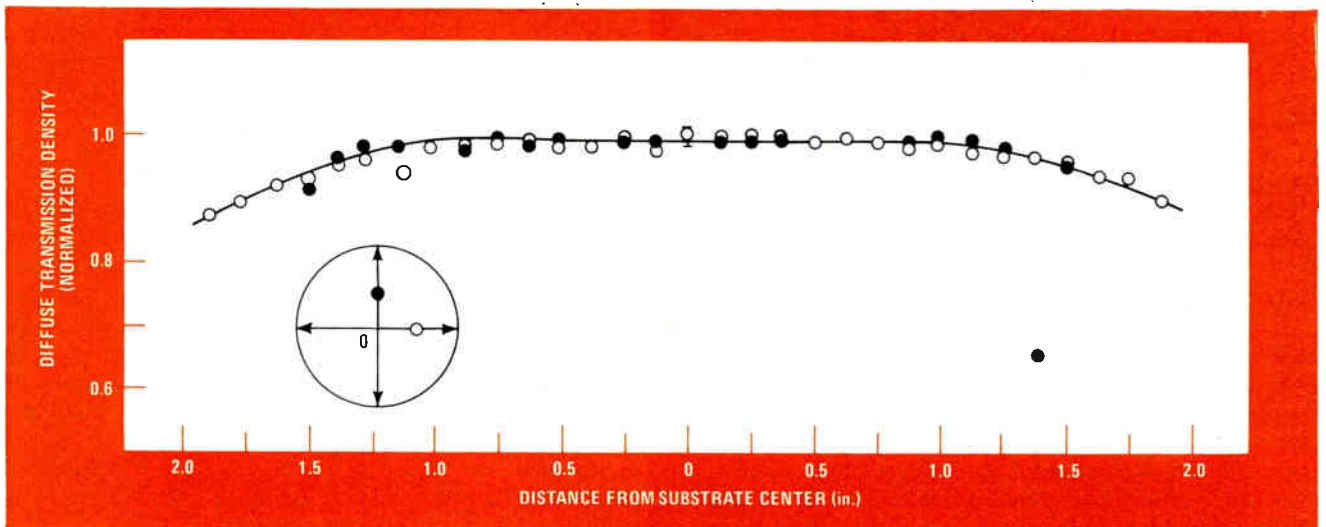

4. Uniform films. Molecular-beam epitaxy can grow extremely uniform films. This film uniformity profile is typical of that achievable with the MBE-GEN II system, which was designed to grow films having uniformities of within $\pm 5\%$ over a 2-in.-diameter wafer.

vacuum systems, permitting operation over periods of weeks during which the vacuum remains unbroken. With the load lock, the time required for specimen exchange is a negligible part of the growth process, and film purity and reproducibility are markedly increased.

The evaporation sources provide ultrahigh-purity molecular beams of the appropriate intensity and uniformity. The superlattice structures described above and the devices discussed below illustrate the exceptional precision that can be achieved by highly accurate control of furnace temperatures and shutter actuation. The ability of the furnaces to provide extremely pure beams is illustrated in part by the electron mobility in MBE-grown GaAs shown in Fig. 3. These values, approaching the highest 77-K Hall mobilities reported between 4×10^{18} and 9×10^{14} molecules per cubic centimeter, are routinely achieved with the system shown in Fig. 2, making possible the fabrication of most GaAs devices. Similar success into the $10^{14}/\text{cm}^3$ range has been achieved with silicon. In addition to furnace and crucible purity, the

ratio of group V to group III molecular beams and the substrate temperature help determine film quality.

The heated substrate holder must provide uniform, strain-free heating of the substrate to the appropriate temperature without contamination. It must allow the substrate to be transferred into and out of the system via the specimen-exchange load lock.

Uniform film thickness

Achievement of epitaxial films with uniform properties over production-size wafers from any combination of eight separate molecular-beam sources requires considerably greater engineering attention than do research systems. Working with Bell Laboratories scientists, Varian Associates has developed the MBE-GEN II system, which uses a continuously rotating substrate to achieve highly uniform film thickness ($\pm 5\%$ variation over 2-inch-diameter substrates). Figure 4 charts an example of the deposition uniformity achievable with this production system. For applications requiring such

uniformity, the usable wafer area, and hence throughput, have been extended approximately tenfold over those of previous research machines.

Process control in the growth direction on an atomic scale is the most notable attribute of MBE. The individual molecular beams can be turned abruptly on or off by shutter actuation and continuously varied by temperature-programming the evaporation sources. However, dopant-incorporation behavior varies widely among

5. The competition. Liquid and vapor processes are currently employed commercially to grow epitaxial layers. A typical liquid-phase epitaxial system is shown in (a). Vapor-phase epitaxy has two forms, halide (b) or metal-organic chemical vapor deposition (c).

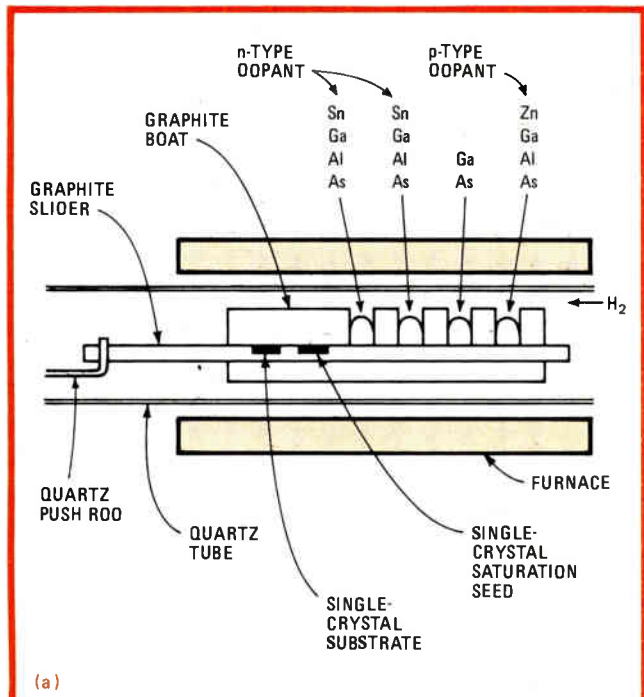

materials and can be extremely complex. The nature of the dopant behavior must be well understood to develop growth processes that achieve the desired dopant properties and profiles.

Fortunately, much information already exists in the published literature, making the use of a variety of dopant materials routine. The interactive-programming capability available with the MBE-GEN II system allows this information to be incorporated into the control software, resulting in a process development and production capability previously unobtainable with other epitaxial techniques.

Cleaning methods

Obtaining a clean, defect-free monocrystalline substrate surface is fundamental to achieving epitaxial growth. The in-place cleaning methods chosen depend on the materials and contaminants involved, as well as on the device structure being grown. The most common procedure is simply heating prepared substrates in an ultrahigh vacuum, sometimes with incident group V molecular beams. Reactive etching and sputter etching with low-energy inert-gas ions (about 500 electronvolts)

TABLE 2: COMPARING PROCESSES FOR GROWING EPITAXIAL GaAs

	Liquid-phase epitaxy	Vapor-phase epitaxy		Molecular-beam epitaxy
		Chemical vapor deposition	Metal-organic CVD	
Growth rate ($\mu\text{m}/\text{min.}$)	~ 1	~ 0.1	~ 0.1	~ 0.01
Growth temperature ($^{\circ}\text{C}$)	850	750	750	550
Thickness control (\AA)	500	250	100(50)	5
Interface width (\AA)	≥ 50	~ 65	$< 20(16)$	$< 15(9)$
Dopant range (cm^{-3})	$10^{13}-10^{19}$	$10^{13}-10^{19}$	$10^{14}-10^{19}$	$10^{14}-10^{19}$
Mobility, 77 K (cm^2/Vs)(n-type GaAs)	150,000-200,000	150,000-200,000	120,000	105,000

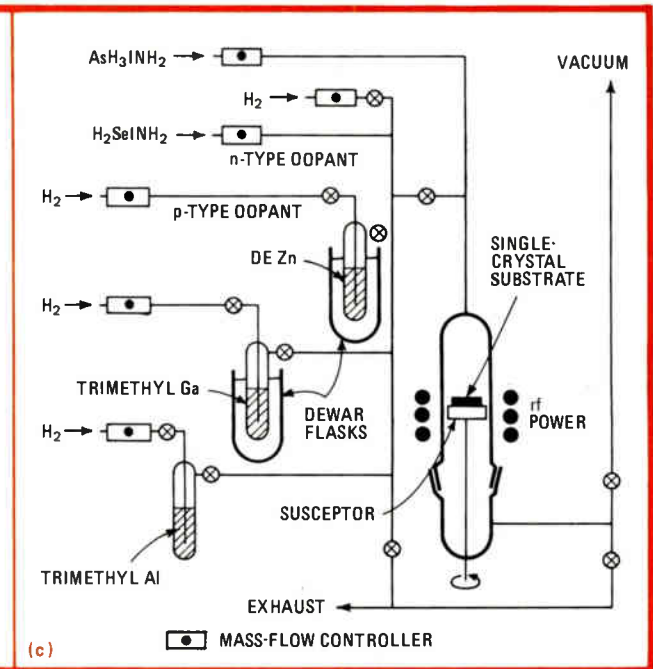
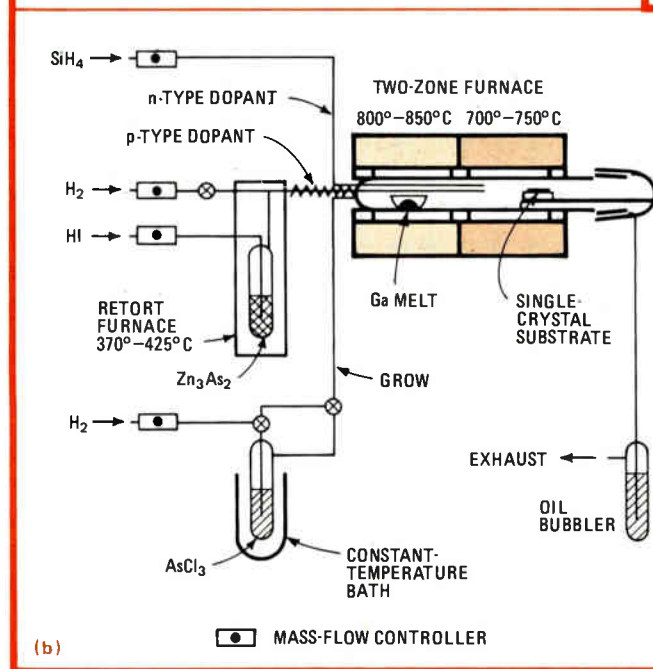

Growing Impatt diodes with MBE

Impatt diodes employ avalanche and transit-time properties to produce a phase lag between the diode's voltage and current at microwave frequencies. This phase lag results in negative conductance, which is employed in microwave amplifiers and oscillators. Impatts are at present the most powerful and efficient solid-state source of high-frequency microwave power.

The figure is a schematic cross section of a typical p⁺ high-low Impatt diode for use in X-band applications. The p⁺n diode is reverse-biased above breakdown with a dc voltage, establishing a very high field in the narrow n avalanche layer and a much lower field in the n⁻ drift layer. Superposition of a sinusoidal signal voltage large enough to modulate the p⁺n junction in and out of avalanche injects periodic pulses of electrons into the drift layer. The phase lag associated with the avalanche process is approximately 90°. The injected charge pulses move at the saturated velocity across the drift layer. If the length of the drift layer is properly chosen, another phase shift of 90° occurs. The ac current induced in the external circuit therefore lags the ac voltage by a total of 180°.

The formation of the abrupt p⁺n junction adjacent to an n⁻ doped region of precise thickness is critical to these

devices' performance. The width of the n-doped region determines the reverse-bias breakdown voltage of the p⁺n junction. The junction quality must be high to ensure abrupt breakdown free of microplasmas.

With vapor-phase growth, abrupt p⁺n and nn⁻ junction formation is difficult. Liquid-phase growth simplifies the junction formation but suffers from severe thickness non-uniformities. Both techniques cannot satisfactorily reproduce thickness and doping characteristics.

At Varian, the MBE system shown in Fig. 2 (p. 161) has yielded over 200 Impatts from a single square centimeter of wafer with a standard deviation of 80 angstroms in the 4,000-Å-thick n avalanche region—four to six times better than commonly achieved with LPE. With the production MBE-GEN II system, better uniformity is expected over an area approximately 20 times as large.

In addition to allowing economical production of multiple devices with very closely matched parameters, the excellent uniformity now available with MBE makes possible larger-area devices, thereby reducing the thermal impedance for high-power applications. The table gives selected characteristics of Impatt structures fabricated by Heirl and Collins of Varian.

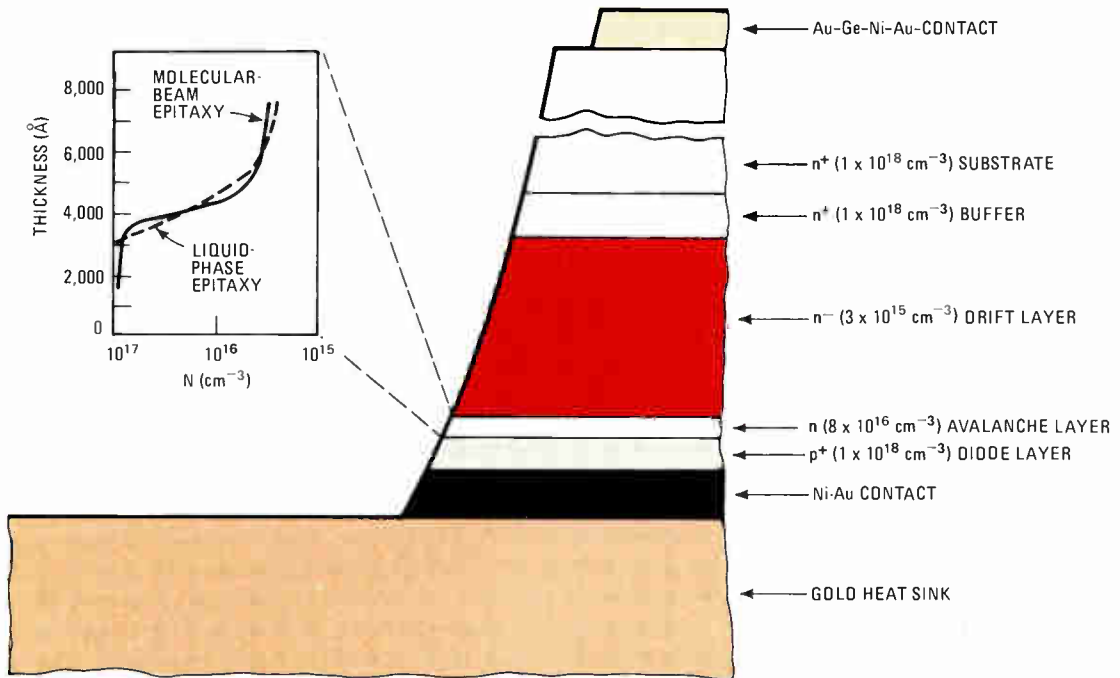

THE BEST RESULTS OBTAINED FROM p⁺ HIGH-LOW IMPATT DIODES GROWN WITH MBE

Duty cycle	Peak power (W)	Efficiency (%)	Frequency (GHz)	Geometry
Continuous wave	6.9	20.1	8.90	single-mesa
33%	21.0	24.2	8.74	ring
25%	23.2	22.7	8.80	four-mesa
20%	25.0	27.0	9.03	four-mesa
10%	31.0	31.0	8.80	ring
1%	31.0	33.0	8.80	ring

followed by annealing are also employed. If the substrate requires more than a very brief heat cleaning, the throughput of the MBE system may be increased by adding a separate preparation chamber.

Unique to MBE among the epitaxial techniques is its ability to include surface-sensitive analytical equipment in the growth environment. Such instrumentation has played and continues to play an extremely valuable role in process development. *In situ* electron diffraction during growth aids in identifying and calibrating epitaxial growth parameters, and auger spectroscopic analysis of

the surface chemistry helps in developing appropriate cleaning procedures. Once a growth process is well developed, however, much of the analytical equipment is no longer essential and may be moved to another system or used simply for periodic process monitoring.

Alternative techniques

Before looking at the applications of MBE, it is helpful to consider the operating principles and shortcomings of MBE's two principal competitors, liquid- and vapor-phase epitaxy.

In liquid-phase epitaxy (LPE), crystal growth results from precipitation from a supersaturated solution in contact with the substrate. Precipitation is induced by allowing the system to cool below its saturation temperature. Figure 5a depicts an LPE system for the growth of n- and p-type (AlGa)As. A graphite slider containing the substrate is advanced from melt to melt by a quartz rod. The entire assembly is inside a heated quartz tube continually flushed with ultrapure hydrogen. At times the substrate may be preceded by a saturation seed, which establishes thermodynamic equilibrium within each melt before its contact with the substrate.

In order to grow both homojunction and heterojunction structures, the substrate must be exposed to a series of melts. Each melt differs in alloy composition, depending on the final device structure desired. Some major obstacles with LPE, which are difficult to overcome, are poor surface and interface morphology and poor layer homogeneity for growth over extended temperature intervals. In addition, stoichiometry is not readily adjustable, and reproducibility (particularly with multicomponent alloys) and process automation are not easily achieved. Nevertheless, LPE has certain advantages that have made it popular for research and for some production applications. These include the relative simplicity of the equipment, the high growth rate (approximately 10 times the vapor growth rate), and the absence of hazardous gases.

Vapor phase

Vapor-phase epitaxy (VPE) is a chemical vapor deposition (CVD) technique in which film growth takes place from the pyrolysis or chemical reaction of vapor-phase compounds at the substrate surface. In large-scale operations, typical of silicon semiconductor growth, over 800 square centimeters of material are produced in each run.

Surface morphology and defect control are generally superior compared with LPE. The composition gradient with layer thickness, common to standard LPE processes, is not present with VPE.

The two most common vapor-phase techniques for GaAs growth involve the use of either halogen compounds (halide CVD) or group III alkyls and group V hydrides (metal-organic CVD).

Figure 5b illustrates an arsenic trichloride system for the growth of n- and p-type gallium arsenide fabricated by Johnson, Steele, and Whittier of Raytheon. Separate heat zones are required for the source and the substrate. Arsenic trichloride serves as both the arsenic source and the transport agent for gallium from the heated melt. The p-type dopant, zinc, is transported as zinc iodide

(ZnI₂) with an inactive gas such as hydrogen. Zinc iodide is generated by the reaction of hydrogen iodide (HI) and zinc arsenide (Zn₃As₂) in a heated retort. The n-type dopant, silicon, is transported as silane (SiH₄).

Doping changes are made by varying the flow rates of the gases into the reaction. Halide CVD heterostructure growth is prevented by the absence of a successful technique for Al_xGa_{1-x}As.

The metal-organic CVD (MO-CVD) technique is commonly employed to grow GaAs-(AlGa)As heterostructures. A simplified schematic diagram of an apparatus of this type built at Rockwell is shown in Fig. 5c. Undoped GaAs is grown by pyrolytic reaction of trimethyl gallium (TM Ga) and arsine (AsH₃). Both compounds are transported to the reaction zone by a hydrogen carrier gas. Trimethyl aluminum (TM Al) is similarly transported when the growth of Al_xGa_{1-x}As is desired. Control of the various reactant partial pressures is maintained by mass-flow controllers. The substrate rests on a graphite susceptor coated with silicon carbide (SiC) that is rotated during deposition to promote film uniformity.

Each of these techniques has advantages and disadvantages in fabricating epitaxial structures for specific devices. Table 2 compares a few of the important growth and material parameters for epitaxial GaAs grown by the various techniques.

Device applications

Fabrication of a variety of microwave and optoelectronic devices by MBE has been described with increasing frequency in the literature over the past seven years. During this time, steady improvement in materials and growth processes has resulted in performance and in fabrication yields that are the equivalent of or that exceed those for similar discrete devices grown by other epitaxial techniques.

Several planar isolation processes unique to MBE have been developed by scientists at Bell Labs and employed in the fabrication of both categories of devices. These techniques, along with selective ion implantation, promise a unique monolithic integration capability.

In addition, MBE's precision has been applied to the development of totally new materials and devices in both the microwave and optoelectronic fields. These studies indicate a great potential for unique and significant commercial applications.

Specific examples of devices fabricated with MBE illustrate the process's important capabilities.

Microwave devices

Varactor diodes with precisely tailored dopant profiles in the diode depletion region have been readily fabricated. The ease and precision with which the dopant profile can be varied with MBE makes production of these devices with a wide range of capacitance versus voltage characteristics straightforward.

Mixer diodes, which require very thin epitaxial layers and extremely abrupt epi-substrate interfaces, are naturals for MBE. Mixers fabricated by MBE by Bellamy and Cho at Bell Labs are already in use in one 18-gigahertz microwave communications system. The lowest noise ever achieved in an 81-GHz resistive mixer was observed

MBE-grown GaAs FETS

Though commercially available metal-semiconductor field-effect transistors made of gallium arsenide have gate lengths of 0.5 to 2 micrometers, improved performance requires shorter gate lengths and thinner channels. A 0.2- μm -gate, low-noise GaAs MES FET was grown at Varian in the molecular-beam epitaxial system shown in Fig. 2 (p. 161). At 8 gigahertz, this device had a gain of 15 decibels and a minimum noise figure of 1.5 dB.

The figure is a schematic cross section of this device. Current flowing in the active channel between source and drain is controlled by the gate bias. The more negative the gate, the greater the channel depletion under the gate and the higher the channel resistance. The 0.9- μm undoped buffer layer, the 1,200-angstrom n-doped ($3.5 \times 10^{17}/\text{cubic centimeter}$) active channel, and the 1,000- \AA n⁺-doped ($2.5 \times 10^{18}/\text{cm}^3$) contact layer were grown by MBE on a chromium-doped GaAs substrate.

Growth of this structure by either liquid- or vapor-phase epitaxy is complicated by the poorer thickness and dopant control and broader interface transitions asso-

ciated with these techniques. Furthermore, increased dopant diffusion from the heavily doped n⁺ layer into the active channel occurs as a result of the higher growth temperatures. The n⁺ contact layer aids formation of low-resistance ohmic source and drain contacts and, by virtue of its relatively high conductivity, allows the source and drain metalization to be placed further from the gate. The latter feature greatly simplifies both the definition and the placement of the channel and the gate.

Although formation of alloyed source and drain contacts is aided by the n⁺ layer, complete elimination of the alloying step is desirable. MBE is unique in making nonalloyed contacts possible. In one process developed at Bell Labs, the n⁺ GaAs contact layer is degenerately doped with tin ($5 \times 10^{19}/\text{cm}^3$), followed by deposition of pure tin at reduced temperature ($T_{\text{sub}} = 150^\circ\text{C}$). In another process at Cornell, the n⁺ contact is degenerately doped with germanium ($3 \times 10^{18}/\text{cm}^3$), followed by epitaxial growth of Ge degenerately doped with arsenic ($1 \times 10^{18}/\text{cm}^3$). Subsequent metalization of both structures yields very low-resistance ohmic contacts without the alloying step. Both these nonalloyed ohmic contacts have been successfully used in power FET fabrication. Similar nonalloyed contacts promise to increase the reliability and decrease the power dissipation of the smaller contact pads required for very large-scale integration.

At Cornell, MBE has been used to tailor the dopant distribution in the channel of power FETs to improve performance. Very linear transfer characteristics have been achieved by exponentially decreasing the dopant concentration away from the buffer layer-active layer interface. In addition to yielding high device linearity, electron mobilities at 77 K in these layers are more than four times those in conventionally doped layers, suggesting that device noise may be significantly reduced in future work.

Growth of lattice-matched buffer layers having a high indirect bandgap, such as $\text{Al}_x\text{Ga}_{1-x}\text{As}$, is straightforward with MBE. The use of such buffers in FET fabrication yields enhanced carrier confinement, more linear I-V curves, and improved output impedance.

MBE's unique ability to deposit epitaxial metal films on complex semiconductor structures with precisely characterized surfaces opens up new fabrication capabilities and the potential for increased performance. Single-crystal FET gates promise lower resistance and more uniform pinch-off voltages (due to the improved uniformity of the zero-bias Schottky depletion potential). This is particularly important in power FETs, which have gate widths of several millimeters.

In certain FET applications—for example, those requiring lower leakage under forward gate bias—replacement of the Schottky gate with a metal-insulator (MIS) structure is desirable. The dielectric layers formed by anodic oxidation or pyrolytic deposition of silicon oxinitride usually exhibit significant dispersion and hysteresis in the transfer characteristics as a result of interfacial states between the active channel and the insulating layer. However, MBE-grown, oxygen-doped $\text{Al}_x\text{Ga}_{1-x}\text{As}$, which is lattice-matched to GaAs, has been shown at Bell Labs to exhibit excellent dielectric properties free of interfacial states and promises to bring MIS technology to GaAs devices.

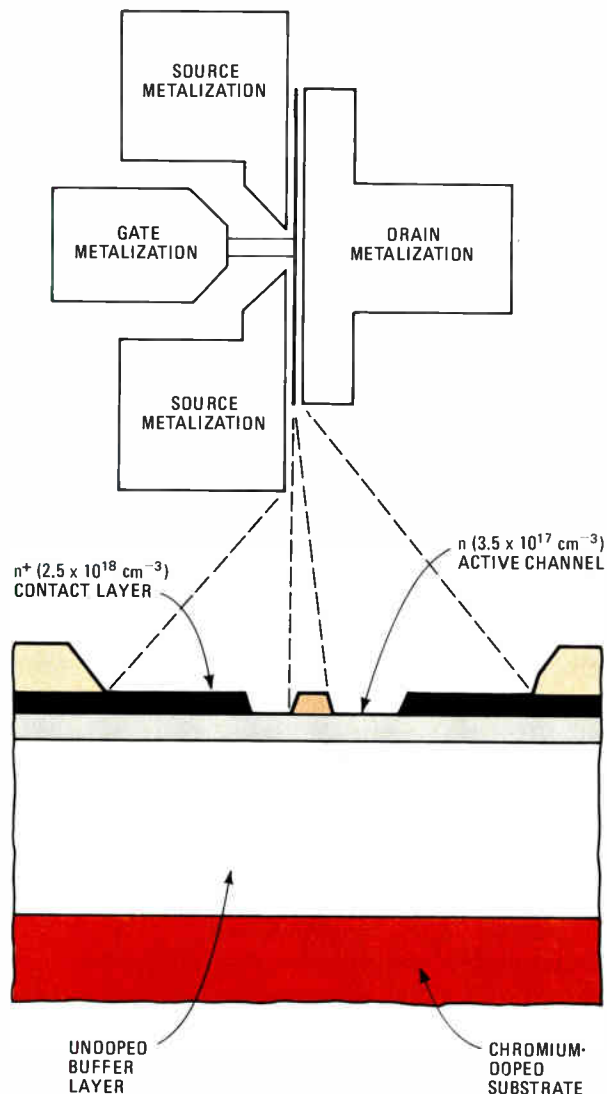

in a cryogenically cooled, MBE-grown mixer at Bell Labs. This device is currently installed in the radio telescope operated by Bell Laboratories in Crawford Hill, N. J. Another MBE-grown mixer has been installed in the radio telescope at the Kitt Peak National Observatory in Tucson, Ariz.

Impatt diodes—the name stands for *impact avalanche transit time*—though inherently noisy, are highly effective converters of dc power into high-frequency microwave power. Their applicability to microwave generation for radar applications makes them important commercial devices. With their numerous dopant homojunctions, Impatts are also natural candidates for MBE fabrication, and X-band devices have been grown by Hierl and Collins of Varian in a system similar to that of Fig. 2 with great success (see “Growing Impatt diodes with MBE,” p. 164).

The demand for low-noise and high-power field-effect transistors corresponds to the enormous growth in the telecommunications market. This market was previously dominated below 8 GHz by silicon bipolar transistors. However, low-noise and power GaAs metal-semiconductor FETs now outperform these devices down to 4 GHz. In fact, GaAs FETs have higher gain and lower noise figures than any other low-noise three-terminal device between 4 and 20 GHz. What's more, the gain advantage of GaAs power FETs increases significantly above 6 GHz, and GaAs power MES FETs now have a good chance of replacing traveling-wave tubes for moderate power requirements at 6 and 8 GHz.

As the demand for higher-performance MES FETs increases, so do the demands for thinner, more uniform epitaxial structures with accurately controlled layer thickness and dopant profiles. These demands can most effectively be met by MBE (see opposite page).

Optoelectronic options

In no other area of electronics do heterostructures play a more pervasive and fundamental role than in optoelectronics. A variety of both passive and active semiconductor electro-optical devices have been fabricated by MBE to advantage.

Of the passive devices, the simplest is the optical waveguide. Since the refractive index of $\text{Al}_x\text{Ga}_{1-x}\text{As}$ is a decreasing function of the number of aluminum atoms, or x , passive waveguides may be constructed by enveloping one appropriately shaped region of $\text{Al}_x\text{Ga}_{1-x}\text{As}$ with another having a larger x . Given its ability to easily grow heterojunctions of widely different chemical composition with extremely smooth interfaces, MBE lends itself to making these devices, and a number of approaches have been successfully demonstrated.

A new approach to optical confinement involving localization of the optical wave field has been demonstrated at Bell Labs using MBE. Waveguide sheaths with periodic variations in the refractive index confined optical radiation to the guide even when the refractive index of the core was lower than that of the surrounding layer.

Light can be injected into and removed from optical waveguides by either active or passive optical couplers. Extremely smooth, gradually tapered optical couplers have been grown by MBE at Bell Labs using shadow

TABLE 3: APPROXIMATE DIE THROUGHPUT FOR DEVICES MADE WITH THE MBE GEN II SYSTEM

Device	Die area (cm ²)	Number of die per 2-in. wafer	Number of wafers per 24 hours	Number of die per 24 hours
Field-effect transistors				
Low-noise	2×10^{-3}	7,500	8	60,000
Power				
5–10 GHz	5×10^{-2}	300	8	2,400
10–15 GHz	5×10^{-3}	3,000	8	24,000
Impatt	2×10^{-3}	7,500	2	15,000
Laser	1.2×10^{-3}	12,500	2	25,000

masks, and coupling efficiencies approaching 100% have been observed. Active electro-optical switching has been demonstrated in a directional coupler switch grown by MBE at the Centre National D'Etudes des Télécommunications (CNET).

The most common light sources for fiber-optic communication are light-emitting diodes and double-heterojunction (DH) lasers. Two different LED structures have been grown by MBE: a gallium arsenide antimonide–gallium arsenide ($\text{GaAs}_{0.9}\text{Sb}_{0.1}$) device with compositional grading to reduce lattice-mismatch problems and a DH lattice-matched $\text{Al}_{0.3}\text{Ga}_{0.7}\text{As}$ –GaAs device. These LEDs were successfully operated with emission wavelengths of 1 and 0.87 μm , respectively.

Although LEDs now available are relatively inexpensive and operate at transmission rates of up to 50 megabits per second, the desire to transmit over long distances at bit rates more than 10 times greater makes laser diodes the preferred choice. These devices exhibit high optical power and rapid response, and their reduced directional divergence permits better coupling with the waveguide. They are, however, complex structures that are extremely difficult to fabricate with present techniques. The difficulties are reflected in their current costs and in their lifetime ratings.

Bell Labs has applied MBE to the growth of laser structures with great success. Its most recent work (by Tsang) in broad-area DH GaAs–(AlGa)As lasers operating at 0.89 μm has demonstrated unprecedented device yield, as well as the lowest reported threshold current. Bell Labs scientists have also demonstrated MBE's capability for growth over distributed feedback gratings, an ability to incorporate taper-coupled waveguides in the laser structure, and the ability to grow lasers with an embedded stripe geometry.

In efforts to depart from the 0.89- μm emission associated with the standard GaAs–(AlGa)As devices, MBE work on different materials has begun. Pulsed room-temperature lasing at an emission wavelength of 1.65 μm has been achieved at Bell Labs in cadmium-diffused, MBE-grown, lattice-matched gallium indium arsenide–indium phosphide ($\text{Ga}_{0.47}\text{In}_{0.53}\text{As}$) structures. The thresholds reported for this device are the lowest yet achieved at this wavelength.

The use of graded buffer layers at Fujitsu has allowed fabrication of non-lattice-matched (GaIn)As–GaAs laser structures that exhibit 77-K lasing at 0.96 μm . Work on (InGa)(AsP)–InP devices is just beginning and should see rapid progress in view of the advantages of

Fabricating laser diodes with MBE

The commercial significance and complex epitaxial structure of laser diodes make them ideal illustrations of the effectiveness of molecular-beam epitaxial fabrication. Figure (a) is a schematic cross section of a typical continuous-wave laser. It is essentially a pn junction formed by two confinement layers, with a thin active layer in the center. The band energies of the confinement and active layers are such that the charge carriers injected under forward bias are trapped in the active region. The higher refractive index of the active layer with respect to the confinement layers forms an optical waveguide that, with the mirror faces, makes up a resonant optical cavity. It is this combination of localized charge and optical radiation in the double-heterojunction active region that is responsible for the structure's ability to lase continuously at or above room temperature.

One factor in the ability of a laser to operate reliably at such temperatures is its threshold current (the forward bias current above which the diode lases). This current, which should be as small as possible, depends strongly on the quality and thickness of the active layer and the number of interfacial states between the active and confinement layers. Theoretical analysis predicts a minimum threshold current for an active layer thickness of approximately 2,000 angstroms. Since the active layer is so thin, achievement of uniform thickness, good homogeneity, and correct pn junction placement is extremely difficult.

The structure shown in (a) has been grown at Bell Labs by molecular-beam epitaxy for active layer thicknesses ranging from 4,000 to 300 Å.

MBE thresholds are noticeably lower than those obtained with LPE, which is currently used in commercial aluminum gallium arsenide laser growth, and equal to the best experimental results recently achieved in MO-CVD research. Perhaps more importantly, device yield across a wafer was nearly 100%—roughly 100 times greater than commonly achieved with LPE.

In order to suppress transverse modes and nonlinearity in the optical power-injection current relationship, lasers are being fabricated in stripe geometries with widths of approximately 5 micrometers. An embedded stripe GaAs-(AlGa)As laser grown by MBE has demonstrated single-transverse-mode lasing at currents up to six times the threshold.

This laser, shown in (b), was fabricated using a planar technique in which a very thin layer of silicon dioxide is deposited on the structure at an intermediate stage of growth. Windows are etched in the silicon dioxide mask external to the MBE system, and the structure is returned to the system and cleaned. Growth in the windows is epitaxial, but on the amorphous SiO₂ it is polycrystalline, with grain sizes of approximately 100 Å. This polycrystalline material is semi-insulating and electrically isolates the single-crystal region.

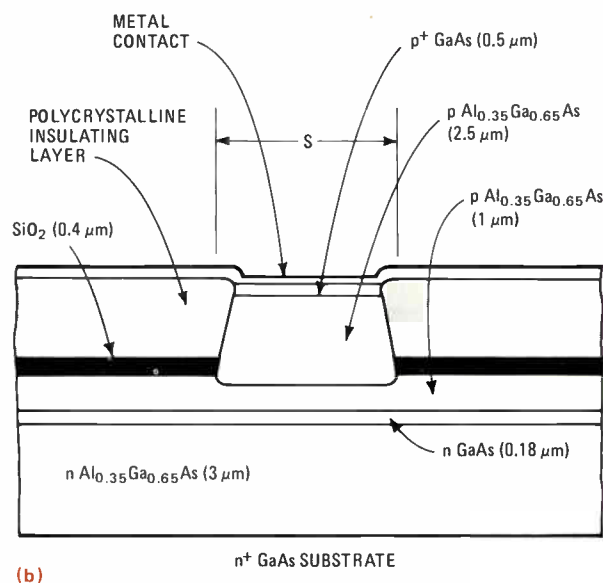
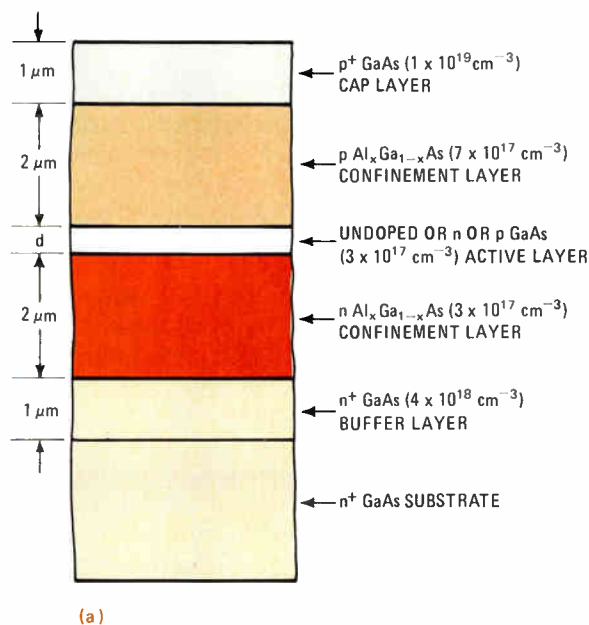

operating at 1.3 μm. The emission wavelength of GaAs-(AlGa)As lasers can be tuned lower by making use of quantum-sized effects that occur in very thin active regions. The ease with which these structures can be reproducibly fabricated makes MBE a promising approach where wavelength flexibility is desirable. (See also "Fabricating laser diodes with MBE.")

One important factor in the consideration of MBE as a technique for the commercial manufacture of sophisticated electronics is device throughput. Table 3 presents

approximate die throughputs for the MBE-GEN II system for each of the device types discussed. The actual device yield depends heavily on processing steps before and after epi growth, as well as on the growth itself. In addition to offering improved performance, the exceptional precision, uniformity, and surface morphology achieved with MBE significantly increases device yield for some complex homojunction structures (like Impatts) and heterojunction structures (like lasers) over other epi techniques. □

300 NANOSECOND VOLTAGE DAC

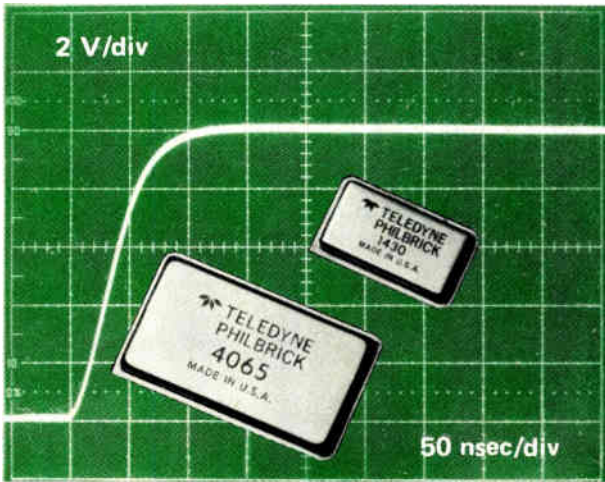

True 12-Bit D To A Conversion

... is achieved by combining our 4065 current DAC and our 1430 fet operational amplifier. The result is a 12-bit hybrid voltage DAC system with a voltage settling of under 300 nsec to 0.01%. In addition, these units offer operation from -55°C to $+125^{\circ}\text{C}$ and the high reliability that is inherent in MIL-STD-883 screening.

For additional information, contact the marketing department at (617) 329-1600



DATA CONVERTERS, V/F/V CONVERTERS, LINEARS, NONLINEARS, POWER SUPPLIES
 Allied Drive at Route 128, Dedham, Massachusetts 02026
 Tel: (617) 329-1600 TWX: (710) 348-6726 Telex: 92-4439

Circle 169 on reader service card

CAMBION IC SOCKETRY.

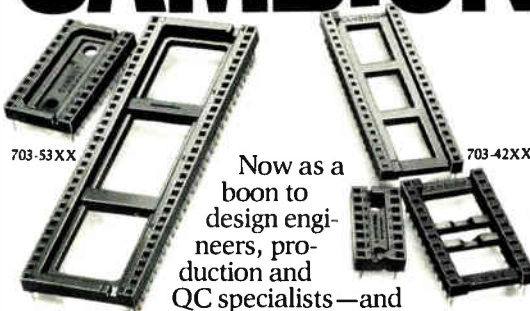

Now as a boon to design engineers, production and QC specialists—and everyone else concerned with loaded PC board performances—Cambion offers TWO great series of LOW PROFILE solder-tab IC sockets: the *new* nylon body 703-53XX Series and the *newest* polyester body 703-42XX Series (UL 94V-0 rated).

Both super-dependable series feature an inverted contact design for excellent lead-in and secure gripping of the flat sides of delicate DIP leads (face-wipe). Both series offer anti-moisture bosses and Kapton® anti-wicking sealing strips. Cambion helps—all across the (PC) board—check out the chart for fast, easy reference, and keep your PO's handy!

CLIP AND SAVE

CAMBION LOW-PROFILE IC SOCKETS

Solder-Tab¹, Electro-Tin Finish², Kapton® seal

Total No. Pins	Centers	Body Length	Series 703-53XX	Series 703-42XX*
			Red Nylon Body	Black Polyester Body
			Cambion Part No.	For Automatic IC Insertion Cambion Part No.
8	.300	.396	703-5308-01-04-12	703-4208-01-04-10
14	.300	.696	703-5314-01-04-12	703-4214-01-04-10
16	.300	.796	703-5316-01-04-12	703-4216-01-04-10
18	.300	.896	703-5318-01-04-12	703-4218-01-04-10
20	.300	.996	—	703-4220-01-04-10
22	.400	1.096	703-5322-01-04-12	703-4222-01-04-10
24	.600	1.196	703-5324-01-04-12	703-4224-01-04-10
28	.600	1.396	703-5328-01-04-12	703-4228-01-04-10
40	.600	1.996	703-5340-01-04-12	703-4240-01-04-10
64	.900	3.196	703-5364-01-04-12	—

Get our new IC Socket Catalog!



¹Mounting Data: Drill no. 67, mtg. hole dia is .032"

²For gold finish, specify -.03 instead of -.04

*Open ended for air circulation and easy access for removal of DIP.

CAMBION
The Right Connection.

Cambridge Thermionic Corporation, 445 Concord Avenue, Cambridge, MA 02238
 Tel: (617) 491-5400, Telex: 92-1480, TWX: (710) 320-6399

Circle 168 on reader service card

NON-TDI NON-MOCA BASED

POLYURETHANE POTTING, ENCAPSULATING
AND CASTING COMPOUNDS

FROM
CONAP

CONATHANE® SYSTEMS combine unique advantages, easier handling and lower costs in urethanes that cure without voids. Series 2500 Systems are offered in a variety of filled and unfilled formulations to meet virtually any requirement for the potting or encapsulating of modules, strain-sensitive components, coils, transformers, and similar devices. The two liquid components of the Conathane Systems mix readily and change to solids with very low exotherm. Working life is excellent and vapor pressure low. Cure is at room or elevated temperatures. And the resulting solid polymers vary from soft elastomers with a Shore A hardness of 70 to tough and rigid plastics.

CHECK THESE OUTSTANDING PROPERTIES

- Non-MOCA* curing systems
- Non-TDI prepolymers — for minimum health hazard to personnel
- Low stress buildup on sensitive embedded components
- Superior thermal shock resistance
- Excellent dielectric properties
- Reversion resistance
- Low water absorption
- Low shrinkage
- Excellent hydrolytic stability
- Dimensional and heat stability.

FOR FLAME RESISTANCE choose the Conathane EN-2540 Series, a new family of filled polyurethane resins specially formulated for general purpose electrical/electronic potting, casting and encapsulating. Provides flame resistance ratings of 94V-0 when tested in accordance with UL-94. Because of fast gelation and cure at low temperatures, is ideal for high volume production.

GET MORE FACTS. Write for Selector Bulletin P-133 on Conathane 2500 Series, or Bulletin P-137 on flame resistant Conathane EN-2540 Series.

* DuPont Trademark

CONAP

CONAP, INC. / OLEAN, N. Y. 14760 / 716-372-9650

Floppy-disk controller adapts to data format and drive

Firmware tailors Z80-based design to a variety of disk drives and computer types

by Bill Morgan and Steve Loring, *Advanced Electronics Design Inc., Sunnyvale, Calif.*

□ Double-density floppy-disk drives can obviously provide designers of small systems with twice the storage of regular drives. But it has been hard to choose controllers for them because their encoding formats differ from the widely used single-density IBM format and there is no common double-density format.

The Flex family of floppy-disk controllers simplifies that choice by means of its microprocessor-based design and software that automatically adapts to the type of drive and type of encoding being used. The new family attaches any floppy-disk drive to a number of computers, eliminating the need for duplicate controllers—and their extra cost—for each type of drive and format encountered by the system.

The first model of the new family, the FLEX02, can attach floppy-disk drives using either a single-density format or the Digital Equipment Corp. type of double-density format to DEC's LSI-11 microcomputer. All that is needed to handle other types of formats or computers is additional firmware that is now being developed—the hardware is essentially the same.

This use of firmware not only allows the systems designer and user the flexibility of changing formats in

the future without redesigning the controller but also ensures that data or software already on floppy disks—whether single- or double-density—does not have to be reformatted to run on the new system. Furthermore, the microprocessor-based design reduces the chip count from the typical 160 to just 50, so that the unit fits onto a single 5-by-8-inch printed-circuit card that will plug directly into the card cage of many microcomputers (Fig. 1).

The right questions to ask

Underlying all these features is the use of the microprocessor. It makes the controller's input/output registers general-purpose, so they can be customized with program logic to suit any application. This approach allows redesign without hardware modification and also improves performance over that of some standard hard-wired controllers.

The microprocessor chosen to implement this design must be able to carry out a fairly complex algorithm for flexible interfacing of the disk drive or drives to the central processing unit. First, it has to interrogate the drive to determine if it is a single- or dual-head drive

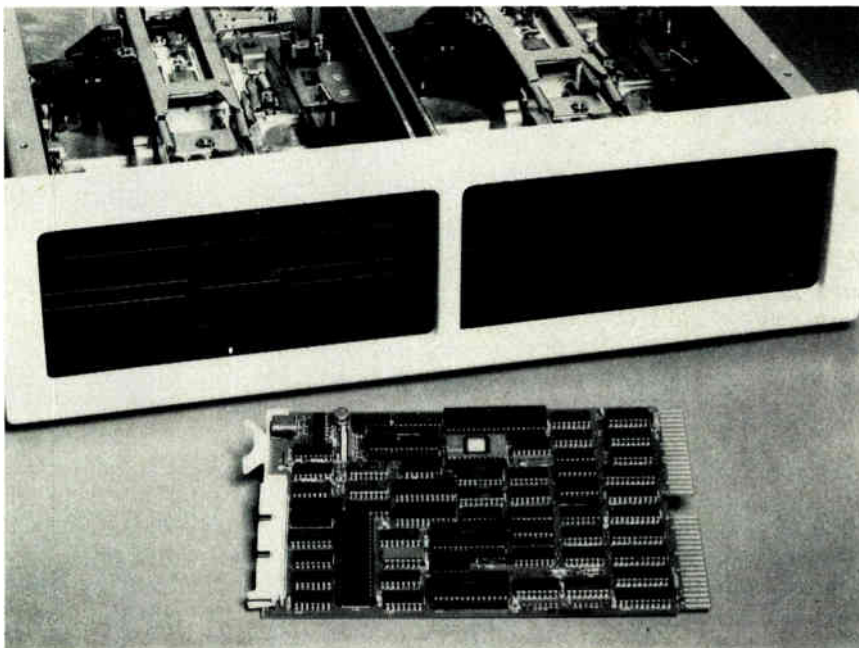

1. First Flex. Z80-based design of Flex family of floppy-disk controller fits on a single 5-by-8-in. printed-circuit card that can be plugged into the card cage of a microcomputer. The initial offering, FLEX02, is designed for the Digital Equipment Corp. LSI-11 backplane (Q-bus).

HOW FLOPPY-DISK CONTROLLERS COMPARE				
Features	Micro-processor (Z 80)-based	Bit-slice processor (2901)-based	Controller chip (Western Digital 1791)	TTL-based
Programmability of disk recording format	yes	yes	no (dedicated to IBM only)	no
Instruction set	high-level	microcode	small dedicated set	none
Bootstrap provisions	yes	no	no	—
Self-check testing	yes	limited	no	no
Speed (average instruction execution time)	1.75 μ s	200 ns	not applicable	as fast as needed
Space required (% of board)	20%	50%	20%	100%
Amount of programmable read-only memory required (bit width)	one 8-bit-wide chip	four to six 8-bit-wide chips	not applicable	not applicable
Cost of processor integrated circuit (in 100s)	\$8	\$18	\$30	—

unit. Then it has to analyze the byte pattern being read from the disk in order to recognize the type of medium—either the single-density format or one of three double-density formats. For writing, the user should also have the option of recording in one of several formats.

Recognizing media

The algorithm the Flex controllers use for media identification employs a guessing technique to identify what the format is before reading it. The controller sets its hardware into one format and attempts to read a sector. If unsuccessful, it tries a succession of formats until it accomplishes a valid read operation. The scheme works because the cyclic redundancy data check word is used to verify whether the data read is correct. This approach enables the controller to read almost any diskette because it does not depend on disk-encoding conventions for identification of the format.

In addition to identifying the format used on the media, the controller must also identify the salient operating features of the disk drive. For instance, a major difference between drives is the stepping rate used to position the read/write head, which the controller determines once again by interrogating the drive. This does away with the need for hardware jumpers.

Moreover, for the logic compression necessary to emulate various computer interfaces and to recognize and decode a number of recording formats, a software approach was clearly the way to go. But a major design concern was determining which of the competing semiconductor technologies would be the best tradeoff.

Which architecture?

The various features desirable in the semiconductor device are summarized in the table. Obviously of primary concern is the programmability of the disk recording format, with cost, size of the device, and its self-checking capabilities following close behind.

Because of its nonprogrammable nature, dedicated TTL was immediately ruled out. Similarly, the Western Digital floppy-disk controller chip was eliminated because it implements the IBM diskette format only. That made the choice a tradeoff between the Z80 single-chip microprocessor and the 2901 bit-slice microprocessor.

The device's speed is dictated by the fact that serial data must be read from or written into the disk at a rate of 2 microseconds per bit. In addition, each bit must be encoded or decoded into a clock-data sequence, where clock pulses or data bits occur at the rate of 1 b/ μ s. Also, the computer's direct-memory-access cycles must be serviced during a 10-to-16- μ s interval per 16-bit word, and host bus timing and control signals are sequenced at a clock rate of from 100 to 200 nanoseconds per sequence step. The drive signals themselves, such as head load or step, are handled at a lower speed, with increments of from 3 to 20 milliseconds.

From the point of view of speed, bit-slice technology has the advantage. Because it is five times faster than the microprocessor approach, it can handle more of these speed requirements directly. The Z80 microprocessor's clock rate of 4 megahertz and instruction rate of about 1 MHz are sufficient for parallel byte transfers and low-speed drive signals. The Z80 does fall short of the requirements for serial data handling and control strobe generation, though a small amount of dedicated logic could take care of these signals. And although the algorithm used to recognize the correct format requires about two disk revolutions to execute in this slower microprocessor, this takes only from 25 to 330 ms—an insignificant time interval.

But when it comes to instruction sets, the scales tip in favor of the microprocessor, which requires just 2 bytes of storage per instruction compared with the 4 to 6 bytes per instruction needed by the bit-slice processor. The microprocessor has a higher-level instruction set that it decodes, whereas bit-slice instructions go directly to particular control points. Furthermore, this higher-level instruction set is byte-wide and can therefore better execute the complex tasks required of the guessing algorithm and format software. Because the bit-slice processor's instructions are less efficient, it ultimately requires two to eight times more circuit board space for program read-only memory chips.

What's more, bit-slice processor chips require the support of numerous peripheral chips, which further consume valuable circuit-board real estate.

The Z80 is the best tradeoff

These competing semiconductor technologies also differ in self-diagnostic capabilities. A microprocessor is excellent in this area because it can check itself, the instruction memory, and random-access memory, as well as the input/output registers. Self-check testing is limited in the bit-slice approach, because even though the processor is well oriented toward execution, the instruction bits are not subject to arithmetic manipulation.

Figure 2 is a diagram of the Flex Z80-based controller with the functions grouped into blocks as they would be in a conventional controller. At the top of the diagram,

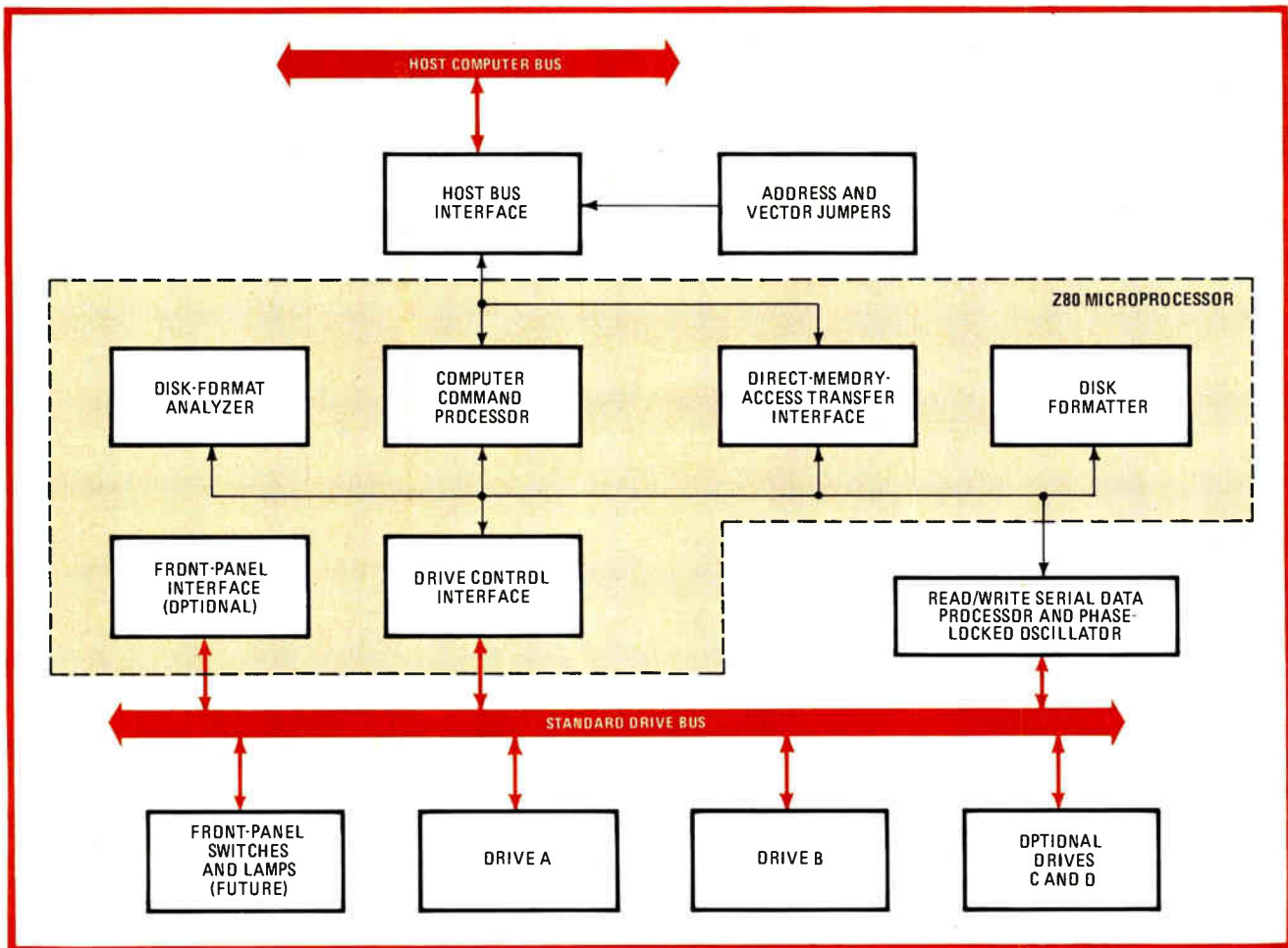

2. Microcode does it. Controller links to the 16-bit bidirectional, parallel host computer bus at one end. At the other, the disk-drive bus connects to up to four floppy-disk drives. Z80 microprocessor executes all of the standard controller functions (shaded blocks).

the controller connects to the host computer's 16-bit bidirectional, parallel bus. At the bottom, a standard (Shugart Associates-type) disk-drive bus connects as many as four floppy-disk drives through multiplexed control lines and the data line. In the future a front-panel interface and front-panel switches and lamps will be available and will multiplex to the drive bus in the same way as a disk drive.

Unlike a standard controller that uses discrete segments of hardwired logic to implement each function, the Z80 microprocessor executes all functions (indicated on the diagram within the dotted line) using firmware stored in on-board read-only memories. These functions include computer-command processor, drive-control interface, disk-format analysis, disk formatter, DMA-transfer interface, and the optional front-panel interface.

Because of the speed limitations of the Z80 microprocessor discussed previously, the host bus interface, the read/write serial data sequencer, and the phase-locked oscillator are implemented in bipolar hardware.

The host bus interface handles the control strobes and the register array, which holds commands from the host processor. When the central processing unit issues a command to the disk controller, the interface detects and decodes the command and feeds it to the Z80. The Z80 program contains the definition of the register com-

mands. The read/write serial data sequencer handles high-speed, serial data transfers to and from the disks while the phase-locked oscillator synchronizes the CPU with this data from the disk. Both of these speed-oriented functions are under the control of the programmable-logic-array (PLA) sequencers clocked at 8 MHz. Although discrete sequential logic could have been used, PLA sequencers reduce chip count.

Z80-executed blocks

From a hardware standpoint, the models making up the Flex family of floppy-disk controllers will be very nearly identical. The differences will be in the firmware stored in ROM that instructs the controller to emulate a specific vendor's computer interface and to identify, read, and write in selected disk media formats. This firmware is executed by the Z80 microprocessor. For instance, the processor firmware directs the Z80 to read 16-bit command data from the bus sequencer's interface register array, translate it, execute it and then write 16-bit status data into the interface register array. At completion it generates a host CPU interrupt.

Under the control of the computer command processor, the drive-control-interface firmware makes the Z80 access the individual floppy-disk drives over the multiplexed bus channels and handle the low-speed control

signals such as head load, drive select, and step. Whenever a disk with a different format is inserted, the computer command processor also initiates operation of the disk-format-analysis firmware, which sequences through the floppy-disk formats it has been programmed for while attempting to read the message. Once the identification is made, the DMA transfer interface firmware sets up the DMA control registers, then transfers data between the disk and an intermediate buffer in the Z80 memory or directly to the host's memory.

Also under control of the computer command processor, the disk-formatter firmware formats a blank diskette into sectors and encodes the appropriate sector headers and clock patterns. With the present Flex models, the user can specify either single- or double-density formats in the DEC RX02. Later models will offer an expanded selection of formats through the addition of extra firmware.

Serial data processor

The read/write serial data processor is a program logic sequencer consisting of a PLA plus a 256-by-8-bit programmable ROM. During the read mode, it controls the phase-locked oscillator and the PLA to synchronize the reading of data with the clock pulses recorded along with the data on the disk. The PLA locks to the clock pattern encoded on the accessed disk and separates the incoming data from clock signals. The serial data processor then assembles the data into byte format in a shift register and sets the data-received flag to let the Z80 know that information is available. Serial information arrives from the accessed disk at the rate of 1 bit every 2 μ s, a higher speed than the MOS circuitry of the Z80 could otherwise handle. However, since the serial data processor requires 16 μ s to assemble the 8 bits of data, the Z80 has sufficient time to read and transfer it. The read data rate can vary $\pm 2\%$ because of speed variations in the induction motors used in most floppy-disk drives.

During the write mode, the serial data processor receives parallel bytes from the Z80 for encoding on the accessed disk. Upon receipt of each byte, it sets the data-empty flag and encodes the information into a serial format adding clock pulses from the board's crystal-controlled clock.

Host interface

The sequencer used in the Flex controller for the host computer bus interface performs speed-oriented functions beyond the capabilities of the Z80 microprocessor.

One of the primary functions of the bus interface is to generate input/output bus control strobes to acknowledge CPU signals and generate timing strobes when the controller acts as bus master during DMA cycles. High speed is essential for this function to avoid slowing down the host CPU's bus.

Another critical function of the bus interface is to synchronize the host CPU and the controller's Z80 processor. A major problem in interfacing any two independent processors is preventing "deadly embrace" situations, where both processors attempt to access a common register simultaneously. Thus the bus interface controls the Z80 ready functions and, for an asynchronous host

CPU bus, also controls bus-cycle acknowledgment, to prevent any cycle contention.

In addition, a section of the bus interface directly supports the Z80 during DMA transfers. The Z80 is only responsible for depositing 2 bytes of data and 1 byte of address into the interface register array. Every time the Z80 passes an even byte address to the bus sequencer, a DMA cycle is initiated. The bus sequencer performs the rest of the DMA cycle so the programmer can use the Z80's block move instruction to do DMA. In a DMA write, for example, the source operand address points to a RAM buffer, the upper bits of the destination operand address point to the bus interface array, and the lower bits of the destination address contain the actual memory address in the host memory. Thus by using the block move instruction it is possible to increment the buffer address and the host memory address and decrement the transfer word count automatically.

Furthermore, certain high-level functions can be performed by the bus-interface sequencer. Consider, for instance, the command GO function. This function is usually signaled when the host CPU loads a command into a particular programmed input/output (PIO) register. The bus sequencer resets the interface-ready status bit, plus any error bits, and signals to the Z80 that a command is ready for execution. Resetting the ready bit in the sequencer allows the host processor to interrogate the controller immediately to determine if it is busy.

A further function of the bus sequencer is to convert 16-bit host CPU bus data into the 8-bit data required by the Z80.

Data-flow diagram

An examination of how data is moved from the disk to the CPU through the Flex controller using its intermediate sector buffer shows how these functional blocks operate together.

In a full/empty buffer operation (Fig. 3a), transferring data between the buffer in the Z80's main memory and the host CPU's memory, the microprocessor puts out addresses to the bus interface sequencer, which, in turn, sends them out to the computer bus. It also puts out addresses to its memory for its internal data buffer and transfers data from there out to the serial sequencer, posting a request.

In read or write between disk and buffer (Fig. 3b), data is read from the accessed disk into the buffer memory. Once again this operation deals with the microprocessor, the serial sequencer, and the microprocessor's memory. The microprocessor reads the data from the serial sequencer in byte format, stores it in the Z80's memory, and indexes through memory for the entire sector. For writing, it does the opposite.

The Z80 can thus be used to speed up the transfer. It makes possible a block move of data from one address in memory to another—in this case, one address is in the Z80's memory and the other address is in the host CPU's memory. When the bus sequencer detects even bytes, it sets up the DMA request, and while waiting for the request to be serviced it will put the microprocessor in a wait state to free it from having to test continually for ready status. In contrast, in the interface between the

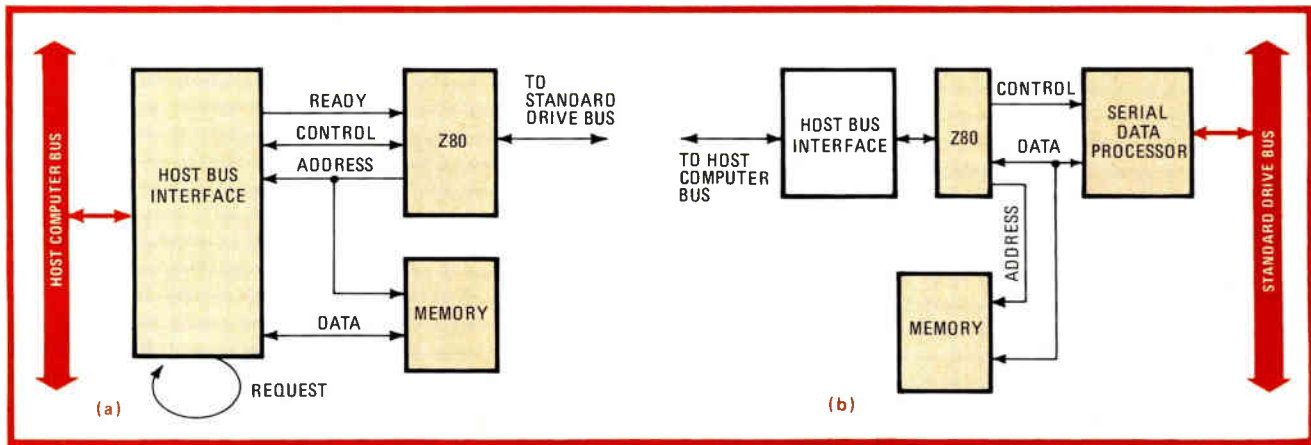

3. Moving data. To transfer data in full/empty buffer operation (a), the microprocessor puts out addresses to the bus interface sequencer, which, in turn, sends them out to the computer bus. In read or write between disk and buffer (b), the microprocessor reads data from the serial sequencer in byte format, stores it in the Z80's memory, and indexes through memory for the entire sector.

disk and buffer, the Z80 is operating asynchronously with the read data and must wait for the data-ready status bit to be set before reading a byte.

In a read or write operation between the disk and CPU memory, it is best if disk data is transferred directly into the computer memory, bypassing the internal memory—a function to be developed in the near future for Flex products. Here the microprocessor tests the serial sequencer to see if there is a byte available. If so, it transfers it directly to the bus sequencer and puts out an address to the bus sequencer that is used to address the computer memory. It reads 2 bytes, transferring a byte at a time to the bus sequencer, with the DMA transfer started on every other byte.

As previously discussed, one significant advantage of the Z80 microprocessor is its self-testing capabilities.

These internal diagnostics are run at power-up time, or whenever the CPU requests it, although the host CPU can run more extensive data-verification diagnostics by using the host computer interface. Essentially, the internal diagnostics consist of a ROM check-sum test, a RAM test, and an interface register test to check the bits in the interface registers. Also a drive-bus access test can be performed to verify proper operation of the various signals and ensure that they can successfully access a drive.

The first member of the Flex family is the -02 model, which includes firmware to emulate DEC's RX02 controller and plugs directly into any LSI-11, 11/2, or 11/23 CPU card cage. It runs the DEC RX02 diagnostics, includes an on-board self-test as well as a built-in 512-byte bootstrap and uses all DEC-provided software without modification. The unit reads and writes in both single and double density using the DEC RX01 and RX02 formats, respectively.

Controllers—past and present

Like other peripheral controllers, floppy-disk controllers are designed to link the drives to the CPU. Once the CPU issues the command, the controller handles the rest. It accesses one of the several drives connected to the drive bus, governs the mechanical operation of head positioning, monitors the identification byte patterns to recognize the desired sector, and transfers data back and

forth between CPU memory and disk.

Of course, disk command protocol varies widely from computer to computer. The DEC interface, to take an example, is a low-cost hardware design employing a two-step read sequence. In the first step, it transfers data from disk to controller. In the second, it transfers data from the controller to the CPU memory. In contrast, the Advanced Electronics Design protocol uses a single-pass read in which the controller transfers data directly from the disk to the CPU memory. By the time the disk revolves past the end of the accessed sector, the data is in the memory.

More complex design

The introduction of double-density encoding brings another level of complexity to the controller design. Since single-density is incompatible with double-density encoding and the various double-density schemes are mutually exclusive, the role of the floppy-disk controller is not only to interpret nonstandard CPU bus protocols, but also to decode a variety of media formats.

The first and most obvious solution was to design controllers uniquely dedicated to a particular CPU and a particular media format. Although this approach is feasible and fills the requirements of many users, it is uneconomical when a user must support a number of different formats.

Another solution for a number of vendors is to build a controller that can recognize and read several media formats. That technique adds a header to the disk file, in single density, indicating that the data to follow is double-density. The multimedia controller always commences to read the disk in single density. If it picks up a byte telling it the encoding is double-density, it then reads and writes on the diskette in double density.

Although such a multimedia controller fills some users' requirements, this somewhat simplistic approach falls short of universality. Regardless of its ability to read any single-density encoding and one variety of double-density, other double-density formats remain incomprehensible, with neither identifying byte nor comparable formatting. A completely programmable design like that described here solves the problem. □

Hall-effect tachometer senses speed, direction of rotation

by Antonio L. Equizabal
Vancouver, British Columbia, Canada

Two Hall-effect sensors placed 90° apart and at an equal distance from the center of a rotating magnet-wheel assembly form the basis for this simple but reliable tachometer. As an added bonus, owing to the circuit's physical configuration, the direction of the rotating wheel can be detected as well.

As shown in the figure, small magnets are radially arranged on the wheel in an alternating north-to-south, south-to-north fashion. When the wheel rotates, each magnet periodically turns Hall sensors H_i and H_q either on or off magnetically, depending on the magnet's instantaneous orientation, thus generating output signals from the sensors that are in quadrature. The leading or lagging relationship of the H_i signal to the H_q signal, as

detected by the 4013 flip-flop (working as a phase comparator), will indicate the wheel's direction of rotation. The frequency of the H_q signal (or for that matter, the H_i output) is directly related to the angular speed of the wheel and may be used to drive counters or frequency-to-voltage converters for linear servoamplifiers.

As for the constructional details, this tachometer's rotating magnet assembly is built using small cylindrical Alnico magnets, 3/16 inch in diameter by 1 in. long, glued into a machined polyvinyl chloride wheel with epoxy. The spacing (air gap) between the assembly and the Hall sensors will vary with the magnets' residual induction, and some tweaking is necessary. For GE519-1 magnets, a gap of 1/16 to 1/8 in. is satisfactory for the Texas Instrument's TL170C sensors used, which require a minimum of 350 gauss to change state.

The output frequency that is generated will be directly proportional to the number of magnets used. To ensure optimum tracking, however, their placement should meet the criterion that when one magnet is directly opposite sensor H_i , H_q should be midway between two other magnets of alternate polarity. Under that condition, the output frequency will be $f = NT/120$ hertz, where N is

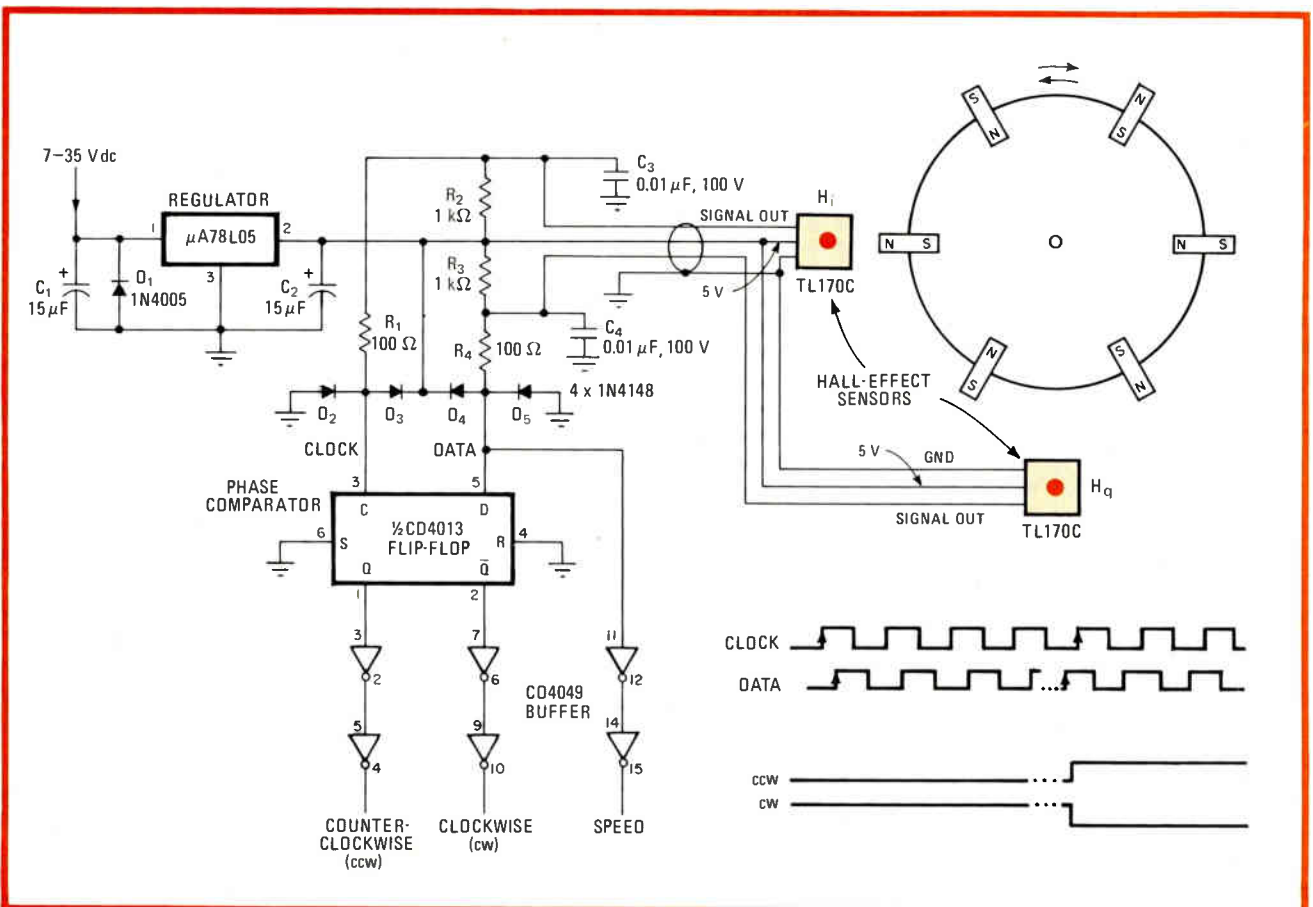

Fleet flux. Hall sensors, placed 90° apart, find wheel's angular speed by detecting instantaneous changes in field strength caused by rotating-magnet assembly. Output frequency produced by sensors is directly proportional to the number of magnets used. Leading and lagging relationship of sensors' quadrature output is also utilized to determine the direction of the rotating wheel.

the number of magnets used, and T is the wheel speed in revolutions per minute. Thus, N will equal 6, 10, 14, . . . for magnets symmetrically arranged at angles of 60°, 36°, 25.7°, . . . respectively.

The Hall sensors are biased from a regulated 5-volt source for optimum performance. Input diode D₁ pro-

tecs the circuit from any input-polarity reversal. The 1-kilohm load resistors bias the open-collector output of the sensors; with C₃ and C₄, they form an rf filter. Diodes D₂ through D₅ protect the input of the D flip-flop from inductive spikes. Noise reduction is ensured by the use of a shielded three-conductor cable. □

Treating the three-state bus as a transmission line

by William A. Palm
Magnetic Peripherals Inc., Minneapolis, Minn.

Though the input/output bus of today's typical small computer system would seem the ideal transmission link for passing data between the system's peripheral three-state TTL devices, difficulties may arise because the length of the bus is an appreciable fraction of the wavelength of the signal being propagated. The resulting loss of data caused by reflections along the bus can be virtually eliminated, however, by simply applying transmission-line matching techniques to the bus, by selecting the proper line drivers, and also by observing design practices that will spare the drivers from damage caused by line transients.

A first obvious option is to use an unterminated line. Pulse distortion from reflections, however, can be severe, depending on the line's length and the data rate. Lines which are a quarter wavelength long or odd multiples thereof at the frequency of interest will cause the worst reflections, and precautions should be made to avoid those lengths. In the typical case there will be ringing on the line and the line receiver will generate data errors.

If the data rate is relatively slow, the errors caused by ringing can be disregarded by sampling the data lines after the line transients have died out. The delay time required before looking at the lines is $t_d = 2L_t$ nanosec-

onds, where L is the line length in feet and t_p is the propagation time per foot.

Terminating a transmission line in its characteristic impedance is fundamental to the theory of transferring power efficiently and without line reflections, however. The figure illustrates a suggested technique of joining several daisy-chained TTL peripherals to a 100- to 300-ohm twisted-pair line. In practice, the line might be flat cable, which enjoys widespread use because of the physical ease with which it is connected to the circuitry.

Single-ended termination has its advantages, too, as in cases where enable or strobe lines are utilized. This method affords elimination of reflections with minimal power consumption. Termination is made as near to the output of the transmitter as possible, since the line receivers are often scattered at various positions along the line. Given proper termination, the system's limiting range factor then becomes the transmitter itself.

As for the hardware, several good bus transmitters and transceivers are available. Among them are the AMD8304, which offers an attractive solution to three-state buses of 20 ft or less in length. The 20-pin transceiver can sink 48 milliamperes and can handle flat cables having an impedance of more than 100 ohms satisfactorily. Used with a terminated 100-ohm cable it will have a saturation voltage of only about 0.4 volts dc at 55 milliamperes. Using higher terminating-resistance values will not appreciably change the saturation voltage, making it an excellent choice for a driver.

Another chip that meets the same line-driving requirements as the AMD8304 is the MC3482/6882. This useful device has latches and is available in inverting or noninverting versions but, unlike the more versatile

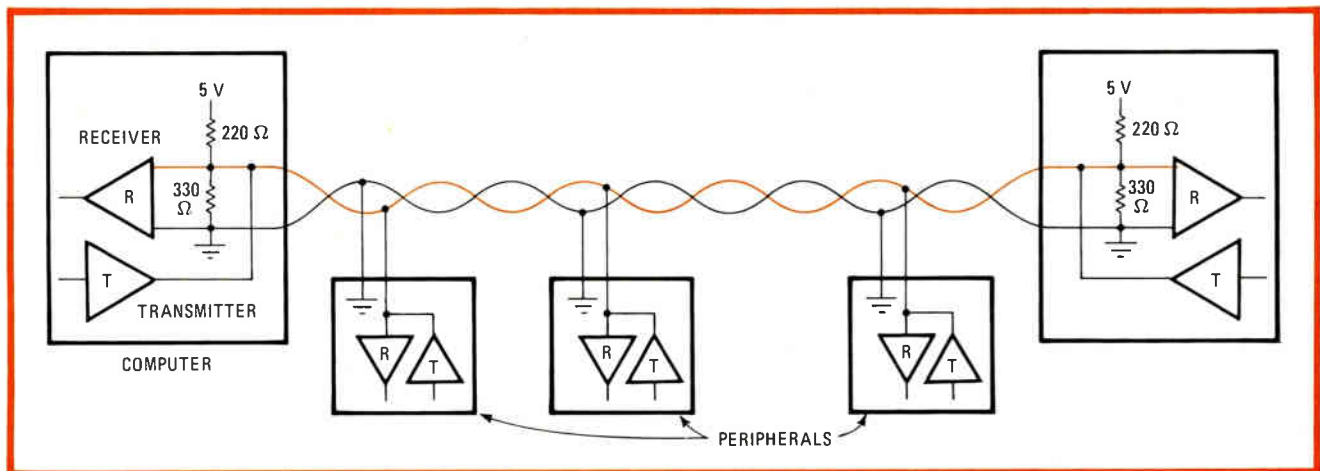

Termination. Ringing at receiver end of typical input/output bus will often leave inadequate 0-1 switching margin. Either singly or doubly terminated bus will reduce reflections. Line transceivers must be selected with care to handle driving requirements satisfactorily. Power sources associated with computer and peripherals should be connected to same line to reduce common-mode voltages on I/O bus.



SAMTEC "SUDDEN SERVICE" as it appears* to our customers

* Actual retouched photo

Of course this is a considerable exaggeration of SAMTEC's service facilities. But, even though our air fleet is strictly imagination, our devotion to "old fashioned" trouble-free service keeps customers coming back for more. The reason? SAMTEC cares about your order as much as you do. Catalogs, samples, quotations go out the same day we get them. Your order is usually on its way to you within 36 hours after we receive it. And trained expeditors follow-thru so that you know how the shipment went out and when to expect delivery.

Call or write today for our new catalogs—
 complete with all specs and ordering data.

Get SAMTEC's "old fashioned service" with your next order.

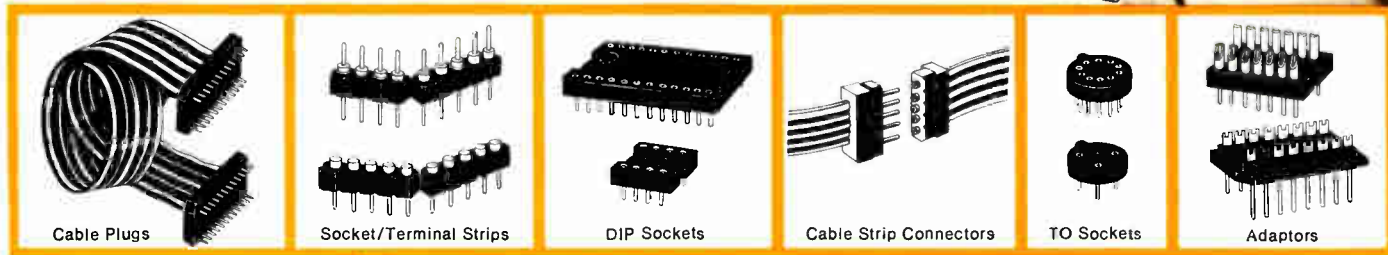

© 1980, Samtec, Inc.

samtec

ELECTRONIC HARDWARE

810 PROGRESS BOULEVARD, NEW ALBANY, INDIANA 47150

(812) 944-6733

Circle 178 on reader service card

AMD8304, is an eight-line transmitter.

The 74LS373 octal transmitter, complete with three-state latches, is another good choice. This device sinks only 24 mA so that terminating a line at both ends is not possible (though this is seldom a problem). The 75450 family of dual-peripheral drivers is useful for those applications that require a terminator at each end of the line. The 74LS245 transceiver is also excellent.

As for circuit details, there is one important point. Specifically, all 60-cycle power cords associated with the

computer and its peripherals must be plugged into the same power-line bus. This arrangement will eliminate any possibility that common-mode voltages between the chassis of different units will appear on the line drivers or receivers. Often, these units have very limited common-mode range. In fact, negative transients that drop below -0.7 V can damage a chip permanently. Also, because all transceivers on a given chip are on a common substrate, a negative transient on any line will cause the other transceivers to change state. □

Probing chip nodes with minimum disturbance

by Anthony M. Marques

The Charles Stark Draper Laboratory Inc., Cambridge, Mass.

Failure analysis of integrated circuits often requires the determination of voltages at internal nodes located on the silicon die. Making these measurements is difficult, however, because many circuit points will be sensitive to straightforward chip probing. The problems may be overcome, however, using two simple techniques.

Generally, internal node voltages can be measured with the aid of a probe consisting of a fine (0.15 mm in diameter), short, sharpened wire, a digital voltmeter, and a microscope to place the probe as desired. Typically, the capacitance of an isolated probe will be 10 pF, and the impedance of the combination probe and voltmeter facing any node will be 10 M Ω shunted by 100 pF.

When the probe is applied to certain points of especially sensitive circuits such as flip-flops and operational amplifiers, however, the node in question may be overloaded so that, in the case of the flip-flop, a state change may occur; or the output of an op amp may be set into oscillation. Just placing a probe near a sensitive point is often enough to upset the circuit.

One recognized but not widely used way to circumvent the difficulty is to place a precision voltage follower between the probe and the voltmeter, as shown in (a), in order to decrease the input capacitance presented to the node. In this circuit, it can be reduced to 30 pF or so. One drawback to this method, however, is that the open-circuit voltage on the probe will be a minimum of 4.6 volts, and this fixed potential may of itself upset the circuit under test.

The trial-and-error method shown in (b) avoids the problem. In this approach, a variable potential is externally applied to the probe in order to minimize the charge that flows into it when contact to the node is made. In simple terms, $\Delta V = Q/C$, where ΔV is the voltage difference between probe and node, and C is the capacitance of the probe/voltmeter system. Because C is fixed, charge, Q , can be minimized only by reducing ΔV , which is controlled by the external voltage source.

In use, the probe's applied voltage is varied until the probed circuit node does not change state (in the case of

flip-flops) when the external potential is removed. As read by the digital voltmeter, little or no change in potential will be indicated. In the case of op amps, means must be found to check for oscillation during the measurement. Assuming no oscillation exists, the voltage at the node will be as indicated by the meter, once the external potential has been removed. Note that because the voltage difference between the source and node is in most cases less than the difference between the node and ground, less current will flow in establishing an equipotential condition.

With practice, node voltages can be successfully measured after two or three tries. It will be found that the external reference voltage will have to be brought to within about 0.5 volt of the potential at the node to be measured to prevent oscillation or a change of state at that node. This method is also useful in measuring ac node voltages, which requires node-synchronous ac signals. □

Engineer's notebook is a regular feature in *Electronics*. We invite readers to submit original design shortcuts, calculation aids, measurement and test techniques, and other ideas for saving engineering time or cost. We'll pay \$50 for each item published.

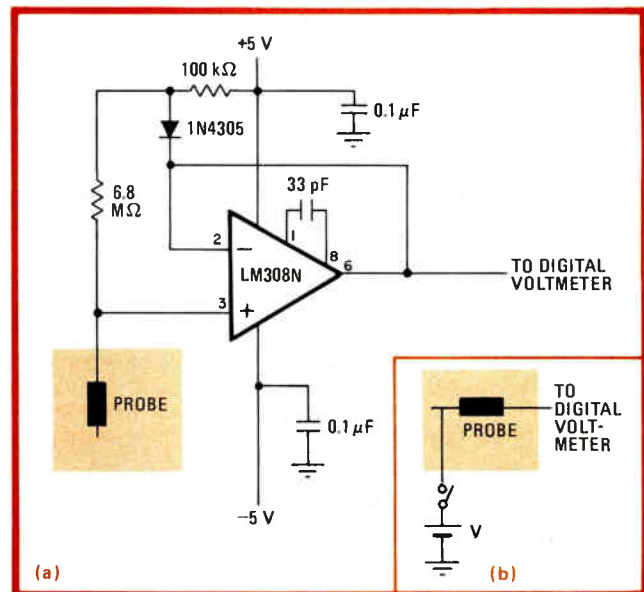

Balanced charges. High-impedance, precision voltage follower (a) reduces shunt capacitance across probed internal nodes of IC, despite inherent offset voltage (across probe) that may upset the circuit point under test. Applying external variable voltage to equalize probe and node potentials (b) solves problem by minimizing flow of charge into probe and permitting accurate voltage measurements.

Program designs active filters

Active-circuit filters, though the preferred approach in the audio and subaudio frequency range, are actively disliked by most designers because of the tedious mathematical manipulations they require. But now Yu Jen Wong of 2251 West Kendra Place, Tuscon, Ariz. 85704, has come to everyone's rescue.

His Fortran IV program enables a designer to come up with a complex high-order active filter with relative ease, for it **prints out a circuit diagram complete with all component values** when it is given a set of filter specifications as inputs. Among other things, a designer may specify Butterworth, Bessel, Chebyshev, or elliptic (Cauer) characteristics for a filter and may have the program perform a sensitivity analysis at frequencies he chooses. The software can be either used to do a specific design at Wong's facility or bought outright. Programs for low-pass, high-pass, bandpass, and band-reject filters are sold separately. Call Wong at (602) 297-4631 for information about the different filter types available and also about sensitivity analyses.

Kit encryptor plugs into home computers

Do you have a personal computer and not want anybody else to see what you are doing? Then encrypt your data—you need only an RS-232-C port and either \$395 if you like to put kits together or \$495 if you prefer to plug things in. The Cryptographic Primer Kit comes assembled or unassembled from Western Digital Corp. at 3128 Red Hill Ave., Newport Beach, Calif. 92663. **Each version of the 300-b/s unit is furnished with an assembly and wiring manual**, as well as a primer on how to do the job.

How to predict when a board won't fly

The ubiquitous printed-circuit board isn't always safe for an intended use. So before disaster strikes, why not check the situation out by getting hold of Underwriters Laboratories Inc.'s **fifth edition of its "Standard for Safety for Printed-Circuit Board"**?

UL-796, which also happens to be an American National Standard, may be obtained from the labs' Publication Stock department at 33 Pfingsten Rd., Northbrook, Ill. 60062. A copy sells for \$3.75, or \$9.00 if you want revisions as they are issued. Call UL at (312) 272-8800 for further information.

Telecommunications— what it costs and how it's done in the UK

Engineers and managers in the international telecommunications community who are involved with the UK, whether as exporters or otherwise, will want a copy of "Telecommunications in Great Britain—a Communications Manager's Guide." In particular, the 92-page book features **a guide to and discussion of the impact there of International Business Machines Corp.'s 750 and larger 375 private branch exchanges.** (Neither of the models has yet been introduced in the U. S., but they are expected to have a great impact on IBM's market position once the company announces them here.)

The book also gives technical and cost details of the UK's various phone, data, and video services, most of which are in the charge of the British Post Office. Price is \$95 from the Telecom Library at 205 West 19th St., New York, N. Y. 10011, or call (212) 691-8215.

-Harvey T. Hindin

Fluke Portable Test Instruments

“What if we...”

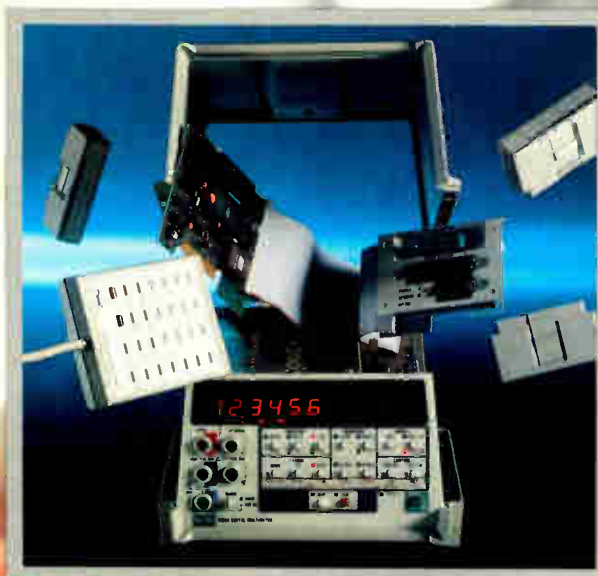

What if we added calculating and programming capabilities to a versatile new 5½-digit multimeter?

FLUKE

You'd call it a fast, easy way DMM. We call it the Fluke

Exclusive Portable Test Instrument Packaging
lets you stack-and-latch the 8860A with other
PTI Instruments from Fluke, including
counters, thermometers and printers.

**5½-digits of resolution with function
annunciators.** Two extra 7-segment LED's
display program steps, exponentials, error
messages and results of limits testing.

**Advanced math functions include offset, hi/lo
limits testing, peak-to-peak mode, and dcV and
ohms zero.**

**With 0.01% basic dc accuracy, 8860A measures
True RMS volts (ac or ac + dc), 2 or 4 terminal
ohms. Safety features include internal
four-terminal ohms and guard shorting links
and recessed input jacks.**

**Calculating controller option uses RPN logic,
is fast and easy to operate.**

**Control section lets technician call up prestored
programs from memory cartridges without the
keyboard attached. REM ("remote") switches
unit to calculating controller operation.**

**Standard features include autoranging,
switchable filter, selectable sample rates, and
rear BNC trigger.**

**Interchangeable
non-volatile memory cartridges
for convenient program storage.**

**Excellent value as a stand-alone or system
instrument: basic 8860A DMM \$1395;
calculating controller option \$550; extra
memory cartridges \$50 each; IEEE-488 interface
option \$295 (U.S. prices only).**



Fast-Response Coupon

IN THE U.S. AND NON-
EUROPEAN COUNTRIES:

John Fluke Mfg. Co., Inc.
P.O. Box 43210 MS #213
Mountlake Terrace, WA 98043
(206) 774-2481
Telex: 152662

IN EUROPE:

Fluke (Holland) B.V.
P.O. Box 5053,
5004 EB Tilburg,
The Netherlands
(013) 673 973 Tlx: 52237

- Please send me complete 8860A specifications
and applications literature.
- I have to see this computing multimeter for
myself. Please have a salesman call.

Name _____

Title _____ Mail Stop _____

Company _____

Address _____

City _____ State _____ Zip _____

Telephone () _____ Ext. _____

For technical data circle no.183

E2 8/80

to program a 8860A Digital Multimeter.

"Our customers asked for a powerful, computing multimeter. We designed just that... a precision benchtop DMM with an optional calculating controller that transforms it into an incredibly intelligent stand-alone measurement system."



Our product designers are proud of the new Fluke 8860A, and rightly so: this unique computing multimeter system represents a significant advance in test and measurement technology.

Because it combines the analog measuring precision of a 5½-digit multimeter with a calculating controller option, the 8860A allows you to manipulate measurements as easily as you manipulate math with a programmable calculator, developing software for your specific application.

The 8860A concept provides a unique solution to some very challenging measurement problems: a system as practical as it is powerful. **Programmable power goes to work for you.**

Use the 8860A's math and programming capabilities to perform statistical analyses. Convert and directly display the output of transducers measuring temperature, pressure, power and other physical events. With powerful software that can both configure and command the DMM, the 8860A will make measurements, execute mathematical operations and branch on conditionals to subroutines.

The keyboard included with the 8860A's calculating controller option works just like any RPN programmable scientific calculator, and can be detached from the multimeter when not being used for program development. An inexpensive IEEE-488 option is also available for full function/range programming of the 8860A.

"Tell me more!"

As a stand-alone system or in an IEEE-488 configuration, the 8860A allows you to automate a wide range of tedious, time-consuming procedures to streamline your applications today, and open new worlds of opportunity for tomorrow. For more information call toll free 800-426-0361; use the coupon; or contact your Fluke sales office or representative.

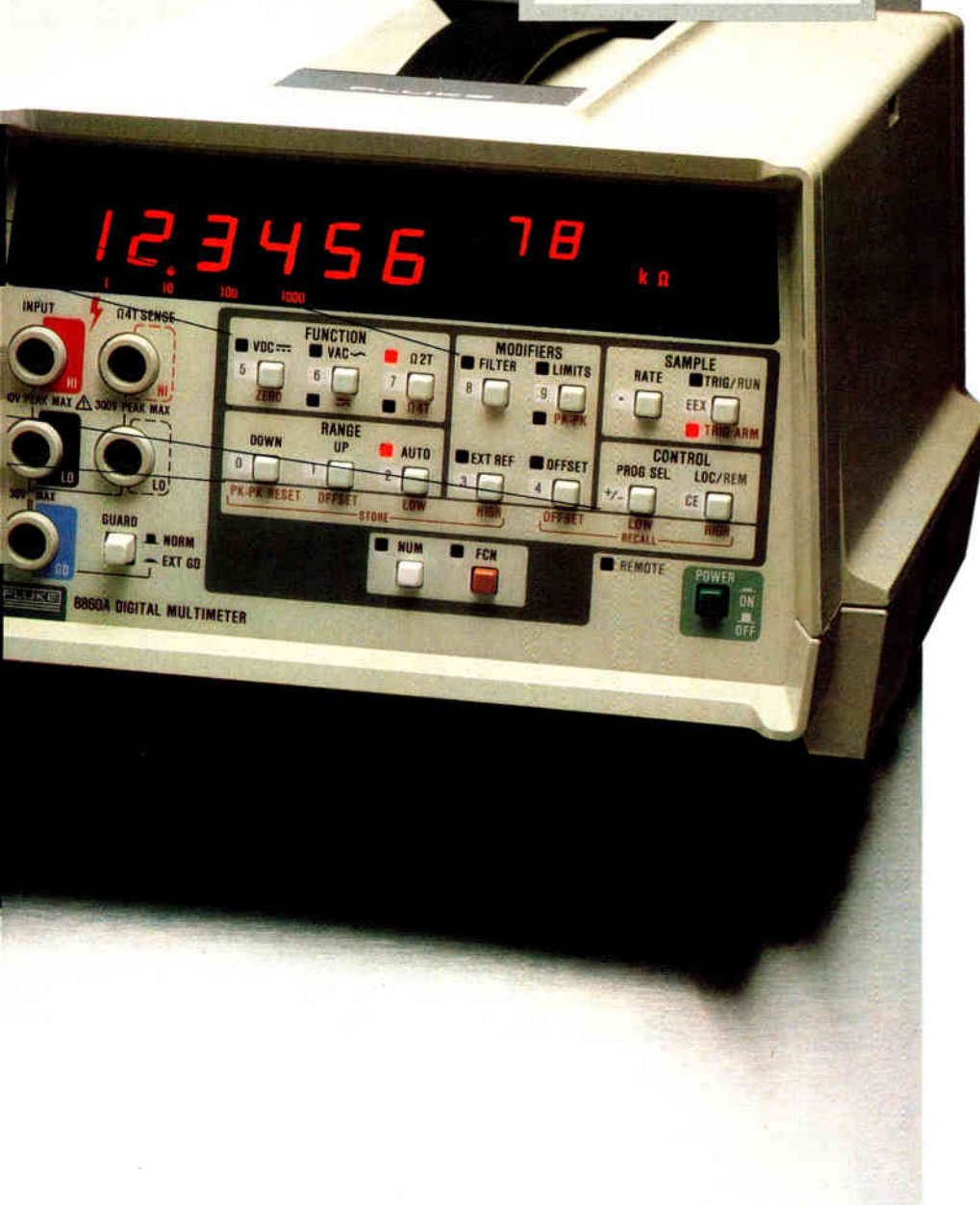

FLUKE[®]

IMAGINE

As your ideas race into the future, you need products to match your stride. Today Zilog offers you the most advanced family of microprocessor products made: components, support devices, software, development systems. All available in production quantities with worldwide support.

Elegant but soundly conservative scaled n-channel manufacturing processes combine with generation-ahead architecture to give Zilog products uncommon performance levels. The 8-bit Zilog Z80 revolution-

ized the microprocessor industry.

Today it's become the still more powerful Zilog Z80B. Its cousin, the Zilog Z8, packs an ingeniously flexible, complete 8-bit microcomputer onto a single chip. And, as you would expect, the incredible 16-bit Zilog Z8000 has set the microprocessor performance standards for the 1980's.

Give your imagination some of our hard, profitable facts to work with. Write: Zilog, Dept. E, 10460 Bubb Road, Cupertino, CA 95014. Or, call your nearby Zilog distributor.

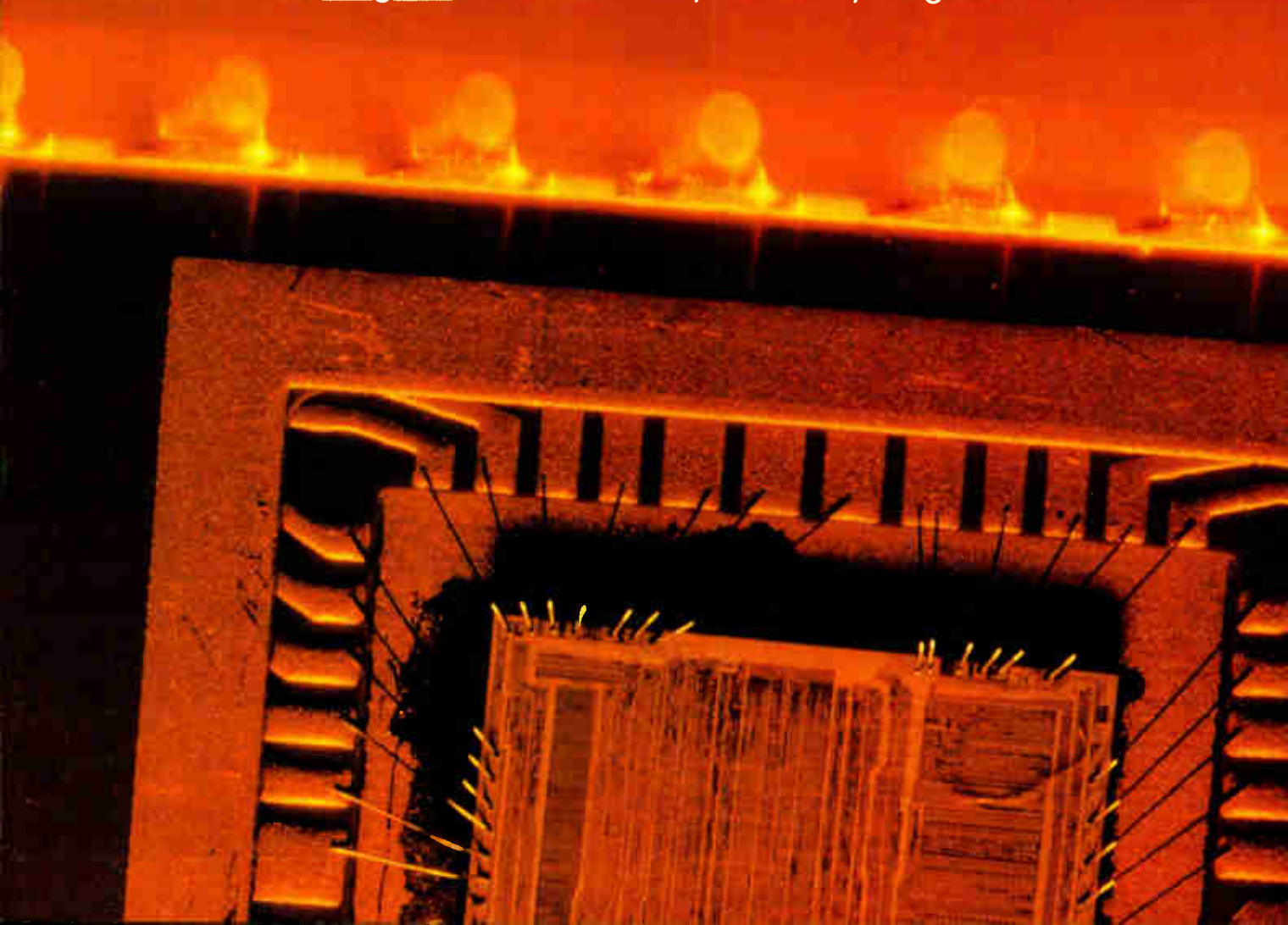

**THE POWER TO DESIGN
THE MOST ADVANCED MICROPROCESSOR-
BASED SYSTEMS IN THE WORLD.
AT YOUR COMMAND TODAY. FROM ZILOG.**

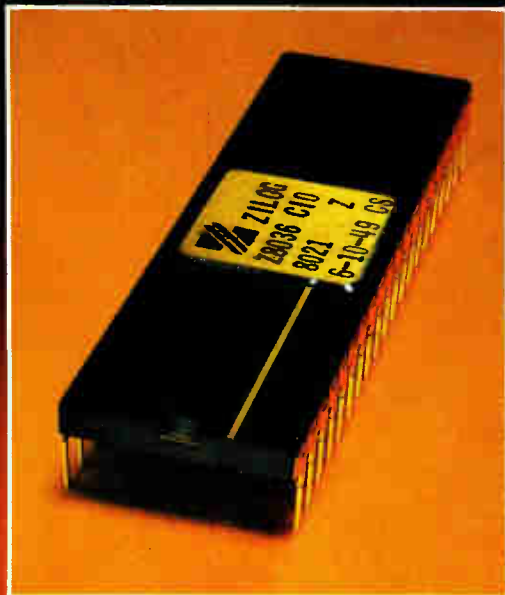

**Meet the most versatile
counter/timer and parallel I/O
ever made.
Zilog's Z8036 CIO.**

Now there's an incredibly flexible way to time and count external events plus control and peripheral I/O interfaces in real time. It's Zilog's new Z8036 CIO. The Z8036 gives you: three fully programmable I/O ports with 20 I/O lines, four 16-bit counter/timers with four external access lines and three programmable output lines, pattern recognition logic, four handshake modes (2- and 3-line), and much more.



An affiliate of **EXON** ENTERPRISES INC.

Circle 185 on reader service card

How STC speeds production testing by a factor of five to one . . .

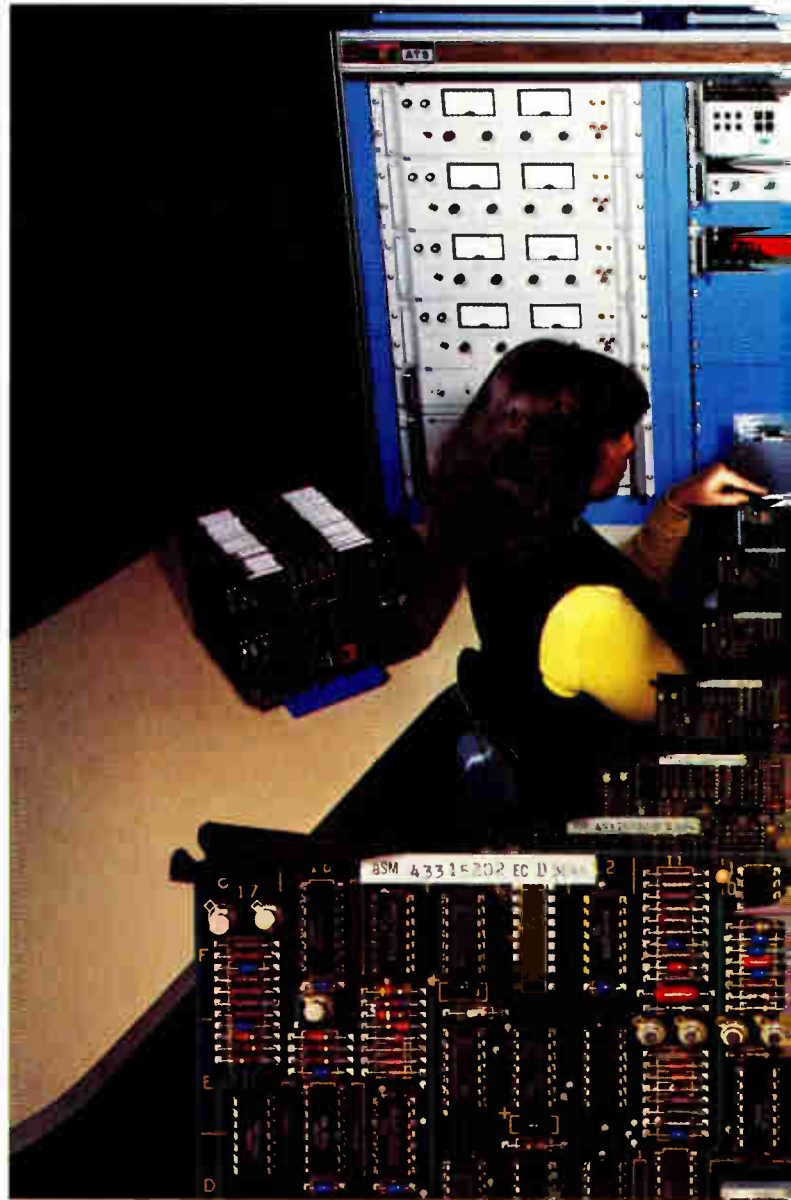

Storage Technology Corporation's revolutionary 8650 Winchester disc subsystem for big, main-frame computers utilizes double-density recording to pack twice the normal amount of data in the same space as a conventional, single-density disc.

Critical to the success of this technology are complex, high-speed, analog read/write and servo boards. In fact, STC's read/write board contains more than 350 separate active and passive components.

When conventional methods were used, it took approximately 15 minutes to test each board. As this testing time became more and more unacceptable, the decision was made by STC to switch to automatic testing.

Paul Zieschang, Manager of Hardware Development, recommended that the company assemble its own system using 12 HP-IB compatible instruments, an HP 9835A Desktop Computer as system controller and a 9885 Disc. Zieschang reports that the 9835A was chosen because its large CRT display made it easy for an operator to interface with the system, and

because of its programming ease. What's more, STC incorporated diagnostics into the system which help STC technicians better understand the testing procedure. This software even helps technicians locate — via a flashing cursor and a graphic display of the board's topology — the position of any component on the board. Finally, the 9835A also delivers a print-out of the component's value and STC part number.

Documentation simplifies system configuration.

According to Zieschang, some of the many application notes supplied by Hewlett-Packard were helpful both in deciding the first configuration and speeding assembly of STC's first HP-IB system.

Flexibility that reduces the chance for obsolescence and speeds assembly.

Twelve HP-IB compatible instruments were chosen for this system, according to Zieschang, because HP's bus architecture and programming ease permit the flexibility necessary to make changes within the system as STC's requirements change and, thus substantially reduce the possibility of system obsolescence.

HP instruments also provide STC with speed of assembly. The company assembled and programmed its first automatic

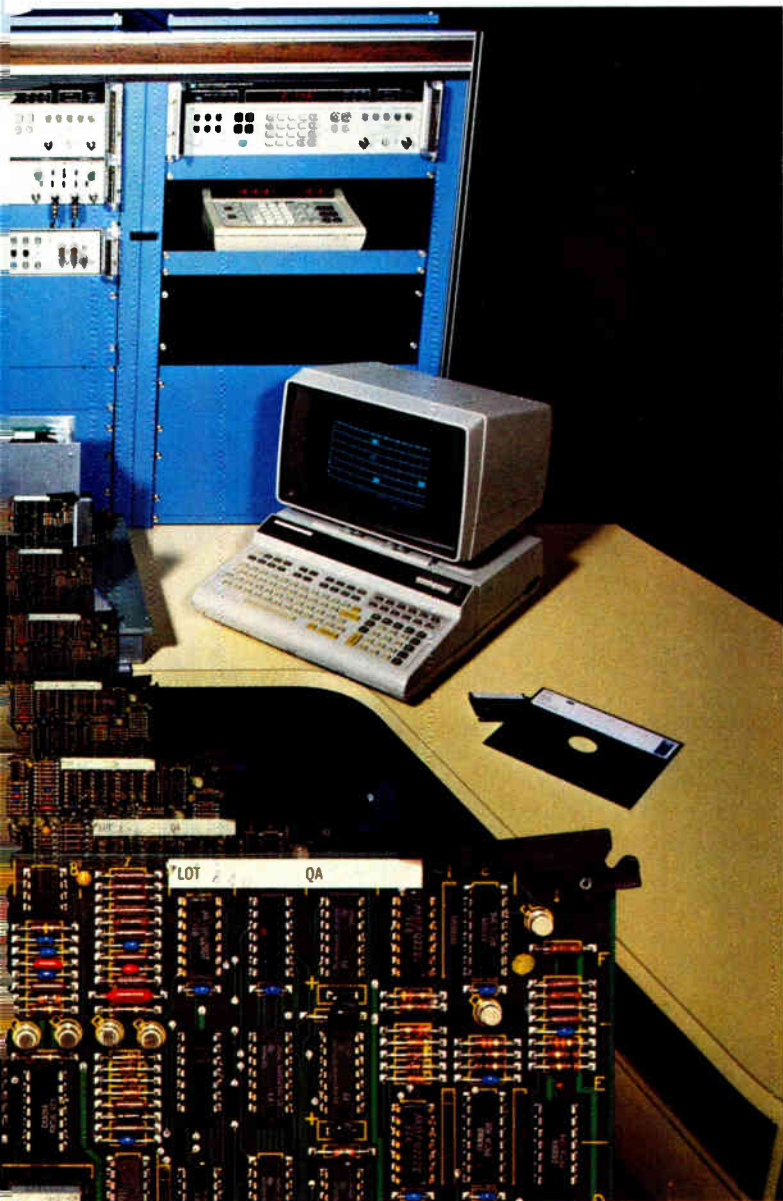

using HP-IB
 “designed
 for systems”
 instruments
 and computers.

test system faster than other comparable ways of solving its system test needs. Zieschang believes they will be able to assemble and program future systems even faster.

The bottom line.

Just as important, Zieschang says the STC HP-IB compatible system will reduce testing time from 15 minutes per board to approximately three minutes. A factor of five to one. The system is also expected to reduce the time required to debug faulty boards from 45 to 20 minutes. In short, STC's HP-IB system will help the company turn out more boards per day.

Why not consider the HP-IB solution for your production test needs? For complete details, send for our brochure, “Do your own system design in weeks, instead of months.” Simply write to Hewlett-Packard, 1507 Page Mill Road, Palo Alto, CA 94304. Or call the HP regional office nearest you: East (201) 265-5000, West (213) 970-7500, Midwest (312) 255-9800, South (404) 955-1500, Canada (416) 678-9430.

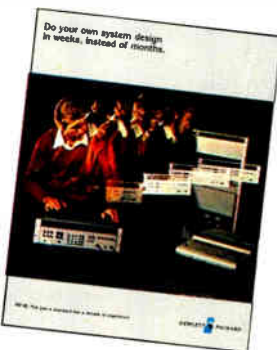

HP-IB: Not just a standard, but a decade of experience.



Circle 187 on reader service card

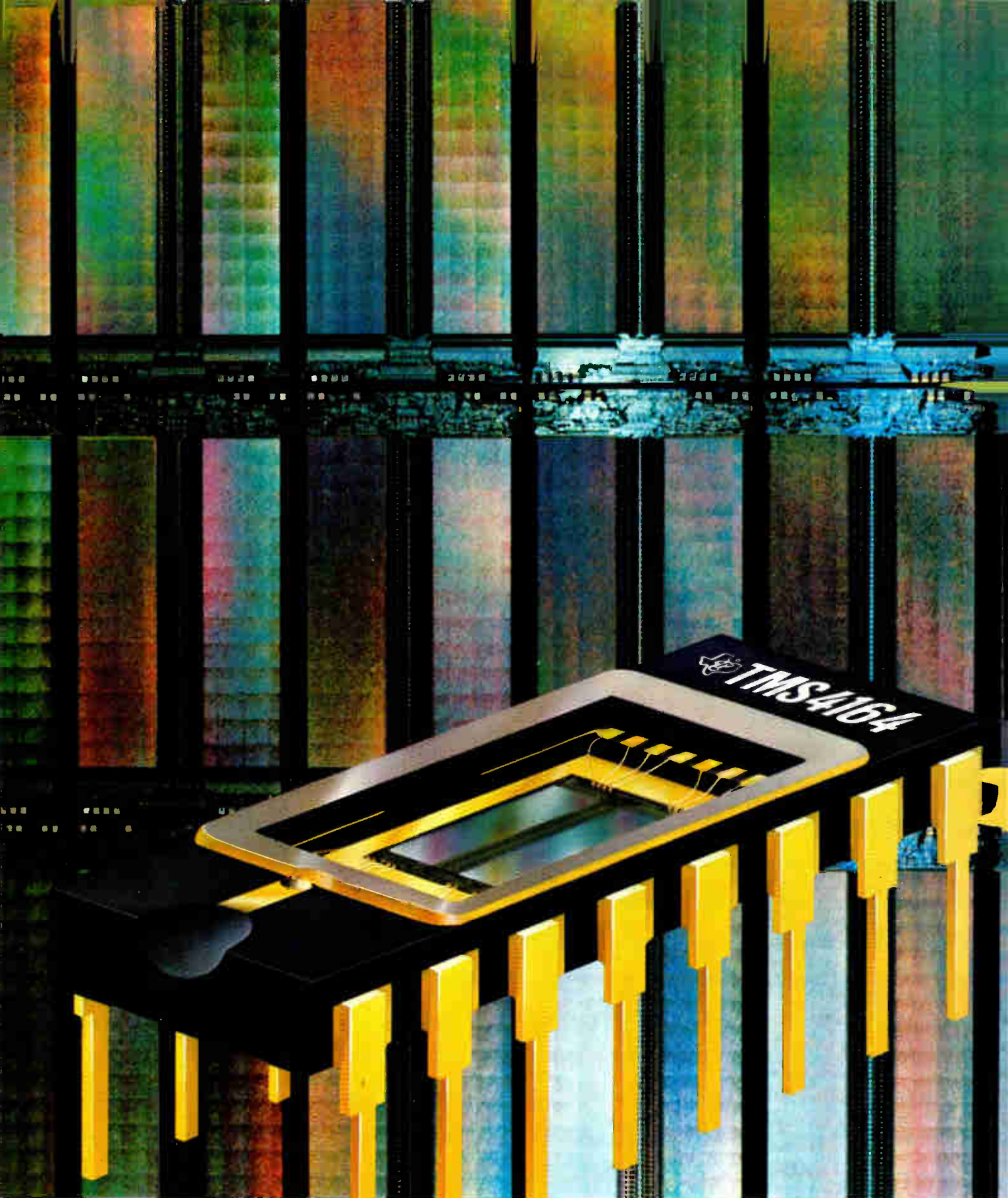

*Another major milestone in MOS memory technology
from Texas Instruments ...*

TI's 64K dynamic RAM is ready for delivery. Now.

TI has paced the industry through generation after generation of semiconductor innovation, pioneering a lion's share of the major milestones in technology and production capability.

The new TMS4164 from Texas Instruments represents the fourth generation of dynamic RAM computer memories, and continues to fulfill the bright promise of innovative MOS technology.

TMS4164. Advanced architecture. Superior performance. High speed. High reliability. Low power. *And ready for delivery.*

Ready with 4 times the capacity of 16K RAMs in the same size package.

Ready with 65,536 bits of random access memory — and that's more than many board-level computers.

Ready with 256 cycle, 4 ms refresh architecture — the optimum organization evolving from all previous industry-standard dynamic RAMs.

Performance has been dramatically enhanced. Speed's up. Power's down. And design innovation makes this the *smallest 64K chip (35K mil²) available anywhere.* From anyone.

Improvements in density, reliability,

system cost and ease of use are some of the features, functions and benefits system designers will appreciate. Here's more:

- 64K bits in a standard, 300-mil, 16-pin package saves valuable board space and reduces system size
- Single 5-volt operation lowers power supply cost and system cooling requirements and improves reliability

TMS4164 256 CYCLE
REFRESH ARCHITECTURE

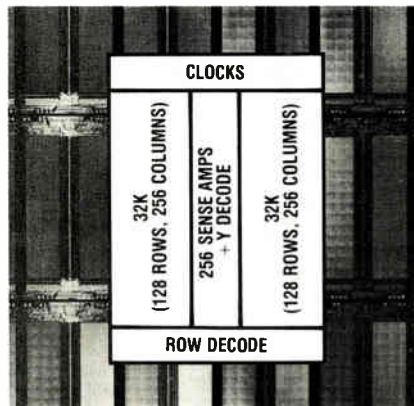

- JEDEC-approved pinout with N/C on pin one assures standardization and guaranteed availability
- High speed: 150-ns access and 280-ns cycle times (min.)
- TTL compatible I/O and clocks

- Lowest power dissipation available: 125 mW typical
- 256 cycle architecture means lower current peaks and reduced system noise
- State-of-the-art SMOS (Scaled MOS) processing

TI's new TMS4164 is perfectly suited for use in mainframe computers and large minicomputers. It also finds ideal application in microprocessor-based systems where smaller size, lower cost and improved performance are important considerations.

TMS4164. The deliverable, practical, usable 64K dynamic RAM. Compare our 256 cycle refresh architecture ... then compare our performance.

TMS4164. Truly another major milestone in MOS memory technology. Truly another example of the total commitment Texas Instruments is making to leadership MOS memory products.

For more information about the deliverable 64K RAM, call your nearest TI field sales office, or write to Texas Instruments Incorporated, P.O. Box 1443, M/S 6965, Houston, Texas 77001.



TEXAS INSTRUMENTS
INCORPORATED



The wide world of technology takes center stage at Disneyland

by Howard Wolff, *Assistant Managing Editor*

□ Setting up their tents this year at Disneyland, the organizers of Wescon/80 have succumbed to the flash and dazzle that fill the air of Anaheim, Calif., giving what they bill as the largest high-technology electronics convention and exhibition the theme "Electronics . . . the Magic Kingdom." All Disneyland glitter aside, Wescon's Sept. 16-18 stand will present to its estimated 50,000 attendees the largest show it has put together since 1969, with nearly 1,200 booth spaces reserved by more than 600 exhibitors.

In this, its first visit to Anaheim (at the Convention Center) in its 29-year-history, Wescon will offer 35

professional sessions with telecommunications, satellite systems, testing, memories, large-scale integration, and microprocessors topping the list.

Perhaps the hottest topic to emerge amid the free-ways, orange groves, and tract houses that surround Disneyland and the Convention Center is the personal computer. What is happening in that market, according to Bob Wickham of Vantage Research Inc. in session 10, is that our information-hungry society will gobble up 1.3 million machines by the end of this year. That pace can only increase as "generic" software and hand-held, low-cost models become available, says the president of the

Palo Alto, Calif., research firm. Other papers will address prospects for the machines in the schools, factories, laboratories, and ultimately the home.

Also on the subject of home computers, the big-name silicon houses will go one-on-one about the next generation of design elements for them in session 2, "Home Computer Design With Newer 8-bit Design Elements." The firms' weapons will be advanced microprocessor chips and their objective will be to move into position for the anticipated advance of personal computers on the consumer. As Dick Brown of Tandy Corp.'s Radio Shack division points out, ease of use and low price will be the keys to proliferation.

Auto electronics drive

Another area almost guaranteed to interest the engineer as designer as well as the engineer as consumer is the electric auto and what will make it go. "State of the Art of Electric Automobiles," a special session, updates the technology in the wake of recent announcements by Gulf + Western Corp. of an electric propulsion system and by General Motors Corp. of plans to produce such cars for the 1984 model year. The battle of the batteries will be covered by Conrad E. Weinlein of Globe Union Inc., Milwaukee, Wis., who feels that the familiar lead-acid system has cost advantages and proven performance in its favor for, at least, near-term use.

An important factor in the performance of electric vehicles is motor drive systems. Here, silicon has a vital role in microcomputer-based choppers for dc-dc conversion and in high-power transistors for driving motors. The power electronics package for EV-1, the U.S. Department of Energy's electric vehicle, will be examined by James W. A. Wilson of the General Electric Co., Schenectady, N. Y.

But Thomas Barber will attempt to put on the brakes with his inquiry into the wisdom of pushing headlong into the area of electric autos. The researcher from Jet Propulsion Laboratory, Pasadena, Calif., believes "we need to look at the future and see if the electric car is really the right idea, economically speaking."

Focusing on other batteries besides those needed in autos is session 20, "Power Cells—Energy Crisis in Miniature," where such matters as rising silver prices and the resulting alternatives to the silver-oxide power cell will be discussed. Among them are zinc-air batteries, sealed rechargeable batteries and charging systems, and long-lived lithium cells.

On the industrial and manufacturing side, the ambitiously entitled session 22, "Trends in Electronics Manufacturing," includes two papers—too few for a subject as broad as this. However, session chairman William Somsak's strong notions about the value of manufacturing systems in electronics—he is manager of product reliability at Transaction Technology Inc. in Los Angeles—fill out the session nicely. Also covered are trends such as IBM Corp.'s production of very large-scale

integrated circuits and the broadening of use of the laser as a tool for parts identification and inscription.

Session 17, "Bubble Memory Applications in Harsh Environments," is one that covers the industrial scene. Applications discussed include a flight-data recorder, a numerical controller, and a remote terminal. For those more interested in the software of industrial computers, session 18 covers "Programming Industrial Microcomputer Applications in Basic."

Communications is the message

For the communications engineer Wescon is an embarrassment of riches, with no less than nine pertinent sessions offering topics from fiber optics to radar. With a few exceptions, the papers are designed so that the novice or the less experienced information seeker can gain perspective on what exists or is expected to exist in the next few years. Those seeking research-oriented, state-of-the-art papers, however, will be disappointed.

One exception is session 5, "Robust Satellite Communication Links," organized by Donald P. Olsen of the technical staff of the Aerospace Corp. in Los Angeles. For Olsen, "There is no doubt that the four papers in my session discuss applications and practical problems not usually talked about in the unclassified literature." Although breadboard hardware has been made in some cases, the papers deal mostly with mathematical modeling and computer simulation of communications channels—especially from satellites. What is unique here is that various communication channel disturbances have been accounted for and included in the system design,

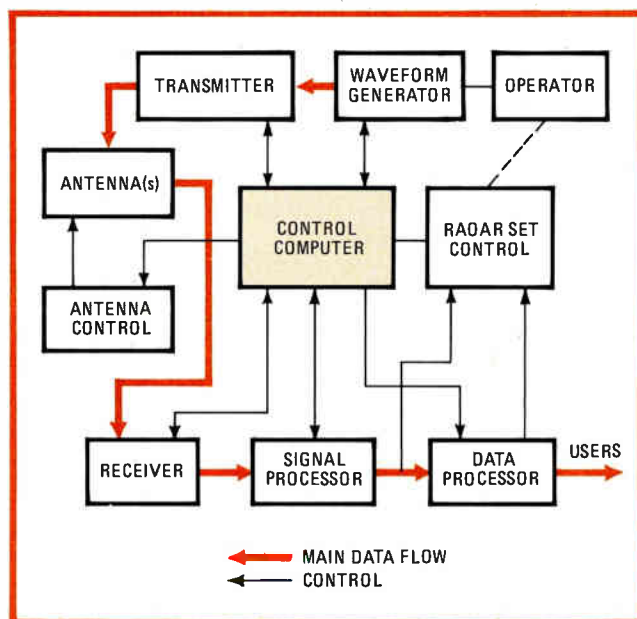

1. Generic radar. The radar set of the 1980s, according to Russell J. Lefevre of Technology Service Corp., and a co-organizer of session 3, will be a microprocessor-and-computer-controlled communication link—a far cry from blips on a display.

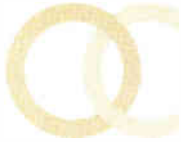

an accounting, Olsen says, for the "experienced folks" that deals with antijamming performance for specific signal modulations, propagation problems and their effects on spread-spectrum systems, and other exotica.

Coming back down to earth, the engineer who has not yet been involved in fiber-optics technology and wants to find out about it cannot do better than attend session 32, "Optical Fiber Transmission Systems," run by Roshan L. Sharma, manager of network analysis, and Neven Karlovac, manager of fiber-optic development, at Rockwell International Corp. in Richardson, Texas. For Sharma, "fiber optics is now a mature technology and the time has come to consider the total system." The four

papers in his session deal with the interaction of components and model systems and analyze the tradeoffs that have to be made. Practical material is the key here, with Karlovac talking about digital systems, Andres Albanese of Bell Laboratories, Holmdel, N. J., taking care of analog light, and the other papers dealing with components and local-link data handling.

"New Technology Trends in Radar Systems," session 3, is organized by John Q. Adams, a systems engineer at ITT Gilfillan in Van Nuys, Calif., and Russell J. Lefevre, manager of the systems division at Technology Service Corp. in Santa Monica, Calif. "We want to introduce new radar engineers on the West Coast to the latest

	TUESDAY			WEDNESDAY		
	9:00 - 11:00 a.m.	12:30 - 2:30 p.m.	3:30 - 5:30 p.m.	9:00 - 11:00 a.m.	12:30 - 2:30 p.m.	3:30 - 5:30 p.m.
Aerospace	New technology trends in radar systems	Robust satellite communication links	New initiatives in satellite systems and services			
		Aircraft collision avoidance - concepts and systems				
Design						Power cells - energy crisis in miniature
Instrumentation and Test	RAMs, codecs, bubbles, gate arrays, and analog microprocessors - how should they be tested?	Automatic testing: IEEE-STD-488 and commercial equipment	What will be the effects of micro-computer pervasiveness on instrumentation markets?			
			Emerging test strategies for digital systems			
Memories				Nonvolatile memories: what to do when power fails	Bubble memory applications in harsh environments	Memory concepts for the '80s
Microcomputers		The single-board computer: is it really needed?	What is happening in the personal computer market?		Programming industrial microcomputer applications in Basic	
Microprocessor	Home-computer design with newer 8-bit design elements					
Packaging and Production				Electronics packaging and interconnections for the '80s		Systems and trends in electronics manufacturing
Telecommunications	Telecommunications from the users' viewpoint			The telecommunications revolution of the 1980s	Advances in telecommunications semiconductor technology	Advances in telephone switching, transmission, and customer-premise equipment
Electric Autos				Special session 9:00 a.m. - 12:00 noon State-of the art of electric automobiles		

technology," Lefevre says, noting that there are few unclassified radar meetings in general and on the West Coast in particular. For the rest of the 1980s, radar systems design will be affected far more than it is at the present time by the microprocessor (see figure) and by millimeter-wave technology, and that's what his session is all about.

It was just a few years back that MOS technology was confined largely to making digital integrated circuits. But the world is hardly a digital one, and the analog circuits needed to process real-world variables, as well as to interface them with digital computer circuits, have historically been of the hybrid-IC and discrete-compo-

nent type. Not any more, though, as session 26, "Analog Circuits Using MOS Technology," points out. The analog-circuit possibilities in MOS ICs, like switched-capacitor filters, signal processors, data converters, and limits to analog MOS integration, are considered here.

To pursue this subject further, the next session, 27, "The Analog Interface to Microcomputers," should not be missed. It is particularly timely, as digital microcomputers are proliferating widely and their interfacing needs for data-acquisition applications have begun to surface. It seems that the applications for digital microcomputers are only the tip of the iceberg, and once rapid advancements occur in analog-world interfaces, these markets are bound to expand rapidly.

Interest is high in liquid-crystal displays

What was not very long ago considered an esoteric technology for displays is now considered a serious contender, judging from the contents of session 28, "Multiplexed Liquid-Crystal Displays." This is not surprising, since LC materials are readily available and manufacturable and LCD construction is comparatively simple. Impressive improvements in multiplexing LCDs and in the LC material's behavior have made LCDs favorable future display candidates.

An interesting aspect of session 27 is a paper on present and future chemicals for multiplexed LCDs (see table 1) by Herbert R. Moeller of Hoffman-La Roche Inc., Nutley, N. J. Unlike past LCD sessions at other technical conferences, this shows that there is more to LCDs than just electronics. In fact, the phenomenon is an electrochemical one, and a good understanding of its chemical nature is in order.

The 16-bit kingdom

The 16-bit microprocessors will receive their share of attention at Wescon this year. As the major manufacturers battle for the small systems market, emphasis is shifting from actual microprocessor features to questions of support. Peripheral chips that perform various tasks are becoming standard items in microprocessor manufacturers' catalogs. As a result, there should be considerable interest in session 31, "16-Bit Microprocessor Peripheral Concepts."

The new chips perform three main tasks. Input/output processors off-load the task of communicating with peripheral subsystems. Memory management hardware handles the large memory spaces needed to implement multiuser systems. The third and most ambitious undertaking involves the use of multiple microprocessors to divide the actual number crunching.

The design and application of the new peripheral chips will be described during session 31 in papers by speakers from Intel Corp., Motorola Inc., Texas Instruments Inc., and Zilog Inc. And the view from the system manufacturer will be presented by Digital Equipment Corp.

But to truly exploit the capabilities of the 16-bit

THURSDAY		
9:00 - 11:00 a.m.	12:30 - 2:30 p.m.	3:30 - 5:30 p.m.
Low power unleashes systems designers	Semicustom LSI - gate arrays	Breadboarding systems for LSI system design
Analog circuits using MOS technology		Computer-aided design of integrated circuits
Multiplexed liquid-crystal displays		
Computer terminals - small, low-cost, or without wires	The analog interface to microcomputers	
Benefits of advanced concepts of 16-bit microprocessors		16-bit microprocessor peripheral concepts
	EMI, electrostatic storage deflection, plastic packaging, and the regulatory agencies	
		Optical-fiber transmission systems



processors, system designers will have to accept and apply concepts that have traditionally been in the domain of mainframe manufacturers. Session 23, "Benefits of Advanced Concepts of 16-Bit Microprocessors," will treat some of these concepts.

For example, Les Kohn of National Semiconductor Corp., Sunnyvale, Calif., will describe how his company's NS16000 microprocessor family can be used to support a virtual memory space exceeding 2^{32} bytes. Multiprocessing also will be discussed by Heather Bryce of Motorola Inc. Other papers include one that deals with the 8086 (from Intel) and another with the evolution of the 8086 to operating system environments (from Intel) and large system aspects of the Z8000 (from Advanced Micro Devices Inc.).

However, significantly absent from the technical program are detailed discussions of the software needed to exploit fully the power of the new microprocessors and their support chips. Most major chip manufacturers appear to realize the need for software support but have traditionally left the job of writing it to software houses. This tendency is definitely changing, but there still seems to be little willingness among chip makers—with some exceptions—to engage in technical discussions of their individual attempts to fill this need.

There are, of course, other sessions at Wescon geared to digital hardware design. The designer with a requirement for nonvolatile storage is still pointed in numerous directions, as session 14, "Nonvolatile Memories: What To Do When Power Fails," attests. For smaller banks, General Instrument Corp. of Hicksville, N. Y., and Nitron Inc., of Cupertino, Calif., present their metal-nitride-oxide semiconductor offerings. Nitron proves that MNOS is good for more than memories with the nonvolatile counters it has in development.

Xicor Inc. of Sunnyvale, Calif., outlines the benefits of its replacement for the 2102 static random-access memory. Electron tunneling to and from a polysilicon floating gate allows Xicor's unique chip to operate from a single +5-v supply—even during programming.

For larger arrays, bubble memories come to mind, and Texas Instruments Inc. is represented. TI now has several board products that span a wide range of storage capacity and error-correction facilities (see table 2). Indeed, the Dallas, Texas, company has even crammed 128 kilobytes onto a 4-by-6-in. STD-bus module.

Intel Corp. of Santa Clara, Calif., discusses its line of ultraviolet-light-erasable PROMs and its compatible 16-K EE-PROM in this session. These devices fit into a larger scheme for pinout compatibility that includes both RAMs and ROMs, but the same Intel author waits until session 21 to unveil these so-called bytewise concepts. Here he is joined by a speaker from Mostek Corp., the Carrollton, Texas, chip maker that harbors similarly strong convictions when it comes to its own 8-bit-wide memories. Included in Mostek's pinout plan are its pseudostatic RAMs, and the company explains their application in

another paper. Finally, to round out the session, comes valuable insight from two memory users.

As for logic, the latest word is an old acronym: C-MOS. Session 24, "Low Power Unleashes Systems Designers," brings together papers on complementary-MOS microprocessors, logic families, data-acquisition components, and the packaging and powering of these and other C-MOS chips.

The processors come from National Semiconductor Corp. of Santa Clara (the NSC800), Motorola Inc.'s Semiconductor division of Austin, Texas (the 146805), and Intersil Inc. of Cupertino, Calif. (the 87C48 and 80C48). With the exception of the 1802 from RCA Corp.'s Solid State division in Somerville, N. J., these are the only 8-bit C-MOS processors on or soon to be on the market, and they will be competing for the same sockets in many cases.

Analog Devices Inc.'s Semiconductor division, Wilmington, Mass., sights the numerous applications for its series of C-MOS data-acquisition components, which includes some very low-power analog-to-digital converters. Mitel Semiconductor of Ottawa, Ontario, Canada, recently introduced and now discusses a new family of handy C-MOS 8-bit-wide logic chips. Fabricated with Mitel's popular oxide-isolated Iso-CMOS process, the parts are fast enough to supplant TTL in many applications. General Electric Co.'s Battery Business group of Gainesville, Fla., has some fresh ideas for powering nonvolatile memories, and Harris Semiconductor Corp. of Melbourne, Fla., describes leadless chip-carriers for C-MOS circuits.

Microprocessors are forever coming to the rescue, it seems, but there are still those occasions where much random logic remains to be consolidated. Gate arrays are a solution, but with their wealth of different densities, technologies, development costs, and production times an engineer's head can be left spinning.

Session 30, "Semicustom LSI—Gate Arrays," helps out. Low-power C-MOS and high-speed bipolar arrays from Interdesign Inc. are described by the Sunnyvale, Calif., company, as are analog and digital master slices from Exar Integrated Systems Inc., also of Sunnyvale. Very high speeds are achieved by Fairchild Camera and Instrument Corp.'s bipolar arrays built with its Isoplanar integrated injection logic, or I²L process. The Mountain View, Calif., firm has also achieved very high densities with a 4,000-gate array called the F9480 that can replace up to 100 TTL packages.

Computer assistance is key to the cost-effective implementation of gate arrays, and TI gives details of its design automation system for semicustom logic in this session. More general topics related to CAD are brought up later, however, in session 34, "Computer-Aided Design of Integrated Circuits." A paper that is written jointly by Motorola and General Motors' Delco Electronics division of Kokomo, Ind., addresses logic fault verification, while Rockwell International Corp.'s Elec-

TABLE 1: DEVELOPMENTS IN LIQUID-CRYSTAL DISPLAY TECHNOLOGY

1968 - 76	1974 - 80	1980 - 83
Dynamic scattering	Twisted nematic field effect	Pleochroic (cholesteric)
Patented by: Optical Coating Laboratory Inc.	Hoffmann-La Roche Inc.	3M Co. (pending)
Applications: watches, clocks, TVs, digital panel meters, point-of-sale terminals, dashboards	watches, calculators, clocks, DPMs, gas pumps	to be defined, but all are possible
Color: <ul style="list-style-type: none"> • gold against golden background • silver against silver background • blue against blue background 	<ul style="list-style-type: none"> • black on white • white on black • color polarizers 	<ul style="list-style-type: none"> • blue, red, green, yellow, cyan, on white background

SOURCE: OPTICAL SCIENCES GROUP

tronic Devices division in Anaheim, Calif., reveals some of its techniques for the automated fabrication of C-MOS circuits on sapphire substrates.

"Electronics Packaging and Interconnections for the 80s" is the title of Wescon's session 15. With the increasing use of high-pinout ICs, interconnection density is reaching new heights. This session focuses on aspects of system design affected by this trend.

Denser circuit boards

The most informative paper of this session is one from the Photocircuits division of the Kollmorgen Corp., Aquebogue, N. Y., which predicts that for future VLSI circuitry the double-sided plated-through-hole pc board will not be displaced by the multilayer board as is generally projected. Developments and process refinements will keep the two-sided board a viable option for a majority of future electronic packages. These improvements will be in lower-cost substrates, better image formation for finer lines, higher-density capability, and for the long range, sequential interconnection graphics (a pc resembling a thick-film hybrid).

The paper notes that in the future lower-cost alternatives to the epoxy glass laminates will be applied to two-sided plated-through-hole boards. These substrates could include metal-core epoxy-coated boards, polysulfone and other molded plastics, and low-cost, punchable, paper-based materials.

In image formation, two-sided boards will be manufactured with fine-line imaging with permanent dry film resists. Also, resistless additive processes such as Photocircuits' Photoformation and Philips' PDR should be

applied extensively to double-sided boards allowing fine lines on many types of materials. The density of the boards will be increased by using small vias—componentless rather than normal plated-through holes. Conceivably the vias could be laser-drilled, making them extremely small in order to save space. New and improved forms of electroless plating will be needed to plate these high-aspect-ratio vias.

The paper discusses what could be the ultimate two-sided board—one with no drilled vias or plated-through holes. In this case, vias would be graphically exposed and created as in the thick- or thin-film process. The end result could be a pc board with two layers of interconnection on one board side.

Buried away in session 24, "Low Power Unleashes System Designs," is an excellent overview on the leadless ceramic chip-carrier from Harris Semiconductor, Melbourne, Fla. Beyond the standard comparisons with dual in-line packages is some useful information on how to apply LCCs.

There is material on testing chips in chip-carriers and on mounting techniques, including a comparison between soldering chip-carriers to pc substrates, or placing them on ceramic motherboards, and the use of tighter-geometry layouts for boards with chip-carriers. The information on direct soldering of chip-carriers to pc substrates details specific soldering methods—vapor-phase reflow or hot solder oil—and soldering preparation and procedures.

For the test community, the coming technologies are a double-edged sword. On the one side, the new devices are harder to test; on the other, they are the basis upon



TABLE 2: BUBBLE MEMORY MODULES MADE BY TEXAS INSTRUMENTS INC.

Module number	Bubble memory device type used	Storage capacity (8-bit bytes)	Interface type	Microprocessor compatibility
TM990/210A	TIB0203S	23 K, 46 K, or 69 K	TM990 bus	9900
TM990/E252	TIB0203S	11.5 K	8-bit parallel E-bus	9981
TBB7090 and TBB7091	TIB0203S	11.5 K, 23 K, 34.6 K, 46 K, 57.7 K, 69 K, 80.8 K, 92 K, 103.8 K	8-bit parallel STD (Prolog) bus	9900, Z80, 8080, 6800
TBB5990	TIB0203S	23 K	development	user-defined
TBB5005	TIB0500	64 K	8-bit parallel	9900, Z80, 8080, 6800
TBB5010	TIB1000	128 K	8-bit parallel	9900, Z80, 8080, 6800
TBB5910	TIB1000	256 K	development	user-defined

SOURCE: TEXAS INSTRUMENTS INC.

which better instruments will be built.

"Testing is one of the limiting factors in the growth of LSI," says Gene Hnatek, operations manager for Lorlin Industries Inc., Sunnyvale, Calif. "Right now, some people are spending as much as 15 minutes testing a single 4-K RAM," he points out, adding that "about 30% of a device's cost is attributable to time spent testing it."

For those reasons, Hnatek organized and will chair session 4, "RAMs, Codecs, Bubbles, Gate Arrays, and Analog Microprocessors—How Should They Be Tested?" The session will be a mini-Cherry Hill (N. J.) conference, examining test strategies and solutions for those important new devices. Bubble devices, for example, were an important topic at last year's automatic test equipment conference in Cherry Hill [*Electronics*, Nov. 8, 1979, p. 98] and their complex characteristics and problems will be clearly presented in a paper by John Ahlstrom of Fairchild Camera and Instrument Corp.'s Xicom Systems division, Chatsworth, Calif.

Bubbles are a good example of how the new device problems can be compounded by a lack of standardization, Hnatek points out. "You have Rockwell, National, TI, and Intel, and they all have different support circuits, different pinouts, different package sizes." The session will be a good place for designers and testers of the new devices to get an understanding of the problems the others face.

One way to get high throughput in testing a new device is to tailor the test system to the device characteristics. This is a lot easier to do now, thanks to the advent of the IEEE-488 interface. But even with the interface, getting optimum performance from such bus-structured

systems is still very much an art rather than a science.

Session 8, "Automatic Testing: IEEE STD-488 and Commercial Equipment," will investigate instrument characteristics pertinent to timing, signal switching, control, and testing. Nelson Urdaneta, chief engineer at Racal-Dana Instruments Inc., Irvine, Calif., and author of an article describing the company's series 1500 delay pulse generator [*Electronics*, Aug. 14, 1980, p. 111] will lead off the session by examining timing requirements for high-speed test systems.

Unfortunately, the other two Wescon testing sessions, 11 and 12 ("What Will Be the Effect of Microcomputer Pervasiveness on Instrumentation Markets?" and "Emerging Test Strategies for Digital Systems") are scheduled concurrently. It would be better if the two were melded into a single super session or at least made consecutive.

Session 12 will include an important paper by Chuck House, manager of logic systems operations for Hewlett-Packard Co.'s Colorado Springs (Colo.) division, who will describe the new instrument functions HP's model 64000 logic development system may perform. House's views on the coming generation of tools for VLSI design and testing will be contrasted with those presented by Ron Imbriale of Tektronix Inc., Beaverton, Ore., and a yet unnamed representative of Intel Corp. The session is a must for program managers and designers who want to stay up with the latest developments.

It should be noted that the program schedule is liable to change. Those interested in particular papers should check to see whether they are on the program at the time of the show. □



**Discover the
Gould world of
high quality
test and measurement
instruments:**

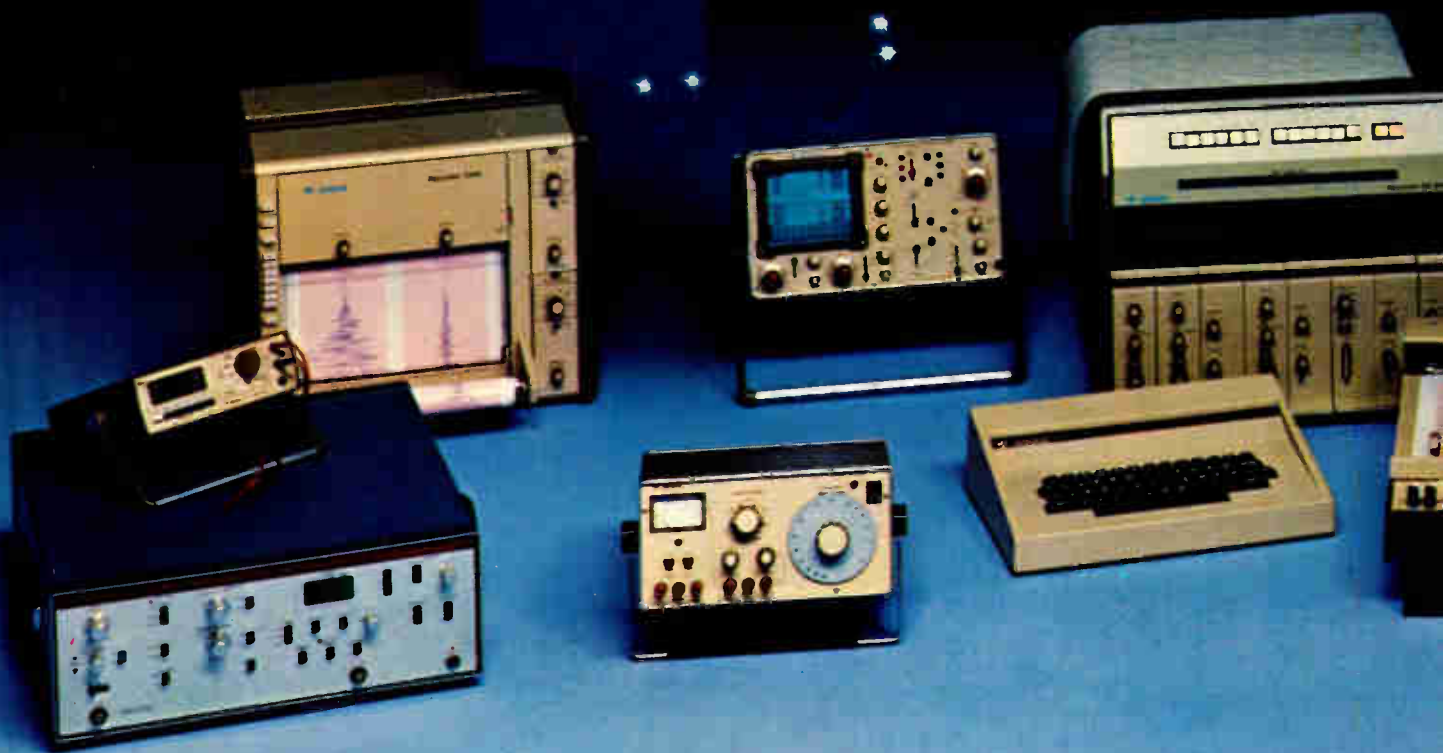

**Wherever you are,
Gould makes the right
instrument for you.**



If you measure, display, store or record, Gould makes an instrument that will get the job done right. A state-of-the-art instrument you can count on for rugged performance and dependable accuracy.

You can also count on Gould's availability. With a sales and service network covering 6 continents, we're never far away no matter where you are.

The next time you need test or measurement instruments that are built to some of the toughest standards in the industry, call on one of the fastest growing instrument companies in the world.

Call on Gould Inc., Instruments Division. Operations in Santa Clara, California; London, England; Paris, France; Frankfurt, Germany; and headquarters at 3631 Perkins Ave., Cleveland, Ohio 44114.

 **GOULD**

An Electrical/Electronics Company

Circle 199 on reader service card

“Our business depends on engineering schedules. So we depend on the capabilities of the

THOMSON-CSF is an international leader in the fast-paced telecommunications industry. They've found Tektronix 8002A emulation and support keeps their projects on schedule.

Jean-Luc Gerner
System Engineer
THOMSON-CSF
Gennevilliers,
France

“Emulation is the quickest, and we think the only way to debug microprocessor designs.”

At Thomson-CSF microprocessor designs have to move quickly from concept to marketplace. That's why engineers like Jean-Luc Gerner prefer the emulation capabilities of the Tektronix 8002A. Says Mr. Gerner: “On paper emulation is supposed to be the same. But we've used other development systems and their emulation has crashed. Tektronix emulation works consistently.” The 8002A's three progressive stages of emulation provide a fast, simplified approach to microprocessor hardware and software integration.

With software development and debug, software/hardware integration, and prototype monitoring emulation modes, Thomson-CSF hardware and software engineers are able to use the same design tool to make changes and corrections right on the spot. “The time saving is incredible,” adds Mr. Gerner.

“We're using microprocessors from two different manufacturers in our application. But we only need one development system for both chips - the 8002A.”



on meeting tight depend on the emulation Tektronix 8002A.”



Tektronix' extensive multiple microprocessor and multi-vendor support saves money. (We now support 25 chips.) That's because designs that need different chips from different manufacturers need just one 8002A, instead of two or more dedicated development systems. Tektronix multi-chip support makes you more productive because you don't have to learn a new command interface for each chip.

"The 8002A lets us remain flexible in microprocessor selection for future designs," says Gerner. With the widest list of microprocessor support available, you aren't tied down to a single chip or family of chips.

"Our Tektronix 8002As have been up and running upon arrival. We like that kind of reliability."

The 8002A is thoroughly pretested, so you can begin designing with it as soon as it arrives. Of course, we provide all the manuals and documentation necessary for installation. We'll even help with installation, if you'd like.

And if you should have any problems, a Tek service rep can be there in



48 hours or less. Our MDL service centers worldwide make sure your projects won't slip because of development system downtime.

"After using the 8002A for two years now," comments Mr. Gerner, "we're confident in it. We now

spend less time and effort in the microprocessor development cycle."

For information on how you can keep your projects on schedule with the 8002A call us toll-free at 1-800-547-1512. Or ask your local Tektronix MDL Specialist.

U.S.A., Asia, Australia, Central & South America, Japan
Tektronix, Inc.
P.O. Box 1700
Beaverton, OR 97075
Phone: 800/547-1512
Oregon only 800/644-9051
503/644-0161
Telex: 910-467-8708
Cable: TEKTRONIX

Europe, Africa, Middle East
Tektronix International, Inc.
European Marketing Centre
Postbox 827
1180 AV Amstelveen
The Netherlands
Telex: 18312

Canada
Tektronix Canada Inc.
P.O. Box 6500
Barrie, Ontario L4M 4V3
Phone: 705/737-2700

Tektronix®
COMMITTED TO EXCELLENCE

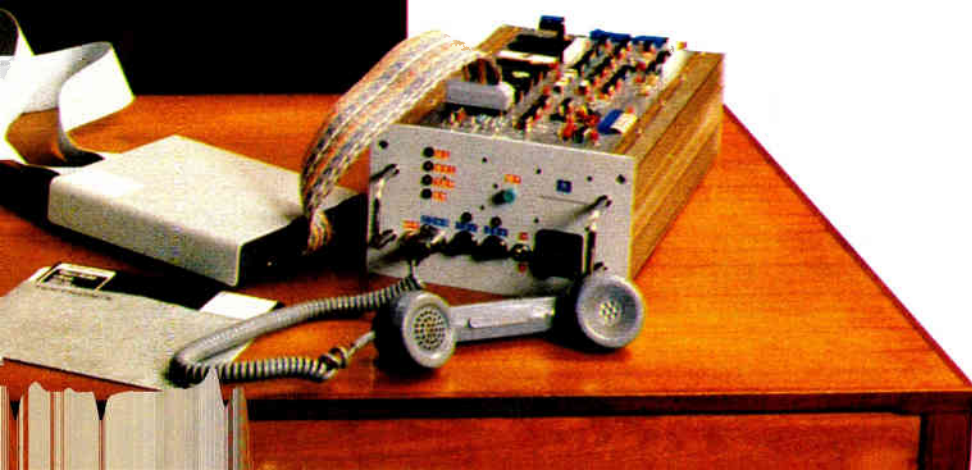

Tektronix MDLs now provide full software development and emulation support for the 8080A, 8085A, 8048, 8039, 8039-6, 8035, 8021, 8022, 8041A, 8049, 6800, 6802, 6806, 3870, 3872, 3874, 3876, F8, Z80A, TMS 9900, SBP 9900, 6500/1 and 1802. Now software development and prototype debug packages for the 8086 and Z8000.

The first functional PCB tester good enough to be called Fairchild.

It's the company behind Series 70 that puts it a generation ahead.

In the world of ATE, no name has so consistently been synonymous with innovative technology, dependable quality, and total systems support as the name Fairchild.



With the introduction of Series 70, Fairchild brings that long tradition of excellence to the functional board tester.

Series 70 offers true state-of-the-art hardware and software, developed for efficient and accurate board test and program simulation. It is modular in design for off-the-shelf economy and cost-effective expansion. It has a computer specifically designed for functional testing. It has a high-speed memory bus and a separate high-speed I/O bus. It can diagnose faults down to the component level with logic clip and probe capability. And it can test all of today's most advanced LSI devices — high-speed digital, analog and hybrid.

Without a doubt, Series 70 is the most complete, comprehensive and capable functional tester available today. And with the increasing complexity of today's PC boards, you can't afford a system that offers less.

And Series 70 is faster, smarter and easier.

While other testers operate at a leisurely 1.8 MHz, Series 70 gives you data rates to 5 MHz across all digital pins in parallel and collects probe data at full test speed. It

offers faster, more accurate fault isolation, and it lets you program timing increments with 20 ns resolution. You can even track bus-related faults at full speed with Series 70.

Thanks to MEDIATOR, Series 70 gives you a high-level conversational test program language instead of low-level code. And MEDIATOR is an English-like, multi-level language so you can write your own hybrid board programs easily and economically.

More accurate, more flexible, and more adaptable.

Compared to today's best known functional tester, Series 70 offers specifications that are truly impressive:

SPEED	Series 70 5 MHz	An older tester 1.8 MHz
PROGRAMMABLE PULLUP RESISTORS	Yes	No
COMPUTER	Specialty designed dual bus architecture 16 bits 64 K words memory (128 K bytes)	PDP-8 12 bits 32 K words memory (48 K bytes)
SIMULATOR	High accuracy Can be run on tester	Longer debug time Have to add memory
MASS STORAGE	12 or 24 MB disk	2.4 MB or 4.8 MB disk
SOFTWARE	Virtual memory	Overlay & linking
EDITOR	Continuous on-line operation	Call-up mode
SYSTEM INITIALIZATION	Totally automatic	Boot from TTY
DIAGNOSTIC CAPABILITY	Fault tracing to the component level with FLO-TRACER	No equivalent
ADVANCED LSI TECHNIQUES	Live data compression	No equivalent
HIGH-SPEED CLOCKS	8 phase with OR capability	No equivalent
HYBRID CAPABILITY	6 bus dual-pole throughout	Limited scanner

The world's first true hybrid tester.

Unlike other functional testers, Series 70 covers all types of boards—bus oriented microprocessors, dense dynamic memo-

ries, fast static memories, complex linear circuits and discrete devices. And it can handle boards from MOS and CMOS to TTL and advanced bipolar.

With Series 70, you also get a wide choice of fixturing systems—universal, edge connector, or optional Thinline® bed-of-nails interface.

And it's from the first family of ATE.

Like all Fairchild test systems, the Series 70 is backed by the largest support network in the industry. Training, applications software, special hardware configurations and maintenance are all part of the Fairchild support package. Together they provide a comprehensive, proven and state-of-the-art solution to your functional PCB testing needs today and tomorrow.

For more information on the new Series 70 Functional Board Tester from Fairchild, call or write for our new brochure:

Fairchild Test Systems Group
Fairchild Technical Center
Billerica, MA 01821
(617) 663-6562

FAIRCHILD

A Schlumberger Company

The First Family of ATE.

High accuracy
simulator

Computer: 16 bits,
64 K words memory

8 bus dual-pole
matrix

Fault tracing to
the component level

12 or 24 MB disk

Dual IEEE bus

Live data
compression

5 MHz data rate

Virtual memory



SERIES

 **TBP24S81**

 **TBP28L86**

**GREATER DENSITY
(2KX/A)**

**REDUCED POWER
($I_{CC} = 100\text{mA}$)**

 **TBP28S86**

 **TBP28L85**

**INCREASED
BOARD
DENSITY**

 **TBP28R86**

**INCREASED
THROUGHPUT**

 **TBP28P86**

**REDUCED
POWER
DISSIPATION**

Two new 8K PROMs: A space saver. And a power miser. Just a sample of many choices to come from Texas Instruments.

Organized 2K by 4, TI's new TBP24S81 comes in a 300-mil wide, 18-pin package. Compared to the standard 24-pin devices, it can save you 60% in board space.

Or look at the new TBP24S81 this way. It has a max access time of 70 ns. And because this new PROM has the industry-standard pinout, you can take advantage of the improved performance with little effort.

If you are presently using an 18-pin, 1K by 4 PROM, you may easily double your density by just plugging in the new TBP24S81.

Samples are available now; volume production in the third quarter. Price: \$25.50* each in 100-piece quantities.

Power-stingy PROM

Joining TI's growing 8K PROM family is the TBP28L86. Typically, it dissipates only 350 mW, about 60% less than TI's standard high-speed PROMs. Without a significant performance penalty. The TBP28L86 is nearly one-third faster than similar devices on the market — 150 ns max access time.

The TBP28L86N is available now in a 600-mil wide, 24-pin package at \$24.00* each in 100-piece quantities.

Another version identical in performance, the TBP28L85, will be available a little later this year in a 300-mil wide, 24-pin package.

New developments coming

The months immediately ahead will see a major expansion of the TI PROM family, already your biggest choice. New types and important improvements are on the way. To boost performance. Cut power requirements. Conserve board space.

● **Registered Output PROMs** — Unlike any others you've seen, these new devices will save space and increase

New PROM numbering system tells you more.

The new numbering system now being used on all TI PROMs is an index to the distinctive qualities of each device. The new code is logical. Convenient. And, with familiarity, easy to understand. Here's how it works:

TBP 2 4S81N — The first digit indicates the Programming Family. All 1s program alike. All 2s alike.

TBP2 4 S81N — The second digit tells you the Output Word Width.

TBP24 S 81N — This letter, or letters, indicates output or performance characteristics. Standard (Schottky) or low-power performance. Power down or registered. Latched. Three state or open collector.

TBP24S 8 1N — This digit, or digits, tells you the complexity. From 256 to 32K bits. 8 means an 8K device.

TBP24S8 1 N — This digit denotes package size and number of pins. In this instance, a 300-mil wide, 18-pin package.

TBP24S81 N — This letter, or letters tells you the temperature range and package type. N alone indicates a plastic dual-in-line package for operation between 0 and 70° C. J alone indicates a ceramic dual-in-line package over the same commercial range, while MJ indicates a ceramic DIP for the military temperature range of +55° C to 125° C.

For a complete description, see the Bipolar Microcomputer Components Data Book, 2nd edition.

throughput substantially. Particularly in pipeline applications.

Data normally stored in external registers will be stored on the PROM chip.

This will allow you to pre-address an instruction in memory and get it from the internal register on the next clock cycle.

You'll also have the flexibility of synchronous or asynchronous operation. Either option is available.

These new registered output PROMs will be upward compatible from standard 8K PROMs. You'll be able to factor them into your system with minimum redesign.

● **Power-Down PROMs** — They'll operate at 20% of the active power level when disabled. With no speed penalty. The chip powers up within normal read address access time.

● **Lower Low-Power PROMs** — Also coming is a new series of low-power PROMs, some with power dissipation of only 250 mW.

● **Greater Densities, Smaller Packages** — New by 8 organizations, including 16Ks, in 300-mil, 24-pin packages will save as much as 50% in board space.

The best of families

Not only is TI's PROM family expanding but all of the members share several outstanding features that ease your design job.

By 4 or by 8 organizations. Proven programming techniques. Low-current pnp inputs that permit interfacing with MOS and bipolar microprocessors. Titanium-tungsten fuse links for faster programming, improved reliability.

To know all about the changes in TI's PROM family, get your copy of the Bipolar Microcomputer Components Data Book, 2nd edition. Call your authorized TI distributor, or write Texas Instruments Incorporated, P. O. Box 225012, M/S 308, Dallas, Texas 75265.





Analyzers sample to 50 MHz

Pegged at about \$7,000 each, two multifunction logic analyzers promise to add a great deal of analytical sophistication to the research and development lab, production testing, and many field service operations. Both units combine logic analysis with signature analysis and hold out the option of adding waveform analysis (roughly \$1,300) and counter/timer capability (also roughly \$1,300) as extras. Each can be programmed via the RS-232 or IEEE-488 or can be set up manually.

The Paratronics models 616 and 648 differ in their number of channels (16 for the 616 and 48 for the 648), as well as in the nature of the analysis offered. The 648 provides synchronous logic-state analysis, samples at rates of up to 15 MHz, and has a memory depth of 250 words. The 616 provides logic-timing analysis and contains a reformattable memory able to record 1,000 words of asynchronous or synchronous 16-channel 50-MHz logic. Alternatively, it can record eight channels of 100-MHz logic with a memory depth of 2,000 words or even split the memory to include a separate 1,000-word glitch memory (to 5-ns glitches) for eight channels of 50-MHz logic. An important feature of both analyzers is that they can be linked with identical units. They can also be tied to each other.

For extremely selective triggering that can differentiate between many nested program paths, the 648 has up to 16 nested levels of trigger qualification, each of which can be programmed to select a specified pass through a subroutine. The 616 has two levels of sequential triggering. Further, the levels of triggering on both analyzers are related by a clock

delay feature containing up to 9,999 counts. These clock delays can be used to specify that the next word-recognition level of triggering must occur before a specified delay count, on it, after it, or at any time other than the specified count.

Each model also contains a full auxiliary memory, which can help establish table-comparison criteria for triggering the analyzer. The difference between the stored table of data and that captured by the analyzer is then shown on a cathode-ray-tube display, while a readout displays the number of correlations between the auxiliary and main memories.

The 648 uses three probes, each containing 16 channels, and two data qualifiers, each drivable by separate clocks for the demultiplexing of data. In addition, each model has

a clock qualifier that can be qualified with an entire 54-bit word (48 data, 6 others), rather than a single line.

Both analyzers provide for optional counter/timer/signature analysis and—on the 616—a waveform analysis function. The counter/timer has eight-digit resolution and accuracy to within 0.01%. It is a 10-MHz counter with a prescaler that boosts its abilities to 100 MHz.

The waveform analyzer option has one input channel—showing 1 M Ω of resistance—that can be used for high-speed a-d transient analysis. It has a 10-MHz bandwidth (3 dB), a 1,000-sample memory, and a 50-MHz maximum sampling rate. It provides 6-bit a-d conversion with an accuracy to within 3% + 1 least significant digit, on voltage ranges of from 5 mV/division to 20 V/div.



When Wescon/80 opens its door next month to a potpourri of new products, the emphasis, as in past years, will be on 'intelligent' systems built around microprocessors to give users more functions to the dollar

The counter/timer boards also contain the signature analysis function, which is ultimately linked with the other functions of the instrument. The maximum speed of the

616's signature analyzer is 50 MHz, while that of the 648 is 15 MHz. Paratronics Inc., 2140 Bering Dr., San Jose, Calif. 95131. Phone (408) 263-2252 [365] Booth 2723

holding data in its shift register and performing one conversion for each 12-bit word, the converter ensures a single output for each new value, as would a conventional parallel-input d-a converter.

12-bit serial d-a converter settles in 2 μ s

The model AD7543 complementary-MOS digital-to-analog converter from Analog Devices Inc. eliminates as many as three fourths of the data lines normally required for 12-bit operation by adopting a serial-input scheme. It uses a maximum of four strobe-input lines to feed data clocked in by a computer or microprocessor. These lines transmit the serial flow of data to a 12-bit shift register, which, when it has a full 12-bit load, passes the information along parallel lines to a second d-a converter register for conversion to analog form.

A current-output device, the converter settles to within $\pm 1/2$ least significant bit in 2 μ s, maximum. Multiplying feedthrough error is 1 LSB maximum at 10 kHz, and power dissipation is not more than 40 mW.

The AD7543's design is a space saver, notes Gerald Whitmore, marketing manager for Analog Devices BV, Limerick, Ireland, where the converter was developed. Needing only four data lines, it fits neatly into a 16-pin dual in-line package; in comparison, parallel-input converters might require as many as 24 pins. Also, the AD7543 needs only one +5-v power supply. That means it runs at logic power levels and

requires no Schottky-diode output protection. The unit therefore lends itself to dense packing on printed-circuit boards.

In distributed process control or communications-based applications, the AD7543's logic-compatible power needs and serial-input data-handling capability work easily with computer or microcomputer lines and data buses, Whitmore says. By

The AD7543 also performs two- and four-quadrant multiplications, acting as a programmable power supply in applications such as input-voltage regulation for automatic test equipment.

The converter holds nonlinearity to $\pm 1/2$ LSB over its operating temperature ranges of 0° to +70°C or -25° to +85°C. A second version of the converter has nonlinearity of ± 1 LSB (2.44 mV for a 10-v full scale). The temperature coefficient typically is 2 ppm/°C; 5 ppm/°C is maximum.

Prices of the AD7543 converters will range from \$14.25 to \$18.75 in lots of 100 following their introduc-

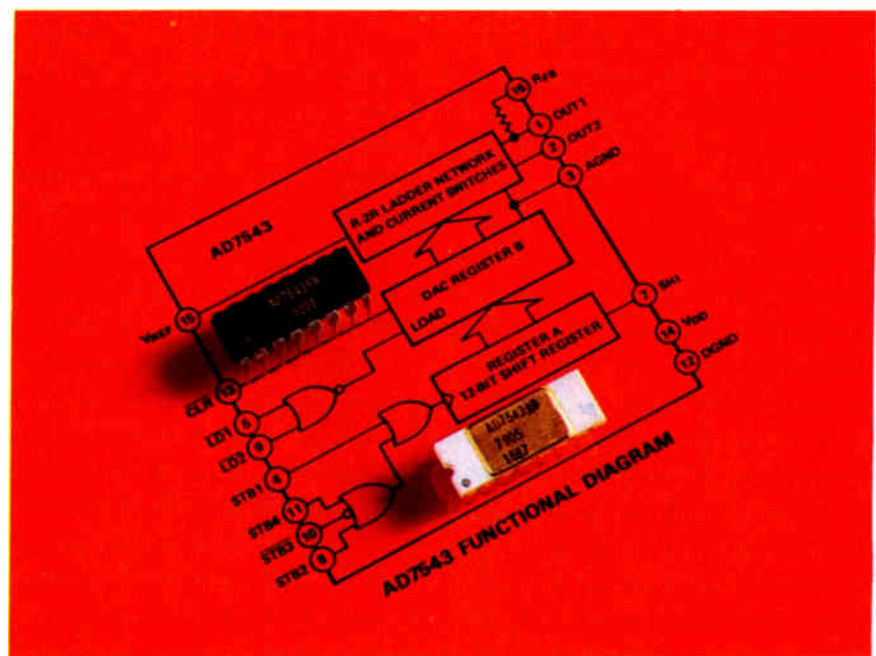

tion at Wescon. Delivery will be from stock to four weeks. A full military-range version of the device is currently also in the works, Whitmore reports.

Analog Devices Inc., Route 1 Industrial Park, P. O. Box 280, Norwood, Mass. 02062. Phone Donald Travers at (617) 935-5565 [351] Booth 1268

2 W/in.³ packed into switching power supply



The switching power supply market is already fiercely competitive. But, if the number of manufacturers selling similar units continues to grow, and if the expected soft market develops, the competitive climate could become yet fiercer, market sources predict. Their advice is to pick out a performance feature and exploit it.

Such is the strategy of Abbott Transistor Laboratories' Industrial Products division with its new Z line of supplies, to be made public at Wescon. "It is more compact than any competitive line of popularly priced power supplies," claims Dan-

iel Ketchum, corporate marketing manager.

The competitive edge offered by Abbott Labs is the supplies' power density of about 2 W/in.³, claimed by the company to be one of the highest. One unit, in a case measuring 6 by 4 by 2.25 in., provides 100 W from an input of 100 to 132 V rms. Efficiency is rated at a nominal 75%, with 100% of rated power provided at 75°C. Cooling is by conduction with heat dissipation assured by a larger-than-usual heat sink.

High-speed switching. Among other specifications is a switching

frequency of 30 MHz. "This frequency was chosen as the optimum trade-off between efficiency, economics, and reliability," says the Abbott marketing executive.

The company sees the Z line as being most attractive to designers needing to save space. Engineers "tend to work themselves into a crack by designing everything else and leaving their power supply until last, when space is at a premium," observes Ketchum, pointing out that perhaps the most telling example of the designer "getting himself into a box" occurs in the computer peripherals field. But the same thing happens in military weapons and command and control applications, as well as industrial process control.

The Z supplies will be available in November, in 14 versions from 3 to 30 V dc. Pricing, not yet final, is expected to be \$200 to \$225.

Abbott Transistor Laboratories, Industrial Products division, 639 S. Glenwood Place, Burbank, Calif. 91506. Phone (213) 841-2510 [363] Booth 4010

80-column thermal printer runs at 120 characters/second

A general-purpose 80-column thermal printer with more than 3.5 times the speed of earlier models made by the same company and improved graphics resolution will be unveiled at Wescon by Telpar Inc.

Key to the PL-80E's performance is a new thin-film thermal print head that uses a vertical row of 16 dots for bidirectional printing on the fly. Since this print head moves in a continuous motion across the heat-sensitive paper, it achieves significantly faster printing speeds than existing Telpar printers using the more common thermal-stepping head that momentarily stops between characters. The standard printing speed for the PL-80E is specified at 120 characters per second, but a compressed

printing mode is also available that runs at the same speed, while increasing the number of columns from 80 to 132. For comparison, Telpar's PPS80-E, an 80-column printer using the stepping head, prints 32 characters a second.

Graphics resolution is also improved using the new head, since the dots on the thin-film head have centers that are 10.5 mils apart. In contrast, the print head used in existing Telpar printers employs a silicon integrated-circuit-controlled 5-by-7-dot matrix with center spacings that are about 17 mils apart. The new thin-film heads come from Displaytek Corp., Addison, Texas, which also supplies heads for Telpar's existing printer line.

PERFORMANCE BEYOND PRICE

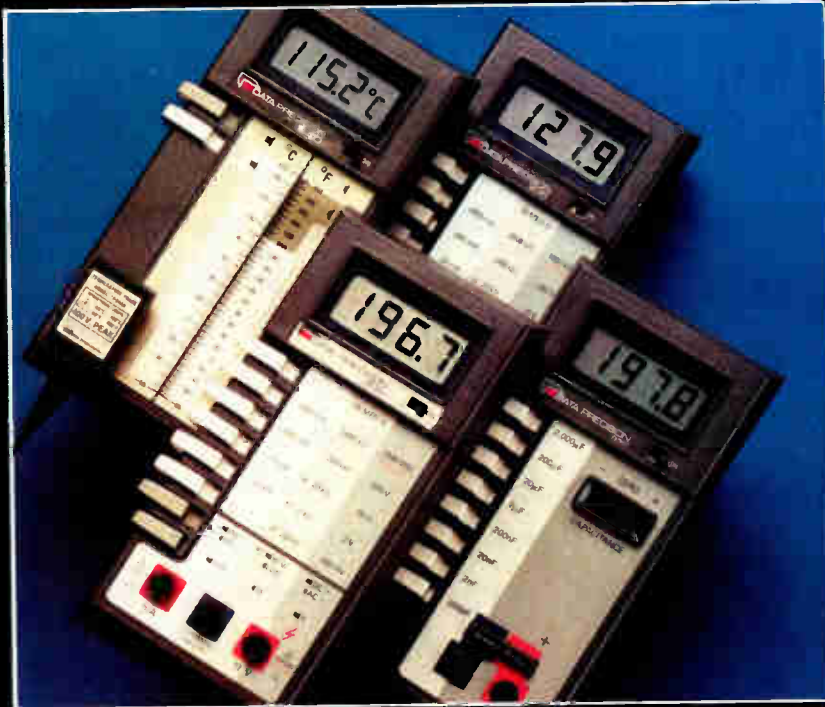

Just what you expect from Data Precision.

The Portable 900 Series.

3 1/2 Digit Multimeters Capacitance Meter Temperature Meter

If you think every hand held unit in our 900 Series delivers the performance, ease of operation, accuracy and dependability that comes with a high price tag...you're right. Except for one thing—the high price tag.

We designed and built our 900 Series to deliver performance above and *beyond* price. That's Data Precision performance.

Whether your needs call for a bench or field instrument, you can fill your voltage, current, resistance, capacitance or temperature measurement needs with one of our 900 Series units.

3 1/2 Digit Multimeters...

Model 936: \$179.

Model 935: \$159.

These hand held portable 3 1/2 digit multimeters deliver 29 ranges and full function capability, 0.1% basic accuracy, protection up to 6kV spikes, easy push button operation, and hi/lo ohms excitation. But listen closely...there is one difference between them. The Model 936 features audible continuity beep and overvoltage alarm. Both these units are tough enough for the field and have the accuracy you need for most bench applications.

Capacitance Meter...Model 938: \$179.

This 3 1/2 digit 0.1% accuracy capacitance meter features measurement ranges 0.1pF to 2000 μ F, immediate direct reading, push button selectability, exceptional accuracy and easy operation. The 938 will outperform all other capacitance meters, DC time constant meters, and even bridges costing 2 to 5 times as much!

Temperature Meter...Model 940: \$189.

All the bench and field accuracy you need is built into this lightweight, one hand operational unit. It reads -60° to 150°C or -85° to 302°F, delivers 0.1° resolution below 200° and comes with a detachable 6" semiconductor probe with 4' cable. It maintains 0.4°C or 0.7°F accuracy and has an extremely short settling time for rapid reading.

Every 900 unit will perform for up to 200 hours on a standard 9V transistor battery.

Performance beyond price? We're totally convinced that our 900 Series will give you just that. That's why we *fully warranty every 900 unit for two years.* They're that good.

Now...convince yourself.

For immediate delivery, demonstration, or further information, contact your local Data Precision distributor or call:

(800) 343-8150

(800) 892-0528 in Massachusetts

Visit us at WESCON

Prices USA

 **DATA PRECISION**[®]
A DIVISION OF ANALOGIC CORPORATION

Data Precision Corporation, A Division of Analogic Corporation, Electronics Avenue, Danvers, MA 01923, (617) 246-1600, TELEX (0650) 921819

For demonstration circle #208

For additional information circle #209

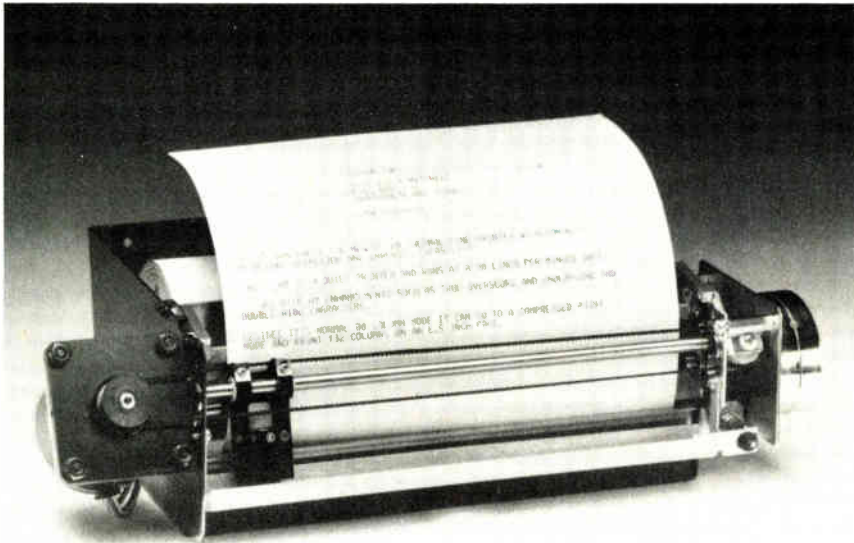

For computers. In addition to general-purpose instrumentation applications, company officials expect the PL-80E to have computer applications. To this end, it includes a 4-kilobyte buffer that facilitates graphics capabilities and is capable of handling cathode-ray-tube "dumps." A 3870-type microcomputer serves as the brains for the printer, which houses its electronics on two 3½-by-8-in. cards. Unlike Telpar's existing printer family, the mechanism for the PL-80E has been hard-tooled with an eye toward mass production, says William Konrad, president.

Operating at rates of up to 9,600 b/s, the PL-80E prints a standard 96-character ASCII set; an additional character generator is available for custom fonts. Though alphanumeric characters are contained within a standard 7-by-11-dot matrix, the maximum print field is 9 by 16 dots.

Printing density is 10 characters/in. and 6 lines/in.

Five switch-selectable interfaces—TTL parallel, TTL serial, RS-232-C, 20-mA current loop, and IEEE 488—are provided as standard on the PL-80E.

Prototypes will be available in October, with production scheduled to begin during the first quarter next year. Initially, the unit will be offered only as a mechanism without a case or power supply. Later plans call for availability of the PL-80E as a free-standing unit.

The price on the 14-in.-wide-by-7¾ in.-deep-by-3⅝-in.-high PL-80E mechanism with full electronics is \$672 in single-unit quantities. At the 100 unit-level, the devices are \$545 each.

Telpar Inc., 4132 Billy Mitchell Rd., Box 796, Addison, Texas 75001. Phone (214) 233-6631 [352]
Booth 1542

cost unit to be unveiled at Wescon/80.

Designated Phoenix-1, AMI's microcomputer development station provides Pascal-based software support for its new seven-member S2200 family of single-chip n-channel MOS microcomputers and S2000 microprocessors. What's more, optional software extends the development capability to the 17 members of the 8-bit S6800 and S9900 16-bit microprocessor families, in addition to other central-processing-unit chips not made and sold by AMI, notes Henry A. Davis, manager of systems engineering.

According to Davis, the main thrust of the Phoenix-1 is "in support of AMI's proprietary silicon," such as its S2000 and S2200 families. However, the assemblers and editors being developed for the Phoenix-1, he claims, "will cross-support software development on the more than 60,000 microprocessor development systems out in the field" from Intel Corp., Motorola Inc., and Tektronix Inc. Thus these competitive machines, he says, can be used to develop programs for the AMI devices, as well as other CPU chips.

Since the software is written in a common base language—Pascal—"it is now possible to transport the operating system, assembler, editor, loader, and all utility programs from one MDS to another," Davis states. In addition to increasing the ease and efficiency of assembling and editing programs, it is very cost-effective. Because all such MDSs would be maintained from a common software base (a small piece of Pascal code in the system's interpreter and I/O section), "if I found a bug in one editor, for example, it would be in all of them. And if I change the code in one system, it is changed in all," he continues.

The system. Phoenix-1, priced at \$5,495, includes a 12-in. diagonal cathode-ray-tube display with room for 1,921 characters, an ASCII keyboard with eight user-definable keys for special functions, 48 kilobytes of dynamic random-access memory,

Development system has Pascal-based software

Having stopped making a system it called its Microcomputer Development Center last year, American

Microsystems Inc. is coming out with a different type of microcomputer development system, a low-

Innovations in visual interface



See us at WESCON '80-booths 1523-27!

INDUSTRIAL ELECTRONIC ENGINEERS, INC. • 7740 Lomona Ave., Van Nuys, CA 91405 • Telephone (213) 787-0311 • TWX: 910-495-1707



two kilobytes of ROM, and three 5.25-in. minifloppy disk drives that provide 306 kilobytes of on-line storage. Additionally the basic system includes two RS-232-C ports for communicating with other computers, the AMIX diskette operating system, and an editor for the S2200, S6800, and S9900 microprocessors.

Assemblers for other members of the S2200, S6800, and S9900 families will be available at a cost of \$125 each, as will be assemblers for the popular Z80, 8080, 8085, 6502, and 2650 microprocessors not manufactured by AMI.

Emulation and compilers. Optional in-circuit emulation modules for most of these central processor chips will be available at a later date, as will Pascal and Fortran compilers and word-processing and other software packages. "There are many old MDSs in the backs of laboratories that are perfectly good computers. We intend to bring them out of the labs and into useful applications," Davis states.

Because AMI "can't build and maintain a commercial computer system as well as a manufacturer that's already set up to do so," Davis notes, the Phoenix-1 hardware will be built and supported by Zenith Data Systems, which last year acquired the Heath Data Systems business from Schlumberger Ltd. AMI will use Zenith's Z89—"a reliable system already in production"—as the hardware core of its microcomputer development station.

The Phoenix-1 will be available

from AMI's distribution channels—"our primary selling vehicle," Davis says—but will also be sold directly by the firm's sales force in support of its devices. Service will be handled at authorized Zenith and Heath cen-

ters. Availability of the development system is from stock to 30 days after receipt of order.

American Microsystems, Inc. 3800 Homestead Rd., Santa Clara, Calif. 95051. [368] Booth 1108

Hall-effect switch operates on 4.75-to-16-V power supply

Able to connect directly to solid-state circuits, EAO Switch Corp.'s latest series of switches resist water and oil. The series 14 push-button and indicator switches offer a full range of light- to medium-duty switch elements, combined with features intended for heavy-duty front-panel construction.

One version includes a solid-state Hall-effect device and has gold-plated universal-type terminals. The Hall-effect switch operates on a power supply of 4.75 to 16 v at 7 to 16 mA. Momentary or locking actuators are offered.

Other versions in the series are a snap-action unit rated for 5 A at 250 V ac or 2 A at 24 V dc and 2 million operations, and a low-level design rated for 100 mA at 50 V ac or 72 V dc and 5 million operations.

In all units, the actuator is sealed against contaminants with a panel seal between the front ring and the panel surface, and an internal seal

around the collar of the actuator sleeve. According to Robert W. Maier, vice president of marketing, these seals make the switches especially useful in petrochemical and chemical processing plants, oceanographic gear, mine safety equipment, and food-processing machinery.

Illumination for the switches is provided by a telephone slide-base lamp or a T 1.75 two-pin lamp with adapter. Connectors for printed-circuit boards are also available as options for the low-level and Hall-effect units. These connectors come in straight and 90°-angle configurations for soldering or wire wrapping.

The series 14 switch with either low-level or snap-acting elements sells for \$6.50 in 1,000-piece quantities. The switch with a Hall-effect element costs about 10% more. Delivery in all cases is from stock.

EAO Switch Corp., 255 Cherry St., Milford, Conn. 06460. Phone (203) 877-4577 [360] Booth 1651

Linear circuit tester now handles converters as well

When Genrad Inc. introduced its 1731 benchtop linear circuit tester last year, nobody said it was to be the first of a family, but it was. Now the second of what may become a group of four 1731 testers has emerged, the 1731 ADC/DAC test system, capable of testing almost all 4- to 12-bit analog-to-digital and

digital-to-analog converters in packages with up to 30 pins.

Now a user can specify a 1731 with either linear or a-d and d-a converter testing capability and add the other later. The model that Genrad will market most aggressively, according to G. Roy Rondoe, product marketing manager, linear prod-

If Thomas Edison had used a Monochip,[™] think how far he could have gone...



If Thomas Edison had used a Monochip,[™] his electric pen might have been a color copy machine. His lightbulb might have been a laser. And his phonograph might have been a stereo system. Why? Because with Monochip, IC turnaround time could have kept pace with the speed of his imagination and the limitations of his budget.

Monochip is the semi-custom IC. That means its circuit components—the first five layers—are already in place when you start designing. All you do is tell us how to connect them to make the circuit your application requires. Working from your layout, we etch the sixth layer and deliver prototypes in only 6 to 8 weeks for \$5,000 or less. Once you've approved them, we'll make production runs of 1,000 to 500,000 parts. It's that easy. Monochip Design Kits are only \$25 to \$59 each, and include everything needed to develop your own custom linear, CMOS, NMOS, CML or bipolar IC.

There's no telling what Edison might have designed if he could have used a Monochip. Now, just imagine how far you can go. Call or write for more information. Interdesign, 1255 Reamwood Avenue, Sunnyvale, CA 94086. (408) 734-8666.

Interdesign



Monochip:[™]
the semi-custom IC.

Interdesign is a Ferranti Company.
Circle 213 on reader service card

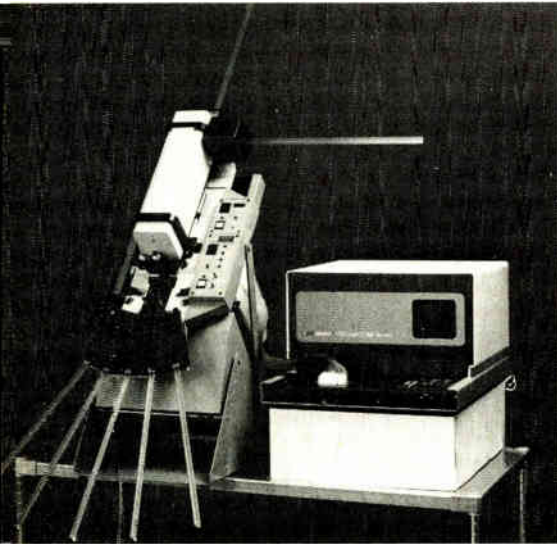

ucts, will be the new \$32,500 converter tester. Buyers can add a linear family board and software for an additional \$3,500.

The 1731 linear circuit tester sells for \$28,500, up from its \$22,900 introductory price [*Electronics*, March 29, 1979, p. 136] but still attractive enough to have been expected to capture more than an 80% share of its market [*Electronics*, Nov. 8, 1979, p. 89]. Thus there is an installed base of 1731s to which users may wish to add converter-testing capabilities. According to Rondoe, the switch from linear-circuit to converter testing is a simple matter of exchanging one family board for another and loading the appropriate software; the whole job should take less than five minutes. The price of the converter tester board, software package, and documentation is \$7,500.

Both the converter and linear-device boards plug into the same small mainframe. Within it are a Z80 microprocessor to manage test operations and a 6502-type microprocessor controlling the cartridge tape system, which serves the dual role of initial program store and test-data storage dump.

Testing, testing. Using a 16-bit reference d-a unit and a precision 10-v reference, the 1731 can test any 4- to 12-bit converter, whether bipo-

lar or MOS, monolithic or hybrid, gated, latched, or multiplexed, and using any of seven digital codes.

In both a-d and d-a tests, the code data is processed by the Z80 to yield where appropriate (as a percentage of full scale): zero error, linearity error, differential linearity error, and superposition error. Gain error in percent also is derived from this data, as is monotonicity.

Sensitivity to power supply variation is measured by changing the output of one or more of the three on-board power supplies and noting changes in output relative to that of the reference d-a converter. If the device under test has, as most do, an internal voltage reference pin, its accuracy can be compared with that of the precision reference on the board.

Most measurements are conducted to an accuracy of within $\pm 0.0032\%$ of the full-scale range of the reference d-a converter. The accuracy of the voltage reference test is to within $\pm 0.025 + 0.0032\%$ of the reference converter's full-scale range.

The 1731 makes parametric tests on converters' digital lines using the current and voltage measurement capabilities of its mainframe. The test-socket pin drivers have program-

mable high and low logic-drive levels ranging from -5 to $+5$ v, with 12-bit resolution and a $400\text{-v}/\mu\text{s}$ slew rate making possible tests of fast converters.

According to Rondoe, the testing of a 12-bit unit, exercising all codes and special code sequences and making a complete series of functional and parametric tests, should take well under 10 seconds. But only rarely will a customer wish to be this thorough, he feels. Users are more apt to check performance based on selected input conditions; thus typical test times should be from 3 to 5 seconds.

GenRad has program data for 15 of the most common converters and will add to the list continually. It expects to have a library of test data on 50 devices by January 1981, soon after the initial deliveries of the new system in December.

Other features include the user's choice of a pass-fail display or a full quantitative display of a unit's performance, system self-testing, operation with automatic handling gear, negative alphanumeric to highlight out-of-specification performance, and a stop-on-first-failure mode.

GenRad Inc., 300 Baker St., Concord, Mass. 01742. Phone (617) 369-4400 [366] Booth 2114

Measurement-to-computer gap bridged by data logger

Although the data-logger market has grown dramatically in recent years, users often find these instruments lack the power and flexibility called for by their applications. Some users wind up buying far more complex and expensive—albeit more powerful—computer-based systems that provide the computer with direct access to analog data via digital multimeters, multichannel scanners, or specially designed input/output devices. Now an intelligent measurement and control link

from John Fluke Manufacturing Co. "bridges the gap" between computers and physical measurements through a family of user-configured I/O options.

Designated the 2400A, the new measurement and control link, as it is called, is a high-frequency data-acquisition system, with programmable control capabilities, based on Texas Instruments Inc.'s 9900 16-bit microcomputer. Easily programmed from a host computer or an instrument controller, such as Fluke's

A pot for every purpose



Spectrol Pots, Trimmers, Dials, and Switches

Spectrol's been supplying the industry with precision potentiometers and related components since 1954. Today, the Spectrol catalog carries more than 150 pages of product illustrations and detailed specifications, covering both wirewound and non-wirewound precision and trimming potentiometers, concentric and digital turns-counting dials, and miniature rotary switches. Send for your copy of the Short Form of our new Spectrol Catalog, or, for the unabridged version, contact your local Spectrol representative.



SPECTROL ELECTRONICS GROUP

UNITED STATES Spectrol Electronics Corporation P.O. Box 1222, City of Industry, Calif. 91714, U.S.A. • TEL: (818) 942-7100 • TWX: 910-010-024

UNITED KINGDOM Spectrol Reliance Ltd. Duxford Way, Sandown, Wiltshire, England • Sandown, Wiltshire, Wiltshire, Wiltshire • TEL: 01223 44000

ITALY SP Elettronica SpA Via Carlo Filadelfo 7, 20026 Pieve (Milano) Italy • Tel. 30 341 • TELEX: 320091

GERMANY Spectrol Electronics GmbH Dornierstrasse 18, 2000 Hamburg 70 West Germany • (041) 7145044 • TELEX: 531814

Circle 215 on reader service card

recently introduced 1720A [*Electronics*, Dec. 20, p. 41], the 2400A can measure and control a wide selection of parameters including temperature, voltage, current, pressure, and rpm. These transducer inputs are converted to engineering units via programmable math functions or 12 standard temperature linearizations.

According to Bob O'Brien, senior product specialist in the Industrial Products division, the 2400 is like a data logger in that it contains a powerful on-board computer that has preprogrammed read-only memories to do thermocouple linearizations. It can also be programmed to perform time-interval scanning, alarm monitoring, $Mx + b$ (linear) scaling, and other data-logger functions independently. At the same time, the instrument's programming is done using a Basic-like language, "providing much more flexibility and power than any data logger," he claims.

The system. The 2400A system consists of: a mainframe chassis containing the central processing unit that controls system operation; up to 28 kilobytes of user-partitioned random-access memory for storing applications programs and buffer data to provide information (instead of raw data) to the host computer; and interfaces for RS-232-C-compatible communication with other devices. The operating system software resides in 16 2716 erasable programmable ROMs, equivalent to 32 kilobytes. Optional analog-to-digital converter and I/O cards or an extender chassis to tailor a system to the size and performance dictated by specific applications may be housed in the mainframe.

Overall, the measurement and control link measures up to 1,000 analog inputs and 1,024 on/off status inputs, as well as 32 digital binary-coded decimal inputs. Also, 1,024 status outputs, 128 analog (voltage/current) outputs, and half as many resistance outputs may be used in an extended system to control operations.

The 2400A is available 90 days after receipt of order. Although

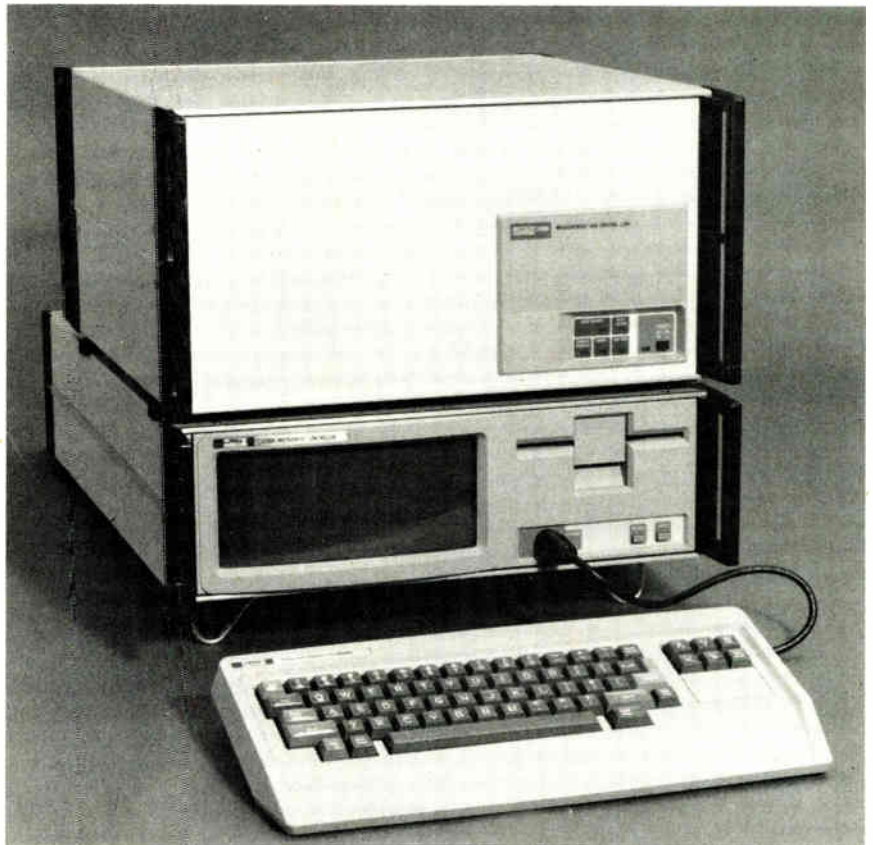

price varies greatly depending upon the system, a minimum configuration consisting of the mainframe, a high-performance a-d converter (3 or 30 readings per second, 16.5-bit voltage resolution, and 0.1°C ther-

mocouple resolution), and a 10-channel scanner costs \$6,270.

John Fluke Manufacturing Co., P.O. Box 43210, Mountlake Terrace, Wash. 98043. Phone (206) 774-2211 [364] Booth 2214

Oscilloscope market gets 50-MHz dual-trace unit

The LBO-17 marks Leader Instruments Corp.'s entry into the 50-MHz oscilloscope market. The unit is a dual-trace, dual-time-base instrument aimed at the test equipment and production test markets.

With the dual-time-base feature, the LBO-17 provides accurate time-interval measurements, in addition to allowing detailed viewing of complex waveforms, according to George W. Zachman, marketing manager. The time bases may be displayed

alternately, allowing the user to view simultaneously the main time base—with the delayed time-base portion intensified—and the delayed time bases for both input channels. "The dual time base greatly expands a complex signal with the top display covering the entire signal and the bottom showing the expanded part," notes Zachman.

Further, a composite triggering capability allows triggering on two asynchronous signals; a trigger-view-

Off-the-shelf or off-the-wall, our cables are on-the-money.



With Amphenol[®] cable assemblies — standard and custom — you buy solutions, not extra people or equipment.



Medical cable assembly
(1/5 actual size)

If your cable assembly already is on our shelves, you cut your lead time. If it's a custom job, you get the benefits of our design and manufacturing experience. Either way, you avoid capital investment, hiring extra people, and inventory problems.

Three brief examples: One is our Modem/Datacom EIA Interface Cable Assembly (above right, actual size). It features upgraded Amphenol[®] 17 Series connectors with

94V-0 rated dielectric and rear-release contacts. It complies with RS 232 and RS 449.

Two, there's our custom-design, connectorized bus cable assembly (above left, actual size). It conforms to all specifications of IEEE Standard 488. And has UL component recognition status.

Finally, another specialized area of our expertise: medical cable assemblies (at left.) Off-the-shelf, with improved mechanical design and electrical integrity, plus squeeze-clip or snap leads (3-5 and 10-14) for stronger mechanical retention even with repeated use.

Again, these are just examples. Bring us your cable assembly problem. Start by calling your nearest Amphenol North America sales office.



AMPHENOL NORTH AMERICA

A Division of Bunker Ramo Corporation

Amphenol North America Division Headquarters: Oak Brook, Illinois 60521

Sales Offices: Atlanta (404) 394-6298 • Boston (617) 475-7055 • Chicago (312) 986-2330 • Dallas (214) 343-8420 • Dayton (513) 294-0461 • Denver (303) 752-4114 • Greensboro (919) 292-9273 • Houston (713) 444-4096 • Indianapolis (317) 842-3245 • Kansas City (816) 737-3937 • Knoxville (615) 690-6765 • Los Angeles (213) 649-5015 • Minneapolis (612) 835-4595 • New York (516) 364-2270 • Orlando (305) 647-5504 • Philadelphia (215) 732-1427 • Phoenix (602) 265-3227 • St. Louis (314) 569-2277 • San Diego (714) 272-5451 • San Francisco (408) 732-8990 • Seattle (206) 455-2525 • Syracuse (315) 455-5786 • Washington, DC (703) 524-8700
Canada: Montreal (514) 482-5520 • Toronto (416) 291-4401 • Vancouver (604) 278-7636 • International: Oak Brook, Illinois TELEX 206-054

Circle 217 on reader service card

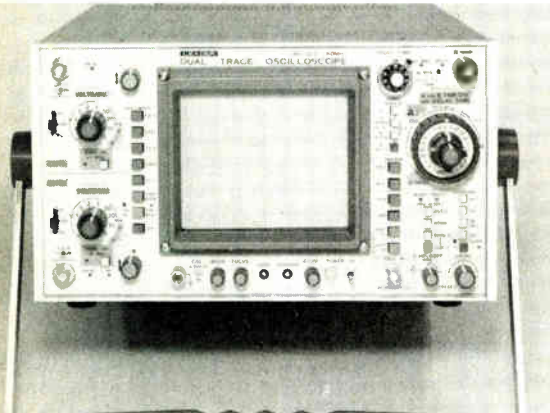

ing function displays the trigger waveform on channel 1.

Sensitivity of the LBO-17 is 1 mV up to 10 MHz and 5 mV beyond that up to 50 MHz. The instrument's dc vertical deflection is between 0 and 50 MHz, while its ac deflection is between 10 Hz and 50 MHz. Rise time is 7 ns and deflection is accurate to within $\pm 3\%$ between 0 and 40°C ($\pm 5\%$ with a five-times multiplier). Five vertical deflection display modes are provided: channel 1, channel 2, alternate, chop, add and subtract—and channel 2 may be inverted. Common-mode rejection is

specified at 26 dB at 1 kHz.

Operating in the external horizontal deflection, or X-Y mode, input is through channel 1 of the vertical amplifier. Bandwidth for dc inputs is from 0 to 1 MHz and from 10 Hz to 1 MHz for ac inputs. In this mode, rise time is 350 ns and phase-shift measurement comes to less than 3°C at 100 kHz.

Several display modes are possible in the sweep mode, including main time base, main time base intensified by delayed time base, alternate main and delayed time base, and delayed time base. The main time base may be displayed in 0.05- μ s/cm increments up to 0.5 s/cm. And the delayed time base has 20 steps starting at 0.05 μ s/cm up to 0.1 s/cm. While in the sweep mode, the user may use the times-10 magnifier that extends the maximum sweep rate to 5 ns/cm.

The LBO-17 comes with two probes and sells for \$1,950. It carries a two-year warranty and can be delivered within 30 days.

Leader Instruments Corp., 380 Oser Ave., Hauppauge, N. Y. 11787 [369] Booth 2314

E-PROM-programmable tester checks IC logic for \$5,495

A logic tester for small-scale integrated circuits that does functional and parametric testing as well as failure analysis is hard to find in an affordable price range. That's what engineers at American ElectroData Inc. concluded when they needed one a few years ago. So they decided to design their own for in-house use and after a couple of generations of improvements are ready to offer the final version—an E-PROM-programmable tester—for \$5,495.

The digital IC tester, dubbed Critic, checks resistor, diode, and TTL as well as complementary-MOS devices. It comes with two preprogrammed erasable programmable read-only

memories that can perform up to 100 tests apiece per logic family.

"There are a total of eight E-PROM sites, so by purchasing additional

E-PROMs at \$100 per family, a user could set up as many as 800 tests in the tester," says Jeffrey C. Schopf, company vice president. He adds that "most other testers use cartridges or hardwire the logic tests, rather than performing the tests via software."

Handling deviation. Critic works from random-access memory after the setup is read from E-PROM. The RAM setup can be modified to handle parts that deviate from standard parametric values, and the memory also can be programmed for sorting. Modified tests that are to be used frequently can be written onto a PROM to save the operator time and avoid errors.

Functional test patterns are applied according to device types in every possible logic state. These tests are done against a known good device that does not even have to be from the same logic family. Tests are set up by keying in three digits, and pressing the test key produces a complete test, which generates both a visual and an audible signal. Parameters are verified by checking logic highs and lows.

In the failure-analysis mode, Critic tries virtually all combinations of parametric variation in order to determine why the device under test fails. Analysis can be done qualitatively or quantitatively—determining which phases fail or determining the limits the device can reach before failure.

Critic can be interfaced with any low-cost, manually operated or automatic handler for medium- or high-



WE TURN OUT MORE LIGHTS THAN ANYBODY ELSE.



We've developed the industry's broadest and most advanced line of infrared LEDs and detectors. We also offer more opto package configurations. And more products available in volume orders.

That's everything you need for precision switching and sensing functions in applications requiring encoding, card and tape sensing, object positioning and detection.

On the emitter side, our LEDs

utilize power efficiently to provide reliable and accurate operation in a variety of packages. We match that capability with high performance photodiodes, phototransistors, photodarlington and photo ICs. Plus, we manufacture the only opto Schmitt component with internal voltage regulation that's compatible with TTL, CMOS, and other standard logic families.

All Spectronics parts are available in volume from a nationwide network of distributors. And our staff of

highly trained engineers is available to answer any questions you may have about the design or implementation of our products.

So, if you've been in the dark about opto design, give us a call. We turn out more lights so you can turn out better designs.

For more information, call us at 214/234-4271. Or write to Spectronics, 830 East Arapaho Road, Richardson, Texas 75081.

Spectronics
A Division of Honeywell

Light years ahead.

TYPICAL SPECS FOR SPECTRONICS' EMITTERS AND DETECTORS

LED
Near IR Emission 880 nm
 I_f 0.6 μA
High efficiency solution grown
 P_D 5 mW @ $I_f = 100$ mA
High pulse current 30 A

PHOTODIODE
 t_r 5 ns
 I_{ph} 40 μA @ $I_f = 5$ mA @ $V_{CE} = 20$ V
Application Linear, analog or hi frequency

PHOTOTRANSISTOR
 t_r 5 μs
 I_{ph} 12 mA @ $I_f = 3$ mA @ $V_{CE} = 10$ V
 V_{CE} (SAT) 0.2 V @ $I_c = 4$ mA
Application General Purpose Detectors

PHOTODARLINGTON
 t_r 100 μs
 I_{ph} 8 mA @ $I_f = 0.2$ mA @ $V_{CE} = 5$ V
 V_{CE} (SAT) 0.7 V @ $I_c = 1$ mA
Application High current or high light sensitivity applications

PHOTO IC
Schmitt Trigger Output
 T_r , T_f 50 ns
Output Sink 30 TTL loads @ $V_{CE} = 4$ V
Propagation Delay 5 μs
 T_{op} -55 to +100°C
Application Opto switching

volume testing. The tester can be delivered in 30 to 60 days. American ElectroData Inc., 566 8th Ave.

N. W., New Brighton, Minn. 55112. Phone (612) 636-6760 [367] Booth 4037

Central processor board meets new IEEE S-100 standard

Microsystems based on the bus structure of the proposed IEEE S-100 standard have been restricted to the popular, but older, 8-bit microprocessors such as the Z80 and 8080 and their 64 kilobytes of addressable space. Piceon Inc.'s OEM Computer Products division has taken the wraps off a new 16-bit central-processor card based on the S-100 bus. The unit "takes full advantage

of the 1-megabyte addressing range of the Intel Corp. 8086 processor," says sales manager Chris Bailey, and "is designed for multiprocessing applications." The IEEE-specified bus arbitration of the C-86 permits it to function as one of up to 16 bus masters operating on a single bus.

To facilitate concurrent operation, the C-86 has an on-board local bus (see illustration), local erasable pro-

grammable read-only memory—organized as 2 K by 16 bits and expandable to 4 K by 16 bits—and an RS-232-C port. A software-programmable timer and a special expansion connector are also on board. According to Bailey, the expansion connector "is particularly important because it allows later addition of other Intel coprocessor chips." He cites arithmetic processors, input/output controllers, and interrupt controllers as possibilities.

Precise timing. To be introduced at Wescon/80, the C-86 incorporates a number of new features added to the S-100 bus by the IEEE standards committee. For example, the new standard—expected to be formally adopted this fall—calls for a precise timing scheme to allow error-free transition from one bus

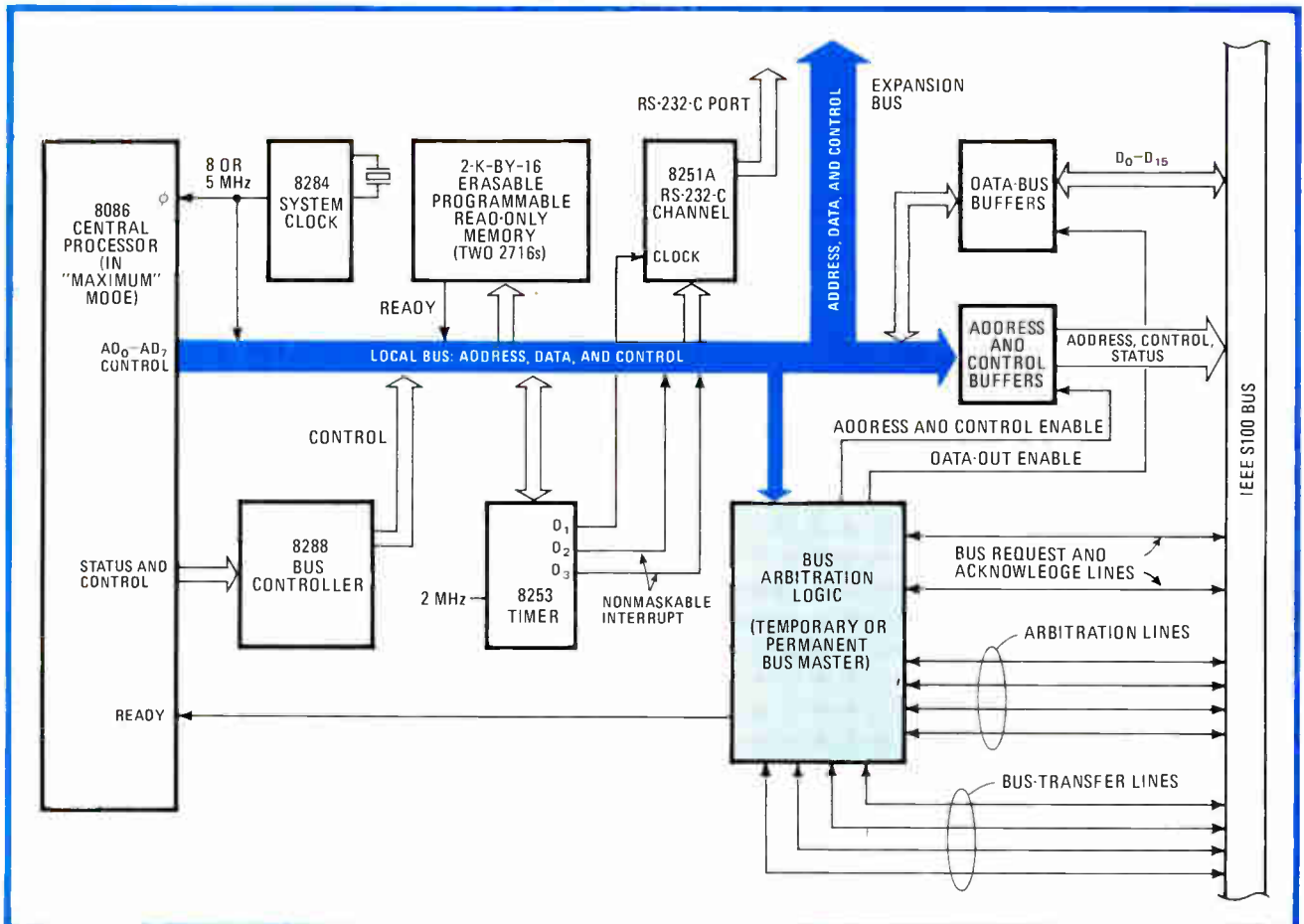

Anticipating the standard. With a local bus, on-board E-PROM, and an RS-232-C port, the C-86 16-bit central-processor card can function as one of up to 16 bus masters operating on a single bus. The design is based on the proposed IEEE S-100 standard.

FAIRCHILD

A Schlumberger Company

Our Bipolar Hi-Rel products are JAN qualified and faster, too.

RAMs, PROMs, micro-processors, bit slices, 100K logic, gate arrays. That's what we have in our full Bipolar LSI Hi-Rel product line. All are capable of meeting military specs in compliance with MIL-M-38510 and MIL-STD-883. And all are made using Isoplanar-S, Fairchild's advanced Bipolar technology, which makes them the fastest parts in the industry.

We've earned our stripes.

We were the first supplier to become JAN qualified on both RAMs and PROMs. And now, we're aggressively pursuing

JAN qualifications over our entire line.

We also can provide the maximum in high density packaging and performance requirements with our leadless chip carriers. In addition, we have flatpack and dual in-line packages. And, as an added benefit, our Isoplanar-S technology gives all of our Bipolar LSI devices excellent radiation hardness.

**Strong troop support.**

At Fairchild, we have the finest trained personnel to supply Bipolar LSI Hi-Rel products that meet with your total satisfaction. So you're always assured of getting exactly what you order.

If you're looking for hi-rel products that perform above and beyond the call of duty, call or write us at Bipolar LSI Hi-Rel, Fairchild Semiconductor Products Group, P.O. Box 880A, Mountain View, California 94042. Telephone: (415) 962-2351. TWX: 910-379-6435.

**Shaping the future of LSI technology.**Fairchild Camera and Instrument Corp

**Speed and performance
beyond the call of duty.**Circle 221 on reader service card

master to another. This scheme calls for one permanent master and up to 15 temporary masters able to pass control of the bus among themselves.

"When multiple requests are made, the master with the highest priority, as determined by the system builder, takes over the bus," Bailey says. "When the bus transaction is completed, rearbitration occurs and the next-highest requesting master gains control." However, he points out, if no temporary master needs the bus, it reverts to control by the permanent master. The C-86 can be used as either a permanent or a temporary master, depending on the placement of jumper wires.

By eliminating some overlapping and seldom used bus lines, the new IEEE bus allows addressing of up to 16 megabytes of memory, of which one 8086 processor can directly address 1 megabyte, Bailey notes. By using the existing unidirectional dual 8-bit data bus as a single 16-bit data bus, he claims, "full-speed 16-bit

processing is achieved by the C-86."

The board operates at a 5-MHz clock rate in its standard configuration, and at the full rated 8 MHz in a C-86-A version. The on-board timer uses the basic processor clock as its master frequency and can generate nonmaskable interrupt signals for use as a real-time clock.

Operating-system software and high-level languages are available from a variety of sources and "allow integration of the C-86 into a microcomputer powerful enough to push into what was previously minicomputer performance," Bailey states.

Available 30 days after receipt of order, the standard C-86 and the C-86-A are priced at \$725 and \$825, respectively, in single quantities. In original-equipment-manufacturer quantities of 100 units, they are priced at \$550 and \$650.

Plicon Inc., OEM Computer Products, 2350 Bering Dr., San Jose, Calif. 95131. Phone (408) 946-8030 [353] Booth 105

the haver functions of the sine and triangle waveforms, which the HP 8165A cannot do. On the other hand, it does not offer a choice of duty cycles (20%, 50%, or 80%) on pulses, triangles, and ramps, as does the HP unit.

Amplitudes on the 178 can be read out in dBm or volts root mean square or peak to peak. They can be varied from 1 mV up to 20 V p-p into 50 Ω (twice that of the 8165A), with accuracies that vary according to range. On the highest range, for example, amplitude accuracy is to within 1% + 20 mV, and on its 1-to-10-mV range amplitude accuracies are to within 4% + 20 mV (square-wave aberrations are less than 5% p-p). Offset voltages can range from 0 to ± 10 V dc across a 50- Ω load. As for spectral purity, the generated waveforms include harmonics that are more than 30 dB down from signal, phase noise 46 dB down in a 30-kHz band centered about the carrier, and spurious signals that are even further down (-60 dB below the carrier to 30 μ V up to 500 kHz and -50 dBc or 30 μ V up to 50 MHz).

Because its frequencies are synthesized, the 178's waveforms are far more stable than ordinary function generators, being resolved to 8 bits, with accuracies to within better than 5 ppm of the program setting. Its long-term stability is 1 ppm.

Linear or log sweeps. As a sweep generator, the 178 allows the user to choose between linear or true log sweeps, either up or down, in a wide range of sweep times. Since the generator has a hold-at-start or stop capability, its 10 preset frequency markers can provide triggers or flag critical frequencies. Sweeps at all frequencies remain phase-continuous even if the sweep is interrupted with a hold and later resumed.

The 178 has a number of convenience features that make it easy to program. For instance, in either remote or manual programming modes, it can receive new settings in any order. It can also accept new settings as an unsegmented string, so

Function generator-sweeper synthesizes range to 50 MHz

Aimed directly at Hewlett-Packard Co.'s market for its 8165A programmable signal source, Wavetek's model 178 represents a significant price reduction (by almost half) at the cost of some feature tradeoffs but including some enhancements. The 178 is a general-purpose-interface-bus-programmable combination of

function generator, frequency synthesizer, and sweeper that allows for trigger, gated, and counted bursts of its generated waveforms. It produces square waves (7-ns rise/fall), sine waves, and amplitude modulation at frequencies from 1 μ Hz up to 50 MHz, triangles to 500 kHz, and ramps to 20 kHz. It also produces

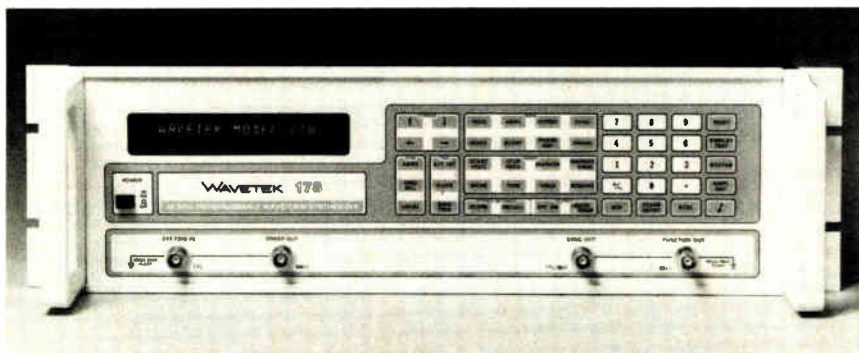

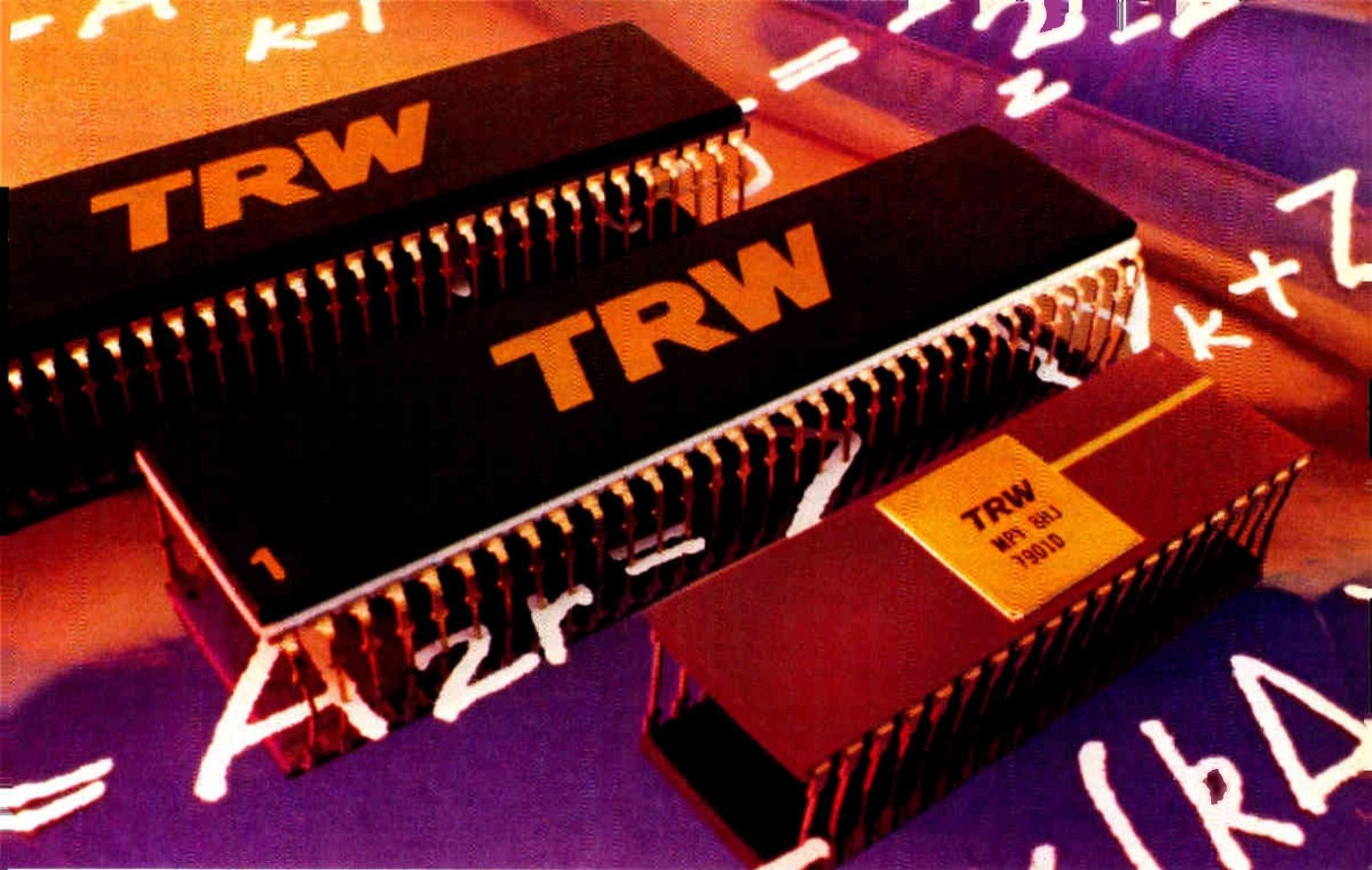

16x16-bit multiplication in only 100 nsec

(From a single chip.)

If you design digital filters or FFT processors... Or if you want to increase the computational speed of a micro-processor... take a look at our "HJ" line of bipolar, monolithic multipliers. These super-fast chips give you added performance at greater speed and save circuitry, power and money in the process. One of our customers used 4 of our MPY-16HJ's and tossed out 98 multipliers he'd previously needed for the same function. That's real savings! One of our "HJs" ought to give you real savings, too.

Plus such important features as...

- On-chip input and output registers with 3-state outputs.
- Two's complement or unsigned magnitude.
- Controllable transparent output registers (12x12 and 16x16 only).
- TTL compatible.
- Double precision product.
- Single power supply, +5V.
- Pin-compatible with our "AJ" series multipliers.

These super-multipliers are in stock at Hamilton/Avnet.

For immediate information, call us at (213) 535-1831 or send us the coupon or just attach your business card to this page and mail it back to us.

Multiplier	Word Size (Bits)	Speed (nsec)	Power (Watts)	Unit Price (in 100s)**
MPY-16HJ*	16x16	100	3.0	\$157
MPY-12HJ*	12x12	80	2.0	\$103
MPY-8HJ*	8x8	65	1.0	\$ 47
MPY-8HUJ	8x8	65	1.2	\$ 47
MPY-8HJ-1*	8x8	45	1.0	\$ 57
MPY-8HUJ-1	8x8	45	1.2	\$ 57

*Guaranteed operation over $T_C = -55^\circ\text{C}$ to $+125^\circ\text{C}$ available for military applications.

**U.S. Prices

TRW LSI Products
 P.O. Box 1125
 Redondo Beach, CA 90278

Please send data sheets on the HJ family of multipliers.

Name _____

Company _____

Div/Dept _____ Mail Code _____

Address _____

City _____

State _____ Zip _____ E-8

TRW keeps you ahead in digital signal processing

TRW LSI PRODUCTS
 An Electronic Components Division of TRW Inc.

that all of its settings can be changed simultaneously for a new measurement. Four cursors aid single-digit changes of program settings, and a beep tone registers the program changes with a single beep or warns the user of an incorrect setting with a double beep. Once entered, up to five collections of instrument settings may be stored in the instrument's memory (an option allows 40 settings) and recalled as needed. For further convenience, the GP-IB coding string of recent program settings can be displayed or placed on the bus in talker mode.

The 178 is capable of both ampli-

tude and phase modulation. For amplitude modulation, a 0-to-10-MHz input signal delivering 5 V p-p into 600 Ω produces 100% modulation of the generated signal, though modulation up to 200% is permitted. Phase modulation is achieved with a 0-to-10-kHz input signal of 5 V p-p maximum into a 10-k Ω impedance. In addition, the 178-generated signal may be phase-locked onto an external clock reference.

Model 178 is priced at \$3,995, with delivery from stock to 30 days. Wavetek, 9045 Balboa Ave., San Diego, Calif. 92123. Phone (714) 279-2200 [362] Booth 2354

with the Signetics 2653 large-scale integrated circuit used for internal character checking, makes possible the board's special data-transfer and handling routines. A receiver buffer is also included for a minimum of 16 characters.

In operation, the 6800 chip provides overall control. Data is received by the 2651 interface chip, which may hold it in the buffer before transfer to the host memory. At the same time, the 2653 chip, while monitoring data lines, does checking on a character-by-character basis—a performance function not offered by DEC on any asynchronous interface, MDB observes. With the new MDB DML-11, this feature is switch-selectable.

Also notable is the flexibility offered to the user by having the data move through the 6800 processor on the way to the programmable interface chip, and between the buffer and host. This arrangement makes it possible to specifically tailor firmware, using the microcomputer development system, to perform formatting, character-sequence recognition, or many dedicated application functions.

Though the new board is unique, it is plug-compatible with the DEC DL-11 input/output interface, which has been in use for more than 10 years. Furthermore, the MDB board can use any DEC software that has a

PDP-11 gets serial interface with 19,200-b/s rate

As requirements for major minicomputer lines become more sophisticated, particularly in data communications, the lack of compatible hardware to meet them becomes more and more apparent. Such is the case with Digital Equipment Corp.'s widely installed PDP-11, which has no Unibus-compatible, asynchronous, direct-memory-access serial-communications interface with only one line for high-speed data transfer.

Bidding to fill this void with its new DML-11, to be introduced at Wescon, is MDB Systems Inc., which specializes in DEC-compatible hardware. The new board runs at speeds of up to 19,200 b/s, making it ideal, says the company, for applications where data must be transferred at high speeds.

Those needing the MDB board usually face a dilemma: either adopt a throughput-limited DEC input/output or operate in a synchronous mode for speed. Unfortunately, the latter decision effectively converts the central processor into a dedicated device. An alternative, if space is available, might be to install a DEC DMA multiplexer with 16 lines and multiple boards, but this is an ineffi-

cient solution when just one line is needed for DMA.

A marriage. Besides filling a promising market void, the new product is expected to generate interest because of its microprocessor control feature, according to MDB officials. The MDB designers have married (for the first time in a DEC application, they say) a Motorola 6800 processor and a Signetics 2651 programmable communications chip. This combination, along

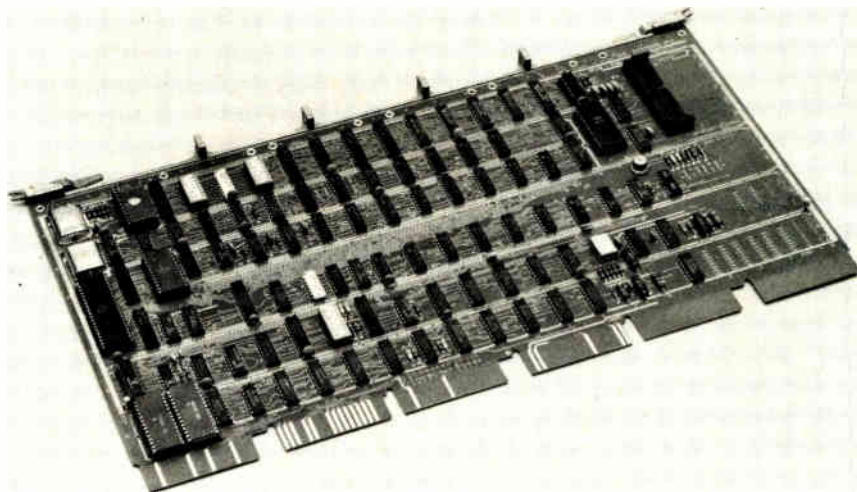

New
Kodastar
WASH-OFF PRODUCTS



©Eastman Kodak Company, 1980

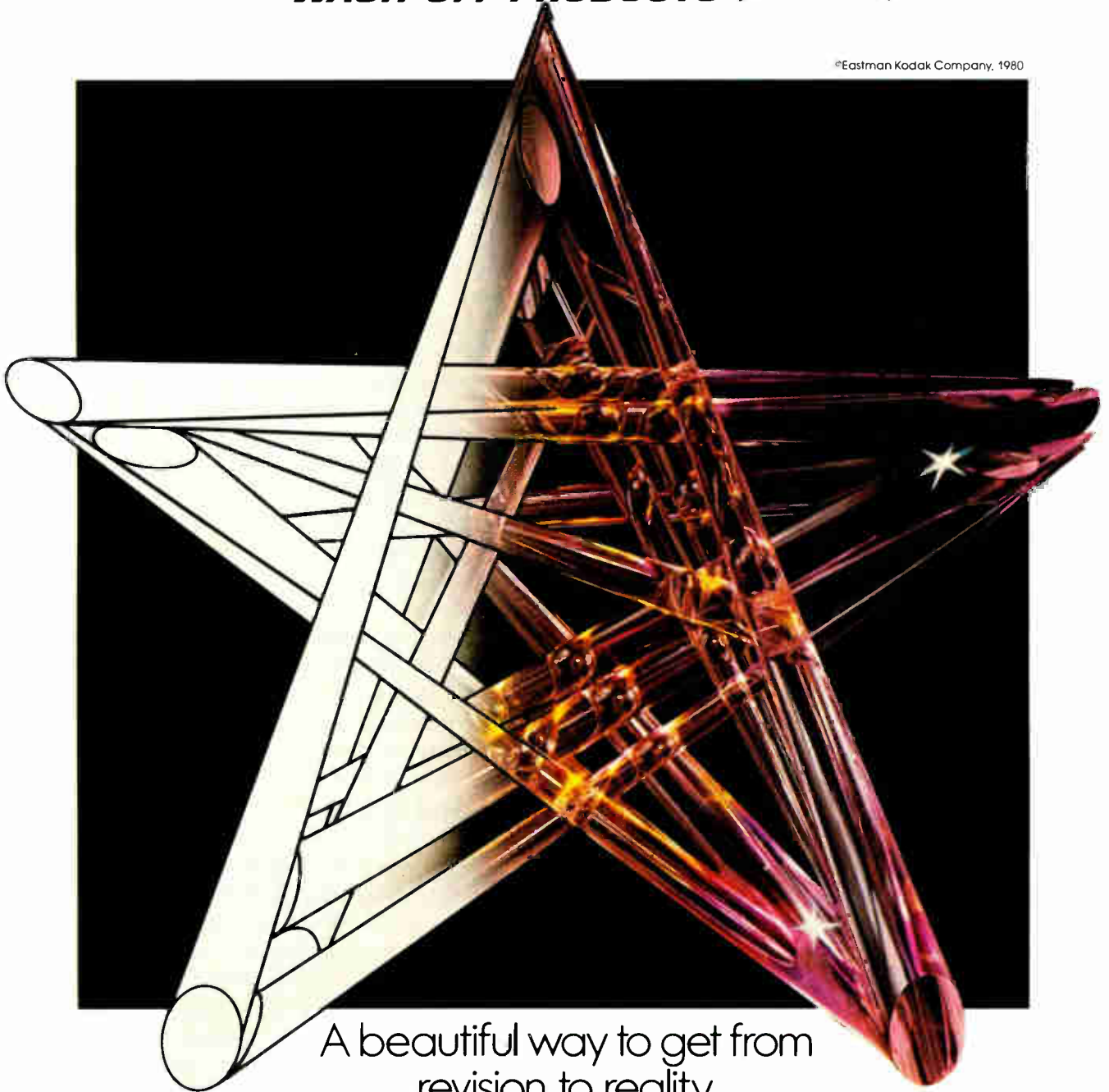

A beautiful way to get from
revision to reality.

Now there's a wash-off film that's mightier than the pen, pencil, and eraser.

A wash-off film that'll take revision, after revision, after revision.

With negligible or no ghosting. One that gives you reproductions so fresh and crisp, you may mistake them for originals. Reproductions that are dimensionally stable and that will not tear, crack, or grow brittle.

Excellent durability. Excellent stability. Excellent erasability. New KODASTAR Wash-Off Films. Now you've got an excellent choice.

SEND FOR A FREE SAMPLE OF NEW KODASTAR WASH-OFF FILM.

Prove to yourself you've never tried anything like it.

Eastman Kodak Company, Dept. GD018, Rochester, NY 14650



Circle 225 on reader service card

Clamping Ideas from Weckesser

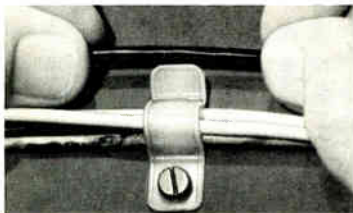

Nylon FLEX-CLIP

Slip wires in or out for changes or removal. Contour of clip plus spring-back flexibility of nylon provides easy assembly, yet holds bundles securely.

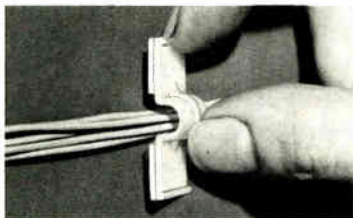

Nylon PRESS CLIP

Peel off... press and it's on to stay. Adhesive-back provides fastest way yet to install clips. Four sizes for bundles from 1/8" to 1/2" dia.

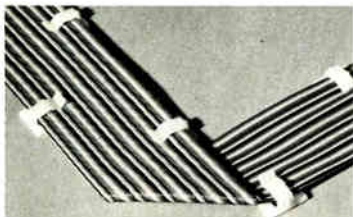

PRESS CLIP for flat cable

One size nylon clip for any width flat or ribbon cable. Used along edges, provides unlimited flexibility in mounting arrangements. Adhesive-back or screw mounting hole.

Write for catalogs.

Weckesser
COMPANY, Inc.

4444 W. Irving Park Road
Chicago, Illinois 60641 (312) 282-8626

Wescon/80

DL-11 A, B, C, or D driver. The DML-11 offers optical isolation and has receiver/drivers for RS-232 or current-loop interfacing.

The MDB board will sell for \$1,850, with initial deliveries in 60

days; later, when production levels are reached, deliveries will be in four to six weeks.

MDB Systems Inc., 1995 N. Batavia, Orange, Calif. 92665. Phone (714) 998-6900 [354] Booth 2639

8½-lb audio power meter reads 300 μW to 10 W full scale

Marconi Instruments' latest audio-frequency power meter is portable enough for field use and accurate enough for a variety of applications. The model 893B covers a full-scale power range from 300 μW to 10 W in 10 ranges and operates over the frequency range of 20 Hz to 35 kHz. The unit provides 48 impedances from 2.5 Ω to 20 kΩ, accurate to ±7% at 1 kHz. Available with balanced or unbalanced inputs, the instrument is directly calibrated in both watts and dBm.

Requiring no power supply, measuring 6 by 9.7 by 13.3 in., and weighing 8½ lb, the power meter is truly portable. In addition to applications in the laboratory and on the production line, notes John M. Gorbald, applications engineer, "the

user can take it into the field to provide on-site measurements, which is a nice feature." He feels that the military should find the 893B especially useful.

Power ranges. The unit's power measurements are accurate to within ±7% of full-scale deflection ±10 μW from 100 Hz to 10 kHz at 5° to 35°C. The power level of the 893B is less than 3 dB down—typically 0.7 dB down—at 20 kHz relative to a 1-kHz level. At 50 Hz, the power level is less than 1 dB down relative to a 1-kHz level. The instrument may be used over the extended frequency range of 20 Hz to 35 kHz with reduced accuracy.

Available also in a sinad version, the power meter incorporates a switchable 1-kHz filter to test signal-



10 to 30 MHz oscilloscopes with more

performance
and reliability
than you
ever thought
possible.



It's easy to see why LEADER oscilloscopes are now specified more than ever. More performance and quality for less cost... with immediate deliveries from over 100 stocking distributors. They also come with the best two-year warranty in the industry... backed by efficient factory service depots on the East and West Coasts.

A full-range of reliable, medium bandwidth oscilloscopes.

LEADER's oscilloscope line includes 11 models, single and dual trace versions, for bench or field use. All models offer comprehensive triggering controls, TTL compatible Z-axis modulation, front panel trace alignment control and convenient, color-keyed front panel layout. Probes are furnished with every oscilloscope and options include probe pouches, carrying cases, front panel covers and rack mounting adapters.

30 MHz delayed sweep - \$1,530.

LBO-515B is a compact, precision oscilloscope at a moderate price. Using a PDA 4-inch CRT with parallax-free internal graticule, it features 5 mV sensitivity and delayed sweep for viewing and measuring complex waveforms. Also has 120 ns signal delay, trigger hold-off and x-y operation at full sensitivity.

30 MHz with signal delay - \$1,100.

LBO-520 combines a 11.7 ns rise time with 5 mV sensitivity and 120 ns signal

The surprising leader.

delay lines. Has single shot triggering, X10 sweep magnifier and bright, sharp PDA CRT. Triggers to 50 MHz.

20 MHz dual and single trace - \$835., \$610.

LBO-508A and LBO-507A give you versatility at low cost. Rise time is 17.5 ns with 1 M Ω (35 pFd) input impedance. Automatic or external triggering, X5 sweep magnifier, 10 mV/cm sensitivity and add/subtract modes.

10 MHz with 1 mV sensitivity - \$645.

LBO-514 has both vertical and horizontal X5 magnifiers. Sensitivity is from 1 mV/cm to 10 V/cm. Sweep speeds from 0.2 s/cm to 0.1 μ s/cm. Auto or normal triggering. Z-axis modulation. (Single trace version, LBO-513, \$495.)

20 MHz battery/ac portable - \$950.

LBO-308S provides lab performance and high reliability in field service applications. Sensitivity is 2 mV with a complete set of triggering controls and 18 sweep ranges to 0.1 μ s/div. with X5 magnifier. Compact, lightweight with 3-inch rectangular, internal graticule CRT. (Optional 2 hour internal battery pack is recharged during ac operation, \$75.00.)

Two-year warranty. Evaluation units.

A history of high reliability permits LEADER to provide a generous 2-year warranty... backed by factory service depots on the East and West Coasts. A free, trial use of LEADER instruments

is available to all qualified companies.

Call toll-free (800) 645-5104 to request:

- an evaluation unit
- our 40-page catalog
- the name of your nearest "Select" distributor
- additional information



Oscilloscopes, frequency counters, function generators, video and audio instruments... a LEADER instrument for almost every need.

When Quality Counts

LEADER
Instruments Corporation

380 Oser Avenue
Hauppauge, N.Y. 11787 (516) 231-6900
Regional Offices:
Chicago, Los Angeles, Dallas.

New EPROM Tester and Duplicator



The new UPP-2700 is now saving thousands of dollars for its owners by testing EPROMS both before and after programming. Many customers like Bell Labs, IBM, Litton and others have found the value of screening marginal EPROMS before they reach their end product.

The UPP-2700 from OAE is the only EPROM duplicator which tests for shorts, opens, excessive leakage, and static damage on both data and address buses. This combined with sink and source current tests makes the UPP-2700 the most advanced production duplicator available today.

Simply touch the AUTO PROG key and the UPP-2700 will TEST-PROGRAM-VERIFY and TEST sixteen 2708's in less than 130 seconds! All EPROMS from 2704's to the new MCM68764 may be both tested and programmed using plug-in firmware modules. Add the UPP-2700S Satellite Tester/Duplicator and program up to 32 devices simultaneously!

For a complete information packet on the UPP-2700 simply fill out and return the form below or call the OAE HOTLINE at (213) 240-0080. Find out why 3 out of 4 manufacturers who try it, buy it!



Oliver Advanced Engineering, Inc.
Dept. 321, 676 West Wilson Avenue
Glendale, CA 91203 (Telex: 194773)

Name _____
Company _____
Div/Dept _____ Mail code _____
Address _____
City _____
State _____ Zip _____

See us at Wescon '80 Booth #2727

228 Circle 228 on reader service card

Wescon/80

to-noise performance. The sinad measurement—signal plus noise plus distortion over noise plus distortion—is a standard test on mobile radio equipment. This test is done by comparing two power-level readings. An initial reading is taken with the notch filter switched out; a second reading is then taken with the filter in to remove the 1-kHz fundamental. The difference between these two readings on the dBm scale gives the sinad ratio.

The 893B's sinad filter has a rejection at its 1-kHz center frequency of at least 20 dB at an input power of

1 W and at least 30 dB at 300 mW or less. The filter has a 3-dB bandwidth not greater than 480 Hz and a 20-dB bandwidth of at least 150 Hz. When the sinad filter is in the circuit, the maximum total input power is 1 W.

The 893B power meter sells for \$1,450 in single quantities. If the sinad filter option is chosen, the price rises to \$1,610. The unit is available for immediate delivery.

Marconi Instruments, a division of Marconi Electronics Inc., 100 Stonehurst Ct., Northvale, N. J., 07647. Phone (201) 767-7250 [359]
Booth 2469

Sample-and-hold amplifier has 5-mV/ms guaranteed droop rate

The 4860 hybrid sample-and-hold amplifier from Teledyne Philbrick uses a high-speed double-diffused MOS field-effect-transistor switch to achieve fast acquisition times. The amplifier takes a guaranteed maximum of 200 ns to acquire data to 0.125% of its 10-v full scale or 100 ns to 0.1%. Its droop rate remains low at a guaranteed 5 mV/ms; 2 mV is typical.

This level of performance can extend the capabilities of data-acquisition and signal-analysis systems, whose major limitation is conversion speed, says Jeffery R. Swift, engineering group leader for data-acquisition products. Working in tandem with a high-speed analog-to-digital converter like Teledyne Philbrick's

4134, the 4860 amplifier makes possible signal analysis of waveforms of up to 250 kHz, Swift says. In its 100-ns version, it could also operate with many 6- and 8-bit chips capable of "flash conversion" times of around 35 ns, he adds, allowing signal analysis to 3.5 MHz.

Gain and offset temperature coefficients both are 10 ppm/°C, and Swift expects the power supply rejection ratio to be a guaranteed 2.5-mV/V change. Feedthrough error for any input from direct current to 2.5-MHz of alternating current is a minimum -70 dB. The inverting device has unity gain and $\pm 0.1\%$ of full scale at dc, and the company rates its linearity at 0.005%.

The amplifier has a 3-dB bandwidth of 10-MHz minimum; 15-MHz is typical. Guaranteed slew rate, typically 350 V, is guaranteed at 250 V. Sample-to-hold settling time is 120 ns to 0.01% of full scale, or 65 ns to 0.1%.

The 4860 requires ± 15 -v ac, and its output is ± 10 v at ± 50 mA. The amplifier is pin-compatible with the HTC-0300 from Analog Devices Inc.'s Computer Laboratories division, Swift says.

Teledyne Philbrick is still working





FREE SAMPLES.

See for yourself
why design engineers
specify more CTS cermet resistor networks
than any other make.

There is one large overriding reason. Reliability!

Each CTS SIP and DIP network is 100% value and tolerance tested before shipment. And, with more than 1 billion element hours of extended load life testing, CTS resistors have exhibited a failure rate of only 0.00047%/1,000 hours @ a 95% confidence level.

CTS networks are built reliable...using top quality materials, precision screening equipment, proprietary cermet formulations and computer controlled lasers for fine tolerance adjustment. Terminals are anchor-locked into the substrate

for maximum mechanical and electrical reliability.

CTS has been a leader in custom designed circuits for over 15 years. Ask us about customizing your special network requirements or choose from 400 standard part numbers available off the shelf from authorized CTS distributors.

For the utmost in cermet network reliability, quality and availability, you can't choose a better network source than CTS. Send for your free samples and resistor network catalog today. Write CTS of Berne, Inc., 406 Parr Road, Berne, Indiana 46711. Telephone: (219) 589-8220.

CTS CORPORATION
ELKHART, INDIANA



A world leader in cermet and variable resistor technology.

**NOW LOOK AT THE PERFORMANCE
YOU CAN GET FOR A 200nS PRICE.**

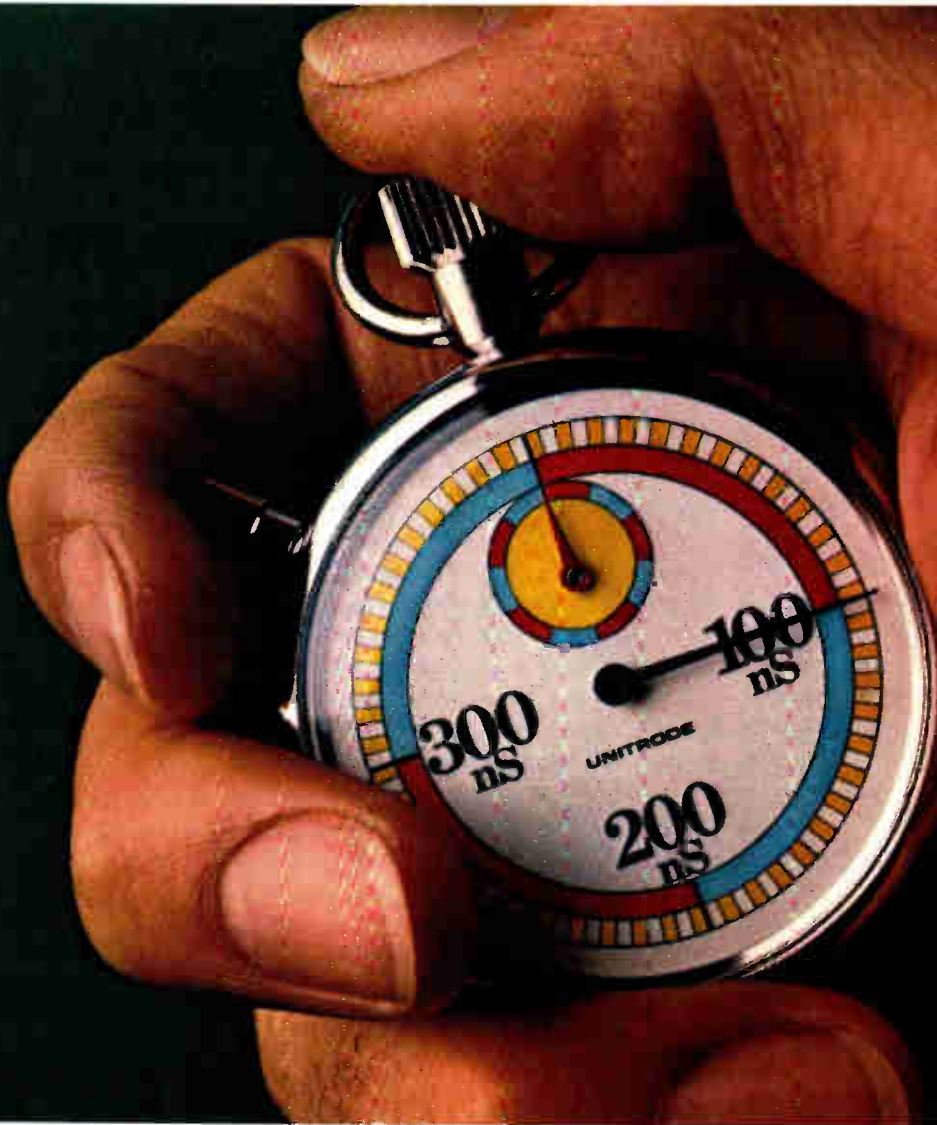

UNITRODE'S NEW 100nS "SES" POWER RECTIFIERS

Sometimes you need more performance than you'd get from an ordinary fast recovery PN junction rectifier. But can't justify the premium you'd pay for a Schottky.

That's why Unitrode developed a whole new line of 100nS Super Efficient Switching "SES" rectifiers.

Although they're priced like ordinary fast recovery rectifiers, they don't perform that way. In

addition to a 100nS recovery time, they also deliver a better forward voltage drop—less than 1V at rating. And since our new SES rectifiers are so

efficient, they generate less heat. Which means you can simplify your circuit design while you're improving its performance.

Our new SES rectifiers are available in seven different packages, with ratings from 2A to 60A and 50V to 150V.

For more information, call your nearest Unitrode representative or distributor listed next to this ad. And find out how you can get twice the performance without paying for it.

Unitrode Corporation,
5 Forbes Rd., Lexington, MA
02173, U.S.A. Telex 95-1064,
TWX 710-326-6509.

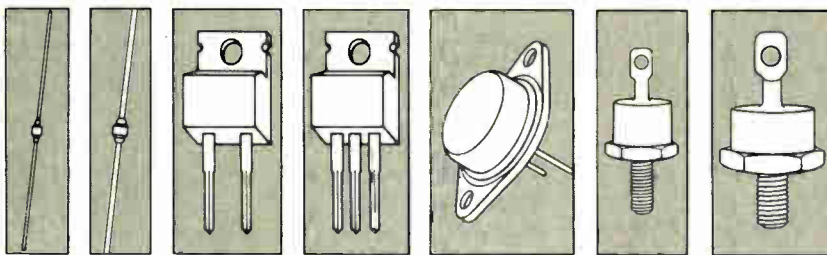

Unitrode Representatives:

Alabama: Conley & Assoc. 205-882-0316
Arizona: Fred Board Assoc. 602-994-9388
California: I² 408-988-3400; Great American Rep Company 714-832-8113; Great American Rep Company 213-990-4870; SR Electronics (San Diego) 714-560-8330
Colorado: Component Sales 303-759-1666
Connecticut: Kanan Assoc. 203-743-1812
Florida: Conley & Assoc. (Oviedo) 305-365-3283; Conley & Assoc. (Boca Raton) 305-395-6108; Conley & Assoc. 813-885-7658
Georgia: Conley & Assoc. 404-447-6992
Illinois: Carlson Electronic Sales 312-956-8240
Indiana: Carlson Electronic Sales 317-842-3740
Iowa: Carlson Electronic Sales 319-377-6341
Kansas: Rush & West Assoc. 913-764-2700
Maryland: New Era Sales 301-768-6666
Massachusetts: Kanan Assoc. 617-944-8484
Michigan: Miltimore Sales 313-349-0260; Miltimore Sales 616-942-9721
Minnesota: Electronic Innovators 612-941-0830
Missouri: Rush & West Assoc. 314-394-7271
New Mexico: Repronix 505-881-8001
New York: Lorac Sales 516-681-8746; Reagan/Compar Albany 518-489-7408; Reagan/Compar Albany 315-732-3775; Reagan/Compar Albany 716-271-2230; Reagan/Compar Albany 607-723-8743
North Carolina: Conley & Assoc. 919-787-8090
Ohio: Baehr, Greenleaf & Assoc. (Cincinnati) 513-891-3826; Baehr, Greenleaf & Assoc. (Dayton) 513-293-1102; Baehr, Greenleaf & Assoc. 216-221-9030; Baehr, Greenleaf & Assoc. 614-486-4046
Oregon: Vantage Corp. 503-297-1714
Pennsylvania: GCM Assoc. 215-233-4600; Bacon Electronic Sales 814-796-2381
Texas: Sundance Sales 214-699-0451; Sundance Sales 512-250-0320
Utah: Component Sales 801-484-4222
Washington: Vantage Corp. 206-455-3460
Wisconsin: Carlson Electronic Sales 414-476-2790
Canada: Kaytronics 514-487-3434; Kaytronics 416-669-2262; Kaytronics 403-276-9844

Unitrode Distributors:

Alabama: Hall-Mark
Arizona: Kierulff Electronics; Wyle Distr. Group
California: (Northern) Arrow Electronics; Components Plus; Kierulff Electronics; Wyle Distr. Group
California: (Southern) Components Plus; Kierulff Electronics; Wyle Distr. Group
Colorado: Arrow Electronics; Bell Industries; Kierulff Electronics; Wyle Distr. Group
Connecticut: Arrow Electronics; Lionex
Florida: Arrow Electronics; Hall-Mark; Kierulff Electronics; Pioneer
Georgia: Arrow Electronics
Illinois: Arrow Electronics; Hall-Mark; Kierulff Electronics; RM Electronics
Indiana: Pioneer; RM Electronics
Kansas: Hall-Mark
Maryland: Arrow Electronics; Hall-Mark
Massachusetts: Arrow Electronics; Kierulff Electronics; Lionex
Michigan: Pioneer; RM Electronics
Minnesota: Arrow Electronics; Hall-Mark; Industrial Components; Kierulff Electronics
Missouri: Hall-Mark
New Hampshire: Arrow Electronics
New Jersey: Arrow Electronics; Kierulff Electronics
New Mexico: Bell Industries
New York: Arrow Electronics; Components Plus; Lionex
North Carolina: Arrow Electronics; Hall-Mark; Hammond Electronics
Ohio: Hall-Mark; Pioneer
Oklahoma: Hall-Mark
Pennsylvania: Arrow Electronics; Hall-Mark; Pioneer
Texas: Arrow Electronics; Components Plus; Hall-Mark; Lenert
Utah: Bell Industries; Kierulff Electronics
Washington: Kierulff Electronics; Shannon, Ltd.; Wyle Distr. Group
Wisconsin: Hall-Mark; Kierulff Electronics; Taylor Electric
Canada: Future Electronics

The NEW Electronics Buyers' Guide is now available!

Completely new listings of catalogs, new phone numbers, new addresses, new manufacturers, sales reps, and distributors! The total market in a book — four directories in one!

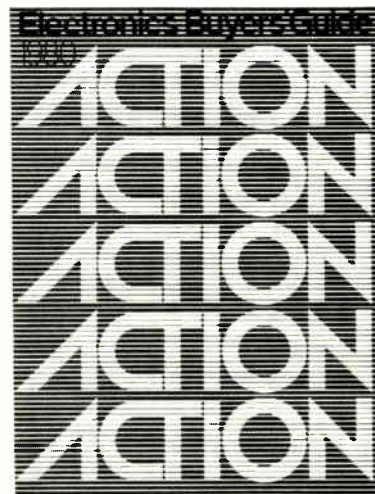

The only book of its kind in the field.

If you haven't got it, you're not in the market.

To insure prompt delivery enclose your check with the coupon now.

Yes, please send me _____ copies of 1980 EBG.

- I've enclosed \$30 per copy delivered in USA or Canada. Address: EBG, 1221 Avenue of the Americas, New York, N.Y. 10020.
 I've enclosed \$52 for air delivery elsewhere. Address: EBG, Shoppenhangers Road, Maidenhead, Berkshire S16, 2Q1 England.

Name _____

Company _____

Street _____

City _____

State _____

Zip _____

Country _____



UNITRODE

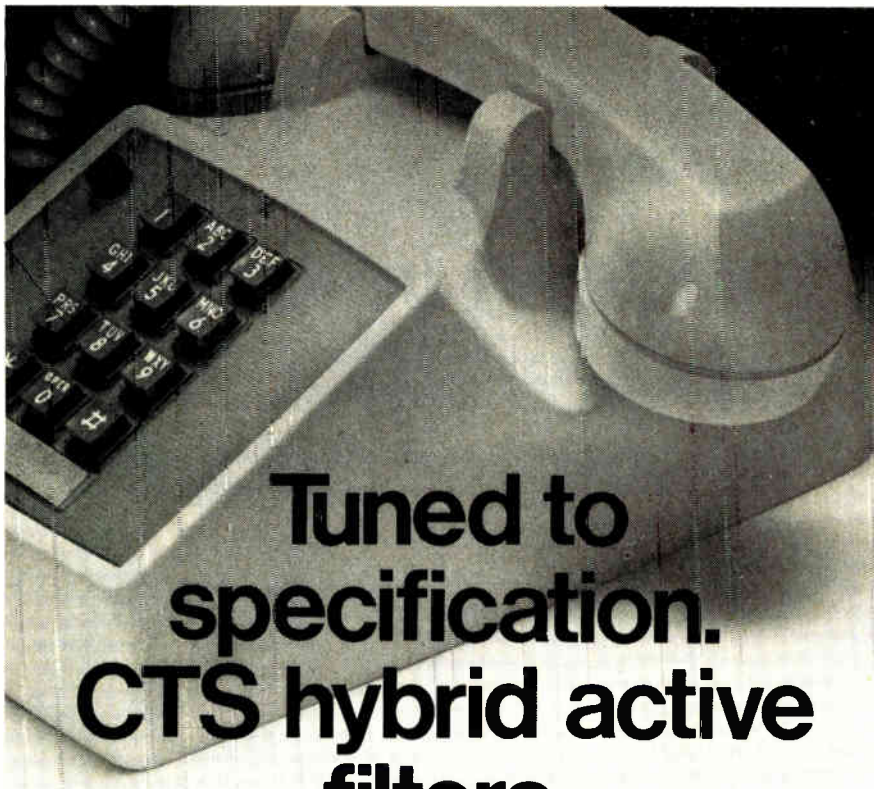

**Tuned to
specification.
CTS hybrid active
filters.**

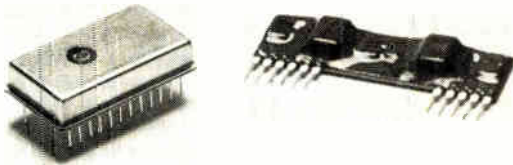

CTS hybrid active filters eliminate costly on-line filter tuning/resistor selection. The SIP configuration saves valuable board space and reduces assembly costs. The 24-pin DIP Band Pass Filters are designed to second source your present suppliers.

CTS offers both Band Split and Band Pass DTMF filters as well as transmit and receive PCM D3 filters (see chart).

For more information, use Reader Service Number or contact CTS Microelectronics, Inc., 1201 Cumberland Avenue, West Lafayette, Indiana 47906. Phone (317) 463-2565.

Filter Type	Package
600538 DTMF High Group Band Split	SIP
600539 DTMF Low Group Band Split	SIP
600540 DTMF Dial Tone Reject	SIP
600623 DTMF Low Group Band Pass	SIP
600624 DTMF High Group Band Pass	SIP
600637 DTMF Low Group Band Pass	Double DIP
600638 DTMF High Group Band Pass	Double DIP
600594 PCM D3 Receive	SIP
600595 PCM D3 Transmit	SIP
600596 PCM D3 Transmit	SIP

CTS CORPORATION

ELKHART, INDIANA



Total capability in thick and thin film hybrid technology.

out a pricing structure for the 4860 amplifiers, Swift reports, but commercial-grade models operating at 0° to +70°C will cost \$215 each, or less than \$175 in lots of a hundred. Military-range models also will be available, as will processing to MIL-STD-883. Delivery times following the 4860's Wescon introduction will range from 12 to 16 weeks.

Teledyne Philbrick, Allied Drive at Rte. 128, Dedham, Mass. 02026. Phone (617) 329-1600 [361]
Booth 2139

**Board features
uncommitted
area for I/O pads**

Vector Electronic Co. will introduce an interface board compatible with the Motorola Exorciser and Rockwell International AIM 65 buses. The 4611 series of boards features a large uncommitted pad area near the top intended to keep the board from becoming input/output-bound during early system development. Engineers can use bus interconnections on the card edge while designing appropriate ribbon-wire connectors to handle I/O requirements. Up to 160 pins can be accommodated.

Three versions are available—bare, with dual-power buses, and with dual-power buses with three-hole pads. These configurations allow flexibility in determining interconnection methods and component placement, the company says. Model 4611, with three-hole pads interspersed with power and ground buses, holds up to 45 16-pin dual in-

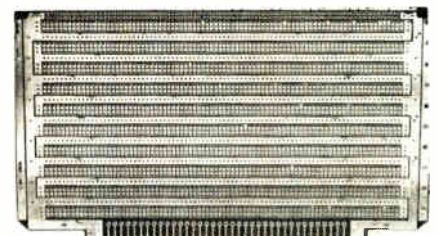

Test drive our high performance compact.

Over 20 million Aromat NF relays in use... built for high performance, with a low profile that's perfectly suited for the busy traffic patterns of today's high density PC boards. Responsive handling is the key to the NFEBS reliability, with shock absorbing construction to ensure smooth long lasting performance. Aromat was the pioneer in plastic sealed relays over 10 years ago, and is now producing the NFEB in the U.S. Extensive test data, gathered here and abroad, prove the dependability of these relays.

SPECIFICATIONS

Contacts
 Arrangement..... 2, 4C
 Rating resistive load
 Max. switching power..... 60W 100VA
 Max. voltage..... 220V AC/DC
 Max. current..... 2A
 UL rating..... 0.5A 125V AC, 2A 30V DC
 VDE rating..... 1A 65V AC, 2A 30V DC
 Expected life, min. operations
 Mechanical..... NF2 3 x 10⁶, NF4/10⁶
 Electrical (2A 30V DC Resistive)..... 10⁶
 (1A 30V DC Resistive)..... 5 x 10⁶
 Initial contact pressure..... approx. 8.5g (0.3 oz)
 Contact bounce..... approx. 1.5 msec.
Contact material
 Movable contact..... Gold-clad silver
 Stationary contact..... Gold-clad silver
 For telephone circuit applications gold-clad silver-palladium type is available rated 0.1A 50V DC 10 x 10⁶ operations
 Initial contact resistance
 Maximum..... 50 mΩ
 Typical..... 25 mΩ
Coil
 Min. operating power (at 25°C)..... approx. NF2/150mW, NF4/240mW
 Nominal operating power (at 25°C)..... approx. NF2/300mW, NF4/480mW
 Max. operating power for continuous duty..... 1W at 40°C 104°F
Characteristics (at 25°C, 50% R.H. sea level)
 Max. operating speed..... 50 cps
 Operate time..... approx. 10 msec.
 Release time..... approx. 5 msec.
Electro static capacitance
 Contact/Contact..... approx. 4 pF
 Contact/Coil..... approx. 7 pF
 Contact/Ground..... approx. 6 pF
Breakdown voltage
 Between open contacts..... 750Vrms
 Between contact sets..... 750Vrms
 Between live parts and ground..... 1,000Vrms
 Between contacts and coil..... 1,000Vrms
 Initial insulation resistance..... 1,000MΩ at 500VDC
 Ambient temperature..... -40 to +65°C
 -40 to +149°F
Shock/Vibration resistance
 Deenergized condition..... 8G 8G 55 cps.
 Energized condition..... 20G/20G 55 cps.
 Unit weight..... approx. NF2/14g (0.5 oz.)
 NF4/16g (0.6 oz.)
Specifications for MBB contact types
 Expected life, min. operations
 Electrical (1A 30V DC Resistive)..... 10⁶
 Breakdown voltage
 Between open contacts..... 200Vrms
 All other characteristics are the same as those of standard types.

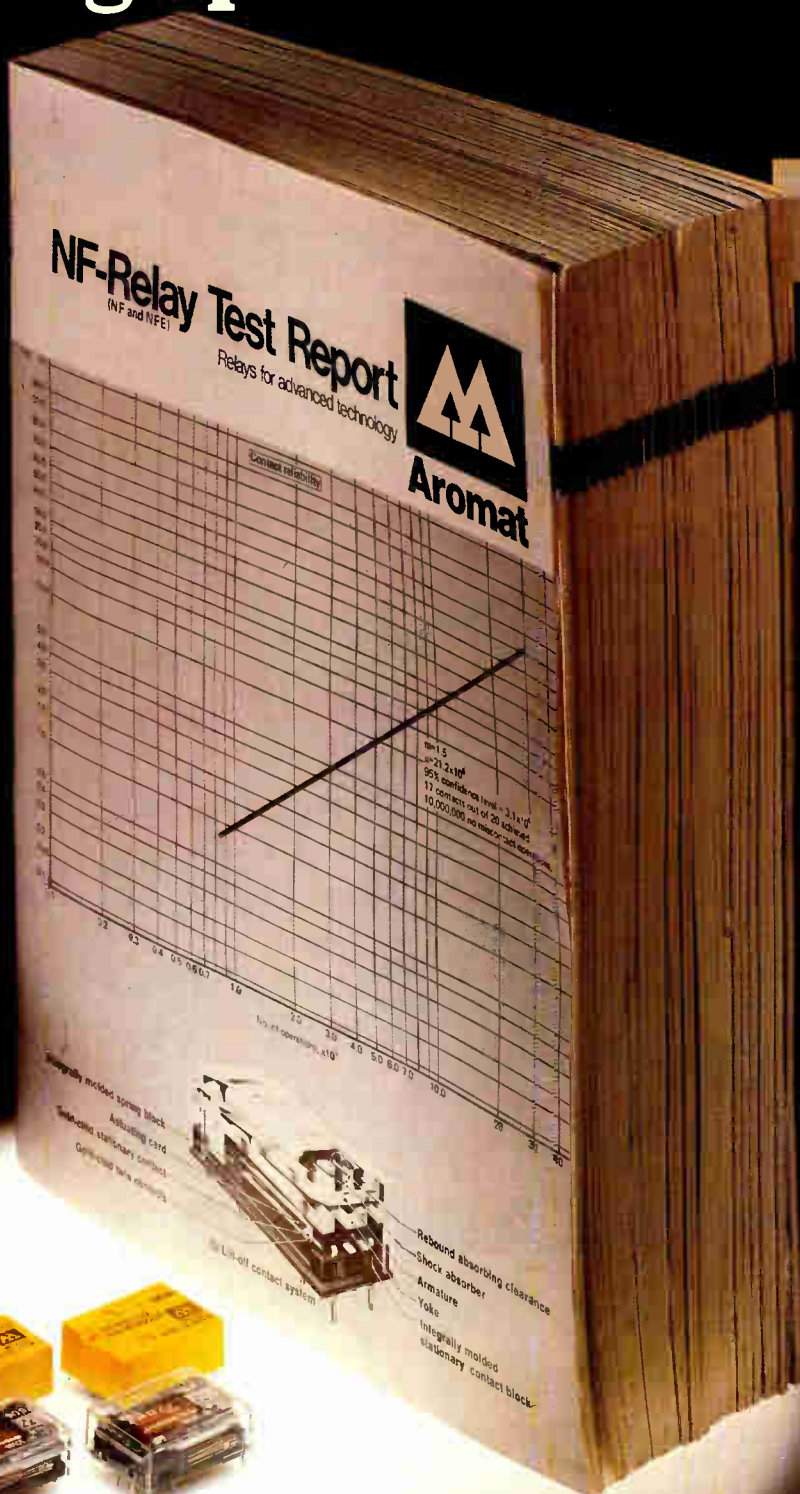

NFEB Amber Relay

SEE US AT WESCON '80/BOOTH #'s 1047, 1049, 1051"

Free Samples. Write to Aromat or your regional distributor today, and get a free sample and test data on the NFEB relay. Once you've driven this engineering marvel, you'll never turn back!



Aromat
 Member of Matsushita Group

Aromat Corporation:
 250 Sheffield Street
 Mountainside, NJ 07092
 (201) 232-4260

Mid-Western Office:
 311 Lively Blvd.
 Suite 1
 Elk Grove Village, IL 60007
 (312) 593-8535

Western Office:
 10400 North Tantau Avenue
 Cupertino, CA 95014
 (408) 446-5000

World's broadest family of smallest PCB switches.

ALCO designed and engineered the TT Series primarily for PC applications. Their small size allows placement between PCB's on 1/2" centers. All terminals and mounts fall into a 0.1" grid.

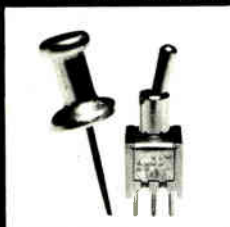

Your choice of toggles, pushbuttons, slides, rockers and LED lighted types in 1, 2 or 4 poles. Right angle types are our specialty and wire wraps too! Gold plated contacts are standard for low-level switching. Silver provides a 3 amp rating and is U.L. listed. A variety of panel mounted types also available. We pride ourselves by stocking hundreds of

standard types, many in production quantities to service your immediate needs. However, our engineers and production group can also provide literally thousands of custom types promptly and economically. We urge you to call or write Customer Service for 160-page ALCOSWITCH catalog and free sample.



standard types, many in production quantities to service your immediate needs. However, our engineers and production group can also provide literally thousands of custom types promptly and economically. We urge you to call or write Customer Service for 160-page ALCOSWITCH catalog and free sample.

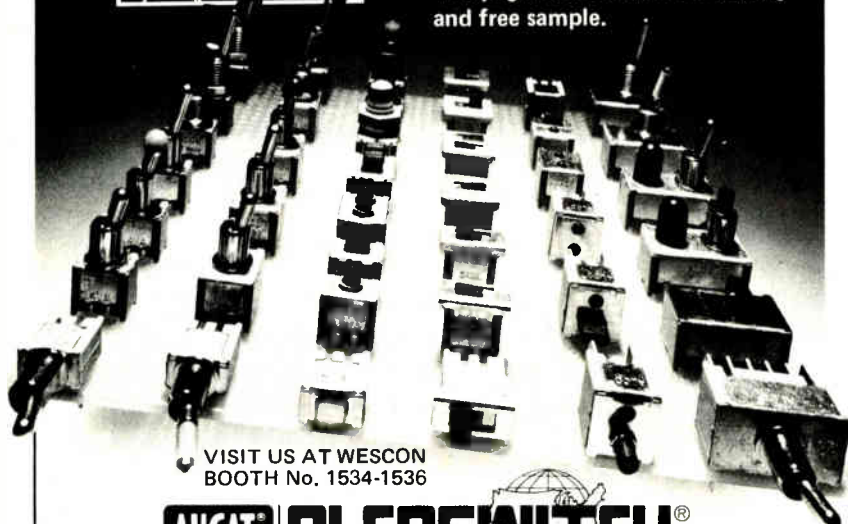

VISIT US AT WESCON
BOOTH No. 1534-1536

AUGAT® ALCOSWITCH®

ALCO ELECTRONIC PRODUCTS, INC.

1551 Osgood St., N. Andover, MA. 01845 (617)685-4371 TWX: 710 342-0552
EUROPE: Augat France SA (Z.I. Sofilic) B.P. 440-CEDEX 94263 Fresnes, France

Circle 234 on reader service card

Wescon/80

line packages or a lesser number of larger devices. It is intended primarily for soldered interconnections or solder mounting of wrap-post IC sockets and discrete components.

The model 4611-1 board is bare except for the edge connector. Used with wrapped-wire interconnections, it holds up to 119 16-pin DIPs.

The model 4611-2 prototyping board has only power and ground buses and is intended for wrapped wiring, holding up to 80 16-pin DIPs or a mix of sizes.

Connectors. All boards have an 8-in.-long uncommitted area for mounting the ribbon-wire connectors with two rows of leads on a 0.1-in. grid. Each has the standard Exorciser 43/86 contact card-edge connector.

Fabricated of blue epoxy-glass composite material, the 4611 series boards have 0.042-in. holes for component leads on 0.1-in. centers. Pads and buses are solder-plated over 2-oz copper.

Completely form- and fit-compatible with Exorciser and AIM 65 boards, the 4611 series boards measure 9.75 in. wide by 6 in. high by 0.062 in. thick. A complete line of terminals, sockets, card ejectors, and tools are available as options.

In single quantities, model 4611 is priced at \$29.95; the 4611-1 is \$19.95; and the model 4611-2 is \$29.95. Delivery is from stock.

Vector Electronic Co., 12460 Gladstone Ave., Sylmar, Calif. 91342 [355]
Booth 1414

NEW 1980 Electronics Buyers' Guide

The only book of its kind in the field. If you haven't got it, you're not in the market.

To insure prompt delivery enclose your check with this coupon.

Yes, please send me _____ copies of 1980 EBG.

I've enclosed \$30 per copy delivered in USA or Canada. Address: EBG, 1221 Avenue of the Americas, New York, N.Y. 10020.

I've enclosed \$52 for air delivery elsewhere. Address: EBG, Shoppenhangers Road, Maidenhead, Berkshire S16, 2Q1 England.

Name _____

Company _____

Street _____

City _____

State _____

Zip _____

Country _____

CRT terminal is comfortable to operate

The idea of providing more computing features at a lower price—along with human engineering to make terminals easier and more comfortable for their operators to use—is picking up a considerable amount of support

Hand-held computer power is here!

An autoranging DMM breakthrough from B&K-PRECISION.

B&K-PRECISION's new microcomputer controlled Model 2845 is a major advance in digital multimeter technology. At a price comparable to ordinary manually operated units the 2845 brings microcomputer intelligence to a handheld portable DMM. When applied to a circuit, its computer selects the range providing maximum resolution without the slow "hunting" action characteristic of many bench-type autoranging DMM's.

The 2845 is certainly the most user oriented hand-held DMM available. No other DMM can match its speed and simplicity of operation. With tilt stand, large display and optional AC power adapter, it becomes a remarkable inexpensive bench DMM.

- Microcomputer autoranging speeds operation and stabilizes readings
- Auto-skip program for best resolution in least time
- Easiest, fastest-to-use DMM available
- 0.1% basic DC accuracy
- 3½ digit, 0.5" LCD display
- Continuity test "beeper"
- Range-lock, holds selected range
- Measures AC/DC voltage; AC/DC current; resistance
- Meets tough U.L. 1244 safety standards

For immediate delivery, contact your local distributor or phone toll-free 800-621-4627 (except in Illinois) for detailed technical information.

B&K PRECISION

**DYNASCAN
CORPORATION**

6460 West Cortland Street
Chicago, Illinois 60635 • 312/889-9087

Int'l. Sales: 6460 W. Cortland St., Chicago, IL 60635
Canadian Sales: Atlas Electronics, Ontario

Model 2845 \$175



Circle #207 for free Demonstration
Circle #235 for Additional Information

Finally...Serious Expansion for the AIM-65



Introducing **Memory-Mate***, the AIM-65 expansion board that lets you spend your time on application solutions, not hardware hassles. Add Memory-Mate to your AIM-65 and make quick work of development and process control projects.

In its primary function, the Memory-Mate board provides 16-48K of RAM expansion assignable in 4K blocks anywhere in the system. Memory-Mate's parity check circuitry insures system RAM integrity (including AIM's 4K on-board RAM) for high reliability applications. The programmable write protect feature eases software development chores. This compact board, which fits directly beneath the AIM, also includes four programmable I/O parts, a tone generator for audible warnings, and sockets for 4K of PROM.

I/O intensive applications are accommodated with Memory-Mate's STD BUS interface option. Use off-the-shelf STD BUS cards to solve your biggest I/O problems.

The Memory-Mate with 16K RAM is priced at \$475, with 16K expansion chip sets (including parity chip) costing \$100 each. With 48-hour active burn-in and warranty for a full year, you won't have to worry about reliability either.

First of the complete AIM-Mate* series, Memory-Mate will be joined shortly by the Video-Mate*, Floppy-Mate* and the AIM-Mate case. For further information on the entire AIM-Mate series, write 'Attn: AIM-Mate Series' at the address below.

*TM Forethought Products

Forethought Products

87070 Dukhobar Rd., Eugene, OR 97402
(503) 485-8575

Circle 236 on reader service card

Wescon/80

among manufacturers in the U. S.

A series of microprocessor-controlled terminals from TEC Inc., to debut at Wescon, includes developments in both areas. Says executive vice president Wim H. J. Selders, "The 600 series is a response to economic aspects." Not only is the model 610 loaded with standard performance features at one of the lower prices in the business—\$1,090 for end users—but it also offers low-priced options for operator comfort.

One feature of the 610 singled out by Selders is its ability to handle data communications at rates of from 100 to 9,600 b/s, permitting "expansion from a simple teletypewriter into a batch-processing operation." There is also a buffer able to store a full page of text supporting the data-communications function. Low-end terminals operating in the Teletype mode usually are limited to providing only character-by-character displays.

Human engineering options include a tiltable terminal that also swivels so operators may adjust viewing angles. The detached keyboard, which also contributes to operating ease, is standard.

Fewer components. Simplicity has been the major design goal for the terminals, says the executive, so the entire logic board consists of just 18 off-the-shelf chips. An Intel Corp. 8039 processor serves as the controller. Cutting the chip count helps in both servicing and reliability, and Selders claims that company calculations, based on military procedures, indicate the terminal should have a 14,000-hour mean-time-between-failure rate.

For users who do not need a detached keyboard, an attached model 510 sells for \$900 in single end-user quantities. Later, higher-performance terminals—the 570 and 670 based on the Intel 8085 processor—will join the TEC line, along with models falling between these top models in the series and the 610.

TEC Inc. 2727 N. Fairview Ave., Tucson, Ariz. 85705. Phone (602) 792-2230 [357]
Booth 1150

Leaders in Electronics

The only reference devoted solely to biographies of the most influential people in electronics

- corporate executives • technical managers • designers and developers • government and military officials • academics • editors/publishers • securities analysts • trade/professional group directors • consultants ... plus an 80-page index of biographies by affiliation.

Prepared by the staff of **Electronics** magazine. 5,240 biographies. 651 pages, clothbound. \$39.50

Electronics Magazine Books
P.O. Box 669, Hightstown, NJ 08520
(609) 448-1700, ext. 5494

Send me _____ copies of *Leaders in Electronics* @ \$39.50 plus applicable sales tax. McGraw-Hill pays regular shipping and handling charges on pre-paid orders.

Payment enclosed Bill firm Bill me

Name _____

Company _____

Street _____

City _____ State _____ Zip _____

Signature _____

The Smart Counters.

Seven digit high and low frequency readouts in only one second!

- Microprocessor control
- 120MHz or 1GHz frequency range
- Auto-triggering on all waveforms
- High-contrast liquid crystal display
- High stability TCXO oscillator: 10^{-7} /month
- Line and battery options
- 15mV RMS sensitivity
- Self-test and self-diagnosis routine
- Easy operation through built-in intelligence

Philips introduces two new microprocessor-based frequency counters that give you easier and more error-free readouts—faster than ever thought possible.

Now you can measure an audio frequency or any low frequency in seven digits and perform this function in *only one second*. That's smart—and fast!

And "The Smart Counters" are also the *small* counters. Philips has dramatically reduced the number of components by utilizing an advanced technology microprocessor, dependable large scale C-MOS digital circuitry and

fully integrated monolithic front ends so that both units can handle a wide range of input signal voltages.

Thanks to Philips' wide-reaching research and development, it is now possible to reduce both the size and price of these counters and, at the same time, increase both their reliability and performance. Reliability and performance you can use and trust everyday in the lab or in the field.

For more information about the PM6667 and PM6668 call 800-631-7172, except in Hawaii, Alaska and New Jersey. In New Jersey call collect (201) 529-3800, or contact Philips Test & Measuring Instruments, Inc., 85 McKee Drive, Mahwah, NJ 07430.



From Philips, of course.



Test & Measuring
Instruments

PHILIPS

Circle 237 on reader service card

An evolutionary
idea from the creators
of the
StereoZoom[®]
Microscopes.

The New Bausch MicroZoom[™]

It solves
the hybrid and
packaged chip
inspection dilemma.

Now your inspectors can quickly scan packaged chips, then "zoom" each objective up to twice its power for closer examination. And that's just one of the many advantages of the new Bausch & Lomb MicroZoom Microscope.

Three long working distance objectives, giving total magnifications from 22.5X to 1000X—and higher—give ample working distances for chip inspection. There's virtually no chance of damaging chip or objective.

Erect, unreversed image for faster, easier inspections. Advanced vertical illumination with aperture control for true color rendition. And all this is standard. No costly add-ons.

But you can make it even more versatile than it already is. Add complete photomicrographic and CCTV accessories.

A dual-viewing system for training. It's the only **complete** microscope you can buy for chip inspections.

The new MicroZoom Microscope. It's exactly what you would expect from Bausch & Lomb.

Bausch & Lomb Microscope.

Take a
closer look.

For a convincing demonstration or
free catalog, return this coupon today.

- Please call for an appointment
 Please send your new MicroZoom
Microscope catalog

Name _____ Title _____

Address _____

City _____ State _____ Zip _____

Bausch & Lomb
Dept. 6606
1400 N. Goodman St.
Rochester, N.Y. 14602

E-82880



It has 3 long working
distance objectives,
each with exclusive
1X-2X zoom.

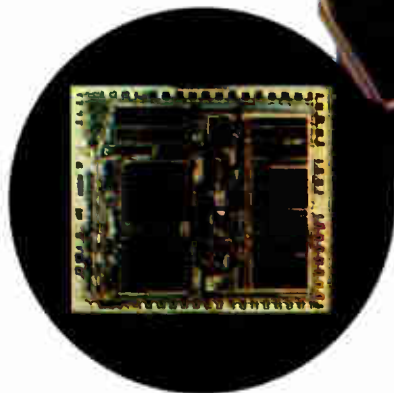

A full 1/4" chip can be
viewed at the lowest
magnification (22.5X).

Chip photo courtesy of Motorola Corp

Expedite your request
by calling toll-free:

800-648-5600
Ask for Operator 72

See the new MicroZoom™ Microscope
at SEMICON/East,
Booth 1303-1304.

BAUSCH & LOMB

Scientific Optical Products Division



Circle 239 on reader service card

**Will they
commit the
resources
we
need?**

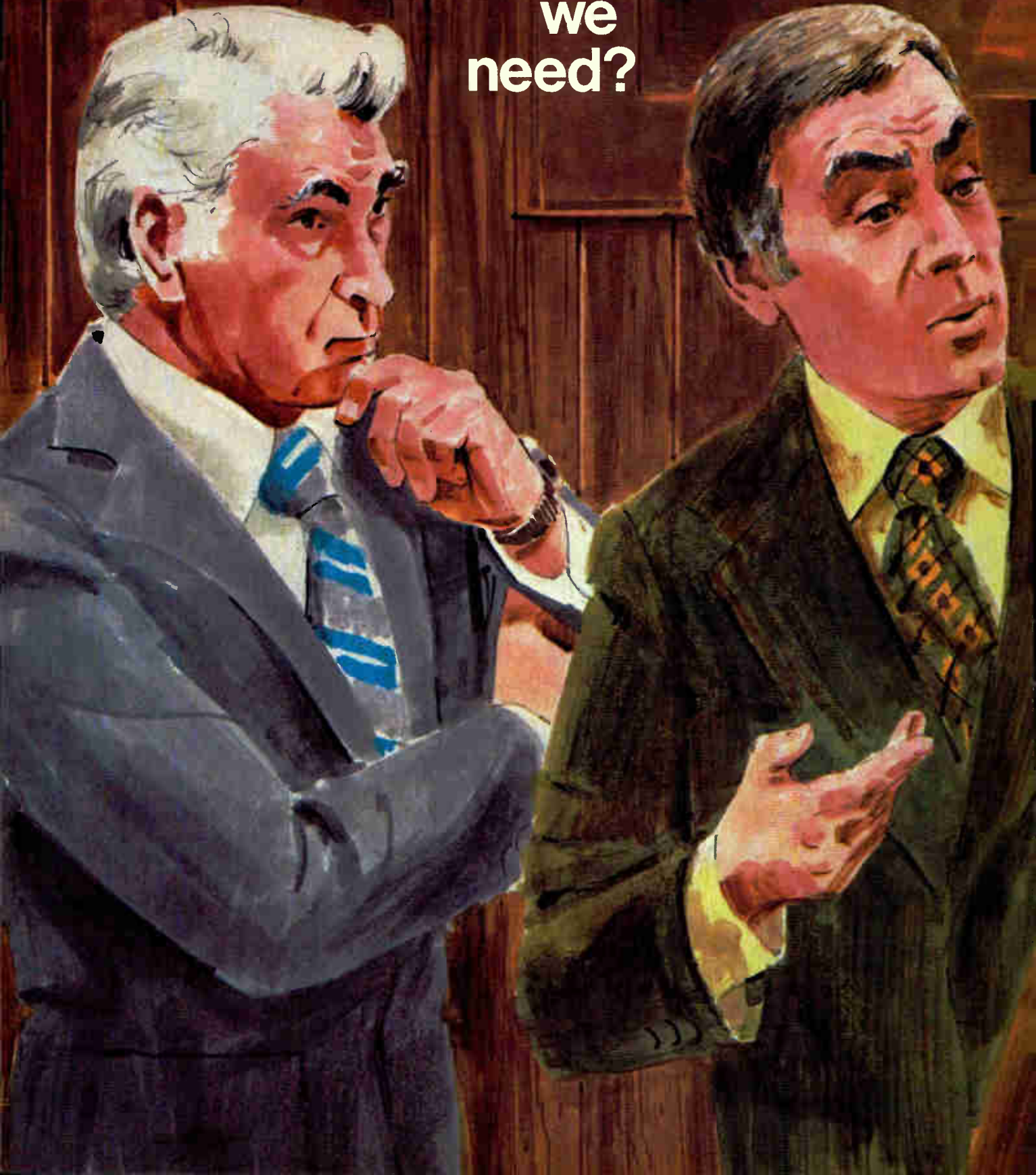



When it's TRW, the answer is yes.

Resources—facilities, people or capital—the TRW Electronics Group has all three and will commit them to your product program requirements. At TRW/ECG, this kind of tangible commitment is a standard company practice—not just an important-sounding phrase.

The long-lasting relationships that TRW/ECG has with its customers are based on much more than product quality, delivery or price. The relationships may have begun with these essentials, but are maintained by our customers' knowledge that they

have a dependable supplier.

To start the process that will make you one of the many organizations that have a long-range, resource-committed association with TRW, call any TRW/ECG sales office or Renfrew Electronics in Canada.

You'll find them listed in EEM, Gold Book, Electronics Buyers' Guide, Who's Who in Electronics, the Electronic Industry Telephone Directory and the Electronic Buyers' Handbook.

TRW CAPACITORS
TRW CINCH CONNECTORS
TRW CINCH-GRAFIK
TRW GLOBE MOTORS
TRW INDUCTIVE PRODUCTS
TRW IRC NETWORKS

TRW IRC RESISTORS
TRW LSI PRODUCTS
TRW OPTRON
TRW POWER SEMICONDUCTORS
TRW RF SEMICONDUCTORS

Circle 241 on reader service card

TRW ELECTRONIC COMPONENTS GROUP

DIVISIONS OF TRW INC.

5725 East River Road • Chicago, Illinois 60631



“No other DIP socket offers so much reliability, for so little cost.”

Joe Bradley, VP/General Manager
Burndy Corporation

Patented GTH™ contact design.

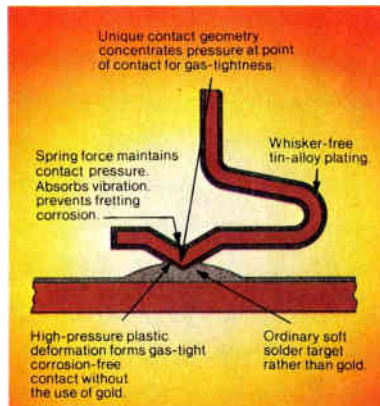

It's our new P-11 DIP socket. And it's designed to deliver all the advantages of IC pluggability! In applications where you never dreamed of using DIP sockets before! At prices you never dreamed possible! And the reliability you always associated only with gold!

In short, it's the most economical DIP socket on the market today. With the same, proven Burndy GTH contact system that completely eliminates the need for gold — *without sacrificing reliability.*

And it's available now. Today. Right off the shelf. Through your local Burndy Distributor.

So before you trade-off IC pluggability because you think it costs too much — do what scores of other electronic equipment manufacturers have already done. Check our

new P-11. Check the performance data. Then check our prices and start saving money right away. For fast action, call me direct: Joe Bradley, VP/General Manager, Burndy Corporation, Components Group, Norwalk, CT 06856. (203) 838-4444.

Good-as-gold GTH reliability at lower-than-ever cost.

CONTACT RESISTANCE TEST DATA (Milliohms): REPORT NO. K 7723-781

TEST PERFORMED	MIN.	MAX.	AVERAGE
GROUP 1			
Mating Force (Lbs.) (Per Contact)	0.445	0.477	0.463
Contact Withdrawal Force (Oz.) (0.008 Blade) 0.5 Oz. Min.	1.120	3.280	2.332
Insulation Resist. (5000 Meg's Min.) 600 VAC for 1 Min.	> 9 × 10 ⁴	> 2 × 10 ⁶	—
Contact Resistance (1 Amp)	5.240	6.670	5.639
GROUP 2			
C.R. After Vibration & Mechanical Shock	3.800	5.170	4.335
Contact Withdrawal Force (Oz.) (0.008 Blade)	0.710	2.930	2.065
Durability (50 Cycles)	3.800	5.200	4.379
Contact Withdrawal Force (Oz.) (0.008 Blade)	1.480	3.120	2.187
Insulation Resist. (5000 Meg's Min.) 600 VAC for 1 Min.	> 2 × 10 ⁶	> 2 × 10 ⁶	—
GROUP 3			
Initial Contact Resistance	4.750	5.900	5.106
After Corrosive Atmosphere	4.850	5.900	5.120

 **BURNDY**
Offices in principal cities throughout the United States.



If Newton Were Measuring Today, He'd Probably Rent A Measurement System From General Electric.

Today, it takes more than a bonk on the bean to make test observations. When you need a measurement system, you can rent the equipment as a single unit from the GE Rental Shop nearest you. (There are 48 nationwide.)

We'll select your equipment from our huge rental inventory of instrumentation from leading manufacturers, calibrated with standards traceable to the NBS.

Our computerized inventory control provides instant information on availability and location of equipment for fastest delivery.

Your phone call sets in motion a convenient weekly or monthly rental program. You can specify components for your

measurement system, or rely on competent GE technicians to configure a system to your requirements. They can rack mount and wire the units for a turnkey operation—even run the test and reduce the data for you.

Down-to-earth service. That's what you get when you "gravitate" to General Electric, your complete instrument rental source.

For your FREE RENTAL CATALOG call collect to the inventory center nearest you: Los Angeles, CA (213) 642-5350 Atlanta, GA

(404) 457-5563 Chicago, IL (312) 854-2994 Detroit, MI (313) 285-6700 Schenectady, NY (518) 385-2195 New York City (201) 227-7900 Houston, TX (713) 672-3570. Or call (518) 372-9900.



GENERAL ELECTRIC COMPANY
Apparatus Service Division
Building 4, Room 210, 1 River Road
Schenectady, New York 12345

GENERAL  ELECTRIC

Bucket brigades weight taps internally

Transversal filter has memory, converters, and peripheral circuits for tap weighting included in the chip design

by Bruce LeBoss, San Francisco regional bureau manager

The growing popularity of dedicated modular systems that are adaptable to microprocessor control is spurring the development of dedicated signal-processing devices, among them adaptive transversal filters. Such filters use a charge-transfer tapped delay line to provide a transform function of the signal. Although these filters are being used with modest success, they possess a distinct disadvantage—each tap requires a functional block to provide a tap-weight coefficient that can be controlled or programmed by a microprocessor or other external controller.

Virtually eliminating the need for such complicated interface circuits, engineers at EG&G Inc.'s Reticon division have developed two monolithic real-time programmable transversal filters. Fabricated with standard double-polysilicon n-channel MOS processing, the 296-by-328-mil chip in each filter incorporates random-access memory and all the multiplying digital-to-analog converters and peripheral circuits needed for tap-weight programming.

The new programmable transversal filters have 16 digitally controllable taps arranged in two configurations. One, the R5404, has 16 asymmetrical function weights, while the other, the R5405, has 32 symmetrical weights. Together, they "provide for a wide variety of adaptive convolutional and correlative signal processing," such as that needed in modems, real-time speech synthesis, waveform synthesis, and pattern-recognition applications, among others, says George Hansell, vice president of component marketing.

In digital communications, for

example, distortion and echos in transmission media cause intersymbol interference in the channels, loss of definition, and clutter. In video data, a programmable filter such as the R5404 or R5405 "could remove these distortions automatically," notes Martin B. Berry, a Reticon development engineer, and "would permit maximum throughput in a digital channel or compensate for echos due to inhomogeneities in the signal-transmission path of acoustic or other imaging systems."

Bucket brigades. The new monolithic filters derive their unique properties through a combination of bucket-brigade structures and state-of-the-art switched-capacitor filter circuit technology. In the R5405, for example, 32 bucket brigades are arranged in a pipe-line organization (see photo) with 16 multiplying d-a converters, each driving a pair of delay lines. The R5404 differs only

in that each d-a converter drives one of the 16 bucket brigades fabricated on the chip.

Incoming analog signals are sampled and held before they are applied to the reference (multiplying) input of the 16 d-a converters, each of which has a static storage register containing nine bits (eight bits plus sign) representing the tap-weight multiplier value, or coefficients, for that tap. Each d-a converter's output goes to one of 16 separate bucket-brigade delay lines with lengths of from 1 to 16 delay periods. A summer/integrator adds the delayed samples before they are resampled. Also, to remove dc drifts, a switched-capacitor feedback network—a high-pass filter and operational amplifier—buffers the sampled circuit.

Both the R5404 and R5405, each of which dissipates a maximum of 210 mW of power, have an on-chip clock-logic circuit to generate timing

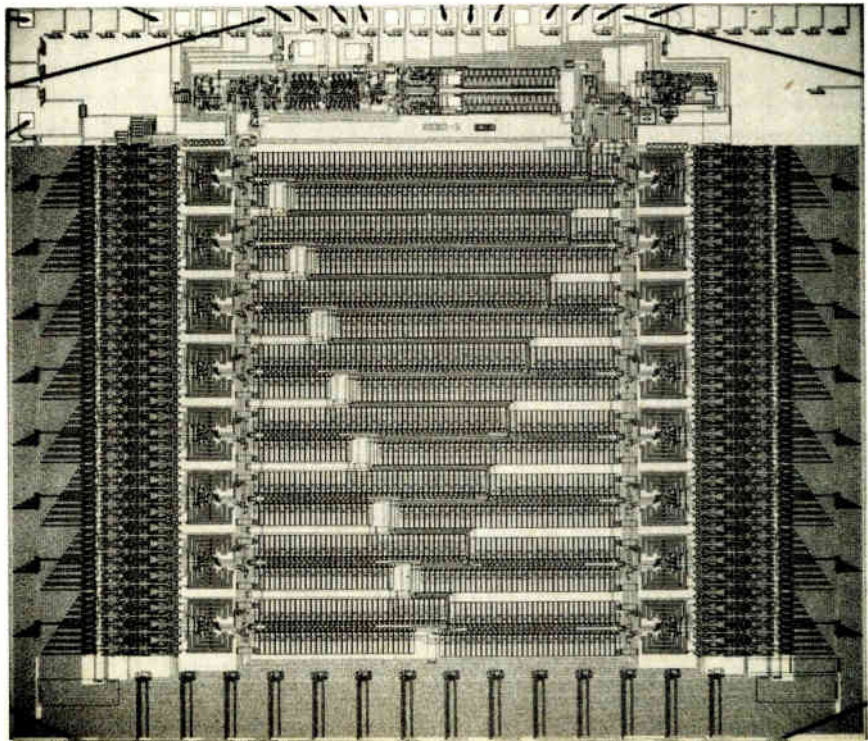

ROMAID

LETS YOU CONTROL
YOUR SOFTWARE
PROBLEMS

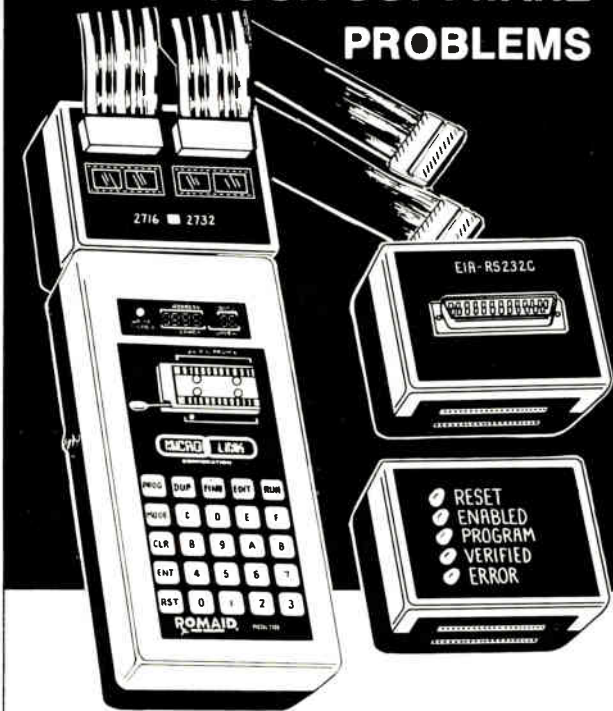

FEATURES:

- in circuit simulation of popular 2758, 2716, 2732 and 2764 PROMS
- programs popular 5 volt PROMS
- RS422 / RS232 / 20mA, data loading capability
- simulates up to four 2716's, two 2732's or one 2764 PROM's simultaneously

Ease of operation and program manipulation, portability and versatility will make the ROMAID PROM Programmer/Simulator the answer to your software debugging problems.

The ROMAID PROM Programmer/Simulator lets you put downtime at a minimum when software problems arise. It features in-circuit emulations of the most popular 1K, 2K, 4K and 8K X 8 PROM's and has full 6 digit hexadecimal display for address and data information.

And we're saving the best till last...Price! ROMAID costs less than other PROM Programmer/Simulators on the market today. Let us tell you more about how this revolutionary software "debugger" can save you time and money.

Write today to:



Micro Link Corporation
624 S. Range Line Road
Carmel, Indiana 46032
Phone (317) 846-1721

New products

signals. Samples are locked in on the falling edge of the master clock only once every four clock pulses. One clock period later, the convolved output is present for two periods, followed by a reset interval two periods in length.

Tap loading requires a 4-bit address, 9 bits of tap data, and a chip-enable strobe pulse. Data and tap-weight values are converted from decimal to binary values through use of a look-up table. Logic levels required by the chips exceed minimum TTL levels, but are compatible with complementary-MOS logic. Since it takes a minimum of 1 μ s to load a tap, the maximum tap-update rate is 1 MHz.

Input signals on the order of 1 V peak-to-peak can be handled with total harmonic distortion (THD) of 0.1%, whereas input-signal levels of 4 V p-p result in a THD specification of 1%. "Different tap-weight functions lead to different THD values," notes Hansell. For low distortion, the input bias added to the analog signal ranges from 8.5 to 11.5 V, notes the marketing executive.

Spectral noise of the R5404 and R5405 resides near -95 dB rms below 3 V p-p in a 10-Hz bandwidth for either broad low-pass or narrow bandpass filter responses.

The dynamic range of the new programmable transversal filters is between 50 to 65 dB, depending upon the filter structure. Sampling frequency ranges from a minimum of 50 Hz to a maximum of 125 kHz. "Sampling frequency as low as 50 Hz is a feature that conventional bucket-brigade structures will not permit without undue degradation from leakage currents," Berry claims. However, the bucket brigades of the new devices, he adds, have been "modified to extend the devices' low-frequency sampling capability."

Housed in 40-pin dual in-line packages, the R5404 and R5405 are priced at \$90 and \$100 each, respectively, for 100-piece purchases. Availability is 30 days after receipt of order.

EG&G Reticon, 345 Potrero Ave, Sunnyvale, Calif., 94086. Phone (408) 738-4266 [338]

THINK BAUSCH & LOMB VALUE

For more than twenty years, StereoZoom® Microscopes have been the first choice of electronics assembly, packaging, and inspection operations.

The reasons all relate to Bausch & Lomb value. Like a dedicated effort to respond to your constantly increasing performance requirements. Persistent attention to quality to help you improve your product reliability. And versatile, high performance features that reduce operator fatigue and increase productivity.

This attention to your requirements has made StereoZoom Microscopes your best value year after year. Call or write today for a detailed catalog, applications assistance, or a personal demonstration.

Performance. Quality. Reliability.
Three good reasons to...
THINK BAUSCH & LOMB VALUE

BAUSCH & LOMB 
Scientific Optical Products Division
ROCHESTER, NEW YORK 14602

Consult Yellow Pages under "Microscopes"

Circle #247 for more information



Robert Bosch announces a new Mini-Giant built to help resist moisture, dust and galloping inflation

Here's a new 30-amp, 12 VDC plug-in relay engineered to do the job better than ever. Yet it's available at or below our 1979 price. The secret is in the housing of rigid polyamide plastic.

Robert Bosch engineers chose this tough, impact-resistant plastic to replace traditional galvanized steel as the housing material. That helps explain the savings—in production costs for us, purchase price for you.

The relay is protected by a seamless housing. Neither moisture nor dust can easily penetrate. The bottom of the unit is vented with a single hole to avoid heat buildup. But for extra heavy-duty, outdoor applications, even this vent can be closed with a Teflon plug that filters out foreign matter while allowing air to circulate.



PCB Relay
0.56 cu. in.

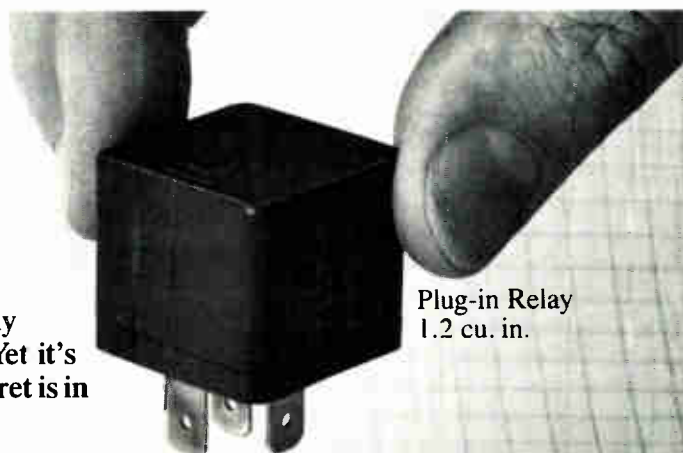

Plug-in Relay
1.2 cu. in.

For free specifications on the full line of Mini-Giant relays, both plug-in and PCB, write:

Robert Bosch Corporation
Dept. O/PGE 4
2800 So. 25th Avenue
Broadview, IL 60153
or phone Dave Robson,
(312) 865-5459

ROBERT BOSCH

©1980 Robert Bosch Corporation

**WE CAN'T GIVE YOU
ONE GOOD REASON TO
BUY THIS IC HANDLER,**



BUT WE CAN GIVE YOU FIFTY GOOD REASONS.

It's not any single feature that makes MCT the best-selling IC handler. It's a combination of many features.

In fact, MCT handling systems combine more reliability, versatility and efficiency than any other handler. That's what makes MCT the most cost-effective handler you can buy.

Take our "dead bug" handling approach for example. It significantly reduces jamming and downtime while allowing MCT handlers to handle the widest range of package types in the industry.

Or consider our superior contacts. They're made from gold-platinum for greater durability and better contact integrity.

And consider our efficient, human engineered design or our range of speeds up to 10,000 DPH.

Above all there's our professional service network — offering the most comprehensive installation, parts, service and training capabilities in the industry.

We could list at least fifty more reasons why MCT handling systems are the best you can buy. But we don't have room for them in this ad.

So, instead, we've put together a brochure that explains our reasons in depth. To get a copy just call (612) 482-5170, or write MCT today.



**THERE'S MORE
TO AN
MCT HANDLER**

MCT

Micro Component Technology, Inc.

P.O. Box 43013, St. Paul, Minn. 55164

'Vise-grip' Contacts



TEST RESULTS

Test	Procedure	Results
Corrosive Atmosphere	Ammonium Polysulfide Nitric Acid	Final $R_C=9.3 \text{ m}\Omega$ Final $R_C=8.4 \text{ m}\Omega$
Salt Spray	MIL-STD-1344, Method 1001	No Damage $R_C=11.7 \text{ m}\Omega$
Humidity	MIL-STD-1344, Method 1002	No Damage $R_C=14.8 \text{ m}\Omega$
Thermal Shock	MIL-STD-1344, Method 1003	No Damage $R_C=11.7 \text{ m}\Omega$
Mechanical Shock	MIL-STD-1344, Method 2004	No Discontinuity
Vibration	MIL-STD-1344, Method 2005	No Discontinuity
Socket Durability	500 mating/ unmating cycles	Initial $R_C=11.8 \text{ m}\Omega$ Final $R_C=11.8 \text{ m}\Omega$
Temperature Life	MIL-STD-1344, Method 1005, 1000 hours	Insulation Resistance > $5 \times 10^9 \Omega$ Initial $R_C=11.1 \text{ m}\Omega$ Final $R_C=14.9 \text{ m}\Omega$

PRODUCTS TESTED: IDS-26-G30 and IDH-26-S1-G30

Unique RN "vise grip" contact clamps cable firmly for gas-tight reliability (microphoto above). Total normal force is applied directly against cable. Vector arrows show normal force is maximized to clamp conductors tightly. No chance for gas penetration or corrosive buildup... even in hostile environments. And a special cut-out evenly distributes stress for long spring life and maximum reliability.

...assure gas-tight reliability

in **RN** IDC flat cable system

Robinson Nugent's unique contact design (microphoto shown at left) offers consistent, long-term dependability in your IDC flat cable interconnect system. Tests prove conclusively that RN "vise-grip" contacts maintain low contact resistance — even in corrosive atmospheres or under severe vibration. Plugs, sockets, edge card and transition connectors all provide the same

low electrical resistance and gas-tight reliability — for a highly reliable, trouble-free flat cable system.

Simple, one-piece connector design allows high speed assembly using IDC tooling already in place. Fewer pieces mean reduced inventory. And you get assured compatibility of cable, connectors and headers . . . because RN supplies them all.

Call or write today for the new Robinson Nugent IDC Flat Cable System catalog — complete with all specifications and technical details.



RN **ROBINSON NUGENT, INC.**

800 East Eighth Street, New Albany, Indiana 47150 • Phone: (812) 945-0211—TWX: 810-540-4082

Circle 251 on reader service card

Not every job needs Viking quality.
But when you need it, you need it.

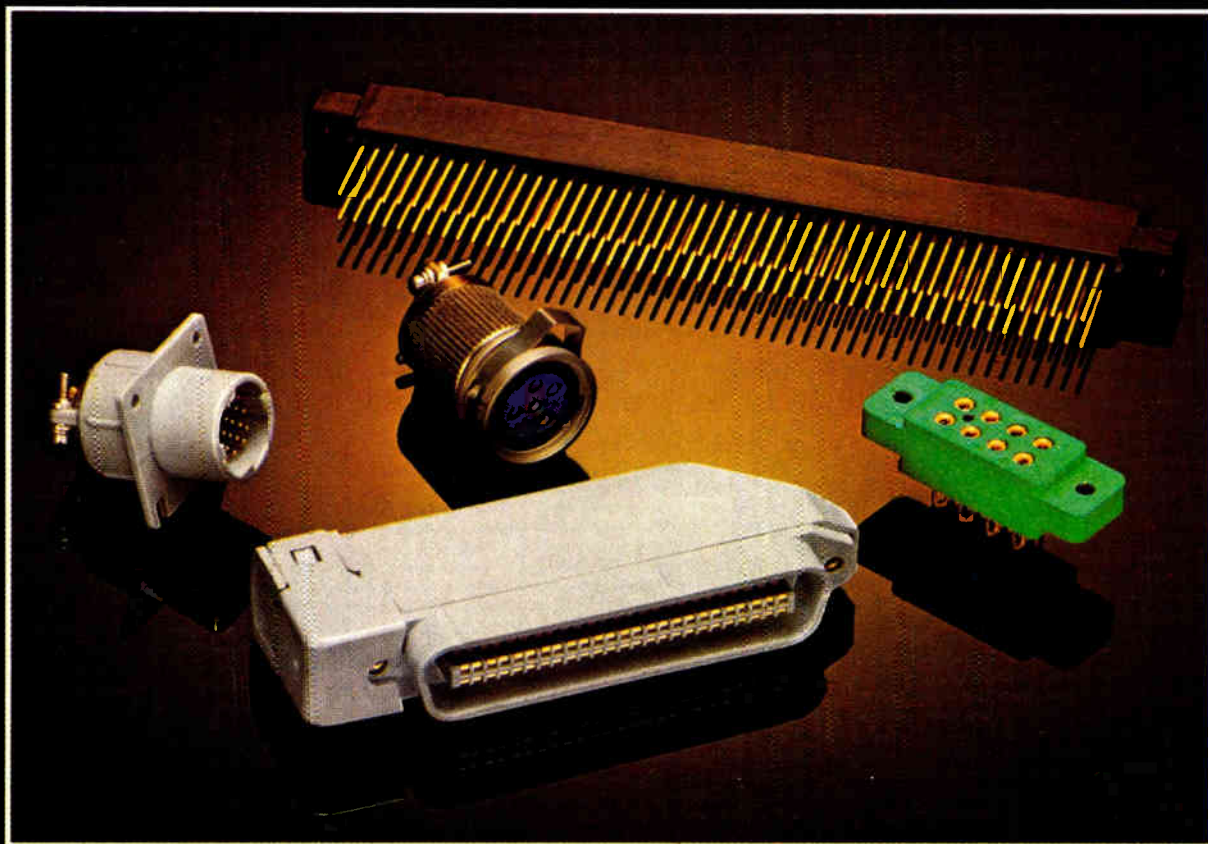

 **Viking**
CONNECTORS

21001 Nordhoff Street/Chatsworth, CA 91311, U.S.A.
(213) 341-4330/TWX 910-494-2094

Circle 252 on reader service card

Chip gives processors the time of day

C-MOS IC supports timekeeping efforts of various microprocessors with a real-time clock and a timer

by John G. Posa, Solid State Editor

If microprocessors are so smart, why is it so hard for them to tell time? Some single-chip microcomputers are blessed with hardware counters, but they are usually not very wide and if the units are not complementary-MOS, then battery backup—a must in these kinds of timekeeping systems—is a problem.

There are peripheral timing chips to relieve the processor of this burden, but none quite as versatile as the just introduced HI-8000 from Holt Inc. The C-MOS chip contains a 16-bit timer and a real-time

clock (see block diagram) that can count out 128 years with a resolution of 15.3 microseconds. The clock can also be used to measure elapsed time and even to take split-time readings. It easily interfaces with Intel Corp.'s 8048 single-chip microcomputer and 8085 and 8086 16-bit microprocessors, as well as with Motorola's 6801 and as yet unannounced 146805 (C-MOS) single-chippers.

Each counter stage feeds a data latch on one side and the alarm comparator on the other. To read the real-time counter, data is transferred

into the data latches and read out on the data bus. An alarm interrupt, if enabled, is generated when the data presented to the comparator coincides with the counter's outputs.

In its free-running divide-by-N mode, it generates a square wave with frequency $f_0/2N$; in its time-delay mode it generates an interrupt after N clock cycles, then stops.

The chip is available in a 28-pin dual in-line package at a 100-piece price of \$52.00.

Holt Inc., 3303 Harbor Blvd., D-5, Costa Mesa, Calif. 92626 [339]

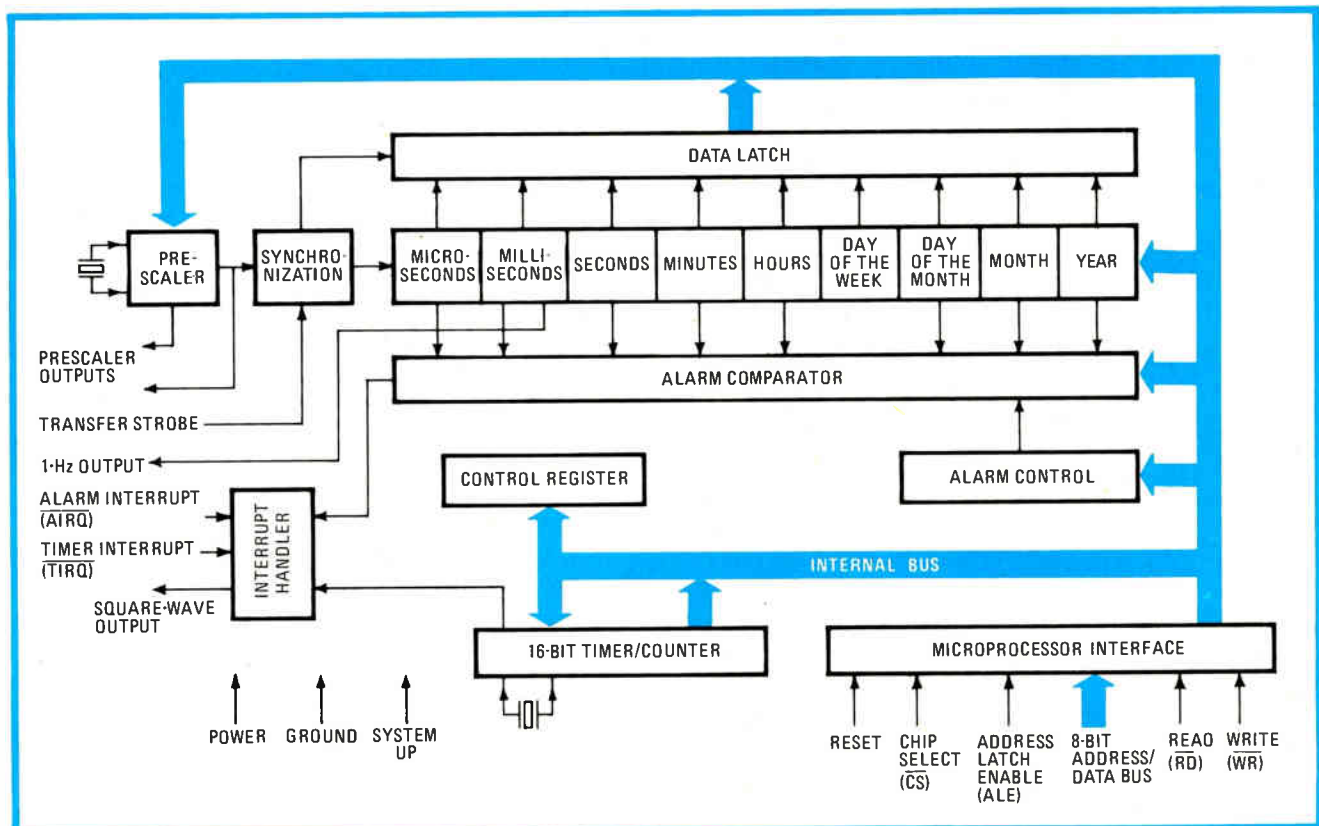

On time. The HI-8000 can count out to 128 years with a resolution of 15.3 microseconds, and since it is built using C-MOS technology, the tallies are easily kept alive with a battery. It is compatible with several 8- and 16-bit microcomputer and microprocessor chips.

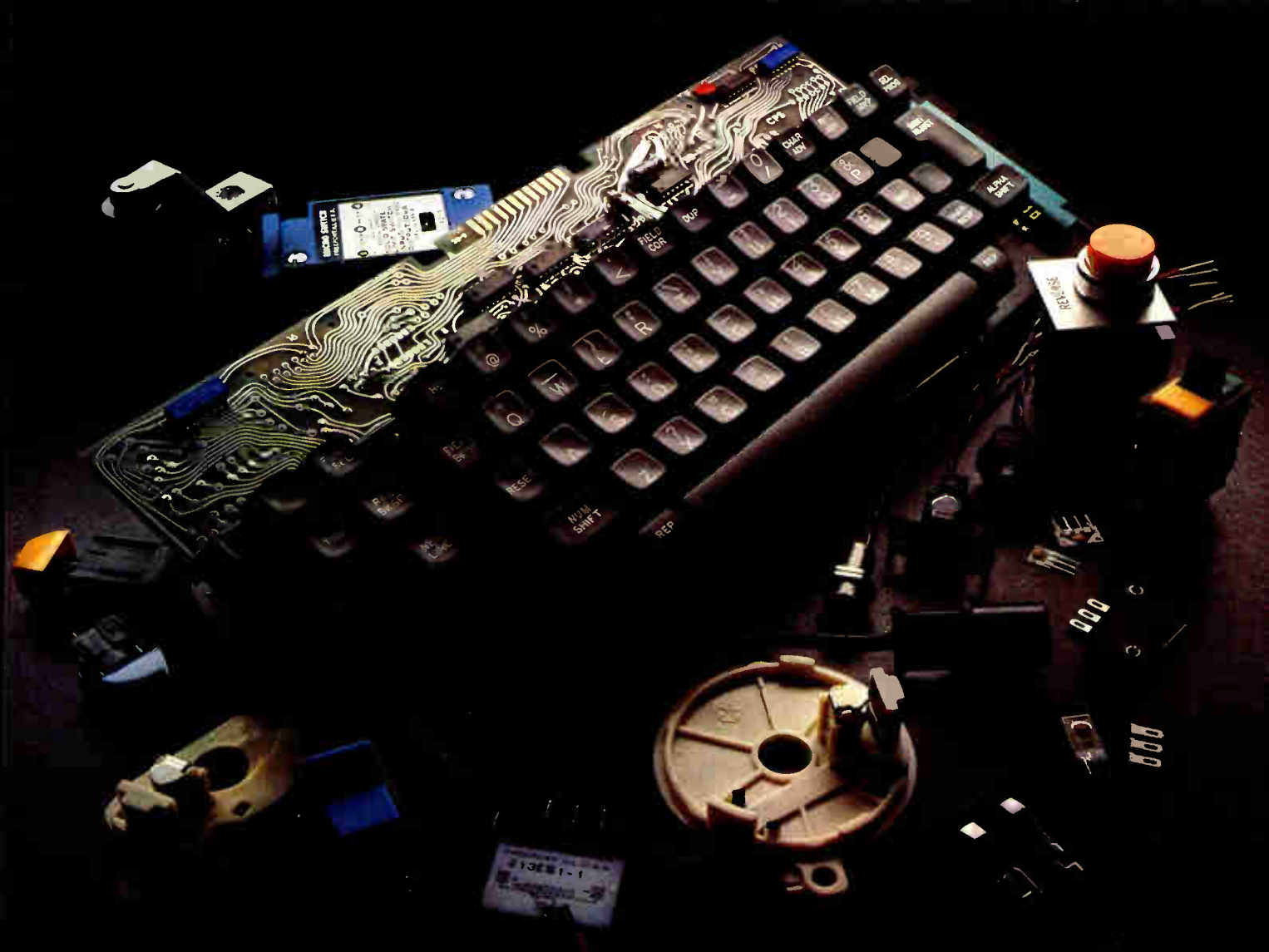

“The new force is exceedingly small, so that we cannot predict any practical applications for it.”

—*The Nation*, December 25, 1879

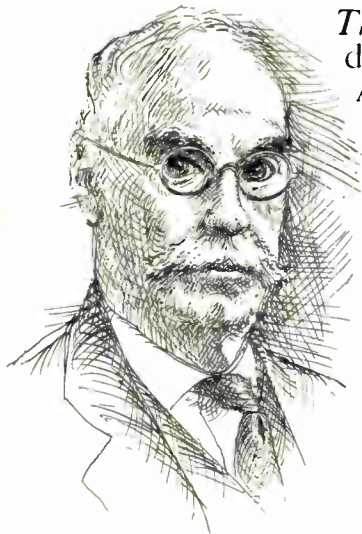

The Nation was talking about the Hall effect, the minute voltage that develops at the edges of current-carrying gold foil in a magnetic field. And back in 1879 when Dr. Edwin Hall first detected it, even the editors of this leading news magazine didn't know what to make of it.

In fact, for eighty-six years, the Hall effect gathered dust in research labs.

But then in 1965, while MICROSWITCH engineers were evaluating different sensor technologies, they made a major breakthrough.

They invented a revolutionary sensor by building the Hall effect into an integrated circuit.

The sensor they developed was smaller and more reliable than any previously designed. That sensor became part of the world's first solid state keyboard.

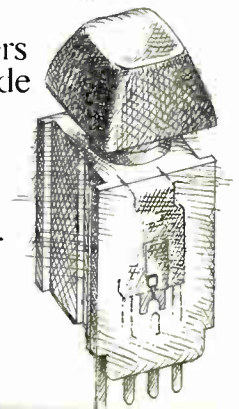

Today, not only is that keyboard still the most reliable one you can buy, our Hall effect technology is the state of the art in the electronics industry.

The fame of Hall.

Since the Hall effect keyboard, we've found other innovative ways to package the Hall effect.

You'll find it in our vane and position sensors. It makes our AML pushbuttons the most reliable ones you can buy. You'll find it in our solid state, oiltight pushbuttons. And now, the Hall effect is in our latest achievement: a linear output position sensor.

Our customers must like the ways we've packaged the Hall effect, because they've found some interesting ways to use them.

For example, pioneers at a leading medical center came to us for a sensor that would control the rhythm of an experimental artificial heart. They chose a Hall effect sensor for its proven reliability.

Hall effect sensors have replaced mechanical breaker points and magnetic reluctance sensors in the ignition systems of over 2 million cars so far. Simply because they're so reliable, and help save fuel.

In fact, designers of a famous race car use

Hall sensors for the same reasons.

And a Hall effect sensor detects the precise needle position for stitching patterns in the first computerized sewing machine.

People are even using the Hall effect

to monitor tire pressure, build better refrigerators, process film and bale hay. Just to name a few.

We have other ways of doing things.

Having made nearly 200 million Hall sensors, we figure that if there's a way to improve the performance of a product using a Hall device, chances are pretty good that we'll find it.

On the other hand, we'll be the first to admit that the Hall effect isn't the only way to do things.

That's why we also have products that work on other principles.

We use piezoresistance for solid state pressure transducers. Eddy current in metal detecting proximity sensors. And optoelectronics in photoelectric controls. Not to mention the precision, snap-action principle we invented in 1932.

But whether you eventually choose Hall devices for your designs, or any of the other ways we have to make switches and sensors work better, we can help you best by helping you early.

That way, you get our nearly 50 years' experience helping customers solve problems. And the most cost-effective product for the job. Whether it's one right off the shelf, or one we design especially for you.

Who knows, maybe we'll come up with a practical application that no one has thought about yet.

For some practical suggestions on how the Hall effect can work for you, write MICRO SWITCH, The Sensor Consultants, Freeport, Illinois 61032. Or call 815-235-6600.

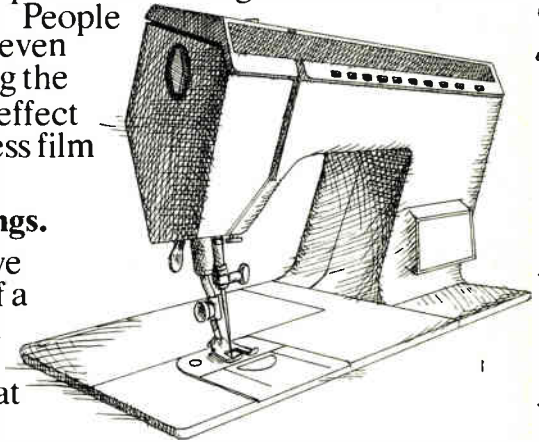
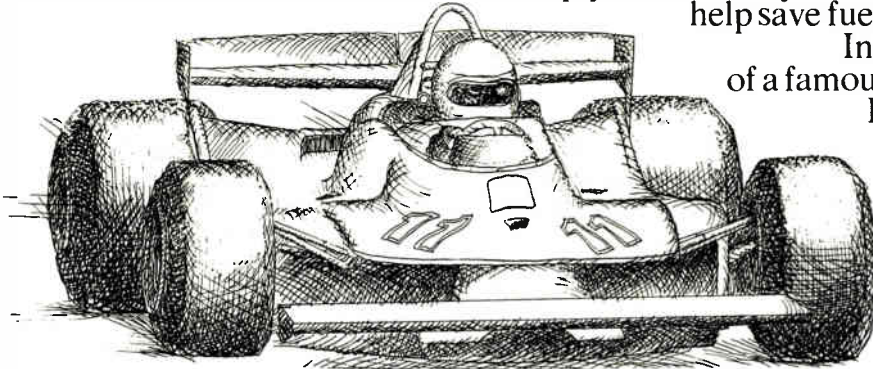
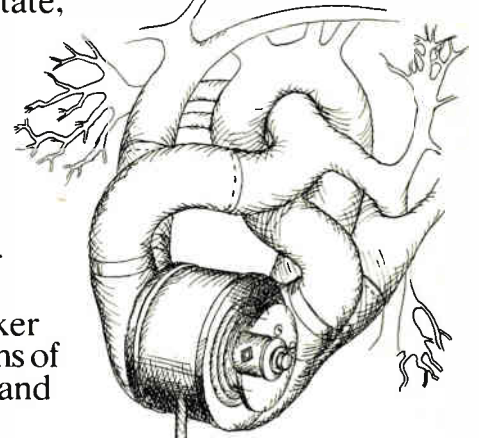

MICRO SWITCH
a Honeywell Division

In a look-alike field, Gordos and cooperation make the



It's true. Due to industry standard specifications and packaging, our products may look like their products. But when your company is setting industry standards of its own, an off-the-shelf product may not meet your needs.

Interface with Intelligence

This is where Gordos comes in — with the depth of experience and the

responsive attitude to deliver the right product, on time and on budget; and with a refreshing willingness to listen and to help solve new challenges in the relay, reed switch, and control field.

Call us. You'll find there are specific advantages to doing business with Gordos. Among them:

Broad standard line

Part of the applications engineering function is to know when a standard part will be adequate — and when it won't. With literally hundreds of standard models, our engineers can often meet your requirements from stock.

Unbiased assistance

In some cases, your application may require

engineering modifications or design services. With our expertise in both reed and optical devices, you and Gordos can make the best decision together.

Materials and process control

Gordos is a totally integrated manufacturer. We specify our own materials and

comes in subtle but important ways — such as special contact materials and higher insulation resistance needed in the automatic test equipment field. Our reputation for custom miniaturization and reliability in the medical field has made us the leading manufacturer of reed devices for today's heart pacemakers.

In-house thick film manufacturing

Gordos was the first solid state relay manufacturer to offer certain models with the higher reliability and cost advantages of hybrid thick film construction. Advanced laser technology allows tighter production tolerances; component values laser-trimmed to $\pm 0.3\%$. In harsh

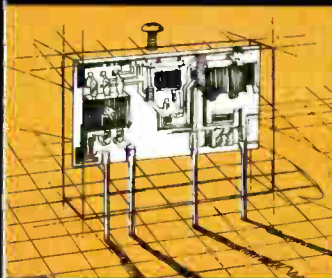

manufacture our own reed switches. The payoff to you



applications experience difference.

environments, thick film affords superior thermal properties, noise immunity,

specifications for the European market. In certain cases, this line of SSR products permits OEMs to eliminate expensive isolation transformers which were previously needed to comply with VDE requirements.

Computer interface systems

Gordos was one of the earliest developers of a plug compatible I/O module system. Newly available are buffered, bus compatible I/O boards to complete your signal and power level interface with the real world.

Distributor network

When one of our standard models will suffice, take advantage of immediate availability from your nearby Gordos Distributor.

and superior resistance to shock and vibration.

VDE compliance

Experience in thick film helped Gordos become the first U.S. manufacturer of relays and I/O modules to conform to VDE

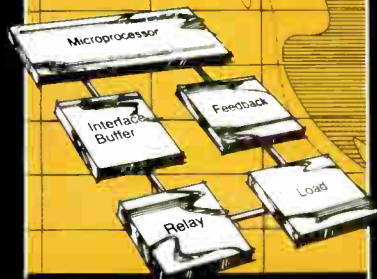

NAME	TITLE
COMPANY	
ADDRESS	
CITY/STATE/ZIP	
PHONE ()	
MY APPLICATION IS	
CHECK BOXES FOR BROCHURES DESIRED:	
<input type="checkbox"/> REED RELAYS <input type="checkbox"/> DRY AND WET SWITCHES 250 GLENWOOD AVENUE, BLOOMFIELD, NJ 07003 USA • TWX 710 994-4747	
<input type="checkbox"/> REED COUPLED AND ALL SOLID STATE SSRs <input type="checkbox"/> I/O SYSTEMS <input type="checkbox"/> VDE SPEC SSRs 1000 N. SECOND STREET, ROGERS, AR 72756 USA • TWX 910 720-7998	
E 980	

Quick-Response Coupon and Toll-Free Hotlines

Fill out the coupon, or simply attach your letterhead or business card and mail to the appropriate address. Or use our Toll-Free Hotlines for applications and ordering assistance.

CALL TOLL-FREE

Reed Relays
Dry and Wet Switches:
1-800-526-1392
In New Jersey 201 743-6800

SSRs and I/O Systems:
1-800-643-3500
In Arkansas 501 636-5000

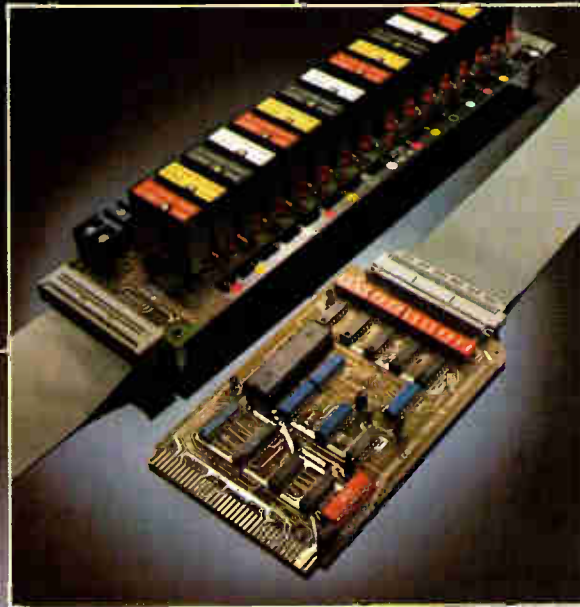
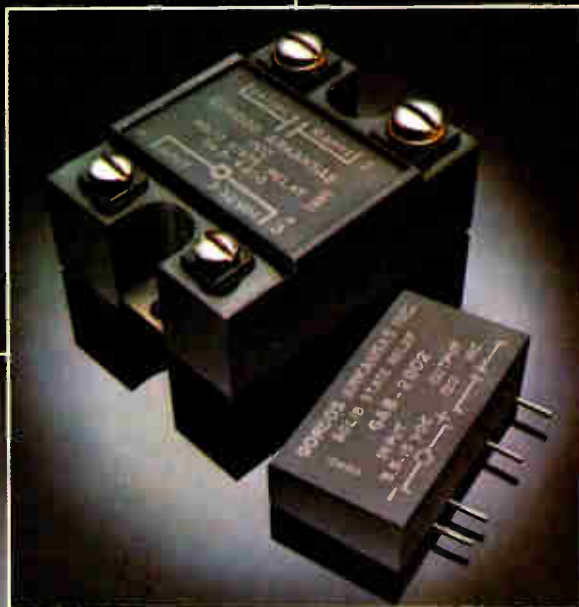

Interface with Intelligence



Look for Gordos at WESCON/80. Booths 1264, 1266.

in the
LIMELIGHT...



...THOMSON-CSF

The semiconductor components you need now...
and tomorrow.

Bearing the hallmark of excellence,
Discrete components and IC's are produced throughout the world
in our 9 semiconductor plants.

SUPERSWITCH[®]

SWITCHING POWER TRANSISTORS

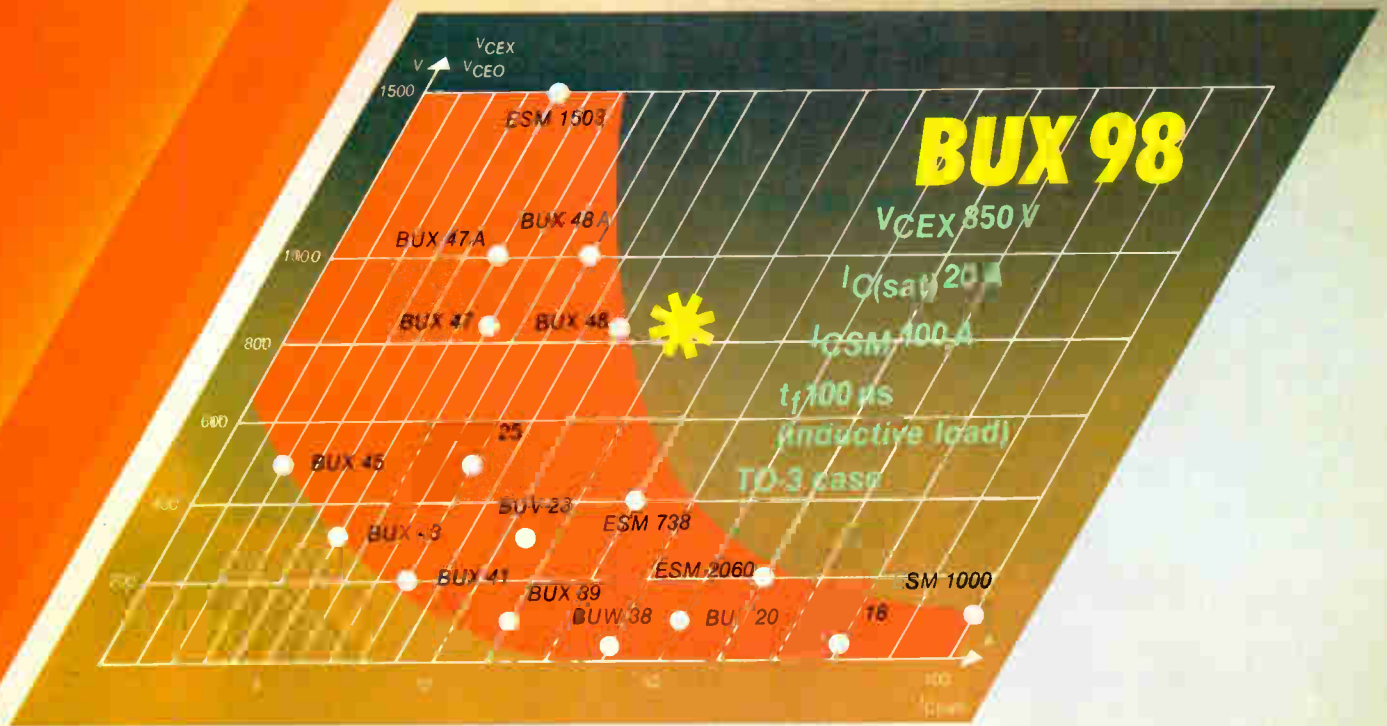

Out-performing the best seller BUX 48 wasn't easy, but we've done it with our BUX 98.

Remember...we introduced the original BUX 48 more than 3 years ago.

Follow the state of the art with our new BUX 98.

You may depend on us, we're never far-away...



THOMSON-CSF
 DIVISION SEMICONDUCTEURS

Circle 259 on reader service card

USA THOMSON-CSF COMPONENTS CORP. P.O. BOX 1454 CANOGA PARK CAL. 91304 / 6660 VARIEL AV. CANOGA PARK CAL. 91303 TEL. (213) 887-1010 TWX 910 494 1954 TLX 69 8481
BELGIUM and the NETHERLANDS THOMSON S.A. N.V. BRUXELLES TEL. (2) 648 64-85 THOMSON S.A. N.V. RA'S GRAVENMOER THE NETHERLANDS TEL. (016) 23-17 600 **BRASIL** THOMSON-CSF COMPONENTES DO BRASIL SAO PAULO TEL. (55-11) 542 47 22 **DENMARK** SCAN SUPPLY COPENHAGEN TEL. (01) 83 50 90 **FINLAND** OY SUPRA AB HELSINKI TEL. (0) 490 931 7490 137 **GERMANY (WEST)** THOMSON-CSF GmbH MUNCHEN TEL. (089) 76 751 **HONG-KONG** KELSON INDUSTRIAL CO. LTD. KOWLOON TEL. (852) 388-09 51 **IRELAND** NELTRONIC LTD DUBLIN TEL. (01) 50 18 45 **ITALIA** THOMSON-CSF COMPONENTI MILANO TEL. (2) 6884-141 **JAPAN** THOMSON-CSF JAPAN K.K. TOKYO TEL. (03) 264 6341 **INTERPIX** TOKYO TEL. (03) 369-11 01 **MOROCCO** SFRM CASABLANCA TEL. 27 91 00 / 27 91 23 **NORWAY** TAHONIC A/S OSLO TEL. (02) 16-16-10 **SINGAPORE** THOMSON-CSF COMPONENTS SEA SINGAPORE TEL. 271-87-01 / 272-94-12 / GENERAL ENGINEERS Corp. Pty. Ltd. SINGAPORE TEL. 272-94-12 **SPAIN** THOMSON-CSF COMPONENTES Y TUBOS BARCELONA TEL. (3) 373-30-11 / (1) 419-66 91 719 65 51 THOMSON-CSF COMPONENTES Y TUBOS MADRID TEL. (1) 419-60-10 / 419-61 55 **SWEDEN** THOMSON-CSF KOMPONENTER & ELEKTRONOR AB STOCKHOLM TEL. (08) 22 58 15 / DISTRIBUTOR TH S ELEKTRONIK AB SPANGA TEL. (08) 760 01 90 **SWITZERLAND** MODULATOR S.A. BERN-LIEBEFELD TEL. (031) 59 22 22 **TAIWAN** HUGO Co. Ltd. TAIPEI REPUBLIC OF CHINA TEL. 761-2070 / 767-9934 **UNITED KINGDOM** THOMSON-CSF COMPONENTS AND MATERIALS Ltd. DANNESHILL BASINGSTOKE HANTS TEL. (0256) 29-155 / AGENT & DISTRIBUTOR TRANSWORLD SCIENTIFIC Ltd. HIGH WYCOMBE BUCKS TEL. (494) 96-581

HEADQUARTER 50, RUE JEAN-PIERRE TIMBAUD BP 5 / F-92403 COURBEVOIE FRANCE TEL. 33 (1) 788-50-01 TLX 610560

New products

Microcomputers & systems

C-MOS board hits n-MOS speeds

With P²C-MOS, single-board computer uses little power, operates on the Multibus

The NSC800 microprocessor introduced late last year by National Semiconductor Corp. [*Electronics*, Nov. 22, 1979, p. 111] is being used for the first time on a single-board computer manufactured by Diversified Technology Inc.'s EiComp division. The new microcomputer, CBC 800, like its central processing unit, provides n-channel-MOS performance while having low, complementary-MOS-level power requirements. In designing the microcom-

puter, the company had two major goals: a computer that was hardware- and software-compatible with the most popular 8-bit microcomputers and one that used double-layer polysilicon C-MOS technology to reduce power dissipation, extend operating temperature range, and improve noise immunity.

8-bit compatible. "Since most of the board-level 8-bit CPUs are based on the Intel Multibus," says Gerald Youngblood, manager of microcomputer products at the company, "we decided to go with that bus." They combined it with the NSC800 to make the microcomputer compatible with the popular Intel 8080 and 8085, as well as with Zilog's Z80.

The end result has been that the Multibus-compatible board executes the Z80 instruction set, operates over 0° to 70°C (-40° to +85°C in an industrial version to come) and dissipates approximately 1 W of power. EiComp rates the reduced

power dissipation to be on the order of 20:1 compared with n-MOS. The first of the CBC 800 series, a commercial version, will be available in a 2.5-MHz version with an instruction-execution time of 1.6 μs. An industrial version that will be available later will operate at 4 MHz with 1.0-μs execution times.

The CBC 800 comes in three versions: CBC 800/204, /208, and /216, which provide 4-, 8-, and 16-K bytes of static C-MOS random-access memory. The on-board RAM runs without wait states. Sockets are provided for up to 32-K bytes of C-MOS or n-MOS read-only memory or programmable ROM. ROM address space can start on any 512-bit boundary for 6654-type, or any 2-K boundary for 2716-type memory.

The 2-K boundaries are important for locating the bootstrap for an optional disk operating system such as the CP/M 2.2 from Digital Research or the company's own

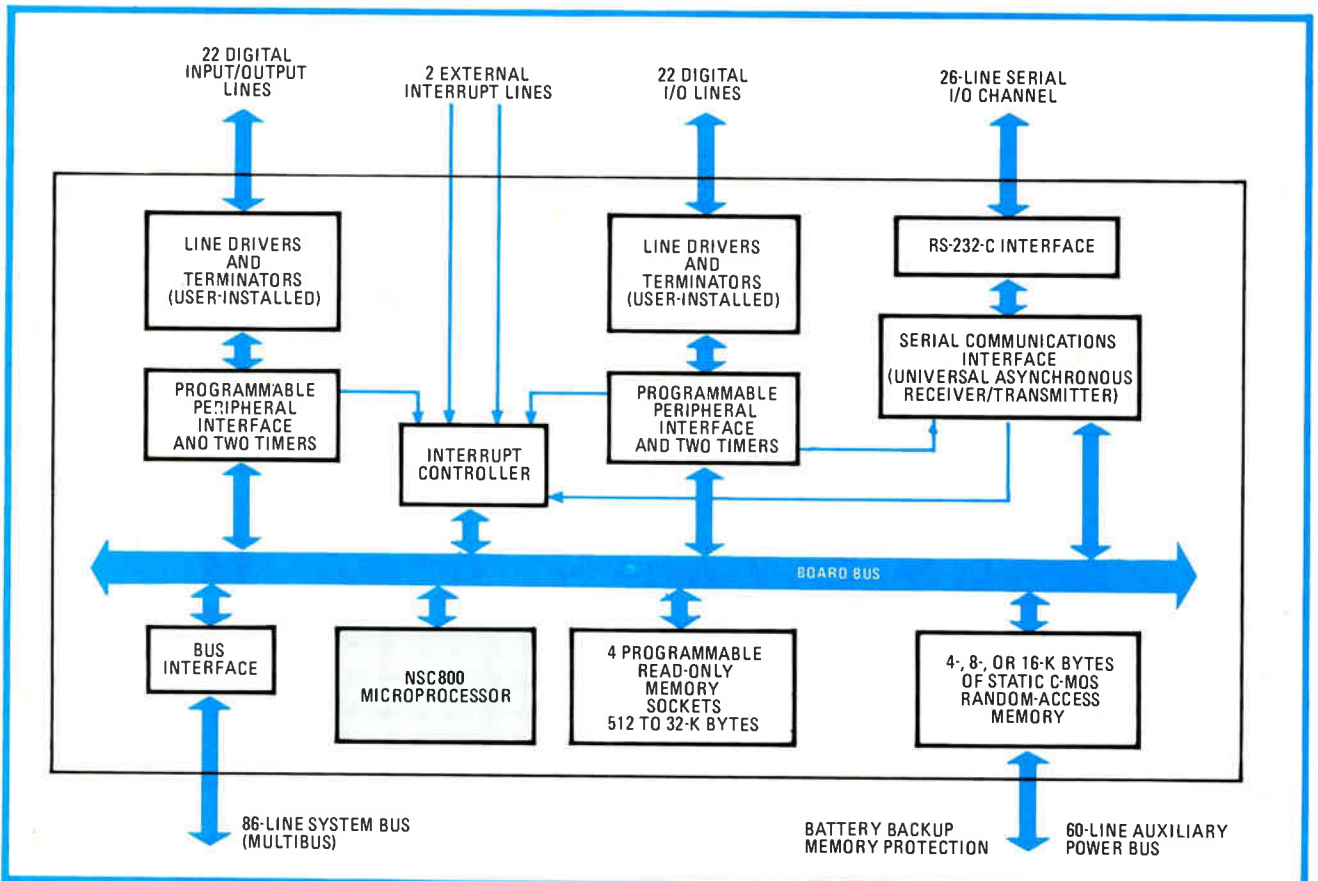

Multibus-compatible. Operating on the Multibus, the CBC 800 single-board computer uses National Semiconductor Corp.'s NSC800 P²C-MOS processor to consume little power and link to the popular 8080, 8085, and Z80 8-bit microprocessors.

SUPERSWITCH[®] Transistors

Initially, the bestseller BUX 48 (10A — 850V V_{CEX}) was designed for a 1 kW switchmode power supply, operating directly on the 220V/240V mains.

One BUX 48 can handle an output power up to 1 kW in a single transistor forward converter.

The BUX 48 can simultaneously withstand a $V_{CE} \geq 400V$ and an I_C of 55A which is a good security margin for a transistor which normally operates at an $I_C = 10A$ or 15A.

Six or more BUX 48 are often used to switch 60 Amps or more. Today by using the BUX 98, you can reduce the number of devices by half. The switching times on resistive load of the BUX 98 are specified as follows in the data sheets: $t_f = 0,8 \mu s$, $t_s = 3 \mu s$ at $I_C = 20A$; but in practice, the values of t_f and t_s can be improved by the correct choice of the circuit and the base drive — this you can even do yourself with the auto-regulated driver (see figures 1 and 2).

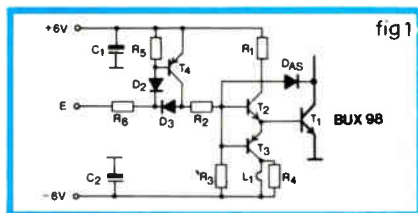

fig 1

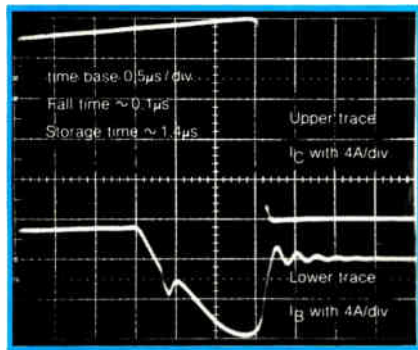

Fig. 2 : BUX 98 driven with auto-regulated driver, switching 20A under 350V.

Circle 261 on reader service card

Transient voltage suppressors "TRANSIL[®]"

7 new series of transient voltage suppressors have been added to the present range.

Packaged in small axial lead metal and plastic cases the TRANSIL[®] are characterized by their high surge capability.

— (350 W, 700 W, 800 W, 1 KW, 1,5 KW, 3 KW, 5 KW/1 ms expo)

— Extremely fast response (time 1 ps) low impedance and complete voltage range (from 5.8 V to 200 V)

TRANSIL[®] are available in unidirectional or bidirectional configuration for AC and DC applications where large voltage transients can damage voltage sensitive components, integrated circuits, transistors... TRANSIL[®] can be used:

- in on board avionic electrical network,
- input output telephonic lines,
- in parallel on other protection devices with slow response time.

Circle 194 on reader service card

Schottky diodes

Several new types have been added to the already extensive range of Schottky diodes featuring very low turn on voltage (0,25 V typ @ 1 mA) and no stored charge.

The DO35 or DO41 double plug sealed glass case given these mass-produced diodes a high ruggedness and an excellent behaviour in polluted or tropical atmosphere.

- BAT 29 mixer diode
NF = 6 db @ 1 GHz
 $Q_s \leq 3 pC$ @ 10 mA
 $C \leq 1 pF$ @ 0 V

- BAT 46 gold bonded germanium replacement

$I_F = 150 mA$
 $V_{RM} = 100 V$
 $V_F \leq 0,45 V$ @ 10 mA

- BYV1040 1A rectifier
 $V_{RM} = 40 V$
 $V_F \leq 0,55 V$ @ 1 A

Circle 195 on reader service card

"The power transistor in its environment"

You need to design power transistor equipment:

- Switchmode power supply
- High power
- DC-AC converter
- Motor drive
- Ultrasonic generator
- Induction heating...

You may be asking yourself any of the following questions:

- How to improve the base drive?
- How to define SOA?
- What would a transistor do in the event of a short circuit on the load?
- To what does the new concept "switch-

ing overload area" correspond?

— What happens to inverse current in power transistor?...

— How to choose a switching power transistor ($I_{CM} - I_C - I_C(sat)$)?

— Is it absolutely necessary to use an emitter resistor when paralleling?

You will find all the foregoing information together with application examples in the handbook:

"THE POWER TRANSISTOR IN ITS ENVIRONMENT"

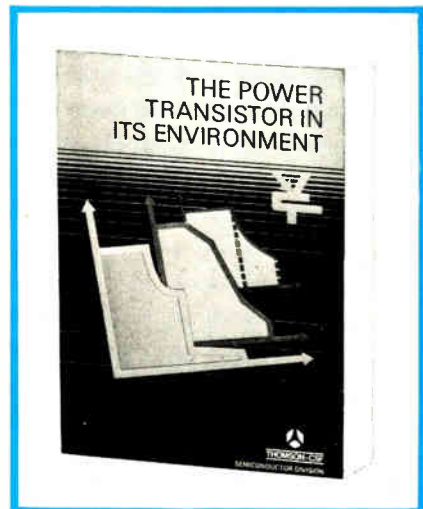

Circle 260 on reader service card

Very fast rectifiers

Two new series of fast recovery rectifiers with low voltage drop have been added to the "SUPERSWITCH[®]" series.

- BYW 98 (50 → 200V)

$I_O = 3 Amp.$
 $t_{rr} \leq 35 ns$
 $V_F \leq 0,85 V$ @ I_O

DO27 A plastic case

- BYW 99 (50 → 150V)

$I_O = 30 Amp.$
 $t_{rr} \leq 50 ns$
 $V_F \leq 0,85 V$ @ 15 A

TO-3 metal case

Circle 193 on reader service card



THOMSON-CSF
DIVISION SEMI-CONDUCTEURS

DELTRON SWITCHERS are NO GLITCHERS

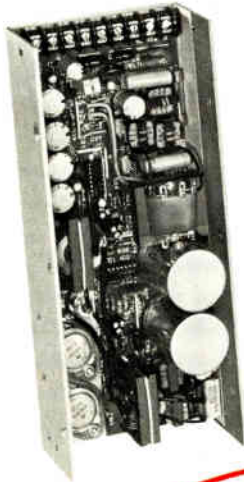

The  Quiet Ones

- Current fed drivers
- DM filters
- CM filters
- $\frac{dv}{dt}$ snubbers
- $\frac{di}{dt}$ limiting
- Shielded case
- Spike limiting varistors
- No fans

Get  Quiet!

1 TO 4 OUTPUT SWITCH MODE **POWER SUPPLIES—**
TO 320 WATTS

- Stock
- UL 478
- All outputs highly regulated
- Exclusive Variable Power Partitioning
- Low cost
- 3 year warranty

COMPLETE POWER SUPPLIERS

- ✓ Switcher
- ✓ Linear

- ✓ Ferro
- ✓ SCR

STANDARDS—CUSTOMS

Deltron inc.

Wissahickon Avenue • North Wales, PA 19454
Tel: 215/699-9261 Twx: 510/661-8061

AC 34

Circle 262 on reader service card

The magazine you're reading now could be your own.

Drop off the routing list. Get your own fresh, unclipped copy mailed to your home or office. Turn to the subscription card in the back of the magazine. If somebody has beat you to it, write: Electronics, P.O. Box 430, Hightstown, N.J. 08520.

262

New products

erasable-PROM-based multiuser interactive operating system called IOS-4. The latter provides assembler, text editor, disk operating system, Forth compiler, multitasker, compiler for programs to be stored in ROM, and interactive debugging interpreter. The compact object code generated by the ROM-program compiler allows the entire language and operating system to be stored in 14-K bytes of E-PROM.

Sharing the bus. The CBC 800 also offers bus-arbitration logic for multiple masters to share the system bus in a serial- or parallel-priority mode of operation. A version of the board that is still in the works will interface using a new C-MOS standard being prepared by EiComp. Two NSC-810 peripheral interface chips incorporate 44 programmable parallel input/output lines and four 16-bit programmable counter/timers. Serial RS-232 communications are provided by a 6402 universal asynchronous receiver/transmitter chip with software-programmable transmission rates of up to 9.6 kilobits/second. On-board logic allows for 20 prioritized interrupts with three operating modes.

Pricing for the 4-K byte CBC 800/204 is anticipated to fall in the \$1,600 range for single-unit quantities. The single-board computer will be available for delivery in its commercial version by December and in an industrial version by the first quarter of 1981. The company also plans to offer a complete line of Multibus-compatible C-MOS board computers and accessories. The first will be an add-on memory and I/O expansion card.

EiComp division, Diversified Technology Inc., 112 E. State St., P. O. Box 465, Ridgeland, Miss. 39157. Phone (601) 856-4121 [371]

Intel offers multi-processor, -user development systems

New offerings from Intel not only upgrade earlier units into high-performance multiuser development systems for the company's 16-bit 8088 and 8086, but they also permit

Electronics/August 28, 1980

Intelligent Graphics from the smart one *that...*

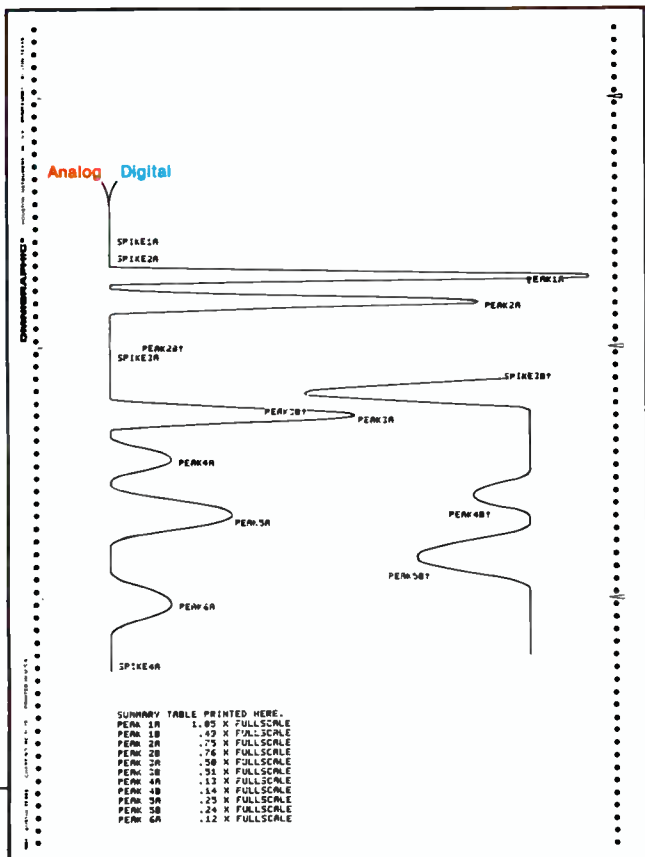

RECORDS GRAPHICS -
FROM AN ANALOG AND/OR
DIGITAL SOURCE.

ANNOTATES -
DURING OR AFTER
PLOTTING

HAS ONE OR TWO
PENS BOTH ANNOTATED

PRINTS COLUMN DATA

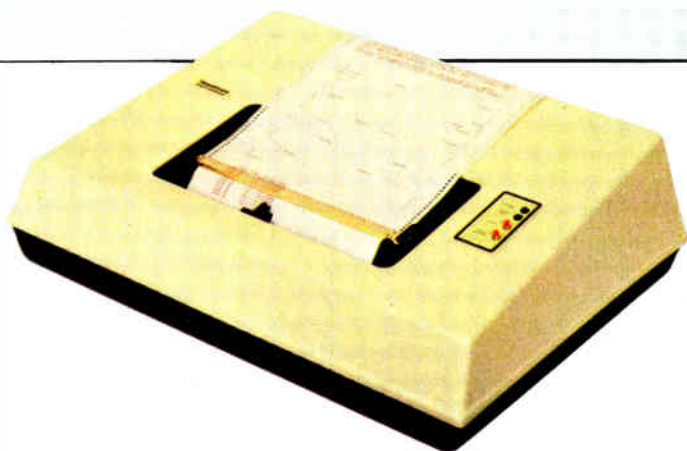

The intelligent one is ideal for microprocessor controlled instrument systems such as—chromatographs, spectrophotometers, densitometers and polarographs.

The TISPP is a new generation of recorder designed to meet your more sophisticated recording needs. IEEE and RS-232-C compatible, under microprocessor control, the TISPP records from either an analog or digital source, functioning as either a strip chart recorder or a digital plotter. And it annotates the data, printing either during or after curve data input. Thermal plotting speed compensation provides uniform trace quality while plotting up to 75 cm (30 in) per second. Print speed 25 characters per second, full scale analog sensitivity from 10MV to 5V full scale, 12 bit binary full scale digital, chart speeds from one second per cm to 62 minutes per cm.

The TISPP is the Intelligent one that will satisfy most of your recorder/printer requirements.

For complete information and descriptive literature contact Houston Instrument, One Houston Square, Austin, Texas 78753. (512) 837-2820. For rush literature requests outside Texas call toll free 1-800-531-5205. In Europe contact Houston Instrument, Rochesterlaan 6, 8240 Gistel, Belgium. Phone 059/27-74-45. Telex Bausch 81399.

houston instrument

GRAPHICS DIVISION OF

BAUSCH & LOMB



Circle #175 for literature
Circle #263 to have a representative call

We don't just build coils. We've set the standards.

At Delevan, our experience in building coils and inductive components has made us recognized leaders. The performance standards we helped to develop still serve as base specifications throughout the entire electronics industry today.

This background gives us a high degree of quality consciousness so you're assured a high degree of reliability and less chance of latent failure in your overall system.

Coils are our only business. We carry a complete line of on-shelf items. And for anything not in the catalog, our engineers are available to help you design and build components to your particular specifications.

For further information, contact your local Delevan representative or call the factory direct.

Delevan
Division



**AMERICAN
PRECISION
INDUSTRIES INC.**

270 QUAKER RD., EAST AURORA, N.Y. 14052 • TEL. 716/652-3600 • TELEX 91-293
OTHER DIVISIONS & SUBSIDIARIES INCLUDE: APITRON, BASCO, DUSTEX,
AMERICAN PRECISION INDUSTRIES (U.K.) LTD., DUSTEX OF CANADA, INC.

New products



the microprocessors to share hard disks introduced earlier.

The model 290 disk-file-sharing system enables up to eight users of Intellec systems to use files simultaneously on one or two hard-disk drives providing up to 15 megabytes of storage capacity.

The model 290, with network manager software and a hard-disk-based development system, sells for \$25,105; the network manager software and interconnection kit sell for \$2,180; and an interconnection kit sells for \$990 per work station.

Another offering, the Intellec series III [*Electronics*, May 22, p. 40], is a 16-bit development system tailored for iAPX-88/86 (8088, 8086) applications. The system's two central processing units enable a user to run 8-bit applications and translators for the 8088 and 16-bit applications and translators for the iAPX-86. The full 16-bit environment ensures faster translation speeds for both applications. The series III addresses 1 megabyte and supports the PL/M, Pascal, and Fortran languages. It sells for \$16,500.

An upgrading kit, which consists of an iAPX-86 CPU board, a 64-kilobyte random-access memory board, and software utilities, converts the Intellec series II into a series III for \$7,500.

A third enhancement is a Pascal-86 compiler that allows separate compilation of program modules, which can be linked later. This compiler is for support of Intel's iAPX-88/86 microprocessors. It runs on an Intellec series III and any existing Intellec microcomputer development system. The price is \$4,000.

Intel Corp., 3065 Bower Ave., Santa Clara, Calif. 95051 [372]



Now, with management tools, you can find a methodology to software madness.

Software tools from SYSTEMS provide the total system solution. They bring to your operation the correct and complete combination of structuring concepts and methodologies to develop or maintain your minicomputer system effectively and efficiently.

In addition, only SYSTEMS offers software management tools which allow you to quantify and control your programmers' efforts, insuring project schedules will be kept and budgets will be met. Management tools available include: design aids for structured programming, inherent in PASCAL and the FORTRAN-77+ languages; a FORTRAN Formatter for clear, consistent and standardized program appearance; a Documenter™ for uniform documentation; and an Interface Documenter™ providing inter-relationships

between program modules. Other management tools include methodologies for testing, integrating, and optimizing (Instrumenters™), and for error detection and correction (Symbolic Debugger).

Many other software tools are available from SYSTEMS. Language tools include PASCAL, FORTRAN 77+, BASIC, COBOL, and MACRO Assembler. A choice of operating system and graphics tools are offered. Data Base Management Systems as well as communications tools that can be ordered round out SYSTEMS' complete software package.

Let SYSTEMS take the madness out of your minicomputer system development and support problems. Write or call for more information. Don't go mad, go SYSTEMS.

SYSTEMS
Proven COMPUTER Performance

SYSTEMS toll-free product information service 1-800-327-9716
Systems Engineering Laboratories, Inc. 6901 W. Sunrise Blvd., Ft. Lauderdale, FL 33313 (305) 587-2900

™ Trademarked products of SOFTOOL Corporation

Circle 265 on reader service card

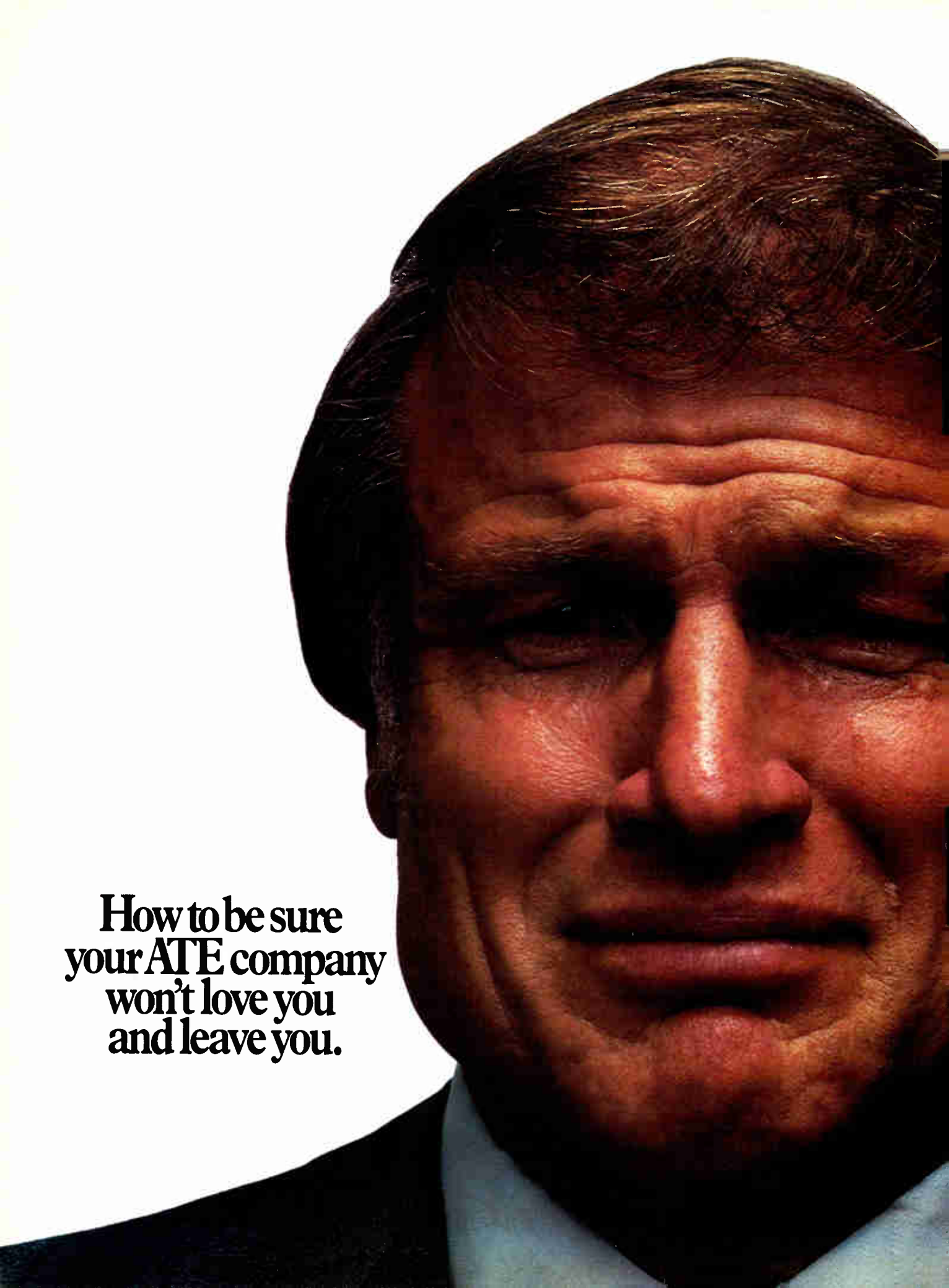

**How to be sure
your ATE company
won't love you
and leave you.**

The last thing you want to do is fall for a sweet-talking ATE company, and find yourself left without any visible means of support.

That won't happen if your ATE company is GenRad. That's because no other company offers you as many different levels of support.

First, you'll meet our Product Specialist. He'll take a close look at your operation and analyze your needs.

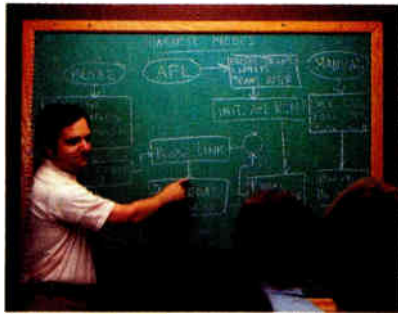

GenRad Applications Engineers work closely with your test system engineers to develop the most effective solutions to your testing problems.

Then you'll meet our Applications and Software Engineers. Their job is to fine-tune both hardware and software to your specific application.

And as your needs change, our Software Support Group is always there to help. Generating software device models and application notes, and working with you on debugging and enhancements. Just give them a call whenever you need them.

GenRad also has a lot of other people you can call on. For instance, our Training Specialists will make sure every one of your programmers understands their new system inside and out.

And our Programming Services Group, made up of full-time applications specialists, can off-load your programmers whenever you need help.

If a problem does occur, we can have a Field Service Specialist right there and solving any problem within hours of your call.

We even help you solve problems *before* they develop by putting you in touch with one of our User Groups.



GenRad User Groups meet often to discuss common concerns and share ideas. One user may already have an answer to a testing problem you're working on.

People like you who own and use GenRad equipment. In many cases, you'll be able to benefit from the experience of someone who's had a testing problem similar to yours.

Altogether, GenRad offers you eight different levels of support. No other ATE company even comes close.

That's something to think about before you let an ATE company get close to you.

For details on our complete ATE line—from product development to field testing—write GenRad, Concord, MA 01742.



GenRad's Programming Services Group is always ready to off-load your programmers whenever you need help.

 **GenRad**

Put our leadership to the test.

Circle 267 on reader service card

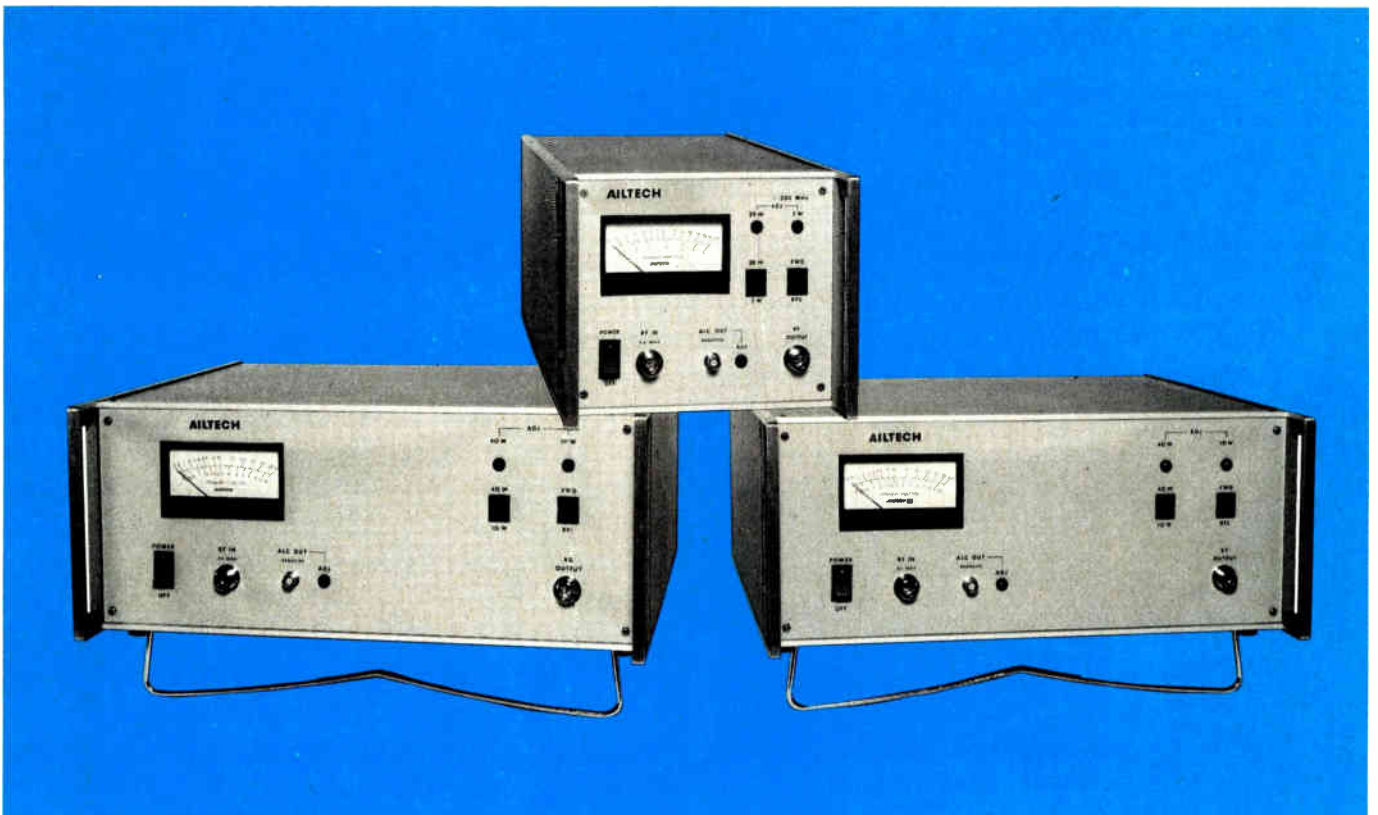

AILTECH high-quality, high-power Broadband Linear Amplifiers.

Frequency range 10 kHz to 1 GHz in 4 bands, 8 models available

- ALC signal provided.
- Dual directional true wattmeter reads true forward and reflected power.
- Up to 50 watts output power.
- All Solid State.
- Positive no-load protection.
- True linearity (ask for a side-by-side comparison before you buy).

Applications: Wattmeter calibration, EMI susceptibility testing, high power testing of transistors, amplifiers, components, NMR systems.

AILTECH RF Power Signal Sources



- 10 kHz to 2.5 GHz
- Plug-in versatility
- Up to 50 Watts output
- AM/FM options

Modules for OEM applications.



Broadband amplifier modules tailored to customer requirements are supplied for OEM applications at considerable cost savings. They are packaged in RFI proof modules and operate from a standard 28 volt power supply. For further information on AILTECH products, contact Eaton Corporation, Electronic Instrumentation Division, 19535 East Walnut Drive, City of Industry, CA 91748. Telephone (213) 965-4911

EATON
Advanced
Electronics

NORPLEX[®] POLYIMIDE-BASE LAMINATES

help you achieve high performance and greater yield.

Norplex G-30 laminates and preregs are premium grade high-temperature base materials using polyimide resin with glass fabric reinforcements.

Developed for use in high-performance printed wiring boards and multilayer circuitry, G-30 polyimide laminates make possible design concepts that cannot be attained with epoxy-base materials. Because of their stability during fabrication and higher operating temperatures, these Norplex laminates are especially suited for microelectronics and guidance systems, computer logics and communications equipment.

Norplex G-30 laminates and preregs have been approved and listed

as qualified products for the military specifications. MIL-P-13949E, MIL-P-55617B and MIL-G-55636B.

Other advantages of G-30 laminates and preregs are their excellent X- and Y-axis dimensional stability, low Z-axis expansion, moisture resistance and outstanding electrical characteristics.

Technical information and assistance is available on these and other laminates from the Norplex Technical Service Department.

Norplex Division, UOP Inc., 1300 Norplex Drive, La Crosse, WI 54601. 608/784-6070. European Headquarters: Wipperfürth, West Germany. Pacific Headquarters: Kowloon, Hong Kong.

Norplex[®] laminates
by UOP



One of The Signal Companies

Circle 269 on reader service card



The Great Precision OP Amp Trial

In Which the Jury Finds in Favor of PMI's No-Fault OP-05, 06 and 07



© PMI 1980

In "Alice's Adventures in Wonderland," the Knave of Hearts went on trial for stealing the Queen's tarts, with her husband, the King, as a very partial judge. There was so little evidence that no verdict could be reached, but that didn't deter the Queen.

"Let the jury consider their verdict," the King said.

"No, no!" said the Queen, not caring to wait for all the evidence. "Sentence first—verdict afterwards!"

Alice argued that no decision could be made based on evidence with no meaning to it.

"If there's no meaning in it," said the King, "that saves a world of trouble, as we needn't try to find any."

There is a great parallel here in the way precision operational amplifier buying decisions are made in Linear Wonderland. The evidence presented by many manufacturers has little meaning for the engineers who use op amps. As a result, they reach the sentence (read: "buying decision") first and reach a verdict later (read: "This doesn't really do the job") based on the only evidence that counts, performance.

Precision Monolithics likes its products to be judged on the evidence before the verdict is reached. Consider the case of our precision operational amplifiers, the OP-05, 06 and 07.

Our OP-05 already is well known to many industry users, as well as to the many competitors who have tried to compete with it in the last couple of years. It is, simply stated, a superlative instrumentation op amp for low signal level applications, with an ultra low TCV_{os} . One feature that has helped many juries find in its favor is its long term stability and nulled temperature drift, which is about the lowest anyone can buy. This comes from the clever thermally balanced chip topography plus PMI's famous process technology.

Our OP-07 series also has been tried, and found faultless, by engineers who need even greater improvement in input offset voltage than is available in the OP-05. PMI's "zener zapping" technique is used (instead of laser trimming, which can cause long-range stability problems) to permanently null V_{os} at the wafer probe stage of manufacturing. This provides V_{os} as low as $25 \mu V$ at the full military temperature range. That's lower than most test systems can test.

Between the two we have now added the OP-06 series, and as you will see from the performance specifications, it is ideal for applications where ultra stability, high gain, and super speed (particularly at gains over 100) are called for. Just look at the testimony in its favor, including an impressive 120 dB minimum A_{vo} and CMRR of 110 dB. That kind of performance allows the OP-06 to resolve and process microvolt level signals with accuracy, stability and speed.

Of course, no jury bases an opinion strictly on the testimony of a partial witness, and we would be in contempt of court if we said we were totally impartial. That's why we submit the following exhibits for the plaintiff:

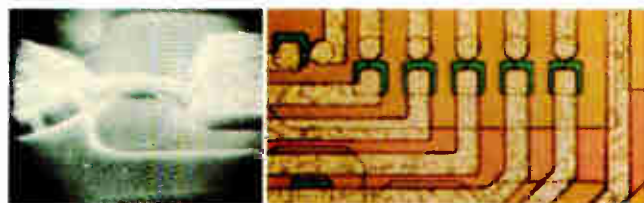
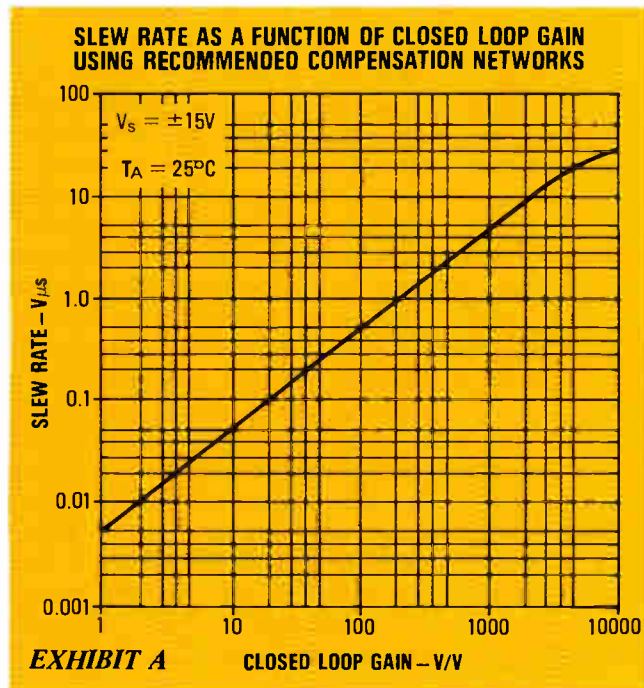

EXHIBIT B S.E.M. photo of PMI Zener Zap showing no surface damage.



EXHIBIT C S.E.M. photo of laser trim showing surface dislocation.

PART NUMBER	TEMP RANGE	V_{os} , MAX μV	GAIN, MIN V/mV	CMRR, MIN dB	TCV_{os} , MAX $\mu V/^\circ C$
OP-05A	MIL	150	300	114	0.5
OP-05	MIL	500	200	114	1.0
OP-05E	COM	500	200	110	0.6
OP-05C	COM	1300	120	100	1.5
OP-06A	MIL	100	1000	120	0.6
OP-06B	MIL	500	1000	120	1.0
OP-06F	COM	500	1000	120	2.0
OP-06G	COM	1300	500	100	4.5
OP-07A	MIL	25	300	110	0.6
OP-07	MIL	75	200	110	1.3
OP-07E	COM	75	200	100	1.3
OP-07C	COM	150	120	100	1.8
OP-07O	COM	150	120	94	2.5

EXHIBIT D ALL SPECIFICATIONS AT 25°C

Now that you've considered the evidence, we'd like to go even further to make certain that when you judge a precision operational amplifier for your instrumentation needs, either nulled or un-nulled, PMI will get a fair hearing for its OP-05, 06 and 07. Just fill in our "JUSTICE MUST BE SERVED" coupon and order the sample you want to put on trial for your own application.

If someone beat you to the coupon, write to us. Or circle #200 for literature.

With that, we rest our case!



Precision Monolithics, Incorporated

1500 Space Park Drive

Santa Clara, California 95050

(408) 246-9222 TWX: 910-338-0528 Cable: MONO

In Europe contact:

Precision Monolithics, Incorporated

c/o BOURNS AG

ZUGERSTRASSE 74, 6340 Baar, Switzerland

Phone: 042/33 33 33 Telex 78722

"JUSTICE MUST BE SERVED"

Just fill in the box for the op amp of your choice and we'll send you a free sample, and put it on trial for your own application. My verdict is in favor of:

OP-05 OP-06 OP-07

Mail to: **Precision Monolithics, Inc.**, 1525 Comstock Avenue, Santa Clara, CA 95050

or **Precision Monolithics, Inc.**, c/o BOURNS AG
Zugerstrasse 74, 6340 Baar, Switzerland

Name _____

Title _____

Company _____

Dept. _____

Address _____

Phone (_____) _____

Check

- Transistors
- Capacitors
- Diodes
- IC's

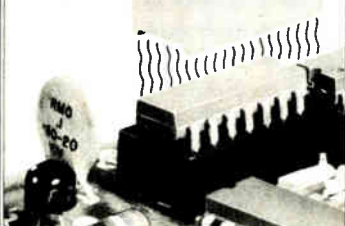

CONTROLLED HEATING
... where it counts

THERMO-PROBE

Heat any integrated circuit or electronic component to its rated temperature with a heat probe. Accuracy $\pm 3^\circ\text{C}$ or better. Or check the component's temperature with a thermo-couple probe. Model 810 Thermo-Probe does both. Reads out directly in $^\circ\text{C}$ and $^\circ\text{F}$ on a large $4\frac{1}{2}$ -inch meter.

MTI MICRO-TECHNICAL INDUSTRIES

P.O. Box 287 South Laguna, CA 92677

TELEPHONE (714) 545-3734

TWX 910 596-1325 MICROTECH LBEH

Circle 272 on reader service card

SOLID STATE TEMPERATURE MONITORING DEVICES MOXIE AND TFT

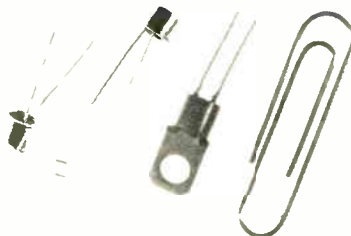

- TCR slopes from 4% to 300%/ $^\circ\text{C}$
- Temperature range -20°C to $+140^\circ\text{C}$
- 1% precision tolerance available
- High reliability, excellent lifetime stability
- Direct device to device interchangeability
- Fast thermal response Time (approx. .5 sec)
- Standard TO-18 and TO-92 packages

CANADIAN THERMOSTATS AND CONTROL DEVICES LTD.

8415 Mountain Site Avenue
Montreal P.Q. H4P2B8
(514) 739-3274 TELEX 05-25277

Also manufacturing a complete line of bi-metallic switching devices

CALLS From Indep. Reps Invited

272 Circle 126 on reader service card

New products

Components

Schottky rectifier protects itself

Internal pn diode

absorbs spikes, gives

33% more breakdown margin

Adding a level of performance to its Schottky power rectifier line, TRW Power Semiconductors is offering a 60-V version. Used in high-current 5-V power supplies, their maker feels these devices make snubber networks—which guard against breakdown—unnecessary.

A construction method is used for the SD-71 line that is new to Schottky diodes but similar to a method used for microwave transistors. "The result is a device with 33% more breakdown margin than most previously available units without sacrifice in other properties," claims William Sebastian, marketing manager for the power line. Besides a 60-V breakdown rating, the devices operate at a junction temperature of up to 175°C (and as low as -55°C). Repetitive peak forward current at half duty cycle is 75 A.

Previously, Schottky power devices tended to show localized junction breakdown when overburdened by a voltage spike larger than rated capacity. Power-circuit designers

therefore protected each rectifier with a snubber, a simple network with a low-value resistor in series with a capacitor. The network damps leakage inductance.

With the new construction, a pn diode is formed in addition to the conventional Schottky barrier. This pn diode by its very nature tolerates larger amounts of reverse energy than the Schottky barrier. It protects the device by evenly absorbing any voltage spikes, explains Sebastian.

Maxima. Other maximum ratings are: repetitive peak reverse working voltage, 50 V; nonrepetitive peak one-cycle surge current, 100 A; and repetitive peak reverse current, 2 A. Typical junction capacitance is 4,000 pF and typical reverse recovery time is 50 ns. The maximum rate of change of reverse voltage is 1,000 V/ μs . Maximum forward voltage at 75 A and 25°C is 0.73 V; at 75 A and 175°C , it is 0.58 V.

TRW application engineers, evaluating the new series in one of its main uses, power supplies, "have brazenly removed all snubbers and suggest our customers do the same," says Sebastian. In the tests, the devices have been avalanched to more than 50% of forward ratings with no loss of performance.

The savings in both component and assembly time that accrues from doing away with the snubber can be a significant cost factor, points out the TRW marketing official, amounting to as much as \$4 to \$5 for each network. Customers already looking

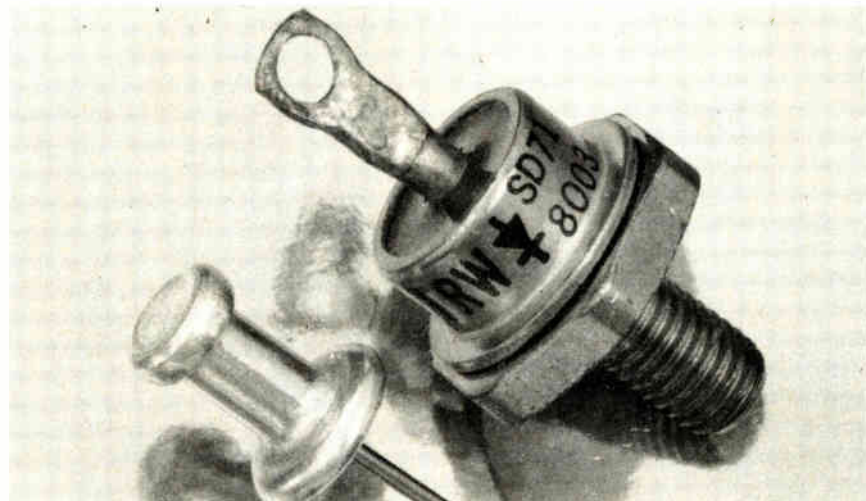

TM 500 now gives you the quickest distortion measurements ever.

Introducing the AA 501 Distortion Analyzer and SG 505 Oscillator. Fast, automated and accurate.

This new pair of TM 500 Plug-ins makes distortion measurement truly automatic to save you both time and money. For production testing, the AA 501's automatic speed provides substantial labor reduction with no loss in accuracy. Together, the AA 501 and SG 505 have the lowest harmonic distortion plus noise (THD+N) rating in the entire industry: 0.0025%.

The SG 505 Oscillator outputs a sine wave with the lowest residual distortion on today's market (.0008%). The AA 501 Distortion Analyzer uses digital processing to lock in on test signals, set levels and adjust the notch filter for nulling. All measurements, including dB levels are precalculated and then displayed on an LED readout.



The AA 501 and SG 505 are both TM 500 Plug-ins that can be installed in any of five main-frames including rackmount, bench and portable. They can also be separated and still used as a team, even though miles apart. Or configured with over 40 other TM 500 Plug-ins currently available.

To find out more about the AA 501 Distortion Analyzer and SG 505 Oscillator, contact your local Tektronix Field Office or write Tektronix, Inc.

TM 500 Designed for Configurability

Tektronix
COMMITTED TO EXCELLENCE

U.S.A.
Tektronix, Inc.
P.O. Box 1700
Beaverton, OR 97075
503 644-1512
Circle 800 644 9051

Asia, Australia, Canada,
Central &
South America, Japan
Tektronix, Inc.
America's Pacific
P.O. Box 1700
Beaverton, OR 97075



PC BOARDS!...

The heart of every Control and Switching device... Finally an economic solution to all of your circuit card storage, inventory control, and protection requirements.

Our patented storage device was **invented** just for you! Don't hesitate... Send for further information now!

We are the Source.



L. O. Drake & Son, Inc.

1662 OLD COUNTRY RD., PLAINVIEW NY 11803 • PHONE (516) 454-9011

Circle 274 on reader service card

Thermocouple Simulator / Calibrator plus...

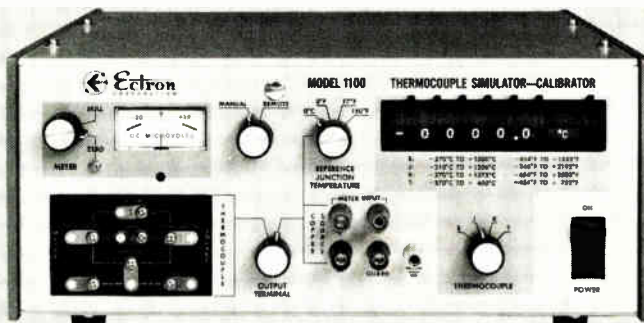

Model 1100—
Dial
Temperature
directly
in degrees
C or F.

This new standard is 4 instruments in 1. It's a thermocouple simulator, thermocouple calibrator, linear DC voltage standard and DC linear differential voltmeter. Simplifies precise calibration of thermocouple measuring instruments. Includes production and lab applications.

FEATURES

Simulates 4 TC types
Dial Temperature in Degrees
Digital Conformity to NBS 0.1°
Self-Contained Ref. Junction
Dial Millivolts Directly
0.01% of Reading Accuracy
Optional Remote Programming

THERMOCOUPLE APPLICATIONS

Calibration of:
Temperature Indicators
Data Systems
Temperature Transmitters
Amplifiers & Linearizers
Temperature Controllers
Thermocouples
(requires bath)

LINEAR APPLICATIONS

Calibration of:
DC Digital Voltmeters
Panel Meters
Strip Chart Recorders
Millivoltmeters
VCO's & Amplifiers
DC Power Supplies

8159 Engineer Road, San Diego, CA 92111
Phone (714) 278-0600 / TWX 910-335-1259



New products

at the device include such computer firms as IBM and NCR. The devices are primarily intended for rectification and commutation in high-current 5-v logic supplies for either military or industrial products.

With 60-v, 75-A ratings, the SD-71 is the flagship of the line; also offered is a companion series with 50-v, 30-A performance. Both device lines come in three packages: DO-4, DO-5, and TO-3. Pricing at the 100-quantity level for the SD-71 is \$6.95, with the 50-v SD-72 at \$6.50. Delivery is immediate.

TRW Power Semiconductors, 14520 Aviation Blvd., Lawndale, Calif. 90513. Phone (213) 679-4561 [341]

Digital potentiometer IC
resolves 3½ digits

The AD7525 integrated circuit functions as a digitally controlled potentiometer, resolving 3½ binary-coded decimal digits (1,999 counts). The manufacturer says it offers guaranteed monotonicity, excellent repeatability, and low drift at the maximum temperature of 25 ppm/°C. The monolithic potentiometer can be used for digitally controlled gain and attenuator circuits in audio equipment, automatic test equipment, and instrumentation.

The device dissipates 15 mW and has a maximum feedthrough error of $\pm 0.1\% \pm 10$ v for a 20-kHz sine wave. Six grades (plus four military versions) are available with either $\pm 1/2$ or ± 1 least significant bit maximum nonlinearity. Packaged in 18-pin plastic or ceramic dual in-line packages, the ICs operate over three temperature ranges: from 0° to +70°C (types KN and LN); from

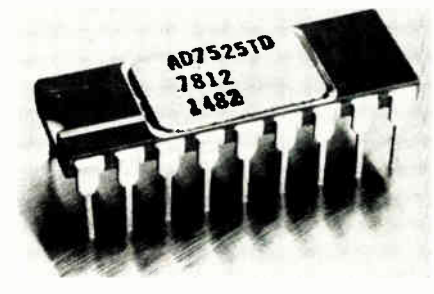

THE HUGHES H800

The fastest route from concept to production...

From concept to design, from prototype to production no other development system can match the speed, the power, the flexibility and the capability of the new Hughes advanced microcomputer development system—the H800.



HUGHES

HUGHES AIRCRAFT COMPANY

Solid State Products Division
Semiconductor Product Line
500 Superior Avenue
Newport Beach, CA 92663
(800) 854-3515 or
(714) 759-2678

State-of-the-art multiprocessor architecture of the H800 includes intelligent peripheral controllers and memory management unit that's expandable to more than 128K. And the H800 is virtually universal, supporting the 1802, 1804, Z80, 3080, 8085, 8048, 6300, 6809, 6502, with additional microprocessor support now in design.

Cost-effective development software of the H800 includes high-level languages through CP/M, a convenient screen editor and a relocatable macroassembler. Additional software features include a library capability, linkage editor and symbolic debug.

The modular operating system of the H800 allows both multi tasking and multiusers, and includes a real-time clock and timer, background printing, logical I/Os, utilities and file management. And with the H800, you can software download to and from any other system.

In-circuit-debug emulator of the H800 provides real-time execution, disassembler in trace, and patch assembler in debug. In addition there are

unlimited hardware, software and special conditional break points, single step/multiple steps, a powerful mapping facility, and a universal real-time Logic Analyzer.

The H800 Advanced Microcomputer Development System... another important addition to the Hughes microprocessor family.

The 1800 Microprocessor Family

(Available Now)

Number	Function
HCMP 1802	CPU
HCMP 1822	256 x 4 RAM
HCMP 1824	32 x 8 RAM
HCMP 1831 2	512 x 8 ROM
HCMP 1833 4	1024 x 8 ROM
HCMP 1835/6	2048 x 8 ROM
HCMP 1851	Prog. I/O
HCMP 1852	I/O Adapter
HCMP 1853	3 to 8 Decoder
HCMP 1854	UART
HCMP 1855	Mul./Div.
HCMP 1356 7	Bus Buffer/ Separator
HCMP 1358/3	Memory Latch/ Decoder
HCMP 1361	TV Interface

A GOLD MINE OF MAGNETIC SHIELDING DATA



64 Pages

Major Designing/Procurement Guidelines Given

2/3 of 64-page book contains valuable technical/engineering information about the entire magnetic shielding field; 1/3 is catalog data.

18 Pages of staff-written technical/engineering articles, inclu-

ding reprints from various trade publications. Plus tables, graphs, trigraphs, engineering reports, 20 solutions to magnetic shielding problems, etc.

Yours for the asking.

AD-VANCE MAGNETICS, INC.

The Problem Solving Magnetic Shielding Specialists

625 Monroe Street, Rochester, Indiana 46975
Phone (219) 223-3158 TWX 810-290-0294

Circle 10 on reader service card

NO BRIDGE TOO FAR.



Gentron spans the entire spectrum of SCR bridge circuits

Here's our newest family addition: the 15-amp and 25-amp B series. Bridges the gap where small size, low cost, high thermal efficiencies are required. Choose either interconnect option: wires or fast-on terminals. The B series features the proven and reliable POWERTHERM process.

A call will bring complete information and our new color catalog. Dial (414) 351-1660. Or write us today.

GENTRON CORPORATION

6667 N. Sidney Place • Milwaukee, Wisconsin USA 53209

276 Circle 11 on reader service card "SEE US AT WESCON '80 BOOTH #3009."

New products

-25° to +85°C (CD, BD); and from -55° to +125°C (UD, TD). The AD7525 sells for from \$14 in hundreds for full accuracy grades.

Analog Devices Semiconductor, 804 Woburn St., Wilmington, Mass. 01887. Phone (617) 935-5565 [343]

Thyristors have turn-off times of 10 to 50 μ s

Depending on the current rating of the devices, the T7SH series of silicon controlled rectifiers have turnoff times of from 10 to 50 μ s. At 400 A, the fast-switching thyristors turn off in between 10 and 50 μ s; at 450 A their turn-off times are from 20 to 50 μ s; at 500 A, from 10 to 20 μ s; and at 600 A, from 20 to 40 μ s.

Contained in a package only 0.6-in. thick, the component has a thermal resistance junction-to-case rating of 0.045°C/w. The minimum repetitive di/dt (rate of rise of peak current) is 500 A/ μ s for the 400- and 500-A SCRs and 600 A/ μ s for the 450- and 600-A units. The minimum nonrepetitive di/dt for all the units is 1,200 A/ μ s. In lots of 100, a single T7SH thyristor rated at 400 A, 1,200 v, and 10- μ s turn-off time is \$216. Delivery takes from six to eight weeks.

Westinghouse Electric Corp., Semiconductor Division, Youngwood, Pa. 15697. Phone (412) 925-7272 [344]

A-d converter operates from 9-V battery for 8,000 h

An analog-to-digital converter chip that dissipates under 1 mW or a maximum of 900 μ W of power operates from a 9-v battery for 8,000 hours. The ICL7126 is a 3½-digit device that contains seven-segment decoders, display drivers, reference, and clock on a single complementary-MOS integrated circuit. Designed to interface directly with a liquid-crystal display, the converter has a guaranteed zero reading for 0 v on all scales and has true polarity for null detection. Other specifica-

HITACHI QUALITY

Expanding the Limits of Excellence
in Semiconductor Design



 **HITACHI**

Hitachi America Ltd., Electronic Devices Sales and Service Division
707 West Algonquin Road, Arlington Heights, IL 60005 (312) 593-7660 TLX 20-6825

Symbol of Semiconductor Quality, Worldwide

Circle 18 on reader service card

GOOD CRT'S COME IN SMALL PACKAGES

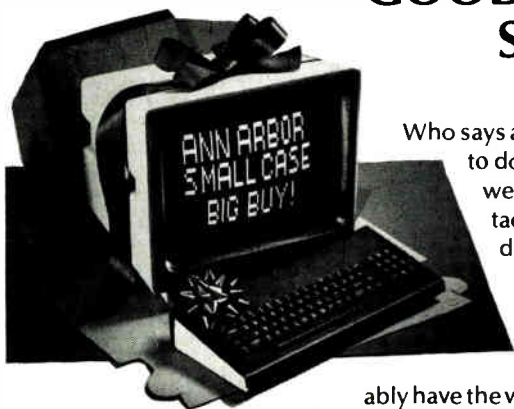

Who says a CRT terminal has to be big and bulky to do a good job? At Ann Arbor Terminals, we offer a full 15-inch screen and detached keyboard as standard on all our desktop terminals. And the case is only 14" wide by 15" high by 13.6" deep.

We're known throughout the industry for our high quality and reliability. On top of this, we probably

have the widest range of available options in the field. Display formats from 256 to 4800 characters. Foreign

language character sets. Special command sets. Custom keyboards. Editing, protected fields and block transmit.

And if your application doesn't lend itself to a desktop terminal, we offer display controllers (especially good in industrial environments) for use with free-standing monitors. Or buy our terminal without the case and mount it in your own console.

So when the CRT is the focal point of your system, why settle for a large case and small screen? You can have excellent readability without taking up a lot of room. And get the features you need. Call us for more information at Ann Arbor Terminals, Inc., 6175 Jackson Road, Ann Arbor, Michigan 48103.

Tel: (313)663-8000. TWX: 810-223-6033.



Circle 20 on reader service card

If you'd like your career to prosper through New England winters and Cape Cod summers, don't miss the Massachusetts Career Opportunities Section in ELECTRONICS' upcoming September 25th issue.

New products

tions include drift of less than $1 \mu\text{V}/^\circ\text{C}$, a maximum input bias current of 10 pA, rollover error of less than one count, and noise of less than $15 \mu\text{V}$ peak to peak.

Contained in 40-pin plastic or ceramic dual in-line packages, the ICL7126 sells for \$11.30 in lots of 100. Delivery is from stock.

Intersil Inc., 10710 North Tantau Ave., Cupertino, Calif. 95014. Phone (408) 996-5000 [346]

Mercury proximity switch surpasses 2 billion cycles

Tested to better than 2 billion mean cycles between failures, the LC2ST-1801 mercury-film proximity switch incorporates a threaded pole piece for easy installation and pull-in or drop-out adjustment. Unlike conventional mercury switches that use fragile glass capsules, the bounce-free unit is housed in a hermetically sealed welded-steel capsule that withstands shock and vibration levels in excess of 30 g. The device can be screwed into a tapped hole or fastened in place by metal or nylon nuts or by Tinnerman speed nuts.

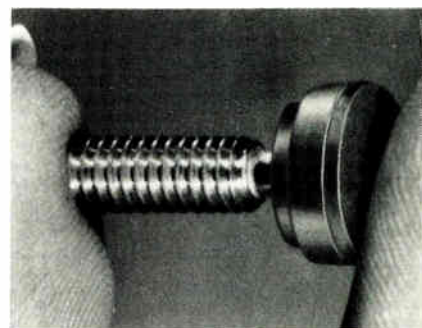

Characteristics of the device include a load-handling current range of from 1 pA to 2 A, contact resistance of only $0.2 \Omega \pm 0.02 \Omega$ over the life of the switch, and a peak contact breakdown voltage specified as 1,200 V ac.

In production quantities, the unit sells for less than \$2.50. Delivery is from stock to four weeks.

Fifth Dimension Inc., 801 New York Ave., Trenton, N. J. 08638. Phone (609) 393-8350 [347]

Itron Advanced Alphanumeric. They'll put your readouts upfront.

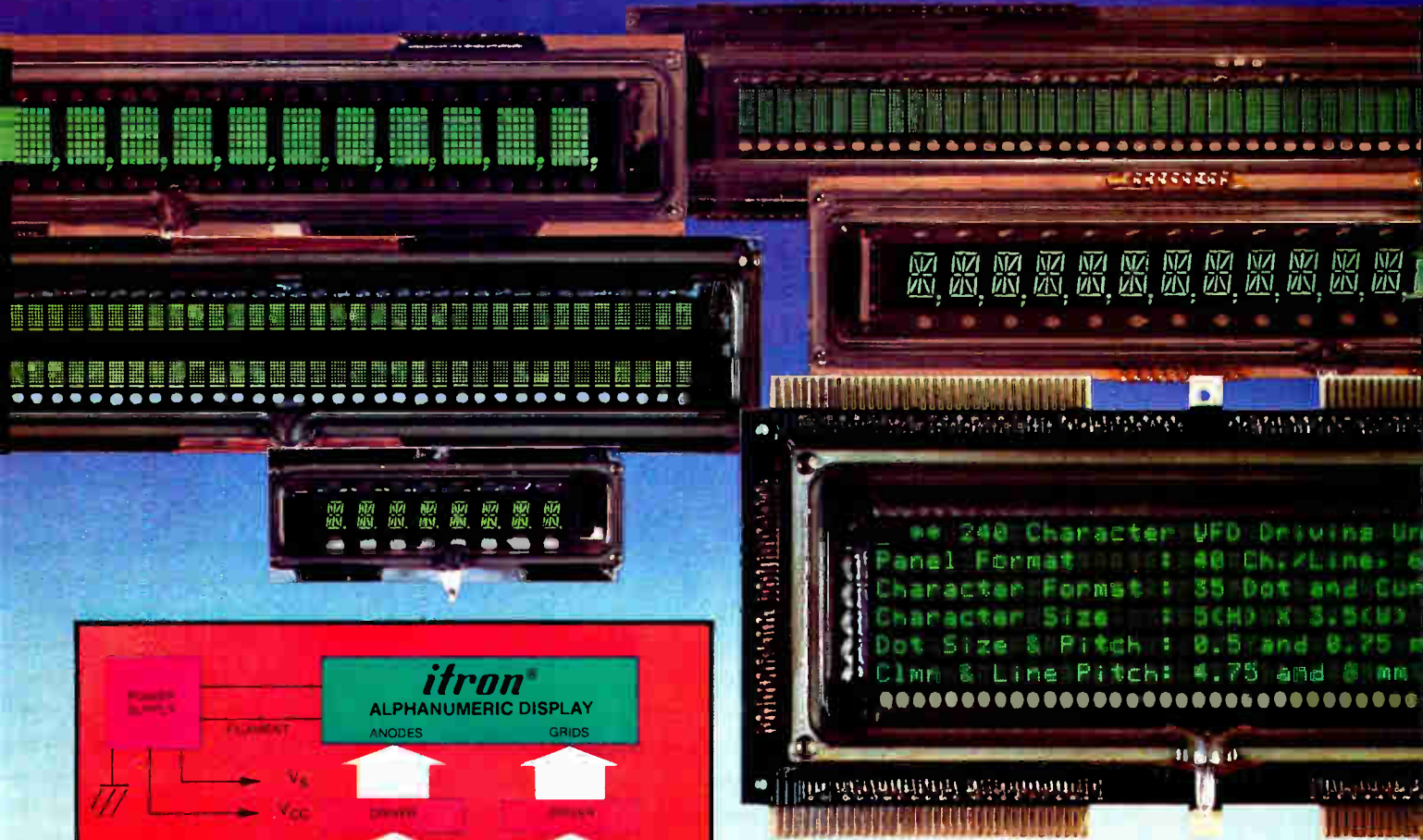

With Itron's evolutionary 14-segment and dot matrix alphanumeric displays, your readout designs are sure to be front-runners everytime. They're offered in a wide selection of character heights from 5 mm to 15 mm, and character counts that range from an 8-character 14-segment mini-package array, all the way up to the unique 240 character, 5 x 7 dot matrix (6 line x 40 characters/line) plug-in panel—and even 5 x 12 dot matrices for upper/lower case fonts.

Their long-term field-proven reliability, even under severe environments, further enhance their desirability for most every application where bright, easy-to-read legibility (even at a distance and under high ambient light), wide viewing angles and flat-glass simple-to-mount packages—plus low voltage and low current-drain are paramount. So, since brevity is called for, contact us to find out all the particulars on how to put your readout designs in the forefront with Itron's Advanced Alphanumerics.

itron[®]
 FLUORESCENT DISPLAYS
 Patented and Manufactured by
 ISE ELECTRONICS CORP.

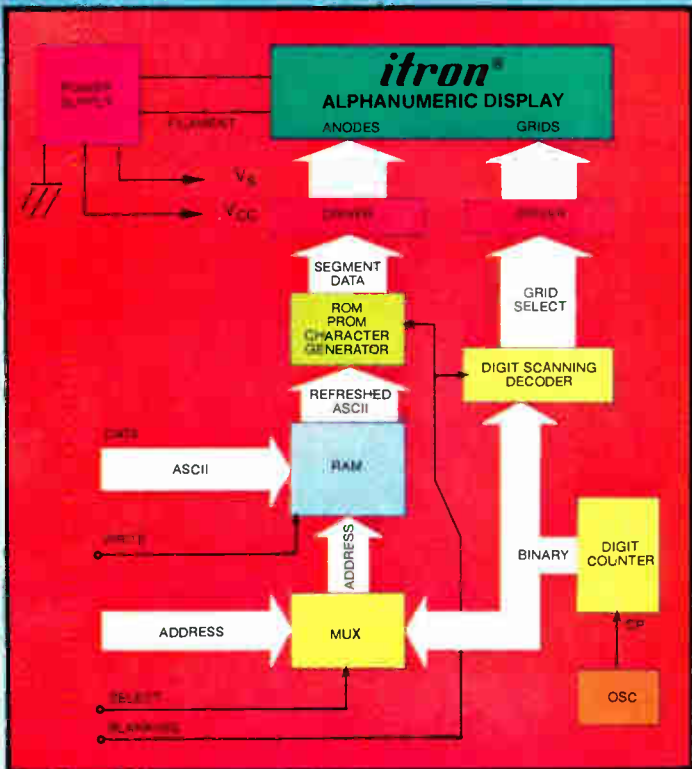

INTERNATIONAL REPRESENTATIVES

- WEST GERMANY: Neumüller GmbH, Eschonstr. 2, 8021, Taufkirchen, Munich. Phone: 089/6118-245. Telex: 522106
- FRANCE: Europavia France, 5 Avenue Leon Harmel 92167 Antony Cedex. Phone: 696-21-10. Telex: 42204381
- UNITED KINGDOM: ITT Meridian, West Road, Harlow, Essex CM20 2BP. Phone: 0279-35351. Telex: 817202
- SWEDEN: AB Nordqvist & Berg, Box 9145 S-10272, Stockholm. Phone: 08-690400. Telex: 10407
- DENMARK: E. V. Johansen Elektronik A-S, Titagade 15-2200, Copenhagen. Phone: 01/839022. Telex: 16522
- HONG KONG: Phone: 5-732420. TAIPEI: Phone: 351-0293.

NORITAKE ELECTRONICS, INC.

- EASTERN OFFICE: 41 Madison Avenue, New York, NY 10010 • (212) 481-3440 • Telex: 12-5469
- CENTRAL OFFICE: 16250 Northland Drive, Southfield, MI 48075 • (313) 569-0088
- WESTERN OFFICE: 22410 Hawthorne Boulevard, Torrance, CA 90505 • (213) 373-6704 • Telex: 67-4910

NORITAKE COMPANY, LIMITED

- JAPAN: 1 - 1, Noritake-Shinmachi, Nishiku, Nagoya-Shi • (052) 562-0336 • Telex: J59738
- EUROPE: Burotel Belgium SA, Rue de la Presse 3-5, 1000 Bruxelles • (02) 217-83-60 • Telex: 4626962

GenRad/Futuredata delivers Intel, Zilog, Motorola, Rockwell, RCA...

8086
8085
8080
Z8000
Z80
6809
6802
6801
6800
6502
1802
3870

WE SUPPORT MORE CHIPS

When it comes to developing development systems that support more microprocessors, no one can touch us. Our universal development system doesn't box you in with a single chip or chip family. Our system sets you free to design with any or all of the most popular processors.

In your smart-product race through the '80's, switching development systems will be the pits. With our system that won't be necessary.

WE ADD NEW CHIP SUPPORT FASTER

Thanks to our unique slave emulation system we can add new chips to your system in a matter of weeks. Remember, we don't make the chips - just the development system. And we don't have to redesign our system for each new chip - we just add another slave emulator. And, that's all you pay for. So, we're faster and more economical, too.

WE SET THE PACE FOR EMULATION

Ours is the only system capable of delivering transparent, non-stop, full-speed emulation



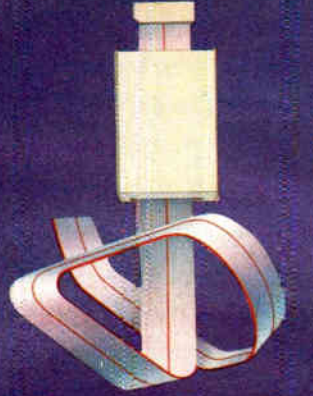

2300
series
advanced
development
systems

to 10 MHz. And it's the only system capable of emulating many different processors simultaneously.

Transparent, non-stop, full-speed emulation takes all the guesswork out of choosing the right microprocessor for your application. It allows you to evaluate each chip thoroughly, accurately and objectively.

The ability to emulate several different chips simultaneously paves the way to development of smart products using more than one processor.

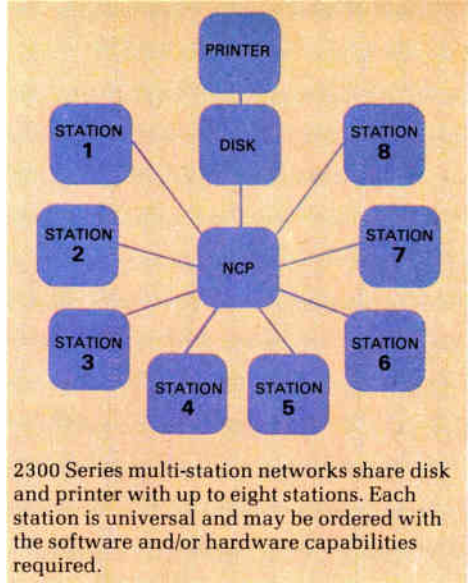

2300 Series multi-station networks share disk and printer with up to eight stations. Each station is universal and may be ordered with the software and/or hardware capabilities required.

WE DELIVER THE MOST COST-EFFECTIVE SOLUTION

Lower initial cost, universality and expandability make our system a prudent, long-term investment. Any of our systems can be upgraded to network status. By sharing costly and under-utilized resources (disks, printers, emulators, analyzers and even software) you can stop paying your designers to stand in line. Networking can lower your cost-per-station by 20% or more.

WE'RE HERE TO STAY

There is no finish in the smart-product race. To stay ahead you're going to need flexible, productive, expandable development systems and a supplier with staying power capable of giving you in-depth, after-sale service and support. Ask for a demonstration of the 2300 Series Advanced Development System. Sales and service offices in major cities.

TYPICAL 8086 SNAPSHOT

The 2302 Slave Emulator allows you to view your program in single-step, snapshot or logic analyzer modes. This view can be formatted to match your requirements even for the most complex memory segmentation, interrupt-driven or multi-processor environments.

WE KEEP YOU IN THE FAST LANE

Our system has been designed to make hardware and software development fast, efficient and productive. With our high-speed CRT, high-level language programming and powerful software, things happen fast - sometimes instantaneously. Now available with highly block structured PASCAL compilers, our system can cut your programming time by 50% or more.



GenRad/Futuredata
5730 Buckingham Parkway
Culver City, CA 90230
(213) 641-7200. TWX: 910-328-7202.

GenRad/Futuredata universal development systems - expanding your world of microprocessor-based design.

"SEE US AT WESCON, BOOTHS 2008, 2010, 2109 and 2111"

Circle 28 on reader service card

“Qualify? Not only do I have to qualify subscribers, I have to ask them for money.”

says our circulation manager, Herb Hunter.

“I remember how much simpler my job was when I worked for a free magazine. When I qualified my subscribers, I was finished. Now that’s just the beginning of my job. I have to ask Electronics subscribers for money.”

The point Herb makes here is often forgotten: It’s not a matter of collecting subscription money instead of qualifying readers, it’s a matter of doing both. In other words, Herb not only has to do it their way, he has to do it our way—qualified and paid.

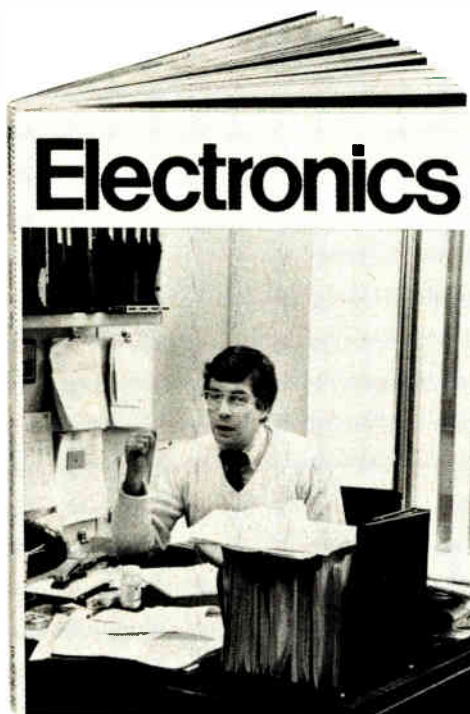

“But I’m not really taking the credit for collecting those subscriptions,” says Herb. “After all, it’s our editors who make the magazine worth \$18.00 in the U.S. and up to \$95.00 overseas. These paid subscriptions show intent to read, separating readers from non-readers. That’s an advertiser benefit!”

Exclusively yours,



Exclusively yours,

Electronics Magazine

Still using CMOS?

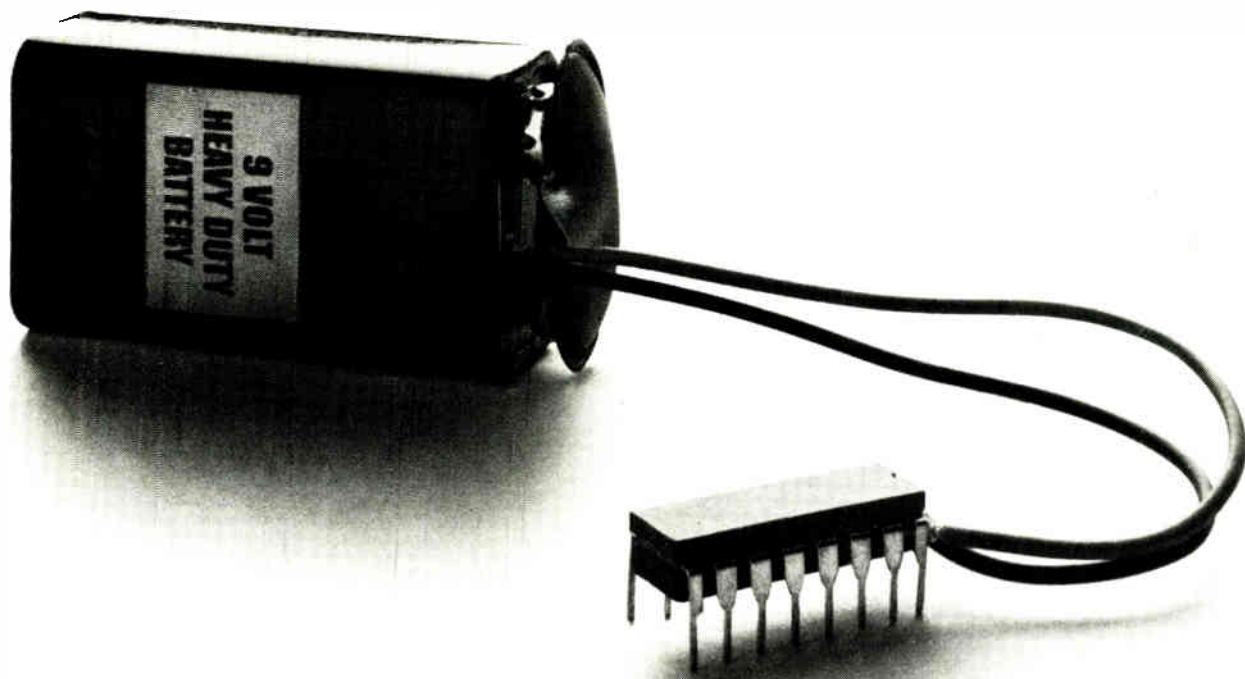

Pity.

Now you can eliminate the one major failing of CMOS — the battery backup.

By eliminating the CMOS. And using Plessey MNOS instead.

The listing shows the start of the new Plessey family of non-volatile MOS. We call it NOVOL because it is. Devices are *guaranteed* to hold their data for at least one year when the power is removed. They all operate from *standard* MOS supplies and are fully compatible with your TTL/CMOS designs.

With our NOVOL devices, you can eliminate the battery

backup, the mechanical relays, the pegboards and thumbwheel switches that you've had to depend on. It's the perfect solution for security code storage, metering, elapsed time indicators and any other application where

you need a little storage with a lot going for it.

For more data, just contact Plessey Semiconductors, 1641 Kaiser Avenue, Irvine, CA 92714. Telephone (714) 540-9979.



Plessey NOVOL MNOS

MN9102	4-Bit Data Latch (+5V, -12V)
MN9105	4-Decade Up/Down Counter (+5V, -12V)
MN9106	6-Decade Up Counter (12V only)
MN9107	100-Hour Timer (12V only)
MN9108	10,000-Hour Timer (12V only)
MN9110	6-Decade Up Counter with Carry (12V only)
MN9210	64 x 4-Bit Memory
COMING SOON	8 x 4-Bit Memory
COMING SOON	6-Decade Up/Down Counter, BCD Output
COMING SOON	6-Decade Up/Down Counter with Preset, BCD Output

Plessey MNOS doesn't forget.

What have Marconi Avionics, Allen Bradley and Burroughs got that you haven't?

In short, a site in Milton Keynes.

Some forty miles north of London you can find a new and fast developing location for the electronics industry: the new city of Milton Keynes.

Already some of the world's biggest commercial names have moved into what's probably the freshest idea in business development in the last twenty years. A completely new industrial and commercial centre designed from scratch to avoid all the problems of longer established trading areas.

It has everything essential for a developing industry. The physical space for any company, large or small, to grow. With the advice and resources to make setting up in Milton Keynes a painless process.

There's land available to build your own facilities or you could take on ready-built offices and factories.

Milton Keynes is set in rural Buckinghamshire with a variety of housing on hand, so it's an easy place to attract all levels of staff.

Within easy reach of London, Milton Keynes is close to the country's main motorway system and major rail routes, making it an ideal base for U.K. and European operations.

London's Heathrow Airport is only a 20 minute journey by a helicopter link scheduled to start soon.

That's what Burroughs, Allen Bradley and Marconi Avionics have got and you haven't.

But if you'd like to change all that, make contact with our representative on Stand No.2342, or write to Commercial Director, Milton Keynes Development Corporation, Wavendon Tower, Milton Keynes MK17 8LX, England.

MILTON KEYNES



Drop by the KYLEX Wescon suite for a look at the latest in dot matrix liquid crystal display systems. KYLEX manufactures the world's most advanced integrated flat screen display system, with direct I/O port interface capability. A whole new dimension in size, in low power drain, in low cost, in simple electronic interface.

See it for yourself at the Quality Inn in Anaheim during Wescon. Sept. 16-18, from 5-9 each evening. In the Groh Associates suite.

KYLEX

THE NEW DIMENSION IN FLAT SCREEN DISPLAYS
420 Bernardo Ave., Mt. View, CA 94043 (415) 969-5200

An affiliate of **EXXON** ENTERPRISES INC.



Kylex at WESCON: See us at Quality Inn ■

HERE AT LAST!

A Standard "Custom" Data Collection Device The Memodyne M80 Cassette Computer

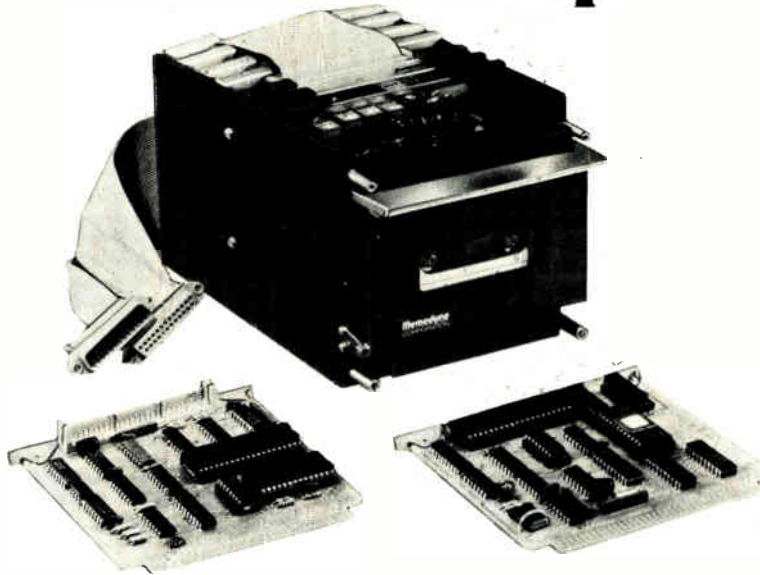

The M80 is a general purpose Z80™ based computer combined with a rugged, high-speed digital cassette drive in a compact, panel mounting module. Modem and terminal RS232C and TTY current-loop serial ports are provided for easy interfacing. A 2K PROM is programmed to implement completely interrupt driven control of the recorder and communications functions. A 1K RAM provides data buffering which allows the M80 to handle continuous streams of data up to 9600 BAUD.

T.M. Z80 is a trademark of ZILOG Corp.

FEATURES:

- Standard program in CPU Card Prom implements 30 recorder and communication commands plus numerous mode selections.
- A Microprocessor based computer that is small and compact, a rugged module that can operate in hostile environments with its own removeable medium memory, immune to hazards that disable disks, printers, and other peripherals.
- High speed: Can read or write continuous data streams at up to 9600 Baud with block size of 100 bytes or more.
- 500,000 Byte formatted capacity.
- ANSI/ECMA-34 compatible tapes, both tracks accessed.
- Programmable block size up to 256 Bytes.
- Recorder control and communications are interrupt driven and transparent to user programs.
- Small cards make for sensible modularity with modern high density ICs and are easily inserted and extracted.
- Small module fits behind standard 5 inch panel.

IF YOU NEED:

1. A Process Control Computer.
 2. A Computing Data Logger.
 3. A Custom Cassette Recorder.
 4. An Airborne Recording Computer.
 5. The Highest Speed RS232C Cassette Recorder.
 6. A Medical Data Acquisition System.
 7. A Numerical Controller.
 8. An Intelligent Cassette Terminal.
 9. An Analytical Instrumentation Recorder.
 10. An Automatic Tester.
- ... An application we haven't thought of ...

**THEN ALL YOU HAVE TO DO
IS PROGRAM OUR PROM
(AND IF YOU DON'T WANT TO
WE WILL).**

WRITE FOR COMPLETE DETAILS INCLUDING
COLOR BROCHURE TO:

Memodyne
CORPORATION

220 RESERVOIR STREET
NEEDHAM HEIGHTS, MA 02194 U.S.A.
TELEPHONE (617) 444-7000
TELEX 922537

MAGNAVOX FAIRCHILD
 TEXAS INSTRUMENTS
 WESTINGHOUSE RCA
 MCDONNELL DOUGLAS
 PENNSYLVANIA SPERRY
 MOTOROLA HAMILTON
 STANDARD PERKINELM
 GENERA ELECT
 BRATT COLLIN
 BRUMM LOCKE
 ONEY HUGHE
 ENER DYNAM



**A few of our customers say
 Abbott MIL Spec power supplies
 are 99% perfect.**

The others say only 98%. For almost fifteen years we have maintained a customer failure rate of 2% for our "C", "S" and "W" MIL Spec power supplies. That's tried and true proof of reliability... in the field.

Our Model "W" family of 400 Hz to DC power supplies is a standard throughout the world for critical military and aerospace applications. They're available with output voltages from 5 to

100 VDC, current levels from 0.3 to 20 amps.

Our "C" family of 28V DC to DC converters and our "S" family of 28V to 400 Hz inverters come in package sizes as small as 2 1/8" x 3 1/2" x 3 1/2", and meet the requirements of eleven separate MIL Specs.

For reliability, call Abbott. For delivery, call Abbott. For additional information, write or call Abbott.

See EEM or GOLD BOOK power supply sections.

abbott transistor
 MILITARY PRODUCTS DIVISION

Circle 36 on reader service card

Eastern Offices, 1224 Anderson Ave., Fort Lee, New Jersey 07024 (201) 224-6900 TELEX 13-5332
 Western Offices, 5200 West Jefferson Blvd., Los Angeles, CA 90016 (213) 936-8185 TELEX 69-1398

"SEE US AT WESCON SHOW, BOOTH NO. 4010"



"Heat Dissipation Problems?"

What you need is a custom made heat sink from AHAM tor. With over 350 aluminum extrusions, and complete in-house production capabilities, AHAM tor can manufacture a heat sink that will fill all of your requirements. Just send us your drawing, and we'll do the rest.

Call or send for a free catalog today, and no more heat dissipation problems!

watts: 1-800-854-5647 Calif. watts: 1-800-472-5679
27901 Front St., Rancho California, Ca. 92390



See us at Wescon Booth #1568
Circle 48 on reader service card



**NEED SERVICE
ON YOUR
SUBSCRIPTION
TO ...**

Electronics

*Do you want to change
your address?
Have you missed an
issue?
Was your copy damaged?*

**CALL
(609) 448-8110***

**FOR IMMEDIATE
HELP**

*9 a.m.-4 p.m. EST



New products

Semiconductors

**Op amp has low
offset voltage**

P-channel MOS and
bipolar transistors
combine forces on one chip

RCA's Solid State division marks its entry into the precision instrumentation operational amplifier market with the CA3193 series, monolithic devices that incorporate both p-channel MOS and bipolar transistors. These internally phase-compensated op amps come in three versions—military, industrial, and commercial—all of which exhibit gain-bandwidth products of 1.2 MHz.

The military CA3193B's specified input offset voltage is 75 μV maximum, 40 μV typically, and its input-offset-voltage temperature coefficient is 2 $\mu\text{V}/^\circ\text{C}$ maximum, 0.6 $\mu\text{V}/^\circ\text{C}$ typically. The commercial CA3193's input offset voltage figure is 500 μV maximum and 300 μV typically, and the temperature coefficient thereof is 5 $\mu\text{V}/^\circ\text{C}$ maximum, 1 $\mu\text{V}/^\circ\text{C}$ typically.

By combining bipolar and p-MOS processes, RCA achieved better performance at a lower cost, according to Leonard A. Metzger, administrator for market planning of linear and industrial integrated circuits. "The

bipolar input gives us low dc noise, which is a primary concern when you are operating with a precision op amp. The first stages in the circuit provide low input offset voltage, and a low input-offset-voltage temperature coefficient," he says.

Three stages. The CA3193 is a three-stage design: the first is a bipolar level of physically cross-connected npn transistors. The second stage consists of a differential amplifier using p-MOS field-effect transistors. In the third stage are Darlington-connected npn transistors.

Common-mode rejection ratio for the military version is a minimum of 120 dB and typically 130 dB. For the commercial version, it is a minimum of 100 dB and typically 110 dB. According to Metzger, the input impedance for the military version is typically 9 M Ω and a minimum of 3 M Ω . "The frequency-range fall-off for the CMRR specification occurs someplace between 10 and 15 Hz."

The op amp's input offset current is 3 nA maximum, 1 nA typically (military) and 10 nA maximum, 5 nA typically (commercial). Power-supply level for the commercial and industrial versions can range from ± 3.5 v to ± 18 v; the military version extends that range out to ± 22 v. Operating temperature ranges for the three parts are from 0 $^\circ$ to 70 $^\circ\text{C}$, -25 $^\circ$ to +85 $^\circ\text{C}$, and -55 $^\circ$ to +125 $^\circ\text{C}$ for the military version.

This series of op amps should find a wide range of application, especially as thermocouple preamplifiers,

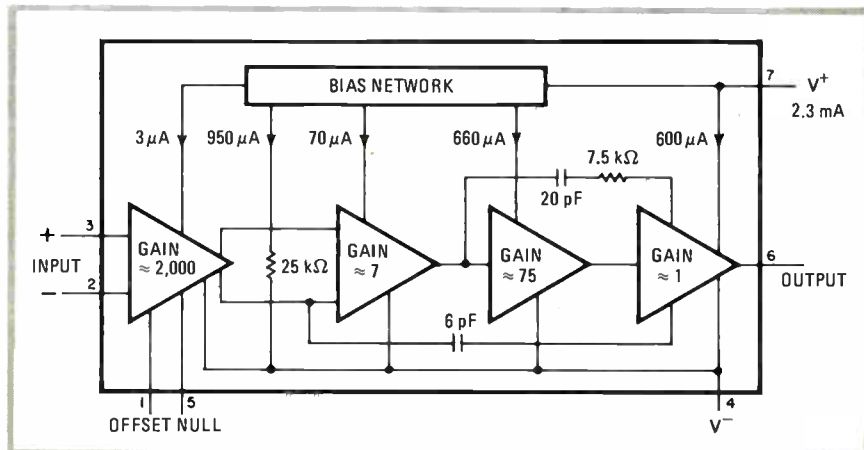

How it's done. An ultrahigh-gain input stage—actually a quad of cross-connected npn transistors—ensures minimal downstream effect on offset voltage characteristics.

Stanley's LEDs feature a luminous intensity of 160mcd at 20mA, embodying excellent performance and superior quality for which Stanley has become world-renowned.

Stanley's Super Bright LEDs are available in four colors (red, yellow, green and amber).

They find applications in toys, audio equipment, auto industry, computer and communication systems, and many others.

THE WORLD'S BRIGHTEST LEDs BY STANLEY

Extra Super Bright LED Series



Engineering assistance is freely provided, and custom made products are available per request.

Our New LEDs Will Be Displayed at Wescon '80

Please Visit Our Booth (Booth Number: 1752, 1754)



STANLEY ELECTRIC CO., LTD.

LED Sales Sect.:

2-9-13, Nakameguro, Meguro-ku, Tokyo 153, Japan
Tel. Tokyo 03-710-2531 Telex. 2466623

LED Agents Overseas ● **USA** A.C. INTERFACE, INC. Tel: (714) 979-9830 Telex: 655328 ● **ENGLAND** ITT MERIDIAN Tel: 0279-35351 Telex: 817202/LOHUIS LAMPS LTD. Tel: (0675) 65195-62270 Telex: 336187 ● **FRANCE** A. JAHNICHEN & CIE Tel: 387-59-09 Telex: 297014 ● **HOLLAND** LOHUIS LAMPEN B.V. Tel: 01606-2080, 01606-2319 Telex: 54145 ● **SWITZERLAND** DEWALD AG Tel: 01-451300 Telex: 52012 ● **WEST GERMANY** ELITE ELEKTRONIK UND LICHT GMBH & CO. KG Tel: 08094-1011 Telex: 527318 ● **SWEDEN** AB BETOMA Tel: 08-820280 Telex: 19389 ● **DENMARK** DITZ SCHWEITZER A-S Tel: (02) 453044 Telex: 15057

CAMBION IC PACKAGING PACKAGED!

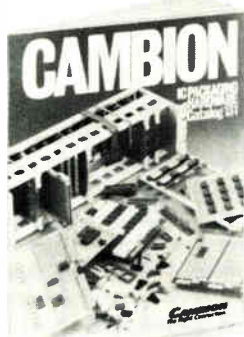

Catalog 131—68 pages chock full of Cambion IC Sockets, breadboards, Cambi-cards®, card files, integrated sockets, panels, interfacing hardware, power planes, power supplies, power and ground systems, and other extremely useful products to answer all of your IC Packaging requirements from loading the PC board to stacking the system! Cost-efficiently. Get the Catalog and Connect with Cambion at over 100 distributor locations! Cambridge Thermionic Corp., 445 Concord Avenue, Cambridge, MA 02238, Tel: (617) 491-5400, Telex: 92-1480, TWX: (710) 320-6399.

CAMBION®
The Right Connection.

Circle 50 on reader service card



NEW SOUND GENERATORS OFFER LOW-COST EFFICIENCY

Projects Unlimited's new line of Piezo Ceramic Benders (Series PCB-1) combine low-cost efficiency with small size, reliable construction and superb performance. These units will sound with as little as 3 VAC applied and are useful over the range of 1.5 to 15 KHz depending on the bender size and model number. High impedance allows the units to be easily driven from conventional I.C. devices.

For more information, write: Projects Unlimited, Inc.,

3680 Wyse Road,
Dayton, Ohio 45414.
Phone: (513) 890-1918.
TWX: 810-450-2523.



290

Circle 51 on reader service card

New products

high-gain filters, buffers, differential amplifiers, strain-gage bridge amplifiers, and voltage references.

Available from stock, the CA3193 is priced at 88¢ each, the CA3193A industrial version at \$1.80, and the CA3193B military version at \$3.19, in thousands, for the plastic DIP. For the standard TO-5 package and formed-lead TO-5 package, those prices increase to 99¢, \$2.00, and \$3.49, respectively.

RCA Solid State Division, Box 3200, Somerville, N.J. 08876 [411]

Bus extender retransmits signals without degradation

Inserted in series with a properly terminated open-collector bus, the Saber integrated circuit automatically repeats and retransmits signals between data-systems equipment without degradation. The 8X41 Saber (Signetics asynchronous bidirectional bus extender and repeater) can transfer data between up to eight pairs of elements in a data-processing or -communications system without external logic. The device is particularly useful for direct memory access. The 8X41 can sink up to 70 mA of current and drive a bus on which up to several hundred peripheral devices are connected. The TTL-compatible IC has a maximum delay time of 30 ns. It is available in a 24-pin plastic dual in-line package for \$25 apiece in quantities of 100.

Signetics, P. O. Box 409, 811 E. Arques, Sunnyvale, Calif. 94086 [413]

IC provides variable-phase control for power switching

An integrated circuit provides variable-phase control for power-switching devices. Operational amplifiers integrated in the component are able to detect errors in its electrical operation and to initiate protective measures. The universally applicable TDA 4700 can be used for ac-line hum suppression, symmetric inputs

Electronics / August 28, 1980

Why you should talk to us the next time you need an electromechanical relay.

You'll find us easy to deal with.

We're big enough to supply a broad selection of general-purpose, power and miniature relays. But small enough to be really responsive to your technical questions. Or to your request for delivery information.

Quality that meets or exceeds industry standards. Tight quality standards begin with our precision tooling, built to old-world levels of craftsmanship. Careful, experienced assembly helps, too. The capstone is that we inspect each relay on the production line. And then inspect a second time in the quality assurance department to a rigid AQL.

The result of our efforts is a remarkably low failure rate in the field.

Price and delivery that's more than competitive. Chances are, we can deliver relays quicker than you might imagine. We often let you slice a week or two off the best delivery you can find elsewhere.

You'll also find us competitive when it comes to price.

Call or write for more data. To find out more, call Don Barkhurst at 714/540-4190. Or write American Zettler, Inc., 16881 Hale Avenue, Irvine, CA 92714.

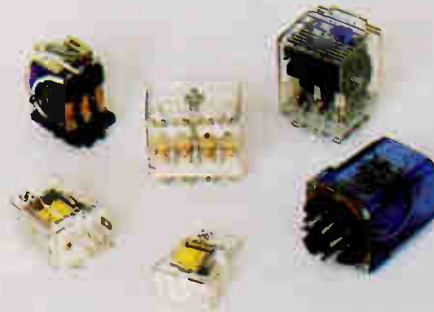

Miniature high-current relays. Large switching capacity in a small package. With a typical UL-rating of 10 amps at 240 volts ac, these relays are ideal for motor controllers and similar high-power applications.

Available in SPDT to 4PDT configurations with 10 to 20-amp contacts. Terminal options include PC, solder, quick-connect or octal base.



General-purpose relays. One will fit your needs exactly. For many applications, you'll find one of our general-purpose relays will precisely fill your requirements. You have a wide choice of contact types, coil voltages and sensitivities, and terminations.

Sealed versions of these relays stand up to harsh production processes and withstand severe environments.



Low-profile relays. Get up to 6-pole switching. In a package less than 1/2-inch high, these relays are especially suited for space-limited applications.

Contact types range from dry circuit to 5 amps, SPDT to 6PDT.

SEALPAK™ versions are immune to contact problems often caused by wave-soldering and dip-cleaning contaminants.

"See us at Wescon, Booth #3213"



"It's a better relay"

AMERICAN ZETTLER, INC.

Circle 52 on reader service card

If this is what you're looking for

HIGH TEMPERATURE CAPACITORS



Specify Standard T Series Custom Capacitors, made with DuPont TEFLON®—for temperatures to 200°C. and beyond.

- Insulation Resistance up to 10^{12} ohms
- Dissipation factor down to .02%
- Temperature Coefficient down to -90 ± 40 ppm/°C.

For complete data and FREE TechniTip, please fill out coupon and mail today.

Also available: C Series Mica for energy storage, and K Series Mica for maximum volumetric efficiency.

Performance Data

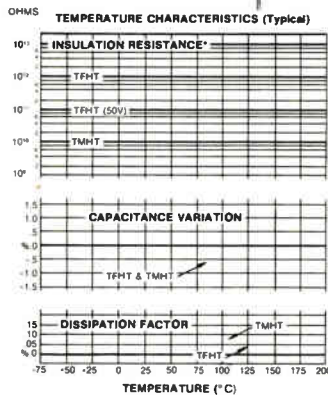

Name _____

Title _____

Company _____

City _____

State _____ Zip _____

Please send FREE TechniTip on Custom T Series Film Capacitors.



CUSTOM ELECTRONICS, INC.
12 Browne St., Oneonta, NY 13820
PH: 607-432-3880 TWX: 510-241-8292

Circle 67 on reader service card

New products

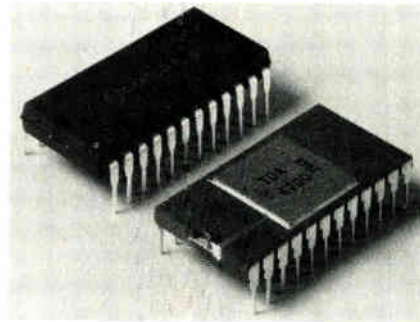

for push-pull converters, dynamic output-current limitation, output-overvoltage and input-undervoltage protection, and soft-start capability. The two outputs, which are transistors with an open collector, work in a push-pull mode, are low-active, and feature a typical output current of 15 mA. The oscillator frequency range is up to 250 kHz. The TDA 4700 in plastic sells for \$5.69 in lots of 1,000. Delivery time is 8 to 12 weeks.

Siemens Corp., 186 Wood Ave. S., Iselin, N. J. 08830 [414]

A Temperature Controller For Every Application



CHOOSE FROM:

- Control: 1, 2, or 3 Mode, On/Off, Limit
- Setpoint: Analog, Digital
- Indication: Full Range, Deviation
- Outputs: Current, Voltage, EM Relay, SS Relay, Power Pack

PLUS:

- Solid State Reliability
 - Computer Tested
 - Modular Construction
 - Space Saving Size
 - Optional Alarms
 - Plug-in Electronics
- AND LOW COST**



For additional information, circle the Reader Service Number or contact:
Process Control Division, 1601 Trapelo Road,
Waltham, MA 02154, 617-890-2000.
In Canada: Lisle-Metrix Ltd., Toronto

See LFE at Wescon, Booths 1436-1438

Circle 68 on reader service card

Sensitive-gate triacs

have 8-A on-state current

Designed for direct use with 5-v low-level logic and microprocessor-based controllers, a new family of triacs has an 8-A on-state current—twice the output current of previous sensitive-gate triacs with similar gate-drive requirements, says the manufacturer. Each of two has peak repetitive voltage ratings ranging from 50 to 800 v. The MAC228-2 through MAC228-10 have a gate sensitivity of 5 mA in three operating modes and sell for 77¢ to \$2.58; the MAC228A-2 through MAC228A-10 have a gate current of 10 mA in



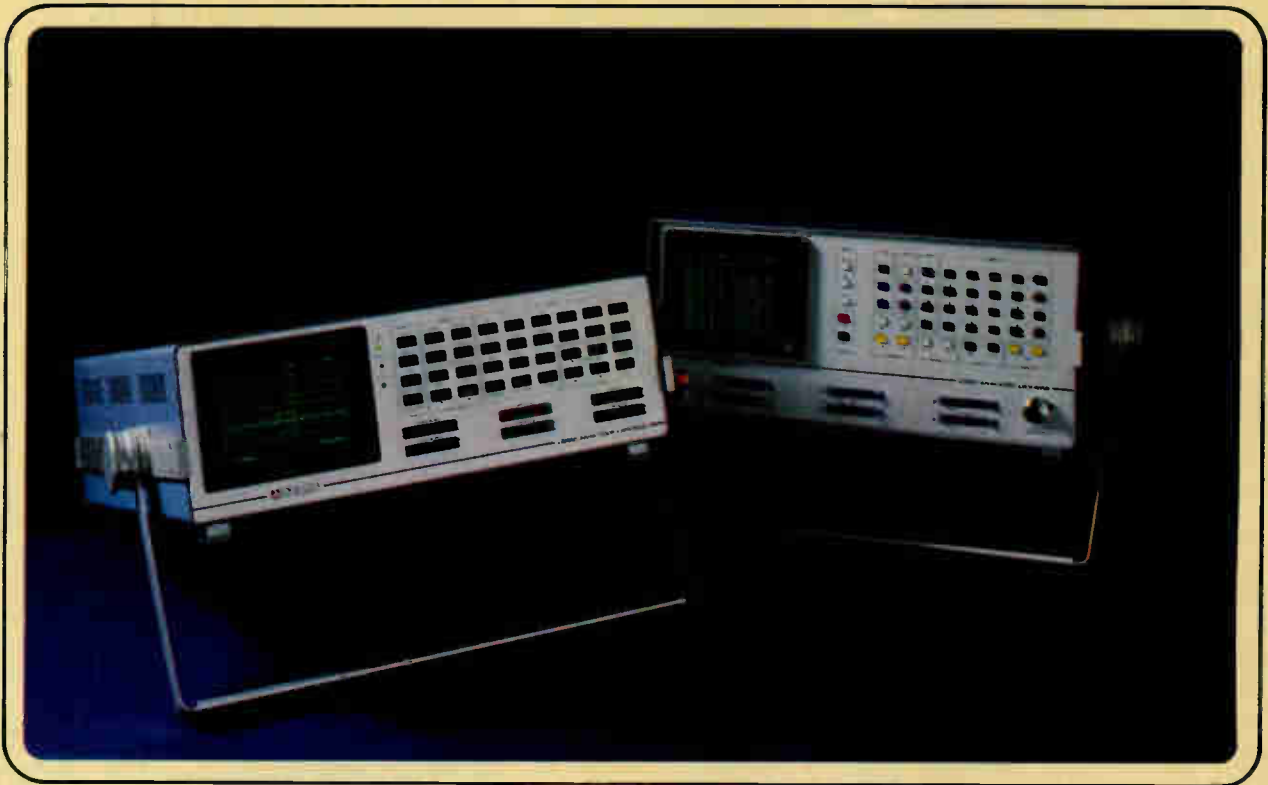

32 & 48 CHANNELS OF Logic Analyzing Flexibility

Other logic analyzers don't have the flexibility you get with our LAM 3250 or LAM 4850 Logic Analyzers. Programming flexibility that allows you to organize recording memory and display format to fit unlimited applications. Multi-level clocking flexibility to give you a bus-demultiplexing capability. Four-level sequential trigger flexibility to debug a faulty piece of software among several nested routines. Channel flexibility so you can switch from 8 to 16 bit microprocessors. System interface flexibility to meet tomorrow's problems.

A number of world firsts in logic analyzers.

The LAM 4850 was first to offer 48 input channels, 3 level simultaneous clocking and "trigger tracing" for real time examination of nested routines.

The LAM 3250 is the first logic analyzer to offer 32 channels of timing display. It also stores as many as six files of menu and display configurations in nonvolatile memory. Turn it off for three months and you can still recall previously programmed operating and display conditions.

Both analyzers have operating simplicity plus:

- 1000 bits of recording and reference memory per channel
- Clock rate to 50 MHz
- Separate menus to set up trace, trigger and compare parameters
- Powerful compare and search modes
- 5 ns glitch catching
- Binary, hex, octal, ASCII, and timing display
- Hard copy printout
- Programmability via GPIB and RS-232 interfaces
- Disassemblers and personality probes for all popular microprocessors

Dolch Logic Analyzers give you more flexibility, more channels, more features . . . plus sales and service nationwide. For more information, contact your nearest representative or our factory. Dolch Logic Instruments, Inc., 2180 Bering Drive, San Jose, CA 95121, (408) 946-6044, (800) 538-7506, TWX 910 338 3023.



REPRESENTATIVES: Alabama (205) 498-3380, Arizona (602) 998-1848, California (213) 433-0977, (213) 446-9620, (714) 551-3722, (408) 244-5508, (415) 348-7291, (714) 569-8038, (714) 755-9179, Colorado (303) 794-1779, Florida (305) 339-0978, (305) 791-2488, (813) 596-5331, Georgia (404) 252-6609, Hawaii (808) 941-1574, Illinois (312) 283-0713, Indiana (317) 844-0114, Massachusetts (617) 933-8150, (617) 935-9530, Maryland (301) 321-1411, Minnesota (612) 835-4818, North Carolina (919) 294-4783, New Jersey (609) 482-0059, New Mexico (505) 266-7951, New York (516) 781-7710, (315) 437-7779, (716) 328-5240, Ohio (513) 252-5627, Oregon (503) 283-0132, Texas (512) 735-5073, Virginia (703) 573-8787, Wisconsin (414) 545-8400, Puerto Rico (809) 762-2688, Canada (416) 742-4488.

Circle #94 for more information
Circle #69 for a demonstration

THE MICRO-PROCESSOR BOARD TESTABILITY BIBLE



This comprehensive 100 page report provides concrete guidelines for design testability and testing methods for microprocessor based PCBs. Brand new and completely state-of-the-art, this report will ease testing headaches, improve productivity and cut testing costs!

PARTIAL CONTENTS

- ATE Techniques
- General Guidelines
- 8080A Family
- 8085A Family
- 8086A Family
- Z80 Family
- Z8000 Family
- 6800 Family
- 68000 Family
- 2901 Family
- Software Initialization
- Mechanical Guidelines

\$95⁰⁰ per book

In California please add 6.5% sales tax (\$6.18)

Order your copies today!

LOGICAL SOLUTIONS, INC.
122 Saratoga Avenue, Suite 14
Santa Clara, CA 95050 • (408) 248-9566

YES! Please ship _____ copies of
Microprocessor Board Testability.
Enclosed is our check for \$_____

NAME _____
COMPANY _____
ADDRESS _____
CITY STATE ZIP _____

Also ask about Consulting Services, in-house Seminars/Workshops and testability reviews of your schematics.

Circle 70 on reader service card

SUPER MINIATURE

Neon Glow Lamps

Circuit Volts.....AC105-125
Series Resistance.....150K Ω
Nominal Current.....0.3mA
Total Flux.....20mlm MIN.
Average Life Hours...30,000

Dimension:mm

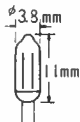

NL-8S

CLEAR-GREEN

Fluorescent Glow Lamps

Circuit Volts.....AC or DC105-125
Series Resistance.....33K Ω
Nominal Current.....1.6mA
Total Flux(MIN).....AC:120mlm,DC:130mlm
Avg. Life Hours.....AC:30,000 DC:40,000

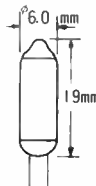

NL-35/G

Circuit Volts.....AC 105-125
Series Resistance.....27K Ω
Nominal Current.....1.5mA
Total Flux.....90mlm MIN.
Avg. Life Hours.....20,000

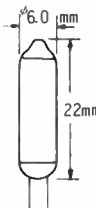

NL-21/G

● MAIN PRODUCT

NEON GLOW LAMP, XENON FLASH LAMP,
RARE GAS, DISCHARGE LAMP,
MINIATURE : BLACK-LIGHT, UV-LIGHT,
FLUORESCENT COLOR-LIGHT.

ELEVAM ELECTRONIC TUBE CO., LTD.

EXPORT DIVISION

NO. 17-8CHUO 2-CHOME OTA-KU, TOKYO JAPAN.
TELEPHONE : 03(774)1231~5 TELEX : 246-8855 ELEVAM

New products

four modes and sell for 77¢ to \$2.58. Prices are for orders of 100 to 999. Delivery is from stock.

Motorola Semiconductor Products Inc., P. O. Box 20912, Phoenix, Ariz. 85036 [415]

16-A transistors switch in 400 ns, handle 500 to 700 V

Housed in TO-220 packages, a series of power transistors have peak currents of 16 A and switch in 400 ns while handling a collector-to-emitter voltage of from 500 to 700 v. The SP6306-7-8 series of the triple-diffused devices is designed for high-voltage inverters, switching regulators, power amplifiers, and power supplies. In 100s, the transistors sell for from \$1.48 to \$1.70 each. Delivery is from stock.

Solitron Devices Inc., 1177 Blue Heron Blvd., Riviera Beach, Fla. 33404. Phone (305) 848-4311 [417]

ICs contain most circuitry to drive ac plasma displays

A family of high-voltage display-driver integrated circuits, the models XR-2284 and XR-2288 contain most of the drive circuitry required to drive ac plasma displays. All channels have independent inputs and outputs and a common toggle switch and substrate. An external diode common to all channels decouples the substrate from ground to allow many driver ICs to be stacked. When ac toggle voltage is applied, the corresponding output can sink or source up to 100 mA of current to the capacitive load. Both units operate with toggle frequencies up to 200 kHz.

Models XR-2284P and XR-2288P are designed for 360-v systems and exhibit a minimum sustaining voltage of 90 v. The commercial versions, XR-2284C and XR-2288CP, are designed for 240-v systems and sell for \$2.40 and \$5.80 each, respectively, for 100 or more units.

Exar Integrated Systems, 750 Palomar Ave., Sunnyvale, Calif. 94086. [418]

RYOHM THERMAL PRINTHEADS

Integrated Electronics — Drive circuits, shift registers and diode matrix are integrated on the printhead.

High Dot Density — Up to eight dots per millimeter.

Wider Print Widths — Print widths up to 10" from single element.

High Speed — 2 milliseconds per line.

Extended Life — MDLBF = 100×10^6

With R-Ohm printheads, thermal printing becomes a practical, reliable alternative for hundreds of applications, including yours.

Contact us today.

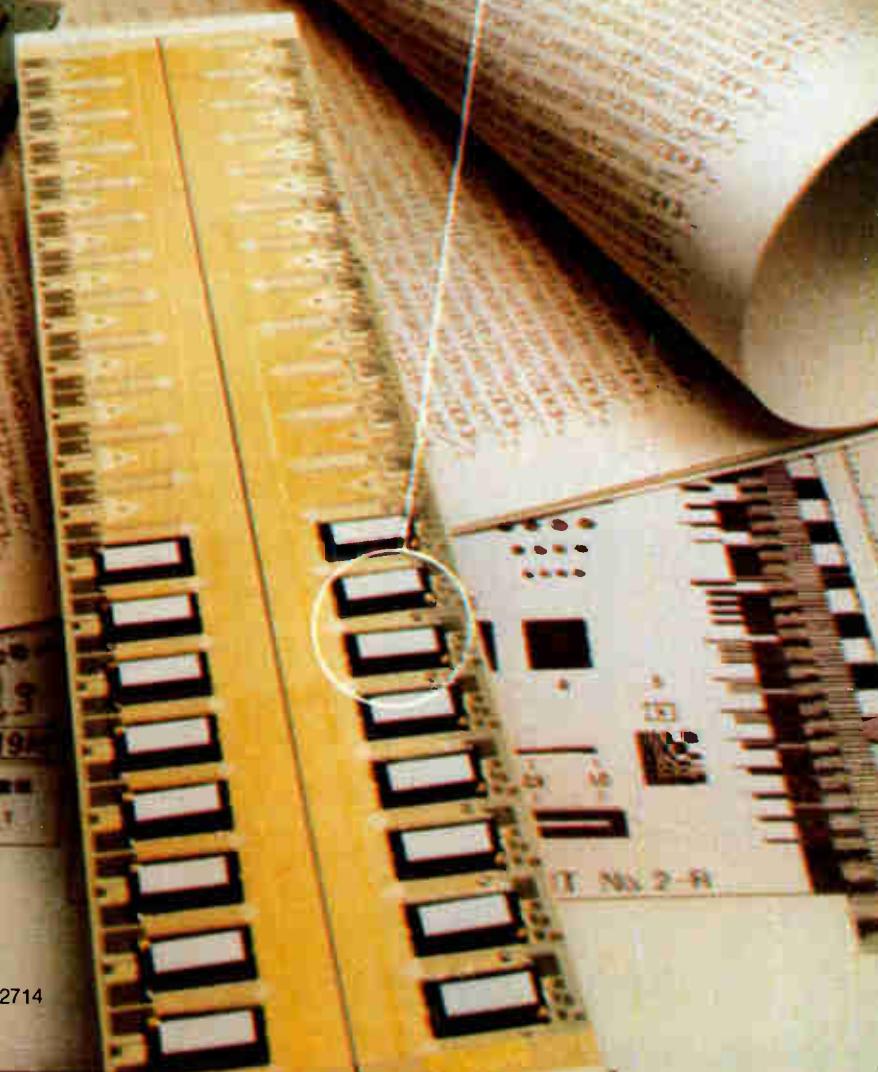
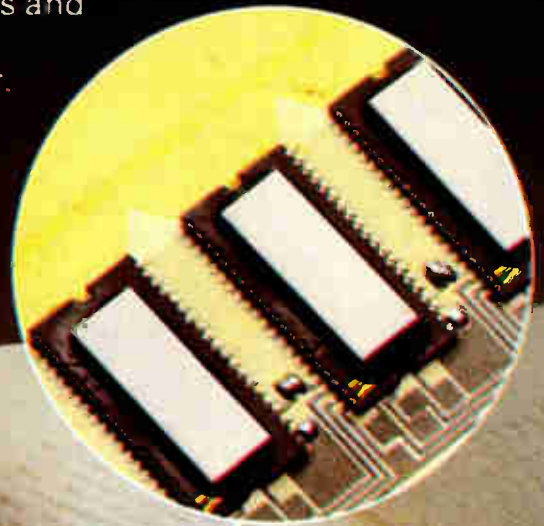

Rohm
QUALITY · RELIABILITY

R-Ohm Corporation, 16931 Milliken Ave., Irvine, CA 92714
(714) 546-7750. Central Office: (312) 843-0404.
Eastern Office: (215) 337-8877. TWX: 910-595-1721

Circle 72 on

Dialight illuminated switches

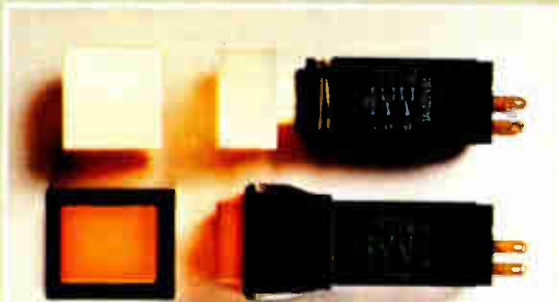

554 SERIES Snap-action illuminated switches with gold or silver contacts . . . Wiping-action switches with gold contacts. Rated life: up to 750,000 operations. Bezel or panel mounting available. Choice of over 300 cap shapes, sizes and colors . . . choice of legends. Listed by Underwriters Laboratories and CSA approved.



554 SERIES A variety of over 240 illuminated switches to choose from with momentary or alternate actions. Low cost . . . computer grade, easy mounting. Over 100,000 switch combinations.

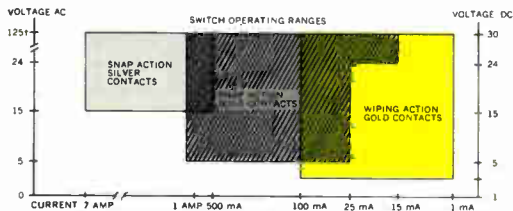

This chart is intended to be used as a general guide only.
*125 VAC applies to snap action switches only.

554 SERIES You'll find a Dialight illuminated switch within your desired operating range. The above chart will make your selection easier.

Dialight meets your needs. So talk to the specialists at Dialight, first. Send for your free copy of Dialight's current catalog today.

DIALIGHT

Dialight, A North American Philips Company
203 Harrison Place, Brooklyn, N. Y. 11237
(212) 497-7600

Circle 73 on reader service card

electronica 80

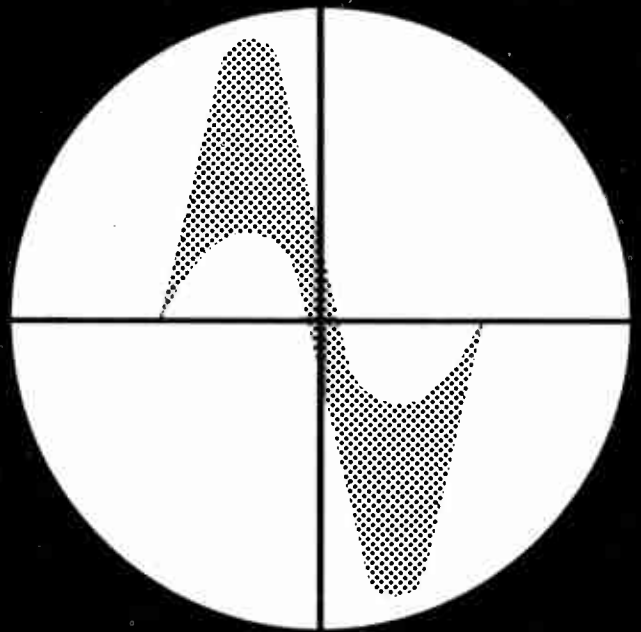

9th International Trade Fair
for Components and
Assemblies in Electronics

MUNICH

6 - 12 November 1980
Fair Grounds

Programme of specialist
conferences 5-7 November
9th International Congress on
Microelectronics
10-12 November



electronica 80 - Coupon

Please forward to my address detailed literature

Name

Address

Information: Gerald G. Kallman Associates, 30 Journal Square,
Jersey City, N.J. 07306, Tel.: (201) 653 3304,
Telex: 710-730-5380 Goodword jcty

Circle 74 on reader service card

Preview our new double feature.

Now that our 9" and 12" CRT monitors have become big box office hits, we're ready to show you two new performers: a 15" model for fans of the big screen, plus a 5" model in the compact category.

As with all C. Itoh CRT monitors, you'll be impressed by the superior bandwidths and resolutions of our models. For example, our 5" features 15 MHz and a 600 line resolution while our 15" offers 30 MHz and 1200 lines on a large 239 mm x 171 mm display area.

Our popular medium-sized 9" and 12" screens offer a horizontal rate of 15.72 KHz. All screens feature separate horizontal drive, vertical drive and video inputs which eliminate composite sync and video signal processing. The simple output circuitry

and integrated PC board construction contribute to the high reliability of our monitors.

Our screens are available in kit or chassis version, equipped with standard P4 phosphor or optional P31 and P39 phosphors. The heavy duty zinc chromate plated chassis can be furnished with a power supply.

Make your reservations for a private screening today and get ready to judge our performance for best picture of the 80's. Contact your nearest C. Itoh representative or C. Itoh Electronics, Inc., 5301 Beethoven Street, Los Angeles, CA 90066; Tel. (213) 390-7778; or 666 Third Avenue, New York, NY 10017; Tel. (212) 682-0420.



 **C. Itoh Electronics, Inc.**

Circle 75 on reader service card

DESIGNER'S CHOICE.

These Bud cabinet racks, and many more, are designed for durability as well as beauty. Their sleek, clean, timeless lines and our reputation for value and quality in every detail make Bud standard enclosures the outstanding choice.

And, there's a Bud Authorized Distributor near you to deliver these standard products from stock. Now, in most cases, you won't have to wait to get the most respected name in enclosures.

Bud offers the industry's largest, most diversified line of standard enclosures, accessories and hardware...from stock. For full information on the Bud family of enclosures, write or call: Bud Industries, Inc. 4605 East 355th Street, Willoughby, Ohio, 44094. Phone: 216/946-3200. Bud West, Inc. 3838 North 36th Avenue, Phoenix, Arizona 85019. Phone 602/269-3151.

BUY BUD

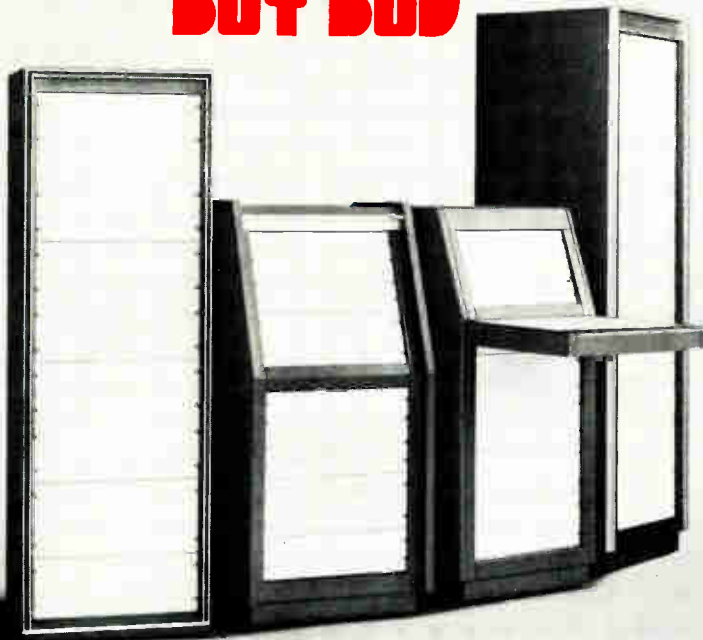

Circle 76 on reader service card

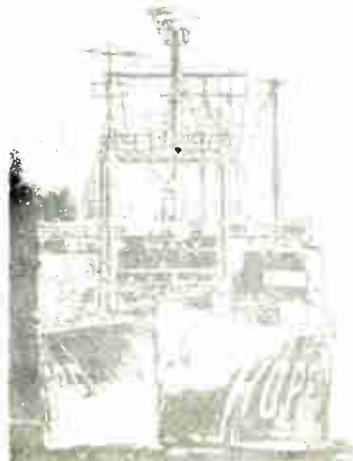

HOPE The project a ship launched.

First there was the hospital ship S.S. HOPE, now retired. Today HOPE is an established project which has carried its goal of improving health through education to 24 developing countries of the world and the United States.

Give to:

**PROJECT
HOPE**

Department A
Washington, D.C. 20007

For more information call these Bud Representatives

AL	Huntsville, Cartwright & Bean Co.	205-533-3509
AZ	Scottsdale, Summit Sales Co.	602-994-4587
AR	Memphis, TN, Cartwright & Bean Co.	901-276-4442
CA	Ingelwood, Jack Berman Co.	213-649-6111
CA	Santa Clara, David Ross Co.	408-988-8111
CO	Denver, Lindberg Co.	303-758-9033
CT	Needham, MA, Mullin Technical Sales, Inc.	617-444-4780
DE	Cherry Hill, N.J. Trinkle Sales, Inc.	609-795-4200
DC	Cherry Hill, N.J. Trinkle Sales, Inc.	609-795-4200
FL	Ft. Lauderdale, Cartwright & Bean Co.	305-735-4900
FL	Orlando, Cartwright & Bean Co.	305-422-4531
GA	Atlanta, Cartwright & Bean Co.	404-233-2939
ID	Denver, Co. Lindberg Co.	303-758-9033
IL	Chicago, Industrial Representatives, Inc.	312-647-7755
IL	Maryland Heights, MO, PMA Corp.	314-569-1220
IN	Carmel, Rich Electronic Marketing, Inc.	317-844-8462
IN	Ft. Wayne, Rich Electronic Marketing, Inc.	219-432-5553
IA	Cedar Rapids, PMA Corp.	319-362-9177
KS	Overland Park, PMA Corp.	913-381-0004
KS	Wichita, PMA Corp.	316-684-4141
KY	Louisville, Rich Electronic Marketing, Inc.	502-239-2747
LA	Metairie, Cartwright & Bean Co.	504-835-6220
ME	Needham, MA, Mullin Technical Sales, Inc.	617-444-4780
MD	Cherry Hill, N.J. Trinkle Sales, Inc.	609-795-4200
MA	Needham, Mullin Technical Sales, Inc.	617-444-4780
MI	E. Detroit, Jack M. Thorpe Co.	313-779-6363
MN	Minnnetonka, Gibb Electronic Sales	612-935-4600
MS	Jackson, Cartwright & Bean Co.	601-981-1170
MO	Maryland Heights, PMA Corp.	314-569-1220
MT	Denver, Co. Lindberg Co.	303-758-9033
NE	Maryland Heights, MO, PMA Corp	314-569-1220
NV	Santa Clara, CA, David Ross Co.	408-988-8111
NV	Scottsdale, AZ, Summit Sales Co.	602-994-4587
NH	Needham, MA, Mullin Technical Sales, Inc.	617-444-4780
NJ	Cherry Hill, Trinkle Sales, Inc.	609-795-4200
NJ	E. Rockaway, N.Y. Willgold Sales Corp.	516-764-4022
NM	Albuquerque, Lindberg Co.	505-881-1006
NY	E. Rockaway, Willgold Sales Corp.	516-764-4022
NY	Rochester, Marchese, Marsey & Barden	716-544-4300
NC	Charlotte, Cartwright & Bean Co.	704-377-5673
NC	Raleigh, Cartwright & Bean Co.	919-781-6560
ND	Minnnetonka, MN, Gibb Electronic Sales	612-935-4600
OH	Cleveland, Marlow Assoc., Inc.	216-991-6500
OH	Columbus, Marlow Assoc., Inc.	614-885-7643
OH	Dayton, Marlow Assoc., Inc.	513-435-5673
OK	Dallas, TX, Lund & Co.	214-243-2606
OR	Portland, Earl & Brown, Inc.	503-245-2283
PA	Cherry Hill, N.J. Trinkle Sales, Inc.	215-922-2080
PA	Pittsburgh, Marlow Assoc., Inc.	412-831-6113
RI	Needham, MA, Mullin Technical Sales, Inc.	617-444-4780
SC	Charlotte, N.C. Cartwright & Bean Co.	704-377-5673
SD	Minnnetonka, MN, Gibb Electronic Sales	612-935-4600
TN	Knoxville, Cartwright & Bean Co.	615-693-7450
TN	Memphis, Cartwright & Bean Co.	901-276-4442
TX	Dallas, Lund & Co., Inc.	214-243-2606
UT	Salt Lake City, Lindberg Co.	801-534-1500
VT	Needham, MA, Mullin Technical Sales, Inc.	617-444-4780
VA	Cherry Hill, N.J. Trinkle Sales, Inc.	609-795-4200
WA	Seattle, Earl & Brown, Inc.	206-284-1121
WV	Cleveland, OH, Marlow Assoc., Inc.	216-991-6500
WI	Milwaukee, Industrial Representatives, Inc.	414-259-0965
WY	Denver, Co. Lindberg Co.	303-758-9033

BUD

BUD INDUSTRIES, INC.
4605 East 355th Street
Willoughby, Ohio 44094
(216) 946-3200

BUD WEST, INC.
3838 North 36th Avenue
Phoenix, Arizona 85019
(602) 269-3151

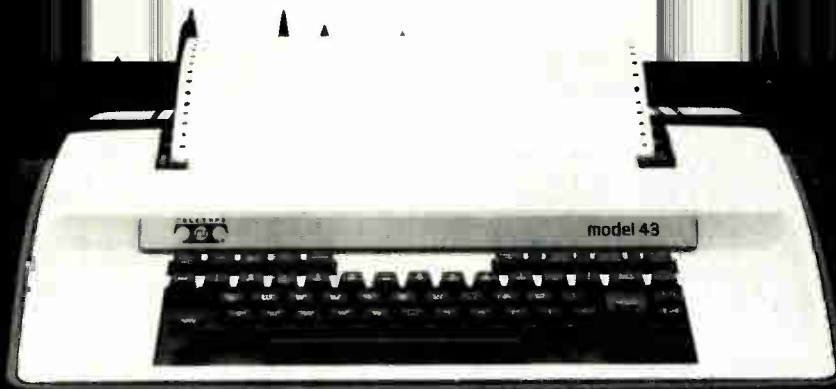

IT'S HARD TO KEEP A GOOD MACHINE DOWN.

At least that's what our customers tell us.

They report that the Teletype* model 43 printer is the most reliable machine they've ever bought.

And that downtime is practically nil.

For example, Mr. Albert Brooks of NCE Terminals writes us to say that, "our records show the Teletype model 43 has the highest reliability and mean time between failure rates of any terminal we presently distribute and service."

Thanks, Mr. Brooks.

And Mr. Robert Jones of Leasametric, a company that currently rents out over 1000 of the model 43 teleprinters, reports that

"according to our records, the failure rate ranges between 1½% and 2%."

And while that may surprise some people, it's no surprise to us.

Because the reason for the model 43 teleprinter's amazing reliability is simple: simplicity.

Now LSI (Large Scale Integration) circuitry performs almost all of the functions that used to be done mechanically. So less moving parts means less chance of downtime.

And less downtime means less aggravation. And isn't that the kind of printer you want working for you?

The Teletype model 43 printer. It's the kind of machine that gets fan mail.



Teletype Corporation
5555 Touhy Avenue, Dept. 3185
Skokie, IL 60077
Telephone (312) 982-2000

*Teletype is a trademark and service mark of the Teletype Corporation.

Circle 78 on reader service card

Introducing the **SUPER ANALYZER**

**Ono Sokki Dual Channel FFT Sound
and Vibration Analyzer**

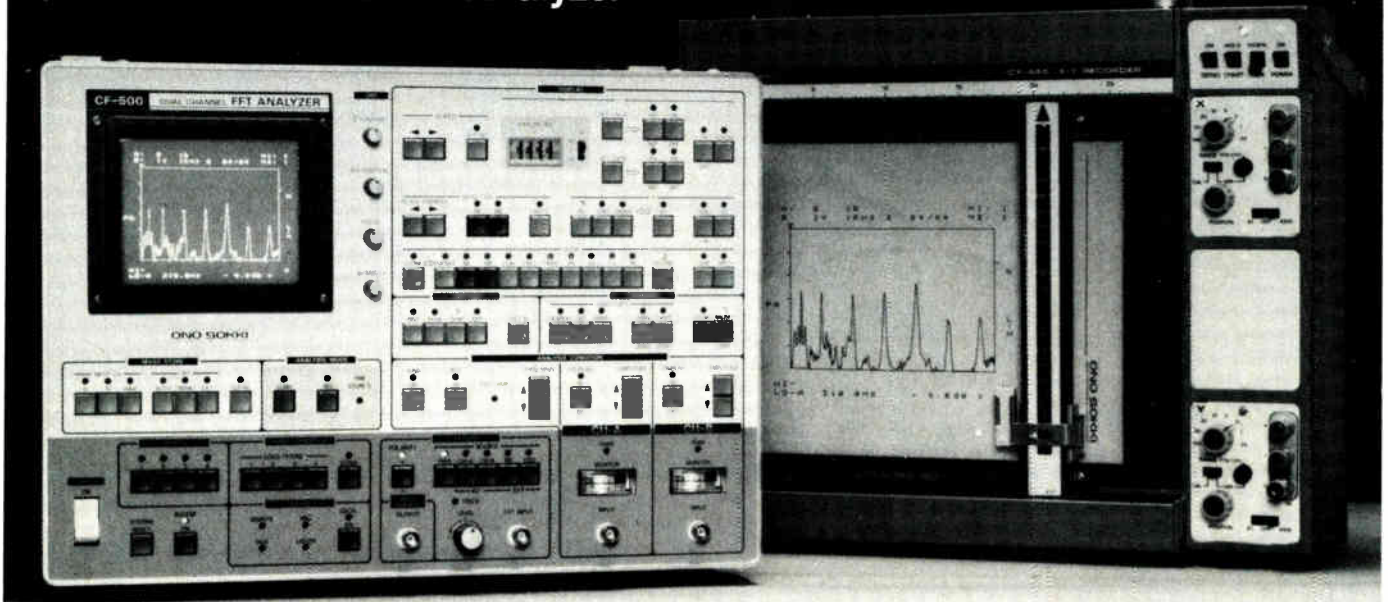

64K byte mass storage data memory user area.

The CF-500 is an all new FFT Analyzer with dual-channels, multi-functions, high accuracy and low cost! It incorporates a 64K byte large-capacity mass storage data memory, and features improved real time FFT analysis. Features include a digital oscilloscope which displays an amazing twenty-eight thousand 12-bit words, and running to 3-dimensional recording of power spectra, and coherence-and-transfer functions. All switches are feather-touch, which combine beautifully with the many functions to make the CF-500 a powerful, highly accurate, easy-to-use analyzer.

Distributors and Sales Representatives wanted.

CALL TOLL-FREE 800 / 323-0315
in Illinois 312 / 640-8640.

Exclusive Agents

SHIGMA, INC.
80 Martin Lane • Elk Grove Village, IL 60007

WESTERN HEADQUARTERS
2471 East Bayshore Suite 501
Palo Alto, California 94303
Telephone (415) 328-3351

Manufacturer **ONO SOKKI** CO., LTD. Tokyo, Japan

Specifications

- Dual-channel, real-time FFT
- 14 ranges from DC to 1 Hz and from DC to 20 kHz, plus external control
- Resolution—401 lines overall
- 12-bit A/D, dynamic range is 68 dB or more
- Transient recording (Memory capacity: 28K words)
Power spectrum (2 ch. simultaneously)
Linear spectrum (2 ch. simultaneously)
1/3 octave analysis
Coherence function
Transfer function (gain/phase)
Multiplication and subtraction of each spectrum
- Provision of a 64K-byte user area data memory
Twenty eight block continuous memory spectrums are possible.
- Complete copies of CRT information with the CX-445 X-Y recorder. Three-dimensional recording is possible.
- GP-1B interface (optional)

SEND FOR
FREE
BROCHURE



"When are you going to get yours?"

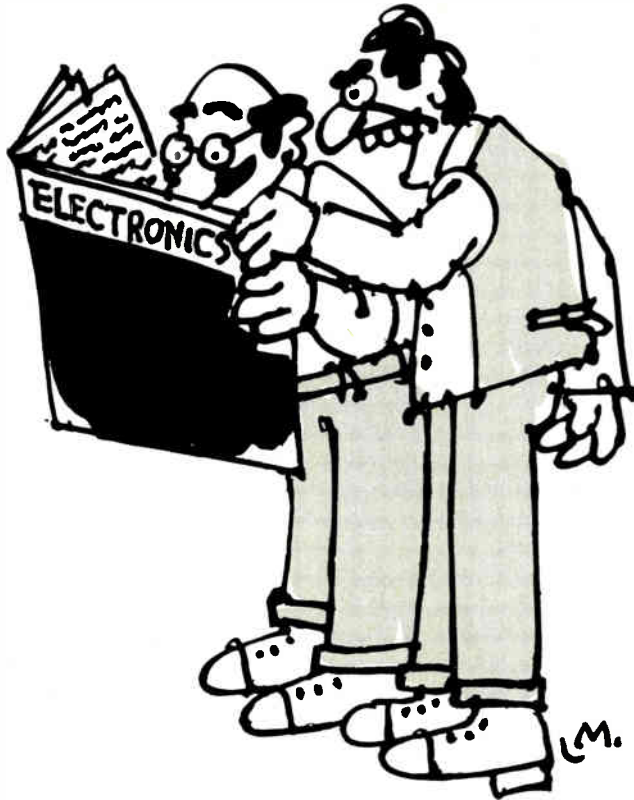

When are you going to get your very own, personal subscription to Electronics? It could be very important to you. And we're not just referring to your status in the office hierarchy.

You (and we) are in a quick-moving business. News breaks frequently. Change is the name of the game. Awareness is the way to win.

You've got to follow what's going on beyond your specialty. Your career may have to last longer than your specialty.

If change is the game, obsolescence is the penalty for losing. Obsolescence of products, of technology and, unfortunately, of people. We can't change this fact. But we can help you cope with it.

Give us one hour of reading time every two weeks and we will keep you aware of what's going on around you and around the changing world of electronics technology.

Move up. Fill out one of the subscription postcards in this issue.

Electronics Magazine. The one worth paying for.

THE SWITCHER!

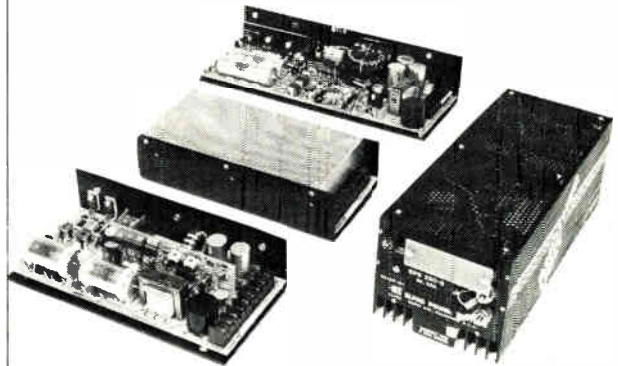

The "quiet" switcher. Low noise, high density, pulse-width modulated, 20KHz. Single and multiple output, open and enclosed frame. State-of-the-art technology providing high regulation, and extended reliability. Available in a wide range of power levels.

ELPAC POWER SYSTEMS
3131 Standard Avenue, Santa Ana, CA 92705
(714) 979-4440 TWX 910-1513

Visit us at WESCON, Booth 1064
Circle 81 on reader service card

THE LINEAR!

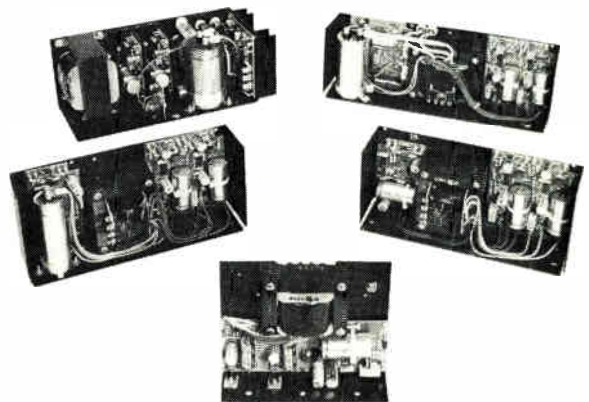

Highly reliable, open and enclosed frame, single and multiple output. Precisely regulated for general purpose as well as MICRO-PROCESSOR based systems. Available from 6 watts to 250 watts standard.

ELPAC POWER SYSTEMS
3131 Standard Avenue, Santa Ana, CA 92705
(714) 979-4440 TWX 910-1513

Visit us at WESCON, Booth 1064

Software

Fortran added to UCSD software

Fortran compiler offers program portability among most microcomputers

The software portability of the UCSD operating system is now available to Fortran language users through SofTech Microsystems' addition of an ANSI-77 Fortran one-pass compiler which produces p-code (pseudo-code). As originally developed at the University of California in San Diego, the UCSD software package was an all-Pascal system to be used with various microcomputers, including the 6502, 6800, 6809, 9900, Z80, and 8080 microprocessors.

By adding the Fortran capability, SofTech hopes "to make the UCSD system software the most complete, most portable, most widely used system software for microcomputers," says company president John W. Brackett. In fact, the new compiler is, as far as the company knows, "the only Fortran compiler available for use on 6502-, 6800- and 9900-based microcomputers."

Pascal, too. "Users now can combine Fortran and Pascal in writing applications and be assured of the portability of their programs among most microcomputers," adds Brackett. Programs written in earlier versions of Fortran can be utilized with few, if any, changes by microcomputer users who already have the UCSD system. The system itself offers a complete operating environment, including screen-editing capability. It allows random accessing of disk files, separate compilation of individual program modules, cross assembly, linkage of assembly-language routines with Pascal and Fortran modules, and interactive input/output.

To run the Fortran package, a minimum configuration of 48 kilobytes of contiguous random-access

memory is required, as well as a floppy-disk subsystem and a terminal. All UCSD system software comes in object-code form, packaged on 8-in. single-density single-sided diskettes that are IBM 3740-compatible. The software can be downloaded to 5¼-in. diskettes and other 8-in. disk formats.

For CP/M users, the standard package provides special routines that do not require the writing of any additional assembly language routines. Since UCSD has its own file-handling operating system, only the BIOS routines of CP/M are used.

The complete UCSD system with Fortran only can be purchased for \$400. The system with both Fortran and Pascal can be purchased for \$500. Users that already have the II.0 version of UCSD Pascal may add the Fortran compiler to their system for \$200. Fortran-77 is available immediately for distribution licensing and single-copy purchases.

SofTech Microsystems Inc., 9494 Black Mountain Rd., San Diego, Calif. 92126. Phone (714) 578-6105 [391]

Forth language available for 6502-based microcomputers

Forth, the high-level, English-based language, is now available for the 6502-based KIM-1, SIM-1, and AIM-1 microcomputer systems, and a version for the Apple II computer is due soon from Technical Services Inc. The new version of Forth contains a built-in 6502 assembler that allows users to drop into assembly language at any time. There is also a text editor for manipulation of Forth source programs and a cassette file-management system. A cassette and all documentation sell for \$94.

Technical Services Inc., 1067 Jadestone Lane, Corona, Calif. 91720 [393]

HP 64000 logic development system gets Pascal compiler

The first of Hewlett-Packard's compilers for its model 64000 logic

development system, the 64810A Pascal/64000 compiler, generates object code for 8080 and 8085 microprocessors. The two-pass compiler allows the use of source programs that are independent of the target processor, so they are portable from system to system. Code generated with the 64810A can be loaded on the 64000 emulator for debugging and optimization in the microprocessor environment. The compiler will sell for \$2,000 in the U. S.; delivery takes two weeks.

Hewlett-Packard Co., Inquiries Manager, 1507 Page Mill Rd., Palo Alto, Calif. 94304 [395]

Fortran plotting for DECwriter II costs \$400

For execution on DECwriters equipped with Selanar Corp.'s Graphics II feature, a new software package allows the use of Fortran plotting subroutines. The PLII package contains 24 standard routines for higher-level graphics and four specialized labeling routines. The Graphics II printed-circuit card used with an LA36 DECwriter II retains most of Digital Equipment Corp.'s original features and adds vector plotting. Using the \$400 PLII software makes implementation of the \$995 Graphics II faster and lower in cost in any Fortran environment.

Selanar Corp., 2403 De La Cruz Blvd., Santa Clara, Calif. 95050. Phone (408) 727-2811 [396]

User-friendly prompter works with system 2000/80

The query/update by example (QUBE) prompting facility works with Intel's system 2000/80 database management system and integrated data dictionary. Like IBM's QBE, the QUBE is a menu-driven data-manipulation program that prompts the user step by step through a transaction. The company claims that the casual user can begin to display and update records with

Current index.

Bussmann's newest Small Dimension Fuse Catalog is indexed by electrical properties for easy selection. And protection.

The Bussmann Small Dimension Fuse Catalog puts component and circuit protection at your fingertips. It's the most complete listing of

small dimension fuses, holders, blocks, indicating devices and accessories in the industry.

And since every-

thing is indexed by electrical characteristics, it's easier than ever to select the right type of protection.

This new, condensed, full-color edition gives you time current characteristic curves, too, so you know how the fuse you select will perform.

To take the guesswork out of circuit and component protection, get our current index — the new Buss Small Dimension Fuse Catalog. Just call your Bussmann representative or your local distributor today and ask for Catalog SFB.

McGraw-Edison

**Bussmann.
The Protection
Experts.**



Bussmann Division
McGraw-Edison Company
P.O. Box 14460
St. Louis MO 63178

PHI-DECK® Cassette Transports

- Fully remote controllable
- Four-motor design
- Cast chassis

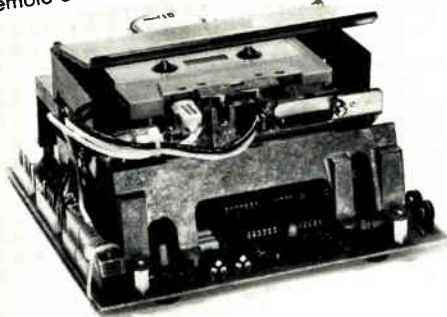

New Phi-Deck Electronics

- Motion Control ... Minimum complexity, Maximum performance.
- Digital ... Read/Write and Motion Control on one board. Recording density to 1600 FRPI.
- Analog ... Two channel Record/Play and Motion Control on one board.

Write or call for information on our specially priced
Design Kits and OEM Modules featuring
PHI-DECK electronics.

4605 N. Stiles P.O. Box 18209 (405) 521-9000
Oklahoma City, OK 73154 TWX: 910-831-3286



Circle 84 on reader service card

BEAT TOUGH, tiny JOBS!

Snap-on 167-TM-B MIDGET SET

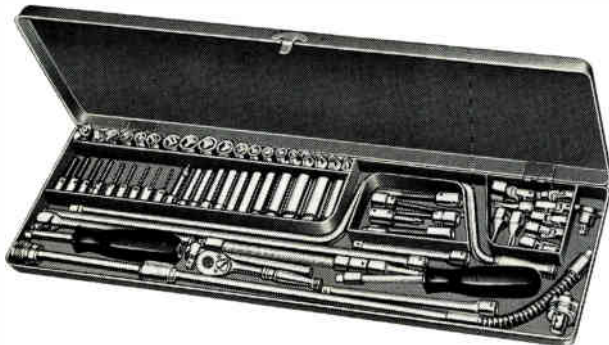

167 ¼-inch drive socket wrenches and handles for a wide range of electrical, electronic and other miniature production and maintenance work. Socket wrench openings from ⅛ inch to ⅝ inch. Other small sets available. See your Snap-on representative.

255

FOR ALL INDUSTRY
SNAP-ON TOOLS
8051-H 28TH AVENUE KENOSHA, WISCONSIN 53140

304 Circle 86 on reader service card

New products

only one hour of training in terminal procedure. QUBE does not require knowledge of syntax to gain on-line access to system 2000/80 data bases. The facility is available for \$20,000.

Intel Corp., Commercial Systems division,
12675 Research Blvd., Austin, Texas 78766.
Phone (512) 258-5171 [397]

Software simplifies manual in-circuit assembly inspection

Users of the L529 and L527 in-circuit assembly inspection systems can get a new software package from Teradyne free. The Applications Control Program (ACP) may be used instead of the standard system program for test-plan development and debugging when manual control over the selection of test conditions and test limits is desired.

ACP takes advantage of the programming routines provided by the standard system software to simplify manual program entries. Users can interact with a board under test, using data relayed by the test system to make programming decisions. By assigning dedicated functions to certain programming keys, ACP also permits rapid updating of such test conditions as selection of force and ground nodes and the guarding status of components.

The software will not only be supplied to all present system users free of charge, but it will be standard with all future system shipments. Its capabilities are described in application report number 143, which is available from the company.

Teradyne Inc., 183 Essex St., Boston, Mass.
02111. Phone (617) 482-2700 [398]

MIPROC-16 computer gets real-time signal processing

A signal-processing package for the Plessey MIPROC-16 computer provides data-acquisition, preprocessing, and real-time signal-processing library functions including a complex fast-Fourier-transform function. The 16-bit computer itself, says

Three Best Sellers for the 80's

1 New 1980-81 Catalog

28 colorful pages with complete details on over 100 standard open-frame and switching D.C. power supplies. Full specs, photos, O&M drawings, and prices on each model.



2 New Tour Guide — A Trip Through Power-One

The next best thing to a personal visit. Our new Tour Guide takes you on a photographic trip through our modern new facility. See why Power-One is the most automated, efficient producer of D.C. power supplies in the world... and why we've been able to hold our prices steady for over 5 years!



3 New Open Frames and Switchers... At Our Same Old Prices!

More new open-frames to choose from — plus new special-purpose models for specific applications such as Microprocessor and Floppy-Disk systems. Also, Power-One now offers a growing line of switching D.C. power supplies with the same quality and high reliability as our open-frame models.

**So Act Now...
Get Our Free "Best Sellers" Today!**



Mail coupon  for fast action or phone us direct.

Rush Me Power-One's New Catalog and Tour Guide!

Name _____

Company _____ Title _____

Address _____

City _____ State _____

Zip _____ Phone _____

 **POWER-ONE**
D.C. POWER SUPPLIES

Power-One, Inc. • Power One Drive • Camarillo, CA 93010
Phone: 805/484-2806 • 805/987-3891 • TWX: 910-336-1297

Circle 88 on reader service card

nVdc and nAdc on the Buss* (488)

Our Model 501J main frame instrument
meets the IEEE 488-1975 interface specs to
let your mini or maxi computer call for:

Voltages of $\pm 10\mu\text{V}$ to $\pm 10\text{Vdc}$

Switching & Settling time: $50\mu\text{ sec.}$

Accuracy: $\pm 0.005\%$ (certified traceable
NBS) with Options: from $\pm 100\text{ nV}$ to ± 1000
Vdc and $\pm 10\text{ nA}$ to $\pm 10\text{ Adc.}$

Applications:

Production Line, Automatic

Calibration of A/D Converters,
Amplifiers, DVM's

ATE System Standard

Data Acquisition System Standard

Process Control System Reference

Prices from \$1,995.00 (export prices
slightly higher)

*Other programming formats also available



For more
information call Bob Ross



ELECTRONIC
DEVELOPMENT
CORPORATION

11 Hamlin St., Boston, MA 02127, Tel: (617) 268-9696

TLX: 955329 • TWX 710 350-7544

New products

the manufacturer, is well suited for processing signals in real time. It can acquire 1,024 points of real data and perform a fast Fourier transform all within 200 ms.

The software package, called Sigpak, supports data acquisition on up to 64 analog channels and can perform a variety of channel preprocessing functions, time-domain statistical computations on channel data, 512-point complex FFTs, power spectrum, spectral averaging, and bivariate analysis functions.

Sigpak is available either as source code to be integrated within other MIPROC programs developed by the user or as firmware in the form of programmable read-only memory on a MIPROC-16 applications card. It is available for immediate delivery for \$940 on a single-density floppy.

Plessey Microsystems, 19546 Clubhouse Rd., Gaithersburg, Md. 20760. Phone Henry Goldstein at (301) 948-2791 [399]

Interactive Score offered for IBM disk-operating systems

An interactive version of Score, a Cobol-program generator, has been introduced by Software Design Associates for the IBM DOS, DOS/VS, and DOS/VSE disk operating systems. The full version of the program includes a prompter for on-line input to a cathode-ray tube. The usual Score guarantee applies to this version, too: if within 60 days of installation, any Cobol programmer fails to generate code at least 25% faster than previous setups, the company offers a full refund.

The basic interactive Score system sells for \$12,500. A full-feature system with a three-day workshop and installation sells for \$19,750. The extra features in the full package include multiple report capabilities, table look-up, a random-number generator for processing or bypassing records, and the prompter for on-line input to a cathode-ray tube.

Software Design Associates, Products Division, 415 Park Ave. So., New York, N.Y. 10016. Phone (212) 481-6800 [400]

Four very small ways Cutler-Hammer switches improve your PC design.

With four types of switches—rockers, pushbuttons, toggles and DIPs—we offer one of the industry's broadest and most unique selections of PC sub-miniatures.

Each of the hundreds of available styles provides the reliability you've come to expect from Cutler-Hammer switches. With ratings to 6 amps, each conforms to standard circuit board mounting requirements.

PC switches, along with accessories and decorative hardware, are distributor stocked for local availability. And since most are manufactured in the United States, we offer fast reaction time on solder lug and wire wrap terminal variations, as well.

To improve your next design in any number of small ways, contact your Cutler-Hammer Sales Office or Switch Distributor. Or write Eaton Corporation, Commercial Controls Division, 4201 N. 27th St., Milwaukee, WI 53216.



Nicolet EXPLORERS



... as easy as I, II, III

Three precise, high resolution digital oscilloscopes for analog signals

- Easy operation — storage at the touch of a button
- High precision
- Up to 20 MHz real-time digitizing rate per channel in two-channel mode
- 4096 word memory
- Optional digital records via internal disk recorder
- Up to 100% pre-trigger information
- XY or YT operation
- Resolution to 0.025% both horizontal and vertical
- Display expansion to 64X, **both** axes
- Superimposed stored & live, stored & stored or live & live waveforms
- Optional parallel 12 bit, RS-232C and IEEE-488-GPIB interfaces

EXPLORERS OUTPERFORM:

- Low frequency analog scopes
- Low frequency storage scopes
- Transient recorders
- XY recorders
- Strip chart recorders
- Light beam recorders
- Other digital oscilloscopes

NICOLET IS A LEADER.

Nicolet is a leading manufacturer of digital electronic measurement instruments (signal averagers and FFT spectrum analyzers), analytical instruments (FT-IR and FT-NMR spectrometers), biomedical computers and digital graphic plotters. Nicolet's expertise in high technology digital instrumentation led to the first Explorer scope in 1973.

To learn how the EXPLORERS can help you, request our new brochure. To discuss your application or to arrange a demonstration call **608/271-3333**.

COMPLETE EXPLORERS START AT \$3990

(U.S. domestic list price)

See the complete line of Explorers at **WESCON/80**. Booth 2225-2227.

 **NICOLET
INSTRUMENT
CORPORATION**
OSCILLOSCOPE DIVISION

5225 Verona Road, Madison, Wisconsin 53711
Telephone: 608/271-3333
TWX: 910-286-2737

Electronics Industry Bursting At Seams

New figures released today show a
may be happening in the
industry. In...

HIGH BORROWING COSTS PUT SQUEEZE ON BUSINESS

...released today show that, contrary to what
...in the rest of the economy, the electronics
...been healthier. Demand for electronic
...supply to the point that extra shifts
...of plants are expanding, and
...be good news. But today,
...an intense shortage of
...ies are being forced
...here is great reduc-
...what may turn
...of produc-
...over and over, according to an in-
...scientific survey conducted by
...electronics firms all over the
...in the credit squeeze, are
...as much as they'd like
...burgeoning demand for
...ducts ranging from "toys
...to sophisticated electronics.

...and Puts Strain On Manufacturers.

Tight Credit Hurts Local Firms

When a production
repair, what does
a bank loan
ductivity
...-

"We're in a position where we should
be expanding, but instead, we have to
cut back," stated Richard Redmond, presi-
dent of Acme Electronics in an interview
with this newspaper. "Up until now it's
been easy to borrow in order to finance
expansion. But today's interest rates
have put a real crimp in our plans."

TEST ENGINEERING MANPOWER SHORT SUPPLY

In an industry beset by manpower shortages, one of the
areas where qualified people are most urgently needed is
test engineering. Because of the high demand, engineers
and technicians are increasingly being pirated away from
one company to another. As a result, electronics firms spend
more and more of their resources on finding and holding
qualified personnel.

AND NOW FOR THE GOOD NEWS.

Forget tight money. And the
even tighter supply of skilled
engineers and technicians. If
you make electronic equip-
ment, you don't have to divert
precious resources in order
to expand manufacturing.

You can have Grumman
Electronics Center produce
your equipment ... from
blueprint right through final
testing. We're the same
Grumman that produces a
wide range of products
including military and space
systems and equipment. We
can do the same for you—on
time, on spec, on budget. How
do we make sure?

Grumman assigns your
project a dedicated team
headed by a highly qualified
program manager. This

program manager supervises
every phase of your project,
including strict in-process
testing. So there's careful con-
trol and follow-through, from
contract to delivery. And by
having one person to call, you
always know the exact status
of your project.

Some of America's best
known companies use us to
make such products as com-
puter, office, petrochemical,
telecommunications and
medical equipment. Find out
how we can help you. Con-
tact Bruno Caputo, General
Manager of Great River
Operations, Grumman Aero-
space Corporation, P.O. Box
608, Great River, NY 11739.

The reliable source ...

GRUMMAN

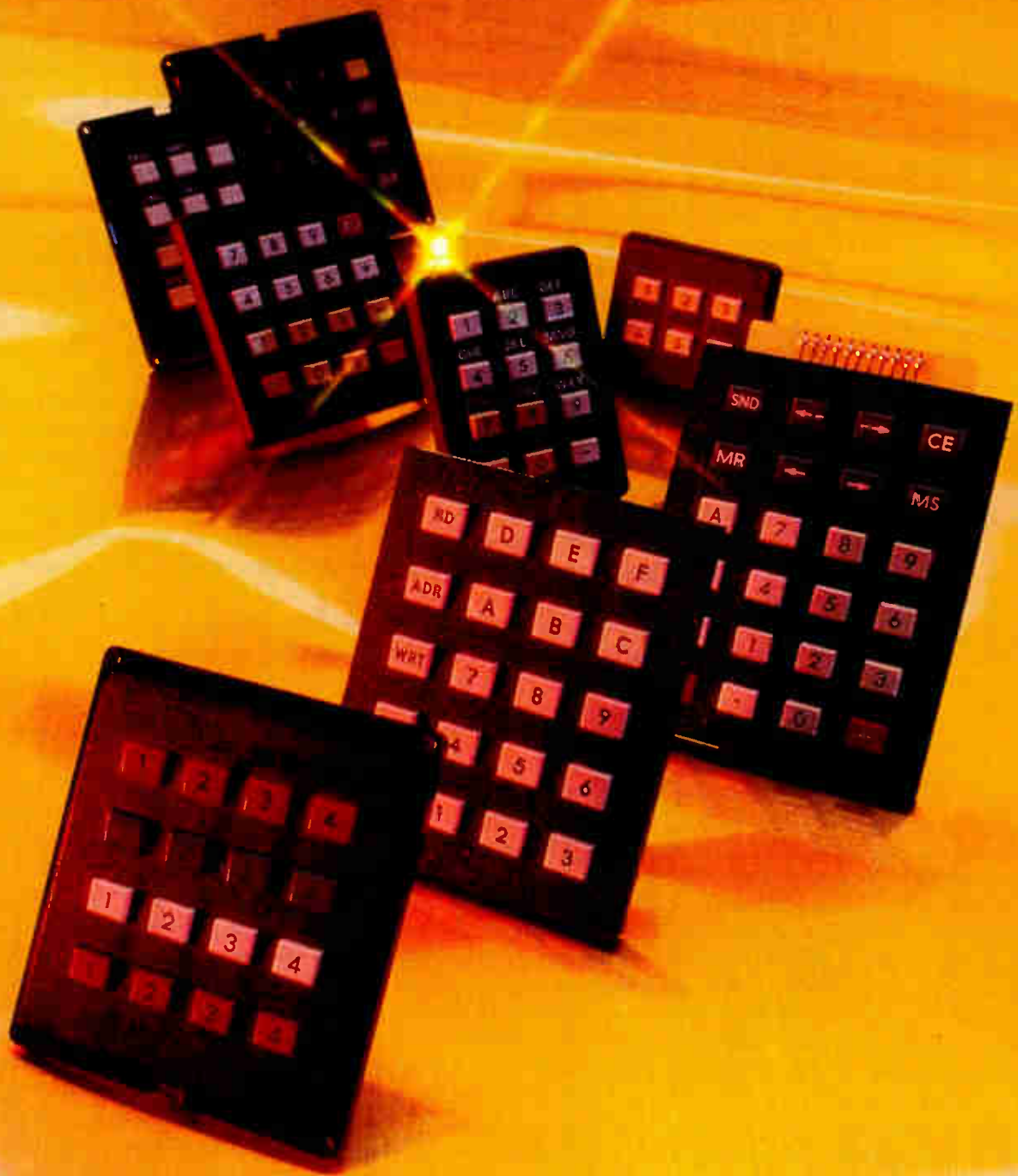

SUPERIORITY at your fingertips. The superiority of Digitran's MINIKEY® is reflected in its tactile feel and unfailingly fast and positive contact closures. And now, for even greater reliability, newly designed with redundant contacts. Our MINIKEY® is so distinctive, it's patented. Whether customized or off-the-shelf, our low-profile keyboards perform better because they are made better.

DIGITRAN

The Digitran Company, a division of Becton, Dickinson and Company

855 South Arroyo Parkway • Pasadena, California 91105 • Phone (213) 449-3110 • TWX 910-588-3794, TELEX 67-5485

The development of fiber optic CRTs
left typesetters flat.

And flat is just the way they like it.



The flat front surface and the high efficiency of a fiber optic CRT means many things to typesetters. This means direct contact with the film or paper to be exposed. This means no costly lens system between CRT and paper. This means high speed and high quality type production. This means a smaller physical package. This also means an exceptional deflection yoke, such as the Syntronic C11955 yoke shown above.

Our precision yokes developed for fiber optic CRTs represent excellent linearity and minimum spot growth center to edge. Our yokes also represent experienced engineering with over 10 years of phototypesetting applications. Contact our sales engineering staff for component and system information.



Precision yokes for exacting displays

Syntronic Instruments, Inc., 100 Industrial Road, Addison, IL 60101 (312) 543-6444

Circle 105 on reader service card

For Military

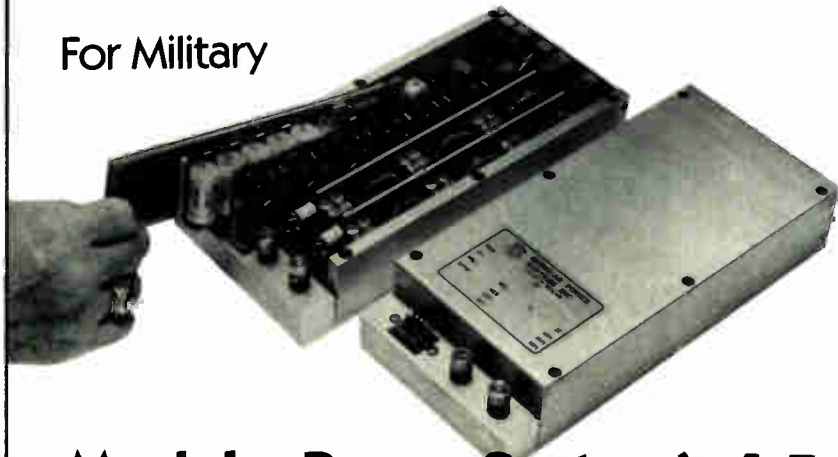

**Modular Power System's 4.5
W/cu. in. 100,000 hr. MTBF
modular switching power
supply system: performance,
maintainability & flexibility
never came so compact.**

- All modular construction
- Outputs to 2,000 W single & multiple outputs
- Low in-rush current
- Low or no NRE
- Extremely wide operating temperature range
- Exacting quality standards

Call for more information

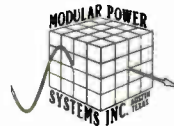

**Modular
Power**

SYSTEMS INC.
8900 Shoal Creek Boulevard
Suite 127
Austin, Texas 78758
(512) 452-8151

312 Circle 106 on reader service card

Electronics / August 28, 1980

New products/materials

A **conductive fabric** called Plasticon is a composite of nylon fabric with a conductive coating applied to both sides. The coating is composed of a fully cured butyl-rubber binder and highly conductive carbon blacks. The Plasticon fabric can be used for such antistatic and grounding applications as semiconductor tapes and special packaging configurations. The material has a tear strength of 4 lb/mil and has excellent abrasion resistance, says the manufacturer. The material also has a resistivity of 5,000 Ω /sq and a breaking strength of 75 lb/in.-width.

Available in rolls of 2 by 250 ft, the material is configured to customer specification. Prices are quoted upon request.

Plastic Systems Inc., 88a Ellsworth St., Worcester, Mass. 01608 [476]

A **nickel-filled urethane coating**, E-Kote 3073, is a two-component electrically conductive material designed to promote adhesion to hard-to-bond surfaces such as polyester sheet- and bulk-molding compounds and polyurethane structural foams. It has a pot life of 24 h when catalyzed at 25°C. When sprayed on with a 1-mil thickness, the material covers 550 ft² per gallon. E-Kote 3073 exhibits a dc sheet resistance of less than 1 Ω /sq and has a shielding effectiveness of up to 65 dB at 14 GHz with no change in properties after exposure for 7 days at 95% relative humidity and 140°F.

Acme Chemicals & Insulation Co., Division of Allied Products Corp., P. O. Box 1404, New Haven, Conn. 06505 [477]

A **two-component epoxy adhesive** for general-purpose bonding applications has a bonding strength of better than 3,000 lb/in.² when joining aluminum to aluminum and cured at room temperature. The high bonding strength of EP24 is unlike that of many other epoxy adhesives; it is rather insensitive to the one-to-one mixing ratio or substrate cleaning procedures, says the manufacturer. With a viscosity of 16,000 centipoises, the epoxy can be applied without sagging or dripping even on vertical surfaces. The high-strength

Hubbell colors them Plenco...

for receptacles that make a difference.



Wiring devices, molded by the Plastics Division of Harvey Hubbell, Incorporated, Newtown, Conn., are on duty wherever easy identification and selection of electrical parts are desired and safe, uninterrupted operation is a must.

Helping Hubbell do it right are our tough, colorful Plenco melamine-phenolic thermoset molding compounds. Plenco 782 Orange for example. It was chosen especially for its color, generally recognized as denoting isolated ground. According to the manufacturer this type of receptacle is seeing increasing application with sensitive electronic equipment unable to stand the "noise" feedback from a normal building ground.

Another instance of apt color usage: Our Plenco 701 Red, selected by Hubbell for color-coded molded switches whose red tops identify them as 20-ampere devices.

Learn how Plenco can help you. Dial us at (414) 458-2121. We'll show you our true colors.

PLENCO
THERMOSET PLASTICS

PLASTICS ENGINEERING COMPANY
Sheboygan, WI 53801

Through Plenco research... a wide range of ready-made or custom-formulated phenolic, melamine-phenolic, alkyd and polyester thermoset molding compounds, and industrial resins.

“How many free subscribers does it take to equal one paid subscriber?”

asks Bob Denmead, our salesman in Chicago.

“I try not to show it, but I can get pretty impatient with the continuing attempts at comparisons in this business. In the real world, there's no way you can compare the guy who gets a free magazine with the guy who pays for his subscription—any more than you can compare apples with oranges.”

As the only paid subscription magazine in the field, we fight a lonely battle. The “free” publishers have done a remarkable job of persuading advertisers that their magazines are comparable to paid magazines. But it just isn't true.



The recipient of a free magazine gets it mailed to him for nothing, simply by filling out a card to qualify. Our paid reader fills out the card to qualify but then goes on to a second, more meaningful decision. He must decide that the magazine is worth dollars to him.

Predictably, our paid reader is a far more constant, far more intense reader—because he has made an investment in the magazine.

“Free is free and paid is paid,” says Denmead. “It's time to stop comparing apples with oranges.”

Exclusively yours,

Bob

Exclusively yours,

Electronics Magazine



Preston delivers everything from A to D

Preston's newly expanded GM Series Analog-to-Digital Conversion Systems now include 43 basic models with 8-bit to 15-bit resolution and conversion speeds from 40,000 conversions-per-second to 900,000 conversions-per-second, plus a broad range of analog input channel options and digital I/O configurations.

As the GM Series block diagram shows, we're prepared to deliver complete ADC systems with literally *everything* you need on *both* sides of your A/D converter:

On the Analog side -

Preston's GM Series ADC Systems are built to your requirements with *exactly* the right amplifiers and multiplexers to match all of your analog signals' amplitude and frequency specifications, including -

GMD Amplifier/Multiplexers -

with DC to 1 MegaHertz frequency range, stability to within $\pm 0.01\%$ for 6 months, fixed-gain full range inputs from 10 millivolts to 10 volts and optional output filters.

GMD-PG Programmable-Gain Amplifiers - with 5 binary gain steps from 1 to 16 for computer-controlled signal-level switching.

GMSH Sample-and-Hold Amplifiers - with a 1 nanosecond hold aperture and $\pm 0.01\%$ combined gain stability and linearity.

GMM Multiplexers - with 128 channel crosstalk below $\pm 0.01\%$.

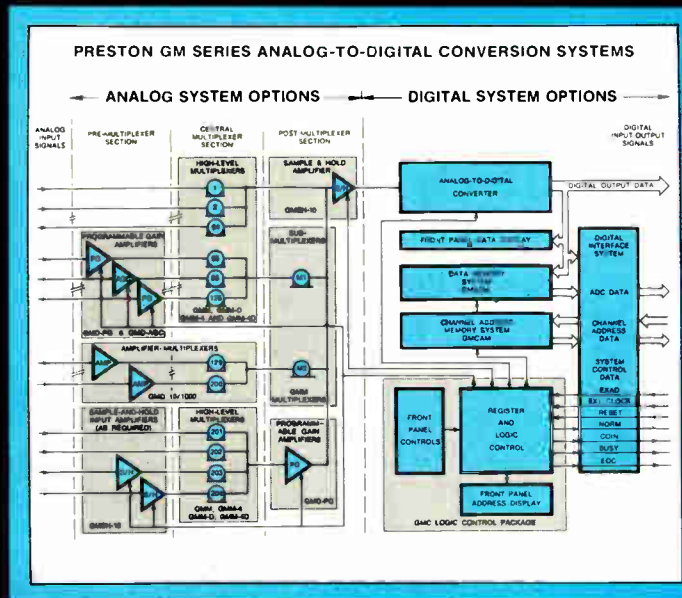

On the Digital side -

Preston's long-standing leadership in high-speed ADC systems now extends to 15-bit conversion rates as high as 400,000 conversions-per-second.

And to keep ahead of the operational complexities of today's advanced data acquisition systems, we've simplified the GM Series' interface to both man and machine by surrounding the analog and digital functions with flexible control systems that include -

Model GMC Logic Control System - for front-panel and remote selection of channel sequence and operating modes.

Digital I/O Interfaces - for Hewlett Packard, Digital Equipment and Data General hardware and software systems.

In-System Digital Memories - for system data memory and channel address memory.

To get complete data on the Preston ADC system that fits your precise requirements, ask for your personal copy of our new 28 page "GM Series" brochure. In it you'll find an ADC selection guide that provides specific examples of the *actual* overall accuracy of typical combinations of GM Series amplifiers, multiplexers and A/D converters, detailed specifications on *every* GM Series sub-system and component, and the fastest, most reliable way ever devised to get your data from "A" to "D"!

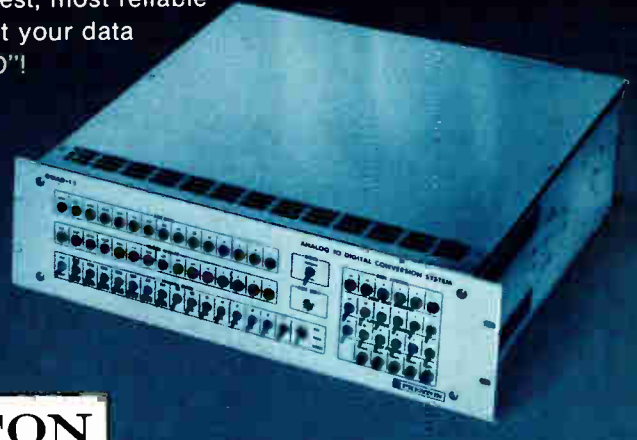

PRESTON

Preston Scientific Incorporated 805 East Cerritos Avenue, Anaheim, California 92805 Telephone: (714) 776-6400 Telex: 65-5321

Preston will be at WESCON in Booth #2000 and at INTERKAMA, Duesseldorf, West Germany in Zeigler Booth #8C33.

Circle 109 on reader service card

There's no body like our new

300x 300x

The new AO STEREOSTAR^{3/4} Zoom "T" microscope features the "T" zoom body with coaxial illumination and photo capabilities. It may be just what you need to boost output in your production, assembly or inspection department.

The Zoom "T" gives you a constant 4" of working room. It has a 1x - 6x magnification range, and with auxiliary lenses and eyepieces it offers a total range of 5x - 300x. Magnification can be conveniently changed with controls on both sides of the body. No matter what magnification you're working with, you get crisp, sharp image definition.

Modular in construction, the Zoom "T" can be ordered with or without the coaxial illuminator. In fact, any accessory can be simply added at any time. However, if you're working with highly reflective opaque surfaces, coaxial illumination is invaluable because it gives contrast without hot spots, glare, reflections or shadows.

We invite you to compare the new AO STEREOSTAR Zoom "T" microscope, feature by feature, with any other competitive microscope.

We're confident you'll immediately see that it offers the outstanding value in its field. See your AO dealer or representative for a demonstration. Or write for a detailed brochure
American Optical,
Scientific Instrument
Division, Box 123,
Buffalo, NY 14240.

AO
American
Optical

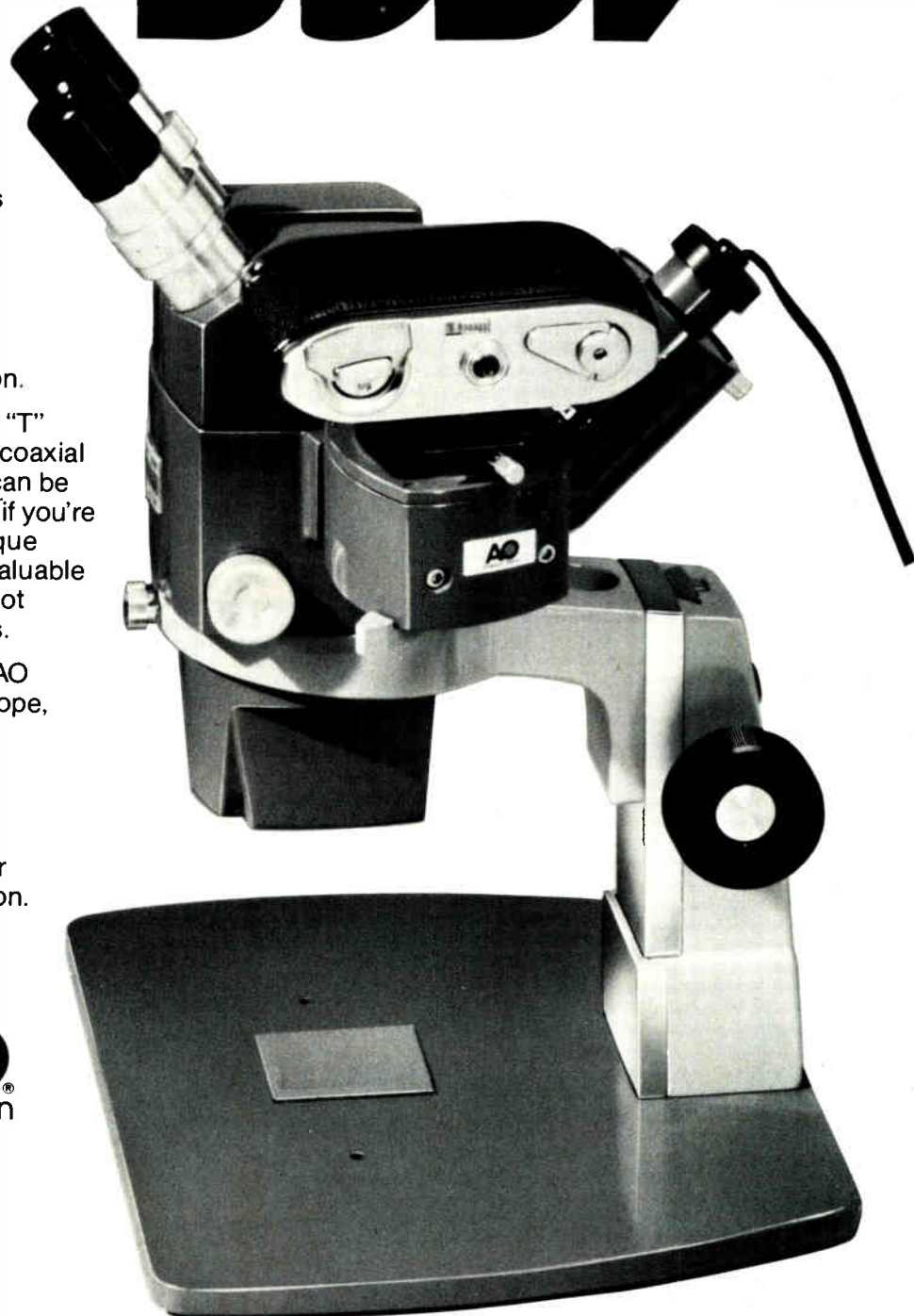



Bendix—We pioneered connector technology. Our Pygmy connectors introduced practical, miniature design and became the world's most copied connector family. Our JT series connectors provided more contacts in less space. And our LJT series were the first 'scoop-proof' connectors that helped prevent blind mating contact damage.

Bendix—We've set milestones. Our multipin cylindrical miniature and sub-miniature connectors became national standards. Our Bristle Brush connector brought about a practical solution to the problem of mating and unmating high contact count printed circuit boards with a low mating force connector. And our square cut RF connectors made 30 second assembly a reality.

Bendix—We do more than just look to the future. We lead the way. The Bendix Corporation Electrical Components Division Sidney, N.Y. 13838 607/563-5315.

We speak connectors.



Circle 179 on reader service card

When positive ID is required



Presenting nine beautiful ways to positively identify function, glorify instrument panel appearance and help guard against static electrical shock.

It's C & K's long-stemmed L3 nylon toggle in red, white, and blue, yellow, green, brown, orange, black, and grey. Get it on.

These plastic covered miniature switches have a contact rating up to 5 amps including dry circuit applications. UL listing available.

The Primary Source Worldwide

C & K Components, Inc.

15 Riverdale Avenue, Newton, MA 02158
Tel: (617) 964-6400, TELEX: 92-2546, TWX: 710-335-1163

The right angle is the right idea.

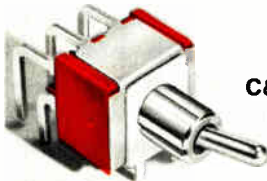

C&K's right angle miniature toggle switch mounts directly on P.C. boards with a low profile that makes a good design look even better. An integral switch support bracket reduces stress on the terminals. Right on.

C&K makes it with a wide range of actuator, and bushing options in 1, 2, 3 and 4-pole versions, with contact ratings of 0.4 VA max. UL listing available.

The Primary Source Worldwide

C & K Components, Inc.

15 Riverdale Avenue, Newton, MA 02158
Tel: (617) 964-6400, TELEX: 92-2546, TWX: 710-335-1163

Visit us at Wescon, Booth # 1458 & 1460

C&K

C&K

C&K

C&K

C&K

C&K

C&K

C&K

C&K

C&K

C&K

C&K

C&K

C&K

C&K

C&K

New products/materials

material is resistant to thermal cycling and chemicals including water, oil, and most organic solvents over the temperature range of -60° to more than $+250^{\circ}$ F. The shelf life of the material is better than one year at 75° F. EP24 sells for from \$50 to \$55 per gallon. Delivery is from stock.

Master Bond Inc., P. O. Box 522, Teaneck, N. J. 07666 [474]

A carbon-fiber paper designated CFP-30-05 has a fiber tensile modulus of 30×10^6 lb/in.² Available in rolls up to 80 in. wide, it can be used alone as an isotropic structural material or in conjunction with carbon, glass, or other fibers in unidirectional and woven composites. It may also be combined with epoxy, phenolic, or polyester materials. The paper can be used to shield against electromagnetic interference for such products as automotive hoods, computer cases, and other electronic housings. Other applications include use of a surface veil to improve smoothness. It has a fiber tensile strength of 350,000 lb/in.² and weighs 0.5 oz/yd. It sells for \$3.15 per square yard. Delivery is from stock.

Stackpole Fibers Co., Foundry Industrial Park, Lowell, Mass. 01852 [478]

A polyurethane casting compound is suited for encapsulating and potting such stress-sensitive electrical components as reed switches, toroidal coils, capacitors, and inductors. The Enelthane system 97 is a two-component material containing Vorite 729 prepolymer and Polycin 989 polyol. Both components are extremely resistant to air entrapment, have low pour points, and will not freeze. The compound has a hardness of 60 on the Shore A test. Other specifications include a volume resistivity of 2.0×10^{14} Ω -cm, a dielectric constant of 3.4 at 1 kHz, and a dielectric strength of 454 v/mil, all when measured at 25° C. The tensile strength is 600 lb/in.² The material can elongate 200% and has a tear strength of 129 lb/linear inch.

NL Chemicals/NL Industries Inc., P. O. Box 700, Highstown, N. J. 08520 [479]

Selection Unlimited



Who offers more types of quality knobs and dials than anyone else in the world?
Rogan . . . only Rogan!

Some companies offer only knobs for instrumentation while others offer only appliance knobs while still others only heavy-duty mechanical knobs. Rogan Corporation manufactures all these types . . . and more.

Our variety, our superior styling details and our emphasis on human factors engineering are all aspects that separate us from the competition.

When specifying knobs and dials for your product line, why not choose the source with the greatest selection . . . Rogan.

Samples are furnished for your evaluation at no charge upon request.

For your *free* copy of the latest edition of the most comprehensive control knob and dial catalog in the industry, call or write:

Rogan Corporation
3455 Woodhead Drive
Northbrook, Illinois 60062
Phone: (312) 498-2300
TWX: 910-686-0008

ROGAN

Quality control knobs and dials since 1939

**From
1400 watts to 0
in 2.2 seconds.**

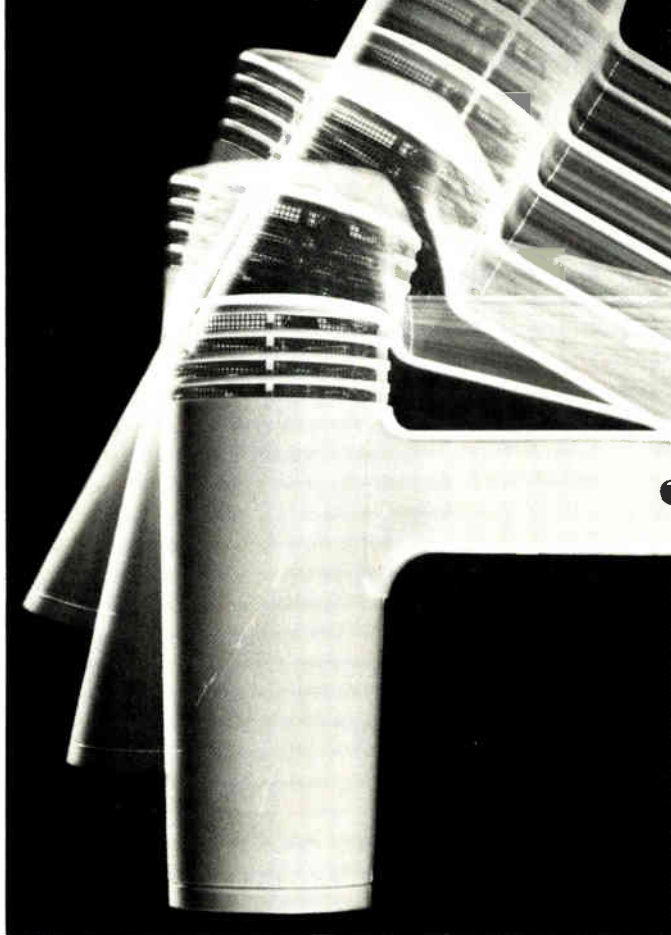

**From 60° to 240° C,
the MICROTEMP® cuts
off thermal hazards fast.**

OEM's need a thermal cutoff they can rely on. Which is why they've relied on the MICROTEMP® over a billion times.

They know the MICROTEMP® thermal cutoff not only works fast, it's designed to protect the average product for its projected lifetime.

So if you're looking for a low cost thermal cutoff you can count on, look no further. Go with the one that's No. 1 around the world.

The MICROTEMP.



 **MICRO DEVICES**
DIVISION OF EMERSON ELECTRIC CO.
1881 SOUTHTOWN BLVD. DAYTON OH 45439
513-294-0581 TELEX 28 8067

New literature

Purchasing computers. "The Insider's Guide to Small Business Computers" is a 70-page book that provides information for businessmen considering the purchase of a small-business computer. It contains detailed financial evaluations of typical cost savings in standard business applications and an analysis of how to calculate the real cost of a computer, including the effects of depreciation and tax investment credits. The main subjects covered are: how to select computer hardware and software and how much they should cost, what are the tradeoffs between buying applications software packages and developing customized packages, how to analyze a computer's cost-effectiveness, and how to calculate the time it will take for the computer to pay for itself. An audio cassette is included in the \$6.95 price. Data General Corp., General Distribution Division, M. S. A-223, Westboro, Mass. 01580.

Switches. Precision snap-action switches are the subject of a 78-page catalog. It gives the features, electrical characteristics, mounting dimensions, termination variations, and ordering information for the devices, plus cutaway drawings. The switch types include: double-pole, double-throw; double-break; tandem standard assemblies; miniature basic; subminiature; and hermetically sealed. Micro Switch, a Honeywell Division, 11 W. Spring St., Freeport, Ill. 61032. Circle reader service number 422.

Optical-fiber measurement. Two technical notes on optical-fiber measurements are available from the National Bureau of Standards. "An Assessment of the Backscatter Technique as a Means for Estimating Loss in Optical Waveguides" (TN 1018) relies on computer modeling to describe the scattering and absorption loss properties of optical fibers. "Measurement of Optical Fiber Bandwidth in the Time Domain" discusses the overall system architecture, precision, and dynamic range and gives typical experimental results. Each publication sells for



Now, OEMs can take the High Road or the Low Road with our Direct-Connect Modem Cards, small enough to mount inside Data Terminals.

As the auld Scottish tune suggests, Racal-Vadic now makes it easy for OEMs to take the high road (1200 bps) or the low road (300 bps), with low cost direct-connect "Modems-on-a-Card," small enough to mount inside CRT displays, teleprinters, POS devices, and other terminals and systems.

The High Road: 1200 bps

Meet the compact VS1200P, a complete modem on a single PC board measuring 5" by 8.35." That's a thrifty 42 square inches of space. It's fully compatible with Bell 202C and S modems. Only better, offering much more in performance, flexibility and test capability. It's registered for direct-connect, too. Connects to the switched network with a

Circle 126 on reader service card

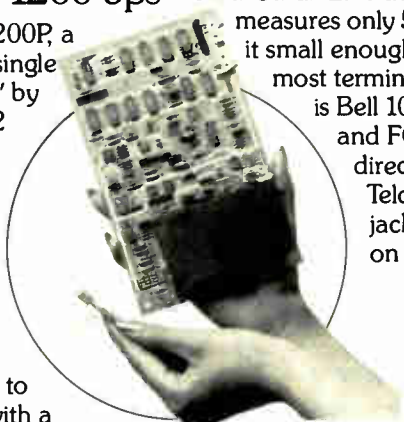

cable that plugs right into a Telco voice or data jack. Built-in 20 pin ribbon connector easily interfaces the VA1200P to your terminal. Price is right, too. Just \$200 in quantities of 100.

The Low Road: 300 bps

The VS300P is a 300 bps full duplex, automatic originate/answer "Modem-on-a-Card." Like the VS1200P, it measures only 5" by 8.35," making it small enough to mount inside most terminals. The VS300P is Bell 103/113 compatible, and FCC Registered for direct connect via a Telco voice or data jack. Mounting holes on each corner make

it a cinch to install. And the price would put a smile on the face of the thrickest Scotsman. Just \$200 in lots of 100.

Both Roads: The TI Story

Two of Texas Instruments new Silent 700* data terminals include Triple Modems custom made by Racal-Vadic. Although small enough to fit into TI's portable 17 pound terminal, this remarkable modem combines a Racal-Vadic VA3400, a Bell 212A, and a Bell 103. Imagine, a full originate/answer direct-connect modem with both 1200 bps full duplex and 300 bps full duplex in such a tiny package. And it can even be acoustically coupled.

We did it for TI, and we can do it for you. Phone or write today.

Racal-Vadic

222 Caspian Drive, Sunnyvale, CA 94086
Tel: (408) 744-0810 • TWX: 910-339-9297

EAST •	(301) 459-7430
NORTHEAST •	(617) 245-8790
CENTRAL •	(312) 296-8018
WEST •	(408) 744-1727
SOUTHWEST •	(817) 277-2246

*Trademark of Texas Instruments

RACAL
The Electronics Group

Keep Up With Change

Ferranti-Packard Electromagnetic Modules Let You Create the System

Three new additions to the Ferranti-Packard 7 Segment Readout Displays—9, 12 and 18-inch characters are ideal for remote-controlled numeric readouts for gas pricing signs, time/temperature signs, speed limit signs, scoreboards and industrial displays.

The light-reflecting display components come in white or fluorescent fade-resistant colors. They're designed to ensure visual impact over an extreme ambient light range, even direct sunlight.

Our Modules are rated for 400 million operations and there are no lamps to burn out.

Save energy too! Magnetic latching retains the data displayed with *zero power input*.

Ferranti-Packard Modules. Visibility. Reliability and Economy no other readout component can match. Before you specify a display, call Ferranti-Packard.

The Pioneer in electromagnetic displays.

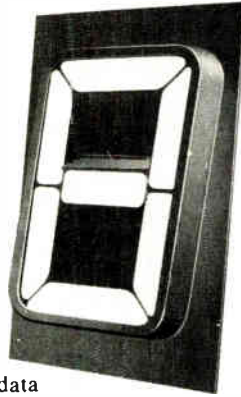

Ferranti-Packard Electronics Ltd.



6030 Ambler Drive, Mississauga
Ontario, Canada L4W 2P1
Telephone: (416) 624-3020
Telex: 06-961437

Circle 42 on reader service card



compas
microsystems

6500 USERS

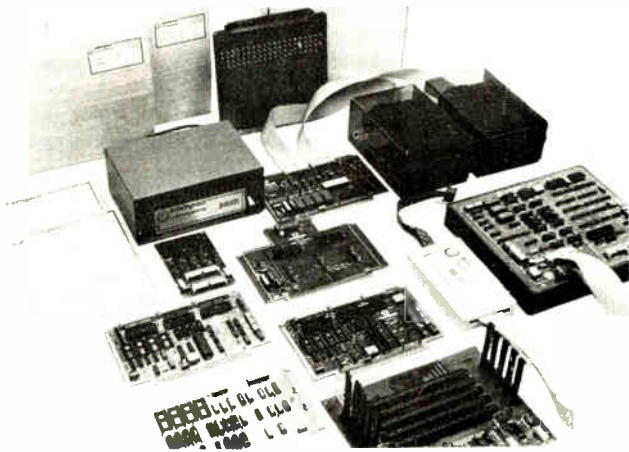

We offer the most complete line of 6500 support tools available — both hardware and software. Our CSB family of single board computers get your project running quickly. The DAIM floppy disk system turns your AIM 65 into a serious development system. The DB/65 provides the debug system you have been looking for. Cross assemblers are available for many popular computers plus CSL/65 — *the* high level language for the 6500 family.

224 SE 16th St. P.O. BOX 687 AMES, IA 50010 (515) 232-8187

322 Circle 44 on reader service card

New literature

\$3.75. When ordering, ask for 003-003-02160-1 (TN 1018) and 003-003-02161-0 (TN 1019). Superintendent of Documents, U. S. Government Printing Office, Washington, D. C. 20402.

Resistors. A 60-page catalog presents specifications for and operating data on a line of resistors and associated hardware. Detailed information is given on axial-lead and fixed and adjustable resistors in either silicon or vitreous-enamel coatings, plus such hardware items as brackets, clips, lugs, mountings, washers, bushings, enclosures, and bolts. Ohmite Manufacturing Co., 3601 Howard St., Skokie, Ill. 60076 [424]

Voltage regulators. Basic operating characteristics, dimensional drawings, and selection guidelines for a line of ac line voltage regulators are supplied in a 12-page catalog. The regulators include constant voltage transformers and microcomputer- and minicomputer-based regulators. Sola Electric, 1717 Busse Rd., Elk Grove Village, Ill. 60007 [425]

Oscillators. A 36-page catalog gives electrical and mechanical specifications plus applications information for a line of modular sine-wave oscillators and related amplitude control modules. Also specified are 26 modular power supplies. Frequency Devices Inc., 25 Locust St., Haverhill, Mass. 01830 [426]

Two-way radios. A collection of data sheets describes the company's land-mobile two-way radios, which include base stations, hand-held units, pocket pagers, remote units, and repeater systems. Standard Communications Corp., P. O. Box 92151, Los Angeles, Calif. 90009 [439]

Active filters. An eight-page application note tells about specifying and using resistive-tunable active band-pass filters. Normalized theoretical amplitude and phase responses are presented in tabular form, along with graphs of amplitude data. Frequency Devices Inc., 25 Locust St., Haverhill, Mass. 01830 [440]

Electronics / August 28, 1980

Want to cut your PC design cost by 50%?

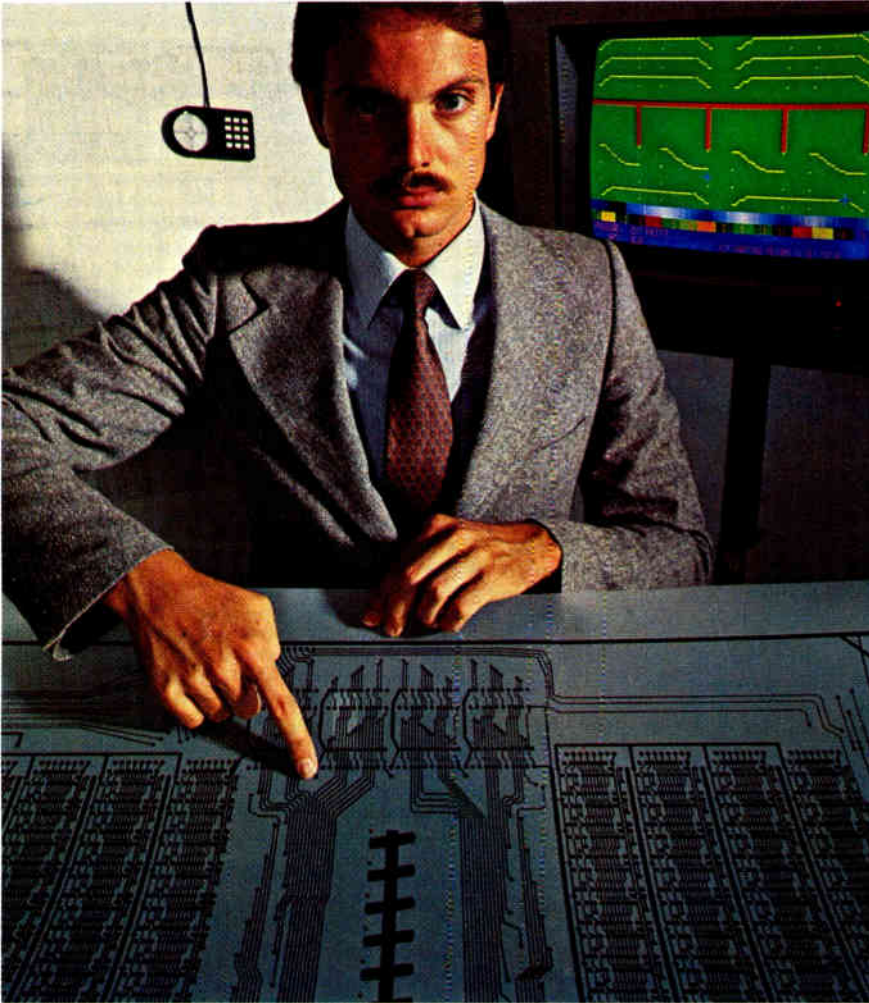

Then check out Nicolet's revolutionary System 80. It's a compact, easy-to-use electronic drafting table that fits right into your design department to speed work through faster than you thought possible.

Multiply your output without extra effort.

Your drafting department will become an efficiency center in no time. Because the System 80 does the drafting while you do the designing. You can work on any of 12 layers—and differentiate all the layers at once through instant color selection. If you move a DIP, you have simultaneous correction of all the layers of the drawing—including assembly drawing, silk screen, solder mask, ground plane, drill drawing and foil art. You pan over or zoom in on large drawings for fast close work. Draft and revise layouts quickly and easily. And automate tedious handwork.

All of which gives your staff more time for designing. And lowers your drafting costs tremendously.

**System 80™ costs less:
\$84,300 to buy.
\$2192 per month to lease*.**

And System 80 offers more capability for the money: more time-saving to cut lead time, more versatility, more options and more return on investment. In fact, you can recover the initial cost within a year.

So if you'd like to cut your PC design costs in half and double or triple your output, get in touch with Nicolet. Today.

*Based on one of our five-year plans now available.



NICOLET CAD CORPORATION A Subsidiary of Nicolet Instrument Corporation

2530 San Pablo Avenue
Berkeley, CA 94702
(415) 848-6600. Ask for Jim Hirst.

Tomorrow's TECHNOLOGY Today

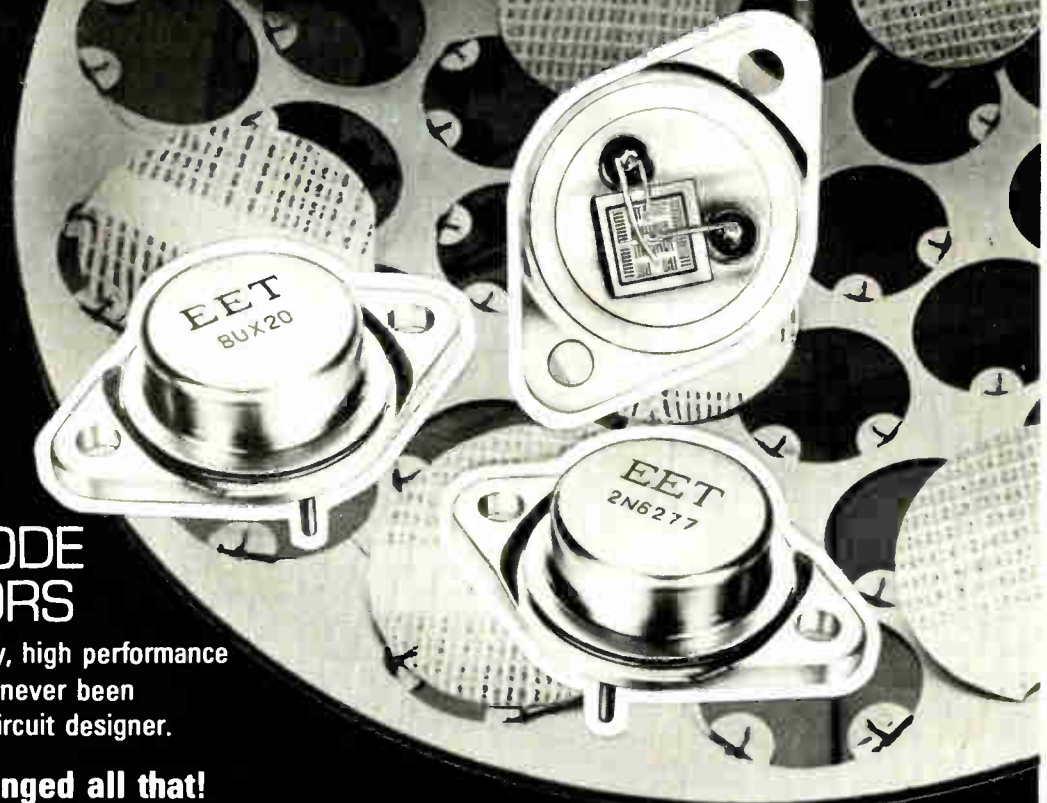

SWITCHMODE TRANSISTORS

The selection of quality, high performance Power Transistors has never been any easy task for the circuit designer.

EE Tech have changed all that!

Advanced semiconductor technology in conjunction with sophisticated manufacturing and test equipment of the very latest design, ensures our in-depth product range offers greater flexibility to the discerning engineer.

Consider specifically our range of high power switchmode transistors:

250 Watt

2N6274 through 2N6277 (JEDEC) Series
 V_{CB0} rating up to 180 volts :
 $I_C = 50$ amperes

350 Watt

BUX20 through BUX 24 (Pro-Electron) Series
 V_{CB0} rating up to 500 volts :
 I_C of 15 to 50 amperes

We are currently the only manufacturer to offer such a device incorporating a single, large area, hard frit glass passivated junction. (Other manufacturers have to resort to paralleling individual junctions, with varying degrees of passivation, in order to achieve near comparable ratings)

Enhanced thermal cycling capability is achieved by utilising a gold eutectic bonding process for mounting the transistor chip onto a molybdenum thermal buffer, which in turn is bonded to the heavy modified TO-3 copper base.

There is no doubt that when selecting a power transistor . . . that a little extra "EETechnology" makes a big difference in performance and cost.

By the way if you have read this and really want a 250 watt monolithic darlington, we can supply those as well.

EE Tech ELECTRONICS
& ENERGY
TECHNOLOGY

2352 UTAH AVENUE • EL SEGUNDO CALIFORNIA 90245 • TELEPHONE (213)675 9141 • TELEX 664455

Measure transmission and reflection with stark simplicity, 1-1500 MHz.

It's a Wiltron.

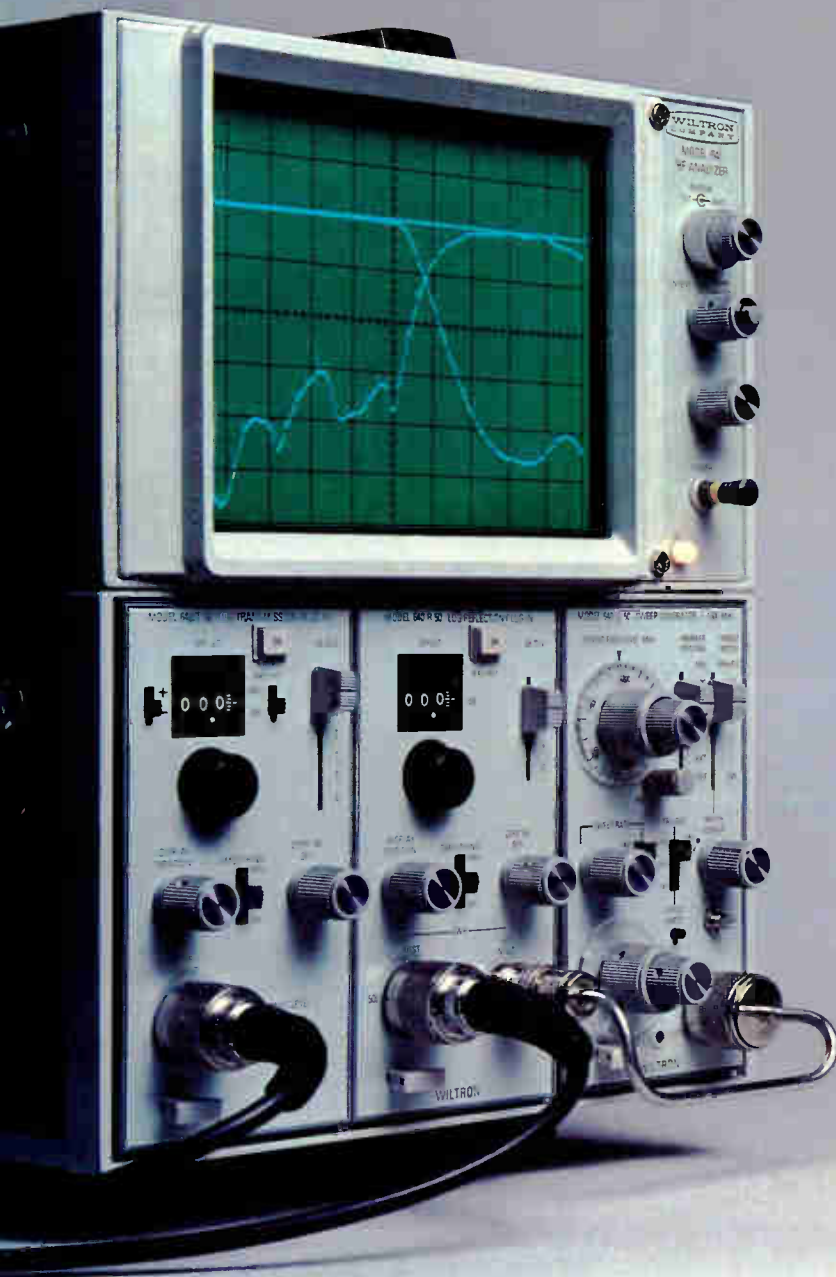

Here in one compact instrument, Wiltron gives you a complete RF Analyzer for swept measurements on 50 Ω or 75 Ω devices over the 1 to 1500 MHz range.

Use the Wiltron 640 to make transmission gain/loss, reflection (return loss/SWR), absolute power and absolute frequency measurements. You'll find the 640 is one of the easiest instruments you've ever used. Simply connect the test device. You won't need an armful of couplers, amplifiers, cables or other equipment. All the circuitry — sweeper, directional signal separator, calibrated amplifiers, detectors and display system — is inside the case.

No more muddled measurements.

Wiltron's 640 offers features you won't find in far bigger, more expensive instruments.

It gives you the most versatile marker system available, stable, crystal accurate, on a dual-trace display with a ± 90 dB calibrated offset.

You can precisely sweep over the entire 1500 MHz range or over just 1 MHz. Dynamic measuring range is 70 dB (+15 to -55 dBm). Measure return loss to below 30 dB (1.06 SWR).

Low cost plug-in flexibility.

Five plug-ins are offered: a swept signal source, log reflection unit, log transmission unit, linear amplifier unit and log transmission/reflection unit for use with external detector and SWR Autotester.

Ask for Technical Review #7.

For complete details ask for a copy of Technical Review #7. For an early demonstration, call Walt Baxter, Wiltron, 825 East Middlefield Road, Mountain View, CA 94043. Phone (415) 969-6500.

WILTRON

Circle 130 on reader service card

NOTHING BEATS THE MATCHLESS PRECISION OF GCA'S MATCHED WAFER STEPPERS.™

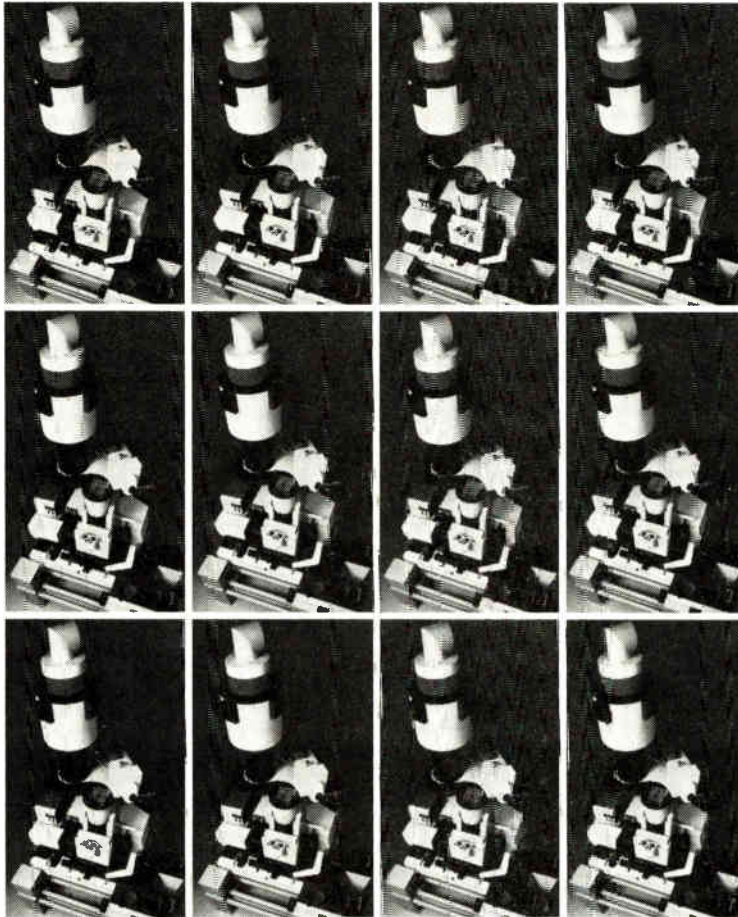

Machine matching allows you to make the most efficient use of every DSW Wafer Stepper™ direct step on the wafer system in your operation. And we guarantee at least 95% registration at ± 0.5 micrometer between every machine in your fab area. So you'll get greater throughput than ever before.

Hardware is matched in several ways: by close

inspection of the lenses for distortion, by reducing the tolerance in setting the reduction ratio, by control of die rotation, and by controlling the parallelism between the image plane and the object plane. Software is used to correct differences in orthogonality and XY scale values.

In short, with matched DSW's, wafers flow non-stop through your fab area. Production bottlenecks are

eliminated. And equipment use is truly maximized.

For more information on the DSW Wafer Stepper, write: GCA Corporation, 209 Burlington Road, Bedford, MA 01730. Or call: (617) 275-5400.



GCA CORPORATION
Burlington Division

209 Burlington Rd.
Bedford, Mass. 01730
(617) 275-5400
Telex: 95-1257

Part of the GCA/IC
Systems Group

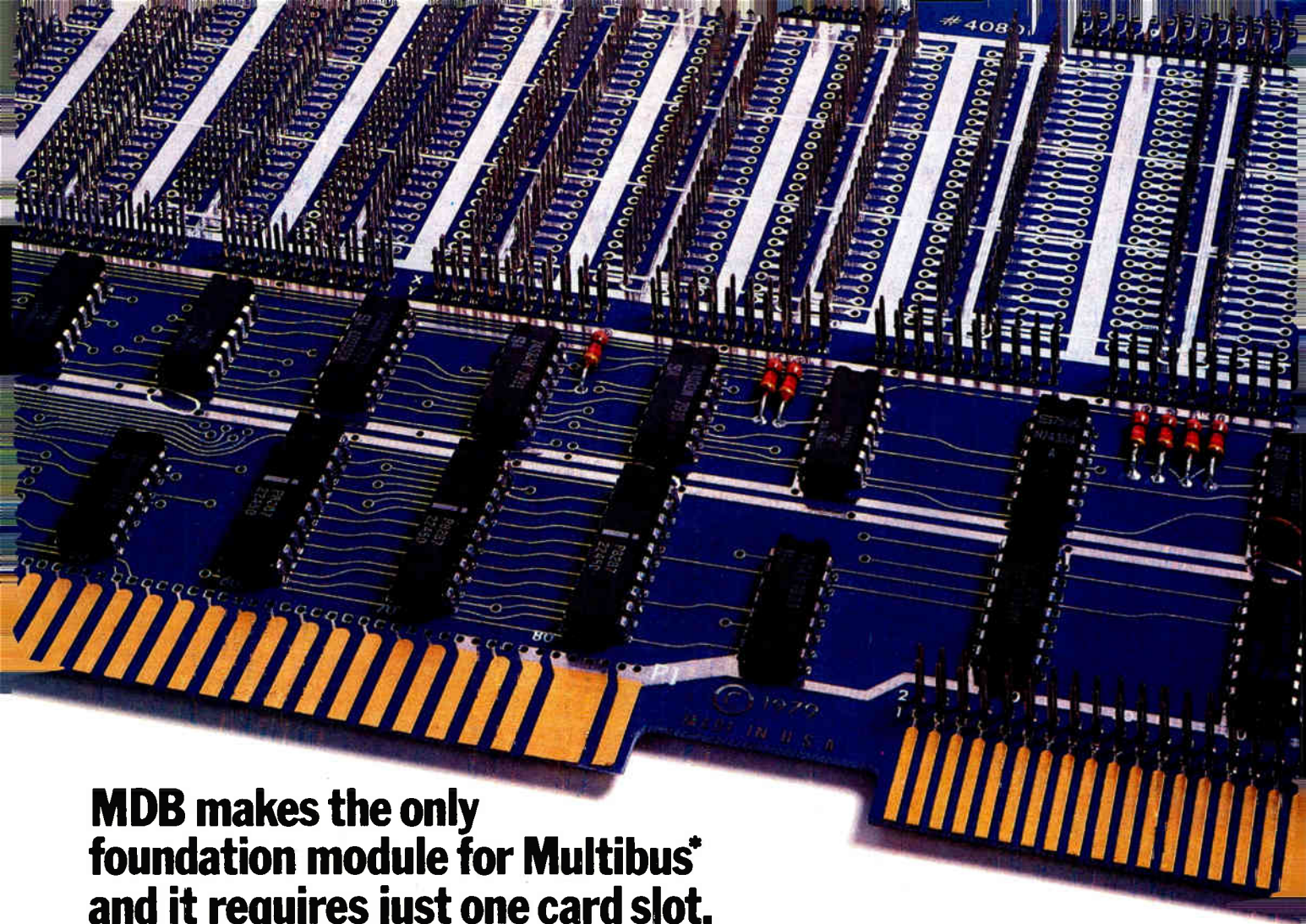

**MDB makes the only
foundation module for Multibus*
and it requires just one card slot.**

Imagine what else we can do!

If you've never been excited about a foundation module before, now's the time. MDB offers the industry's first module for use with Intel 16 and 8 bit single board computers. It gives low cost Multibus-to-peripheral interface with complete address and interrupt logic, standard Intel board spacing and room for up to 38 sockets or IC devices of any size on the wire wrap portion of the board. Because all wire wrap pins and components are on the same side of the board, the module requires only one card slot. And it takes any configuration DIP package and provides three 50-pin edge connector positions. In addition, MDB makes a pure wire wrap general purpose module in a single slot configuration which has space for 60 IC positions. This is the kind of flexibility a logic designer dreams about.

See us at Wescon #2639.

*Trademark Intel Corp. **Trademark Digital Equipment Corp

Circle 134 for Intel, 135 for LSI-11, 136 for PDP-11,
137 for DG, 138 for PE, 139 for IBM.

If you're not an Intel user, you can still get MDB design flexibility—in single slot bus foundation and wire wrap modules for PDP**-11, LSI**-11, Data General and Perkin-Elmer computers and wire wrap boards for IBM Series/1. Even the dedicated portions of these modules are application adaptable in that they allow a change of functionality by the use of wire wrap pins.

What else can MDB do for you? Look at our line printer controllers. We offer more than 100 computer/printer combinations. If you need communications modules, interprocessor links, multiplexors and PROM boards, we've got them all with the built-in quality MDB is famous for.

MDB interface products are warranted for a full year; most can be delivered in 30 days or less, and you can buy them under GSA contract #GS-00C-01960. What can we do for you?

MDB 1995 N. Batavia Street
Orange, California 92665
714-998-6900
SYSTEMS INC. TWX: 910-593-1339



BRAIN CELLS.

They're Gates Energy Cells. And they're limited only by your imagination.

Our cells offer hundreds of recharges, greater than 8 years life in float applications, and have superior storage life.

That's why dozens of manufacturers have chosen Gates Energy Cells to power their products safely and reliably.

Our Cells are now available in our basic 2V sizes, ranging from 2.5 to 25Ah, for dozens of battery configurations.

Learn more about the cells imaginative engineers are using to make great products even better.

Write: Gates Energy Products, Inc., 1050 South Broadway, P.O. Box 5887, Denver, CO 80217. Phone (303) 744-4806.

GATES ENERGY



MMI improves speed, power dissipation in bipolar PROMs

Monolithic Memories Inc., Sunnyvale, Calif., will soon introduce two Schottky (S) and low-power Schottky (LS) families of bipolar programmable read-only memories that **rely on titanium-tungsten fuses to obtain faster speeds and lower power dissipation than PROMs using traditional nickel-chromium fuses.** The LS family, available in 256-by-4- and 512-by-4-bit configurations with three-state or open-collector outputs, maintains the 60-ns switching speed of MMI's earlier NiCr PROMs but nearly halves power consumption (to 35 mW from 65 mW). Available in the same configurations, the S family of PROMs consumes the same power as the older NiCr devices, but yields a 25% speed improvement (down to 45 ns from 60 ns).

National Semiconductor to introduce five low-power COPS

Look for National Semiconductor Corp., Santa Clara, Calif., to take the wraps off five new **low-power members of its COPS (control-oriented processors) family of single-chip microcontrollers.** Fabricated using n-channel silicon-gate MOS technology, the new additions include the 444L and 445L which have 23 and 19 input/output lines, respectively, and contain 2 K by 8 bits of read-only memory and 128 by 4 bits of random access memory. They dissipate 55 mW of power at 5 V when in operation. Also available will be a 410L (19 I/O lines) and 411L (16 I/O lines) with one-fourth the memory of the 444L and 445L, as well as the 404L, a ROM-less version of the 444L.

Software looks for unsuspected hardware flaws . . .

The only thing worse than a software error may be an unsuspected hardware malfunction. Information Systems Consultants Inc., Phoenix, Ariz., now offers a validation system that should avoid some of the pain such failures cause users of Cobol, Fortran, and the Honeywell GCOS operating system. Validating the execution of certain instructions in these languages, **XEIS identifies failed processor functions that can sometimes go undetected,** flaws that can quickly degrade both programs and data bases.

. . . as load generator exercises Honeywell operating system

Also new from ISC is the Load Generator System II, a systems and management tool that **simulates on-line activity to exercise Honeywell's GCOS operating system** and measures on-line activity's effect on GCOS and its sub-executives: TDS, DMIV-TP, TPE-II, TSS, and ETS. The system measures performance, tests system integrity, performs capacity management and a number of auxiliary functions.

MOS FET power switches driven by 5-V signals

Sitronix, a member of the Siemens Group in Broomfield, Colo., has a new line of MOS field-effect-transistor power switches that can be driven directly from 5-v logic levels (see p. 145). The family **includes devices with 0.03- Ω on-resistances and others with 1,000-v breakdown-voltage ratings.** Current ratings range up to 40 A. The transistors are housed in TO-3, TO-220, and TO-238 packages and are priced to be competitive with other MOS FETs. For example, the BUZ20, a 100-v, 8-A, 0.2- Ω device in a TO-220 case sells for \$7.22 in lots of 50 to 99. The family spans the breakdown-voltage range of 50 to 1,000 v, the on-resistance range of 0.03 to 4.5 Ω , and the current range of 2 to 40 A.

Your partner in productivity.

DIP Printing Systems

MARKEM'S Model 521 singulated DIP print/cure system was designed totally around the productivity idea.

That's why the 521 is designed for one operator. Its L-shaped work area is compact, just 2' x 2'.

That's why the 521 can handle up to 25 tubes of DIP's at one time.

That's why the 521 has special product control features which minimize damage to ceramic packages.

That's why there are few transfer points – and there's easy access to printing elements, the conveyor belt, tubes in magazine, and inking adjustments.

The 521 DIP printer is built for reliable, sustained operations and consistent throughput. And it is available with in-line UV curing.



UV Curing Systems

Markem has housed economical ultraviolet light energy in a free-standing, parts-handling conveyor – the new Model 550 UV Conveyor System – for curing imprinted flat-product substrates.

The Markem 550 system cures decorative and identifying prints *instantly* – so inspection, assembly and packaging can start immediately.

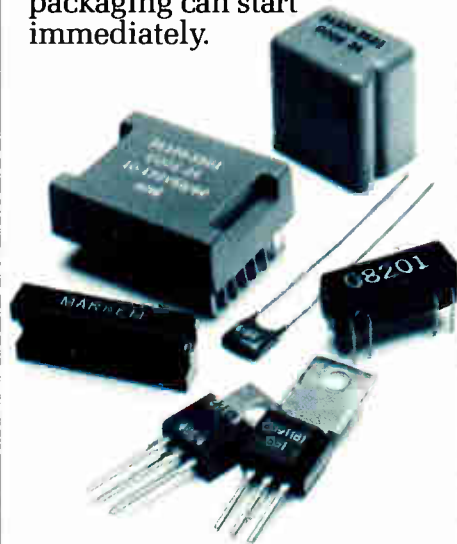

The system ends the need for bulky batch curing ovens, drying shelves and storage racks. It also exposes products to less heat, thus reducing the risk of damage to sensitive products.

The 550 requires only one operator.

Laser Printing System

The day of laser printing is upon us.

No conventional printing system can compete with a laser printing system for:

- speed;
- legend quality;
- high printing reliability;
- low cost per print;
- ease of legend change.

Markem's first System 8000 Laser Printer is a micro-processor-controlled TO92 printer. The previously coated TO92's are fed, printed and discharged at rates up to 18,000 per hour. Capitalizing on laser technology, the system sets a new standard for small character legibility, consistent operation and reliability.

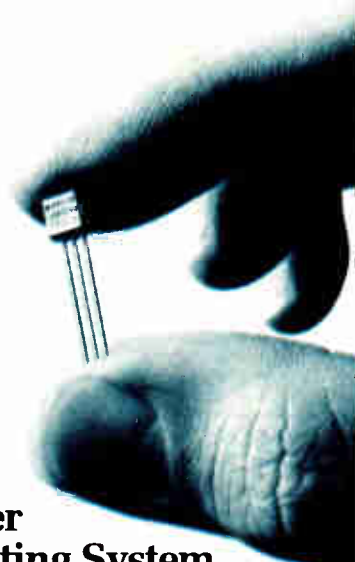

For productivity's sake, call Roger Langley in Keene at (603) 352-1130.

Circle 141 on reader service card

MARKEM

150 Congress St., Keene, NH 03431

See us at the Semicon / West Show, Booth #1045

By **SESCO**...
it works!



The Cook-able Computer

Configure Your Severe Environment System With Our SECS 80/10A Microcomputer And Support Modules

Buy a few cards or a complete system

Take our ruggedized SECS 80/10A Microcomputer, a functional counterpart of Intel's standard iSBC* single board computer, surround it with our equally ruggedized support modules, and you have the building blocks you need to design a system which will operate under the most severe environments.

This versatile SECS 80 System likes it cold — or hot. Meets Mil-E-5400, 4158, 16400- and more, making it perfect for space, missile and other military systems and tough industrial applications.

A multitude of modules

With these versatile modules, you'll save valuable time and development costs.

- SECS 80/10A Microcomputer
- RAM, ROM & EPROM Memories
- Digital Tape Recorder & Controller
- 1553 Serial I/O Board
- Digital Input/Output Board
- Analog To Digital Converter
- High Speed Arithmetic Unit
- Power Supplies

EMM SESCO

A Subsidiary of Electronic Memories & Magnetics Corporation

20630 Plummer Street • P.O. Box 668 • Chatsworth, California 91311
Telephone: (213) 998-9090 • Telex: 69-1404

System packaging

All system modules are mounted on 9" by 6" shock and vibration resistant boards. A 7.62" by 4.88" 12.62" chassis (1/2 ATR) holds up to 6 boards.

Other EMM-SESCO products

We've got core and semiconductor memories for military and commercial use, a Digital Data Acquisition System for the 1553 bus, and a compact Digital Tape System with 23 megabit capacity.

When you're faced with
a tough environment —
"Buy SESCO... it works!"

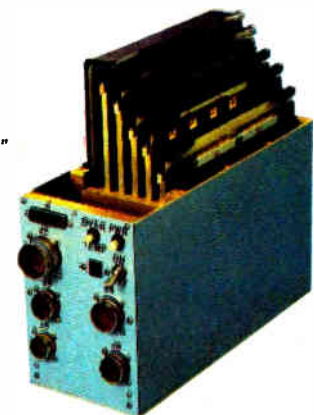

*Trademark of Intel Corporation

Circle 145 on reader service card

An Advanced Memory Test System for the 1980s.



Minato Electronics new 9300M Automatic High-Speed, Large Capacity Memory Test System has surpassed present memory developments with a high 30 MHz memory testing speed and four simultaneous parallel test functions. In addition, a pin matrix function increases yields. And hybrid circuits and a pattern generator for free testing of memory capacity are also featured. The 9300M Memory Test System has extensive functions and capabilities which meet stringent memory test requirements of the 1980s.

- Test speed: 30 MHz
- Hybrid circuits: Driver, comparator, etc.
- Four tests including a function test and DC test can be accomplished simultaneously
- A pin matrix function which eliminates test board wiring
- A memory test pattern generator
Microprogramming is facilitated with 700 commands
Control memory capacity is expandable to 1K words
- Address multi memory measurement
An address multi scramble function is utilized
- Fault analysis
Expandable 256K bits of failure memory
A real time memory is utilized
- Timing generator
Resolution: 100ps
Split level: 16 levels
- Partial and area inversion test are possible
- Built-in auto-skew adjustment
- Software
RX-11 with high through-put is employed

Automatic High-Speed Testing at 30 MHz

9300M

Memory Test System



MINATO ELECTRONICS INC.

4105, Minami Yamada-cho, Kohoku-ku,
Yokohama 223, Japan
Phone: 045-591-5611
Cable: MINATOELEC YOKOHAMA

Need Membrane Switches?

Come to Oak— The Switch Experts

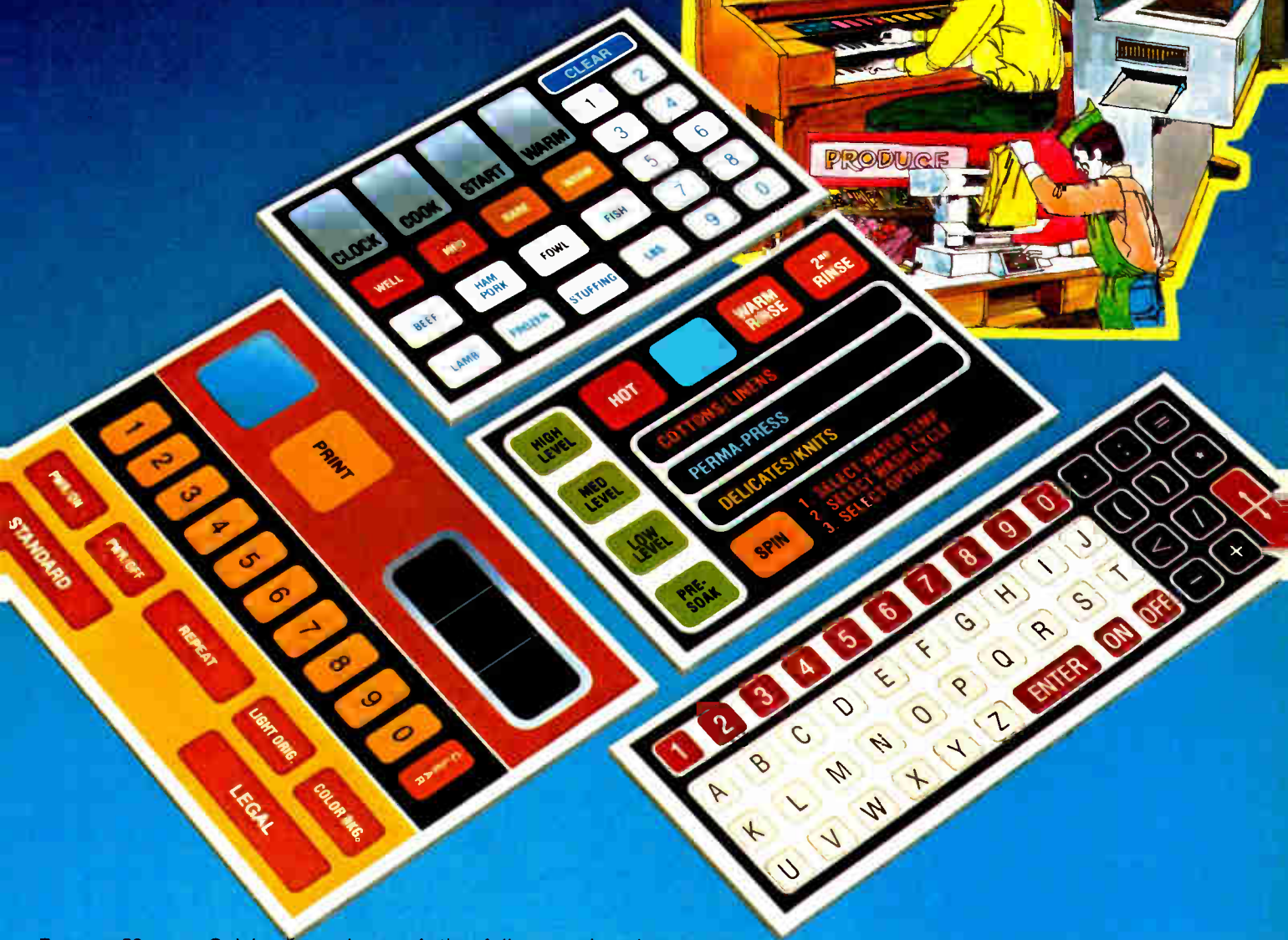

For over 50 years, Oak has been designing and building switches of all types. That experience and technology now has been applied to the TIP switch—Oak's dependable membrane switch.

Fully tested through 500 million cycles, covering 21 different parameters, from life expectancy to environmental/physical stability—insuring long life and reliability.

Active, fully-operating, demonstration panels are used by your local, factory-trained Oak field sales engineer to help you in your volume TIP switch application.

For further information, contact any of the Oak sales offices listed in EEM and the Electronic Industry Telephone Directory, or call Oak at 815-459-5000.

For further information circle #147
For a salesman to call circle #149

IN TOUCH WITH TOMORROW

OAK Technology Inc.

SWITCH DIVISION / Crystal Lake, Illinois 60014
Telephone: 815-459-5000 • TWX: 910-634-3353 TELEX: 72-2447

One small word about computers.

Osborne

The Leader in Microcomputer Books

ASSEMBLY LANGUAGE is currently being used by thousands of microcomputer programmers. It provides maximum execution speed and utilization of memory crucial to many applications and system programs, and enables the closest control and monitoring of peripheral devices.

OSBORNE continues to provide Assembly Language Programming texts for every major microprocessor, the Z8000 and 6809 forthcoming. The four previous texts, the 6502, Z80, 6800 and 8080A/8085, have already earned the Osborne Assembly Language Programming series an excellent reputation among educators and programmers alike.

CONTENTS. In each book you'll find over 80 programming examples tailored for use on your microcomputer, with source program, object code, flowcharts and explanatory text; entire instruction set

fully explained; assembler conventions, I/O devices and interfacing methods, and how to program the interrupt system.

A NEW SERIES of microprocessor texts will begin this July. The books will combine instruction on hardware and logic configurations with usage of assembly language.

The first release will be **The 8086 Book**. A handbook for all 8086 users, this book includes basic 8086 programming information, a thorough analysis of the 8086 instruction set, and detailed hardware and interfacing guides that reveal the full power of the 8086 multiprocessing capabilities. All examples are programmed in Assembly Language, providing the most efficient solutions to many practical problems.

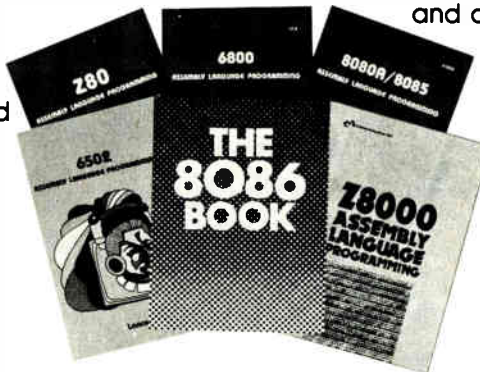

Learn to program your microcomputer using Assembly Language

Z8000 Assembly Language Programming available September	# 36-5	\$12.50	6502 Assembly Language Programming	#27-0	\$12.50
6809 Assembly Language Programming available this fall	# 35-7	\$12.50	Z80 Assembly Language Programming	#21-7	\$12.50
The 8086 Book	#29-2	\$15.00	6800 Assembly Language Programming	#12-8	\$12.50
			8080A/8085 Assembly Language Programming	#10-1	\$12.50

To order, return coupon with check or money order. Include 75¢ per item for 4th class mail, \$1.25 per book UPS, or \$2.50 per book air mail in the U.S. California residents also include local sales tax. To place an order by phone call 415/548-2805.

Notify me when available: Z8000 ALP
 6809 ALP

OSBORNE/McGraw-Hill
630 Bancroft Way Dept. E22
Berkeley, CA 94710

Book	Price	Quantity	Amount

Name _____ Tax

Address _____ Shipping

City _____ State _____ ZIP _____

Phone _____ HOW TO SHIP _____ TOTAL

THE CELCO MACHINE



LANDSAT DATA



XEROX DATA



MAGI DATA



N.Y. INST. OF TECH. DATA

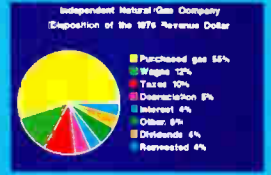

DARKROOM DATA

records your data at the world's highest resolution and fastest speed on color film.

Today the world is looking to CELCO for answers to the problems arising in the exciting field of color graphic arts. And now you can create your own color slides on THE CELCO MACHINE. CELCO's High-Speed, High-Resolution Color Film Recorder.

The CELCO MACHINE provides rapid production of high resolution color film from 16mm to 105mm. 4 x 5 and 8 x 10 inch color Polaroid is also available for instant monitoring.

CELCO MACHINES in the field are now producing over 180 (35mm) color slides per hour, 24 hours per day, day after day, month after month,

year after year. At 4600 line resolution and in less than 20 seconds per slide. For black and white requirements, THE CELCO MACHINE provides even faster speeds and higher resolution.

Unequaled performance. In an independent survey for the U.S. government, THE CELCO MACHINE was shown to provide the highest resolution and speed of all the laser and CRT film recording systems available in the world. Think what this can mean in savings alone to your organization. Instant data management from your own computer-generated image data.

Picture your imaging requirements on THE CELCO MACHINE. Whatever the demands of your unique software for business slide generation, CAD/CAM applications, Landsat, animation, microfiche and micro-publishing. Or for other applications ... from architecture and design to city planning. You can record it on color film on THE CELCO MACHINE.

Send for our colorful and detailed data brochure. Or call Paul Constantine, Vice-President, at 201-327-1123 in Mahwah, NJ for immediate information on THE CELCO MACHINE for YOU. (CELCO Pacific Division: 714-985-9868)



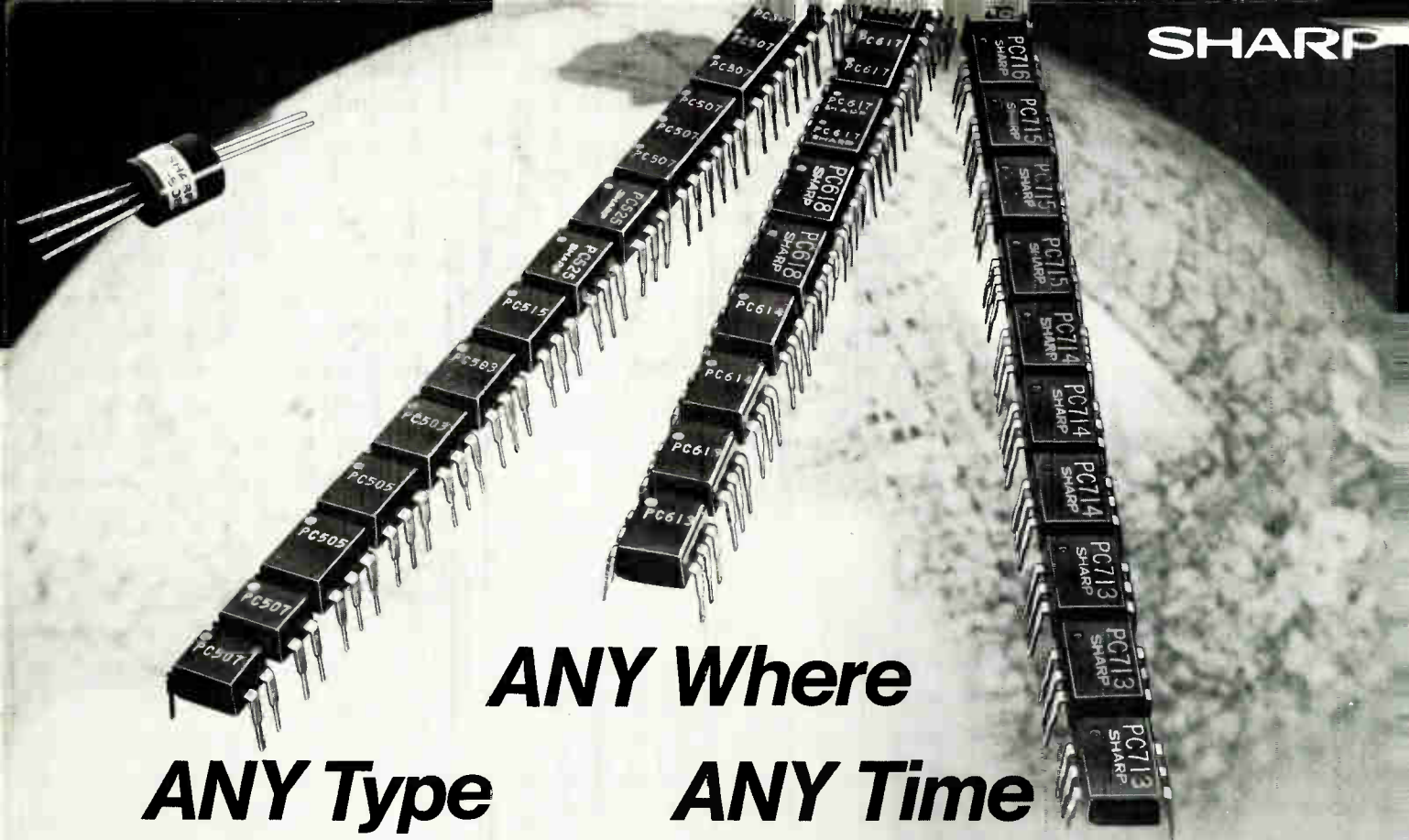

ANY Where
ANY Type **ANY Time**
SHARP PHOTOCOUPPLERS

PC - 500/600/700 Series

- **Plenty Model**
 Sharp's photocouplers have 3 series of PC-500, PC-600, PC-700 (High withstand voltage), so that you can choose for your purpose.
- **Compatibility**
 Since Sharp's photocouplers are pin Compatible type, they are exchangeable for those TI's, GE's, Monsanto's, Fairchild's and other makers.

- **High Quality**
 Sharp's photocouplers adopt GaAs emitting diode as light emitting device and Si planar phototransistor as photosensitive device.
- **Wide Application**
 Sharp's photocouplers are useful in interface and noise cut for system appliances, and also useful in conveying signals of unmatching voltage or impedance.



Type No.	Package	Absolute Maximum Ratings				CRT (%)			Response time		
		I _F (mA)	V _{CEO} (V)	P _{tot} (mW)	V _{ISO} (kV)	TYP.	V _{CE} (V)	I _F (mA)	t _r (μs) TYP.	I _C (mA)	R _L (Ω)
PC-508	Tubular 5P (base)	50	45	—	5.0	67	5	30	6.0	1	100
PC-525	DIP 6P (Darlington)	70	200	350	1.5	600	2	5	25	20	100
PC-627	DIP 8P (2 ch)	70	35	200	2.0	120	5	5	4.0	2	100
PC-637	DIP 12P (3 ch)	70	35	200	2.0	120	5	5	4.0	2	100
PC-713	DIP 6P	50	35	170	5.0	100	5	5	4.0	2	100
PC-714	DIP 6P	50	35	170	5.0	100	5	5	4.0	2	100
PC-715	DIP 6P	50	35	170	5.0	1,600	2	1	60	10	100
PC-716	DIP 6P	50	35	350	5.0	3,000	2	1	130	20	100
PC-618	DIP 8P	25	(V _{EBO}) 5	100	2.0	20	4.5	16	(t _{rPHL}) 0.3 (t _{rHL}) 0.3	(I _F) 16 (I _F) 16	1,900 1,900

Absolute Maximum Ratings T_{oper.} -25~100°C • PC-713/714/715/716: High Withstand Voltage Type • PC-618: High Speed Type

SHARP CORPORATION
 International Division
 Electronic Components Export Sales Department
 22-22, Nagaike-cho, Abeno-ku, Osaka 545, JAPAN
 Phone: (06) 621-1221 Cable: LABOMET OSAKA
 Telex: J63428 Attn: OSKPA (LABOMET A-D)

U.S.A. : SHARP ELECTRONICS CORPORATION
 10 Keystone Place, Paramus, New Jersey 07652
 Tel: (201) 265-5600 For further information, write to: Mr. N. Yagi

EUROPE: SHARP ELECTRONICS (EUROPE) GMBH
 SonninstraÙe 3, 2000 Hamburg 1, F.R. Germany
 Tel: (040) 28511 Attention: Mr. H. Asano

Career outlook

IEEE ballot has catches

■ Now in the mail to the more than 160,000 voting members of the Institute of Electrical and Electronic Engineers are the ballots for the 1980 elections. This year the ballot includes an amendment to the IEEE constitution that, if it should pass, will transfer control of the election from the members to the board of directors.

Sponsored by the board, the amendment is ostensibly aimed at establishing the office of a president-elect, who, besides serving for one year before assuming the presidential role, would also serve for a year afterward as past-president. More importantly, however, it makes the methods and scheduling of the nomination and election part of the bylaws, so that the board of directors could easily alter them by a vote at its meetings, rather than putting them before the entire membership for a referendum.

Other procedural matters the board wishes to move into the bylaws include filling board vacancies and setting the quorum requirements for board meetings.

"People think it's just a procedural change in the presidential status," says Robert A. Rivers, an IEEE fellow opposed to the amendment. "They haven't noticed the change in the bylaws the board is trying to effect. From my point of view it's a reduction in the members' privileges." Rivers, who is president of Aircorn Inc., Union, N. H., will be mounting a letter campaign against the amendment shortly.

"Bylaws can be and are changed at almost every meeting of the board of directors. You would not know with certainty when the balloting would take place and would effectively be deprived of a right to support the candidate of your choice," he notes in his statement against the proposed amendment.

Candidates. The presidential and executive vice presidential candidates on the ballot this year were nominated by the board and are unopposed. Richard W. Damon, director of the applied physics labo-

ratory at the Sperry Research Center, Sudbury, Mass., is running as president, and Robert W. Lucky, the director of the electronic and computer systems research laboratory for Bell Laboratories, Holmdel, N. J., as executive vice president.

Damon wants to further enhance the role of the IEEE in the social and political spheres, as well as giving increased support to the career development of individual engineers. "The constitution of the IEEE clearly states [the Institute's] dual technical and professional purposes. We must synthesize these into an effective whole," he says in his candidate's statement.

Lucky will try to expand the IEEE's membership to include the computer software profession because "I see more and more hardware jobs turning into software jobs, and I know too many young software people who don't belong to the IEEE," he says.

Personal computing. A special report aimed at the personal computer user has been published by Datapro Research Corp., 1805 Underwood Blvd., Delran, N. J. 08075. Included in its 68 pages is information on applications software, popular options, prices, and other data pertaining to 15 of the most widely used personal computers. The \$25 report also contains directories on other manufacturers, plus sources for peripherals, software, and periodicals.

Man-machine interface. Aimed at those engineers and systems analysts who will be planning, designing, and implementing voice input and output systems to computers, the "VIO—Voice Input/Output for Computers" course being given by Integrated Computer Systems starts this September in Washington, D. C., and continues all over the country throughout the fall. It will provide an understanding of voice-processing algorithms and software and an evaluation of available voice input and output hardware, among other exercises. The fee for the four-day course 430, including all materials, is \$795. To enroll, contact Integrated Com-

More Microprocessors

The latest microelectronics hardware advances and software breakthroughs

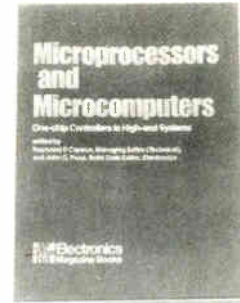

Microprocessors and Microcomputers

One-chip Controllers to High-end Systems

edited by Raymond P. Capece, Managing Editor, and John G. Posa, Solid State Editor, *Electronics*, 482 pages, \$13.95, softcover

Some three years of run-away microelectronics advances—including the appearance of second- and third-generation 8-bit devices, the development of high-performance 16-bit devices, and the birth of the one-chip microcomputer complete with memory and I/O control—are all brought together here in an outstanding overview of both hardware and software applications.

Order your copy today!

Electronics Magazine Books
P.O. Box 669, Hightstown, NJ 08520
Tel. 609/448-1700, ext. 5494



Send me _____ copies of *Microprocessors & Microcomputers* @ \$13.95 plus applicable sales tax. McGraw-Hill pays regular shipping and handling charges on pre-paid orders.

Payment enclosed Bill firm Bill me
Ten-day money-back guarantee.

Name _____

Title _____

Company _____

Street _____

City _____

State _____

Zip _____

IT'S NEW! THE 3PX158

A dual drive, double -sided flexible disk certifier

Yes, Three Phoenix Company now offers the ultimate in FLEXIBLE DISK CERTIFICATION equipment...the 3PX158. And it's ideally suited for MANUFACTURERS, OEM SUPPLIERS AND END USERS alike.

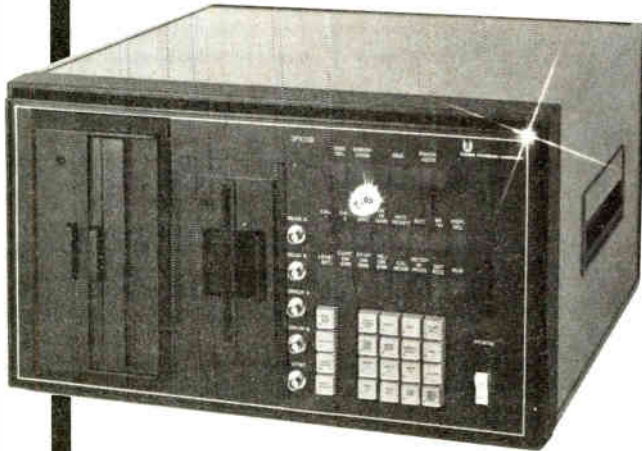

The 3PX158 is really two testers in one. It's an internally programmed, 8085-microprocessor controlled system, providing totally independent, but concurrent testing of 8-inch flexible disks and consecutive testing of 5-1/4-inch disks...single or dual-sided.

Operation is simple. You can select any one of three operating modes...Automatic Reject, Stop on Error, or Continue on Error...or you can manually perform selected tests on any desired track. In all, the 3PX158 performs a series of comprehensive tests to provide Engineering with an evaluation tool, Quality Control with incoming inspection, and End Users with GO-NO GO testing capabilities...including the separation of 100 percent disks from marginal disks for specific applications.

Performed tests include:

- Amplitude
- Modulation
- Resolution
- Extra Pulse
- Missing Pulse
- Peak Jitter
- Overwrite

And check these features:

- Interactive CRT
- Hard Copy Printer
- Manual slewing to any track
- Comprehensive front panel control/display functions

Remember, at Three Phoenix we specialize in automatic test and certification equipment.

For further information, contact:



THREE PHOENIX COMPANY
21639 North 14th Avenue/Phoenix, Arizona 85027
(602) 242-6300

Career outlook

puter Systems, 3304 Pico Blvd., P. O. Box 5339, Santa Monica, Calif. 90405, or call either (213) 450-2060 in California or (800) 421-8166 outside of that state.

Entrepreneurial planning. Control Data's Management Institute is offering a two-day course entitled "Successful Business Planning for Entrepreneurs: Techniques for Improving the Operations of Owner/Manager and Medium-sized Profit Center Businesses." Planning skills in three areas—financing, cost control, and management succession—will be examined closely, as well as the implications of merging or selling a business. The seminar will be held in Chicago on Sept. 18-19, in Washington, D. C., in October, in Houston in November, and in San Francisco in December. The tuition is \$345 per person. To register, call (301) 468-8400 or write Control Data Management Institute, 6003 Executive Blvd., Rockville, Md. 20852.

CAD/CAM data exchange. The National Bureau of Standards has been working on a specification to facilitate the exchange of graphic or geometric information from one computer-aided design and computer-aided manufacturing system to another. The initial graphic exchange specification (IGES)—the outcome of these efforts—has recently been endorsed by the Computer and Automated System Association of the Society of Manufacturing Engineers (CASA/SME). According to CASA/SME, graphics users are not limited to one graphics systems with IGES. IGES will be demonstrated by several exhibitors at the Autofact West conference and exposition in Anaheim, Calif., Nov. 17-20. For more information on IGES, write to Roger Nagel, National Bureau of Standards, Building 220, Room A-123, Washington, D. C. 20234. For more information on Autofact West, write to Kevin Miller, Society of Manufacturing Engineers, One SME Dr., P. O. Box 930, Dearborn, Mich., 48128 or call him at (313) 271-1500.

Classified section FOR ENGINEERING/TECHNICAL EMPLOYMENT OPPORTUNITIES

Your Ultimate Choice

COMMUNICATIONS ENGINEERS

Salary area \$36,000

Experienced communications specialists with E.E. degrees are being sought for Houston-based openings involving the design and application of communications systems. Areas of interest are micro-wave, LHF, UHF, and telephone switching. Working as a member of project team includes interfacing with vendors and contractors. May elect overseas tour at later date.

For further information contact **Glen Bixler** or **Bill McDaniel** at (713) 943-2860

All Fees Assumed By Client Companies

M. David Lowe
PERSONNEL SERVICES

436 Houston Natural Gas Building
1200 Travis
Houston, Texas 77002
(713) 943-2860

WE'RE THE FASTEST GROWING COMPANY IN OUR FIELD,

BUT YOU MAY NOT HAVE EVEN HEARD OF US.

We're the Electronics & Space Division of Emerson Electric . . . A St. Louis based highly diversified firm ranked among the best managed companies in America, and we're looking for forward-thinking engineers, operations, and financial people.

At E&S our people work in a division that operates like an independent

moderate-sized company. This means that individuals and their contribution are more easily recognized and rewarded.

Yes, you may not have heard of us, but organizations and governments all over the world have come to us for our broad range of mechanical and electronic products and systems.

Here are just a few of the many opportunities at E&S:

ATE

Design
Applications software/hardware
ENGINEERING SUPPORT
Scientific & business programmer
Failure analysis, fracture mechanics
Maintainability engineer
Maintenance engineer
Quality assurance
Program management
Manufacturing engineers
Operations people

DESIGN/ANALYSIS

Close combat weapons systems
Fire control systems
Air defense systems
Combat support systems for artillery

ELECTRONIC SYSTEMS

Electronics packaging design
SIGINT/EW Systems
Electrical/Optical tracker systems
Coherent radar systems
Analog and digital hardware design
RF and video circuit design



Interested in finding out more? Just call 1-800-325-0783 (In Missouri, call collect (314) 553-4303).

Or send resume to Personnel Resources, Station 4303, Dept. EW-PSI, 8100 W. Florissant, St. Louis, Mo. 63136.

Electronics ← Space Division

EMERSON ELECTRIC

8100 W. Florissant • St. Louis, Mo. • 63136

AN EQUAL OPPORTUNITY EMPLOYER

Engineers

- Design
- Development
- Project
- Software

\$20,000-\$50,000

Riddick Associates' Engineering Division specializes in placement of electrical and electronics engineers with top companies in the Southeast and throughout the U.S. We provide advice on careers, resumes and interviews for a position tailored to your skills. Client companies pay all fees. For details call or send resume in strict confidence to Phil Riddick, President.

Riddick Associates, Ltd.
9 Koger Executive Center
Norfolk, VA 23502
Area 804-461-3994

ENGINEERS

Engineers/MBA's with B.S. in technical disciplines.

ELECTRIC ENGINEERS MECHANICAL ENGINEERS SYSTEMS ENGINEERS

\$20,000-\$45,000 range.

Our clients seek experience in design and development of computer peripherals or similar electro-mechanical devices.

Forward resume to:

HOWARD BOND AND ASSOCIATES
1141 Hunting Drive
Palatine, IL 60067
Attn: Levi Lipscomb

ENGINEERS

Our clients are seeking engineers for opportunities in DIGITAL, ANALOG, MICROCOMPUTER, HARD/SOFTWARE, COMPUTER SYS., & and other high technology areas.

We specialize in Nationwide placement of ELECTRONIC and COMPUTER engineers. All expenses and fees paid.

Write or mail resume to Paul Brody, . . .

ENGINEERS UNLIMITED

6797 N. High St., Suite 130-E
Worthington, Ohio 43085

TEXAS SALES ENGINEER POSITIONS EE'S, CHEM E'S, ME'S

Fees and expenses paid. Our speciality is technical sales. Excellent positions now available. Send resume/goals to: **Sherman Stone, RECRUITERS OF TEXAS**, Personnel Recruiters, 4000 Medical Parkway, Suite 131, Austin, TX 78756 (512) 454-9546.

S.W. & SUNBELT

- System EE's
- Design EE's
- Product EE's
- Software
- Design ME's
- Communications

\$20,000 to \$50,000
100% Fee Paid

Specializing in placing technical people with data acquisition and peripheral equipment manufacturers located across southern U.S. Send complete resume, salary history and geographic preferences to:

J. Robert Thompson Companies, Inc.
Management & Employment Consultants
2200 West Loop South, Suite 800
Houston, Texas 77027 713/627-1940

ENGINEERS
BALL HAS
MAJOR PROJECT
ASSIGNMENTS
NOW!
Ball

ENGINEERING PROFESSIONALS
JOIN OUR TEAM and LIVE IN BOULDER,
COLORADO

Ball Aerospace Systems, a Division of the Ball Corporation, is seeking engineers who want challenging career opportunities in the aerospace industry.

We have become a leader in the development of space science instrumentation, electro-optics, antennas, military electronics, satellite systems and subsystems.

We would like to talk to qualified individuals in the following areas

- | | |
|-----------------------------|--------------------------|
| Electrical Engineers | Quality Engineers |
| Mechanical Engineers | Antenna Engineers |

Ball Aerospace Today: People and Ideas working together in Boulder—a community nestled in the foothills of the Rocky Mountains. Nearby you can hike, fish, hunt, ski and enjoy some of America's greatest recreational areas. You and your family will have time to relax in cool, colorful Colorado.

We offer an excellent salary and benefits package including medical, dental, life insurance, stock purchase plan, credit union, 100% tuition reimbursement and **FOUR WEEKS VACATION after one year**. If you are seeking a career with a leader in the industry, send your resume to the attention of Joni Colfin.



AEROSPACE SYSTEMS DIVISION

Employee Relations Department
P.O. Box 1062
Boulder, Colorado 80306
Call Collect: (303) 441-4111

Equal Opportunity Employer M/F

OUR ENERGY ISN'T
HARD TO MEASURE

... It's Great!

At ITT Barton, we know we have a measurable effect on the energy industry. The instruments our talented engineers devise make a big difference to the efficiency of our nation's gas and oil field operations.

We're a leading manufacturer of monitoring, analysis, reporting and measuring hardware used in the petroleum/petrochemical industries. Almost any one of our components contribute to the saving or recovery of awesome amounts of energy.

If you're an engineer who wants a job to fit your abilities and your ideals, we'd like to talk to you about a career where your contributions are measurable. We're always searching for engineers for the following areas:

- Project Engineers
- Electronic Engineers
- Mechanical Engineers
- Application Engineers
- Designers
- Drafting Technicians

Related experience is required for all the above positions.

We can offer a high salary, a pleasant location, complete benefits including dental and tuition reimbursement plans and projects that are their own reward. For immediate consideration, please send your resume to:

ITT Barton Instruments
Employment EL
900 S. Turnbull Canyon
City of Industry, CA 91749

Affirmative Action Employer



NOTICE
TO
EMPLOYERS:

Why
we can recommend
our readers
for the top jobs

The subscribers to this magazine have qualified professionally to receive it. They are also paid subscribers—interested enough in the technological content to have paid a minimum of \$18 for a subscription.

As subscribers to *ELECTRONICS*, our readers have told you several things about themselves. They are ambitious. They are interested in expanding their knowledge in specific areas of the technology. And they are sophisticated in their need for and use of business and technology information.

Our readers are now in senior engineering or engineering management, or they are on the road toward those levels. In either case, they are prime applicants for the top jobs in almost any area.

If you are interested in recruiting the best people in electronics, these pages are open to you for your recruitment advertising.

Our readers are not "job-hoppers". To interest them you will have to combine present reward with challenge and opportunity for future career advancement.

The cost of recruitment advertising on these pages is \$71 per advertising inch. For information call or write:

Electronics

Post Office Box 900, New York, NY 10020
Phone 212/997-2556

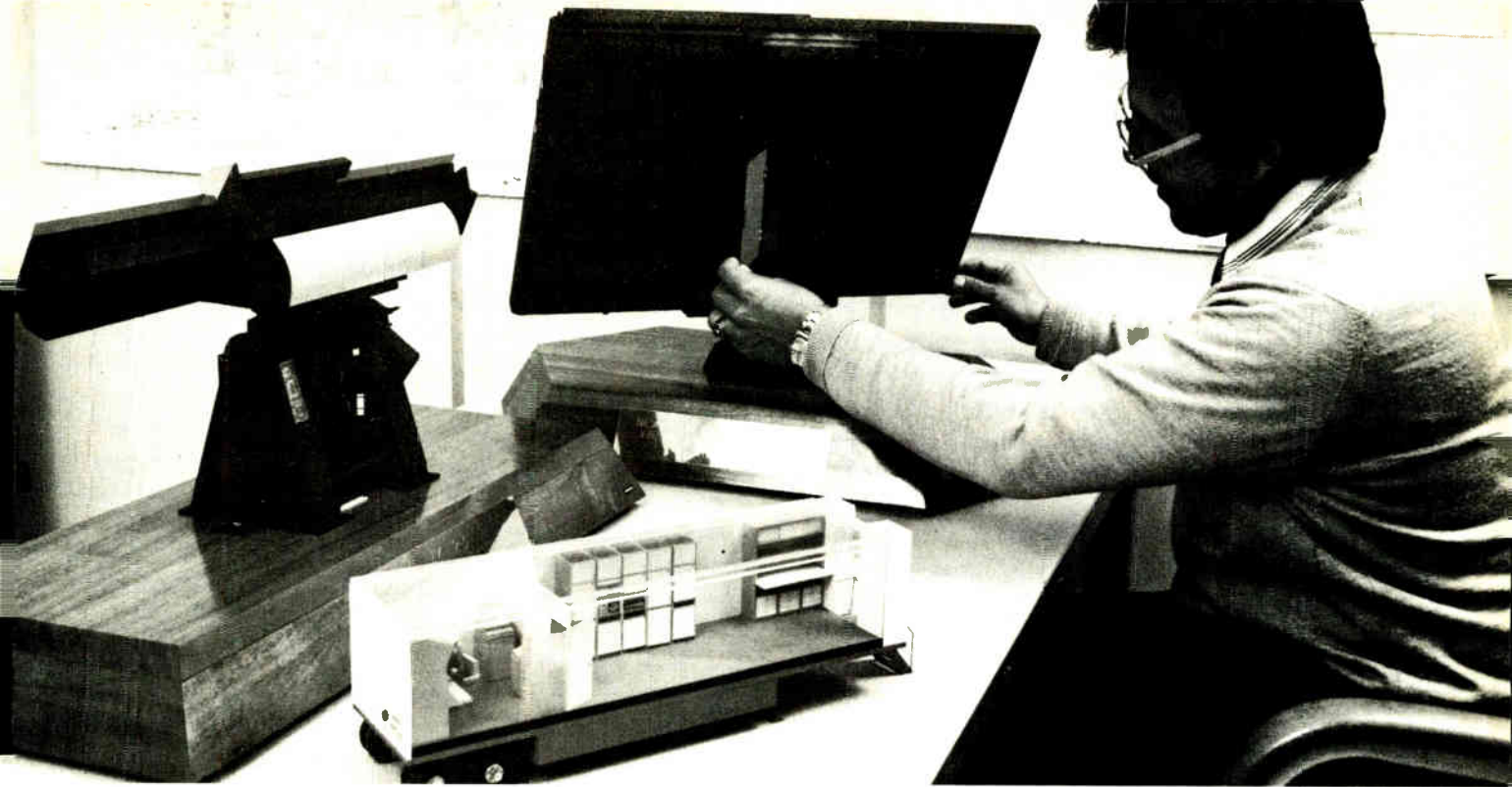

Look over our resume.

If you want to start at the state of the art, and move ahead from there—

Better make sure the place you go to work in the Eighties has a record of reaching beyond the ordinary.

We have.

Join us, and you'll be welcome to use everything we know.

About interactive CAD/CAM technology. Surface acoustic waves. Satellite antennas. Active sonar signal-processing with VLSI. High-resolution 2000-line displays. And much, much more.

We will pay you well, and advance you far and fast, if you can start—and not stop—at the present limits of our knowledge.

Item: We invented 3-D electronically scanned radar in the Fifties. Nowadays we make radar that can spot an artillery shell in mid-air and tell—before the shell lands—where it was fired from.

Item: We have become the world's leading developer of electronic air defense systems on a national scale and larger. (Our system for NATO stretches from Norway to Turkey!) In the process, we have learned a bundle about computers, integration of multiple sensors, communication . . .

And you can use our discoveries to help you make some of your own.

Our company has a 4½ billion dollar backlog—more than 1,500 high-technology projects. Many of the most challenging are here, at Hughes Ground Systems in Southern California's easy living Orange County.

If you are an electronic engineer, computer science graduate, mechanical engineer, mathematician, or physicist, we need you and your imagination.

Make us a job offer.

Now that you've read a couple of our credentials, please send us your own resume. Tell us what you've been doing lately, and what you'd like to be doing soon.

We think we have the combination of salary, outstanding benefits, and second-to-none education assistance to keep you content, while you help keep us in the forefront of one of our electronics specialties.

Address that resume of yours to:

Hughes Aircraft Company
Ground Systems Group
Professional Employment Dept. E-8B
1901 W. Malvern Ave.
Fullerton, CA 92634

*Developed at G.S.G. (L to R):
 I.P.D./T.A.S.*

(Improved Point Defense/Target Acquisition System) for use with shipboard missile and gun fire control systems against anti-ship cruise missiles.

Radar Operations Cabin,

For the surveillance and determination of proper retaliatory weapons selection.

Improved SPA-72,

Shipboard antenna system provides long range surveillance of enemy aircraft.

HUGHES

HUGHES AIRCRAFT COMPANY

GROUND SYSTEMS

U.S. citizenship required
 Equal Opportunity M/F/H/C Employer

Have questions about Allen-Bradley's opportunity for Engineers?

We have answers...
Just call toll free
1-800-321-6980
(In Ohio Call 1-800-362-6120)

Talk to Tom O'Brien about your skills and background. Our continuing growth creates openings for many engineering disciplines including...

Software Engineers Capitalize on your Comp. Sci. or related degree and apply your software experience - assembly languages, PASCAL, FORTRAN. Utilize our VAX11/780, DEC11/34 or TEKTRONIX Development Systems to support your designs.

Hardware/Firmware Design Engineers Design NC and PC systems employing advanced digital techniques. Degree and 2+ years experience desired. Your involvement would include design verification using VAX11/780, DEC11/34 or TEKTRONIX Development Systems.

Application Engineers Define customer control system requirements, prepare proposals and assist new product planning.

Product/Marketing Engineers Research and identify product opportunities based on industry requirements utilizing your degree and 2+ years of electronics or industrial experience.

We are a dynamic part of an international corporation employing over 17,000 people. Our products apply "leading edge" computer and microprocessor technology that increases productivity for all types of industry.

**Our careers are challenging and rewarding...
Let's Talk About It - Call Today!**

or if you prefer, send your resume to:



ALLEN-BRADLEY
747 Alpha Drive, Highland Heights, Ohio 44143

An Equal Opportunity Employer M/F

Systems Engineer-Interface graphics terminals to SEL 32/35 computer; write I/O handlers. Provide maintenance for interactive graphics software. Development of mathematical models in their simulation, including models of 6 DOF rigid body kinematics. Operate and serve as Systems Coordinator for SEL system. Requires knowledge SELRTM operating system and job control language. Position requires MSEE, at least 1 year systems programming experience and knowledge of Fortran assembly and microprogramming. Salary is \$19,000 per year, 40 hours per week. Send resumes to: Denise Deffe, Rothe Development, Inc., P.O. Box 53038, Houston, TX 77058, 713-488-7529. Equal Opportunity Employer.

Murkett Associates Qualified Reputable Management placement with national affiliates—fee paid. Box 527 Montgomery, Al 36101.

EMPLOYMENT SERVICES

Electronic engineering growth positions with clients located nationally. Our service is enhanced by the fact that I am an EE with 20 years in industry and over 10 years in placing professionals on an employer fee paid basis. Send your resume to Joe Torcassi, Director, J. Anthony & Associates, PO Drawer AD, Lynchburg, OH 45142. 513/364-2305.

In sonics or phonics, why ELECTRONICS?

Because in these and hundreds of other fields, electronics applications are taking over. If your firm is looking for smart new electronics engineering graduates, you'll find them—and all other technical disciplines—through McGraw-Hill's **Graduating Engineer**.

Graduating Engineer is specifically designed to put the recruitment stories of technically based firms before 70,000 newly graduating engineers in all disciplines, via request circulation to the college campuses of every major engineering school in the U.S. Call or write the Classified Representative at your nearest McGraw-Hill Regional Office for complete information. Or contact Arlene Anns, Publisher, at (212) 997-3306.

**GRADUATING
ENGINEER**



McGraw-Hill Publications Co.
1221 Avenue of the Americas
New York, N.Y. 10020

At the new Brazilian national telecommunication R & D centre several interesting development projects are now in progress.

These projects are being carried out with the aid of

international experts recruited (on contracts ranging from 2 months to 3 years) through the International Telecommunication Union - ITU. At present there are several openings for high level telecommunication specialists in the following areas:



UNIQUE OPPORTUNITY IN BRAZIL

SPC TIME DIVISION SWITCHING

- Electrical/mechanical packing
- System testing
- Software testing
- Special components
- Operation and maintenance
- System reliability
- Production
- Documentation
- Software documentation

A minimum of 5 years experience with a major telecommunication industry and evidence of having completed at least one major switching product development in the field of speciality is required.

SATELLITE COMMUNICATION

- Design of Ground Control Equipment for Satellite communication

A minimum of 5 years experience is required in system design of GCE and SCPC/FM equipment.

ENGINEERING SERVICES

- Semiconductor component reliability
- Technical documentation

The right men will have experience in both setting-up and running respective laboratories for semiconductor reliability evaluation, modern technical information and/or technical documentation centres.

LOCATION

The R & D centre is located in Campinas in the State of São Paulo. Campinas was some years ago the coffee centre of the world, but it is known today as an important Brazilian scientific and cultural centre, where there is rapid growth of light industry. The town has some of the best medical service facilities in South America and excellent educational facilities (among the latter an excellent American school).

For information about the posts and contractual conditions please contact:

MRS. INA WICKIHALDER
Caixa Postal 1579
13 100 - Campinas
Brazil
Telex: 191 070

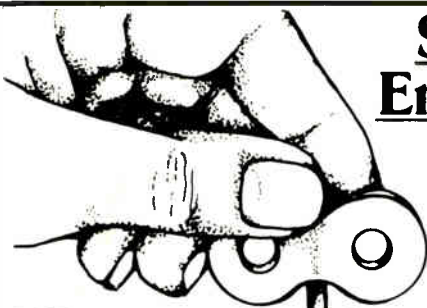

Software Engineers.

You wind you up. We turn you on.

Coulter Electronics is a world leader in medical electronics and instrumentation. An innovator in precision products related to health care and hematological functions.

The technology involved — and the diversified application problems — require constant upgrading in **software design and engineering.**

Obviously, we can't rely on yesterday's technology.

We need engineers with a grasp on tomorrow. Professionals who care about contributing to a project totally — from concept through implementation.

Which is why from day one at Coulter Electronics, **you're highly visible.** You're contributing. You're recognized.

We turn you loose. We turn you on. Expecting excellence because we have a tradition of engineering excellence.

Right now, we need **Software Engineers with micro-processor/mini-computer experience for our top-down design, structured programming environment.**

This is your chance to utilize your degree in Math, Computer Science, or Electrical Engineering — and your process control experience.

This is your chance to grow.

Send in your resume and salary history to: **Mr. Pete Chylko, Employment Manager, Dept. E, P.O. Box 5-2794, Miami, Florida 33152.**

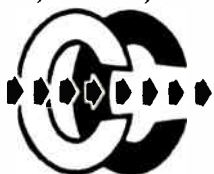

COULTER ELECTRONICS, INC.
INNOVATING A VITAL TECHNOLOGY.

An Equal Opportunity Employer M/F

HIGH VOLTAGE ELECTRICAL ENGINEER

Cambridge laboratory of rapidly growing instrumentation company requires creative electrical engineer with 3-5 years experience in design and engineering of high voltage power supply systems and high voltage switching circuitry for challenging R&D project. Attractive salary and benefit program. Intellectually exciting and congenial environment.

Contact:

Dr. Sohval or Dr. Hearn

elscint inc.

Cambridge Advanced Research
Laboratories
143 Binney Street
Cambridge, MA 02142
617-661-0490

YOUR CAREER STRATEGY

Could help you increase your income \$10,000 or more per year. This is the opportunity of your life. Free information.

MER

Box 2042

Bloomington, Ind. 47402

R&S DATA SYSTEMS

Specializing in Data Processing Field, Service Engineers and Biomedical Engineers

We currently have several key positions with major companies that offer dynamic growth opportunities. For immediate and confidential consideration please forward your resume or call: **Sylvia M. Fazer, Executive Search and Recruiting, P.O. Box 4242, Burbank, CA 91503 (213) 764-0107**

ENGINEERS

ELECTRONICS ENGINEERS, \$60,000. Choice entry level to management positions immediately available in Pennsylvania & national locations. Reply in strict confidence to **J. G. Weir, President, WEIR PERSONNEL SERVICES, 535 Court St., Reading, PA 19603 (215/376-8486).**

ELECTRONICS ENGINEERS, \$18,000-\$40,000. Nationwide positions in digital, analog, microprocessor, microwave & instrumentation technology. For immediate confidential response, send resume w/ salary history to **Glenn English, President, GLENN ENGLISH AGENCY, 7840 Mission Center Ct., San Diego, CA 92108 (714/291-9220).**

DESIGN ENGINEERS to \$38K. Central Penna. & nationwide. Design connectors/terminals, microprocessors & controls. Reply in confidence to **Z. A. Gonglewski, MECK ASSOC. PERSONNEL, 1517 Cedar Cliff, Camp Hill, PA 17011 (717/761-4777).**



NATIONAL
PERSONNEL
CONSULTANTS

SOUTH & SOUTHWEST POSITIONS

Engineering and Management positions throughout the South, Southwest and U.S. Employers pay all fees. Send resume in confidence to: **Bob Hogue, P.E.**

SouthWest Technical
P.O. Box 33070,
San Antonio, Texas 78233

FREE Your dream job.

We hope you're happy in your current position, but there's always that ideal job you'd prefer if you knew about it.

That's why it makes sense to have your resume on file in the Electronics Manpower Register, a computerized data bank containing the qualifications of career-conscious ELECTRONICS readers just like yourself.

You'll benefit from nation-wide exposure to industry firms privileged to search the system, and since the computer never forgets, if you match up with their job requirements you'll be brought together in confidence.

To take advantage of this free service, mail your resume to the address below.

ELECTRONICS MANPOWER REGISTER

Post Office Box 900/New York, N.Y. 10020

THE CHALLENGE:

To apply advanced VLSI design concepts toward the development of custom fabricated semiconductor devices... to outperform the competition in R&D and process development... and to achieve ultimate cost effectiveness. We're shooting for number one.

That's the challenge.

Here's how we're gearing up at Sperry Univac Semiconductor to meet it head-on. We're assembling a nucleus of highly motivated technologically skilled professionals in just about every engineering and technical discipline, plus we'll be staffing for a substantial number of plant personnel as well.

It's a total commitment of over \$50 million that includes the creation of a brand new complex in suburban Minneapolis/St. Paul to house these accelerated activities. It's an exciting time for us. And it could be equally exciting for you.

SEMICONDUCTOR OPPORTUNITIES:

Our plans for the 80's set the pace for fast-track career advancement and unique individual involvements in the following key areas of engineering:

BIPOLAR.

Positions exist for Device, Product and Process Development Engineers to direct analytic investigations in ECL and Schottky Technologies.

Advanced process development programs include: Lithography (Projection and Step on Wafer), Plasma Etch, Plasma Deposition, Ion Implant and Sputtered Metallizations.

MOS.

Aggressively scaled NMOS and CMOS activities present a variety of opportunities for Design, Device, Product, and Process Development Engineers.

Principal responsibilities involve the design, development and testing of critical VLSI functions for both Data Processor and Signal Analysis applications. Excellent design/support facilities maximize opportunities for innovation and technical growth through the use of interactive graphics, automated design tools, and large scale engineering test systems.

Substantial efforts in the following areas of process development are paralleling current MOS design

activities: Photo Lithography (Projection and Step on Wafer), Dry Etch (Plasma, RIE, Parallel Plate and In-line techniques), Ion Implantation, Plasma Depositions, Diffusion and Sputtered Metallizations.

EQUIPMENT & FACILITIES.

The challenge here lies in building "from the ground up." Experienced Facilities, Equipment, and Mechanical Engineering professionals will be required to devote "hands-on" involvement in all phases of the planning and implementation to help get the Division's new state-of-the-art facility up and running.

SUPPORT.

Within the major areas of semiconductor support, several positions in Reliability, Quality, Test Engineering, or CAD are available.

THE BOTTOM LINE:

The ultimate decision is yours. Each position presents its own unique set of accomplishments to be mastered. And we invite you to explore them.

But there's one other major consideration... relocation. This, too, is a challenge... whether it's across town or halfway across the country.

The Twin Cities location of our new Semiconductor Division was selected for several very good reasons.

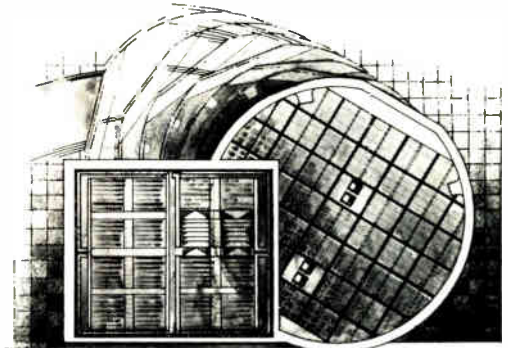

Statistically, Minneapolis/St. Paul ranks at or near the top in every major "Quality of Life" category: Theater, arts, recreation, fresh, clean air and all the things that help make for comfortable living. Plus, there's a refreshingly friendly and open attitude among Minnesotans that makes this a very special community.

These highlights are just a part of the total story. For some good firsthand information, call **BILL DAHLEN, COLLECT at (612) 456-2894**. Or send a resume to his attention at: **SPERRY UNIVAC SEMICONDUCTOR DIVISION (E), P.O. BOX 3525, ST. PAUL, MN 55165**.

SPERRY UNIVAC
SEMICONDUCTOR
DIVISION

"THE CHALLENGE IS HERE AND NOW."

An Affirmative Action Employer M/F

NORTHROP ENGINEERS IN THE 21ST CENTURY

Northrop DSD is at the threshold of the 21st century because Northrop Engineers remain at the leading edge of tomorrow's technology through sound, creative applications of their skills and expertise. Northrop Engineers continue to open new paths, blaze new trails, confront new frontiers.

If you are ready to move into the 21st century, look into the professional opportunities at Northrop, today. We offer excellent compensation packages and exciting technological challenges. Forward resume with salary history to: Professional Employment Manager, Dept. E28 or call our 24-hour toll free 800 numbers: 1-800-821-2280, ext. 927; MO. RES: 1-800-892-7655, ext. 927.

Sr. Systems Engineers - Design/development of applications for advanced ECM/EW systems using digital/analog, microwave and RF technologies.

Sr. ATE Engineers - Systems analysis, design/development of automatic digital test stations for airborne ECMs.

Sr. Power Systems Engineers - Design/develop military power systems for advanced airborne ECMs.

Sr. Mechanical Engineers - Heat transfer analysis/structural load/stress analysis of airborne electronic systems.

NORTHROP CORPORATION
Defense Systems Division
600 Hicks Rd. • Rolling Meadows, IL 60008

NORTHROP
MAKING ADVANCED TECHNOLOGY WORK.

As an equal opportunity employer, we encourage minorities, females, veterans and the handicapped to apply.

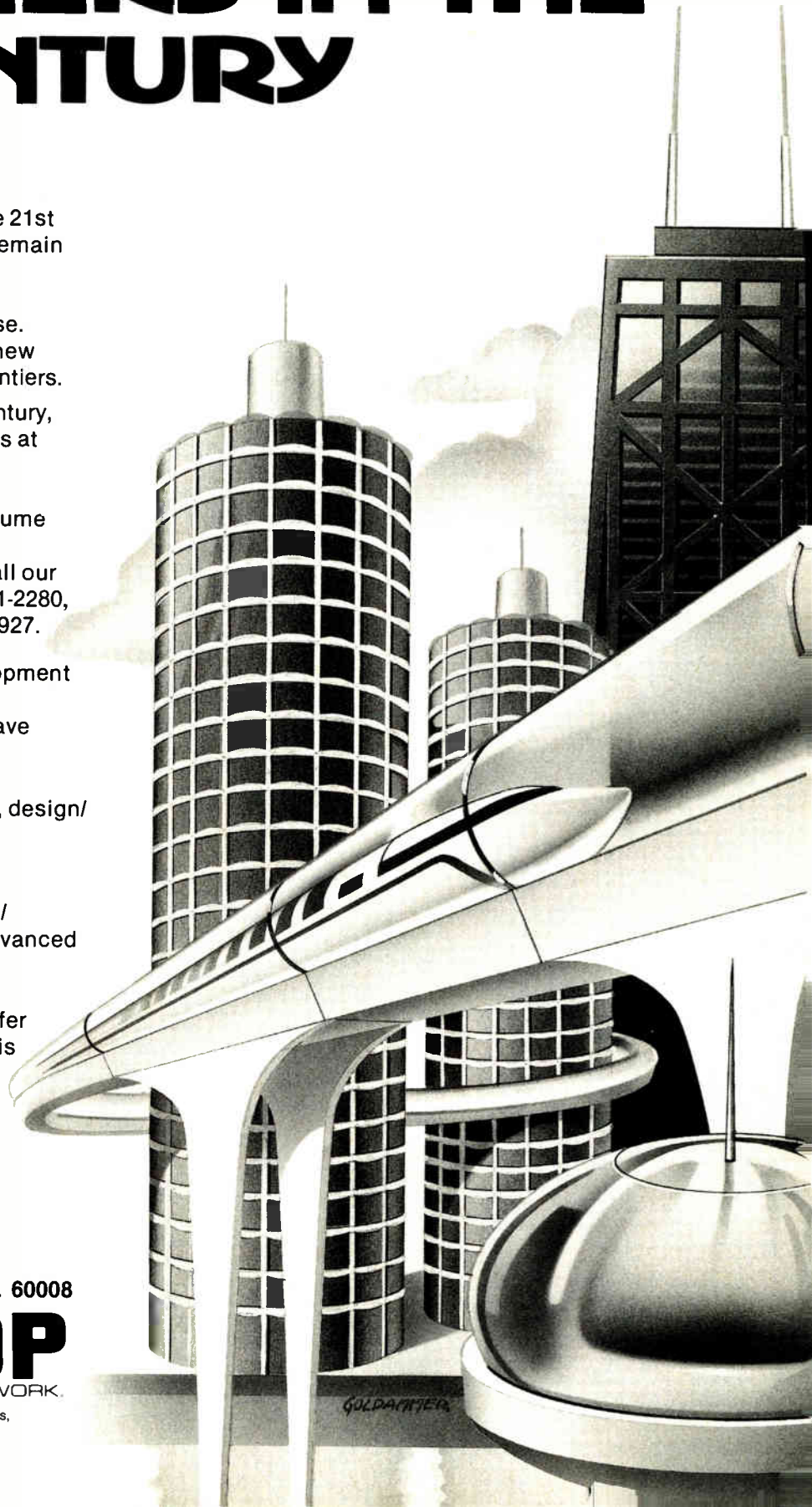

GOLDMANN

YESTERDAY'S INVENTIONS ARE TODAY'S STANDARDS

At Hitachi America, Ltd., our objective today is to develop telecommunications products that will be the standards for tomorrow.

To achieve this level of recognition, we have created a unique R & D environment where innovative and creative Telecommunications Engineers can be a part of the development of a new family of PBX and PABX equipment.

As a prestigious, worldwide manufacturer of advanced telephone switching systems, we can offer experienced Telecommunications Engineers an ideal career situation...exceptional growth potential and an ideal location in Atlanta, Georgia.

The individuals who join us in this unique environment must have a background which includes: a BSEE or BSCS with an advanced degree preferred and a minimum of 3-5 years of directly related experience in a manufacturing or R & D environment.

Successful candidates must have familiarity with development of system architecture, monitoring of hardware and software development programs and ensuring that systems requirements and architectures are achieved.

Positions available in areas of:

- Call Processing**
- Administration Software**
- Analog Interface & Voice Transmission**
- Digital Interface and Data Transmission**
- Maintenance Software**
- Virtual Computer**
- Physical Design**
- Reliability and Cost Analysis**

If you would like to learn more about the challenges and rewards that will exist in this dynamic environment, send your resume, including salary history, to:

HITACHI AMERICA, LTD.

Telecom R & D Division
6745 Peachtree
Industrial Blvd.
Atlanta, Georgia 30360

An Equal Opportunity
Employer M/F/H

*Alexander Graham Bell
American Scientist*



ALEXANDER HAD THE SPIRIT.

Communication.

Transmitting the human voice electrically. For the very first time.

A lone man pursued his dream and invented the telephone.

It was a unique moment in history. When dedication, curiosity and creativity converged to achieve the impossible.

The spirit of innovation that inspired Alexander Graham Bell to greatness lives on today—at Harris Semiconductor in Melbourne, Florida.

Where the simple transmission of electrical current has developed

into the highly complex world of microelectronics.

Where state-of-the-art IC technology and commitment to excellence are a way of life.

At Harris Semiconductor, we realize that real progress cannot occur without creative freedom in an environment that encourages and rewards achievement. And we are dedicated to providing just that for our engineering professionals.

Alexander Graham Bell's achievement opened the door to a future of electronic technology. Harris Semiconductor is the future of microelectronics.

You missed the first historic

communications connection. Don't miss this opportunity to make engineering history at Harris today.

If you have the spirit—fill out this confidential mini-application and rush it to **Ken Judson, Professional Staffing, Harris Semiconductor, P.O. Box 883, Dept. 259, Melbourne, Florida 32901.** (Openings also exist in our San Francisco and Poughkeepsie, New York, facilities.)



HARRIS
SEMICONDUCTOR GROUP

An Equal Opportunity Employer M/F/V/H

THE SPIRIT IS ALIVE.

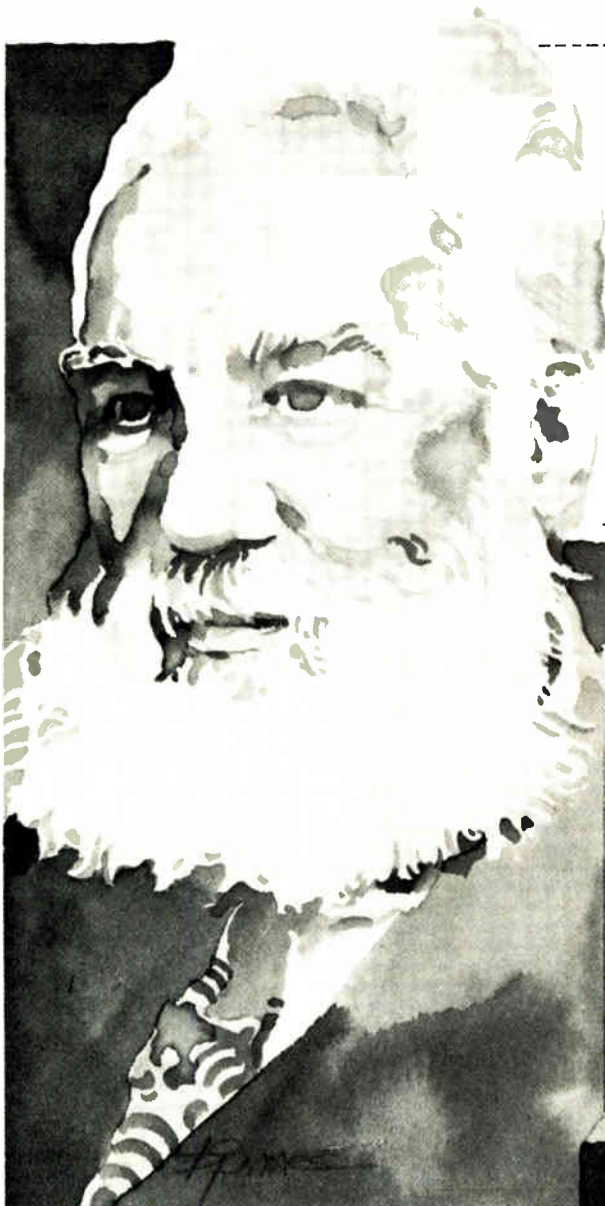

NAME _____

ADDRESS _____

CITY _____ STATE _____ ZIP _____

HOME PHONE _____ HIGHEST LEVEL OF EDUCATION _____

PRESENT EMPLOYER _____

JOB TITLE _____

PRESENT DUTIES _____

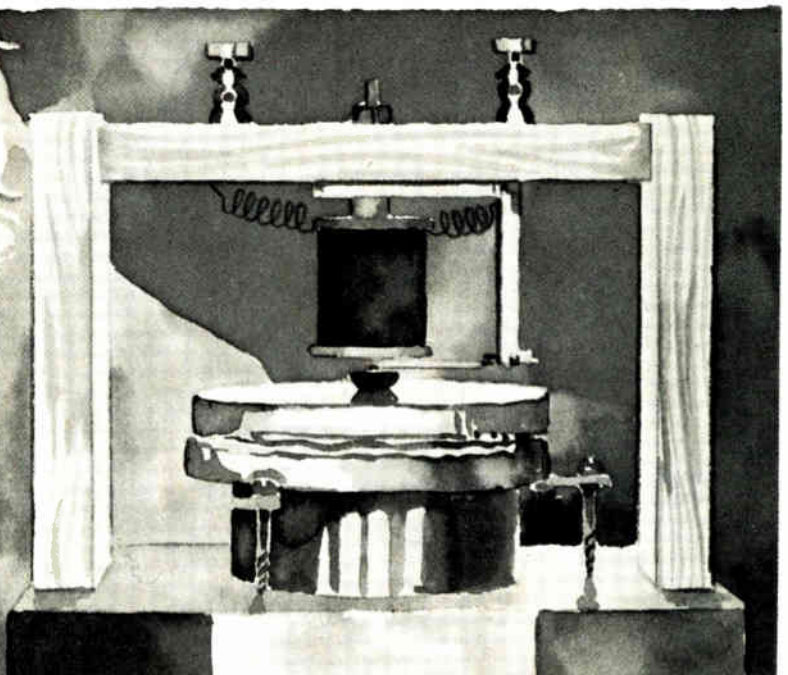

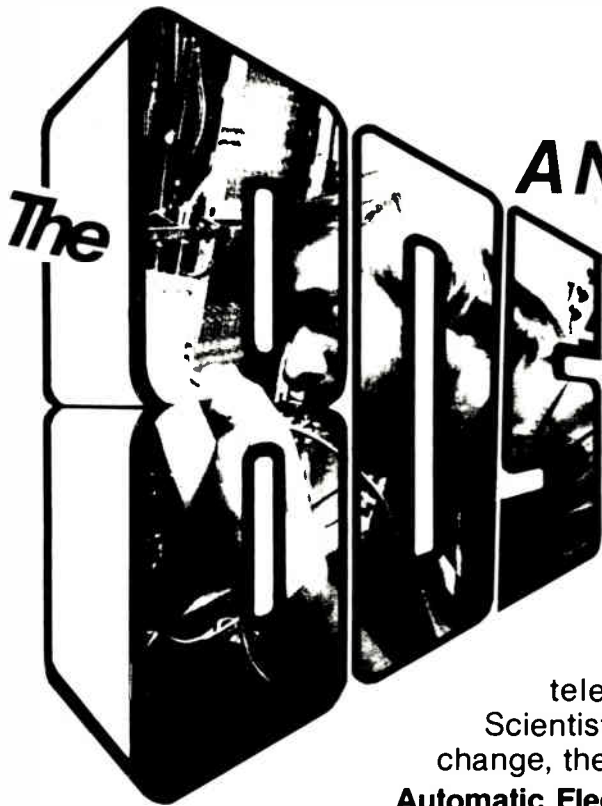

*A New Decade...
A New Generation...*

**BE PART OF IT...
AT GTE AUTOMATIC
ELECTRIC LABS!**

We can count on the 1980's to bring exciting and rapid change . . . especially in telecommunications. And for Computer Scientists and Engineers who want to be part of that change, there's no more exciting place to be than **GTE Automatic Electric Laboratories** in Phoenix.

At **GTE**, our engineers utilize the newest generation hardware and software technology. From our on-line, real-time control programs using the latest in structured programming, off-line support, and diagnostic software to our hardware support including IBM 3032/3033 systems, our environment offers a never ending source of professional challenge.

If you have a degree and experience in Computer Science, Electrical Engineering or related discipline, you owe it to yourself to find out more about **GTE**. Currently, we have openings in the following areas:

- **OPERATING SYSTEM SOFTWARE**
- **ON-LINE RECOVERY AND DIAGNOSTIC SOFTWARE**
- **TEST UTILITY SOFTWARE**
- **DEVELOPMENT SUPPORT SOFTWARE**
- **CALL PROCESSING AND ADMINISTRATIVE SOFTWARE**

As a leader in the design and development of advanced digital systems, **GTE** can offer you an excellent salary, complete corporate benefits package and a rare potential for personal and professional development. To be a part of it, send your resume to: **GTE Automatic Electric Laboratories, Manager of Employment, Department EM828, 11226 N. 23 Avenue, Phoenix, AZ 85029.**



Research and
Development

We are an equal opportunity employer m/f/h

The Next Generation of Computer Technology

Become Part of IT at HEATH

Join an aggressive, innovative, productive team which is hard at work on solutions for the future.

Achieve in an environment where nearly one-third of our products are the direct result of our Engineer's ideas.

SENIOR SOFTWARE ENGINEER

BSCS and five or more years experience in software development and maintenance required. Project leadership would be desirable. Microcomputer background necessary.

QA SYSTEMS ENGINEER

BSEE or BSCS required. Will be involved in establishing software and hardware test routines; developing test and fixture requirements for circuit board assemblies; and identifying and analyzing component product and reliability problems.

For consideration, send a letter or resume in complete confidence to:

Wayne Petzke
HEATH COMPANY
St. Joseph, Michigan 49085
(616) 982-3369

An equal opportunity employer M/F

Enjoy rewards that are professionally and personally satisfying. Salaries are definitely competitive. Benefits are generous. And our location affords a "quality of life" that is second to none.

DOCUMENTATION WRITER

BSCS and 2 years personal computing experience with ability to write 8080 or 2-80 code are essential. Must have good writing and communication skills, as well as ability to evaluate user applications software and prepare for distribution.

DIAGNOSTIC SOFTWARE ENGINEER

BSEE or BSCS and two years experience in writing hardware diagnostic routines for microprocessor-based products required. One year experience with 2-80 or 8080 assembly languages necessary.



Abqaiq, Saudi Arabia

No baseball, no morning paper,
no pizza, no autumn leaves.

But here's the great life that makes
Aramco people stay on and on.



If you never considered working in Saudi Arabia because you think it's all sand and hardships, consider this.

3,900 Americans like you work for Aramco in Saudi Arabia now. Ask them why they stay and they'll tell you that, besides money, it's the casual lifestyle, American-style hometowns, top-notch schools, and vacation travel they used to only daydream about.

Where on earth is Abqaiq?

Located close to the world's largest oil field (Ghawar), Abqaiq is the center of a giant oil-gathering and processing system that handles 60% of all the oil produced by Aramco, the world's largest producer.

Does Aramco's paycheck justify living in a desert kingdom?

Yes! You get a base salary competitive with top U.S. oil firms. We compensate you for overseas cost-of-living differences.

On top of that, Aramco pays an **incentive of up to 40%** for overseas employment, and you are reimbursed for any foreign or U.S. Federal income tax on the premium. So your premium is tax-protected.

Another benefit: employees overseas participate in Aramco's Retirement Income Plan on an **accelerated** basis.

With this financial package, no wonder 3,900 Americans like you work for Aramco in Saudi Arabia today.

What can you do with all that money stuck out in the desert?

Aramco people use 40-day paid vacations



Aramcos vacation in Asia, Africa, the Middle East and Europe

(every 12½ months) and 12 paid holidays (average) to visit fabulous places like the Pyramids, Greek Islands, Mt. Everest, the Serengeti Plain, Hong Kong.

Doesn't a child's education suffer so far away?

No! Aramco has a modern American school system. Teachers are primarily American and more than 75% of them have master's degrees. The teacher-student ratio is 1 to 15 in grades 1 to 6; 1 to 20 in grades 7 to 9.

Where do you go if you get seriously ill, or need dental surgery?

Aramco's Dhahran Health Center is one of three hospital systems outside the

U.S. accredited by the Joint Commission on Accreditation of Hospitals. The Dental Clinic is as fine as any in the States. Better than most.

Aramco recruiting ads mention "comfortable housing." Is that on the level?

At first, you'll live approximately 18 months in adequate but not terribly attractive off-camp temporary housing. Next, it's on to comfortable on-camp temporary housing. Then, based on a housing priority-point system using job level and length of service, you'll get your permanent residence. Many of these are like homes you'd want to live in, in the States.

What jobs are open today? Can a person advance?

Aramco's operations are so big that our job opportunities are probably unduplicated anywhere. Challenging jobs are open in administration, refineries, gas plants, support facilities, everywhere.

We need accountants, medical personnel, technicians, teachers, vocational trainers, communications specialists and materials forecasting specialists. And scores of engineers: in construction, project management, operations and maintenance—for operations in oil, gas, petrochemicals, EDP, computers, transportation, utilities, name it.

You'll have challenges, responsibilities, and management advancement opportunities.

Interested? Send your résumé in confidence to: Aramco Services Company, Department ELT082880GENA, 1100 Milam Building, Houston, Texas 77002.

CHALLENGE BY CHOICE

ARAMCO
SERVICES COMPANY

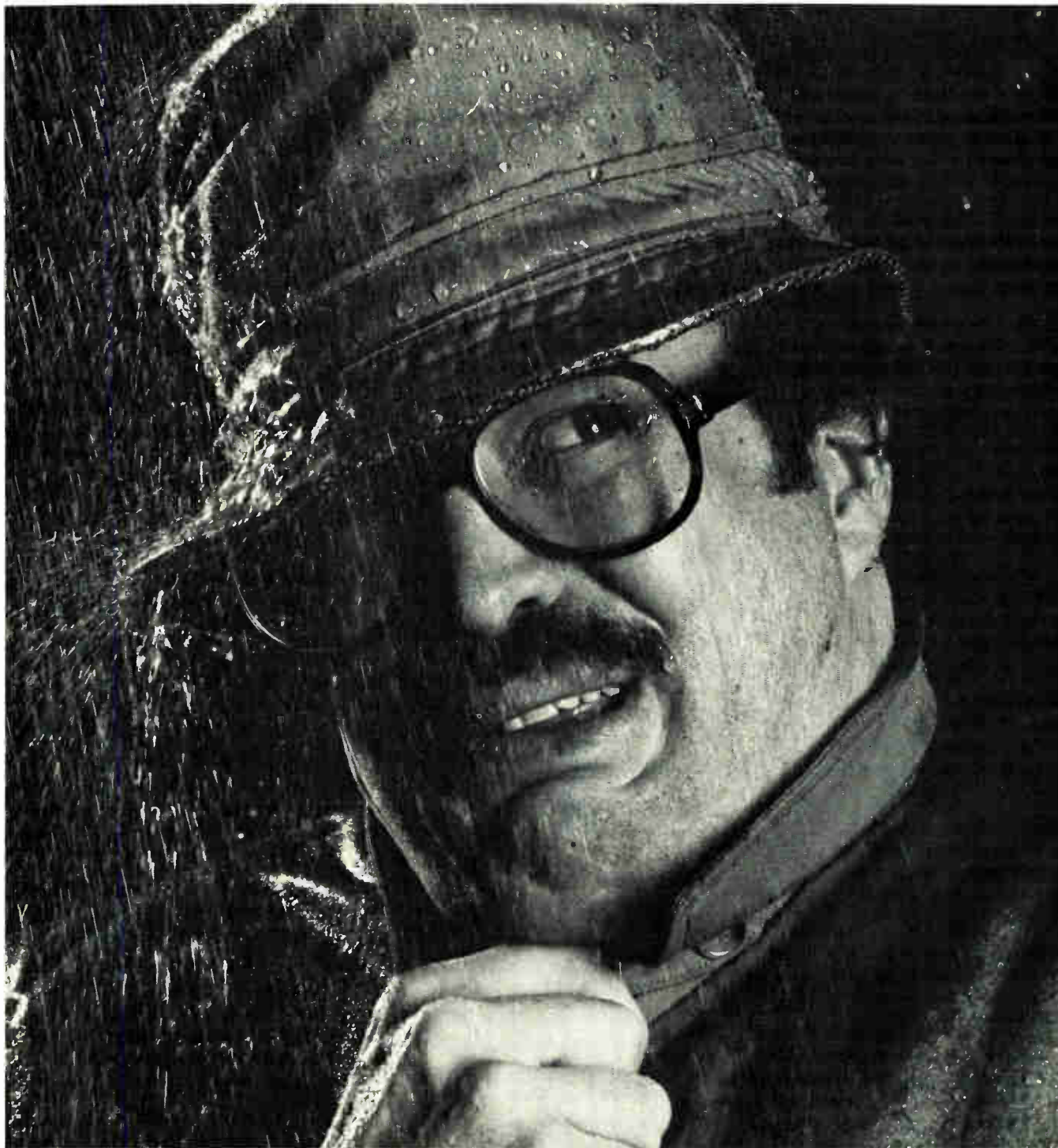

THE BIG MYTH ABOUT WORKING IN SEATTLE.

Myth: It rains all the time.

Fact: Seattle's total annual precipitation averages 34.1 inches. Less than in Cleveland, New York, Houston and a lot of other cities. Plus our climate is mild, the air is fresh and the grass is green all year long.

It's also a fact that, if you're an engineer, you should take a good look at Boeing in Seattle.

Because with two new airplanes to build — the 767 and 757 — plus a backlog of orders for 727s, 737s and 747s that extends well into the 80s, we have plenty of

opportunities for good people.

Rain or shine.

To find out more facts about Boeing, send your résumé to The Boeing Company, P.O. Box 3707-BCZ, Seattle, WA 98124.

An equal opportunity employer.

BOEING
GETTING PEOPLE TOGETHER

NCR is making a massive investment in semiconductor technology...and in your career.



\$155 Million. That's how much NCR will invest during the next four years to *double* the space, and capabilities and professional staff of our microelectronics manufacturing and engineering centers in Miamisburg, Ohio; Fort Collins and Colorado Springs, Colorado. As a result, the portion of internally produced custom semiconductors used in NCR computers will grow from 40% to 60%.

This dramatic growth of NCR's microelectronics operations creates new opportunities for you to become involved in products that include MNOS non-volatile memories, high density RAM's, VLSI logic components, CMOS memory and logic devices, and technologies that include ion-implanted 2-micron geometry. Silicide development. Plasma etching. Fine line lithography. And computer modeling of devices and processes.

You'll have the resources . . . and strengths . . . of a giant, heavily semiconductor-committed, \$3 billion computer company behind you. In short, if your credentials include a BS or MS or PhD in Electrical Engineering, Solid State Physics or Chemistry, now is the time, and here are the places to make optimum use of your background . . .

Openings in Miamisburg:

- VLSI Logic Design Engineers
- VLSI Memory Design Engineers

Write to: Ms. Marcia Laderman,
NCR Corporation, Microelectronics,
Dept. C78, 8181 Byers Road,
Miamisburg, Ohio 45342.

Openings in Ft. Collins:

- CMOS Logic Designer
- CMOS Memory Designer
- Failure Analysis Engineer

Write to: Mr. Richard Veldhouse,
NCR Corporation, Microelectronics,
Dept. C78, 2001 Danfield Court,
Fort Collins, Colorado 80525.

Openings in Colorado Springs

IN SEMICONDUCTORS:

- CAD Analyst/Software Engineer
- Product Engineer
- Process Equipment Engineer, R&D
- Quality Assurance Engineer
- Device Modeling

IN ELECTRONIC DISPLAYS:

- Thick Film Process Engineer

Write to: Mr. Stanley Bloom,
NCR Corporation, Microelectronics,
Dept. C78, 2850 North El Paso Street,
Colorado Springs, Colorado 80907.



Complete Computer Systems

An equal opportunity employer

The price of perfection.

Any company that sets perfection as its goal has a big job on its hands.

And in high technology areas especially, history is full of great technical ideas that didn't quite make it into solid business propositions.

But at INMOS, we recognize the true price of perfection and have sound funding and innovative management to meet the challenge.

For example, we've invested heavily in a total package of manufacturing equipment that no other IC manufacturer can match.

We've built our new, highly sophisticated technology center in a uniquely beautiful area. Because we know that people who expect a lot from their work expect no less from their leisure.

We've created a management structure with the emphasis on freedom and not on structure because we know ideas need room to breathe.

And we encourage every member of our team to contribute their thoughts because we know the best ideas come quietly down the hall when you least expect them.

If you can empathize with our ideals, and you're cut out for any of these jobs, you'll probably find that we are perfect for each other.

Engineering and Support Staff

Manager of Packaging Development Group

Prefer advanced degree plus 5 years I.C. experience. To develop assembly and packaging processes for state-of-the-art VLSI MOS memories and microcomputers.

Assembly/Test Manufacturing Manager

BA or BS with 5 to 7 years wafer fabrication manufacturing experience. With strong forecasting background both in people and capital expenditure for production.

Senior CAD Engineer

Prefer MS plus 3 to 5 years experience. To support and develop software to meet user requirements.

Failure Analysis Engineer

Prefer MS plus 3 years I.C. experience. To diagnose failure modes, probe rejected wafers, analyze stress tests.

Device Engineer

BSEE with knowledge of semiconductor devices. Familiarity with electronic measuring equipment and FORTRAN programming knowledge.

Marketing Staff

European Sales Manager

Bristol, England
Prefer BSEE + 5 to 10 years I.C. sales and sales management experience. To set up and run European sales organization.

Regional Sales Managers

Boston and Dallas
Prefer BSEE + 5 to 10 years I.C. sales and sales management experience. To set up and run regional sales offices.

Distribution Sales Manager

BS preferred plus in-depth knowledge of the I.C. distribution marketplace.

Central Marketing Group Staff

People with experience in advertising, product sales, customer service and strategic marketing definition.

Please send your resume to Denny Grady, Dept. EL/2, INMOS Corporation, P.O. Box 16000, Colorado Springs, Colorado 80935.

Honoring human resources in every respect
we are an equal opportunity employer M/F.



We're building a great company. Together.

Abbott Transistors Labs	287	Data I/O Corporation	91	GCA Burlington	326
■ Ad-Vance Magnetics, Inc.	276	■ Data Precision	209	General Electric Company Semiconductor	75
Advanced Micro Devices	10, 11	■ Datal-Interail	144	‡ General Electric Instrument Rental Div.	244
AHAM for	288	■ Delevan Division, American Precision	264	General Instrument Microelectronics	117
■ Alco Electronic Products (Sub. of Augat)	234	Deltron, Inc.	262	General Instrument Opto Electronics Div.	105-108
■ American Optical Scientific Instrument Div.	316	■ Diallight	296	■ Genrad, Inc.	266, 267
‡ American Zettler, Inc.	291	‡ Digital Equipment Corp., Microcomputer	56, 57	GenRad/Futuredata	280, 281
AMF, Inc. (Electro-Components Div.)	45	‡ Digitran Company	311	Gentron Corporation	276
■ AMP, Inc.	18, 19	Dit-MCO	114	‡ Global Specialties Corporation	38
■ Amphenol North America	217	‡ Diversified Technology	35	Gordos	256, 257
Ann Arbor Terminals, Inc.	278	Dolch Logic Instruments	293	Gould Inc., Biomation Division	22, 23
A.P. Products	122	L.O. Drake & Son	274	Gould, Inc., Electric Fuse Division	43
‡ Aromat	233	• Ducati Elettrotecnica Microfarad	225	Gould Inc./Foil Division	9
Bausch & Lomb Scientific Optical Products	238, 239, 247	‡ Eastman Kodak Co., Graphic Markets Div.	225	Gould Inc., Instruments Division	197-199
‡ Beckman Instruments AEPD	62, 63	‡ Eaton Corp., Cutler Hammer	307	‡ Grumman Aerospace	310
Belden Corporation	69-72	Eaton Corp., Electronic Instrumentation	268	■ Hewlett-Packard	1, 2, 81-83, 92, 93, 95 97, 99, 101, 103, 121 123, 125, 186, 187
■ F.W. Bell, Inc.	156	■ Ectron	274	Hilevel Technology, Inc.	143
■ Bendix Electrical Components Division	317	Electronic Development Corporation	306	Hitech America, Ltd.	277
■ B & K Precision	235	■ Electronic Navigation Industries	6	Houston Instrument	263
Robert Bosch Corporation	247	Electronics & Energy Technology	324	Hughes Aircraft	77
■ Bourns, Inc.	20	Elevam Electronic Tube Co., Ltd.	294	Hughes Aircraft Co., Solid State Products	47, 275
■ Bud Industries	298	■ Elpac Power Supplies	301	Hytek Microsystems	359
‡ Burndy	242, 243	■ EMI Technology	124	IEE Industrial Electronic Engineers, Inc.	211
■ Bussmann Manufacturing	303	EMM SESCO	331	INCO	116
Cambion	169, 290	Enertec Schlumberger (Velizy)	2E	Intel MIO/MCO	20, 21
Canadian Thermostats & Control Devices	272	LM Ericsson Telematerial AB	360	Intel MPO	28, 29
The Carborundum Company	100	Fairchild Semiconductor	221	Interdesign, Inc.	213
■ CELCO (Constantine Engineering Labs. Co.)	335	Fairchild Test Systems	27, 202, 203	International Crystal Manufacturing Co.	16
■ Cherry Electrical Products	13	• FEME S.P.A.	4E	Intersil	36, 37
■ C & K Components	318	■ Ferranti-Packard, Ltd.	322	Iskra Commerce Marketing	119
■ Clairex Electronics	40	■ First Computer Corporation	15	C. Itoh	297
■ Compas Microsystems	322	John Fluke Manufacturing Co.	126, 127, 181-183	• ITT Capacitors	233
Computer Automation Naked Mini	111	Forethought Products	236	Iwatsu Electric Co., Ltd.	246
■ Conap, Inc.	170	• FRINI ANTENNE	8E	• Jepico Co., Ltd.	6E
■ Corcom	66	‡ Fujitsu America, Inc.	58	■ Kepco, Inc.	7
‡ CTS Corporation/Berne Div.	229, 232	• Fujitsu, Ltd.	35	Milton Keynes Development Corp.	284
■ Custom Electronics	292	Gates Energy Products, Inc.	328	‡ Kylex	285

‡	Leader Instruments Corp.	227	Palisades Institute	118	■	Teledyne Relays	17
■	LFE Corporation	292	* Phillips Elcoma	5E		Teletype	299
	Litronix	132	* Phillips Elcoma Market Promotion	64		Texas Instruments Semiconductor	188, 189, 204, 205
	Logical Solutions, Inc.	294	* Phillips T&M	7E		Textool Products	14
•	LTX	240, 241	‡ Phillips TMI	237		Thomas & Skinner, Inc.	359
	Markem	330	Plastica Engineering Company	313		Thomson CSF / DSC	258, 259, 261
	Matrox Electronic Systems	104	Plessey Semiconductor	158, 159, 283		Thomson CSF / DTE	115
	MDB Systems, Inc.	327	Power One, Inc.	305		Three Phoenix Company	338
■	Memodyne Corporation	286	Precision Monolithics	270, 271		Triple I, Inc.	304
	Mepco / Electra	32	■ Preston Scientific	315	‡	TRW Electric Components	240, 241
■	Micro Component Technology	248, 249	■ Projects Unlimited	290		TRW LSI Products	223
	Micro Devices, Div. Emerson Electric	320	Pro-Log	25	•	Ulmic France	63
‡	Micro Link Corporation	246	* Racal Dana Instruments, Ltd.	38		Unitrode Corporation	230, 231
■	Microswitch, Div. of Honeywell	254, 255	Racal-Vedic	321	■	Vectec, Inc.	26
■	Microtechnical Industries	272	RCA Solid State	86, 87	‡	Viking Industries	252
	Minato Electronics, Inc.	332	Robinson Nugent, Inc.	250, 251	■	Wabash Relay & Electronics	16
■	Mini-Circuits Laboratory	5	Rogan Corporation	319		Weckesser Company, Inc.	226
	Mitel Semiconductor, Inc.	112	‡ Rohm Corporation	295		Wells Electronics	54
	Modular Power Systems	312	Semtec	178		White Industrial Products S.S.	360
	Mostek Corporation	30, 31, 79	* SEPA S.p.A.	244		Wilhelm Westermann	8
‡	Motorola Corporate	64, 65	Sharp Corporation	336		Wiltron	325
	Motorola Inc., Component Products	148	Shigma, Inc., G&C Division	300		Zenith Radio Corporation	55
	Motorola Semiconductor Products	128, 129	* Siemens AG	1E, 229		Zilog	184, 185
	Munich Fair Authority	296	Simpson Electric	84, 85			
•	Murata Manufacturing Co., Ltd.	233	Snap-on Tools	304			
	National Semiconductor	49-52	■ Spectrol Electronics	215			
•	NEOHM SPA	58	■ Spectronica	219			
	New Long Seimitsu Kogyo, Ltd.	53	Sprague Electric	61			
	Nicolet Cad Corporation	323	Stanley Electric Company	289			
‡	Nicolet Instrument Corporation	308, 309	Strathclyde Industrial Development	314			
	Nippon Electric Company, Ltd.	130, 131	■ Syntronic Instruments, Inc.	312			
	Noritake Electronics, Inc.	279	Systems Engineering Labs	265			
	Norplex Division UOP, Inc.	269	* TEAC Corporation	57			
	Oak Industries	333	Tecnetics	12			
	Oliver Advanced Engineering, Inc.	228	Tektronix	200, 201, 273			
■	Opto 22	3C	Teledyne Crystalonics	102			
	Osborne & Associates, Inc.	334	Teledyne Philbrick	169			

Classified and employment advertising

F. J. Eberle, Manager 212-997-2557

Allen-Bradley Co.	342
Aramco Services	351
Boeing Co.	352
Coulter Electronics	344
Elcint Inc.	344
Emerson Electric Co.	339
Engineers Unlimited	339
Executive Search & Recruitment	344
GTE Automated Electric Lab.	349
Harris Semiconductor	348
Heath / Zenith Co.	350
Howard Bond & Assoc.	339
Hughes Aircraft Co.	341
Hitachi America Ltd.	347
Inmos	354
International Telecommunication Union	343
Itt Barton	340
M. David Lowe Personnel Service	339
Mer Co.	344
National Personnel Consultants Inc.	344
NcR	353
Northrup	346
Recruiters of Texas	339
Riddick Assoc., Ltd.	339
Southwest Technical	344
Sperry Univac Semiconductor	345
J. Robert Thompson Consultants Inc.	339

For more information of complete product line see advertisement in the latest Electronics Buyers Guide
 • Advertisers in Electronics International
 ‡ Advertisers in Electronics domestic edition

Just published!

Your guide into the fascinating world of...

PERSONAL COMPUTING Hardware and Software Basics

A reliable, easy-to-use resource that tells you...

What's available in hardware and software, including costs.

Who's using it, and what they've experienced.

How it all works.

Why it's caught on so fast, including practical applications to use now.

Some of the most exciting advances in computing are taking place, not in research labs and commercial facilities, but in homes across the country. All sorts of people with a basic background in mathematics and electronics are taking the computer revolution into their own hands—experimenting with new equipment and technology, and devising their own *personal* applications.

If you've considered joining them, if you've thought about building or buying your own computer—this is a fast, up-to-date guide that answers all your questions precisely and reliably.

At your fingertips, all the most needed information on...

- what's available in personal computers
- the most popular microprocessor chips
- programming at microprocessor level and in high-level languages
- design hitches and how to prevent them
- where to buy
- plus a glossary of the most current terms in home computing

Drawn from major publications throughout the industry...

To get all the up-to-the-minute information and guidelines presented here, you'd have to read through numerous issues of...

- Electronics • Datamation • Mini-Micro Systems • BYTE
- Interface Age • IEEE Spectrum • Kilobaud • People's Computers

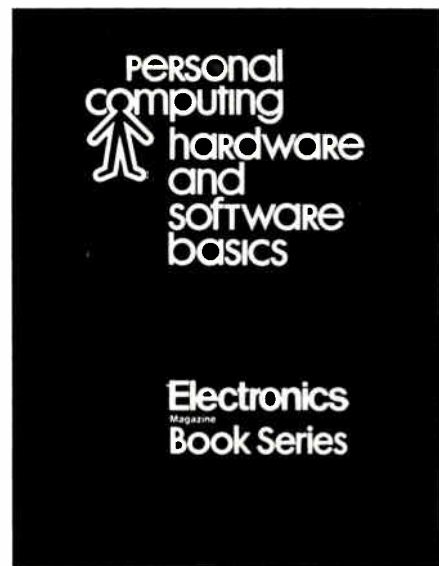

edited by

Raymond P. Capece, Solid State Editor,
Electronics Magazine

266 pages, \$11.95

Table of Contents

Part 1: Introduction to Personal Computing.

The term defined, equipment and components, costs, applications.

Part 2: Basic Computer Theory.

Microcomputer architecture with the emphasis on memory.

Part 3: Advanced Microcomputer Theory.

Board-level computers using the most popular microprocessor chips.

Part 4: Reviews of Personal Computers.

Features and capabilities of the most widely used microcomputers.

Part 5: Software for Microcomputers and Microprocessors.

Description and uses of both machine-level and high-level programming languages.

Part 6: Specifications and Other Useful Information.

Glossaries, microprocessor specs, electronics symbols, buying used equipment.

Electronics Magazine Books

P.O. Box 669, Hightstown, NJ 08520
(609) 448-1700, ext. 5494

No. of Copies	Title	Price
_____	Microprocessors	\$ 8.95
_____	Applying Microprocessors	\$ 9.95
_____	Large Scale Integration	\$ 9.95
_____	Basics of Data Communications	\$12.95
_____	Circuits for Electronics Engineers	\$15.95
_____	Design Techniques for Electronics Engineers	\$15.95
_____	Memory Design: Microcomputers to Mainframes	\$12.95
_____	Personal Computing: Hardware and Software Basics	\$11.95
_____	New Product Trends in Electronics	\$14.95



If after my 10-day free-trial examination I am not fully satisfied I understand that my payment will be refunded.

Payment enclosed Bill firm Bill me

Charge to my credit card:

American Express Diners Club
 Visa Master Charge*

Acct. No. _____

Date Exp. _____

*On Master Charge only, first numbers above name _____

Name _____

Title _____

Company _____

Street _____

City _____

State _____

Zip _____

Signature _____

Discounts of 40% on orders of 10 or more copies of each book.

Books of special interest to our readers

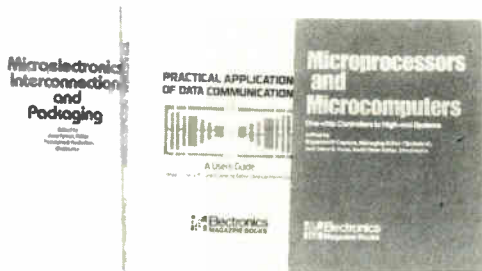

Applying Microprocessors

Reprinted from *Electronics*, completes the EE's transition from the old methods of electronic design to microprocessor engineering. Pub. 1977. 191 pp. Order #R-701, \$9.95

Basics of Data Communications

This compilation of essential articles from *Data Communications* magazine includes chapters on terminals, acoustic couplers and modems, communications processors, networking, channel performance, data link controls, network diagnostics, interfaces, and regulations and policy. Pub. 1976. 303 pp. Order #R-603, \$12.95

Circuits for Electronics Engineers

Almost 350 circuits arranged by 51 of the most useful functions for designers. Taken from the popular "Designer's Casebook" of *Electronics*, these circuits have been designed by engineers for the achievement of specific engineering objectives. Pub. 1977. 396 pp. Order #R-711, \$15.95

Design Techniques for Electronics Engineers

Expert guidance at every point in the development of an engineering project—making measurements, interpreting data, making calculations, choosing materials, controlling environment, laying out and purchasing components, and interconnecting them swiftly and accurately. Nearly 300 articles from *Electronics*' "Engineer's Notebook." Pub. 1977. 370 pp. Order #R-726, \$15.95

Microelectronics Interconnection and Packaging

Up-to-date articles from *Electronics* include sections on lithography and processing for integrated circuits, thick- and thin-film hybrids, printed-circuit-board technology, automatic wiring technology, IC packages and connectors, environmental factors affecting interconnections and packages, computer-aided design, and automatic testing. Pub. 1980. 320 pp. Order #R-927, \$12.95

Large Scale Integration

As published in *Electronics*, covers the entire range of design applications in sections on bipolar LSI, MOS LSI, new devices, system design, computer-aided design, testing, and applications. Pub. 1976. 208 pp. Order #R-732, \$12.95

Memory Design:

Microcomputers to Mainframes

The technology, devices, and applications that link memory components and system design. How to apply the new technology to meet specific design goals. Edited from the pages of *Electronics*. Pub. 1978. 180 pp. Order #R-602, \$9.95

Microprocessors

The basic book on microprocessor technology for the design engineer. Published in 1975, articles are drawn from *Electronics*. 150 pp. Order #R-520, \$8.95

Personal Computing:

Hardware and Software Basics

More than 50 articles from leading publications give you up-to-date information on personal computing hardware, software, theory, and applications. Pub. 1979. 266 pp. Order #R-903, \$11.95

Practical Applications of

Data Communications:

A User's Guide

Articles from *Data Communications* magazine cover architecture and protocols, data-link performance, distributed data processing, software, data security, testing and diagnostics, communications processors, and digitized-voice and data-plus-voice. Pub. 1980. 424 pp. Order #R-005, \$13.95

Microprocessors and Microcomputers:

One-chip Controllers to High-end Systems

Practical orientation to second- and third-generation 8-bit devices, the latest 16-bit devices, one-chip microcomputers, and software for microprocessors in 95 articles from *Electronics*. Pub. 1980. 482 pp. Order #R-011, \$13.95

Advertising Sales Staff

Advertising sales manager: Norman Rosen
3200 Wilshire Blvd., South Tower
Los Angeles Calif. 90010 [213] 487-1160

Market managers:

Components: William Boyle, Rochester, N.Y.
Computers & Peripherals: Frank Mitchell, Boston
Test & Measurement: Don Farris, San Francisco
Semiconductors: Norman Rosen, Los Angeles

Atlanta, Ga. 30309: Peter Stien
100 Colony Square, 1175 Peachtree St., N.E.
[404] 892-2868

Boston, Mass. 02118: Frank Mitchell
607 Boylston St., [617] 262-1160

Cleveland, Ohio 44113: William J. Boyle
[716] 248-5620

Fort Lauderdale, Fla. 33308: Peter Stien
3000 N.E. 30th Place, Suite #400
[305] 563-9111

New York, N.Y. 10020

1221 Avenue of the Americas
John Gallie [212] 997-3616
Matthew T. Reseska [212] 997-3617

Philadelphia, Pa. 19102: Matthew T. Reseska
Three Parkway, [212] 997-3617

Pittsburgh, Pa. 15222: Matthew T. Reseska
4 Gateway Center, [212] 997-3617

Rochester, N.Y. 14534: William J. Boyle
Powder Mill Office Park, 1163 Pittsford-Victor Rd.,
Pittsford, N.Y. 14534 [716] 248-5620

Chicago, Ill. 60611

645 North Michigan Avenue
Jack Anderson [312] 751-3739
Robert M. Denmead [312] 751-3738

Detroit, Michigan 48202: Jack Anderson
1400 Fisher Bldg., [313] 873-7410

Dallas, Texas 75201: John J. Uphues
2001 Bryan Tower, Suite 1070
[214] 742-1747

Denver, Colo. 80203: Harry B. Doyle, Jr.
655 Broadway, Suite 325
[303] 825-6731

Houston, Texas 77002: John J. Uphues
601 Jefferson Street, Dresser Tower
[713] 659-8381

Los Angeles, Calif. 90010: Chuck Crowe
3200 Wilshire Blvd., South Tower
[213] 487-1160

Costa Mesa, Calif. 92626: Edward E. Callahan
3001 Red Hill Ave. Bldg. #1 Suite 222
[714] 557-6292

San Francisco, Calif. 94111: Don Farris,
Larry Goldstein, 425 Battery Street,
[415] 362-4600

Paris: Michael Sales
17 Rue-Georges Bizet, 75116 Paris, France
Tel: 720-16-80

United Kingdom: Simon Smith
34 Dover Street, London W1
Tel: 01-493-1451

Scandinavia: Andrew Karnig and Assoc.
and Simon Smith
Kungsholmsgatan 10
112 27 Stockholm, Sweden
Tel: 08-51-68-70 Telex: 179-51

Milan: Ferruccio Silvera
1 via Baracchini, Italy
Tel: 86-90-656

Brussels:
23 Chaussee de Wavre
Brussels 1040, Belgium
Tel: 513-73-95

Frankfurt/Main: Fritz Krusebecker
Liebigstrasse 27c, Germany
Tel: 72-01-81

Tokyo: Akio Saijo and Hirokazu Nakamura
McGraw-Hill Publications Overseas Corporation,
Kasumigaseki Building 2-5, 3-chome,
Kasumigaseki, Chiyoda-Ku, Tokyo, Japan
[581] 9811

Business Department

Thomas M. Egan
Production Director
[212] 997-3140

Carol Gallagher
Production Manager
[212] 997-2045

Betty Preis
Production Manager Domestic
[212] 997-2908

Thomas Kazich
Production Manager Related Products
[212] 997-2044

Karen Walpole
Production Assistant
[212] 997-2843

Frances Vallone
Reader Service Manager
[212] 997-6057

Electronics Buyers' Guide

H.T. Howland, General Manager
[212] 997-6642

Regina Hera, Directory Manager
[212] 997-2544

Classified and Employment Advertising

Frank Eberle, Manager
[212] 997-2557

Order today using this coupon!

Electronics Magazine Books
P.O. Box 669
Hightstown, NJ 08520
Tel. (609) 448-1700, ext. 5494



Order #	Qty.	Price
R-_____	_____	\$ _____
R-_____	_____	\$ _____
R-_____	_____	\$ _____
R-_____	_____	\$ _____
R-_____	_____	\$ _____
Total		\$ _____

Name _____

Title _____

Company _____

Street/P.O. address _____

City/state/zip _____

Payment enclosed (payment must accompany orders under \$25)

Bill my company (or attach company Purchase Order)

Bill me Send a free copy of the *Electronics* Editorial Reprints brochure.

Ten-day money-back guarantee applies on all books.

CRYSTAL CLOCK OSCILLATORS.

- We have more than 50 standard frequencies
- We can ship within 48 hours from receipt of your order.
- All Oscillators feature hermetic D.I.P. Packaging.
- Included are direct replacement for 16 manufacturers, such as the following series: K1100, MX0, X0, M1100, HS, CM, BW, 1300, 7400, and QT.
- Specify these Hytek Part numbers:

TTL	HY 4550 - 250 KHZ to 75 MHZ
CMOS	HY 4560 - 600 HZ to 5 MHZ
Z80(A)	HY 4580 - 4 MHZ

hytek microsystems
incorporated

16780 LARK AVENUE, LOS GATOS, CALIFORNIA 95030
PHONE (408) 358-1991 TWX 910-597-5393

Circle 154 on reader service card

**if you need service
on your subscription
Call (609) 448-8110 ***

Electronics

*Do you want to change your
address?*

Have you missed an issue?

Was your copy damaged?

*Your service
representative can offer
immediate help.
9 A.M.-4 P.M. EST.



ALNICO PERMANENT MAGNETS

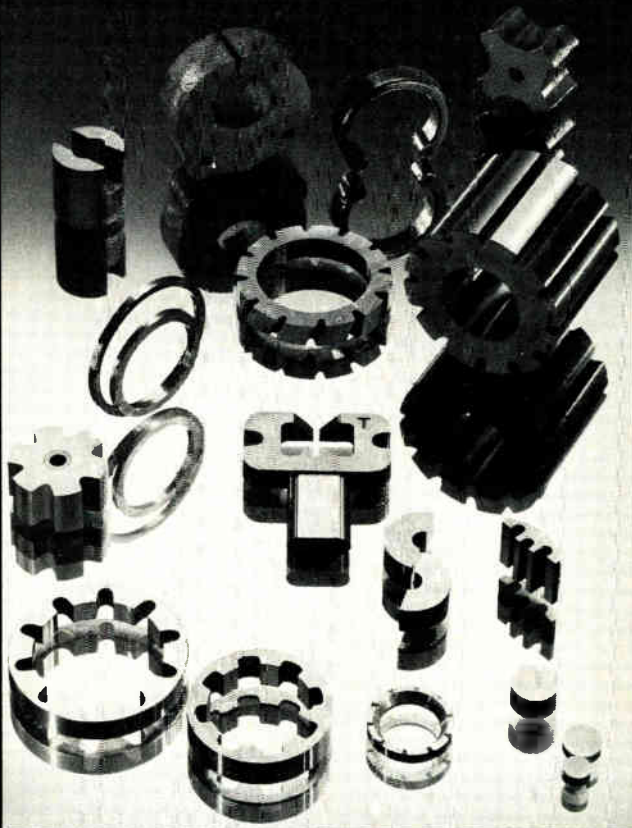

DEMAGNETIZATION & ENERGY PRODUCT CURVES (TYPICAL)

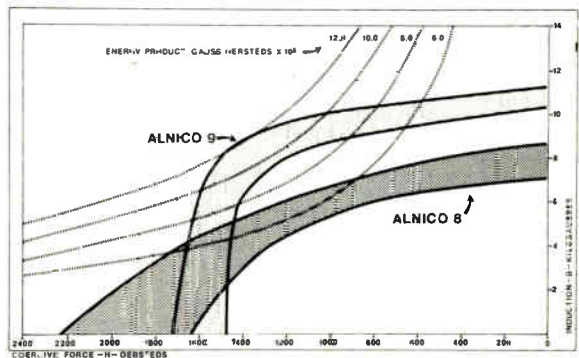

ALNICO 8 & 9 and other metallic alloy Permanent Magnets from T&S are ideally suited for use in:

**MOTORS • MICROWAVE DEVICES • GENERATORS • GEOPHONES •
TWT's • ACCELEROMETERS • TACHOMETERS**

Contact T&S engineers for a review of your Permanent Magnet requirements.

SEE US AT BOOTH 4235—WESCON '80



Thomas & Skinner, Inc.

1120 EAST 23rd. ST., INDIANAPOLIS, INDIANA 46205
MAIL P.O. BOX 150B, ZIP 46206 • 317/923-2501 • TELEX 27-335

One tool does it all.

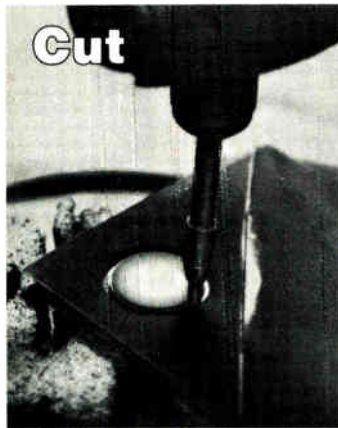

Cut



Clean

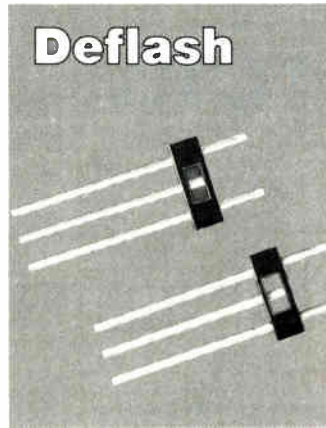

Deflash



Drill/Etch

Airbrasive®

Why buy 12 high-tolerance production tools when one inexpensive Airbrasive unit will do? This "Wonder Tool" /abrades/cleans/cuts/deburrs/deflashes/drills/etches/laps/peens/shapes/strips and/trimms to critical tolerances using a cool, shockless stream of micro-abrasive particles. It's perfect for boosting production in many electronic component manufacturing operations: cleaning potted leads; removing brazing spatter and excess solder; labeling custom components; coding parts; roughening contacts for maximum conductivity; angle-cutting silicon wafers; trimming resistors and capacitors; and more.



Pay for your first Airbrasive unit in labor savings alone: Model K—for lab and light production—\$1,155.00; Model H—production workhorse—\$2,275.00; Model HME—high capacity, heavy duty—\$3,095.00.

Call 201-752-8300 for demonstration and brochure. Or write S.S. White Industrial Products, Pennwalt Corporation, 151 Old New Brunswick Road, Piscataway, NJ 08854.

S.S. WHITE INDUSTRIAL PRODUCTS



Circle 157 on reader service card

Everybody's talking about AXE components

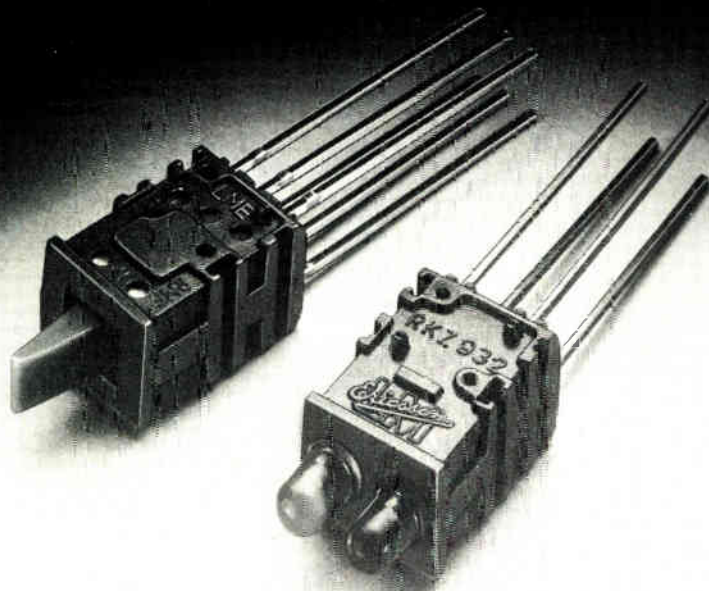

Because they are so versatile. They are of uniform design, based on a modular system where $M=1$ ". Dimensions: 3 x 4 x 6". These components are intended for front assembly on PCB but can also be assembled vertically. Since the module is the same as the one used for PCB's, a high component density is possible. The components are manufactured of dark-coloured thermoplastic.

In the picture, you can see a toggle switch, RMF 350, with two change-over goldplated contacts and a miniature light-emitting diode unit, RKZ 932, with plastic light-diffusing cap. The AXE component series also includes a new type of proximity switch, RMF 351, with Hall element for 5-12 V nominal voltage and a transistor outlet with open collector.

LM ERICSSON
TELEMATERIEL AB

Components Department
Box 401, S-135 24 Tyresö, Sweden
Telex 109 20 LMSBO S

We are a major supplier of components for the industrial market. We belong to the Ericsson Group, one of the world's leading telecommunications manufacturers.

360 Circle 158 on reader service card

Electronics / August 28, 1980

ADDRESSABLE I/O SYSTEMS FROM OPTO 22



(PB 16S1)

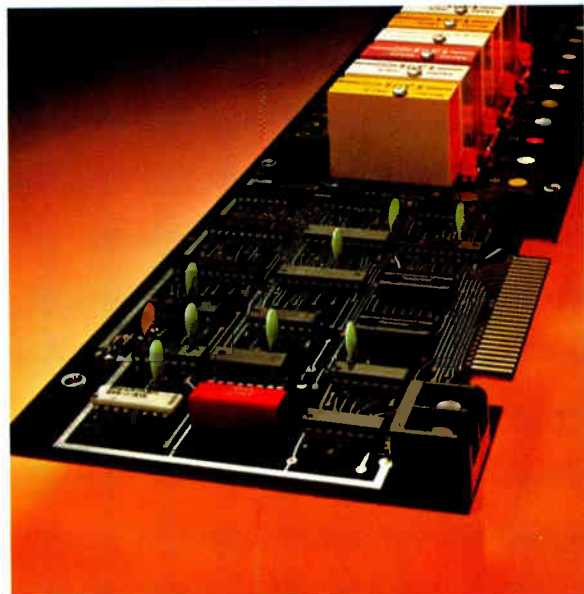

(PB 16P1)

Huntington Beach, California . . . Opto 22, originators of the industry standard I/O system, announces the second generation in I/O Systems in both serial and parallel configurations.

SERIAL ADDRESSABLE RACK (PB 16S1)

Communication with multiple input/output stations.
32 station address capability per serial loop.
Up to 16 power I/O modules per station.

Switch selectable baud rate.

Opto 22 provided firmware includes message protocol, event counter, self test, watch dog timer and more.

Plug in modules provide choice of:

1. 20 Ma Current Loop.

2. RS 422 Balanced Differential Drivers and Receivers.
3. Optically Coupled Drivers and Receivers.
4. RS 232

PARALLEL ADDRESSABLE RACK (PB 16P1)

Bidirectional Communication with input or output modules.

64 station address capability.

Up to 16 Power Input/Output modules per station.

50 Conductor Daisy-Chain cable connects all racks to host controller.

On-board station address select switch.

15272 Relay Circle, Huntington Beach, CA 92649
(714) 892-3313

opto 22

Another Opto 22 product available for immediate shipment.

CUSTOM OPTICAL SWITCHES

from Clairex

fast switching...all solid state...no electrical noise

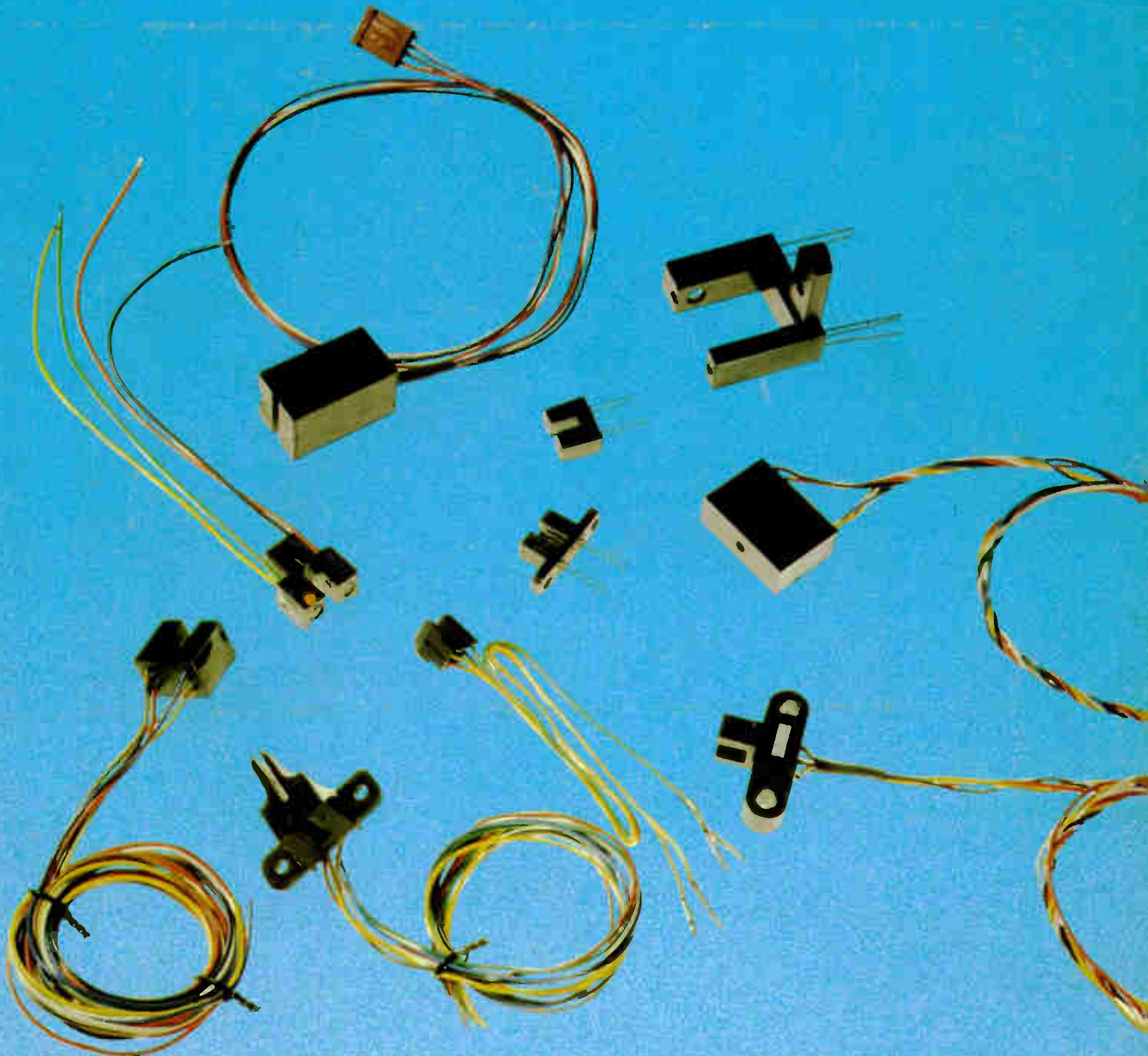

Most applications for optical switches require one or more variations from a standard unit. That makes it a custom design... a detector with specific characteristics, a special emitter,

a precisely designed gap, a glass or plastic lens to align the light beam, or hermetic sealing to resist hostile environments.

If you have an optical switching problem, come to Clairex[®], the specialist in solving

"light" problems. Whether you need a custom design or a standard unit, call (914) 664-6602, or write Clairex, 560 South Third Avenue, Mount Vernon, New York 10550.

CLAIREX ELECTRONICS

A Division of Clairex Corporation

Circle 902 on reader service card